



California State University  
**MONTEREY BAY**



# California State University, Monterey Bay Master Plan

## Final Environmental Impact Report - Volume II **APPENDICES**

---

Prepared for California State University, Monterey Bay  
May 2022 - SCH No. 2017051042



**FINAL**

**Environmental Impact Report  
California State University Monterey Bay  
Master Plan  
SCH No. 2017051042**

**VOLUME II  
APPENDICES**

*Prepared for:*

**California State University Monterey Bay**  
100 Campus Center  
Seaside, California 93955  
*Contact: Anya Spear, LEED AP, AICP*

*Prepared by:*

**DUDEK**

725 Front Street, Suite 400  
Santa Cruz, California 95060

**MAY 2022**



# **APPENDIX A**

## **Notice of Preparation (NOP) & Revision to Previously Issued Notice of Preparation**

INTENTIONALLY LEFT BLANK

**Notice of  
Preparation**

May 12, 2017

INTENTIONALLY LEFT BLANK



Campus Planning & Development  
100 Campus Center  
Mountain Hall A  
Seaside, CA 93955-8001

[831] 582-3709  
FAX [831] 582-4436

## NOTICE OF PREPARATION

### ENVIRONMENTAL IMPACT REPORT FOR THE CALIFORNIA STATE UNIVERSITY MONTEREY BAY MASTER PLAN

**DATE:** May 12, 2017

**TO:** Agencies, Organizations, and Interested Parties

**PROJECT TITLE:** California State University Monterey Bay Master Plan

**LEAD AGENCY:** The Board of Trustees of the California State University  
401 Golden Shore  
Long Beach, California 90802-4210  
  
California State University Monterey Bay (CSUMB)  
100 Campus Center  
Seaside, California 93955

**SUBJECT:** Notice of Preparation of an Environmental Impact Report for the CSUMB Master Plan

The Board of Trustees of the California State University (Trustees) is the lead agency for the preparation of an environmental impact report (EIR) in accordance with the California Environmental Quality Act (CEQA) (California Public Resources Code, Section 21000 et seq.) and the CEQA Guidelines (Title 14 of the California Code of Regulations [CCR] 15000 et seq.). Per California Education Code Section 66606, the Board of Trustee is the governing body and owner of the California State University Monterey Bay (CSUMB) campus, and has the authority to certify the EIR, adopt the Master Plan, and provide for schematic design approvals. CSUMB will act as point of contact for the CEQA process.

The Trustees prepared this Notice of Preparation (NOP) in accordance with CEQA Guidelines (14 CCR 15082 and 15375). The EIR will address the environmental effects of the proposed CSUMB Master Plan (project) at a program level. Implementation of the proposed Master Plan would

include space and facility needs to support planned growth to 12,700 full-time-equivalent (FTE) students, with housing for 60% of students and 65% of faculty and staff. Overall, the proposed Master Plan identifies 3.0 million gross square feet of approved and new building space, 4,500 new student beds, and 460 units of faculty and staff housing that would be converted from existing student housing. The project location, project background, project description, and the potential environmental effects are contained in the attached materials. The EIR will also assess environmental impacts of six “near-term projects” at a project level of analysis.

**Agencies:** The Trustees request agencies’ views on the scope and content of the environmental information that is germane to an agency’s statutory responsibilities in connection with the project, in accordance with CEQA Guidelines Sections 15082(b) and 15103. Agencies may need to use the EIR to consider permits or other approvals.

**Organizations and Interested Parties:** The Trustees request comments and concerns regarding the scope and evaluation of potential environmental issues associated with the project.

**Public Review Period:** The Trustees have issued this NOP for public review and comment pursuant to the CEQA Guidelines (14 CCR 15082 and 15375). The Trustees have established a 30-day public review and scoping period from **May 12, 2017** through **June 12, 2017**, in accordance with the CEQA Guidelines (14 CCR 15082). During this period, the NOP will be available for review online here: <https://csumb.edu/campusplanning/proposed-projects>.

**Scoping Comments:** At this time, the Trustees are soliciting comments on the scope and content of the EIR. Comments may be submitted by mail, email, or fax, or by attending the Public Scoping Meeting (see details below) and submitting a written comment. All comments should indicate a contact person for the agency or organization, if applicable. All comments should be sent to the following address, to arrive no later than 5 p.m. on **June 12, 2017**:

Anya Spear, LEED AP  
Associate Director of Campus Planning  
CSUMB, Campus Planning & Development  
100 Campus Center  
Seaside, California 93955  
T: 831.582.5098  
F: 831-582-3545  
[aspear@csumb.edu](mailto:aspear@csumb.edu)

**Public Scoping Meeting:** The Trustees will hold Scoping Meetings to give the public an opportunity to receive more information on the proposed Master Plan, and to provide comments and suggestions on the scope of the EIR. All members of the public and interested persons are welcome to attend and provide comments. The meetings will be held on **May 23, 2017**, starting at both 4 p.m. and 6 p.m. at the Student Center West Lounge (next to Starbucks) on the CSUMB campus. See the campus map

provided at the following location for details about the meeting location: <https://csumb.edu/sites/default/files/images/st-block-156-1431028320687-raw-studentcenter.pdf>.

**Further Information:** For environmental review information or questions about the project, please contact Anya Spear (831.582.5098 or [aspear@csumb.edu](mailto:aspear@csumb.edu)).

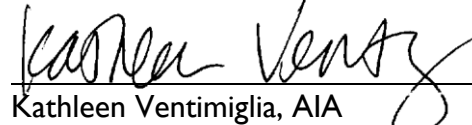
  
\_\_\_\_\_  
Kathleen Ventimiglia, AIA  
Director of Campus Planning & Development  
California State University Monterey Bay

May 11, 2017  
Date

INTENTIONALLY LEFT BLANK

# NOTICE OF PREPARATION

## CSUMB MASTER PLAN ENVIRONMENTAL IMPACT REPORT

### 1 INTRODUCTION

The purpose of an environmental impact report (EIR) is to inform decision makers and the general public of the potential environmental effects of a proposed project. The environmental review process is intended to provide public agencies with the environmental information required to evaluate a proposed project to determine whether it may have a significant effect on the environment, to establish methods for reducing adverse environmental impacts, and to consider alternatives prior to approval. This section provides a project overview, location of the project, and project background.

#### 1.1 Project and CEQA Overview

The EIR addresses the potential environmental effects of implementation of the proposed California State University Monterey Bay (CSUMB) Master Plan (Master Plan or project). The proposed Master Plan provides a guide for the physical development of the +1,350-acre campus.

The proposed Master Plan would include projects identified in the CSUMB's 5-Year Capital Improvement Program 2016/2017 through 2020/2021, plus the additional space and facility needs to support planned growth to 12,700 full-time-equivalent (FTE) students, with on-campus housing for 60% of students and 65% of faculty and staff. Growth anticipated in the proposed Master Plan will be evaluated at a program level. The project would also include six "near-term projects" that are expected to be developed within the next 3 to 7 years. The EIR for the proposed Master Plan will provide the description of these projects and evaluate them at a project-specific level. The distinctions between a "program" and a "project" EIR and associated analyses are provided below:

- **Program EIR:** Under state and California State University California Environmental Quality Act (CEQA) Guidelines, the EIR is being prepared as a "program" EIR. A program EIR may be prepared for a series of actions that are related geographically, or as part of a series of actions for adopting rules, regulations, plans, or general criteria for a continuing program or for individual activities carried out under the same authorizing law or regulation. CEQA environmental review conducted for future individual projects that are proposed in accordance with the proposed Master Plan will be tiered from the EIR to the extent that this program-level analysis remains adequate for such purposes in accordance with Section 15152(b) of the State CEQA Guidelines.
- **Project EIR:** Under state and California State University CEQA Guidelines, a portion of the EIR is being prepared as a "project" EIR. A project EIR examines the environmental impacts of a specific development project. This portion of the EIR will focus primarily on the changes in the environment that would result from the six near-term projects

proposed as part of the campus development. The EIR will examine all phases of these projects at a site-specific level, including planning, construction, and operation.

## 1.2 Project Location

The project site is located at the existing CSUMB campus, on the former U.S. Department of the Army (Army) military facility known as Fort Ord. The CSUMB campus is approximately 100 miles south of San Francisco and is located north of the Monterey Peninsula and west of the Salinas Valley, as shown in Figure 1. Portions of the existing CSUMB campus are within the city boundaries of Seaside and Marina, and within the unincorporated Monterey County, as shown in Figure 2.

## 1.3 Project Background

Three prior Master Plans for the CSUMB campus were prepared and adopted by the Board of Trustees of the California State University (Trustees) in 1998, 2004, and 2007. Previous environmental review of the project area includes four EIRs that were certified by the Trustees: the Campus Acquisition EIR, based on the Fort Ord Disposal and Reuse Environmental Impact Statement prepared by the United States government, and a Master Plan EIR for each of the three prior Master Plans. The most recent 2007 Master Plan and EIR considered land uses and space requirements commensurate with enrollment projections for three planning horizons: Planning Horizon I (2005–2014), Planning Horizon II (2015–2024), and Planning Horizon III (beyond 2025). The 2007 Master Plan projected an on-campus traditional student enrollment of 8,500 FTE students, with an additional 3,500 FTE non-traditional, primarily off-campus students, for a total of 12,000 FTE students at buildout (2025), with 1,900 faculty, staff, and management personnel. There were approximately 6,731 FTE on-campus students in 2015–2016.

In 2015, CSUMB initiated a process to update the 2007 Master Plan. This initiative was driven by several factors: new leadership, a new academic plan, revised growth projections, and university goals for carbon neutrality, among other issues. Many of the assumptions and priorities underlying the plan had evolved, and a further update to the Master Plan was needed. The proposed Master Plan was prepared to address these issues, and is available for review at [https://csumb.edu/campusplanning/campus-master-plan-2016?\\_search=Master%20Plan](https://csumb.edu/campusplanning/campus-master-plan-2016?_search=Master%20Plan).

## 2 PROJECT DESCRIPTION

### 2.1 Master Plan

The vision for the proposed Master Plan is distilled into three core sustainability tenets: placemaking, stewardship, and partnership. These tenets are reflected in the nine sustainability elements and the accompanying objectives that were prioritized as part of the Master Plan outreach.

The proposed Master Plan program outlines the space and facility needs for the campus' academic, student life, administration, residential, athletics, recreation, and support functions. It

includes the projects identified in the CSUMB's 5-Year Capital Improvement Program 2016/2017 through 2020/2021, plus the additional space and facility needs to support planned growth to 12,700 FTE students and associated growth to 1,490 FTE faculty and staff. As there were approximately 6,731 FTE students on campus in 2015–2016, the proposed Master Plan would increase enrollment by 4,200 FTE students over the existing on-campus enrollment ceiling of 8,500 FTE students from the adopted 2007 Master Plan, and by approximately 5,969 FTE students over existing enrollment levels.

The proposed Master Plan program includes academic and administrative support, residential, campus life, recreation, institutional partnerships, and operations and maintenance space. This includes accommodation of residence halls and classroom buildings, and also a mix of amenities such as museums, performing arts centers, ethnic centers, faculty lounges and work space, child care centers, greenhouses, and other uses that would contribute toward a diverse and dynamic campus life. On-campus housing would be provided for 60% of students (a total of 7,620 beds), and 65% of faculty and staff (a total of 970 units). This would be accomplished through new student housing construction on the main campus, and reallocation of existing student housing to provide for the faculty and staff units.

Table I summarizes the development planned in the 5-Year Capital Improvement Plan to serve existing enrollment and the development planned to serve additional growth contemplated in the proposed Master Plan. According to the proposed Master Plan Implementation Plan, of the approximately 3.0 million gross square feet (GSF) of approved and new development, approximately 1.7 million GSF would occur in Horizon I (2016–2025) and approximately 1.2 million GSF would occur in Horizon II (2026–2035). The proposed Master Plan program also accounts for growth in outdoor athletics and recreation, with space for various fields, courts, and a pool. Figure 3 shows a plan of the location of existing and future buildings on the campus. The future building locations and orientations are illustrative only, and may be refined through the proposed Master Plan development process.

The proposed Master Plan Land Use Plan builds on and densifies the existing pattern of land uses while shifting the overall campus center of gravity toward the north to better integrate housing with the campus core. The proposed Master Plan Land Use Plan is shown in Figure 4. Cars and parking would be separated from the pedestrian-oriented campus core by creating two multimodal parking hubs on the east and west side of campus, while still preserving some visitor and ADA parking in the core. Academic and student life uses would be further consolidated in the campus core to enhance vitality in this area by increasing the opportunity for student interactions. The existing and inherited student housing in the campus core remains for the foreseeable future as part of a mixed-use core where students live, study, and socialize. The plan expands the existing student housing clusters at North Quad Housing and Promontory to create residential neighborhoods; a third residential neighborhood is sited east of 6th Avenue. The athletics and recreation areas would be expanded and reorganized. Future development sites beyond the scope of this proposed Master Plan, as well as areas for future institutional partnership sites, are also identified. The proposed

Master Plan suggests development around and connected to open spaces. The open space framework calls for improving existing open spaces and adding new spaces to enhance community interaction and connection with the natural environment. Several areas on campus are designated as natural open space.

**TABLE 1  
 PROPOSED MASTER PLAN BUILDING PROGRAM**

| Campus Space  | Beds/Units                    | Gross Square Feet |
|---|-------------------------------|-------------------|
| <b>EXISTING OCCUPIED SPACE</b>                              |                               |                   |
| Main Campus Facilities                                      | —                             | 1,270,000         |
| Student Housing   | 3,254 beds                    | 895,081           |
| Faculty, Staff, and Community Partners Housing              | 742 units                     | 840,666           |
| <b>Total Existing Space</b>                                 | <b>3,254 beds / 742 units</b> | <b>3,005,747</b>  |
| <b>PENDING OR APPROVED BUT NOT YET CONSTRUCTED PROJECTS</b> |                               |                   |
| Academic III  | —                             | 50,800            |
| Student Union   | —                             | 80,000            |
| Facilities Buildings  | —                             | 50,000            |
| Monterey Bay Charter School                                 | —                             | 60,000            |
| <b>Total Pending or Approved Space</b>                      | <b>—</b>                      | <b>240,800</b>    |
| <b>MASTER PLAN BUILDING PROGRAM</b>                         |                               |                   |
| Academic and Support Buildings                              | —                             | 380,360           |
| Institutional Partnership Buildings                         | —                             | 63,695            |
| Administration Buildings                                    | —                             | 77,454            |
| Campus Life Buildings                                       | —                             | 250,764           |
| Recreation Buildings and Facilities                         | —                             | 165,343           |
| Facilities Buildings  | —                             | 23,590            |
| Housing   | 4,500 beds/460 units*         | 1,800,000         |
| <b>Total New Master Plan Space</b>                          | <b>4,500 beds/460 units*</b>  | <b>2,761,206</b>  |
| <b>TOTAL APPROVED &amp; NEW MASTER PLAN SPACE</b>           | <b>4,500 beds/460 units*</b>  | <b>3,002,006</b>  |

**Note:**

\* The 460 units for faculty and staff housing will be provided by reallocating existing student housing for faculty and staff housing units. No new faculty and staff housing units would be constructed with the proposed Master Plan.



The proposed Master Plan includes the pursuit of an “ambitious” Transportation Scenario to strengthen and expand the campus’ Transportation Demand Management (TDM) strategies. The scenario’s 2016–2026 goal (Horizon 1) is a mode split of 28% drive alone, 22% shared ride, 25% transit, 13% walk, 10% bicycle, and 2% other. To reach this mode split goal, many TDM strategies will need to be employed. The proposed Master Plan is built on the following assumptions: pedestrian travel will be prioritized over other modes of travel; the transit program will continue to offer unlimited free rides for CSUMB ID card holders; CSUMB will house 60% of students and 65% of staff and faculty on campus; parking will be limited and consolidated to the campus periphery; vehicle travel will be separated from bicycles and pedestrians where possible; academic buildings will be concentrated in the campus core within a 0.25-mile walking distance; ADA accessibility will be improved on existing streets and corridors, and be a primary consideration for new facilities; and new TDM strategies will be introduced and proposed for funding. The mobility goals and plans in the proposed Master Plan are designed to meet the above, and include plans for vehicle, shuttle, bicycle, and pedestrian circulation. The plan includes restricting and/or limiting vehicle access through the campus core; providing for a new extension of Fifth Street toward Eight Street; providing for improved shuttle service, frequency, and routing; creating two multimodal hubs and designation of other peripheral surface parking locations; providing for transit infrastructure; and creating specific trail and path improvements. Once finalized, the Mobility chapter of the proposed Master Plan will serve as the TDM Plan for the campus.

The proposed Master Plan identifies infrastructure improvements to serve campus growth. The Marina Coast Water District, which provides potable water and wastewater collection services to the campus, has plans for water line and storage improvements at the campus, and replacement of older sewer lines, although the plan notes that the existing water distribution and sanitary sewer collection infrastructure is generally adequate to service the proposed Master Plan improvements. Development outside of areas currently served by existing trunk mains could require extension of trunk mains at the university’s expense. According to the proposed Master Plan, the campus aspires to sustainably manage all stormwater on campus through a combination of decentralized and centralized “low-impact development” stormwater drainage features that are integrated into open space and public space areas. For energy use and utilities, the proposed Master Plan seeks to reduce demand for energy through energy-efficient design and efficient technologies, and developing campus energy supply and distribution systems that enable the campus to meet its carbon neutrality goals as the population and campus building square footage increases.

## 2.2 Near-Term Projects

The EIR will also address specific development projects expected to be constructed in the next 3 to 7 years that are referred to as “near-term projects.” These projects are included in the building space program presented in Table I and shown in Figure 3. The EIR will include environmental analysis for the following near-term projects at a project-specific level. The dates provided are the anticipated construction start date.

### I. Student Housing Phase III – 600 beds (2020)

2. Panetta Institute for Public Policy – 37,600 square feet (2020)
3. Academic IV – 72,200 square feet (2021)
4. Student Recreation Center – 70,000 square feet (2021)
5. Student Housing IIB – 400 beds (2022)
6. Academic V – 76,704 square feet (2024)

### 3 ENVIRONMENTAL ISSUES AND PROBABLE EFFECTS TO BE ADDRESSED IN EIR

The following key environmental issues are proposed to be addressed at a program level for the proposed Master Plan and a project-specific level for the near-term projects. Direct and indirect impacts will be analyzed for the short term (construction) and long term (life of project) based on thresholds of significance that meet state guidelines and accepted professional standards and practice. Mitigation measures will be identified for impacts determined to be significant. The EIR will include a section that identifies other issues that were found to not result in significant impacts.

**Aesthetics.** The existing visual characteristics of the campus and surrounding area will be described. The EIR will review potential impacts on the visual character of the campus and surrounding areas based on the proposed Master Plan land uses and building sites. If potentially significant visual impacts are identified, feasible mitigation measures will be included in the EIR.

**Air Quality.** This section of the EIR will be based on estimates of emissions and associated changes in air quality that are likely to occur based on activities that result from the development accommodated by the proposed Master Plan and near-term projects. The EIR will update and summarize recent revisions to air quality regulations and ambient air pollutant data from the local monitoring station and other stations representative of regional air quality conditions. Pollutants of concern will include criteria pollutants and toxic air contaminants. An assessment of the air quality impacts will be conducted, and emissions will be estimated using the California Emissions Estimator Model (CalEEMod) land use and air quality model. The results will be compared to significance thresholds developed by the Monterey Bay Air Resources District.<sup>1</sup>

**Biological Resources.** The EIR will identify, characterize, and evaluate biological resource issues, including sensitive habitats, special-status species, and wildlife nesting/breeding. Existing biological resources will be described based on previous and new biological studies conducted for CSUMB. The proposed areas of planned development and open space and conservation areas will be reviewed to determine potential impacts to biological resources, including sensitive habitats, special-status species, and wildlife nesting/breeding.

---

<sup>1</sup> Formally referred to as the Monterey Bay Unified Air Pollution Control District.

In addition, the EIR will describe the Habitat Management Plan prepared by the U.S. Army Corps of Engineers and the Draft Habitat Conservation Plan being prepared by FORA as they relate to the campus property. Although all campus property is considered Designated Development or Borderlands (there are no designated Habitat Management Areas on campus), the proposed Master Plan indicates that the campus has designated its own natural open space areas. It is understood that the ultimate completion and approval of the Habitat Conservation Plan for Fort Ord is intended to cover future CSUMB activities that may result in take of listed species covered by the Habitat Conservation Plan. The EIR will identify mitigation measures to reduce the significance of identified biological resources impacts.

**Cultural Resources.** The 2007 Master Plan EIR provides an overview of regional history and archaeological and historic resources in the former Fort Ord area. Studies conducted for the U.S. Army Corps of Engineers as part of the Fort Ord base closure and reuse planning process identified archeological sensitivity areas and historic structures potentially eligible for listing in the National Register of Historic Places. Based on these studies and as reported in the 2007 Master Plan EIR, the campus is not located in an area that has a high potential for archaeological resources. According to the Record of Decision for acquisition of the campus, there are no historic sites on the campus that have been identified as being eligible or potentially eligible for listing in the National Register in past studies. The EIR will use existing documentation, supplemented with updated records searches and field reconnaissance surveys, to evaluate potential impacts of development accommodated by the proposed Master Plan and near-term projects on cultural resources. The EIR section will address all archaeological, historical, and cultural resource issues. Tribal cultural resources will be addressed in accordance with changes in state law since the 2007 Master Plan EIR was certified. The EIR will identify mitigation measures to ensure that cultural resources that may be unexpectedly found during construction are protected.

**Geology/Soils.** Geologic and soils impacts resulting from future development will be assessed based on previous geologic and soils studies conducted in the previous Master Plan EIRs, which included identification of soils, faults, and subsurface characteristics within the campus boundaries. The EIR will determine whether implementation of the proposed Master Plan or near-term projects would result in potential significant impacts. Mitigation measures will be identified to reduce potentially significant geology and soils impacts.

**Greenhouse Gas Emissions.** The EIR will include a setting and background discussion consisting of a summary of the greenhouse effect and global climate change; potential changes to the global climate system and to California; and emissions inventories at the national, state, and local levels, including the CSUMB greenhouse gas (GHG) emissions inventory and future projections. It will also include a summary of the key regulatory measures at the federal and state levels as the regulatory setting for this topic. GHG emissions resulting from the proposed Master Plan and near-term projects will be estimated using the CalEEMod emissions model. The net change in operational GHG emissions relative to those under the baseline scenario will be calculated. Impact significance

will be assessed in accordance state and regional guidelines and standards. Mitigation measures will be identified to reduce potentially significant GHG impacts.

**Hazards and Hazardous Materials.** The campus is located within the former Fort Ord. The EIR will review past and present land use practices and operations to identify potential hazardous conditions. Existing studies will be used to identify hazardous materials and emergency response issues, including the current status of cleanup sites, munitions response sites (at East Campus Open Space Zone parcel), groundwater contamination, and asbestos-containing materials and lead-based-paint hazards. Where potentially significant impacts are identified, mitigation measures to reduce impacts will be presented.

**Hydrology and Water Quality.** Drainage and water quality impacts will be evaluated, taking into account campus stormwater plans and state requirements. The EIR will include a review of the project's regulatory context, development standards pertaining to water quality, and their applicability to campus improvements. Potential impacts will be compared against existing conditions, and additional mitigation measures will be identified, where necessary, to avoid or substantially reduce impacts.

**Land Use and Planning.** The EIR will evaluate the proposed Master Plan to determine whether the project would physically divide an established community or conflict with any applicable land use plan, policy, or regulation of an agency with jurisdiction over the project, per Appendix G of the CEQA Guidelines. Conflicts with existing or planned land uses adjacent to the campus will also be evaluated where such conflicts could result in environmental impacts. The EIR will summarize and address relevant provisions of the Fort Ord Base Reuse Plan as it relates to CSUMB development and resource management.

**Noise and Vibration.** As part of the EIR for the project, Dudek will prepare an acoustical analysis evaluating noise impacts resulting from project-generated traffic and other on-site operations activities associated with buildout under the proposed Master Plan and near-term projects. The EIR will also evaluate noise exposure levels for proposed noise-sensitive project components (i.e., student residential buildings). Noise measurements will be conducted to determine existing noise levels. Future on-site traffic noise levels at the proposed noise-sensitive facilities will be determined based on the results of the noise measurements and modeling of future traffic volumes using Federal Highway Administration models. Off-site traffic noise impacts associated with project-generated traffic along the adjoining roads will also be evaluated. Future noise levels at noise-sensitive receptors on campus and off campus will be reviewed. Noise mitigation measures will be recommended as necessary.

**Population and Housing.** The EIR will evaluate the proposed Master Plan to determine whether implementation would induce substantial population growth, create a substantial new demand for housing that exceeds existing or planned supply, or displace a substantial number of existing housing or people requiring the construction of replacement housing. Campus population growth and

housing demand will be reviewed, and the EIR analysis will address the growth of campus population and its implications for housing demand. Regional population and housing forecasts and local adopted Housing Elements of General Plans will be reviewed and considered as relevant as part of the housing analysis.

**Public Services and Recreation.** Existing conditions related to fire protection service, police protection service, parks and recreation, and schools will be described. The increase in campus population as a result of the project will be reviewed to determine whether the project would result in potentially significant impacts to performance levels of these public services, and thus result in substantial physical impacts associated with the provision of new or physically altered governmental facilities, consistent with CEQA Guidelines Appendix G guidance. The EIR will consider impacts related to recreation and the potential for increased demand for parks and recreation facilities as a result of on-campus housing and population.

**Transportation and Traffic.** A traffic impact analysis will be prepared for the EIR to evaluate potential impacts of the proposed Master Plan and the near-term projects on intersection and freeway levels of service and campus access and circulation systems based on updated traffic counts. Using data from the CSUMB Annual Traffic Generation Study, peak-hour trip generation data from other California State University campus surveys, and other relevant information, trip rates will be estimated and project impacts will be assessed. The campus has committed to a sustainable campus Master Plan, which includes recommendations for a robust TDM program and a parking management plan as a means to reduce vehicle trips to the campus. The transportation analysis will account for implementation of the TDM program and parking management plan, and through the analysis process, additional TDM and parking management strategies may be considered. The analysis will also consider changes in land use on the campus under the proposed Master Plan and in the immediate vicinity of the campus, including increases in on-campus housing and the availability of increased student amenities.

**Utilities and Service Systems.** The EIR will address water supply, wastewater treatment, solid waste, and electrical and natural gas utility services. Stormwater drainage utilities will be addressed in the hydrology section of the EIR. The EIR will document and update existing conditions, and provide impact assessments for these utilities.

**Other CEQA-Required Sections.** In accordance with CEQA requirements, cumulative impacts, alternatives, and growth-inducement effects of the proposed Master Plan and near-term projects will be analyzed.

INTENTIONALLY LEFT BLANK

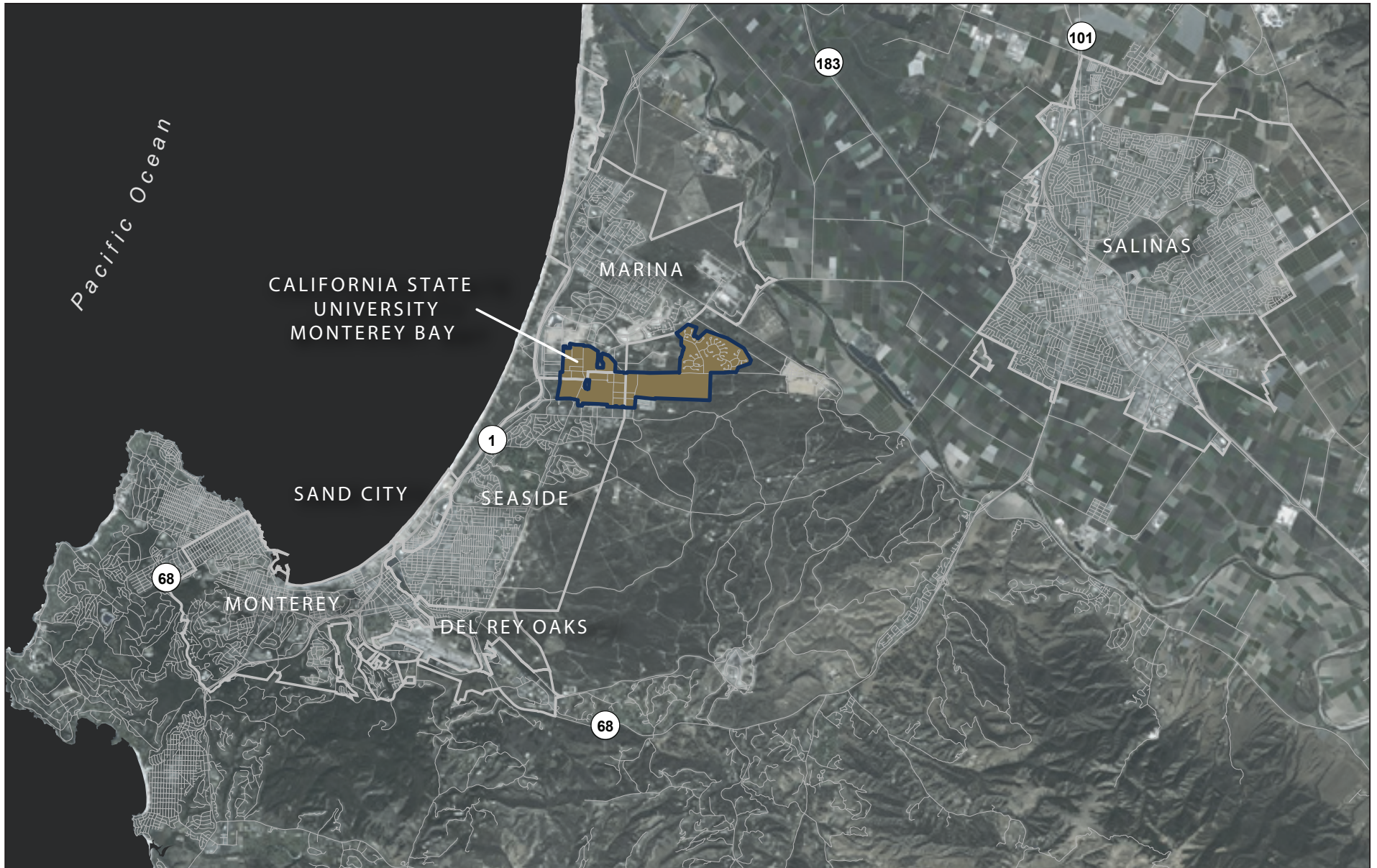

**DUDEK**

SOURCE: Page/BMS Design Group (2017)

CSU Monterey Bay Master Plan EIR

**FIGURE 1**  
**Regional Location**

INTENTIONALLY LEFT BLANK



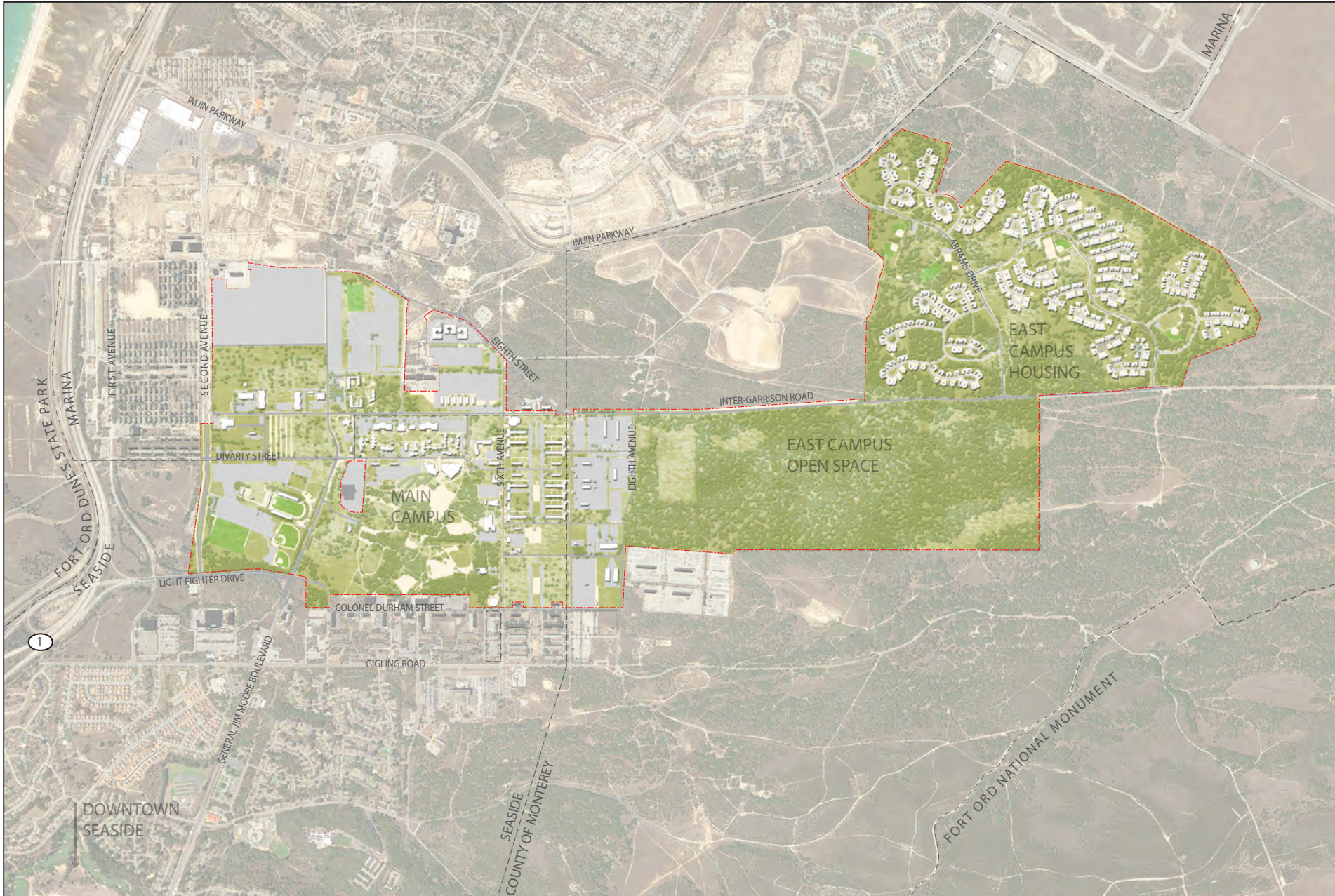

SOURCE: Page/BMS Design Group (2017)

**DUDEK**

CSU Monterey Bay Master Plan EIR

**FIGURE 2**  
**CSUMB Campus**

INTENTIONALLY LEFT BLANK

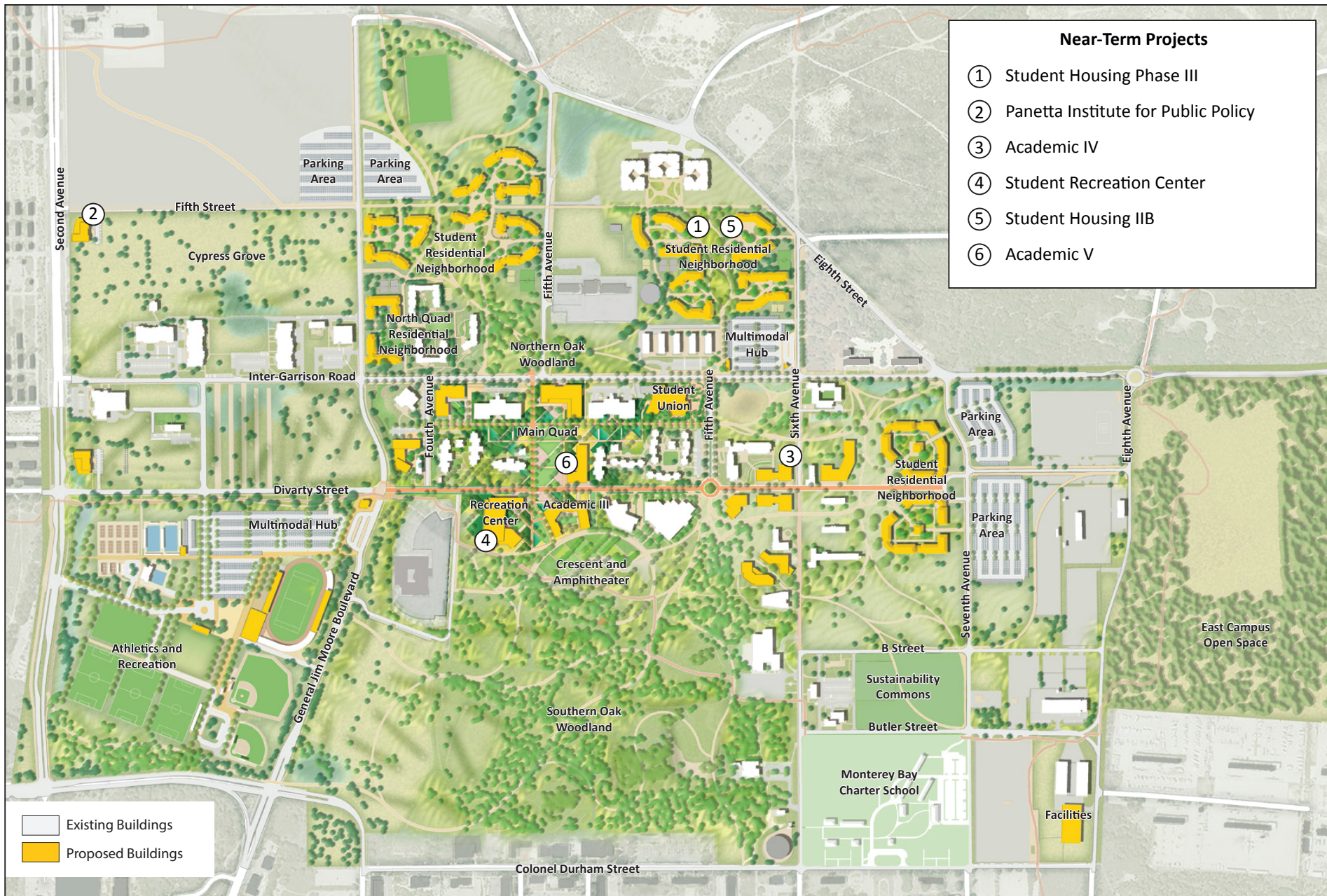

SOURCE: Page/BMS Design Group, as modified by Dudek (2017)

**DUDEK**

CSU Monterey Bay Master Plan EIR

**FIGURE 3**  
**Illustrative Plan**

INTENTIONALLY LEFT BLANK

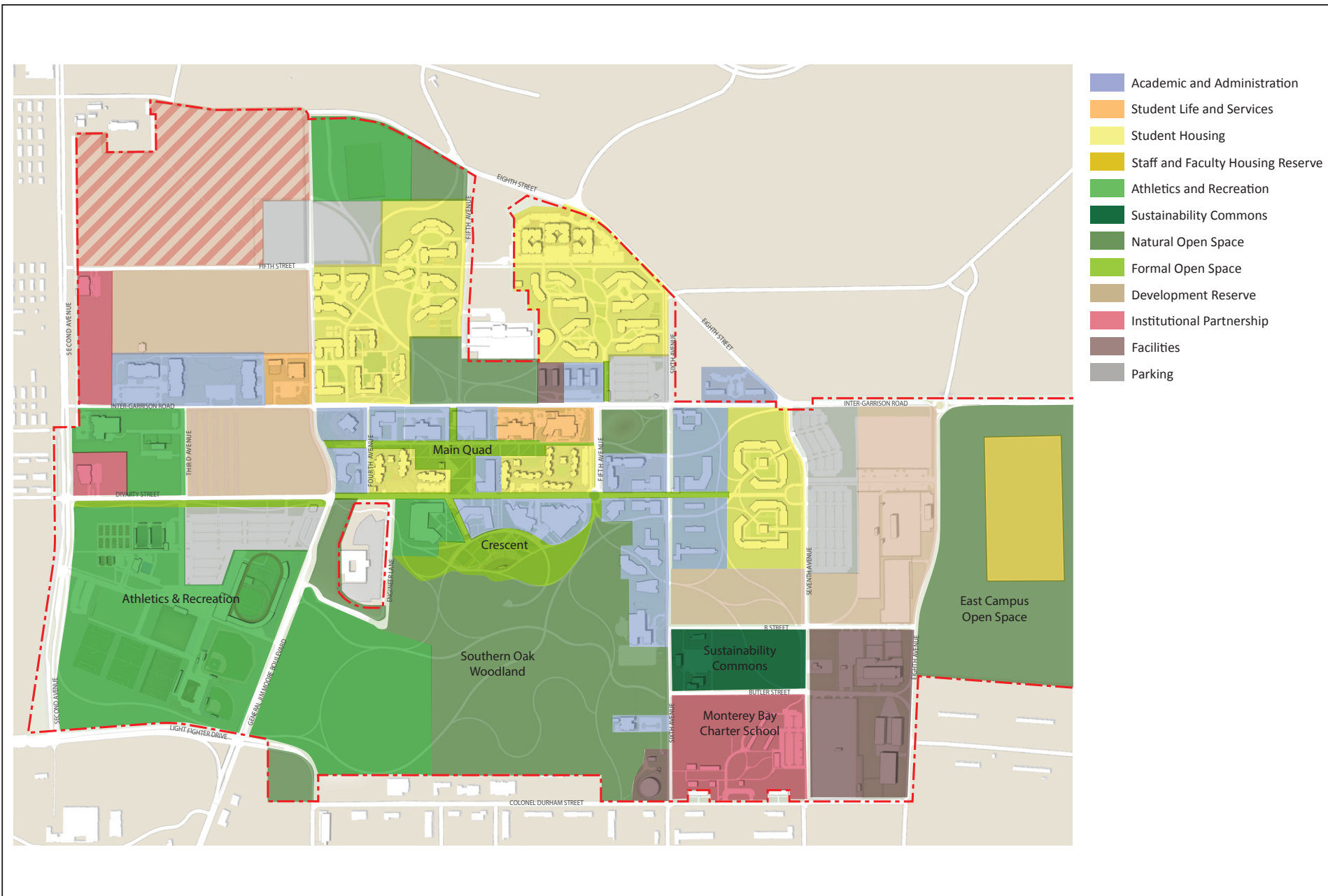

SOURCE: Page/BMS Design Group (2017)

**DUDEK**

CSU Monterey Bay Master Plan EIR

**FIGURE 4**  
**Land Use Plan**

INTENTIONALLY LEFT BLANK

**Revision to  
Previously Issued  
Notice of Preparation**

August 9, 2019

INTENTIONALLY LEFT BLANK



Campus Planning & Development  
100 Campus Center  
Mountain Hall A  
Seaside, CA 93955-8001

(831) 582-3709  
FAX (831) 582-4436

## REVISION TO PREVIOUSLY ISSUED NOTICE OF PREPARATION

### ENVIRONMENTAL IMPACT REPORT FOR THE CALIFORNIA STATE UNIVERSITY MONTEREY BAY MASTER PLAN

**DATE:** August 9, 2019

**TO:** Agencies, Organizations, and Interested Parties

**PROJECT TITLE:** California State University Monterey Bay Master Plan (Project)

**LEAD AGENCY:** The Board of Trustees of the California State University (Trustees)  
401 Golden Shore  
Long Beach, California 90802-4210

On behalf of California State University Monterey Bay (CSUMB)  
100 Campus Center  
Seaside, California 93955

**SUBJECT:** Revised Notice of Preparation of an Environmental Impact Report for the CSUMB Master Plan

A Notice of Preparation (NOP) for the pending CSUMB Master Plan Environmental Impact Report (EIR) was issued by the Board of Trustees of the California State University (Trustees) on May 17, 2017 and is located at <https://csumb.edu/campusplanning/draft-campus-master-plan-2017>. Per California Education Code (Cal. Code Regs. tit. 3, §66606), the Trustees is the governing body and owner of the California State University Monterey Bay (CSUMB) campus, and has the authority to certify the EIR, adopt the Master Plan, and provide for schematic design approvals. CSUMB is acting as point of contact for the CEQA process.

As the lead agency for the preparation of the EIR for the Project, the Trustees prepared this Revision to Previously Issued NOP to notify agencies, organizations, and other interested parties that the methodology to be used in the EIR in assessing potential transportation-related impacts has been modified from that indicated in the original NOP. Specifically, the original NOP indicates that intersection and freeway levels of service (LOS) would be the basis for the evaluation of potential

transportation impacts related to vehicle travel in the EIR. However, in response to Senate Bill 743 and the associated revisions to the CEQA Guidelines that became effective December 28, 2018, after release of the original NOP, the proposed analysis methodology has been modified, as further explained below. In all other respects, the NOP issued May 17, 2017, is unchanged.

**NOP Revision – Transportation and Traffic:** NOP page 9 is revised to read as follows: A transportation impact analysis will be prepared as part of the EIR to evaluate potential impacts of the proposed Master Plan and the near-term projects relative to vehicle miles traveled (VMT) and other applicable transportation criteria, consistent with the December 2018 revisions to the CEQA Guidelines. The analysis will consider campus growth and land use changes anticipated under the proposed Master Plan, including increases in on-campus housing and the availability of increased student amenities. The campus has committed to a sustainable campus Master Plan, which includes recommendations for a transportation demand management (TDM) program and a parking management plan as a means to manage vehicle trips to the campus and parking demand. While the transportation analysis will acknowledge the implementation of the TDM program and parking management plan as part of the Project, the estimates of vehicle travel in the transportation analysis are based on observed existing travel behavior to provide for a reasonable worst-case estimate of likely transportation conditions with the Project. Intersection and freeway LOS analysis will be provided for information and campus planning purposes only; significant impact determinations relative to vehicular travel and mitigation, if applicable, will be identified based upon the 2018 CEQA Guidelines, which require VMT analysis.

**Organizations and Interested Parties:** The Trustees request comments and concerns regarding the proposed revised analytical methodology, as described in this Revision to Previously Issued NOP, to be applied in the transportation impact analysis associated with the Project.

**Public Review Period:** The Trustees have issued this Revision to Previously Issued NOP for public review and comment pursuant to the CEQA Guidelines (Cal. Code Regs. tit. 14, §15082 and §15375). The Trustees have established a 30-day public scoping period from **August 12, 2019** through **September 10, 2019**, in accordance with the CEQA Guidelines (Cal. Code Regs. tit. 14, §15082). The Revision to Previously Issued NOP, along with the original NOP dated May 17, 2017, is available for review online at the following location: <https://csumb.edu/campusplanning/draft-campus-master-plan-2017>.

**Scoping Comments:** The Trustees are soliciting comments only on the revised analytical methodology to be applied in the transportation impact analysis of the pending EIR as described in this Revision to Previously Issued NOP. All prior scoping comments will be disclosed and considered in the pending EIR and do not need to be resubmitted. Comments on the transportation impact analysis may be submitted by mail, email, or fax. All comments should indicate a contact person for the agency or organization, if applicable. All comments should be sent to the following address, to arrive no later than 5:00 p.m. on **September 10, 2019**:

Anya Spear, LEED AP  
Associate Director of Campus Planning  
CSUMB, Campus Planning & Development  
100 Campus Center, Seaside, California 93955  
T: 831.582.5098 F: 831.582.3545 [aspear@csumb.edu](mailto:aspear@csumb.edu)

**Public Scoping Meeting:** Two scoping meetings were previously held in May of 2017. The Trustees will hold one additional Scoping Meeting to give the public an opportunity to receive more information about the revised analytical methodology to be applied in the transportation impact analysis of the pending EIR, and to provide comments and suggestions related thereto. All members of the public and interested persons are welcome to attend and provide written comments. The Scoping Meeting will be held on **August 27, 2019**, from **5:00 p.m. to 6:30 p.m.** at the Student Center West Lounge (next to Starbucks) on the CSUMB campus. See the campus map at the following location: <https://csumb.edu/directory/building/12>.

**Further Information:** For environmental review information or questions about the Project, please contact Anya Spear (831.582.5098 or [aspear@csumb.edu](mailto:aspear@csumb.edu)).

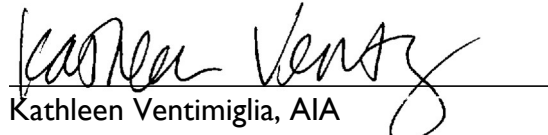
  
Kathleen Ventimiglia, AIA  
Director of Campus Planning & Development  
California State University Monterey Bay

August 9, 2019  
Date

INTENTIONALLY LEFT BLANK

# **APPENDIX B**

## **Comment Letters Received During Scoping Periods**

INTENTIONALLY LEFT BLANK

**Notice of  
Preparation**

May 12, 2017

INTENTIONALLY LEFT BLANK



# CSUMB Master Plan EIR - scoping comments

Inbox x



**Guidi, Robert G CIV USARMY IMCOM CENTRAL (US)**

11:39 AM (2 hours ago)

to me, Joelle

Good day Anya,

Hope all is going well. Thank you for the opportunity to provide input on the CSUMB Master Plan EIR scoping process. Please consider the comments for in-depth environmental analyses as follows:

1. **WATER RESOURCES** - A solid evaluation should be made when addressing sustainable water sources required to support future growth of the CSUMB Campus. Efforts to bring about a "regional" water solution are finally being realized after decades of planning. Nonetheless, the "regional solution" should not be viewed as the panacea for water needs. There are several local and site specific measures that should be addressed in the forthcoming EIR. Those measures include but are not limited to water conservation programs in graywater treatment/recycling, storm water diversion for reuse, low-flow water fixtures and developing a separate water works system.
2. **STORM WATER MANAGEMENT** - There should be a significant effort made to address Low-Impact Development (LID) measures and on-site water management. There could be opportunities to lessen or eliminate environmental impacts from storm water runoff by sharing facilities with others such as developers and neighboring property owners. Possible ways to reduce environmental impacts of storm water runoff should be examined.
3. **ALTERNATIVE MODES OF TRANSPORTATION** - CSUMB and MST continue to partner in providing additional transportation services. The EIR should address potential mitigations measures designed to further reduce the need for motorized vehicle use within the interior campus areas (e.g. enhancing shuttle bus services, providing incentives to bolster usage of bicycles or pedestrian activity.)
4. **TRANSPORTATION CIRCULATION** - CSUMB continues its positive efforts to create a uniform traffic flow and minimize the amount of motorized vehicles moving within inner campus areas. Extending the environmental impact analysis beyond the campus is strongly encouraged. Arterial roads and intersections now on the periphery still experience low Levels of Service (LOS) during peaking traffic times. Those areas now located on the outer limits many very well be within the main campus as it expands over time. The overall sphere of influence associated with transportation circulation/traffic flow should be part of the environmental analysis.

Please contact me if you require any clarification or have questions about the comments submitted. I look forward to participating in future meetings/workshops and reviewing the draft of this important environmental document.

Robert Guidi  
Directorate of Public Works  
Master Planning Division  
Presidio of Monterey, CA  
[831-242-7928](tel:831-242-7928) (M-F 8 A.M. to 6 P.M. Pacific)

**DEPARTMENT OF TRANSPORTATION**

50 HIGUERA STREET  
SAN LUIS OBISPO, CA 93401-5415  
PHONE (805) 549-3101  
FAX (805) 549-3329  
TTY 711  
<http://www.dot.ca.gov/dist05/>



*Serious drought  
Help save water!*

June 8, 2017

MON-1-R83.4  
SCH#2017051042

Ms. Anya Spear  
California State University Monterey Bay Master Plan  
100 Campus Center  
Seaside, CA 93955

Dear Ms. Spear:

**COMMENTS FOR THE NOTICE OF PREPARATION (NOP) FOR THE CALIFORNIA STATE UNIVERSITY MONTEREY BAY MASTER PLAN DRAFT ENVIRONMENTAL IMPACT REPORT (DEIR) – (2<sup>ND</sup> AVENUE/INTER-GARRISON) MONTEREY, CA**

The California Department of Transportation (Caltrans), District 5, Development Review, has reviewed the NOP for the California State University Monterey Bay Master Plan DEIR including projects identified in the university's Five-Year Capital Improvement Program 2016/2017 through 2020/2021 located adjacent to Highway 1. Caltrans supports local development that is consistent with State planning priorities intended to promote equity, strengthen the economy, protect the environment, and promote public health and safety. We accomplish this by working with local jurisdictions to achieve a shared vision of how the transportation system should and can accommodate interregional and local travel and development. Projects that support smart growth principles which include improvements to pedestrian, bicycle, and transit infrastructure (or other key Transportation Demand Strategies) are supported by Caltrans and are consistent with our mission, vision, and goals.

Further, we seek to reduce vehicle trips and new vehicle miles traveled associated with the development by appropriate measures that avoid, minimize, or mitigate impacts through smart mobility community design and multimodal demand strategies. Caltrans offers the following comments in response to the NOP for the California State University Monterey Bay Master Plan DEIR:

1. The Transportation Agency for Monterey County (TAMC) collects development impact fees to help fund transportation projects of regional significance to address project long-range traffic impacts. Caltrans supports payment of the adopted TAMC development impact fees as required to mitigate any cumulative impacts.

Ms. Spear  
June 8, 2017  
Page 2

2. Please be aware that if any work is completed in the State's right-of-way it will require an encroachment permit from Caltrans, and must be done to our engineering and environmental standards, and at no cost to the State. The conditions of approval and the requirements for the encroachment permit are issued at the sole discretion of the Permits Office, and nothing in this letter shall be implied as limiting those future conditioned and requirements. For more information regarding the encroachment permit process, please visit our Encroachment Permit Website at: <http://www.dot.ca.gov/trafficops/ep/index.html>.
3. At any time during the environmental review and approval process, Caltrans retains the statutory right to request a formal scoping meeting to resolve any issues of concern. Such formal scoping meeting requests are allowed per the provisions of the California Public Resources Code Section 21083.9 [a] [1].
4. Since the master plan is proposing an increase of full time student population, Caltrans looks forward to reviewing the detailed traffic analysis provided when the EIR document is circulated. With early coordination, we hope to identify the university's off campus traffic impacts and work together to develop the mitigation package to mitigate these consistent with CEQA and other current case-law relative to university expansion.

Thank you for the opportunity to review and comment on the proposed project. If you have any questions, or need further clarification on items discussed above, please contact me at (805) 549-3282 or email [jill.morales@dot.ca.gov](mailto:jill.morales@dot.ca.gov).

Sincerely,



JILLIAN R. LEAL-MORALES  
Associate Transportation Planner, District 5  
[jill.morales@dot.ca.gov](mailto:jill.morales@dot.ca.gov)

cc: Orchid Monroy-Ochoa (D5)  
Grant Leonard (TAMC)  
Heather Adamson (AMBAG)

## NATIVE AMERICAN HERITAGE COMMISSION

Environmental and Cultural Department  
1550 Harbor Blvd., Suite 100  
West Sacramento, CA 95691  
Phone (916) 373-3710  
Fax (916) 373-5471  
Email: [nahc@nahc.ca.gov](mailto:nahc@nahc.ca.gov)  
Website: <http://www.nahc.ca.gov>  
Twitter: @CA\_NAHC



May 17, 2017

Anya Spear  
California State University, Monterey Bay  
100 Campus Center  
Seaside, CA 93955

RE: SCH#2017051042 California State University Monterey Bay Master Plan, Monterey County

Dear Ms. Spear:

The Native American Heritage Commission has received the Notice of Preparation (NOP), Draft Environmental Impact Report (DEIR) or Early Consultation for the project referenced above. The California Environmental Quality Act (CEQA) (Pub. Resources Code § 21000 et seq.), specifically Public Resources Code section 21084.1, states that a project that may cause a substantial adverse change in the significance of an historical resource is a project that may have a significant effect on the environment. (Pub. Resources Code § 21084.1; Cal. Code Regs., tit.14, § 15064.5 (b) (CEQA Guidelines Section 15064.5 (b)). If there is substantial evidence, in light of the whole record before a lead agency, that a project may have a significant effect on the environment, an environmental impact report (EIR) shall be prepared. (Pub. Resources Code § 21080 (d); Cal. Code Regs., tit. 14, § 15064 subd.(a)(1) (CEQA Guidelines § 15064 (a)(1)). In order to determine whether a project will cause a substantial adverse change in the significance of a historical resource, a lead agency will need to determine whether there are historical resources with the area of project effect (APE).

CEQA was amended significantly in 2014. Assembly Bill 52 (Gatto, Chapter 532, Statutes of 2014) (AB 52) amended CEQA to create a separate category of cultural resources, "tribal cultural resources" (Pub. Resources Code § 21074) and provides that a project with an effect that may cause a substantial adverse change in the significance of a tribal cultural resource is a project that may have a significant effect on the environment. (Pub. Resources Code § 21084.2). Public agencies shall, when feasible, avoid damaging effects to any tribal cultural resource. (Pub. Resources Code § 21084.3 (a)). **AB 52 applies to any project for which a notice of preparation or a notice of negative declaration or mitigated negative declaration is filed on or after July 1, 2015.** If your project involves the adoption of or amendment to a general plan or a specific plan, or the designation or proposed designation of open space, on or after March 1, 2005, it may also be subject to Senate Bill 18 (Burton, Chapter 905, Statutes of 2004) (SB 18). **Both SB 18 and AB 52 have tribal consultation requirements.** If your project is also subject to the federal National Environmental Policy Act (42 U.S.C. § 4321 et seq.) (NEPA), the tribal consultation requirements of Section 106 of the National Historic Preservation Act of 1966 (154 U.S.C. 300101, 36 C.F.R. § 800 et seq.) may also apply.

The NAHC recommends consultation with California Native American tribes that are traditionally and culturally affiliated with the geographic area of your proposed project as early as possible in order to avoid inadvertent discoveries of Native American human remains and best protect tribal cultural resources. Below is a brief summary of portions of AB 52 and SB 18 as well as the NAHC's recommendations for conducting cultural resources assessments. **Consult your legal counsel about compliance with AB 52 and SB 18 as well as compliance with any other applicable laws.**

AB 52 has added to CEQA the additional requirements listed below, along with many other requirements:

1. Fourteen Day Period to Provide Notice of Completion of an Application/Decision to Undertake a Project: Within fourteen (14) days of determining that an application for a project is complete or of a decision by a public agency to undertake a project, a lead agency shall provide formal notification to a designated contact of, or tribal representative of, traditionally and culturally affiliated California Native American tribes that have requested notice, to be accomplished by at least one written notice that includes:
  - a. A brief description of the project.
  - b. The lead agency contact information.
  - c. Notification that the California Native American tribe has 30 days to request consultation. (Pub. Resources Code § 21080.3.1 (d)).
  - d. A "California Native American tribe" is defined as a Native American tribe located in California that is on the contact list maintained by the NAHC for the purposes of Chapter 905 of Statutes of 2004 (SB 18). (Pub. Resources Code § 21073).
2. Begin Consultation Within 30 Days of Receiving a Tribe's Request for Consultation and Before Releasing a Negative Declaration, Mitigated Negative Declaration, or Environmental Impact Report: A lead agency shall begin the consultation process within 30 days of receiving a request for consultation from a California Native American tribe that is traditionally and culturally affiliated with the geographic area of the proposed project. (Pub. Resources Code § 21080.3.1, subds. (d) and (e)) and prior to the release of a negative declaration, mitigated negative declaration or environmental impact report. (Pub. Resources Code § 21080.3.1(b)).
  - a. For purposes of AB 52, "consultation shall have the same meaning as provided in Gov. Code § 65352.4 (SB 18). (Pub. Resources Code § 21080.3.1 (b)).
3. Mandatory Topics of Consultation If Requested by a Tribe: The following topics of consultation, if a tribe requests to discuss them, are mandatory topics of consultation:
  - a. Alternatives to the project.
  - b. Recommended mitigation measures.
  - c. Significant effects. (Pub. Resources Code § 21080.3.2 (a)).
4. Discretionary Topics of Consultation: The following topics are discretionary topics of consultation:
  - a. Type of environmental review necessary.
  - b. Significance of the tribal cultural resources.
  - c. Significance of the project's impacts on tribal cultural resources.
  - d. If necessary, project alternatives or appropriate measures for preservation or mitigation that the tribe may recommend to the lead agency. (Pub. Resources Code § 21080.3.2 (a)).
5. Confidentiality of Information Submitted by a Tribe During the Environmental Review Process: With some exceptions, any information, including but not limited to, the location, description, and use of tribal cultural resources submitted by a California Native American tribe during the environmental review process shall not be included in the environmental document or otherwise disclosed by the lead agency or any other public agency to the public, consistent with Government Code sections 6254 (r) and 6254.10. Any information submitted by a California Native American tribe during the consultation or environmental review process shall be published in a confidential appendix to the environmental document unless the tribe that provided the information consents, in writing, to the disclosure of some or all of the information to the public. (Pub. Resources Code § 21082.3 (c)(1)).
6. Discussion of Impacts to Tribal Cultural Resources in the Environmental Document: If a project may have a significant impact on a tribal cultural resource, the lead agency's environmental document shall discuss both of the following:
  - a. Whether the proposed project has a significant impact on an identified tribal cultural resource.
  - b. Whether feasible alternatives or mitigation measures, including those measures that may be agreed to pursuant to Public Resources Code section 21082.3, subdivision (a), avoid or substantially lessen the impact on the identified tribal cultural resource. (Pub. Resources Code § 21082.3 (b)).
7. Conclusion of Consultation: Consultation with a tribe shall be considered concluded when either of the following occurs:

- a. The parties agree to measures to mitigate or avoid a significant effect, if a significant effect exists, on a tribal cultural resource; or
  - b. A party, acting in good faith and after reasonable effort, concludes that mutual agreement cannot be reached. (Pub. Resources Code § 21080.3.2 (b)).
8. Recommending Mitigation Measures Agreed Upon in Consultation in the Environmental Document: Any mitigation measures agreed upon in the consultation conducted pursuant to Public Resources Code section 21080.3.2 shall be recommended for inclusion in the environmental document and in an adopted mitigation monitoring and reporting program, if determined to avoid or lessen the impact pursuant to Public Resources Code section 21082.3, subdivision (b), paragraph 2, and shall be fully enforceable. (Pub. Resources Code § 21082.3 (a)).
9. Required Consideration of Feasible Mitigation: If mitigation measures recommended by the staff of the lead agency as a result of the consultation process are not included in the environmental document or if there are no agreed upon mitigation measures at the conclusion of consultation, or if consultation does not occur, and if substantial evidence demonstrates that a project will cause a significant effect to a tribal cultural resource, the lead agency shall consider feasible mitigation pursuant to Public Resources Code section 21084.3 (b). (Pub. Resources Code § 21082.3 (e)).
10. Examples of Mitigation Measures That, If Feasible, May Be Considered to Avoid or Minimize Significant Adverse Impacts to Tribal Cultural Resources:
- a. Avoidance and preservation of the resources in place, including, but not limited to:
    - i. Planning and construction to avoid the resources and protect the cultural and natural context.
    - ii. Planning greenspace, parks, or other open space, to incorporate the resources with culturally appropriate protection and management criteria.
  - b. Treating the resource with culturally appropriate dignity, taking into account the tribal cultural values and meaning of the resource, including, but not limited to, the following:
    - i. Protecting the cultural character and integrity of the resource.
    - ii. Protecting the traditional use of the resource.
    - iii. Protecting the confidentiality of the resource.
  - c. Permanent conservation easements or other interests in real property, with culturally appropriate management criteria for the purposes of preserving or utilizing the resources or places.
  - d. Protecting the resource. (Pub. Resource Code § 21084.3 (b)).
  - e. Please note that a federally recognized California Native American tribe or a nonfederally recognized California Native American tribe that is on the contact list maintained by the NAHC to protect a California prehistoric, archaeological, cultural, spiritual, or ceremonial place may acquire and hold conservation easements if the conservation easement is voluntarily conveyed. (Civ. Code § 815.3 (c)).
  - f. Please note that it is the policy of the state that Native American remains and associated grave artifacts shall be repatriated. (Pub. Resources Code § 5097.991).
11. Prerequisites for Certifying an Environmental Impact Report or Adopting a Mitigated Negative Declaration or Negative Declaration with a Significant Impact on an Identified Tribal Cultural Resource: An environmental impact report may not be certified, nor may a mitigated negative declaration or a negative declaration be adopted unless one of the following occurs:
- a. The consultation process between the tribes and the lead agency has occurred as provided in Public Resources Code sections 21080.3.1 and 21080.3.2 and concluded pursuant to Public Resources Code section 21080.3.2.
  - b. The tribe that requested consultation failed to provide comments to the lead agency or otherwise failed to engage in the consultation process.
  - c. The lead agency provided notice of the project to the tribe in compliance with Public Resources Code section 21080.3.1 (d) and the tribe failed to request consultation within 30 days. (Pub. Resources Code § 21082.3 (d)).

The NAHC's PowerPoint presentation titled, "Tribal Consultation Under AB 52: Requirements and Best Practices" may be found online at: [http://nahc.ca.gov/wp-content/uploads/2015/10/AB52TribalConsultation\\_CalEPAPDF.pdf](http://nahc.ca.gov/wp-content/uploads/2015/10/AB52TribalConsultation_CalEPAPDF.pdf)

SB 18 applies to local governments and requires local governments to contact, provide notice to, refer plans to, and consult with tribes prior to the adoption or amendment of a general plan or a specific plan, or the designation of open space. (Gov. Code § 65352.3). Local governments should consult the Governor's Office of Planning and Research's "Tribal Consultation Guidelines," which can be found online at: [https://www.opr.ca.gov/docs/09\\_14\\_05\\_Updated\\_Guidelines\\_922.pdf](https://www.opr.ca.gov/docs/09_14_05_Updated_Guidelines_922.pdf)

Some of SB 18's provisions include:

1. **Tribal Consultation:** If a local government considers a proposal to adopt or amend a general plan or a specific plan, or to designate open space it is required to contact the appropriate tribes identified by the NAHC by requesting a "Tribal Consultation List." If a tribe, once contacted, requests consultation the local government must consult with the tribe on the plan proposal. **A tribe has 90 days from the date of receipt of notification to request consultation unless a shorter timeframe has been agreed to by the tribe.** (Gov. Code § 65352.3 (a)(2)).
2. **No Statutory Time Limit on SB 18 Tribal Consultation.** There is no statutory time limit on SB 18 tribal consultation.
3. **Confidentiality:** Consistent with the guidelines developed and adopted by the Office of Planning and Research pursuant to Gov. Code section 65040.2, the city or county shall protect the confidentiality of the information concerning the specific identity, location, character, and use of places, features and objects described in Public Resources Code sections 5097.9 and 5097.993 that are within the city's or county's jurisdiction. (Gov. Code § 65352.3 (b)).
4. **Conclusion of SB 18 Tribal Consultation:** Consultation should be concluded at the point in which:
  - a. The parties to the consultation come to a mutual agreement concerning the appropriate measures for preservation or mitigation; or
  - b. Either the local government or the tribe, acting in good faith and after reasonable effort, concludes that mutual agreement cannot be reached concerning the appropriate measures of preservation or mitigation. (Tribal Consultation Guidelines, Governor's Office of Planning and Research (2005) at p. 18).

Agencies should be aware that neither AB 52 nor SB 18 precludes agencies from initiating tribal consultation with tribes that are traditionally and culturally affiliated with their jurisdictions before the timeframes provided in AB 52 and SB 18. For that reason, we urge you to continue to request Native American Tribal Contact Lists and "Sacred Lands File" searches from the NAHC. The request forms can be found online at: <http://nahc.ca.gov/resources/forms/>

#### NAHC Recommendations for Cultural Resources Assessments

To adequately assess the existence and significance of tribal cultural resources and plan for avoidance, preservation in place, or barring both, mitigation of project-related impacts to tribal cultural resources, the NAHC recommends the following actions:

1. Contact the appropriate regional California Historical Research Information System (CHRIS) Center ([http://ohp.parks.ca.gov/?page\\_id=1068](http://ohp.parks.ca.gov/?page_id=1068)) for an archaeological records search. The records search will determine:
  - a. If part or all of the APE has been previously surveyed for cultural resources.
  - b. If any known cultural resources have been already been recorded on or adjacent to the APE.
  - c. If the probability is low, moderate, or high that cultural resources are located in the APE.
  - d. If a survey is required to determine whether previously unrecorded cultural resources are present.
2. If an archaeological inventory survey is required, the final stage is the preparation of a professional report detailing the findings and recommendations of the records search and field survey.
  - a. The final report containing site forms, site significance, and mitigation measures should be submitted immediately to the planning department. All information regarding site locations, Native American human remains, and associated funerary objects should be in a separate confidential addendum and not be made available for public disclosure.
  - b. The final written report should be submitted within 3 months after work has been completed to the appropriate regional CHRIS center.



3. Contact the NAHC for:
  - a. A Sacred Lands File search. Remember that tribes do not always record their sacred sites in the Sacred Lands File, nor are they required to do so. A Sacred Lands File search is not a substitute for consultation with tribes that are traditionally and culturally affiliated with the geographic area of the project's APE.
  - b. A Native American Tribal Consultation List of appropriate tribes for consultation concerning the project site and to assist in planning for avoidance, preservation in place, or, failing both, mitigation measures.
4. Remember that the lack of surface evidence of archaeological resources (including tribal cultural resources) does not preclude their subsurface existence.
  - a. Lead agencies should include in their mitigation and monitoring reporting program plan provisions for the identification and evaluation of inadvertently discovered archaeological resources per Cal. Code Regs., tit. 14, section 15064.5(f) (CEQA Guidelines section 15064.5(f)). In areas of identified archaeological sensitivity, a certified archaeologist and a culturally affiliated Native American with knowledge of cultural resources should monitor all ground-disturbing activities.
  - b. Lead agencies should include in their mitigation and monitoring reporting program plans provisions for the disposition of recovered cultural items that are not burial associated in consultation with culturally affiliated Native Americans.
  - c. Lead agencies should include in their mitigation and monitoring reporting program plans provisions for the treatment and disposition of inadvertently discovered Native American human remains. Health and Safety Code section 7050.5, Public Resources Code section 5097.98, and Cal. Code Regs., tit. 14, section 15064.5, subdivisions (d) and (e) (CEQA Guidelines section 15064.5, subs. (d) and (e)) address the processes to be followed in the event of an inadvertent discovery of any Native American human remains and associated grave goods in a location other than a dedicated cemetery.

If you have any questions, please contact me at my email address: [frank.lienert@nahc.ca.gov](mailto:frank.lienert@nahc.ca.gov)

Sincerely,



*for* Frank Lienert  
Associate Governmental Program Analyst

cc: State Clearinghouse



# FORT ORD REUSE AUTHORITY

920 2<sup>nd</sup> Avenue, Suite A, Marina, CA 93933

Phone: (831) 883-3672 | Fax: (831) 883-3675 | [www.fora.org](http://www.fora.org)

June 9, 2017

Anya Spear, LEED AP  
Associate Director of Campus Planning  
California State University Monterey Bay, Campus Planning & Development  
100 Campus Center, Seaside, California 93955

Re: Notice of Preparation dated May 11, 2017 for an Environmental Impact Report for the California State University Monterey Bay Master Plan

Dear Ms. Spear:

We are in receipt of the Notice of Preparation document dated May 11, 2017 for an Environmental Impact Report (EIR) for the California State University Monterey Bay Master Plan (CSUMB Plan). In that regard, we are providing the following comments and concerns about the impacts the Master Plan could have on the environment in the future from the perspective of the Fort Ord Reuse Authority's (FORA's) overall mission of regional recovery.

A primary concern and mandate of FORA is to minimize the increase in demand for transportation infrastructure and services both within the base area and the region. The Base Reuse Plan Circulation Concept for the former Fort Ord includes strategies and improvements for the system within the base, as well as for those regionally significant facilities that provide access to the former Fort Ord. This plan includes building or improving roadway facilities and a demand management network that consists of strategies and actions that can be used to minimize the demand for vehicle trips as an alternative to increasing roadway capacity. In developing the CSUMB Plan EIR, traffic volumes on roadways must be evaluated. FORA recently conducted a fee reallocation study; we urge your team to use the information gained from our study in your analysis. Furthermore, we applaud your effort to eliminate or reduce traffic-related impacts and anticipate that the transition to the scenario's 2016-2026 goals of modes (28% drive alone, 22% shared ride, 25% transit, 13% walk, 10% bicycle, 2% other) will be gradual. We recommend your team evaluate traffic flow and load in phases from road closures and extensions, so that traffic impacts during the transition are precisely measured and mitigated appropriately in each phase. In addition, discuss how you can maximize your transit options in coordination with Monterey Salinas Transit during this gradual transition.

FORA is currently invested in helping the lead jurisdictions, Monterey County and City of Seaside, work collaboratively to plan for regional Oak Woodland protection on former Fort Ord. They are completing several policies and programs that the Base Reuse Plan requires to preserve contiguous areas of native Oak Woodland habitat. Your offices have been offered the opportunity to plan with them so that some 40 to 70 acres of

CSUMB's native Oak Woodland can be included in the regional corridor connecting Habitat Management Areas (HMAs) southeast of the CSUMB campus to the Landfill HMA to the north. The area in discussion is "East Campus Open Space." We find these policies to be aligned with your Master Plan's objective to retain Oak Woodlands. They also relate to your need to offset your project-related impacts. We urge you to embrace the opportunity to be a part of the Oak Woodland Conservation Area and to grant these agencies the opportunity to set aside conservation easements. The EIR should address how these specific areas are defined as mitigation for Oak Woodlands impacted by activities of the Master Plan and serve as components of regional mitigation areas. Also, coordinate with the County and Seaside to refer to related measures to be taken to protect and manage Oak Woodland habitat values. It is an excellent opportunity to align with the historic Fort Ord jurisdictions toward cohesive regional conservation planning.

In closing, we appreciate the opportunity to provide these comments. FORA is supportive of CSU's efforts to complete the promise of the Monterey Bay campus and look forward to the campus' central role in the regional recovery from the Fort Ord closure.

Sincerely,

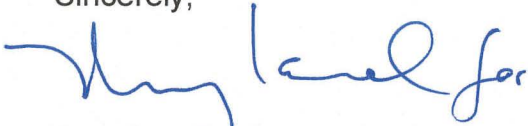
A handwritten signature in blue ink, appearing to read "Jonathan Brinkmann".

Jonathan Brinkmann  
Principal Planner

cc: Michael Houlemard, Executive Officer

State Clearinghouse  
P.O. Box 3044  
Sacramento, CA 95812-3044

# MONTEREY COUNTY RESOURCE MANAGEMENT AGENCY

Carl P. Holm, AICP, Director



Building Services / Environmental Services / Planning Services / Public Works & Facilities  
168 W. Alisal Street, 2nd Floor (831)755-4800  
Salinas, California 93901 www.co.monterey.ca.us/rma

June 12, 2017

Anya Spear  
CSUMB Campus Planning and Development  
100 Campus Center  
Seaside, CA 93955

Subject: NOP for CSUMB Master Plan

Dear Ms. Spear,

Thank you for the opportunity to review the NOP for the CSUMB Master Plan. Monterey County land use departments have reviewed the NOP and have the following comments:

#### Office of the Sheriff

The area of the project/construction is not in the actual jurisdiction of the Monterey County Sheriff's Office. (MCSO).

However, there are areas on the Former Ft. Ord property that fall under the jurisdiction of the MCSO (Beat areas 6C and 4C).

These areas are near the borders of the CSUMB campus.

Due to this project, with the increase in housing, the population will increase. This does have the potential to increase calls for service in the surrounding areas of the campus, and thus could impact those areas in the jurisdiction of MCSO.

Also, in the event of a major crime/emergency, the CSUMB Police Department could request the assistance of MCSO.

At this time, even with these factors considered, the impact to MCSO services would be **less than significant**.

Thank you again for the opportunity to comment on the NOP.

Sincerely,

A handwritten signature in cursive script that reads 'Bob Schubert'.

Bob Schubert, AICP  
Senior Planner

# MONTEREY COUNTY RESOURCE MANAGEMENT AGENCY

Carl P. Holm, AICP, Director



---

LAND USE & COMMUNITY DEVELOPMENT | PUBLIC WORKS & FACILITIES | PARKS  
1441 Schilling Place, South 2<sup>nd</sup> Floor (831)755-4800  
Salinas, California 93901-4527 www.co.monterey.ca.us/rma

June 12, 2017

Anya Spear, LEED AP  
Associate Director of Campus Planning  
CSUMB, Campus Planning & Development  
100 Campus Center  
Seaside, California 93955

**SUBJECT: COMMENTS TO NOTICE OF PREPARATION OF AN ENVIRONMENTAL  
IMPACT REPORT FOR THE CALIFORNIA STATE UNIVERSITY  
MONTEREY BAY MASTER PLAN**

Dear Ms. Spear,

Monterey County Resource Management Agency - Public Works (RMA-PW) has reviewed the Notice of Preparation (NOP) of an EIR for the CSUMB Master Plan, dated May 12, 2017. Based on the NOP, the proposed Master Plan would include projects identified in the CSUMB's 5-Year Capital Improvement Program, plus the additional space and facility needs to support planned growth to 12,700 full-time-equivalent (FTE) students, with on-campus housing for students, faculty and staff. The project would also include six "near-term projects." The RMA-PW is very interested to know about the project's potential impacts to County Roads and the surrounding traffic circulation network, especially given the severe congestion currently experienced in the vicinity of the campus.

We offer the following information and recommendations to aid you with the environmental review process:

- Any mitigation measure(s) proposed by the project should conform to regional planning documents, such as the Monterey County General Plan and TAMC's Regional Transportation Plan.
- The methodologies used to calculate the Levels of Service (LOS) should be consistent with the methods in the latest edition of the Highway Capacity Manual (2010 HCM). The analysis should use the latest Institute of Transportation Engineers (ITE) trip generation manual for trip rates (please refer to the County of Monterey's guide for the preparation of traffic impact studies <http://www.co.monterey.ca.us/home/showdocument?id=3846>).
- The Traffic Study should identify mitigation measures for all traffic circulation impacts on County roads. The significance criteria for County roads is described as follows:
  - Signalized Intersection: A significant impact would occur if an intersection operating at LOS A, B, C, or D degrades to E, F. For intersections already operating at unacceptable levels E, a significant impact would occur if a project adds 0.01 during peak hour or more to the critical movement's volume-to-capacity ratio. If the intersection is already operating at LOS F any increase (one vehicle) in the critical movement's volume-to-capacity ratio is considered significant.

- Unsignalized Intersections: A significant impact would occur if any traffic movement has LOS F or any traffic signal warrant is met.
- Road segments: A significant impact would occur if a roadway segment operating at A through E degrades to a lower level of service of E, or F. If a segment is already operating at LOS F any increase during peak hour (one vehicle) is considered significant.
- The EIR/Traffic Study should address the project's impacts on all county, regional, and city roadways. The geographic area covered in the scope of the traffic study should be of sufficient size to adequately identify all of the project's impacts. The traffic report should disclose all projects' access points and analyze the effects on county, cities, and regional roadway systems.
- In developing the cumulative scenarios for the traffic forecasts, trip distributions and traffic analysis, should be consistent with regional traffic model projections, i.e. AMBAG model.
- At a minimum, the following project scenarios should be analyzed: Existing Conditions, Existing plus Project, Background, Background plus project, Cumulative No Project, and Cumulative plus Project.
- As noted in the NOP, the campus is committed to a sustainable campus master plan, which includes plans and recommendations to reduce vehicle trips to campus. The report should provide details for the implementation of effectiveness of such vehicle trip reduction strategies. Also, the report should include the needs and benefits of providing pedestrian/bicycle facilities.
- In order to identify the project's potential impacts to the roadway system, the EIR will require:
  - Level of Service Analysis (LOS) for the following intersections:
    - Inter-Garrison Rd/Reservation Rd
    - Reservation Rd/Davis Rd
    - Davis Rd/Blanco Rd.
  - Level of Service Analysis (LOS) for the following road segment:
    - Reservation Rd from Inter-Garrison Rd to Davis Rd
    - Davis Rd from Reservation Rd to Blanco Rd
    - Davis Rd from Blanco Rd to Market St.
    - Blanco Rd from Reservation Rd to Davis Rd.
- The report needs to consider traffic while school is in regular and summer sessions and consider all planned development within the vicinity of the project.

We welcome the opportunity to participate and consult with you in developing the scope of the traffic analysis. We also look forward to reviewing and commenting on the Draft Environmental Impact Report. Should you have any further questions please contact me at (831) 755-4628, or email at [martinezrr@co.monterey.ca.us](mailto:martinezrr@co.monterey.ca.us).

Sincerely,



**Raul Martinez, Assistant Engineer.  
Resource Management Agency, Public Works & Facilities Division  
Traffic Section**



May 17, 2017

Ms. Anya Spear, LEED AP  
Associate Director of Campus Planning  
CSUMB, Campus Planning & Development  
100 Campus Center  
Seaside, California 93955

**Subject: Notice of Preparation – Environmental Impact Report for the California State University Monterey Bay Master Plan**

Dear Ms. Spear:

The Monterey Peninsula Water Management District (MPWMD or District) appreciates the opportunity to comment on the Environmental Impact Report (EIR) dated May 2017 for California State University Monterey Bay's (CSUMB) Master Plan. The California State University Monterey Bay campus is physically located on the former Fort Ord.

The CSUMB campus is outside of the MPWMD's boundaries and is not subject to our Rules and Regulations. The project will be served by Marina Coast Water District, a Water Distribution System not regulated by MPWMD. Inquiries regarding construction at the CSUMB campus should be addressed to Marina Coast Water District.

Thank you for the opportunity to review and provide feedback on the Environmental Impact Report for California State University Monterey Bay's Master Plan. If you have questions, please contact me at [gabby@mpwmd.net](mailto:gabby@mpwmd.net) or 831-658-5601

Sincerely,

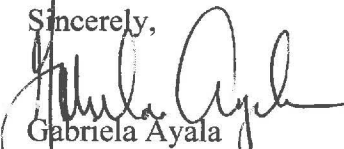
  
Gabriela Ayala  
Conservation Analyst

U:\demand\CEQA Docs\20170517\_CSUMB\_MasterPlanEIR\_Ayala.docx

RECEIVED

MAY 24 2017

CSUMB CP&D



**RESOURCE MANAGEMENT SERVICES**

440 Harcourt Avenue  
Seaside, CA 93955

Telephone (831) 899-6737  
FAX (831) 899-6211  
TDD (831) 899-6207

June 9, 2017

Anya Spear, LEED AP  
CSMUB, Campus Planning and Development  
100 Campus Center  
Seaside, CA 93955

RE: Notice of Preparation CSUMB Master Plan EIR

The City of Seaside is submitting the following comments on the scope and content of the CSUMB Master Plan EIR.

| Section   | Comments  |
|---|---|
| 2.1, Page 3                                       | Provide explanation and/or example of type of institutional partnerships CSUMB can enter into with the City of Seaside.   |
| 2.1, Page 3                                       | Provide explanation how athletics and recreation areas would be expanded near Seaside Municipal Boundaries.   |
| 2.1, Page 5                                       | Identify development outside of areas currently served by existing trunk mains on CUMB Campus that could require extension of trunk mains at the university's expense.  |
| Section 3, Hydrology and Water Quality, Page 8    | Has CSUMB identified locations for potential bio swale treatment areas.   |
| Section 3, Population Housing, Page 8             | The City of Seaside would encourage CSUMB to develop higher density residential structures on the south side of the campus at heights of four stories or more to match the housing development on the "Promnitory" project site |
| Section 3, Public Services and Recreation, Page 9 | Identify whether the EIR should evaluate wildland fire maintenance and fire protection services.<br><br>Identify how mutual aid would be coordinated between adjacent municipal jurisdictions.                                  |

The City of Seaside wants to thank CSUMB and its consultants for providing the City of Seaside with the opportunity to provide its written comments on the CSUMB Master Plan EIR.

Sincerely

Rick Medina  
Senior Planner





June 12, 2017

Anya Spear  
Associate Director of Campus Planning  
CSUMB, Campus Planning and Development  
100 Campus Center  
Seaside, CA 93955

**SUBJECT: Comments on the Notice of Preparation for the CSUMB Master Plan**

Dear Ms. Spear:

The Transportation Agency for Monterey County is the Regional Transportation Planning and Congestion Management Agency for Monterey County. Agency staff has reviewed the Notice of Preparation for the CSUMB Master plan Environmental Impact Report and offers the following comments:

1. The Agency supports the development of a detailed Traffic Impact Analysis to inform the EIR about the impacts to local and regional road networks. In particular, we support the detailed analysis of the Master Plan's proposed Travel Demand Management (TDM) strategies.
2. The Agency looks forward to providing comments on the draft environmental impact report.

Thank you for the opportunity to comment on the proposed project. If you have any questions, please contact Grant Leonard of my staff at 831-775-0903.

Sincerely,

  
Debra L. Hale  
Executive Director

# NOP EIR Master Plan

Inbox x



**Mark Lasnik**

11:33 AM (23 minutes ago)

to me

Hi Anya. I hope that you and your family are well.

My initial feedback about the pursuit of an "ambitious" Transportation Scenario is:

due to the fact that parking will be limited and consolidated to the campus periphery, there is no stated plan to encourage employees to use active transportation. I'd like to see in print a plan that CSUMB management has to create a positive employment environment between supervisor and line staff, in regards to the impact that using active transportation has on start and end time. Let's not re-invent the wheel. How do universities and private employers handle start and end times where active transportation is the primary source?

If management does not initiate the conversation with staff to utilize active transportation, the vast majority of staff will not initiate that conversation. An "improved shuttle service" needs definition...will the arrival time at the multimodal hubs qualify as arriving to work "on time"? Will transit and shuttle schedules be so coordinated that our culture will eliminate supervisors' need to pay attention to work start and end times?

My best to you,  
M

Thank you.

Mark Lasnik, LEED® AP

[831-582-5216](tel:831-582-5216)

CSU Monterey Bay

Please do not print this email unless absolutely necessary.

**Revision to  
Previously Issued  
Notice of Preparation**

August 9, 2019

INTENTIONALLY LEFT BLANK

NATIVE AMERICAN HERITAGE COMMISSION  
Cultural and Environmental Department  
1550 Harbor Blvd., Suite 100  
West Sacramento, CA 95691 Phone: (916) 373-3710  
Email: [nahc@nahc.ca.gov](mailto:nahc@nahc.ca.gov)  
Website: <http://www.nahc.ca.gov>



RECEIVED  
AUG 22 2019  
CSUMB CP&D

August 15, 2019

Anya Spear  
California State University, Monterey Bay  
100 Campus Center  
Seaside, CA 93955

RE: SCH# 2017051042, California State University Monterey Bay Master Plan Project, Monterey County

Dear Ms. Spear:

The Native American Heritage Commission (NAHC) has received the Notice of Preparation (NOP) for the project referenced above. The California Environmental Quality Act (CEQA) (Pub. Resources Code §21000 et seq.), specifically Public Resources Code §21084.1, states that a project that may cause a substantial adverse change in the significance of a historical resource, is a project that may have a significant effect on the environment. (Pub. Resources Code § 21084.1; Cal. Code Regs., tit.14, §15064.5 (b) (CEQA Guidelines §15064.5 (b)). If there is substantial evidence, in light of the whole record before a lead agency, that a project may have a significant effect on the environment, an Environmental Impact Report (EIR) shall be prepared. (Pub. Resources Code §21080 (d); Cal. Code Regs., tit. 14, § 5064 subd.(a)(1) (CEQA Guidelines §15064 (a)(1)). In order to determine whether a project will cause a substantial adverse change in the significance of a historical resource, a lead agency will need to determine whether there are historical resources within the area of potential effect (APE).

CEQA was amended significantly in 2014. Assembly Bill 52 (Gatto, Chapter 532, Statutes of 2014) (AB 52) amended CEQA to create a separate category of cultural resources, "tribal cultural resources" (Pub. Resources Code §21074) and provides that a project with an effect that may cause a substantial adverse change in the significance of a tribal cultural resource is a project that may have a significant effect on the environment. (Pub. Resources Code §21084.2). Public agencies shall, when feasible, avoid damaging effects to any tribal cultural resource. (Pub. Resources Code §21084.3 (a)). **AB 52 applies to any project for which a notice of preparation, a notice of negative declaration, or a mitigated negative declaration is filed on or after July 1, 2015.** If your project involves the adoption of or amendment to a general plan or a specific plan, or the designation or proposed designation of open space, on or after March 1, 2005, it may also be subject to Senate Bill 18 (Burton, Chapter 905, Statutes of 2004) (SB 18). **Both SB 18 and AB 52 have tribal consultation requirements.** If your project is also subject to the federal National Environmental Policy Act (42 U.S.C. § 4321 et seq.) (NEPA), the tribal consultation requirements of Section 106 of the National Historic Preservation Act of 1966 (154 U.S.C. 300101, 36 C.F.R. §800 et seq.) may also apply.

The NAHC recommends consultation with California Native American tribes that are traditionally and culturally affiliated with the geographic area of your proposed project as early as possible in order to avoid inadvertent discoveries of Native American human remains and best protect tribal cultural resources. Below is a brief summary of portions of AB 52 and SB 18 as well as the NAHC's recommendations for conducting cultural resources assessments.

**Consult your legal counsel about compliance with AB 52 and SB 18 as well as compliance with any other applicable laws.**

AB 52 has added to CEQA the additional requirements listed below, along with many other requirements:

1. Fourteen Day Period to Provide Notice of Completion of an Application/Decision to Undertake a Project: Within fourteen (14) days of determining that an application for a project is complete or of a decision by a public agency to undertake a project, a lead agency shall provide formal notification to a designated contact of, or tribal representative of, traditionally and culturally affiliated California Native American tribes that have requested notice, to be accomplished by at least one written notice that includes:
  - a. A brief description of the project.
  - b. The lead agency contact information.
  - c. Notification that the California Native American tribe has 30 days to request consultation. (Pub. Resources Code §21080.3.1 (d)).
  - d. A "California Native American tribe" is defined as a Native American tribe located in California that is on the contact list maintained by the NAHC for the purposes of Chapter 905 of Statutes of 2004 (SB 18). (Pub. Resources Code §21073).
2. Begin Consultation Within 30 Days of Receiving a Tribe's Request for Consultation and Before Releasing a Negative Declaration, Mitigated Negative Declaration, or Environmental Impact Report: A lead agency shall begin the consultation process within 30 days of receiving a request for consultation from a California Native American tribe that is traditionally and culturally affiliated with the geographic area of the proposed project. (Pub. Resources Code §21080.3.1, subs. (d) and (e)) and prior to the release of a negative declaration, mitigated negative declaration or Environmental Impact Report. (Pub. Resources Code §21080.3.1(b)).
  - a. For purposes of AB 52, "consultation shall have the same meaning as provided in Gov. Code §65352.4 (SB 18). (Pub. Resources Code §21080.3.1 (b)).
3. Mandatory Topics of Consultation If Requested by a Tribe: The following topics of consultation, if a tribe requests to discuss them, are mandatory topics of consultation:
  - a. Alternatives to the project.
  - b. Recommended mitigation measures.
  - c. Significant effects. (Pub. Resources Code §21080.3.2 (a)).
4. Discretionary Topics of Consultation: The following topics are discretionary topics of consultation:
  - a. Type of environmental review necessary.
  - b. Significance of the tribal cultural resources.
  - c. Significance of the project's impacts on tribal cultural resources.
  - d. If necessary, project alternatives or appropriate measures for preservation or mitigation that the tribe may recommend to the lead agency. (Pub. Resources Code §21080.3.2 (a)).
5. Confidentiality of Information Submitted by a Tribe During the Environmental Review Process: With some exceptions, any information, including but not limited to, the location, description, and use of tribal cultural resources submitted by a California Native American tribe during the environmental review process shall not be included in the environmental document or otherwise disclosed by the lead agency or any other public agency to the public, consistent with Government Code §6254 (r) and §6254.10. Any information submitted by a California Native American tribe during the consultation or environmental review process shall be published in a confidential appendix to the environmental document unless the tribe that provided the information consents, in writing, to the disclosure of some or all of the information to the public. (Pub. Resources Code §21082.3 (c)(1)).
6. Discussion of Impacts to Tribal Cultural Resources in the Environmental Document: If a project may have a significant impact on a tribal cultural resource, the lead agency's environmental document shall discuss both of the following:
  - a. Whether the proposed project has a significant impact on an identified tribal cultural resource.
  - b. Whether feasible alternatives or mitigation measures, including those measures that may be agreed to pursuant to Public Resources Code §21082.3, subdivision (a), avoid or substantially lessen the impact on the identified tribal cultural resource. (Pub. Resources Code §21082.3 (b)).

7. Conclusion of Consultation: Consultation with a tribe shall be considered concluded when either of the following occurs:
  - a. The parties agree to measures to mitigate or avoid a significant effect, if a significant effect exists, on a tribal cultural resource; or
  - b. A party, acting in good faith and after reasonable effort, concludes that mutual agreement cannot be reached. (Pub. Resources Code §21080.3.2 (b)).
  
8. Recommending Mitigation Measures Agreed Upon in Consultation in the Environmental Document: Any mitigation measures agreed upon in the consultation conducted pursuant to Public Resources Code §21080.3.2 shall be recommended for inclusion in the environmental document and in an adopted mitigation monitoring and reporting program, if determined to avoid or lessen the impact pursuant to Public Resources Code §21082.3, subdivision (b), paragraph 2, and shall be fully enforceable. (Pub. Resources Code §21082.3 (a)).
  
9. Required Consideration of Feasible Mitigation: If mitigation measures recommended by the staff of the lead agency as a result of the consultation process are not included in the environmental document or if there are no agreed upon mitigation measures at the conclusion of consultation, or if consultation does not occur, and if substantial evidence demonstrates that a project will cause a significant effect to a tribal cultural resource, the lead agency shall consider feasible mitigation pursuant to Public Resources Code §21084.3 (b). (Pub. Resources Code §21082.3 (e)).
  
10. Examples of Mitigation Measures That, If Feasible, May Be Considered to Avoid or Minimize Significant Adverse Impacts to Tribal Cultural Resources:
  - a. Avoidance and preservation of the resources in place, including, but not limited to:
    - i. Planning and construction to avoid the resources and protect the cultural and natural context.
    - ii. Planning greenspace, parks, or other open space, to incorporate the resources with culturally appropriate protection and management criteria.
  - b. Treating the resource with culturally appropriate dignity, taking into account the tribal cultural values and meaning of the resource, including, but not limited to, the following:
    - i. Protecting the cultural character and integrity of the resource.
    - ii. Protecting the traditional use of the resource.
    - iii. Protecting the confidentiality of the resource.
  - c. Permanent conservation easements or other interests in real property, with culturally appropriate management criteria for the purposes of preserving or utilizing the resources or places.
  - d. Protecting the resource. (Pub. Resource Code §21084.3 (b)).
  - e. Please note that a federally recognized California Native American tribe or a non-federally recognized California Native American tribe that is on the contact list maintained by the NAHC to protect a California prehistoric, archaeological, cultural, spiritual, or ceremonial place may acquire and hold conservation easements if the conservation easement is voluntarily conveyed. (Civ. Code §815.3 (c)).
  - f. Please note that it is the policy of the state that Native American remains and associated grave artifacts shall be repatriated. (Pub. Resources Code §5097.991).
  
11. Prerequisites for Certifying an Environmental Impact Report or Adopting a Mitigated Negative Declaration or Negative Declaration with a Significant Impact on an Identified Tribal Cultural Resource: An Environmental Impact Report may not be certified, nor may a mitigated negative declaration or a negative declaration be adopted unless one of the following occurs:
  - a. The consultation process between the tribes and the lead agency has occurred as provided in Public Resources Code §21080.3.1 and §21080.3.2 and concluded pursuant to Public Resources Code §21080.3.2.
  - b. The tribe that requested consultation failed to provide comments to the lead agency or otherwise failed to engage in the consultation process.
  - c. The lead agency provided notice of the project to the tribe in compliance with Public Resources Code §21080.3.1 (d) and the tribe failed to request consultation within 30 days. (Pub. Resources Code §21082.3 (d)).

The NAHC's PowerPoint presentation titled, "Tribal Consultation Under AB 52: Requirements and Best Practices" may be found online at: [http://nahc.ca.gov/wp-content/uploads/2015/10/AB52TribalConsultation\\_CalEPAPDF.pdf](http://nahc.ca.gov/wp-content/uploads/2015/10/AB52TribalConsultation_CalEPAPDF.pdf)

## SB 18

SB 18 applies to local governments and requires local governments to contact, provide notice to, refer plans to, and consult with tribes prior to the adoption or amendment of a general plan or a specific plan, or the designation of open space. (Gov. Code §65352.3). Local governments should consult the Governor's Office of Planning and Research's "Tribal Consultation Guidelines," which can be found online at: [https://www.opr.ca.gov/docs/09\\_14\\_05\\_Updated\\_Guidelines\\_922.pdf](https://www.opr.ca.gov/docs/09_14_05_Updated_Guidelines_922.pdf).

Some of SB 18's provisions include:

1. **Tribal Consultation**: If a local government considers a proposal to adopt or amend a general plan or a specific plan, or to designate open space it is required to contact the appropriate tribes identified by the NAHC by requesting a "Tribal Consultation List." If a tribe, once contacted, requests consultation the local government must consult with the tribe on the plan proposal. **A tribe has 90 days from the date of receipt of notification to request consultation unless a shorter timeframe has been agreed to by the tribe.** (Gov. Code §65352.3 (a)(2)).
2. **No Statutory Time Limit on SB 18 Tribal Consultation**. There is no statutory time limit on SB 18 tribal consultation.
3. **Confidentiality**: Consistent with the guidelines developed and adopted by the Office of Planning and Research pursuant to Gov. Code §65040.2, the city or county shall protect the confidentiality of the information concerning the specific identity, location, character, and use of places, features and objects described in Public Resources Code §5097.9 and §5097.993 that are within the city's or county's jurisdiction. (Gov. Code §65352.3 (b)).
4. **Conclusion of SB 18 Tribal Consultation**: Consultation should be concluded at the point in which:
  - a. The parties to the consultation come to a mutual agreement concerning the appropriate measures for preservation or mitigation; or
  - b. Either the local government or the tribe, acting in good faith and after reasonable effort, concludes that mutual agreement cannot be reached concerning the appropriate measures of preservation or mitigation. (Tribal Consultation Guidelines, Governor's Office of Planning and Research (2005) at p. 18).

Agencies should be aware that neither AB 52 nor SB 18 precludes agencies from initiating tribal consultation with tribes that are traditionally and culturally affiliated with their jurisdictions before the timeframes provided in AB 52 and SB 18. For that reason, we urge you to continue to request Native American Tribal Contact Lists and "Sacred Lands File" searches from the NAHC. The request forms can be found online at: <http://nahc.ca.gov/resources/forms/>

## NAHC Recommendations for Cultural Resources Assessments

To adequately assess the existence and significance of tribal cultural resources and plan for avoidance, preservation in place, or barring both, mitigation of project-related impacts to tribal cultural resources, the NAHC recommends the following actions:

1. Contact the appropriate regional California Historical Research Information System (CHRIS) Center ([http://ohp.parks.ca.gov/?page\\_id=1068](http://ohp.parks.ca.gov/?page_id=1068)) for an archaeological records search. The records search will determine:
  - a. If part or all of the APE has been previously surveyed for cultural resources.
  - b. If any known cultural resources have already been recorded on or adjacent to the APE.
  - c. If the probability is low, moderate, or high that cultural resources are located in the APE.
  - d. If a survey is required to determine whether previously unrecorded cultural resources are present.
2. If an archaeological inventory survey is required, the final stage is the preparation of a professional report detailing the findings and recommendations of the records search and field survey.
  - a. The final report containing site forms, site significance, and mitigation measures should be submitted immediately to the planning department. All information regarding site locations, Native American human remains, and associated funerary objects should be in a separate confidential addendum and not be made available for public disclosure.
  - b. The final written report should be submitted within 3 months after work has been completed to the appropriate regional CHRIS center.



3. Contact the NAHC for:
  - a. A Sacred Lands File search. Remember that tribes do not always record their sacred sites in the Sacred Lands File, nor are they required to do so. A Sacred Lands File search is not a substitute for consultation with tribes that are traditionally and culturally affiliated with the geographic area of the project's APE.
  - b. A Native American Tribal Consultation List of appropriate tribes for consultation concerning the project site and to assist in planning for avoidance, preservation in place, or, failing both, mitigation measures.
4. Remember that the lack of surface evidence of archaeological resources (including tribal cultural resources) does not preclude their subsurface existence.
  - a. Lead agencies should include in their mitigation and monitoring reporting program plan provisions for the identification and evaluation of inadvertently discovered archaeological resources per Cal. Code Regs., tit. 14, §15064.5(f) (CEQA Guidelines §15064.5(f)). In areas of identified archaeological sensitivity, a certified archaeologist and a culturally affiliated Native American with knowledge of cultural resources should monitor all ground-disturbing activities.
  - b. Lead agencies should include in their mitigation and monitoring reporting program plans provisions for the disposition of recovered cultural items that are not burial associated in consultation with culturally affiliated Native Americans.
  - c. Lead agencies should include in their mitigation and monitoring reporting program plans provisions for the treatment and disposition of inadvertently discovered Native American human remains. Health and Safety Code §7050.5, Public Resources Code §5097.98, and Cal. Code Regs., tit. 14, §15064.5, subdivisions (d) and (e) (CEQA Guidelines §15064.5, subds. (d) and (e)) address the processes to be followed in the event of an inadvertent discovery of any Native American human remains and associated grave goods in a location other than a dedicated cemetery.

If you have any questions or need additional information, please contact me at my email address:  
[Andrew.Green@nahc.ca.gov](mailto:Andrew.Green@nahc.ca.gov).

Sincerely,



Andrew Green  
Staff Services Analyst

cc: State Clearinghouse



September 5, 2019

Anya Spear, LEED AP  
Associate Director of Campus Planning  
CSUMB, Campus Planning & Development  
100 Campus Center  
Seaside, CA 93955

**SUBJECT: Comments on the Revised Notice of Preparation for the Environmental Impact Report for the CSUMB Master Plan**

Dear Anya Spear:

The Transportation Agency for Monterey County (TAMC) is the Regional Transportation Planning and Congestion Management Agency for Monterey County. TAMC staff have reviewed the CSUMB Master Plan and revised Notice of Preparation and offer the following comments:

1. As TAMC indicated in our comment letter on the original NOP dated June 12, 2017, the Agency supports the development of a detailed Traffic Impact Analysis to inform the EIR about the impacts to local and regional road networks. In particular, we support the detailed analysis of the Master Plan's proposed Transportation Demand Management (TDM) strategies.
2. Although not expressly stated, the proposed TDM measures identified in the Master Plan are either currently provided through TAMC's Go831 program or in line with Go831 regional trip reduction goals. Because student travel is not confined to CSUMB's jurisdictional boundary, and because big life changes (like starting a new school or new job) are critical opportunities for travel behavior change, please consider including the following information in the Mobility chapter:
  - Under "TDM Resources" consider adding:
    - i. Regional TDM Coordination with TAMC's Go831 program – The Go831 program operates in Monterey County and provides resources to employers and schools to develop or enhance their own TDM programs.
    - ii. New Student & Staff Transportation Orientation – integrate TDM resources into new student orientation activities and provide hands-on opportunities to try a variety of transportation options. Example: a

lunchtime workshop where students can learn about benefits, tips and resources to carpool, while meeting potential carpool buddies.

- iii. Personal Trip Reduction Plans – provide personal trip reduction plans to new student and faculty as part of their orientation. Personal trip reduction plans allow for new students and staff to receive more specific TDM information that is relevant to their needs and interests instead of overwhelming them with all of the transportation options available.
3. TAMC encourages the use of Intersections Control Evaluations (ICE analysis) when determining intersection control type for primary intersections. The Agency recommends including ICE analyses in the EIR traffic and circulation technical study for the intersections identified in the Master Plan as “Campus Entry” points:
    - Inter-Garrison Rd / 7<sup>th</sup> Ave / 8<sup>th</sup> St
    - 8<sup>th</sup> St / 6<sup>th</sup> Ave / Engineering Equipment Rd
    - Divarty St. / General Jim Moore Blvd
    - General Jim Moore Blvd / Lightfighter Drive.
  4. Please consider a roundabout at 2<sup>nd</sup> Ave and the CSUMB Sports Complex, between Divarty Street and Lightfighter Drive.
  5. Please consider coordination between the CSUMB Master Plan and the adjacent Seaside Campus Town Project.
  6. TAMC strongly supports the Master Plan’s prioritization and proposal of increased bicycles and pedestrian access on the CSUMB campus. TAMC supports the Master Plan’s prioritization of pedestrian travel as the primary mode of travel on campus, and the Master Plan’s vision of a bicycle share program, and covered bicycle parking with supporting Fix-it stations. We encourage consideration of the connectivity of the proposed bicycle and pedestrian paths with the neighboring communities
  7. TAMC is grateful for CSUMB’s ongoing consideration and coordination with the proposed Fort Ord Regional Trail and Greenway (FORTAG) trail alignment in relation to the CSUMB campus, with specific emphasis on bicycle and pedestrian connections to the proposed trail.
  8. The Transportation Agency recommends coordination with Monterey-Salinas Transit (MST) about the Master Plan’s vision for transit. Monterey-Salinas Transit’s *Designing for Transit* Guideline Manual should be used as a resource for accommodating the existing (16, 18, 19, 25, 26, 74) and potential future transit access to the project site.
  9. TAMC supports the Master Plan’s goal to improve wayfinding to promote pedestrian and bicycle travel within the CSUMB campus and throughout neighboring communities. TAMC encourages utilizing the Agency’s *Wayfinding Plan* and *Wayfinding Sign Design Package* as resources.

Additionally, the Agency offers the following minor edit:

Figure 7.10 and 7.11 of the Master Plan should use the recently updated Fort Ord Regional Trail and Greenway (FORTAG) alignment. Enclosed is a geographic file (.kmz) containing the current alignment. TAMC recommends coordination regarding FORTAG with Stefania Castillo, Transportation Planner, at [stefania@tamcmonterey.org](mailto:stefania@tamcmonterey.org).

Thank you for the opportunity to comment on the proposed project. TAMC looks forward to providing comments on the draft environmental impact report.

If you have any questions, please contact Madilyn Jacobsen of my staff at 831-775-4402 or [madilyn@tamcmonterey.org](mailto:madilyn@tamcmonterey.org).

Sincerely,

A handwritten signature in blue ink, appearing to read 'DLH', with a long horizontal flourish extending to the right.

Debra L. Hale  
Executive Director

Enclosures:

- FORTAG Alignment (.kmz)
- FORTAG Alignment (.pdf)

Figure 1 FORTAG Alignment

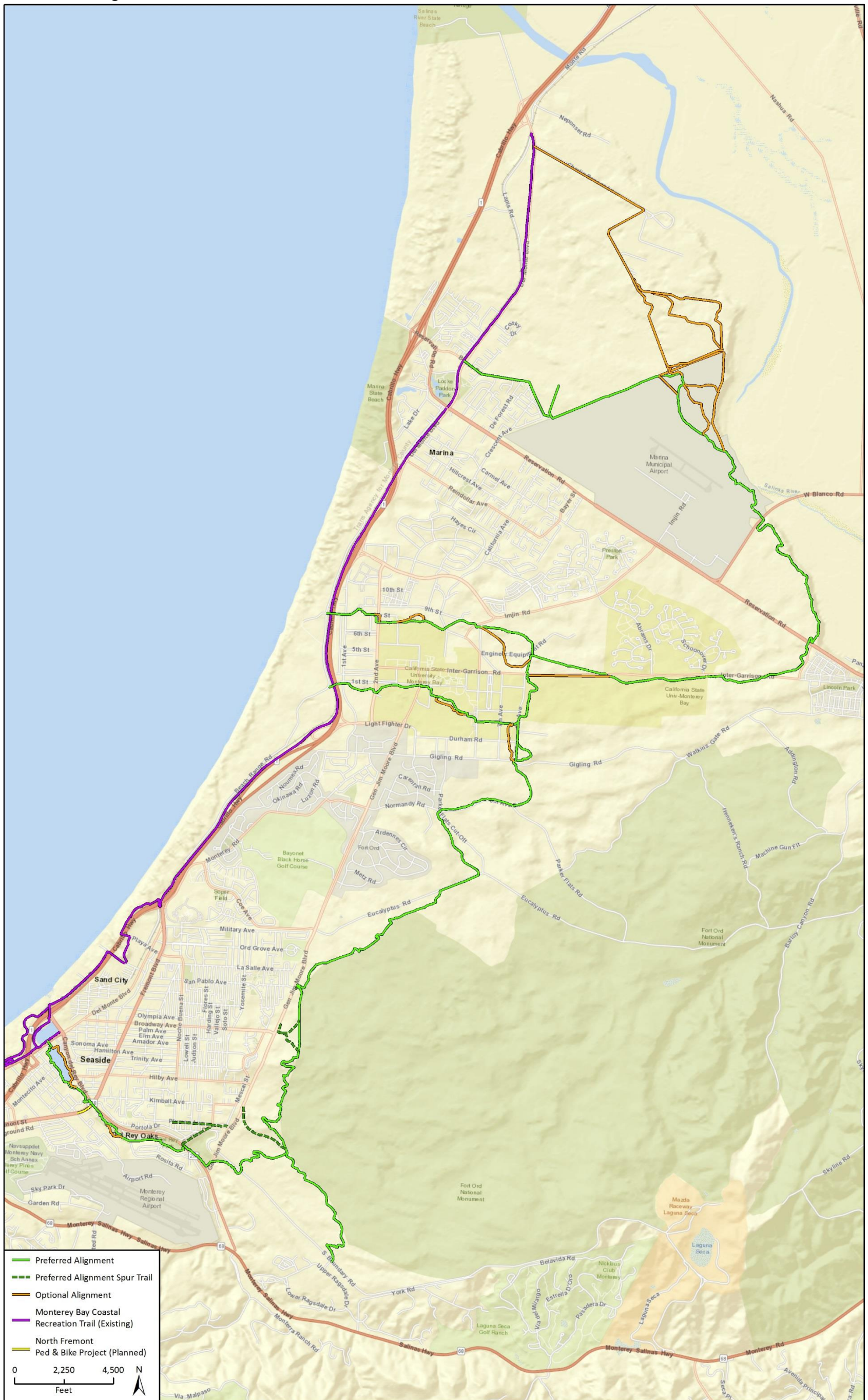

Imagery provided by ESRI and its licensors © 2019.  
Additional data provided by Alta, 2019.

Fig 1 FORTAG Proposed Alignment

INTENTIONALLY LEFT BLANK

**APPENDIX C**  
**CSUMB Student Housing and  
Parking Guidelines**

INTENTIONALLY LEFT BLANK





California State University  
**MONTEREY BAY**

## California State University, Monterey Bay Student Housing & Parking Management Guidelines

February 2022

### Introduction

The primary goals of this California State University, Monterey Bay (CSUMB) Student Housing and Parking Management Guidelines (Guidelines) are to:

1. Ensure that at least 60% of the student population lives on campus; and
2. Reduce vehicle traffic both on and off campus.

These goals will be met by implementing transportation planning elements identified in the 2007 Campus Master Plan and proposed Master Plan Guidelines documents, as well as by implementing an existing International Programs on-campus housing goal.

These Housing and Parking Management Guidelines require the following:

1. Freshman and sophomore students<sup>1</sup> are to live in on-campus housing.
2. 90% of International Program students<sup>2</sup> are to live in on-campus housing.

---

<sup>1</sup> **On-campus residency requirement exemptions** from this policy may include: living in the tri-county area prior to acceptance, marital, parental, military and health status. Exemption/waiver requests are reviewed on a case-by-case basis.

<sup>2</sup> **International Students** are full time undergraduate semester, year or degree seeking students. Not included within this directive are upper-division, graduate or students enrolled in extended education language programs.

3. All freshman and sophomore on-campus residents<sup>3</sup> are prohibited from parking or maintaining personal automobiles<sup>4</sup> on campus and purchasing parking permits.<sup>5</sup>

These measures will be implemented at a time determined by the President, based upon key milestones,<sup>6</sup> and before 12,700 Full Time Equivalent Students are enrolled.

## Directives and Rationale

---

### 1. Freshman and sophomore students will live on campus.

---

#### Rationale:

- **Precedent:** CSUMB has required full-time freshmen and sophomores to live on-campus since its inception in 1994 when the CSU acquired 1,253 East Campus Housing apartment style units and 1,811 beds on the Main Campus. This is consistent with research indicating that on-campus students are significantly more likely than their off-campus peers to succeed academically, to be involved in campus activities, to graduate, and to feel positive about their college experience. Furthermore, in 2018, the Monterey Bay Corporation adopted its own Student Housing policy<sup>7</sup> which required full time freshmen and sophomores to live on- campus.
- **Master Plan goal to house 60% of students:** The last three versions of the campus Master Plan (2004, 2007, current proposed) have included goals to house 60% of students on campus. The requirement takes advantage of the large housing stock, and the adopted good planning practices to co-locate housing, jobs and school. As of the fall 2016 semester, approximately 60% of the enrolled 6,634 Full Time Equivalent Students resided in on-campus housing. As the campus continues to grow, implementing these guidelines will

---

<sup>4</sup> **Automobile** – Includes

<sup>5</sup> **Parking permits** - Include all permit types

<sup>6</sup> **Milestones** – Will be determined based on data indicating the campus’ progress toward meeting its transportation and housing goals.

<sup>7</sup> University Corporation at Monterey Bay Student Housing Policy 410-001-A  
[https://gallery.mailchimp.com/3a9bc2d0b4b7b35594002815a/files/5d12d933-02a5-4666-b3d8-7f8a22c6f50c/410\\_001A\\_Student\\_Housing\\_Policy2\\_draft\\_1\\_.pdf](https://gallery.mailchimp.com/3a9bc2d0b4b7b35594002815a/files/5d12d933-02a5-4666-b3d8-7f8a22c6f50c/410_001A_Student_Housing_Policy2_draft_1_.pdf)

maintain this percentage and will require commitment to ensure students remain a primary focus of future housing development.

- **Response to the housing crisis:** Providing on-campus housing reduces competition between students and residents for limited affordable housing. Furthermore, students coming to the Monterey Area from outside the area often have trouble finding off-campus affordable housing.
- **Transportation Demand Management (TDM) programs address transportation challenges:** Attending class while living on campus does not require car ownership. The campus currently provides, and is in the process of expanding, TDM programs (ex. car-share, scooter-share, universal transit access pass, bike parking, etc.), which increasingly meet the mobility needs of those who do not have the financial means or desire to own a car. Therefore, living on campus is a car-free option and alternative transportation programs allow students to access off-campus commitments and resources such as Service Learning or employment.

---

## 2. 90% of International Program students will live on-campus

---

### Rationale:

- **Precedent:** International Students (IS) have generally been guaranteed on-campus housing if they apply by posted deadlines. As of the fall of 2017, approximately 87%<sup>8</sup> of IS enrolled at CSUMB already lived on campus.
- **International Programs housing goal:** International Programs has a goal to house 90% of full time undergraduate IS on campus.
- **Response to the housing crisis:** Acquiring off-campus housing can be especially challenging for IS living abroad, due to limited financial resources, language or cultural barriers, and lack of knowledge of the Monterey area.
- **Community:** Living on campus provides a built-in community with target resources close at hand, which help IS start their CSUMB career off on the right footing.
- **TDM programs address transportation challenges:** IS typically do not have access to an automobile once they arrive in the area. Living on campus provides access to campus TDM programs to meet their needs.

---

<sup>8</sup> Email from Brian Childs, Director of International Student and Scholar Services on 07/16/2018

---

3. All freshman and sophomore student residents will be prohibited from bringing personal automobiles and motor vehicles to campus, and from purchasing parking permits.

---

**Rationale:**

- **TDM definition:** Managing demand is about providing travelers, regardless of whether they drive alone, with travel choices, such as work location, route, time of travel and mode. In the broadest sense, demand management is defined as providing travelers with effective choices to improve travel reliability.
  - **TDM requirement:** The CSU Transportation and Parking Policy requires e
- 10
- **Cost effectiveness:** TDM programs can be more cost effective<sup>11</sup> than increasing parking facilities.
  - **Parking permit TDM strategy:** Parking permits encourage driving and do not incentivize sustainable travel modes. Parking management (restrictions, locations and pricing) is a TDM strategy that can reduce on- and off-campus traffic by requiring or encouraging people to choose other transportation modes (ride-share, car-share, bike-share, scooter-share, etc.). As the presence and visibility of sustainable transportation modes increase, so will the adoption of these programs as the primary modes of transportation.
  - **Equity:** Resident students do not require a car to fulfill their academic commitments. Parking spaces should be made available to commuter students, staff and faculty, those with a disability or documented exemption/waiver from the parking permit guidelines requirements.
  - **Land use, transportation and safety strategy:** The proposed Master Plan Guidelines place new buildings on existing centrally located parking lots and reallocates space

---

<sup>9</sup> US Department of Transportation – Organizing and Planning for Operations - [https://ops.fhwa.dot.gov/plan4ops/trans\\_demand.htm](https://ops.fhwa.dot.gov/plan4ops/trans_demand.htm)

<sup>10</sup> California State University Transportation and Parking Policy <https://calstate.policystat.com/policy/9869842/latest/>

<sup>11</sup> Innovative Parking Management Strategies for Universities: Accommodating Multiple Objectives in a Constrained Environment [https://www.researchgate.net/publication/305720913\\_Innovative\\_Parking\\_Management\\_Strategies\\_for\\_Universities\\_Accommodating\\_Multiple\\_Objectives\\_in\\_a\\_Constrained\\_Environment](https://www.researchgate.net/publication/305720913_Innovative_Parking_Management_Strategies_for_Universities_Accommodating_Multiple_Objectives_in_a_Constrained_Environment)

previously used for car storage, to use by people in support of their academic success (academic buildings, pathways, gathering spaces, etc.). Utilizing existing parking quantities efficiently throughout the buildout of the proposed Master Plan will allow the campus to develop a car-free and safer central campus for walking and biking and protect our natural open spaces from being developed.



# **APPENDIX D**

## **Revised Air Quality, Greenhouse Gas Emissions, and Energy Calculations**

INTENTIONALLY LEFT BLANK



## REVISED APPENDIX D CLARIFICATIONS<sup>1</sup>

### Mobile Sources

Following re-evaluation of the Draft EIR's mobile source emissions calculations in response to comments, the vehicle miles traveled (VMT) inputs for the California Emissions Estimator Model (CalEEMod) were revised, which resulted in changes to the emissions outputs for the air quality and GHG analyses, as well as the fuel consumption data for the energy analysis. The re-calculation effort was undertaken because the Draft EIR mis-applied the daily VMT estimates for both the existing conditions and the Project provided in the Fehr & Peers Transportation Analysis prepared for the Project (see EIR Appendix H) and, therefore, underestimated both existing conditions and Project emissions. As revised, the existing conditions and Project emissions incrementally increased in a proportional fashion. The revised GHG emissions generated for the Project would still be expected to result in a potentially significant impact prior to application of mitigation, as previously presented in the Draft EIR (Section 4.6, Greenhouse Gas Emissions). Further discussion of the refinements made to the mobile source component of the emissions inventories is provided below.

As discussed in EIR Section 4.2, Air Quality and incorporated by reference in EIR Section 4.6, Greenhouse Gas Emissions, mobile sources for the Project would primarily be motor vehicles (automobiles and light-duty trucks) traveling to and from the campus. Motor vehicles may be fueled with gasoline, diesel, or alternative fuels. The default vehicle mix provided in CalEEMod 2020.4.0, which is based on CARB's Mobile Source Emissions Inventory model, EMFAC, version 2017, was applied for both existing and Project conditions. Emission factors representing the vehicle mix and emissions for 2035 (the first full year of operation) were used to estimate emissions associated with the Project. For the existing scenario, 2018 was assumed for the vehicle emissions factors and vehicle fleet mix.

Trip generation rates for existing and Project conditions were based on the Transportation Analysis. As such, default weekday vehicle trip generation rates included in CalEEMod were adjusted to mathematically match the existing campus and the Project's weekday trip generation estimates (28,181 weekday trips for existing conditions and 39,873 weekday trips for the Project) from the Transportation Analysis. Saturday and Sunday trip rates for both the existing campus and the Project were adjusted in proportion to the CalEEMod weekday trip rates because weekend trip-generation rates were not provided in the Transportation Analysis.

For the revised calculations, the default vehicle trip lengths included in CalEEMod also were adjusted to match the daily VMT for the existing campus (178,500 miles) and the Project (295,500

---

<sup>1</sup> Given that the modeling was updated in this appendix as part of the Final EIR and this revised appendix replaces Appendix D included in the Draft EIR, ~~underline/strikethrough~~ is not used in this revised appendix.

miles), as taken from EIR Section 4.13, Transportation, Tables 4.13-2 and 4.13-8. For the existing conditions, the revised trip length was estimated to be 6.33 miles (178,500 miles ÷ 28,181 trips = 6.33 miles) while the Project's revised trip length was estimated to be 7.41 miles (295,500 miles ÷ 39,873 trips = 7.41 miles).

In addition to trip rates and trip lengths, the trip purpose is also a factor in the calculation of vehicle-generated emissions. In general, CalEEMod determines an overall average trip length for primary, diverted, and pass-by trip link types where primary trips are 100 percent of the trip length, diverted trips are 25 percent of the primary trip length, and pass-by trips are 0.1 mile (CAPCOA 2021). For this Project analysis, the CalEEMod default trip type percentages were adjusted to assume 100 percent primary trips so that the CalEEMod-generated VMT would mathematically match the overall weekday VMT data provided in the Project's Transportation Analysis. This approach is consistent with the transportation modeling, which accounts for a full inventory of trip categories; that is, both primary and shorter trips are already assessed in the model (i.e., the modeled VMT estimates provided in the Transportation Analysis reflect primary trip, diverted trips, and pass-by trips).

The VMT estimates discussed above include students, faculty/staff, and guests, which are considered in one trip rate (under the University/College land use sub type in CalEEMod) rather than separated. Specifically, the Project's estimated VMT includes the 2,446 faculty and staff and the 12,700 students since it is based on the trip generation and VMT assessment provided by Fehr & Peers.

### Solid Waste

The Project would generate solid waste, and therefore, result in CO<sub>2</sub>e emissions associated with landfill off-gassing. CalEEMod default values for solid waste generation were used to estimate GHG emissions associated with solid waste for the Project. For the Project, CalEEMod inputs were revised to account for the 90 percent solid waste diversion rate for non-construction and demolition waste per the CSUMB Campus Sustainability Plan and CSUMB Materials Management and Conservation Plan.

### Water Supply and Wastewater

Supply, conveyance, treatment, and distribution of water require the use of electricity, which would result in associated indirect GHG emissions. Similarly, wastewater generated by the Project requires the use of electricity for conveyance and treatment, along with GHG emissions generated during wastewater treatment. CalEEMod default values were revised based on the consumption and future forecast data provided by CSUMB, as presented in EIR Section 4.14, Utilities and Energy (Table 4.14-7). At buildout, the Project would result in 716 AFY, of which 427 AFY would be related to building use and 290 AFY would be related to irrigation.

## References

CAPCOA (California Air Pollution Control Officers Association). 2021. California Emissions Estimator Model® (CalEEMod). <http://www.caleemod.com/>.

GHG Threshold - Carbon Neutral by 2045 Using STARS Baseline Inventory

State Reduction Targets

| Milestone Year | Statewide Existing and Target Emissions (MMT CO <sub>2</sub> e) | Target Percent Reduction from 2018 | Notes   |
|----------------|---|------------------------------------|---|
| 1990           | 311   | NA                                 | Based on baseline GHG inventory in CARB's 2017 Scoping Plan. Excludes industrial, agriculture, and high global warming potential sources. |
| 2018           | 283   | NA                                 | From CARB 2018 GHG Inventory  |
| 2030           | 187   | 34%                                | SB 32 - 40% below 1990 level  |
| 2035           | 124   | 56%                                | 2035 is planning horizon for proposed Master Plan   |
| 2040           | 62  | 78%                                | Estimated by applying a linear regression between the 2030 and 2045 GHG inventory state goals.  |
| 2045           | 0   | 100%                               | EO B-55-18 - Carbon neutrality  |

Note: CARB state inventory for 2018 excludes industrial, agriculture, and High GWP sources

|                                      | Unit   |   |
|--------------------------------------|--|---|
| CSUMB 2018 Inventory                 | 13,399 MT CO <sub>2</sub> e/year               | GHG emissions from STARS 2018 Annual Report |
| CSUMB 2035 Emissions Limit           | 5,893 MT CO <sub>2</sub> e/year                |   |
| 2035 Population (students+employees) | 15,790 Total Population (students + employees) |   |
| Per Capita (students+employees)      | 0.37 2035 MT CO <sub>2</sub> e/capita          |   |
| Total New Students                   | 6,323 Students                                 |   |
| Total New Faculty                    | 1,036 Faculty                                  |   |
| Total New Student and Faculty        | 7,359 Students + Faculty                       |   |
| <b>Mass Emission Limit</b>           | <b>2,747 MT CO<sub>2</sub>e/year</b>           |   |

Note:

STARS 2018 Annual Report located at: <https://reports.aashe.org/institutions/california-state-university-monterey-bay-ca/report/2019-05-20/OP/air-climate/OP-1/>  
 GHG inventory for 1990 is from the California Air Resources Board 2017 Scoping Plan and 2018 inventory is from <https://ww2.arb.ca.gov/ghg-inventory-data>

**2018 STARS Inventory**

| Fiscal Year | Scope | Source                     | CO2 (kg)  | CO2 (MTCDE) | CH4 (kg) | CH4 (MTCDE) | N2O (kg) | N2O (MTCDE) | GHG MTCDE |
|-------------|-------|----------------------------|-----------|-------------|----------|-------------|----------|-------------|-----------|
| 2018        | 1     | Other On-Campus Stationary | 3,620,895 | 3,620.89    | 360      | 10.09       | 7        | 1.91        | 3,632.89  |
| 2018        | 1     | Direct Transportation      | 232,321   | 232.32      | 46       | 1.3         | 16       | 4.14        | 237.76    |
| 2018        | 1     | Fertilizer & Animals       | 0         | 0           | 0        | 0           | 4        | 1.13        | 1.13      |
| 2018        | 2     | Purchased Electricity      | 3,313,610 | 3,313.61    | 193      | 5.4         | 24       | 6.23        | 3,325.24  |
| 2018        | 3     | Faculty Commuting          | 277,630   | 277.63      | 55       | 1.55        | 19       | 4.95        | 284.13    |
| 2018        | 3     | Staff Commuting            | 969,930   | 969.93      | 201      | 5.64        | 68       | 17.89       | 993.47    |
| 2018        | 3     | Student Commuting          | 4,647,819 | 4,647.82    | 930      | 26.03       | 313      | 82.98       | 4,756.83  |
| 2018        | 3     | T&D Losses                 | 166,707   | 166.71      | 10       | 0.27        | 1        | 0.31        | 167.29    |

| Fiscal Year | Scope | CO2 (kg)  | CH4 (kg) | N2O (kg) | GHG MTCDE |
|-------------|-------|-----------|----------|----------|-----------|
| 2018        | 1     | 3,853,216 | 407      | 27       | 3,871.78  |
| 2018        | 2     | 3,313,610 | 193      | 24       | 3,325.24  |
| 2018        | 3     | 6,062,087 | 1,196    | 401      | 6,201.72  |

| Fiscal Year | CO2 (kg)   | CH4 (kg) | N2O (kg) | Gross MTCDE | Offsets (MTCDE) | Compost (MTCDE) | Non-Addition | Biogenic (MTCDE) | Net MTCDE        |
|-------------|------------|----------|----------|-------------|-----------------|-----------------|--------------|------------------|------------------|
| 2018        | 13,228,913 | 1,796    | 451      | 13,398.75   | 0               | 0               | 0            | 0                | <b>13,398.75</b> |

### 1990 GHG Emissions by Scoping Plan Category

| Scoping Plan Category           | 1990 Emissions (MMT CO <sub>2</sub> e) |
|---------------------------------|--|
| Transportation                  | 152                                    |
| Industrial uses                 | 98                                     |
| Electricity generation          | 108                                    |
| Residential and commercial uses | 44                                     |
| Agriculture                     | 26                                     |
| High GWP substances             | 3                                      |
| Recycling and waste             | 7                                      |
| <b>Total</b>                    | <b>311</b>                             |

\*Total excludes High GWP, industrial, and agriculture uses.

Source: California Air Resources Board 2017 Scoping Plan.

### 2018 GHG Emissions by Scoping Plan Category

| Scoping Plan Category           | 2018 Emissions (MMT CO <sub>2</sub> e) |
|---------------------------------|--|
| Transportation                  | 170                                    |
| Industrial uses                 | 89                                     |
| Electricity generation          | 63                                     |
| Residential and commercial uses | 41                                     |
| Agriculture                     | 33                                     |
| High GWP substances             | 20                                     |
| Recycling and waste             | 9                                      |
| <b>Total</b>                    | <b>283</b>                             |

\*Total excludes High GWP, industrial, and agriculture uses.

Source: California Air Resources Board (2021). <https://ww2.arb.ca.gov/ghg-inventory-data>







Existing

| CalEEMod Trip Rates |                    |                      |                      |       |       |       |            |          |                   |              |            |               |                |              |             |               |              |            |               |
|---------------------|--------------------|----------------------|----------------------|-------|-------|-------|------------|----------|-------------------|--------------|------------|---------------|----------------|--------------|-------------|---------------|--------------|------------|---------------|
| Land Use Type       | Land Use Sub Type  | Land Use Unit/Amount | Land Use Size Metric | WD_TR | ST_TR | SU_TR | Saturday % | Sunday % | Project Trip Rate | New Saturday | New Sunday | Weekday Trips | Saturday Trips | Sunday Trips | Trip Length | Weekday VMT   | Saturday VMT | Sunday VMT | Total VMT     |
|                     |                    |                      |                      |       |       |       |            |          |                   |              |            |               |                |              |             |               |              |            |               |
| Educational         | University/College | 6,634                | Student              | 1.58  | 1.30  | 0.00  | 83.33%     | 0.00%    | 4.25              | 3.54         | 0.25       | 28,181        | 23,484         | 1,691        | 6.33        | 178,500.00    | 148,750.00   | 10,710.00  | 337,960.00    |
|                     |                    |                      |                      |       |       |       |            |          |                   |              |            | 28,181        | 23,484         | 1,691        |             | 178,500.00    | 148,750.00   | 10,710.00  | 337,960.00    |
|                     |                    |                      |                      |       |       |       |            |          |                   |              |            | 34,093,500.00 |                |              |             | 34,093,500.00 | 5,652,500.00 | 406,980.00 | 40,152,980.00 |
|                     |                    |                      |                      |       |       |       |            |          |                   |              |            |               |                |              |             |               |              |            | 34,678,532.00 |
|                     |                    |                      |                      |       |       |       |            |          |                   |              |            |               |                |              |             |               |              |            | 73%           |
|                     |                    |                      |                      |       |       |       |            |          |                   |              |            | Included      |                | 4.00         |             | 131,080.82    | 109,234.02   |            | 40,166,894.00 |
|                     |                    |                      |                      |       |       |       |            |          |                   |              |            |               |                |              |             |               |              |            | 100%          |

Project

| CalEEMod Trip Rates |                    |                      |                      |       |       |       |            |          |                   |              |            |               |                |              |             |               |              |            |               |
|---------------------|--------------------|----------------------|----------------------|-------|-------|-------|------------|----------|-------------------|--------------|------------|---------------|----------------|--------------|-------------|---------------|--------------|------------|---------------|
| Land Use Type       | Land Use Sub Type  | Land Use Unit/Amount | Land Use Size Metric | WD_TR | ST_TR | SU_TR | Saturday % | Sunday % | Project Trip Rate | New Saturday | New Sunday | Weekday Trips | Saturday Trips | Sunday Trips | Trip Length | Weekday VMT   | Saturday VMT | Sunday VMT | Total VMT     |
|                     |                    |                      |                      |       |       |       |            |          |                   |              |            |               |                |              |             |               |              |            |               |
| Educational         | University/College | 12,700               | Student              | 1.58  | 1.30  | 0.00  | 83.33%     | 0.00%    | 3.14              | 2.62         | 0.19       | 39,873        | 33,228         | 2,392        | 7.41        | 295,500.00    | 246,250.00   | 17,730.00  | 559,480.00    |
|                     |                    |                      |                      |       |       |       |            |          |                   |              |            | 39,873        | 33,228         | 2,392        |             | 295,500.00    | 246,250.00   | 17,730.00  | 559,480.00    |
|                     |                    |                      |                      |       |       |       |            |          |                   |              |            | 56,440,500.00 |                |              |             | 56,440,500.00 | 9,357,500.00 | 673,740.00 | 66,471,740.00 |
|                     |                    |                      |                      |       |       |       |            |          |                   |              |            |               |                |              |             |               |              |            | 90,079,870.00 |
|                     |                    |                      |                      |       |       |       |            |          |                   |              |            |               |                |              |             |               |              |            | 73%           |
|                     |                    |                      |                      |       |       |       |            |          |                   |              |            | Included      |                | 5.44         |             | 216,851.70    | 180,709.75   |            | 66,820,822.00 |
|                     |                    |                      |                      |       |       |       |            |          |                   |              |            |               |                |              |             |               |              |            | 100%          |

267 Assumed 267 days per year, which accounts for academic schedule, holidays, and enrollment levels during summer

73%

100%

267 Assumed 267 days per year, which accounts for academic schedule, holidays, and enrollment levels during summer

73%

100%

**EMFAC Off-Model Adjustment Factors for Gasoline Light Duty Vehicle to Account for the SAFE Vehicle Rule Not Applied**

**CSUMB Master Plan - Construction  
Monterey Bay Unified APCD Air District, Annual**

**1.0 Project Characteristics**

**1.1 Land Usage**

| Land Uses                  | Size     | Metric  | Lot Acreage | Floor Surface Area | Population |
|----------------------------|----------|---------|-------------|--------------------|------------|
| University/College (4yr)   | 1,634.00 | Student | 6.89        | 300,000.00         | 0          |
| Other Non-Asphalt Surfaces | 1.80     | Acre    | 1.80        | 78,408.00          | 0          |

**1.2 Other Project Characteristics**

|                                |                                  |                                |       |                                  |       |
|--------------------------------|----------------------------------|--------------------------------|-------|----------------------------------|-------|
| <b>Urbanization</b>            | Urban                            | <b>Wind Speed (m/s)</b>        | 2.8   | <b>Precipitation Freq (Days)</b> | 53    |
| <b>Climate Zone</b>            | 4                                |                                |       | <b>Operational Year</b>          | 2024  |
| <b>Utility Company</b>         | Pacific Gas and Electric Company |                                |       |                                  |       |
| <b>CO2 Intensity (lb/MWhr)</b> | 203.98                           | <b>CH4 Intensity (lb/MWhr)</b> | 0.033 | <b>N2O Intensity (lb/MWhr)</b>   | 0.004 |

**1.3 User Entered Comments & Non-Default Data**

Project Characteristics - CSU Monterey Bay Master Plan. MBARD. Construction Scenario.

Land Use - Maximum development of approximately 300 GSF and 1.8 acres of paving.

Construction Phase - Default schedule assumed.

Off-road Equipment - Default equipment

Off-road Equipment - Default equipment

Off-road Equipment - Default equipment

Off-road Equipment - Default equipment

**EMFAC Off-Model Adjustment Factors for Gasoline Light Duty Vehicle to Account for the SAFE Vehicle Rule Not Applied**

Off-road Equipment - Default equipment

Off-road Equipment - Default equipment

Demolition - Assume demolition of 10,500 SF.

Grading -

Trips and VMT - Default trips

Construction Off-road Equipment Mitigation - Water twice daily

Architectural Coating - MBARD Rule 426 - interior 50 g/L, exterior 100 g/L

| Table Name              | Column Name                | Default Value | New Value  |
|-------------------------|----------------------------|---------------|------------|
| tblArchitecturalCoating | EF_Nonresidential_Exterior | 150.00        | 100.00     |
| tblArchitecturalCoating | EF_Nonresidential_Interior | 150.00        | 50.00      |
| tblArchitecturalCoating | EF_Parking                 | 150.00        | 100.00     |
| tblLandUse              | LandUseSquareFeet          | 300,325.06    | 300,000.00 |
| tblTripsAndVMT          | HaulingTripNumber          | 48.00         | 200.00     |

**EMFAC Off-Model Adjustment Factors for Gasoline Light Duty Vehicle to Account for the SAFE Vehicle Rule Not Applied**

**2.0 Emissions Summary**

**2.1 Overall Construction**

**Unmitigated Construction**

|                | ROG           | NOx           | CO            | SO2                | Fugitive PM10 | Exhaust PM10  | PM10 Total    | Fugitive PM2.5 | Exhaust PM2.5 | PM2.5 Total   | Bio- CO2      | NBio- CO2       | Total CO2       | CH4           | N2O           | CO2e            |
|----------------|---------------|---------------|---------------|--------------------|---------------|---------------|---------------|----------------|---------------|---------------|---------------|-----------------|-----------------|---------------|---------------|-----------------|
| Year           | tons/yr       |               |               |                    |               |               |               |                |               |               | MT/yr         |                 |                 |               |               |                 |
| 2022           | 0.3166        | 2.7313        | 2.8206        | 6.4300e-003        | 0.3550        | 0.1201        | 0.4751        | 0.1346         | 0.1125        | 0.2471        | 0.0000        | 576.3589        | 576.3589        | 0.0876        | 0.0245        | 585.8618        |
| 2023           | 0.9155        | 0.2955        | 0.3940        | 8.0000e-004        | 0.0205        | 0.0131        | 0.0336        | 5.5400e-003    | 0.0123        | 0.0178        | 0.0000        | 71.7031         | 71.7031         | 0.0127        | 2.2400e-003   | 72.6901         |
| <b>Maximum</b> | <b>0.9155</b> | <b>2.7313</b> | <b>2.8206</b> | <b>6.4300e-003</b> | <b>0.3550</b> | <b>0.1201</b> | <b>0.4751</b> | <b>0.1346</b>  | <b>0.1125</b> | <b>0.2471</b> | <b>0.0000</b> | <b>576.3589</b> | <b>576.3589</b> | <b>0.0876</b> | <b>0.0245</b> | <b>585.8618</b> |

**Mitigated Construction**

|                | ROG           | NOx           | CO            | SO2                | Fugitive PM10 | Exhaust PM10  | PM10 Total    | Fugitive PM2.5 | Exhaust PM2.5 | PM2.5 Total   | Bio- CO2      | NBio- CO2       | Total CO2       | CH4           | N2O           | CO2e            |
|----------------|---------------|---------------|---------------|--------------------|---------------|---------------|---------------|----------------|---------------|---------------|---------------|-----------------|-----------------|---------------|---------------|-----------------|
| Year           | tons/yr       |               |               |                    |               |               |               |                |               |               | MT/yr         |                 |                 |               |               |                 |
| 2022           | 0.3166        | 2.7313        | 2.8206        | 6.4300e-003        | 0.2591        | 0.1201        | 0.3792        | 0.0875         | 0.1125        | 0.2001        | 0.0000        | 576.3585        | 576.3585        | 0.0876        | 0.0245        | 585.8614        |
| 2023           | 0.9155        | 0.2955        | 0.3940        | 8.0000e-004        | 0.0205        | 0.0131        | 0.0336        | 5.5400e-003    | 0.0123        | 0.0178        | 0.0000        | 71.7031         | 71.7031         | 0.0127        | 2.2400e-003   | 72.6900         |
| <b>Maximum</b> | <b>0.9155</b> | <b>2.7313</b> | <b>2.8206</b> | <b>6.4300e-003</b> | <b>0.2591</b> | <b>0.1201</b> | <b>0.3792</b> | <b>0.0875</b>  | <b>0.1125</b> | <b>0.2001</b> | <b>0.0000</b> | <b>576.3585</b> | <b>576.3585</b> | <b>0.0876</b> | <b>0.0245</b> | <b>585.8614</b> |

**EMFAC Off-Model Adjustment Factors for Gasoline Light Duty Vehicle to Account for the SAFE Vehicle Rule Not Applied**

|                   | ROG  | NOx  | CO   | SO2  | Fugitive PM10 | Exhaust PM10 | PM10 Total | Fugitive PM2.5 | Exhaust PM2.5 | PM2.5 Total | Bio- CO2 | NBio-CO2 | Total CO2 | CH4  | N2O  | CO2e |
|-------------------|------|------|------|------|---------------|--------------|------------|----------------|---------------|-------------|----------|----------|-----------|------|------|------|
| Percent Reduction | 0.00 | 0.00 | 0.00 | 0.00 | 25.54         | 0.00         | 18.85      | 33.59          | 0.00          | 17.76       | 0.00     | 0.00     | 0.00      | 0.00 | 0.00 | 0.00 |

**3.0 Construction Detail**

**Construction Phase**

| Phase Number | Phase Name            | Phase Type            | Start Date | End Date  | Num Days Week | Num Days | Phase Description |
|--------------|-----------------------|-----------------------|------------|-----------|---------------|----------|-------------------|
| 1            | Demolition            | Demolition            | 1/3/2022   | 1/28/2022 | 5             | 20       |                   |
| 2            | Site Preparation      | Site Preparation      | 1/29/2022  | 2/11/2022 | 5             | 10       |                   |
| 3            | Grading               | Grading               | 2/12/2022  | 3/11/2022 | 5             | 20       |                   |
| 4            | Building Construction | Building Construction | 3/12/2022  | 1/27/2023 | 5             | 230      |                   |
| 5            | Paving                | Paving                | 1/28/2023  | 2/24/2023 | 5             | 20       |                   |
| 6            | Architectural Coating | Architectural Coating | 2/25/2023  | 3/24/2023 | 5             | 20       |                   |

**Acres of Grading (Site Preparation Phase): 15**

**Acres of Grading (Grading Phase): 20**

**Acres of Paving: 1.8**

**Residential Indoor: 0; Residential Outdoor: 0; Non-Residential Indoor: 450,000; Non-Residential Outdoor: 150,000; Striped Parking Area: 4,704**

**EMFAC Off-Model Adjustment Factors for Gasoline Light Duty Vehicle to Account for the SAFE Vehicle Rule Not Applied****OffRoad Equipment**

| Phase Name            | Offroad Equipment Type    | Amount | Usage Hours | Horse Power | Load Factor |
|-----------------------|---------------------------|--------|-------------|-------------|-------------|
| Demolition            | Concrete/Industrial Saws  | 1      | 8.00        | 81          | 0.73        |
| Demolition            | Excavators                | 3      | 8.00        | 158         | 0.38        |
| Demolition            | Rubber Tired Dozers       | 2      | 8.00        | 247         | 0.40        |
| Site Preparation      | Rubber Tired Dozers       | 3      | 8.00        | 247         | 0.40        |
| Site Preparation      | Tractors/Loaders/Backhoes | 4      | 8.00        | 97          | 0.37        |
| Grading               | Excavators                | 1      | 8.00        | 158         | 0.38        |
| Grading               | Graders                   | 1      | 8.00        | 187         | 0.41        |
| Grading               | Rubber Tired Dozers       | 1      | 8.00        | 247         | 0.40        |
| Grading               | Tractors/Loaders/Backhoes | 3      | 8.00        | 97          | 0.37        |
| Building Construction | Cranes                    | 1      | 7.00        | 231         | 0.29        |
| Building Construction | Forklifts                 | 3      | 8.00        | 89          | 0.20        |
| Building Construction | Generator Sets            | 1      | 8.00        | 84          | 0.74        |
| Building Construction | Tractors/Loaders/Backhoes | 3      | 7.00        | 97          | 0.37        |
| Building Construction | Welders                   | 1      | 8.00        | 46          | 0.45        |
| Paving                | Pavers                    | 2      | 8.00        | 130         | 0.42        |
| Paving                | Paving Equipment          | 2      | 8.00        | 132         | 0.36        |
| Paving                | Rollers                   | 2      | 8.00        | 80          | 0.38        |
| Architectural Coating | Air Compressors           | 1      | 6.00        | 78          | 0.48        |

**EMFAC Off-Model Adjustment Factors for Gasoline Light Duty Vehicle to Account for the SAFE Vehicle Rule Not Applied**

**Trips and VMT**

| Phase Name            | Offroad Equipment Count | Worker Trip Number | Vendor Trip Number | Hauling Trip Number | Worker Trip Length | Vendor Trip Length | Hauling Trip Length | Worker Vehicle Class | Vendor Vehicle Class | Hauling Vehicle Class |
|-----------------------|-------------------------|--------------------|--------------------|---------------------|--------------------|--------------------|---------------------|----------------------|----------------------|-----------------------|
| Demolition            | 6                       | 15.00              | 0.00               | 200.00              | 10.80              | 7.30               | 20.00               | LD_Mix               | HDT_Mix              | HHDT                  |
| Site Preparation      | 7                       | 18.00              | 0.00               | 0.00                | 10.80              | 7.30               | 20.00               | LD_Mix               | HDT_Mix              | HHDT                  |
| Grading               | 6                       | 15.00              | 0.00               | 0.00                | 10.80              | 7.30               | 20.00               | LD_Mix               | HDT_Mix              | HHDT                  |
| Building Construction | 9                       | 159.00             | 62.00              | 0.00                | 10.80              | 7.30               | 20.00               | LD_Mix               | HDT_Mix              | HHDT                  |
| Paving                | 6                       | 15.00              | 0.00               | 0.00                | 10.80              | 7.30               | 20.00               | LD_Mix               | HDT_Mix              | HHDT                  |
| Architectural Coating | 1                       | 32.00              | 0.00               | 0.00                | 10.80              | 7.30               | 20.00               | LD_Mix               | HDT_Mix              | HHDT                  |

**3.1 Mitigation Measures Construction**

Water Exposed Area

**EMFAC Off-Model Adjustment Factors for Gasoline Light Duty Vehicle to Account for the SAFE Vehicle Rule Not Applied**

**3.2 Demolition - 2022**

**Unmitigated Construction On-Site**

|               | ROG           | NOx           | CO            | SO2                | Fugitive PM10      | Exhaust PM10  | PM10 Total    | Fugitive PM2.5     | Exhaust PM2.5 | PM2.5 Total   | Bio- CO2      | NBio- CO2      | Total CO2      | CH4                | N2O           | CO2e           |
|---------------|---------------|---------------|---------------|--------------------|--------------------|---------------|---------------|--------------------|---------------|---------------|---------------|----------------|----------------|--------------------|---------------|----------------|
| Category      | tons/yr       |               |               |                    |                    |               |               |                    |               |               | MT/yr         |                |                |                    |               |                |
| Fugitive Dust |               |               |               |                    | 5.2700e-003        | 0.0000        | 5.2700e-003   | 8.0000e-004        | 0.0000        | 8.0000e-004   | 0.0000        | 0.0000         | 0.0000         | 0.0000             | 0.0000        | 0.0000         |
| Off-Road      | 0.0264        | 0.2572        | 0.2059        | 3.9000e-004        |                    | 0.0124        | 0.0124        |                    | 0.0116        | 0.0116        | 0.0000        | 33.9902        | 33.9902        | 9.5500e-003        | 0.0000        | 34.2289        |
| <b>Total</b>  | <b>0.0264</b> | <b>0.2572</b> | <b>0.2059</b> | <b>3.9000e-004</b> | <b>5.2700e-003</b> | <b>0.0124</b> | <b>0.0177</b> | <b>8.0000e-004</b> | <b>0.0116</b> | <b>0.0124</b> | <b>0.0000</b> | <b>33.9902</b> | <b>33.9902</b> | <b>9.5500e-003</b> | <b>0.0000</b> | <b>34.2289</b> |

**Unmitigated Construction Off-Site**

|              | ROG                | NOx           | CO                 | SO2                | Fugitive PM10      | Exhaust PM10       | PM10 Total         | Fugitive PM2.5     | Exhaust PM2.5      | PM2.5 Total        | Bio- CO2      | NBio- CO2     | Total CO2     | CH4                | N2O                | CO2e          |
|--------------|--------------------|---------------|--------------------|--------------------|--------------------|--------------------|--------------------|--------------------|--------------------|--------------------|---------------|---------------|---------------|--------------------|--------------------|---------------|
| Category     | tons/yr            |               |                    |                    |                    |                    |                    |                    |                    |                    | MT/yr         |               |               |                    |                    |               |
| Hauling      | 3.9000e-004        | 0.0170        | 3.2500e-003        | 6.0000e-005        | 1.7000e-003        | 1.6000e-004        | 1.8600e-003        | 4.7000e-004        | 1.6000e-004        | 6.2000e-004        | 0.0000        | 6.0472        | 6.0472        | 7.0000e-005        | 9.5000e-004        | 6.3330        |
| Vendor       | 0.0000             | 0.0000        | 0.0000             | 0.0000             | 0.0000             | 0.0000             | 0.0000             | 0.0000             | 0.0000             | 0.0000             | 0.0000        | 0.0000        | 0.0000        | 0.0000             | 0.0000             | 0.0000        |
| Worker       | 5.3000e-004        | 4.3000e-004   | 4.5800e-003        | 1.0000e-005        | 1.1900e-003        | 1.0000e-005        | 1.2000e-003        | 3.2000e-004        | 1.0000e-005        | 3.2000e-004        | 0.0000        | 1.0222        | 1.0222        | 4.0000e-005        | 3.0000e-005        | 1.0334        |
| <b>Total</b> | <b>9.2000e-004</b> | <b>0.0174</b> | <b>7.8300e-003</b> | <b>7.0000e-005</b> | <b>2.8900e-003</b> | <b>1.7000e-004</b> | <b>3.0600e-003</b> | <b>7.9000e-004</b> | <b>1.7000e-004</b> | <b>9.4000e-004</b> | <b>0.0000</b> | <b>7.0695</b> | <b>7.0695</b> | <b>1.1000e-004</b> | <b>9.8000e-004</b> | <b>7.3664</b> |



**EMFAC Off-Model Adjustment Factors for Gasoline Light Duty Vehicle to Account for the SAFE Vehicle Rule Not Applied**

**Mitigated Construction On-Site**

|               | ROG           | NOx           | CO            | SO2                | Fugitive PM10      | Exhaust PM10  | PM10 Total    | Fugitive PM2.5     | Exhaust PM2.5 | PM2.5 Total   | Bio- CO2      | NBio- CO2      | Total CO2      | CH4                | N2O           | CO2e           |
|---------------|---------------|---------------|---------------|--------------------|--------------------|---------------|---------------|--------------------|---------------|---------------|---------------|----------------|----------------|--------------------|---------------|----------------|
| Category      | tons/yr       |               |               |                    |                    |               |               |                    |               |               | MT/yr         |                |                |                    |               |                |
| Fugitive Dust |               |               |               |                    | 2.3700e-003        | 0.0000        | 2.3700e-003   | 3.6000e-004        | 0.0000        | 3.6000e-004   | 0.0000        | 0.0000         | 0.0000         | 0.0000             | 0.0000        | 0.0000         |
| Off-Road      | 0.0264        | 0.2572        | 0.2059        | 3.9000e-004        |                    | 0.0124        | 0.0124        |                    | 0.0116        | 0.0116        | 0.0000        | 33.9902        | 33.9902        | 9.5500e-003        | 0.0000        | 34.2289        |
| <b>Total</b>  | <b>0.0264</b> | <b>0.2572</b> | <b>0.2059</b> | <b>3.9000e-004</b> | <b>2.3700e-003</b> | <b>0.0124</b> | <b>0.0148</b> | <b>3.6000e-004</b> | <b>0.0116</b> | <b>0.0119</b> | <b>0.0000</b> | <b>33.9902</b> | <b>33.9902</b> | <b>9.5500e-003</b> | <b>0.0000</b> | <b>34.2289</b> |

**Mitigated Construction Off-Site**

|              | ROG                | NOx           | CO                 | SO2                | Fugitive PM10      | Exhaust PM10       | PM10 Total         | Fugitive PM2.5     | Exhaust PM2.5      | PM2.5 Total        | Bio- CO2      | NBio- CO2     | Total CO2     | CH4                | N2O                | CO2e          |
|--------------|--------------------|---------------|--------------------|--------------------|--------------------|--------------------|--------------------|--------------------|--------------------|--------------------|---------------|---------------|---------------|--------------------|--------------------|---------------|
| Category     | tons/yr            |               |                    |                    |                    |                    |                    |                    |                    |                    | MT/yr         |               |               |                    |                    |               |
| Hauling      | 3.9000e-004        | 0.0170        | 3.2500e-003        | 6.0000e-005        | 1.7000e-003        | 1.6000e-004        | 1.8600e-003        | 4.7000e-004        | 1.6000e-004        | 6.2000e-004        | 0.0000        | 6.0472        | 6.0472        | 7.0000e-005        | 9.5000e-004        | 6.3330        |
| Vendor       | 0.0000             | 0.0000        | 0.0000             | 0.0000             | 0.0000             | 0.0000             | 0.0000             | 0.0000             | 0.0000             | 0.0000             | 0.0000        | 0.0000        | 0.0000        | 0.0000             | 0.0000             | 0.0000        |
| Worker       | 5.3000e-004        | 4.3000e-004   | 4.5800e-003        | 1.0000e-005        | 1.1900e-003        | 1.0000e-005        | 1.2000e-003        | 3.2000e-004        | 1.0000e-005        | 3.2000e-004        | 0.0000        | 1.0222        | 1.0222        | 4.0000e-005        | 3.0000e-005        | 1.0334        |
| <b>Total</b> | <b>9.2000e-004</b> | <b>0.0174</b> | <b>7.8300e-003</b> | <b>7.0000e-005</b> | <b>2.8900e-003</b> | <b>1.7000e-004</b> | <b>3.0600e-003</b> | <b>7.9000e-004</b> | <b>1.7000e-004</b> | <b>9.4000e-004</b> | <b>0.0000</b> | <b>7.0695</b> | <b>7.0695</b> | <b>1.1000e-004</b> | <b>9.8000e-004</b> | <b>7.3664</b> |

**EMFAC Off-Model Adjustment Factors for Gasoline Light Duty Vehicle to Account for the SAFE Vehicle Rule Not Applied**

**3.3 Site Preparation - 2022**

**Unmitigated Construction On-Site**

|               | ROG           | NOx           | CO            | SO2                | Fugitive PM10 | Exhaust PM10       | PM10 Total    | Fugitive PM2.5 | Exhaust PM2.5      | PM2.5 Total   | Bio- CO2      | NBio- CO2      | Total CO2      | CH4                | N2O           | CO2e           |
|---------------|---------------|---------------|---------------|--------------------|---------------|--------------------|---------------|----------------|--------------------|---------------|---------------|----------------|----------------|--------------------|---------------|----------------|
| Category      | tons/yr       |               |               |                    |               |                    |               |                |                    |               | MT/yr         |                |                |                    |               |                |
| Fugitive Dust |               |               |               |                    | 0.0983        | 0.0000             | 0.0983        | 0.0505         | 0.0000             | 0.0505        | 0.0000        | 0.0000         | 0.0000         | 0.0000             | 0.0000        | 0.0000         |
| Off-Road      | 0.0159        | 0.1654        | 0.0985        | 1.9000e-004        |               | 8.0600e-003        | 8.0600e-003   |                | 7.4200e-003        | 7.4200e-003   | 0.0000        | 16.7197        | 16.7197        | 5.4100e-003        | 0.0000        | 16.8549        |
| <b>Total</b>  | <b>0.0159</b> | <b>0.1654</b> | <b>0.0985</b> | <b>1.9000e-004</b> | <b>0.0983</b> | <b>8.0600e-003</b> | <b>0.1064</b> | <b>0.0505</b>  | <b>7.4200e-003</b> | <b>0.0579</b> | <b>0.0000</b> | <b>16.7197</b> | <b>16.7197</b> | <b>5.4100e-003</b> | <b>0.0000</b> | <b>16.8549</b> |

**Unmitigated Construction Off-Site**

|              | ROG                | NOx                | CO                 | SO2                | Fugitive PM10      | Exhaust PM10  | PM10 Total         | Fugitive PM2.5     | Exhaust PM2.5 | PM2.5 Total        | Bio- CO2      | NBio- CO2     | Total CO2     | CH4                | N2O                | CO2e          |
|--------------|--------------------|--------------------|--------------------|--------------------|--------------------|---------------|--------------------|--------------------|---------------|--------------------|---------------|---------------|---------------|--------------------|--------------------|---------------|
| Category     | tons/yr            |                    |                    |                    |                    |               |                    |                    |               |                    | MT/yr         |               |               |                    |                    |               |
| Hauling      | 0.0000             | 0.0000             | 0.0000             | 0.0000             | 0.0000             | 0.0000        | 0.0000             | 0.0000             | 0.0000        | 0.0000             | 0.0000        | 0.0000        | 0.0000        | 0.0000             | 0.0000             | 0.0000        |
| Vendor       | 0.0000             | 0.0000             | 0.0000             | 0.0000             | 0.0000             | 0.0000        | 0.0000             | 0.0000             | 0.0000        | 0.0000             | 0.0000        | 0.0000        | 0.0000        | 0.0000             | 0.0000             | 0.0000        |
| Worker       | 3.2000e-004        | 2.6000e-004        | 2.7500e-003        | 1.0000e-005        | 7.2000e-004        | 0.0000        | 7.2000e-004        | 1.9000e-004        | 0.0000        | 1.9000e-004        | 0.0000        | 0.6133        | 0.6133        | 2.0000e-005        | 2.0000e-005        | 0.6200        |
| <b>Total</b> | <b>3.2000e-004</b> | <b>2.6000e-004</b> | <b>2.7500e-003</b> | <b>1.0000e-005</b> | <b>7.2000e-004</b> | <b>0.0000</b> | <b>7.2000e-004</b> | <b>1.9000e-004</b> | <b>0.0000</b> | <b>1.9000e-004</b> | <b>0.0000</b> | <b>0.6133</b> | <b>0.6133</b> | <b>2.0000e-005</b> | <b>2.0000e-005</b> | <b>0.6200</b> |

**EMFAC Off-Model Adjustment Factors for Gasoline Light Duty Vehicle to Account for the SAFE Vehicle Rule Not Applied**

**Mitigated Construction On-Site**

|               | ROG           | NOx           | CO            | SO2                | Fugitive PM10 | Exhaust PM10       | PM10 Total    | Fugitive PM2.5 | Exhaust PM2.5      | PM2.5 Total   | Bio- CO2      | NBio- CO2      | Total CO2      | CH4                | N2O           | CO2e           |
|---------------|---------------|---------------|---------------|--------------------|---------------|--------------------|---------------|----------------|--------------------|---------------|---------------|----------------|----------------|--------------------|---------------|----------------|
| Category      | tons/yr       |               |               |                    |               |                    |               |                |                    |               | MT/yr         |                |                |                    |               |                |
| Fugitive Dust |               |               |               |                    | 0.0442        | 0.0000             | 0.0442        | 0.0227         | 0.0000             | 0.0227        | 0.0000        | 0.0000         | 0.0000         | 0.0000             | 0.0000        | 0.0000         |
| Off-Road      | 0.0159        | 0.1654        | 0.0985        | 1.9000e-004        |               | 8.0600e-003        | 8.0600e-003   |                | 7.4200e-003        | 7.4200e-003   | 0.0000        | 16.7197        | 16.7197        | 5.4100e-003        | 0.0000        | 16.8549        |
| <b>Total</b>  | <b>0.0159</b> | <b>0.1654</b> | <b>0.0985</b> | <b>1.9000e-004</b> | <b>0.0442</b> | <b>8.0600e-003</b> | <b>0.0523</b> | <b>0.0227</b>  | <b>7.4200e-003</b> | <b>0.0302</b> | <b>0.0000</b> | <b>16.7197</b> | <b>16.7197</b> | <b>5.4100e-003</b> | <b>0.0000</b> | <b>16.8549</b> |

**Mitigated Construction Off-Site**

|              | ROG                | NOx                | CO                 | SO2                | Fugitive PM10      | Exhaust PM10  | PM10 Total         | Fugitive PM2.5     | Exhaust PM2.5 | PM2.5 Total        | Bio- CO2      | NBio- CO2     | Total CO2     | CH4                | N2O                | CO2e          |
|--------------|--------------------|--------------------|--------------------|--------------------|--------------------|---------------|--------------------|--------------------|---------------|--------------------|---------------|---------------|---------------|--------------------|--------------------|---------------|
| Category     | tons/yr            |                    |                    |                    |                    |               |                    |                    |               |                    | MT/yr         |               |               |                    |                    |               |
| Hauling      | 0.0000             | 0.0000             | 0.0000             | 0.0000             | 0.0000             | 0.0000        | 0.0000             | 0.0000             | 0.0000        | 0.0000             | 0.0000        | 0.0000        | 0.0000        | 0.0000             | 0.0000             | 0.0000        |
| Vendor       | 0.0000             | 0.0000             | 0.0000             | 0.0000             | 0.0000             | 0.0000        | 0.0000             | 0.0000             | 0.0000        | 0.0000             | 0.0000        | 0.0000        | 0.0000        | 0.0000             | 0.0000             | 0.0000        |
| Worker       | 3.2000e-004        | 2.6000e-004        | 2.7500e-003        | 1.0000e-005        | 7.2000e-004        | 0.0000        | 7.2000e-004        | 1.9000e-004        | 0.0000        | 1.9000e-004        | 0.0000        | 0.6133        | 0.6133        | 2.0000e-005        | 2.0000e-005        | 0.6200        |
| <b>Total</b> | <b>3.2000e-004</b> | <b>2.6000e-004</b> | <b>2.7500e-003</b> | <b>1.0000e-005</b> | <b>7.2000e-004</b> | <b>0.0000</b> | <b>7.2000e-004</b> | <b>1.9000e-004</b> | <b>0.0000</b> | <b>1.9000e-004</b> | <b>0.0000</b> | <b>0.6133</b> | <b>0.6133</b> | <b>2.0000e-005</b> | <b>2.0000e-005</b> | <b>0.6200</b> |

**EMFAC Off-Model Adjustment Factors for Gasoline Light Duty Vehicle to Account for the SAFE Vehicle Rule Not Applied**

**3.4 Grading - 2022**

**Unmitigated Construction On-Site**

|               | ROG           | NOx           | CO            | SO2                | Fugitive PM10 | Exhaust PM10       | PM10 Total    | Fugitive PM2.5 | Exhaust PM2.5      | PM2.5 Total   | Bio- CO2      | NBio- CO2      | Total CO2      | CH4                | N2O           | CO2e           |
|---------------|---------------|---------------|---------------|--------------------|---------------|--------------------|---------------|----------------|--------------------|---------------|---------------|----------------|----------------|--------------------|---------------|----------------|
| Category      | tons/yr       |               |               |                    |               |                    |               |                |                    |               | MT/yr         |                |                |                    |               |                |
| Fugitive Dust |               |               |               |                    | 0.0708        | 0.0000             | 0.0708        | 0.0343         | 0.0000             | 0.0343        | 0.0000        | 0.0000         | 0.0000         | 0.0000             | 0.0000        | 0.0000         |
| Off-Road      | 0.0195        | 0.2086        | 0.1527        | 3.0000e-004        |               | 9.4100e-003        | 9.4100e-003   |                | 8.6600e-003        | 8.6600e-003   | 0.0000        | 26.0548        | 26.0548        | 8.4300e-003        | 0.0000        | 26.2654        |
| <b>Total</b>  | <b>0.0195</b> | <b>0.2086</b> | <b>0.1527</b> | <b>3.0000e-004</b> | <b>0.0708</b> | <b>9.4100e-003</b> | <b>0.0802</b> | <b>0.0343</b>  | <b>8.6600e-003</b> | <b>0.0429</b> | <b>0.0000</b> | <b>26.0548</b> | <b>26.0548</b> | <b>8.4300e-003</b> | <b>0.0000</b> | <b>26.2654</b> |

**Unmitigated Construction Off-Site**

|              | ROG                | NOx                | CO                 | SO2                | Fugitive PM10      | Exhaust PM10       | PM10 Total         | Fugitive PM2.5     | Exhaust PM2.5      | PM2.5 Total        | Bio- CO2      | NBio- CO2     | Total CO2     | CH4                | N2O                | CO2e          |
|--------------|--------------------|--------------------|--------------------|--------------------|--------------------|--------------------|--------------------|--------------------|--------------------|--------------------|---------------|---------------|---------------|--------------------|--------------------|---------------|
| Category     | tons/yr            |                    |                    |                    |                    |                    |                    |                    |                    |                    | MT/yr         |               |               |                    |                    |               |
| Hauling      | 0.0000             | 0.0000             | 0.0000             | 0.0000             | 0.0000             | 0.0000             | 0.0000             | 0.0000             | 0.0000             | 0.0000             | 0.0000        | 0.0000        | 0.0000        | 0.0000             | 0.0000             | 0.0000        |
| Vendor       | 0.0000             | 0.0000             | 0.0000             | 0.0000             | 0.0000             | 0.0000             | 0.0000             | 0.0000             | 0.0000             | 0.0000             | 0.0000        | 0.0000        | 0.0000        | 0.0000             | 0.0000             | 0.0000        |
| Worker       | 5.3000e-004        | 4.3000e-004        | 4.5800e-003        | 1.0000e-005        | 1.1900e-003        | 1.0000e-005        | 1.2000e-003        | 3.2000e-004        | 1.0000e-005        | 3.2000e-004        | 0.0000        | 1.0222        | 1.0222        | 4.0000e-005        | 3.0000e-005        | 1.0334        |
| <b>Total</b> | <b>5.3000e-004</b> | <b>4.3000e-004</b> | <b>4.5800e-003</b> | <b>1.0000e-005</b> | <b>1.1900e-003</b> | <b>1.0000e-005</b> | <b>1.2000e-003</b> | <b>3.2000e-004</b> | <b>1.0000e-005</b> | <b>3.2000e-004</b> | <b>0.0000</b> | <b>1.0222</b> | <b>1.0222</b> | <b>4.0000e-005</b> | <b>3.0000e-005</b> | <b>1.0334</b> |

**EMFAC Off-Model Adjustment Factors for Gasoline Light Duty Vehicle to Account for the SAFE Vehicle Rule Not Applied**

**Mitigated Construction On-Site**

|               | ROG           | NOx           | CO            | SO2                | Fugitive PM10 | Exhaust PM10       | PM10 Total    | Fugitive PM2.5 | Exhaust PM2.5      | PM2.5 Total   | Bio- CO2      | NBio- CO2      | Total CO2      | CH4                | N2O           | CO2e           |
|---------------|---------------|---------------|---------------|--------------------|---------------|--------------------|---------------|----------------|--------------------|---------------|---------------|----------------|----------------|--------------------|---------------|----------------|
| Category      | tons/yr       |               |               |                    |               |                    |               |                |                    |               | MT/yr         |                |                |                    |               |                |
| Fugitive Dust |               |               |               |                    | 0.0319        | 0.0000             | 0.0319        | 0.0154         | 0.0000             | 0.0154        | 0.0000        | 0.0000         | 0.0000         | 0.0000             | 0.0000        | 0.0000         |
| Off-Road      | 0.0195        | 0.2086        | 0.1527        | 3.0000e-004        |               | 9.4100e-003        | 9.4100e-003   |                | 8.6600e-003        | 8.6600e-003   | 0.0000        | 26.0547        | 26.0547        | 8.4300e-003        | 0.0000        | 26.2654        |
| <b>Total</b>  | <b>0.0195</b> | <b>0.2086</b> | <b>0.1527</b> | <b>3.0000e-004</b> | <b>0.0319</b> | <b>9.4100e-003</b> | <b>0.0413</b> | <b>0.0154</b>  | <b>8.6600e-003</b> | <b>0.0241</b> | <b>0.0000</b> | <b>26.0547</b> | <b>26.0547</b> | <b>8.4300e-003</b> | <b>0.0000</b> | <b>26.2654</b> |

**Mitigated Construction Off-Site**

|              | ROG                | NOx                | CO                 | SO2                | Fugitive PM10      | Exhaust PM10       | PM10 Total         | Fugitive PM2.5     | Exhaust PM2.5      | PM2.5 Total        | Bio- CO2      | NBio- CO2     | Total CO2     | CH4                | N2O                | CO2e          |
|--------------|--------------------|--------------------|--------------------|--------------------|--------------------|--------------------|--------------------|--------------------|--------------------|--------------------|---------------|---------------|---------------|--------------------|--------------------|---------------|
| Category     | tons/yr            |                    |                    |                    |                    |                    |                    |                    |                    |                    | MT/yr         |               |               |                    |                    |               |
| Hauling      | 0.0000             | 0.0000             | 0.0000             | 0.0000             | 0.0000             | 0.0000             | 0.0000             | 0.0000             | 0.0000             | 0.0000             | 0.0000        | 0.0000        | 0.0000        | 0.0000             | 0.0000             | 0.0000        |
| Vendor       | 0.0000             | 0.0000             | 0.0000             | 0.0000             | 0.0000             | 0.0000             | 0.0000             | 0.0000             | 0.0000             | 0.0000             | 0.0000        | 0.0000        | 0.0000        | 0.0000             | 0.0000             | 0.0000        |
| Worker       | 5.3000e-004        | 4.3000e-004        | 4.5800e-003        | 1.0000e-005        | 1.1900e-003        | 1.0000e-005        | 1.2000e-003        | 3.2000e-004        | 1.0000e-005        | 3.2000e-004        | 0.0000        | 1.0222        | 1.0222        | 4.0000e-005        | 3.0000e-005        | 1.0334        |
| <b>Total</b> | <b>5.3000e-004</b> | <b>4.3000e-004</b> | <b>4.5800e-003</b> | <b>1.0000e-005</b> | <b>1.1900e-003</b> | <b>1.0000e-005</b> | <b>1.2000e-003</b> | <b>3.2000e-004</b> | <b>1.0000e-005</b> | <b>3.2000e-004</b> | <b>0.0000</b> | <b>1.0222</b> | <b>1.0222</b> | <b>4.0000e-005</b> | <b>3.0000e-005</b> | <b>1.0334</b> |

**EMFAC Off-Model Adjustment Factors for Gasoline Light Duty Vehicle to Account for the SAFE Vehicle Rule Not Applied**

**3.5 Building Construction - 2022**

**Unmitigated Construction On-Site**

|              | ROG           | NOx           | CO            | SO2                | Fugitive PM10 | Exhaust PM10  | PM10 Total    | Fugitive PM2.5 | Exhaust PM2.5 | PM2.5 Total   | Bio- CO2      | NBio- CO2       | Total CO2       | CH4           | N2O           | CO2e            |
|--------------|---------------|---------------|---------------|--------------------|---------------|---------------|---------------|----------------|---------------|---------------|---------------|-----------------|-----------------|---------------|---------------|-----------------|
| Category     | tons/yr       |               |               |                    |               |               |               |                |               |               | MT/yr         |                 |                 |               |               |                 |
| Off-Road     | 0.1792        | 1.6396        | 1.7182        | 2.8300e-003        |               | 0.0850        | 0.0850        |                | 0.0799        | 0.0799        | 0.0000        | 243.3115        | 243.3115        | 0.0583        | 0.0000        | 244.7688        |
| <b>Total</b> | <b>0.1792</b> | <b>1.6396</b> | <b>1.7182</b> | <b>2.8300e-003</b> |               | <b>0.0850</b> | <b>0.0850</b> |                | <b>0.0799</b> | <b>0.0799</b> | <b>0.0000</b> | <b>243.3115</b> | <b>243.3115</b> | <b>0.0583</b> | <b>0.0000</b> | <b>244.7688</b> |

**Unmitigated Construction Off-Site**

|              | ROG           | NOx           | CO            | SO2                | Fugitive PM10 | Exhaust PM10       | PM10 Total    | Fugitive PM2.5 | Exhaust PM2.5      | PM2.5 Total   | Bio- CO2      | NBio- CO2       | Total CO2       | CH4                | N2O           | CO2e            |
|--------------|---------------|---------------|---------------|--------------------|---------------|--------------------|---------------|----------------|--------------------|---------------|---------------|-----------------|-----------------|--------------------|---------------|-----------------|
| Category     | tons/yr       |               |               |                    |               |                    |               |                |                    |               | MT/yr         |                 |                 |                    |               |                 |
| Hauling      | 0.0000        | 0.0000        | 0.0000        | 0.0000             | 0.0000        | 0.0000             | 0.0000        | 0.0000         | 0.0000             | 0.0000        | 0.0000        | 0.0000          | 0.0000          | 0.0000             | 0.0000        | 0.0000          |
| Vendor       | 0.0153        | 0.3950        | 0.1198        | 1.3900e-003        | 0.0430        | 4.1500e-003        | 0.0471        | 0.0124         | 3.9700e-003        | 0.0164        | 0.0000        | 133.8062        | 133.8062        | 1.4000e-003        | 0.0197        | 139.7078        |
| Worker       | 0.0587        | 0.0474        | 0.5103        | 1.2400e-003        | 0.1328        | 9.2000e-004        | 0.1337        | 0.0353         | 8.5000e-004        | 0.0362        | 0.0000        | 113.7715        | 113.7715        | 4.3700e-003        | 3.8100e-003   | 115.0161        |
| <b>Total</b> | <b>0.0739</b> | <b>0.4424</b> | <b>0.6301</b> | <b>2.6300e-003</b> | <b>0.1758</b> | <b>5.0700e-003</b> | <b>0.1809</b> | <b>0.0477</b>  | <b>4.8200e-003</b> | <b>0.0526</b> | <b>0.0000</b> | <b>247.5778</b> | <b>247.5778</b> | <b>5.7700e-003</b> | <b>0.0235</b> | <b>254.7240</b> |

**EMFAC Off-Model Adjustment Factors for Gasoline Light Duty Vehicle to Account for the SAFE Vehicle Rule Not Applied**

**Mitigated Construction On-Site**

|              | ROG           | NOx           | CO            | SO2                | Fugitive PM10 | Exhaust PM10  | PM10 Total    | Fugitive PM2.5 | Exhaust PM2.5 | PM2.5 Total   | Bio- CO2      | NBio- CO2       | Total CO2       | CH4           | N2O           | CO2e            |
|--------------|---------------|---------------|---------------|--------------------|---------------|---------------|---------------|----------------|---------------|---------------|---------------|-----------------|-----------------|---------------|---------------|-----------------|
| Category     | tons/yr       |               |               |                    |               |               |               |                |               |               | MT/yr         |                 |                 |               |               |                 |
| Off-Road     | 0.1792        | 1.6396        | 1.7182        | 2.8300e-003        |               | 0.0850        | 0.0850        |                | 0.0799        | 0.0799        | 0.0000        | 243.3112        | 243.3112        | 0.0583        | 0.0000        | 244.7685        |
| <b>Total</b> | <b>0.1792</b> | <b>1.6396</b> | <b>1.7182</b> | <b>2.8300e-003</b> |               | <b>0.0850</b> | <b>0.0850</b> |                | <b>0.0799</b> | <b>0.0799</b> | <b>0.0000</b> | <b>243.3112</b> | <b>243.3112</b> | <b>0.0583</b> | <b>0.0000</b> | <b>244.7685</b> |

**Mitigated Construction Off-Site**

|              | ROG           | NOx           | CO            | SO2                | Fugitive PM10 | Exhaust PM10       | PM10 Total    | Fugitive PM2.5 | Exhaust PM2.5      | PM2.5 Total   | Bio- CO2      | NBio- CO2       | Total CO2       | CH4                | N2O           | CO2e            |
|--------------|---------------|---------------|---------------|--------------------|---------------|--------------------|---------------|----------------|--------------------|---------------|---------------|-----------------|-----------------|--------------------|---------------|-----------------|
| Category     | tons/yr       |               |               |                    |               |                    |               |                |                    |               | MT/yr         |                 |                 |                    |               |                 |
| Hauling      | 0.0000        | 0.0000        | 0.0000        | 0.0000             | 0.0000        | 0.0000             | 0.0000        | 0.0000         | 0.0000             | 0.0000        | 0.0000        | 0.0000          | 0.0000          | 0.0000             | 0.0000        | 0.0000          |
| Vendor       | 0.0153        | 0.3950        | 0.1198        | 1.3900e-003        | 0.0430        | 4.1500e-003        | 0.0471        | 0.0124         | 3.9700e-003        | 0.0164        | 0.0000        | 133.8062        | 133.8062        | 1.4000e-003        | 0.0197        | 139.7078        |
| Worker       | 0.0587        | 0.0474        | 0.5103        | 1.2400e-003        | 0.1328        | 9.2000e-004        | 0.1337        | 0.0353         | 8.5000e-004        | 0.0362        | 0.0000        | 113.7715        | 113.7715        | 4.3700e-003        | 3.8100e-003   | 115.0161        |
| <b>Total</b> | <b>0.0739</b> | <b>0.4424</b> | <b>0.6301</b> | <b>2.6300e-003</b> | <b>0.1758</b> | <b>5.0700e-003</b> | <b>0.1809</b> | <b>0.0477</b>  | <b>4.8200e-003</b> | <b>0.0526</b> | <b>0.0000</b> | <b>247.5778</b> | <b>247.5778</b> | <b>5.7700e-003</b> | <b>0.0235</b> | <b>254.7240</b> |

**EMFAC Off-Model Adjustment Factors for Gasoline Light Duty Vehicle to Account for the SAFE Vehicle Rule Not Applied**

**3.5 Building Construction - 2023**

**Unmitigated Construction On-Site**

|              | ROG           | NOx           | CO            | SO2                | Fugitive PM10 | Exhaust PM10       | PM10 Total         | Fugitive PM2.5 | Exhaust PM2.5      | PM2.5 Total        | Bio- CO2      | NBio- CO2      | Total CO2      | CH4                | N2O           | CO2e           |
|--------------|---------------|---------------|---------------|--------------------|---------------|--------------------|--------------------|----------------|--------------------|--------------------|---------------|----------------|----------------|--------------------|---------------|----------------|
| Category     | tons/yr       |               |               |                    |               |                    |                    |                |                    |                    | MT/yr         |                |                |                    |               |                |
| Off-Road     | 0.0157        | 0.1439        | 0.1624        | 2.7000e-004        |               | 7.0000e-003        | 7.0000e-003        |                | 6.5800e-003        | 6.5800e-003        | 0.0000        | 23.1805        | 23.1805        | 5.5100e-003        | 0.0000        | 23.3183        |
| <b>Total</b> | <b>0.0157</b> | <b>0.1439</b> | <b>0.1624</b> | <b>2.7000e-004</b> |               | <b>7.0000e-003</b> | <b>7.0000e-003</b> |                | <b>6.5800e-003</b> | <b>6.5800e-003</b> | <b>0.0000</b> | <b>23.1805</b> | <b>23.1805</b> | <b>5.5100e-003</b> | <b>0.0000</b> | <b>23.3183</b> |

**Unmitigated Construction Off-Site**

|              | ROG                | NOx           | CO            | SO2                | Fugitive PM10 | Exhaust PM10       | PM10 Total    | Fugitive PM2.5     | Exhaust PM2.5      | PM2.5 Total        | Bio- CO2      | NBio- CO2      | Total CO2      | CH4                | N2O                | CO2e           |
|--------------|--------------------|---------------|---------------|--------------------|---------------|--------------------|---------------|--------------------|--------------------|--------------------|---------------|----------------|----------------|--------------------|--------------------|----------------|
| Category     | tons/yr            |               |               |                    |               |                    |               |                    |                    |                    | MT/yr         |                |                |                    |                    |                |
| Hauling      | 0.0000             | 0.0000        | 0.0000        | 0.0000             | 0.0000        | 0.0000             | 0.0000        | 0.0000             | 0.0000             | 0.0000             | 0.0000        | 0.0000         | 0.0000         | 0.0000             | 0.0000             | 0.0000         |
| Vendor       | 8.8000e-004        | 0.0316        | 9.9500e-003   | 1.3000e-004        | 4.0900e-003   | 2.0000e-004        | 4.2900e-003   | 1.1800e-003        | 1.9000e-004        | 1.3800e-003        | 0.0000        | 12.3300        | 12.3300        | 1.1000e-004        | 1.8100e-003        | 12.8724        |
| Worker       | 5.1900e-003        | 3.9800e-003   | 0.0445        | 1.1000e-004        | 0.0127        | 8.0000e-005        | 0.0127        | 3.3600e-003        | 8.0000e-005        | 3.4400e-003        | 0.0000        | 10.5068        | 10.5068        | 3.7000e-004        | 3.3000e-004        | 10.6155        |
| <b>Total</b> | <b>6.0700e-003</b> | <b>0.0355</b> | <b>0.0544</b> | <b>2.4000e-004</b> | <b>0.0167</b> | <b>2.8000e-004</b> | <b>0.0170</b> | <b>4.5400e-003</b> | <b>2.7000e-004</b> | <b>4.8200e-003</b> | <b>0.0000</b> | <b>22.8368</b> | <b>22.8368</b> | <b>4.8000e-004</b> | <b>2.1400e-003</b> | <b>23.4879</b> |



**EMFAC Off-Model Adjustment Factors for Gasoline Light Duty Vehicle to Account for the SAFE Vehicle Rule Not Applied**

**Mitigated Construction On-Site**

|              | ROG           | NOx           | CO            | SO2                | Fugitive PM10 | Exhaust PM10       | PM10 Total         | Fugitive PM2.5 | Exhaust PM2.5      | PM2.5 Total        | Bio- CO2      | NBio- CO2      | Total CO2      | CH4                | N2O           | CO2e           |
|--------------|---------------|---------------|---------------|--------------------|---------------|--------------------|--------------------|----------------|--------------------|--------------------|---------------|----------------|----------------|--------------------|---------------|----------------|
| Category     | tons/yr       |               |               |                    |               |                    |                    |                |                    |                    | MT/yr         |                |                |                    |               |                |
| Off-Road     | 0.0157        | 0.1439        | 0.1624        | 2.7000e-004        |               | 7.0000e-003        | 7.0000e-003        |                | 6.5800e-003        | 6.5800e-003        | 0.0000        | 23.1805        | 23.1805        | 5.5100e-003        | 0.0000        | 23.3183        |
| <b>Total</b> | <b>0.0157</b> | <b>0.1439</b> | <b>0.1624</b> | <b>2.7000e-004</b> |               | <b>7.0000e-003</b> | <b>7.0000e-003</b> |                | <b>6.5800e-003</b> | <b>6.5800e-003</b> | <b>0.0000</b> | <b>23.1805</b> | <b>23.1805</b> | <b>5.5100e-003</b> | <b>0.0000</b> | <b>23.3183</b> |

**Mitigated Construction Off-Site**

|              | ROG                | NOx           | CO            | SO2                | Fugitive PM10 | Exhaust PM10       | PM10 Total    | Fugitive PM2.5     | Exhaust PM2.5      | PM2.5 Total        | Bio- CO2      | NBio- CO2      | Total CO2      | CH4                | N2O                | CO2e           |
|--------------|--------------------|---------------|---------------|--------------------|---------------|--------------------|---------------|--------------------|--------------------|--------------------|---------------|----------------|----------------|--------------------|--------------------|----------------|
| Category     | tons/yr            |               |               |                    |               |                    |               |                    |                    |                    | MT/yr         |                |                |                    |                    |                |
| Hauling      | 0.0000             | 0.0000        | 0.0000        | 0.0000             | 0.0000        | 0.0000             | 0.0000        | 0.0000             | 0.0000             | 0.0000             | 0.0000        | 0.0000         | 0.0000         | 0.0000             | 0.0000             | 0.0000         |
| Vendor       | 8.8000e-004        | 0.0316        | 9.9500e-003   | 1.3000e-004        | 4.0900e-003   | 2.0000e-004        | 4.2900e-003   | 1.1800e-003        | 1.9000e-004        | 1.3800e-003        | 0.0000        | 12.3300        | 12.3300        | 1.1000e-004        | 1.8100e-003        | 12.8724        |
| Worker       | 5.1900e-003        | 3.9800e-003   | 0.0445        | 1.1000e-004        | 0.0127        | 8.0000e-005        | 0.0127        | 3.3600e-003        | 8.0000e-005        | 3.4400e-003        | 0.0000        | 10.5068        | 10.5068        | 3.7000e-004        | 3.3000e-004        | 10.6155        |
| <b>Total</b> | <b>6.0700e-003</b> | <b>0.0355</b> | <b>0.0544</b> | <b>2.4000e-004</b> | <b>0.0167</b> | <b>2.8000e-004</b> | <b>0.0170</b> | <b>4.5400e-003</b> | <b>2.7000e-004</b> | <b>4.8200e-003</b> | <b>0.0000</b> | <b>22.8368</b> | <b>22.8368</b> | <b>4.8000e-004</b> | <b>2.1400e-003</b> | <b>23.4879</b> |

**EMFAC Off-Model Adjustment Factors for Gasoline Light Duty Vehicle to Account for the SAFE Vehicle Rule Not Applied**

**3.6 Paving - 2023**

**Unmitigated Construction On-Site**

|              | ROG           | NOx           | CO            | SO2                | Fugitive PM10 | Exhaust PM10       | PM10 Total         | Fugitive PM2.5 | Exhaust PM2.5      | PM2.5 Total        | Bio- CO2      | NBio- CO2      | Total CO2      | CH4                | N2O           | CO2e           |
|--------------|---------------|---------------|---------------|--------------------|---------------|--------------------|--------------------|----------------|--------------------|--------------------|---------------|----------------|----------------|--------------------|---------------|----------------|
| Category     | tons/yr       |               |               |                    |               |                    |                    |                |                    |                    | MT/yr         |                |                |                    |               |                |
| Off-Road     | 0.0103        | 0.1019        | 0.1458        | 2.3000e-004        |               | 5.1000e-003        | 5.1000e-003        |                | 4.6900e-003        | 4.6900e-003        | 0.0000        | 20.0269        | 20.0269        | 6.4800e-003        | 0.0000        | 20.1888        |
| Paving       | 0.0000        |               |               |                    |               | 0.0000             | 0.0000             |                | 0.0000             | 0.0000             | 0.0000        | 0.0000         | 0.0000         | 0.0000             | 0.0000        | 0.0000         |
| <b>Total</b> | <b>0.0103</b> | <b>0.1019</b> | <b>0.1458</b> | <b>2.3000e-004</b> |               | <b>5.1000e-003</b> | <b>5.1000e-003</b> |                | <b>4.6900e-003</b> | <b>4.6900e-003</b> | <b>0.0000</b> | <b>20.0269</b> | <b>20.0269</b> | <b>6.4800e-003</b> | <b>0.0000</b> | <b>20.1888</b> |

**Unmitigated Construction Off-Site**

|              | ROG                | NOx                | CO                 | SO2                | Fugitive PM10      | Exhaust PM10       | PM10 Total         | Fugitive PM2.5     | Exhaust PM2.5      | PM2.5 Total        | Bio- CO2      | NBio- CO2     | Total CO2     | CH4                | N2O                | CO2e          |
|--------------|--------------------|--------------------|--------------------|--------------------|--------------------|--------------------|--------------------|--------------------|--------------------|--------------------|---------------|---------------|---------------|--------------------|--------------------|---------------|
| Category     | tons/yr            |                    |                    |                    |                    |                    |                    |                    |                    |                    | MT/yr         |               |               |                    |                    |               |
| Hauling      | 0.0000             | 0.0000             | 0.0000             | 0.0000             | 0.0000             | 0.0000             | 0.0000             | 0.0000             | 0.0000             | 0.0000             | 0.0000        | 0.0000        | 0.0000        | 0.0000             | 0.0000             | 0.0000        |
| Vendor       | 0.0000             | 0.0000             | 0.0000             | 0.0000             | 0.0000             | 0.0000             | 0.0000             | 0.0000             | 0.0000             | 0.0000             | 0.0000        | 0.0000        | 0.0000        | 0.0000             | 0.0000             | 0.0000        |
| Worker       | 4.9000e-004        | 3.8000e-004        | 4.2000e-003        | 1.0000e-005        | 1.1900e-003        | 1.0000e-005        | 1.2000e-003        | 3.2000e-004        | 1.0000e-005        | 3.2000e-004        | 0.0000        | 0.9912        | 0.9912        | 4.0000e-005        | 3.0000e-005        | 1.0015        |
| <b>Total</b> | <b>4.9000e-004</b> | <b>3.8000e-004</b> | <b>4.2000e-003</b> | <b>1.0000e-005</b> | <b>1.1900e-003</b> | <b>1.0000e-005</b> | <b>1.2000e-003</b> | <b>3.2000e-004</b> | <b>1.0000e-005</b> | <b>3.2000e-004</b> | <b>0.0000</b> | <b>0.9912</b> | <b>0.9912</b> | <b>4.0000e-005</b> | <b>3.0000e-005</b> | <b>1.0015</b> |

**EMFAC Off-Model Adjustment Factors for Gasoline Light Duty Vehicle to Account for the SAFE Vehicle Rule Not Applied**

**Mitigated Construction On-Site**

|              | ROG           | NOx           | CO            | SO2                | Fugitive PM10 | Exhaust PM10       | PM10 Total         | Fugitive PM2.5 | Exhaust PM2.5      | PM2.5 Total        | Bio- CO2      | NBio- CO2      | Total CO2      | CH4                | N2O           | CO2e           |
|--------------|---------------|---------------|---------------|--------------------|---------------|--------------------|--------------------|----------------|--------------------|--------------------|---------------|----------------|----------------|--------------------|---------------|----------------|
| Category     | tons/yr       |               |               |                    |               |                    |                    |                |                    |                    | MT/yr         |                |                |                    |               |                |
| Off-Road     | 0.0103        | 0.1019        | 0.1458        | 2.3000e-004        |               | 5.1000e-003        | 5.1000e-003        |                | 4.6900e-003        | 4.6900e-003        | 0.0000        | 20.0268        | 20.0268        | 6.4800e-003        | 0.0000        | 20.1888        |
| Paving       | 0.0000        |               |               |                    |               | 0.0000             | 0.0000             |                | 0.0000             | 0.0000             | 0.0000        | 0.0000         | 0.0000         | 0.0000             | 0.0000        | 0.0000         |
| <b>Total</b> | <b>0.0103</b> | <b>0.1019</b> | <b>0.1458</b> | <b>2.3000e-004</b> |               | <b>5.1000e-003</b> | <b>5.1000e-003</b> |                | <b>4.6900e-003</b> | <b>4.6900e-003</b> | <b>0.0000</b> | <b>20.0268</b> | <b>20.0268</b> | <b>6.4800e-003</b> | <b>0.0000</b> | <b>20.1888</b> |

**Mitigated Construction Off-Site**

|              | ROG                | NOx                | CO                 | SO2                | Fugitive PM10      | Exhaust PM10       | PM10 Total         | Fugitive PM2.5     | Exhaust PM2.5      | PM2.5 Total        | Bio- CO2      | NBio- CO2     | Total CO2     | CH4                | N2O                | CO2e          |
|--------------|--------------------|--------------------|--------------------|--------------------|--------------------|--------------------|--------------------|--------------------|--------------------|--------------------|---------------|---------------|---------------|--------------------|--------------------|---------------|
| Category     | tons/yr            |                    |                    |                    |                    |                    |                    |                    |                    |                    | MT/yr         |               |               |                    |                    |               |
| Hauling      | 0.0000             | 0.0000             | 0.0000             | 0.0000             | 0.0000             | 0.0000             | 0.0000             | 0.0000             | 0.0000             | 0.0000             | 0.0000        | 0.0000        | 0.0000        | 0.0000             | 0.0000             | 0.0000        |
| Vendor       | 0.0000             | 0.0000             | 0.0000             | 0.0000             | 0.0000             | 0.0000             | 0.0000             | 0.0000             | 0.0000             | 0.0000             | 0.0000        | 0.0000        | 0.0000        | 0.0000             | 0.0000             | 0.0000        |
| Worker       | 4.9000e-004        | 3.8000e-004        | 4.2000e-003        | 1.0000e-005        | 1.1900e-003        | 1.0000e-005        | 1.2000e-003        | 3.2000e-004        | 1.0000e-005        | 3.2000e-004        | 0.0000        | 0.9912        | 0.9912        | 4.0000e-005        | 3.0000e-005        | 1.0015        |
| <b>Total</b> | <b>4.9000e-004</b> | <b>3.8000e-004</b> | <b>4.2000e-003</b> | <b>1.0000e-005</b> | <b>1.1900e-003</b> | <b>1.0000e-005</b> | <b>1.2000e-003</b> | <b>3.2000e-004</b> | <b>1.0000e-005</b> | <b>3.2000e-004</b> | <b>0.0000</b> | <b>0.9912</b> | <b>0.9912</b> | <b>4.0000e-005</b> | <b>3.0000e-005</b> | <b>1.0015</b> |

**EMFAC Off-Model Adjustment Factors for Gasoline Light Duty Vehicle to Account for the SAFE Vehicle Rule Not Applied**

**3.7 Architectural Coating - 2023**

**Unmitigated Construction On-Site**

|                 | ROG           | NOx           | CO            | SO2                | Fugitive PM10 | Exhaust PM10       | PM10 Total         | Fugitive PM2.5 | Exhaust PM2.5      | PM2.5 Total        | Bio- CO2      | NBio- CO2     | Total CO2     | CH4                | N2O           | CO2e          |
|-----------------|---------------|---------------|---------------|--------------------|---------------|--------------------|--------------------|----------------|--------------------|--------------------|---------------|---------------|---------------|--------------------|---------------|---------------|
| Category        | tons/yr       |               |               |                    |               |                    |                    |                |                    |                    | MT/yr         |               |               |                    |               |               |
| Archit. Coating | 0.8800        |               |               |                    |               | 0.0000             | 0.0000             |                | 0.0000             | 0.0000             | 0.0000        | 0.0000        | 0.0000        | 0.0000             | 0.0000        | 0.0000        |
| Off-Road        | 1.9200e-003   | 0.0130        | 0.0181        | 3.0000e-005        |               | 7.1000e-004        | 7.1000e-004        |                | 7.1000e-004        | 7.1000e-004        | 0.0000        | 2.5533        | 2.5533        | 1.5000e-004        | 0.0000        | 2.5571        |
| <b>Total</b>    | <b>0.8819</b> | <b>0.0130</b> | <b>0.0181</b> | <b>3.0000e-005</b> |               | <b>7.1000e-004</b> | <b>7.1000e-004</b> |                | <b>7.1000e-004</b> | <b>7.1000e-004</b> | <b>0.0000</b> | <b>2.5533</b> | <b>2.5533</b> | <b>1.5000e-004</b> | <b>0.0000</b> | <b>2.5571</b> |

**Unmitigated Construction Off-Site**

|              | ROG                | NOx                | CO                 | SO2                | Fugitive PM10      | Exhaust PM10       | PM10 Total         | Fugitive PM2.5     | Exhaust PM2.5      | PM2.5 Total        | Bio- CO2      | NBio- CO2     | Total CO2     | CH4                | N2O                | CO2e          |
|--------------|--------------------|--------------------|--------------------|--------------------|--------------------|--------------------|--------------------|--------------------|--------------------|--------------------|---------------|---------------|---------------|--------------------|--------------------|---------------|
| Category     | tons/yr            |                    |                    |                    |                    |                    |                    |                    |                    |                    | MT/yr         |               |               |                    |                    |               |
| Hauling      | 0.0000             | 0.0000             | 0.0000             | 0.0000             | 0.0000             | 0.0000             | 0.0000             | 0.0000             | 0.0000             | 0.0000             | 0.0000        | 0.0000        | 0.0000        | 0.0000             | 0.0000             | 0.0000        |
| Vendor       | 0.0000             | 0.0000             | 0.0000             | 0.0000             | 0.0000             | 0.0000             | 0.0000             | 0.0000             | 0.0000             | 0.0000             | 0.0000        | 0.0000        | 0.0000        | 0.0000             | 0.0000             | 0.0000        |
| Worker       | 1.0400e-003        | 8.0000e-004        | 8.9500e-003        | 2.0000e-005        | 2.5500e-003        | 2.0000e-005        | 2.5600e-003        | 6.8000e-004        | 2.0000e-005        | 6.9000e-004        | 0.0000        | 2.1146        | 2.1146        | 8.0000e-005        | 7.0000e-005        | 2.1365        |
| <b>Total</b> | <b>1.0400e-003</b> | <b>8.0000e-004</b> | <b>8.9500e-003</b> | <b>2.0000e-005</b> | <b>2.5500e-003</b> | <b>2.0000e-005</b> | <b>2.5600e-003</b> | <b>6.8000e-004</b> | <b>2.0000e-005</b> | <b>6.9000e-004</b> | <b>0.0000</b> | <b>2.1146</b> | <b>2.1146</b> | <b>8.0000e-005</b> | <b>7.0000e-005</b> | <b>2.1365</b> |

**EMFAC Off-Model Adjustment Factors for Gasoline Light Duty Vehicle to Account for the SAFE Vehicle Rule Not Applied**

**Mitigated Construction On-Site**

|                 | ROG           | NOx           | CO            | SO2                | Fugitive PM10 | Exhaust PM10       | PM10 Total         | Fugitive PM2.5 | Exhaust PM2.5      | PM2.5 Total        | Bio- CO2      | NBio- CO2     | Total CO2     | CH4                | N2O           | CO2e          |
|-----------------|---------------|---------------|---------------|--------------------|---------------|--------------------|--------------------|----------------|--------------------|--------------------|---------------|---------------|---------------|--------------------|---------------|---------------|
| Category        | tons/yr       |               |               |                    |               |                    |                    |                |                    |                    | MT/yr         |               |               |                    |               |               |
| Archit. Coating | 0.8800        |               |               |                    |               | 0.0000             | 0.0000             |                | 0.0000             | 0.0000             | 0.0000        | 0.0000        | 0.0000        | 0.0000             | 0.0000        | 0.0000        |
| Off-Road        | 1.9200e-003   | 0.0130        | 0.0181        | 3.0000e-005        |               | 7.1000e-004        | 7.1000e-004        |                | 7.1000e-004        | 7.1000e-004        | 0.0000        | 2.5533        | 2.5533        | 1.5000e-004        | 0.0000        | 2.5571        |
| <b>Total</b>    | <b>0.8819</b> | <b>0.0130</b> | <b>0.0181</b> | <b>3.0000e-005</b> |               | <b>7.1000e-004</b> | <b>7.1000e-004</b> |                | <b>7.1000e-004</b> | <b>7.1000e-004</b> | <b>0.0000</b> | <b>2.5533</b> | <b>2.5533</b> | <b>1.5000e-004</b> | <b>0.0000</b> | <b>2.5571</b> |

**Mitigated Construction Off-Site**

|              | ROG                | NOx                | CO                 | SO2                | Fugitive PM10      | Exhaust PM10       | PM10 Total         | Fugitive PM2.5     | Exhaust PM2.5      | PM2.5 Total        | Bio- CO2      | NBio- CO2     | Total CO2     | CH4                | N2O                | CO2e          |
|--------------|--------------------|--------------------|--------------------|--------------------|--------------------|--------------------|--------------------|--------------------|--------------------|--------------------|---------------|---------------|---------------|--------------------|--------------------|---------------|
| Category     | tons/yr            |                    |                    |                    |                    |                    |                    |                    |                    |                    | MT/yr         |               |               |                    |                    |               |
| Hauling      | 0.0000             | 0.0000             | 0.0000             | 0.0000             | 0.0000             | 0.0000             | 0.0000             | 0.0000             | 0.0000             | 0.0000             | 0.0000        | 0.0000        | 0.0000        | 0.0000             | 0.0000             | 0.0000        |
| Vendor       | 0.0000             | 0.0000             | 0.0000             | 0.0000             | 0.0000             | 0.0000             | 0.0000             | 0.0000             | 0.0000             | 0.0000             | 0.0000        | 0.0000        | 0.0000        | 0.0000             | 0.0000             | 0.0000        |
| Worker       | 1.0400e-003        | 8.0000e-004        | 8.9500e-003        | 2.0000e-005        | 2.5500e-003        | 2.0000e-005        | 2.5600e-003        | 6.8000e-004        | 2.0000e-005        | 6.9000e-004        | 0.0000        | 2.1146        | 2.1146        | 8.0000e-005        | 7.0000e-005        | 2.1365        |
| <b>Total</b> | <b>1.0400e-003</b> | <b>8.0000e-004</b> | <b>8.9500e-003</b> | <b>2.0000e-005</b> | <b>2.5500e-003</b> | <b>2.0000e-005</b> | <b>2.5600e-003</b> | <b>6.8000e-004</b> | <b>2.0000e-005</b> | <b>6.9000e-004</b> | <b>0.0000</b> | <b>2.1146</b> | <b>2.1146</b> | <b>8.0000e-005</b> | <b>7.0000e-005</b> | <b>2.1365</b> |

**EMFAC Off-Model Adjustment Factors for Gasoline Light Duty Vehicle to Account for the SAFE Vehicle Rule Not Applied**

**CSUMB Master Plan - Construction  
Monterey Bay Unified APCD Air District, Summer**

**1.0 Project Characteristics**

**1.1 Land Usage**

| Land Uses                  | Size     | Metric  | Lot Acreage | Floor Surface Area | Population |
|----------------------------|----------|---------|-------------|--------------------|------------|
| University/College (4yr)   | 1,634.00 | Student | 6.89        | 300,000.00         | 0          |
| Other Non-Asphalt Surfaces | 1.80     | Acre    | 1.80        | 78,408.00          | 0          |

**1.2 Other Project Characteristics**

|                                |                                  |                                |       |                                  |       |
|--------------------------------|----------------------------------|--------------------------------|-------|----------------------------------|-------|
| <b>Urbanization</b>            | Urban                            | <b>Wind Speed (m/s)</b>        | 2.8   | <b>Precipitation Freq (Days)</b> | 53    |
| <b>Climate Zone</b>            | 4                                |                                |       | <b>Operational Year</b>          | 2024  |
| <b>Utility Company</b>         | Pacific Gas and Electric Company |                                |       |                                  |       |
| <b>CO2 Intensity (lb/MWhr)</b> | 203.98                           | <b>CH4 Intensity (lb/MWhr)</b> | 0.033 | <b>N2O Intensity (lb/MWhr)</b>   | 0.004 |

**1.3 User Entered Comments & Non-Default Data**

Project Characteristics - CSU Monterey Bay Master Plan. MBARD. Construction Scenario.

Land Use - Maximum development of approximately 300 GSF and 1.8 acres of paving.

Construction Phase - Default schedule assumed.

Off-road Equipment - Default equipment

Off-road Equipment - Default equipment

Off-road Equipment - Default equipment

Off-road Equipment - Default equipment

**EMFAC Off-Model Adjustment Factors for Gasoline Light Duty Vehicle to Account for the SAFE Vehicle Rule Not Applied**

Off-road Equipment - Default equipment

Off-road Equipment - Default equipment

Demolition - Assume demolition of 10,500 SF.

Grading -

Trips and VMT - Default trips

Construction Off-road Equipment Mitigation - Water twice daily

Architectural Coating - MBARD Rule 426 - interior 50 g/L, exterior 100 g/L

| Table Name              | Column Name                | Default Value | New Value  |
|-------------------------|----------------------------|---------------|------------|
| tblArchitecturalCoating | EF_Nonresidential_Exterior | 150.00        | 100.00     |
| tblArchitecturalCoating | EF_Nonresidential_Interior | 150.00        | 50.00      |
| tblArchitecturalCoating | EF_Parking                 | 150.00        | 100.00     |
| tblLandUse              | LandUseSquareFeet          | 300,325.06    | 300,000.00 |
| tblTripsAndVMT          | HaulingTripNumber          | 48.00         | 200.00     |

**EMFAC Off-Model Adjustment Factors for Gasoline Light Duty Vehicle to Account for the SAFE Vehicle Rule Not Applied**

**2.0 Emissions Summary**

**2.1 Overall Construction (Maximum Daily Emission)**

**Unmitigated Construction**

|         | ROG     | NOx     | CO      | SO2    | Fugitive PM10 | Exhaust PM10 | PM10 Total | Fugitive PM2.5 | Exhaust PM2.5 | PM2.5 Total | Bio- CO2 | NBio- CO2  | Total CO2  | CH4    | N2O    | CO2e       |
|---------|---------|---------|---------|--------|---------------|--------------|------------|----------------|---------------|-------------|----------|------------|------------|--------|--------|------------|
| Year    | lb/day  |         |         |        |               |              |            |                |               |             | lb/day   |            |            |        |        |            |
| 2022    | 3.2345  | 33.1284 | 22.6069 | 0.0526 | 19.8049       | 1.6136       | 21.4184    | 10.1417        | 1.4845        | 11.6262     | 0.0000   | 5,216.0934 | 5,216.0934 | 1.1971 | 0.2430 | 5,305.2635 |
| 2023    | 88.2941 | 17.7732 | 21.8987 | 0.0518 | 1.7261        | 0.7281       | 2.4542     | 0.4674         | 0.6853        | 1.1526      | 0.0000   | 5,132.5254 | 5,132.5254 | 0.7177 | 0.2330 | 5,218.4241 |
| Maximum | 88.2941 | 33.1284 | 22.6069 | 0.0526 | 19.8049       | 1.6136       | 21.4184    | 10.1417        | 1.4845        | 11.6262     | 0.0000   | 5,216.0934 | 5,216.0934 | 1.1971 | 0.2430 | 5,305.2635 |

**Mitigated Construction**

|         | ROG     | NOx     | CO      | SO2    | Fugitive PM10 | Exhaust PM10 | PM10 Total | Fugitive PM2.5 | Exhaust PM2.5 | PM2.5 Total | Bio- CO2 | NBio- CO2  | Total CO2  | CH4    | N2O    | CO2e       |
|---------|---------|---------|---------|--------|---------------|--------------|------------|----------------|---------------|-------------|----------|------------|------------|--------|--------|------------|
| Year    | lb/day  |         |         |        |               |              |            |                |               |             | lb/day   |            |            |        |        |            |
| 2022    | 3.2345  | 33.1284 | 22.6069 | 0.0526 | 8.9935        | 1.6136       | 10.6071    | 4.5853         | 1.4845        | 6.0698      | 0.0000   | 5,216.0934 | 5,216.0934 | 1.1971 | 0.2430 | 5,305.2635 |
| 2023    | 88.2941 | 17.7732 | 21.8987 | 0.0518 | 1.7261        | 0.7281       | 2.4542     | 0.4674         | 0.6853        | 1.1526      | 0.0000   | 5,132.5254 | 5,132.5254 | 0.7177 | 0.2330 | 5,218.4241 |
| Maximum | 88.2941 | 33.1284 | 22.6069 | 0.0526 | 8.9935        | 1.6136       | 10.6071    | 4.5853         | 1.4845        | 6.0698      | 0.0000   | 5,216.0934 | 5,216.0934 | 1.1971 | 0.2430 | 5,305.2635 |



**EMFAC Off-Model Adjustment Factors for Gasoline Light Duty Vehicle to Account for the SAFE Vehicle Rule Not Applied**

|                   | ROG  | NOx  | CO   | SO2  | Fugitive PM10 | Exhaust PM10 | PM10 Total | Fugitive PM2.5 | Exhaust PM2.5 | PM2.5 Total | Bio- CO2 | NBio-CO2 | Total CO2 | CH4  | N2O  | CO2e |
|-------------------|------|------|------|------|---------------|--------------|------------|----------------|---------------|-------------|----------|----------|-----------|------|------|------|
| Percent Reduction | 0.00 | 0.00 | 0.00 | 0.00 | 50.21         | 0.00         | 45.29      | 52.37          | 0.00          | 43.48       | 0.00     | 0.00     | 0.00      | 0.00 | 0.00 | 0.00 |

**3.0 Construction Detail****Construction Phase**

| Phase Number | Phase Name            | Phase Type            | Start Date | End Date  | Num Days Week | Num Days | Phase Description |
|--------------|-----------------------|-----------------------|------------|-----------|---------------|----------|-------------------|
| 1            | Demolition            | Demolition            | 1/3/2022   | 1/28/2022 | 5             | 20       |                   |
| 2            | Site Preparation      | Site Preparation      | 1/29/2022  | 2/11/2022 | 5             | 10       |                   |
| 3            | Grading               | Grading               | 2/12/2022  | 3/11/2022 | 5             | 20       |                   |
| 4            | Building Construction | Building Construction | 3/12/2022  | 1/27/2023 | 5             | 230      |                   |
| 5            | Paving                | Paving                | 1/28/2023  | 2/24/2023 | 5             | 20       |                   |
| 6            | Architectural Coating | Architectural Coating | 2/25/2023  | 3/24/2023 | 5             | 20       |                   |

Acres of Grading (Site Preparation Phase): 15

Acres of Grading (Grading Phase): 20

Acres of Paving: 1.8

Residential Indoor: 0; Residential Outdoor: 0; Non-Residential Indoor: 450,000; Non-Residential Outdoor: 150,000; Striped Parking Area: 4,704

**EMFAC Off-Model Adjustment Factors for Gasoline Light Duty Vehicle to Account for the SAFE Vehicle Rule Not Applied****OffRoad Equipment**

| Phase Name            | Offroad Equipment Type    | Amount | Usage Hours | Horse Power | Load Factor |
|-----------------------|---------------------------|--------|-------------|-------------|-------------|
| Demolition            | Concrete/Industrial Saws  | 1      | 8.00        | 81          | 0.73        |
| Demolition            | Excavators                | 3      | 8.00        | 158         | 0.38        |
| Demolition            | Rubber Tired Dozers       | 2      | 8.00        | 247         | 0.40        |
| Site Preparation      | Rubber Tired Dozers       | 3      | 8.00        | 247         | 0.40        |
| Site Preparation      | Tractors/Loaders/Backhoes | 4      | 8.00        | 97          | 0.37        |
| Grading               | Excavators                | 1      | 8.00        | 158         | 0.38        |
| Grading               | Graders                   | 1      | 8.00        | 187         | 0.41        |
| Grading               | Rubber Tired Dozers       | 1      | 8.00        | 247         | 0.40        |
| Grading               | Tractors/Loaders/Backhoes | 3      | 8.00        | 97          | 0.37        |
| Building Construction | Cranes                    | 1      | 7.00        | 231         | 0.29        |
| Building Construction | Forklifts                 | 3      | 8.00        | 89          | 0.20        |
| Building Construction | Generator Sets            | 1      | 8.00        | 84          | 0.74        |
| Building Construction | Tractors/Loaders/Backhoes | 3      | 7.00        | 97          | 0.37        |
| Building Construction | Welders                   | 1      | 8.00        | 46          | 0.45        |
| Paving                | Pavers                    | 2      | 8.00        | 130         | 0.42        |
| Paving                | Paving Equipment          | 2      | 8.00        | 132         | 0.36        |
| Paving                | Rollers                   | 2      | 8.00        | 80          | 0.38        |
| Architectural Coating | Air Compressors           | 1      | 6.00        | 78          | 0.48        |

**EMFAC Off-Model Adjustment Factors for Gasoline Light Duty Vehicle to Account for the SAFE Vehicle Rule Not Applied****Trips and VMT**

| Phase Name            | Offroad Equipment Count | Worker Trip Number | Vendor Trip Number | Hauling Trip Number | Worker Trip Length | Vendor Trip Length | Hauling Trip Length | Worker Vehicle Class | Vendor Vehicle Class | Hauling Vehicle Class |
|-----------------------|-------------------------|--------------------|--------------------|---------------------|--------------------|--------------------|---------------------|----------------------|----------------------|-----------------------|
| Demolition            | 6                       | 15.00              | 0.00               | 200.00              | 10.80              | 7.30               | 20.00               | LD_Mix               | HDT_Mix              | HHDT                  |
| Site Preparation      | 7                       | 18.00              | 0.00               | 0.00                | 10.80              | 7.30               | 20.00               | LD_Mix               | HDT_Mix              | HHDT                  |
| Grading               | 6                       | 15.00              | 0.00               | 0.00                | 10.80              | 7.30               | 20.00               | LD_Mix               | HDT_Mix              | HHDT                  |
| Building Construction | 9                       | 159.00             | 62.00              | 0.00                | 10.80              | 7.30               | 20.00               | LD_Mix               | HDT_Mix              | HHDT                  |
| Paving                | 6                       | 15.00              | 0.00               | 0.00                | 10.80              | 7.30               | 20.00               | LD_Mix               | HDT_Mix              | HHDT                  |
| Architectural Coating | 1                       | 32.00              | 0.00               | 0.00                | 10.80              | 7.30               | 20.00               | LD_Mix               | HDT_Mix              | HHDT                  |

**3.1 Mitigation Measures Construction**

Water Exposed Area

**EMFAC Off-Model Adjustment Factors for Gasoline Light Duty Vehicle to Account for the SAFE Vehicle Rule Not Applied**

**3.2 Demolition - 2022**

**Unmitigated Construction On-Site**

|               | ROG           | NOx            | CO             | SO2           | Fugitive PM10 | Exhaust PM10  | PM10 Total    | Fugitive PM2.5 | Exhaust PM2.5 | PM2.5 Total   | Bio- CO2 | NBio- CO2         | Total CO2         | CH4           | N2O | CO2e              |
|---------------|---------------|----------------|----------------|---------------|---------------|---------------|---------------|----------------|---------------|---------------|----------|-------------------|-------------------|---------------|-----|-------------------|
| Category      | lb/day        |                |                |               |               |               |               |                |               |               | lb/day   |                   |                   |               |     |                   |
| Fugitive Dust |               |                |                |               | 0.5266        | 0.0000        | 0.5266        | 0.0797         | 0.0000        | 0.0797        |          |                   | 0.0000            |               |     | 0.0000            |
| Off-Road      | 2.6392        | 25.7194        | 20.5941        | 0.0388        |               | 1.2427        | 1.2427        |                | 1.1553        | 1.1553        |          | 3,746.7812        | 3,746.7812        | 1.0524        |     | 3,773.0920        |
| <b>Total</b>  | <b>2.6392</b> | <b>25.7194</b> | <b>20.5941</b> | <b>0.0388</b> | <b>0.5266</b> | <b>1.2427</b> | <b>1.7692</b> | <b>0.0797</b>  | <b>1.1553</b> | <b>1.2350</b> |          | <b>3,746.7812</b> | <b>3,746.7812</b> | <b>1.0524</b> |     | <b>3,773.0920</b> |

**Unmitigated Construction Off-Site**

|              | ROG           | NOx           | CO            | SO2                | Fugitive PM10 | Exhaust PM10  | PM10 Total    | Fugitive PM2.5 | Exhaust PM2.5 | PM2.5 Total   | Bio- CO2 | NBio- CO2       | Total CO2       | CH4           | N2O           | CO2e            |
|--------------|---------------|---------------|---------------|--------------------|---------------|---------------|---------------|----------------|---------------|---------------|----------|-----------------|-----------------|---------------|---------------|-----------------|
| Category     | lb/day        |               |               |                    |               |               |               |                |               |               | lb/day   |                 |                 |               |               |                 |
| Hauling      | 0.0397        | 1.6368        | 0.3215        | 6.2400e-003        | 0.1750        | 0.0162        | 0.1912        | 0.0480         | 0.0155        | 0.0635        |          | 666.4063        | 666.4063        | 7.8400e-003   | 0.1050        | 697.9010        |
| Vendor       | 0.0000        | 0.0000        | 0.0000        | 0.0000             | 0.0000        | 0.0000        | 0.0000        | 0.0000         | 0.0000        | 0.0000        |          | 0.0000          | 0.0000          | 0.0000        | 0.0000        | 0.0000          |
| Worker       | 0.0536        | 0.0374        | 0.4828        | 1.1700e-003        | 0.1232        | 8.2000e-004   | 0.1241        | 0.0327         | 7.6000e-004   | 0.0334        |          | 118.6349        | 118.6349        | 4.1000e-003   | 3.4500e-003   | 119.7671        |
| <b>Total</b> | <b>0.0933</b> | <b>1.6742</b> | <b>0.8043</b> | <b>7.4100e-003</b> | <b>0.2982</b> | <b>0.0170</b> | <b>0.3152</b> | <b>0.0806</b>  | <b>0.0163</b> | <b>0.0969</b> |          | <b>785.0412</b> | <b>785.0412</b> | <b>0.0119</b> | <b>0.1085</b> | <b>817.6681</b> |

**EMFAC Off-Model Adjustment Factors for Gasoline Light Duty Vehicle to Account for the SAFE Vehicle Rule Not Applied**

**Mitigated Construction On-Site**

|               | ROG           | NOx            | CO             | SO2           | Fugitive PM10 | Exhaust PM10  | PM10 Total    | Fugitive PM2.5 | Exhaust PM2.5 | PM2.5 Total   | Bio- CO2      | NBio- CO2         | Total CO2         | CH4           | N2O | CO2e              |
|---------------|---------------|----------------|----------------|---------------|---------------|---------------|---------------|----------------|---------------|---------------|---------------|-------------------|-------------------|---------------|-----|-------------------|
| Category      | lb/day        |                |                |               |               |               |               |                |               |               | lb/day        |                   |                   |               |     |                   |
| Fugitive Dust |               |                |                |               | 0.2370        | 0.0000        | 0.2370        | 0.0359         | 0.0000        | 0.0359        |               |                   | 0.0000            |               |     | 0.0000            |
| Off-Road      | 2.6392        | 25.7194        | 20.5941        | 0.0388        |               | 1.2427        | 1.2427        |                | 1.1553        | 1.1553        | 0.0000        | 3,746.7812        | 3,746.7812        | 1.0524        |     | 3,773.0920        |
| <b>Total</b>  | <b>2.6392</b> | <b>25.7194</b> | <b>20.5941</b> | <b>0.0388</b> | <b>0.2370</b> | <b>1.2427</b> | <b>1.4796</b> | <b>0.0359</b>  | <b>1.1553</b> | <b>1.1911</b> | <b>0.0000</b> | <b>3,746.7812</b> | <b>3,746.7812</b> | <b>1.0524</b> |     | <b>3,773.0920</b> |

**Mitigated Construction Off-Site**

|              | ROG           | NOx           | CO            | SO2                | Fugitive PM10 | Exhaust PM10  | PM10 Total    | Fugitive PM2.5 | Exhaust PM2.5 | PM2.5 Total   | Bio- CO2 | NBio- CO2       | Total CO2       | CH4           | N2O           | CO2e            |
|--------------|---------------|---------------|---------------|--------------------|---------------|---------------|---------------|----------------|---------------|---------------|----------|-----------------|-----------------|---------------|---------------|-----------------|
| Category     | lb/day        |               |               |                    |               |               |               |                |               |               | lb/day   |                 |                 |               |               |                 |
| Hauling      | 0.0397        | 1.6368        | 0.3215        | 6.2400e-003        | 0.1750        | 0.0162        | 0.1912        | 0.0480         | 0.0155        | 0.0635        |          | 666.4063        | 666.4063        | 7.8400e-003   | 0.1050        | 697.9010        |
| Vendor       | 0.0000        | 0.0000        | 0.0000        | 0.0000             | 0.0000        | 0.0000        | 0.0000        | 0.0000         | 0.0000        | 0.0000        |          | 0.0000          | 0.0000          | 0.0000        | 0.0000        | 0.0000          |
| Worker       | 0.0536        | 0.0374        | 0.4828        | 1.1700e-003        | 0.1232        | 8.2000e-004   | 0.1241        | 0.0327         | 7.6000e-004   | 0.0334        |          | 118.6349        | 118.6349        | 4.1000e-003   | 3.4500e-003   | 119.7671        |
| <b>Total</b> | <b>0.0933</b> | <b>1.6742</b> | <b>0.8043</b> | <b>7.4100e-003</b> | <b>0.2982</b> | <b>0.0170</b> | <b>0.3152</b> | <b>0.0806</b>  | <b>0.0163</b> | <b>0.0969</b> |          | <b>785.0412</b> | <b>785.0412</b> | <b>0.0119</b> | <b>0.1085</b> | <b>817.6681</b> |

**EMFAC Off-Model Adjustment Factors for Gasoline Light Duty Vehicle to Account for the SAFE Vehicle Rule Not Applied**

**3.3 Site Preparation - 2022**

**Unmitigated Construction On-Site**

|               | ROG           | NOx            | CO             | SO2           | Fugitive PM10  | Exhaust PM10  | PM10 Total     | Fugitive PM2.5 | Exhaust PM2.5 | PM2.5 Total    | Bio- CO2 | NBio- CO2         | Total CO2         | CH4           | N2O | CO2e              |
|---------------|---------------|----------------|----------------|---------------|----------------|---------------|----------------|----------------|---------------|----------------|----------|-------------------|-------------------|---------------|-----|-------------------|
| Category      | lb/day        |                |                |               |                |               |                |                |               |                | lb/day   |                   |                   |               |     |                   |
| Fugitive Dust |               |                |                |               | 19.6570        | 0.0000        | 19.6570        | 10.1025        | 0.0000        | 10.1025        |          |                   | 0.0000            |               |     | 0.0000            |
| Off-Road      | 3.1701        | 33.0835        | 19.6978        | 0.0380        |                | 1.6126        | 1.6126         |                | 1.4836        | 1.4836         |          | 3,686.0619        | 3,686.0619        | 1.1922        |     | 3,715.8655        |
| <b>Total</b>  | <b>3.1701</b> | <b>33.0835</b> | <b>19.6978</b> | <b>0.0380</b> | <b>19.6570</b> | <b>1.6126</b> | <b>21.2696</b> | <b>10.1025</b> | <b>1.4836</b> | <b>11.5860</b> |          | <b>3,686.0619</b> | <b>3,686.0619</b> | <b>1.1922</b> |     | <b>3,715.8655</b> |

**Unmitigated Construction Off-Site**

|              | ROG           | NOx           | CO            | SO2                | Fugitive PM10 | Exhaust PM10       | PM10 Total    | Fugitive PM2.5 | Exhaust PM2.5      | PM2.5 Total   | Bio- CO2 | NBio- CO2       | Total CO2       | CH4                | N2O                | CO2e            |
|--------------|---------------|---------------|---------------|--------------------|---------------|--------------------|---------------|----------------|--------------------|---------------|----------|-----------------|-----------------|--------------------|--------------------|-----------------|
| Category     | lb/day        |               |               |                    |               |                    |               |                |                    |               | lb/day   |                 |                 |                    |                    |                 |
| Hauling      | 0.0000        | 0.0000        | 0.0000        | 0.0000             | 0.0000        | 0.0000             | 0.0000        | 0.0000         | 0.0000             | 0.0000        |          | 0.0000          | 0.0000          | 0.0000             | 0.0000             | 0.0000          |
| Vendor       | 0.0000        | 0.0000        | 0.0000        | 0.0000             | 0.0000        | 0.0000             | 0.0000        | 0.0000         | 0.0000             | 0.0000        |          | 0.0000          | 0.0000          | 0.0000             | 0.0000             | 0.0000          |
| Worker       | 0.0643        | 0.0449        | 0.5793        | 1.4100e-003        | 0.1479        | 9.9000e-004        | 0.1489        | 0.0392         | 9.1000e-004        | 0.0401        |          | 142.3619        | 142.3619        | 4.9200e-003        | 4.1500e-003        | 143.7205        |
| <b>Total</b> | <b>0.0643</b> | <b>0.0449</b> | <b>0.5793</b> | <b>1.4100e-003</b> | <b>0.1479</b> | <b>9.9000e-004</b> | <b>0.1489</b> | <b>0.0392</b>  | <b>9.1000e-004</b> | <b>0.0401</b> |          | <b>142.3619</b> | <b>142.3619</b> | <b>4.9200e-003</b> | <b>4.1500e-003</b> | <b>143.7205</b> |

**EMFAC Off-Model Adjustment Factors for Gasoline Light Duty Vehicle to Account for the SAFE Vehicle Rule Not Applied**

**Mitigated Construction On-Site**

|               | ROG           | NOx            | CO             | SO2           | Fugitive PM10 | Exhaust PM10  | PM10 Total     | Fugitive PM2.5 | Exhaust PM2.5 | PM2.5 Total   | Bio- CO2      | NBio- CO2         | Total CO2         | CH4           | N2O | CO2e              |
|---------------|---------------|----------------|----------------|---------------|---------------|---------------|----------------|----------------|---------------|---------------|---------------|-------------------|-------------------|---------------|-----|-------------------|
| Category      | lb/day        |                |                |               |               |               |                |                |               |               | lb/day        |                   |                   |               |     |                   |
| Fugitive Dust |               |                |                |               | 8.8457        | 0.0000        | 8.8457         | 4.5461         | 0.0000        | 4.5461        |               |                   | 0.0000            |               |     | 0.0000            |
| Off-Road      | 3.1701        | 33.0835        | 19.6978        | 0.0380        |               | 1.6126        | 1.6126         |                | 1.4836        | 1.4836        | 0.0000        | 3,686.0619        | 3,686.0619        | 1.1922        |     | 3,715.8655        |
| <b>Total</b>  | <b>3.1701</b> | <b>33.0835</b> | <b>19.6978</b> | <b>0.0380</b> | <b>8.8457</b> | <b>1.6126</b> | <b>10.4582</b> | <b>4.5461</b>  | <b>1.4836</b> | <b>6.0297</b> | <b>0.0000</b> | <b>3,686.0619</b> | <b>3,686.0619</b> | <b>1.1922</b> |     | <b>3,715.8655</b> |

**Mitigated Construction Off-Site**

|              | ROG           | NOx           | CO            | SO2                | Fugitive PM10 | Exhaust PM10       | PM10 Total    | Fugitive PM2.5 | Exhaust PM2.5      | PM2.5 Total   | Bio- CO2 | NBio- CO2       | Total CO2       | CH4                | N2O                | CO2e            |
|--------------|---------------|---------------|---------------|--------------------|---------------|--------------------|---------------|----------------|--------------------|---------------|----------|-----------------|-----------------|--------------------|--------------------|-----------------|
| Category     | lb/day        |               |               |                    |               |                    |               |                |                    |               | lb/day   |                 |                 |                    |                    |                 |
| Hauling      | 0.0000        | 0.0000        | 0.0000        | 0.0000             | 0.0000        | 0.0000             | 0.0000        | 0.0000         | 0.0000             | 0.0000        |          | 0.0000          | 0.0000          | 0.0000             | 0.0000             | 0.0000          |
| Vendor       | 0.0000        | 0.0000        | 0.0000        | 0.0000             | 0.0000        | 0.0000             | 0.0000        | 0.0000         | 0.0000             | 0.0000        |          | 0.0000          | 0.0000          | 0.0000             | 0.0000             | 0.0000          |
| Worker       | 0.0643        | 0.0449        | 0.5793        | 1.4100e-003        | 0.1479        | 9.9000e-004        | 0.1489        | 0.0392         | 9.1000e-004        | 0.0401        |          | 142.3619        | 142.3619        | 4.9200e-003        | 4.1500e-003        | 143.7205        |
| <b>Total</b> | <b>0.0643</b> | <b>0.0449</b> | <b>0.5793</b> | <b>1.4100e-003</b> | <b>0.1479</b> | <b>9.9000e-004</b> | <b>0.1489</b> | <b>0.0392</b>  | <b>9.1000e-004</b> | <b>0.0401</b> |          | <b>142.3619</b> | <b>142.3619</b> | <b>4.9200e-003</b> | <b>4.1500e-003</b> | <b>143.7205</b> |

**EMFAC Off-Model Adjustment Factors for Gasoline Light Duty Vehicle to Account for the SAFE Vehicle Rule Not Applied**

**3.4 Grading - 2022**

**Unmitigated Construction On-Site**

|               | ROG           | NOx            | CO             | SO2           | Fugitive PM10 | Exhaust PM10  | PM10 Total    | Fugitive PM2.5 | Exhaust PM2.5 | PM2.5 Total   | Bio- CO2 | NBio- CO2         | Total CO2         | CH4           | N2O | CO2e              |
|---------------|---------------|----------------|----------------|---------------|---------------|---------------|---------------|----------------|---------------|---------------|----------|-------------------|-------------------|---------------|-----|-------------------|
| Category      | lb/day        |                |                |               |               |               |               |                |               |               | lb/day   |                   |                   |               |     |                   |
| Fugitive Dust |               |                |                |               | 7.0826        | 0.0000        | 7.0826        | 3.4247         | 0.0000        | 3.4247        |          |                   | 0.0000            |               |     | 0.0000            |
| Off-Road      | 1.9486        | 20.8551        | 15.2727        | 0.0297        |               | 0.9409        | 0.9409        |                | 0.8656        | 0.8656        |          | 2,872.0464        | 2,872.0464        | 0.9289        |     | 2,895.2684        |
| <b>Total</b>  | <b>1.9486</b> | <b>20.8551</b> | <b>15.2727</b> | <b>0.0297</b> | <b>7.0826</b> | <b>0.9409</b> | <b>8.0234</b> | <b>3.4247</b>  | <b>0.8656</b> | <b>4.2903</b> |          | <b>2,872.0464</b> | <b>2,872.0464</b> | <b>0.9289</b> |     | <b>2,895.2684</b> |

**Unmitigated Construction Off-Site**

|              | ROG           | NOx           | CO            | SO2                | Fugitive PM10 | Exhaust PM10       | PM10 Total    | Fugitive PM2.5 | Exhaust PM2.5      | PM2.5 Total   | Bio- CO2 | NBio- CO2       | Total CO2       | CH4                | N2O                | CO2e            |
|--------------|---------------|---------------|---------------|--------------------|---------------|--------------------|---------------|----------------|--------------------|---------------|----------|-----------------|-----------------|--------------------|--------------------|-----------------|
| Category     | lb/day        |               |               |                    |               |                    |               |                |                    |               | lb/day   |                 |                 |                    |                    |                 |
| Hauling      | 0.0000        | 0.0000        | 0.0000        | 0.0000             | 0.0000        | 0.0000             | 0.0000        | 0.0000         | 0.0000             | 0.0000        |          | 0.0000          | 0.0000          | 0.0000             | 0.0000             | 0.0000          |
| Vendor       | 0.0000        | 0.0000        | 0.0000        | 0.0000             | 0.0000        | 0.0000             | 0.0000        | 0.0000         | 0.0000             | 0.0000        |          | 0.0000          | 0.0000          | 0.0000             | 0.0000             | 0.0000          |
| Worker       | 0.0536        | 0.0374        | 0.4828        | 1.1700e-003        | 0.1232        | 8.2000e-004        | 0.1241        | 0.0327         | 7.6000e-004        | 0.0334        |          | 118.6349        | 118.6349        | 4.1000e-003        | 3.4500e-003        | 119.7671        |
| <b>Total</b> | <b>0.0536</b> | <b>0.0374</b> | <b>0.4828</b> | <b>1.1700e-003</b> | <b>0.1232</b> | <b>8.2000e-004</b> | <b>0.1241</b> | <b>0.0327</b>  | <b>7.6000e-004</b> | <b>0.0334</b> |          | <b>118.6349</b> | <b>118.6349</b> | <b>4.1000e-003</b> | <b>3.4500e-003</b> | <b>119.7671</b> |



**EMFAC Off-Model Adjustment Factors for Gasoline Light Duty Vehicle to Account for the SAFE Vehicle Rule Not Applied**

**Mitigated Construction On-Site**

|               | ROG           | NOx            | CO             | SO2           | Fugitive PM10 | Exhaust PM10  | PM10 Total    | Fugitive PM2.5 | Exhaust PM2.5 | PM2.5 Total   | Bio- CO2      | NBio- CO2         | Total CO2         | CH4           | N2O | CO2e              |
|---------------|---------------|----------------|----------------|---------------|---------------|---------------|---------------|----------------|---------------|---------------|---------------|-------------------|-------------------|---------------|-----|-------------------|
| Category      | lb/day        |                |                |               |               |               |               |                |               |               | lb/day        |                   |                   |               |     |                   |
| Fugitive Dust |               |                |                |               | 3.1872        | 0.0000        | 3.1872        | 1.5411         | 0.0000        | 1.5411        |               |                   | 0.0000            |               |     | 0.0000            |
| Off-Road      | 1.9486        | 20.8551        | 15.2727        | 0.0297        |               | 0.9409        | 0.9409        |                | 0.8656        | 0.8656        | 0.0000        | 2,872.0464        | 2,872.0464        | 0.9289        |     | 2,895.2684        |
| <b>Total</b>  | <b>1.9486</b> | <b>20.8551</b> | <b>15.2727</b> | <b>0.0297</b> | <b>3.1872</b> | <b>0.9409</b> | <b>4.1280</b> | <b>1.5411</b>  | <b>0.8656</b> | <b>2.4067</b> | <b>0.0000</b> | <b>2,872.0464</b> | <b>2,872.0464</b> | <b>0.9289</b> |     | <b>2,895.2684</b> |

**Mitigated Construction Off-Site**

|              | ROG           | NOx           | CO            | SO2                | Fugitive PM10 | Exhaust PM10       | PM10 Total    | Fugitive PM2.5 | Exhaust PM2.5      | PM2.5 Total   | Bio- CO2 | NBio- CO2       | Total CO2       | CH4                | N2O                | CO2e            |
|--------------|---------------|---------------|---------------|--------------------|---------------|--------------------|---------------|----------------|--------------------|---------------|----------|-----------------|-----------------|--------------------|--------------------|-----------------|
| Category     | lb/day        |               |               |                    |               |                    |               |                |                    |               | lb/day   |                 |                 |                    |                    |                 |
| Hauling      | 0.0000        | 0.0000        | 0.0000        | 0.0000             | 0.0000        | 0.0000             | 0.0000        | 0.0000         | 0.0000             | 0.0000        |          | 0.0000          | 0.0000          | 0.0000             | 0.0000             | 0.0000          |
| Vendor       | 0.0000        | 0.0000        | 0.0000        | 0.0000             | 0.0000        | 0.0000             | 0.0000        | 0.0000         | 0.0000             | 0.0000        |          | 0.0000          | 0.0000          | 0.0000             | 0.0000             | 0.0000          |
| Worker       | 0.0536        | 0.0374        | 0.4828        | 1.1700e-003        | 0.1232        | 8.2000e-004        | 0.1241        | 0.0327         | 7.6000e-004        | 0.0334        |          | 118.6349        | 118.6349        | 4.1000e-003        | 3.4500e-003        | 119.7671        |
| <b>Total</b> | <b>0.0536</b> | <b>0.0374</b> | <b>0.4828</b> | <b>1.1700e-003</b> | <b>0.1232</b> | <b>8.2000e-004</b> | <b>0.1241</b> | <b>0.0327</b>  | <b>7.6000e-004</b> | <b>0.0334</b> |          | <b>118.6349</b> | <b>118.6349</b> | <b>4.1000e-003</b> | <b>3.4500e-003</b> | <b>119.7671</b> |

**EMFAC Off-Model Adjustment Factors for Gasoline Light Duty Vehicle to Account for the SAFE Vehicle Rule Not Applied**

**3.5 Building Construction - 2022**

**Unmitigated Construction On-Site**

|              | ROG           | NOx            | CO             | SO2           | Fugitive PM10 | Exhaust PM10  | PM10 Total    | Fugitive PM2.5 | Exhaust PM2.5 | PM2.5 Total   | Bio- CO2 | NBio- CO2         | Total CO2         | CH4           | N2O | CO2e              |
|--------------|---------------|----------------|----------------|---------------|---------------|---------------|---------------|----------------|---------------|---------------|----------|-------------------|-------------------|---------------|-----|-------------------|
| Category     | lb/day        |                |                |               |               |               |               |                |               |               | lb/day   |                   |                   |               |     |                   |
| Off-Road     | 1.7062        | 15.6156        | 16.3634        | 0.0269        |               | 0.8090        | 0.8090        |                | 0.7612        | 0.7612        |          | 2,554.3336        | 2,554.3336        | 0.6120        |     | 2,569.6322        |
| <b>Total</b> | <b>1.7062</b> | <b>15.6156</b> | <b>16.3634</b> | <b>0.0269</b> |               | <b>0.8090</b> | <b>0.8090</b> |                | <b>0.7612</b> | <b>0.7612</b> |          | <b>2,554.3336</b> | <b>2,554.3336</b> | <b>0.6120</b> |     | <b>2,569.6322</b> |

**Unmitigated Construction Off-Site**

|              | ROG           | NOx           | CO            | SO2           | Fugitive PM10 | Exhaust PM10  | PM10 Total    | Fugitive PM2.5 | Exhaust PM2.5 | PM2.5 Total   | Bio- CO2 | NBio- CO2         | Total CO2         | CH4           | N2O           | CO2e              |
|--------------|---------------|---------------|---------------|---------------|---------------|---------------|---------------|----------------|---------------|---------------|----------|-------------------|-------------------|---------------|---------------|-------------------|
| Category     | lb/day        |               |               |               |               |               |               |                |               |               | lb/day   |                   |                   |               |               |                   |
| Hauling      | 0.0000        | 0.0000        | 0.0000        | 0.0000        | 0.0000        | 0.0000        | 0.0000        | 0.0000         | 0.0000        | 0.0000        |          | 0.0000            | 0.0000            | 0.0000        | 0.0000        | 0.0000            |
| Vendor       | 0.1466        | 3.6264        | 1.1263        | 0.0132        | 0.4200        | 0.0395        | 0.4595        | 0.1209         | 0.0378        | 0.1587        |          | 1,404.2295        | 1,404.2295        | 0.0148        | 0.2064        | 1,466.1003        |
| Worker       | 0.5683        | 0.3962        | 5.1172        | 0.0124        | 1.3062        | 8.7400e-003   | 1.3149        | 0.3465         | 8.0600e-003   | 0.3545        |          | 1,257.5303        | 1,257.5303        | 0.0435        | 0.0366        | 1,269.5309        |
| <b>Total</b> | <b>0.7149</b> | <b>4.0226</b> | <b>6.2435</b> | <b>0.0257</b> | <b>1.7261</b> | <b>0.0483</b> | <b>1.7744</b> | <b>0.4674</b>  | <b>0.0459</b> | <b>0.5132</b> |          | <b>2,661.7598</b> | <b>2,661.7598</b> | <b>0.0583</b> | <b>0.2430</b> | <b>2,735.6313</b> |

**EMFAC Off-Model Adjustment Factors for Gasoline Light Duty Vehicle to Account for the SAFE Vehicle Rule Not Applied**

**Mitigated Construction On-Site**

|              | ROG           | NOx            | CO             | SO2           | Fugitive PM10 | Exhaust PM10  | PM10 Total    | Fugitive PM2.5 | Exhaust PM2.5 | PM2.5 Total   | Bio- CO2      | NBio- CO2         | Total CO2         | CH4           | N2O | CO2e              |
|--------------|---------------|----------------|----------------|---------------|---------------|---------------|---------------|----------------|---------------|---------------|---------------|-------------------|-------------------|---------------|-----|-------------------|
| Category     | lb/day        |                |                |               |               |               |               |                |               |               | lb/day        |                   |                   |               |     |                   |
| Off-Road     | 1.7062        | 15.6156        | 16.3634        | 0.0269        |               | 0.8090        | 0.8090        |                | 0.7612        | 0.7612        | 0.0000        | 2,554.3336        | 2,554.3336        | 0.6120        |     | 2,569.6322        |
| <b>Total</b> | <b>1.7062</b> | <b>15.6156</b> | <b>16.3634</b> | <b>0.0269</b> |               | <b>0.8090</b> | <b>0.8090</b> |                | <b>0.7612</b> | <b>0.7612</b> | <b>0.0000</b> | <b>2,554.3336</b> | <b>2,554.3336</b> | <b>0.6120</b> |     | <b>2,569.6322</b> |

**Mitigated Construction Off-Site**

|              | ROG           | NOx           | CO            | SO2           | Fugitive PM10 | Exhaust PM10  | PM10 Total    | Fugitive PM2.5 | Exhaust PM2.5 | PM2.5 Total   | Bio- CO2 | NBio- CO2         | Total CO2         | CH4           | N2O           | CO2e              |
|--------------|---------------|---------------|---------------|---------------|---------------|---------------|---------------|----------------|---------------|---------------|----------|-------------------|-------------------|---------------|---------------|-------------------|
| Category     | lb/day        |               |               |               |               |               |               |                |               |               | lb/day   |                   |                   |               |               |                   |
| Hauling      | 0.0000        | 0.0000        | 0.0000        | 0.0000        | 0.0000        | 0.0000        | 0.0000        | 0.0000         | 0.0000        | 0.0000        |          | 0.0000            | 0.0000            | 0.0000        | 0.0000        | 0.0000            |
| Vendor       | 0.1466        | 3.6264        | 1.1263        | 0.0132        | 0.4200        | 0.0395        | 0.4595        | 0.1209         | 0.0378        | 0.1587        |          | 1,404.2295        | 1,404.2295        | 0.0148        | 0.2064        | 1,466.1003        |
| Worker       | 0.5683        | 0.3962        | 5.1172        | 0.0124        | 1.3062        | 8.7400e-003   | 1.3149        | 0.3465         | 8.0600e-003   | 0.3545        |          | 1,257.5303        | 1,257.5303        | 0.0435        | 0.0366        | 1,269.5309        |
| <b>Total</b> | <b>0.7149</b> | <b>4.0226</b> | <b>6.2435</b> | <b>0.0257</b> | <b>1.7261</b> | <b>0.0483</b> | <b>1.7744</b> | <b>0.4674</b>  | <b>0.0459</b> | <b>0.5132</b> |          | <b>2,661.7598</b> | <b>2,661.7598</b> | <b>0.0583</b> | <b>0.2430</b> | <b>2,735.6313</b> |

**EMFAC Off-Model Adjustment Factors for Gasoline Light Duty Vehicle to Account for the SAFE Vehicle Rule Not Applied**

**3.5 Building Construction - 2023**

**Unmitigated Construction On-Site**

|              | ROG           | NOx            | CO             | SO2           | Fugitive PM10 | Exhaust PM10  | PM10 Total    | Fugitive PM2.5 | Exhaust PM2.5 | PM2.5 Total   | Bio- CO2 | NBio- CO2         | Total CO2         | CH4           | N2O | CO2e              |
|--------------|---------------|----------------|----------------|---------------|---------------|---------------|---------------|----------------|---------------|---------------|----------|-------------------|-------------------|---------------|-----|-------------------|
| Category     | lb/day        |                |                |               |               |               |               |                |               |               | lb/day   |                   |                   |               |     |                   |
| Off-Road     | 1.5728        | 14.3849        | 16.2440        | 0.0269        |               | 0.6997        | 0.6997        |                | 0.6584        | 0.6584        |          | 2,555.2099        | 2,555.2099        | 0.6079        |     | 2,570.4061        |
| <b>Total</b> | <b>1.5728</b> | <b>14.3849</b> | <b>16.2440</b> | <b>0.0269</b> |               | <b>0.6997</b> | <b>0.6997</b> |                | <b>0.6584</b> | <b>0.6584</b> |          | <b>2,555.2099</b> | <b>2,555.2099</b> | <b>0.6079</b> |     | <b>2,570.4061</b> |

**Unmitigated Construction Off-Site**

|              | ROG           | NOx           | CO            | SO2           | Fugitive PM10 | Exhaust PM10  | PM10 Total    | Fugitive PM2.5 | Exhaust PM2.5 | PM2.5 Total   | Bio- CO2 | NBio- CO2         | Total CO2         | CH4           | N2O           | CO2e              |
|--------------|---------------|---------------|---------------|---------------|---------------|---------------|---------------|----------------|---------------|---------------|----------|-------------------|-------------------|---------------|---------------|-------------------|
| Category     | lb/day        |               |               |               |               |               |               |                |               |               | lb/day   |                   |                   |               |               |                   |
| Hauling      | 0.0000        | 0.0000        | 0.0000        | 0.0000        | 0.0000        | 0.0000        | 0.0000        | 0.0000         | 0.0000        | 0.0000        |          | 0.0000            | 0.0000            | 0.0000        | 0.0000        | 0.0000            |
| Vendor       | 0.0896        | 3.0392        | 0.9817        | 0.0128        | 0.4200        | 0.0201        | 0.4401        | 0.1209         | 0.0193        | 0.1402        |          | 1,358.1176        | 1,358.1176        | 0.0119        | 0.1993        | 1,417.8112        |
| Worker       | 0.5270        | 0.3491        | 4.6730        | 0.0121        | 1.3062        | 8.2300e-003   | 1.3144        | 0.3465         | 7.5800e-003   | 0.3540        |          | 1,219.1979        | 1,219.1979        | 0.0390        | 0.0337        | 1,230.2069        |
| <b>Total</b> | <b>0.6166</b> | <b>3.3883</b> | <b>5.6547</b> | <b>0.0249</b> | <b>1.7261</b> | <b>0.0284</b> | <b>1.7545</b> | <b>0.4674</b>  | <b>0.0268</b> | <b>0.4942</b> |          | <b>2,577.3155</b> | <b>2,577.3155</b> | <b>0.0509</b> | <b>0.2330</b> | <b>2,648.0180</b> |

**EMFAC Off-Model Adjustment Factors for Gasoline Light Duty Vehicle to Account for the SAFE Vehicle Rule Not Applied**

**Mitigated Construction On-Site**

|              | ROG           | NOx            | CO             | SO2           | Fugitive PM10 | Exhaust PM10  | PM10 Total    | Fugitive PM2.5 | Exhaust PM2.5 | PM2.5 Total   | Bio- CO2      | NBio- CO2         | Total CO2         | CH4           | N2O | CO2e              |
|--------------|---------------|----------------|----------------|---------------|---------------|---------------|---------------|----------------|---------------|---------------|---------------|-------------------|-------------------|---------------|-----|-------------------|
| Category     | lb/day        |                |                |               |               |               |               |                |               |               | lb/day        |                   |                   |               |     |                   |
| Off-Road     | 1.5728        | 14.3849        | 16.2440        | 0.0269        |               | 0.6997        | 0.6997        |                | 0.6584        | 0.6584        | 0.0000        | 2,555.2099        | 2,555.2099        | 0.6079        |     | 2,570.4061        |
| <b>Total</b> | <b>1.5728</b> | <b>14.3849</b> | <b>16.2440</b> | <b>0.0269</b> |               | <b>0.6997</b> | <b>0.6997</b> |                | <b>0.6584</b> | <b>0.6584</b> | <b>0.0000</b> | <b>2,555.2099</b> | <b>2,555.2099</b> | <b>0.6079</b> |     | <b>2,570.4061</b> |

**Mitigated Construction Off-Site**

|              | ROG           | NOx           | CO            | SO2           | Fugitive PM10 | Exhaust PM10  | PM10 Total    | Fugitive PM2.5 | Exhaust PM2.5 | PM2.5 Total   | Bio- CO2 | NBio- CO2         | Total CO2         | CH4           | N2O           | CO2e              |
|--------------|---------------|---------------|---------------|---------------|---------------|---------------|---------------|----------------|---------------|---------------|----------|-------------------|-------------------|---------------|---------------|-------------------|
| Category     | lb/day        |               |               |               |               |               |               |                |               |               | lb/day   |                   |                   |               |               |                   |
| Hauling      | 0.0000        | 0.0000        | 0.0000        | 0.0000        | 0.0000        | 0.0000        | 0.0000        | 0.0000         | 0.0000        | 0.0000        |          | 0.0000            | 0.0000            | 0.0000        | 0.0000        | 0.0000            |
| Vendor       | 0.0896        | 3.0392        | 0.9817        | 0.0128        | 0.4200        | 0.0201        | 0.4401        | 0.1209         | 0.0193        | 0.1402        |          | 1,358.1176        | 1,358.1176        | 0.0119        | 0.1993        | 1,417.8112        |
| Worker       | 0.5270        | 0.3491        | 4.6730        | 0.0121        | 1.3062        | 8.2300e-003   | 1.3144        | 0.3465         | 7.5800e-003   | 0.3540        |          | 1,219.1979        | 1,219.1979        | 0.0390        | 0.0337        | 1,230.2069        |
| <b>Total</b> | <b>0.6166</b> | <b>3.3883</b> | <b>5.6547</b> | <b>0.0249</b> | <b>1.7261</b> | <b>0.0284</b> | <b>1.7545</b> | <b>0.4674</b>  | <b>0.0268</b> | <b>0.4942</b> |          | <b>2,577.3155</b> | <b>2,577.3155</b> | <b>0.0509</b> | <b>0.2330</b> | <b>2,648.0180</b> |

**EMFAC Off-Model Adjustment Factors for Gasoline Light Duty Vehicle to Account for the SAFE Vehicle Rule Not Applied**

**3.6 Paving - 2023**

**Unmitigated Construction On-Site**

|              | ROG           | NOx            | CO             | SO2           | Fugitive PM10 | Exhaust PM10  | PM10 Total    | Fugitive PM2.5 | Exhaust PM2.5 | PM2.5 Total   | Bio- CO2 | NBio- CO2         | Total CO2         | CH4           | N2O | CO2e              |
|--------------|---------------|----------------|----------------|---------------|---------------|---------------|---------------|----------------|---------------|---------------|----------|-------------------|-------------------|---------------|-----|-------------------|
| Category     | lb/day        |                |                |               |               |               |               |                |               |               | lb/day   |                   |                   |               |     |                   |
| Off-Road     | 1.0327        | 10.1917        | 14.5842        | 0.0228        |               | 0.5102        | 0.5102        |                | 0.4694        | 0.4694        |          | 2,207.5841        | 2,207.5841        | 0.7140        |     | 2,225.4336        |
| Paving       | 0.0000        |                |                |               |               | 0.0000        | 0.0000        |                | 0.0000        | 0.0000        |          |                   | 0.0000            |               |     | 0.0000            |
| <b>Total</b> | <b>1.0327</b> | <b>10.1917</b> | <b>14.5842</b> | <b>0.0228</b> |               | <b>0.5102</b> | <b>0.5102</b> |                | <b>0.4694</b> | <b>0.4694</b> |          | <b>2,207.5841</b> | <b>2,207.5841</b> | <b>0.7140</b> |     | <b>2,225.4336</b> |

**Unmitigated Construction Off-Site**

|              | ROG           | NOx           | CO            | SO2                | Fugitive PM10 | Exhaust PM10       | PM10 Total    | Fugitive PM2.5 | Exhaust PM2.5      | PM2.5 Total   | Bio- CO2 | NBio- CO2       | Total CO2       | CH4                | N2O                | CO2e            |
|--------------|---------------|---------------|---------------|--------------------|---------------|--------------------|---------------|----------------|--------------------|---------------|----------|-----------------|-----------------|--------------------|--------------------|-----------------|
| Category     | lb/day        |               |               |                    |               |                    |               |                |                    |               | lb/day   |                 |                 |                    |                    |                 |
| Hauling      | 0.0000        | 0.0000        | 0.0000        | 0.0000             | 0.0000        | 0.0000             | 0.0000        | 0.0000         | 0.0000             | 0.0000        |          | 0.0000          | 0.0000          | 0.0000             | 0.0000             | 0.0000          |
| Vendor       | 0.0000        | 0.0000        | 0.0000        | 0.0000             | 0.0000        | 0.0000             | 0.0000        | 0.0000         | 0.0000             | 0.0000        |          | 0.0000          | 0.0000          | 0.0000             | 0.0000             | 0.0000          |
| Worker       | 0.0497        | 0.0329        | 0.4409        | 1.1400e-003        | 0.1232        | 7.8000e-004        | 0.1240        | 0.0327         | 7.2000e-004        | 0.0334        |          | 115.0187        | 115.0187        | 3.6800e-003        | 3.1800e-003        | 116.0573        |
| <b>Total</b> | <b>0.0497</b> | <b>0.0329</b> | <b>0.4409</b> | <b>1.1400e-003</b> | <b>0.1232</b> | <b>7.8000e-004</b> | <b>0.1240</b> | <b>0.0327</b>  | <b>7.2000e-004</b> | <b>0.0334</b> |          | <b>115.0187</b> | <b>115.0187</b> | <b>3.6800e-003</b> | <b>3.1800e-003</b> | <b>116.0573</b> |

**EMFAC Off-Model Adjustment Factors for Gasoline Light Duty Vehicle to Account for the SAFE Vehicle Rule Not Applied**

**Mitigated Construction On-Site**

|              | ROG           | NOx            | CO             | SO2           | Fugitive PM10 | Exhaust PM10  | PM10 Total    | Fugitive PM2.5 | Exhaust PM2.5 | PM2.5 Total   | Bio- CO2      | NBio- CO2         | Total CO2         | CH4           | N2O | CO2e              |
|--------------|---------------|----------------|----------------|---------------|---------------|---------------|---------------|----------------|---------------|---------------|---------------|-------------------|-------------------|---------------|-----|-------------------|
| Category     | lb/day        |                |                |               |               |               |               |                |               |               | lb/day        |                   |                   |               |     |                   |
| Off-Road     | 1.0327        | 10.1917        | 14.5842        | 0.0228        |               | 0.5102        | 0.5102        |                | 0.4694        | 0.4694        | 0.0000        | 2,207.5841        | 2,207.5841        | 0.7140        |     | 2,225.4336        |
| Paving       | 0.0000        |                |                |               |               | 0.0000        | 0.0000        |                | 0.0000        | 0.0000        |               |                   | 0.0000            |               |     | 0.0000            |
| <b>Total</b> | <b>1.0327</b> | <b>10.1917</b> | <b>14.5842</b> | <b>0.0228</b> |               | <b>0.5102</b> | <b>0.5102</b> |                | <b>0.4694</b> | <b>0.4694</b> | <b>0.0000</b> | <b>2,207.5841</b> | <b>2,207.5841</b> | <b>0.7140</b> |     | <b>2,225.4336</b> |

**Mitigated Construction Off-Site**

|              | ROG           | NOx           | CO            | SO2                | Fugitive PM10 | Exhaust PM10       | PM10 Total    | Fugitive PM2.5 | Exhaust PM2.5      | PM2.5 Total   | Bio- CO2 | NBio- CO2       | Total CO2       | CH4                | N2O                | CO2e            |
|--------------|---------------|---------------|---------------|--------------------|---------------|--------------------|---------------|----------------|--------------------|---------------|----------|-----------------|-----------------|--------------------|--------------------|-----------------|
| Category     | lb/day        |               |               |                    |               |                    |               |                |                    |               | lb/day   |                 |                 |                    |                    |                 |
| Hauling      | 0.0000        | 0.0000        | 0.0000        | 0.0000             | 0.0000        | 0.0000             | 0.0000        | 0.0000         | 0.0000             | 0.0000        |          | 0.0000          | 0.0000          | 0.0000             | 0.0000             | 0.0000          |
| Vendor       | 0.0000        | 0.0000        | 0.0000        | 0.0000             | 0.0000        | 0.0000             | 0.0000        | 0.0000         | 0.0000             | 0.0000        |          | 0.0000          | 0.0000          | 0.0000             | 0.0000             | 0.0000          |
| Worker       | 0.0497        | 0.0329        | 0.4409        | 1.1400e-003        | 0.1232        | 7.8000e-004        | 0.1240        | 0.0327         | 7.2000e-004        | 0.0334        |          | 115.0187        | 115.0187        | 3.6800e-003        | 3.1800e-003        | 116.0573        |
| <b>Total</b> | <b>0.0497</b> | <b>0.0329</b> | <b>0.4409</b> | <b>1.1400e-003</b> | <b>0.1232</b> | <b>7.8000e-004</b> | <b>0.1240</b> | <b>0.0327</b>  | <b>7.2000e-004</b> | <b>0.0334</b> |          | <b>115.0187</b> | <b>115.0187</b> | <b>3.6800e-003</b> | <b>3.1800e-003</b> | <b>116.0573</b> |

**EMFAC Off-Model Adjustment Factors for Gasoline Light Duty Vehicle to Account for the SAFE Vehicle Rule Not Applied**

**3.7 Architectural Coating - 2023**

**Unmitigated Construction On-Site**

|                 | ROG            | NOx           | CO            | SO2                | Fugitive PM10 | Exhaust PM10  | PM10 Total    | Fugitive PM2.5 | Exhaust PM2.5 | PM2.5 Total   | Bio- CO2 | NBio- CO2       | Total CO2       | CH4           | N2O | CO2e            |
|-----------------|----------------|---------------|---------------|--------------------|---------------|---------------|---------------|----------------|---------------|---------------|----------|-----------------|-----------------|---------------|-----|-----------------|
| Category        | lb/day         |               |               |                    |               |               |               |                |               |               | lb/day   |                 |                 |               |     |                 |
| Archit. Coating | 87.9964        |               |               |                    |               | 0.0000        | 0.0000        |                | 0.0000        | 0.0000        |          |                 | 0.0000          |               |     | 0.0000          |
| Off-Road        | 0.1917         | 1.3030        | 1.8111        | 2.9700e-003        |               | 0.0708        | 0.0708        |                | 0.0708        | 0.0708        |          | 281.4481        | 281.4481        | 0.0168        |     | 281.8690        |
| <b>Total</b>    | <b>88.1881</b> | <b>1.3030</b> | <b>1.8111</b> | <b>2.9700e-003</b> |               | <b>0.0708</b> | <b>0.0708</b> |                | <b>0.0708</b> | <b>0.0708</b> |          | <b>281.4481</b> | <b>281.4481</b> | <b>0.0168</b> |     | <b>281.8690</b> |

**Unmitigated Construction Off-Site**

|              | ROG           | NOx           | CO            | SO2                | Fugitive PM10 | Exhaust PM10       | PM10 Total    | Fugitive PM2.5 | Exhaust PM2.5      | PM2.5 Total   | Bio- CO2 | NBio- CO2       | Total CO2       | CH4                | N2O                | CO2e            |
|--------------|---------------|---------------|---------------|--------------------|---------------|--------------------|---------------|----------------|--------------------|---------------|----------|-----------------|-----------------|--------------------|--------------------|-----------------|
| Category     | lb/day        |               |               |                    |               |                    |               |                |                    |               | lb/day   |                 |                 |                    |                    |                 |
| Hauling      | 0.0000        | 0.0000        | 0.0000        | 0.0000             | 0.0000        | 0.0000             | 0.0000        | 0.0000         | 0.0000             | 0.0000        |          | 0.0000          | 0.0000          | 0.0000             | 0.0000             | 0.0000          |
| Vendor       | 0.0000        | 0.0000        | 0.0000        | 0.0000             | 0.0000        | 0.0000             | 0.0000        | 0.0000         | 0.0000             | 0.0000        |          | 0.0000          | 0.0000          | 0.0000             | 0.0000             | 0.0000          |
| Worker       | 0.1061        | 0.0703        | 0.9405        | 2.4300e-003        | 0.2629        | 1.6600e-003        | 0.2645        | 0.0697         | 1.5300e-003        | 0.0713        |          | 245.3732        | 245.3732        | 7.8500e-003        | 6.7800e-003        | 247.5888        |
| <b>Total</b> | <b>0.1061</b> | <b>0.0703</b> | <b>0.9405</b> | <b>2.4300e-003</b> | <b>0.2629</b> | <b>1.6600e-003</b> | <b>0.2645</b> | <b>0.0697</b>  | <b>1.5300e-003</b> | <b>0.0713</b> |          | <b>245.3732</b> | <b>245.3732</b> | <b>7.8500e-003</b> | <b>6.7800e-003</b> | <b>247.5888</b> |



**EMFAC Off-Model Adjustment Factors for Gasoline Light Duty Vehicle to Account for the SAFE Vehicle Rule Not Applied****Mitigated Construction On-Site**

|                 | ROG            | NOx           | CO            | SO2                | Fugitive PM10 | Exhaust PM10  | PM10 Total    | Fugitive PM2.5 | Exhaust PM2.5 | PM2.5 Total   | Bio- CO2      | NBio- CO2       | Total CO2       | CH4           | N2O | CO2e |                 |
|-----------------|----------------|---------------|---------------|--------------------|---------------|---------------|---------------|----------------|---------------|---------------|---------------|-----------------|-----------------|---------------|-----|------|-----------------|
| Category        | lb/day         |               |               |                    |               |               |               |                |               |               | lb/day        |                 |                 |               |     |      |                 |
| Archit. Coating | 87.9964        |               |               |                    |               | 0.0000        | 0.0000        |                | 0.0000        | 0.0000        |               |                 | 0.0000          |               |     |      | 0.0000          |
| Off-Road        | 0.1917         | 1.3030        | 1.8111        | 2.9700e-003        |               | 0.0708        | 0.0708        |                | 0.0708        | 0.0708        | 0.0000        | 281.4481        | 281.4481        | 0.0168        |     |      | 281.8690        |
| <b>Total</b>    | <b>88.1881</b> | <b>1.3030</b> | <b>1.8111</b> | <b>2.9700e-003</b> |               | <b>0.0708</b> | <b>0.0708</b> |                | <b>0.0708</b> | <b>0.0708</b> | <b>0.0000</b> | <b>281.4481</b> | <b>281.4481</b> | <b>0.0168</b> |     |      | <b>281.8690</b> |

**Mitigated Construction Off-Site**

|              | ROG           | NOx           | CO            | SO2                | Fugitive PM10 | Exhaust PM10       | PM10 Total    | Fugitive PM2.5 | Exhaust PM2.5      | PM2.5 Total   | Bio- CO2 | NBio- CO2       | Total CO2       | CH4                | N2O                | CO2e            |
|--------------|---------------|---------------|---------------|--------------------|---------------|--------------------|---------------|----------------|--------------------|---------------|----------|-----------------|-----------------|--------------------|--------------------|-----------------|
| Category     | lb/day        |               |               |                    |               |                    |               |                |                    |               | lb/day   |                 |                 |                    |                    |                 |
| Hauling      | 0.0000        | 0.0000        | 0.0000        | 0.0000             | 0.0000        | 0.0000             | 0.0000        | 0.0000         | 0.0000             | 0.0000        |          | 0.0000          | 0.0000          | 0.0000             | 0.0000             | 0.0000          |
| Vendor       | 0.0000        | 0.0000        | 0.0000        | 0.0000             | 0.0000        | 0.0000             | 0.0000        | 0.0000         | 0.0000             | 0.0000        |          | 0.0000          | 0.0000          | 0.0000             | 0.0000             | 0.0000          |
| Worker       | 0.1061        | 0.0703        | 0.9405        | 2.4300e-003        | 0.2629        | 1.6600e-003        | 0.2645        | 0.0697         | 1.5300e-003        | 0.0713        |          | 245.3732        | 245.3732        | 7.8500e-003        | 6.7800e-003        | 247.5888        |
| <b>Total</b> | <b>0.1061</b> | <b>0.0703</b> | <b>0.9405</b> | <b>2.4300e-003</b> | <b>0.2629</b> | <b>1.6600e-003</b> | <b>0.2645</b> | <b>0.0697</b>  | <b>1.5300e-003</b> | <b>0.0713</b> |          | <b>245.3732</b> | <b>245.3732</b> | <b>7.8500e-003</b> | <b>6.7800e-003</b> | <b>247.5888</b> |

**EMFAC Off-Model Adjustment Factors for Gasoline Light Duty Vehicle to Account for the SAFE Vehicle Rule Not Applied**

**CSUMB Master Plan - Construction  
Monterey Bay Unified APCD Air District, Winter**

**1.0 Project Characteristics**

**1.1 Land Usage**

| Land Uses                  | Size     | Metric  | Lot Acreage | Floor Surface Area | Population |
|----------------------------|----------|---------|-------------|--------------------|------------|
| University/College (4yr)   | 1,634.00 | Student | 6.89        | 300,000.00         | 0          |
| Other Non-Asphalt Surfaces | 1.80     | Acre    | 1.80        | 78,408.00          | 0          |

**1.2 Other Project Characteristics**

|                                |                                  |                                |       |                                  |       |
|--------------------------------|----------------------------------|--------------------------------|-------|----------------------------------|-------|
| <b>Urbanization</b>            | Urban                            | <b>Wind Speed (m/s)</b>        | 2.8   | <b>Precipitation Freq (Days)</b> | 53    |
| <b>Climate Zone</b>            | 4                                |                                |       | <b>Operational Year</b>          | 2024  |
| <b>Utility Company</b>         | Pacific Gas and Electric Company |                                |       |                                  |       |
| <b>CO2 Intensity (lb/MWhr)</b> | 203.98                           | <b>CH4 Intensity (lb/MWhr)</b> | 0.033 | <b>N2O Intensity (lb/MWhr)</b>   | 0.004 |

**1.3 User Entered Comments & Non-Default Data**

Project Characteristics - CSU Monterey Bay Master Plan. MBARD. Construction Scenario.

Land Use - Maximum development of approximately 300 GSF and 1.8 acres of paving.

Construction Phase - Default schedule assumed.

Off-road Equipment - Default equipment

Off-road Equipment - Default equipment

Off-road Equipment - Default equipment

Off-road Equipment - Default equipment

**EMFAC Off-Model Adjustment Factors for Gasoline Light Duty Vehicle to Account for the SAFE Vehicle Rule Not Applied**

Off-road Equipment - Default equipment

Off-road Equipment - Default equipment

Demolition - Assume demolition of 10,500 SF.

Grading -

Trips and VMT - Default trips

Construction Off-road Equipment Mitigation - Water twice daily

Architectural Coating - MBARD Rule 426 - interior 50 g/L, exterior 100 g/L

| Table Name              | Column Name                | Default Value | New Value  |
|-------------------------|----------------------------|---------------|------------|
| tblArchitecturalCoating | EF_Nonresidential_Exterior | 150.00        | 100.00     |
| tblArchitecturalCoating | EF_Nonresidential_Interior | 150.00        | 50.00      |
| tblArchitecturalCoating | EF_Parking                 | 150.00        | 100.00     |
| tblLandUse              | LandUseSquareFeet          | 300,325.06    | 300,000.00 |
| tblTripsAndVMT          | HaulingTripNumber          | 48.00         | 200.00     |

**EMFAC Off-Model Adjustment Factors for Gasoline Light Duty Vehicle to Account for the SAFE Vehicle Rule Not Applied**

**2.0 Emissions Summary**

**2.1 Overall Construction (Maximum Daily Emission)**

**Unmitigated Construction**

|         | ROG     | NOx     | CO      | SO2    | Fugitive PM10 | Exhaust PM10 | PM10 Total | Fugitive PM2.5 | Exhaust PM2.5 | PM2.5 Total | Bio- CO2 | NBio- CO2  | Total CO2  | CH4    | N2O    | CO2e       |
|---------|---------|---------|---------|--------|---------------|--------------|------------|----------------|---------------|-------------|----------|------------|------------|--------|--------|------------|
| Year    | lb/day  |         |         |        |               |              |            |                |               |             | lb/day   |            |            |        |        |            |
| 2022    | 3.2384  | 33.1397 | 22.5728 | 0.0520 | 19.8049       | 1.6136       | 21.4184    | 10.1417        | 1.4845        | 11.6262     | 0.0000   | 5,149.6884 | 5,149.6884 | 1.1977 | 0.2495 | 5,240.9286 |
| 2023    | 88.3009 | 18.0400 | 21.8829 | 0.0512 | 1.7261        | 0.7282       | 2.4543     | 0.4674         | 0.6853        | 1.1527      | 0.0000   | 5,069.6292 | 5,069.6292 | 0.7181 | 0.2392 | 5,157.4826 |
| Maximum | 88.3009 | 33.1397 | 22.5728 | 0.0520 | 19.8049       | 1.6136       | 21.4184    | 10.1417        | 1.4845        | 11.6262     | 0.0000   | 5,149.6884 | 5,149.6884 | 1.1977 | 0.2495 | 5,240.9286 |

**Mitigated Construction**

|         | ROG     | NOx     | CO      | SO2    | Fugitive PM10 | Exhaust PM10 | PM10 Total | Fugitive PM2.5 | Exhaust PM2.5 | PM2.5 Total | Bio- CO2 | NBio- CO2  | Total CO2  | CH4    | N2O    | CO2e       |
|---------|---------|---------|---------|--------|---------------|--------------|------------|----------------|---------------|-------------|----------|------------|------------|--------|--------|------------|
| Year    | lb/day  |         |         |        |               |              |            |                |               |             | lb/day   |            |            |        |        |            |
| 2022    | 3.2384  | 33.1397 | 22.5728 | 0.0520 | 8.9935        | 1.6136       | 10.6071    | 4.5853         | 1.4845        | 6.0698      | 0.0000   | 5,149.6884 | 5,149.6884 | 1.1977 | 0.2495 | 5,240.9286 |
| 2023    | 88.3009 | 18.0400 | 21.8829 | 0.0512 | 1.7261        | 0.7282       | 2.4543     | 0.4674         | 0.6853        | 1.1527      | 0.0000   | 5,069.6292 | 5,069.6292 | 0.7181 | 0.2392 | 5,157.4825 |
| Maximum | 88.3009 | 33.1397 | 22.5728 | 0.0520 | 8.9935        | 1.6136       | 10.6071    | 4.5853         | 1.4845        | 6.0698      | 0.0000   | 5,149.6884 | 5,149.6884 | 1.1977 | 0.2495 | 5,240.9286 |

**EMFAC Off-Model Adjustment Factors for Gasoline Light Duty Vehicle to Account for the SAFE Vehicle Rule Not Applied**

|                   | ROG  | NOx  | CO   | SO2  | Fugitive PM10 | Exhaust PM10 | PM10 Total | Fugitive PM2.5 | Exhaust PM2.5 | PM2.5 Total | Bio- CO2 | NBio-CO2 | Total CO2 | CH4  | N2O  | CO2e |
|-------------------|------|------|------|------|---------------|--------------|------------|----------------|---------------|-------------|----------|----------|-----------|------|------|------|
| Percent Reduction | 0.00 | 0.00 | 0.00 | 0.00 | 50.21         | 0.00         | 45.29      | 52.37          | 0.00          | 43.48       | 0.00     | 0.00     | 0.00      | 0.00 | 0.00 | 0.00 |

**3.0 Construction Detail****Construction Phase**

| Phase Number | Phase Name            | Phase Type            | Start Date | End Date  | Num Days Week | Num Days | Phase Description |
|--------------|-----------------------|-----------------------|------------|-----------|---------------|----------|-------------------|
| 1            | Demolition            | Demolition            | 1/3/2022   | 1/28/2022 | 5             | 20       |                   |
| 2            | Site Preparation      | Site Preparation      | 1/29/2022  | 2/11/2022 | 5             | 10       |                   |
| 3            | Grading               | Grading               | 2/12/2022  | 3/11/2022 | 5             | 20       |                   |
| 4            | Building Construction | Building Construction | 3/12/2022  | 1/27/2023 | 5             | 230      |                   |
| 5            | Paving                | Paving                | 1/28/2023  | 2/24/2023 | 5             | 20       |                   |
| 6            | Architectural Coating | Architectural Coating | 2/25/2023  | 3/24/2023 | 5             | 20       |                   |

Acres of Grading (Site Preparation Phase): 15

Acres of Grading (Grading Phase): 20

Acres of Paving: 1.8

Residential Indoor: 0; Residential Outdoor: 0; Non-Residential Indoor: 450,000; Non-Residential Outdoor: 150,000; Striped Parking Area: 4,704

**EMFAC Off-Model Adjustment Factors for Gasoline Light Duty Vehicle to Account for the SAFE Vehicle Rule Not Applied****OffRoad Equipment**

| Phase Name            | Offroad Equipment Type    | Amount | Usage Hours | Horse Power | Load Factor |
|-----------------------|---------------------------|--------|-------------|-------------|-------------|
| Demolition            | Concrete/Industrial Saws  | 1      | 8.00        | 81          | 0.73        |
| Demolition            | Excavators                | 3      | 8.00        | 158         | 0.38        |
| Demolition            | Rubber Tired Dozers       | 2      | 8.00        | 247         | 0.40        |
| Site Preparation      | Rubber Tired Dozers       | 3      | 8.00        | 247         | 0.40        |
| Site Preparation      | Tractors/Loaders/Backhoes | 4      | 8.00        | 97          | 0.37        |
| Grading               | Excavators                | 1      | 8.00        | 158         | 0.38        |
| Grading               | Graders                   | 1      | 8.00        | 187         | 0.41        |
| Grading               | Rubber Tired Dozers       | 1      | 8.00        | 247         | 0.40        |
| Grading               | Tractors/Loaders/Backhoes | 3      | 8.00        | 97          | 0.37        |
| Building Construction | Cranes                    | 1      | 7.00        | 231         | 0.29        |
| Building Construction | Forklifts                 | 3      | 8.00        | 89          | 0.20        |
| Building Construction | Generator Sets            | 1      | 8.00        | 84          | 0.74        |
| Building Construction | Tractors/Loaders/Backhoes | 3      | 7.00        | 97          | 0.37        |
| Building Construction | Welders                   | 1      | 8.00        | 46          | 0.45        |
| Paving                | Pavers                    | 2      | 8.00        | 130         | 0.42        |
| Paving                | Paving Equipment          | 2      | 8.00        | 132         | 0.36        |
| Paving                | Rollers                   | 2      | 8.00        | 80          | 0.38        |
| Architectural Coating | Air Compressors           | 1      | 6.00        | 78          | 0.48        |

**EMFAC Off-Model Adjustment Factors for Gasoline Light Duty Vehicle to Account for the SAFE Vehicle Rule Not Applied**

**Trips and VMT**

| Phase Name            | Offroad Equipment Count | Worker Trip Number | Vendor Trip Number | Hauling Trip Number | Worker Trip Length | Vendor Trip Length | Hauling Trip Length | Worker Vehicle Class | Vendor Vehicle Class | Hauling Vehicle Class |
|-----------------------|-------------------------|--------------------|--------------------|---------------------|--------------------|--------------------|---------------------|----------------------|----------------------|-----------------------|
| Demolition            | 6                       | 15.00              | 0.00               | 200.00              | 10.80              | 7.30               | 20.00               | LD_Mix               | HDT_Mix              | HHDT                  |
| Site Preparation      | 7                       | 18.00              | 0.00               | 0.00                | 10.80              | 7.30               | 20.00               | LD_Mix               | HDT_Mix              | HHDT                  |
| Grading               | 6                       | 15.00              | 0.00               | 0.00                | 10.80              | 7.30               | 20.00               | LD_Mix               | HDT_Mix              | HHDT                  |
| Building Construction | 9                       | 159.00             | 62.00              | 0.00                | 10.80              | 7.30               | 20.00               | LD_Mix               | HDT_Mix              | HHDT                  |
| Paving                | 6                       | 15.00              | 0.00               | 0.00                | 10.80              | 7.30               | 20.00               | LD_Mix               | HDT_Mix              | HHDT                  |
| Architectural Coating | 1                       | 32.00              | 0.00               | 0.00                | 10.80              | 7.30               | 20.00               | LD_Mix               | HDT_Mix              | HHDT                  |

**3.1 Mitigation Measures Construction**

Water Exposed Area

**EMFAC Off-Model Adjustment Factors for Gasoline Light Duty Vehicle to Account for the SAFE Vehicle Rule Not Applied**

**3.2 Demolition - 2022**

**Unmitigated Construction On-Site**

|               | ROG           | NOx            | CO             | SO2           | Fugitive PM10 | Exhaust PM10  | PM10 Total    | Fugitive PM2.5 | Exhaust PM2.5 | PM2.5 Total   | Bio- CO2 | NBio- CO2         | Total CO2         | CH4           | N2O | CO2e              |
|---------------|---------------|----------------|----------------|---------------|---------------|---------------|---------------|----------------|---------------|---------------|----------|-------------------|-------------------|---------------|-----|-------------------|
| Category      | lb/day        |                |                |               |               |               |               |                |               |               | lb/day   |                   |                   |               |     |                   |
| Fugitive Dust |               |                |                |               | 0.5266        | 0.0000        | 0.5266        | 0.0797         | 0.0000        | 0.0797        |          |                   | 0.0000            |               |     | 0.0000            |
| Off-Road      | 2.6392        | 25.7194        | 20.5941        | 0.0388        |               | 1.2427        | 1.2427        |                | 1.1553        | 1.1553        |          | 3,746.7812        | 3,746.7812        | 1.0524        |     | 3,773.0920        |
| <b>Total</b>  | <b>2.6392</b> | <b>25.7194</b> | <b>20.5941</b> | <b>0.0388</b> | <b>0.5266</b> | <b>1.2427</b> | <b>1.7692</b> | <b>0.0797</b>  | <b>1.1553</b> | <b>1.2350</b> |          | <b>3,746.7812</b> | <b>3,746.7812</b> | <b>1.0524</b> |     | <b>3,773.0920</b> |

**Unmitigated Construction Off-Site**

|              | ROG           | NOx           | CO            | SO2                | Fugitive PM10 | Exhaust PM10  | PM10 Total    | Fugitive PM2.5 | Exhaust PM2.5 | PM2.5 Total   | Bio- CO2 | NBio- CO2       | Total CO2       | CH4           | N2O           | CO2e            |
|--------------|---------------|---------------|---------------|--------------------|---------------|---------------|---------------|----------------|---------------|---------------|----------|-----------------|-----------------|---------------|---------------|-----------------|
| Category     | lb/day        |               |               |                    |               |               |               |                |               |               | lb/day   |                 |                 |               |               |                 |
| Hauling      | 0.0382        | 1.7269        | 0.3288        | 6.2400e-003        | 0.1750        | 0.0162        | 0.1912        | 0.0480         | 0.0155        | 0.0635        |          | 666.8525        | 666.8525        | 7.7700e-003   | 0.1051        | 698.3671        |
| Vendor       | 0.0000        | 0.0000        | 0.0000        | 0.0000             | 0.0000        | 0.0000        | 0.0000        | 0.0000         | 0.0000        | 0.0000        |          | 0.0000          | 0.0000          | 0.0000        | 0.0000        | 0.0000          |
| Worker       | 0.0569        | 0.0468        | 0.4763        | 1.1100e-003        | 0.1232        | 8.2000e-004   | 0.1241        | 0.0327         | 7.6000e-004   | 0.0334        |          | 112.2572        | 112.2572        | 4.6000e-003   | 4.0200e-003   | 113.5704        |
| <b>Total</b> | <b>0.0951</b> | <b>1.7737</b> | <b>0.8051</b> | <b>7.3500e-003</b> | <b>0.2982</b> | <b>0.0171</b> | <b>0.3152</b> | <b>0.0806</b>  | <b>0.0163</b> | <b>0.0969</b> |          | <b>779.1097</b> | <b>779.1097</b> | <b>0.0124</b> | <b>0.1091</b> | <b>811.9375</b> |



**EMFAC Off-Model Adjustment Factors for Gasoline Light Duty Vehicle to Account for the SAFE Vehicle Rule Not Applied**

**Mitigated Construction On-Site**

|               | ROG           | NOx            | CO             | SO2           | Fugitive PM10 | Exhaust PM10  | PM10 Total    | Fugitive PM2.5 | Exhaust PM2.5 | PM2.5 Total   | Bio- CO2      | NBio- CO2         | Total CO2         | CH4           | N2O | CO2e              |
|---------------|---------------|----------------|----------------|---------------|---------------|---------------|---------------|----------------|---------------|---------------|---------------|-------------------|-------------------|---------------|-----|-------------------|
| Category      | lb/day        |                |                |               |               |               |               |                |               |               | lb/day        |                   |                   |               |     |                   |
| Fugitive Dust |               |                |                |               | 0.2370        | 0.0000        | 0.2370        | 0.0359         | 0.0000        | 0.0359        |               |                   | 0.0000            |               |     | 0.0000            |
| Off-Road      | 2.6392        | 25.7194        | 20.5941        | 0.0388        |               | 1.2427        | 1.2427        |                | 1.1553        | 1.1553        | 0.0000        | 3,746.7812        | 3,746.7812        | 1.0524        |     | 3,773.0920        |
| <b>Total</b>  | <b>2.6392</b> | <b>25.7194</b> | <b>20.5941</b> | <b>0.0388</b> | <b>0.2370</b> | <b>1.2427</b> | <b>1.4796</b> | <b>0.0359</b>  | <b>1.1553</b> | <b>1.1911</b> | <b>0.0000</b> | <b>3,746.7812</b> | <b>3,746.7812</b> | <b>1.0524</b> |     | <b>3,773.0920</b> |

**Mitigated Construction Off-Site**

|              | ROG           | NOx           | CO            | SO2                | Fugitive PM10 | Exhaust PM10  | PM10 Total    | Fugitive PM2.5 | Exhaust PM2.5 | PM2.5 Total   | Bio- CO2 | NBio- CO2       | Total CO2       | CH4           | N2O           | CO2e            |
|--------------|---------------|---------------|---------------|--------------------|---------------|---------------|---------------|----------------|---------------|---------------|----------|-----------------|-----------------|---------------|---------------|-----------------|
| Category     | lb/day        |               |               |                    |               |               |               |                |               |               | lb/day   |                 |                 |               |               |                 |
| Hauling      | 0.0382        | 1.7269        | 0.3288        | 6.2400e-003        | 0.1750        | 0.0162        | 0.1912        | 0.0480         | 0.0155        | 0.0635        |          | 666.8525        | 666.8525        | 7.7700e-003   | 0.1051        | 698.3671        |
| Vendor       | 0.0000        | 0.0000        | 0.0000        | 0.0000             | 0.0000        | 0.0000        | 0.0000        | 0.0000         | 0.0000        | 0.0000        |          | 0.0000          | 0.0000          | 0.0000        | 0.0000        | 0.0000          |
| Worker       | 0.0569        | 0.0468        | 0.4763        | 1.1100e-003        | 0.1232        | 8.2000e-004   | 0.1241        | 0.0327         | 7.6000e-004   | 0.0334        |          | 112.2572        | 112.2572        | 4.6000e-003   | 4.0200e-003   | 113.5704        |
| <b>Total</b> | <b>0.0951</b> | <b>1.7737</b> | <b>0.8051</b> | <b>7.3500e-003</b> | <b>0.2982</b> | <b>0.0171</b> | <b>0.3152</b> | <b>0.0806</b>  | <b>0.0163</b> | <b>0.0969</b> |          | <b>779.1097</b> | <b>779.1097</b> | <b>0.0124</b> | <b>0.1091</b> | <b>811.9375</b> |

**EMFAC Off-Model Adjustment Factors for Gasoline Light Duty Vehicle to Account for the SAFE Vehicle Rule Not Applied**

**3.3 Site Preparation - 2022**

**Unmitigated Construction On-Site**

|               | ROG           | NOx            | CO             | SO2           | Fugitive PM10  | Exhaust PM10  | PM10 Total     | Fugitive PM2.5 | Exhaust PM2.5 | PM2.5 Total    | Bio- CO2 | NBio- CO2         | Total CO2         | CH4           | N2O | CO2e              |
|---------------|---------------|----------------|----------------|---------------|----------------|---------------|----------------|----------------|---------------|----------------|----------|-------------------|-------------------|---------------|-----|-------------------|
| Category      | lb/day        |                |                |               |                |               |                |                |               |                | lb/day   |                   |                   |               |     |                   |
| Fugitive Dust |               |                |                |               | 19.6570        | 0.0000        | 19.6570        | 10.1025        | 0.0000        | 10.1025        |          |                   | 0.0000            |               |     | 0.0000            |
| Off-Road      | 3.1701        | 33.0835        | 19.6978        | 0.0380        |                | 1.6126        | 1.6126         |                | 1.4836        | 1.4836         |          | 3,686.0619        | 3,686.0619        | 1.1922        |     | 3,715.8655        |
| <b>Total</b>  | <b>3.1701</b> | <b>33.0835</b> | <b>19.6978</b> | <b>0.0380</b> | <b>19.6570</b> | <b>1.6126</b> | <b>21.2696</b> | <b>10.1025</b> | <b>1.4836</b> | <b>11.5860</b> |          | <b>3,686.0619</b> | <b>3,686.0619</b> | <b>1.1922</b> |     | <b>3,715.8655</b> |

|              | ROG           | NOx           | CO            | SO2                | Fugitive PM10 | Exhaust PM10       | PM10 Total    | Fugitive PM2.5 | Exhaust PM2.5      | PM2.5 Total   | Bio- CO2 | NBio- CO2       | Total CO2       | CH4                | N2O                | CO2e            |
|--------------|---------------|---------------|---------------|--------------------|---------------|--------------------|---------------|----------------|--------------------|---------------|----------|-----------------|-----------------|--------------------|--------------------|-----------------|
| Category     | lb/day        |               |               |                    |               |                    |               |                |                    |               | lb/day   |                 |                 |                    |                    |                 |
| Hauling      | 0.0000        | 0.0000        | 0.0000        | 0.0000             | 0.0000        | 0.0000             | 0.0000        | 0.0000         | 0.0000             | 0.0000        |          | 0.0000          | 0.0000          | 0.0000             | 0.0000             | 0.0000          |
| Vendor       | 0.0000        | 0.0000        | 0.0000        | 0.0000             | 0.0000        | 0.0000             | 0.0000        | 0.0000         | 0.0000             | 0.0000        |          | 0.0000          | 0.0000          | 0.0000             | 0.0000             | 0.0000          |
| Worker       | 0.0682        | 0.0561        | 0.5715        | 1.3300e-003        | 0.1479        | 9.9000e-004        | 0.1489        | 0.0392         | 9.1000e-004        | 0.0401        |          | 134.7087        | 134.7087        | 5.5200e-003        | 4.8200e-003        | 136.2844        |
| <b>Total</b> | <b>0.0682</b> | <b>0.0561</b> | <b>0.5715</b> | <b>1.3300e-003</b> | <b>0.1479</b> | <b>9.9000e-004</b> | <b>0.1489</b> | <b>0.0392</b>  | <b>9.1000e-004</b> | <b>0.0401</b> |          | <b>134.7087</b> | <b>134.7087</b> | <b>5.5200e-003</b> | <b>4.8200e-003</b> | <b>136.2844</b> |

**EMFAC Off-Model Adjustment Factors for Gasoline Light Duty Vehicle to Account for the SAFE Vehicle Rule Not Applied**

**Mitigated Construction On-Site**

|               | ROG           | NOx            | CO             | SO2           | Fugitive PM10 | Exhaust PM10  | PM10 Total     | Fugitive PM2.5 | Exhaust PM2.5 | PM2.5 Total   | Bio- CO2      | NBio- CO2         | Total CO2         | CH4           | N2O | CO2e              |
|---------------|---------------|----------------|----------------|---------------|---------------|---------------|----------------|----------------|---------------|---------------|---------------|-------------------|-------------------|---------------|-----|-------------------|
| Category      | lb/day        |                |                |               |               |               |                |                |               |               | lb/day        |                   |                   |               |     |                   |
| Fugitive Dust |               |                |                |               | 8.8457        | 0.0000        | 8.8457         | 4.5461         | 0.0000        | 4.5461        |               |                   | 0.0000            |               |     | 0.0000            |
| Off-Road      | 3.1701        | 33.0835        | 19.6978        | 0.0380        |               | 1.6126        | 1.6126         |                | 1.4836        | 1.4836        | 0.0000        | 3,686.0619        | 3,686.0619        | 1.1922        |     | 3,715.8655        |
| <b>Total</b>  | <b>3.1701</b> | <b>33.0835</b> | <b>19.6978</b> | <b>0.0380</b> | <b>8.8457</b> | <b>1.6126</b> | <b>10.4582</b> | <b>4.5461</b>  | <b>1.4836</b> | <b>6.0297</b> | <b>0.0000</b> | <b>3,686.0619</b> | <b>3,686.0619</b> | <b>1.1922</b> |     | <b>3,715.8655</b> |

**Mitigated Construction Off-Site**

|              | ROG           | NOx           | CO            | SO2                | Fugitive PM10 | Exhaust PM10       | PM10 Total    | Fugitive PM2.5 | Exhaust PM2.5      | PM2.5 Total   | Bio- CO2 | NBio- CO2       | Total CO2       | CH4                | N2O                | CO2e            |
|--------------|---------------|---------------|---------------|--------------------|---------------|--------------------|---------------|----------------|--------------------|---------------|----------|-----------------|-----------------|--------------------|--------------------|-----------------|
| Category     | lb/day        |               |               |                    |               |                    |               |                |                    |               | lb/day   |                 |                 |                    |                    |                 |
| Hauling      | 0.0000        | 0.0000        | 0.0000        | 0.0000             | 0.0000        | 0.0000             | 0.0000        | 0.0000         | 0.0000             | 0.0000        |          | 0.0000          | 0.0000          | 0.0000             | 0.0000             | 0.0000          |
| Vendor       | 0.0000        | 0.0000        | 0.0000        | 0.0000             | 0.0000        | 0.0000             | 0.0000        | 0.0000         | 0.0000             | 0.0000        |          | 0.0000          | 0.0000          | 0.0000             | 0.0000             | 0.0000          |
| Worker       | 0.0682        | 0.0561        | 0.5715        | 1.3300e-003        | 0.1479        | 9.9000e-004        | 0.1489        | 0.0392         | 9.1000e-004        | 0.0401        |          | 134.7087        | 134.7087        | 5.5200e-003        | 4.8200e-003        | 136.2844        |
| <b>Total</b> | <b>0.0682</b> | <b>0.0561</b> | <b>0.5715</b> | <b>1.3300e-003</b> | <b>0.1479</b> | <b>9.9000e-004</b> | <b>0.1489</b> | <b>0.0392</b>  | <b>9.1000e-004</b> | <b>0.0401</b> |          | <b>134.7087</b> | <b>134.7087</b> | <b>5.5200e-003</b> | <b>4.8200e-003</b> | <b>136.2844</b> |

**EMFAC Off-Model Adjustment Factors for Gasoline Light Duty Vehicle to Account for the SAFE Vehicle Rule Not Applied**

**3.4 Grading - 2022**

**Unmitigated Construction On-Site**

|               | ROG           | NOx            | CO             | SO2           | Fugitive PM10 | Exhaust PM10  | PM10 Total    | Fugitive PM2.5 | Exhaust PM2.5 | PM2.5 Total   | Bio- CO2 | NBio- CO2         | Total CO2         | CH4           | N2O | CO2e              |
|---------------|---------------|----------------|----------------|---------------|---------------|---------------|---------------|----------------|---------------|---------------|----------|-------------------|-------------------|---------------|-----|-------------------|
| Category      | lb/day        |                |                |               |               |               |               |                |               |               | lb/day   |                   |                   |               |     |                   |
| Fugitive Dust |               |                |                |               | 7.0826        | 0.0000        | 7.0826        | 3.4247         | 0.0000        | 3.4247        |          |                   | 0.0000            |               |     | 0.0000            |
| Off-Road      | 1.9486        | 20.8551        | 15.2727        | 0.0297        |               | 0.9409        | 0.9409        |                | 0.8656        | 0.8656        |          | 2,872.0464        | 2,872.0464        | 0.9289        |     | 2,895.2684        |
| <b>Total</b>  | <b>1.9486</b> | <b>20.8551</b> | <b>15.2727</b> | <b>0.0297</b> | <b>7.0826</b> | <b>0.9409</b> | <b>8.0234</b> | <b>3.4247</b>  | <b>0.8656</b> | <b>4.2903</b> |          | <b>2,872.0464</b> | <b>2,872.0464</b> | <b>0.9289</b> |     | <b>2,895.2684</b> |

**Unmitigated Construction Off-Site**

|              | ROG           | NOx           | CO            | SO2                | Fugitive PM10 | Exhaust PM10       | PM10 Total    | Fugitive PM2.5 | Exhaust PM2.5      | PM2.5 Total   | Bio- CO2 | NBio- CO2       | Total CO2       | CH4                | N2O                | CO2e            |
|--------------|---------------|---------------|---------------|--------------------|---------------|--------------------|---------------|----------------|--------------------|---------------|----------|-----------------|-----------------|--------------------|--------------------|-----------------|
| Category     | lb/day        |               |               |                    |               |                    |               |                |                    |               | lb/day   |                 |                 |                    |                    |                 |
| Hauling      | 0.0000        | 0.0000        | 0.0000        | 0.0000             | 0.0000        | 0.0000             | 0.0000        | 0.0000         | 0.0000             | 0.0000        |          | 0.0000          | 0.0000          | 0.0000             | 0.0000             | 0.0000          |
| Vendor       | 0.0000        | 0.0000        | 0.0000        | 0.0000             | 0.0000        | 0.0000             | 0.0000        | 0.0000         | 0.0000             | 0.0000        |          | 0.0000          | 0.0000          | 0.0000             | 0.0000             | 0.0000          |
| Worker       | 0.0569        | 0.0468        | 0.4763        | 1.1100e-003        | 0.1232        | 8.2000e-004        | 0.1241        | 0.0327         | 7.6000e-004        | 0.0334        |          | 112.2572        | 112.2572        | 4.6000e-003        | 4.0200e-003        | 113.5704        |
| <b>Total</b> | <b>0.0569</b> | <b>0.0468</b> | <b>0.4763</b> | <b>1.1100e-003</b> | <b>0.1232</b> | <b>8.2000e-004</b> | <b>0.1241</b> | <b>0.0327</b>  | <b>7.6000e-004</b> | <b>0.0334</b> |          | <b>112.2572</b> | <b>112.2572</b> | <b>4.6000e-003</b> | <b>4.0200e-003</b> | <b>113.5704</b> |

**EMFAC Off-Model Adjustment Factors for Gasoline Light Duty Vehicle to Account for the SAFE Vehicle Rule Not Applied**

**Mitigated Construction On-Site**

|               | ROG           | NOx            | CO             | SO2           | Fugitive PM10 | Exhaust PM10  | PM10 Total    | Fugitive PM2.5 | Exhaust PM2.5 | PM2.5 Total   | Bio- CO2      | NBio- CO2         | Total CO2         | CH4           | N2O | CO2e              |
|---------------|---------------|----------------|----------------|---------------|---------------|---------------|---------------|----------------|---------------|---------------|---------------|-------------------|-------------------|---------------|-----|-------------------|
| Category      | lb/day        |                |                |               |               |               |               |                |               |               | lb/day        |                   |                   |               |     |                   |
| Fugitive Dust |               |                |                |               | 3.1872        | 0.0000        | 3.1872        | 1.5411         | 0.0000        | 1.5411        |               |                   | 0.0000            |               |     | 0.0000            |
| Off-Road      | 1.9486        | 20.8551        | 15.2727        | 0.0297        |               | 0.9409        | 0.9409        |                | 0.8656        | 0.8656        | 0.0000        | 2,872.0464        | 2,872.0464        | 0.9289        |     | 2,895.2684        |
| <b>Total</b>  | <b>1.9486</b> | <b>20.8551</b> | <b>15.2727</b> | <b>0.0297</b> | <b>3.1872</b> | <b>0.9409</b> | <b>4.1280</b> | <b>1.5411</b>  | <b>0.8656</b> | <b>2.4067</b> | <b>0.0000</b> | <b>2,872.0464</b> | <b>2,872.0464</b> | <b>0.9289</b> |     | <b>2,895.2684</b> |

**Mitigated Construction Off-Site**

|              | ROG           | NOx           | CO            | SO2                | Fugitive PM10 | Exhaust PM10       | PM10 Total    | Fugitive PM2.5 | Exhaust PM2.5      | PM2.5 Total   | Bio- CO2 | NBio- CO2       | Total CO2       | CH4                | N2O                | CO2e            |
|--------------|---------------|---------------|---------------|--------------------|---------------|--------------------|---------------|----------------|--------------------|---------------|----------|-----------------|-----------------|--------------------|--------------------|-----------------|
| Category     | lb/day        |               |               |                    |               |                    |               |                |                    |               | lb/day   |                 |                 |                    |                    |                 |
| Hauling      | 0.0000        | 0.0000        | 0.0000        | 0.0000             | 0.0000        | 0.0000             | 0.0000        | 0.0000         | 0.0000             | 0.0000        |          | 0.0000          | 0.0000          | 0.0000             | 0.0000             | 0.0000          |
| Vendor       | 0.0000        | 0.0000        | 0.0000        | 0.0000             | 0.0000        | 0.0000             | 0.0000        | 0.0000         | 0.0000             | 0.0000        |          | 0.0000          | 0.0000          | 0.0000             | 0.0000             | 0.0000          |
| Worker       | 0.0569        | 0.0468        | 0.4763        | 1.1100e-003        | 0.1232        | 8.2000e-004        | 0.1241        | 0.0327         | 7.6000e-004        | 0.0334        |          | 112.2572        | 112.2572        | 4.6000e-003        | 4.0200e-003        | 113.5704        |
| <b>Total</b> | <b>0.0569</b> | <b>0.0468</b> | <b>0.4763</b> | <b>1.1100e-003</b> | <b>0.1232</b> | <b>8.2000e-004</b> | <b>0.1241</b> | <b>0.0327</b>  | <b>7.6000e-004</b> | <b>0.0334</b> |          | <b>112.2572</b> | <b>112.2572</b> | <b>4.6000e-003</b> | <b>4.0200e-003</b> | <b>113.5704</b> |

**EMFAC Off-Model Adjustment Factors for Gasoline Light Duty Vehicle to Account for the SAFE Vehicle Rule Not Applied**

**3.5 Building Construction - 2022**

**Unmitigated Construction On-Site**

|              | ROG           | NOx            | CO             | SO2           | Fugitive PM10 | Exhaust PM10  | PM10 Total    | Fugitive PM2.5 | Exhaust PM2.5 | PM2.5 Total   | Bio- CO2 | NBio- CO2         | Total CO2         | CH4           | N2O | CO2e              |
|--------------|---------------|----------------|----------------|---------------|---------------|---------------|---------------|----------------|---------------|---------------|----------|-------------------|-------------------|---------------|-----|-------------------|
| Category     | lb/day        |                |                |               |               |               |               |                |               |               | lb/day   |                   |                   |               |     |                   |
| Off-Road     | 1.7062        | 15.6156        | 16.3634        | 0.0269        |               | 0.8090        | 0.8090        |                | 0.7612        | 0.7612        |          | 2,554.3336        | 2,554.3336        | 0.6120        |     | 2,569.6322        |
| <b>Total</b> | <b>1.7062</b> | <b>15.6156</b> | <b>16.3634</b> | <b>0.0269</b> |               | <b>0.8090</b> | <b>0.8090</b> |                | <b>0.7612</b> | <b>0.7612</b> |          | <b>2,554.3336</b> | <b>2,554.3336</b> | <b>0.6120</b> |     | <b>2,569.6322</b> |

**Unmitigated Construction Off-Site**

|              | ROG           | NOx           | CO            | SO2           | Fugitive PM10 | Exhaust PM10  | PM10 Total    | Fugitive PM2.5 | Exhaust PM2.5 | PM2.5 Total   | Bio- CO2 | NBio- CO2         | Total CO2         | CH4           | N2O           | CO2e              |
|--------------|---------------|---------------|---------------|---------------|---------------|---------------|---------------|----------------|---------------|---------------|----------|-------------------|-------------------|---------------|---------------|-------------------|
| Category     | lb/day        |               |               |               |               |               |               |                |               |               | lb/day   |                   |                   |               |               |                   |
| Hauling      | 0.0000        | 0.0000        | 0.0000        | 0.0000        | 0.0000        | 0.0000        | 0.0000        | 0.0000         | 0.0000        | 0.0000        |          | 0.0000            | 0.0000            | 0.0000        | 0.0000        | 0.0000            |
| Vendor       | 0.1450        | 3.8285        | 1.1611        | 0.0133        | 0.4200        | 0.0397        | 0.4596        | 0.1209         | 0.0379        | 0.1588        |          | 1,405.4282        | 1,405.4282        | 0.0145        | 0.2069        | 1,467.4505        |
| Worker       | 0.6028        | 0.4958        | 5.0483        | 0.0118        | 1.3062        | 8.7400e-003   | 1.3149        | 0.3465         | 8.0600e-003   | 0.3545        |          | 1,189.9266        | 1,189.9266        | 0.0488        | 0.0426        | 1,203.8458        |
| <b>Total</b> | <b>0.7478</b> | <b>4.3244</b> | <b>6.2094</b> | <b>0.0250</b> | <b>1.7261</b> | <b>0.0484</b> | <b>1.7745</b> | <b>0.4674</b>  | <b>0.0460</b> | <b>0.5133</b> |          | <b>2,595.3548</b> | <b>2,595.3548</b> | <b>0.0633</b> | <b>0.2495</b> | <b>2,671.2964</b> |

**EMFAC Off-Model Adjustment Factors for Gasoline Light Duty Vehicle to Account for the SAFE Vehicle Rule Not Applied**

**Mitigated Construction On-Site**

|              | ROG           | NOx            | CO             | SO2           | Fugitive PM10 | Exhaust PM10  | PM10 Total    | Fugitive PM2.5 | Exhaust PM2.5 | PM2.5 Total   | Bio- CO2      | NBio- CO2         | Total CO2         | CH4           | N2O | CO2e              |
|--------------|---------------|----------------|----------------|---------------|---------------|---------------|---------------|----------------|---------------|---------------|---------------|-------------------|-------------------|---------------|-----|-------------------|
| Category     | lb/day        |                |                |               |               |               |               |                |               |               | lb/day        |                   |                   |               |     |                   |
| Off-Road     | 1.7062        | 15.6156        | 16.3634        | 0.0269        |               | 0.8090        | 0.8090        |                | 0.7612        | 0.7612        | 0.0000        | 2,554.3336        | 2,554.3336        | 0.6120        |     | 2,569.6322        |
| <b>Total</b> | <b>1.7062</b> | <b>15.6156</b> | <b>16.3634</b> | <b>0.0269</b> |               | <b>0.8090</b> | <b>0.8090</b> |                | <b>0.7612</b> | <b>0.7612</b> | <b>0.0000</b> | <b>2,554.3336</b> | <b>2,554.3336</b> | <b>0.6120</b> |     | <b>2,569.6322</b> |

**Mitigated Construction Off-Site**

|              | ROG           | NOx           | CO            | SO2           | Fugitive PM10 | Exhaust PM10  | PM10 Total    | Fugitive PM2.5 | Exhaust PM2.5 | PM2.5 Total   | Bio- CO2 | NBio- CO2         | Total CO2         | CH4           | N2O           | CO2e              |
|--------------|---------------|---------------|---------------|---------------|---------------|---------------|---------------|----------------|---------------|---------------|----------|-------------------|-------------------|---------------|---------------|-------------------|
| Category     | lb/day        |               |               |               |               |               |               |                |               |               | lb/day   |                   |                   |               |               |                   |
| Hauling      | 0.0000        | 0.0000        | 0.0000        | 0.0000        | 0.0000        | 0.0000        | 0.0000        | 0.0000         | 0.0000        | 0.0000        |          | 0.0000            | 0.0000            | 0.0000        | 0.0000        | 0.0000            |
| Vendor       | 0.1450        | 3.8285        | 1.1611        | 0.0133        | 0.4200        | 0.0397        | 0.4596        | 0.1209         | 0.0379        | 0.1588        |          | 1,405.4282        | 1,405.4282        | 0.0145        | 0.2069        | 1,467.4505        |
| Worker       | 0.6028        | 0.4958        | 5.0483        | 0.0118        | 1.3062        | 8.7400e-003   | 1.3149        | 0.3465         | 8.0600e-003   | 0.3545        |          | 1,189.9266        | 1,189.9266        | 0.0488        | 0.0426        | 1,203.8458        |
| <b>Total</b> | <b>0.7478</b> | <b>4.3244</b> | <b>6.2094</b> | <b>0.0250</b> | <b>1.7261</b> | <b>0.0484</b> | <b>1.7745</b> | <b>0.4674</b>  | <b>0.0460</b> | <b>0.5133</b> |          | <b>2,595.3548</b> | <b>2,595.3548</b> | <b>0.0633</b> | <b>0.2495</b> | <b>2,671.2964</b> |

**EMFAC Off-Model Adjustment Factors for Gasoline Light Duty Vehicle to Account for the SAFE Vehicle Rule Not Applied**

**3.5 Building Construction - 2023**

**Unmitigated Construction On-Site**

|              | ROG           | NOx            | CO             | SO2           | Fugitive PM10 | Exhaust PM10  | PM10 Total    | Fugitive PM2.5 | Exhaust PM2.5 | PM2.5 Total   | Bio- CO2 | NBio- CO2         | Total CO2         | CH4           | N2O | CO2e |                   |
|--------------|---------------|----------------|----------------|---------------|---------------|---------------|---------------|----------------|---------------|---------------|----------|-------------------|-------------------|---------------|-----|------|-------------------|
| Category     | lb/day        |                |                |               |               |               |               |                |               |               | lb/day   |                   |                   |               |     |      |                   |
| Off-Road     | 1.5728        | 14.3849        | 16.2440        | 0.0269        |               | 0.6997        | 0.6997        |                | 0.6584        | 0.6584        |          | 2,555.2099        | 2,555.2099        | 0.6079        |     |      | 2,570.4061        |
| <b>Total</b> | <b>1.5728</b> | <b>14.3849</b> | <b>16.2440</b> | <b>0.0269</b> |               | <b>0.6997</b> | <b>0.6997</b> |                | <b>0.6584</b> | <b>0.6584</b> |          | <b>2,555.2099</b> | <b>2,555.2099</b> | <b>0.6079</b> |     |      | <b>2,570.4061</b> |

**Unmitigated Construction Off-Site**

|              | ROG           | NOx           | CO            | SO2           | Fugitive PM10 | Exhaust PM10  | PM10 Total    | Fugitive PM2.5 | Exhaust PM2.5 | PM2.5 Total   | Bio- CO2 | NBio- CO2         | Total CO2         | CH4           | N2O           | CO2e              |
|--------------|---------------|---------------|---------------|---------------|---------------|---------------|---------------|----------------|---------------|---------------|----------|-------------------|-------------------|---------------|---------------|-------------------|
| Category     | lb/day        |               |               |               |               |               |               |                |               |               | lb/day   |                   |                   |               |               |                   |
| Hauling      | 0.0000        | 0.0000        | 0.0000        | 0.0000        | 0.0000        | 0.0000        | 0.0000        | 0.0000         | 0.0000        | 0.0000        |          | 0.0000            | 0.0000            | 0.0000        | 0.0000        | 0.0000            |
| Vendor       | 0.0871        | 3.2184        | 1.0115        | 0.0128        | 0.4200        | 0.0202        | 0.4402        | 0.1209         | 0.0193        | 0.1402        |          | 1,360.5808        | 1,360.5808        | 0.0117        | 0.2000        | 1,420.4704        |
| Worker       | 0.5604        | 0.4367        | 4.6274        | 0.0114        | 1.3062        | 8.2300e-003   | 1.3144        | 0.3465         | 7.5800e-003   | 0.3540        |          | 1,153.8385        | 1,153.8385        | 0.0439        | 0.0392        | 1,166.6061        |
| <b>Total</b> | <b>0.6475</b> | <b>3.6551</b> | <b>5.6389</b> | <b>0.0242</b> | <b>1.7261</b> | <b>0.0284</b> | <b>1.7546</b> | <b>0.4674</b>  | <b>0.0269</b> | <b>0.4943</b> |          | <b>2,514.4192</b> | <b>2,514.4192</b> | <b>0.0556</b> | <b>0.2392</b> | <b>2,587.0765</b> |



**EMFAC Off-Model Adjustment Factors for Gasoline Light Duty Vehicle to Account for the SAFE Vehicle Rule Not Applied**

**Mitigated Construction On-Site**

|              | ROG           | NOx            | CO             | SO2           | Fugitive PM10 | Exhaust PM10  | PM10 Total    | Fugitive PM2.5 | Exhaust PM2.5 | PM2.5 Total   | Bio- CO2      | NBio- CO2         | Total CO2         | CH4           | N2O | CO2e              |
|--------------|---------------|----------------|----------------|---------------|---------------|---------------|---------------|----------------|---------------|---------------|---------------|-------------------|-------------------|---------------|-----|-------------------|
| Category     | lb/day        |                |                |               |               |               |               |                |               |               | lb/day        |                   |                   |               |     |                   |
| Off-Road     | 1.5728        | 14.3849        | 16.2440        | 0.0269        |               | 0.6997        | 0.6997        |                | 0.6584        | 0.6584        | 0.0000        | 2,555.2099        | 2,555.2099        | 0.6079        |     | 2,570.4061        |
| <b>Total</b> | <b>1.5728</b> | <b>14.3849</b> | <b>16.2440</b> | <b>0.0269</b> |               | <b>0.6997</b> | <b>0.6997</b> |                | <b>0.6584</b> | <b>0.6584</b> | <b>0.0000</b> | <b>2,555.2099</b> | <b>2,555.2099</b> | <b>0.6079</b> |     | <b>2,570.4061</b> |

**Mitigated Construction Off-Site**

|              | ROG           | NOx           | CO            | SO2           | Fugitive PM10 | Exhaust PM10  | PM10 Total    | Fugitive PM2.5 | Exhaust PM2.5 | PM2.5 Total   | Bio- CO2 | NBio- CO2         | Total CO2         | CH4           | N2O           | CO2e              |
|--------------|---------------|---------------|---------------|---------------|---------------|---------------|---------------|----------------|---------------|---------------|----------|-------------------|-------------------|---------------|---------------|-------------------|
| Category     | lb/day        |               |               |               |               |               |               |                |               |               | lb/day   |                   |                   |               |               |                   |
| Hauling      | 0.0000        | 0.0000        | 0.0000        | 0.0000        | 0.0000        | 0.0000        | 0.0000        | 0.0000         | 0.0000        | 0.0000        |          | 0.0000            | 0.0000            | 0.0000        | 0.0000        | 0.0000            |
| Vendor       | 0.0871        | 3.2184        | 1.0115        | 0.0128        | 0.4200        | 0.0202        | 0.4402        | 0.1209         | 0.0193        | 0.1402        |          | 1,360.5808        | 1,360.5808        | 0.0117        | 0.2000        | 1,420.4704        |
| Worker       | 0.5604        | 0.4367        | 4.6274        | 0.0114        | 1.3062        | 8.2300e-003   | 1.3144        | 0.3465         | 7.5800e-003   | 0.3540        |          | 1,153.8385        | 1,153.8385        | 0.0439        | 0.0392        | 1,166.6061        |
| <b>Total</b> | <b>0.6475</b> | <b>3.6551</b> | <b>5.6389</b> | <b>0.0242</b> | <b>1.7261</b> | <b>0.0284</b> | <b>1.7546</b> | <b>0.4674</b>  | <b>0.0269</b> | <b>0.4943</b> |          | <b>2,514.4192</b> | <b>2,514.4192</b> | <b>0.0556</b> | <b>0.2392</b> | <b>2,587.0765</b> |

**EMFAC Off-Model Adjustment Factors for Gasoline Light Duty Vehicle to Account for the SAFE Vehicle Rule Not Applied**

**3.6 Paving - 2023**

**Unmitigated Construction On-Site**

|              | ROG           | NOx            | CO             | SO2           | Fugitive PM10 | Exhaust PM10  | PM10 Total    | Fugitive PM2.5 | Exhaust PM2.5 | PM2.5 Total   | Bio- CO2 | NBio- CO2         | Total CO2         | CH4           | N2O | CO2e              |
|--------------|---------------|----------------|----------------|---------------|---------------|---------------|---------------|----------------|---------------|---------------|----------|-------------------|-------------------|---------------|-----|-------------------|
| Category     | lb/day        |                |                |               |               |               |               |                |               |               | lb/day   |                   |                   |               |     |                   |
| Off-Road     | 1.0327        | 10.1917        | 14.5842        | 0.0228        |               | 0.5102        | 0.5102        |                | 0.4694        | 0.4694        |          | 2,207.5841        | 2,207.5841        | 0.7140        |     | 2,225.4336        |
| Paving       | 0.0000        |                |                |               |               | 0.0000        | 0.0000        |                | 0.0000        | 0.0000        |          |                   | 0.0000            |               |     | 0.0000            |
| <b>Total</b> | <b>1.0327</b> | <b>10.1917</b> | <b>14.5842</b> | <b>0.0228</b> |               | <b>0.5102</b> | <b>0.5102</b> |                | <b>0.4694</b> | <b>0.4694</b> |          | <b>2,207.5841</b> | <b>2,207.5841</b> | <b>0.7140</b> |     | <b>2,225.4336</b> |

**Unmitigated Construction Off-Site**

|              | ROG           | NOx           | CO            | SO2                | Fugitive PM10 | Exhaust PM10       | PM10 Total    | Fugitive PM2.5 | Exhaust PM2.5      | PM2.5 Total   | Bio- CO2 | NBio- CO2       | Total CO2       | CH4                | N2O                | CO2e            |
|--------------|---------------|---------------|---------------|--------------------|---------------|--------------------|---------------|----------------|--------------------|---------------|----------|-----------------|-----------------|--------------------|--------------------|-----------------|
| Category     | lb/day        |               |               |                    |               |                    |               |                |                    |               | lb/day   |                 |                 |                    |                    |                 |
| Hauling      | 0.0000        | 0.0000        | 0.0000        | 0.0000             | 0.0000        | 0.0000             | 0.0000        | 0.0000         | 0.0000             | 0.0000        |          | 0.0000          | 0.0000          | 0.0000             | 0.0000             | 0.0000          |
| Vendor       | 0.0000        | 0.0000        | 0.0000        | 0.0000             | 0.0000        | 0.0000             | 0.0000        | 0.0000         | 0.0000             | 0.0000        |          | 0.0000          | 0.0000          | 0.0000             | 0.0000             | 0.0000          |
| Worker       | 0.0529        | 0.0412        | 0.4366        | 1.0800e-003        | 0.1232        | 7.8000e-004        | 0.1240        | 0.0327         | 7.2000e-004        | 0.0334        |          | 108.8527        | 108.8527        | 4.1400e-003        | 3.6900e-003        | 110.0572        |
| <b>Total</b> | <b>0.0529</b> | <b>0.0412</b> | <b>0.4366</b> | <b>1.0800e-003</b> | <b>0.1232</b> | <b>7.8000e-004</b> | <b>0.1240</b> | <b>0.0327</b>  | <b>7.2000e-004</b> | <b>0.0334</b> |          | <b>108.8527</b> | <b>108.8527</b> | <b>4.1400e-003</b> | <b>3.6900e-003</b> | <b>110.0572</b> |

**EMFAC Off-Model Adjustment Factors for Gasoline Light Duty Vehicle to Account for the SAFE Vehicle Rule Not Applied**

**Mitigated Construction On-Site**

|              | ROG           | NOx            | CO             | SO2           | Fugitive PM10 | Exhaust PM10  | PM10 Total    | Fugitive PM2.5 | Exhaust PM2.5 | PM2.5 Total   | Bio- CO2      | NBio- CO2         | Total CO2         | CH4           | N2O | CO2e              |
|--------------|---------------|----------------|----------------|---------------|---------------|---------------|---------------|----------------|---------------|---------------|---------------|-------------------|-------------------|---------------|-----|-------------------|
| Category     | lb/day        |                |                |               |               |               |               |                |               |               | lb/day        |                   |                   |               |     |                   |
| Off-Road     | 1.0327        | 10.1917        | 14.5842        | 0.0228        |               | 0.5102        | 0.5102        |                | 0.4694        | 0.4694        | 0.0000        | 2,207.5841        | 2,207.5841        | 0.7140        |     | 2,225.4336        |
| Paving       | 0.0000        |                |                |               |               | 0.0000        | 0.0000        |                | 0.0000        | 0.0000        |               |                   | 0.0000            |               |     | 0.0000            |
| <b>Total</b> | <b>1.0327</b> | <b>10.1917</b> | <b>14.5842</b> | <b>0.0228</b> |               | <b>0.5102</b> | <b>0.5102</b> |                | <b>0.4694</b> | <b>0.4694</b> | <b>0.0000</b> | <b>2,207.5841</b> | <b>2,207.5841</b> | <b>0.7140</b> |     | <b>2,225.4336</b> |

**Mitigated Construction Off-Site**

|              | ROG           | NOx           | CO            | SO2                | Fugitive PM10 | Exhaust PM10       | PM10 Total    | Fugitive PM2.5 | Exhaust PM2.5      | PM2.5 Total   | Bio- CO2 | NBio- CO2       | Total CO2       | CH4                | N2O                | CO2e            |
|--------------|---------------|---------------|---------------|--------------------|---------------|--------------------|---------------|----------------|--------------------|---------------|----------|-----------------|-----------------|--------------------|--------------------|-----------------|
| Category     | lb/day        |               |               |                    |               |                    |               |                |                    |               | lb/day   |                 |                 |                    |                    |                 |
| Hauling      | 0.0000        | 0.0000        | 0.0000        | 0.0000             | 0.0000        | 0.0000             | 0.0000        | 0.0000         | 0.0000             | 0.0000        |          | 0.0000          | 0.0000          | 0.0000             | 0.0000             | 0.0000          |
| Vendor       | 0.0000        | 0.0000        | 0.0000        | 0.0000             | 0.0000        | 0.0000             | 0.0000        | 0.0000         | 0.0000             | 0.0000        |          | 0.0000          | 0.0000          | 0.0000             | 0.0000             | 0.0000          |
| Worker       | 0.0529        | 0.0412        | 0.4366        | 1.0800e-003        | 0.1232        | 7.8000e-004        | 0.1240        | 0.0327         | 7.2000e-004        | 0.0334        |          | 108.8527        | 108.8527        | 4.1400e-003        | 3.6900e-003        | 110.0572        |
| <b>Total</b> | <b>0.0529</b> | <b>0.0412</b> | <b>0.4366</b> | <b>1.0800e-003</b> | <b>0.1232</b> | <b>7.8000e-004</b> | <b>0.1240</b> | <b>0.0327</b>  | <b>7.2000e-004</b> | <b>0.0334</b> |          | <b>108.8527</b> | <b>108.8527</b> | <b>4.1400e-003</b> | <b>3.6900e-003</b> | <b>110.0572</b> |

**EMFAC Off-Model Adjustment Factors for Gasoline Light Duty Vehicle to Account for the SAFE Vehicle Rule Not Applied****3.7 Architectural Coating - 2023****Unmitigated Construction On-Site**

|                 | ROG            | NOx           | CO            | SO2                | Fugitive PM10 | Exhaust PM10  | PM10 Total    | Fugitive PM2.5 | Exhaust PM2.5 | PM2.5 Total   | Bio- CO2 | NBio- CO2       | Total CO2       | CH4           | N2O | CO2e            |
|-----------------|----------------|---------------|---------------|--------------------|---------------|---------------|---------------|----------------|---------------|---------------|----------|-----------------|-----------------|---------------|-----|-----------------|
| Category        | lb/day         |               |               |                    |               |               |               |                |               |               | lb/day   |                 |                 |               |     |                 |
| Archit. Coating | 87.9964        |               |               |                    |               | 0.0000        | 0.0000        |                | 0.0000        | 0.0000        |          |                 | 0.0000          |               |     | 0.0000          |
| Off-Road        | 0.1917         | 1.3030        | 1.8111        | 2.9700e-003        |               | 0.0708        | 0.0708        |                | 0.0708        | 0.0708        |          | 281.4481        | 281.4481        | 0.0168        |     | 281.8690        |
| <b>Total</b>    | <b>88.1881</b> | <b>1.3030</b> | <b>1.8111</b> | <b>2.9700e-003</b> |               | <b>0.0708</b> | <b>0.0708</b> |                | <b>0.0708</b> | <b>0.0708</b> |          | <b>281.4481</b> | <b>281.4481</b> | <b>0.0168</b> |     | <b>281.8690</b> |

**Unmitigated Construction Off-Site**

|              | ROG           | NOx           | CO            | SO2                | Fugitive PM10 | Exhaust PM10       | PM10 Total    | Fugitive PM2.5 | Exhaust PM2.5      | PM2.5 Total   | Bio- CO2 | NBio- CO2       | Total CO2       | CH4                | N2O                | CO2e            |
|--------------|---------------|---------------|---------------|--------------------|---------------|--------------------|---------------|----------------|--------------------|---------------|----------|-----------------|-----------------|--------------------|--------------------|-----------------|
| Category     | lb/day        |               |               |                    |               |                    |               |                |                    |               | lb/day   |                 |                 |                    |                    |                 |
| Hauling      | 0.0000        | 0.0000        | 0.0000        | 0.0000             | 0.0000        | 0.0000             | 0.0000        | 0.0000         | 0.0000             | 0.0000        |          | 0.0000          | 0.0000          | 0.0000             | 0.0000             | 0.0000          |
| Vendor       | 0.0000        | 0.0000        | 0.0000        | 0.0000             | 0.0000        | 0.0000             | 0.0000        | 0.0000         | 0.0000             | 0.0000        |          | 0.0000          | 0.0000          | 0.0000             | 0.0000             | 0.0000          |
| Worker       | 0.1128        | 0.0879        | 0.9313        | 2.3000e-003        | 0.2629        | 1.6600e-003        | 0.2645        | 0.0697         | 1.5300e-003        | 0.0713        |          | 232.2191        | 232.2191        | 8.8300e-003        | 7.8800e-003        | 234.7886        |
| <b>Total</b> | <b>0.1128</b> | <b>0.0879</b> | <b>0.9313</b> | <b>2.3000e-003</b> | <b>0.2629</b> | <b>1.6600e-003</b> | <b>0.2645</b> | <b>0.0697</b>  | <b>1.5300e-003</b> | <b>0.0713</b> |          | <b>232.2191</b> | <b>232.2191</b> | <b>8.8300e-003</b> | <b>7.8800e-003</b> | <b>234.7886</b> |

**EMFAC Off-Model Adjustment Factors for Gasoline Light Duty Vehicle to Account for the SAFE Vehicle Rule Not Applied**

**Mitigated Construction On-Site**

|                 | ROG            | NOx           | CO            | SO2                | Fugitive PM10 | Exhaust PM10  | PM10 Total    | Fugitive PM2.5 | Exhaust PM2.5 | PM2.5 Total   | Bio- CO2      | NBio- CO2       | Total CO2       | CH4           | N2O | CO2e            |
|-----------------|----------------|---------------|---------------|--------------------|---------------|---------------|---------------|----------------|---------------|---------------|---------------|-----------------|-----------------|---------------|-----|-----------------|
| Category        | lb/day         |               |               |                    |               |               |               |                |               |               | lb/day        |                 |                 |               |     |                 |
| Archit. Coating | 87.9964        |               |               |                    |               | 0.0000        | 0.0000        |                | 0.0000        | 0.0000        |               |                 | 0.0000          |               |     | 0.0000          |
| Off-Road        | 0.1917         | 1.3030        | 1.8111        | 2.9700e-003        |               | 0.0708        | 0.0708        |                | 0.0708        | 0.0708        | 0.0000        | 281.4481        | 281.4481        | 0.0168        |     | 281.8690        |
| <b>Total</b>    | <b>88.1881</b> | <b>1.3030</b> | <b>1.8111</b> | <b>2.9700e-003</b> |               | <b>0.0708</b> | <b>0.0708</b> |                | <b>0.0708</b> | <b>0.0708</b> | <b>0.0000</b> | <b>281.4481</b> | <b>281.4481</b> | <b>0.0168</b> |     | <b>281.8690</b> |

**Mitigated Construction Off-Site**

|              | ROG           | NOx           | CO            | SO2                | Fugitive PM10 | Exhaust PM10       | PM10 Total    | Fugitive PM2.5 | Exhaust PM2.5      | PM2.5 Total   | Bio- CO2 | NBio- CO2       | Total CO2       | CH4                | N2O                | CO2e            |
|--------------|---------------|---------------|---------------|--------------------|---------------|--------------------|---------------|----------------|--------------------|---------------|----------|-----------------|-----------------|--------------------|--------------------|-----------------|
| Category     | lb/day        |               |               |                    |               |                    |               |                |                    |               | lb/day   |                 |                 |                    |                    |                 |
| Hauling      | 0.0000        | 0.0000        | 0.0000        | 0.0000             | 0.0000        | 0.0000             | 0.0000        | 0.0000         | 0.0000             | 0.0000        |          | 0.0000          | 0.0000          | 0.0000             | 0.0000             | 0.0000          |
| Vendor       | 0.0000        | 0.0000        | 0.0000        | 0.0000             | 0.0000        | 0.0000             | 0.0000        | 0.0000         | 0.0000             | 0.0000        |          | 0.0000          | 0.0000          | 0.0000             | 0.0000             | 0.0000          |
| Worker       | 0.1128        | 0.0879        | 0.9313        | 2.3000e-003        | 0.2629        | 1.6600e-003        | 0.2645        | 0.0697         | 1.5300e-003        | 0.0713        |          | 232.2191        | 232.2191        | 8.8300e-003        | 7.8800e-003        | 234.7886        |
| <b>Total</b> | <b>0.1128</b> | <b>0.0879</b> | <b>0.9313</b> | <b>2.3000e-003</b> | <b>0.2629</b> | <b>1.6600e-003</b> | <b>0.2645</b> | <b>0.0697</b>  | <b>1.5300e-003</b> | <b>0.0713</b> |          | <b>232.2191</b> | <b>232.2191</b> | <b>8.8300e-003</b> | <b>7.8800e-003</b> | <b>234.7886</b> |

**EMFAC Off-Model Adjustment Factors for Gasoline Light Duty Vehicle to Account for the SAFE Vehicle Rule Applied**

**CSUMB - Master Plan Buildout (Annual)  
Monterey Bay Unified APCD Air District, Annual**

**1.0 Project Characteristics**

**1.1 Land Usage**

| Land Uses                | Size      | Metric        | Lot Acreage | Floor Surface Area | Population |
|--------------------------|-----------|---------------|-------------|--------------------|------------|
| University/College (4yr) | 12,700.00 | Student       | 53.59       | 2,060,401.00       | 0          |
| Apartments Mid Rise      | 9,020.00  | Dwelling Unit | 237.37      | 3,807,779.00       | 13920      |

**1.2 Other Project Characteristics**

|                                |                                  |                                |       |                                  |       |
|--------------------------------|----------------------------------|--------------------------------|-------|----------------------------------|-------|
| <b>Urbanization</b>            | Urban                            | <b>Wind Speed (m/s)</b>        | 2.8   | <b>Precipitation Freq (Days)</b> | 53    |
| <b>Climate Zone</b>            | 4                                |                                |       | <b>Operational Year</b>          | 2035  |
| <b>Utility Company</b>         | Pacific Gas and Electric Company |                                |       |                                  |       |
| <b>CO2 Intensity (lb/MWhr)</b> | 167                              | <b>CH4 Intensity (lb/MWhr)</b> | 0.033 | <b>N2O Intensity (lb/MWhr)</b>   | 0.004 |

**1.3 User Entered Comments & Non-Default Data**

Project Characteristics - CSUMB Master Plan. MBUAPCD.

Land Use - Total Master Plan (Campus: 2,256,767 and Student housing 3,807,779) and approved buildings (60,000) minus demolition (256,366) also includes 3,820 beds/1,220 DU. 12,700 FTE students and 1,220 DU occuied by staff/faculty.

Construction Phase - Modeling operations only.

Vehicle Trips - Update trip rate and trip length per TRA for annual emissions. Assumed 100% primary trips. Based Sunday trip rates from Junior College land use since since University default is 0. Adjusted calculated trip rate to match annual VMT.

Woodstoves - Assumed no fireplaces.

Area Coating - Use of low-VOC (50 g/L) arch coatings.

**EMFAC Off-Model Adjustment Factors for Gasoline Light Duty Vehicle to Account for the SAFE Vehicle Rule Applied**

Energy Use - Updated energy intensities based on date provided.

Water And Wastewater - Revised water and wastewater based on projections provided by CSUMB. Total demand in 2035 would be 427 AF building use and 290 AF for irrigation

Solid Waste - Default solid waste generation rates assumed.

Sequestration - Plant 2,030 new trees on campus.

Water Mitigation - RUWAP irrigation would account for 32% of outdoor irrigation water.

Waste Mitigation - Update per campus waste reduction goal.

| Table Name     | Column Name                     | Default Value | New Value |
|----------------|---------------------------------|---------------|-----------|
| tblAreaCoating | Area_EF_Nonresidential_Exterior | 150           | 50        |
| tblAreaCoating | Area_EF_Nonresidential_Interior | 150           | 50        |
| tblAreaCoating | Area_EF_Residential_Exterior    | 100           | 50        |
| tblAreaCoating | Area_EF_Residential_Interior    | 100           | 50        |
| tblAreaCoating | Area_Nonresidential_Exterior    | 1030200       | 1079895   |
| tblAreaCoating | Area_Nonresidential_Interior    | 3090600       | 3239685   |
| tblAreaCoating | Area_Residential_Exterior       | 2570252       | 2597252   |
| tblAreaCoating | Area_Residential_Interior       | 7710755       | 7791755   |
| tblEnergyUse   | LightingElect                   | 741.44        | 0.00      |
| tblEnergyUse   | LightingElect                   | 2.91          | 5.01      |
| tblEnergyUse   | NT24E                           | 3,054.10      | 0.00      |
| tblEnergyUse   | NT24E                           | 2.27          | 3.90      |
| tblEnergyUse   | NT24NG                          | 3,155.00      | 0.00      |
| tblEnergyUse   | NT24NG                          | 3.30          | 7.41      |
| tblEnergyUse   | T24E                            | 70.89         | 0.00      |
| tblEnergyUse   | T24E                            | 2.44          | 4.20      |
| tblEnergyUse   | T24NG                           | 5,226.68      | 0.00      |
| tblEnergyUse   | T24NG                           | 20.62         | 46.31     |

**EMFAC Off-Model Adjustment Factors for Gasoline Light Duty Vehicle to Account for the SAFE Vehicle Rule Applied**

|                           |                     |                |                |
|---------------------------|---------------------|----------------|----------------|
| tblFireplaces             | NumberGas           | 9,020.00       | 0.00           |
| tblFireplaces             | NumberNoFireplace   | 0.00           | 9,020.00       |
| tblLandUse                | LandUseSquareFeet   | 2,334,227.85   | 2,060,401.00   |
| tblLandUse                | LandUseSquareFeet   | 9,020,000.00   | 3,807,779.00   |
| tblLandUse                | Population          | 25,797.00      | 13,920.00      |
| tblProjectCharacteristics | CO2IntensityFactor  | 203.98         | 167            |
| tblSequestration          | NumberOfNewTrees    | 0.00           | 2,030.00       |
| tblVehicleTrips           | CC_TL               | 7.30           | 5.45           |
| tblVehicleTrips           | CNW_TL              | 7.30           | 5.45           |
| tblVehicleTrips           | CW_TL               | 9.50           | 5.45           |
| tblVehicleTrips           | DV_TP               | 9.00           | 0.00           |
| tblVehicleTrips           | HO_TL               | 7.50           | 0.00           |
| tblVehicleTrips           | HS_TL               | 7.30           | 0.00           |
| tblVehicleTrips           | HW_TL               | 10.80          | 0.00           |
| tblVehicleTrips           | PR_TP               | 91.00          | 100.00         |
| tblVehicleTrips           | ST_TR               | 4.91           | 0.00           |
| tblVehicleTrips           | ST_TR               | 1.30           | 2.62           |
| tblVehicleTrips           | SU_TR               | 4.09           | 0.00           |
| tblVehicleTrips           | SU_TR               | 0.00           | 0.19           |
| tblVehicleTrips           | WD_TR               | 5.44           | 0.00           |
| tblVehicleTrips           | WD_TR               | 1.56           | 3.14           |
| tblWater                  | IndoorWaterUseRate  | 587,689,311.11 | 0.00           |
| tblWater                  | IndoorWaterUseRate  | 27,191,970.00  | 139,138,377.00 |
| tblWater                  | OutdoorWaterUseRate | 370,499,783.09 | 0.00           |
| tblWater                  | OutdoorWaterUseRate | 42,531,030.00  | 94,496,790.00  |



**EMFAC Off-Model Adjustment Factors for Gasoline Light Duty Vehicle to Account for the SAFE Vehicle Rule Applied**

|                    |   |     |    |
|--------------------|---|-----|----|
| tblWaterMitigation | UseWaterEfficientIrrigationSystemPercentReduction | 6.1 | 32 |
|--------------------|---|-----|----|

**2.0 Emissions Summary**

**2.2 Overall Operational**

**Unmitigated Operational**

|              | ROG            | NOx            | CO              | SO2           | Fugitive PM10  | Exhaust PM10  | PM10 Total     | Fugitive PM2.5 | Exhaust PM2.5 | PM2.5 Total   | Bio- CO2          | NBio- CO2          | Total CO2          | CH4            | N2O           | CO2e               |
|--------------|----------------|----------------|-----------------|---------------|----------------|---------------|----------------|----------------|---------------|---------------|-------------------|--------------------|--------------------|----------------|---------------|--------------------|
| Category     | tons/yr        |                |                 |               |                |               |                |                |               |               | MT/yr             |                    |                    |                |               |                    |
| Area         | 27.4088        | 1.0709         | 92.8544         | 4.9200e-003   |                | 0.5164        | 0.5164         |                | 0.5164        | 0.5164        | 0.0000            | 152.2620           | 152.2620           | 0.1455         | 0.0000        | 155.8984           |
| Energy       | 0.5968         | 5.4256         | 4.5575          | 0.0326        |                | 0.4124        | 0.4124         |                | 0.4124        | 0.4124        | 0.0000            | 7,952.1695         | 7,952.1695         | 0.5175         | 0.1573        | 8,011.9764         |
| Mobile       | 10.3717        | 11.1493        | 95.4557         | 0.1921        | 24.7229        | 0.1298        | 24.8527        | 6.6013         | 0.1212        | 6.7224        | 0.0000            | 19,156.5259        | 19,156.5259        | 1.2318         | 0.8981        | 19,454.9370        |
| Waste        |                |                |                 |               |                | 0.0000        | 0.0000         |                | 0.0000        | 0.0000        | 1,312.7324        | 0.0000             | 1,312.7324         | 77.5803        | 0.0000        | 3,252.2390         |
| Water        |                |                |                 |               |                | 0.0000        | 0.0000         |                | 0.0000        | 0.0000        | 44.1422           | 82.0839            | 126.2261           | 4.5501         | 0.1090        | 272.4650           |
| <b>Total</b> | <b>38.3772</b> | <b>17.6458</b> | <b>192.8676</b> | <b>0.2295</b> | <b>24.7229</b> | <b>1.0586</b> | <b>25.7815</b> | <b>6.6013</b>  | <b>1.0499</b> | <b>7.6512</b> | <b>1,356.8746</b> | <b>27,343.0413</b> | <b>28,699.9159</b> | <b>84.0250</b> | <b>1.1644</b> | <b>31,147.5159</b> |

**EMFAC Off-Model Adjustment Factors for Gasoline Light Duty Vehicle to Account for the SAFE Vehicle Rule Applied**

**Mitigated Operational**

|              | ROG            | NOx            | CO              | SO2           | Fugitive PM10  | Exhaust PM10  | PM10 Total     | Fugitive PM2.5 | Exhaust PM2.5 | PM2.5 Total   | Bio- CO2        | NBio- CO2          | Total CO2          | CH4            | N2O           | CO2e               |
|--------------|----------------|----------------|-----------------|---------------|----------------|---------------|----------------|----------------|---------------|---------------|-----------------|--------------------|--------------------|----------------|---------------|--------------------|
| Category     | tons/yr        |                |                 |               |                |               |                |                |               |               | MT/yr           |                    |                    |                |               |                    |
| Area         | 27.4088        | 1.0709         | 92.8544         | 4.9200e-003   |                | 0.5164        | 0.5164         |                | 0.5164        | 0.5164        | 0.0000          | 152.2620           | 152.2620           | 0.1455         | 0.0000        | 155.8984           |
| Energy       | 0.5968         | 5.4256         | 4.5575          | 0.0326        |                | 0.4124        | 0.4124         |                | 0.4124        | 0.4124        | 0.0000          | 7,952.1695         | 7,952.1695         | 0.5175         | 0.1573        | 8,011.9764         |
| Mobile       | 10.3717        | 11.1493        | 95.4557         | 0.1921        | 24.7229        | 0.1298        | 24.8527        | 6.6013         | 0.1212        | 6.7224        | 0.0000          | 19,156.5259        | 19,156.5259        | 1.2318         | 0.8981        | 19,454.9370        |
| Waste        |                |                |                 |               |                | 0.0000        | 0.0000         |                | 0.0000        | 0.0000        | 131.2732        | 0.0000             | 131.2732           | 7.7580         | 0.0000        | 325.2239           |
| Water        |                |                |                 |               |                | 0.0000        | 0.0000         |                | 0.0000        | 0.0000        | 44.1422         | 74.0668            | 118.2090           | 4.5485         | 0.1088        | 264.3511           |
| <b>Total</b> | <b>38.3772</b> | <b>17.6458</b> | <b>192.8676</b> | <b>0.2295</b> | <b>24.7229</b> | <b>1.0586</b> | <b>25.7815</b> | <b>6.6013</b>  | <b>1.0499</b> | <b>7.6512</b> | <b>175.4154</b> | <b>27,335.0242</b> | <b>27,510.4396</b> | <b>14.2012</b> | <b>1.1642</b> | <b>28,212.3869</b> |

|                          | ROG         | NOx         | CO          | SO2         | Fugitive PM10 | Exhaust PM10 | PM10 Total  | Fugitive PM2.5 | Exhaust PM2.5 | PM2.5 Total | Bio- CO2     | NBio- CO2   | Total CO2   | CH4          | N2O         | CO2e        |
|--------------------------|-------------|-------------|-------------|-------------|---------------|--------------|-------------|----------------|---------------|-------------|--------------|-------------|-------------|--------------|-------------|-------------|
| <b>Percent Reduction</b> | <b>0.00</b> | <b>0.00</b> | <b>0.00</b> | <b>0.00</b> | <b>0.00</b>   | <b>0.00</b>  | <b>0.00</b> | <b>0.00</b>    | <b>0.00</b>   | <b>0.00</b> | <b>87.07</b> | <b>0.03</b> | <b>4.14</b> | <b>83.10</b> | <b>0.02</b> | <b>9.42</b> |

**EMFAC Off-Model Adjustment Factors for Gasoline Light Duty Vehicle to Account for the SAFE Vehicle Rule Applied**

**2.3 Vegetation**

**Vegetation**

|              | CO2e              |
|--------------|-------------------|
| Category     | MT                |
| New Trees    | 1,437.2400        |
| <b>Total</b> | <b>1,437.2400</b> |

**EMFAC Off-Model Adjustment Factors for Gasoline Light Duty Vehicle to Account for the SAFE Vehicle Rule Applied**

**4.0 Operational Detail - Mobile**

**4.1 Mitigation Measures Mobile**

|             | ROG     | NOx     | CO      | SO2    | Fugitive PM10 | Exhaust PM10 | PM10 Total | Fugitive PM2.5 | Exhaust PM2.5 | PM2.5 Total | Bio- CO2 | NBio- CO2   | Total CO2   | CH4    | N2O    | CO2e        |
|-------------|---------|---------|---------|--------|---------------|--------------|------------|----------------|---------------|-------------|----------|-------------|-------------|--------|--------|-------------|
| Category    | tons/yr |         |         |        |               |              |            |                |               |             | MT/yr    |             |             |        |        |             |
| Mitigated   | 10.3717 | 11.1493 | 95.4557 | 0.1921 | 24.7229       | 0.1298       | 24.8527    | 6.6013         | 0.1212        | 6.7224      | 0.0000   | 19,156.5259 | 19,156.5259 | 1.2318 | 0.8981 | 19,454.9370 |
| Unmitigated | 10.3717 | 11.1493 | 95.4557 | 0.1921 | 24.7229       | 0.1298       | 24.8527    | 6.6013         | 0.1212        | 6.7224      | 0.0000   | 19,156.5259 | 19,156.5259 | 1.2318 | 0.8981 | 19,454.9370 |

**4.2 Trip Summary Information**

| Land Use                 | Average Daily Trip Rate |                  |                 | Unmitigated       | Mitigated         |
|--------------------------|-------------------------|------------------|-----------------|-------------------|-------------------|
|                          | Weekday                 | Saturday         | Sunday          | Annual VMT        | Annual VMT        |
| Apartments Mid Rise      | 0.00                    | 0.00             | 0.00            |                   |                   |
| University/College (4yr) | 39,878.00               | 33,274.00        | 2,413.00        | 66,620,822        | 66,620,822        |
| <b>Total</b>             | <b>39,878.00</b>        | <b>33,274.00</b> | <b>2,413.00</b> | <b>66,620,822</b> | <b>66,620,822</b> |

**4.3 Trip Type Information**

| Land Use                 | Miles      |            |             | Trip %     |            |             | Trip Purpose % |          |         |
|--------------------------|------------|------------|-------------|------------|------------|-------------|----------------|----------|---------|
|                          | H-W or C-W | H-S or C-C | H-O or C-NW | H-W or C-W | H-S or C-C | H-O or C-NW | Primary        | Diverted | Pass-by |
| Apartments Mid Rise      | 0.00       | 0.00       | 0.00        | 44.00      | 18.80      | 37.20       | 86             | 11       | 3       |
| University/College (4yr) | 5.45       | 5.45       | 5.45        | 6.40       | 88.60      | 5.00        | 100            | 0        | 0       |

**EMFAC Off-Model Adjustment Factors for Gasoline Light Duty Vehicle to Account for the SAFE Vehicle Rule Applied**

**4.4 Fleet Mix**

| Land Use                 | LDA      | LDT1     | LDT2     | MDV      | LHD1     | LHD2     | MHD      | HHD      | OBUS     | UBUS     | MCY      | SBUS     | MH       |
|--------------------------|----------|----------|----------|----------|----------|----------|----------|----------|----------|----------|----------|----------|----------|
| Apartments Mid Rise      | 0.555052 | 0.055883 | 0.188820 | 0.126929 | 0.020456 | 0.005379 | 0.009845 | 0.008677 | 0.000965 | 0.000515 | 0.024108 | 0.001007 | 0.002365 |
| University/College (4yr) | 0.555052 | 0.055883 | 0.188820 | 0.126929 | 0.020456 | 0.005379 | 0.009845 | 0.008677 | 0.000965 | 0.000515 | 0.024108 | 0.001007 | 0.002365 |

**5.0 Energy Detail**

Historical Energy Use: N

**5.1 Mitigation Measures Energy**

|                         | ROG     | NOx    | CO     | SO2    | Fugitive PM10 | Exhaust PM10 | PM10 Total | Fugitive PM2.5 | Exhaust PM2.5 | PM2.5 Total | Bio- CO2 | NBio- CO2  | Total CO2  | CH4    | N2O    | CO2e       |
|-------------------------|---------|--------|--------|--------|---------------|--------------|------------|----------------|---------------|-------------|----------|------------|------------|--------|--------|------------|
| Category                | tons/yr |        |        |        |               |              |            |                |               |             | MT/yr    |            |            |        |        |            |
| Electricity Mitigated   |         |        |        |        |               | 0.0000       | 0.0000     |                | 0.0000        | 0.0000      | 0.0000   | 2,045.7092 | 2,045.7092 | 0.4042 | 0.0490 | 2,070.4169 |
| Electricity Unmitigated |         |        |        |        |               | 0.0000       | 0.0000     |                | 0.0000        | 0.0000      | 0.0000   | 2,045.7092 | 2,045.7092 | 0.4042 | 0.0490 | 2,070.4169 |
| NaturalGas Mitigated    | 0.5968  | 5.4256 | 4.5575 | 0.0326 |               | 0.4124       | 0.4124     |                | 0.4124        | 0.4124      | 0.0000   | 5,906.4604 | 5,906.4604 | 0.1132 | 0.1083 | 5,941.5595 |
| NaturalGas Unmitigated  | 0.5968  | 5.4256 | 4.5575 | 0.0326 |               | 0.4124       | 0.4124     |                | 0.4124        | 0.4124      | 0.0000   | 5,906.4604 | 5,906.4604 | 0.1132 | 0.1083 | 5,941.5595 |

**EMFAC Off-Model Adjustment Factors for Gasoline Light Duty Vehicle to Account for the SAFE Vehicle Rule Applied**

**5.2 Energy by Land Use - NaturalGas**

**Unmitigated**

|                          | NaturalGas Use | ROG           | NOx           | CO            | SO2           | Fugitive PM10 | Exhaust PM10  | PM10 Total    | Fugitive PM2.5 | Exhaust PM2.5 | PM2.5 Total   | Bio- CO2      | NBio- CO2         | Total CO2         | CH4           | N2O           | CO2e              |
|--------------------------|----------------|---------------|---------------|---------------|---------------|---------------|---------------|---------------|----------------|---------------|---------------|---------------|-------------------|-------------------|---------------|---------------|-------------------|
| Land Use                 | kBTU/yr        | tons/yr       |               |               |               |               |               |               |                |               |               | MT/yr         |                   |                   |               |               |                   |
| Apartments Mid Rise      | 0              | 0.0000        | 0.0000        | 0.0000        | 0.0000        |               | 0.0000        | 0.0000        |                | 0.0000        | 0.0000        | 0.0000        | 0.0000            | 0.0000            | 0.0000        | 0.0000        | 0.0000            |
| University/College (4yr) | 1.10683e+008   | 0.5968        | 5.4256        | 4.5575        | 0.0326        |               | 0.4124        | 0.4124        |                | 0.4124        | 0.4124        | 0.0000        | 5,906.4604        | 5,906.4604        | 0.1132        | 0.1083        | 5,941.5595        |
| <b>Total</b>             |                | <b>0.5968</b> | <b>5.4256</b> | <b>4.5575</b> | <b>0.0326</b> |               | <b>0.4124</b> | <b>0.4124</b> |                | <b>0.4124</b> | <b>0.4124</b> | <b>0.0000</b> | <b>5,906.4604</b> | <b>5,906.4604</b> | <b>0.1132</b> | <b>0.1083</b> | <b>5,941.5595</b> |

**Mitigated**

|                          | NaturalGas Use | ROG           | NOx           | CO            | SO2           | Fugitive PM10 | Exhaust PM10  | PM10 Total    | Fugitive PM2.5 | Exhaust PM2.5 | PM2.5 Total   | Bio- CO2      | NBio- CO2         | Total CO2         | CH4           | N2O           | CO2e              |
|--------------------------|----------------|---------------|---------------|---------------|---------------|---------------|---------------|---------------|----------------|---------------|---------------|---------------|-------------------|-------------------|---------------|---------------|-------------------|
| Land Use                 | kBTU/yr        | tons/yr       |               |               |               |               |               |               |                |               |               | MT/yr         |                   |                   |               |               |                   |
| Apartments Mid Rise      | 0              | 0.0000        | 0.0000        | 0.0000        | 0.0000        |               | 0.0000        | 0.0000        |                | 0.0000        | 0.0000        | 0.0000        | 0.0000            | 0.0000            | 0.0000        | 0.0000        | 0.0000            |
| University/College (4yr) | 1.10683e+008   | 0.5968        | 5.4256        | 4.5575        | 0.0326        |               | 0.4124        | 0.4124        |                | 0.4124        | 0.4124        | 0.0000        | 5,906.4604        | 5,906.4604        | 0.1132        | 0.1083        | 5,941.5595        |
| <b>Total</b>             |                | <b>0.5968</b> | <b>5.4256</b> | <b>4.5575</b> | <b>0.0326</b> |               | <b>0.4124</b> | <b>0.4124</b> |                | <b>0.4124</b> | <b>0.4124</b> | <b>0.0000</b> | <b>5,906.4604</b> | <b>5,906.4604</b> | <b>0.1132</b> | <b>0.1083</b> | <b>5,941.5595</b> |

**EMFAC Off-Model Adjustment Factors for Gasoline Light Duty Vehicle to Account for the SAFE Vehicle Rule Applied**

**5.3 Energy by Land Use - Electricity**

**Unmitigated**

|                          | Electricity Use | Total CO2         | CH4           | N2O           | CO2e              |
|--------------------------|-----------------|-------------------|---------------|---------------|-------------------|
| Land Use                 | kWh/yr          | MT/yr             |               |               |                   |
| Apartments Mid Rise      | 0               | 0.0000            | 0.0000        | 0.0000        | 0.0000            |
| University/College (4yr) | 2.70061e+007    | 2,045.7092        | 0.4042        | 0.0490        | 2,070.4169        |
| <b>Total</b>             |                 | <b>2,045.7092</b> | <b>0.4042</b> | <b>0.0490</b> | <b>2,070.4169</b> |

**Mitigated**

|                          | Electricity Use | Total CO2         | CH4           | N2O           | CO2e              |
|--------------------------|-----------------|-------------------|---------------|---------------|-------------------|
| Land Use                 | kWh/yr          | MT/yr             |               |               |                   |
| Apartments Mid Rise      | 0               | 0.0000            | 0.0000        | 0.0000        | 0.0000            |
| University/College (4yr) | 2.70061e+007    | 2,045.7092        | 0.4042        | 0.0490        | 2,070.4169        |
| <b>Total</b>             |                 | <b>2,045.7092</b> | <b>0.4042</b> | <b>0.0490</b> | <b>2,070.4169</b> |

**EMFAC Off-Model Adjustment Factors for Gasoline Light Duty Vehicle to Account for the SAFE Vehicle Rule Applied**

**6.0 Area Detail**

**6.1 Mitigation Measures Area**

|             | ROG     | NOx    | CO      | SO2         | Fugitive PM10 | Exhaust PM10 | PM10 Total | Fugitive PM2.5 | Exhaust PM2.5 | PM2.5 Total | Bio- CO2 | NBio- CO2 | Total CO2 | CH4    | N2O    | CO2e     |
|-------------|---------|--------|---------|-------------|---------------|--------------|------------|----------------|---------------|-------------|----------|-----------|-----------|--------|--------|----------|
| Category    | tons/yr |        |         |             |               |              |            |                |               |             | MT/yr    |           |           |        |        |          |
| Mitigated   | 27.4088 | 1.0709 | 92.8544 | 4.9200e-003 |               | 0.5164       | 0.5164     |                | 0.5164        | 0.5164      | 0.0000   | 152.2620  | 152.2620  | 0.1455 | 0.0000 | 155.8984 |
| Unmitigated | 27.4088 | 1.0709 | 92.8544 | 4.9200e-003 |               | 0.5164       | 0.5164     |                | 0.5164        | 0.5164      | 0.0000   | 152.2620  | 152.2620  | 0.1455 | 0.0000 | 155.8984 |

**6.2 Area by SubCategory**

**Unmitigated**

|                       | ROG            | NOx           | CO             | SO2                | Fugitive PM10 | Exhaust PM10  | PM10 Total    | Fugitive PM2.5 | Exhaust PM2.5 | PM2.5 Total   | Bio- CO2      | NBio- CO2       | Total CO2       | CH4           | N2O           | CO2e            |
|-----------------------|----------------|---------------|----------------|--------------------|---------------|---------------|---------------|----------------|---------------|---------------|---------------|-----------------|-----------------|---------------|---------------|-----------------|
| SubCategory           | tons/yr        |               |                |                    |               |               |               |                |               |               | MT/yr         |                 |                 |               |               |                 |
| Architectural Coating | 1.7044         |               |                |                    |               | 0.0000        | 0.0000        |                | 0.0000        | 0.0000        | 0.0000        | 0.0000          | 0.0000          | 0.0000        | 0.0000        | 0.0000          |
| Consumer Products     | 22.9182        |               |                |                    |               | 0.0000        | 0.0000        |                | 0.0000        | 0.0000        | 0.0000        | 0.0000          | 0.0000          | 0.0000        | 0.0000        | 0.0000          |
| Hearth                | 0.0000         | 0.0000        | 0.0000         | 0.0000             |               | 0.0000        | 0.0000        |                | 0.0000        | 0.0000        | 0.0000        | 0.0000          | 0.0000          | 0.0000        | 0.0000        | 0.0000          |
| Landscaping           | 2.7862         | 1.0709        | 92.8544        | 4.9200e-003        |               | 0.5164        | 0.5164        |                | 0.5164        | 0.5164        | 0.0000        | 152.2620        | 152.2620        | 0.1455        | 0.0000        | 155.8984        |
| <b>Total</b>          | <b>27.4088</b> | <b>1.0709</b> | <b>92.8544</b> | <b>4.9200e-003</b> |               | <b>0.5164</b> | <b>0.5164</b> |                | <b>0.5164</b> | <b>0.5164</b> | <b>0.0000</b> | <b>152.2620</b> | <b>152.2620</b> | <b>0.1455</b> | <b>0.0000</b> | <b>155.8984</b> |



**EMFAC Off-Model Adjustment Factors for Gasoline Light Duty Vehicle to Account for the SAFE Vehicle Rule Applied**

**Mitigated**

|                       | ROG            | NOx           | CO             | SO2                | Fugitive PM10 | Exhaust PM10  | PM10 Total    | Fugitive PM2.5 | Exhaust PM2.5 | PM2.5 Total   | Bio- CO2      | NBio- CO2       | Total CO2       | CH4           | N2O           | CO2e            |
|-----------------------|----------------|---------------|----------------|--------------------|---------------|---------------|---------------|----------------|---------------|---------------|---------------|-----------------|-----------------|---------------|---------------|-----------------|
| SubCategory           | tons/yr        |               |                |                    |               |               |               |                |               |               | MT/yr         |                 |                 |               |               |                 |
| Architectural Coating | 1.7044         |               |                |                    |               | 0.0000        | 0.0000        |                | 0.0000        | 0.0000        | 0.0000        | 0.0000          | 0.0000          | 0.0000        | 0.0000        | 0.0000          |
| Consumer Products     | 22.9182        |               |                |                    |               | 0.0000        | 0.0000        |                | 0.0000        | 0.0000        | 0.0000        | 0.0000          | 0.0000          | 0.0000        | 0.0000        | 0.0000          |
| Hearth                | 0.0000         | 0.0000        | 0.0000         | 0.0000             |               | 0.0000        | 0.0000        |                | 0.0000        | 0.0000        | 0.0000        | 0.0000          | 0.0000          | 0.0000        | 0.0000        | 0.0000          |
| Landscaping           | 2.7862         | 1.0709        | 92.8544        | 4.9200e-003        |               | 0.5164        | 0.5164        |                | 0.5164        | 0.5164        | 0.0000        | 152.2620        | 152.2620        | 0.1455        | 0.0000        | 155.8984        |
| <b>Total</b>          | <b>27.4088</b> | <b>1.0709</b> | <b>92.8544</b> | <b>4.9200e-003</b> |               | <b>0.5164</b> | <b>0.5164</b> |                | <b>0.5164</b> | <b>0.5164</b> | <b>0.0000</b> | <b>152.2620</b> | <b>152.2620</b> | <b>0.1455</b> | <b>0.0000</b> | <b>155.8984</b> |

**7.0 Water Detail**

**7.1 Mitigation Measures Water**

Use Water Efficient Irrigation System

**EMFAC Off-Model Adjustment Factors for Gasoline Light Duty Vehicle to Account for the SAFE Vehicle Rule Applied**

|             | Total CO2 | CH4    | N2O    | CO2e     |
|-------------|-----------|--------|--------|----------|
| Category    | MT/yr     |        |        |          |
| Mitigated   | 118.2090  | 4.5485 | 0.1088 | 264.3511 |
| Unmitigated | 126.2261  | 4.5501 | 0.1090 | 272.4650 |

**7.2 Water by Land Use**

**Unmitigated**

|                          | Indoor/Outdoor Use | Total CO2       | CH4           | N2O           | CO2e            |
|--------------------------|--------------------|-----------------|---------------|---------------|-----------------|
| Land Use                 | Mgal               | MT/yr           |               |               |                 |
| Apartments Mid Rise      | 0 / 0              | 0.0000          | 0.0000        | 0.0000        | 0.0000          |
| University/College (4yr) | 139.138 / 94.4968  | 126.2261        | 4.5501        | 0.1090        | 272.4650        |
| <b>Total</b>             |                    | <b>126.2261</b> | <b>4.5501</b> | <b>0.1090</b> | <b>272.4650</b> |

**EMFAC Off-Model Adjustment Factors for Gasoline Light Duty Vehicle to Account for the SAFE Vehicle Rule Applied**

**Mitigated**

| Indoor/Outdoor Use       |                   | Total CO2       | CH4           | N2O           | CO2e            |
|--------------------------|-------------------|-----------------|---------------|---------------|-----------------|
| Land Use                 | Mgal              | MT/yr           |               |               |                 |
| Apartments Mid Rise      | 0 / 0             | 0.0000          | 0.0000        | 0.0000        | 0.0000          |
| University/College (4yr) | 139.138 / 64.2578 | 118.2090        | 4.5485        | 0.1088        | 264.3511        |
| <b>Total</b>             |                   | <b>118.2090</b> | <b>4.5485</b> | <b>0.1088</b> | <b>264.3511</b> |

**8.0 Waste Detail**

**8.1 Mitigation Measures Waste**

Institute Recycling and Composting Services

**Category/Year**

|             | Total CO2  | CH4     | N2O    | CO2e       |
|-------------|------------|---------|--------|------------|
|             | MT/yr      |         |        |            |
| Mitigated   | 131.2732   | 7.7580  | 0.0000 | 325.2239   |
| Unmitigated | 1,312.7324 | 77.5803 | 0.0000 | 3,252.2390 |

**EMFAC Off-Model Adjustment Factors for Gasoline Light Duty Vehicle to Account for the SAFE Vehicle Rule Applied**

**8.2 Waste by Land Use**

**Unmitigated**

|                          | Waste Disposed | Total CO2         | CH4            | N2O           | CO2e              |
|--------------------------|----------------|-------------------|----------------|---------------|-------------------|
| Land Use                 | tons           | MT/yr             |                |               |                   |
| Apartments Mid Rise      | 4149.2         | 842.2501          | 49.7756        | 0.0000        | 2,086.6390        |
| University/College (4yr) | 2317.75        | 470.4823          | 27.8047        | 0.0000        | 1,165.6000        |
| <b>Total</b>             |                | <b>1,312.7324</b> | <b>77.5803</b> | <b>0.0000</b> | <b>3,252.2390</b> |

**Mitigated**

|                          | Waste Disposed | Total CO2       | CH4           | N2O           | CO2e            |
|--------------------------|----------------|-----------------|---------------|---------------|-----------------|
| Land Use                 | tons           | MT/yr           |               |               |                 |
| Apartments Mid Rise      | 414.92         | 84.2250         | 4.9776        | 0.0000        | 208.6639        |
| University/College (4yr) | 231.775        | 47.0482         | 2.7805        | 0.0000        | 116.5600        |
| <b>Total</b>             |                | <b>131.2732</b> | <b>7.7580</b> | <b>0.0000</b> | <b>325.2239</b> |

**EMFAC Off-Model Adjustment Factors for Gasoline Light Duty Vehicle to Account for the SAFE Vehicle Rule Applied**

**11.0 Vegetation**

|             | Total CO2  | CH4    | N2O    | CO2e       |
|-------------|------------|--------|--------|------------|
| Category    | MT         |        |        |            |
| Unmitigated | 1,437.2400 | 0.0000 | 0.0000 | 1,437.2400 |

**11.2 Net New Trees**

**Species Class**

|               | Number of Trees | Total CO2         | CH4           | N2O           | CO2e              |
|---------------|-----------------|-------------------|---------------|---------------|-------------------|
|               |                 | MT                |               |               |                   |
| Miscellaneous | 2030            | 1,437.2400        | 0.0000        | 0.0000        | 1,437.2400        |
| <b>Total</b>  |                 | <b>1,437.2400</b> | <b>0.0000</b> | <b>0.0000</b> | <b>1,437.2400</b> |

**EMFAC Off-Model Adjustment Factors for Gasoline Light Duty Vehicle to Account for the SAFE Vehicle Rule Applied**

**CSUMB - Master Plan Buildout (Daily)  
Monterey Bay Unified APCD Air District, Summer**

**1.0 Project Characteristics**

**1.1 Land Usage**

| Land Uses                | Size      | Metric        | Lot Acreage | Floor Surface Area | Population |
|--------------------------|-----------|---------------|-------------|--------------------|------------|
| University/College (4yr) | 12,700.00 | Student       | 53.59       | 2,060,401.00       | 0          |
| Apartments Mid Rise      | 9,020.00  | Dwelling Unit | 237.37      | 3,807,779.00       | 13920      |

**1.2 Other Project Characteristics**

|                                |                                  |                                |       |                                  |       |
|--------------------------------|----------------------------------|--------------------------------|-------|----------------------------------|-------|
| <b>Urbanization</b>            | Urban                            | <b>Wind Speed (m/s)</b>        | 2.8   | <b>Precipitation Freq (Days)</b> | 53    |
| <b>Climate Zone</b>            | 4                                |                                |       | <b>Operational Year</b>          | 2035  |
| <b>Utility Company</b>         | Pacific Gas and Electric Company |                                |       |                                  |       |
| <b>CO2 Intensity (lb/MWhr)</b> | 167                              | <b>CH4 Intensity (lb/MWhr)</b> | 0.033 | <b>N2O Intensity (lb/MWhr)</b>   | 0.004 |

**1.3 User Entered Comments & Non-Default Data**

Project Characteristics - CSUMB Master Plan. MBUAPCD.

Land Use - Total Master Plan (Campus: 2,256,767 and Student housing 3,807,779) and approved buildings (60,000) minus demolition (256,366) also includes 3,820 beds/1,220 DU. 12,700 FTE students and 1,220 DU occuied by staff/faculty.

Construction Phase - Modeling operations only.

Vehicle Trips - Update trip rate and trip length per TRA. Assumed 100% primary trips. Based Sunday trip rates from Junior College land use since since University default is 0.

Woodstoves - Assumed no fireplaces.

Area Coating - Use of low-VOC (50 g/L) arch coatings.

**EMFAC Off-Model Adjustment Factors for Gasoline Light Duty Vehicle to Account for the SAFE Vehicle Rule Applied**

Energy Use - Revised energy intensities based on consumption projections provided by CSUMB.

Water And Wastewater - Revised water and wastewater based on projections provided by CSUMB. Total demand in 2035 would be 427 AF building use and 290 AF for irrigation

Solid Waste - Default solid waste generation rates assumed.

Sequestration - Plant 2,030 new trees on campus.

Water Mitigation - RUWAP irrigation would account for 32% of outdoor irrigation water.

Waste Mitigation - Update per campus waste reduction goal.

| Table Name     | Column Name                     | Default Value | New Value |
|----------------|---------------------------------|---------------|-----------|
| tblAreaCoating | Area_EF_Nonresidential_Exterior | 150           | 50        |
| tblAreaCoating | Area_EF_Nonresidential_Interior | 150           | 50        |
| tblAreaCoating | Area_EF_Residential_Exterior    | 100           | 50        |
| tblAreaCoating | Area_EF_Residential_Interior    | 100           | 50        |
| tblAreaCoating | Area_Nonresidential_Exterior    | 1030200       | 1079895   |
| tblAreaCoating | Area_Nonresidential_Interior    | 3090600       | 3239685   |
| tblAreaCoating | Area_Residential_Exterior       | 2570252       | 2597252   |
| tblAreaCoating | Area_Residential_Interior       | 7710755       | 7791755   |
| tblEnergyUse   | LightingElect                   | 741.44        | 0.00      |
| tblEnergyUse   | LightingElect                   | 2.91          | 5.01      |
| tblEnergyUse   | NT24E                           | 3,054.10      | 0.00      |
| tblEnergyUse   | NT24E                           | 2.27          | 3.90      |
| tblEnergyUse   | NT24NG                          | 3,155.00      | 0.00      |
| tblEnergyUse   | NT24NG                          | 3.30          | 7.41      |
| tblEnergyUse   | T24E                            | 70.89         | 0.00      |
| tblEnergyUse   | T24E                            | 2.44          | 4.20      |
| tblEnergyUse   | T24NG                           | 5,226.68      | 0.00      |
| tblEnergyUse   | T24NG                           | 20.62         | 46.31     |

**EMFAC Off-Model Adjustment Factors for Gasoline Light Duty Vehicle to Account for the SAFE Vehicle Rule Applied**

|                           |                     |                |                |
|---------------------------|---------------------|----------------|----------------|
| tblFireplaces             | NumberGas           | 9,020.00       | 0.00           |
| tblFireplaces             | NumberNoFireplace   | 0.00           | 9,020.00       |
| tblLandUse                | LandUseSquareFeet   | 2,334,227.85   | 2,060,401.00   |
| tblLandUse                | LandUseSquareFeet   | 9,020,000.00   | 3,807,779.00   |
| tblLandUse                | Population          | 25,797.00      | 13,920.00      |
| tblProjectCharacteristics | CO2IntensityFactor  | 203.98         | 167            |
| tblSequestration          | NumberOfNewTrees    | 0.00           | 2,030.00       |
| tblVehicleTrips           | CC_TL               | 7.30           | 7.41           |
| tblVehicleTrips           | CNW_TL              | 7.30           | 7.41           |
| tblVehicleTrips           | CW_TL               | 9.50           | 7.41           |
| tblVehicleTrips           | DV_TP               | 9.00           | 0.00           |
| tblVehicleTrips           | HO_TL               | 7.50           | 0.00           |
| tblVehicleTrips           | HS_TL               | 7.30           | 0.00           |
| tblVehicleTrips           | HW_TL               | 10.80          | 0.00           |
| tblVehicleTrips           | PR_TP               | 91.00          | 100.00         |
| tblVehicleTrips           | ST_TR               | 4.91           | 0.00           |
| tblVehicleTrips           | ST_TR               | 1.30           | 2.62           |
| tblVehicleTrips           | SU_TR               | 4.09           | 0.00           |
| tblVehicleTrips           | SU_TR               | 0.00           | 0.19           |
| tblVehicleTrips           | WD_TR               | 5.44           | 0.00           |
| tblVehicleTrips           | WD_TR               | 1.56           | 3.14           |
| tblWater                  | IndoorWaterUseRate  | 587,689,311.11 | 0.00           |
| tblWater                  | IndoorWaterUseRate  | 27,191,970.00  | 139,138,377.00 |
| tblWater                  | OutdoorWaterUseRate | 370,499,783.09 | 0.00           |
| tblWater                  | OutdoorWaterUseRate | 42,531,030.00  | 94,496,790.00  |



**EMFAC Off-Model Adjustment Factors for Gasoline Light Duty Vehicle to Account for the SAFE Vehicle Rule Applied**

|                  |   |     |    |
|------------------|---|-----|----|
| Water Mitigation | Use Water Efficient Irrigation System Percent Reduction | 6.1 | 32 |
|------------------|---|-----|----|

**2.0 Emissions Summary**

**2.2 Overall Operational**

**Unmitigated Operational**

|              | ROG             | NOx             | CO                | SO2           | Fugitive PM10   | Exhaust PM10  | PM10 Total      | Fugitive PM2.5 | Exhaust PM2.5 | PM2.5 Total    | Bio- CO2      | NBio- CO2           | Total CO2           | CH4            | N2O           | CO2e                |
|--------------|-----------------|-----------------|-------------------|---------------|-----------------|---------------|-----------------|----------------|---------------|----------------|---------------|---------------------|---------------------|----------------|---------------|---------------------|
| Category     | lb/day          |                 |                   |               |                 |               |                 |                |               |                | lb/day        |                     |                     |                |               |                     |
| Area         | 157.2079        | 8.5669          | 742.8350          | 0.0394        |                 | 4.1313        | 4.1313          |                | 4.1313        | 4.1313         | 0.0000        | 1,342.7212          | 1,342.7212          | 1.2827         | 0.0000        | 1,374.7889          |
| Energy       | 3.2703          | 29.7300         | 24.9732           | 0.1784        |                 | 2.2595        | 2.2595          |                | 2.2595        | 2.2595         |               | 35,675.9844         | 35,675.9844         | 0.6838         | 0.6541        | 35,887.9890         |
| Mobile       | 84.6892         | 83.7632         | 762.6182          | 1.7575        | 193.2585        | 1.1164        | 194.3749        | 52.1636        | 1.0426        | 53.2062        |               | 193,365.2128        | 193,365.2128        | 10.3833        | 7.6894        | 195,916.2342        |
| <b>Total</b> | <b>245.1673</b> | <b>122.0601</b> | <b>1,530.4264</b> | <b>1.9752</b> | <b>193.2585</b> | <b>7.5072</b> | <b>200.7657</b> | <b>52.1636</b> | <b>7.4334</b> | <b>59.5970</b> | <b>0.0000</b> | <b>230,383.9184</b> | <b>230,383.9184</b> | <b>12.3498</b> | <b>8.3435</b> | <b>233,179.0121</b> |



**EMFAC Off-Model Adjustment Factors for Gasoline Light Duty Vehicle to Account for the SAFE Vehicle Rule Applied**

**4.0 Operational Detail - Mobile**

**4.1 Mitigation Measures Mobile**

| Category    | ROG     | NOx     | CO       | SO2    | Fugitive PM10 | Exhaust PM10 | PM10 Total | Fugitive PM2.5 | Exhaust PM2.5 | PM2.5 Total | Bio- CO2 | NBio- CO2   | Total CO2  | CH4     | N2O    | CO2e        |
|-------------|---------|---------|----------|--------|---------------|--------------|------------|----------------|---------------|-------------|----------|-------------|------------|---------|--------|-------------|
| lb/day      |         |         |          |        |               |              |            |                |               |             | lb/day   |             |            |         |        |             |
| Mitigated   | 84.6892 | 83.7632 | 762.6182 | 1.7575 | 193.2585      | 1.1164       | 194.3749   | 52.1636        | 1.0426        | 53.2062     |          | 193,365.212 | 193,365.21 | 10.3833 | 7.6894 | 195,916.234 |
| Unmitigated | 84.6892 | 83.7632 | 762.6182 | 1.7575 | 193.2585      | 1.1164       | 194.3749   | 52.1636        | 1.0426        | 53.2062     |          | 193,365.212 | 193,365.21 | 10.3833 | 7.6894 | 195,916.234 |

**4.2 Trip Summary Information**

| Land Use                 | Average Daily Trip Rate |                  |                 | Unmitigated       | Mitigated         |
|--------------------------|-------------------------|------------------|-----------------|-------------------|-------------------|
|                          | Weekday                 | Saturday         | Sunday          | Annual VMT        | Annual VMT        |
| Apartments Mid Rise      | 0.00                    | 0.00             | 0.00            |                   |                   |
| University/College (4yr) | 39,878.00               | 33,274.00        | 2,413.00        | 90,579,870        | 90,579,870        |
| <b>Total</b>             | <b>39,878.00</b>        | <b>33,274.00</b> | <b>2,413.00</b> | <b>90,579,870</b> | <b>90,579,870</b> |

**4.3 Trip Type Information**

| Land Use                 | Miles      |            |             | Trip %     |            |             | Trip Purpose % |          |         |
|--------------------------|------------|------------|-------------|------------|------------|-------------|----------------|----------|---------|
|                          | H-W or C-W | H-S or C-C | H-O or C-NW | H-W or C-W | H-S or C-C | H-O or C-NW | Primary        | Diverted | Pass-by |
| Apartments Mid Rise      | 0.00       | 0.00       | 0.00        | 44.00      | 18.80      | 37.20       | 86             | 11       | 3       |
| University/College (4yr) | 7.41       | 7.41       | 7.41        | 6.40       | 88.60      | 5.00        | 100            | 0        | 0       |

**4.4 Fleet Mix**

| Land Use                 | LDA      | LDT1     | LDT2     | MDV      | LHD1     | LHD2     | MHD      | HHD      | OBUS     | UBUS     | MCY      | SBUS     | MH       |
|--------------------------|----------|----------|----------|----------|----------|----------|----------|----------|----------|----------|----------|----------|----------|
| Apartments Mid Rise      | 0.555052 | 0.055883 | 0.188820 | 0.126929 | 0.020456 | 0.005379 | 0.009845 | 0.008677 | 0.000965 | 0.000515 | 0.024108 | 0.001007 | 0.002365 |
| University/College (4yr) | 0.555052 | 0.055883 | 0.188820 | 0.126929 | 0.020456 | 0.005379 | 0.009845 | 0.008677 | 0.000965 | 0.000515 | 0.024108 | 0.001007 | 0.002365 |

**EMFAC Off-Model Adjustment Factors for Gasoline Light Duty Vehicle to Account for the SAFE Vehicle Rule Applied**

**5.0 Energy Detail**

Historical Energy Use: N

**5.1 Mitigation Measures Energy**

|                        | ROG    | NOx     | CO      | SO2    | Fugitive PM10 | Exhaust PM10 | PM10 Total | Fugitive PM2.5 | Exhaust PM2.5 | PM2.5 Total | Bio- CO2 | NBio- CO2   | Total CO2   | CH4    | N2O    | CO2e        |
|------------------------|--------|---------|---------|--------|---------------|--------------|------------|----------------|---------------|-------------|----------|-------------|-------------|--------|--------|-------------|
| Category               | lb/day |         |         |        |               |              |            |                |               |             | lb/day   |             |             |        |        |             |
| NaturalGas Mitigated   | 3.2703 | 29.7300 | 24.9732 | 0.1784 |               | 2.2595       | 2.2595     |                | 2.2595        | 2.2595      |          | 35,675.9844 | 35,675.9844 | 0.6838 | 0.6541 | 35,887.9890 |
| NaturalGas Unmitigated | 3.2703 | 29.7300 | 24.9732 | 0.1784 |               | 2.2595       | 2.2595     |                | 2.2595        | 2.2595      |          | 35,675.9844 | 35,675.9844 | 0.6838 | 0.6541 | 35,887.9890 |

**5.2 Energy by Land Use - NaturalGas**

**Unmitigated**

|                          | NaturalGas Use | ROG           | NOx            | CO             | SO2           | Fugitive PM10 | Exhaust PM10  | PM10 Total    | Fugitive PM2.5 | Exhaust PM2.5 | PM2.5 Total   | Bio- CO2 | NBio- CO2          | Total CO2          | CH4           | N2O           | CO2e               |
|--------------------------|----------------|---------------|----------------|----------------|---------------|---------------|---------------|---------------|----------------|---------------|---------------|----------|--------------------|--------------------|---------------|---------------|--------------------|
| Land Use                 | kBTU/yr        | lb/day        |                |                |               |               |               |               |                |               |               | lb/day   |                    |                    |               |               |                    |
| Apartments Mid Rise      | 0              | 0.0000        | 0.0000         | 0.0000         | 0.0000        |               | 0.0000        | 0.0000        |                | 0.0000        | 0.0000        |          | 0.0000             | 0.0000             | 0.0000        | 0.0000        | 0.0000             |
| University/College (4yr) | 303246         | 3.2703        | 29.7300        | 24.9732        | 0.1784        |               | 2.2595        | 2.2595        |                | 2.2595        | 2.2595        |          | 35,675.9844        | 35,675.9844        | 0.6838        | 0.6541        | 35,887.9890        |
| <b>Total</b>             |                | <b>3.2703</b> | <b>29.7300</b> | <b>24.9732</b> | <b>0.1784</b> |               | <b>2.2595</b> | <b>2.2595</b> |                | <b>2.2595</b> | <b>2.2595</b> |          | <b>35,675.9844</b> | <b>35,675.9844</b> | <b>0.6838</b> | <b>0.6541</b> | <b>35,887.9890</b> |

**EMFAC Off-Model Adjustment Factors for Gasoline Light Duty Vehicle to Account for the SAFE Vehicle Rule Applied**

**Mitigated**

|                          | Natural Gas Use | ROG           | NOx            | CO             | SO2           | Fugitive PM10 | Exhaust PM10  | PM10 Total    | Fugitive PM2.5 | Exhaust PM2.5 | PM2.5 Total   | Bio- CO2 | NBio- CO2               | Total CO2               | CH4           | N2O           | CO2e                    |
|--------------------------|-----------------|---------------|----------------|----------------|---------------|---------------|---------------|---------------|----------------|---------------|---------------|----------|-------------------------|-------------------------|---------------|---------------|-------------------------|
| Land Use                 | kBTU/yr         | lb/day        |                |                |               |               |               |               |                |               |               | lb/day   |                         |                         |               |               |                         |
| Apartments Mid Rise      | 0               | 0.0000        | 0.0000         | 0.0000         | 0.0000        |               | 0.0000        | 0.0000        |                | 0.0000        | 0.0000        |          | 0.0000                  | 0.0000                  | 0.0000        | 0.0000        | 0.0000                  |
| University/College (4yr) | 303.246         | 3.2703        | 29.7300        | 24.9732        | 0.1784        |               | 2.2595        | 2.2595        |                | 2.2595        | 2.2595        |          | 35,675.984<br>4         | 35,675.984<br>4         | 0.6838        | 0.6541        | 35,887.989<br>0         |
| <b>Total</b>             |                 | <b>3.2703</b> | <b>29.7300</b> | <b>24.9732</b> | <b>0.1784</b> |               | <b>2.2595</b> | <b>2.2595</b> |                | <b>2.2595</b> | <b>2.2595</b> |          | <b>35,675.984<br/>4</b> | <b>35,675.984<br/>4</b> | <b>0.6838</b> | <b>0.6541</b> | <b>35,887.989<br/>0</b> |

**6.0 Area Detail**

**6.1 Mitigation Measures Area**

|             | ROG      | NOx    | CO       | SO2    | Fugitive PM10 | Exhaust PM10 | PM10 Total | Fugitive PM2.5 | Exhaust PM2.5 | PM2.5 Total | Bio- CO2 | NBio- CO2  | Total CO2  | CH4    | N2O    | CO2e       |
|-------------|----------|--------|----------|--------|---------------|--------------|------------|----------------|---------------|-------------|----------|------------|------------|--------|--------|------------|
| Category    | lb/day   |        |          |        |               |              |            |                |               |             | lb/day   |            |            |        |        |            |
| Mitigated   | 157.2079 | 8.5669 | 742.8350 | 0.0394 |               | 4.1313       | 4.1313     |                | 4.1313        | 4.1313      | 0.0000   | 1,342.7212 | 1,342.7212 | 1.2827 | 0.0000 | 1,374.7889 |
| Unmitigated | 157.2079 | 8.5669 | 742.8350 | 0.0394 |               | 4.1313       | 4.1313     |                | 4.1313        | 4.1313      | 0.0000   | 1,342.7212 | 1,342.7212 | 1.2827 | 0.0000 | 1,374.7889 |

**EMFAC Off-Model Adjustment Factors for Gasoline Light Duty Vehicle to Account for the SAFE Vehicle Rule Applied**

**6.2 Area by SubCategory**

**Unmitigated**

|                       | ROG             | NOx           | CO              | SO2           | Fugitive PM10 | Exhaust PM10  | PM10 Total    | Fugitive PM2.5 | Exhaust PM2.5 | PM2.5 Total   | Bio- CO2      | NBio- CO2         | Total CO2         | CH4           | N2O           | CO2e              |
|-----------------------|-----------------|---------------|-----------------|---------------|---------------|---------------|---------------|----------------|---------------|---------------|---------------|-------------------|-------------------|---------------|---------------|-------------------|
| SubCategory           | lb/day          |               |                 |               |               |               |               |                |               |               | lb/day        |                   |                   |               |               |                   |
| Architectural Coating | 9.3390          |               |                 |               |               | 0.0000        | 0.0000        |                | 0.0000        | 0.0000        |               |                   | 0.0000            |               |               | 0.0000            |
| Consumer Products     | 125.5791        |               |                 |               |               | 0.0000        | 0.0000        |                | 0.0000        | 0.0000        |               |                   | 0.0000            |               |               | 0.0000            |
| Hearth                | 0.0000          | 0.0000        | 0.0000          | 0.0000        |               | 0.0000        | 0.0000        |                | 0.0000        | 0.0000        | 0.0000        | 0.0000            | 0.0000            | 0.0000        | 0.0000        | 0.0000            |
| Landscaping           | 22.2899         | 8.5669        | 742.8350        | 0.0394        |               | 4.1313        | 4.1313        |                | 4.1313        | 4.1313        |               | 1,342.7212        | 1,342.7212        | 1.2827        |               | 1,374.7889        |
| <b>Total</b>          | <b>157.2079</b> | <b>8.5669</b> | <b>742.8350</b> | <b>0.0394</b> |               | <b>4.1313</b> | <b>4.1313</b> |                | <b>4.1313</b> | <b>4.1313</b> | <b>0.0000</b> | <b>1,342.7212</b> | <b>1,342.7212</b> | <b>1.2827</b> | <b>0.0000</b> | <b>1,374.7889</b> |

**EMFAC Off-Model Adjustment Factors for Gasoline Light Duty Vehicle to Account for the SAFE Vehicle Rule Applied**

**Mitigated**

|                       | ROG             | NOx           | CO              | SO2           | Fugitive PM10 | Exhaust PM10  | PM10 Total    | Fugitive PM2.5 | Exhaust PM2.5 | PM2.5 Total   | Bio- CO2      | NBio- CO2         | Total CO2         | CH4           | N2O           | CO2e              |
|-----------------------|-----------------|---------------|-----------------|---------------|---------------|---------------|---------------|----------------|---------------|---------------|---------------|-------------------|-------------------|---------------|---------------|-------------------|
| SubCategory           | lb/day          |               |                 |               |               |               |               |                |               |               | lb/day        |                   |                   |               |               |                   |
| Architectural Coating | 9.3390          |               |                 |               |               | 0.0000        | 0.0000        |                | 0.0000        | 0.0000        |               |                   | 0.0000            |               |               | 0.0000            |
| Consumer Products     | 125.5791        |               |                 |               |               | 0.0000        | 0.0000        |                | 0.0000        | 0.0000        |               |                   | 0.0000            |               |               | 0.0000            |
| Hearth                | 0.0000          | 0.0000        | 0.0000          | 0.0000        |               | 0.0000        | 0.0000        |                | 0.0000        | 0.0000        | 0.0000        | 0.0000            | 0.0000            | 0.0000        | 0.0000        | 0.0000            |
| Landscaping           | 22.2899         | 8.5669        | 742.8350        | 0.0394        |               | 4.1313        | 4.1313        |                | 4.1313        | 4.1313        |               | 1,342.7212        | 1,342.7212        | 1.2827        |               | 1,374.7889        |
| <b>Total</b>          | <b>157.2079</b> | <b>8.5669</b> | <b>742.8350</b> | <b>0.0394</b> |               | <b>4.1313</b> | <b>4.1313</b> |                | <b>4.1313</b> | <b>4.1313</b> | <b>0.0000</b> | <b>1,342.7212</b> | <b>1,342.7212</b> | <b>1.2827</b> | <b>0.0000</b> | <b>1,374.7889</b> |

**EMFAC Off-Model Adjustment Factors for Gasoline Light Duty Vehicle to Account for the SAFE Vehicle Rule Applied**

**CSUMB - Master Plan Buildout (Daily)  
Monterey Bay Unified APCD Air District, Winter**

**1.0 Project Characteristics**

**1.1 Land Usage**

| Land Uses                | Size      | Metric        | Lot Acreage | Floor Surface Area | Population |
|--------------------------|-----------|---------------|-------------|--------------------|------------|
| University/College (4yr) | 12,700.00 | Student       | 53.59       | 2,060,401.00       | 0          |
| Apartments Mid Rise      | 9,020.00  | Dwelling Unit | 237.37      | 3,807,779.00       | 13920      |

**1.2 Other Project Characteristics**

|                                |                                  |                                |       |                                  |       |
|--------------------------------|----------------------------------|--------------------------------|-------|----------------------------------|-------|
| <b>Urbanization</b>            | Urban                            | <b>Wind Speed (m/s)</b>        | 2.8   | <b>Precipitation Freq (Days)</b> | 53    |
| <b>Climate Zone</b>            | 4                                |                                |       | <b>Operational Year</b>          | 2035  |
| <b>Utility Company</b>         | Pacific Gas and Electric Company |                                |       |                                  |       |
| <b>CO2 Intensity (lb/MWhr)</b> | 167                              | <b>CH4 Intensity (lb/MWhr)</b> | 0.033 | <b>N2O Intensity (lb/MWhr)</b>   | 0.004 |

**1.3 User Entered Comments & Non-Default Data**

Project Characteristics - CSUMB Master Plan. MBUAPCD.

Land Use - Total Master Plan (Campus: 2,256,767 and Student housing 3,807,779) and approved buildings (60,000) minus demolition (256,366) also includes 3,820 beds/1,220 DU. 12,700 FTE students and 1,220 DU occuied by staff/faculty.

Construction Phase - Modeling operations only.

Vehicle Trips - Update trip rate and trip length per TRA. Assumed 100% primary trips. Based Sunday trip rates from Junior College land use since since University default is 0.

Woodstoves - Assumed no fireplaces.

Area Coating - Use of low-VOC (50 g/L) arch coatings.



**EMFAC Off-Model Adjustment Factors for Gasoline Light Duty Vehicle to Account for the SAFE Vehicle Rule Applied**

Energy Use - Revised energy intensities based on consumption projections provided by CSUMB.

Water And Wastewater - Revised water and wastewater based on projections provided by CSUMB. Total demand in 2035 would be 427 AF building use and 290 AF for irrigation

Solid Waste - Default solid waste generation rates assumed.

Sequestration - Plant 2,030 new trees on campus.

Water Mitigation - RUWAP irrigation would account for 32% of outdoor irrigation water.

Waste Mitigation - Update per campus waste reduction goal.

| Table Name     | Column Name                     | Default Value | New Value |
|----------------|---------------------------------|---------------|-----------|
| tblAreaCoating | Area_EF_Nonresidential_Exterior | 150           | 50        |
| tblAreaCoating | Area_EF_Nonresidential_Interior | 150           | 50        |
| tblAreaCoating | Area_EF_Residential_Exterior    | 100           | 50        |
| tblAreaCoating | Area_EF_Residential_Interior    | 100           | 50        |
| tblAreaCoating | Area_Nonresidential_Exterior    | 1030200       | 1079895   |
| tblAreaCoating | Area_Nonresidential_Interior    | 3090600       | 3239685   |
| tblAreaCoating | Area_Residential_Exterior       | 2570252       | 2597252   |
| tblAreaCoating | Area_Residential_Interior       | 7710755       | 7791755   |
| tblEnergyUse   | LightingElect                   | 741.44        | 0.00      |
| tblEnergyUse   | LightingElect                   | 2.91          | 5.01      |
| tblEnergyUse   | NT24E                           | 3,054.10      | 0.00      |
| tblEnergyUse   | NT24E                           | 2.27          | 3.90      |
| tblEnergyUse   | NT24NG                          | 3,155.00      | 0.00      |
| tblEnergyUse   | NT24NG                          | 3.30          | 7.41      |
| tblEnergyUse   | T24E                            | 70.89         | 0.00      |
| tblEnergyUse   | T24E                            | 2.44          | 4.20      |
| tblEnergyUse   | T24NG                           | 5,226.68      | 0.00      |
| tblEnergyUse   | T24NG                           | 20.62         | 46.31     |

**EMFAC Off-Model Adjustment Factors for Gasoline Light Duty Vehicle to Account for the SAFE Vehicle Rule Applied**

|                           |                     |                |                |
|---------------------------|---------------------|----------------|----------------|
| tblFireplaces             | NumberGas           | 9,020.00       | 0.00           |
| tblFireplaces             | NumberNoFireplace   | 0.00           | 9,020.00       |
| tblLandUse                | LandUseSquareFeet   | 2,334,227.85   | 2,060,401.00   |
| tblLandUse                | LandUseSquareFeet   | 9,020,000.00   | 3,807,779.00   |
| tblLandUse                | Population          | 25,797.00      | 13,920.00      |
| tblProjectCharacteristics | CO2IntensityFactor  | 203.98         | 167            |
| tblSequestration          | NumberOfNewTrees    | 0.00           | 2,030.00       |
| tblVehicleTrips           | CC_TL               | 7.30           | 7.41           |
| tblVehicleTrips           | CNW_TL              | 7.30           | 7.41           |
| tblVehicleTrips           | CW_TL               | 9.50           | 7.41           |
| tblVehicleTrips           | DV_TP               | 9.00           | 0.00           |
| tblVehicleTrips           | HO_TL               | 7.50           | 0.00           |
| tblVehicleTrips           | HS_TL               | 7.30           | 0.00           |
| tblVehicleTrips           | HW_TL               | 10.80          | 0.00           |
| tblVehicleTrips           | PR_TP               | 91.00          | 100.00         |
| tblVehicleTrips           | ST_TR               | 4.91           | 0.00           |
| tblVehicleTrips           | ST_TR               | 1.30           | 2.62           |
| tblVehicleTrips           | SU_TR               | 4.09           | 0.00           |
| tblVehicleTrips           | SU_TR               | 0.00           | 0.19           |
| tblVehicleTrips           | WD_TR               | 5.44           | 0.00           |
| tblVehicleTrips           | WD_TR               | 1.56           | 3.14           |
| tblWater                  | IndoorWaterUseRate  | 587,689,311.11 | 0.00           |
| tblWater                  | IndoorWaterUseRate  | 27,191,970.00  | 139,138,377.00 |
| tblWater                  | OutdoorWaterUseRate | 370,499,783.09 | 0.00           |
| tblWater                  | OutdoorWaterUseRate | 42,531,030.00  | 94,496,790.00  |

**EMFAC Off-Model Adjustment Factors for Gasoline Light Duty Vehicle to Account for the SAFE Vehicle Rule Applied**

|                   |   |     |    |
|-------------------|---|-----|----|
| tbWaterMitigation | UseWaterEfficientIrrigationSystemPercentReduction | 6.1 | 32 |
|-------------------|---|-----|----|

**2.0 Emissions Summary**

**2.2 Overall Operational  
Unmitigated Operational**

|              | ROG             | NOx             | CO                | SO2           | Fugitive PM10   | Exhaust PM10  | PM10 Total      | Fugitive PM2.5 | Exhaust PM2.5 | PM2.5 Total    | Bio- CO2      | NBio- CO2           | Total CO2           | CH4            | N2O           | CO2e                |
|--------------|-----------------|-----------------|-------------------|---------------|-----------------|---------------|-----------------|----------------|---------------|----------------|---------------|---------------------|---------------------|----------------|---------------|---------------------|
| Category     | lb/day          |                 |                   |               |                 |               |                 |                |               |                | lb/day        |                     |                     |                |               |                     |
| Area         | 157.2079        | 8.5669          | 742.8350          | 0.0394        |                 | 4.1313        | 4.1313          |                | 4.1313        | 4.1313         | 0.0000        | 1,342.7212          | 1,342.7212          | 1.2827         | 0.0000        | 1,374.7889          |
| Energy       | 3.2703          | 29.7300         | 24.9732           | 0.1784        |                 | 2.2595        | 2.2595          |                | 2.2595        | 2.2595         |               | 35,675.9844         | 35,675.9844         | 0.6838         | 0.6541        | 35,887.9890         |
| Mobile       | 79.1788         | 95.9374         | 838.4702          | 1.6841        | 193.2585        | 1.1170        | 194.3755        | 52.1636        | 1.0432        | 53.2068        |               | 185,205.7079        | 185,205.7079        | 11.4968        | 8.4160        | 188,001.0976        |
| <b>Total</b> | <b>239.6569</b> | <b>134.2343</b> | <b>1,606.2784</b> | <b>1.9019</b> | <b>193.2585</b> | <b>7.5078</b> | <b>200.7663</b> | <b>52.1636</b> | <b>7.4340</b> | <b>59.5976</b> | <b>0.0000</b> | <b>222,224.4136</b> | <b>222,224.4136</b> | <b>13.4633</b> | <b>9.0701</b> | <b>225,263.8755</b> |

**EMFAC Off-Model Adjustment Factors for Gasoline Light Duty Vehicle to Account for the SAFE Vehicle Rule Applied**

**Mitigated Operational**

|              | ROG             | NOx             | CO                | SO2           | Fugitive PM10   | Exhaust PM10  | PM10 Total      | Fugitive PM2.5 | Exhaust PM2.5 | PM2.5 Total    | Bio- CO2      | NBio- CO2           | Total CO2           | CH4            | N2O           | CO2e                |
|--------------|-----------------|-----------------|-------------------|---------------|-----------------|---------------|-----------------|----------------|---------------|----------------|---------------|---------------------|---------------------|----------------|---------------|---------------------|
| Category     | lb/day          |                 |                   |               |                 |               |                 |                |               |                | lb/day        |                     |                     |                |               |                     |
| Area         | 157.2079        | 8.5669          | 742.8350          | 0.0394        |                 | 4.1313        | 4.1313          |                | 4.1313        | 4.1313         | 0.0000        | 1,342.7212          | 1,342.7212          | 1.2827         | 0.0000        | 1,374.7889          |
| Energy       | 3.2703          | 29.7300         | 24.9732           | 0.1784        |                 | 2.2595        | 2.2595          |                | 2.2595        | 2.2595         |               | 35,675.9844         | 35,675.9844         | 0.6838         | 0.6541        | 35,887.9890         |
| Mobile       | 79.1788         | 95.9374         | 838.4702          | 1.6841        | 193.2585        | 1.1170        | 194.3755        | 52.1636        | 1.0432        | 53.2068        |               | 185,205.7079        | 185,205.7079        | 11.4968        | 8.4160        | 188,001.0976        |
| <b>Total</b> | <b>239.6569</b> | <b>134.2343</b> | <b>1,606.2784</b> | <b>1.9019</b> | <b>193.2585</b> | <b>7.5078</b> | <b>200.7663</b> | <b>52.1636</b> | <b>7.4340</b> | <b>59.5976</b> | <b>0.0000</b> | <b>222,224.4136</b> | <b>222,224.4136</b> | <b>13.4633</b> | <b>9.0701</b> | <b>225,263.8755</b> |

|                   | ROG  | NOx  | CO   | SO2  | Fugitive PM10 | Exhaust PM10 | PM10 Total | Fugitive PM2.5 | Exhaust PM2.5 | PM2.5 Total | Bio- CO2 | NBio- CO2 | Total CO2 | CH4  | N2O  | CO2e |
|-------------------|------|------|------|------|---------------|--------------|------------|----------------|---------------|-------------|----------|-----------|-----------|------|------|------|
| Percent Reduction | 0.00 | 0.00 | 0.00 | 0.00 | 0.00          | 0.00         | 0.00       | 0.00           | 0.00          | 0.00        | 0.00     | 0.00      | 0.00      | 0.00 | 0.00 | 0.00 |

**4.0 Operational Detail - Mobile**

**4.1 Mitigation Measures Mobile**

|             | ROG     | NOx     | CO       | SO2    | Fugitive PM10 | Exhaust PM10 | PM10 Total | Fugitive PM2.5 | Exhaust PM2.5 | PM2.5 Total | Bio- CO2 | NBio- CO2    | Total CO2    | CH4     | N2O    | CO2e         |
|-------------|---------|---------|----------|--------|---------------|--------------|------------|----------------|---------------|-------------|----------|--------------|--------------|---------|--------|--------------|
| Category    | lb/day  |         |          |        |               |              |            |                |               |             | lb/day   |              |              |         |        |              |
| Mitigated   | 79.1788 | 95.9374 | 838.4702 | 1.6841 | 193.2585      | 1.1170       | 194.3755   | 52.1636        | 1.0432        | 53.2068     |          | 185,205.7079 | 185,205.7079 | 11.4968 | 8.4160 | 188,001.0976 |
| Unmitigated | 79.1788 | 95.9374 | 838.4702 | 1.6841 | 193.2585      | 1.1170       | 194.3755   | 52.1636        | 1.0432        | 53.2068     |          | 185,205.7079 | 185,205.7079 | 11.4968 | 8.4160 | 188,001.0976 |

**EMFAC Off-Model Adjustment Factors for Gasoline Light Duty Vehicle to Account for the SAFE Vehicle Rule Applied**

**4.2 Trip Summary Information**

| Land Use                 | Average Daily Trip Rate |                  |                 | Unmitigated       | Mitigated         |
|--------------------------|-------------------------|------------------|-----------------|-------------------|-------------------|
|                          | Weekday                 | Saturday         | Sunday          | Annual VMT        | Annual VMT        |
| Apartments Mid Rise      | 0.00                    | 0.00             | 0.00            |                   |                   |
| University/College (4yr) | 39,878.00               | 33,274.00        | 2,413.00        | 90,579,870        | 90,579,870        |
| <b>Total</b>             | <b>39,878.00</b>        | <b>33,274.00</b> | <b>2,413.00</b> | <b>90,579,870</b> | <b>90,579,870</b> |

**4.3 Trip Type Information**

| Land Use                 | Miles      |            |             | Trip %     |            |             | Trip Purpose % |          |         |
|--------------------------|------------|------------|-------------|------------|------------|-------------|----------------|----------|---------|
|                          | H-W or C-W | H-S or C-C | H-O or C-NW | H-W or C-W | H-S or C-C | H-O or C-NW | Primary        | Diverted | Pass-by |
| Apartments Mid Rise      | 0.00       | 0.00       | 0.00        | 44.00      | 18.80      | 37.20       | 86             | 11       | 3       |
| University/College (4yr) | 7.41       | 7.41       | 7.41        | 6.40       | 88.60      | 5.00        | 100            | 0        | 0       |

**4.4 Fleet Mix**

| Land Use                 | LDA      | LDT1     | LDT2     | MDV      | LHD1     | LHD2     | MHD      | HHD      | OBUS     | UBUS     | MCY      | SBUS     | MH       |
|--------------------------|----------|----------|----------|----------|----------|----------|----------|----------|----------|----------|----------|----------|----------|
| Apartments Mid Rise      | 0.555052 | 0.055883 | 0.188820 | 0.126929 | 0.020456 | 0.005379 | 0.009845 | 0.008677 | 0.000965 | 0.000515 | 0.024108 | 0.001007 | 0.002365 |
| University/College (4yr) | 0.555052 | 0.055883 | 0.188820 | 0.126929 | 0.020456 | 0.005379 | 0.009845 | 0.008677 | 0.000965 | 0.000515 | 0.024108 | 0.001007 | 0.002365 |

**5.0 Energy Detail**

Historical Energy Use: N

**5.1 Mitigation Measures Energy**

**EMFAC Off-Model Adjustment Factors for Gasoline Light Duty Vehicle to Account for the SAFE Vehicle Rule Applied**

|                        | ROG    | NOx     | CO      | SO2    | Fugitive PM10 | Exhaust PM10 | PM10 Total | Fugitive PM2.5 | Exhaust PM2.5 | PM2.5 Total | Bio- CO2 | NBio- CO2   | Total CO2   | CH4    | N2O    | CO2e        |
|------------------------|--------|---------|---------|--------|---------------|--------------|------------|----------------|---------------|-------------|----------|-------------|-------------|--------|--------|-------------|
| Category               | lb/day |         |         |        |               |              |            |                |               |             | lb/day   |             |             |        |        |             |
| NaturalGas Mitigated   | 3.2703 | 29.7300 | 24.9732 | 0.1784 |               | 2.2595       | 2.2595     |                | 2.2595        | 2.2595      |          | 35,675.9844 | 35,675.9844 | 0.6838 | 0.6541 | 35,887.9890 |
| NaturalGas Unmitigated | 3.2703 | 29.7300 | 24.9732 | 0.1784 |               | 2.2595       | 2.2595     |                | 2.2595        | 2.2595      |          | 35,675.9844 | 35,675.9844 | 0.6838 | 0.6541 | 35,887.9890 |

**5.2 Energy by Land Use - NaturalGas**

**Unmitigated**

|                          | NaturalGas Use | ROG           | NOx            | CO             | SO2           | Fugitive PM10 | Exhaust PM10  | PM10 Total    | Fugitive PM2.5 | Exhaust PM2.5 | PM2.5 Total   | Bio- CO2 | NBio- CO2          | Total CO2          | CH4           | N2O           | CO2e               |
|--------------------------|----------------|---------------|----------------|----------------|---------------|---------------|---------------|---------------|----------------|---------------|---------------|----------|--------------------|--------------------|---------------|---------------|--------------------|
| Land Use                 | kBTU/yr        | lb/day        |                |                |               |               |               |               |                |               |               | lb/day   |                    |                    |               |               |                    |
| Apartments Mid Rise      | 0              | 0.0000        | 0.0000         | 0.0000         | 0.0000        |               | 0.0000        | 0.0000        |                | 0.0000        | 0.0000        |          | 0.0000             | 0.0000             | 0.0000        | 0.0000        | 0.0000             |
| University/College (4yr) | 303246         | 3.2703        | 29.7300        | 24.9732        | 0.1784        |               | 2.2595        | 2.2595        |                | 2.2595        | 2.2595        |          | 35,675.9844        | 35,675.9844        | 0.6838        | 0.6541        | 35,887.9890        |
| <b>Total</b>             |                | <b>3.2703</b> | <b>29.7300</b> | <b>24.9732</b> | <b>0.1784</b> |               | <b>2.2595</b> | <b>2.2595</b> |                | <b>2.2595</b> | <b>2.2595</b> |          | <b>35,675.9844</b> | <b>35,675.9844</b> | <b>0.6838</b> | <b>0.6541</b> | <b>35,887.9890</b> |

**EMFAC Off-Model Adjustment Factors for Gasoline Light Duty Vehicle to Account for the SAFE Vehicle Rule Applied**

**Mitigated**

|                          | Natural Gas Use | ROG           | NOx            | CO             | SO2           | Fugitive PM10 | Exhaust PM10  | PM10 Total    | Fugitive PM2.5 | Exhaust PM2.5 | PM2.5 Total   | Bio- CO2 | NBio- CO2          | Total CO2          | CH4           | N2O           | CO2e               |
|--------------------------|-----------------|---------------|----------------|----------------|---------------|---------------|---------------|---------------|----------------|---------------|---------------|----------|--------------------|--------------------|---------------|---------------|--------------------|
| Land Use                 | kBTU/yr         | lb/day        |                |                |               |               |               |               |                |               |               | lb/day   |                    |                    |               |               |                    |
| Apartments Mid Rise      | 0               | 0.0000        | 0.0000         | 0.0000         | 0.0000        |               | 0.0000        | 0.0000        |                | 0.0000        | 0.0000        |          | 0.0000             | 0.0000             | 0.0000        | 0.0000        | 0.0000             |
| University/College (4yr) | 303.246         | 3.2703        | 29.7300        | 24.9732        | 0.1784        |               | 2.2595        | 2.2595        |                | 2.2595        | 2.2595        |          | 35,675.9844        | 35,675.9844        | 0.6838        | 0.6541        | 35,887.9890        |
| <b>Total</b>             |                 | <b>3.2703</b> | <b>29.7300</b> | <b>24.9732</b> | <b>0.1784</b> |               | <b>2.2595</b> | <b>2.2595</b> |                | <b>2.2595</b> | <b>2.2595</b> |          | <b>35,675.9844</b> | <b>35,675.9844</b> | <b>0.6838</b> | <b>0.6541</b> | <b>35,887.9890</b> |

**6.0 Area Detail**

**6.1 Mitigation Measures Area**

|             | ROG      | NOx    | CO       | SO2    | Fugitive PM10 | Exhaust PM10 | PM10 Total | Fugitive PM2.5 | Exhaust PM2.5 | PM2.5 Total | Bio- CO2 | NBio- CO2  | Total CO2  | CH4    | N2O    | CO2e       |
|-------------|----------|--------|----------|--------|---------------|--------------|------------|----------------|---------------|-------------|----------|------------|------------|--------|--------|------------|
| Category    | lb/day   |        |          |        |               |              |            |                |               |             | lb/day   |            |            |        |        |            |
| Mitigated   | 157.2079 | 8.5669 | 742.8350 | 0.0394 |               | 4.1313       | 4.1313     |                | 4.1313        | 4.1313      | 0.0000   | 1,342.7212 | 1,342.7212 | 1.2827 | 0.0000 | 1,374.7889 |
| Unmitigated | 157.2079 | 8.5669 | 742.8350 | 0.0394 |               | 4.1313       | 4.1313     |                | 4.1313        | 4.1313      | 0.0000   | 1,342.7212 | 1,342.7212 | 1.2827 | 0.0000 | 1,374.7889 |

**EMFAC Off-Model Adjustment Factors for Gasoline Light Duty Vehicle to Account for the SAFE Vehicle Rule Applied**

**6.2 Area by SubCategory**

**Unmitigated**

|                       | ROG             | NOx           | CO              | SO2           | Fugitive PM10 | Exhaust PM10  | PM10 Total    | Fugitive PM2.5 | Exhaust PM2.5 | PM2.5 Total   | Bio- CO2      | NBio- CO2         | Total CO2         | CH4           | N2O           | CO2e              |
|-----------------------|-----------------|---------------|-----------------|---------------|---------------|---------------|---------------|----------------|---------------|---------------|---------------|-------------------|-------------------|---------------|---------------|-------------------|
| SubCategory           | lb/day          |               |                 |               |               |               |               |                |               |               | lb/day        |                   |                   |               |               |                   |
| Architectural Coating | 9.3390          |               |                 |               |               | 0.0000        | 0.0000        |                | 0.0000        | 0.0000        |               |                   | 0.0000            |               |               | 0.0000            |
| Consumer Products     | 125.5791        |               |                 |               |               | 0.0000        | 0.0000        |                | 0.0000        | 0.0000        |               |                   | 0.0000            |               |               | 0.0000            |
| Hearth                | 0.0000          | 0.0000        | 0.0000          | 0.0000        |               | 0.0000        | 0.0000        |                | 0.0000        | 0.0000        | 0.0000        | 0.0000            | 0.0000            | 0.0000        | 0.0000        | 0.0000            |
| Landscaping           | 22.2899         | 8.5669        | 742.8350        | 0.0394        |               | 4.1313        | 4.1313        |                | 4.1313        | 4.1313        |               | 1,342.7212        | 1,342.7212        | 1.2827        |               | 1,374.7889        |
| <b>Total</b>          | <b>157.2079</b> | <b>8.5669</b> | <b>742.8350</b> | <b>0.0394</b> |               | <b>4.1313</b> | <b>4.1313</b> |                | <b>4.1313</b> | <b>4.1313</b> | <b>0.0000</b> | <b>1,342.7212</b> | <b>1,342.7212</b> | <b>1.2827</b> | <b>0.0000</b> | <b>1,374.7889</b> |



**EMFAC Off-Model Adjustment Factors for Gasoline Light Duty Vehicle to Account for the SAFE Vehicle Rule Applied**

**Mitigated**

|                       | ROG             | NOx           | CO              | SO2           | Fugitive PM10 | Exhaust PM10  | PM10 Total    | Fugitive PM2.5 | Exhaust PM2.5 | PM2.5 Total   | Bio- CO2      | NBio- CO2         | Total CO2         | CH4           | N2O           | CO2e              |
|-----------------------|-----------------|---------------|-----------------|---------------|---------------|---------------|---------------|----------------|---------------|---------------|---------------|-------------------|-------------------|---------------|---------------|-------------------|
| SubCategory           | lb/day          |               |                 |               |               |               |               |                |               |               | lb/day        |                   |                   |               |               |                   |
| Architectural Coating | 9.3390          |               |                 |               |               | 0.0000        | 0.0000        |                | 0.0000        | 0.0000        |               |                   | 0.0000            |               |               | 0.0000            |
| Consumer Products     | 125.5791        |               |                 |               |               | 0.0000        | 0.0000        |                | 0.0000        | 0.0000        |               |                   | 0.0000            |               |               | 0.0000            |
| Hearth                | 0.0000          | 0.0000        | 0.0000          | 0.0000        |               | 0.0000        | 0.0000        |                | 0.0000        | 0.0000        | 0.0000        | 0.0000            | 0.0000            | 0.0000        | 0.0000        | 0.0000            |
| Landscaping           | 22.2899         | 8.5669        | 742.8350        | 0.0394        |               | 4.1313        | 4.1313        |                | 4.1313        | 4.1313        |               | 1,342.7212        | 1,342.7212        | 1.2827        |               | 1,374.7889        |
| <b>Total</b>          | <b>157.2079</b> | <b>8.5669</b> | <b>742.8350</b> | <b>0.0394</b> |               | <b>4.1313</b> | <b>4.1313</b> |                | <b>4.1313</b> | <b>4.1313</b> | <b>0.0000</b> | <b>1,342.7212</b> | <b>1,342.7212</b> | <b>1.2827</b> | <b>0.0000</b> | <b>1,374.7889</b> |

**EMFAC Off-Model Adjustment Factors for Gasoline Light Duty Vehicle to Account for the SAFE Vehicle Rule Applied**

**CSUMB - Existing Campus (Annual)  
Monterey Bay Unified APCD Air District, Annual**

**1.0 Project Characteristics**

**1.1 Land Usage**

| Land Uses                | Size     | Metric        | Lot Acreage | Floor Surface Area | Population |
|--------------------------|----------|---------------|-------------|--------------------|------------|
| University/College (4yr) | 6,634.00 | Student       | 27.99       | 1,142,777.00       | 0          |
| Apartments Mid Rise      | 5,200.00 | Dwelling Unit | 136.84      | 2,047,779.00       | 7097       |

**1.2 Other Project Characteristics**

|                                |                                  |                                |       |                                  |       |
|--------------------------------|----------------------------------|--------------------------------|-------|----------------------------------|-------|
| <b>Urbanization</b>            | Urban                            | <b>Wind Speed (m/s)</b>        | 2.8   | <b>Precipitation Freq (Days)</b> | 53    |
| <b>Climate Zone</b>            | 4                                |                                |       | <b>Operational Year</b>          | 2018  |
| <b>Utility Company</b>         | Pacific Gas and Electric Company |                                |       |                                  |       |
| <b>CO2 Intensity (lb/MWhr)</b> | 203.98                           | <b>CH4 Intensity (lb/MWhr)</b> | 0.033 | <b>N2O Intensity (lb/MWhr)</b>   | 0.004 |

**1.3 User Entered Comments & Non-Default Data**

Project Characteristics - CSUMB Master Plan. MBUAPCD.

Land Use - Existing campus includes 1,142,777 SF of campus facilities and 3,980 beds/1,220 DU. 6,634 FTE students in 2016-17 and 463 DU occuied by staff/faculty.

Construction Phase - Modeling operations only.

Vehicle Trips - Update trip rate and trip length per TRA for annual emissions. Adjusted calculated trip rate tp match annual VMT. Assumed 100% primary trips. Based Sunday trip rates from Junior College land use since Univeristy default is 0.

Woodstoves - Assumed no fireplaces.

Area Coating - Use of low-VOC (50 g/L) arch coatings.

Energy Use - Updated energy intensities based on data provided.

**EMFAC Off-Model Adjustment Factors for Gasoline Light Duty Vehicle to Account for the SAFE Vehicle Rule Applied**

Water And Wastewater - Revised water and wastewater based on consumption data provided by CSUMB.

Solid Waste - Default solid waste generation rates assumed.

| Table Name     | Column Name                     | Default Value | New Value    |
|----------------|---------------------------------|---------------|--------------|
| tblAreaCoating | Area_EF_Nonresidential_Exterior | 150           | 50           |
| tblAreaCoating | Area_EF_Nonresidential_Interior | 150           | 50           |
| tblAreaCoating | Area_EF_Residential_Exterior    | 100           | 50           |
| tblAreaCoating | Area_EF_Residential_Interior    | 100           | 50           |
| tblAreaCoating | Area_Nonresidential_Exterior    | 571390        | 609655       |
| tblAreaCoating | Area_Nonresidential_Interior    | 1714170       | 1828965      |
| tblAreaCoating | Area_Residential_Exterior       | 1382252       | 3142800      |
| tblAreaCoating | Area_Residential_Interior       | 4146755       | 9428400      |
| tblEnergyUse   | LightingElect                   | 741.44        | 0.00         |
| tblEnergyUse   | LightingElect                   | 2.91          | 3.83         |
| tblEnergyUse   | NT24E                           | 3,054.10      | 0.00         |
| tblEnergyUse   | NT24E                           | 2.27          | 2.99         |
| tblEnergyUse   | NT24NG                          | 3,155.00      | 0.00         |
| tblEnergyUse   | NT24NG                          | 3.30          | 6.71         |
| tblEnergyUse   | T24E                            | 70.89         | 0.00         |
| tblEnergyUse   | T24E                            | 2.44          | 3.21         |
| tblEnergyUse   | T24NG                           | 5,226.68      | 0.00         |
| tblEnergyUse   | T24NG                           | 20.62         | 41.92        |
| tblFireplaces  | NumberGas                       | 5,200.00      | 0.00         |
| tblFireplaces  | NumberNoFireplace               | 0.00          | 5,200.00     |
| tblLandUse     | LandUseSquareFeet               | 1,219,312.41  | 1,142,777.00 |
| tblLandUse     | LandUseSquareFeet               | 5,200,000.00  | 2,047,779.00 |

**EMFAC Off-Model Adjustment Factors for Gasoline Light Duty Vehicle to Account for the SAFE Vehicle Rule Applied**

|                           |                          |                |               |
|---------------------------|--------------------------|----------------|---------------|
| tblLandUse                | Population               | 14,872.00      | 7,097.00      |
| tblProjectCharacteristics | CH4IntensityFactor       | 0.033          | 0             |
| tblProjectCharacteristics | N2OIntensityFactor       | 0.004          | 0             |
| tblSolidWaste             | SolidWasteGenerationRate | 2,392.00       | 2,141.76      |
| tblVehicleTrips           | CC_TL                    | 7.30           | 4.65          |
| tblVehicleTrips           | CNW_TL                   | 7.30           | 4.65          |
| tblVehicleTrips           | CW_TL                    | 9.50           | 4.65          |
| tblVehicleTrips           | DV_TP                    | 9.00           | 0.00          |
| tblVehicleTrips           | HO_TL                    | 7.50           | 0.00          |
| tblVehicleTrips           | HS_TL                    | 7.30           | 0.00          |
| tblVehicleTrips           | HW_TL                    | 10.80          | 0.00          |
| tblVehicleTrips           | PR_TP                    | 91.00          | 100.00        |
| tblVehicleTrips           | ST_TR                    | 4.91           | 0.00          |
| tblVehicleTrips           | ST_TR                    | 1.30           | 3.54          |
| tblVehicleTrips           | SU_TR                    | 4.09           | 0.00          |
| tblVehicleTrips           | SU_TR                    | 0.00           | 0.25          |
| tblVehicleTrips           | WD_TR                    | 5.44           | 0.00          |
| tblVehicleTrips           | WD_TR                    | 1.56           | 4.25          |
| tblWater                  | IndoorWaterUseRate       | 338,800,933.23 | 0.00          |
| tblWater                  | IndoorWaterUseRate       | 14,204,057.40  | 32,827,469.00 |
| tblWater                  | OutdoorWaterUseRate      | 213,591,892.69 | 0.00          |
| tblWater                  | OutdoorWaterUseRate      | 22,216,602.60  | 21,879,743.00 |

**EMFAC Off-Model Adjustment Factors for Gasoline Light Duty Vehicle to Account for the SAFE Vehicle Rule Applied**

**2.0 Emissions Summary**

**2.2 Overall Operational  
Unmitigated Operational**

|              | ROG            | NOx            | CO              | SO2           | Fugitive PM10  | Exhaust PM10  | PM10 Total     | Fugitive PM2.5 | Exhaust PM2.5 | PM2.5 Total   | Bio- CO2        | NBio- CO2          | Total CO2          | CH4            | N2O           | CO2e               |
|--------------|----------------|----------------|-----------------|---------------|----------------|---------------|----------------|----------------|---------------|---------------|-----------------|--------------------|--------------------|----------------|---------------|--------------------|
| Category     | tons/yr        |                |                 |               |                |               |                |                |               |               | MT/yr           |                    |                    |                |               |                    |
| Area         | 15.8729        | 0.6276         | 54.0909         | 2.8400e-003   |                | 0.2951        | 0.2951         |                | 0.2951        | 0.2951        | 0.0000          | 87.7615            | 87.7615            | 0.0873         | 0.0000        | 89.9431            |
| Energy       | 0.2997         | 2.7242         | 2.2883          | 0.0164        |                | 0.2070        | 0.2070         |                | 0.2070        | 0.2070        | 0.0000          | 4,026.1124         | 4,026.1124         | 0.0568         | 0.0544        | 4,043.7355         |
| Mobile       | 16.3233        | 23.2635        | 132.8500        | 0.1868        | 14.9725        | 0.3091        | 15.2816        | 4.0083         | 0.2916        | 4.2999        | 0.0000          | 17,244.2846        | 17,244.2846        | 1.8595         | 1.1840        | 17,643.6091        |
| Waste        |                |                |                 |               |                | 0.0000        | 0.0000         |                | 0.0000        | 0.0000        | 680.5191        | 0.0000             | 680.5191           | 40.2175        | 0.0000        | 1,685.9572         |
| Water        |                |                |                 |               |                | 0.0000        | 0.0000         |                | 0.0000        | 0.0000        | 10.4146         | 23.5203            | 33.9350            | 1.0697         | 0.0253        | 68.2038            |
| <b>Total</b> | <b>32.4959</b> | <b>26.6153</b> | <b>189.2292</b> | <b>0.2060</b> | <b>14.9725</b> | <b>0.8112</b> | <b>15.7837</b> | <b>4.0083</b>  | <b>0.7937</b> | <b>4.8020</b> | <b>690.9337</b> | <b>21,381.6788</b> | <b>22,072.6126</b> | <b>43.2908</b> | <b>1.2637</b> | <b>23,531.4487</b> |



**EMFAC Off-Model Adjustment Factors for Gasoline Light Duty Vehicle to Account for the SAFE Vehicle Rule Applied**

**4.0 Operational Detail - Mobile**

**4.1 Mitigation Measures Mobile**

|             | ROG     | NOx     | CO       | SO2    | Fugitive PM10 | Exhaust PM10 | PM10 Total | Fugitive PM2.5 | Exhaust PM2.5 | PM2.5 Total | Bio- CO2 | NBio- CO2   | Total CO2   | CH4    | N2O    | CO2e        |
|-------------|---------|---------|----------|--------|---------------|--------------|------------|----------------|---------------|-------------|----------|-------------|-------------|--------|--------|-------------|
| Category    | tons/yr |         |          |        |               |              |            |                |               |             | MT/yr    |             |             |        |        |             |
| Mitigated   | 16.3233 | 23.2635 | 132.8500 | 0.1868 | 14.9725       | 0.3091       | 15.2816    | 4.0083         | 0.2916        | 4.2999      | 0.0000   | 17,244.2846 | 17,244.2846 | 1.8595 | 1.1840 | 17,643.6091 |
| Unmitigated | 16.3233 | 23.2635 | 132.8500 | 0.1868 | 14.9725       | 0.3091       | 15.2816    | 4.0083         | 0.2916        | 4.2999      | 0.0000   | 17,244.2846 | 17,244.2846 | 1.8595 | 1.1840 | 17,643.6091 |

**4.2 Trip Summary Information**

| Land Use                 | Average Daily Trip Rate |                  |                 | Unmitigated       | Mitigated         |
|--------------------------|-------------------------|------------------|-----------------|-------------------|-------------------|
|                          | Weekday                 | Saturday         | Sunday          | Annual VMT        | Annual VMT        |
| Apartments Mid Rise      | 0.00                    | 0.00             | 0.00            |                   |                   |
| University/College (4yr) | 28,194.50               | 23,484.36        | 1,658.50        | 40,166,694        | 40,166,694        |
| <b>Total</b>             | <b>28,194.50</b>        | <b>23,484.36</b> | <b>1,658.50</b> | <b>40,166,694</b> | <b>40,166,694</b> |

**4.3 Trip Type Information**

| Land Use                 | Miles      |            |             | Trip %     |            |             | Trip Purpose % |          |         |
|--------------------------|------------|------------|-------------|------------|------------|-------------|----------------|----------|---------|
|                          | H-W or C-W | H-S or C-C | H-O or C-NW | H-W or C-W | H-S or C-C | H-O or C-NW | Primary        | Diverted | Pass-by |
| Apartments Mid Rise      | 0.00       | 0.00       | 0.00        | 44.00      | 18.80      | 37.20       | 86             | 11       | 3       |
| University/College (4yr) | 4.65       | 4.65       | 4.65        | 6.40       | 88.60      | 5.00        | 100            | 0        | 0       |

**EMFAC Off-Model Adjustment Factors for Gasoline Light Duty Vehicle to Account for the SAFE Vehicle Rule Applied**

**4.4 Fleet Mix**

| Land Use                 | LDA      | LDT1     | LDT2     | MDV      | LHD1     | LHD2     | MHD      | HHD      | OBUS     | UBUS     | MCY      | SBUS     | MH       |
|--------------------------|----------|----------|----------|----------|----------|----------|----------|----------|----------|----------|----------|----------|----------|
| Apartments Mid Rise      | 0.472891 | 0.048916 | 0.201626 | 0.172765 | 0.037062 | 0.008202 | 0.011598 | 0.008545 | 0.001485 | 0.000584 | 0.029640 | 0.001456 | 0.005230 |
| University/College (4yr) | 0.472891 | 0.048916 | 0.201626 | 0.172765 | 0.037062 | 0.008202 | 0.011598 | 0.008545 | 0.001485 | 0.000584 | 0.029640 | 0.001456 | 0.005230 |

**5.0 Energy Detail**

Historical Energy Use: N

**5.1 Mitigation Measures Energy**

| Category                | ROG     | NOx    | CO     | SO2    | Fugitive PM10 | Exhaust PM10 | PM10 Total | Fugitive PM2.5 | Exhaust PM2.5 | PM2.5 Total | Bio- CO2 | NBio- CO2  | Total CO2  | CH4    | N2O    | CO2e       |
|-------------------------|---------|--------|--------|--------|---------------|--------------|------------|----------------|---------------|-------------|----------|------------|------------|--------|--------|------------|
|                         | tons/yr |        |        |        |               |              |            |                |               |             | MT/yr    |            |            |        |        |            |
| Electricity Mitigated   |         |        |        |        |               | 0.0000       | 0.0000     |                | 0.0000        | 0.0000      | 0.0000   | 1,060.5124 | 1,060.5124 | 0.0000 | 0.0000 | 1,060.5124 |
| Electricity Unmitigated |         |        |        |        |               | 0.0000       | 0.0000     |                | 0.0000        | 0.0000      | 0.0000   | 1,060.5124 | 1,060.5124 | 0.0000 | 0.0000 | 1,060.5124 |
| NaturalGas Mitigated    | 0.2997  | 2.7242 | 2.2883 | 0.0164 |               | 0.2070       | 0.2070     |                | 0.2070        | 0.2070      | 0.0000   | 2,965.6000 | 2,965.6000 | 0.0568 | 0.0544 | 2,983.2231 |
| NaturalGas Unmitigated  | 0.2997  | 2.7242 | 2.2883 | 0.0164 |               | 0.2070       | 0.2070     |                | 0.2070        | 0.2070      | 0.0000   | 2,965.6000 | 2,965.6000 | 0.0568 | 0.0544 | 2,983.2231 |



**EMFAC Off-Model Adjustment Factors for Gasoline Light Duty Vehicle to Account for the SAFE Vehicle Rule Applied**

**5.2 Energy by Land Use - NaturalGas**

**Unmitigated**

|                          | NaturalGas Use | ROG           | NOx           | CO            | SO2           | Fugitive PM10 | Exhaust PM10  | PM10 Total    | Fugitive PM2.5 | Exhaust PM2.5 | PM2.5 Total   | Bio- CO2      | NBio- CO2         | Total CO2         | CH4           | N2O           | CO2e              |        |
|--------------------------|----------------|---------------|---------------|---------------|---------------|---------------|---------------|---------------|----------------|---------------|---------------|---------------|-------------------|-------------------|---------------|---------------|-------------------|--------|
| Land Use                 | kBTU/yr        | tons/yr       |               |               |               |               |               |               |                |               |               | MT/yr         |                   |                   |               |               |                   |        |
| Apartments Mid Rise      | 0              | 0.0000        | 0.0000        | 0.0000        | 0.0000        |               | 0.0000        | 0.0000        |                | 0.0000        | 0.0000        | 0.0000        | 0.0000            | 0.0000            | 0.0000        | 0.0000        | 0.0000            | 0.0000 |
| University/College (4yr) | 5.55732e+007   | 0.2997        | 2.7242        | 2.2883        | 0.0164        |               | 0.2070        | 0.2070        |                | 0.2070        | 0.2070        | 0.0000        | 2,965.6000        | 2,965.6000        | 0.0568        | 0.0544        | 2,983.2231        |        |
| <b>Total</b>             |                | <b>0.2997</b> | <b>2.7242</b> | <b>2.2883</b> | <b>0.0164</b> |               | <b>0.2070</b> | <b>0.2070</b> |                | <b>0.2070</b> | <b>0.2070</b> | <b>0.0000</b> | <b>2,965.6000</b> | <b>2,965.6000</b> | <b>0.0568</b> | <b>0.0544</b> | <b>2,983.2231</b> |        |

**Mitigated**

|                          | NaturalGas Use | ROG           | NOx           | CO            | SO2           | Fugitive PM10 | Exhaust PM10  | PM10 Total    | Fugitive PM2.5 | Exhaust PM2.5 | PM2.5 Total   | Bio- CO2      | NBio- CO2         | Total CO2         | CH4           | N2O           | CO2e              |
|--------------------------|----------------|---------------|---------------|---------------|---------------|---------------|---------------|---------------|----------------|---------------|---------------|---------------|-------------------|-------------------|---------------|---------------|-------------------|
| Land Use                 | kBTU/yr        | tons/yr       |               |               |               |               |               |               |                |               |               | MT/yr         |                   |                   |               |               |                   |
| Apartments Mid Rise      | 0              | 0.0000        | 0.0000        | 0.0000        | 0.0000        |               | 0.0000        | 0.0000        |                | 0.0000        | 0.0000        | 0.0000        | 0.0000            | 0.0000            | 0.0000        | 0.0000        | 0.0000            |
| University/College (4yr) | 5.55732e+007   | 0.2997        | 2.7242        | 2.2883        | 0.0164        |               | 0.2070        | 0.2070        |                | 0.2070        | 0.2070        | 0.0000        | 2,965.6000        | 2,965.6000        | 0.0568        | 0.0544        | 2,983.2231        |
| <b>Total</b>             |                | <b>0.2997</b> | <b>2.7242</b> | <b>2.2883</b> | <b>0.0164</b> |               | <b>0.2070</b> | <b>0.2070</b> |                | <b>0.2070</b> | <b>0.2070</b> | <b>0.0000</b> | <b>2,965.6000</b> | <b>2,965.6000</b> | <b>0.0568</b> | <b>0.0544</b> | <b>2,983.2231</b> |

**EMFAC Off-Model Adjustment Factors for Gasoline Light Duty Vehicle to Account for the SAFE Vehicle Rule Applied**

**5.3 Energy by Land Use - Electricity**

**Unmitigated**

|                          | Electricity Use | Total CO2         | CH4           | N2O           | CO2e              |
|--------------------------|-----------------|-------------------|---------------|---------------|-------------------|
| Land Use                 | kWh/yr          | MT/yr             |               |               |                   |
| Apartments Mid Rise      | 0               | 0.0000            | 0.0000        | 0.0000        | 0.0000            |
| University/College (4yr) | 1.14621e+007    | 1,060.5124        | 0.0000        | 0.0000        | 1,060.5124        |
| <b>Total</b>             |                 | <b>1,060.5124</b> | <b>0.0000</b> | <b>0.0000</b> | <b>1,060.5124</b> |

**Mitigated**

|                          | Electricity Use | Total CO2         | CH4           | N2O           | CO2e              |
|--------------------------|-----------------|-------------------|---------------|---------------|-------------------|
| Land Use                 | kWh/yr          | MT/yr             |               |               |                   |
| Apartments Mid Rise      | 0               | 0.0000            | 0.0000        | 0.0000        | 0.0000            |
| University/College (4yr) | 1.14621e+007    | 1,060.5124        | 0.0000        | 0.0000        | 1,060.5124        |
| <b>Total</b>             |                 | <b>1,060.5124</b> | <b>0.0000</b> | <b>0.0000</b> | <b>1,060.5124</b> |

**EMFAC Off-Model Adjustment Factors for Gasoline Light Duty Vehicle to Account for the SAFE Vehicle Rule Applied**

**6.0 Area Detail**

**6.1 Mitigation Measures Area**

|             | ROG     | NOx    | CO      | SO2         | Fugitive PM10 | Exhaust PM10 | PM10 Total | Fugitive PM2.5 | Exhaust PM2.5 | PM2.5 Total | Bio- CO2 | NBio- CO2 | Total CO2 | CH4    | N2O    | CO2e    |
|-------------|---------|--------|---------|-------------|---------------|--------------|------------|----------------|---------------|-------------|----------|-----------|-----------|--------|--------|---------|
| Category    | tons/yr |        |         |             |               |              |            |                |               |             | MT/yr    |           |           |        |        |         |
| Mitigated   | 15.8729 | 0.6276 | 54.0909 | 2.8400e-003 |               | 0.2951       | 0.2951     |                | 0.2951        | 0.2951      | 0.0000   | 87.7615   | 87.7615   | 0.0873 | 0.0000 | 89.9431 |
| Unmitigated | 15.8729 | 0.6276 | 54.0909 | 2.8400e-003 |               | 0.2951       | 0.2951     |                | 0.2951        | 0.2951      | 0.0000   | 87.7615   | 87.7615   | 0.0873 | 0.0000 | 89.9431 |

**EMFAC Off-Model Adjustment Factors for Gasoline Light Duty Vehicle to Account for the SAFE Vehicle Rule Applied**

**6.2 Area by SubCategory**

**Unmitigated**

|                       | ROG            | NOx           | CO             | SO2                | Fugitive PM10 | Exhaust PM10  | PM10 Total    | Fugitive PM2.5 | Exhaust PM2.5 | PM2.5 Total   | Bio- CO2      | NBio- CO2      | Total CO2      | CH4           | N2O           | CO2e           |
|-----------------------|----------------|---------------|----------------|--------------------|---------------|---------------|---------------|----------------|---------------|---------------|---------------|----------------|----------------|---------------|---------------|----------------|
| SubCategory           | tons/yr        |               |                |                    |               |               |               |                |               |               | MT/yr         |                |                |               |               |                |
| Architectural Coating | 1.7393         |               |                |                    |               | 0.0000        | 0.0000        |                | 0.0000        | 0.0000        | 0.0000        | 0.0000         | 0.0000         | 0.0000        | 0.0000        | 0.0000         |
| Consumer Products     | 12.4607        |               |                |                    |               | 0.0000        | 0.0000        |                | 0.0000        | 0.0000        | 0.0000        | 0.0000         | 0.0000         | 0.0000        | 0.0000        | 0.0000         |
| Hearth                | 0.0000         | 0.0000        | 0.0000         | 0.0000             |               | 0.0000        | 0.0000        |                | 0.0000        | 0.0000        | 0.0000        | 0.0000         | 0.0000         | 0.0000        | 0.0000        | 0.0000         |
| Landscaping           | 1.6730         | 0.6276        | 54.0909        | 2.8400e-003        |               | 0.2951        | 0.2951        |                | 0.2951        | 0.2951        | 0.0000        | 87.7615        | 87.7615        | 0.0873        | 0.0000        | 89.9431        |
| <b>Total</b>          | <b>15.8729</b> | <b>0.6276</b> | <b>54.0909</b> | <b>2.8400e-003</b> |               | <b>0.2951</b> | <b>0.2951</b> |                | <b>0.2951</b> | <b>0.2951</b> | <b>0.0000</b> | <b>87.7615</b> | <b>87.7615</b> | <b>0.0873</b> | <b>0.0000</b> | <b>89.9431</b> |

**EMFAC Off-Model Adjustment Factors for Gasoline Light Duty Vehicle to Account for the SAFE Vehicle Rule Applied**

**Mitigated**

|                       | ROG            | NOx           | CO             | SO2                | Fugitive PM10 | Exhaust PM10  | PM10 Total    | Fugitive PM2.5 | Exhaust PM2.5 | PM2.5 Total   | Bio- CO2      | NBio- CO2      | Total CO2      | CH4           | N2O           | CO2e           |
|-----------------------|----------------|---------------|----------------|--------------------|---------------|---------------|---------------|----------------|---------------|---------------|---------------|----------------|----------------|---------------|---------------|----------------|
| SubCategory           | tons/yr        |               |                |                    |               |               |               |                |               |               | MT/yr         |                |                |               |               |                |
| Architectural Coating | 1.7393         |               |                |                    |               | 0.0000        | 0.0000        |                | 0.0000        | 0.0000        | 0.0000        | 0.0000         | 0.0000         | 0.0000        | 0.0000        | 0.0000         |
| Consumer Products     | 12.4607        |               |                |                    |               | 0.0000        | 0.0000        |                | 0.0000        | 0.0000        | 0.0000        | 0.0000         | 0.0000         | 0.0000        | 0.0000        | 0.0000         |
| Hearth                | 0.0000         | 0.0000        | 0.0000         | 0.0000             |               | 0.0000        | 0.0000        |                | 0.0000        | 0.0000        | 0.0000        | 0.0000         | 0.0000         | 0.0000        | 0.0000        | 0.0000         |
| Landscaping           | 1.6730         | 0.6276        | 54.0909        | 2.8400e-003        |               | 0.2951        | 0.2951        |                | 0.2951        | 0.2951        | 0.0000        | 87.7615        | 87.7615        | 0.0873        | 0.0000        | 89.9431        |
| <b>Total</b>          | <b>15.8729</b> | <b>0.6276</b> | <b>54.0909</b> | <b>2.8400e-003</b> |               | <b>0.2951</b> | <b>0.2951</b> |                | <b>0.2951</b> | <b>0.2951</b> | <b>0.0000</b> | <b>87.7615</b> | <b>87.7615</b> | <b>0.0873</b> | <b>0.0000</b> | <b>89.9431</b> |

**7.0 Water Detail**

**7.1 Mitigation Measures Water**

|             | Total CO2 | CH4    | N2O    | CO2e    |
|-------------|-----------|--------|--------|---------|
| Category    | MT/yr     |        |        |         |
| Mitigated   | 33.9350   | 1.0697 | 0.0253 | 68.2038 |
| Unmitigated | 33.9350   | 1.0697 | 0.0253 | 68.2038 |

**EMFAC Off-Model Adjustment Factors for Gasoline Light Duty Vehicle to Account for the SAFE Vehicle Rule Applied**

**7.2 Water by Land Use**

**Unmitigated**

| Indoor/Outdoor Use       |                   | Total CO2      | CH4           | N2O           | CO2e           |
|--------------------------|-------------------|----------------|---------------|---------------|----------------|
| Land Use                 | Mgal              | MT/yr          |               |               |                |
| Apartments Mid Rise      | 0 / 0             | 0.0000         | 0.0000        | 0.0000        | 0.0000         |
| University/College (4yr) | 32.8275 / 21.8797 | 33.9350        | 1.0697        | 0.0253        | 68.2038        |
| <b>Total</b>             |                   | <b>33.9350</b> | <b>1.0697</b> | <b>0.0253</b> | <b>68.2038</b> |

**Mitigated**

| Indoor/Outdoor Use       |                   | Total CO2      | CH4           | N2O           | CO2e           |
|--------------------------|-------------------|----------------|---------------|---------------|----------------|
| Land Use                 | Mgal              | MT/yr          |               |               |                |
| Apartments Mid Rise      | 0 / 0             | 0.0000         | 0.0000        | 0.0000        | 0.0000         |
| University/College (4yr) | 32.8275 / 21.8797 | 33.9350        | 1.0697        | 0.0253        | 68.4438        |
| <b>Total</b>             |                   | <b>33.9350</b> | <b>1.0697</b> | <b>0.0253</b> | <b>68.4438</b> |

**EMFAC Off-Model Adjustment Factors for Gasoline Light Duty Vehicle to Account for the SAFE Vehicle Rule Applied**

**8.0 Waste Detail**

**8.1 Mitigation Measures Waste**

Category/Year

|             | Total CO2 | CH4     | N2O    | CO2e       |
|-------------|-----------|---------|--------|------------|
|             | MT/yr     |         |        |            |
| Mitigated   | 680.5191  | 40.2175 | 0.0000 | 1,685.9572 |
| Unmitigated | 680.5191  | 40.2175 | 0.0000 | 1,685.9572 |

**8.2 Waste by Land Use**

Unmitigated

|                          | Waste Disposed | Total CO2       | CH4            | N2O           | CO2e              |
|--------------------------|----------------|-----------------|----------------|---------------|-------------------|
| Land Use                 | tons           | MT/yr           |                |               |                   |
| Apartments Mid Rise      | 2141.76        | 434.7579        | 25.6935        | 0.0000        | 1,077.0944        |
| University/College (4yr) | 1210.7         | 245.7612        | 14.5241        | 0.0000        | 608.8629          |
| <b>Total</b>             |                | <b>680.5191</b> | <b>40.2175</b> | <b>0.0000</b> | <b>1,685.9572</b> |

**EMFAC Off-Model Adjustment Factors for Gasoline Light Duty Vehicle to Account for the SAFE Vehicle Rule Applied**

**Mitigated**

|                          | Waste Disposed | Total CO2       | CH4            | N2O           | CO2e              |
|--------------------------|----------------|-----------------|----------------|---------------|-------------------|
| Land Use                 | tons           | MT/yr           |                |               |                   |
| Apartments Mid Rise      | 2141.76        | 434.7579        | 25.6935        | 0.0000        | 1,077.0944        |
| University/College (4yr) | 1210.7         | 245.7612        | 14.5241        | 0.0000        | 608.8629          |
| <b>Total</b>             |                | <b>680.5191</b> | <b>40.2175</b> | <b>0.0000</b> | <b>1,685.9572</b> |



**EMFAC Off-Model Adjustment Factors for Gasoline Light Duty Vehicle to Account for the SAFE Vehicle Rule Applied**

**CSUMB - Existing Campus (Daily)  
Monterey Bay Unified APCD Air District, Summer**

**1.0 Project Characteristics**

**1.1 Land Usage**

| Land Uses                | Size     | Metric        | Lot Acreage | Floor Surface Area | Population |
|--------------------------|----------|---------------|-------------|--------------------|------------|
| University/College (4yr) | 6,634.00 | Student       | 27.99       | 1,142,777.00       | 0          |
| Apartments Mid Rise      | 5,200.00 | Dwelling Unit | 136.84      | 2,047,779.00       | 7097       |

**1.2 Other Project Characteristics**

|                                |                                  |                                |       |                                  |       |
|--------------------------------|----------------------------------|--------------------------------|-------|----------------------------------|-------|
| <b>Urbanization</b>            | Urban                            | <b>Wind Speed (m/s)</b>        | 2.8   | <b>Precipitation Freq (Days)</b> | 53    |
| <b>Climate Zone</b>            | 4                                |                                |       | <b>Operational Year</b>          | 2018  |
| <b>Utility Company</b>         | Pacific Gas and Electric Company |                                |       |                                  |       |
| <b>CO2 Intensity (lb/MWhr)</b> | 203.98                           | <b>CH4 Intensity (lb/MWhr)</b> | 0.033 | <b>N2O Intensity (lb/MWhr)</b>   | 0.004 |

**1.3 User Entered Comments & Non-Default Data**

Project Characteristics - CSUMB Master Plan. MBUAPCD.

Land Use - Existing campus includes 1,142,777 SF of campus facilities and 3,980 beds/1,220 DU. 6,634 FTE students in 2016-17 and 463 DU occuied by staff/faculty.

Construction Phase - Modeling operations only.

Vehicle Trips - Update trip rate and trip length per TRA. Assumed 100% primary trips. Based Sunday trip rates from Junior College land use since Univeristy default is 0.

Woodstoves - Assumed no fireplaces.

Area Coating - Use of low-VOC (50 g/L) arch coatings.

Energy Use - Updated energy intensities per provided consumption data.

**EMFAC Off-Model Adjustment Factors for Gasoline Light Duty Vehicle to Account for the SAFE Vehicle Rule Applied**

Water And Wastewater - Revised water and wastewater based on consumption data provided by CSUMB.

Solid Waste - Default solid waste generation rates assumed.

| Table Name     | Column Name                     | Default Value | New Value    |
|----------------|---------------------------------|---------------|--------------|
| tblAreaCoating | Area_EF_Nonresidential_Exterior | 150           | 50           |
| tblAreaCoating | Area_EF_Nonresidential_Interior | 150           | 50           |
| tblAreaCoating | Area_EF_Residential_Exterior    | 100           | 50           |
| tblAreaCoating | Area_EF_Residential_Interior    | 100           | 50           |
| tblAreaCoating | Area_Nonresidential_Exterior    | 571390        | 609655       |
| tblAreaCoating | Area_Nonresidential_Interior    | 1714170       | 1828965      |
| tblAreaCoating | Area_Residential_Exterior       | 1382252       | 3142800      |
| tblAreaCoating | Area_Residential_Interior       | 4146755       | 9428400      |
| tblEnergyUse   | LightingElect                   | 741.44        | 0.00         |
| tblEnergyUse   | LightingElect                   | 2.91          | 3.83         |
| tblEnergyUse   | NT24E                           | 3,054.10      | 0.00         |
| tblEnergyUse   | NT24E                           | 2.27          | 2.99         |
| tblEnergyUse   | NT24NG                          | 3,155.00      | 0.00         |
| tblEnergyUse   | NT24NG                          | 3.30          | 6.71         |
| tblEnergyUse   | T24E                            | 70.89         | 0.00         |
| tblEnergyUse   | T24E                            | 2.44          | 3.21         |
| tblEnergyUse   | T24NG                           | 5,226.68      | 0.00         |
| tblEnergyUse   | T24NG                           | 20.62         | 41.92        |
| tblFireplaces  | NumberGas                       | 5,200.00      | 0.00         |
| tblFireplaces  | NumberNoFireplace               | 0.00          | 5,200.00     |
| tblLandUse     | LandUseSquareFeet               | 1,219,312.41  | 1,142,777.00 |
| tblLandUse     | LandUseSquareFeet               | 5,200,000.00  | 2,047,779.00 |

**EMFAC Off-Model Adjustment Factors for Gasoline Light Duty Vehicle to Account for the SAFE Vehicle Rule Applied**

|                 |                          |                |               |
|-----------------|--------------------------|----------------|---------------|
| tblLandUse      | Population               | 14,872.00      | 7,097.00      |
| tblSolidWaste   | SolidWasteGenerationRate | 2,392.00       | 2,141.76      |
| tblVehicleTrips | CC_TL                    | 7.30           | 6.33          |
| tblVehicleTrips | CNW_TL                   | 7.30           | 6.33          |
| tblVehicleTrips | CW_TL                    | 9.50           | 6.33          |
| tblVehicleTrips | DV_TP                    | 9.00           | 0.00          |
| tblVehicleTrips | HO_TL                    | 7.50           | 0.00          |
| tblVehicleTrips | HS_TL                    | 7.30           | 0.00          |
| tblVehicleTrips | HW_TL                    | 10.80          | 0.00          |
| tblVehicleTrips | PR_TP                    | 91.00          | 100.00        |
| tblVehicleTrips | ST_TR                    | 4.91           | 0.00          |
| tblVehicleTrips | ST_TR                    | 1.30           | 3.54          |
| tblVehicleTrips | SU_TR                    | 4.09           | 0.00          |
| tblVehicleTrips | SU_TR                    | 0.00           | 0.25          |
| tblVehicleTrips | WD_TR                    | 5.44           | 0.00          |
| tblVehicleTrips | WD_TR                    | 1.56           | 4.25          |
| tblWater        | IndoorWaterUseRate       | 338,800,933.23 | 0.00          |
| tblWater        | IndoorWaterUseRate       | 14,204,057.40  | 32,827,469.00 |
| tblWater        | OutdoorWaterUseRate      | 213,591,892.69 | 0.00          |
| tblWater        | OutdoorWaterUseRate      | 22,216,602.60  | 21,879,743.00 |

**EMFAC Off-Model Adjustment Factors for Gasoline Light Duty Vehicle to Account for the SAFE Vehicle Rule Applied**

**2.0 Emissions Summary**

**2.2 Overall Operational**

**Unmitigated Operational**

|              | ROG             | NOx             | CO                | SO2           | Fugitive PM10   | Exhaust PM10  | PM10 Total      | Fugitive PM2.5 | Exhaust PM2.5 | PM2.5 Total    | Bio- CO2      | NBio- CO2           | Total CO2           | CH4            | N2O            | CO2e                |
|--------------|-----------------|-----------------|-------------------|---------------|-----------------|---------------|-----------------|----------------|---------------|----------------|---------------|---------------------|---------------------|----------------|----------------|---------------------|
| Category     | lb/day          |                 |                   |               |                 |               |                 |                |               |                | lb/day        |                     |                     |                |                |                     |
| Area         | 91.1918         | 5.0210          | 432.7271          | 0.0227        |                 | 2.3605        | 2.3605          |                | 2.3605        | 2.3605         | 0.0000        | 773.9238            | 773.9238            | 0.7695         | 0.0000         | 793.1619            |
| Energy       | 1.6420          | 14.9270         | 12.5387           | 0.0896        |                 | 1.1345        | 1.1345          |                | 1.1345        | 1.1345         |               | 17,912.4079         | 17,912.4079         | 0.3433         | 0.3284         | 18,018.8524         |
| Mobile       | 127.0859        | 179.2398        | 1,100.7519        | 1.7100        | 137.3367        | 2.6868        | 140.0235        | 36.6709        | 2.5359        | 39.2068        |               | 173,920.1369        | 173,920.1369        | 14.7665        | 10.0779        | 177,292.4988        |
| <b>Total</b> | <b>219.9197</b> | <b>199.1879</b> | <b>1,546.0177</b> | <b>1.8222</b> | <b>137.3367</b> | <b>6.1817</b> | <b>143.5184</b> | <b>36.6709</b> | <b>6.0309</b> | <b>42.7017</b> | <b>0.0000</b> | <b>192,606.4687</b> | <b>192,606.4687</b> | <b>15.8793</b> | <b>10.4062</b> | <b>196,104.5131</b> |

**Mitigated Operational**

|              | ROG             | NOx             | CO                | SO2           | Fugitive PM10   | Exhaust PM10  | PM10 Total      | Fugitive PM2.5 | Exhaust PM2.5 | PM2.5 Total    | Bio- CO2      | NBio- CO2           | Total CO2           | CH4            | N2O            | CO2e                |
|--------------|-----------------|-----------------|-------------------|---------------|-----------------|---------------|-----------------|----------------|---------------|----------------|---------------|---------------------|---------------------|----------------|----------------|---------------------|
| Category     | lb/day          |                 |                   |               |                 |               |                 |                |               |                | lb/day        |                     |                     |                |                |                     |
| Area         | 91.1918         | 5.0210          | 432.7271          | 0.0227        |                 | 2.3605        | 2.3605          |                | 2.3605        | 2.3605         | 0.0000        | 773.9238            | 773.9238            | 0.7695         | 0.0000         | 793.1619            |
| Energy       | 1.6420          | 14.9270         | 12.5387           | 0.0896        |                 | 1.1345        | 1.1345          |                | 1.1345        | 1.1345         |               | 17,912.4079         | 17,912.4079         | 0.3433         | 0.3284         | 18,018.8524         |
| Mobile       | 127.0859        | 179.2398        | 1,100.7519        | 1.7100        | 137.3367        | 2.6868        | 140.0235        | 36.6709        | 2.5359        | 39.2068        |               | 173,920.1369        | 173,920.1369        | 14.7665        | 10.0779        | 177,292.4988        |
| <b>Total</b> | <b>219.9197</b> | <b>199.1879</b> | <b>1,546.0177</b> | <b>1.8222</b> | <b>137.3367</b> | <b>6.1817</b> | <b>143.5184</b> | <b>36.6709</b> | <b>6.0309</b> | <b>42.7017</b> | <b>0.0000</b> | <b>192,606.4687</b> | <b>192,606.4687</b> | <b>15.8793</b> | <b>10.4062</b> | <b>196,104.5131</b> |

**EMFAC Off-Model Adjustment Factors for Gasoline Light Duty Vehicle to Account for the SAFE Vehicle Rule Applied**

|                   | ROG  | NOx  | CO   | SO2  | Fugitive PM10 | Exhaust PM10 | PM10 Total | Fugitive PM2.5 | Exhaust PM2.5 | PM2.5 Total | Bio- CO2 | NBio-CO2 | Total CO2 | CH4  | N2O  | CO2e |
|-------------------|------|------|------|------|---------------|--------------|------------|----------------|---------------|-------------|----------|----------|-----------|------|------|------|
| Percent Reduction | 0.00 | 0.00 | 0.00 | 0.00 | 0.00          | 0.00         | 0.00       | 0.00           | 0.00          | 0.00        | 0.00     | 0.00     | 0.00      | 0.00 | 0.00 | 0.00 |

**4.0 Operational Detail - Mobile**

**4.1 Mitigation Measures Mobile**

|             | ROG      | NOx      | CO         | SO2    | Fugitive PM10 | Exhaust PM10 | PM10 Total | Fugitive PM2.5 | Exhaust PM2.5 | PM2.5 Total | Bio- CO2 | NBio- CO2   | Total CO2  | CH4     | N2O     | CO2e        |
|-------------|----------|----------|------------|--------|---------------|--------------|------------|----------------|---------------|-------------|----------|-------------|------------|---------|---------|-------------|
| Category    | lb/day   |          |            |        |               |              |            |                |               |             | lb/day   |             |            |         |         |             |
| Mitigated   | 127.0859 | 179.2398 | 1,100.7519 | 1.7100 | 137.3367      | 2.6868       | 140.0235   | 36.6709        | 2.5359        | 39.2068     |          | 173,920.136 | 173,920.13 | 14.7665 | 10.0779 | 177,292.498 |
| Unmitigated | 127.0859 | 179.2398 | 1,100.7519 | 1.7100 | 137.3367      | 2.6868       | 140.0235   | 36.6709        | 2.5359        | 39.2068     |          | 173,920.136 | 173,920.13 | 14.7665 | 10.0779 | 177,292.498 |

**4.2 Trip Summary Information**

| Land Use                 | Average Daily Trip Rate |           |          | Unmitigated | Mitigated  |
|--------------------------|-------------------------|-----------|----------|-------------|------------|
|                          | Weekday                 | Saturday  | Sunday   | Annual VMT  | Annual VMT |
| Apartments Mid Rise      | 0.00                    | 0.00      | 0.00     |             |            |
| University/College (4yr) | 28,194.50               | 23,484.36 | 1,658.50 | 54,678,532  | 54,678,532 |
| Total                    | 28,194.50               | 23,484.36 | 1,658.50 | 54,678,532  | 54,678,532 |

**EMFAC Off-Model Adjustment Factors for Gasoline Light Duty Vehicle to Account for the SAFE Vehicle Rule Applied**

**4.3 Trip Type Information**

| Land Use                 | Miles      |            |             | Trip %     |            |             | Trip Purpose % |          |         |
|--------------------------|------------|------------|-------------|------------|------------|-------------|----------------|----------|---------|
|                          | H-W or C-W | H-S or C-C | H-O or C-NW | H-W or C-W | H-S or C-C | H-O or C-NW | Primary        | Diverted | Pass-by |
| Apartments Mid Rise      | 0.00       | 0.00       | 0.00        | 44.00      | 18.80      | 37.20       | 86             | 11       | 3       |
| University/College (4yr) | 6.33       | 6.33       | 6.33        | 6.40       | 88.60      | 5.00        | 100            | 0        | 0       |

**4.4 Fleet Mix**

| Land Use                 | LDA      | LDT1     | LDT2     | MDV      | LHD1     | LHD2     | MHD      | HHD      | OBUS     | UBUS     | MCY      | SBUS     | MH       |
|--------------------------|----------|----------|----------|----------|----------|----------|----------|----------|----------|----------|----------|----------|----------|
| Apartments Mid Rise      | 0.472891 | 0.048916 | 0.201626 | 0.172765 | 0.037062 | 0.008202 | 0.011598 | 0.008545 | 0.001485 | 0.000584 | 0.029640 | 0.001456 | 0.005230 |
| University/College (4yr) | 0.472891 | 0.048916 | 0.201626 | 0.172765 | 0.037062 | 0.008202 | 0.011598 | 0.008545 | 0.001485 | 0.000584 | 0.029640 | 0.001456 | 0.005230 |

**5.0 Energy Detail**

Historical Energy Use: N

**5.1 Mitigation Measures Energy**

| Category               | ROG    | NOx     | CO      | SO2    | Fugitive PM10 | Exhaust PM10 | PM10 Total | Fugitive PM2.5 | Exhaust PM2.5 | PM2.5 Total | Bio- CO2 | NBio- CO2   | Total CO2   | CH4    | N2O    | CO2e        |
|------------------------|--------|---------|---------|--------|---------------|--------------|------------|----------------|---------------|-------------|----------|-------------|-------------|--------|--------|-------------|
|                        | lb/day |         |         |        |               |              |            |                |               |             | lb/day   |             |             |        |        |             |
| NaturalGas Mitigated   | 1.6420 | 14.9270 | 12.5387 | 0.0896 |               | 1.1345       | 1.1345     |                | 1.1345        | 1.1345      |          | 17,912.4079 | 17,912.4079 | 0.3433 | 0.3284 | 18,018.8524 |
| NaturalGas Unmitigated | 1.6420 | 14.9270 | 12.5387 | 0.0896 |               | 1.1345       | 1.1345     |                | 1.1345        | 1.1345      |          | 17,912.4079 | 17,912.4079 | 0.3433 | 0.3284 | 18,018.8524 |

**EMFAC Off-Model Adjustment Factors for Gasoline Light Duty Vehicle to Account for the SAFE Vehicle Rule Applied**

**5.2 Energy by Land Use - NaturalGas**

**Unmitigated**

|                          | NaturalGas Use | ROG           | NOx            | CO             | SO2           | Fugitive PM10 | Exhaust PM10  | PM10 Total    | Fugitive PM2.5 | Exhaust PM2.5 | PM2.5 Total   | Bio- CO2 | NBio- CO2          | Total CO2          | CH4           | N2O           | CO2e               |
|--------------------------|----------------|---------------|----------------|----------------|---------------|---------------|---------------|---------------|----------------|---------------|---------------|----------|--------------------|--------------------|---------------|---------------|--------------------|
| Land Use                 | kBTU/yr        | lb/day        |                |                |               |               |               |               |                |               |               | lb/day   |                    |                    |               |               |                    |
| Apartments Mid Rise      | 0              | 0.0000        | 0.0000         | 0.0000         | 0.0000        |               | 0.0000        | 0.0000        |                | 0.0000        | 0.0000        |          | 0.0000             | 0.0000             | 0.0000        | 0.0000        | 0.0000             |
| University/College (4yr) | 152255         | 1.6420        | 14.9270        | 12.5387        | 0.0896        |               | 1.1345        | 1.1345        |                | 1.1345        | 1.1345        |          | 17,912.4079        | 17,912.4079        | 0.3433        | 0.3284        | 18,018.8524        |
| <b>Total</b>             |                | <b>1.6420</b> | <b>14.9270</b> | <b>12.5387</b> | <b>0.0896</b> |               | <b>1.1345</b> | <b>1.1345</b> |                | <b>1.1345</b> | <b>1.1345</b> |          | <b>17,912.4079</b> | <b>17,912.4079</b> | <b>0.3433</b> | <b>0.3284</b> | <b>18,018.8524</b> |

**Mitigated**

|                          | NaturalGas Use | ROG           | NOx            | CO             | SO2           | Fugitive PM10 | Exhaust PM10  | PM10 Total    | Fugitive PM2.5 | Exhaust PM2.5 | PM2.5 Total   | Bio- CO2 | NBio- CO2          | Total CO2          | CH4           | N2O           | CO2e               |
|--------------------------|----------------|---------------|----------------|----------------|---------------|---------------|---------------|---------------|----------------|---------------|---------------|----------|--------------------|--------------------|---------------|---------------|--------------------|
| Land Use                 | kBTU/yr        | lb/day        |                |                |               |               |               |               |                |               |               | lb/day   |                    |                    |               |               |                    |
| Apartments Mid Rise      | 0              | 0.0000        | 0.0000         | 0.0000         | 0.0000        |               | 0.0000        | 0.0000        |                | 0.0000        | 0.0000        |          | 0.0000             | 0.0000             | 0.0000        | 0.0000        | 0.0000             |
| University/College (4yr) | 152.255        | 1.6420        | 14.9270        | 12.5387        | 0.0896        |               | 1.1345        | 1.1345        |                | 1.1345        | 1.1345        |          | 17,912.4079        | 17,912.4079        | 0.3433        | 0.3284        | 18,018.8524        |
| <b>Total</b>             |                | <b>1.6420</b> | <b>14.9270</b> | <b>12.5387</b> | <b>0.0896</b> |               | <b>1.1345</b> | <b>1.1345</b> |                | <b>1.1345</b> | <b>1.1345</b> |          | <b>17,912.4079</b> | <b>17,912.4079</b> | <b>0.3433</b> | <b>0.3284</b> | <b>18,018.8524</b> |

**EMFAC Off-Model Adjustment Factors for Gasoline Light Duty Vehicle to Account for the SAFE Vehicle Rule Applied**

**6.0 Area Detail**

**6.1 Mitigation Measures Area**

|             | ROG     | NOx    | CO       | SO2    | Fugitive PM10 | Exhaust PM10 | PM10 Total | Fugitive PM2.5 | Exhaust PM2.5 | PM2.5 Total | Bio- CO2 | NBio- CO2 | Total CO2 | CH4    | N2O    | CO2e     |
|-------------|---------|--------|----------|--------|---------------|--------------|------------|----------------|---------------|-------------|----------|-----------|-----------|--------|--------|----------|
| Category    | lb/day  |        |          |        |               |              |            |                |               |             | lb/day   |           |           |        |        |          |
| Mitigated   | 91.1918 | 5.0210 | 432.7271 | 0.0227 |               | 2.3605       | 2.3605     |                | 2.3605        | 2.3605      | 0.0000   | 773.9238  | 773.9238  | 0.7695 | 0.0000 | 793.1619 |
| Unmitigated | 91.1918 | 5.0210 | 432.7271 | 0.0227 |               | 2.3605       | 2.3605     |                | 2.3605        | 2.3605      | 0.0000   | 773.9238  | 773.9238  | 0.7695 | 0.0000 | 793.1619 |

**6.2 Area by SubCategory**

**Unmitigated**

|                       | ROG            | NOx           | CO              | SO2           | Fugitive PM10 | Exhaust PM10  | PM10 Total    | Fugitive PM2.5 | Exhaust PM2.5 | PM2.5 Total   | Bio- CO2      | NBio- CO2       | Total CO2       | CH4           | N2O           | CO2e            |
|-----------------------|----------------|---------------|-----------------|---------------|---------------|---------------|---------------|----------------|---------------|---------------|---------------|-----------------|-----------------|---------------|---------------|-----------------|
| SubCategory           | lb/day         |               |                 |               |               |               |               |                |               |               | lb/day        |                 |                 |               |               |                 |
| Architectural Coating | 9.5302         |               |                 |               |               | 0.0000        | 0.0000        |                | 0.0000        | 0.0000        |               |                 | 0.0000          |               |               | 0.0000          |
| Consumer Products     | 68.2779        |               |                 |               |               | 0.0000        | 0.0000        |                | 0.0000        | 0.0000        |               |                 | 0.0000          |               |               | 0.0000          |
| Hearth                | 0.0000         | 0.0000        | 0.0000          | 0.0000        |               | 0.0000        | 0.0000        |                | 0.0000        | 0.0000        | 0.0000        | 0.0000          | 0.0000          | 0.0000        | 0.0000        | 0.0000          |
| Landscaping           | 13.3837        | 5.0210        | 432.7271        | 0.0227        |               | 2.3605        | 2.3605        |                | 2.3605        | 2.3605        |               | 773.9238        | 773.9238        | 0.7695        |               | 793.1619        |
| <b>Total</b>          | <b>91.1918</b> | <b>5.0210</b> | <b>432.7271</b> | <b>0.0227</b> |               | <b>2.3605</b> | <b>2.3605</b> |                | <b>2.3605</b> | <b>2.3605</b> | <b>0.0000</b> | <b>773.9238</b> | <b>773.9238</b> | <b>0.7695</b> | <b>0.0000</b> | <b>793.1619</b> |



**EMFAC Off-Model Adjustment Factors for Gasoline Light Duty Vehicle to Account for the SAFE Vehicle Rule Applied**

**Mitigated**

|                       | ROG            | NOx           | CO              | SO2           | Fugitive PM10 | Exhaust PM10  | PM10 Total    | Fugitive PM2.5 | Exhaust PM2.5 | PM2.5 Total   | Bio- CO2      | NBio- CO2       | Total CO2       | CH4           | N2O           | CO2e            |
|-----------------------|----------------|---------------|-----------------|---------------|---------------|---------------|---------------|----------------|---------------|---------------|---------------|-----------------|-----------------|---------------|---------------|-----------------|
| SubCategory           | lb/day         |               |                 |               |               |               |               |                |               |               | lb/day        |                 |                 |               |               |                 |
| Architectural Coating | 9.5302         |               |                 |               |               | 0.0000        | 0.0000        |                | 0.0000        | 0.0000        |               |                 | 0.0000          |               |               | 0.0000          |
| Consumer Products     | 68.2779        |               |                 |               |               | 0.0000        | 0.0000        |                | 0.0000        | 0.0000        |               |                 | 0.0000          |               |               | 0.0000          |
| Hearth                | 0.0000         | 0.0000        | 0.0000          | 0.0000        |               | 0.0000        | 0.0000        |                | 0.0000        | 0.0000        | 0.0000        | 0.0000          | 0.0000          | 0.0000        | 0.0000        | 0.0000          |
| Landscaping           | 13.3837        | 5.0210        | 432.7271        | 0.0227        |               | 2.3605        | 2.3605        |                | 2.3605        | 2.3605        |               | 773.9238        | 773.9238        | 0.7695        |               | 793.1619        |
| <b>Total</b>          | <b>91.1918</b> | <b>5.0210</b> | <b>432.7271</b> | <b>0.0227</b> |               | <b>2.3605</b> | <b>2.3605</b> |                | <b>2.3605</b> | <b>2.3605</b> | <b>0.0000</b> | <b>773.9238</b> | <b>773.9238</b> | <b>0.7695</b> | <b>0.0000</b> | <b>793.1619</b> |

**EMFAC Off-Model Adjustment Factors for Gasoline Light Duty Vehicle to Account for the SAFE Vehicle Rule Applied**

**CSUMB - Existing Campus  
Monterey Bay Unified APCD Air District, Winter**

**1.0 Project Characteristics**

**1.1 Land Usage**

| Land Uses                | Size     | Metric        | Lot Acreage | Floor Surface Area | Population |
|--------------------------|----------|---------------|-------------|--------------------|------------|
| University/College (4yr) | 6,634.00 | Student       | 27.99       | 1,142,777.00       | 0          |
| Apartments Mid Rise      | 5,200.00 | Dwelling Unit | 136.84      | 2,047,779.00       | 7097       |

**1.2 Other Project Characteristics**

|                                |                                  |                                |       |                                  |       |
|--------------------------------|----------------------------------|--------------------------------|-------|----------------------------------|-------|
| <b>Urbanization</b>            | Urban                            | <b>Wind Speed (m/s)</b>        | 2.8   | <b>Precipitation Freq (Days)</b> | 53    |
| <b>Climate Zone</b>            | 4                                |                                |       | <b>Operational Year</b>          | 2018  |
| <b>Utility Company</b>         | Pacific Gas and Electric Company |                                |       |                                  |       |
| <b>CO2 Intensity (lb/MWhr)</b> | 203.98                           | <b>CH4 Intensity (lb/MWhr)</b> | 0.033 | <b>N2O Intensity (lb/MWhr)</b>   | 0.004 |

**1.3 User Entered Comments & Non-Default Data**

Project Characteristics - CSUMB Master Plan. MBUAPCD.

Land Use - Existing campus includes 1,142,777 SF of campus facilities and 3,980 beds/1,220 DU. 6,634 FTE students in 2016-17 and 463 DU occuied by staff/faculty.

Construction Phase - Modeling operations only.

Vehicle Trips - Update trip rate and trip length per TRA. Assumed 100% primary trips. Based Sunday trip rates from Junior College land use since Univeristy default is 0.

Woodstoves - Assumed no fireplaces.

Area Coating - Use of low-VOC (50 g/L) arch coatings.

Energy Use - Updated energy intensities per provided consumption data.

**EMFAC Off-Model Adjustment Factors for Gasoline Light Duty Vehicle to Account for the SAFE Vehicle Rule Applied**

Water And Wastewater - Revised water and wastewater based on consumption data provided by CSUMB.

Solid Waste - Default solid waste generation rates assumed.

| Table Name     | Column Name                     | Default Value | New Value    |
|----------------|---------------------------------|---------------|--------------|
| tblAreaCoating | Area_EF_Nonresidential_Exterior | 150           | 50           |
| tblAreaCoating | Area_EF_Nonresidential_Interior | 150           | 50           |
| tblAreaCoating | Area_EF_Residential_Exterior    | 100           | 50           |
| tblAreaCoating | Area_EF_Residential_Interior    | 100           | 50           |
| tblAreaCoating | Area_Nonresidential_Exterior    | 571390        | 609655       |
| tblAreaCoating | Area_Nonresidential_Interior    | 1714170       | 1828965      |
| tblAreaCoating | Area_Residential_Exterior       | 1382252       | 3142800      |
| tblAreaCoating | Area_Residential_Interior       | 4146755       | 9428400      |
| tblEnergyUse   | LightingElect                   | 741.44        | 0.00         |
| tblEnergyUse   | LightingElect                   | 2.91          | 3.83         |
| tblEnergyUse   | NT24E                           | 3,054.10      | 0.00         |
| tblEnergyUse   | NT24E                           | 2.27          | 2.99         |
| tblEnergyUse   | NT24NG                          | 3,155.00      | 0.00         |
| tblEnergyUse   | NT24NG                          | 3.30          | 6.71         |
| tblEnergyUse   | T24E                            | 70.89         | 0.00         |
| tblEnergyUse   | T24E                            | 2.44          | 3.21         |
| tblEnergyUse   | T24NG                           | 5,226.68      | 0.00         |
| tblEnergyUse   | T24NG                           | 20.62         | 41.92        |
| tblFireplaces  | NumberGas                       | 5,200.00      | 0.00         |
| tblFireplaces  | NumberNoFireplace               | 0.00          | 5,200.00     |
| tblLandUse     | LandUseSquareFeet               | 1,219,312.41  | 1,142,777.00 |
| tblLandUse     | LandUseSquareFeet               | 5,200,000.00  | 2,047,779.00 |

**EMFAC Off-Model Adjustment Factors for Gasoline Light Duty Vehicle to Account for the SAFE Vehicle Rule Applied**

|                 |                          |                |               |
|-----------------|--------------------------|----------------|---------------|
| tblLandUse      | Population               | 14,872.00      | 7,097.00      |
| tblSolidWaste   | SolidWasteGenerationRate | 2,392.00       | 2,141.76      |
| tblVehicleTrips | CC_TL                    | 7.30           | 6.33          |
| tblVehicleTrips | CNW_TL                   | 7.30           | 6.33          |
| tblVehicleTrips | CW_TL                    | 9.50           | 6.33          |
| tblVehicleTrips | DV_TP                    | 9.00           | 0.00          |
| tblVehicleTrips | HO_TL                    | 7.50           | 0.00          |
| tblVehicleTrips | HS_TL                    | 7.30           | 0.00          |
| tblVehicleTrips | HW_TL                    | 10.80          | 0.00          |
| tblVehicleTrips | PR_TP                    | 91.00          | 100.00        |
| tblVehicleTrips | ST_TR                    | 4.91           | 0.00          |
| tblVehicleTrips | ST_TR                    | 1.30           | 3.54          |
| tblVehicleTrips | SU_TR                    | 4.09           | 0.00          |
| tblVehicleTrips | SU_TR                    | 0.00           | 0.25          |
| tblVehicleTrips | WD_TR                    | 5.44           | 0.00          |
| tblVehicleTrips | WD_TR                    | 1.56           | 4.25          |
| tblWater        | IndoorWaterUseRate       | 338,800,933.23 | 0.00          |
| tblWater        | IndoorWaterUseRate       | 14,204,057.40  | 32,827,469.00 |
| tblWater        | OutdoorWaterUseRate      | 213,591,892.69 | 0.00          |
| tblWater        | OutdoorWaterUseRate      | 22,216,602.60  | 21,879,743.00 |

**EMFAC Off-Model Adjustment Factors for Gasoline Light Duty Vehicle to Account for the SAFE Vehicle Rule Applied**

**2.0 Emissions Summary**

**2.2 Overall Operational**

**Unmitigated Operational**

|              | ROG             | NOx             | CO                | SO2           | Fugitive PM10   | Exhaust PM10  | PM10 Total      | Fugitive PM2.5 | Exhaust PM2.5 | PM2.5 Total    | Bio- CO2      | NBio- CO2           | Total CO2           | CH4            | N2O            | CO2e                |
|--------------|-----------------|-----------------|-------------------|---------------|-----------------|---------------|-----------------|----------------|---------------|----------------|---------------|---------------------|---------------------|----------------|----------------|---------------------|
| Category     | lb/day          |                 |                   |               |                 |               |                 |                |               |                | lb/day        |                     |                     |                |                |                     |
| Area         | 91.1918         | 5.0210          | 432.7271          | 0.0227        |                 | 2.3605        | 2.3605          |                | 2.3605        | 2.3605         | 0.0000        | 773.9238            | 773.9238            | 0.7695         | 0.0000         | 793.1619            |
| Energy       | 1.6420          | 14.9270         | 12.5387           | 0.0896        |                 | 1.1345        | 1.1345          |                | 1.1345        | 1.1345         |               | 17,912.4079         | 17,912.4079         | 0.3433         | 0.3284         | 18,018.8524         |
| Mobile       | 123.3493        | 206.2309        | 1,176.0031        | 1.6402        | 137.3367        | 2.6904        | 140.0271        | 36.6709        | 2.5394        | 39.2102        |               | 166,874.4053        | 166,874.4053        | 16.8836        | 11.2223        | 170,640.7408        |
| <b>Total</b> | <b>216.1830</b> | <b>226.1789</b> | <b>1,621.2689</b> | <b>1.7524</b> | <b>137.3367</b> | <b>6.1853</b> | <b>143.5220</b> | <b>36.6709</b> | <b>6.0343</b> | <b>42.7052</b> | <b>0.0000</b> | <b>185,560.7371</b> | <b>185,560.7371</b> | <b>17.9965</b> | <b>11.5507</b> | <b>189,452.7551</b> |

**Mitigated Operational**

|              | ROG             | NOx             | CO                | SO2           | Fugitive PM10   | Exhaust PM10  | PM10 Total      | Fugitive PM2.5 | Exhaust PM2.5 | PM2.5 Total    | Bio- CO2      | NBio- CO2           | Total CO2           | CH4            | N2O            | CO2e                |
|--------------|-----------------|-----------------|-------------------|---------------|-----------------|---------------|-----------------|----------------|---------------|----------------|---------------|---------------------|---------------------|----------------|----------------|---------------------|
| Category     | lb/day          |                 |                   |               |                 |               |                 |                |               |                | lb/day        |                     |                     |                |                |                     |
| Area         | 91.1918         | 5.0210          | 432.7271          | 0.0227        |                 | 2.3605        | 2.3605          |                | 2.3605        | 2.3605         | 0.0000        | 773.9238            | 773.9238            | 0.7695         | 0.0000         | 793.1619            |
| Energy       | 1.6420          | 14.9270         | 12.5387           | 0.0896        |                 | 1.1345        | 1.1345          |                | 1.1345        | 1.1345         |               | 17,912.4079         | 17,912.4079         | 0.3433         | 0.3284         | 18,018.8524         |
| Mobile       | 123.3493        | 206.2309        | 1,176.0031        | 1.6402        | 137.3367        | 2.6904        | 140.0271        | 36.6709        | 2.5394        | 39.2102        |               | 166,874.4053        | 166,874.4053        | 16.8836        | 11.2223        | 170,640.7408        |
| <b>Total</b> | <b>216.1830</b> | <b>226.1789</b> | <b>1,621.2689</b> | <b>1.7524</b> | <b>137.3367</b> | <b>6.1853</b> | <b>143.5220</b> | <b>36.6709</b> | <b>6.0343</b> | <b>42.7052</b> | <b>0.0000</b> | <b>185,560.7371</b> | <b>185,560.7371</b> | <b>17.9965</b> | <b>11.5507</b> | <b>189,452.7551</b> |



**EMFAC Off-Model Adjustment Factors for Gasoline Light Duty Vehicle to Account for the SAFE Vehicle Rule Applied**

**4.0 Operational Detail - Mobile**

**4.1 Mitigation Measures Mobile**

| Category    | ROG      | NOx      | CO         | SO2    | Fugitive PM10 | Exhaust PM10 | PM10 Total | Fugitive PM2.5 | Exhaust PM2.5 | PM2.5 Total | Bio- CO2 | NBio- CO2   | Total CO2  | CH4     | N2O     | CO2e        |
|-------------|----------|----------|------------|--------|---------------|--------------|------------|----------------|---------------|-------------|----------|-------------|------------|---------|---------|-------------|
| lb/day      |          |          |            |        |               |              |            |                |               |             | lb/day   |             |            |         |         |             |
| Mitigated   | 123.3493 | 206.2309 | 1,176.0031 | 1.6402 | 137.3367      | 2.6904       | 140.0271   | 36.6709        | 2.5394        | 39.2102     |          | 166,874.405 | 166,874.40 | 16.8836 | 11.2223 | 170,640.740 |
| Unmitigated | 123.3493 | 206.2309 | 1,176.0031 | 1.6402 | 137.3367      | 2.6904       | 140.0271   | 36.6709        | 2.5394        | 39.2102     |          | 166,874.405 | 166,874.40 | 16.8836 | 11.2223 | 170,640.740 |

**4.2 Trip Summary Information**

| Land Use                 | Average Daily Trip Rate |                  |                 | Unmitigated       | Mitigated         |
|--------------------------|-------------------------|------------------|-----------------|-------------------|-------------------|
|                          | Weekday                 | Saturday         | Sunday          | Annual VMT        | Annual VMT        |
| Apartments Mid Rise      | 0.00                    | 0.00             | 0.00            |                   |                   |
| University/College (4yr) | 28,194.50               | 23,484.36        | 1,658.50        | 54,678,532        | 54,678,532        |
| <b>Total</b>             | <b>28,194.50</b>        | <b>23,484.36</b> | <b>1,658.50</b> | <b>54,678,532</b> | <b>54,678,532</b> |

**4.3 Trip Type Information**

| Land Use                 | Miles      |            |             | Trip %     |            |             | Trip Purpose % |          |         |
|--------------------------|------------|------------|-------------|------------|------------|-------------|----------------|----------|---------|
|                          | H-W or C-W | H-S or C-C | H-O or C-NW | H-W or C-W | H-S or C-C | H-O or C-NW | Primary        | Diverted | Pass-by |
| Apartments Mid Rise      | 0.00       | 0.00       | 0.00        | 44.00      | 18.80      | 37.20       | 86             | 11       | 3       |
| University/College (4yr) | 6.33       | 6.33       | 6.33        | 6.40       | 88.60      | 5.00        | 100            | 0        | 0       |

**4.4 Fleet Mix**

| Land Use                 | LDA      | LDT1     | LDT2     | MDV      | LHD1     | LHD2     | MHD      | HHD      | OBUS     | UBUS     | MCY      | SBUS     | MH       |
|--------------------------|----------|----------|----------|----------|----------|----------|----------|----------|----------|----------|----------|----------|----------|
| Apartments Mid Rise      | 0.472891 | 0.048916 | 0.201626 | 0.172765 | 0.037062 | 0.008202 | 0.011598 | 0.008545 | 0.001485 | 0.000584 | 0.029640 | 0.001456 | 0.005230 |
| University/College (4yr) | 0.472891 | 0.048916 | 0.201626 | 0.172765 | 0.037062 | 0.008202 | 0.011598 | 0.008545 | 0.001485 | 0.000584 | 0.029640 | 0.001456 | 0.005230 |

**EMFAC Off-Model Adjustment Factors for Gasoline Light Duty Vehicle to Account for the SAFE Vehicle Rule Applied**

**5.0 Energy Detail**

Historical Energy Use: N

**5.1 Mitigation Measures Energy**

|                        | ROG    | NOx     | CO      | SO2    | Fugitive PM10 | Exhaust PM10 | PM10 Total | Fugitive PM2.5 | Exhaust PM2.5 | PM2.5 Total | Bio- CO2 | NBio- CO2   | Total CO2   | CH4    | N2O    | CO2e        |
|------------------------|--------|---------|---------|--------|---------------|--------------|------------|----------------|---------------|-------------|----------|-------------|-------------|--------|--------|-------------|
| Category               | lb/day |         |         |        |               |              |            |                |               |             | lb/day   |             |             |        |        |             |
| NaturalGas Mitigated   | 1.6420 | 14.9270 | 12.5387 | 0.0896 |               | 1.1345       | 1.1345     |                | 1.1345        | 1.1345      |          | 17,912.4079 | 17,912.4079 | 0.3433 | 0.3284 | 18,018.8524 |
| NaturalGas Unmitigated | 1.6420 | 14.9270 | 12.5387 | 0.0896 |               | 1.1345       | 1.1345     |                | 1.1345        | 1.1345      |          | 17,912.4079 | 17,912.4079 | 0.3433 | 0.3284 | 18,018.8524 |



**EMFAC Off-Model Adjustment Factors for Gasoline Light Duty Vehicle to Account for the SAFE Vehicle Rule Applied**

**5.2 Energy by Land Use - NaturalGas**

**Unmitigated**

|                          | NaturalGas Use | ROG           | NOx            | CO             | SO2           | Fugitive PM10 | Exhaust PM10  | PM10 Total    | Fugitive PM2.5 | Exhaust PM2.5 | PM2.5 Total   | Bio- CO2 | NBio- CO2          | Total CO2          | CH4           | N2O           | CO2e               |
|--------------------------|----------------|---------------|----------------|----------------|---------------|---------------|---------------|---------------|----------------|---------------|---------------|----------|--------------------|--------------------|---------------|---------------|--------------------|
| Land Use                 | kBTU/yr        | lb/day        |                |                |               |               |               |               |                |               |               | lb/day   |                    |                    |               |               |                    |
| Apartments Mid Rise      | 0              | 0.0000        | 0.0000         | 0.0000         | 0.0000        |               | 0.0000        | 0.0000        |                | 0.0000        | 0.0000        |          | 0.0000             | 0.0000             | 0.0000        | 0.0000        | 0.0000             |
| University/College (4yr) | 152255         | 1.6420        | 14.9270        | 12.5387        | 0.0896        |               | 1.1345        | 1.1345        |                | 1.1345        | 1.1345        |          | 17,912.4079        | 17,912.4079        | 0.3433        | 0.3284        | 18,018.8524        |
| <b>Total</b>             |                | <b>1.6420</b> | <b>14.9270</b> | <b>12.5387</b> | <b>0.0896</b> |               | <b>1.1345</b> | <b>1.1345</b> |                | <b>1.1345</b> | <b>1.1345</b> |          | <b>17,912.4079</b> | <b>17,912.4079</b> | <b>0.3433</b> | <b>0.3284</b> | <b>18,018.8524</b> |

**Mitigated**

|                          | NaturalGas Use | ROG           | NOx            | CO             | SO2           | Fugitive PM10 | Exhaust PM10  | PM10 Total    | Fugitive PM2.5 | Exhaust PM2.5 | PM2.5 Total   | Bio- CO2 | NBio- CO2          | Total CO2          | CH4           | N2O           | CO2e               |
|--------------------------|----------------|---------------|----------------|----------------|---------------|---------------|---------------|---------------|----------------|---------------|---------------|----------|--------------------|--------------------|---------------|---------------|--------------------|
| Land Use                 | kBTU/yr        | lb/day        |                |                |               |               |               |               |                |               |               | lb/day   |                    |                    |               |               |                    |
| Apartments Mid Rise      | 0              | 0.0000        | 0.0000         | 0.0000         | 0.0000        |               | 0.0000        | 0.0000        |                | 0.0000        | 0.0000        |          | 0.0000             | 0.0000             | 0.0000        | 0.0000        | 0.0000             |
| University/College (4yr) | 152.255        | 1.6420        | 14.9270        | 12.5387        | 0.0896        |               | 1.1345        | 1.1345        |                | 1.1345        | 1.1345        |          | 17,912.4079        | 17,912.4079        | 0.3433        | 0.3284        | 18,018.8524        |
| <b>Total</b>             |                | <b>1.6420</b> | <b>14.9270</b> | <b>12.5387</b> | <b>0.0896</b> |               | <b>1.1345</b> | <b>1.1345</b> |                | <b>1.1345</b> | <b>1.1345</b> |          | <b>17,912.4079</b> | <b>17,912.4079</b> | <b>0.3433</b> | <b>0.3284</b> | <b>18,018.8524</b> |

**EMFAC Off-Model Adjustment Factors for Gasoline Light Duty Vehicle to Account for the SAFE Vehicle Rule Applied**

**6.0 Area Detail**

**6.1 Mitigation Measures Area**

|             | ROG     | NOx    | CO       | SO2    | Fugitive PM10 | Exhaust PM10 | PM10 Total | Fugitive PM2.5 | Exhaust PM2.5 | PM2.5 Total | Bio- CO2 | NBio- CO2 | Total CO2 | CH4    | N2O    | CO2e     |
|-------------|---------|--------|----------|--------|---------------|--------------|------------|----------------|---------------|-------------|----------|-----------|-----------|--------|--------|----------|
| Category    | lb/day  |        |          |        |               |              |            |                |               |             | lb/day   |           |           |        |        |          |
| Mitigated   | 91.1918 | 5.0210 | 432.7271 | 0.0227 |               | 2.3605       | 2.3605     |                | 2.3605        | 2.3605      | 0.0000   | 773.9238  | 773.9238  | 0.7695 | 0.0000 | 793.1619 |
| Unmitigated | 91.1918 | 5.0210 | 432.7271 | 0.0227 |               | 2.3605       | 2.3605     |                | 2.3605        | 2.3605      | 0.0000   | 773.9238  | 773.9238  | 0.7695 | 0.0000 | 793.1619 |

**6.2 Area by SubCategory**

**Unmitigated**

|                       | ROG            | NOx           | CO              | SO2           | Fugitive PM10 | Exhaust PM10  | PM10 Total    | Fugitive PM2.5 | Exhaust PM2.5 | PM2.5 Total   | Bio- CO2      | NBio- CO2       | Total CO2       | CH4           | N2O           | CO2e            |
|-----------------------|----------------|---------------|-----------------|---------------|---------------|---------------|---------------|----------------|---------------|---------------|---------------|-----------------|-----------------|---------------|---------------|-----------------|
| SubCategory           | lb/day         |               |                 |               |               |               |               |                |               |               | lb/day        |                 |                 |               |               |                 |
| Architectural Coating | 9.5302         |               |                 |               |               | 0.0000        | 0.0000        |                | 0.0000        | 0.0000        |               |                 | 0.0000          |               |               | 0.0000          |
| Consumer Products     | 68.2779        |               |                 |               |               | 0.0000        | 0.0000        |                | 0.0000        | 0.0000        |               |                 | 0.0000          |               |               | 0.0000          |
| Hearth                | 0.0000         | 0.0000        | 0.0000          | 0.0000        |               | 0.0000        | 0.0000        |                | 0.0000        | 0.0000        | 0.0000        | 0.0000          | 0.0000          | 0.0000        | 0.0000        | 0.0000          |
| Landscaping           | 13.3837        | 5.0210        | 432.7271        | 0.0227        |               | 2.3605        | 2.3605        |                | 2.3605        | 2.3605        |               | 773.9238        | 773.9238        | 0.7695        |               | 793.1619        |
| <b>Total</b>          | <b>91.1918</b> | <b>5.0210</b> | <b>432.7271</b> | <b>0.0227</b> |               | <b>2.3605</b> | <b>2.3605</b> |                | <b>2.3605</b> | <b>2.3605</b> | <b>0.0000</b> | <b>773.9238</b> | <b>773.9238</b> | <b>0.7695</b> | <b>0.0000</b> | <b>793.1619</b> |

**EMFAC Off-Model Adjustment Factors for Gasoline Light Duty Vehicle to Account for the SAFE Vehicle Rule Applied**

**Mitigated**

|                       | ROG            | NOx           | CO              | SO2           | Fugitive PM10 | Exhaust PM10  | PM10 Total    | Fugitive PM2.5 | Exhaust PM2.5 | PM2.5 Total   | Bio- CO2      | NBio- CO2       | Total CO2       | CH4           | N2O           | CO2e            |
|-----------------------|----------------|---------------|-----------------|---------------|---------------|---------------|---------------|----------------|---------------|---------------|---------------|-----------------|-----------------|---------------|---------------|-----------------|
| SubCategory           | lb/day         |               |                 |               |               |               |               |                |               |               | lb/day        |                 |                 |               |               |                 |
| Architectural Coating | 9.5302         |               |                 |               |               | 0.0000        | 0.0000        |                | 0.0000        | 0.0000        |               |                 | 0.0000          |               |               | 0.0000          |
| Consumer Products     | 68.2779        |               |                 |               |               | 0.0000        | 0.0000        |                | 0.0000        | 0.0000        |               |                 | 0.0000          |               |               | 0.0000          |
| Hearth                | 0.0000         | 0.0000        | 0.0000          | 0.0000        |               | 0.0000        | 0.0000        |                | 0.0000        | 0.0000        | 0.0000        | 0.0000          | 0.0000          | 0.0000        | 0.0000        | 0.0000          |
| Landscaping           | 13.3837        | 5.0210        | 432.7271        | 0.0227        |               | 2.3605        | 2.3605        |                | 2.3605        | 2.3605        |               | 773.9238        | 773.9238        | 0.7695        |               | 793.1619        |
| <b>Total</b>          | <b>91.1918</b> | <b>5.0210</b> | <b>432.7271</b> | <b>0.0227</b> |               | <b>2.3605</b> | <b>2.3605</b> |                | <b>2.3605</b> | <b>2.3605</b> | <b>0.0000</b> | <b>773.9238</b> | <b>773.9238</b> | <b>0.7695</b> | <b>0.0000</b> | <b>793.1619</b> |

### Hours of Operation for Construction Equipment

| Phase                 | Equipment Type            | Number of |           | Phase Duration | Hours of Equipment |               | Total Hours Over Buildout |
|-----------------------|---------------------------|-----------|-----------|----------------|--------------------|---------------|---------------------------|
|                       |                           | Equipment | Hours/day |                | Use                | Subtotals     |                           |
| Demolition            | Concrete/Industrial Saws  | 1         | 8         | 8              | 20                 | 160           |                           |
| Demolition            | Excavators                | 3         | 8         | 8              | 20                 | 480           |                           |
| Demolition            | Rubber Tired Dozers       | 2         | 8         | 8              | 20                 | 320           | 960 4,800                 |
| Site Preparation      | Rubber Tired Dozers       | 3         | 8         | 8              | 10                 | 240           |                           |
| Site Preparation      | Tractors/Loaders/Backhoes | 4         | 8         | 8              | 10                 | 320           | 560 2,800                 |
| Grading               | Graders                   | 1         | 8         | 8              | 20                 | 160           |                           |
| Grading               | Rubber Tired Dozers       | 1         | 8         | 8              | 20                 | 160           |                           |
| Grading               | Tractors/Loaders/Backhoes | 2         | 7         | 7              | 20                 | 280           |                           |
| Grading               | Trenchers                 | 1         | 8         | 8              | 20                 | 160           | 760 3,800                 |
| Building Construction | Cranes                    | 1         | 7         | 7              | 230                | 1,610         |                           |
| Building Construction | Forklifts                 | 3         | 8         | 8              | 230                | 5,520         |                           |
| Building Construction | Generator Sets            | 1         | 8         | 8              | 230                | 1,840         |                           |
| Building Construction | Tractors/Loaders/Backhoes | 3         | 7         | 7              | 230                | 4,830         |                           |
| Building Construction | Welders                   | 3         | 7         | 7              | 230                | 4,830         | 18,630 93,150             |
| Paving                | Pavers                    | 2         | 8         | 8              | 20                 | 320           |                           |
| Paving                | Paving Equipment          | 2         | 8         | 8              | 20                 | 320           |                           |
| Paving                | Rollers                   | 2         | 8         | 8              | 20                 | 320           | 960 4,800                 |
| Architectural Coating | Air Compressors           | 1         | 6         | 6              | 20                 | 120           | 120 600                   |
| <b>Total</b>          |                           |           |           |                |                    | <b>21,990</b> | <b>109,950</b>            |

### Construction Equipment Diesel Demand

| Phase                 | Pieces of Equipment | Equipment |               | Gallons (2022-2023) | Gallons (Buildout) |  |
|-----------------------|---------------------|-----------|---------------|---------------------|--------------------|--|
|                       |                     | CO2 (MT)  | Kg/CO2/Gallon |                     |                    |  |
| Demolition            | 6                   | 33.99     | 10.21         | 3,329.09            | 16,645.45          |  |
| Site Preparation      | 7                   | 16.72     | 10.21         | 1,637.58            | 8,187.90           |  |
| Grading               | 5                   | 26.05     | 10.21         | 2,551.89            | 12,759.45          |  |
| Building Construction | 11                  | 266.49    | 10.21         | 26,101.08           | 130,505.39         |  |
| Paving                | 6                   | 20.03     | 10.21         | 1,961.50            | 9,807.49           |  |
| Architectural Coating | 1                   | 2.55      | 10.21         | 250.08              | 1,250.39           |  |
| <b>Total</b>          |                     |           |               | <b>35,831.21</b>    | <b>179,156.07</b>  |  |

### Construction Worker Gasoline Demand

| Phase                 | Trips  | Vehicle  |               | Gallons (2022-2023) | Gallons (Buildout) |  |
|-----------------------|--------|----------|---------------|---------------------|--------------------|--|
|                       |        | CO2 (MT) | Kg/CO2/Gallon |                     |                    |  |
| Demolition            | 300    | 1.02     | 8.78          | 116.42              | 582.12             |  |
| Site Preparation      | 180    | 0.61     | 8.78          | 69.85               | 349.26             |  |
| Grading               | 300    | 1.02     | 8.78          | 116.42              | 582.12             |  |
| Building Construction | 36,570 | 124.28   | 8.78          | 14,154.70           | 70,773.52          |  |
| Paving                | 300    | 0.99     | 8.78          | 112.89              | 564.46             |  |
| Architectural Coating | 640    | 2.11     | 8.78          | 240.84              | 1,204.21           |  |
| <b>Total</b>          |        |          |               | <b>14,811.14</b>    | <b>74,055.69</b>   |  |

### Construction Vendor Truck Diesel Demand

| Phase                 | Trips  | Vehicle  |               | Gallons (2022-2023) | Gallons (Buildout) |  |
|-----------------------|--------|----------|---------------|---------------------|--------------------|--|
|                       |        | CO2 (MT) | Kg/CO2/Gallon |                     |                    |  |
| Demolition            | 0      | 0.00     | 10.21         | 0.00                | 0.00               |  |
| Site Preparation      | 0      | 0.00     | 10.21         | 0.00                | 0.00               |  |
| Grading               | 0      | 0.00     | 10.21         | 0.00                | 0.00               |  |
| Building Construction | 14,260 | 146.14   | 10.21         | 14,313.05           | 71,565.23          |  |
| Paving                | 0      | 0.00     | 10.21         | 0.00                | 0.00               |  |
| Architectural Coating | 0      | 0.00     | 10.21         | 0.00                | 0.00               |  |
| <b>Total</b>          |        |          |               | <b>14,313.05</b>    | <b>71,565.23</b>   |  |

### Construction Haul Truck Diesel Demand

| Phase                 | Trips | Vehicle  |               | Gallons (2022-2023) | Gallons (Buildout) |  |
|-----------------------|-------|----------|---------------|---------------------|--------------------|--|
|                       |       | CO2 (MT) | Kg/CO2/Gallon |                     |                    |  |
| Demolition            | 200   | 6.05     | 10.21         | 592.28              | 2,961.41           |  |
| Site Preparation      | 0     | 0.00     | 10.21         | 0.00                | 0.00               |  |
| Grading               | 0     | 0.00     | 10.21         | 0.00                | 0.00               |  |
| Paving                | 0     | 0.00     | 10.21         | 0.00                | 0.00               |  |
| Building Construction | 0     | 0.00     | 10.21         | 0.00                | 0.00               |  |
| Architectural Coating | 0     | 0.00     | 10.21         | 0.00                | 0.00               |  |
| <b>Total</b>          |       |          |               | <b>592.28</b>       | <b>2,961.41</b>    |  |

|                        | Near-Term | Buildout   |
|------------------------|-----------|------------|
| <b>Total Gasoline</b>  | 14,811.14 | 74,055.69  |
| <b>Total Diesel</b>    | 50,736.54 | 253,682.71 |
| <b>Total Petroleum</b> | 65,547.68 | 327,738.41 |

*Check*                      65,547.68      327,738.41

**CSUMB - Operational Petroleum Consumption**

|                           | Annual CO2 MT | %<br>GAS | %<br>DSL | MT CO2<br>GAS | MT CO2<br>DSL | Diesel<br>kg CO2/Gallons | Gasoline<br>kg CO2/Gallons | Diesel<br>Gallons/yr | Gasoline<br>Gallons/yr | Petro<br>Gallons/yr |
|---------------------------|---------------|----------|----------|---------------|---------------|--------------------------|----------------------------|----------------------|------------------------|---------------------|
| <b>Project - Buildout</b> | 19,156.53     | 92.58%   | 7.42%    | 17,735.84     | 1,420.69      | 10.21                    | 8.78                       | 139,146.55           | 2,020,027.29           | 2,159,173.84        |
| <b>Project - Existing</b> | 17,244.28     | 95.08%   | 4.92%    | 16,395.73     | 848.56        | 10.21                    | 8.78                       | 83,110.36            | 1,867,394.97           | 1,950,505.33        |
|                           |               |          |          |               |               |                          |                            |                      | <b>Net Increase</b>    | <b>208,668.51</b>   |

**APPENDIX E**  
**Biological Resources Report**

INTENTIONALLY LEFT BLANK



# **DRAFT BIOLOGICAL RESOURCES REPORT**

---

## **PROPOSED CALIFORNIA STATE UNIVERSITY, MONTEREY BAY MASTER PLAN AND NEAR-TERM DEVELOPMENT COMPONENTS**

**FEBRUARY 2022**



**PREPARED BY:**



**Denise Duffy & Associates, Inc.**

Contact: Erin Harwayne, AICP

947 Cass Street, Suite 5

Monterey, California 93940

---

**PREPARED FOR:**

**California State University, Monterey Bay**

Contact: Anya Spear

Director of Strategic Initiatives, CSUMB Office of the President

100 Campus Center, Building 1

Seaside, California 93955

*This page left intentionally blank*

## TABLE OF CONTENTS

|  |    |
|--|----|
| 1.0 PROJECT SUMMARY .....  | 3  |
| 1.1 Summary of Results .....   | 3  |
| 2.0 INTRODUCTION .....   | 7  |
| 2.1 Project Location and Area .....  | 7  |
| 2.2 Project Description .....  | 7  |
| 3.0 METHODS .....  | 18 |
| 3.1 Personnel and Survey Dates .....   | 18 |
| 3.2 Special-Status Species .....   | 20 |
| 3.3 Sensitive Habitats .....   | 21 |
| 3.4 Data Sources .....   | 21 |
| 3.5 Regulatory Setting .....   | 23 |
| 4.0 RESULTS .....  | 30 |
| 4.1 Vegetation Types .....   | 30 |
| 4.2 Special-Status Species .....   | 38 |
| 4.3 Sensitive Habitats .....   | 60 |
| 5.0 IMPACTS AND MITIGATION .....   | 62 |
| 5.1 Impact Analysis Approach .....   | 62 |
| 5.2 Impacts and Mitigation Measures – Master Plan .....                      | 64 |
| 5.3 Impacts and Mitigation Measures – Near-Term Development Components ..... | 73 |
| 6.0 REFERENCES .....   | 78 |
| <b>APPENDIX A: SPECIAL-STATUS SPECIES TABLE</b>                              |    |
| <b>APPENDIX B: CNDDDB OCCURRENCE REPORT</b>                                  |    |
| <b>APPENDIX C: IPAC RESOURCES LIST FOR CSUMB CAMPUS</b>                      |    |
| <b>APPENDIX D: THE BIRDS OF FORT ORD EAST OF ROUTE 1</b>                     |    |

**FIGURES**

Figure 1. Project Location..... 10

Figure 2. CSUMB Campus ..... 11

Figure 3. Implementation Plan and Near-Term Project Sites ..... 12

Figure 4. Near-Term Development Component Sites ..... 14

Figure 5. Survey Areas ..... 19

Figure 6. Vegetation Types..... 31

Figure 7. Special-Status Plants Observed ..... 33

Figure 8. Former Fort Ord CTS Aquatic Resources ..... 42

Figure 9. CTS Upland Habitat – USFWS Analysis ..... 44

Figure 10. CTS Upland Habitat – CDFW Analysis..... 45

Figure 11. CRLF Aquatic Resources ..... 49

Figure 12. Smith’s Blue Butterfly Potential Habitat Observed..... 50

Figure 13. Special-Status Plant CNDDDB Occurrences within Project Site..... 55

**TABLES**

Table 3-1. Biological Survey Dates within the Project Site..... 18

Table 4-1. Vegetation Types within the Project Site<sup>1</sup> ..... 30

Table 4-2. Vegetation Types within the Near-Term Development Sites and Staging Areas..... 30

Table 4-2. Potential for Special-Status Wildlife Species Presence within the Project Site ..... 39

Table 4-3. Area of Potential CTS Habitat within the Project Site ..... 43

Table 4-4. Potential for Special-Status Plant Species Presence within the Project Site ..... 52

Table 4-5. Area of Special-Status Plant Species within the Survey Area..... 53

## 1.0 PROJECT SUMMARY

The Project consists of the proposed California State University Monterey Bay (CSUMB) Master Plan (proposed Master Plan), including Project Design Features (PDFs) drawn from the 2019 CSUMB Master Plan Guidelines (Master Plan Guidelines<sup>1</sup>), and five “near-term” development components to be constructed pursuant to the proposed Master Plan (collectively, the Project). The Project would provide a blueprint for land uses and building and facility space requirements to support a campus enrollment of 12,700 full-time-equivalent (FTE) students and 1,776 FTE faculty and staff by the year 2035. The campus is located on approximately 1,396 acres of land within the former Fort Ord military base, in Monterey County, California. This report presents the findings of a biological resources assessment conducted by Denise Duffy & Associates, Inc. (DD&A) for the Project. The emphasis of this study is to describe existing and potential biological resources within and surrounding the Project site, assess potential impacts to biological resources that may result from implementation of the proposed Master Plan, and recommend appropriate mitigation measures necessary to reduce those impacts in accordance with the California Environmental Quality Act (CEQA). This analysis evaluates potential impacts to sensitive biological resources within the Project site at a programmatic-level commensurate with the conceptual level of project information available and the approval being considered. In addition, this analysis addresses specific development projects expected to be constructed in the next ten years, which are referred to as “near-term development components.” The five near-term development components are described and evaluated at a project-specific level in this study.

### 1.1 Summary of Results

Five vegetation types were observed within the Project site: coast live oak woodland, central maritime chaparral, central coastal scrub, non-native grassland, and ruderal/disturbed. In addition, several areas were identified where these vegetation types intergrade with one another and some areas are developed. Central maritime chaparral habitat (including the central maritime chaparral/non-native grassland, central maritime chaparral/central coastal scrub, and central maritime chaparral/coast live oak woodland mix habitats) are listed as sensitive on the California Department of Fish and Wildlife’s (CDFW’s) *Natural Communities List* (CDFW, 2010).

Several special-status plant species are known or have the potential to occur within the Project site based on observations, presence of appropriate habitat, and known occurrences within the vicinity. Please refer to **Appendix A** and **Section 4.0 “Results”** for an analysis of each species within the Project site. All other species evaluated have a low potential to occur but are unlikely to be impacted, are assumed “unlikely to occur,” or were determined “not present” within the Project site for the species-specific reasons presented in **Appendix A**.

The special-status wildlife species that are known to or have been determined to have a moderate or high potential to occur within or immediately adjacent the Project site are discussed below. All other species presented in **Appendix A** are assumed “unlikely to occur” or have a low potential to occur but are unlikely to be impacted for the species-specific reasons presented. Although the likelihood for California red-legged

---

<sup>1</sup> The Master Plan Guidelines were made available to the general public and local agencies for review and comment in 2017 under the title CSUMB Comprehensive Master Plan. Since that time the title has been changed to Master Plan Guidelines.

frog (CRLF) to occur within the Project site is unlikely, a discussion of this species is included below as this is a federally listed species that is known to occur in other portions of the former Fort Ord.

The following special-status wildlife species are known or have been determined to have a moderate or high potential to occur within or immediately adjacent the Project site:

- Townsend’s big-eared bat (*Corynorhinus townsendii*) – CSC<sup>2</sup>,
- Hoary bat (*Lasiurus cinereus*) – CNDDDB,
- Monterey dusky-footed woodrat (*Neotoma macrotis fuscipes*) – CSC,
- Monterey shrew (*Sorex ornatus salarius*) – CSC/HMP,
- American badger (*Taxidea taxus*) – CSC,
- California tiger salamander (CTS, *Ambystoma californiense*) – FT/ST/HMP,
- Northern California legless lizard (*Anniella pulchra*) – CSC/HMP,
- Coast horned lizard (*Phrynosoma blainvillii*) – CSC,
- Obscure bumble bee (*Bombus caliginosus*) – CNDDDB,
- Western bumble bee (*Bombus occidentalis*) – CNDDDB,
- Smith’s blue butterfly (SBB, *Euphilotes enoptes smithi*) – FE/HMP, and
- Nesting raptors and other protected avian species, including:
  - Burrowing owl (*Athene cunicularia*) – CSC,
  - White-tailed kite (*Elanus leucurus*) – CFP, and
  - California horned lark (*Eremophila alpestris actia*) – CNDDDB.

The following special-status plant species are known or have been determined to have a moderate or high potential to occur within or immediately adjacent the Project site:

- Toro manzanita (*Arctostaphylos montereyensis*) – CRPR 1B/HMP,
- Sandmat manzanita (*A. pumila*) – CRPR 1B/HMP,
- Pajaro manzanita (*A. pajaorensis*) – CRPR 1B,
- Hooker’s manzanita (*A. hookeri*) – CRPR 1B/HMP,
- Monterey ceanothus (*Ceanothus rigidus*) – CRPR 4/HMP,
- Fort Ord spineflower (*Chorizanthe minutiflora*) – CRPR 1B,
- Monterey spineflower (*C. pungens* var. *pungens*) – FT/CRPR 1B/HMP,
- Seaside bird’s-beak (*Cordylanthus rigidus* ssp. *littoralis*) – SE/CRPR 1B/HMP,
- Eastwood’s goldenbush (*Ericameria fasciculata*) – CRPR 1B/HMP,
- Sand-loving wallflower (*Erysimum ammophilum*) – CRPR 1B/HMP,
- Sand gilia (*Gilia tenuiflora* ssp. *arenaria*) – FE/ST/CRPR 1B/HMP,
- Kellogg’s horkelia (*Horkelia cuneata* var. *sericea*) – CRPR 1B,
- Point Reyes horkelia (*H. marinensis*) – CRPR 1B,
- Marsh microseris (*Microseris paludosa*) – CRPR 1B,
- Northern curly-leaved monardella (*Monardella sinuata* ssp. *nigrescens*) – CRPR 1B,

<sup>2</sup> Status Definitions – FE – Federally endangered, FT: Federally threatened; ST: State threatened; CSC: California Species of Concern; CFP: California Fully Protected Species; HMP: Fort Ord Habitat Management Plan Species; CRPR 1B: California Native Plant Society (CNPS) California Rare Plant Rank (CRPR) 1B Species (rare, threatened, or endangered in California and elsewhere); CRPR 4: CNPS CRPR 4 Species (plants of limited distribution – a watch list); CNDDDB: animal species on the CNDDDB “Special Animals” list that are not assigned any of the other status designations but the CDFW considers to be those of greatest conservation need, regardless of their legal or protection status.

- Woodland woollythreads (*Monolopia gracilens*) – CRPR 1B,
- Yadon’s piperia (*Piperia yadonii*) – FE/CRPR 1B/HMP,
- Santa Cruz microseris (*Stebbinsoseris decipiens*) – CRPR 1B,
- Santa Cruz clover (*Trifolium buckwestiorum*) – CRPR 1B, and
- Pacific Grove clover (*T. polyodon*) – CRPR 1B.

The proposed near-term development components are generally located on sites that have been disturbed and are mostly developed. However, the construction of the near-term development components may result in direct loss of individuals and habitat for a number of special-status wildlife species, including special-status bat species, Monterey dusky-footed woodrat, Northern California legless lizard, and nesting raptors and other protected avian species. In addition, the construction of the near-term development components may also result in direct loss of individuals and habitat for Monterey spineflower.

The implementation of the proposed Master Plan or near-term development components would not result in significant impacts to any sensitive biological resources known or with the potential to occur within the Project site with implementation of the mitigation identified in **Sections 5.2** and **5.3**.

*This page left intentionally blank*



## 2.0 INTRODUCTION

The Project consists of the proposed Master Plan, including PDFs drawn from the CSUMB Master Plan Guidelines (Master Plan Guidelines), and more detailed evaluation of five “near-term” development components to be constructed pursuant to the proposed Master Plan (collectively, the Project). The Project would provide a blueprint for land uses and building and facility space requirements to support a campus enrollment of 12,700 FTE students and 1,776 FTE faculty and staff by the year 2035. The campus is located on approximately 1,396 acres of land within the former Fort Ord military base, in Monterey County, California (**Figure 1**). This report presents the findings of a biological resources assessment conducted by DD&A for the Project. The emphasis of this study is to describe existing and potential biological resources within and surrounding the Project, assess potential impacts to biological resources that may result from implementation of the proposed Master Plan, and recommend appropriate mitigation measures necessary to reduce those impacts in accordance with CEQA. This analysis evaluates potential impacts to sensitive biological resources within the Project site at a programmatic level commensurate with the conceptual level of project information available and the approval being considered. In addition, this analysis addresses specific development projects expected to be constructed in the next ten years, which are referred to as “near-term Development components.” The five near-term development components are described and evaluated at a project-specific level in this study.

### 2.1 Project Location and Area

The Project site is located at the existing CSUMB campus, on the former U.S. Department of the Army (Army) military facility known as Fort Ord. The CSUMB campus is approximately 100 miles south of San Francisco and is located north of the Monterey Peninsula and west of the Salinas Valley, as shown in **Figure 1**. Portions of the existing CSUMB campus are within the city boundaries of Seaside and Marina, and within the unincorporated Monterey County, as shown in **Figure 2**.

### 2.2 Project Description

#### 2.2.1 Master Plan

As indicated previously, the Project would provide a blueprint for land uses and building and facility space requirements to support an on-campus enrollment of 12,700 full-time-equivalent students (FTES<sup>3</sup>) and 1,776 FTE faculty and staff by the year 2035. Achieving this growth would result in an increase of approximately 6,066 FTES and 752 FTE faculty/staff over existing levels in academic year 2016-2017, which were 6,634 FTES and 1,024 FTE faculty/staff.

The Project also would result in a net increase of approximately 2.6 million gross square feet (GSF) of new academic, administration, student life, athletic and recreational, and institutional partnership<sup>4</sup> facilities, and housing (see **Table 2-1**). On-campus housing would be constructed sufficient to continue to accommodate 60 percent of FTES and existing housing would accommodate 65 percent of FTE faculty and staff, with a projected increase of 3,820 student beds and 757 converted residential units for faculty

<sup>3</sup> Full-time equivalent student (FTES) is the unit of measurement used to convert class load to student enrollment. At CSUMB, one FTES is equal to 15 units. Thus, one FTES is equal to one student enrolled in 15 units or three students each enrolled in 5 units. A related unit of measurement is “headcount.” In the case of one student taking 15 units, the headcount is 1; in the case of three students collectively taking 15 units, the headcount is 3.

<sup>4</sup> Institutional partnerships are projects involving public-public or public-private partnerships and long-term contractual relationships that use or develop CSU real property to further the educational mission of the campus.

and staff. The Project also would accommodate redevelopment and growth in outdoor athletics and recreation facilities to serve campus needs, with space set aside for additional athletic fields, tennis courts, and pools, as well as for replacement of the existing stadium, field house, and pool house.

**Table 2-1. Proposed Master Plan Development**

| Campus Space   | Beds/Units                      | GSF <sup>1</sup> | Implementation |            |
|--|---------------------------------|------------------|----------------|------------|
|  |                                 |                  | Horizon I      | Horizon II |
| <i>Existing Space (2016-2017)</i>  |                                 |                  |                |            |
| Main Campus Facilities (Non-Residential) <sup>2</sup>                          | —                               | 1,142,777        | NA             |            |
| Student Housing Main Campus  | 2,600 beds                      | 1,171,264        | NA             |            |
| Student Housing East Campus Housing <sup>3</sup>                               | 1,380 beds / 466 units          |                  |                |            |
| Faculty, Staff & Community Partners Housing (East Campus Housing) <sup>4</sup> | 754 units                       | 876,515          | NA             |            |
| <b>Total Existing Space</b>  | <b>3,980 beds / 1,220 units</b> | <b>3,190,556</b> | NA             |            |
| <i>Approved but not Constructed Project</i>                                    |                                 |                  |                |            |
| Monterey Bay Charter School  | —                               | 60,000           | ✓              |            |
| <b>Total Pending or Approved Space</b>   | —                               | <b>60,000</b>    | ✓              |            |
| <i>Proposed Master Plan - New Development<sup>5</sup></i>                      |                                 |                  |                |            |
| Academic Space   |                                 | 403,160          |                |            |
| • Academic IV  |                                 | 95,000           | ✓              |            |
| • Academic V   |                                 | 76,704           | ✓              |            |
| • Academic VI  | —                               | 76,704           |                | ✓          |
| • Academic VII   |                                 | 76,704           |                | ✓          |
| • Academic VIII  |                                 | 76,704           |                | ✓          |
| • Greenhouses <sup>6</sup>   |                                 | 1,344            | ✓              |            |
| Institutional Partnerships - Panetta Institute                                 | —                               | 64,000           | ✓              |            |
| Administration Buildings   | —                               | 77,454           | ✓              |            |
| “Student Life” Buildings   |                                 | 270,764          |                |            |
| • Childcare Center   |                                 | 23,000           | ✓              |            |
| • Student Life Space (Phase I and II) <sup>6</sup>                             | —                               | 145,473          | ✓              |            |
| • Campus Arts & Auditorium   |                                 | 82,291           |                | ✓          |
| • Student Union Phase II   |                                 | 20,000           |                | ✓          |
| Indoor Recreation Buildings and Facilities                                     |                                 | 165,343          |                |            |
| • Recreation Center (Phase I and II)   | —                               | 70,000           | ✓              |            |
| • Recreation Center Addition (Phase III)                                       |                                 | 64,574           |                | ✓          |
| • Wellness Center  |                                 | 30,769           | ✓              |            |
| Outdoor Athletics & Recreation Support   | —                               | 59,679           |                |            |
| • Stadium House  |                                 | 40,177           | ✓              |            |
| • Otter Retail Space   |                                 | 10,502           | ✓              |            |
| • Aquatics Center  | —                               | 7,000            |                | ✓          |
| • Field House  |                                 | 2,000            | ✓              |            |
| Facilities Building  |                                 | 73,590           |                |            |
| • Facilities Building  | —                               | 23,590           | ✓              |            |
| • Facilities Storage Buildings   |                                 | 50,000           | ✓              |            |
| Housing  | 3,820 beds / 757 units          | 1,760,000        |                |            |
| • East Campus Housing Conversion <sup>7</sup>                                  | -1,380 beds / 757 units         | NA               | ✓              |            |

**Table 2-1. Proposed Master Plan Development**



| Campus Space   | Beds/Units                      | GSF <sup>1</sup> | Implementation |            |
|--|---------------------------------|------------------|----------------|------------|
|  |                                 |                  | Horizon I      | Horizon II |
| • Student Housing Phase IIB  | 400 beds                        | 160,000          | ✓              |            |
| • Student Housing Phase III  | 600 beds                        | 200,000          | ✓              |            |
| • Student Housing Phase IV   | 600 beds                        | 200,000          | ✓              |            |
| • Student Housing Phase V  | 600 beds                        | 200,000          | ✓              |            |
| • Student Housing Phase VI   | 600 beds                        | 200,000          | ✓              |            |
| • Student Housing Phase VII  | 600 beds                        | 200,000          |                | ✓          |
| • Student Housing Phase VIII                                       | 600 beds                        | 200,000          |                | ✓          |
| • Student Housing Phase IX   | 600 beds                        | 200,000          |                | ✓          |
| • Student Housing Phase X  | 600 beds                        | 200,000          |                | ✓          |
| <b>Total New Space with Master Plan<sup>7</sup></b>                | <b>3,820 beds / 757 units</b>   | <b>2,873,990</b> | NA             |            |
| <b>Existing Building</b>   | <b>3,980 beds / 1,220 units</b> | <b>3,190,556</b> | NA             |            |
| <b>Approved and Pending Building Projects</b>                      | NA                              | <b>60,000</b>    | NA             |            |
| <b>Total New Building Space with Master Plan<sup>7</sup></b>       | <b>3,820 beds / 757 units</b>   | <b>2,873,990</b> | NA             |            |
| <b>Total Building Space to be Demolished</b>                       | NA                              | <b>-256,366</b>  | NA             |            |
| <b>Net Increase in Building Space with Master Plan<sup>6</sup></b> | <b>3,820 beds / 757 units</b>   | <b>2,617,624</b> | NA             |            |
| <b>TOTAL FUTURE BUILDING SPACE</b>                                 | <b>7,800 beds / 1,220 units</b> | <b>5,868,180</b> | NA             |            |

As part of the Project, numerous PDFs are included that address various topics including open space, transportation, water and wastewater systems, energy systems and greenhouse gas reduction, and design. For example, transportation PDFs will enhance and expand the campus’ existing Transportation Demand Management (TDM) program in order to further reduce vehicle trips and prioritize pedestrian and bicycle movement.

As noted above, the Project includes specific development components identified in the proposed Master Plan and expected to be constructed in the next 10 years; these Project components are referred to throughout this EIR as “near-term development components.” These near-term development components include: (1) Student Housing Phase III (600 student housing beds); (2) Academic IV (95,000 GSF of classroom/instructional space); (3) Student Recreation Center (70,000 GSF of recreation space); (4) Student Housing Phase IIB (400 student housing beds); and (5) Academic V (76,700 GSF of classroom/instructional space).

Portions of the campus not currently proposed for development under this Project could be the subject of future development proposals. Such development proposals could be institutional partnerships or campus projects. Environmental review under CEQA would be pursued if and when such development proposals are pursued.

See CSUMB Master Plan Draft EIR Chapter 3, Project Description for additional details for the Project.

 Former Fort Ord Boundary  
 CSUMB Campus

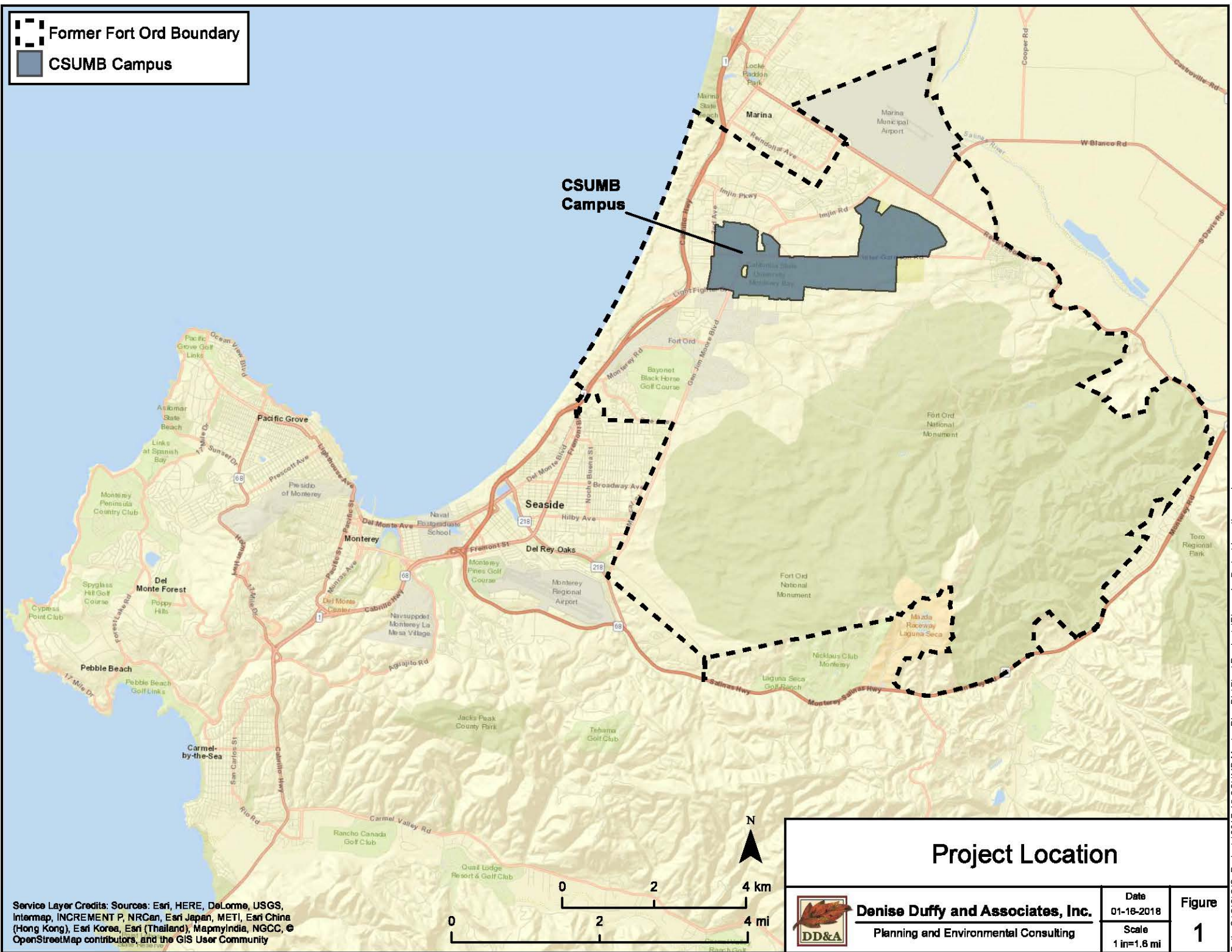

**CSUMB Campus**

### Project Location



**Denise Duffy and Associates, Inc.**  
 Planning and Environmental Consulting

Date  
01-16-2018  
 Scale  
1 in=1.6 mi

Figure  
**1**

Service Layer Credits: Sources: Esri, HERE, DeLorme, USGS, Intermap, INCREMENT P, NRCan, Esri Japan, METI, Esri China (Hong Kong), Esri Korea, Esri (Thailand), MapmyIndia, NGCC, OpenStreetMap contributors, and the GIS User Community

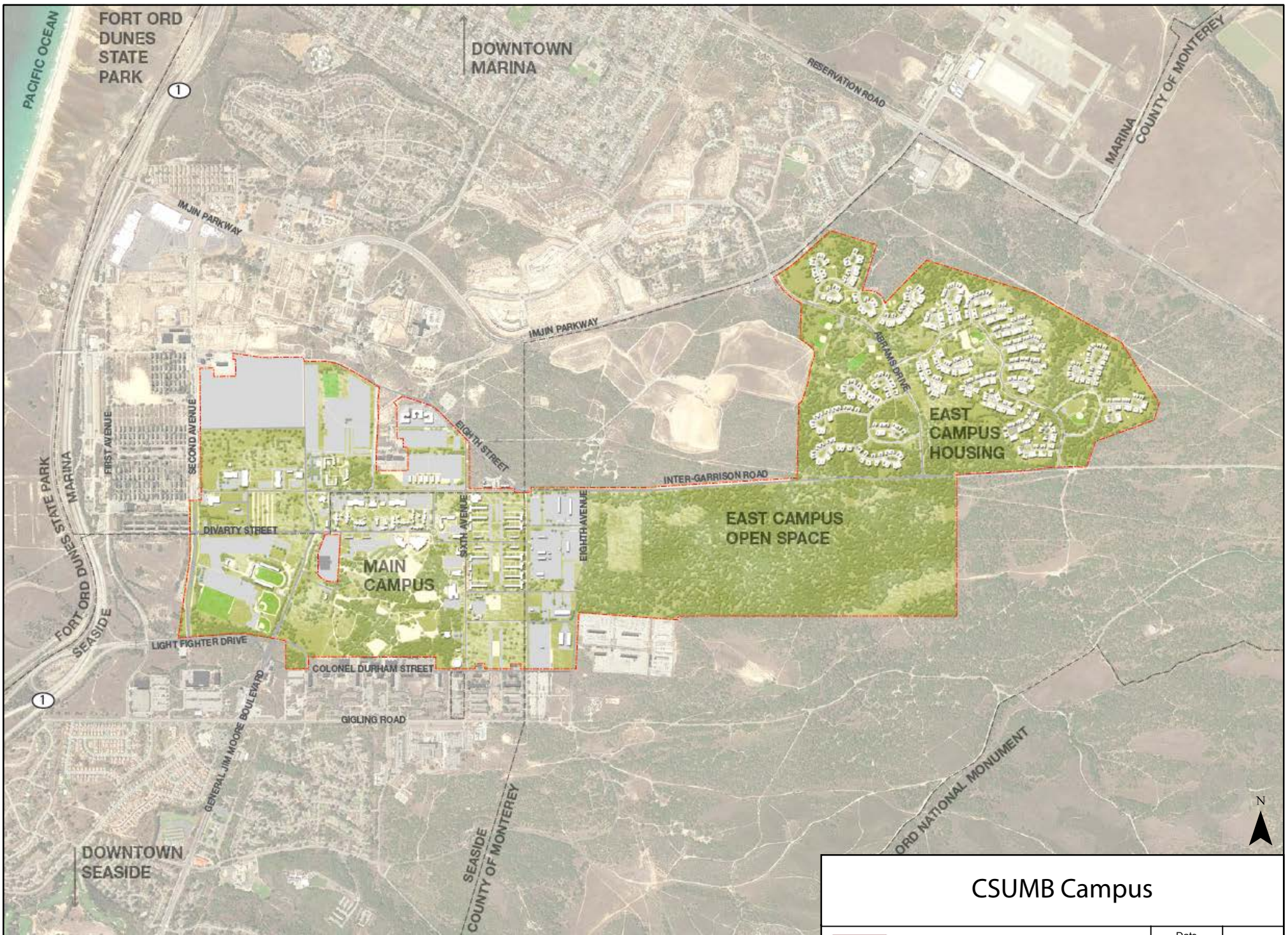

Source: CSUMB Comprehensive Master Plan, Draft June 2017

|   |  |                    |
|---|--|--------------------|
| <h2>CSUMB Campus</h2>   |  |                    |
|  | <b>Denise Duffy and Associates, Inc.</b> |                    |
|   | Planning and Environmental Consulting    |                    |
|   | Date<br>09-08-2017                       | Figure<br><b>2</b> |
|   | Scale<br>1 in=1.6 mi                     |                    |

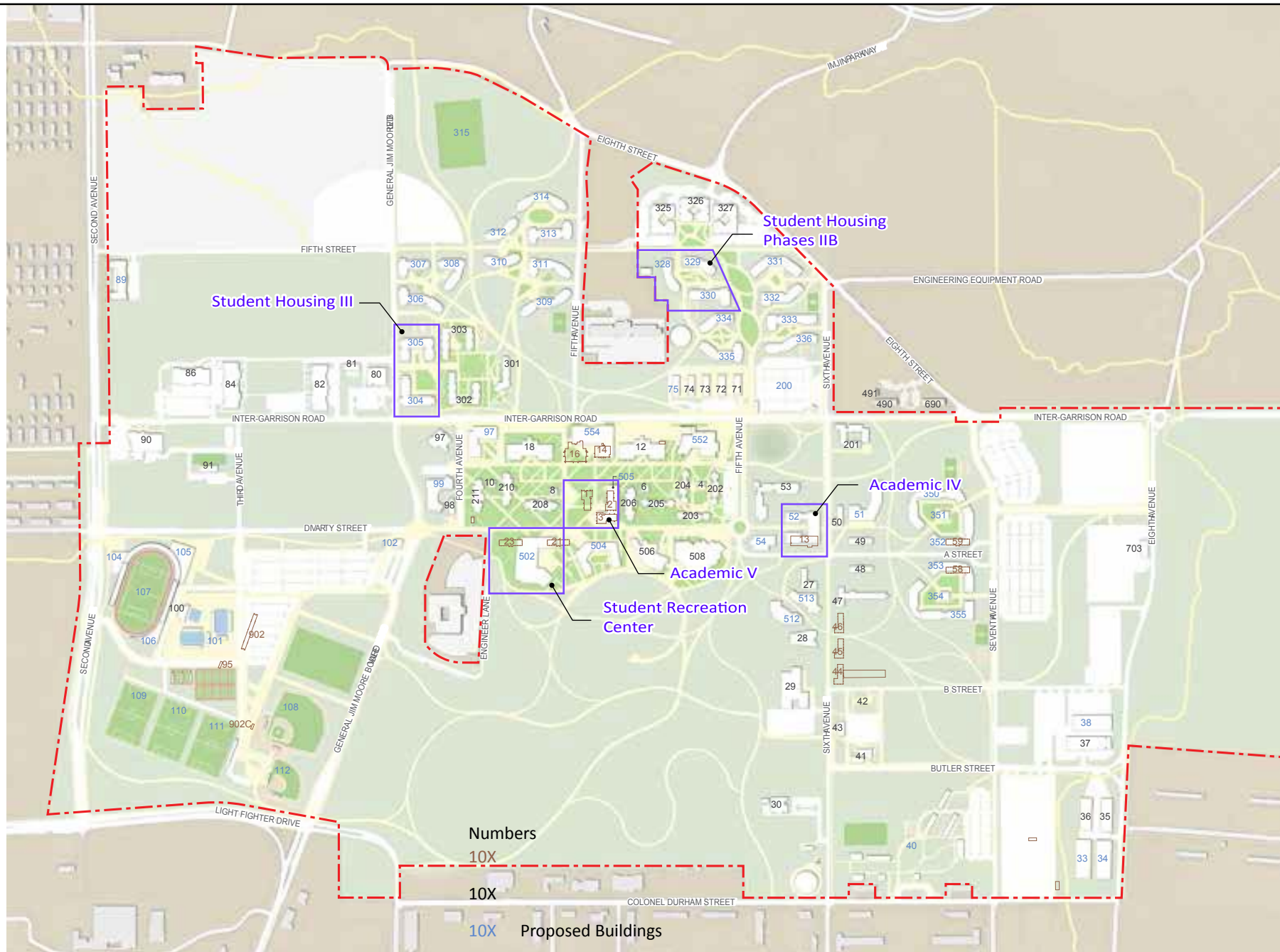

- |         |                              |                            |
|---------|------------------------------|----------------------------|
| Numbers |                              |                            |
| 10X     | Existing Buildings Removed   | Existing Buildings Removed |
| 10X     | Existing Buildings to Remain | Near-Term Projects         |
| 10X     | Proposed Buildings           |                            |

## Implementation Plan and Near-Term Project Sites



**Denise Duffy and Associates, Inc.**  
 Planning and Environmental Consulting

Date  
 01-17-2018  
 Scale  
 1 in=1.6 mi

Figure  
**3**

### 2.2.2 Near-Term Development Components

In addition to providing a framework for the development of facilities to accommodate the proposed student, faculty and staff growth, the Project includes near-term development components. A brief description of each project is provided below, including anticipated year of construction; site locations are shown on **Figures 3, 4a, and 4b**.

1. **Student Housing Phase III.** Student Housing Phase III would provide an approximately 200,000-square-foot residential building complex with 600 beds on an approximately 6.4-acre site in the North Quad on an existing parking lot. The planned four-story buildings would provide a range of housing types. At least one apartment in each building would be dedicated to CSUMB Housing staff/student staff space.





Amenities would include: multi-purpose rooms and AV-connected classroom space,<sup>5</sup> laundry, indoor bike parking, lounges/communal rooms, half courts outside (basketball and/or sand volleyball), picnic tables, urban agriculture/garden, outdoor social spaces, art, and connections to pedestrian/bicycle paths and trails. An approximately 7,600-square-foot dining facility would be located on the ground floor.

New utility connections to adjacent services would be installed with this development. Additionally, appropriate building/site scale LID BMPs would be implemented. Construction staging would occur north of the North Quad in existing paved area.

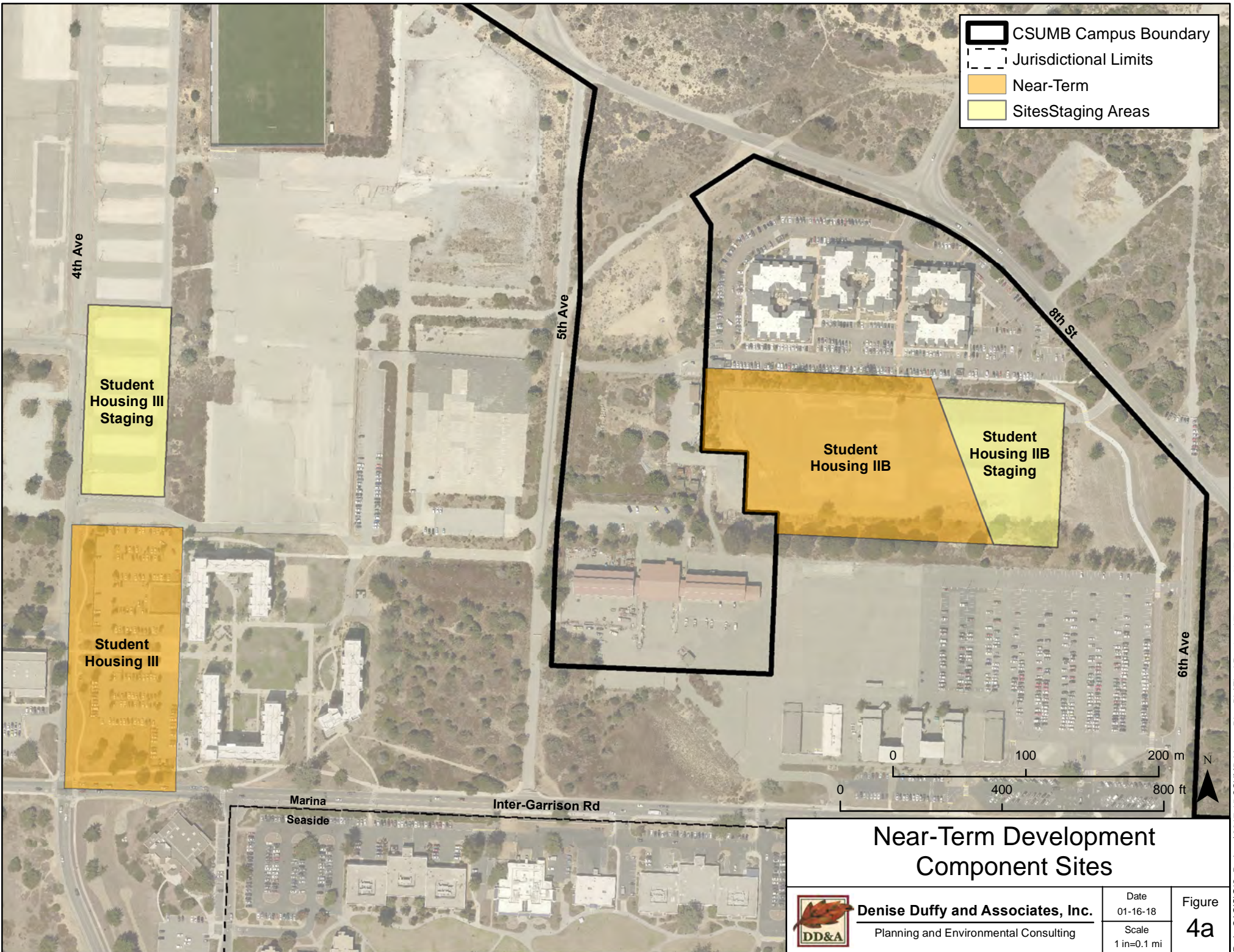
---

<sup>5</sup> Multipurpose space could be used as classroom space during the day and for housing programs at other times.



-  CSUMB Campus Boundary
-  Jurisdictional Limits
-  Near-Term
-  Sites Staging Areas

## Near-Term Development Component Sites



**Denise Duffy and Associates, Inc.**

Planning and Environmental Consulting

Date

01-16-18

Scale

1 in=0.1 mi

Figure

**4a**



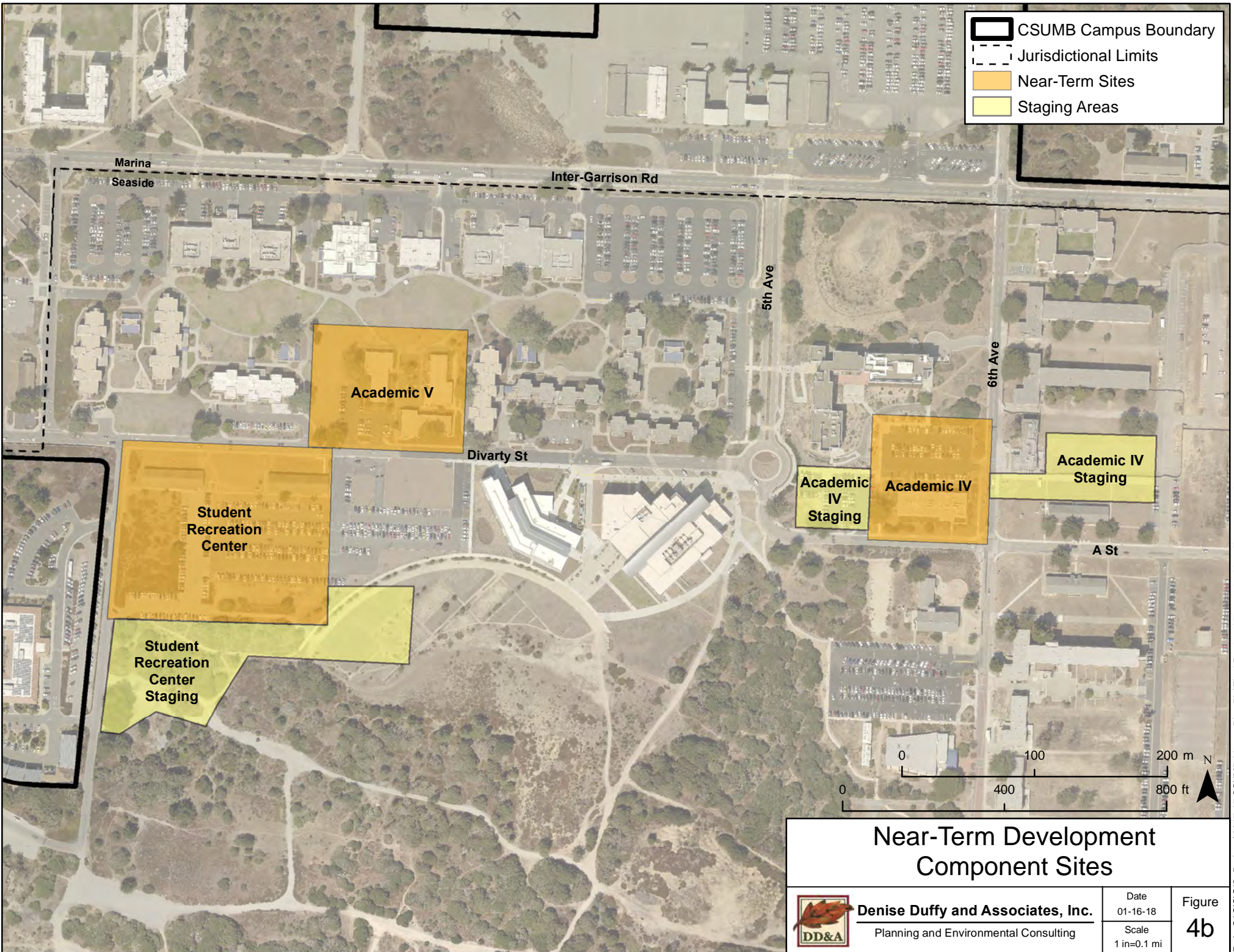

**Near-Term Development Component Sites**

|   |                      |                     |
|---|----------------------|---------------------|
|  <b>Denise Duffy and Associates, Inc.</b><br>Planning and Environmental Consulting | Date<br>01-16-18     | Figure<br><b>4b</b> |
|   | Scale<br>1 in=0.1 mi |                     |

2. **Academic IV Building.** Academic IV would provide an approximately 95,000-square-foot science building devoted to laboratory, lecture, and office space located in the campus core on an approximately 4.0-acre site. The building would be up to four stories and would include an on-site emergency generator. Future construction would require demolition of existing Building 13 (Science Research Lab Annex) and portions of parking lot areas 13 and 19. The development would include construction of a pedestrian/bike path north of existing Building 53 (Chapman Science Academic Center) for improved connectivity to the multimodal hub and parking to the east.

New utility connections to adjacent services would be installed with this development. Additionally, appropriate building/site scale LID BMPs would be implemented. Construction and staging would likely use parking lots 13 and 19 and/or close A Street between 5th and 6th Avenues.

3. **Student Recreation Center.** The approximately 70,000-square-foot Student Recreation Center would be located on an approximately 8.5-acre site south of the Main Quad and Divarty Street and includes demolition of Building 21 (Beach Hall) and Building 23 (Tide Hall), and portions of parking lots 23 and 508. This facility would primarily house recreation (potentially up to 75 percent) and the remaining space allocated to the Kinesiology department. Kinesiology has demonstrated steady growth in the last 5 years and lacks appropriate teaching spaces to support the curriculum.

The building would be up to two stories and would be constructed in two phases (Phase I – 2021, approximately 33,000 square feet; Phase II – 2026, approximately 36,000 square feet). The building would include multi-use indoor courts (for uses such as intramural basketball, soccer and volleyball), including bleachers/seating, weight room (free weights and machines), a climbing wall, fitness rooms, cardio-dance studios indoor, lockers and restrooms, laundry rooms, equipment check out area, storage, Kinesiology department special instruction rooms, Kinesiology department faculty office, administrative office space and conference room, and outdoor court areas. Only intramural sports would occur in the Recreation Center, not indoor athletic team competitions.

New utility connections to adjacent services would be installed with this development. Additionally, appropriate building/site scale LID BMPs would be implemented. Construction staging would take place south of the building site and within the Crescent in previously disturbed open space areas with little or no habitat value.

4. **Student Housing Phase IIB.** Student Housing Phase IIB would provide an approximately 160,000-square-foot, student residential building complex south of the Promontory on a vacant paved lot approximately 7.2-acres in size. The planned four-story buildings would provide approximately 400 beds in apartments or suites for sophomores, juniors, and seniors. At least one apartment in each building would be dedicated to CSUMB Housing staff/student staff space. Planned amenities include laundry, indoor bike parking, lounges/communal rooms, half courts outside (basketball or sand volleyball), picnic tables, urban agriculture/garden, outdoor social spaces, art, and connections to pedestrian/bicycle paths and nature. A convenience store would be included.

New utility connections to adjacent services would be installed with this development. Additionally, appropriate building/site scale LID BMPs would be implemented. Construction staging is planned just east of the building in already paved areas.

5. **Academic V.** Academic V would provide an approximately 76,700-square-foot academic building on an approximately 2.7-acre site in the Main Quad and includes demolition of existing Buildings 1, 2, and 3 (Administration, Playa, and Del Mar buildings) and parking lot 18. The development would involve temporary relocation of the administration offices until the new Administration Building, another new building identified on the proposed Master Plan, is constructed. The building would support academic uses, i.e., learning and meeting spaces. The building would be up to four stories.

New utility connections to adjacent services would be installed with this development. Appropriate building/site scale LID BMPs would also be implemented. Construction staging would be conducted within the site boundaries on the Main Quad, and if necessary, in previously disturbed open space areas south of the Crescent

### 3.0 METHODS

#### 3.1 Personnel and Survey Dates

Reconnaissance-level wildlife and general habitat surveys were completed by DD&A biologists Matthew Johnson (Senior Environmental Scientist), Jami Colley (Associate Environmental Scientist), Shaelyn Hession (Assistant Environmental Scientist), and Patric Krabacher (Assistant Environmental Scientist) in December 2016 (for a separate, overlapping project under contract with the Fort Ord Reuse Authority [FORA]) that included the Main Campus and East Campus Open Space areas (**Figure 5**). Focused botanical surveys were conducted within a designated survey area within the Project site in April and June 2016 by DD&A biologists. Reconnaissance-level wildlife and general habitat surveys were completed by DD&A biologists in August 2017 within the East Campus Housing area and portions of Main Campus that were not surveyed during previous surveys. Reconnaissance-level surveys for special-status plant and wildlife species habitat were conducted by DD&A biologists in January 2018 within the five Near-Term Development sites and proposed associated staging areas. An additional focused survey for SBB habitat was conducted in March 2019 at the Academic IV site and staging areas based on information that habitat had previously been observed by CSUMB faculty at this site. The focused botanical survey area and Near-Term Development sites were defined by maps provided by the CSUMB Campus Planning & Development (CPD) Department, which included portions of the Main Campus and East Campus Open Space areas. The dates for each of these surveys are outlined in **Table 3-1**.





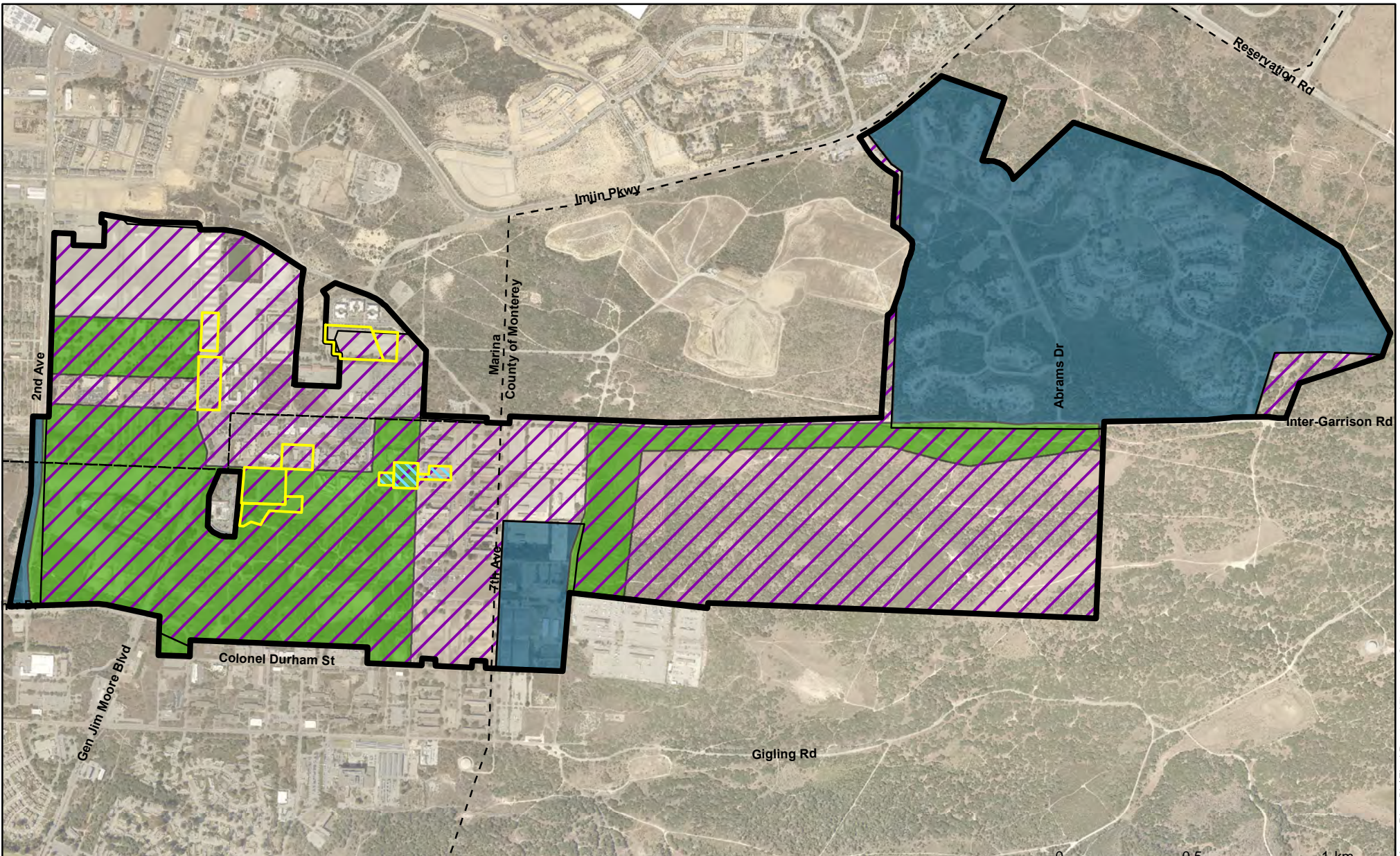

**Table 3-1. Biological Survey Dates within the Project Site**

| Survey Type   | Location  | Date(s)                    |
|---|---|----------------------------|
| Focused spring-flowering plant species survey                                 | Survey Area                                     | April 2016                 |
| Focused summer-flowering plant species survey                                 | Survey Area                                     | July 2016                  |
| Reconnaissance-level wildlife and general habitat survey                      | Main Campus and East Campus Open Space          | December 2016 <sup>6</sup> |
| Reconnaissance-level wildlife and general habitat survey                      | East Campus Housing and Portions of Main Campus | August 2017                |
| Reconnaissance-level special-status plant and wildlife species habitat survey | Near-Term Development Sites                     | January 2018               |
| Focused Smith's blue butterfly habitat survey                                 | Academic IV and Staging sites                   | March 2019                 |

Prior to surveys in 2016, local reference populations of Monterey spineflower and sand gilia were checked on an approximately weekly basis from mid-March until the time of the survey to ensure these species would be in peak bloom during the time of the survey. In 2016, local reference populations for seaside bird's-beak and Yadon's piperia were checked on an approximately weekly basis for two to three weeks prior to the surveys.

<sup>6</sup> Surveys completed in December 2016 for the Oak Woodlands Conservation Area Project under contract with FORA.



-  CSUMB Campus Boundary
-  Jurisdictional Limits
-  Reconnaissance-Level Wildlife and Habitat Surveys (August 2017)
-  Focused Botanical Surveys (April and July 2016)
-  Reconnaissance-Level Wildlife and Habitat Surveys (December 2017)
-  Reconnaissance-Level Special-Status Species Habitat Surveys (January 2018)
-  Focused Smith's Blue Butterfly Habitat Survey (March 2018)

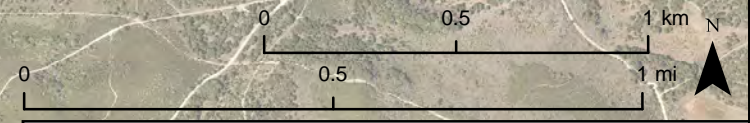

|   |   |
|---|---|
| <h2 style="margin: 0;">Survey Areas</h2>  |   |
|  | <b>Denise Duffy and Associates, Inc.</b><br>Planning and Environmental Consulting |
| Date<br>03-13-2019  | Figure<br><b>5</b>  |
| Scale<br>1 in=0.3 mi  |   |

Reconnaissance-level wildlife and general habitat survey methods included using aerial maps to identify general habitat types and potential sensitive habitats and verifying conditions in the field. General habitat types were mapped using a combination of GPS and hand drawing on aerial maps, which were later digitized using ArcGIS software.

Available reference materials were reviewed prior to conducting the field surveys, including the California Department of Fish and Wildlife's (CDFW's) California Natural Diversity Database (CNDDDB) occurrence reports (**Appendix B**, CDFW, 2017a), current agency status information from the U.S. Fish and Wildlife Service (USFWS or Service) and CDFW for species listed, proposed for listing, or candidates for listing as threatened or endangered under the federal Endangered Species Act (ESA) or California ESA (CESA), and those considered CDFW "species of special concern" (**Appendix C**, Service, 2017a; **Appendix B**, CDFW, 2017a and 2017b), aerial photographs of the Project site, and numerous biological reports prepared for the former Fort Ord (see "Data Sources" below).

Portions of the campus were surveyed for botanical resources following the applicable guidelines outlined in: *Guidelines for Conducting and Reporting Botanical Inventories for Federally listed, Proposed and Candidate Plants* (Service, 2000), *Protocols for Surveying and Evaluating Impacts to Special Status Native Plant Populations and Natural Communities* (CDFW, 2009), and *CNPS Botanical Survey Guidelines* (CNPS, 2001). All special-status plant species identified were mapped using a Trimble Pro XH GPS unit, which were later digitized using ArcGIS software. Populations of plants with greater than six individuals were mapped as a polygon and the density of the population was documented. Densities were recorded as low (1-33% cover), medium (34-66% cover) and high (67-100% cover). Individual plants or populations of less than six individuals were mapped as a point and a count of the number of individual plants was documented. Populations included all individuals within approximately three feet of another individual; individual plants further away than three feet were mapped as a separate polygon or point. Data collected during the surveys was used to assess the environmental conditions of the Project site and its surroundings, evaluate environmental constraints at the site and within the local vicinity, and provide a basis for recommendations to minimize and avoid impacts.

### 3.2 Special-Status Species

Special-status species are those plants and animals that have been formally listed or proposed for listing as endangered or threatened, or are candidates for such listing under the ESA or CESA. Listed species are afforded legal protection under the ESA and CESA. Species that meet the definition of rare or endangered under the CEQA Section 15380 are also considered special-status species. Animals on the CDFW's list of "species of special concern" (most of which are species whose breeding populations in California may face extirpation if current population trends continue) meet this definition and are typically provided management consideration through the CEQA process, although they are not legally protected under the ESA or CESA. Additionally, the CDFW also includes some animal species that are not assigned any of the other status designations on their "Special Animals" list (CDFW, 2017b). The CDFW considers the taxa on this list to be those of greatest conservation need, regardless of their legal or protection status.

Plants listed as rare under the California Native Plant Protection Act (CNPPA) or included in California Native Plant Society (CNPS) California Rare Plant Ranks (CRPR)<sup>7</sup> 1A, 1B, 2A, and 2B are also treated as special-status species as they meet the definitions of Sections 2062 and 2067 of the CESA and in accordance with CEQA Guidelines Section 15380. In general, the CDFW requires that CRPR 1A species (Plants presumed extirpated in California and Either Rare or Extinct Elsewhere), CRPR 1B species (Plants rare, threatened, or endangered in California and elsewhere), CRPR 2A species (Plants presumed extirpated in California, but more common elsewhere); and CRPR 2B species (Plants rare, threatened, or endangered in California, but more common elsewhere) of the CNPS *Inventory of Rare and Endangered Vascular Plants of California* (CNPS, 2017) be fully considered during the preparation of environmental documents relating to CEQA.<sup>8</sup> In addition, species of vascular plants, bryophytes, and lichens listed as having special-status by CDFW are considered special-status plant species (CDFW, 2017a).

Raptors (e.g., eagles, hawks, and owls) and their nests are protected under both federal and state laws and regulations. The federal Migratory Bird Treaty Act (MBTA) of 1918 and California Fish and Game Code (FGC) Section 3513 prohibit killing, possessing, or trading migratory birds except in accordance with regulation prescribed by the Secretary of the Interior. Birds of prey are protected in California under FGC Section 3503.5. Section 3503.5 states that it is “unlawful to take, possess, or destroy the nest or eggs of any such bird except otherwise provided by this code or any regulation adopted pursuant thereto.” In addition, fully protected species under the FGC Section 3511 (birds), Section 4700 (mammals), Section 5515 (fish), and Section 5050 (reptiles and amphibians) are also considered special-status animal species. Species with no formal special-status designation but thought by experts to be rare or in serious decline are also considered special-status animal species (CDFW, 2017a).

### 3.3 Sensitive Habitats

Sensitive habitats include riparian corridors, wetlands, habitats for legally protected species, areas of high biological diversity, areas supporting rare or special-status wildlife habitat, and unusual or regionally restricted habitat types. Habitat types considered sensitive include those listed as sensitive on the on CDFW’s *Natural Communities List* (CDFW, 2010), those that are occupied by species listed under ESA or are critical habitat in accordance with ESA, and those that are defined as Environmentally Sensitive Habitat Areas (ESHA) under the California Coastal Act (CCA). Specific habitats may also be identified as sensitive in city or county general plans or ordinances. Sensitive habitats are regulated under federal regulations (such as the Clean Water Act [CWA] and Executive Order 11990 – Protection of Wetlands), state regulations (such as CEQA and FGC Section 1600-1616), or local ordinances or policies (such as city or county tree ordinances and general plan policies).

### 3.4 Data Sources

The primary literature and data sources reviewed in order to determine the occurrence or potential for occurrence of special-status species at the Project site are as follows: current agency status information from the Service and CDFW for species listed, proposed for listing, or candidates for listing as threatened

<sup>7</sup> Formerly known as CNPS Lists. CNPS initially created five CRPR in an effort to categorize degrees of concern; however, in order to better define and categorize rarity in California’s flora, the CNPS Rare Plant Program and Rare Plant Program Committee have developed the new CRPR 2A and CRPR 2B.

<sup>8</sup> Species on CRPR 3 (Plants about which we need more information - a review list) and CRPR 4 (Plants of limited distribution - a watch list) may, but generally do not, meet the definitions of Sections 2062 and 2067 of CESA, and are not typically considered in environmental documents relating to CEQA.

or endangered under ESA or CESA and those considered CDFW “species of special concern” (**Appendix C**, Service, 2017a; **Appendix B**, CDFW, 2017a and 2017b); the CNPS *Inventory of Rare and Endangered Vascular Plants of California* (CNPS, 2017); CNDDDB occurrence reports (**Appendix B**, CDFW, 2017a); the Service’s Critical Habitat Mapper (2017b); *Flora and Fauna Baseline Study of Fort Ord* (U.S. Army Corps of Engineers [ACOE], 1992); and the *Installation-Wide Multispecies Habitat Management Plan for Former Fort Ord* (HMP) (ACOE, 1997). The U.S. Geological Survey (USGS) Marina quadrangle and the six surrounding quadrangles (Monterey, Moss Landing, Prunedale, Salinas, Seaside, and Spreckels) from the CNDDDB were reviewed for documented special-status species occurrences in the vicinity of the Project site.

In addition, all of the comment letters received in response to the Notice of Preparation (NOP) for the Project’s Environmental Impact Report (EIR) were reviewed to ensure all potential biological resources known or with the potential to occur were evaluated and concerns were addressed in accordance with CEQA.

From these resources, a list of special-status plant and wildlife species known or with the potential to occur in the vicinity of the Project site was created (**Appendix A**). The list presents these species along with their legal status, habitat requirements, and a brief statement of the likelihood to occur.

#### 3.4.1 Botany

The classification and characterization of the vegetation of the Project site is based on field observations and the *Manual of California Vegetation* (Sawyer et.al., 2009). A generalized nomenclature for vegetation types is used within this document for ease of reference; however, each vegetation type description also lists the *Manual of California Vegetation* (Sawyer et.al. 2009) vegetation type(s) in order to provide a crosswalk to the *Natural Communities List* (CDFW, 2010).

Information regarding the distribution and habitats of local and state vascular plants was also reviewed (Howitt and Howell, 1964 and 1973; Munz and Keck, 1973; Matthews and Mitchell, 2015; Baldwin, et. al, 2012; Jepson Flora Project, 2017; ACOE, 1992; ACOE, 1997). All plants observed within the Project site were identified to species or intraspecific taxon using keys and descriptions in Baldwin, et. al, (2012) and Matthews and Mitchell (2015). Scientific nomenclature for plants in this report follows Baldwin, et.al., (2012) and common names follow Matthews and Mitchell (2015). A full botanical inventory was not recorded for the Project site; however, the dominant species within each habitat were recorded and all plant species encountered were identified to species or intraspecific taxon necessary to eliminate them as being special-status species. Dominant plant species are those which are more numerous than its competitors in an ecological community or makes up more of the biomass; generally, the species that are most abundant. Most ecological communities are defined by their dominant species.

#### 3.4.2 Wildlife

The following literature and data sources were reviewed: CDFW reports on special-status wildlife (Remsen, 1978; Williams, 1986; Jennings and Hayes, 1994; Thelander, 1994); *Monterey Birds* (Roberson 2002); California Wildlife Habitat Relationships Program species-habitat models (CDFW, 2008; Zeiner et al., 1988 and 1990); *Flora and Fauna Baseline Study of Fort Ord* (ACOE, 1992); and the HMP (ACOE, 1997); and general wildlife references (Stebbins, 1985).



### 3.5 Regulatory Setting

#### 3.5.1 Federal Regulations

##### *Federal Endangered Species Act*

Provisions of the ESA of 1973 (16 USC 1532 et seq., as amended) protect federally-listed threatened or endangered species and their habitats from unlawful take. Listed species include those for which proposed and final rules have been published in the Federal Register (FR). The ESA is administered by the Service or the National Oceanic and Atmospheric Administration National Marine Fisheries Service (NMFS). In general, the NMFS is responsible for the protection of ESA-listed marine species and anadromous fish, whereas other listed species are under Service jurisdiction.

Section 9 of ESA prohibits the take of any fish or wildlife species listed under ESA as endangered or threatened. Take, as defined by ESA, is “to harass, harm, pursue, hunt, shoot, wound, kill, trap, capture, or collect, or attempt to engage in any such conduct.” Harm is defined as “any act that kills or injures the fish or wildlife...including significant habitat modification or degradation that significantly impairs essential behavioral patterns of fish or wildlife.” In addition, Section 9 prohibits removing, digging up, and maliciously damaging or destroying federally-listed plants on sites under federal jurisdiction. Section 9 does not prohibit take of federally-listed plants on sites not under federal jurisdiction. If there is the potential for incidental take of a federally-listed fish or wildlife species, take of listed species can be authorized through either the Section 7 consultation process for federal actions or a Section 10 incidental take permit process for non-federal actions. Federal agency actions include activities that are on federal land, conducted by a federal agency, funded by a federal agency, or authorized by a federal agency (including issuance of federal permits).

##### *Critical Habitat*

Critical habitat is a term defined and used in the ESA. It is a specific geographic area(s) that contains features essential for the conservation of a threatened or endangered species and that may require special management and protection. Critical habitat may include an area that is not currently occupied by the species but that will be needed for its recovery. An area is designated as "critical habitat" after the Service publishes a proposed federal regulation in the Federal Register and then public comments are received and considered on the proposal. The final boundaries of the critical habitat area are also published in the Federal Register. Federal agencies are required to consult with the Service on actions they carry out, fund, or authorize to ensure that their actions will not destroy or adversely modify critical habitat. In this way, a critical habitat designation protects areas that are necessary for the conservation of the species. No critical habitat for federally listed species is designated within the Project site.

##### *Recovery Plans*

The ultimate goal of the ESA is the recovery (and subsequent conservation) of endangered and threatened species and the ecosystems on which they depend. A variety of methods and procedures are used to recover listed species, such as protective measures to prevent extinction or further decline, consultation to avoid adverse impacts of federal activities, habitat acquisition and restoration, and other on-the-ground activities for managing and monitoring endangered and threatened species. The collaborative efforts of the Service and its many partners (federal, state, and local agencies, tribal governments, conservation organizations,

the business community, landowners, and other concerned citizens) are critical to the recovery of listed species.

Two recovery plans have been prepared for listed species known or with the potential to occur within the Project site:

- Recovery Plan for the Central California Distinct Population Segment of the California Tiger Salamander (*Ambystoma californiense*) (Service, 2017c) and
- Smith’s Blue Butterfly Recovery Plan (Service, 1984).

#### *Migratory Bird Treaty Act*

The MBTA (16 USC 703 et seq.) of 1918 prohibits killing, possessing, or trading migratory birds except in accordance with regulation prescribed by the Secretary of the Interior. Most actions that result in taking or in permanent or temporary possession of a protected species constitute violations of the MBTA. The Service is responsible for overseeing compliance with the MBTA and implements Conventions (treaties) between the United States and four countries for the protection of migratory birds – Canada, Mexico, Japan, and Russia. The Service maintains a list of migratory bird species that are protected under the MBTA, which was updated in 2010 to: 1) correct previous mistakes, such as misspellings or removing species no longer known to occur within the United States; 2) add species, as a result of expanding the geographic scope to include Hawaii and U.S. territories and new evidence of occurrence in the United States or U.S. territories; and 3) update name changes based on new taxonomy (Service, 2013).

#### *Clean Water Act*

The ACOE and Environmental Protection Agency (EPA) regulate discharge of dredged and fill material into “Waters of the United States” (waters of the U.S.) under Section 404 of the CWA (33 USC 1344). Waters of the U.S. are defined broadly as waters susceptible to use in commerce (including waters subject to tides, interstate waters, and interstate wetlands) and other waters (such as interstate lakes, rivers, streams, mudflats, sandflats, wetlands, sloughs, prairie potholes, wet meadows, playa lakes, or natural ponds) (33 CFR 328.3). Potential wetland areas are identified as “those areas that are inundated or saturated by surface or ground water at a frequency and duration sufficient to support, and that under normal circumstances do support, a prevalence of vegetation typically adapted for life in saturated soils conditions.”

Under Section 401 of the CWA (33 USC 1341), any applicant receiving a Section 404 permit from the ACOE must also obtain a Section 401 Water Quality Certification from the Regional Water Quality Control Board (RWQCB). A Section 401 Water Quality Certification is issued when a project is demonstrated to comply with state water quality standards and other aquatic resource protection requirements.

#### *Executive Order 11990 - Protection of Wetlands*

Executive Order 11990 - Protection of Wetlands (42 FR 26961) calls for no net loss of wetlands. For the regulatory process, the ACOE and EPA jointly define wetlands as follows: "Those areas that are inundated or saturated by surface or ground water at a frequency and duration sufficient to support, and that under normal circumstances do support, a prevalence of vegetation typically adapted for life in saturated soil conditions." Federal agencies are required to implement the following procedures for any federal action that involves wetlands: 1) provide an opportunity for early public involvement; 2) consider alternatives that

would avoid wetlands, and if avoidance is not possible, measures to minimize harm to wetlands must be included in the action; 3) prepare a “Wetlands Only Practicable Alternative Finding” for actions that require an Environmental Impact Study.

#### *Executive Order 13112-Invasive Species*

Executive Order 13112 - Invasive Species (64 FR 6183) requires the prevention of introduction and spread of invasive species. Invasive species are defined as “alien species whose introduction does or is likely to cause economic or environmental harm or harm to human health.” Each federal agency whose actions may affect the status of invasive species on a project site shall, to the extent practicable and permitted by law, subject to the availability of appropriations, use relevant programs and authorities to: 1) prevent the introduction of invasive species; 2) detect and respond rapidly to and control populations of such species in a cost-effective and environmentally sound manner; 3) monitor invasive species populations accurately and reliably; 4) provide for restoration of native species and habitat conditions in ecosystems that have been invaded; 5) conduct research on invasive species and develop technologies to prevent introduction and provide for environmentally sound control of invasive species; and 6) promote public education on invasive species and the means to address them. A national invasive species management plan was prepared by the National Invasive Species Council and the Invasive Species Advisory Committee that recommends objectives and measures to implement the Executive Order. The California Invasive Plant Council (Cal-IPC) Inventory categorizes non-native invasive plants that threaten California’s wildlands. Categorization is based on an assessment of the ecological impacts of each plant. The Cal-IPC Inventory represents the best available knowledge of invasive plant experts in the state. Although the impact of each plant varies regionally, its rating represents cumulative impacts statewide. Therefore, a plant whose statewide impacts are categorized as Limited may have more severe impacts in a particular region. Conversely, a plant categorized as having a High cumulative impact across California may have very little impact in some regions.

#### 3.5.2 State Regulations

##### *California Endangered Species Act*

The CESA (FGC 2050 et seq.) was enacted in 1984. The California Code of Regulations (14 CCR 670.5) lists animal species considered endangered or threatened by the state. Section 2090 of CESA requires state agencies to comply with endangered species protection and recovery and to promote conservation of these species. Section 2080 of the FGC prohibits “take” of any species that the commission determines to be an endangered species or a threatened species. “Take” is defined in Section 86 of the FGC as “hunt, pursue, catch, capture, or kill, or attempt to hunt, pursue, catch, capture, or kill.” A Section 2081 Incidental Take Permit from the CDFW may be obtained to authorize “take” of any state listed species.

##### *California Fish and Game Code*

Birds: Section 3503 of the FGC states that it is “unlawful to take, possess, or destroy the nest or eggs of any such bird except as otherwise provided by this code or any regulation adopted pursuant thereto.” Section 3503.5 prohibits the killing, possession, or destruction of any birds in the orders Falconiformes or Strigiformes (birds-of-prey). Section 3511 prohibits take or possession of fully protected birds. Section 3513 prohibits the take or possession of any migratory nongame birds designated under the federal MBTA. Section 3800 prohibits take of nongame birds.

*Fully Protected Species:* The classification of fully protected was the state's initial effort in the 1960's to identify and provide additional protection to those animals that were rare or faced possible extinction. Lists were created for fish (Section 5515), mammals (Section 4700), amphibians and reptiles (Section 5050), and birds (Section 3511). Most fully protected species have also been listed as threatened or endangered species under the more recent endangered species laws and regulations. Fully protected species may not be taken or possessed at any time and no licenses or permits may be issued for their take except for collecting these species for necessary scientific research and relocation of the bird species for the protection of livestock.

*Species of Special Concern:* As noted above, CDFW also maintains a list of animal “species of special concern.” Although these species have no legal status, CDFW recommends considering these species during analysis of project impacts to protect declining populations and avoid the need to list them as endangered in the future.

*Lake and Streambeds:* Under Sections 1600-1616 of the California Fish and Game Code, the CDFW regulates activities that would alter the flow, bed, channel, or bank of streams and lakes. The limits of CDFW’s jurisdiction are defined in the code as the “... bed, channel or bank of any river, stream, or lake designated by the department in which there is at any time an existing fish or wildlife resource or from which these resources derive benefit ...” (Section 1601). In practice, the CDFW usually marks its jurisdictional limit at the top of the stream or bank, or at the outer edge of the riparian vegetation, whichever is wider.

#### *Native Plant Protection Act*

The CNPPA (FGC 1900 et seq.) of 1977 directed the CDFW to carry out the legislature’s intent to “preserve, protect and enhance rare and endangered plants in the state.” The CNPPA prohibits importing rare and endangered plants into California, taking rare and endangered plants, and selling rare and endangered plants. The CESA and CNPPA authorized the Fish and Game Commission to designate endangered, threatened and rare species and to regulate the taking of these species (FGC Section 2050-2098). Plants listed as rare under the CNPPA are not protected under CESA.

#### *Porter-Cologne Water Quality Control Act*

The Porter-Cologne Water Quality Control Act of 1969 (Porter-Cologne; California Water Code [CWC] 13000 et seq.) is California’s statutory authority for the protection of water quality and applies to surface waters, wetlands, and groundwater, and to both point and nonpoint sources. Under the Porter-Cologne, the State Water Resources Control Board (State Board) has the ultimate authority over State water rights and water quality policy. However, Porter-Cologne also establishes nine RWQCBs to oversee water quality on a day-to-day basis at the local/regional level. The Project site is located within Region 3 – Central Coast RWQCB. Porter-Cologne incorporates many provisions of the federal CWA, such as delegation to the State Board and RWQCBs of the National Pollutant Discharge Elimination System (NPDES) permitting program.

Under Porter-Cologne, the state must adopt water quality policies, plans, and objectives that protect the state’s waters for the use and enjoyment of the people. Regional authority for planning, permitting, and enforcement is delegate to the nine RWQCBs. The regional boards are required to formulate and adopt water quality control plans for all areas in the region and establish water quality objectives in the plans.

The Porter-Cologne sets forth the obligations of the State Board and RWQCBs to adopt and periodically update water quality control plans (basin plans). The act also requires waste dischargers to notify the RWQCBs of such activities through filing of Reports of Waste Discharge (RWD) and authorizes the State Board and RWQCBs to issue and enforce waste discharge requirements (WDRs), NPDES permits, Section 401 water quality certifications, or other approvals. The RWQCBs also have authority to issue waivers to RWD requirements and WDRs for broad categories of “low threat” discharge activities that have minimal potential for adverse water quality effects, when implemented according to prescribed terms and conditions.

The term “Waters of the State” is defined by Porter-Cologne as “any surface water or groundwater, including saline waters, within the boundaries of the state.” The RWQCB protects all waters in its regulatory scope but has special responsibility for wetlands, riparian areas, and headwaters, including isolated wetlands, and waters that many not be regulated by the ACOE under Section 404 of the CWA. Waters of the State are regulated by the RWQCB under the State Water Quality Certification Program, which regulates discharges of fill and dredged material under Section 401 of the CWA and the Porter-Cologne.

#### *CSUMB Tree Restoration Program*

CSUMB has established a tree restoration program for impacts to coast live oak and other trees resulting from projects that take place on campus. This program requires that for every tree greater than 4” diameter breast height (dbh) removed, two coast live oak trees would be replanted, and assumed to survive, in the identified restoration area on campus. In some cases, more than two trees would need to be planted to achieve this survival rate. The implementation of this program is required for all projects that would result in impacts to trees 4” dbh or greater.

#### 3.5.3 Local Regulations

As a state entity, CSUMB is not subject to local government planning or ordinances, such as the general plans and ordinances for the cities of Marina and Seaside and the County of Monterey. Accordingly, because neither local general plans or any other local land use plans or ordinances are applicable to CSUMB, such local plans and ordinances are not summarized here or further analyzed in this section. However, there are a number of local plans that have come out of the former Fort Ord Base Reuse process, which are summarized below.

#### *Fort Ord Habitat Management Plan*

The U.S. Army’s decision to close and dispose of the Fort Ord military base was considered a major federal action that could affect listed species under the ESA. The Service issued a Final Biological Opinion (BO) on the disposal and reuse of former Fort Ord requiring that an HMP be developed and implemented to reduce the incidental take of listed species and loss of habitat that supports these species (October 19, 1993). The HMP was prepared to assess impacts on vegetation and wildlife resources and provide mitigation for their loss associated with the disposal and reuse of former Fort Ord (ACOE, 1997).

The HMP establishes guidelines for the conservation and management of HMP species and their habitats on former Fort Ord lands by identifying lands that are available for development, lands that have some restrictions with development, and habitat reserve areas. The intent of the plan is to establish large, contiguous habitat conservation areas and corridors to compensate for future development in other areas of

the former base. The HMP establishes a habitat conservation area and corridor system with parcel-specific land use categories and management requirements for all lands on former Fort Ord. The HMP identifies what type of activities can occur on each parcel at former Fort Ord and parcels are designated as “development with no restrictions,” “habitat reserves with management requirements,” or “habitat reserves with development restrictions.” Within these land use designations, parcels may also be identified as Borderlands with specific requirements for lands adjacent to BLM and contain future road corridors, easements, and rights of way. The HMP sets the standards to assure the long-term viability of former Fort Ord's biological resources in the context of base reuse so that no further mitigation should be necessary for impacts to species and habitats considered in the HMP. This plan has been approved by the Service; the HMP, deed restrictions, and Memoranda of Agreement between the Army and various land recipients, including the Board of Trustees of the California State University, provide the legal mechanism to assure HMP implementation. It is a legally binding document, and all recipients of former Fort Ord lands are required to abide by its management requirements and procedures.

The HMP anticipates some losses to HMP special-status species and HMP sensitive habitats as a result of redevelopment of the former Fort Ord. With the designated reserves and corridors and habitat management requirements in place, the losses of individuals of species and sensitive habitats considered in the HMP are not expected to jeopardize the long-term viability of those species, their populations, or sensitive habitats on former Fort Ord. Recipients of disposed land with restrictions or management guidelines designated by the HMP will be obligated to implement those specific measures through the HMP and through deed covenants.

The Coordinated Resource Management and Planning (CRMP) process is a multi-agency multi-jurisdictional land use planning effort developed under the sponsorship of the California CRMP Memorandum of Understanding (MOU). This MOU has been signed by 14 federal and state agencies, including the Bureau of Land Management (BLM), CDFW, Service, Monterey County, and University of California. The CRMP program provides a mechanism for public agencies to share resources to deliver the most efficient habitat protection and public services for the money expended.

However, the HMP does not provide specific authorization for incidental take of federal or state listed species to existing or future non-federal land recipients under the ESA or CESA. In compliance with the ESA and CESA, the Fort Ord Reuse Authority (FORA) is currently in the process of obtaining a Section 10(a)(1)(B) Incidental Take Permit from the Service and Section 2081 Incidental Take Permit from the CDFW, which will provide base-wide coverage for the take of federal and state listed wildlife and plant species to all non-federal entities receiving land on the former Fort Ord. This process involves the preparation of a Habitat Conservation Plan (HCP) and Implementing Agreement (IA). The Administrative Draft Fort Ord HCP (ICF International, Inc., 2017) and IA are currently in draft form and being reviewed by the resource agencies. The base-wide Incidental Take Permits are expected to be issued by the Service and CDFW in summer of 2019.

The entire Project site is located within designated “development” parcels under the HMP. Additionally, a portion of the campus, along the southeastern boundary of the East Campus Open Space parcel (Army parcel number S1.3.2), is designated in the HMP as having Borderlands requirements. Borderlands are designated development parcels or habitat reserve parcels at the urban/wildland interface where specific design considerations and management activities are required to minimize effects of development on HMP

species and natural communities. For the East Campus Open Space parcel, these activities include interim management activities, including but not limited to, the installation and maintenance of firebreaks and vehicle barriers where appropriate to separate developed and developing area from natural lands. To minimize the possibility of fire damage to the adjacent habitat reserve as well as structures on the development parcels, parking lots, greenbelts, or other nonflammable or fire-resistant land uses will be located as a buffer between the habitat reserve and development. Measures will also be taken to reduce potential for erosion in these parcels so as not to affect the adjacent habitat reserve from stormwater runoff that may originate in this parcel. This parcel is to be conserved and managed until development occurs. Non-native species (i.e., iceplant, scotch broom, and pampas grass) controls will also be in place to avoid spreading to the adjacent habitat reserve.

Parcels designated as “development” do not have management requirements relative to HMP species. However, the BO and HMP require the identification of sensitive biological resources within the development parcels that may be salvaged for use in restoration activities in reserve areas. In addition, the campus is required to implement the Borderlands requirements within the East Campus Open Space parcel.

#### *Habitat Conservation Plans or NCCP*

There are no adopted HCPs or Natural Community Conservation Plans (NCCP) associated with the Project site. Please refer to the discussion of the Draft HCP currently in progress in the Fort Ord Habitat Management Plan section above.

#### *Fort Ord Oak Woodland Conservation Requirements*

FORA is assisting the City of Seaside and Monterey County in preparing an Oak Woodland Conservation Area Map and an Oak Woodlands Management and Monitoring Plan on the former Fort Ord Property. The map and plan will address oak woodland areas in the City of Seaside and Monterey County, and has proposed including the use of CSUMB property to connect key oak woodland areas on Fort Ord. These agencies are obligated to comply with Oak Woodland Policy B-2 and Programs B-2.1 and B-2.2, which are described in the 1997 Base Reuse Plan (BRP) (EDAW and EMC 1996), and 2012 BRP Reassessment Report (FORA and EMC 2012).

CSUMB is involved in meeting with these agencies on the in-progress map and plan related to conservation areas that may ultimately be identified on the CSUMB campus (A. Spear, personal communication 2019).

## 4.0 RESULTS

### 4.1 Vegetation Types

The survey results include mapping and quantification of the acreage of five vegetation types within the Project site (**Figure 6**). Several areas were identified where these vegetation types intergrade with one another; these areas are identified as “mix” habitats and the dominant species from each of the two separate vegetation types are approximately evenly distributed throughout these areas. Additionally, some areas of the project site are developed. **Table 4-1** provides the acreages of these vegetation types and developed areas within the Project site and **Table 4-2** provides the acreages within the Near-Term Development sites. A brief description of each of these vegetation types and developed areas can be found below, along with a statement of the presence or potential presence of special-status species within each, and identification of whether the vegetation type is considered a sensitive habitat. In addition, each description identifies the *Manual of California Vegetation* (Sawyer et.al. 2009) vegetation type(s).

**Table 4-1. Vegetation Types within the Project Site<sup>1</sup>**

| Vegetation Types   | Total Area (Acres) |
|--|--------------------|
| <i>Coast Live Oak Woodland</i>                                       | 336.4              |
| <i>Ruderal/Disturbed</i>   | 327.6              |
| <b><i>Central Maritime Chaparral</i></b>                             | 74.9               |
| <b><i>Central Maritime Chaparral/Coast Live Oak Woodland Mix</i></b> | 46.3               |
| <i>Coast Live Oak Woodland/Non-Native Grassland Mix</i>              | 23.5               |
| <i>Non-Native Grassland</i>  | 33.9               |
| <i>Coast Live Oak Woodland/Central Coastal Scrub Mix</i>             | 10.4               |
| <i>Central Coastal Scrub</i>   | 8.6                |
| <i>Central Coastal Scrub/Non-Native Grassland Mix</i>                | 4.6                |
| <b><i>Central Maritime Chaparral/Central Coastal Scrub Mix</i></b>   | 3.1                |
| <i>Developed</i>   | 526.5              |
| <b>Total</b>   | <b>1,395.8</b>     |

<sup>1</sup> **Bold** indicates sensitive habitat addressed in the Fort Ord HMP.

**Table 4-2. Vegetation Types within Near-Term Development Component Sites and Staging Areas**

| Vegetation Types               | Student Housing Phase III (Acres) |            | Academic IV Building (Acres) |            | Student Recreation Center (Acres) |            | Student Housing Phase IIB (Acres) |            | Academic V Building (Acres) |          |
|--------------------------------|-----------------------------------|------------|------------------------------|------------|-----------------------------------|------------|-----------------------------------|------------|-----------------------------|----------|
|                                | Site                              | Staging    | Site                         | Staging    | Site                              | Staging    | Site                              | Staging    | Site                        | Staging  |
| <i>Coast Live Oak Woodland</i> | 0                                 | 0          | 0                            | 0          | 0                                 | 0.01       | 0                                 | 0          | 0                           | 0        |
| <i>Ruderal/Disturbed</i>       | 0                                 | 0.1        | 0.5                          | 0.9        | 2.5                               | 2.0        | 1.4                               | 0.2        | 0                           | 0        |
| <i>Developed</i>               | 4.1                               | 2.2        | 1.6                          | 1.0        | 2.9                               | 1.1        | 3.9                               | 1.7        | 2.7                         | 0        |
| <b>Total</b>                   | <b>4.1</b>                        | <b>2.3</b> | <b>2.1</b>                   | <b>1.9</b> | <b>5.4</b>                        | <b>3.1</b> | <b>5.3</b>                        | <b>1.9</b> | <b>2.7</b>                  | <b>0</b> |



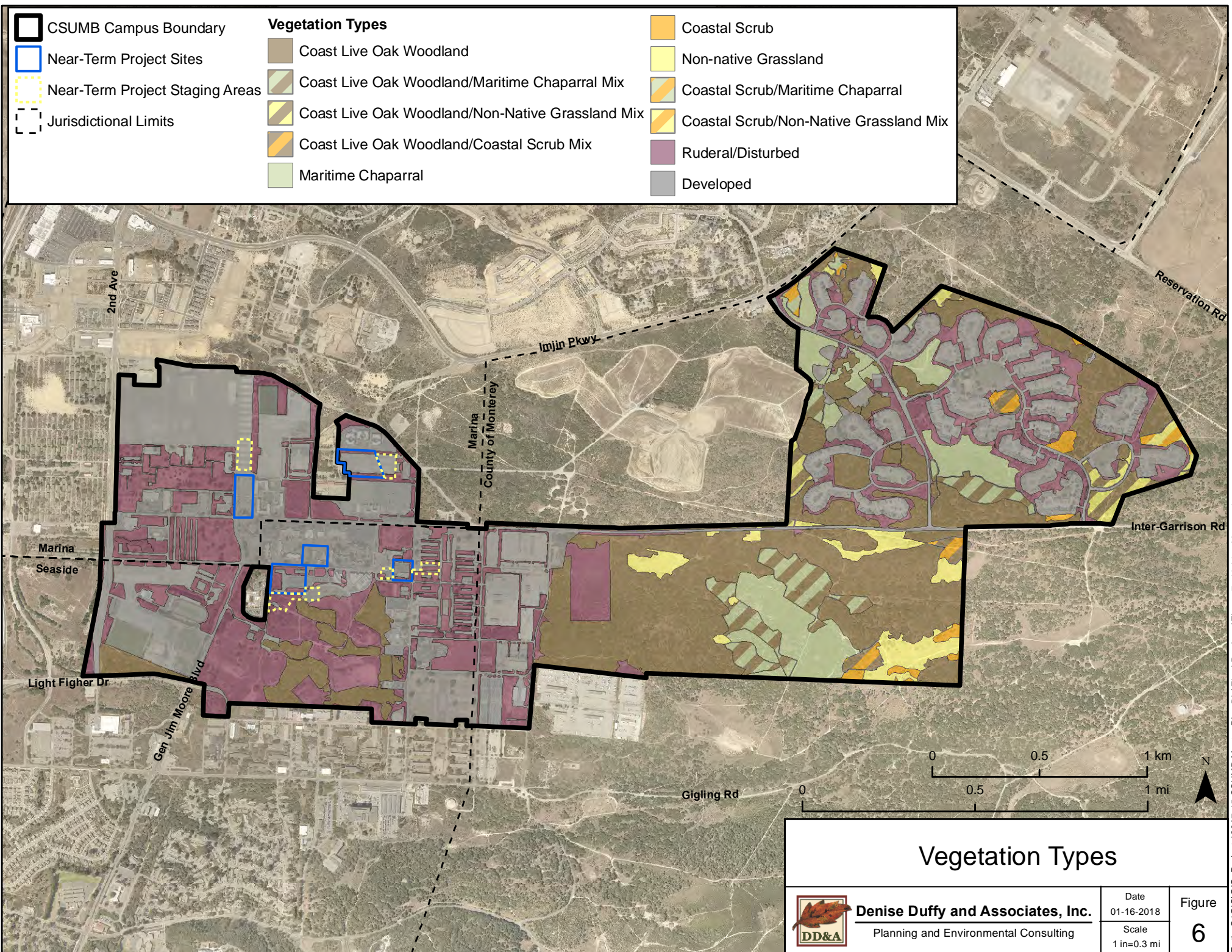

- CSUMB Campus Boundary
- Near-Term Project Sites
- Near-Term Project Staging Areas
- Jurisdictional Limits

- Vegetation Types**
- Coast Live Oak Woodland
  - Coast Live Oak Woodland/Maritime Chaparral Mix
  - Coast Live Oak Woodland/Non-Native Grassland Mix
  - Coast Live Oak Woodland/Coastal Scrub Mix
  - Maritime Chaparral
  - Coastal Scrub
  - Non-native Grassland
  - Coastal Scrub/Maritime Chaparral
  - Coastal Scrub/Non-Native Grassland Mix
  - Ruderal/Disturbed
  - Developed

## Vegetation Types

|   |                      |                    |
|---|----------------------|--------------------|
|  <b>Denise Duffy and Associates, Inc.</b><br>Planning and Environmental Consulting | Date<br>01-16-2018   | Figure<br><b>6</b> |
|   | Scale<br>1 in=0.3 mi |                    |

#### 4.1.1 Coast Live Oak Woodland

- **A Manual of California Vegetation classification:** coast live oak woodland (*Quercus agrifolia*/*Toxicodendron diversilobum*/grass association)

Coast live oak woodland is the dominant habitat type within the Project site (**Figure 6**). Coast live oak woodland is an open-canopied to nearly closed-canopied community with a grass or sparsely scattered shrub understory. Three coast live oak communities, each with different growth characteristics, understory associates, and canopy cover, have been recognized on the former Fort Ord: coastal coast live oak woodland, inland coast live oak woodland, and coast live oak savanna (ACOE, 1992). “Coastal” coast live oak woodland is the dominant vegetation type within the project site (**Figure 7**). The distinction of “coastal” is given based on the proximity of the coast live oak woodland to the coast. In coastal coast live oak woodland, coast live oaks grow in unprotected sites and are exposed to the combined stresses of strong winds, salt spray, and sterile, sandy soils, which are often referred to as “sand hills.” These environmental factors create an oak woodland characterized by short, wind-pruned trees that intergrades with the surrounding coastal scrub and maritime chaparral communities.

Oak woodlands within the project site are largely homogeneous, in species composition. Within the project site, the coast live oak (*Quercus agrifolia*) canopy is quite dense in many areas with an understory dominated by poison oak or, in some areas, invasive ice plant. Other plant species observed within the coast live oak woodland include hedge-nettle (*Stachys* sp.), slender wild oat (*Avena barbata*), sheep sorrel (*Rumex acetosella*), fiesta flower (*Pholistoma auritum*), and scattered shrubs such as fuchsia-flowered gooseberry (*Ribes speciosum*), California coffeeberry (*Frangula californica*), and sticky monkey flower (*Mimulus aurantiacus*).

In several areas, the coast live oak woodland intergrades with other vegetative communities, including maritime chaparral, coastal scrub, and non-native grassland. Where these vegetative communities comprise of approximately half of the dominant species, the areas have been mapped as coast live oak mixes (**Figure 7**). The dominant plant species and the common wildlife found in these mixed vegetation types are generally the same as those described for the individual vegetation types.

Coast live oak woodland is important habitat to many wildlife species. Oaks provide nesting sites for many avian species and cover for a variety of mammals, including mourning dove (*Zenaidura macroura*), American kestrel (*Falco sparverius*), California ground squirrel (*Spermophilus beecheyi*), and California pocket mouse (*Chaetodipus californicus*). Acorns provide an important food source for acorn woodpecker (*Melanerpes formicivorus*), western scrub jay (*Aphelocoma californica*), and black-tailed deer (*Odocoileus hemionus columbianus*). Other common wildlife species found in the coast live oak woodland are raccoon (*Procyon lotor*), Nuttall’s woodpecker (*Picoides nuttallii*), northern flicker (*Colaptes auratus*), bobcat (*Lynx rufus*), and coyote (*Canis latrans*). Generally, red-tailed hawks (*Buteo jamaicensis*) and great-horned owls (*Bubo virginianus*) nest and roost in the coast live oaks. Additional avian species that may be found within the oak woodland habitat are presented in **Appendix D**.

Special-status plant species were identified within some grassy openings of the coast live oak woodland habitat, mostly at the edges in transition areas with other habitats, within the area surveyed in 2016, including Monterey spineflower, Kellogg’s horkelia, sandmat manzanita, and Toro manzanita (**Figure 7**). Additional special-status plant species that may occur within the coast live oak woodland habitat, outside

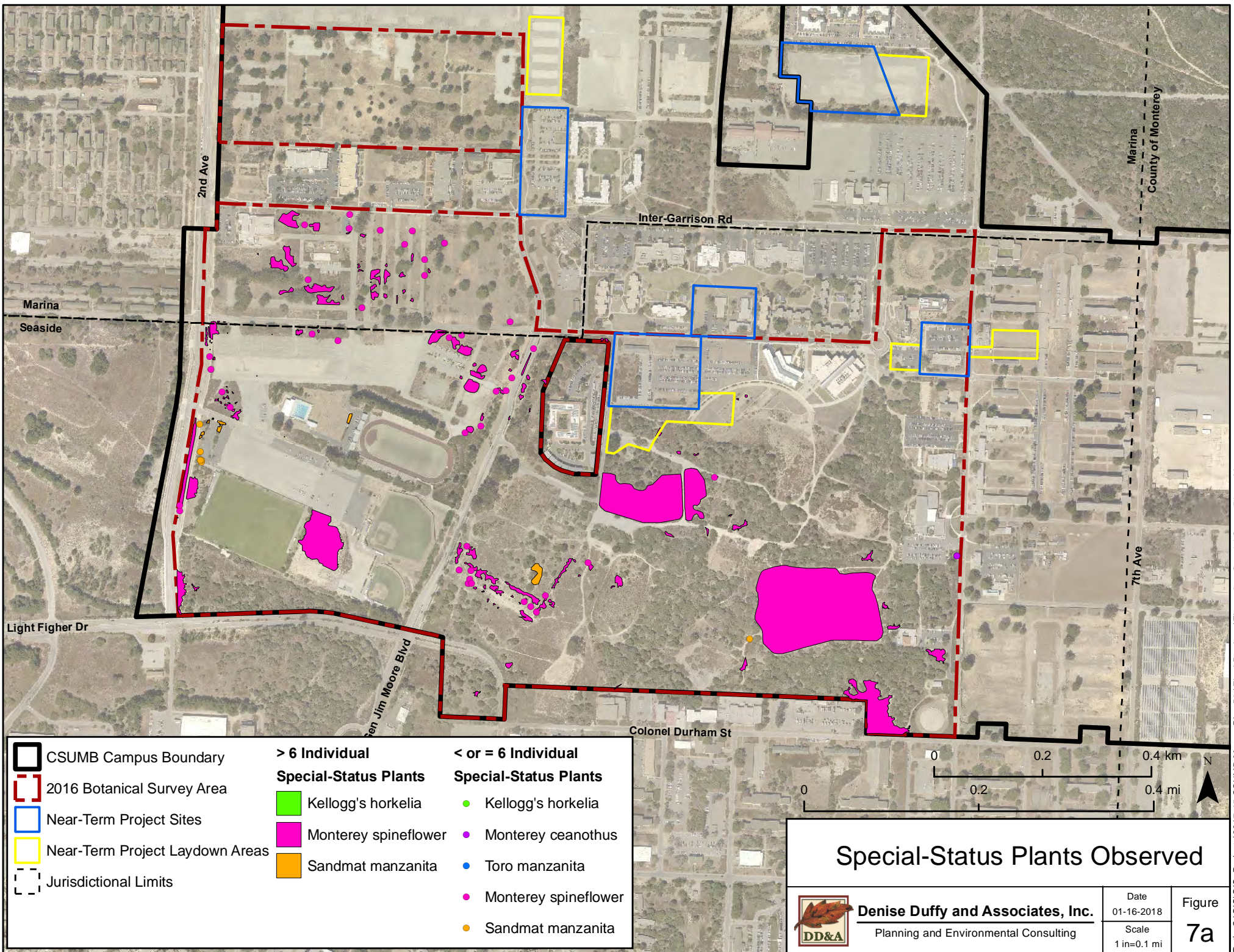

- CSUMB Campus Boundary
- 2016 Botanical Survey Area
- Near-Term Project Sites
- Near-Term Project Laydown Areas
- Jurisdictional Limits

- |  |   |
|--|---|
| <p><b>&gt; 6 Individual Special-Status Plants</b></p> <ul style="list-style-type: none"> <li> Kellogg's horkelia</li> <li> Monterey spineflower</li> <li> Sandmat manzanita</li> </ul> | <p><b>&lt; or = 6 Individual Special-Status Plants</b></p> <ul style="list-style-type: none"> <li> Kellogg's horkelia</li> <li> Monterey ceanothus</li> <li> Toro manzanita</li> <li> Monterey spineflower</li> <li> Sandmat manzanita</li> </ul> |
|--|---|



## Special-Status Plants Observed

|   |                      |                     |
|---|----------------------|---------------------|
| <b>Denise Duffy and Associates, Inc.</b><br>Planning and Environmental Consulting | Date<br>01-16-2018   | Figure<br><b>7a</b> |
|   | Scale<br>1 in=0.1 mi |                     |

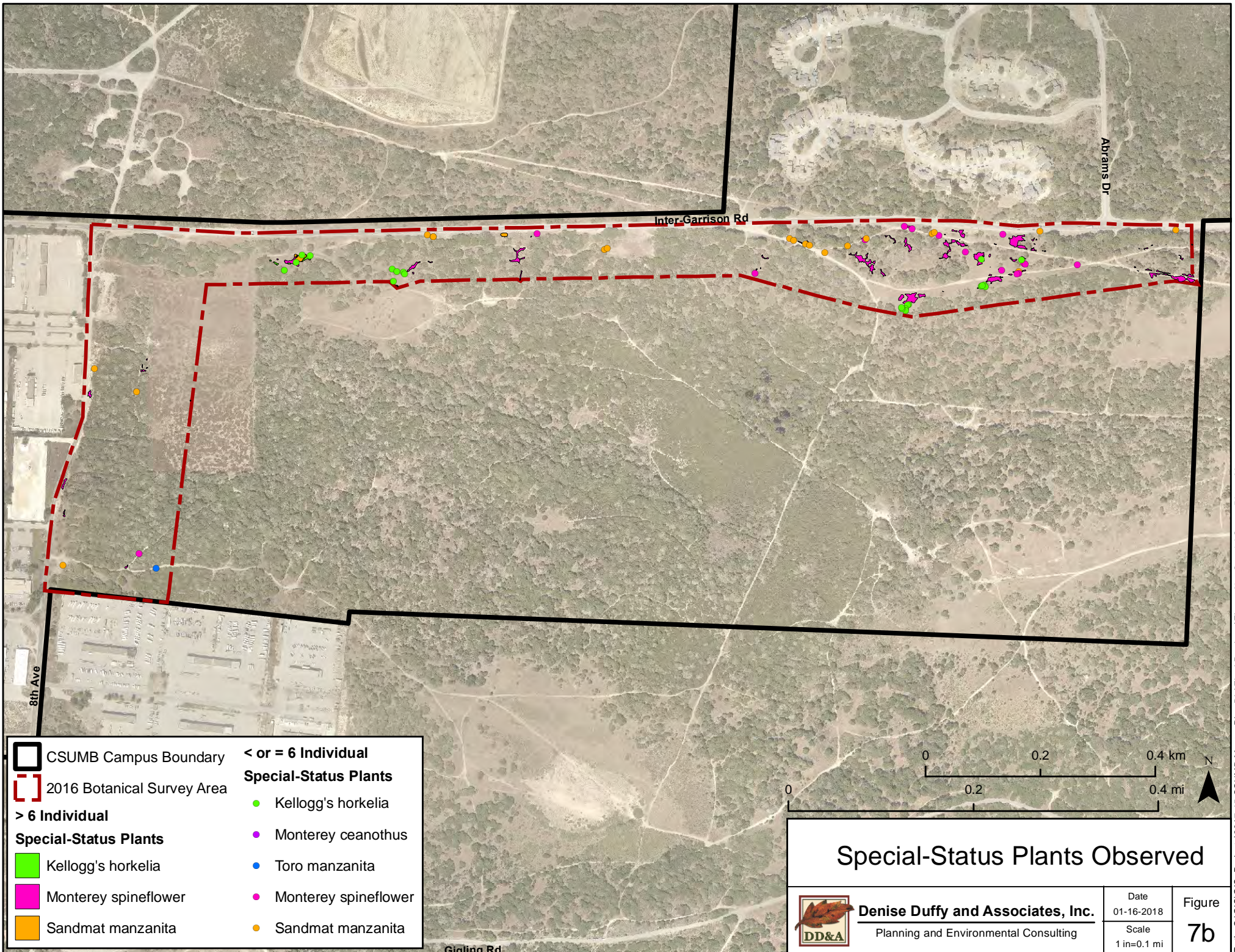

|  |                            |   |  |                      |
|--|----------------------------|---|--|----------------------|
|  | CSUMB Campus Boundary      | <b>&lt; or = 6 Individual Special-Status Plants</b> |  | Kellogg's horkelia   |
|  | 2016 Botanical Survey Area | <b>&gt; 6 Individual Special-Status Plants</b>      |  | Monterey ceanothus   |
|  |                            |   |  | Toro manzanita       |
|  |                            |   |  | Monterey spineflower |
|  |                            |   |  | Sandmat manzanita    |

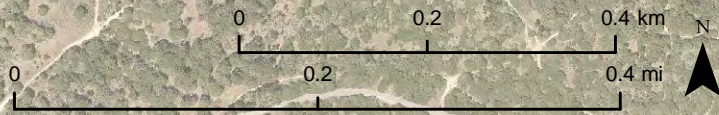

## Special-Status Plants Observed

|   |                      |                     |
|---|----------------------|---------------------|
| <b>Denise Duffy and Associates, Inc.</b><br>Planning and Environmental Consulting | Date<br>01-16-2018   | Figure<br><b>7b</b> |
|   | Scale<br>1 in=0.1 mi |                     |

of the area surveyed in 2016, include Hooker's manzanita, seaside bird's-beak, woodland woollythreads, and Santa Cruz clover.

No special-status wildlife species were observed within the coast live oak woodland habitat; however, the presence of several large woodrat nests indicates the presence of Monterey dusky-footed woodrats within the Project site. The Northern California legless lizard may use this habitat type for foraging and cover, and white-tailed kite, other raptors and protected avian species, and special-status bat species may nest or roost within the coast live oak trees. Figure B-18 in the HMP identifies this habitat type as potential habitat for the Monterey ornate shrew. Additionally, most of coast live oak woodland habitat within the Project site is within the known dispersal range of the CTS and may be used as upland aestivation and dispersal habitat for this species.

Oak woodlands are considered important natural communities because they provide a variety of ecological, aesthetic, and economical values. The extent of oak woodland in California has declined due to agricultural conversion, urban development, fuelwood harvesting, and grazing activities. Coast live oak woodland is not considered a sensitive habitat by CDFW (CDFW, 2010); however, as a native tree and habitat, impacts to coast live oak trees and woodland are typically addressed and mitigated under CEQA.

#### 4.1.2 Central Maritime Chaparral

- ***A Manual of California Vegetation classifications:*** brittle leaf-wooly leaf manzanita chaparral (*Arctostaphylos* [crustacea, tomentosa] shrubland alliance) and sandmat manzanita chaparral (*Arctostaphylos pumila* provisional shrubland alliance)

Central maritime chaparral within the Project site (**Figure 6**) is dominated by shaggy-barked manzanita, sandmat manzanita, dwarf ceanothus, coyote brush (*Baccharis pilularis*), chamise, and sticky monkey flower. Additional species within this habitat type include California coffeeberry, fuchsia-flowered gooseberry, chaparral currant (*Ribes malvaceum*), poison oak, black sage (*Salvia mellifera*), sticky cinquefoil (*Drymocallis glandulosa*), and creeping snowberry (*Symphoricarpos mollis*).

Common wildlife species that occur within central maritime chaparral habitat include California quail (*Callipepla californica*), California towhee (*Melospiza crissalis*), California thrasher (*Toxostoma redivivum*), common poorwill (*Phalaenoptilus nuttallii*), Anna's hummingbird (*Calypte anna*), wrentit (*Chamaea fasciata*), western scrub jay, northern pacific rattlesnake (*Crotalus oreganus* ssp. *oreganus*), coast range fence lizard (*Sceloporus occidentalis bocourtii*), gopher snake (*Pituophis catenifer catenifer*), coast gartersnake (*Thamnophis elegans terrestris*), and brush rabbit (*Sylvilagus bachmani*). Additional avian species that may be found within the central maritime chaparral habitat are presented in **Appendix D**.

No special-status plant species were observed within the maritime chaparral habitat within the area surveyed in 2016. However, special-status plant species that may occur or are assumed present within this habitat type outside of the surveyed area include: Hooker's manzanita, Toro manzanita, Pajaro manzanita, sandmat manzanita, Monterey ceanothus, Fort Ord spineflower, Monterey spineflower, seaside bird's-beak, Eastwood's goldenbush, sand-loving wallflower, sand gilia, Kellogg's horkelia, Northern curly-leaved monardella, Yadon's piperia, and Santa Cruz microseris.

No special-status wildlife species were observed within the central maritime chaparral habitat; however, the presence of several large woodrat nests distributed throughout this habitat type indicates the presence

of Monterey dusky-footed woodrats within the Project site. Northern California legless lizard and coast horned lizard may occur throughout this habitat type. Special-status raptor and bat species may also forage within this habitat type, including white-tailed kite, Townsend's big-eared bat, and hoary bat. Figure B-18 in the HMP also identifies this habitat type as potential habitat for the Monterey ornate shrew. Additionally, most of the central maritime chaparral within the project site is within the known dispersal range of the CTS and may be used as upland aestivation and dispersal habitat for this species.

#### 4.1.3 Central Coastal Scrub

- ***A Manual of California Vegetation classifications:*** coyote brush scrub (*Baccharis pilularis* shrubland alliance) and black sage scrub (*Salvia mellifera* shrubland alliance)

Holland (1986) describes central coastal scrub habitat as an area with dense shrubs, approximately one to two meters tall, which lacks grassy openings and is often integrated with other habitat types. Dominant shrub species in the central coastal scrub habitat within the Project site (**Figure 6**) include black sage, coyote brush, poison oak, sticky monkey flower, and coast sagebrush (*Artemisia californica*).

Central coastal scrub habitats provide cover and food for a number of wildlife species, including songbirds, snakes, lizards, rodents, and other small mammals. Common species that may occur within the central coastal scrub habitat include California quail, blue-gray gnatcatcher (*Polioptila caerulea*), Anna's hummingbird, coast range fence lizard, northern pacific rattlesnake, gopher snake, brush rabbit, and California ground squirrel. Additional avian species that may be found within the central coastal scrub habitat are presented in **Appendix D**.

Monterey spineflower and sandmat manzanita were identified within central coastal scrub habitat, within the area surveyed in 2016 (**Figure 7**). Additionally, special-status plant species that may occur or are assumed present within this habitat type, outside of the surveyed area, include: Hooker's manzanita, Toro manzanita, Monterey ceanothus, Fort Ord spineflower, seaside bird's-beak, Eastwood's goldenbush, sand-loving wallflower, sand gilia, Kellogg's horkelia, Point Reyes horkelia, Northern curly-leaved monardella, and Santa Cruz microseris.

No special-status wildlife species were observed within this habitat type; however, Northern California legless lizard and coast horned lizard may occur throughout the central coastal scrub on the Project site. Figure B-18 in the HMP also identifies this habitat type as potential habitat for the Monterey ornate shrew. Special-status raptor and bat species may also forage within this habitat type, including white-tailed kite, Townsend's big-eared bat, and hoary bat. The CTS may use the central coastal scrub as upland and dispersal habitat. Additionally, most of the central coastal scrub within the project site is within the known dispersal range of the CTS and may be used as upland aestivation and dispersal habitat for this species.

#### 4.1.4 Non-Native Grassland

- ***A Manual of California Vegetation classification:*** annual brome grasslands (*Bromus diandrus*-*Avena* spp. Association)

Throughout California, non-native grasslands typically occur in open areas of valleys and foothills, usually on fine-textured clay or loam soils that are somewhat poorly drained (Holland, 1986). Non-native grasslands are often dominated by non-native annual grasses and forbs along with scattered native grasses and wildflowers. The dominant species observed in this habitat within the Project site (**Figure 6**) include

slender oat, ripgut grass (*Bromus diandrus*), soft chess (*Bromus hordeaceus*), rat-tail fescue (*Festuca myuros*), slender wild oat (*Avena barbata*), and long-beaked filaree (*Erodium botrys*). Additional species found within this habitat include needlegrass (*Stipa* sp.), sky lupine (*Lupinus nanus*), California poppy (*Eschscholzia californica*), wedge-leaved horkelia (*Horkelia cuneata*), sheep sorrel, and telegraphweed (*Heterotheca grandiflora*).

Non-native grasslands provide habitat to a number of common wildlife species. Botta's pocket gopher (*Thomomys bottae*), California ground squirrel, American badger, and several rodent species use non-native grasslands for foraging and cover. Raptors are also known to forage in this habitat, including red-tailed hawk. Reptiles, such as northern pacific rattlesnake, gopher snake, and coast range fence lizard, are also common non-native grassland species. Avian species that may be found within the non-native grassland habitat include grasshopper sparrow (*Ammodramus savannarum*), savannah sparrow (*Passerculus sandwichensis*), western kingbird (*Tyrannus verticalis*), and red-tailed hawk. Additional avian species are presented in **Appendix D**.

Monterey spineflower, Kellogg's horkelia, and sandmat manzanita were identified within non-native grassland habitat, within the area surveyed in 2016 (**Figure 7**). Additionally, special-status plant species that may occur or are assumed present within this habitat type, outside of the surveyed area, include: Point Reyes horkelia, woodland woollythreads, Santa Cruz microseris, Santa Cruz clover, and Pacific Grove clover.

No special-status wildlife was observed within the non-native grassland during field visits. However, special-status raptor and bat species may forage within this habitat type, including white-tailed kite, Townsend's big-eared bat, and hoary bat. Additionally, burrowing owl and California horned lark may nest and forage within the non-native grassland habitat. The American badger and Northern California legless lizard may use this habitat type for foraging and cover while coast horned lizard may utilize open, sandy areas within the non-native grassland for basking. Figure B-18 in the HMP also identifies this habitat type as potential habitat for the Monterey ornate shrew. Additionally, most of the non-native grassland within the project site is within the known dispersal range of the CTS and may be used as upland aestivation and dispersal habitat for this species.

#### 4.1.5 Ruderal/Disturbed

- ***A Manual of California Vegetation classification:*** none

Ruderal, disturbed areas are those areas which have been disturbed by human activities and are dominated by non-native annual grasses and other "weedy" species. Ruderal areas within the project site includes areas around the developed areas that are regularly disturbed and other areas of historic disturbance (**Figure 6**). The ruderal areas include vegetation dominated by hottentot fig, ripgut grass, slender oat, cut-leaved plantain (*Plantago coronopus*), English plantain (*P. lanceolata*), sand mat (*Cardionema ramosissimum*), long-beaked filaree, and telegraphweed.

Common wildlife species which do well in urbanized and disturbed areas can utilize this habitat, such as the American crow (*Corvus brachyrhynchos*), California ground squirrel, raccoon, striped skunk (*Mephitis mephitis*), western scrub jay, European starling (*Sturnus vulgaris*), coast range fence lizard, and rock pigeon (*Columba livia*). This habitat type is considered to have low biological value, as it generally dominated by

non-native plant species and consists of relatively low-quality habitat from a wildlife perspective. Additional avian species are presented in **Appendix D**.

Two special-status plant species were observed within ruderal habitat in the area surveyed in 2016: Monterey spineflower and sandmat manzanita (**Figure 7**). Additionally, special-status plant species that may occur or are assumed present within this habitat type, outside of the surveyed area, include: Monterey spineflower, sandmat manzanita, Monterey ceanothus, Eastwood's goldenbush, sand-loving wallflower, sand gilia, Kellogg's horkelia, woodland woollythreads, and Yadon's piperia.

No special-status wildlife species were observed within the ruderal areas; however, some special-status wildlife species may occur. Coast horned lizards often occupy open, sandy areas and may be present within this habitat type. The presence of shrubs throughout may provide habitat for the Northern California legless lizard. American badgers may also forage within portions of this habitat type in proximity to more commonly used habitat types, such as non-native grassland. A portion of the ruderal areas within the project site is also within the known dispersal range of the CTS and may be used as upland aestivation and dispersal habitat for this species.

#### 4.1.6 Developed

- ***A Manual of California Vegetation classification:*** none

Developed areas comprise the majority of the project site (**Figure 6**). These areas include paved roads and parking lots, structures, and landscaping. Very little natural vegetation is present within these areas and they are considered to have little biological value. However, some common wildlife species that do well in urbanized areas may be found foraging within the developed areas, including American crow, California ground squirrel, raccoon, striped skunk, western scrub jay, European starling, and rock pigeon.

No special-status plant species were identified within the developed areas within the areas surveyed in 2016 and none are expected to occur within developed areas outside of the survey area.

No special-status wildlife species were observed within the developed areas of the Project; however, raptors, other migratory birds, and Townsend's big-eared bat may nest/roost within the abandoned buildings or mature trees within the developed areas.

## 4.2 Special-Status Species

Published occurrence data within the Project area and surrounding USGS Quads were evaluated to compile a table of special-status species known to occur in the vicinity of the Project site (please refer to **Section 3 "Methods"** and **Appendix A**). Each of these species was evaluated for their likelihood to occur within and immediately adjacent to the Project site (**Appendix A**).<sup>9</sup> The special-status species that are known to or have been determined to have a moderate or high potential to occur within or immediately adjacent the Project site are discussed below. All other species presented in **Appendix A** are assumed "unlikely to occur" or have a low potential to occur but are unlikely to be impacted for the species-specific reasons presented. Please note that only those species that are known or have a moderate or high potential to occur within the proposed Project site are discussed in the impacts and mitigation section of this document.

<sup>9</sup> Please see **Appendix A** for the evaluation standards for the potential for species to occur.



4.2.1 Special-Status Wildlife Species

The Project site and adjacent areas were evaluated for the presence or potential presence of a variety of special-status wildlife species (**Appendix A**). The following species are discussed due to their moderate or high potential to occur or known presence within the Project site and potential to be impacted by the Project. **Table 4-2** summarizes the potential for these species to occur within the Project site. Although the likelihood for CRLF to occur within the Project site is unlikely, a discussion of this species is included below as this is a federally listed species that is known to occur in other portions of the former Fort Ord.

**Table 4-2. Potential for Special-Status Wildlife Species Presence within the Project Site**

| Species   | Potential Occurrence within Project Site | Potential Occurrence within Near-Term Development Sites |                      |                           |                           |                     |
|---|--|---|----------------------|---------------------------|---------------------------|---------------------|
|   |  | Student Housing Phase III                               | Academic IV Building | Student Recreation Center | Student Housing Phase IIB | Academic V Building |
| Townsend’s big-eared bat  | Moderate                                 | Unlikely  | Moderate             | Moderate                  | Moderate                  | Unlikely            |
| Hoary bat   | Moderate                                 | Unlikely  | Unlikely             | Moderate                  | Moderate                  | Unlikely            |
| Monterey dusky-footed woodrat                                     | Present                                  | Unlikely  | Unlikely             | Moderate                  | Unlikely                  | Unlikely            |
| <b>Monterey ornate shrew</b>                                      | High                                     | Unlikely  | Unlikely             | Unlikely                  | Unlikely                  | Unlikely            |
| American badger   | High                                     | Unlikely  | Unlikely             | Unlikely                  | Unlikely                  | Unlikely            |
| <b>California tiger salamander</b>                                | Present                                  | Unlikely  | Unlikely             | Unlikely                  | Unlikely                  | Unlikely            |
| <b>Northern California legless lizard</b>                         | High                                     | Moderate  | Moderate             | Moderate                  | Moderate                  | Unlikely            |
| Coast horned lizard   | High                                     | Low   | Low                  | Low                       | Low                       | Unlikely            |
| <b>California red-legged frog</b>                                 | Unlikely                                 | Unlikely  | Unlikely             | Unlikely                  | Unlikely                  | Unlikely            |
| <b>Smith’s blue butterfly</b>                                     | Moderate                                 | Not Present   | Moderate             | Not Present               | Not Present               | Not Present         |
| Obscure bumble bee  | Moderate                                 | Unlikely  | Unlikely             | Unlikely                  | Unlikely                  | Unlikely            |
| Western bumble bee  | Moderate                                 | Unlikely  | Unlikely             | Unlikely                  | Unlikely                  | Unlikely            |
| Burrowing owl   | Moderate                                 | Unlikely  | Unlikely             | Unlikely                  | Unlikely                  | Unlikely            |
| Nesting Raptors, Migratory Birds, & Other Protected Avian Species | Moderate - High                          | Moderate  | Moderate             | Moderate                  | Moderate                  | Moderate            |

<sup>3</sup> **Bold** indicates Fort Ord HMP Species.

*Special-Status Bat Species*

Special-status bat species with the potential to occur in the vicinity that use oak woodland, central coastal scrub, and central maritime chaparral habitats and abandoned buildings as either maternity, migratory, or foraging roosts include the Townsends’s big-eared bat and hoary bat.

These species may utilize some of the coast live oak trees within the Project site for night roosts and may forage over all undeveloped areas of the Project site. Any abandoned buildings within the Project site may also provide day roost or maternity roost habitat for Townsends’s big-eared bat. Special-status bat species have a moderate potential to occur within these areas at the Project site.

*Monterey Dusky-Footed Woodrat*

The Monterey dusky-footed woodrat is a CDFW species of special concern. This is a subspecies of the dusky-footed woodrat (*Neotoma macrotis*), which is common to oak woodlands and other forest types throughout California. Dusky-footed woodrats are frequently found in forest habitats with moderate canopy cover and a moderate to dense understory, including riparian forests; however, they may also be found in

chaparral communities. Relatively large nests are constructed of grass, leaves, sticks, and feathers and are built in protected spots, such as rocky outcrops or dense brambles of blackberry and/or poison oak. Typical food sources for this species include leaves, flowers, nuts, berries, and truffles. Dusky-footed woodrats may be a significant food source for small- to medium-sized predators. Populations of this species may be limited by the availability of nest material. Within suitable habitat, nests are often found in close proximity to each other.

The CNDDDB does not report any occurrences of Monterey dusky-footed woodrat within the seven quadrangles reviewed. However, this species is known to occur throughout the former Fort Ord and woodrat nests were observed within the Project site during field surveys. Therefore, the Monterey dusky-footed woodrat is assumed present within suitable habitat areas.

#### *Monterey Ornate Shrew*

The Monterey ornate shrew, also known as the Salinas ornate shrew, is a CDFW species of special concern and HMP species. In general, this shrew is common in the southern two-thirds of California west of the Sierra Nevada, from Mendocino to Butte counties, south to the Mexican border. It occupies a variety of mostly moist or riparian woodland habitats and also occurs within chaparral, grassland, and emergent wetland habitats where there is thick duff or downed logs. The breeding season is long; while most pregnancies occur in March and April, they may occur from February through October. The litter size is about six and females may have more than one litter per year. Most individuals do not live to breed a second year. Foraging occurs under logs rocks and leaf litter, and prey items are mostly insects and some other invertebrates.

The CNDDDB does not report any occurrences of the Monterey ornate shrew within the seven quadrangles reviewed; however, Figure B-18 in the HMP identifies the project site as containing potential habitat for this species (ACOE, 1997). As with most shrews, little is known about their ecology since they are hard to locate and do not survive well in traps due to very high metabolic rates. However, field surveys on the UC Fort Ord Natural Reserve found that habitats within the Project site (e.g., non-native grassland, coast live oak woodland, central coastal scrub, central maritime chaparral, riparian, and mixes of these habitats) are likely considered suitable habitat for the shrew. Therefore, there is a high potential for the Monterey ornate shrew to occur within these habitats in the project site.

#### *American Badger*

The American badger is a CDFW species of special concern. Badgers occupy a diversity of habitats within California. The principal requirements seem to be sufficient food, friable soils, and relatively open, uncultivated grounds. Grasslands, savannas, and mountain meadows near timberline are preferred. Badgers feed primarily of burrowing rodents, such as gophers, squirrels, mice, and kangaroo rats, as well as some insects and reptiles. Badgers also break open beehives to eat both the brood and honey. They are active all year long and are nocturnal and diurnal. Mating occurs in summer and early fall and two to five young are born in burrows dug in relatively dry, often sandy soil, usually with sparse overstory cover.

The CNDDDB reports eight occurrences of American badger within the seven quadrangles reviewed, the nearest of which located within the eastern portion of the project site, near Inter-Garrison Road. Additionally, this species is known to occur throughout the former Fort Ord. Suitable habitat is present

within the non-native grassland, central maritime chaparral/non-native grassland mix, and central coastal scrub/non-native grassland mix, and within ruderal habitat in close proximity to the aforementioned more commonly used habitats within the project site. As such, the American badger has a high potential to occur within suitable habitat areas.

### *California Tiger Salamander*

The CTS was listed as a federally threatened species on August 4, 2004 (69 FR 47211-47248). Critical habitat was designated for CTS on August 23, 2005 (70 FR 49379-49458), and went into effect on September 22, 2005. Additionally, CTS was listed as a state threatened species on March 3, 2010.

The CTS is a large, stocky salamander most commonly found in annual grassland habitat, but also occurring in the grassy understory of valley-foothill hardwood and chaparral habitats, and uncommonly along stream courses in valley-foothill riparian habitats (Service, 2004). Adults spend most of their lives underground, typically in burrows of ground squirrels and other animals (Service, 2004). The CTS has been eliminated from an estimated 55 percent of its documented historic breeding sites. Currently, about 150 known populations of CTS remain. The CTS persists in disjunct remnant vernal pool complexes in Sonoma County and Santa Barbara County, in vernal pool complexes and isolated stockponds scattered along a narrow strip of rangeland on the fringes of the Central Valley from southern Colusa County south to northern Kern County, and in sag ponds and human-maintained stockponds in the coast ranges from the San Francisco Bay Area south to the Temblor Range.

Above-ground migratory and breeding activity may occur under suitable environmental conditions from mid-October through May. Adults may travel long distances between upland and breeding sites; adults have been found more than two kilometers (1.24 miles) from breeding sites (Service, 2004). Breeding occurs from November to February, following relatively warm rains (Stebbins, 2003). The CTS breeds and lays eggs primarily in vernal pools and other temporary rainwater ponds. Permanent human-made ponds are sometimes utilized if predatory fishes are absent; streams are rarely used for reproduction. Eggs are laid singly or in clumps on both submerged and emergent vegetation and on submerged debris in shallow water (Stebbins, 1972; Jennings and Hayes, 1994). Males typically spend 6-8 weeks at breeding ponds, while females typically spend only 1-2 weeks (Loredo et al., 1996). Eggs hatch within 10-14 days (Service, 2004) and a minimum of 10 weeks is required to complete development through metamorphosis (Jennings and Hayes, 1994), although the larval stage may last up to six months and some larvae in Contra Costa and Alameda Counties may remain in their breeding sites over the summer (Service, 2004).

The project site is not located within designated critical habitat for CTS. The CNDDDB reports 49 occurrences of CTS within the seven quadrangles evaluated, 25 of which occur within the former Fort Ord. Extensive surveys have been conducted within the former Fort Ord to determine the aquatic resources that are known or have the potential to be occupied by CTS (**Figure 8**). No potential or known CTS breeding (aquatic) habitat is present within the Project site. The nearest known CTS-occupied pond is 0.4 mile (0.6 km) from the project site (Pond 101 East).

The Service considers suitable upland aestivation habitat within two kilometers of known or potential breeding locations for CTS as occupied habitat unless protocol-level surveys are conducted with negative results pursuant to the *Interim Guidance on Site Assessment and Field Surveys for Determining Presence or a Negative Finding of the California Tiger Salamander* (Service and CDFW, 2003). Portions of the

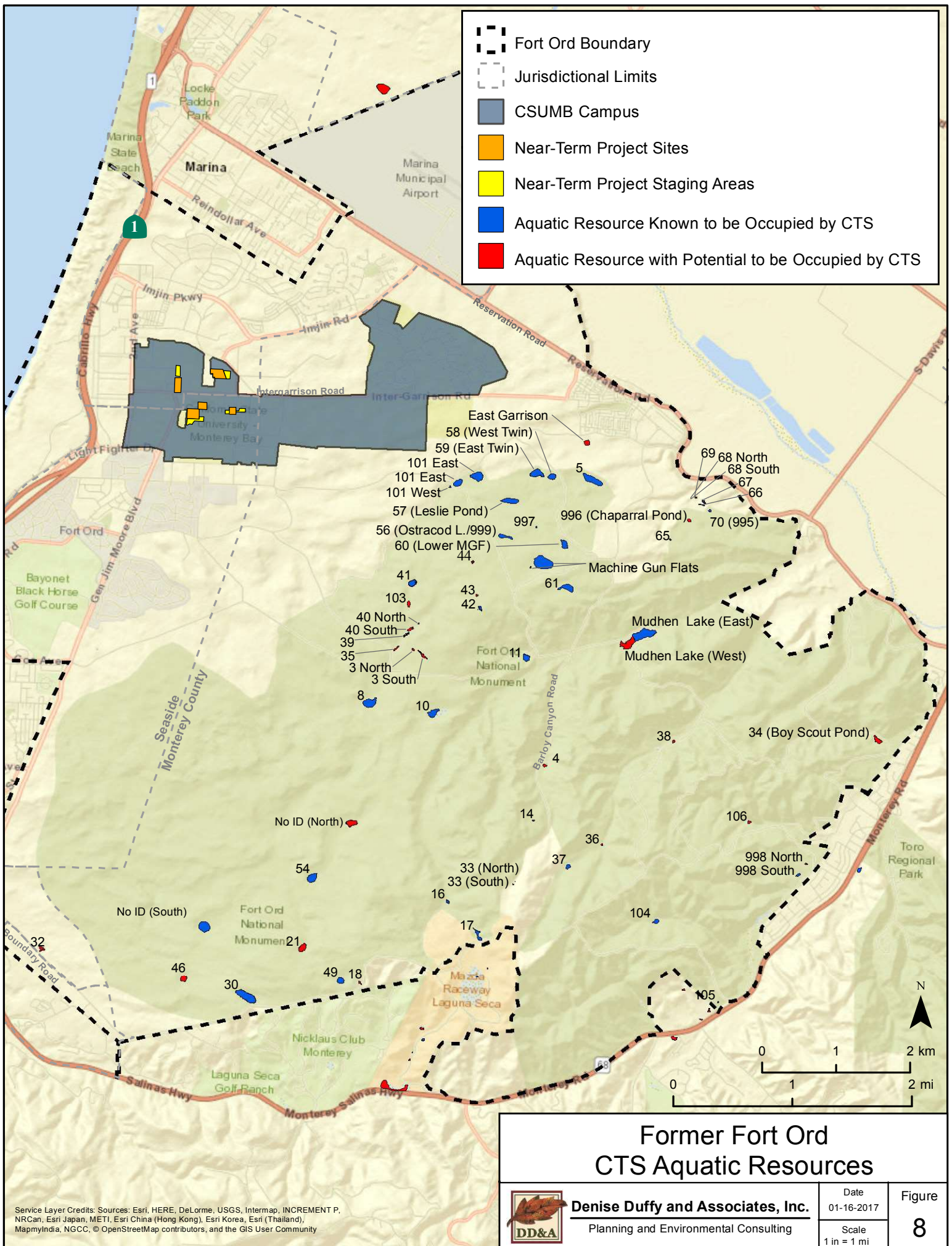

Project site are within two kilometers of several aquatic resources known or with the potential to be occupied by CTS. **Figure 9** and **Table 4-3** present the area of habitats within the Project site assumed by the Service as occupied by CTS in the absence of protocol-level surveys. Please note that areas designated as “developed” are not included in these calculations as it is assumed these areas do not provide CTS upland habitat.

The CDFW uses a four-zone methodology to determine the relative impact of a project to CTS. The zones are as follows:

- Zone 1: 380 meters (0.24 mile) –the distance that greater than 50% of dispersing CTS adults and approximately 50% of dispersing CTS sub-adults will travel from the breeding pond;
- Zone 2: 630 meters (0.39 mile) – the distance within which greater than 95% of dispersing CTS are found;
- Zone 3: 1 km (0.62 mile) – the distance that ongoing studies have shown that adults and juveniles routinely move; and
- Zone 4: 2.2 km (1.3 miles) – the greatest distance adults have been found to move from a breeding site.





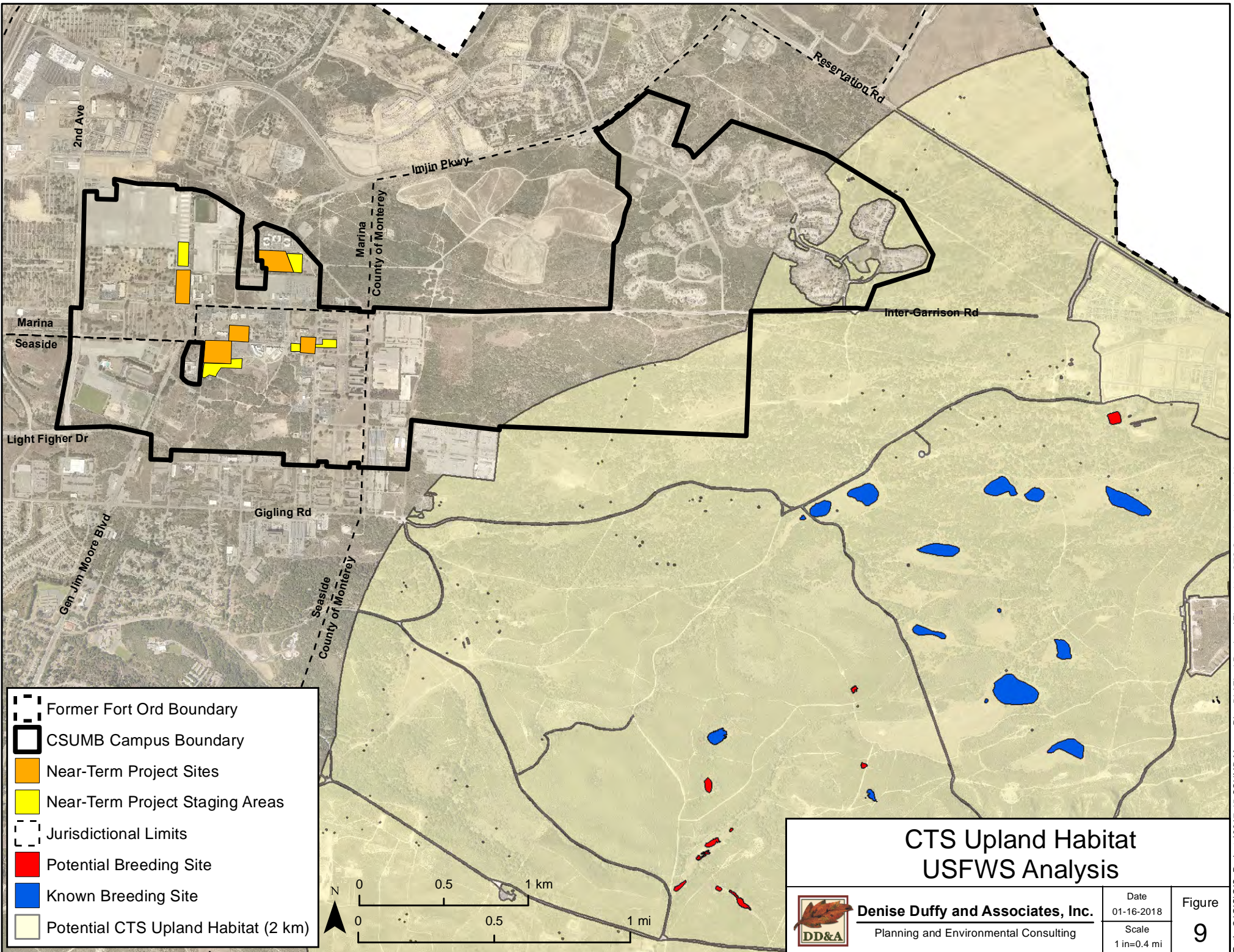

Portions of the Project site fall within the Zone 2, Zone 3, and Zone 4 distances from aquatic resources known or with the potential to be occupied by CTS. **Figure 10** and **Table 4-3** present the area of habitats within the Project site that fall within these zones. Please note that areas designated as “developed” are not included in these calculations as it is assumed these areas do not provide CTS upland habitat. Additionally, none of the Near-Term Development sites fall within potential CTS Habitat.

**Table 4-3. Area of Potential CTS Habitat within the Project Site**

| <b>Habitat</b>   | <i>Service<br/>(2km)</i> | <i>DFW Zone 2<br/>(630 m)</i> | <i>DFW Zone 3<br/>(1km)</i> | <i>DFW Zone 4<br/>(2.2km)</i> |
|--|--------------------------|-------------------------------|-----------------------------|-------------------------------|
| <i>Coast Live Oak Woodland</i>                                     | 89.1                     | 0.9                           | 19.4                        | 236.1                         |
| <i>Central Maritime Chaparral</i>                                  | 31.6                     | 0                             | 0                           | 65.4                          |
| <i>Central Coastal Scrub</i>                                       | 7.8                      | 0                             | 4.8                         | 3.1                           |
| <i>Non-native Grassland</i>  | 18.0                     | 0                             | 14.4                        | 18.0                          |
| <i>Central Coastal Scrub/<br/>Non-Native Grassland Mix</i>         | 4.5                      | 0                             | 0                           | 4.5                           |
| <i>Central Maritime Chaparral/<br/>Coast Live Oak Woodland Mix</i> | 19.9                     | 0                             | 0                           | 45.8                          |
| <i>Central Coastal Scrub/<br/>Coast Live Oak Woodland Mix</i>      | 5.1                      | 0                             | 2.7                         | 7.5                           |
| <i>Non-Native Grassland/<br/>Coast Live Oak Woodland Mix</i>       | 11.9                     | 0                             | 0                           | 18.2                          |
| <i>Ruderal</i>   | 10.5                     | 0                             | 0                           | 35.9                          |
| <b>Total</b>   | <b>198.4</b>             | <b>0.9</b>                    | <b>41.3</b>                 | <b>434.5</b>                  |

In addition to the potential CTS upland habitat within the Project site, DD&A biologists encountered an individual CTS within the compound used for the Army’s Munitions and Explosives of Concern (MEC) remediation project, located immediately adjacent to the Project site (ITSI Gilbane Company, 2014). In the absence of protocol-level surveys, it is assumed that CTS are present within suitable upland habitat within the Project site.



-  Former Fort Ord Boundary
-  CSUMB Campus Boundary
-  Near-Term Project Sites
-  Near-Term Project Staging Areas
-  Jurisdictional Limits
-  Potential Breeding Site
-  Known Breeding Site
-  Potential CTS Upland Habitat (2 km)

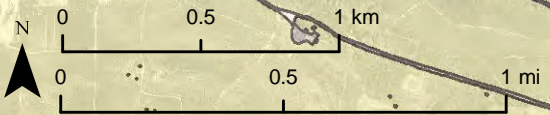

## CTS Upland Habitat USFWS Analysis

|   |                      |                    |
|---|----------------------|--------------------|
|  <b>Denise Duffy and Associates, Inc.</b><br>Planning and Environmental Consulting | Date<br>01-16-2018   | Figure<br><b>9</b> |
|   | Scale<br>1 in=0.4 mi |                    |

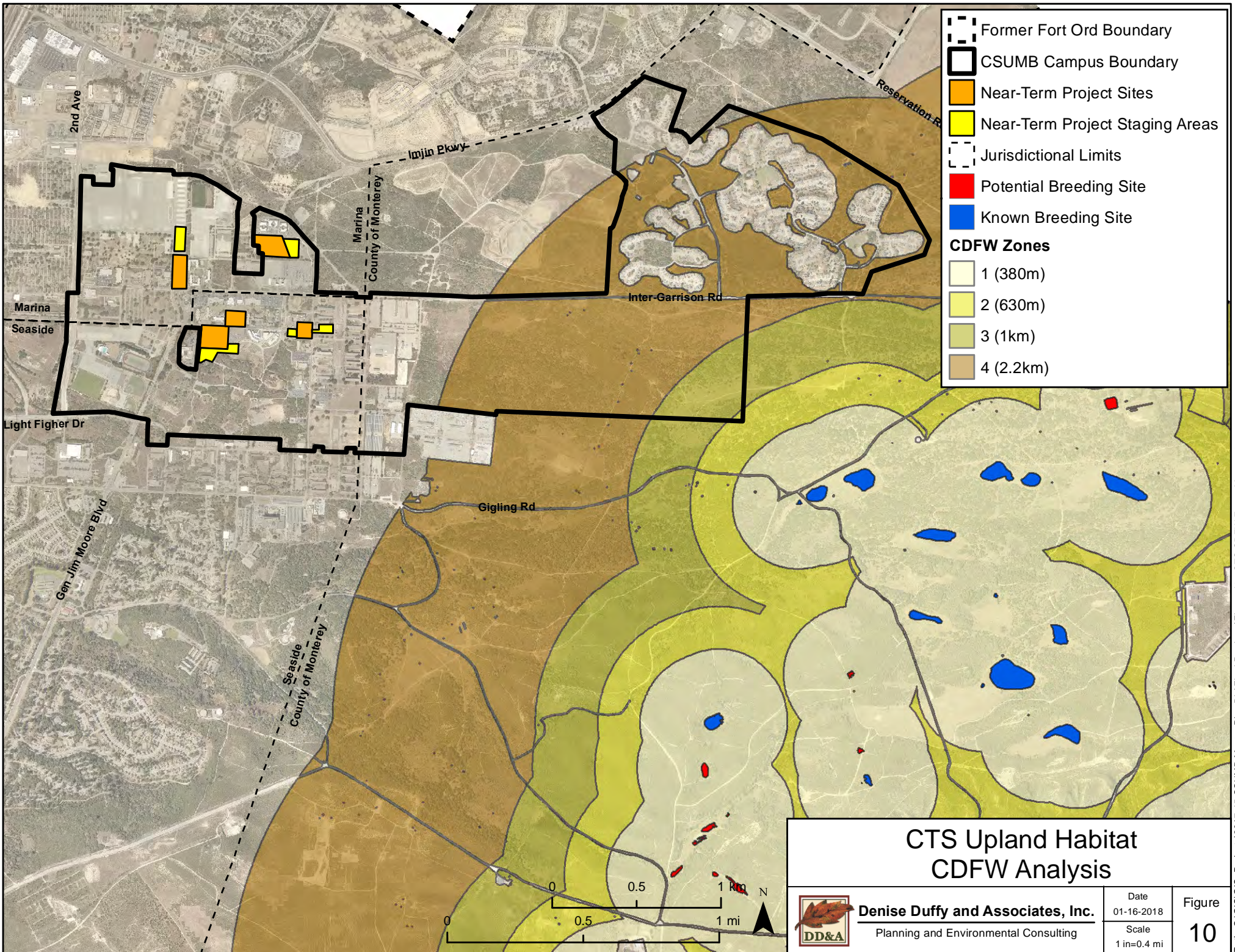

## CTS Upland Habitat CDFW Analysis



**Denise Duffy and Associates, Inc.**  
Planning and Environmental Consulting

|       |             |
|-------|-------------|
| Date  | 01-16-2018  |
| Scale | 1 in=0.4 mi |

Figure  
**10**

### *Northern California Legless Lizard*

The Northern California legless lizard is a CDFW species of special concern, as well as an HMP species.<sup>10</sup> This fossorial (burrowing) species typically inhabits sandy or loose (friable) soils. Habitats known to support Northern California legless lizard include (but are not limited to) coastal dunes, valley and foothill grasslands, chaparral, and coastal scrub at elevations from near sea level to approximately 1,800 meters (6,000 feet). The Northern California legless lizard forages on invertebrates beneath the leaf litter or duff layer at the base of bushes and trees or under wood, rocks, and slash in appropriate habitats. The diet of this species likely overlaps to some extent with that of juvenile alligator lizards and perhaps some other salamanders. This species may be preyed upon by alligator lizards, snakes, birds, and small mammals. Little is known about the specific habitat requirements for courtship and breeding; however, the mating season for this species is believed to begin late spring or early summer, with one to four live young born between September and November.

The CNDDDB reports 38 occurrences of Northern California legless lizard within the seven quadrangles reviewed, including one occurrence that includes the northeastern portion of the Project site. An additional CNDDDB occurrence is located immediately north of the western portion of the Project site. Suitable habitat for Northern California legless lizard is present throughout all undeveloped areas of the Project site where appropriate cover conditions occur. Therefore, the Northern California legless lizard has a high potential to occur within the project site.

### *Coast Horned Lizard*

The coast horned lizard is a CDFW species of special concern. Horned lizards occur in valley-foothill hardwood, conifer, and riparian habitats, as well as in pine-cypress, juniper, chaparral, and annual grass habitats. This species generally inhabits open country, especially sandy areas, washes, flood plains, and wind-blown deposits in a wide variety of habitats. Coast horned lizards rely on camouflage for protection and will often lay motionless when approached. Horned lizards often bask in the early morning on the ground or on elevated objects such as low boulders or rocks. Predators and extreme heat are avoided by burrowing into loose soil. Periods of inactivity and winter hibernation are spent burrowed into the soil or under surface objects. Little is known about the habitat requirements for breeding and egg-laying of this species. Prey species include ants, beetles, wasps, grasshoppers, flies, and caterpillars.

The CNDDDB reports five occurrences of the coast horned lizard within the seven quadrangles reviewed, one occurrence within the northeastern portion of the Project site. Additionally, this species has been observed throughout Fort Ord by DD&A biologists. Suitable habitat for this species is present within the Project site within the central maritime chaparral and central coastal scrub habitats, including the mixed

---

<sup>10</sup> The HMP identifies this species as black-legless lizard (*Anniella pulchra* ssp. *nigra*) in order to differentiate it from the previously identified silvery-legless lizard (*A. p.* ssp. *pulchra*). These subspecies are based primarily on phenotypic differences (black-legless lizard being much darker, having fewer scales on the back, and a relatively shorter tail) and very limited genetic work. Further, the range of the black-legless lizard has historically been classified as “restricted to coastal and interior dune sand other areas of sandy soils in the vicinity of Monterey Bay and the Monterey Peninsula” (Service, 1998), while the range of silvery-legless lizard has been classified as widespread throughout central California (Parham and Papenfuss, 2008). However, recent genetic studies have revealed five lineages of this species that correspond with different geographic areas of California (Parham and Papenfuss, 2008). These studies do not, however, identify the legless lizards occurring on the coast of Monterey Bay (i.e. the currently designated black-legless lizard) as a separate lineage. Currently, CDFW identifies both subspecies as the Northern California legless lizard and this document, therefore, follows the current regulatory identification.



habitats, and may utilize open sandy areas of the non-native grassland and ruderal habitats. Therefore, there is a high potential for the coast horned lizard to occur within these habitats within the Project site.

### *California Red-Legged Frog*

The CRLF was listed as a federally threatened species on June 24, 1996 (61 FR 25813-25833) and is also a CDFW species of special concern. Critical habitat was designated for CRLF on April 13, 2006 (71 FR 19244-19346) and revised on March 17, 2010 (75 FR 12816-12959). The revised critical habitat went into effect on April 16, 2010.

The CRLF is the largest native frog in California (44-131 mm snout-vent length) and was historically widely distributed in the central and southern portions of the state (Jennings & Hayes, 1994). Adults generally inhabit aquatic habitats with riparian vegetation, overhanging banks, or plunge pools for cover, especially during the breeding season (Jennings and Hayes, 1988). They may take refuge in small mammal burrows, leaf litter, or other moist areas during periods of inactivity or to avoid desiccation (Rathbun, et al., 1993; Jennings and Hayes, 1994). Radiotelemetry data indicates that adults engage in straight-line breeding season movements irrespective of riparian corridors or topography and they may move up to two miles between non-breeding and breeding sites (Bulger et. al., 2003). During the non-breeding season, a wider variety of aquatic habitats are used including small pools in coastal streams, springs, water traps, and other ephemeral water bodies (Service, 1996). CRLF may also move up to 300 feet from aquatic habitats into surrounding uplands, especially following rains, where individuals may spend days or weeks (Bulger et al., 2003).

This species requires still or slow-moving water during the breeding season where it can deposit large egg masses, which are most often attached to submergent or emergent vegetation. Breeding typically occurs between December and April depending on annual environmental conditions and locality. Eggs require six to 12 days to hatch and metamorphosis generally occurs after 3.5 to seven months, although larvae are also capable of over-wintering. Following metamorphosis, generally between July and September, juveniles are 25-35 mm in size. Juvenile CRLF appear to have different habitat needs than adults. Jennings and Hayes (1988) recorded juvenile frogs mostly from sites with shallow water and limited shoreline or emergent vegetation. Additionally, it was important that there be small one-meter breaks in the vegetation or clearings in the dense riparian cover to allow juveniles to sun themselves and forage, but to also have close escape cover from predators. Jennings and Hayes also noted that tadpoles have different habitat needs and that in addition to vegetation cover, tadpoles use mud. It is speculated that CRLF larvae are algae grazers, however, foraging larval ecology remains unknown (Jennings, et. al., 1993).

It has been shown that occurrences of CRLF are negatively correlated with presence of non-native bullfrogs (Moyle, 1973; Jennings and Hayes, 1986 and 1988), although both species are able to persist at certain locations, particularly in the coastal zone. It is estimated that CRLF has disappeared from approximately 75% of its former range and has been nearly extirpated from the Sierra Nevada, Central Valley, and much of southern California (Service, 1996).

The project site is not located within designated critical habitat for CRLF. The CNDDDB reports 52 occurrences of CRLF within the seven quadrangles reviewed, the nearest of which is located approximately three miles north of the Project site, within the Salinas River riparian corridor. No aquatic breeding, aquatic non-breeding, or optimal dispersal habitat is present within the Project site. The nearest known breeding

pond on former Fort Ord is approximately 4.7 miles southeast of the Project site (**Figure 11**). The Project site is within one mile (1.6 km) of several potential CRLF breeding ponds, the general distance provided by the Service for CRLF site assessments (Service and CDFW, 2005). These ponds are located east and south of the Project site, no potential breeding ponds are present north or west of the Project site on Fort Ord, and the availability of non-breeding aquatic resources to the north and west of the Project site is little to none. The nearest potential breeding pond to the Project site is 0.4 mile (0.6 km) away (Pond 101 East). As such, there is a very low potential for CRLF to disperse through the Project site. As noted above, CRLF may move up to 300 feet from aquatic habitats into surrounding uplands (Bulger et al., 2003); however, no aquatic resources are present within 300 feet of the Project site. Additionally, CRLF have not been observed breeding in this pond since the initial detection and there have been recent observations of large goldfish in the pond, which may inhibit further use by CRLF. Therefore, this species is unlikely to occur within the Project site.









### *Smith's Blue Butterfly*

The SBB was listed as a federally Endangered species on June 1, 1976 (41 FR 22041-22044). This species historically ranged along the California coast from Monterey Bay south through Big Sur to near Point Gorda, occurring in scattered populations in association with coastal dune, coastal scrub, chaparral, and grassland vegetation types. The primary limiting factor for SBB populations is the occurrence of their host plants, dune buckwheat (*Eriogonum parvifolium*) and coast buckwheat (*E. latifolium*), in which they are associated with for their entire life span. There is also a potential for SBB to use naked buckwheat (*E. nudum*) within a range of the obligate host species (pers. comm. Dave Dixon, State Parks).

The presence of the host plant, however, is not always an indication of the occurrence of the butterfly, as the host plant distribution is much more extensive than that of the butterfly.

Individual adult males and females live approximately one week. Adult emergence and seasonal activity are synchronized with the blooming period of the particular buckwheat used at a given site. Dispersal data from capture-recapture studies (Arnold, 1983) indicate that most adults are quite sedentary, with home ranges no more than a few acres. The SBB has only one generation per year. Females lay single eggs into buckwheat flower heads, which hatch in approximately one week. Caterpillars mature over a span of approximately three to four weeks, feeding on petals and seeds of the buckwheat plant. Chrysalis formation then takes place in the buckwheat flower head and the chrysalis eventually falls into the leaf litter and topsoil beneath the plant where it remains for approximately 47 weeks until the cycle begins again (Dixon, 1999).

The CNDDDB reports 17 occurrences of SBB within the quadrangles reviewed, the nearest of which is located approximately 0.7 mile from the Project site, within the Monterey Dunes State Park. Small areas of dune buckwheat were identified within the survey area near the intersection of 6<sup>th</sup> Avenue and Butler Street (0.1 ac and 6 individuals) and the intersection of 6<sup>th</sup> Avenue and A Street (23 individuals). Additionally, a small area of dune buckwheat (0.02 ac and 1 individual) is known from previous surveys conducted for the Fort Ord HCP, along Inter-Garrison Road near the main campus quad. Four dune buckwheat individuals were identified within the Academic IV project site. These areas may provide habitat for SBB (**Figure 12**). Host plant species for SBB may also occur within the unsurveyed areas of the Project site. Therefore, this species has a moderate potential to occur within the Project site. No buckwheat plant

-  Former Fort Ord Boundary
-  Jurisdictional Limits
-  CSUMB Campus
-  1.6 km Buffer of Known and Potential CRLF Breeding Sites
-  Near-Term Project Sites
-  Aquatic Resource Known to be Occupied by CRLF
-  Near-Term Project Staging Areas
-  Aquatic Resource with Potential to be Occupied by CRLF

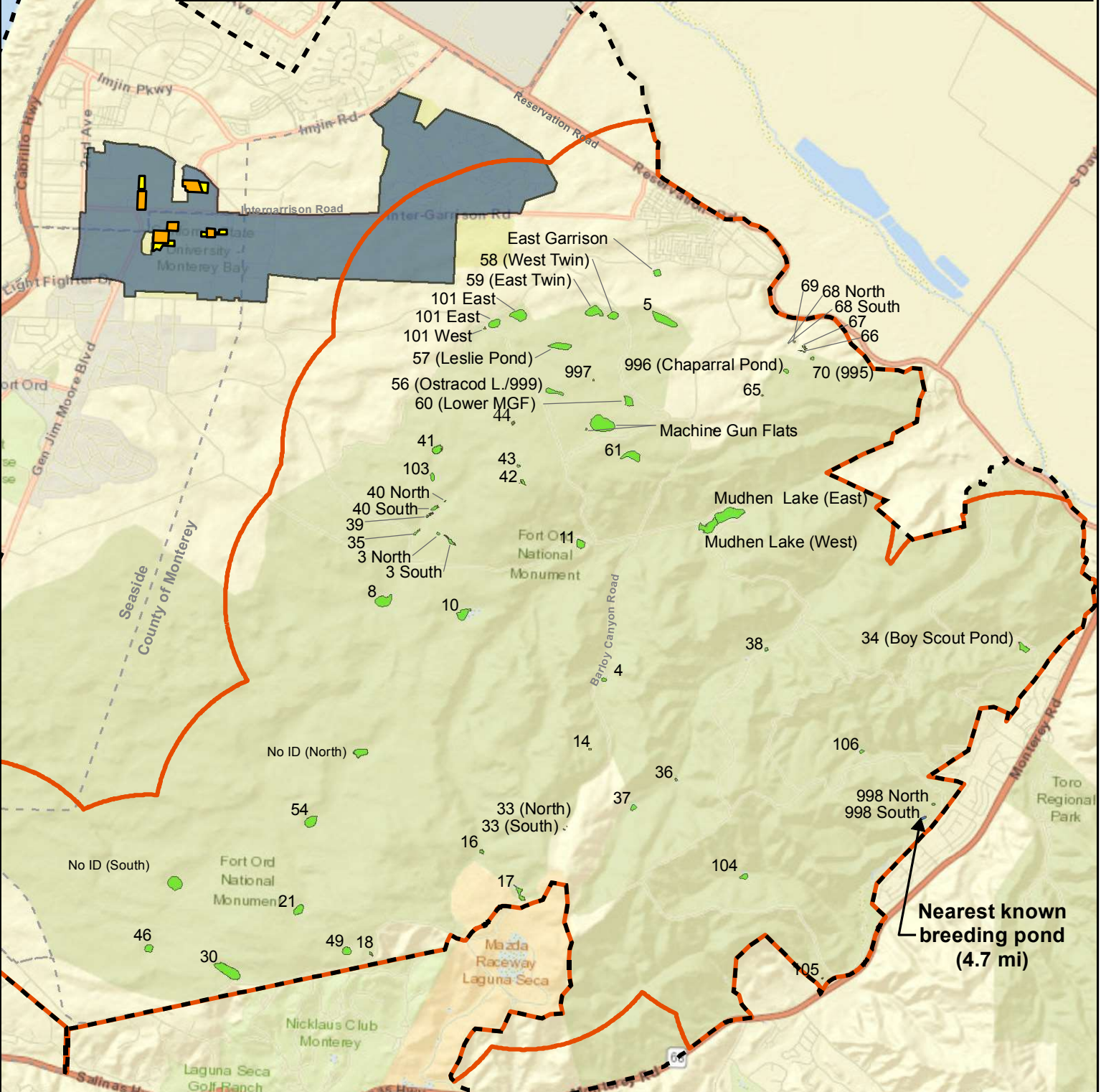

## CRLF Aquatic Resources

Service Layer Credits: Sources: Esri, HERE, DeLorme, USGS, Intermap, INCREMENT P, NRCan, Esri Japan, METI, Esri China (Hong Kong), Esri Korea, Esri (Thailand), MapmyIndia, NGCC, © OpenStreetMap contributors, and the GIS User Community

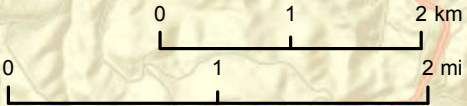

**Denise Duffy and Associates, Inc.**  
Planning and Environmental Consulting

Date: 01-16-2018  
Scale: 1 in = 0.9 mi

Figure  
**11**

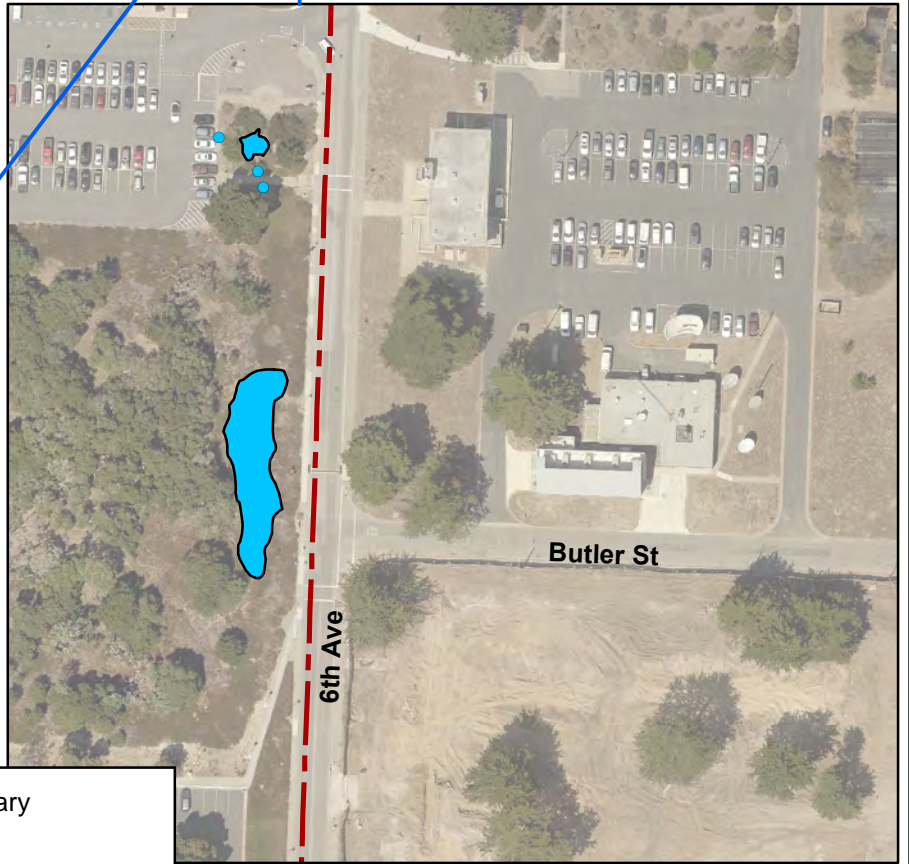
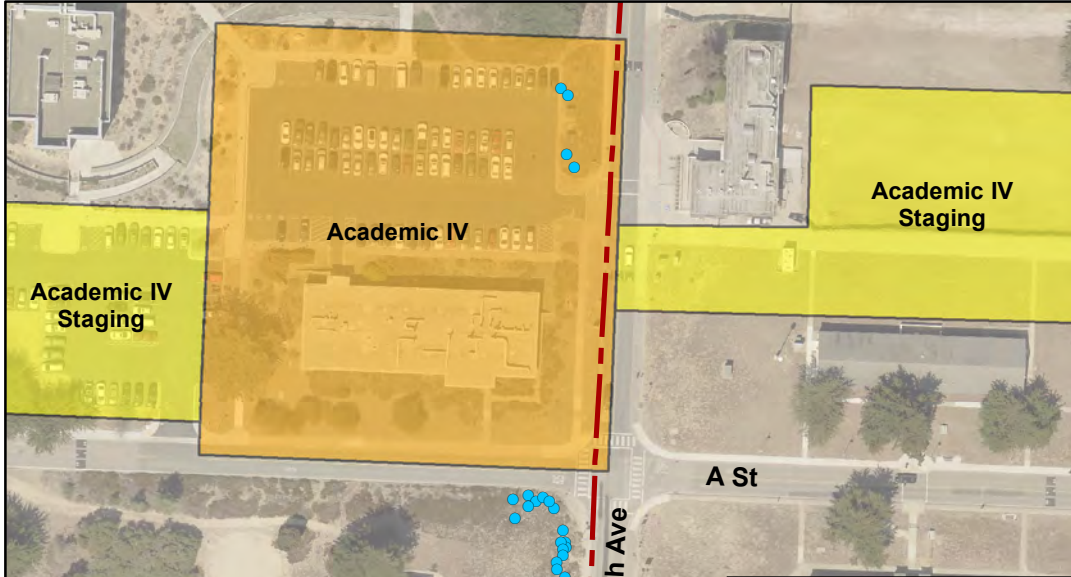
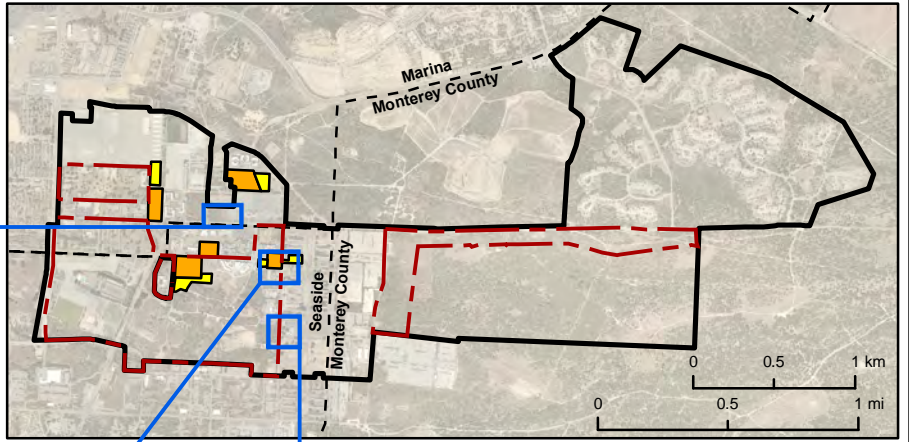
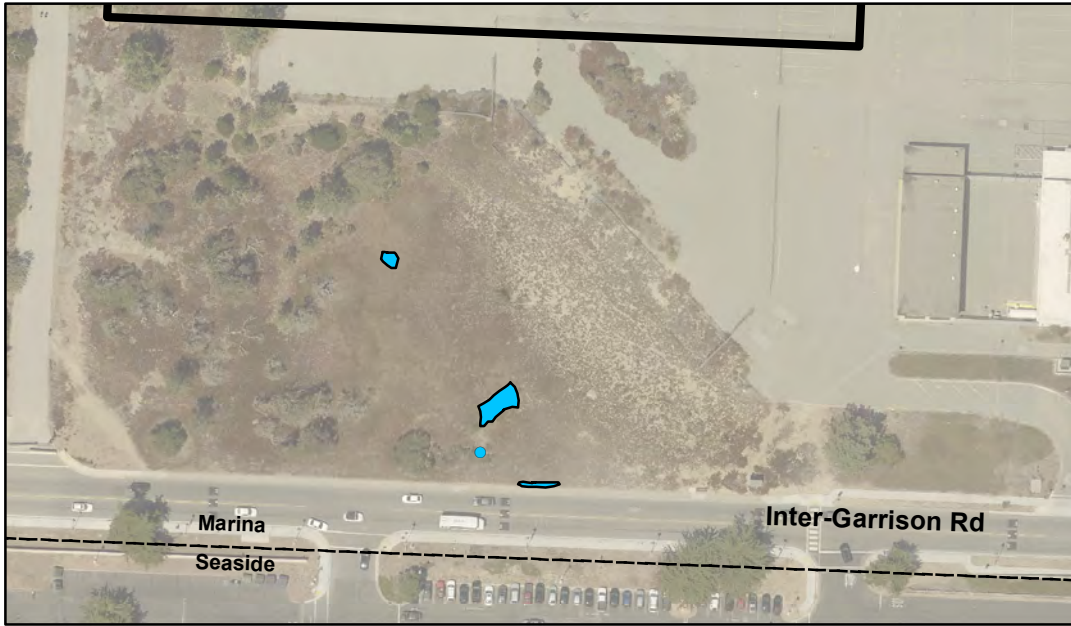

- CSUMB Campus Boundary
- Near-Term Project Sites
- Near-Term Project Staging Areas
- 2016 Botanical Survey Area
- Jurisdictional Limits
- Potential Smith's Blue Butterfly Habitat

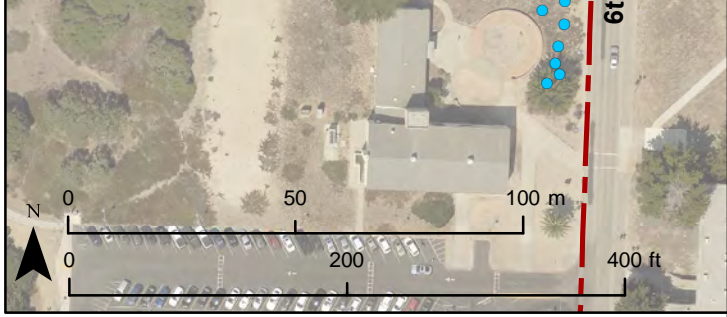

|  |  |                     |
|--|--|---------------------|
| <b>Smith's Blue Butterfly<br/>Potential Habitat Observed</b> |  |                     |
|  | <b>Denise Duffy and Associates, Inc.</b> |                     |
|  | Planning and Environmental Consulting    |                     |
|  | Date<br>03-13-2019                       | Figure<br><b>12</b> |
|  | Scale<br>1 in=0 mi                       |                     |

species suitable for SBB habitat were observed within the other Near-Term Development sites or proposed staging areas.

#### *Obscure Bumble Bee*

The obscure bumble bee occurs in Mediterranean California and along the Pacific Coast from southern California to southern British Columbia in Canada (Williams et. al., 2014). This species occurs primarily along the coast in grassy prairies and meadows. Select food genera include *Baccharis*, *Cirsium*, *Lupinus*, *Lotus*, *Grindelia*, and *Phacelia* (Pollinator Partnership and U.S. Forest Service [USFS], 2012). The obscure bumble bee nests both underground and above ground (abandoned bird nests are often utilized).

The CNDDDB reports four occurrences of the obscure bumble bee within the quads evaluated. The nearest CNDDDB occurrence of obscure bumble bee is approximately 5.8 miles from the Project site. Suitable habitat for this species may be present within the non-native grassland, non-native grassland mix habitats, and portions of the ruderal habitat within the Project site. This species has a moderate potential to occur within suitable habitat at the Project site.

#### *Western Bumble Bee*

The western bumble bee was formerly common from the Pacific coast to the Colorado Rocky Mountains; however, populations from central California to southern British Columbia, Canada and west of the Sierra-Cascade Ranges have declined sharply since the late 1990s (Pollinator Partnership and USFS, 2012; Williams et. al., 2014). Select food genera include *Melilotus*, *Cirsium*, *Trifolium*, *Centaurea*, *Chrysothamnus*, and *Eriogonum* (Pollinator Partnership and USFS, 2012). The western bumble bee generally nests underground.

The CNDDDB reports six occurrences of the western bumble bee within the quads evaluated. The nearest CNDDDB occurrence of this species is approximately 4.6 miles from the Project site. Suitable habitat for this species may be present within the non-native grassland, non-native grassland/coast live oak woodland mix, non-native grassland/central coastal scrub, and portions of the ruderal areas within the Project site. This species has a moderate potential to occur within suitable habitat at the Project site.

#### *Nesting Raptors, Migratory Birds, and Other Protected Avian Species*

Raptors and their nests and migratory birds are protected under FGC and the MBTA. While the life histories of these species vary, overlapping nesting and foraging similarities (approximately February through August) allow for their concurrent discussion. Most raptors are breeding residents throughout most of the wooded portions of the state. Stands of live oak, riparian deciduous, or other forest habitats, as well as open grasslands, are used most frequently for nesting. Breeding occurs February through August, with peak activity May through July. Prey for these species includes small birds, small mammals, and some reptiles and amphibians. Many raptor species hunt in open woodland and habitat edges. Various species of raptors (such as red-tailed hawk, red-shouldered hawk [*Buteo lineatus*], great horned owl, American kestrel, and turkey vulture [*Cathartes aura*]) have a potential to nest within any of the large coast live oak, Monterey pine, or Monterey cypress trees present within the Project site. Additionally, migratory bird species that may be present within the Project site include, but is not limited to, common poorwill, blue-gray gnatcatcher, Townsend's warbler (*Setophaga townsendii*), western tanager (*Piranga ludoviciana*),

savannah sparrow, ash-throated fly catcher (*Myiarchus cinerascens*), and violet-green swallow (*Tachycineta thalassina*).

Avian species identified as CDFW species of special concern or Fully Protected Species (such as the white-tailed kite, western burrowing owl, and California horned lark) have the potential to occur within the Project site. Suitable nesting habitat for the white-tailed kite is present within the coast live oak woodland habitat. This species may also forage over any of the undeveloped areas within the Project site. In addition, marginally suitable nesting and foraging habitat for the western burrowing owl and California horned lark is present within the non-native grassland habitat. Therefore, nesting raptors, migratory birds, and other protected avian species have a moderate to high potential to occur within the Project site.

4.2.2 Special-Status Plant Species

The Project site and adjacent areas were evaluated for the presence or potential presence of a variety of special-status plant species (**Appendix A**). Focused surveys were conducted within a portion of the Project site; this area is identified as the “survey area” on **Figure 6**. The following special-status plant species are discussed due to their known presence within the Project site, as observed during the focused botanical surveys (**Figure 7**), or for their moderate to high potential to occur in the un-surveyed areas of the Project site, based on known occurrences in the vicinity and presence of suitable habitat. **Table 4-4** summarizes the potential for these species to occur within the Project site. **Figure 7** and **Table 4-5** identifies the area of each of species observed within the survey area. All other species presented in **Appendix A** are assumed “unlikely to occur” based on the lack of suitable habitat within un-surveyed portions of the Project site and/or the results of the focused surveys within the survey area, or have a low potential to occur but are unlikely to be impacted. Please note that only those special-status plant species that are known or have the potential to occur within the Project site are discussed in the impacts and mitigation section of this document.

**Table 4-4. Potential for Special-Status Plant Species Presence within the Project Site**

| Species                | Potential Occurrence within Project Site | Potential Occurrence within Near-Term Development Component Sites and Staging Areas |                                    |                           |                           |                     |
|------------------------|--|---|------------------------------------|---------------------------|---------------------------|---------------------|
|                        |  | Student Housing Phase III   | Academic IV Building <sup>11</sup> | Student Recreation Center | Student Housing Phase IIB | Academic V Building |
| Hooker’s manzanita     | Moderate                                 | Not Present   | Not Present                        | Not Present               | Not Present               | Not Present         |
| Toro manzanita         | Present                                  | Not Present   | Not Present                        | Not Present               | Not Present               | Not Present         |
| Pajaro manzanita       | Moderate                                 | Not Present   | Not Present                        | Not Present               | Not Present               | Not Present         |
| Sandmat manzanita      | Present                                  | Not Present   | Not Present                        | Not Present               | Not Present               | Not Present         |
| Monterey ceanothus     | Present                                  | Not Present   | Not Present                        | Not Present               | Not Present               | Not Present         |
| Fort Ord spineflower   | Moderate                                 | Unlikely  | Unlikely                           | Not Present               | Unlikely                  | Unlikely            |
| Monterey spineflower   | Present                                  | Low   | Low                                | Present                   | Low                       | Unlikely            |
| Seaside bird’s-beak    | High                                     | Unlikely  | Unlikely                           | Not Present               | Unlikely                  | Unlikely            |
| Eastwood’s goldenbush  | High                                     | Not Present   | Not Present                        | Not Present               | Not Present               | Not Present         |
| Sand-loving wallflower | High                                     | Unlikely  | Unlikely                           | Not Present               | Unlikely                  | Unlikely            |

<sup>11</sup> The Academic IV Building site and a portion of the staging area was included in the survey area for botanical surveys conducted in 2017; however, a portion of the staging area was not included. Therefore, special-status plant species listed with potential to occur for this site may occur only within the unsurveyed portions of the staging area. No special-status plant species were observed within the surveyed areas of the Academic IV Building site in 2017.

| Species                          | Potential Occurrence within Project Site | Potential Occurrence within Near-Term Development |                                    |                           |                           |                     |
|----------------------------------|--|---|------------------------------------|---------------------------|---------------------------|---------------------|
|                                  |  | Student Housing Phase III                         | Academic IV Building <sup>11</sup> | Student Recreation Center | Student Housing Phase IIB | Academic V Building |
| <b>Sand gilia</b>                | High                                     | Low   | Low                                | Not Present               | Low                       | Unlikely            |
| Kellogg's horkelia               | Present                                  | Not Present                                       | Not Present                        | Not Present               | Not Present               | Not Present         |
| Point Reyes horkelia             | Moderate                                 | Unlikely  | Unlikely                           | Not Present               | Unlikely                  | Unlikely            |
| Marsh microseris                 | Moderate                                 | Unlikely  | Unlikely                           | Not Present               | Unlikely                  | Unlikely            |
| Northern curly-leaved monardella | Moderate                                 | Unlikely  | Unlikely                           | Not Present               | Unlikely                  | Unlikely            |
| Woodland woolythreads            | Moderate                                 | Unlikely  | Unlikely                           | Not Present               | Unlikely                  | Unlikely            |
| <b>Yadon's piperia</b>           | High                                     | Unlikely  | Unlikely                           | Not Present               | Low                       | Unlikely            |
| Santa Cruz microseris            | Moderate                                 | Unlikely  | Unlikely                           | Not Present               | Unlikely                  | Unlikely            |
| Santa Cruz clover                | Moderate                                 | Unlikely  | Unlikely                           | Not Present               | Unlikely                  | Unlikely            |
| Pacific Grove clover             | Moderate                                 | Unlikely  | Unlikely                           | Not Present               | Unlikely                  | Unlikely            |

<sup>3</sup> **Bold** indicates Fort Ord HMP Species.

**Table 4-5. Area of Special-Status Plant Species within the Survey Area<sup>12</sup>**

| Species                     | Area (acres) |        |      | Individuals |
|-----------------------------|--------------|--------|------|-------------|
|                             | Low          | Medium | High |             |
| <b>Toro Manzanita</b>       | 0            | 0      | 0    | 1           |
| <b>Sandmat Manzanita</b>    | 0.01         | 0.02   | 0.3  | 30          |
| <b>Monterey Ceanothus</b>   | 0            | 0      | 0    | 2           |
| <b>Monterey Spineflower</b> | 16.5         | 1.1    | 0.1  | 120         |
| Kellogg's Horkelia          | 0.03         | 0.003  | 0    | 48          |

*Hooker's Manzanita*

Hooker's manzanita is a CNPS CRPR 1B and HMP species in the Ericaceae family. This evergreen shrub is associated with closed-cone coniferous forest, chaparral, cismontane woodland and coastal scrub habitats on sandy soils at a range of 85-536 meters in elevation. The blooming period is from January to June.

The CNDDDB reports 19 occurrences of this species within the quads evaluated, the nearest of which is located approximately 0.2 mile south of the Project site. This species was not observed within the survey area during surveys in 2016; however, suitable habitat for this species is present within the unsurveyed portions of the Project site. Therefore, this species has a moderate potential to occur within the Project site.

*Toro Manzanita*

Toro manzanita (also often referred to as Monterey manzanita) is a CNPS CRPR 1B and HMP species. This evergreen shrub in the Ericaceae family blooms from February-March. Toro manzanita is associated with maritime chaparral, cismontane woodland, and coastal scrub on sandy soils at elevations of 30-730 meters.

<sup>12</sup> Please note that the areas presented in Table 4-4 only represent the areas of the Project site where focused special-status plant surveys were completed in 2016. **Bold** indicates Fort Ord HMP Species.

The CNDDDB reports an occurrence of this species within the project site (**Figure 14**). One individual Toro manzanita was identified within the survey area during the 2016 botanical surveys (**Figure 7**). This species may also occur within the unsurveyed portions of the Project site.

#### *Pajaro Manzanita*

Pajaro manzanita is a CNPS CRPR 1B species in the Ericaceae family. This evergreen shrub is associated with chaparral on sandy soils at a range of 30-760 meters in elevation. The blooming period is December to March.

The CNDDDB reports 18 occurrences of this species within the quads evaluated, the nearest of which includes a very small portion of the southwestern corner of the Project site (**Figure 13**). This occurrence is associated with the main entrance to Fort Ord and the Highway 1 overpass, and is, therefore, unlikely within the Project site. This species was not observed within the survey area during surveys in 2016; however, Pajaro manzanita is known to occur in other areas of the Former Fort Ord and suitable habitat is present within the unsurveyed portions of the Project site. Therefore, this species has a moderate potential to occur within the Project site.

#### *Sandmat Manzanita*

Sandmat manzanita is a CNPS CRPR 1B and HMP species. This evergreen shrub in the Ericaceae family blooms from February to May. Sandmat manzanita is associated with openings in chaparral, coastal scrub, closed cone coniferous forest, coastal dunes, and cismontane woodland habitats on sandy soils at elevations between 3-205 meters.

The CNDDDB reports 17 occurrences of this species within the quads evaluated, including two specific occurrences within project site (**Figure 13**). Sandmat manzanita was identified within the survey area during the 2016 botanical surveys (**Figure 7**). This species may also occur within the unsurveyed portions of the Project site.

#### *Monterey Ceanothus*

Monterey ceanothus is a CNPS CRPR 4 and HMP species. This evergreen shrub in the Rhamnaceae family blooms from February to April (sometimes through June). This species is associated with closed-cone coniferous forests, chaparral, and coastal scrub on sandy soils at elevations between 3-550 meters.

The CNDDDB does not report any occurrences of this species; however, it is known to occur throughout the former Fort Ord. Two individual Monterey ceanothus were identified within the survey area during the 2016 botanical surveys (**Figure 7**). This species may also occur within the unsurveyed portions of the Project site.



Service Layer Credits: Sources: Earl, HERE, DeLorme, TomTom, Intermap, Increment P Corp., GEBCO, USGS, FAO, NPS, NRCAN, GeoBase, IGN, Kadaster NL, Ordnance

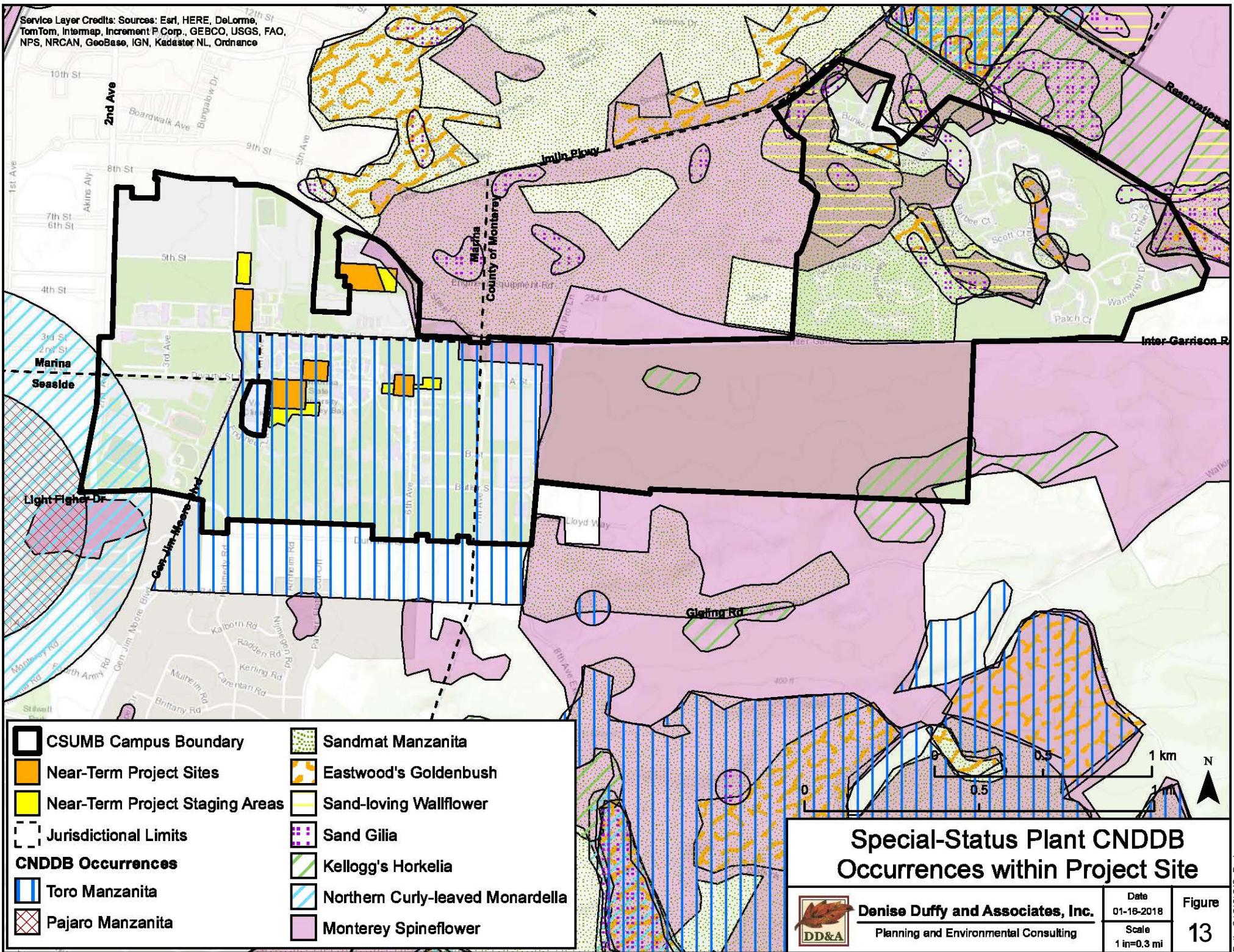

- |                                 |                                  |
|---------------------------------|----------------------------------|
| CSUMB Campus Boundary           | Sandmat Manzanita                |
| Near-Term Project Sites         | Eastwood's Goldenbush            |
| Near-Term Project Staging Areas | Sand-loving Wallflower           |
| Jurisdictional Limits           | Sand Gilia                       |
| <b>CNDDB Occurrences</b>        |                                  |
| Toro Manzanita                  | Kellogg's Horkelia               |
| Pajaro Manzanita                | Northern Curly-leaved Monardella |
|                                 | Monterey Spineflower             |

## Special-Status Plant CNDDB Occurrences within Project Site

|   |                      |              |
|---|----------------------|--------------|
| <b>Denise Duffy and Associates, Inc.</b><br>Planning and Environmental Consulting | Date<br>01-16-2018   | Figure<br>13 |
|   | Scale<br>1 in=0.3 mi |              |

### *Fort Ord Spineflower*

Fort Ord spineflower is a CNPS CRPR 1B species. This annual herb in the Polygonaceae family is associated with sandy openings of maritime chaparral and coastal scrub at elevations of 55-150 meters. The blooming period is April to July.

The CNDDDB reports five occurrences of this species within the quads evaluated, the nearest of which is located 0.3 mile south of the Project site. This species was not observed within the survey area during surveys in 2016; however, Fort Ord spineflower is known to occur in other areas of the Former Fort Ord and suitable habitat is present within the unsurveyed portions of the Project site. Therefore, this species has a moderate potential to occur within the Project site.

### *Monterey Spineflower*

Monterey spineflower and is a federally threatened, CNPS CRPR 1B, and HMP species. It is a small, prostrate annual herb in the Polygonaceae family that blooms from April to June. The white to rose floral tube of Monterey spineflower distinguishes it from the more common, but closely related, diffuse spineflower (*Chorizanthe diffusa*), which has a lemon-yellow floral tube. Monterey spineflower typically occurs on open sandy or gravelly soils on relic dunes in coastal dune, coastal scrub, and maritime chaparral habitats, though it can also be associated with cismontane woodlands and valley and foothill grasslands, within a range of 3-450 meters in elevation.

The CNDDDB reports an occurrence of this species that includes the majority of Project site (**Figure 13**). Monterey spineflower was identified within the survey area during the 2016 botanical surveys, including a small population that overlaps with the Student Recreation Center proposed staging area (**Figure 7**). This species may also occur within the unsurveyed portions of the Project site.

### *Seaside Bird's-Beak*

Seaside bird's-beak is a state endangered, CNPS CRPR 1B, and HMP species. It is a hemiparasitic annual in the Scrophulariaceae family and blooms April through October. Seaside bird's-beak is typically associated with closed-cone coniferous forest, chaparral, cismontane woodlands, coastal dunes, and coastal scrub in sandy soils and often in disturbed areas, within the range of 0-425 meters in elevation.

The CNDDDB reports 17 occurrences of this species within the quads evaluated, the nearest of which is located approximately 0.3 mile from the Project site (**Figure 13**). This species was not observed within the survey area during surveys in 2016; however, seaside bird's-beak is known to occur in other areas of the Former Fort Ord and suitable habitat is present within the unsurveyed portions of the Project site. Therefore, this species has a high potential to occur within the Project site.

### *Eastwood's Goldenbush*

Eastwood's goldenbush (also often referred to as Eastwood's goldenfleece) is a CNPS CRPR 1B and HMP species. This evergreen shrub in the Asteraceae is associated with openings in closed-cone coniferous forest, maritime chaparral, coastal dunes, and coastal scrub on sandy soils at elevations of 30-275 meters. The blooming period is from July-October.

The CNDDDB reports 17 occurrences of this species within the quads evaluated, including a specific occurrence in the northeastern portion of the Project site (**Figure 13**). This species was not observed within the survey area during surveys in 2016; however, suitable habitat is present within the unsurveyed portions of the Project site. Based on this information, Eastwood's goldenbush has a high potential to occur within the Project site, outside of the survey area.

#### *Sand-loving Wallflower*

Sand-loving wallflower is a CNPS CRPR 1B and HMP species in the Brassicaceae family. This perennial herb is associated with openings in maritime chaparral, coastal dunes, and coastal scrub on sandy soils at elevations of 0-60 meters. The blooming period is February to June.

The CNDDDB reports 16 occurrences of this species within the quads evaluated, including a specific occurrence in the northeastern portion of the Project site (**Figure 13**). This species was not observed within the survey area during surveys in 2016; however, suitable habitat is present within the unsurveyed portions of the Project site. Based on this information, sand-loving wallflower has a high potential to occur within the Project site, outside of the survey area.

#### *Sand Gilia*

Sand gilia is a federally Endangered, state Threatened, CNPS CRPR 1B, and HMP species. This annual herb in the Polemoniaceae blooms from April through June and is found in sandy openings of maritime chaparral, cismontane woodland, coastal dune and coastal scrub habitats within the range of 0-45 meters in elevation.

The CNDDDB reports 30 occurrences of this species within the quads evaluated, including a specific occurrence in the northeastern portion of the Project site (**Figure 13**). This species was not observed within the survey area during surveys in 2016; however, suitable habitat is present within the unsurveyed portions of the Project site. Based on this information, sand gilia has a high potential to occur within the Project site, outside of the survey area.

#### *Kellogg's Horkelia*

Kellogg's horkelia is a CNPS CRPR 1B species. It is a perennial herb in the Rosaceae family and blooms April through June. Kellogg's horkelia is typically associated with openings in closed cone coniferous forest, maritime chaparral, and coastal scrub in sandy or gravelly soils on relic dunes, within a range of 10 to 200 meters in elevation.

The CNDDDB reports three occurrences of this species that overlap with the Project site (**Figure 13**). This species was identified within the survey area during the 2016 botanical surveys (**Figure 7**). This species may also occur within the unsurveyed portions of the Project site.

#### *Point Reyes Horkelia*

Point Reyes horkelia is a CNPS CRPR 1B species. It is a perennial herb in the Rosaceae family and blooms May through September. Point Reyes horkelia is typically associated with coastal dunes, coastal prairie, and coastal scrub in sandy soils, within a range of 5-755 meters in elevation.

The CNDDDB reports one occurrence of this species within the quads evaluated, located approximately 1.5 miles northwest of the Project site. This species was not observed within the survey area during surveys in 2016; however, suitable habitat is present within the unsurveyed portions of the Project site. Based on this information, Point Reyes horkelia has a moderate potential to occur within the Project site.

#### *Marsh Microseris*

Marsh microseris is a CNPS CRPR 1B species in the Asteraceae family. This rhizomatous, perennial herb is found in closed-cone coniferous forest, cismontane woodland, coastal scrub, and valley and foothill grassland habitats at elevations from 5-300 meters. The blooming period is from April through July.

The CNDDDB reports 10 occurrences of this species within the quads evaluated, the nearest of which is located approximately 0.9 mile southeast of the Project site. This species was not observed within the survey area during surveys in 2016; however, suitable habitat may be present within the unsurveyed portions of the Project site. Therefore, marsh microseris has a moderate potential to occur within the Project site.

#### *Northern Curly-leaved Monardella*

Northern curly-leaved monardella is a CNPS CRPR 1B species in the Lamiaceae family. This annual herb is found in chaparral, coastal dunes, and coastal scrub at elevations of 0-300 meters. This species may also be found in ponderosa pine sandhills in Santa Cruz County and valley and foothill grassland habitats at elevations from 5-300 meters. The blooming period is from April through September.

The CNDDDB reports eight occurrences of this species within the quads evaluated, the nearest of which includes a portion of the southwestern corner of the Project site (**Figure 13**). This occurrence is a non-specific occurrence based on collections from 1908 to 1919 and the exact location is unknown. This species was not observed within this portion of the project site or any other portions of the survey area during surveys in 2016. However, Northern curly-leaved monardella is known to occur in other areas of the Former Fort Ord and suitable habitat is present within the unsurveyed portions of the Project site. Therefore, this species has a moderate potential to occur within the Project site.

#### *Woodland Woollythreads*

Woodland woollythreads is a CNPS CRPR 1B species. It is an annual herb in the Asteraceae family and blooms between March and July. This species is typically associated with openings in broadleaved upland forest, chaparral, cismontane woodland, north coast coniferous forest and valley and foothill grasslands on serpentine soils, within a range of 100-1,200 meters in elevation. This species may occur within the non-native grassland habitat on the Project site.

The CNDDDB reports two occurrences of this species within the quads evaluated, the nearest of which is located approximately 5.1 miles southwest of the Project site. This species was not observed within the survey area during surveys in 2016; however, suitable habitat is present within the unsurveyed portions of the Project site. Based on this information, woodland woollythreads has a moderate potential to within the Project site.

*Yadon's Piperia*

Yadon's piperia is a federally endangered, CNPS CRPR 1B, and HMP species. This perennial herb in the Orchidaceae family blooms from May to August and is found in closed-cone coniferous forest, maritime chaparral on sandy soils, and coastal bluff scrub at elevations from 10-510 meters. Overall, this species favors a well-drained, sandy soil substrate with podzolic conditions, and areas that retain moisture during the rainy season but are not subject to inundation (V.Yadon in litt. 2002). As in some other plant taxa, individual orchids that flower in one year may not have the necessary energy reserves to flower in the following year. As a result, an unknown proportion of a population may be dormant in any given year, thus making it difficult to track population dynamics through monitoring of population size (Wells, 1981; Rasmussen, 1995; A. Graff in litt., 2002). However, it would be expected that some percentage of a resident population would flower in any given year. As a result, while it may be difficult to track population dynamics in any given year, determining presence or absence for a specific area is not.

The CNDDDB reports 22 occurrences of this species within the quads evaluated, the nearest of which is located approximately 0.9 mile north of the Project site. DD&A biologists have also found Yadon's piperia approximately 0.1 mile west of the Project site on 1<sup>st</sup> Street. This species was not observed within the survey area during surveys in 2016; however, suitable habitat is present within the unsurveyed portions of the Project site and this species is known to occur within other portions of the Former Fort Ord. Based on this information, Yadon's piperia has a high potential to within the Project site.

*Santa Cruz Microseris*

Santa Cruz microseris is a CNPS CRPR 1B species. This annual herb in the Asteraceae family is found in broadleaved upland forest, closed cone coniferous forest, chaparral, coastal prairie, coastal scrub, and valley and foothill grasslands in open areas, sometimes on serpentinite soils. The elevation range for Santa Cruz microseris is 10-500 meters and the blooming period is from April to May.

The CNDDDB reports two occurrences of this species within the quads evaluated, the nearest of which is located approximately 4.6 miles south of the Project site. This species was not observed within the survey area during surveys in 2016; however, suitable habitat is present within the unsurveyed portions of the Project site. Based on this information, Santa Cruz microseris has a moderate potential to within the Project site.

*Santa Cruz Clover*

Santa Cruz clover is a CNPS CRPR 1B species in the Fabaceae family. This annual herb is associated with broad-leaved upland forest, cismontane woodland, and margins of coastal prairie on gravelly soils, at elevations of 105-610 meters. The blooming period is from April-October.

The CNDDDB reports four occurrences of this species within the quads evaluated, the nearest of which is located approximately 0.5 miles southeast of the Project site. This species was not observed within the survey area during surveys in 2016; however, suitable habitat is present within the unsurveyed portions of the Project site. Based on this information, Santa Cruz clover has a moderate potential to within the Project site.

### *Pacific Grove Clover*

Pacific Grove clover is a CNPS CRPR 1B species in the Fabaceae family. This annual herb is found in closed-cone coniferous forest, coastal prairie, meadows, seeps, and mesic areas in valley and foothill grassland at elevations of 5-120 meters. The blooming period is from April-June.

The CNDDDB reports 12 occurrences of this species within the quads evaluated, the nearest of which is located approximately 4.9 miles south of the Project site. This species was not observed within the survey area during surveys in 2016; however, suitable habitat may be present within the unsurveyed portions of the Project site. Based on this information, Pacific Grove clover has a moderate potential to within the Project site.

## **4.3 Sensitive Habitats**

One sensitive habitat was identified within the Project site: central maritime chaparral (which includes the central maritime chaparral mix habitats).

### **4.3.1 Central Maritime Chaparral**

Central maritime chaparral habitat (**Figure 6**), including the central maritime chaparral/central coastal scrub and central maritime chaparral/coast live oak woodland mix habitats, is identified as a sensitive habitat on the CDFW's *Natural Communities List* (CDFW, 2010). Central maritime chaparral is also identified as a sensitive habitat in the HMP. Approximately 124.3 acres of central maritime chaparral habitat, including mix habitats, occurs within the Project site. No central maritime chaparral or mix habitats occur within the Near-Term Development sites.

*This page left intentionally blank*

## 5.0 IMPACTS AND MITIGATION

### 5.1 Impact Analysis Approach

The biological analysis herein includes two levels of analysis: program-level for the Master Plan (**Section 5.2 “Impacts and Mitigation Measures – Master Plan”**), and project-level for the Near-Term Development Components (**Section 5.3 “Impacts and Mitigation Measures – Near-Term Development Components”**). Specific subsequent projects, their associated locations, and physical effects on the environment from the implementation of the proposed Master Plan are not known at this time. Thus, this analysis uses a programmatic approach to evaluating potential impacts to sensitive biological resources that may result from implementation of the proposed Master Plan, commensurate with the conceptual level of project information available and the approval being considered (i.e., CSU BOT approval of the proposed Master Plan).

A project-level approach was used to evaluate the potential impacts to sensitive biological resources that may result from implementation of the proposed Near-Term Developments, commensurate with the site- and project-specific detail available. The Proposed Master Plan Project and Mitigation Measures identified in **Section 5.2** for the Master Plan remain applicable and are not repeated. Additional mitigation measures also are included, where warranted, to respond to project-specific impacts.

#### 5.1.1 HMP Species and Habitat Impact Analysis

The entire proposed Project site is located within parcels designated by the HMP as “development” and no uses beyond what is permissible by the HMP are proposed with the Project. As described above, parcels designated as “development” do not have management requirements. However, CSUMB is required to implement Borderlands requirements within the East Campus Open Space parcel and required to identify sensitive biological resources within development parcels that may be salvaged for use in restoration activities in habitat reserve areas. Through implementation of the HMP, impacts to HMP species and habitats occurring within the designated development parcels were anticipated and mitigated off campus through the establishment of habitat reserves and corridors and the implementation of habitat management requirements within habitat reserve parcels on former Fort Ord.

The HMP species known or with the potential to occur within the Project site include: Monterey spineflower, sand gilia, sandmat manzanita, Hooker’s manzanita, Toro manzanita, Monterey ceanothus, seaside bird’s-beak, sand-loving wallflower, Eastwood’s goldenbush, Yadon’s piperia, CTS, SBB, Northern California legless lizard, and Monterey ornate shrew (Appendix A). With the designated off campus habitat reserves and corridors and habitat management requirements of the HMP in place, the loss of these species associated with development in the Fort Ord area is not expected to jeopardize the long-term viability of these species and their populations on the former Fort Ord (Service, 1993). This is such because the recipients of disposed land with habitat management requirements and development restrictions designated by the HMP will be obligated to implement those specific measures through the HMP and deed covenants.

In addition to the HMP species identified, impacts to sensitive central maritime chaparral habitat are also addressed in the HMP and, therefore, impacts to this habitat are also considered mitigated through the implementation of the HMP based on the same conclusions: because the Project is: 1) only proposing



development activities within designated development parcels; 2) required to comply with the HMP; and 3) would not result in any additional impacts to HMP species and habitats beyond those anticipated in the HMP, no additional mitigation measures for these HMP species or central maritime chaparral habitat are required. Impacts to these special-status species and central maritime chaparral are considered less than significant.

The HMP, as well as the BO, require the identification of sensitive biological resources within development parcels that may be salvaged for use in restoration activities in habitat reserve areas. In addition, CSUMB is required to implement Borderlands requirements in the East Campus Open Space parcel. CSUMB is required to implement HMP requirements in accordance with the deed covenants, which apply to all parcels within the campus boundaries. Therefore, this analysis assumes that salvage of HMP species will be conducted in accordance with this requirement.

However, as described earlier in this report, the HMP does not exempt existing or future land recipients from the federal and state requirements of ESA and CESA. Of the 14 HMP species known or with the potential to occur within the Project site, there are six federal and/or state listed species that have the potential to be impacted by the Project and may require take authorization from the resource agencies (Service and/or CDFW): Monterey spineflower, federally threatened; sand gilia, federally endangered and state threatened; seaside bird's-beak, state endangered; Yadon's piperia, federally endangered; CTS, federal and state threatened; and SBB, federally endangered. Therefore, although these species are HMP species, the take of these species is prohibited under the ESA and/or CESA. Development resulting in take of these species would need to be authorized by the Service and/or CDFW through the issuance of incidental take permits from the applicable agency to avoid violation of the ESA and/or CESA.

It is also important to note that these four species are currently being considered for take coverage under a base-wide Draft HCP. The Project is included in the Draft HCP as a covered activity, and, therefore, the incidental take of these four species would be authorized under the base-wide Incidental Take Permits issued by the Service and CDFW once the HCP and IA are approved. In the event that the HCP and IA are approved prior to construction of the Project, no additional mitigation measures would be required. However, if specific projects under the proposed Master Plan are initiated prior to HCP and IA approval, implementation of the specific projects may require take authorization from the Service and/or CDFW at an individual project level to avoid violation of the ESA and/or CESA.

#### 5.1.2 Applicable Project Design Features

The PDFs drawn from the Master Plan Guidelines identify numerous measures that would reduce impacts to sensitive biological resources (see CSUMB Master Plan Draft EIR Chapter 3, Project Description). The impact analysis assumes that these measures will be implemented; however, additional mitigation measures are identified to reduce impacts to sensitive biological resources identified herein to a less-than-significant level, where necessary.

### 5.1.3 Thresholds of Significance

Based on the significance criteria contained in Appendix G of the CEQA Guidelines, a project may have a significant adverse impact on the environment if it will:

- (a) Have a substantial adverse effect, either directly or through habitat modifications, on any species identified as a candidate, sensitive, or special status species in local or regional plans, policies, or regulations, or by the California Department of Fish and Wildlife or U.S. Fish and Wildlife Service;
- (b) Have a substantial adverse effect on any riparian habitat or other sensitive natural community identified in local or regional plans, policies, or regulations or by the California Department of Fish and Wildlife or US Fish and Wildlife Service;
- (c) Have a substantial adverse effect on state or federally protected wetlands (including, but not limited to, marsh, vernal pool, coastal, etc.) through direct removal, filling, hydrological interruption, or other means;
- (d) Interfere substantially with the movement of any native resident or migratory fish or wildlife species or with established native resident or migratory wildlife corridors, or impede the use of native wildlife nursery sites;
- (e) Conflict with any local policies or ordinances protecting biological resources, such as a tree preservation policy or ordinance; or
- (f) Conflict with the provisions of an adopted Habitat Conservation Plan, Natural Community Conservation Plan, or other approved local, regional, or state habitat conservation plan.

## 5.2 **Impacts and Mitigation Measures – Master Plan**

---

**Impact BIO-1: Impacts to Special-Status Species and Habitat.** *Implementation of the proposed Master Plan could result in removal of special-status plant and wildlife species and their habitat. This is a potentially significant impact that can be reduced to a less-than-significant level with the implementation of the mitigation measures identified below.*

---

Future development on the CSUMB campus could result in direct loss of individuals and habitat for a number of special-status wildlife species, including special-status bat species, Monterey dusky-footed woodrat, Monterey ornate shrew, American badger, Northern California legless lizard, coast horned lizard, CTS, SBB, obscure bumble bee, western bumble bee, and nesting raptors and other protected avian species. In addition, future development within the Project site could also result in direct loss of individuals and habitat for a number of special-status plant species, including Toro manzanita, Hooker's manzanita, Pajaro manzanita, sandmat manzanita, Monterey ceanothus, Fort Ord spineflower, Monterey spineflower, seaside bird's beak, Eastwood's goldenbush, sand-loving wallflower, sand gilia, Kellogg's horkelia, Point Reyes horkelia, marsh microseris, Northern curly-leaved monardella, woodland woollythreads, Yadon's piperia, Santa Cruz microseris, Santa Cruz clover, and Pacific Grove clover.

As described in the Impact Analysis Approach section above, impacts to HMP plant and wildlife species are considered less than significant. These species include: CTS, SBB, Northern California legless lizard, Monterey ornate shrew, Monterey spineflower, sand gilia, sandmat manzanita, Hooker's manzanita, Toro manzanita, Monterey ceanothus, seaside bird's-beak, sand-loving wallflower, Eastwood's goldenbush and Yadon's piperia (Appendix A). While not required to reduce a significant impact, Mitigation BIO-1.1 will be implemented to further reduce the less-than-significant impact. This measure would ensure that sensitive biological resources are identified on development sites in advance of construction and that take authorization is obtained, were needed. Per the HMP and the BO requirements in deed covenants, **Mitigation BIO-1.1** acknowledges that CSUMB will identify sensitive biological resources within all development parcels prior to any future construction to determine whether salvage is feasible and if so, seed and topsoil salvage would occur to support reseeding and restoration efforts on- or off-site. In addition, CSUMB is required to implement Borderlands requirements in the East Campus Open Space parcel. Implementation of these requirements are included in **Mitigation BIO-1d**, which includes measures to avoid and minimize impacts to biological resources in adjacent open space areas. Additionally, in the absence of an approved based-wide incidental take permit, Project impacts to species listed as threatened or endangered by CDFW and/or the Service may also require agency consultation and/or incidental take permits. These species include: Monterey spineflower, federally threatened; sand gilia, federally endangered and state threatened; seaside bird's-beak, state endangered; Yadon's piperia, federally endangered; CTS, federal and state threatened; and SBB, federally endangered. Therefore, although these species are HMP species, the take of these species is prohibited under the ESA and/or CESA. Impacts resulting in take of these species would need to be authorized by the Service and/or CDFW through the issuance of incidental take permits from the applicable agency to avoid violation of the ESA and/or CESA.

If a project would result in impacts to special-status species not included in the HMP, such impacts would be potentially significant and mitigation will be required. Special-status species not included in the HMP that would require mitigation include: Kellogg's horkelia, Pajaro manzanita, Fort Ord spineflower, Point Reyes horkelia, marsh microseris, Northern curly-leaved monardella, woodland woolythreads, Santa Cruz microseris, Santa Cruz clover, Pacific Grove Clover, special-status bat species, Monterey dusky-footed woodrat, American badger, coast horned lizard, western bumble bee, and obscure bumble bee (Appendix A). These species are not listed under ESA or CESA and take authorization from the Service or CDFW is not required; however, impacts to these species would be considered potentially significant under CEQA. This potentially significant impact can be reduced to a less-than-significant level with implementation of **Mitigation Measure BIO-1.2** provided below, which includes project-specific biological assessments for future development to determine presence/absence of special-status species and identification of measures necessary to avoid, minimize, and/or compensate for any identified impacts.

The MBTA protects the majority of migrating birds breeding in the U.S., regardless of their official federal or state listing status under the ESA or CESA. The law applies to the disturbance or removal of active nests occupied by migratory birds during their breeding season. It is specifically a violation of the MBTA to directly kill or destroy an occupied nest of any bird species covered by the MBTA. CDFW Code Section 3503 protects the nest and eggs of native non-game birds. Under this law, it is unlawful to take, possess, or destroy any such birds or to take, possess, or destroy the nests or eggs of any such bird. FGC Section 86 defines "take" as "hunt, pursue, catch, capture, or kill, or attempt to hunt, pursue, catch, capture, or kill." Most of the birds observed or with the potential to occur within the Project site are protected under both the MBTA and FGC Section 3503, and, in addition, birds may be designated as California species of special

concern. Construction-related activities (e.g., trimming and removal of vegetation, and equipment noise, vibration, and lighting) that result in harm, injury, or death of individuals, or abandonment of an active nest is a potentially significant impact that can be reduced to a less-than-significant level with implementation of **Mitigation Measure BIO-1.3** identified below, which includes surveys to identify the presence of active nests prior to construction and measures to avoid active nests if found.

New development proposed adjacent to open space areas has the potential to adversely affect special-status species and natural communities within the open space areas. Damaging effects may include vandalism, dumping of trash, trampling, mountain bike use, equestrian use, and off-road vehicle use; runoff from adjacent streets and landscaped areas containing lawn fertilizer, pesticides, and vehicle waste (petroleum byproducts); introduction of invasive non-native species; off-trail activity resulting in habitat destruction and/or fragmentation and spread of invasive species; lights and noise from nearby development; unregulated movement of domestic animals; and a lack of barriers to special-status species that may enter developed areas, which may result in individual mortality. These adverse effects may be the result of activities occurring within development areas and indirectly affecting the adjacent habitat areas (e.g., water runoff), or result of increased public access and use of the open space areas due to the increase in local population and availability of open space recreational amenities. This is considered a potentially significant impact that can be reduced to a less-than-significant level with implementation of **Mitigation Measure BIO-1.4** provided below, which includes implementation of open space requirements.

#### Mitigation Measures for Impacts to Special-Status Species

Implementation of the following mitigation measures will reduce the potentially significant impacts to special-status species to a less-than-significant level. Mitigation measures may be refined as part of EIR preparation. Additionally, although impacts to HMP plant and wildlife species are considered less than significant, **Mitigation BIO-1.1** below will be implemented to further reduce the less-than-significant impact consistent with the HMP and the BO requirements in deed covenants.

**BIO-1.1: Project-Specific Biological Assessments (HMP Species).** The CSUMB CPD Department shall require that a biological survey of development sites be conducted by a qualified biologist to determine if the development could potentially impact HMP species of potential habitat. A report describing the results of the surveys will be provided to the CSUMB CPD Department prior to any ground disturbing activities. The report will include, but not be limited to: 1) a description of the biological conditions at the site; 2) identification of the potential for HMP species to occur or HMP species observed, if any; and 3) maps of the locations of HMP species or potential habitat, if observed.

If HMP species that do not require take authorization from the Service or CDFW are identified within the development site, salvage efforts for these species will be evaluated by a qualified biologist in coordination with CSUMB CPD Department to further reduce impacts per the requirements of the HMP and BO. Where salvage is determined feasible and proposed, seed collection should occur from plants within the development site and/or topsoil should be salvaged within occupied areas to be disturbed. Seeds should be collected during the appropriate time of year for each species by qualified biologists. The collected seeds and topsoil should be used to revegetate temporarily disturbed construction areas and reseeded and restoration efforts on- or off-site, as determined appropriate by the qualified biologist and CSUMB CPD Department.

If HMP species that require take authorization from the Service and/or CDFW are identified within the development site, the CSUMB CPD Department will comply with ESA and CESA and obtain necessary permits prior to construction.

**BIO-1.2: Project-Specific Biological Assessments (Non-HMP Species).** The CSUMB CPD Department shall require that a biological survey of development sites be conducted by a qualified biologist to determine if the development could potentially impact a special-status species or their habitat. A report describing the results of the surveys will be provided to the CSUMB CPD Department prior to any ground disturbing activities. The report will include, but not be limited to: 1) a description of the biological conditions at the site; 2) identification of the potential for special-status species to occur or special-status species observed, if any; 3) maps of the locations of special-status species or potential habitat, if observed; and 4) recommended mitigation measures, if applicable.

If special-status species are determined not to occur at the development site, no additional mitigation is necessary.

If special-status species are observed or determined to have the potential to occur, the project biologist shall recommend measures necessary to avoid, minimize, and/or compensate for identified impacts. Measures may include, but are not limited to, revisions to the project design and project modifications, pre-construction surveys, construction buffers, construction best management practices, monitoring, non-native species control, restoration and preservation, and salvage and relocation.

**BIO-1.3: Pre-Construction Surveys for Protected Avian Species.** Construction activities that may directly (e.g., vegetation removal) or indirectly (e.g., noise/ground disturbance) affect protected nesting avian species will be timed to avoid the breeding and nesting season. Specifically, vegetation and/or tree removal can be scheduled after September 16 and before January 31. Alternatively, a qualified biologist will be retained by the CSUMB CPD Department to conduct pre-construction surveys for nesting raptors and other protected avian species within 500 feet of proposed construction activities if construction occurs between February 1 and September 15. Pre-construction surveys will be conducted no more than 14 days prior to the start of construction activities during the early part of the breeding season (February through April) and no more than 30 days prior to the initiation

of these activities during the late part of the breeding season (May through August). Because some bird species nest early in spring and others nest later in summer, surveys for nesting birds may be required to continue during construction to address new arrivals, and because some species breed multiple times in a season. The necessity and timing of these continued surveys will be determined by the qualified biologist based on review of the final construction plans and in coordination with the Service and CDFW, as needed.

If raptors or other protected avian species nests are identified during the pre-construction surveys, the qualified biologist will notify the CSUMB CPD Department and an appropriate no-disturbance buffer will be imposed within which no construction activities or disturbance shall take place (generally 500 feet in all directions for raptors; other avian species may have species-specific requirements) until the young of the year have fledged and are no longer reliant upon the nest or parental care for survival, as determined by a qualified biologist.

**BIO-1.4: Implement Open Space Protection Requirements.** For open space areas adjacent to the campus development, the following measures shall be implemented:

- Conduct an access assessment to identify necessary access controls. In some cases, structures including fences or other appropriate barriers may be required within the new development parcel to control access into the habitat areas. An assessment of access issues and necessary controls will be completed as part of planning for the development and submitted to the CSUMB CPD Department for review and approval, prior to development.
- Signs, interpretive displays, trailhead markers, or other information will be installed and maintained at identified urban/wildland interface that illustrate the importance of the adjacent habitat area and prohibit trespass, motor vehicle entry, dumping of trash or yard wastes, pets off-leash, capture or harassment of wildlife, impacts to special-status species, and other unauthorized activities.
- Incorporate non-native species control features into site design. Detention ponds or other water features associated with new development will be sited as far from the urban/wildland interface as possible. Suitable barriers will be located between these features and the habitat area boundary to prevent these features from becoming “sinks” for special-status wildlife species, as well as sources for invasive non-natives that could then move into the adjacent habitat area.

If detention ponds or other waterbodies must be located at the urban/wildland interface, a specific management program addressing control of non-native animals (e.g., bullfrogs) must be prepared and submitted for review and approval by the CSUMB CPD Department, prior to development.

- Landscaping within the areas adjacent to open space areas will consist of native or non-native plant species that will not colonize reserve areas in the former Fort Ord

outside the campus boundaries. Any landscaping or replanting required for the project will not use species listed as noxious by the CDFA. All landscape plans will be reviewed by the CSUMB CPD Department.

- Limit artificial lighting at the urban/wildland interface. Outdoor lighting associated with new development will be low intensity, focused, and directional to preclude night illumination of the adjacent habitat area. Outdoor lighting will be placed as far from the urban/wildland interface as possible given safety constraints. Facilities such as ball parks and fields that require high intensity night lighting (i.e., flood lights) will be sited as far from the urban/wildland interface as possible. High-intensity lighting facing the habitat areas will be directional and as low to the ground as possible to minimize long distance glare.
- Develop and implement erosion control measures to prevent sediment transport into and within habitat areas. Erosion control measures will be required where vegetation removal or soil disturbance occurs as a result of all facility construction and maintenance, including trail, road, or fuelbreak construction/maintenance, access controls, or stormwater management, consistent with existing stormwater management plans. Specific measures to be implemented shall be detailed in an erosion control plan. The erosion control plan will include, at a minimum, the following measures.
  - Re-contour eroded areas.
  - Maintain and grade areas along the reserve perimeter and main roads as appropriate to avoid washouts. Gullies will be repaired as needed.
  - Install drainage features such as outlet ditches, rolling dips (similar to waterbars), and berms as needed to facilitate the proper drainage of storm runoff.
  - Add soil amendments such as fertilizers and gypsum for designated development areas only.
  - Prevent sediments from entering basins or swales that could be used by HCP species during erosion control activities.
  - Design and conduct erosion control measures to minimize the footprint of the structures and repairs, and design structures to minimize potential impacts on CTS that may be moving between breeding and upland habitats.
  - Use weed-free mulch, weed-free rice, sterile barley straw, or other similar functioning product where needed for erosion control. Seed native plant species to stabilize soils disturbed by erosion control activities and prevent colonization by invasive weeds. Incorporate native plant species to the extent practicable.

---

**Impact BIO-2: Impacts to Riparian Habitat, State or Federally Protected Wetlands, or other Sensitive Natural Community.** *Implementation of the proposed Master Plan could result in removal of riparian habitat or other sensitive community as identified in local or regional plans, policies, or regulations or by the California Department of Fish and Wildlife or US Fish and Wildlife Service, or state or federally protected wetlands (including, but not limited to, marsh, vernal pool, coastal, etc.) through direct removal, filling, hydrological interruption, or other means. This is a potentially significant impact that can be reduced to a less-than-significant level with implementation of the mitigation measures below.*

---

Vegetation types occurring within the Project site that are listed as sensitive on the CDFW's *Natural Communities List* (CDFW, 2010) include central maritime chaparral and central maritime chaparral mix types. Approximately 124.3 acres of central maritime chaparral (including central maritime chaparral mix types) are present within the Project site. The proposed Master Plan does not site new development in the areas where central maritime chaparral is located; however, these sensitive vegetation types could be impacted if trail or other similar development occurs in the East Campus Housing or East Campus Open Space areas.

As described in the Impact Analysis Approach, the implementation of the HMP mitigates for the loss of central maritime chaparral by preserving the same habitat within the habitat reserve areas on the former Fort Ord. Therefore, impacts to central maritime chaparral are considered less than significant with the implementation of the HMP.

Although not observed on the Project site during the surveys in 2016 and 2017, there is a low potential for future establishment of riparian habitat, state or federally protected wetlands, and/or other sensitive communities within the campus boundaries. Development that occurs within or adjacent to sensitive natural communities may result in a significant impact. The presence of sensitive natural communities on a development site must be evaluated prior to approval of the development. Any impacts to sensitive natural communities are considered a significant impact that can be reduced to a less-than-significant level with implementation of **Mitigation Measure BIO 1.5** identified below, which includes project-specific biological assessments for future development to determine presence/absence of sensitive habitats and identification of measures necessary to avoid, minimize, and/or compensate for any identified impacts.

#### Mitigation Measures for Impacts to Sensitive Natural Communities

Implementation of the following mitigation measure will reduce the potentially significant impacts to sensitive natural communities to a less-than-significant level. Mitigation measures may be refined as part of EIR preparation.

**BIO-1.5: Project-Specific Sensitive Natural Community Assessments.** The CSUMB CPD Department shall require that any development that could potentially impact a sensitive natural community shall be required to conduct a survey of the site by a qualified biologist. A report describing the results of the survey will be provided to the CSUMB CPD Department prior to any ground disturbing activities. The report will include, but is not limited to: 1) a description of the biological conditions at the site; 2) identification of the potential for sensitive habitats or sensitive habitats observed, if any; 3) maps of the locations of sensitive habitats or potential sensitive habitat, if observed; and 4) recommended avoidance and minimization measures, if applicable. If a potential state or



federally protected wetland is newly identified to be present on the site, a formal wetland delineation will be conducted in accordance to ACOE methodology.

If a proposed development cannot avoid impacts to sensitive habitat areas, the CSUMB CPD Department shall require a compensatory habitat-based mitigation to reduce impacts. Compensatory mitigation must involve the preservation, restoration, or purchase of off-site mitigation credits for impacts to sensitive habitats. Mitigation must be conducted in-kind or within an approved mitigation bank in the region. The specific mitigation ratio for habitat-based mitigation will be determined through consultation with the appropriate agency (i.e., CDFW, Service, or ACOE) on a project-by-project basis.

Impacts to sensitive habitats, including but not limited to, vernal pools, streambeds, waterways, or riparian habitat, protected under Section 1600 of Fish and Wildlife Code and Sections 401 and 404 of the CWA, require regulatory permitting to reduce impacts. Acquisition of permits and implementation of the approved mitigation strategy would ensure impacts are fully mitigated and “no net loss” of wetland habitat would occur.

---

**Impact BIO-3: Impacts to Movement of Wildlife.** *Implementation of the proposed Master Plan would not result in interference with wildlife migration or corridors. No impact will occur.*

---

Wildlife movement corridors are pathways or habitat linkages that connect discrete areas of natural open space otherwise separated or fragmented by topography, changes in vegetation, and other natural or man-made factors, such as urbanization. The fragmentation of natural habitat creates isolated “islands” of vegetation that may not provide sufficient area or resources to accommodate sustainable populations for a number of species, and therefore, adversely affect both genetic and species diversity. Corridors often partially or largely mitigate the adverse effects of fragmentation by: 1) allowing animals to move between remaining habitats to replenish depleted populations and increase the gene pool available; 2) providing escape routes from fire, predators, and human disturbances, thus, reducing the risk that catastrophic events (e.g., fire and disease) will result in population or species extinction; and 3) serving as travel paths for individual animals moving throughout their home range in search of food, water, mates, and other needs, or for dispersing juveniles in search of new home ranges.

The East Campus Open Space connects with other planned habitat areas to the east, south, and north and is considered an important area for wildlife movement. The majority of the area is proposed to be retained in Open Space and the remainder of the area is designated as a Development Reserve and is not proposed for development as part of the proposed Master Plan, thus maintaining wildlife movement through this area. No other areas of the campus contain significant open space areas that would support wildlife movement. Therefore, no impacts to movement of wildlife would result from implementation of the proposed Master Plan.

#### Mitigation Measures for Impacts to Movement of Wildlife

As no impacts to movement of wildlife resulting from implementation of the proposed Master Plan would occur, no additional mitigation measures are required.

---

**Impact BIO-4: Conflicts with Local Biological Policies and Ordinances.** *Implementation of the proposed Master Plan would not conflict with local policies and ordinances protecting biological resources, including tree preservation policies. This is a less-than-significant impact.*

---

Implementation of the proposed Master Plan may result in impacts to trees within the campus boundaries. However, CSUMB has established a tree restoration program for impacts to coast live oak and other trees resulting from projects that take place on campus. This program requires that for every tree greater than 4” dbh removed, a minimum of two coast live oak trees would be replanted in the identified restoration area on campus. The implementation of this program is required for all development that would result in impacts to trees at least 4” dbh. The replanting specifications would be required in subsequent project plans and permits. Proposed PDF OS-4, continues and expands this program to maximize the health and stability of existing and replacement trees. Therefore, implementation of the proposed Master Plan would not conflict with the CSUMB tree restoration program and the impact would be less than significant.

Mitigation Measures for Impacts Related to Conflict with Local Policies

As impacts related to conflicts with local policies would be less than significant, no additional mitigation measures are required.

---

**Impact BIO-5: Conflicts with any Adopted HCP, NCCP, or Other Approved Conservation Plan.** *Implementation of the proposed Master Plan would not conflict with any adopted HCP, NCCP, or other approved conservation plan. No impact will occur.*

---

As described in **Section 3.5.3**, the Project site is not located within an approved HCP or NCCP area. However, the Project site is located within the approved Fort Ord HMP area. The entire Project site is located within parcels designated by the HMP as “development.” As described above in the Regulatory section, parcels designated as “development” do not have habitat requirements. Additionally, a portion of the campus, along the southeastern boundary of the East Campus Open Space parcel (Army parcel number S1.3.2), is designated in the HMP as having Borderlands requirements. Borderlands are designated development parcels or habitat reserve parcels at the urban/wildland interface where specific design considerations and management activities are required to minimize effects of development on HMP species and natural communities.

CSUMB is required to implement HMP requirements in accordance with the deed covenants, which apply to all parcels within the campus boundaries. Therefore, although impacts to HMP plant and wildlife species are considered less than significant, **Mitigation BIO-1.1** will be implemented to further reduce the less-than-significant impact. Therefore, implementation of the proposed Master Plan would not conflict with the approved HMP and no impact would occur.

Mitigation Measures for Impacts Related to Conflict with an Adopted HCP

As no impacts related to conflicts with an adopted HCP would occur, no additional mitigation measures are required. However, although impacts to HMP plant and wildlife species are considered less than significant, **Mitigation BIO-1.1** (see above) will be implemented to further reduce the less-than-significant impact consistent with the HMP and the BO requirements in deed covenants.

### 5.3 Impacts and Mitigation Measures – Near-Term Development Components

**Impact BIO-1: Impacts to Special-Status Species and Habitat.** *Implementation of the proposed near-term development components could result in removal of special-status plant and wildlife species and their habitat. This is a potentially significant impact that can be reduced to a less-than-significant level with the implementation of the mitigation measures identified below.*

The proposed near-term development components are generally located on disturbed and mostly developed sites. However, the construction of the near-term development components may result in direct loss of individuals and habitat for a number of special-status wildlife species, including special-status bat species, Monterey dusky-footed woodrat, SBB, Northern California legless lizard, and nesting raptors and other protected avian species. In addition, construction of the near-term development components may also result in direct loss of individuals and habitat for Monterey spineflower. The known and potential special-status species and habitat within each of the near-term development component sites are described below.

1. Near-Term Development Component #1 (Student Housing Phase III)

This development site is primarily developed, but the site does contain some suitable habitat for the Northern California legless lizard. In addition, trees within and adjacent to the site may provide nesting habitat for raptors, migratory birds, and other protected avian species.

2. Near-Term Development Component #2 (Academic IV Building)

This development site contains mostly developed areas with some ruderal/disturbed areas and would require building demolition. Four dune buckwheat individuals were identified within this site. These areas may provide habitat for this species (**Figure 12**). Therefore, this species has a moderate potential to occur within the Project site. In areas not surveyed (i.e., the staging area, see Figure 6), the ruderal/disturbed habitat may provide suitable habitat for Northern California legless lizard. In addition, mature trees and existing buildings within and adjacent to the site may provide nesting habitat for raptors, migratory birds, and other protected avian species and Townsend's big-eared bat. No special-status plant species were observed within the development site and staging area, and none are expected to occur in these areas.

3. Near-Term Development Component #3 (Student Recreation Center)

The ruderal/disturbed habitat within the site may provide suitable habitat for Northern California legless lizard. In addition, mature trees and existing buildings within and adjacent to the site may provide nesting habitat for raptors, migratory birds, and other protected avian species, as well as the Townsend's big-eared bat and hoary bat. Although the hoary bat may roost and forage within some of the oak trees during the winter, they are not known to breed in California. Therefore, impacts to hoary bat are unlikely. The oak trees may provide suitable habitat for the Monterey dusky-footed woodrat. Additionally, approximately 0.01 acre of Monterey spineflower was observed within the development site.

4. Near-Term Development Component #4 (Student Housing Phase IIB)

This development site is primarily developed with some ruderal/disturbed areas. The ruderal/disturbed habitat within the site may provide suitable habitat for Northern California legless lizard. In addition, mature trees within and adjacent to the site may provide nesting habitat for raptors, migratory birds, and other protected avian species, as well as the Townsend's big-eared bat and hoary bat. However, for the same reasons as identified for Near-Term Development #3, impacts to hoary bat are unlikely.

5. Near-Term Development Component #5 (Academic V Building)

This development site is completely developed; however, trees within and adjacent to the site may provide nesting habitat for raptors, migratory birds, and other protected avian species.

As described in the Impact Analysis Approach section above, impacts to HMP plant and wildlife species are considered less than significant unless take authorization is required from the Service and/or CDFW. Since impacts to the Northern California legless lizard and Monterey spineflower would not require take authorization from the Service and/or CDFW, no additional mitigation is required for these two species. However, near-term development component #2 has the potential to impact SBB habitat, which would require take authorization from the Service to avoid violation of ESA. Implementation of **Mitigation Measure BIO-1.6** identified below would reduce the potential impacts to SBB to a less-than-significant level by avoiding SBB habitat if possible, and if not possible, requiring compliance with ESA in advance of construction.

Per the discussions above, near-term development components #1-5 have the potential to impact nesting habitat for raptors, migratory birds, and other protected avian species. Implementation of **Mitigation Measure BIO-1.3** identified in **Section 5.2** above would reduce the potential impacts to nesting raptors, migratory birds, and other protected avian species to a less-than-significant level. No additional project-specific mitigation is required.

Near-term development components #3, 4, and 5 have the potential to impact Townsend's big-eared bat. Implementation of **Mitigation Measures BIO-1.2** and **BIO-1.4** identified above and **Mitigation Measure BIO-1.7** identified below would reduce the potential impacts to Townsend's big-eared bat to a less-than-significant level by conducting pre-constructions survey and implementing avoidance and minimization measures if any Townsend's big-eared bats or their roosts are found. No additional project-specific mitigation is required.

Near-term development component #3 has the potential to impact Monterey dusky-footed woodrat. Implementation of **Mitigation Measures BIO-1.2** and **BIO-1.4** identified above and **Mitigation Measure BIO-1.8** identified below would reduce the potential impacts to Monterey dusky-footed woodrat to a less-than-significant level by conducting pre-constructions survey and implementing avoidance and minimization measures if any Monterey dusky-footed woodrats or their nests are found. No additional project-specific mitigation is required.

### Mitigation Measures for Impacts to Special-Status Species

Implementation of **Mitigation Measures BIO-1.2** through **BIO-1.4** and the following mitigation measures will reduce the potential impacts to special-status species associated with the near-term development components to a less-than-significant level.

**BIO-1.6: Smith's Blue Butterfly Habitat Avoidance/ESA Compliance.** SBB habitat (i.e. dune buckwheat) shall be avoided to the greatest extent feasible. SBB habitat that will not be impacted by the project shall be protected prior to and during construction to the maximum possible through the use of exclusionary fencing and/or flagging. A biological monitor will supervise the installation of protective fencing/flagging and monitor at least once per week until construction is complete to ensure that the protective fencing/flagging remains intact.

If all SBB habitat is avoided, no additional mitigation is necessary. If the project will impact SBB habitat, CSUMB will comply with the FESA and obtain necessary authorizations prior to construction due to the assumed presence of the Federally listed SBB. CSUMB shall be required to initiate consultation with the Service to receive take authorization. Take authorization would be granted through the issuance of an individual, project-specific incidental take permit. Mitigation for take likely would require restoration at a 3:1 ratio of impacted habitat. Dune buckwheat plants and/or seed salvage may also be required prior to ground disturbing activities.

**BIO-1.7: Pre-Construction Bat Assessment and Surveys.** To avoid and reduce impacts to Townsend's big-eared bat, a qualified bat specialist or wildlife biologist shall conduct site surveys during the reproductive season (May 1 through September 15) to characterize bat utilization of the site and potential species present (techniques utilized to be determined by the biologist) prior to structure removal. Based on the results of these initial surveys, one or more of the following will occur:

- If it is determined that bats are not present at the site, no additional mitigation is required.
- If it is determined that bats are utilizing the site and may be impacted by the development, pre-construction surveys will be conducted no more than 30 days prior to any structure removal. If, according to the bat specialist, no bats or bat signs are observed in the course of the pre-construction surveys, structure removal may proceed. If bats and/or bat signs are observed during the pre-construction surveys, the biologist will determine if disturbance will jeopardize the roost (i.e., maternity, day, or night).
- If a single bat and/or only adult bats are roosting, removal of buildings may proceed after the bats have been safely excluded from the roost. Exclusion techniques will be determined by the biologist and depend on the roost type; the biologist will prepare a mitigation plan for provision of alternative habitat to be approved by the CDFW.
- If an active maternity roost is detected, avoidance is preferred. Work in the vicinity of the roost (buffer to be determined by biologist) will be postponed until

the biologist monitoring the roost(s) determines that the young are no longer dependent on the roost. The monitor will ensure that all bats have left the area of disturbance prior to initiation of structure removal. If avoidance is not possible and a maternity roost must be disrupted, a depredation permit would be required prior to removal of the roost.

**BIO-1.8: Pre-Construction Monterey Dusky-Footed Woodrat Surveys.** Not more than thirty (30) days prior to the start of construction (including vegetation removal), a qualified biologist shall conduct a survey of the development sites to locate existing Monterey dusky-footed woodrat nests. All Monterey dusky-footed woodrat nests shall be mapped and flagged for avoidance. Graphics depicting all Monterey dusky-footed woodrat nests shall be provided to CSUMB and the construction contractor. Any Monterey dusky-footed woodrat nests that cannot be avoided shall be relocated according to the following procedures.

Each active nest shall be disturbed by the qualified biologist to the degree that the woodrats leave the nest and seek refuge elsewhere. After the nests have been disturbed, the nest sticks shall be removed from the impact areas and placed outside of areas planned for impacts. Nests shall be dismantled during the non-breeding season (between October 1 and December 31), if possible. If a litter of young is found or suspected, nest material shall be replaced and the nest left alone for 2-3 weeks, after this time the nest will be rechecked to verify that young are capable of independent survival before proceeding with nest dismantling.

---

**Impact BIO-2: Impacts to Riparian Habitat, State or Federally Protected Wetlands, or other Sensitive Natural Community.** *Implementation of the proposed near-term development components would not result in removal of riparian habitat or other sensitive community as identified in local or regional plans, policies, or regulations or by the California Department of Fish and Wildlife or US Fish and Wildlife Service, or state or federally protected wetlands (including, but not limited to, marsh, vernal pool, coastal, etc.) through direct removal, filling, hydrological interruption, or other means. No impact would occur.*

---

The proposed near-term development components are generally located on sites that have been disturbed and are mostly developed. No sensitive communities occur within the near-term development component sites; therefore, no impacts would occur.

---

**Impact BIO-3: Impacts to Movement of Wildlife.** *Implementation of the proposed near-term development components would not result in interference with wildlife migration or corridors. No impacts would occur.*

---

The proposed near-term development components are generally located on sites that have been disturbed and are mostly developed. These sites do not contain significant wildlife habitat used for migration or movement corridor; therefore, no impacts would occur.

---

**Impact BIO-4: Conflicts with Local Biological Policies and Ordinances.** *Implementation of the proposed near-term development components would not conflict with local policies and ordinances protecting biological resources, including tree preservation policies. This is a less-than-significant impact.*

---

Implementation of the proposed near-term development component #3 (Student Recreation Center) may result in impacts to trees within the campus boundaries; other near-term developments would not result in tree removal. However, CSUMB has established a tree restoration program for impacts to coast live oak and other trees resulting from projects that take place on campus. This program requires that for tree 4” dbh or greater removed, a minimum of two coast live oak trees would be replanted in the identified restoration area on campus. The implementation of this program is required for all projects that would result in impacts to trees. Further, proposed PDF OS-4 continues and expands this program to maximize the health and stability of existing and replacement tree species, including replacement of all removed trees 4” dbh or greater at a minimum 2:1 ratio. Therefore, as a feature of the project design, two coast live oak trees would be replanted for every tree greater than 4” dbh removed. The replanting specifications would be required in final project plans. Therefore, the potential to conflict with the CSUMB tree restoration program is less than significant.

---

**Impact BIO-5: Conflicts with any Adopted HCP, NCCP, or Other Approved Conservation Plan.** *Implementation of the proposed near-term development components would not conflict with any adopted HCP, NCCP, or other approved conservation plan. No impact will occur.*

---

As described in **Section 3.5.3**, the campus is not located within an approved HCP or NCCP area. However, the campus is located within the approved Fort Ord HMP area. All of the proposed near-term development component sites are located within parcels designated by the HMP as “development.” CSUMB is required to implement HMP requirements, applicable to all parcels within the campus boundaries, which is acknowledged and described in Mitigation BIO-1.1 (see Impact BIO-1). Therefore, as described above in **Section 5.2**, implementation of the proposed near-term development components would not conflict with the approved HMP and no impact would occur.

## 6.0 REFERENCES

- Arnold, R.A., 1983. Ecological studies of six endangered butterflies (Lepidoptera: Lycaenidae): Island biogeography, patch dynamics, and design of habitat preserves. University of California Publications in Entomology, Vol. 99. Pp. 1-161.
- Baldwin, B. G, et. al. 2012. The Jepson Manual – Vascular Plants of California, Second Edition, Thoroughly Revised and Expanded. University of California Press. Berkeley, CA. 1600 pp.
- Bulger, J.B., N.J. Scott Jr., and R.B. Seymour. 2003. Terrestrial activity and conservation of adult California red-legged frog *Rana aurora draytonii* in coastal forests and grasslands. Biological Conservation, Vol. 110. Pp. 85-95.
- California Department of Fish and Wildlife (CDFW). 2008. California Wildlife Relationships System: Life History Accounts. Database Version 8.2.
- CDFW. 2009. Protocols for Surveying and Evaluating Impacts to Special Status Native Plant Populations and Natural Communities. Available online at: [http://www.dfg.ca.gov/biogeodata/cnddb/pdfs/Protocols\\_for\\_Surveying\\_and\\_Evaluating\\_Impacts.pdf](http://www.dfg.ca.gov/biogeodata/cnddb/pdfs/Protocols_for_Surveying_and_Evaluating_Impacts.pdf)
- CDFW. 2010. List of Vegetation Alliances and Associations (Natural Communities List). Available online at: <https://www.wildlife.ca.gov/Data/VegCAMP/Natural-Communities/List>.
- CDFW. 2017a. California Natural Diversity Data Base Rare Find Report (August, 2017).
- CDFW. 2017b. Special Animals List. Available online at: <http://www.dfg.ca.gov/biogeodata/cnddb/pdfs/SPAnimals.pdf> (January 2011).
- California Native Plant Society (CNPS). 2001. Botanical Survey Guidelines. Available Online at: [http://www.cnps.org/cnps/rareplants/pdf/cnps\\_survey\\_guidelines.pdf](http://www.cnps.org/cnps/rareplants/pdf/cnps_survey_guidelines.pdf)
- CNPS. 2017. Inventory of Rare and Endangered Plants (online edition, v8-03 0.39). California Native Plant Society. Sacramento, CA. Available online at: <http://www.rareplants.cnps.org/>
- Dixon, Dave. 1999. Dunes Alive-The endangered Smith's blue and marina blue butterflies. A closer look at coastal dune wildlife of south Monterey Bay. Tideline, Vol. 19 (3). Pp. 1-3.
- Holland, R.F. 1986. Preliminary descriptions of the terrestrial natural communities of California. Nongame-Heritage Program, California Department of Fish and Wildlife, Sacramento, CA. 156 pp.
- Howitt, B.F. and J.T. Howell. 1964. The vascular plants of Monterey County, California.
- Howitt, B.F. and J.T. Howell. 1973. Supplement to the vascular plants of Monterey County, California. Pacific Grove Museum of Natural History Association, Pacific Grove, CA. 60 pp.
- ICF International, Inc. 2017. Administrative Draft Fort Ord Habitat Conservation Plan. August. San Francisco, CA. Prepared for the Fort Ord Reuse Authority, Marina, CA. Unpublished.
- ITSI Gilbane. 2014. 2013 Annual Biological Monitoring Report, Former Fort Ord, California, Worldwide Environmental Remediation Services Contract No. W912DY-10-D-0024. Available online at: [http://docs.fortordcleanup.com/ar\\_pdfs/AR-BW-2686//BW-2686.pdf](http://docs.fortordcleanup.com/ar_pdfs/AR-BW-2686//BW-2686.pdf)



- Jennings, M.R. and M.P. Hayes. 1986. Decline of ranid frog species in western North America: are bullfrogs (*Rana catesbeiana*) responsible? *Journal of Herpetology* Vol. 20 (4). Pp. 490-509.
- Jennings, M.R. and M.P. Hayes. 1988. Habitat correlates of distribution of the California red-legged frog (*Rana draytonii*) and the foothill yellow-legged frog (*Rana boylei*): implications for management. *Proceedings from Management of Amphibians, Reptiles and Small Mammals in North America Symposium 1988*.
- Jennings, M.R. and M.P. Hayes. 1994. Amphibian and reptile species of special concern in California. Final report to the California Department of Fish and Wildlife, Inland Fisheries Division. 255 pp.
- Jepson Flora Project. 2017. Jepson Online Interchange for California floristics. Available online at: <http://ucjeps.berkeley.edu/interchange.html>
- Loredo et al. 1996. Habitat use and migration behavior of the California tiger salamander. *Journal of Herpetology*, Vol. 30(2). Pp. 282-285.
- Matthews, M.A and M. Mitchell. 2015. *The Plants of Monterey County; an Illustrated Field Key (Second Edition)*. California Native Plant Society, Sacramento, California. 446 pp.
- Moyle, P.B. 1973. Effects of introduced bullfrogs, *Rana catesbeiana*, on the native frogs of the San Joaquin Valley, California. *Copeia* 1973. Pp. 18-22.
- Munz, P. A. and D. D. Keck. 1973. *A California flora and supplement*. University of California Press, Berkeley, CA. 1681 pp., + 224 pp. supplement.
- Parham, J.F. and T.J. Papenfuss. 2008. High genetic diversity among fossorial lizard populations (*Anniella pulchra*) in a rapidly developing landscape (Central California). *Conservation Genetics*, Vol 10. Pp. 169-176.
- Pollinator Partnership and U.S. Forest Service [USFS], 2012. *Bumble Bees of the Western United States*. Available online at: <http://www.pollinator.org/PDFs/BumbleBee.GuideWestern.FINAL.pdf>
- Rathbun, G.B., M.R. Jennings, T.G. Murphey, and N.R. Siepel. 1993. Status and ecology of sensitive aquatic vertebrates in lower San Simeon and Pico Creeks, San Luis Obispo County, California. Unpublished report, National Ecology Research Center, Pederast Blancas Research Station, San Simeon, California. 103 pp.
- Remsen, J.V. Jr. 1978. Bird species of special concern in California. California Dept. of Fish and Wildlife, Nongame Wildlife Investigations, Wildlife Management Branch Administrative Report No. 78-1.
- Roberson, D. 2002. *Monterey Birds*. Monterey Peninsula Audubon Society, Carmel, CA. 536 pp.
- Sawyer, J.O., T. Keeler-Wolf, and J.M. Evens. 2009. *A manual of California vegetation 2<sup>nd</sup> Edition*. California Native Plant Society, Sacramento, CA. 1300 pp.
- Stebbins, R.C. 1972. *California Amphibians and Reptiles*. University of California Press, Berkeley. 152 pp.
- Stebbins, R.C. 1985. *Western reptiles and amphibians*. Houghton Mifflin Company, Boston, MA. 336 pp.

- Stebbins, R.C. 2003. Western reptiles and amphibians, 3<sup>rd</sup> edition. Houghton Mifflin Company, New York, NY. 533 pp.
- Thelander, C. (ed.). 1994. Life on the edge: A guide to California's endangered natural resources: wildlife. BioSystems Books, Santa Cruz, CA.
- U.S. Army Corps of Engineers (ACOE), Sacramento District. 1992. Flora and Fauna Baseline Study of Fort Ord, California. With technical assistance from Jones and Stokes Associates, Inc. Sacramento, California.
- ACOE, Sacramento District. 1997. Installation-Wide Multispecies Habitat Management Plan for Former Fort Ord, California. April 1997. Sacramento, CA.
- U.S. Fish and Wildlife Service (Service). 1976. Determination That Six Species of Butterflies are Endangered Species; 41 FR 22041-22044 (Lotis blue, *Lycaeides argyrognomon lotis*; El Segundo blue, *Shijimiaeoides battoides allyni*; Smith's blue, *Shijimiaeoides enoptes smithi*; Mission blue, *Icaricia icarioides missionensis*; San Bruno elfin, *Callophrys mossi bayensis*; Lange's metalmark, *Apodemia mormo langei*). Federal Register, Vol. 41(106). Pp. 22041-22044.
- Service. 1984. Smith's Blue Butterfly Recovery Plan. Available Online at: [https://ecos.fws.gov/docs/recovery\\_plan/841109.pdf](https://ecos.fws.gov/docs/recovery_plan/841109.pdf)
- Service. 1993. Biological Opinion for the Disposal and Reuse of Fort Ord, Monterey County, California (1-8-93-F-14).
- Service. 1996. Endangered and Threatened Wildlife and Plants; Determination of Threatened Status for the California Red-legged Frog; Final Rule. Federal Register, Vol. 61(101). Pp. 25813-25833.
- Service. 1998. Endangered and threatened wildlife and plants; Withdrawal of Proposed Rule to List the Black Legless Lizard, Proposed rule. Federal Register, Vol. 69(149). Pp. 47211-47248.
- Service. 2000. Guidelines for Conducting and Reporting Botanical Inventories for Federally Listed, Proposed, and Candidate Plants. Available online at: [http://www.fws.gov/ventura/speciesinfo/protocols\\_guidelines/docs/botanicalinventories.pdf](http://www.fws.gov/ventura/speciesinfo/protocols_guidelines/docs/botanicalinventories.pdf)
- Service. 2004. Endangered and threatened wildlife and plants; Determination of threatened status for the California Tiger Salamander; and special rule exemption for existing routine ranching activities; Final rule. Federal Register, Vol. 69(149). Pp. 47211-47248.
- Service. 2005. Endangered and Threatened Wildlife and Plants; Designation of Critical Habitat for the California Tiger Salamander; Central Population; Final Rule. Federal Register, Vol. 70(162). Pp 49379-49458.
- Service. 2006. Endangered and Threatened Wildlife and Plants; Designation of Critical Habitat for the California Red-legged Frog and Special Rule Exemption Associated with Final Listing for Existing Routine Ranching Activities; Final rule. Federal Register, Vol. 71(71). Pp. 19244-19346.
- Service. 2010. Endangered and Threatened Wildlife and Plants; Revised Designation of Critical Habitat for the California Red-legged Frog; Final rule. Federal Register, Vol. 75(51). Pp. 12816-12959.

- Service. 2013. Birds Protected by the Migratory Bird Treaty Act. Available online at: <http://www.fws.gov/migratorybirds/RegulationsPolicies/mbta/mbtintro.html>
- Service. 2017a. Information Planning and Consultation (IPaC) Resources List for the CSUMB Master Plan Project site.
- Service, 2017b. Critical Habitat Mapper. Available online at: <https://ecos.fws.gov/ecp/report/table/critical-habitat.html>
- Service. 2017c. Recovery Plan for the Central California Distinct Population Segment of the California Tiger Salamander (*Ambystoma californiense*). Available online at: <https://ecos.fws.gov/ecp0/profile/speciesProfile?scode=D01T>
- U.S. Fish and Wildlife Service and California Department of Fish and Wildlife. 2003. Interim guidance on site assessment and field surveys for determining presence of a negative finding of the California tiger salamander.
- United States Fish and Wildlife Service and California Department of Fish and Wildlife. 2005. Revised guidance on site assessments and field surveys for the California red-legged frog. Available online at: [http://www.fws.gov/sacramento/es/Survey-Protocols-Guidelines/Documents/crf\\_survey\\_guidance\\_aug2005.pdf](http://www.fws.gov/sacramento/es/Survey-Protocols-Guidelines/Documents/crf_survey_guidance_aug2005.pdf)
- Williams, D. 1986. Mammalian species of special concern in California. California Department of Fish and Wildlife Report 86-1. 112 pp.
- Williams, P., R. Thorp, L. Richardson, and S. Colla. 2014. Bumble Bees of North America: An Identification Guide. Princeton University Press, Princeton, New Jersey. 209 pp.
- Zeiner, D. C., W. F. Laudenslayer, Jr., K. E. Mayer, and M. White (eds.). 1988. California's wildlife, Volume I: Amphibians and reptiles. California Department of Fish and Wildlife, Sacramento, California. 272 pp.
- Zeiner, D. C., W. F. Laudenslayer, Jr., K. E. Mayer, and M. White (eds.). 1990. California's Wildlife, Volume II: Birds. California Department of Fish and Wildlife, Sacramento, California. 731 pp.



## **APPENDIX A.**

Table of Special-Status Species Known or With the Potential to Occur in the vicinity of the  
Monterey Downs Specific Plan Project Site

(CNDDDB Rare Plant Report from the Marina quadrangle and the six surrounding quadrangles  
[Monterey, Moss Landing, Prunedale, Salinas, Seaside, and Spreckels])

*This page left intentionally blank*

## Special-Status Species Known or With the Potential to Occur in the Vicinity of the CSUMB Proposed Master Plan Project

| Species  | Status<br>(Service/<br>CDFW/CNPS) | General<br>Habitat  | Potential Occurrence within Project Vicinity   |
|--|-----------------------------------|---|--|
| <b>MAMMALS</b>   |                                   |   |  |
| <i>Corynorhinus townsendii</i><br>Townsend's big-eared bat           | -- / CSC / --                     | Found primarily in rural settings from inland deserts to coastal redwoods, oak woodland of the inner Coast Ranges and Sierra foothills, and low to mid-elevation mixed coniferous-deciduous forests. Typically roost during the day in limestone caves, lava tubes, and mines, but can roost in buildings that offer suitable conditions. Night roosts are in more open settings and include bridges, rock crevices, and trees. | <b>Moderate:</b> The abandoned buildings within the Project site may provide low quality day roost or maternity roost habitat. Additionally, this species may forage over all other areas of the Project site. The nearest CNDDDB occurrence is approximately 1.2 miles east of the Project site within the East Garrison development area.  |
| <i>Enhydra lutris nereis</i><br>Southern sea otter                   | FT / CFP / --                     | Found in nearshore marine habitats environments of California from Ano Nuevo to Point Sal. Often associated with giant kelp and bull kelp, these opportunistic foragers eat mainly abalones, sea urchins, crabs, and clams.   | <b>Not Present:</b> No suitable habitat present within Project site.   |
| <i>Lasiurus cinereus</i><br>Hoary bat                                | -- / CNDDDB / --                  | Prefers open habitats or habitat mosaics with access to trees for cover and open areas or edge for feeding. Generally roost in dense foliage of trees; does not use buildings for roosting. Winters in California and Mexico and often migrates towards summer quarters in the north and east during the spring. Young are born and reared in summer grounds, which is unlikely to occur in California.                         | <b>Moderate:</b> May roost within some of the trees within the oak woodland habitat and may forage over all undeveloped areas of the Project site. However, while the species may utilize the Project site as winter grounds, they are unlikely to occur during the summer months and it is unlikely that birth and rearing occur on the site. The nearest CNDDDB occurrence is approximately 5.0 miles southwest of the Project site. |
| <i>Neotoma macrotis luciana</i><br>Monterey dusky-footed woodrat     | -- / CSC / --                     | Forest and oak woodland habitats of moderate canopy with moderate to dense understory. Also occurs in chaparral habitats.   | <b>Present:</b> Numerous woodrat nests were observed throughout the Project site. This species is known to occur throughout Fort Ord. Therefore, this species is assumed present within the Project site.  |
| <i>Reithrodontomys megalotis distichlis</i><br>Salinas harvest mouse | -- / CNDDDB / --                  | Known only to occur from the Monterey Bay region. Occurs in fresh and brackish water wetlands and probably in the adjacent uplands around the mouth of the Salinas River.   | <b>Unlikely:</b> No suitable habitat present within Project site.  |
| <i>Sorex ornatus salarius</i> *<br><b>Monterey ornate shrew</b>      | -- / CSC / --                     | Mostly moist or riparian woodland habitats and within chaparral, grassland, and emergent wetland habitats where there is a thick duff or downed logs.   | <b>High:</b> Suitable habitat is present within the Project site. The CNDDDB does not report any occurrences of this species; however Figure B-18 in the HMP identifies the Project site as containing potential habitat for this species and recent studies on the Fort Ord Natural Reserve have identified Monterey ornate shrew in the same habitat types on the former Fort Ord.   |
| <i>Taxidea taxus</i><br>American badger                              | -- / CSC / --                     | Dry, open grasslands, fields, pastures savannas, and mountain meadows near timberline are preferred. The principal requirements seem to be sufficient food, friable soils, and relatively open, uncultivated grounds.   | <b>High:</b> The CNDDDB reports one occurrence of this species within the eastern portion of the Project site, near Inter-Garrison Rd. Suitable habitat for this species is present within the non-native grassland habitat on the Project site.   |
| <b>BIRDS</b>   |                                   |   |  |
| <i>Agelaius tricolor</i><br>Tricolored blackbird<br>(nesting colony) | -- / SC&CSC / --                  | Nest in colonies in dense riparian vegetation, along rivers, lagoons, lakes, and ponds. Forages over grassland or aquatic habitats.   | <b>Unlikely:</b> No suitable nesting habitat is present within the Project site.   |

| Species   | Status<br>(Service/<br>CDFW/CNPS) | General<br>Habitat   | Potential Occurrence within Project Vicinity   |
|---|-----------------------------------|--|--|
| <i>Asio flammeus</i><br>Short-eared owl<br>(nesting)                              | -- / CSC / --                     | Usually found in open areas with few trees, such as annual and perennial grasslands, prairies, meadows, dunes, irrigated lands, and saline and freshwater emergent marshes. Dense vegetation is required for roosting and nesting cover. This includes tall grasses, brush, ditches, and wetlands. Open, treeless areas containing elevated sites for perching, such as fence posts or small mounds, are also needed. Some individuals breed in northern California. | <b>Unlikely:</b> No suitable nesting habitat is present within the Project site.   |
| <i>Athene cucularia</i><br>Burrowing owl<br>(burrow sites & some wintering sites) | -- / CSC / --                     | Year round resident of open, dry grassland and desert habitats, and in grass, forb and open shrub stages of pinyon-juniper and ponderosa pine habitats. Frequent open grasslands and shrublands with perches and burrows. Use rodent burrows (often California ground squirrel) for roosting and nesting cover. Pipes, culverts, and nest boxes may be substituted for burrows in areas where burrows are not available.   | <b>Moderate:</b> Marginally suitable habitat is present within the Project site within the non-native grassland habitat and some portions of the ruderal areas. The nearest CNDDDB occurrence is 0.6 miles north of the Project site.  |
| <i>Brachyramphus marmoratus</i><br>Marbled murrelet                               | FT / SE / --                      | Occur year-round in marine subtidal and pelagic habitats from the Oregon border to Point Sal. Partial to coastlines with stands of mature redwood and Douglas-fir. Require dense old growth forests of redwood and/or Douglas-fir in higher elevations for breeding and nesting.   | <b>Not Present:</b> No suitable habitat is present within the Project site.  |
| <i>Buteo regalis</i><br>Ferruginous hawk<br>(wintering)                           | -- / CNDDDB / --                  | An uncommon winter resident and migrant at lower elevations and open grasslands in the Modoc Plateau, Central Valley, and Coast Ranges and a fairly common winter resident of grassland and agricultural areas in southwestern California. Frequent open grasslands, sagebrush flats, desert scrub, low foothills surrounding valleys, and fringes of pinyon-juniper habitats. Does not breed in California.   | <b>Low:</b> Only poor quality wintering habitat present within Project site. No breeding habitat present within Project site. The nearest CNDDDB occurrence is 2.0 miles north of the Project site at the Armstrong Ranch.   |
| <i>Charadrius nivosus</i><br>Western snowy plover                                 | FT / CSC / --                     | Sandy beaches on marine and estuarine shores, also salt pond levees and the shores of large alkali lakes. Requires sandy, gravelly or friable soil substrate for nesting.  | <b>Not Present:</b> No suitable habitat present within Project site.   |
| <i>Cypseloides niger</i><br>Black swift<br>(nesting)                              | -- / CSC / --                     | Regularly nests in moist crevice or cave on sea cliffs above the surf, or on cliffs behind, or adjacent to, waterfalls in deep canyons. Forages widely over many habitats.   | <b>Not Present:</b> No suitable nesting habitat present within Project site.   |
| <i>Elanus leucurus</i><br>White-tailed kite<br>(nesting)                          | -- / CFP / --                     | Open groves, river valleys, marshes, and grasslands. Prefer such area with low roosts (fences etc.). Nest in shrubs and trees adjacent to grasslands.  | <b>High:</b> Suitable nesting and foraging habitat present within Project site. The nearest CNDDDB occurrence is 10 miles north of the Project site; however, this species has also been observed by DD&A biologists 0.5 mile east of the Project site, on the north side of Reservation Road.             |
| <i>Empidonax traillii extimus</i><br>Southwestern willow flycatcher               | FE / SE / --                      | Dense willow thickets are required for nesting and roosting. Low, exposed branches are used for singing posts and hunting perches. Open, cup nest is placed in an upright fork of willow or other shrub, or occasionally on a horizontal limb. Most numerous where extensive thickets of low, dense willows edge on wet meadows, ponds, or backwaters.   | <b>Not Present:</b> No suitable habitat present within Project site.   |
| <i>Eremophila alpestris actia</i><br>California horned lark                       | -- / CNDDDB / --                  | Variety of open habitats, usually where large trees and/or shrubs are absent. Found from grasslands along the coast to deserts at sea-level and alpine dwarf-shrub habitats are higher elevations. Builds open cup-like nests on the ground.   | <b>High:</b> Suitable habitat is present within the non-native grassland habitat on the Project site. The nearest CNDDDB occurrence is 1.0 mile from the Project site. This species has also been observed by DD&A biologists 3.5 miles south of the Project site, within the Former Fort Ord Impact Area. |



| Species  | Status<br>(Service/<br>CDFW/CNPS) | General<br>Habitat  | Potential Occurrence within Project Vicinity   |
|--|-----------------------------------|---|--|
| <i>Falco mexicanus</i><br>Prairie falcon<br>(nesting)  | -- / CNDDDB / --                  | Associated primarily with perennial grasslands, savannahs, rangeland, some agricultural fields, and desert scrub areas. Nests in open terrain with canyons, cliffs, escarpments, and rock outcrops.   | <b>Low:</b> Although this species may forage within the Project site, no suitable nesting habitat present.   |
| <i>Falco peregrinus anatum</i><br>American peregrine falcon  | -- / CFP / --                     | Forages for other birds over a variety of habitats. Breeds primarily on rocky cliffs.   | <b>Low:</b> Although this species may forage within the Project site, no suitable nesting habitat present.   |
| <i>Gymnogyps californianus</i><br>California condor  | FE / SE / --                      | Roosting sites in isolated rocky cliffs, rugged chaparral, and pine covered mountains 2000-6000 ft above sea level. Foraging area removed from nesting/roosting site (includes rangeland and coastal area - up to 19 mile commute one way). Nest sites in cliffs, crevices, and potholes. | <b>Not Present:</b> No suitable habitat present within Project site.   |
| <i>Laterallus jamaicensis coturniculus</i><br>California black rail  | -- / ST & CFP / --                | Inhabits freshwater marshes, wet meadows & shallow margins of saltwater marshes bordering larger bays. Needs water depths of about 1 inch that does not fluctuate during the year & dense vegetation for nesting habitat.   | <b>Not Present:</b> No suitable habitat present within Project site.   |
| <i>Pelecanus occidentalis californicus</i><br>California brown pelican<br>(nesting colony & communal roosts) | -- / CFP / --                     | Found in estuarine, marine subtidal, and marine pelagic waters along the California coast. Usually rests on water or inaccessible rocks, but also uses mudflats, sandy beaches, wharfs, and jetties.  | <b>Not Present:</b> No suitable habitat present within Project site.   |
| <i>Rallus obsoletus obsoletus</i><br>California Ridgeway's rail  | FE / SE & CFP / --                | Salt and brackish marshes.  | <b>Not Present:</b> No suitable habitat present within Project site.   |
| <i>Riparia riparia</i><br>Bank swallow<br>(nesting)  | -- / ST / --                      | Nest colonially in sand banks. Found near water; fields, marshes, streams, and lakes.   | <b>Not Present:</b> No suitable habitat present within Project site.   |
| <i>Sterna antillarum browni</i><br>California least tern   | FE / SE / --                      | Prefers undisturbed nest sites on open, sandy/gravelly shores near shallow-water feeding areas in estuaries. Sea beaches, bays, large rivers, bars.   | <b>Not Present:</b> No suitable habitat present within Project site.   |
| <i>Vireo bellii pusillus</i><br>Least Bell's vireo   | FE / SE / --                      | Riparian areas and drainages. Primarily found in Southern California.   | <b>Not Present:</b> No suitable habitat present within Project site.   |
| REPTILES AND AMPHIBIANS  |                                   |   |  |
| <i>Ambystoma californiense</i><br>California tiger salamander  | FT / ST / --                      | Annual grassland and grassy understory of valley-foothill hardwood habitats in central and northern California. Need underground refuges and vernal pools or other seasonal water sources.  | <b>Present:</b> No aquatic breeding habitat is present within the Project site; however, potential upland habitat (i.e., suitable habitat within 2.2 km of known and potential breeding ponds) is present. The nearest CNDDDB occurrence is within the eastern portion of the Project site. Additionally, DD&A biologists encountered this species immediately adjacent to the Project site, and relocated the individual to the nearest suitable upland habitat, which was located within the Project site. |

| Species  | Status<br>(Service/<br>CDFW/CNPS) | General<br>Habitat  | Potential Occurrence within Project Vicinity  |
|--|-----------------------------------|---|---|
| <i>Ambystoma macrodactylum croceum</i><br>Santa Cruz long-toed salamander  | FE / SE&CFP / --                  | Preferred habitats include ponderosa pine, montane hardwood-conifer, mixed conifer, montane riparian, red fir and wet meadows. Occurs in a small number of localities in Santa Cruz and Monterey Counties. Adults spend the majority of the time in underground burrows and beneath objects. Larvae prefer shallow water with clumps of vegetation. | <b>Unlikely:</b> Project site is outside of the known range for this species.   |
| <i>Anniella pulchra</i><br><b>Northern California legless lizard</b><br>(includes <i>A. p. nigra</i> as recognized by the HMP) | -- / CSC / --                     | Requires moist, warm habitats with loose soil for burrowing and prostrate plant cover, often forages in leaf litter at plant bases; may be found on beaches, sandy washes, and in woodland, chaparral, and riparian areas.  | <b>High:</b> Suitable habitat is present within the Project site. The CNDDDB an occurrence that includes the eastern portion of the Project site and an occurrence immediately north of the western portion of the Project site. This species has been observed in several areas of Fort Ord.   |
| <i>Emys marmorata</i><br>Western pond turtle   | UR / CSC / --                     | Associated with permanent or nearly permanent water in a wide variety of habitats including streams, lakes, ponds, irrigation ditches, etc. Require basking sites such as partially submerged logs, rocks, mats of vegetation, or open banks.   | <b>Not Present:</b> No suitable habitat present within Project site.  |
| <i>Phrynosoma blainvillii</i><br>Coast horned lizard   | -- / CSC / --                     | Associated with open patches of sandy soils in washes, chaparral, scrub, and grasslands.  | <b>High:</b> Suitable habitat is present within the coastal scrub, maritime chaparral, grassland, and ruderal habitats within the Project site. This species is known to occur and has been observed by DD&A biologists throughout Fort Ord. The CNDDDB also reports an occurrence of this species within the northeastern portion of the Project site.   |
| <i>Rana boylei</i><br>Foothill yellow-legged frog  | -- / SC / --                      | Partly-shaded, shallow streams and riffles with a rocky substrate in a variety of habitats, including hardwood, pine, and riparian forests, scrub, chaparral, and wet meadows. Rarely encountered far from permanent water.   | <b>Unlikely:</b> Project site is outside of the known range for this species.   |
| <i>Rana draytonii</i><br><b>California red-legged frog</b>   | FT / CSC / --                     | Lowlands and foothills in or near permanent or late-season sources of deep water with dense, shrubby, or emergent riparian vegetation. During late summer or fall adults are known to utilize a variety of upland habitats with leaf litter or mammal burrows.  | <b>Unlikely:</b> No breeding habitat is present within the Project site; however, portions of the Project site are within 1.6 km of potential breeding ponds. The nearest CNDDDB occurrence is approximately 3.0 miles north of the Project site at the Salinas River. The nearest known breeding pond on Fort Ord is 4.7 miles, and the nearest potential breeding pond is 0.4 mile from the Project site. Although the species has the potential to spread to the ponds near the Project site, the potential for CRLF to occur within the Project site at this time is unlikely based on the proximity to the known breeding locations. |
| <i>Taricha torosa torosa</i><br>Coast Range newt<br>(Monterey County south only)   | -- / CSC / --                     | Occurs mainly in valley-foothill hardwood, valley-foothill hardwood-conifer, coastal scrub, and mixed chaparral but is known to occur in grasslands and mixed conifer types. Seek cover under rocks and logs, in mammal burrows, rock fissures, or man-made structures such as wells. Breed in intermittent ponds, streams, lakes, and reservoir.   | <b>Low:</b> No suitable breeding habitat within the Project site. Although suitable upland habitat for this species is present within the Project site, this species has only been documented to breed within one pond on Fort Ord, located approximately 2.2 miles south of the Project site within the Former Fort Ord Impact Area. The nearest CNDDDB occurrence is approximately 10 miles from the Project site at Palo Corona Regional Park.   |
| <i>Thamnophis hammondi</i><br>Two-striped garter snake   | -- / CSC / --                     | Associated with permanent or semi-permanent bodies of water bordered by dense vegetation in a variety of habitats from sea level to 2400m elevation.  | <b>Not Present:</b> No suitable habitat present within Project site.  |

| Species  | Status<br>(Service/<br>CDFW/CNPS) | General<br>Habitat  | Potential Occurrence within Project Vicinity   |
|--|-----------------------------------|---|--|
| <b>FISH</b>  |                                   |   |  |
| <i>Eucyclogobius newberryi</i><br>Tidewater goby   | FE / CSC / --                     | Brackish water habitats, found in shallow lagoons and lower stream reaches.   | <b>Not Present:</b> No suitable habitat present within Project site.   |
| <i>Oncorhynchus mykiss irideus</i><br>Steelhead<br>(South/Central California Coast<br>ESU) | FT / -- / --                      | Coastal perennial and near perennial streams, with suitable spawning and rearing habitat and no major barriers.   | <b>Not Present:</b> No suitable habitat present within Project site.   |
| <i>Spirinchus thaleichthys</i><br>Longfin smelt  | FC / ST / --                      | Euryhaline, nektonic & anadromous. Found in open waters of estuaries, mostly in middle or bottom of water column. Prefers salinities of 15-30 PPT, but can be found in completely freshwater to almost pure seawater.   | <b>Not Present:</b> No suitable habitat present within Project site.   |
| <b>INVERTEBRATES</b>   |                                   |   |  |
| <i>Bombus caliginosus</i><br>Obscure bumble bee  | -- / CNDDDB / --                  | Native to the West Coast of the United States. Occurs primarily along the coast in grassy prairies and meadows within the Coast Range. This species can nest both under and above ground. When nesting above ground the species may utilize abandoned bird nests. Found in areas that are relatively humid including areas that are frequently foggy. | <b>Moderate:</b> Marginally suitable habitat is present within the Project site within the non-native grassland habitat and some portions of the ruderal areas. The nearest CNDDDB occurrence is 5.8 miles west of the Project site.   |
| <i>Bombus occidentalis</i><br>Western bumble bee   | -- / CNDDDB / --                  | Occurs in open grassy areas, urban parks, urban gardens, chaparral, and meadows. This species generally nest underground.   | <b>Moderate:</b> Marginally suitable habitat is present within the Project site within the non-native grassland and chaparral habitats, and some portions of the ruderal areas. The nearest CNDDDB occurrence is 4.6 miles east of the Project site.   |
| <i>Brachminecta lynchi</i><br>Vernal pool fairy shrimp                                     | FT / -- / --                      | Require ephemeral pools with no flow. Associated with vernal pools/grasslands from near Red Bluff (Shasta County), through the central valley, and into the south Coast Mountains region.   | <b>Not Present:</b> No suitable habitat present within Project site.   |
| <i>Coelus globosus</i><br>Globose dune beetle  | -- / CNDDDB / --                  | Coastal dunes. These beetles are primarily subterranean, tunneling through sand underneath dune vegetation.   | <b>Not Present:</b> No suitable habitat present within Project site.   |
| <i>Danaus plexippus</i><br>Monarch butterfly   | -- / CNDDDB / --                  | Overwinters in coastal California using colonial roosts generally found in Eucalyptus, pine, and acacia trees. Overwintering habitat for this species within the Coastal Zone represents ESHA. Local ordinances often protect this species as well.   | <b>Low:</b> Although a small grove of Eucalyptus trees are present within the western portion of the Project site, no occurrences of this species are known to use these trees. The density of the Eucalyptus trees are unlikely to provide suitable wintering habitat for this species, and while a few individuals may occur within the Project site during the overwintering season, aggregations of monarch butterfly are unlikely to occur. |
| <i>Euphilotes enoptes smithi</i><br><b>Smith's blue butterfly</b>                          | FE / -- / --                      | Most commonly associated with coastal dunes and coastal sage scrub plant communities in Monterey and Santa Cruz Counties. Plant hosts are <i>Eriogonum latifolium</i> and <i>E. parvifolium</i> .   | <b>Moderate:</b> <i>E. parvifolium</i> is present at three locations within the Project site and may occur in other unsurveyed areas. This species may provide suitable habitat for Smith's blue butterfly.  |
| <i>Linderiella occidentalis</i><br><b>California linderiella</b>                           | -- / CNDDDB / --                  | Ephemeral ponds with no flow. Generally associated with hardpans.   | <b>Unlikely:</b> No suitable habitat present within Project site.  |
| <i>Tryonia imitator</i><br>Mimic tryonia (California<br>brackishwater snail)               | -- / CNDDDB / --                  | Inhabits coastal lagoons, estuaries and salt marshes. Found only in permanently submerged areas in a variety of sediment types. Tolerant of a wide range of salinities.   | <b>Not Present:</b> No suitable habitat present within Project site.   |

| Species   | Status<br>(Service/<br>CDFW/CNPS) | General<br>Habitat  | Potential Occurrence within Project Vicinity   |
|---|-----------------------------------|---|--|
| <b>PLANTS</b>   |                                   |   |  |
| <i>Agrostis lacuna-vernalis</i><br>Vernal pool bent grass               | -- / -- / 1B                      | Vernal pools (mima mounds) at elevations of 115-145 meters. Annual herb in the Poaceae family; blooms April-May.  | <b>Unlikely:</b> Not identified within survey area in 2016. No suitable habitat present within Project site.   |
| <i>Allium hickmanii</i><br>Hickman's onion                              | -- / -- / 1B                      | Closed-cone coniferous forests, maritime chaparral, coastal prairie, coastal scrub, and valley and foothill grasslands at elevations of 5-200 meters. Bulbiferous perennial herb in the Alliaceae family; blooms March-May.   | <b>Unlikely:</b> Not identified within survey area in 2016. No suitable habitat present within Project site.   |
| <i>Arctostaphylos hookeri</i> ssp. <i>hookeri</i><br>Hooker's manzanita | -- / -- / 1B                      | Closed-cone coniferous forest, chaparral, cismontane woodland, and coastal scrub on sandy soils at elevations of 85-536 meters. Evergreen shrub in the Ericaceae family; blooms January-June.   | <b>Moderate:</b> Not identified within survey area in 2016; however, this species may occur within the Project site, outside of the survey area.   |
| <i>Arctostaphylos montereyensis</i><br>Toro manzanita                   | -- / -- / 1B                      | Maritime chaparral, cismontane woodland, and coastal scrub on sandy soils at elevations of 30-730 meters. Evergreen shrub in the Ericaceae family; blooms February-March.   | <b>Present:</b> Identified within survey area in 2016. May also occur within the Project site, outside of survey area.   |
| <i>Arctostaphylos pajaroensis</i><br>Pajaro manzanita                   | -- / -- / 1B                      | Chaparral on sandy soils at elevations of 30-760 meters. Evergreen shrub in the Ericaceae family; blooms December-March.  | <b>Moderate:</b> Not identified within survey area in 2016; however, this species may occur within the Project site, outside of the survey area.   |
| <i>Arctostaphylos pumila</i><br>Sandmat manzanita                       | -- / -- / 1B                      | Openings of closed-cone coniferous forests, maritime chaparral, cismontane woodland, coastal dunes, and coastal scrub on sandy soils at elevations of 3-205 meters. Evergreen shrub in the Ericaceae family; blooms February-May.   | <b>Present:</b> Identified within survey area in 2016. May also occur within the Project site, outside of survey area.   |
| <i>Arenaria paludicola</i><br>Marsh sandwort                            | FE / SE 1B                        | Known from only two natural occurrences in Black Lake Canyon and at Oso Flaco Lake. Sandy openings of freshwater or brackish marshes and swamps at elevations of 3-170 meters. Stoloniferous perennial herb in the Caryophyllaceae family; blooms May-August.   | <b>Unlikely:</b> Not identified within survey area in 2016. No suitable habitat present within Project site. Project site is outside of the currently known range for this species.  |
| <i>Astragalus tener</i> var. <i>tener</i><br>Alkali milk-vetch          | -- / -- / 1B                      | Playas, valley and foothill grassland on adobe clay, and vernal pools on alkaline soils at elevations of 1-60 meters. Annual herb in the Fabaceae family; blooms March-June.  | <b>Unlikely:</b> Not identified within survey area in 2016. No suitable habitat present within Project site.   |
| <i>Astragalus tener</i> var. <i>titi</i><br>Coastal dunes milk-vetch    | FE / SE / 1B                      | Vernally mesic, sandy areas of coastal bluff scrub, coastal dunes, and coastal prairie at elevations of 1-50 meters. Annual herb in the Fabaceae family; blooms March-May.  | <b>Unlikely:</b> Not identified within survey area in 2016. No suitable habitat present within Project site.   |
| <i>Bryoria spiralis</i><br>Twisted horsehair lichen                     | -- / -- / 1B                      | California North Coast coniferous forest at elevations of 0-30 meters. Often found on conifers, including <i>Picea sitchensis</i> , <i>Pinus contorta</i> var. <i>contorta</i> , <i>Pseudotsuga menziesii</i> , <i>Abies grandis</i> , and <i>Tsuga heterophylla</i> . Fruticose lichen in the Parmeliaceae family. | <b>Unlikely:</b> Not identified within survey area in 2016. No suitable habitat present within Project site.   |
| <i>Castilleja ambigua</i> ssp. <i>insalutata</i><br>Pink johnny-nip     | -- / -- / 1B                      | Coastal prairie and coastal scrub at elevations of 0-100 meters. Annual herb in the Orobanchaceae family; blooms May-August.  | <b>Low:</b> Not identified within survey area during in 2016. Low quality habitat present within the coastal scrub habitat within the Project site, outside of the survey area. The CNDDDB reports a non-specific occurrence within the Project site; however, the CNDDDB identifies that the species was found in the "mima mounds" area of Fort Ord, which does not occur within the Project site. |

| Species  | Status<br>(Service/<br>CDFW/CNPS) | General<br>Habitat  | Potential Occurrence within Project Vicinity   |
|--|-----------------------------------|---|--|
| <i>Ceanothus cuneatus</i> ssp. <i>rigidus</i><br><b>Monterey ceanothus</b>                 | -- / -- / List 4                  | Closed cone coniferous forest, chaparral, and coastal scrub on sandy soils at elevations of 3-550 meters. Evergreen shrub in the Rhamnaceae family; blooms February-June.   | <b>Present:</b> Identified within survey area in 2016. May also occur within the Project site, outside of survey area.   |
| <i>Centromadia parryi</i> ssp. <i>congdonii</i><br>Congdon's tarplant                      | -- / -- / 1B                      | Mesic areas of valley and foothill grassland on alkaline soils at elevations of 0-230 meters. Annual herb in the Asteraceae family; blooms May-November.  | <b>Unlikely:</b> Not identified within survey area in 2016. No suitable habitat present within Project site, outside of survey area.   |
| <i>Chorizanthe minutiflora</i><br>Fort Ord spineflower                                     | -- / -- / 1B                      | Sandy openings of maritime chaparral and coastal scrub at elevations of 55-150 meters. Annual herb in the Polygonaceae family; blooms April-July.   | <b>Moderate:</b> Suitable habitat for this species is present within the maritime chaparral and coastal scrub habitats within Project site <sup>1</sup> .  |
| <i>Chorizanthe pungens</i> var. <i>pungens</i><br><b>Monterey spineflower</b>              | FT / -- / 1B                      | Maritime chaparral, cismontane woodland, coastal dunes, coastal scrub, and valley and foothill grassland on sandy soils at elevations of 3-450 meters. Annual herb in the Polygonaceae family; blooms April-July.   | <b>Present:</b> Identified within survey area in 2016. May also occur within the Project site, outside of survey area.   |
| <i>Chorizanthe robusta</i> var. <i>robusta</i><br><b>Robust spineflower</b>                | FE / -- / 1B                      | Openings in cismontane woodland, coastal dunes, maritime chaparral, and coastal scrub on sandy or gravelly soils at elevations of 3-300 meters. Annual herb in the Polygonaceae family; blooms April-September.   | <b>Unlikely:</b> Not identified during surveys in 2016. Although suitable habitat is present within the Project site, outside of survey area, the Project site is outside of the currently known range for this species.   |
| <i>Clarkia jolonensis</i><br>Jolon clarkia   | -- / -- / 1B                      | Cismontane woodland, chaparral, riparian woodland, and coastal scrub at elevations of 20-660 meters. Annual herb in the Onagraceae family; blooms April-June.   | <b>Low:</b> Not identified during surveys in 2016. Low quality habitat present within the coast live oak woodland and coastal scrub habitats within the Project site, outside of the survey area. No occurrences of this species are known on the Former Fort Ord. |
| <i>Collinsia multicolor</i><br>San Francisco collinsia                                     | -- / -- / 1B                      | Closed-cone coniferous forest and coastal scrub, sometimes on serpentinite soils, at elevations of 30-250 meters. Annual herb in the Plantaginaceae family; blooms March-May.   | <b>Unlikely:</b> Not identified within survey area in 2016. No suitable habitat present within Project site, outside of survey area.   |
| <i>Cordylanthus rigidus</i> ssp. <i>littoralis</i><br><b>Seaside bird's-beak</b>           | -- / SE / 1B                      | Closed-cone coniferous forests, maritime chaparral, cismontane woodlands, coastal dunes, and coastal scrub on sandy soils, often on disturbed sites, at elevations of 0-425 meters. Annual hemi-parasitic herb in the Orobanchaceae family; blooms April-October. | <b>High:</b> Not identified within survey area in 2016; however, this species may occur within the Project site, outside of the survey area. The nearest CNDDDB occurrence is approximately 0.3 mile from the Project site.  |
| <i>Delphinium californicum</i> ssp. <i>interius</i><br>Hospital Canyon California larkspur | -- / -- / 1B                      | Openings in chaparral, coastal scrub, and mesic areas of cismontane woodland at elevations of 230-1095 meters. Perennial herb in the Ranunculaceae family; blooms April-June.   | <b>Unlikely:</b> Not identified within survey area in 2016. No suitable habitat present within Project site. Project site is below the known elevation range for this species.   |
| <i>Delphinium hutchinsoniae</i><br>Hutchinson's larkspur                                   | -- / -- / 1B                      | Broadleaved upland forest, chaparral, coastal scrub, and coastal prairie at elevations of 0-427 meters. Perennial herb in the Ranunculaceae family; blooms March-June.  | <b>Unlikely:</b> Not identified within survey area in 2016. No suitable habitat present within Project site, outside of the survey area.   |
| <i>Ericameria fasciculata</i><br><b>Eastwood's goldenbush</b>                              | -- / -- / 1B                      | Openings in closed-cone coniferous forest, maritime chaparral, coastal dunes, and coastal scrub on sandy soils at elevations of 30-275 meters. Evergreen shrub in the Asteraceae family; blooms July-October.   | <b>High:</b> Not identified within survey area in 2016; however, the CNDDDB reports and occurrence of this species outside of the survey area and suitable habitat is present.   |
| <i>Erysimum ammophilum</i><br><b>Sand-loving wallflower</b>                                | -- / -- / 1B                      | Openings in maritime chaparral, coastal dunes, and coastal scrub on sandy soils at elevations of 0-60 meters. Perennial herb in the Brassicaceae family; blooms February-June.  | <b>High:</b> Not identified within survey area in 2016; however, this species may occur within the Project site, outside of the survey area.   |

<sup>1</sup> Occurrences of this species were not identified in the CNDDDB search conducted prior to the surveys in 2016. Therefore, this species was not included in the 2016 surveys.

| Species   | Status<br>(Service/<br>CDFW/CNPS) | General<br>Habitat   | Potential Occurrence within Project Vicinity  |
|---|-----------------------------------|--|---|
| <i>Erysimum menziesii</i><br>Menzies' wallflower                  | FE / SE / 1B                      | Coastal dunes at elevations of 0-35 meters. Perennial herb in the Brassicaceae family; blooms March-June.  | <b>Unlikely:</b> Not identified during surveys in 2016. No suitable habitat present within Project site.  |
| <i>Fritillaria liliacea</i><br>Fragrant fritillaria               | -- / -- / 1B                      | Cismontane woodland, coastal prairie, coastal scrub, and valley and foothill grassland, often serpentine, at elevations of 3-410 meters. Bulbiferous perennial herb in the Liliaceae family; blooms February-April.                                | <b>Unlikely:</b> Not identified within survey area in 2016. No suitable habitat present within Project site, outside of the survey area.  |
| <i>Gilia tenuiflora</i> ssp. <i>arenaria</i><br><b>Sand gilia</b> | FE / ST / 1B                      | Sandy openings of maritime chaparral, cismontane woodland, coastal dunes, and coastal scrub at elevations of 0-45 meters. Annual herb in the Polemoniaceae family; blooms April-June.  | <b>High:</b> Not identified within survey area in 2016; however, the CNDDDB reports and occurrence of this species outside of the survey area and suitable habitat is present.  |
| <i>Hesperocyparis goveniana</i><br>Gowen cypress                  | FT / -- / 1B                      | Closed-cone coniferous forest and maritime chaparral at elevations of 30-300 meters. Evergreen tree in the Cupressaceae family. Natively occurring only at Point Lobos near Gibson Creek and the Huckleberry Hill Nature Preserve near Highway 68. | <b>Not Present:</b> Not identified within survey area in 2016. No suitable habitat present within Project site, outside of the survey area. Project site is outside of the highly endemic range for this species.   |
| <i>Hesperocyparis macrocarpa</i><br>Monterey cypress              | -- / -- / 1B                      | Closed-cone coniferous forest at elevations of 10-30 meters. Evergreen tree in the Cupressaceae family. Natively occurring only at Cypress Point in Pebble Beach and Point Lobos State Park; widely planted and naturalized elsewhere.             | <b>Not Present:</b> Although Monterey cypress trees are present within the Project site, these individuals were planted and are from unknown genetic stock. The Project site is outside of the known native range for this species, and thus the individuals within the Project site are not considered special-status species. |
| <i>Holocarpha macradenia</i><br>Santa Cruz tarplant               | FT / SE / 1B                      | Coastal prairies and valley foothill grasslands, often clay or sandy soils, at elevations of 10-220 meters. Annual herb in the Asteraceae family; blooms June-October.   | <b>Unlikely:</b> Not identified during surveys in 2016. Although suitable habitat is present within the Project site, outside of survey area, the Project site is outside of the currently known range for this species.  |
| <i>Horkelia cuneata</i> ssp. <i>sericea</i><br>Kellogg's horkelia | -- / -- / 1B                      | Openings of closed-cone coniferous forests, maritime chaparral, coastal dunes, and coastal scrub on sandy or gravelly soils at elevations of 10-200 meters. Perennial herb in the Rosaceae family; blooms April-September.                         | <b>Present:</b> Identified within survey area in 2016. May also occur within the Project site, outside of survey area   |
| <i>Horkelia marinensis</i><br>Point Reyes horkelia                | -- / -- / 1B                      | Coastal dunes, coastal prairie, and coastal scrub on sandy soils at elevations of 5-350 meters. Perennial herb in the Rosaceae family; blooms May-September.   | <b>Moderate:</b> Not identified within survey area in 2016; however, this species may occur within the Project site, outside of the survey area.  |
| <i>Lasthenia conjugens</i><br>Contra Costa goldfields             | FE / -- / 1B                      | Mesic areas of valley and foothill grassland, alkaline playas, cismontane woodland, and vernal pools at elevations of 0-470 meters. Annual herb in the Asteraceae family; blooms March-June.   | <b>Unlikely:</b> Not identified within survey area in 2016. No suitable habitat present within Project site, outside of the survey area; this species is only known to occur within a few vernal pools on the Former Fort Ord.  |
| <i>Layia carnosa</i><br>Beach layia                               | FE / SE / 1B                      | Coastal dunes and coastal scrub on sandy soils at elevations of 0-60 meters. Annual herb in the Asteraceae family; blooms March-July.  | <b>Unlikely:</b> Not identified within survey area in 2016. No suitable habitat present within Project site, outside of the survey area.  |
| <i>Legenere limosa</i><br>Legenere                                | -- / -- / 1B                      | Vernal pools at elevations of 1-880 meters. Annual herb in the Campanulaceae family; blooms April-June.  | <b>Unlikely:</b> Not identified within survey area in 2016. No suitable habitat present within Project site, outside of the survey area.  |
| <i>Lupinus tidestromii</i><br>Tidestrom's lupine                  | FE / SE / 1B                      | Coastal dunes at elevations of 0-100 meters. Perennial rhizomatous herb in the Fabaceae family; blooms April-June.   | <b>Unlikely:</b> Not identified within survey area in 2016. No suitable habitat present within Project site, outside of the survey area.  |

| Species   | Status<br>(Service/<br>CDFW/CNPS) | General<br>Habitat  | Potential Occurrence within Project Vicinity   |
|---|-----------------------------------|---|--|
| <i>Malacothamnus palmeri</i> var.<br><i>involutus</i><br>Carmel Valley bush-mallow      | -- / -- / 1B                      | Chaparral, cismontane woodland, and coastal scrub at elevations of 30-1100 meters. Deciduous shrub in the Malvaceae family; blooms May-August.  | <b>Unlikely:</b> Not identified within survey area in 2016. Although suitable habitat for this species is present within the Project site, outside of the survey area, all known CNDDDB occurrences are located south of the Former Fort Ord and the Project site is likely outside of the range for this species.           |
| <i>Malacothrix saxatilis</i> var.<br><i>arachnoidea</i><br>Carmel Valley macrothrix     | -- / -- / 1B                      | Chaparral and coastal scrub on rocky soils at elevations of 25-1036 meters. Perennial rhizomatous herb in the Asteraceae family; blooms June-December.  | <b>Unlikely:</b> Not identified within survey area in 2016. Although suitable habitat for this species is present within the Project site, outside of the survey area, all known CNDDDB occurrences are located south of the Former Fort Ord and the Project site is likely outside of the range for this species.           |
| <i>Meconella oregana</i><br>Oregon meconella  | -- / -- / 1B                      | Coastal prairie and coastal scrub at elevations of 250-620 meters. Annual herb in the Papaveraceae Family; blooms March-April.  | <b>Unlikely:</b> Not identified within survey area in 2016. Although suitable habitat for this species is present within the Project site, outside of the survey area, the Project site is below the known elevation range for this species.   |
| <i>Microseris paludosa</i><br>Marsh microseris  | -- / -- / 1B                      | Mesic areas of closed-cone coniferous forest cismontane woodland, coastal scrub, and valley and foothill grasslands at elevations of 3-300 meters. Perennial herb in the Asteraceae family; blooms April-July.  | <b>Moderate:</b> Not identified within survey area in 2016; however, this species may occur within the Project site, outside of the survey area.   |
| <i>Monardella sinuata</i> ssp.<br><i>nigrescens</i><br>Northern curly-leaved monardella | -- / -- / 1B                      | Chaparral, coastal dunes, coastal scrub, and lower montane coniferous forest (ponderosa pine sandhills) on sandy soils at elevations of 0-300 meters. Annual herb in the Lamiaceae family; blooms April-September.  | <b>Moderate:</b> Not identified within survey area in 2016; however, this species may occur within the Project site, outside of the survey area.   |
| <i>Monolopia gracilens</i><br>Woodland woollythreads                                    | -- / -- / 1B                      | Openings of broadleaved upland forest, chaparral, cismontane woodland, North Coast coniferous forest, and valley and foothill grassland on serpentinite soils at elevations of 100-1200 meters. Annual herb in the Asteraceae family; blooms February-July. | <b>Moderate:</b> Not identified within survey area in 2016; however, this species may occur within the Project site, outside of the survey area.   |
| <i>Pinus radiata</i><br>Monterey pine   | -- / -- / 1B                      | Closed-cone coniferous forest and cismontane woodland at elevations of 25-185 meters. Evergreen tree in the Pinaceae family. Only three native stands in CA, at Ano Nuevo, Cambria, and the Monterey Peninsula; introduced in many areas.                   | <b>Not Present:</b> Although Monterey pine trees are present within the Project site, these individuals were planted and are from unknown genetic stock. The Project site is outside of the known native range for this species, and thus the individuals within the Project site are not considered special status species. |
| <i>Piperia yadonii</i><br>Yadon's piperia   | FE / -- / 1B                      | Sandy soils in coastal bluff scrub, closed-cone coniferous forest, and maritime chaparral at elevations of 10-510 meters. Annual herb in the Orchidaceae family; blooms May-August.   | <b>High:</b> Not identified within survey area in 2016; however, this species may occur within the Project site, outside of the survey area.   |
| <i>Plagiobothrys chorisianus</i> var.<br><i>chorisianus</i><br>Choris' popcornflower    | -- / -- / 1B                      | Mesic areas of chaparral, coastal prairie, and coastal scrub at elevations of 15-160 meters. Annual herb in the Boraginaceae family; blooms March-June.   | <b>Unlikely:</b> Not identified within survey area in 2016. No suitable habitat present within Project site, outside of the survey area; this species is only known to occur within a few vernal pools on the Former Fort Ord.   |
| <i>Potentilla hickmanii</i><br>Hickman's cinquefoil                                     | FE / SE / 1B                      | Coastal bluff scrub, closed-cone coniferous forests, vernal mesic meadows, and freshwater marshes and swamps at elevations of 10-149 meters. Perennial herb in the Rosaceae family; blooms April-August.  | <b>Unlikely:</b> Not identified within survey area in 2016. No suitable habitat present within Project site, outside of the survey area.   |

| Species  | Status<br>(Service/<br>CDFW/CNPS) | General<br>Habitat  | Potential Occurrence within Project Vicinity   |
|--|-----------------------------------|---|--|
| <i>Ramalina thrausta</i><br>Angel's hair lichen          | -- / -- / 2B                      | North coast coniferous forest on dead twigs and other lichens. Epiphytic fructose lichen in the Ramalinaceae family. In northern CA it is usually found on dead twigs, and has been found on <i>Alnus rubra</i> , <i>Calocedrus decurrens</i> , <i>Pseudotsuga menziesii</i> , <i>Quercus garryana</i> , and <i>Rubus spectabilis</i> . In Sonoma County it grows on and among dangling mats of <i>R. menziesii</i> and <i>Usnea</i> spp. | <b>Unlikely:</b> Not identified within survey area in 2016. No suitable habitat present within Project site, outside of the survey area.         |
| <i>Rosa pinetorum</i><br>Pine rose                       | -- / -- / 1B                      | Closed-cone coniferous forest at elevations of 2-300 meters. Perennial shrub in the Rosaceae family; blooms May-July. Possible hybrid of <i>R. spithamea</i> , <i>R. gymnocarpa</i> , or others; further study needed.  | <b>Unlikely:</b> Not identified within survey area in 2016. No suitable habitat present within Project site, outside of the survey area.         |
| <i>Stebbinsoseris decipiens</i><br>Santa Cruz microseris | -- / -- / 1B                      | Broadleaved upland forest, closed-cone coniferous forest, chaparral, coastal prairie, coastal scrub, and openings in valley and foothill grassland, sometimes on serpentinite, at elevations of 10-500 meters. Annual herb in the Asteraceae family; blooms April-May.  | <b>Moderate:</b> Not identified within survey area in 2016; however, this species may occur within the Project site, outside of the survey area. |
| <i>Trifolium buckwestiorum</i><br>Santa Cruz clover      | -- / -- / 1B                      | Broadleaved upland forest, cismontane woodland, and margins of coastal prairie on gravelly soils at elevations of 105-610 meters. Annual herb in the Fabaceae family; blooms April-October.   | <b>Moderate:</b> Not identified within survey area in 2016; however, this species may occur within the Project site, outside of the survey area. |
| <i>Trifolium hydrophilum</i><br>Saline clover            | -- / -- / 1B                      | Marshes and swamps, mesic and alkaline valley and foothill grassland, and vernal pools at elevations of 0-300 meters. Annual herb in the Fabaceae family; blooms April-June.  | <b>Unlikely:</b> Not identified within survey area in 2016. No suitable habitat present within Project site, outside of the survey area.         |
| <i>Trifolium polyodon</i><br>Pacific Grove clover        | -- / SR / 1B                      | Mesic areas of closed-cone coniferous forest, coastal prairie, meadows and seeps, and valley and foothill grassland at elevations of 5-120 meters. Annual herb in the Fabaceae family; blooms April-June.   | <b>Moderate:</b> Not identified within survey area in 2016; however, this species may occur within the Project site, outside of the survey area. |
| <i>Trifolium trichocalyx</i><br>Monterey clover          | FE / SE / 1B                      | Sandy openings and burned areas of closed-cone coniferous forest at elevations of 30-240 meters. Annual herb in the Fabaceae family; blooms April-June.   | <b>Unlikely:</b> Not identified within survey area in 2016. No suitable habitat present within Project site, outside of the survey area.         |



| Species   | Status<br>(Service/<br>CDFW/CNPS) | General<br>Habitat | Potential Occurrence within Project Vicinity |
|---|-----------------------------------|--------------------|--|
| <p><b>STATUS DEFINITIONS:</b></p> <p><b>Federal</b></p> <p>FE = listed as Endangered under the federal Endangered Species Act<br/> FT = listed as Threatened under the federal Endangered Species Act<br/> FC = Candidate for listing under the federal Endangered Species Act<br/> UR = Species that have been petitioned for listing under the ESA and for which a 90 day and/or 12 Month finding has not been published in the Federal Register, as well as species being reviewed through the candidate process but the CNOR has not yet been signed<br/> -- = no listing</p> <p><b>State</b></p> <p>SE = listed as Endangered under the California Endangered Species Act<br/> ST = listed as Threatened under the California Endangered Species Act<br/> SC = Candidate for listing under the California Endangered Species Act<br/> SR = listed as Rare under the California Endangered Species Act<br/> CFP = California Fully Protected Species<br/> CSC = California Department of Fish and Wildlife Species of Concern<br/> CNDDDB = This designation is being assigned to animal species that are not assigned any of the other status designations defined in this table. These animal species are included in CDFW's CNDDDB "Special Animals" list (2017b), which includes all taxa the CNDDDB is interested in tracking, regardless of their legal or protection status. This list is also referred to as the list of "species at risk" or "special-status species." The California Department of Fish and Wildlife considers the taxa on this list to be those of greatest conservation need.<br/> -- = no listing</p> <p><b>California Native Plant Society</b></p> <p>1B = California Rare Plant Rank 1B species; plants rare, threatened, or endangered in California and elsewhere<br/> 2B = California Rare Plant Rank 2B species; plants rare, threatened, or endangered in California, but more common elsewhere<br/> -- = no listing</p> <p><b>*Bold font indicates Fort Ord HMP Species</b></p> <p><b><u>POTENTIAL TO OCCUR:</u></b></p> <p>Present – known occurrence of species within the site; presence of suitable habitat conditions; or observed during field surveys<br/> High – known occurrence of species in the vicinity from the CNDDDB or other documentation; presence of suitable habitat conditions<br/> Moderate – known occurrence of species in the vicinity from the CNDDDB or other documentation; presence of marginal habitat conditions<br/> Low – species known to occur in the vicinity from the CNDDDB or other documentation; presence of low quality habitat conditions<br/> Unlikely – species not known to occur in the vicinity from the CNDDDB or other documentation; no suitable habitat is present<br/> Not Present – species not observed during surveys</p> |                                   |                    |  |

*This page left intentionally blank*

## **APPENDIX B.**

CNDDDB Occurrence Report

*This page left intentionally blank*



# Selected Elements by Scientific Name

California Department of Fish and Wildlife

California Natural Diversity Database



**Query Criteria:** Quad (Seaside (3612157) OR Monterey (3612158) OR Marina (3612167) OR Spreckels (3612156) OR Salinas (3612166) OR Moss Landing (3612177) OR Prunedale (3612176)) AND Taxonomic Group (Fish OR Amphibians OR Reptiles OR Birds OR Mammals OR Mollusks OR Arachnids OR Crustaceans OR Insects OR Ferns OR Gymnosperms OR Monocots OR Dicots OR Lichens OR Bryophytes)

| Species   | Element Code | Federal Status | State Status            | Global Rank | State Rank | Rare Plant Rank/CDFW SSC or FP |
|---|--------------|----------------|-------------------------|-------------|------------|--------------------------------|
| <i>Agelaius tricolor</i><br>tricolored blackbird                          | ABPBXB0020   | None           | Candidate<br>Endangered | G2G3        | S1S2       | SSC                            |
| <i>Agrostis lacuna-vernalis</i><br>vernal pool bent grass                 | PMPOA041N0   | None           | None                    | G1          | S1         | 1B.1                           |
| <i>Allium hickmanii</i><br>Hickman's onion                                | PMLIL02140   | None           | None                    | G2          | S2         | 1B.2                           |
| <i>Ambystoma californiense</i><br>California tiger salamander             | AAAAA01180   | Threatened     | Threatened              | G2G3        | S2S3       | WL                             |
| <i>Ambystoma macrodactylum croceum</i><br>Santa Cruz long-toed salamander | AAAAA01082   | Endangered     | Endangered              | G5T1T2      | S1S2       | FP                             |
| <i>Anniella pulchra</i><br>northern California legless lizard             | ARACC01020   | None           | None                    | G3          | S3         | SSC                            |
| <i>Arctostaphylos hookeri ssp. hookeri</i><br>Hooker's manzanita          | PDERI040J1   | None           | None                    | G3T2        | S2         | 1B.2                           |
| <i>Arctostaphylos montereyensis</i><br>Toro manzanita                     | PDERI040R0   | None           | None                    | G2G3        | S2S3       | 1B.2                           |
| <i>Arctostaphylos pajaroensis</i><br>Pajaro manzanita                     | PDERI04100   | None           | None                    | G1          | S1         | 1B.1                           |
| <i>Arctostaphylos pumila</i><br>sandmat manzanita                         | PDERI04180   | None           | None                    | G1          | S1         | 1B.2                           |
| <i>Asio flammeus</i><br>short-eared owl                                   | ABNSB13040   | None           | None                    | G5          | S3         | SSC                            |
| <i>Astragalus tener var. tener</i><br>alkali milk-vetch                   | PDFAB0F8R1   | None           | None                    | G2T2        | S2         | 1B.2                           |
| <i>Astragalus tener var. titi</i><br>coastal dunes milk-vetch             | PDFAB0F8R2   | Endangered     | Endangered              | G2T1        | S1         | 1B.1                           |
| <i>Athene cunicularia</i><br>burrowing owl                                | ABNSB10010   | None           | None                    | G4          | S3         | SSC                            |
| <i>Bombus caliginosus</i><br>obscure bumble bee                           | IIHYM24380   | None           | None                    | G4?         | S1S2       |                                |
| <i>Bombus occidentalis</i><br>western bumble bee                          | IIHYM24250   | None           | None                    | G2G3        | S1         |                                |
| <i>Bryoria spiralifera</i><br>twisted horsehair lichen                    | NLTEST5460   | None           | None                    | G3          | S1S2       | 1B.1                           |



Selected Elements by Scientific Name  
California Department of Fish and Wildlife  
California Natural Diversity Database



| Species   | Element Code | Federal Status | State Status | Global Rank | State Rank | Rare Plant Rank/CDFW SSC or FP |
|---|--------------|----------------|--------------|-------------|------------|--------------------------------|
| <i>Buteo regalis</i><br>ferruginous hawk  | ABNKC19120   | None           | None         | G4          | S3S4       | WL                             |
| <i>Castilleja ambigua</i> var. <i>insalutata</i><br>pink Johnny-nip             | PDSCR0D403   | None           | None         | G4T2        | S2         | 1B.1                           |
| <i>Centromadia parryi</i> ssp. <i>congdonii</i><br>Congdon's tarplant           | PDAST4R0P1   | None           | None         | G3T2        | S2         | 1B.1                           |
| <i>Charadrius alexandrinus nivosus</i><br>western snowy plover                  | ABNNB03031   | Threatened     | None         | G3T3        | S2S3       | SSC                            |
| <i>Chorizanthe minutiflora</i><br>Fort Ord spineflower                          | PDPGN04100   | None           | None         | G1          | S1         | 1B.2                           |
| <i>Chorizanthe pungens</i> var. <i>pungens</i><br>Monterey spineflower          | PDPGN040M2   | Threatened     | None         | G2T2        | S2         | 1B.2                           |
| <i>Chorizanthe robusta</i> var. <i>robusta</i><br>robust spineflower            | PDPGN040Q2   | Endangered     | None         | G2T1        | S1         | 1B.1                           |
| <i>Clarkia jolonensis</i><br>Jolon clarkia                                      | PDONA050L0   | None           | None         | G2          | S2         | 1B.2                           |
| <i>Coelus globosus</i><br>globose dune beetle                                   | IICOL4A010   | None           | None         | G1G2        | S1S2       |                                |
| <i>Collinsia multicolor</i><br>San Francisco collinsia                          | PDSCR0H0B0   | None           | None         | G2          | S2         | 1B.2                           |
| <i>Cordylanthus rigidus</i> ssp. <i>littoralis</i><br>seaside bird's-beak       | PDSCR0J0P2   | None           | Endangered   | G5T2        | S2         | 1B.1                           |
| <i>Corynorhinus townsendii</i><br>Townsend's big-eared bat                      | AMACC08010   | None           | None         | G3G4        | S2         | SSC                            |
| <i>Cypseloides niger</i><br>black swift   | ABNUA01010   | None           | None         | G4          | S2         | SSC                            |
| <i>Danaus plexippus</i> pop. 1<br>monarch - California overwintering population | IILEPP2012   | None           | None         | G4T2T3      | S2S3       |                                |
| <i>Delphinium californicum</i> ssp. <i>interius</i><br>Hospital Canyon larkspur | PDRAN0B0A2   | None           | None         | G3T3        | S3         | 1B.2                           |
| <i>Delphinium hutchinsoniae</i><br>Hutchinson's larkspur                        | PDRAN0B0V0   | None           | None         | G2          | S2         | 1B.2                           |
| <i>Delphinium umbraculorum</i><br>umbrella larkspur                             | PDRAN0B1W0   | None           | None         | G3          | S3         | 1B.3                           |
| <i>Elanus leucurus</i><br>white-tailed kite                                     | ABNKC06010   | None           | None         | G5          | S3S4       | FP                             |
| <i>Emys marmorata</i><br>western pond turtle                                    | ARAAD02030   | None           | None         | G3G4        | S3         | SSC                            |
| <i>Eremophila alpestris actia</i><br>California horned lark                     | ABPAT02011   | None           | None         | G5T4Q       | S4         | WL                             |
| <i>Ericameria fasciculata</i><br>Eastwood's goldenbush                          | PDAST3L080   | None           | None         | G2          | S2         | 1B.1                           |



Selected Elements by Scientific Name  
California Department of Fish and Wildlife  
California Natural Diversity Database



| Species   | Element Code | Federal Status | State Status | Global Rank | State Rank | Rare Plant Rank/CDFW SSC or FP |
|---|--------------|----------------|--------------|-------------|------------|--------------------------------|
| <i>Erysimum ammophilum</i><br>sand-loving wallflower                        | PDBRA16010   | None           | None         | G2          | S2         | 1B.2                           |
| <i>Erysimum menziesii</i><br>Menzies' wallflower                            | PDBRA160R0   | Endangered     | Endangered   | G1          | S1         | 1B.1                           |
| <i>Eucyclogobius newberryi</i><br>tidewater goby                            | AFCQN04010   | Endangered     | None         | G3          | S3         | SSC                            |
| <i>Euphilotes enoptes smithi</i><br>Smith's blue butterfly                  | IILEPG2026   | Endangered     | None         | G5T1T2      | S1S2       |                                |
| <i>Falco mexicanus</i><br>prairie falcon                                    | ABNKD06090   | None           | None         | G5          | S4         | WL                             |
| <i>Falco peregrinus anatum</i><br>American peregrine falcon                 | ABNKD06071   | Delisted       | Delisted     | G4T4        | S3S4       | FP                             |
| <i>Fritillaria liliacea</i><br>fragrant fritillary                          | PMLIL0V0C0   | None           | None         | G2          | S2         | 1B.2                           |
| <i>Gilia tenuiflora ssp. arenaria</i><br>Monterey gilia                     | PDPLM041P2   | Endangered     | Threatened   | G3G4T2      | S2         | 1B.2                           |
| <i>Hesperocyparis goveniana</i><br>Gowen cypress                            | PGCUP04031   | Threatened     | None         | G1          | S1         | 1B.2                           |
| <i>Hesperocyparis macrocarpa</i><br>Monterey cypress                        | PGCUP04060   | None           | None         | G1          | S1         | 1B.2                           |
| <i>Holocarpha macradenia</i><br>Santa Cruz tarplant                         | PDAST4X020   | Threatened     | Endangered   | G1          | S1         | 1B.1                           |
| <i>Horkelia cuneata var. sericea</i><br>Kellogg's horkelia                  | PDROS0W043   | None           | None         | G4T1?       | S1?        | 1B.1                           |
| <i>Horkelia marinensis</i><br>Point Reyes horkelia                          | PDROS0W0B0   | None           | None         | G2          | S2         | 1B.2                           |
| <i>Lasiurus cinereus</i><br>hoary bat                                       | AMACC05030   | None           | None         | G5          | S4         |                                |
| <i>Lasthenia conjugens</i><br>Contra Costa goldfields                       | PDAST5L040   | Endangered     | None         | G1          | S1         | 1B.1                           |
| <i>Laterallus jamaicensis coturniculus</i><br>California black rail         | ABNME03041   | None           | Threatened   | G3G4T1      | S1         | FP                             |
| <i>Layia carnosa</i><br>beach layia   | PDAST5N010   | Endangered     | Endangered   | G2          | S2         | 1B.1                           |
| <i>Legenere limosa</i><br>legenere  | PDCAM0C010   | None           | None         | G2          | S2         | 1B.1                           |
| <i>Linderiella occidentalis</i><br>California linderiella                   | ICBRA06010   | None           | None         | G2G3        | S2S3       |                                |
| <i>Lupinus tidestromii</i><br>Tidestrom's lupine                            | PDFAB2B3Y0   | Endangered     | Endangered   | G1          | S1         | 1B.1                           |
| <i>Malacothamnus palmeri var. involucratus</i><br>Carmel Valley bush-mallow | PDMAL0Q0B1   | None           | None         | G3T2Q       | S2         | 1B.2                           |



Selected Elements by Scientific Name  
California Department of Fish and Wildlife  
California Natural Diversity Database



| Species   | Element Code | Federal Status | State Status         | Global Rank | State Rank | Rare Plant Rank/CDFW SSC or FP |
|---|--------------|----------------|----------------------|-------------|------------|--------------------------------|
| <b><i>Malacothrix saxatilis</i> var. <i>arachnoidea</i></b><br>Carmel Valley malacothrix    | PDAST660C2   | None           | None                 | G5T2        | S2         | 1B.2                           |
| <b><i>Meconella oregana</i></b><br>Oregon meconella   | PDPAP0G030   | None           | None                 | G2G3        | S2         | 1B.1                           |
| <b><i>Microseris paludosa</i></b><br>marsh microseris                                       | PDAST6E0D0   | None           | None                 | G2          | S2         | 1B.2                           |
| <b><i>Monardella sinuata</i> ssp. <i>nigrescens</i></b><br>northern curly-leaved monardella | PDLAM18162   | None           | None                 | G3T2        | S2         | 1B.2                           |
| <b><i>Monolopia gracilens</i></b><br>woodland woollythreads                                 | PDAST6G010   | None           | None                 | G3          | S3         | 1B.2                           |
| <b><i>Oncorhynchus mykiss irideus</i></b><br>steelhead - south-central California coast DPS | AFCHA0209H   | Threatened     | None                 | G5T2Q       | S2         |                                |
| <b><i>Pelecanus occidentalis californicus</i></b><br>California brown pelican               | ABNFC01021   | Delisted       | Delisted             | G4T3        | S3         | FP                             |
| <b><i>Phrynosoma blainvillii</i></b><br>coast horned lizard                                 | ARACF12100   | None           | None                 | G3G4        | S3S4       | SSC                            |
| <b><i>Pinus radiata</i></b><br>Monterey pine  | PGPIN040V0   | None           | None                 | G1          | S1         | 1B.1                           |
| <b><i>Piperia yadonii</i></b><br>Yadon's rein orchid  | PMORC1X070   | Endangered     | None                 | G1          | S1         | 1B.1                           |
| <b><i>Plagiobothrys chorisianus</i> var. <i>chorisianus</i></b><br>Choris' popcornflower    | PDBOR0V061   | None           | None                 | G3T2Q       | S2         | 1B.2                           |
| <b><i>Potentilla hickmanii</i></b><br>Hickman's cinquefoil                                  | PDROS1B0U0   | Endangered     | Endangered           | G1          | S1         | 1B.1                           |
| <b><i>Rallus obsoletus obsoletus</i></b><br>California Ridgway's rail                       | ABNME05016   | Endangered     | Endangered           | G5T1        | S1         | FP                             |
| <b><i>Ramalina thrausta</i></b><br>angel's hair lichen                                      | NLLEC3S340   | None           | None                 | G5          | S2?        | 2B.1                           |
| <b><i>Rana boylei</i></b><br>foothill yellow-legged frog                                    | AAABH01050   | None           | Candidate Threatened | G3          | S3         | SSC                            |
| <b><i>Rana draytonii</i></b><br>California red-legged frog                                  | AAABH01022   | Threatened     | None                 | G2G3        | S2S3       | SSC                            |
| <b><i>Reithrodontomys megalotis distichlis</i></b><br>Salinas harvest mouse                 | AMAFF02032   | None           | None                 | G5T1        | S1         |                                |
| <b><i>Riparia riparia</i></b><br>bank swallow   | ABPAU08010   | None           | Threatened           | G5          | S2         |                                |
| <b><i>Rosa pinetorum</i></b><br>pine rose   | PDROS1J0W0   | None           | None                 | G2          | S2         | 1B.2                           |
| <b><i>Sidalcea malachroides</i></b><br>maple-leaved checkerbloom                            | PDMAL110E0   | None           | None                 | G3          | S3         | 4.2                            |
| <b><i>Spirinchus thaleichthys</i></b><br>longfin smelt                                      | AFCHB03010   | Candidate      | Threatened           | G5          | S1         | SSC                            |





Selected Elements by Scientific Name  
California Department of Fish and Wildlife  
California Natural Diversity Database



| Species   | Element Code | Federal Status | State Status | Global Rank | State Rank | Rare Plant Rank/CDFW SSC or FP |
|---|--------------|----------------|--------------|-------------|------------|--------------------------------|
| <b><i>Stebbinsoseris decipiens</i></b><br>Santa Cruz microseris                   | PDAST6E050   | None           | None         | G2          | S2         | 1B.2                           |
| <b><i>Taricha torosa</i></b><br>Coast Range newt                                  | AAAAF02032   | None           | None         | G4          | S4         | SSC                            |
| <b><i>Taxidea taxus</i></b><br>American badger                                    | AMAJF04010   | None           | None         | G5          | S3         | SSC                            |
| <b><i>Thamnophis hammondi</i></b><br>two-striped gartersnake                      | ARADB36160   | None           | None         | G4          | S3S4       | SSC                            |
| <b><i>Trifolium buckwestiorum</i></b><br>Santa Cruz clover                        | PDFAB402W0   | None           | None         | G2          | S2         | 1B.1                           |
| <b><i>Trifolium hydrophilum</i></b><br>saline clover                              | PDFAB400R5   | None           | None         | G2          | S2         | 1B.2                           |
| <b><i>Trifolium polyodon</i></b><br>Pacific Grove clover                          | PDFAB402H0   | None           | Rare         | G1          | S1         | 1B.1                           |
| <b><i>Trifolium trichocalyx</i></b><br>Monterey clover                            | PDFAB402J0   | Endangered     | Endangered   | G1          | S1         | 1B.1                           |
| <b><i>Tryonia imitator</i></b><br>mimic tryonia (=California brackishwater snail) | IMGASJ7040   | None           | None         | G2          | S2         |                                |

Record Count: 89

*This page left intentionally blank*

## **APPENDIX C.**

IPAC Resources List for CSUMB Campus

*This page left intentionally blank*



# United States Department of the Interior



## FISH AND WILDLIFE SERVICE

Ventura Fish And Wildlife Office  
2493 Portola Road, Suite B  
Ventura, CA 93003-7726  
Phone: (805) 644-1766 Fax: (805) 644-3958

In Reply Refer To:

August 04, 2017

Consultation Code: 08EVEN00-2017-SLI-0573

Event Code: 08EVEN00-2017-E-01268

Project Name: CSUMB Master Plan

Subject: List of threatened and endangered species that may occur in your proposed project location, and/or may be affected by your proposed project

To Whom It May Concern:

The enclosed list identifies species listed as threatened and endangered, species proposed for listing as threatened or endangered, designated and proposed critical habitat, and species that are candidates for listing that may occur within the boundary of the area you have indicated using the U.S. Fish and Wildlife Service's (Service) Information Planning and Conservation System (IPaC). The species list fulfills the requirements under section 7(c) of the Endangered Species Act (Act) of 1973, as amended (16 U.S.C. 1531 et seq.). Please note that under 50 CFR 402.12(e) of the regulations implementing section 7 of the Act, the species list should be verified after 90 days. We recommend that verification be completed by visiting the IPaC website at regular intervals during project planning and implementation for updates to species lists following the same process you used to receive the enclosed list. Please include the Consultation Tracking Number in the header of this letter with any correspondence about the species list.

Due to staff shortages and excessive workload, we are unable to provide an official list more specific to your area. Numerous other sources of information are available for you to narrow the list to the habitats and conditions of the site in which you are interested. For example, we recommend conducting a biological site assessment or surveys for plants and animals that could help refine the list.

If a Federal agency is involved in the project, that agency has the responsibility to review its proposed activities and determine whether any listed species may be affected. If the project is a major construction project\*, the Federal agency has the responsibility to prepare a biological assessment to make a determination of the effects of the action on the listed species or critical habitat. If the Federal agency determines that a listed species or critical habitat is likely to be adversely affected, it should request, in writing through our office, formal consultation pursuant to section 7 of the Act. Informal consultation may be used to exchange information and resolve conflicts with respect to threatened or endangered species or their critical habitat prior to a

written request for formal consultation. During this review process, the Federal agency may engage in planning efforts but may not make any irreversible commitment of resources. Such a commitment could constitute a violation of section 7(d) of the Act.

Federal agencies are required to confer with the Service, pursuant to section 7(a)(4) of the Act, when an agency action is likely to jeopardize the continued existence of any proposed species or result in the destruction or adverse modification of proposed critical habitat (50 CFR 402.10(a)). A request for formal conference must be in writing and should include the same information that would be provided for a request for formal consultation. Conferences can also include discussions between the Service and the Federal agency to identify and resolve potential conflicts between an action and proposed species or proposed critical habitat early in the decision-making process. The Service recommends ways to minimize or avoid adverse effects of the action. These recommendations are advisory because the jeopardy prohibition of section 7(a)(2) of the Act does not apply until the species is listed or the proposed critical habitat is designated. The conference process fulfills the need to inform Federal agencies of possible steps that an agency might take at an early stage to adjust its actions to avoid jeopardizing a proposed species.

When a proposed species or proposed critical habitat may be affected by an action, the lead Federal agency may elect to enter into formal conference with the Service even if the action is not likely to jeopardize or result in the destruction or adverse modification of proposed critical habitat. If the proposed species is listed or the proposed critical habitat is designated after completion of the conference, the Federal agency may ask the Service, in writing, to confirm the conference as a formal consultation. If the Service reviews the proposed action and finds that no significant changes in the action as planned or in the information used during the conference have occurred, the Service will confirm the conference as a formal consultation on the project and no further section 7 consultation will be necessary. Use of the formal conference process in this manner can prevent delays in the event the proposed species is listed or the proposed critical habitat is designated during project development or implementation.

Candidate species are those species presently under review by the Service for consideration for Federal listing. Candidate species should be considered in the planning process because they may become listed or proposed for listing prior to project completion. Preparation of a biological assessment, as described in section 7(c) of the Act, is not required for candidate species. If early evaluation of your project indicates that it is likely to affect a candidate species, you may wish to request technical assistance from this office.

Only listed species receive protection under the Act. However, sensitive species should be considered in the planning process in the event they become listed or proposed for listing prior to project completion. We recommend that you review information in the California Department of Fish and Wildlife's Natural Diversity Data Base. You can contact the California Department of Fish and Wildlife at (916) 324-3812 for information on other sensitive species that may occur in this area.

[\*A Biological Assessment is required for construction projects (or other undertakings having

---

similar physical impacts) that are major Federal actions significantly affecting the quality of the human environment as defined in the National Environmental Policy Act (42 U.S.C. 4332(2)(c)). For projects other than major construction activities, the Service suggests that a biological evaluation similar to a Biological Assessment be prepared to determine whether the project may affect listed or proposed species and/or designated or proposed critical habitat. Recommended contents of a Biological Assessment are described at 50 CFR 402.12.]

Attachment(s):

- Official Species List

## Official Species List

This list is provided pursuant to Section 7 of the Endangered Species Act, and fulfills the requirement for Federal agencies to "request of the Secretary of the Interior information whether any species which is listed or proposed to be listed may be present in the area of a proposed action".

This species list is provided by:

**Ventura Fish And Wildlife Office**

2493 Portola Road, Suite B

Ventura, CA 93003-7726

(805) 644-1766

---



## Project Summary

Consultation Code: 08EVEN00-2017-SLI-0573

Event Code: 08EVEN00-2017-E-01268

Project Name: CSUMB Master Plan

Project Type: \*\* OTHER \*\*

Project Description: Master Plan for California State University Monterey Bay

Project Location:

Approximate location of the project can be viewed in Google Maps:

<https://www.google.com/maps/place/36.65656217050322N121.7652391355764W>

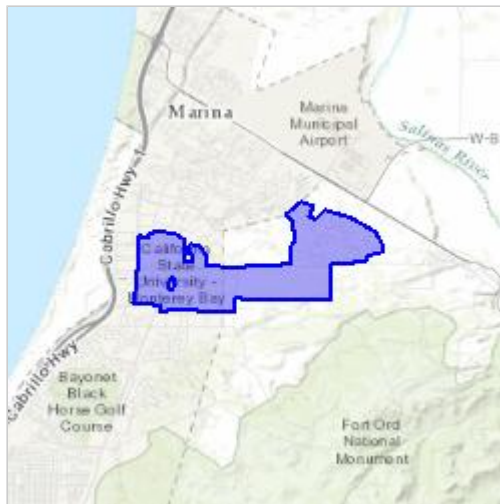

Counties: Monterey, CA

## Endangered Species Act Species

There is a total of 19 threatened, endangered, or candidate species on this species list. Species on this list should be considered in an effects analysis for your project and could include species that exist in another geographic area. For example, certain fish may appear on the species list because a project could affect downstream species. See the "Critical habitats" section below for those critical habitats that lie wholly or partially within your project area under this office's jurisdiction. Please contact the designated FWS office if you have questions.

### Mammals

| NAME   | STATUS     |
|--|------------|
| Southern Sea Otter <i>Enhydra lutris nereis</i><br>No critical habitat has been designated for this species.<br>Species profile: <a href="https://ecos.fws.gov/ecp/species/8560">https://ecos.fws.gov/ecp/species/8560</a> | Threatened |

---

## Birds

| NAME   | STATUS     |
|--|------------|
| <p>California Condor <i>Gymnogyps californianus</i></p> <p>Population: U.S.A. only, except where listed as an experimental population</p> <p>There is a <b>final critical habitat</b> designated for this species. Your location is outside the designated critical habitat.</p> <p>Species profile: <a href="https://ecos.fws.gov/ecp/species/8193">https://ecos.fws.gov/ecp/species/8193</a></p>   | Endangered |
| <p>California Least Tern <i>Sterna antillarum browni</i></p> <p>No critical habitat has been designated for this species.</p> <p>Species profile: <a href="https://ecos.fws.gov/ecp/species/8104">https://ecos.fws.gov/ecp/species/8104</a></p>  | Endangered |
| <p>Least Bell's Vireo <i>Vireo bellii pusillus</i></p> <p>There is a <b>final critical habitat</b> designated for this species. Your location is outside the designated critical habitat.</p> <p>Species profile: <a href="https://ecos.fws.gov/ecp/species/5945">https://ecos.fws.gov/ecp/species/5945</a></p>  | Endangered |
| <p>Marbled Murrelet <i>Brachyramphus marmoratus</i></p> <p>Population: U.S.A. (CA, OR, WA)</p> <p>There is a <b>final critical habitat</b> designated for this species. Your location is outside the designated critical habitat.</p> <p>Species profile: <a href="https://ecos.fws.gov/ecp/species/4467">https://ecos.fws.gov/ecp/species/4467</a></p>  | Threatened |
| <p>Southwestern Willow Flycatcher <i>Empidonax traillii extimus</i></p> <p>There is a <b>final critical habitat</b> designated for this species. Your location is outside the designated critical habitat.</p> <p>Species profile: <a href="https://ecos.fws.gov/ecp/species/6749">https://ecos.fws.gov/ecp/species/6749</a></p>   | Endangered |
| <p>Western Snowy Plover <i>Charadrius alexandrinus nivosus</i></p> <p>Population: Pacific Coast population DPS-U.S.A. (CA, OR, WA), Mexico (within 50 miles of Pacific coast)</p> <p>There is a <b>final critical habitat</b> designated for this species. Your location is outside the designated critical habitat.</p> <p>Species profile: <a href="https://ecos.fws.gov/ecp/species/8035">https://ecos.fws.gov/ecp/species/8035</a></p> | Threatened |

---

## Amphibians

| NAME  | STATUS     |
|---|------------|
| <p>California Red-legged Frog <i>Rana draytonii</i></p> <p>There is a <b>final critical habitat</b> designated for this species. Your location is outside the designated critical habitat.</p> <p>Species profile: <a href="https://ecos.fws.gov/ecp/species/2891">https://ecos.fws.gov/ecp/species/2891</a></p>  | Threatened |
| <p>California Tiger Salamander <i>Ambystoma californiense</i></p> <p>Population: U.S.A. (Central CA DPS)</p> <p>There is a <b>final critical habitat</b> designated for this species. Your location is outside the designated critical habitat.</p> <p>Species profile: <a href="https://ecos.fws.gov/ecp/species/2076">https://ecos.fws.gov/ecp/species/2076</a></p> | Threatened |
| <p>Santa Cruz Long-toed Salamander <i>Ambystoma macrodactylum croceum</i></p> <p>No critical habitat has been designated for this species.</p> <p>Species profile: <a href="https://ecos.fws.gov/ecp/species/7405">https://ecos.fws.gov/ecp/species/7405</a></p>  | Endangered |

## Fishes

| NAME  | STATUS     |
|---|------------|
| <p>Tidewater Goby <i>Eucyclogobius newberryi</i></p> <p>There is a <b>final critical habitat</b> designated for this species. Your location is outside the designated critical habitat.</p> <p>Species profile: <a href="https://ecos.fws.gov/ecp/species/57">https://ecos.fws.gov/ecp/species/57</a></p> | Endangered |

## Insects

| NAME  | STATUS     |
|---|------------|
| <p>Smith's Blue Butterfly <i>Euphilotes enoptes smithi</i></p> <p>No critical habitat has been designated for this species.</p> <p>Species profile: <a href="https://ecos.fws.gov/ecp/species/4418">https://ecos.fws.gov/ecp/species/4418</a></p> | Endangered |

## Crustaceans

| NAME  | STATUS     |
|---|------------|
| <p>Vernal Pool Fairy Shrimp <i>Branchinecta lynchi</i></p> <p>There is a <b>final critical habitat</b> designated for this species. Your location is outside the designated critical habitat.</p> <p>Species profile: <a href="https://ecos.fws.gov/ecp/species/498">https://ecos.fws.gov/ecp/species/498</a></p> | Threatened |

---

## Flowering Plants

| NAME  | STATUS     |
|---|------------|
| Contra Costa Goldfields <i>Lasthenia conjugens</i><br>There is a <b>final critical habitat</b> designated for this species. Your location is outside the designated critical habitat.<br>Species profile: <a href="https://ecos.fws.gov/ecp/species/7058">https://ecos.fws.gov/ecp/species/7058</a>       | Endangered |
| Marsh Sandwort <i>Arenaria paludicola</i><br>No critical habitat has been designated for this species.<br>Species profile: <a href="https://ecos.fws.gov/ecp/species/2229">https://ecos.fws.gov/ecp/species/2229</a>  | Endangered |
| Menzies' Wallflower <i>Erysimum menziesii</i><br>No critical habitat has been designated for this species.<br>Species profile: <a href="https://ecos.fws.gov/ecp/species/2935">https://ecos.fws.gov/ecp/species/2935</a>  | Endangered |
| Monterey Gilia <i>Gilia tenuiflora ssp. arenaria</i><br>No critical habitat has been designated for this species.<br>Species profile: <a href="https://ecos.fws.gov/ecp/species/856">https://ecos.fws.gov/ecp/species/856</a>   | Endangered |
| Monterey Spineflower <i>Chorizanthe pungens var. pungens</i><br>There is a <b>final critical habitat</b> designated for this species. Your location overlaps the designated critical habitat.<br>Species profile: <a href="https://ecos.fws.gov/ecp/species/396">https://ecos.fws.gov/ecp/species/396</a> | Threatened |
| Yadon's Piperia <i>Piperia yadonii</i><br>There is a <b>final critical habitat</b> designated for this species. Your location is outside the designated critical habitat.<br>Species profile: <a href="https://ecos.fws.gov/ecp/species/4205">https://ecos.fws.gov/ecp/species/4205</a>                   | Endangered |

## Critical habitats

There is 1 critical habitat wholly or partially within your project area under this office's jurisdiction.

| NAME  | STATUS           |
|---|------------------|
| Monterey Spineflower <i>Chorizanthe pungens var. pungens</i><br><a href="https://ecos.fws.gov/ecp/species/396#crithab">https://ecos.fws.gov/ecp/species/396#crithab</a> | Final designated |

---

*This page left intentionally blank*

## **APPENDIX D.**

The Birds of Fort Ord East of Route 1

*This page left intentionally blank*



## THE BIRDS OF FORT ORD EAST OF ROUTE 1

Revised 5 Feb 07

David Styer with historic data provided by Don Roberson

An asterisk (\*) after a bird's name means that the species was probably breeding, or confirmed breeding on Fort Ord east of Route 1. This list is based almost entirely on my own inventories. These have taken place during the following time periods: 25 Feb - 16 Jun 96, 9 Jul - 16 Aug 97, 27 Jun - 16 Aug 98, 27 Jul - 19 Aug 99, 7 Jun - 28 Jun 00, 5 Feb 01 - 3 Mar 01, 17 Sep 01 - 2 Nov 01, 13 Dec - 31 Dec 01, and most of 2002 and 2003. In 2004–2006 only the more outstanding sightings were noted. The few records based on other people's sightings are noted. All collective references to Christmas Bird Counts (CBCs) refer to the nine Monterey CBCs provided by Roberson. This count takes place in a 15-mile diameter circle that includes the southwest portion of Ft. Ord.

1. Cackling Goose  
1 record: 1 seen by D. Roberson's CBC group on 29 Dec 00.
2. Canada Goose\*  
Seen in small numbers. Nested, but unsuccessfully in 2002.  
Successfully nested at Machine Gun Flats in 2005.
3. Wood Duck  
The first record was 5 males at Boy Scout Lake on 12 Oct 05. Some were seen there until 7 Dec 05.
4. Gadwall\*  
The first record was five seen on 8 Aug 98 on a vernal pond.  
Expected in small numbers. In 2002 there were 3 records from 12 Mar to 24 Mar, and 5 records from 29 Aug to 29 Oct, all at Mudhen Lake. Seen in January and December in 2003. Nested on Machine Gun Flats in 2005; young noted on 22 May 05.
5. American Wigeon  
Winter visitor. A pair was on Mudhen Lake on 18 Feb 01; 3 were there on 23 Mar 02, and 1 to 2 pairs were there from 23 Nov 02 through 31 Jan 03. Seen regularly at the vernal pools 29 Jan 05 through 2 Apr 05. Also, seen regularly at Boy Scout Lake Nov and Dec 05, with approximately 10 there on 13 Dec.
6. Mallard\*  
Seen on ponds through year. Young seen on Mudhen Lake 6 Jun 96 and on Boy Scout Pond on 2 Jun 96. Young seen on several ponds in 1998. One hundred to three hundred regularly visited Mudhen Lake in the fall of 2001. There were 87 visiting the vernal pool at Machine Gun Flats on 2 Mar 04. Bill Collins saw around 500 on the pond behind Range 37 in the fall of 2000. Ronnie L. Ryno found young at Mudhen Lake on 9 Jun 89 during the Monterey County Breeding Bird Atlas project.
7. Cinnamon Teal  
First record: 1 male on the pond behind Range 37 on 31 Mar 96.  
Two spent most of Aug 99 on Fox Pond. There were several records in Mar 05, and 3 were on Mudhen Lake on 21 Jul 05. In early 2006 they were seen on Boy Scout Lake: 2 on 24 Jan and 4 on 21 Feb.
8. Northern Shoveler  
A pair was at Mudhen Lake on 29 Oct 01, 6 were there 6 Oct 02 and 3 were there on 25 Oct 05.
9. Northern Pintail  
First record: 3 females on Mudhen Lake on 22 Oct 01. Six were there, including a male, on 2 Nov 01, 2 were there on 22 Oct 02, and a pair was at Boy Scout Lake on 13 Dec 05.

10. Green-winged Teal  
A pair was at Mudhen Lake from 30 Mar to 7 Apr 96. They visited Mudhen Lake in early Nov 02, and 20 were there on 5 Nov 02. On 12 Dec 05 19 males were on Mudhen Lake. The next day a flock of 35 (males and females) were on Boy Scout Lake. They were seen there in dwindling numbers up until 21 Feb 06.
11. Redhead  
A male was seen at Mudhen Lake from 13 Dec 01 through 4 Feb 02.
12. Ring-necked Duck  
An occasional fall and winter visitor. 1st record: 1 male in holding pond near west end of Eucalyptus Rd. on 28 Jun 98. There were 5 females on Mudhen Lake on 20 and 27 Nov, and 1 male there on 1 Dec 06. Notably, Bill Collins saw around 35 in the pond behind Range 37 in the fall of 2000.
13. Greater Scaup  
1 record: 1 female in the holding pond at the west end of Eucalyptus Road on 26 Oct 01.
14. Bufflehead  
One female spent the entire summer of 1998 on the same pond (see ring-necked Duck). 2 females were on the same pond in Jan 03. A pair was on Machine Gun Flats on 22 Feb 05.
15. Common Goldeneye  
Seen in winter 1996 on above-mentioned pond before inventory started, and in Dec 01.
16. Hooded Merganser  
2 records: One immature male on Mudhen Lake 25 Feb - 24 Mar 96, and 1 female on Mudhen Lake on 24 Nov 06.
17. Common Merganser  
1 record: seen in the Salinas River on 30 Apr 05.
18. Ruddy Duck  
Occasional visitor. 2 males on the vernal pool on Machine Gun Flats on 17 Jul 98, and 1 female on the Catfish Pond on 18 Oct 02. Two females spent much of Dec 05 on Mudhen Lake. A resident of Mudhen Lake beginning 9 Oct 06.
19. Wild Turkey\*  
Seen irregularly during the inventory. Dick Pitschka and I saw 3 adult females and 7 young across Jacks Road from Mudhen Lake on 21 Jun 00. Noticeably more common by 2001 than in the past. In 2003 and 2004, 2 or 3 flocks of up to 20 were seen, and they continue to have young.
20. California Quail\*  
Seen, except in the most open grassland, throughout Ft. Ord, throughout the inventory. Possibly increasing: in 1996 most coveys with 10 or fewer birds. In 2001 many coveys with 10 to 20 birds. They continue roughly the same size through 2006. I have been told that coveys with a 100 California Quail were common in the past.
21. Loon species  
2 flew over the BLM office area on 2 Nov 01.
22. Pied-billed Grebe\*  
Seen throughout the year on permanent ponds. In 1996 and 1997 young produced only on Mudhen Lake. In 1998 young were produced on at least four vernal ponds.
23. Eared Grebe  
2 records: 1 stayed at the holding pond on the west end of Eucalyptus Road from 4 Oct to 11 Oct 01, and 1 was on Mudhen lake from 15 Nov 05 through 29 Nov 05.

24. Double-crested Cormorant Winter visitor to Mudhen Lake. Seen late December through March, irregularly until May. Up to 5 have been seen at once. On 30 Nov 06 30 flew over Mudhen Lake.
25. American Bittern 1 record: 1 seen at Mudhen Lake on and around 7 Aug 99.
26. Great Blue Heron One or two regularly visit the permanent ponds.
27. Great Egret Occasional visitor to the permanent ponds. 1 frequently seen at the dwindling Mudhen Lake in 2003. One at a puddle in East Garrison on 22 Mar 05 was a surprise.
28. Green Heron 4 records prior to 2006: 1 seen by Sam Fitton on 6 Apr 98, 1 seen at Mudhen Lake 11 Jun 02, 1 seen by Steve Moore at the pond on Crescent Bluff Road on 25 Apr 03, and 1 flew from Toro Creek Pond on 7 Jul 05. Bruce Gerow saw them regularly at the mouth of El Toro Creek, just off Ft. Ord. There were 5 records at Mudhen Lake and Boy Scout Lake in 2006.
29. Turkey Vulture Seen throughout Ft. Ord throughout the year, although uncommon in the backcountry in the fall. Possibly breeding, but not confirmed, although evidence continues to build. Numbers on CBCs have increased almost steadily from 1 in 1984 to 17 in 2001.
30. Osprey 1<sup>st</sup> record: 1 eating on top of high-tension tower by Range 45 on 6 Apr 96. 1 flew over Mudhen Lake on 19 Oct 01. In 2002 Osprey were seen on 4 Jan, 8 Jan, and 11 Apr. In 2003 there were 3 records: 1 on 3 Jan at Mudhen Lake, 1 in April flying over Ingman Court, and 1 on 3 May at El Toro Creek. Again, one was seen at Mudhen Lake on 3 Jan 04.
31. White-tailed Kite\* Seen in small numbers (1 or 2) over grasslands and vernal pools. In the spring of 1998 Roberto Maceira saw approximately 10 spending the day by one pool, and in the summer of 2006 Tim Buhl saw a group of 11, including young.
32. Bald Eagle An immature bird was seen at Mudhen Lake in the spring of 1999. On 4 Mar 02 Bill Collins saw 1 subadult on Machine Gun Flats.
33. Northern Harrier A winter resident on the grasslands, and an occasional migrant elsewhere. 1 to 3 are usually seen in grasslands. One summer record: 1 on 8 Jul 98.
34. Sharp-shinned Hawk Fairly common fall migrant, arriving in Sep, and uncommon spring migrant. Also seen on 1 and 2 Aug 99. A winter resident in 2003 and 2004.
35. Cooper's Hawk\* Seen throughout the inventory, and widely, but thinly spread over Ft. Ord.
36. Red-shouldered Hawk\* Common year-round in the "front" of Ft. Ord, near housing. Seen less in other locations. Ronnie L Ryno observed an occupied nest near Mudhen Lake 16 Apr 86.

37. Red-tailed Hawk\* Seen throughout Ft. Ord throughout the year. Eleven Red-tailed Hawks wheeling over the BLM office on 25 Jul 98 was an extraordinary sight. Nests are seen regularly; for example, Ronnie L. Ryno saw on occupied nest on 16 Apr 86. Usually around 10 are seen on CBCs, but on 28 Dec 84 there were 25 counted.
38. Ferruginous Hawk 2 records: Don Roberson saw one in the Grasslands on 28 Dec 84, and I saw 1 near Imjin Rd. on 14 Apr 02.
39. Golden Eagle 1st record: 1 over grassland, Oil Well Rd., on 6 Apr 96. An uncommon fall migrant, rare in other seasons. Seen in February, March, and September in 2003. One was seen on the CBC on 29 Dec 00, and on Lightfighter Road during the CBC on 27 Dec 05.
40. Crested Caracara 1 record: Tim Buhl saw 1 fly across Highway 1 on 11 Sep 06.
41. American Kestrel\* Seen throughout the year. Perhaps 4 to 8 pairs breed on Ft. Ord. Especially visible on the grasslands. On the 9 CBCs the low count was 4 and the high count was 14.
42. Merlin Uncommon migrant or winter visitor: 1 was seen near Laguna Seca during the CBC on 27 Dec 89. 1 at Machine Gun Flats on 9 Mar 96 and on 11 Jan 02, 1 on First Ave. on 19 Oct 01, 1 at Parker Flats on 30 Dec 03, and 1 by Fox Pond on 9 Dec 04. 1 was seen at El Toro Creek on 26 Feb 05, and another was seen at Machine Gun Flats on 25 Mar 05.
43. Peregrine Falcon One seen circling over First Ave. on 4 Oct 01.
44. Prairie Falcon 3 records: 1 seen at Machine Gun Flats on 19 Oct 01, 1 seen by Bill Reese on 27 Dec 04, and 1 was seen flying over Old Reservation Rd. on 30 Aug 06.
45. Virginia Rail 1 record: 1 first heard on 28 Oct responded repeatedly to a taped call on 30 Oct 06.
46. Sora Few records: 1 on pond behind Range 37 on 31 Mar 96; 1 seen on Mudhen Lake on 1 and 2 Mar 01, and 1 was at the Catfish Pond much of Oct 04. They were heard from 21 Oct to 13 Nov 06 on Mudhen Lake, with a maximum of 3 heard on 26 Oct.
47. Common Moorhen 2 records of single individuals on Mudhen Lake: on 23 Oct 01, and seen from 16 Oct to 23 Oct 06.
48. American Coot\* In 1996 common through April, then most gone. Approximately 2 young produced in 1996 and 1997. In 1998 seen in summer on at least 6 ponds, with at least 25 young produced. In the dry year, 2001, only a pair at the Catfish Pond produced young (5). By summer 2004 all ponds except the Catfish Pond had dried, so Coots could only be seen there. Coots returned to the refilled Mudhen Lake by 25 Mar 05, and approximately 40 were seen there on 14 Nov 06.

49. Killdeer  
Seen at Mudhen Lake through Mar 96, but not later that year. Up to 8 seen at the vernal pool behind the BLM buildings in July and August of 1998. Larger numbers, e.g., 26 on 11 Dec 02, seen in fall or winter in fields such as Parker Flats.
50. Spotted Sandpiper  
1 record: 2 in breeding plumage at Fox Pond on 4 Jul 98.
51. Solitary Sandpiper  
3 records: 1 bird at vernal pond behind BLM headquarters on 1 Aug 98, 1 at the Catfish Pond on 29 Jul 03, and there was also 1 on the Salinas River at the mouth of El Toro Creek on 3 May 03.
52. Greater Yellowlegs  
2 March records in 1996: 6 on Reserve 12 on 9 Mar and 1 heard at Mudhen Lake on 24 Mar. Seen visiting the mud-flats behind the BLM buildings in July and August of 1998, at Fox Pond in Aug 99, 3 on Machine Gun Flats on 11 Jan 02. Visited Mudhen Lake and Machine Gun Flats in March, April, October, and November in 2003. There were 14 on Machine Gun Flats on 2 Mar 04, and 22 on 14 Mar 05. 1 flew over South Boundary Road during the CBC on 29 Dec 00.
53. Whimbrel  
1 record: on 29 Jul 03 one flew over me on Parker Flats Road, and circled around and called.
54. Western Sandpiper  
1 record: 1 at Fox Pond on 14 Aug 99.
55. Least Sandpiper  
1 stayed at Fox Pond in 1999. First record: 31 Jul 99. Mary Paul saw 2 at Boy Scout Lake on 19 Dec 05, and 1 was seen at the pond by Riso Ridge Road on 13 Nov 06.
56. Long-billed Dowitcher  
Visitors to Fox Pond in 1999. I saw 1 on 5 Aug, the first record, and 10 or more on 18 Aug.
57. Wilson's Snipe  
Steve Moore and Suzy Worcester have seen several at vernal pools; e.g., they saw 1 at Twin Pond on 6 Apr 03. In 2004 there was 1 at Machine Gun Flats on 22 Apr, and there were 2 at the Catfish Pond on 16 and 21 Oct. 3 records in 2005: 10 were counted at Machine Gun Flats on 29 Jan, 2 at Mudhen Lake on 29 Oct, and 1 at Toro Creek Pond on 23 Nov. One was at Machine Gun Flats on 23 Jan 06.
58. Wilson's Phalarope  
First record: 1 immature bird on pond behind BLM office on 2 Aug 98. There were 3 on Fox Pond in Aug 99.
59. Red-necked Phalarope  
3 on the pond on Reserve 5 on 26 Jul 97, up to 19 on Fox Pond in Aug 99, and up to 6 on Mudhen Lake in Aug 06.
60. Red Phalarope  
1 record: 1 seen by Bill Reese's CBC group on Mudhen Lake on 27 Dec 05.
61. Mew Gull  
1 record: a large and varied group of gulls were on top of the Commissary building during the CBC count on 28 Dec 84, when Ft. Ord was an active military base. There were 130 of these gulls.
62. California Gull  
Several are regularly seen flying over Ft. Ord and visiting such places as Burger King in fall and winter. Don Roberson saw 1105 on the commissary roof during the CBC on 28 Dec 84.
63. Herring Gull  
1 record: 38 on 28 Dec 84 (see comment at Mew Gull).

64. Thayer's Gull 1 record: 1 adult on 28 Dec84 (see comment at Mew Gull).
65. Western Gull 2 records: Don Roberson counted 159 on the Commissary roof during the 28 Dec 84 CBC, and a flock of approximately 6 were seen flying over CSUMB on 19 Jul 98.
66. Glaucous-winged Gull 1 record: 1 on 28 Dec84 (see comment at Mew Gull).
67. Black-legged Kittiwake 1 record: an exhausted individual found by Shirley Tudor in the Inland Ranges on 25 Feb 11.
68. Elegant Tern 2 records: Sam Fitton heard 1 on 26 Jul 97, and Bruce Gerow heard 1 on 1 Aug 98.
69. Rock Pigeon\* In spite of being common in the housing areas of Ft. Ord, they are infrequently seen in the interior backcountry. There are a few records each year.
70. Band-tailed Pigeon Chuck Haugen had seen them along El Toro Creek. Charlie Saunders and I saw 5 on 18 Mar 03 flying over Trail 22. Following that, I saw 24 on 9 May, 7 on 16 Jun, and 3 on 11 Nov 03. In 2006 there were 6 at the BLM Offices on 4 Jan, 10 at Engineer Canyon Road on 8 Mar, and 30 down from Mudhen Lake on 5 Apr. Fifteen were seen on the CBC on 27 Dec 96.
71. Eurasian Collared-Dove
72. Mourning Dove\* Seen, usually 1 to 4 at a time, throughout the inventory and in all areas. On 24 Jul 97, Robin Whatley and I counted over 60 in one spot along Oil Well Road, and I saw approximately 60 by Eucalyptus Road on 15 Oct 06. Less common in the dry years of 2002 and 2003, but a flock of 30 was seen in the grasslands on 2 Dec 03.
73. Greater Roadrunner\* Few records: near Mudhen Lake: 1 heard on 6 Apr 96 and 1 heard on 2 Nov 01. Also seen by Barloy Canyon Road and Trail 22 in the spring of 2002. People have said they see them down Crescent Bluff Road, and Engineering Canyon Road. Steve Moore and Eric Morgan independently saw 1 at Machine Gun Flats on 19 Apr 03, our only 2003 record. A Roadrunner on Eucalyptus Road entertained the volunteers on 18 May 04. Tammy Jakl saw 1 on Trail 10 on 26 Oct 05. Ronnie Ryno saw 1 near Mudhen Lake on 16 Apr 89. Don Roberson saw 2 on the CBC on 28 Dec 84, and 1 on the CBC on 28 Dec 99.
74. Barn Owl\* Resident, but few seen. In Aug 98 they were found to come out at dusk over the grasslands at Skyline and Oil Well Roads, and hover like Red-tailed Hawks. [Id. aided by Sam Fitton.] In Jul 06 Wendi Wendt showed us a cliff-side nest with 4 young.
75. Western Screech-Owl\* Resident. Seen once or twice each year, including an adult and 1 young on 26 Jul 97.
76. Great Horned Owl\* A permanent resident, and breeding bird, seen throughout Ft. Ord. At least 5 pairs live in the vicinity of Eucalyptus Road. Mark Littlefield observed a nest with young on 25 Feb 91.

77. Burrowing Owl  
 Jack Massera reported that they used to live in the grasslands. Bruce Delgado saw 2 in Nov 97. The Fittons and I looked for them on 15 Aug 98, and we found pellets that were no more than a week old [fida Sam Fitton]. The volunteer group saw 1 on 4 Feb 03 near the corner of Skyline and Guidotti Roads. In late Oct 05 Jessie Quinn saw 3 or 4, and Phil Smith found 1 that stood by its hole under a Coyote Brush bush. Smith reported at least 12 on a subsequent trip that winter (2005-06). Observed on the 1993, 1994, 1998, 2005, and 2006 CBCs.
78. Common Poorwill\*  
 In the chaparral throughout the inventory. Infrequently calls in July and August. Heard calling as early as 31 Jan 03. In fall they are seen but not heard. Late records: 6 on 20 Oct 01, and 4 on 28 Oct 06.
79. Vaux's Swift
80. White-throated Swift  
 Appears to be nesting under the highway bridges adjacent to Ft. Ord. Seen widely over Ft. Ord on 19 Feb 01, as in a migration. Seen throughout the year, but usually scarce in winter. One was seen on the CBC of 29 Dec 94. They were common on the Reservation Road bridge over El Toro Creek in the fall of 2006, with at least 28 seen on 16 Nov, and seen until my last trip to the area on 24 Dec.
81. Anna's Hummingbird\*  
 One to several seen everywhere except pure grassland throughout the year. Most actively breeding in winter. Ronnie Ryno saw an occupied nest on 8 May 89, and I watched nest activity at the BLM office area from 5 Jan to 16 Feb 06. Usually between 40 and 70 individuals have been counted on the CBCs, but 179 were noted on the 1984 CBC.
82. Rufous Hummingbird  
 Bruce Gerow said that a big migratory wave of Rufous Hummingbirds passed through Ft. Ord in April 1989.
83. Allen's Hummingbird\*  
 Seen at BLM compound in 1996 and at the Catfish Pond from 16 Mar to 8 Jun 03, and again in 2004, starting 15 Feb. In 2004, also noted in the BLM office area on 11 Feb, and along El Toro Creek on 10 Mar.
84. Belted Kingfisher  
 One or two seem to visit Ft. Ord regularly, except during the breeding season. Seen most regularly at Mudhen Lake. They are more regular, and possibly nesting, in the Salinas River area, a region not inventoried prior to 2006.
85. Lewis's Woodpecker  
 From 20 Dec 93 to 6 May 94 there were "dozens" on eastern Ft. Ord. For example, 5 were seen on the CBC on 28 Dec 93. [See Don Roberson, *Monterey Birds*, 2<sup>nd</sup> Edition, 2002.] Tim Buhl saw 1 at the Catfish Pond on 2 Oct 03. It was still there the next day.
86. Acorn Woodpecker\*  
 In 1996 most individuals were along El Toro Creek. In 1998 there was a small colony next to Mudhen Lake. In the falls of 2001 and 2005, strong acorn years, Acorn Woodpeckers were widely distributed all over Ft. Ord. One to five could be seen in many places. By the end of the dry, low yield year, 2002, Acorn Woodpeckers were again scarce on Ft. Ord, with a total of 2 at Mudhen Lake.

87. Red-breasted Sapsucker 3 records of 1 near Mudhen Lake: 7 Apr 96, 12 Nov 02, and 21 Oct 06. In 2003 there were 3 records of 1 in the BLM office area: 4 Mar, 18 Mar, and 31 Dec. Not seen on CBCs.
88. Nuttall's Woodpecker\* Seen in oak trees throughout the year. Usually just 1 or 2 seen. Perhaps more easily seen in sycamore trees along El Toro Creek. Anywhere from 1 to 8 have been seen on CBCs.
89. Downy Woodpecker\* Thinly spread over riparian locations throughout the year. At most 2 have been seen on any CBC, but the count circle excludes most of the riparian areas of Ft. Ord.
90. Hairy Woodpecker\* Widely distributed on Ft. Ord in very small numbers. For example, a pair can usually be seen at Mudhen Lake. Much more widely distributed in the fall of 2001. At most 3 have been noted on any CBC.
91. Northern Flicker\* Seen throughout oak savannah throughout the inventory. Up to 10 seen per field trip. From 10 to 20 have been noted on most CBCs.
92. Olive-sided Flycatcher\* Uncommon spring migrant; 3 records of 1 each: on Crescent Bluff Rd. on 28 Apr 96, at El Toro Creek on 7 May 02, and Machine Gun Flats on 14 May 03. In 2004 through 2006 a pair nested in the BLM office area. On 13 Jul 04 an adult was seen with 2 fledglings.
93. Western Wood-Pewee 4 records: 1 seen at the camp ground by West Camp Street on 15 Aug 99, and 1 May 03 (singing), 2 at the BLM office area on 8 May 03, and Bruce Gerow saw 1 at Mudhen Lake on 21 Apr 04.
94. Gray Flycatcher 1 record: Jane Styer and I saw one near Skyline Road on 2 May 03.
95. Pacific-slope Flycatcher\* Summer resident in trees in riparian locations. First spring record: 17 Mar 04. In 1998 nested under eaves at front entrance to BLM main building. The latest annual record was 1 seen 27 Sep 01. Early arrival in 2004 with 3 March records; and in 2005 with arrival noted on 25 Mar.
96. Black Phoebe\* 1 or 2 pairs are seen at most riparian locations throughout the year. On CBCs prior to 1999 fewer than 8 individuals were noted per count; from 1999 on 10 or more have been noted per count
97. Say's Phoebe Winter resident on grasslands: last seen on 7 May 02. First fall record: 10 Sep 02. Usually fewer than 5 seen on one field trip. Usually 5 to 15 individuals have been seen per CBC.
98. Ash-throated Flycatcher\* Summer resident throughout oak-chaparral. First spring record: 2 Apr 05. Infrequently seen in August. Latest record: 13 Aug 02.
99. Cassin's Kingbird Bruce Gerow saw 1 very vocal bird on Ft. Ord near the Toro Estates Entrance from 19 to 21 May 01. Another vocal bird was seen at Boy Scout Lake on 19 Aug 05.



100. Western Kingbird\* 1 or 2 pairs breed on the grasslands near El Toro Creek. The 1<sup>st</sup> spring records are usually in early April. Seen on 27 Mar 04. A “fall” migrant was on Machine Gun Flats on 2 Aug 99. Bruce Gerow confirmed breeding in 2001.
101. Loggerhead Shrike Not seen in 1996. Uncommon, but widely distributed in somewhat open areas since then.
102. Hutton’s Vireo\* Year-round resident in the Coast Live Oaks. When they are singing I can usually detect 1 to 4 individuals in one place. Most CBCs have recorded between 2 and 7 individuals.
103. Warbling Vireo\* Likely breeding in dense willow locations. Seen only in spring, and in drier years likely only a migrant. Earliest records: 27 Apr 02, 21 Apr 04, and 18 Apr 05. I was surprised that there was one at the Dam Crossing on 22 Jun 04.
104. Steller’s Jay Usually associated with El Toro Creek community, first recorded on Ft. Ord on 27 Jul 97. Widely distributed over Ft. Ord in the fall of 2001, a good acorn year. Noted around Mudhen Lake in November and December 05.
105. Western Scrub-Jay\* Highly visible common bird throughout the oak-chaparral throughout the inventory. The CBCs have recorded between 32 and 90 individuals.
106. American Crow\* Although abundant in the housing areas on Ft. Ord, it is uncommon in the backcountry. The CBCs have recorded between 16 and 90 individuals.
107. Common Raven Infrequent visitor. Bruce Gerow saw two fly over the vicinity of Mudhen Lake in the spring of 1999. From then through 2003 I have widely scattered records: 10 Jun 00, 21 Oct 01, 3 May 02, 8 Aug 02, 17 Nov 02, 21 May 03, and 11 Sep 03. The six records in 2004 of up to 5 individuals suggest a population increase. In 2005 there were 4 records, and in 2006 there were 11 records of 1 to 4 individuals.
108. Horned Lark\* Seen in high grassland throughout the year. Young birds observed in June and July. They appear to be much more common in winter. They were uncommon in 2002. Five of the 9 CBCs have recorded no Horned Larks. The 28 Dec 93 CBC recorded 69 larks, far more than any other Ft. Ord count.
109. Purple Martin 1 record: four flew west over Mudhen Lake on 14 Aug 99.
110. Tree Swallow\* Seen at ponds in small numbers. In 1996 first seen on 9 Mar, in 2001 on 12 Feb, in 2002 on 8 Feb, and in 2003 on 9 Mar. In July/August inventories, not seen in 1997, and last seen on 12 Jul 98, 1 Oct 01, 15 Jun 02, and 8 Jun 03. A possible migration peak in April. Three were seen on the 29 Dec 98 CBC.

111. Violet-green Swallow\* At ponds in small numbers during the winter/spring inventory of 1996. Early record: 10 Feb 01. Around 60 birds seen on 2 Mar 01. Rarely seen in summer. In 2002 seen regularly from 6 Mar until 11 Jun, but not otherwise. In 2003 and 2004 seen until mid-June, probably nesting in a cliff face on Barloy Canyon Road. Also, 4 seen on the 29 Dec 98 CBC, and 3 were at Mudhen Lake on 30 Dec 03.
112. Northern Rough-winged Swallow Seen in small numbers from early March (5 Mar 02) to early July (8 Jul 98). Seen as early as 12 Feb 01.
113. Cliff Swallow\* Summer resident. Until 2003 the early inventory date was 2 May 02. In 2003 approximately 50 were flying along El Toro Creek on 6 Apr, and in 2004 they were seen as early as 15 Mar. The most common swallow into August. Not seen in Sep 01, and last seen on 7 Aug 02, 12 Aug 03, and 19 Aug 05.
114. Barn Swallow\* Summer resident with nests observed. Usually first seen in March. One individual was seen on 20 Jan 06. Seen over the grasslands as well as over ponds. The 20 Barn Swallows seen over the vernal pond behind the BLM office appeared migratory. In Aug 04 a flock settled around the corner of Eucalyptus and Parker Flats Roads. Approximately 60 were seen there on the 20<sup>th</sup>. Some last records for the year are: 22 Sep 01, 12 Sep 02, and 12 Aug 03. One was seen on the 29 Dec 98 CBC.
115. Chestnut-backed Chickadee\* Seen throughout the inventory in scattered localities where there are oak trees. Up to 10 may be seen in a given location. The 1993 CBC reported 43 individuals, but the count has usually seen fewer than 15.
116. Oak Titmouse\* Common in the oaks and riparian woods throughout the year. Usually fewer than 10 are seen. The 1993 CBC reported 54 titmice, all other CBCs found 17 or fewer individuals.
117. Bushtit\* Common throughout the year wherever there are trees or chaparral. Usually seen in flocks (of up to 30 birds). Usually 100–200 are seen during CBCs, but 326 were counted on 28 Dec 84.
118. Red-breasted Nuthatch Infrequent winter resident, noted on several CBCs.: 1 in '96, 2 on the golf course in '98, 3 in '00, and 1 seen near BLM office on 28 Dec 01. A small "wave" came through in the fall of 2004, with the 1<sup>st</sup> heard in Coast Live Oaks on 29 Sep., and one wintered in the BLM office area and was last seen on 30 Apr 05.
119. White-breasted Nuthatch 5 records: 1 or 2 in the Valley Oaks near El Toro Creek on 27 Jul 97, 15 Aug 99, and 28 Oct 03; one was seen near El Toro Creek on 18 Sep 01. One was in the Coast Live Oaks at Boy Scout Lake on 16 Nov 05
120. Pygmy Nuthatch\* 1 record prior to 2006: Don Roberson saw 2 on the golf course on the CBC on 28 Dec 99. On 6 Mar 06 a pair was seen mating in the pine planting along South Boundary Road. On 5 Jun they were seen feeding fledglings in the same location.

121. Brown Creeper Uncommon winter resident. They have been seen at the golf course on several CBCs: 1998, 2000, and 2005. There was 1 at BLM offices from 11 Dec 02 until 28 Jan 03.
122. Rock Wren One was in an eroded area not far from the top of Oil Well Road, seen on 21 and 27 Oct 01.
123. Bewick's Wren\* Common in the trees, brush, and chaparral throughout the inventory. During the height of song one may hear roughly 10 singing. On CBCs anywhere from the teens to the 30s have usually been recorded. On 28 Dec 93 52 were counted.
124. House Wren\* Seen in riparian locations from March until July. Latest records: 19 Aug 99, 13 Oct 02, and 17 Oct 06. Less frequent, and last noted on 17 May, in the dry year 2004.
125. Marsh Wren One singing on Mudhen Lake 25 Feb to 2 Mar 01, and 1 at the Catfish Pond in the fall (8 Oct) of 2002, in Mar 03, and Oct 04. Previously seen by Bill Collins in the pond near Range 36. They were seen at Mudhen Lake from 26 Oct to 15 Dec 06, with a maximum of 4 seen on 13 Dec.
126. Golden-crowned Kinglet Few winter records. There were 2 noted on the golf course on the 1998 CBC. Seen in Dec 01 until 10 Mar 02. Not seen again until 12 Dec 02.
127. Ruby-crowned Kinglet Winter resident in trees. Last seen on 6 Apr 96, 12 Apr 02, and 6 Apr 03. Main fall arrival in early October, e.g. 3 Oct 02, 6 Oct 03. Usually fewer than 10 are seen, but in the fall of 2006 up to 30 could be seen at a single place. Usually 15–30 are seen on the CBCs.
128. Blue-gray Gnatcatcher\* Recorded from 30 Mar 96 and 10 Mar 02 through spring in oak-chaparral areas. Last records: 7 Jul 98, 19 Aug 99, 2 seen in chaparral on the 2001 CBC, and 20 Aug 02. Robert Horn saw 1 near Creekside on 1 Nov 03.
129. Western Bluebird\* Seen throughout the year, although recorded on a minority of the stops. The flocks usually have 5 or fewer individuals. Bluebirds may have become more common on Ft. Ord between 1996 and 2006.
130. Mountain Bluebird 7 seen on Camp Ord on 3 Jan 37. [See Don Roberson, *Monterey Birds*, 2<sup>nd</sup> Edition, 2002.]
131. Townsend's Solitaire 1 record: 1 seen and photographed by the BLM Office on 22 Oct 07.
132. Swainson's Thrush First heard singing in dense willows along Crescent Bluff Road on 4 May 96. Heard singing on 8 and 16 Jun 96 near Guidotti Gate. Migrant heard singing on 14 May 02. In 2003 a May migrant. Noted 23 to 30 Apr 05. Just 1 or 2 seen per day.
133. Hermit Thrush Widely spread fall records of 1 to 3 birds starting 18 Oct 01, 13 Oct 02, and 14 Oct 03. A winter resident; most have left by the end of February. Sporadic records up to 6 Apr (2003). A surprising 9 seen at once at the Huffman Tank on 23 Nov 02. On the 9 CBCs a high of 22 were counted on 28 Dec 99 and a low of 3 were noted on 27 Dec 96.

134. American Robin\* A few present in certain locations, e.g. Mudhen Lake, and the BLM compound. Seen throughout the year. On 15 Aug 98 there was a "fall" flock of ten by the BLM office. Only 1 record from 18 Sep through 18 Oct 01. After that, more frequently seen. In 2003 seen on 6 Jun, and not again until 7 Nov. On 3 Feb 04 there was a winter flock of 32 at the corner of Eucalyptus and Barloy Canyon Roads. An outstanding record was the 1190 counted on the 1994 CBC.
135. Varied Thrush Seen by Don Roberson at Lower Pilarcitos Pond on 2 CBCs: 1 seen on 28 Dec 92 and 3 seen on 28 Dec 99. Also seen, 1 each, on 24 Nov and 25 Dec 06 at the BLM office area, and on 1 Dec 06 near Lower Pilarcitos Pond. The 24 Nov and 1 Dec birds were singing.
136. Wrentit\* Seen (heard) throughout the chaparral throughout the year.
137. Northern Mockingbird\* Small numbers usually seen near housing areas, but also seen around trees or shrubs in the grasslands.
138. Brown Thrasher 1 seen near Mudhen Lake on 14 Oct 84. [See Don Roberson, *Monterey Birds*, 2<sup>nd</sup> Edition, 2002.]
139. California Thrasher\* Seen (heard) throughout the chaparral throughout the year, but with lower frequency than the Wrentit.
140. European Starling Seen in many locations throughout the year. Common along El Toro Creek; however, infrequently seen at many places. In 2006 they were more common throughout Ft. Ord.
141. American Pipit Winter visitor: 7 at Fox Pond on 14 Feb 01; 39 not far from the top of Oil Well Road on 17 Feb 01. In 2003 last seen on 21 Mar, and in 2004 on 12 Apr.
142. Cedar Waxwing Winter resident. First fall record: 10 seen on 3 Oct 01. On 26 Feb 01 there were 44 by El Toro Creek. Late records: on 7 May 02 there were about 10 by El Toro Creek, and on 25 May 03 there were 32 in the same location; in 2004 there were 50 seen on 19 May and 7 seen on 4 Jun. In 2005 seen mainly in April. Seen just 3 times in 2006.
143. Phainopepla 2 seen along Crescent Bluff Road on 12 Apr 02. Reported by Chuck Haugen in July 2002. Up to 3 seen visiting elderberries along El Toro Creek on 25 and 26 Jul 02. Next seen 28 and 29 Sep 06, when 2 visited an elderberry on the corner of Eucalyptus and Barloy Canyon Roads. Previously reported by Bruce Gerow as a non-breeding visitor during the Monterey Breeding Bird Atlas project.
144. Orange-crowned Warbler\* First annual records: 9 Mar 96, 1 Mar 01, 9 Mar 03, 15 Feb 04, 18 Feb 05. On 9 Mar 03, 16 were heard singing. Frequently recorded in chaparral/oaks from 14 Apr on. Infrequently recorded in July and August. In 2001 a noticeable fall migration in September and October, and 2 were seen on 1 Nov. In 2003 later individuals included 1 on 22 Oct and 1 on 4 Dec, both near water. They have been seen on approximately half of the CBCs.
145. Nashville Warbler Migrant. 1<sup>st</sup> record: 1 at El Toro Creek on 17 Sep 01. Other records of 1 individual from 6 to 9 Oct 01, 11 Mar 03, and 21 Apr 03.

146. Northern Parula  
1 sure record: 1 on 5 Oct 01 on 7<sup>th</sup> Street. Also, likely an immature female seen on Parker Flats Cutoff on 27 Oct 02.
147. Yellow Warbler  
Spring records: 1 heard near Mudhen Lake on 21 Apr 96, and ones seen on 14 May and 16 May 02, 17 Apr 03, and 17 and 25 Apr 04. In 2001 one to three were regularly seen from mid-September to mid-October.
148. Yellow-rumped Warbler  
Winter resident. Peak on 6 Apr 96, and last seen on 20 Apr 96 and 12 Apr 02. First seen on 27 Sep 01, 1 Oct 02, and 26 Sep 06. Also, there was an isolated record of 1 on Ingman Ct. on 15 Aug 02. Nearly all are of the Audubon's race. I saw 1 bird of the Myrtle race on 2 Nov 01, and 2 on 19 Nov 03. On 9 CBCs a low of 27 were seen in 1989 and a high of 104 were seen in 1993. The 1993 CBC count included 12 of the Myrtle race.
149. Black-throated Gray Warbler  
4 spring records: 20 Apr, 28 Apr, 4 May 96, and 28 Apr 03. A female was seen on the golf course during the CBC on 29 Dec 98.
150. Townsend's Warbler  
Winter resident. Earliest fall record 20 Sep 01. Seen through February in 2001. Six or fewer seen per field trip. Spring records: a female seen on 1 Jun 96 and 3 males on 23 Mar 02; in 2003 seen from 9 Mar until 8 May. On 9 CBCs fewer than 10 were noted on 4 years, and more than 10 on 5 years, with a maximum of 33 in 1993.
151. Hermit Warbler  
3 records, all at the BLM office area: 1 on 5 May 03, 5 seen on 8 May 03, and 1 on 28 Apr 05.
152. Black-and-white Warbler  
1 record: 1 seen by Don Roberson on the 28 Dec 84 CBC.
153. MacGillivray's Warbler  
In the spring of 1999 Bruce Gerow encountered a singing male in the chaparral on Crescent Bluff.
154. Common Yellowthroat\*  
Probably to be found all year at the corner of Barloy Canyon and Eucalyptus Roads and/or Mudhen Lake prior to the 2003 burn. In 2003 not seen in these areas following the July fire. In the dry year of 2004, just a few records from 21 Apr to 30 Jun. Mainly noted around Mudhen Lake in 2006.
155. Wilson's Warbler\*  
Summer resident some years along upper El Toro Creek. Earliest records: 7 Apr 96 and 27 Mar 04. Latest record: 2 Aug 97. A migratory flock of 10 at the BLM office on 8 May 03 was unusual.
156. Yellow-breasted Chat  
1 record: 1 heard singing in a tangle along Crescent Bluff Rd. on
157. Western Tanager  
Spring migrants recorded on 4 May and 1 Jun 96, and from 1 to 8 May 03. In 2005 the early record was 24 Apr, and by 30 Apr a flock of 3 was seen. Two flocks noted in May 03, with a maximum of 10 at the BLM office on the 8<sup>th</sup>. Fall migrants on 25 Jul to 2 Aug 98, and until 20 Sep 01. A late bird was seen near Parker Flats Cut-off on 29 Oct 05.
158. [Green-tailed Towhee  
1 seen on 28 Feb 02 on Parker Flats Road near Eucalyptus Road. Efforts to find the bird later failed.]

159. Spotted Towhee\* A permanent resident seen throughout the chaparral. In comparison with the California Towhee, this bird is more restricted in habitat and fewer are seen.
160. California Towhee\* Common throughout the year, and widely distributed. Seen on virtually all trips, although not in large flocks. On 9 CBCs a low of 18 were seen in 1989 and a high of 63 were noted in 1993.
161. Rufous-crowned Sparrow\* In April of 2000 Sam Fitton found 2 singing by the big washout into Mudhen Lake. One was still there at least as late as 21 Jun 00. Seen along Barloy Canyon Road on 9 and 14 May 02, and from 13 Feb until 18 Mar in 2003.
162. Chipping Sparrow\* 1 record prior to 2004: 2 at the campground on Watkins Gate Rd. on 11 May 03. Regularly seen in the burn area in the spring of 2004, with nesting probable. Seen there again in 2005.
163. Lark Sparrow\* Seen all year, but infrequently in the winter. Most commonly seen in the grasslands, but also apparently breeding in or near the chaparral areas. Regularly seen at the BLM compound.
164. (Bell's) Sage Sparrow\* Resident. Thinly spread over the burned chaparral areas. I likely overlooked them before Bruce Gerow pointed out that they were there. My first record: 4 Jul 98. Birds with young fledgling seen on 3 Jul 06. Don Roberson noted between 1 and 4 individuals on the CBCs in 1993, 1996, 1998, and 2000.
165. Savannah Sparrow Winter resident in the grasslands. Approximately 60 seen high in the grasslands on 17 Dec 06. Last spring record: 28 Apr 96. First fall records: 26 Sep 01, and 22 Oct 02.
166. Grasshopper Sparrow\* Breeding bird of the grasslands. First seen on 14 Apr 96, on 27 Apr 02, on 21 Mar 03, on 9 Mar 04, and 16 Mar 05. Approximately 30 singing birds detected in 1996, 5 or 6 of these were on Machine Gun Flats. Bird in juvenal plumage seen on 16 Jun 96. Seen until the end of the inventory in 1996. There were 35 or more singing birds on Ft. Ord in Jun 00. There were likely as many in Jun 02, but likely fewer in 2003.
167. Fox Sparrow Winter resident, but much more common in fall. First noted in chaparral on 5 Oct 01, 1 Oct 02, 30 Sep 03, and 29 Sep 05. Last seen on 25 Jan 02 and 14 Mar 03. Usually 1 or 2 seen, but 10 to 20 were at the Huffman Tank on 29 Oct 02. 84 were seen on the 28 Dec 84 CBC. All Fox Sparrows seen have been of the 'Sooty' race.
168. Song Sparrow\* There are 2 to 6 individuals at nearly every pond throughout the inventory.
169. Lincoln's Sparrow Mostly a spring and fall migrant, but few recorded per year. The 2 that Sam Fitton and I saw at Fox Pond on 11 Aug 99 were unusually early.
170. White-throated Sparrow 1 record: 1, perhaps immature, at Mudhen Lake 15 Oct 01.
171. Harris's Sparrow One immature seen on Trail 22 on 16 Jan and 25 Jan 02.

172. White-crowned Sparrow Winter resident in backcountry Ft. Ord. Last seen on 29 Apr 05. Earliest fall record: 2 at Fox Pond on 13 Aug 99. In the fall of 2001 the main migration arrived by 26 Sep. I usually record fewer than 10, but I saw approximately 50 along El Toro Creek on 30 Nov 03.
173. Golden-crowned Sparrow Common winter resident, October through April. Last seen on 21 Apr 96, and on 2 May 02. Seen in good numbers, around 20, by 5 Oct 01 (and 6 Oct 03). First noted in fall on 1 Oct 02 and 30 Sep 03.
174. Dark-eyed Junco\* Common breeding bird in oak woods and at the BLM compound. Seen throughout the year. In 2003 flocks of 50 were seen in October, but in other seasons 20 or fewer were seen.
175. Black-headed Grosbeak\* Summer resident near Guidotti Gate. Seen as early as 16 Apr 02 and 7 Apr 03, and as late as 1 Aug 99.
176. Lazuli Bunting\* 4 records prior to 2002: 28 Apr 96, 4 May 96, and 28 Jun 98, 1 Aug 99. The June record was of a singing male at Mudhen Lake. Strong migration in 2002, seen from 23 Apr to 25 May, with a peak of around 15 seen on 7 May. Weak migration in 2003, seen from 1 May until 6 Jun. A strong migration again in 2004; noted 19 Apr to 30 Jun, with around 30 individuals in the burn area alone. Probable breeding in the burn area followed the migration. In 2006 they probably bred in the 2005 burn area off Parker Flats Road.
177. Red-winged Blackbird\* Concentrated near ponds and also seen elsewhere throughout the year, although scarce in August, except, possibly, at the roost at the pond on Watkins Gate Road near West Camp Street.
178. Tricolored Blackbird\* The known colony on Oil Well Road has been active most years. The colony has maintained over 50 birds. On 26 Jul 98 I watched them come to feed at the play fields of El Toro Creek community. Ten or more visit the Equestrian Center in winter. They were seen there up to 28 Feb 02. 120 were counted on the 27 Dec 89 CBC, and 200 on the 28 Dec 93 CBC.
179. Western Meadowlark\* Small numbers on grassland and Machine Gun Flats in the spring and summer. Larger, more widespread groups of up to 50 seen in the fall and winter. Usually seen in double digits on the CBCs; a low of 8 was seen on the 29 Dec 01 count, and a high of 323 on 28 Dec 93.
180. Brewer's Blackbird\* Present throughout the inventory. Especially common at the BLM compound, prior to the fall of 2001. Common in residential areas. 850 were noted on the 27 Dec 89 CBC.
181. Brown-headed Cowbird 5 records: 22 Mar 96, 30 May 02, 23 May 03, 29 Apr and 30 Apr 05.
182. Hooded Oriole\* Added to inventory on 11 Jul 98. Sam Fitton pointed out that they were near El Toro Creek. I found at least 3 pairs breeding in Fan Palms in El Toro community, and using Ft. Ord to feed. They continue to be seen only in this area.

183. Bullock's Oriole\* Summer resident. Earliest records: 20 Apr 02 and 2 Apr 03. Breeding along El Toro Creek, and possibly other riparian areas with tall (Eucalyptus) trees. Not seen after mid-August. Bruce Gerow noted especially large numbers of both oriole species nesting in the El Toro Creek area in 2001.
184. Purple Finch\* Present in the oaks and at the BLM compound throughout the inventory. Usually no more than 5, but sometimes 10 or 20 are in a flock.
185. House Finch\* Seen in small numbers throughout Ft. Ord throughout the inventory. Seen at the BLM compound in larger numbers. Abundant in the housing areas of Ft. Ord.
186. Pine Siskin\* At BLM compound from first inventory until 2001. However, not encountered in the fall (inventory in 2001). Seen Jan 02 through 23 Apr 02, and then gone: perhaps sensitive to drought. In the drought year of 2003 seen only from 23 Jan to 28 Apr. No Siskins noted in the dry year of 2004, and a few were noted in 2005 or 2006.
187. Lesser Goldfinch\* Seen throughout the inventory wherever there are trees. Uncommon in the backcountry in the dry season of 2002. Hardly seen after Jul 03, another dry season, and in 2006 not noted after 7 Dec.
188. Lawrence's Goldfinch\* Seen at the BLM compound and in riparian locations in the chaparral. First seen on 24 Mar 96. Not seen at all in 1998. In 2000 last seen on 15 Jun. The 2002 records span 14 Apr to 20 Aug. In 2003 just 2 records of 2 each on 23 May and 16 Jun. The year 2004 was a strong one with records regularly from 19 Apr to 10 Sep, especially in the burn area where they probably bred. Two fall records: 2 near El Toro Creek on 27 Oct 01, and 1 at recent burn on 19 Oct 06.
189. American Goldfinch Fall and winter resident. 1<sup>st</sup> record: approximately 50 near El Toro Creek on 9 Feb 01. Smaller numbers seen in fall starting 24 Oct 01, 22 Oct 03, and 1 Nov 05. Usually the first fall records are in October.
190. House Sparrow\* Common in the housing areas on Ft. Ord. Barely seen in Backcountry Ft. Ord.



# **APPENDIX F**

## **Cultural Resources and Built Environment Reports**

INTENTIONALLY LEFT BLANK

# **APPENDIX F1**

## **Cultural Resources Inventory, Evaluation, and Finding of Effect Report**

INTENTIONALLY LEFT BLANK

July 5, 2019

Anya Spear  
Associate Director of Campus Planning  
CSU Monterey Bay, Campus Planning and Development  
100 Campus Center  
Seaside, California 93955-8001

***Subject: Cultural Resource Inventory for the CSU Monterey Bay EIR Master Plan Project, Monterey County, California***

Dear Ms. Spear:

This memorandum presents data from the cultural resources records search and survey conducted in compliance with Section 15064.5(a)(2)-(3) of the California Environmental Quality Act (CEQA) Guidelines for California State University Monterey Bay's (CSUMB) proposed EIR Master Plan Project (Project). The Project is located on the campus of CSUMB near the southern-central portion of the Monterey Bay, northeast of the Monterey Peninsula (Figure 1). The campus covers 1,396 acres that compose the northwestern portion of the U. S. Department of Army Fort Ord Military Reservation, and includes portions of the cities of Seaside and Marina, as well as unincorporated portions of Monterey County. The Project is composed of Proposed CSUMB 2019 Project Design Features described in the 2019 CSUMB Master Plan Guidelines, along with five "near-term" projects that are to be constructed within the next 3 to 7 years. Overall, the Project includes work that will demolish several buildings, build new structures, and provide new infrastructure to allow for expected on-campus growth and improve usability of space within the core campus area. Attachment 1 summarizes this study in a National Archaeology Database Information form.

## **SUMMARY OF WORK**

Researchers at the Northwest Information Center (NWIC) of the California Historical Resources Information System (CHRIS) at Sonoma State University, Rohnert Park, conducted a records search on September 20, 2017 (NWIC File No. 17-0608). The records search encompassed the proposed Project Area along with a one-mile radius buffer (Attachment 2). The results of the records search indicated the approximate location of one previously recorded archaeological site (P-27-000385), which could be within the Project Area. However, the site record provides no

locational data other than “On the Fort Ord Military Reservation,” which extends well beyond the Project Area (Pilling 1950). Furthermore, the site’s recorder, Pilling, described that the site was “destroyed by bulldozing in ca. 1940” (Pilling 1950). The results of the record search also indicate two historic sites within a one-mile radius of the Project Area. One is a historic ranch (P-27-001724) and one is a World War II era military site (P-27-002915). Sixteen Built Environment resources exist within one mile of the Project Area, but it is beyond the scope of this project to address them. Thirteen previously conducted studies include portions of the Project Area. Twenty-nine additional studies have occurred within a one-mile radius of the Project Area.

Dudek archaeologists Ryan Brady, MA, RPA, and Sarah Brewer, BA, surveyed of the location of the proposed Project Area on November 22, 2017. The archaeologists applied a mixed-intensity strategy for the survey, using intensive-level 15-meter transects when possible, and adopting a less intensive reconnaissance-level approach in highly developed areas. The archaeologists focused intensive-level survey in areas that will be affected by “near-term” projects. Dudek archaeologists conducted a supplemental on February 6, 2019 to investigate additional potential resources. Dudek archaeologists did not identify any new archaeological resources. Dudek’s level of effort and findings on this project fulfills the CEQA requirements for cultural resource investigations. By applying standard mitigation measures for the treatment of unanticipated discoveries, Dudek recommends that the proposed Project will have no significant effect on Historic Resources.

## **PROJECT LOCATION AND DESCRIPTION**

CSUMB is located approximately 100 miles south of San Francisco near the southern-central portion of the Monterey Bay, northeast of the Monterey Peninsula. The campus covers 1,396 acres that compose the northwestern portion of the U.S. Department of Army Fort Ord Military Reservation, and includes portions of the cities of Seaside and Marina, as well as unincorporated portions of Monterey County (Figure 1).

The Project consists of the proposed California State University Monterey Bay (CSUMB) Master Plan (proposed Master Plan), including Project Design Features (PDFs) drawn from the CSUMB Master Plan Guidelines (Master Plan Guidelines). In addition to a program level evaluation of the entire Master Plan and PDFs, the pending EIR will provide project-level evaluation of 5 “near-term” developments to be constructed pursuant to the proposed Master Plan within the next 10 years (Figure 2). Overall, the Project includes work that will demolish numerous buildings, build new buildings and structures, and provide new infrastructure to allow for expected on-campus growth and improve usability of space within the core campus area. The near-term projects include construction of the following buildings and associated landscapes:

1. Student Recreation Center (70,000 square feet)
2. Student Housing Phase IIB (400 beds);

3. Student Housing Phase III (600 beds);
4. Academic IV (72,200 square feet);
5. Academic V (76,7000 square feet)

## **REGULATORY SETTING**

The Project is funded by California State University, which also serves as the lead agency; therefore, the current project must comply with State environmental regulations, which are addressed in broad scope under the California Environmental Quality Act (CEQA).

### **State of California**

#### ***The California Register of Historical Resources***

In California, the term “historical resource” includes “any object, building, structure, site, area, place, record, or manuscript which is historically or archaeologically significant, or is significant in the architectural, engineering, scientific, economic, agricultural, educational, social, political, military, or cultural annals of California” (Public Resources Code (PRC) Section 5020.1(j)). In 1992, the California legislature established the California Register of Historical Resources (CRHR) “to be used by state and local agencies, private groups, and citizens to identify the state’s historical resources and to indicate what properties are to be protected, to the extent prudent and feasible, from substantial adverse change” (PRC Section 5024.1(a)). The criteria for listing resources on the CRHR, enumerated in the following text, were developed to be in accordance with previously established criteria developed for listing in the NRHP. According to PRC Section 5024.1(c)(1–4), a resource is considered historically significant if it (i) retains “substantial integrity,” and (ii) meets at least one of the following criteria:

1. Is associated with events that have made a significant contribution to the broad patterns of California’s history and cultural heritage
2. Is associated with the lives of persons important in our past
3. Embodies the distinctive characteristics of a type, period, region, or method of construction, or represents the work of an important creative individual, or possesses high artistic values
4. Has yielded, or may be likely to yield, information important in prehistory or history

To understand the historic importance of a resource, sufficient time must have passed to obtain a scholarly perspective on the events or individuals associated with the resource. A resource less than 50 years old may be considered for listing in the CRHR if it can be demonstrated that sufficient time has passed to understand its historical importance (see 14 CCR 4852(d)(2)).

The CRHR protects cultural resources by requiring evaluations of the significance of prehistoric and historic resources. The criteria for the CRHR are nearly identical to those for the NRHP, and properties listed or formally designated as eligible for listing in the NRHP are automatically listed in the CRHR, as are state landmarks and points of interest. The CRHR also includes properties designated under local ordinances or identified through local historical resource surveys.

### **California Environmental Quality Act**

As described further in the following text, the following CEQA statutes and CEQA Guidelines are of relevance to the analysis of archaeological, historic, and tribal cultural resources:

PRC Section 21083.2(g) defines “unique archaeological resource.”

PRC Section 21084.1 and CEQA Guidelines Section 15064.5(a) define “historical resources.”

In addition, CEQA Guidelines Section 15064.5(b) defines the phrase “substantial adverse change in the significance of an historical resource.” It also defines the circumstances when a project would materially impair the significance of a historical resource.

PRC Section 21074(a) defines “tribal cultural resources.”

PRC Section 5097.98 and CEQA Guidelines Section 15064.5(e) set forth standards and steps to be employed following the accidental discovery of human remains in any location other than a dedicated ceremony.

PRC Sections 21083.2(b)–(c) and CEQA Guidelines Section 15126.4 provide information regarding the mitigation framework for archaeological and historic resources, including examples of preservation-in-place mitigation measures; preservation-in-place is the preferred manner of mitigating impacts to significant archaeological sites because it maintains the relationship between artifacts and the archaeological context, and may also help avoid conflict with religious or cultural values of groups associated with the archaeological site(s).

Under CEQA, a project may have a significant effect on the environment if it may cause “a substantial adverse change in the significance of an historical resource” (PRC Section 21084.1; CEQA Guidelines Section 15064.5(b)). A site is considered to be a “historical resource” if it is either determined to be listed or is eligible for listing in the CRHR, included in a local register of historic resources, or identified as significant in a historical resources survey (meeting the requirements of PRC Section 5024.1(q)). If a resource is determined to be a “historical resource,” it is historically or culturally significant for purposes of CEQA (PRC Section 21084.1; CEQA Guidelines Section 15064.5(a)). The lead agency is not precluded from determining that a resource is a historical resource, even if it does not fall within this presumption (PRC Section 21084.1; CEQA Guidelines Section 15064.5(a)).



A “substantial adverse change in the significance of an historical resource” reflecting a significant effect under CEQA means “physical demolition, destruction, relocation, or alteration of the resource or its immediate surroundings such that the significance of an historical resource would be materially impaired” (CEQA Guidelines Section 15064.5(b)(1); PRC Section 5020.1(q)). In turn, the significance of a historical resource is materially impaired when a project does any of the following:

1. Demolishes or materially alters in an adverse manner those physical characteristics of an historical resource that convey its historical significance and that justify its inclusion in, or eligibility for, inclusion in the California Register; or
2. Demolishes or materially alters in an adverse manner those physical characteristics that account for its inclusion in a local register of historical resources pursuant to Section 5020.1(k) of the PRC or its identification in an historical resources survey meeting the requirements of Section 5024.1(g) of the PRC, unless the public agency reviewing the effects of the project establishes by a preponderance of evidence that the resource is not historically or culturally significant; or
3. Demolishes or materially alters in an adverse manner those physical characteristics of a historical resource that convey its historical significance and that justify its eligibility for inclusion in the California Register as determined by a lead agency for purposes of CEQA [CEQA Guidelines Section 15064.5(b)(2)].

Pursuant to these sections, the CEQA inquiry begins with evaluating whether a project site contains any “historical resources,” then evaluates whether that project will cause a substantial adverse change in the significance of a historical resource such that the resource’s historical significance is materially impaired.

If it can be demonstrated that a project will cause damage to a unique archaeological resource, the lead agency may require reasonable efforts be made to permit any or all of these resources to be preserved in place or left in an undisturbed state. To the extent that they cannot be left undisturbed, mitigation measures are required (Section 21083.2(a), (b), and (c)).

Section 21083.2(g) defines a unique archaeological resource as an archaeological artifact, object, or site about which it can be clearly demonstrated that without merely adding to the current body of knowledge, there is a high probability that it meets any of the following criteria:

1. Contains information needed to answer important scientific research questions and that there is a demonstrable public interest in that information

*Subject: Cultural Resource Inventory for the CSU Monterey Bay EIR Master Plan Project,  
Monterey County, California*

---

2. Has a special and particular quality such as being the oldest of its type or the best available example of its type
3. Is directly associated with a scientifically recognized important prehistoric or historic event or person

Impacts to non-unique archaeological resources are generally not considered a significant environmental impact (PRC Section 21083.2(a); CEQA Guidelines Section 15064.5(c)(4)). However, if a non-unique archaeological resource qualifies as tribal cultural resource (PRC 21074(c); 21083.2(h)), further consideration of significant impacts is required.

CEQA Guidelines Section 15064.5 assigns special importance to human remains and specifies procedures to be used when Native American remains are discovered. As described in the following text, these procedures are detailed in PRC Section 5097.98.

**California State Assembly Bill 52**

AB 52 of 2014 amended PRC Section 5097.94 and added PRC Sections 21073, 21074, 21080.3.1, 21080.3.2, 21082.3, 21083.09, 21084.2, and 21084.3. AB 52 established that TCRs must be considered under CEQA and also provided for additional Native American consultation requirements for the lead agency. Section 21074 describes a TCR as a site, feature, place, cultural landscape, sacred place, or object that is considered of cultural value to a California Native American Tribe and that is either:

- On or determined to be eligible for the California Register of Historical Resources or a local historic register; or
- A resource determined by the lead agency, in its discretion and supported by substantial evidence, to be significant pursuant to criteria set forth in subdivision (c) of Section 5024.1.

AB 52 formalizes the lead agency–tribal consultation process, requiring the lead agency to initiate consultation with California Native American groups that are traditionally and culturally affiliated with the project site, including tribes that may not be federally recognized. Lead agencies are required to begin consultation prior to the release of a negative declaration, mitigated negative declaration, or environmental impact report.

Section 1 (a)(9) of AB 52 establishes that “a substantial adverse change to a tribal cultural resource has a significant effect on the environment.” Effects on TCRs should be considered under CEQA. Section 6 of AB 52 adds Section 21080.3.2 to the PRC, which states that parties may propose mitigation measures “capable of avoiding or substantially lessening potential significant impacts to a tribal cultural resource or alternatives that would avoid significant impacts to a tribal cultural

resource.” Further, if a California Native American tribe requests consultation regarding project alternatives, mitigation measures, or significant effects to tribal cultural resources, the consultation shall include those topics (PRC Section 21080.3.2[a]). The environmental document and the mitigation monitoring and reporting program (where applicable) shall include any mitigation measures that are adopted (PRC Section 21082.3[a]).

### ***Native American Historic Cultural Sites***

State law (PRC Section 5097 et seq.) addresses the disposition of Native American burials in archaeological sites and protects such remains from disturbance, vandalism, or inadvertent destruction; establishes procedures to be implemented if Native American skeletal remains are discovered during construction of a project; and established the Native American Heritage Commission (NAHC) to resolve disputes regarding the disposition of such remains. In addition, the Native American Historic Resource Protection Act makes it a misdemeanor punishable by up to 1 year in jail to deface or destroy an Indian historic or cultural site that is listed or may be eligible for listing in the CRHR.

Additionally, PRC Section 5097.9 mandates that public agencies or private parties may not interfere with free expression of Native American religion or cause severe or irreparable damage to a Native American place of worship, ceremonial site, or sanctified cemetery.

### ***California Health and Safety Code Section 7050.5***

In the event that Native American human remains or related cultural material are encountered, Section 15064.5(e) of the CEQA Guidelines (as incorporated from PRC Section 5097.98) and California Health and Safety Code Section 7050.5 define the subsequent protocol. If human remains are encountered, excavation or other disturbances shall be suspended of the site or any nearby area reasonably suspected to overlie adjacent human remains or related material. Protocol requires that a county-approved coroner be contacted in order to determine if the remains are of Native American origin. Should the coroner determine the remains to be Native American, the coroner must contact the NAHC within 24 hours. The most likely descendent may make recommendations to the landowner or the person responsible for the excavation work, for means of treating, with appropriate dignity, the human remains and any associated grave goods as provided in PRC Section 5097.98 (14 CCR 15064.5(e)).

## **NATURAL AND CULTURAL CONTEXT**

### **Environmental Context**

CSUMB is located approximately 100 miles south of San Francisco near the southern-central portion of the Monterey Bay, northeast of the Monterey Peninsula. The CSUMB campus, 0.75 miles east of the Pacific Ocean shoreline, is situated on a sandy substrate that comprises leveled dune landforms. Geology of the Project Area is classified as Quaternary sand deposits (USGS 2018). Soils are predominantly Baywood sand with 2-15 percent slopes with portions of the southern and western campus comprising Oceano loamy sand with 2-15 percent slopes (USDA NRCS 2018). Neither soil type typically contains buried A-horizons. The vegetation community of the campus is categorized as Northern seashore community (Elymus-Baccharis) (Küchler 1977). This plant community includes dune shrubs and grasses, as well as Monterey Pine and other trees. The climate is characterized as Mediterranean with mild summers and cooler wet winters. Mean annual temperature ranges between 46.4°F and 62.7°F, with 14.9 inches of annual rainfall (Western Regional Climate Center 2018). The proximity of the Pacific Ocean mediates dramatic temperature fluctuations throughout the year.

### **Cultural Setting**

#### ***Prehistoric***

The Project Area lies within the territory prehistorically occupied by the Costanoan or Ohlone people. Costanoan refers to eight separate Penutian-stock language groups situated roughly from modern-day Richmond in the north to Big Sur in the south. The Rumsen tribelet occupied the Monterey area (Levy 1978). Of the Rumsen-speaking groups, Milliken and Johnson (2010) identifies four local groups in the area, of which, the *Calenda Ruc* inhabited the project vicinity.

Glimpses into the ways of life for prehistoric Californians continue to be pieced together through studies of ethnography and archaeology. Early European explorers from the 16<sup>th</sup> and 18<sup>th</sup> centuries provided the first written descriptions about the native Californians they encountered, although details are sparse. Attempts at systematic ethnographies did not occur until the early 20<sup>th</sup> century, generations after the effects of missionization and integration had altered Costanoan/Ohlone lifestyles drastically. Much of these studies focused on recording Native languages before they fell into disuse. Archaeologists extrapolate trends in tool use, trade, diet and migration from studies on archaeological sites. Costanoan/Ohlone descendants are often invited to participate in decisions about their ancestral sites as well as educate others about their traditional lifeways.

Information from the archaeological record continues to fill in the gaps of our understanding of prehistoric lifeways. Prehistoric research in the Monterey Bay dates back to the early 1900s,

although the bulk of archaeological excavations date to the 1960s and later. Early research was conducted by Beardsley (1946). More recent excavations and surveys include the work of Cartier (1993), Dietz and Jackson (1981), Dietz et al. (1988), Hildebrandt and Mikkelsen (1993), Hylkema (1991), Jones (1993), Jones and Ferneau (2002a), Jones et al. (1996) and Milliken et al. (1999) among others referenced below. Jones et al. (2007) presents a synthetic overview of prehistoric adaptive change in the Central Coast. This temporal framework, for the prehistoric era of greater Central California coast, spans a period of approximately 10,000–12,000 years, and divides into six different periods. Researchers distinguish these periods by perceived changes in prehistoric settlement patterns, subsistence practices, and technological advances. These adaptive shifts identify differences in temporally discrete artifact assemblages, site locations, and site types. Table 1 summarizes the cultural chronology presented by Jones et al. (2007).

**Table 1**  
**California Central Coast Chronology**

| <b>Temporal Period</b>          | <b>Date Range*</b>            |
|---------------------------------|-------------------------------|
| Paleo-Indian                    | pre-8000 cal B.C.             |
| Millingstone (or Early Archaic) | 8000 to 3500 cal B.C.         |
| Early                           | 3500 to 600 cal B.C.          |
| Middle                          | 600 cal B.C. to cal A.D. 1000 |
| Middle-Late Transition          | cal A.D. 1000-1250            |
| Late                            | cal A.D. to 1250-1769         |

Source: Jones et al. (2007).

### ***Paleo-Indian***

The Paleo-Indian era represents people’s initial occupation of the region and is quite sparse across the Monterey Bay region. Evidence of this era is generally expressed through isolated artifacts or sparse lithic scatters (Bertrando 2004). Further south, in the San Luis Obispo area, fluted points characterizing this era are documented near the town of Nipomo (Mills et al. 2005) and Santa Margarita (Gibson 1996). No points of this type have been found yet in the Monterey Bay. Possible occupation dating to the Paleo-Indian period is reported at CA-SCR-38/123, at Wilder Ranch (Bryne 2002), and in CA-SCR-177 in Scotts Valley (Cartier 1993). The traditional interpretation is that people living during this time were highly mobile hunters who focused subsistence efforts on large mammals. In contrast, Erlandson et al. (2007) proposes a “kelp highway” hypothesis for the peopling of the Americas. Proponents of this model argue that the earliest inhabitants of the region focused their economic pursuits on coastal resources. Archaeological sites that support this hypothesis are mainly from the Santa Barbara Channel Islands. Some scholars hypothesize that Paleo-Indian sites in the Bay Area may exist but are inundated due to rising ocean levels throughout the Holocene (Jones 1992).

## **Millingstone**

Settlement in the Monterey Bay appears with more frequency in the Millingstone Period. Sites of this era have been discovered in Big Sur (Jones 2003; Fitzgerald and Jones 1999) and Moss Landing (Jones and Jones 1992; Milliken et al. 1999). Assemblages are characterized by abundant millingstones and handstones, core and core-cobble tools, thick rectangular (L-series) *Olivella* beads, and a low incidence of projectile points, generally lanceolate or large side-notched varieties (Jones et al. 2007). Eccentric crescents are also found in Millingstone components. Sites are often associated with shellfish remains and small mammal bone, which suggest a collecting-focused economy. Newsome et al. (2004) report that stable isotope studies on human bone, from a Millingstone component, indicate a diet composed of 70%–84% marine resources. Contrary to these findings, deer remains are abundant at some Millingstone sites (cf. Jones et al. 2008), which suggests a flexible subsistence focus. People living during the Millingstone era are thought to have been highly mobile.

## **Early**

The Early Period corresponds with the earliest era of what Rogers (1929) called the “Hunting Culture.” According to Rogers, the “Hunting Culture” continues through to the Middle-Late Transition in the present framework. The Early Period is marked by a greater emphasis on formalized flaked stone tools, such as projectile points and bifaces, and the initial use of mortar and pestle technology. Early Period sites are located in more varied environmental contexts than millingstone sites, suggesting more intensive use of the landscape than previous evidence suggested (Jones and Waugh 1997).

Early Period artifact assemblages are characterized by Large Side-notched points, Rossi Square-stemmed points, Spire-lopped (A), End-ground (B2b and B2c), Cap (B4), and Rectangular (L-series) *Olivella* beads. Other artifacts include less temporally diagnostic Contracting-stemmed and Año Nuevo long-stemmed points, and bone gorges.

Early Period sites are common and often found in estuary settings along the coast or along river terraces inland and are present in both Monterey and Santa Cruz Counties. Coastal sites dating to this period include CA-MNT-108 (Breschini and Haversat 1992a), CA-SCR-7 (Jones and Hildebrandt 1990), and CA-SCR-38/123 (Jones and Hildebrandt 1994).

Archaeologists have long debated whether the shift in site locations and artifact assemblages during this time represent either population intrusion as a result of mid-Holocene warming trends, or an in-situ adaptive shift (cf. Mikkelsen et al. 2000). The initial use of mortars and pestles during this time appears to reflect a more labor intensive economy associated with the adoption of acorn processing (cf. Basgall 1987)

## **Middle**

The trend toward greater labor investment is apparent in the Middle Period. During this time, there is increased use of plant resources, more long-term occupation at habitation sites, and a greater variety of smaller “use-specific” localities. Artifacts common to this era include Contracting-stemmed projectile points, a greater variety of *Olivella* shell beads and *Haliotis* ornaments that include discs and rings (Jones 2003). Bone tools and ornaments are also common, especially in the richer coastal contexts (Jones and Ferneau 2002a; Jones and Waugh 1995), and circular shell fishhooks are present for the first time. Grooved stone net sinkers are also found in coastal sites. Mortars and pestles become more common than millstones and handstones at some sites (Jones et al. 2007). Important Middle Period sites include CA-MNT-282 at Willow Creek (Jones 2003; Pohorecky 1976), and CA-MNT-229 at Elkhorn Slough (Dietz et al. 1988). Middle Period sites north of the Monterey Bay include CA-SCR-9 and CA-SMA 218 at Año Nuevo (Hylkema 1991).

Jones et al. (2007) discuss the Middle Period in the context of Rogers’ “Hunting Culture” because it is seen as a continuation of the pattern that begins in the Early Period. The pattern reflects a greater emphasis on labor-intensive technologies that include projectile and plant processing. Additionally, faunal evidence highlight a shift toward prey species that are more labor intensive to capture, either by search and processing time or technological needs. These labor-intensive species include small schooling fishes, sea otters, rabbits, and plants such as acorn. Jones and Haney (2005) offer that Early and Middle Period sites are difficult to distinguish without shell beads due to the similarity of artifact assemblages.

## **Middle-Late Transition**

The Middle-Late Transition also marks the end of Rogers’ “Hunting Culture,” which seems to occur sometime during this era. Artifacts associated with the Middle-Late Transition include contracting-stemmed, double side-notched, and small leaf-shaped projectile points. The latter are thought to represent the introduction of bow and arrow technology to the region. A variety of *Olivella* shell bead types are found in these deposits and include B2, B3, G1, G2, G6, and K1 varieties (Jones 1995), notched line sinkers, hopper mortars, and circular shell fishhooks (Jones et al. 2007). Sites in Monterey County that correspond with this time are CA-MNT-1233 and -281 at Willow Creek (Pohorecky 1976), CA-MNT-1754, and CA-MNT-745 in Priest Valley (Hildebrandt 2006).

The Middle-Late Transition is a time that appears to correspond with social reorganization across the region. This era is also a period of rapid climatic change known as the Medieval Climatic Anomaly (cf. Stine 1994). The Medieval Climatic Anomaly is proposed as an impetus for the cultural change that was a response to fluctuations between cool-wet and warm-dry conditions that

characterize the event (Jones et al. 1999). Archaeological sites are rarer during this period, which may reflect a decline in regional population (Jones and Ferneau 2002b).

### **Late**

Late Period sites are found in a variety of environmental conditions and include newly occupied task sites and encampments, as well as previously occupied localities. Artifacts associated with this era include Cottonwood and Desert Side-notched arrow points, flaked stone drills, steatite and clamshell disc beads, *Haliotis* disc beads, *Olivella* bead types E1 and E2, and earlier used B2, B3, G1, G6, and K1 types. Millingstones, handstones, mortars, pestles, and circular shell fishhooks also continue to be used (Jones et al. 2007). Sites dating to this era are found in coastal and interior contexts. In the Monterey Bay area, Late Period sites include CA-MNT-143 at Asilomar State Beach (Brady et al. 2009), CA-MNT-1765 at Moro Cojo Slough (Fitzgerald et al. 1995), CA-MNT-1485/H and -1486/H at Rancho San Carlos (Breschini and Haversat 1992b), and CA-SCR-177 at Davenport Landing (Fitzgerald and Ruby 1997).

Coastal sites dating to the Late Period tend to be more resource acquisition or processing sites, while residential occupation is more common inland (Jones et al. 2007).

### **Historic**

The first European to explore the Monterey Bay was Sebastián Vizcaíno, who, in 1602, was sent by the Spanish government to map the Californian coastline (Holm et al. 2013). It was Vizcaíno who named the area “Puerto de Monterey” after the viceroy of New Spain. The location of Vizcaíno’s landing (and later Junipero Serra) lies within the Lower Presidio Park in downtown Monterey. The Gaspar de Portolá expedition traveled through the region in 1769 and returned again in 1770 to establish both the Monterey Presidio, Spain’s first military base in Alta California, and Mission San Carlos Borreméo de Carmelo.

The establishment of the Spanish missions drastically altered the lifeways of the Native Americans. The Spanish conscripted members of local Native American communities to move to the Mission San Carlos Borreméo de Carmelo, where they were indoctrinated as Catholic neophytes.

Mexico gained independence from Spain in 1821. In 1834, the Mexican government secularized the mission lands releasing the Native Americans from control of the mission-system. The City of Monterey continued as the capital of Alta California and the *Californios*, the Mexicans who settled in the region, were given land grants. The United States of America acquired Alta California after landing at Monterey in the 1848 during the Mexican-American War. California became a state in 1850.



## **Fort Ord**

The CSUMB campus is located on a portion of Fort Ord, a military training installation. The Fort was established in 1917, originally called Camp Gigling. Prior to decommissioning, Fort Ord covered 28,000 acres. The Fort was originally used to train cavalry troops stationed at Presidio of Monterey. The Army did not make permanent improvements, which included administrative buildings, barracks, mess halls, tent pads and a sewage treatment plant, on the land until the 1930s. By 1939, the location became known as Camp Ord, then Fort Ord in 1940. From 1940 to 1975, Fort Ord served as a basic training center, then by light infantry troops of the 7<sup>th</sup> Infantry Division. The base began the transition to closure in 1990 and was decommissioned in 1994 (Rughe 2016).

## **Records Search**

In order to identify cultural resources potentially affected by the proposed undertaking, Dudek defined a Study Area, which includes the location of the proposed CSU Monterey Bay EIR Master Plan Project and a one-mile buffer. Dudek submitted a records search request to the Northwest Information Center (NWIC) of the California Historical Resources Information System (CHRIS) at Sonoma State University on August 27, 2017. The Records Search request included lands within one mile of the study area and reviewed:

- Archaeological and non-archaeological resource records and reports on file at NWIC
- OHP Historic Properties Directory
- OHP Archaeological Determinations of Eligibility
- California Inventory of Historical Resources (1976)
- Historical Maps
- Local Inventories
- GLO and/or rancho Plat Maps

## **Previously Recorded Resources**

Researchers at the Northwest Information Center (NWIC) of the California Historical Resources Information System (CHRIS) at Sonoma State University conducted a records search on September 20, 2017 (Attachment 2). The results of the records search indicated the approximate location of one previously recorded prehistoric site on the former Fort Ord, potentially within the Project Area; two historic sites and sixteen Built Environment resources are located within a one-mile radius of the Project Area (Table 2). The location of prehistoric site (P-27-000385) is unknown; the site record provides no locational data other than “On the Fort Ord Military Reservation”, which extends well beyond the Project Area (Pilling 1950). Furthermore, the site was described as “destroyed by bulldozing in ca. 1940” (Pilling 1950). The two historic sites within

*Subject: Cultural Resource Inventory for the CSU Monterey Bay EIR Master Plan Project, Monterey County, California*

---

a one-mile radius of the Project Area are a historic ranch (P-27-001724) and a World War II era military site (P-27-002915). Sixteen Built Environment resources exist within one mile of the Project Area, but it is beyond the scope of this project to address them. Thirteen previously conducted studies include portions of the Project Area; twenty-nine additional studies have occurred within a one-mile radius of the Project Area (Table 3).

**Table 2. Cultural Resources within a One-Mile Radius of CSUMB**

| Primary     | Trinomial    | Resource Name                                | Res Type  | Age         | Recording Events   | NRHP Eligibility                                   |
|-------------|--------------|--|-----------|-------------|--|--|
| P-27-000385 | CA-MNT-280   | [none]                                       | Site      | Prehistoric | 1950 (A.R. Pilling, UCAS)  | Unlikely eligible                                  |
| P-27-001724 | CA-MNT-1818H | Henneken                                     | Site      | Historic    | 1993 (David Fee, Harding Lawson Associates);<br>1993 (David W. Babson, [none]);<br>1994 (David W. Babson, Tri-Services Cultural Resource Center, USA-CERL) | Strong potential for NRHP eligibility, Criterion D |
| P-27-002717 |              | CA-1025A                                     | Structure | Historic    | 2001 (Lorna Billat, Earth Touch, Inc.)   | Unknown  |
| P-27-002749 |              | Auto Shop                                    | Building  | Historic    | 2003 (Jody R. Stock, Architectural Resources Group);<br>2007 (Ian Alexander, Juan Cervantes, Matthew Clark, Holman & Associates)                           | Unknown  |
| P-27-002880 |              | Building 2019, latrine, former Fort Ord      | Building  | Historic    | 2007 (Matt Bischoff, CSP, Monterey District)   | Unknown  |
| P-27-002881 |              | Building TR9070, office, former Fort Ord     | Building  | Historic    | 2007 (Matt Bischoff, CSP, Monterey District)   | Unknown  |
| P-27-002882 |              | Building 2066, warehouse, former Fort Ord    | Building  | Historic    | 2007 (Matt Bischoff, CSP, Monterey District)   | Unknown  |
| P-27-002883 |              | Building 2079, former Fort Ord               | Building  | Historic    | 2007 (Matt Bischoff, CSP, Monterey District)   | Unknown  |
| P-27-002891 |              | Building 924, metal storage, former Fort Ord | Structure | Historic    | 2007 (Matt Bischoff, CSP, Monterey District)   | Unknown  |
| P-27-002892 |              | Building 1A39, office, former Fort Ord       | Structure | Historic    | 2007 (Matt Bischoff, CSP, Monterey District)   | Unknown  |
| P-27-002893 |              | Building 1A99, office, former Fort Ord       | Structure | Historic    | 2007 (Matt Bischoff, CSP, Monterey District)   | Unknown  |
| P-27-002894 |              | Building 2026Z, storehouse, former Fort Ord  | Building  | Historic    | 2007 (Matt Bischoff, CSP, Monterey District)   | Unknown  |
| P-27-002895 |              | Building TR9080, former Fort Ord             | Building  | Historic    | 2007 (Matt Bischoff, CSP, Monterey District)   | Unknown  |
| P-27-002896 |              | Building TR9081, former Fort Ord             | Building  | Historic    | 2007 (Matt Bischoff, CSP, Monterey District)   | Unknown  |
| P-27-002913 |              | Feature EGP-2                                | Structure | Historic    | 2007 (Ian Alexander, Juan Cervantes, Matthew Clark, Holman and Associates)   | Unknown  |
| P-27-002915 |              | Feature EGP-4, WWII Tent Area                | Site      | Historic    | 2007 (Matthew Clark, Holman and Associates)  | Unknown  |
| P-27-002916 |              | Feature EGP-5                                | Structure | Historic    | 2007 (Matthew Clark, Holman and Associates)  | Unknown  |

*Subject: Cultural Resource Inventory for the CSU Monterey Bay EIR Master Plan Project, Monterey County, California*

| Primary     | Trinomial | Resource Name                            | Res Type  | Age      | Recording Events  | NRHP Eligibility |
|-------------|-----------|--|-----------|----------|---|------------------|
| P-27-003170 |           | Marina Municipal Airport Tower           | Building  | Historic | 2012 (Dana E. Supernowicz, Historic Resource Associates)  | Unknown          |
| P-27-003383 |           | PG&E Sal-Del Transmission Tower No. 4/62 | Structure | Historic | 2013 (Dana E. Supernowicz, Historic Resources Associates) | Unknown          |

**P-27-000385 (CA-MNT-280)**

A. R. Pilling (1950) recorded this site as an “Occupation site” on the Fort Ord Military Reservation. There is no specific description of the location of the site nor the characteristics of the site, other than it was “destroyed by bull-dozing in ca. 1940”. Due to the vast size of the Fort Ord Military Reservation, at 19,220 acres, and the destroyed site condition, it is difficult to speculate more about the precise location or characteristics of the site.

**Previously Conducted Studies**

A review of NWIC records indicates that thirteen previously-conducted studies included portions of the Project area. Twenty-nine other previous technical studies have been conducted within a mile radius of the Project Area (Table 3).

**Table 3. Prior Cultural Resource Studies Conducted within a One-Mile Radius of CSUMB**

| Report Number | Authors                         | Year | Title   | Publisher                  | Report Type  | Within Project APE |
|---------------|---------------------------------|------|---|----------------------------|--|--------------------|
| S-003345      | Tony F. Weber and Ann S. Peak   | 1976 | Monterey Peninsula Regional Wastewater Treatment System Expansion Project   | Ann S. Peak & Associates   | Archaeological, Excavation, Field study                                    | No                 |
| S-003345a     | Ann S. Peak                     | 1976 | Appendix I Cultural Resource Assessment of the Interceptor Line -- East of Blanco Road and West of Davis Road (Augmentation of Monterey Peninsula Regional Wastewater Treatment System) | Ann S. Peak & Associates   | Archaeological, Field study  | No                 |
| S-003345b     | Ann S. Peak and Melinda A. Peak | 1978 | Cultural Resource Assessment of the Selected Alternative of the Monterey Regional Wastewater Treatment System, Monterey County, California.   | Ann S. Peak and Associates | Archaeological, Field study  | No                 |
| S-003418      |                                 | 1978 | Cultural Resource Assessment of the Proposed Effluent Disposal System, Fort Ord, Monterey County, California  | Ann S. Peak & Associates   | Archaeological, Field study  | Yes                |
| S-003441      |                                 | 1975 | Archeological Survey, Fort Ord, Monterey County   |                            | Archaeological, Field study  | Yes                |
| S-005210      | Michael Swernoff                | 1982 | A Reconnaissance Cultural Resources Survey of Fort Ord, California.   | Professional Analysts      | Archaeological, Architectural/historical, Field study, Management/planning | Yes                |
| S-005210a     | Michael Swernoff                | 1981 | A Reconnaissance Cultural Resources Survey of Fort Ord, California, Draft Report  | Professional Analysts      | Archaeological, Architectural/historical, Field study                      | Yes                |

**Subject: Cultural Resource Inventory for the CSU Monterey Bay EIR Master Plan Project,  
Monterey County, California**

| Report Number | Authors   | Year | Title   | Publisher   | Report Type   | Within Project APE |
|---------------|---|------|---|---|---|--------------------|
| S-014001      | Anna Runnings and Gary S. Breschini                               | 1992 | Preliminary Cultural Resources Reconnaissance for the MPWMD Desalinization Pipeline, Monterey County, California  | Archaeological Consulting   | Archaeological, Field study                           | No                 |
| S-016225      | James E. Bowman and Robert Chenier                                | 1994 | Report on the Historic Period Archaeological Survey at Henneken's Ranch and the Windmill Site, Fort Ord, Monterey County, California  | Tri-Services Cultural Resources Research Center, U.S. Army Corps of Engineers, Construction Engineering Research Laboratories | Archaeological, Excavation, Field study               | No                 |
| S-018372      | Philip R. Waite   | 1995 | A Cultural Resources Survey of 783 Hectares, Fort Ord, Monterey County, California  | Geo-Marine, Inc.  | Archaeological, Architectural/historical, Field study | Yes                |
| S-020626      | Sunshine Psota  | 1998 | Review of Historic Resources for Site SF-754-01, New Monopole at 1st Ave. and 2nd St., Fort Ord, Monterey County, CA (letter report)  | Anthropological Studies Center, Sonoma State University   | Literature search                                     | No                 |
| S-020626a     | Sunshine Psota  | 1998 | Review of Historic Resources for Site SF754-01, New Monopole at 6th Army Avenue, Fort Ord, Monterey County, CA (letter report)  | Anthropological Studies Center, Sonoma State University   | Archaeological, Field study                           | No                 |
| S-022537      | Kelda Wilson  | 2000 | Negative Archaeological Survey Report, 05-MON-1 PM R80.7-R85.3 CU 05-168 EA 05-0A3301, Proposal to Place an Asphalt Concrete Overlay on the Class 1 Bike Path on State Route 1 in Seaside and Marina, Monterey County | Caltrans  | Archaeological, Field study                           | No                 |
| S-022657      | Izaak Sawyer, Laurie Pfeiffer, Karen Rasmussen, and Judy Berryman | 2000 | Phase 1 Archaeological Survey Along Onshore Portions of the Global West Fiber Optic Cable Project   | Science Applications International Corporation  | Archaeological, Field study                           | No                 |
| S-022738      | Mary Doane and Trudy Haversat                                     | 2000 | Preliminary Archaeological Reconnaissance of the MBEST 18" Water Pipeline Project, Marina, Monterey County, California  | Archaeological Consulting   | Archaeological, Field study                           | Yes                |
| S-023023      | Mary Doane and Trudy Haversat                                     | 2000 | Preliminary Archaeological Reconnaissance of the 2nd Avenue/12th Street Project, in the Former Fort Ord, Monterey County, California  | Archaeological Consulting   | Archaeological, Field study                           | Yes                |
| S-023331      | Mary Doane and Trudy Haversat                                     | 2000 | Preliminary Archaeological Reconnaissance of the Seaside Resort Project on the Former Fort Ord Golf Courses, Seaside, Monterey County, California   | Archaeological Consulting   | Archaeological, Field study                           | No                 |
| S-024030      | Loma Billat   | 2001 | Proposed Telecommunications Facility; Nextel Site CA-1025A "Fort Ord" (letter report)   | Earth Touch, LLC  | Archaeological, Field study                           | No                 |
| S-025416      | Mary Doane and Trudy Haversat                                     | 2002 | Preliminary Archaeological Reconnaissance for the First Tee Project and Two Separate Recreational Facility Sites in the Former Fort Ord, Monterey County, California  | Archaeological Consulting   | Archaeological, Field study                           | Yes                |
| S-025535      | Colin I. Busby  | 2001 | Negative Archaeological Survey Report, signal and other roadway improvements at the intersection of Reservation Road and Imjin Road, City of Marina, Monterey County  | Basin Research Associates, Inc.   | Archaeological, Field study                           | No                 |

***Subject: Cultural Resource Inventory for the CSU Monterey Bay EIR Master Plan Project,  
Monterey County, California***

| Report Number | Authors  | Year | Title   | Publisher   | Report Type  | Within Project APE |
|---------------|--|------|---|---|--|--------------------|
| S-028012      | Colin I. Busby   | 2002 | Cultural Resources Assessment - Three Inundation Areas, Fort Ord Reuse Authority, Monterey County, California (letter report)   | Basin Research Associates, Inc.                     | Archaeological, Field study                                | No                 |
| S-029425      | Scott Billat   | 2004 | Construction of a 70 foot Monopole and New Equipment Shelter, Mars/SF-1036 (resubmittal), 599 DX Road, Marina Ca.   | EarthTouch, Inc.                                    | Architectural/historical, Management/planning              | No                 |
| S-029425a     | Erika Thal   | 2004 | Cultural Resource Assessment for the Mars (SF-1036) Cellular Facility on 599 DX Road, Marina, Monterey County, California   | EarthTouch Inc.                                     | Archaeological, Field study                                | No                 |
| S-029932      | Michael Darcangelo and Laura Leach-Palm                | 2004 | Archaeological Survey Report on the University Villages Specific Plan, 390 Acre Project Area, at Former Fort Ord, Monterey County, California.  | Far Western Anthropological Research Group, Inc.    | Archaeological, Field study                                | No                 |
| S-031953      | Wayne H. Bonner and James M. Keasling                  | 2006 | Cultural Resource Records Search Results and Site Visit for T-Mobile Telecommunications Facility Candidate SF15153 (Metro Marina Monopine/Amateur Radio Club), 599 DX Drive, Marina, Monterey County, California (letter report)                                | Michael Brandman Associates                         | Archaeological, Architectural/historical, Field study      | No                 |
| S-032063      |  | 2004 | Fort Ord, East Garrison Historic Resources Assessment   | Architectural Resources Group                       | Architectural/historical, Field study, Management/planning | No                 |
| S-032063a     |  | 2003 | Draft: Fort Ord, East Garrison, Historic Resources Assessment; July 28, 2003  | Architectural Resources Group                       | Architectural/historical, Field study, Management/planning | No                 |
| S-032063b     |  | 2006 | East Garrison Preservation Plan, Fort Ord, Monterey County  | Architectural Resources Group                       | Architectural/historical, Management/planning              | No                 |
| S-032063c     |  | 2004 | Guidelines for Rehabilitating Buildings at the East Garrison, Fort Ord, Monterey County, California   | Architectural Resources Group                       | Architectural/historical, Management/planning              | No                 |
| S-032063d     |  | 2006 | Mothball Plan and Existing Conditions Survey for Fort Ord, East Garrison, Monterey, California  | Architectural Resources Group                       | Architectural/historical, Management/planning              | No                 |
| S-033596      | Mary L. Manieri and Cindy L. Baker                     | 2007 | Cultural Resource Inventory and Evaluation of United States Army Reserve 63D Regional Readiness Command Facilities; Contract No. W912C8-05-P-0052   | PAR Environmental Services, Inc.                    | Archaeological, Architectural/historical, Field study      | No                 |
| S-033596a     | U.S. Army Reserve and PAR Environmental Services, Inc. | 2007 | Cultural Resources Inventory and Evaluation of the United States Army Reserve Heroic War Dead USAR Center/Area Maintenance Support Activity 85 (G), Oakland, California; P-01-[010831], 63D Regional Readiness Command Facility CA036, Contract No. W912C8-05-P | U.S. Army Reserve; PAR Environmental Services, Inc. | Architectural/historical, Evaluation, Field study          | No                 |
| S-033596b     | U.S. Army Reserve and PAR Environmental Services, Inc. | 2007 | Cultural Resources Inventory and Evaluation of the United States Army Reserve Oakland USAR Center #2, Oakland, California; P-01-01830, 63D Regional Readiness Command Facility CA-125, Contract No. W912C8-05-P-0052  | U.S. Army Reserve; PAR Environmental Services, Inc. | Architectural/historical, Evaluation, Field study          | No                 |

***Subject: Cultural Resource Inventory for the CSU Monterey Bay EIR Master Plan Project, Monterey County, California***

| Report Number | Authors  | Year | Title   | Publisher   | Report Type                                       | Within Project APE |
|---------------|--|------|---|---|---|--------------------|
| S-033596c     | U.S. Army Reserve and PAR Environmental Services, Inc. | 2007 | Cultural Resources Inventory and Evaluation of the United States Army Reserve PFC Bacciglieri Armed Forces Reserve Center, Concord, California; P-07-002752, 63 D Regional Readiness Command Facility CA007, Contract No. W912C8-P-0052 | U.S. Army Reserve; PAR Environmental Services, Inc. | Architectural/historical, Evaluation, Field study | No                 |
| S-033596d     | U.S. Army Reserve and PAR Environmental Services, Inc. | 2007 | Cultural Resources Inventory and Evaluation of the United States Army Reserve Col. Hunter Hall USAR Center, San Pablo, California; P-07-002753, 63D Regional Readiness Command Facility CA 070, Contract No. W912C8-05-P-0052           | U.S. Army Reserve; PAR Environmental Services, Inc. | Architectural/historical, Evaluation, Field study | No                 |
| S-033596e     | U.S. Army Reserve and PAR Environmental Services, Inc. | 2007 | Cultural Resources Inventory and Evaluation of the United States Army Reserve Fort Ord USAR Center, Marina, California; 63D Regional Readiness Command Facility CA012, Contract No. W912C8-05-P-0052                                    | U.S. Army Reserve; PAR Environmental Services, Inc. | Architectural/historical, Evaluation, Field study | No                 |
| S-033596f     | U.S. Army Reserve and PAR Environmental Services, Inc. | 2007 | Cultural Resources Inventory and Evaluation of the United States Army Reserve Moss Landing Local Training Area, Moss Landing, California; 63D Regional Readiness Command Facility CA189, Contract No. W912C8-05-P-0052                  | U.S. Army Reserve; PAR Environmental Services, Inc. | Architectural/historical, Evaluation, Field study | No                 |
| S-033596g     | U.S. Army Reserve and PAR Environmental Services, Inc. | 2007 | Cultural Resources Inventory and Evaluation of the United States Army Reserve Jones Hall USAR Center, Mountain View, California; P-43-001836, 63D Regional Readiness Command Facility CA031, Contract No. W912C8-05-P-0052              | U.S. Army Reserve; PAR Environmental Services, Inc. | Architectural/historical, Evaluation, Field study | No                 |
| S-033596h     | U.S. Army Reserve and PAR Environmental Services, Inc. | 2007 | Cultural Resources Inventory and Evaluation of the United States Army Reserve Richey Hall USAR Center, San Jose, California; P-43-000728, 63D Regional Readiness Command Facility CA069, Contract No. W912C8-05-P-0052                  | U.S. Army Reserve; PAR Environmental Services, Inc. | Architectural/historical, Evaluation, Field study | No                 |
| S-033596i     | U.S. Army Reserve and PAR Environmental Services, Inc. | 2007 | Cultural Resources Inventory and Evaluation of the United States Army Reserve Moffett USAR Center, Mountain View, California; P-43-001837, 63D Regional Readiness Command Facility CA120, Contract No. W912C8-05-P-0052                 | U.S. Army Reserve; PAR Environmental Services, Inc. | Architectural/historical, Evaluation, Field study | No                 |
| S-033596j     | U.S. Army Reserve and PAR Environmental Services, Inc. | 2007 | Cultural Resources Inventory and Evaluation of the United States Army Reserve PFC Young USAR Center, Vallejo, California; P-[48-000752], 63D Regional Readiness Command Facility CA-090, Contract No. W912C8-05-P-0052                  | U.S. Army Reserve; PAR Environmental Services, Inc. | Architectural/historical, Evaluation, Field study | No                 |
| S-033596k     | Milford Wayne Donaldson and James O. Anderson          | 2007 | USA070613A; Inventory and Evaluation of Historic Resources at 63D Regional Readiness Command, US Army Reserve Center in California  | Office of Historic Preservation; US Army            | OHP Correspondence                                | No                 |
| S-033677      | Mary Doane and Trudy Haversat                          | 1999 | Preliminary Archaeological Reconnaissance of the Marina Coast Water District Recycled Water Pipeline Project, Monterey County, California   | Archaeological Consulting                           | Archaeological, Field study                       | Yes                |
| S-033677a     | Mary Doane and Trudy Haversat                          | 2006 | Phase 1 Archaeological Reconnaissance for the Marina Coast Water District Regional Urban Water Augmentation Project, Recycled Water Component, Northern Segment, In Marina and Seaside, Monterey County, California                     | Archaeological Consulting                           | Archaeological, Field study                       | Yes                |

**Subject: Cultural Resource Inventory for the CSU Monterey Bay EIR Master Plan Project, Monterey County, California**

| Report Number | Authors                             | Year | Title   | Publisher                       | Report Type  | Within Project APE |
|---------------|-------------------------------------|------|---|---------------------------------|--|--------------------|
| S-033677b     | Mary Doane and Gary S. Breschini    | 2007 | Phase I Archaeological Reconnaissance for the Marina Coast Water District Regional Urban Water Augmentation Project, Recycled Water Component, in Marina, Ord Community, Seaside and Monterey, Monterey County, California (Revised May 22, 2007) | Archaeological Consulting       | Archaeological, Field study  | Yes                |
| S-033677c     | Mary Doane and Gary S. Breschini    | 2006 | Phase 1 Archaeological Reconnaissance for the Marina Coast Water District Regional Urban Water Augmentation Project, Recycled Water Component, in Marina, Ord Community, Seaside and Monterey, Monterey County, California                        | Archaeological Consulting       | Archaeological, Field study  | Yes                |
| S-033677d     | Mary Doane and Gary S. Breschini    | 2007 | Phase 1 Archaeological Reconnaissance for Two Additional Alignments for the Marina Coast Water District Regional Urban Water Augmentation Project, Recycled Water Component, In Marina, Monterey County, California                               | Archaeological Consulting       | Archaeological, Field study  | Yes                |
| S-033677e     | Mary Doane and Gary S. Breschini    | 2007 | Preliminary Archaeological Reconnaissance for the Marina Coast Water District Well 34 Project, In Marina, Monterey County, California   | Archaeological Consulting       | Archaeological, Field study  | Yes                |
| S-034302      | James Keasling                      | 2008 | Cultural Resource Records Search and Site Visit Results for Sprint Nextel Candidate MO45XCO18 (Fort Ord), 4251 General Jim Moore Boulevard, Seaside, Monterey County, California  | Michael Brandman and Associates | Archaeological, Field study  | No                 |
| S-034406      | Scott Billat                        | 2007 | New Tower ("NT") Submission Packet FCC Form 620, Fort Ord Seaside, SF-18350A  | EarthTouch, Inc.                | Archaeological, Field study  | No                 |
| S-035060      | Mary Doane and Gary Breschini       | 2008 | Preliminary Archaeological Reconnaissance for the Projects at Main Gate in the Former Fort Ord, Seaside, Monterey County, California  | Archaeological Consulting       | Archaeological, Field study  | Yes                |
| S-035143      | Matthew Clark                       | 2006 | Archaeological Surface and Subsurface Reconnaissance and Historic Feature Recording for the East Garrison Project Area, Monterey County, California   | Holman and Associates           | Archaeological, Evaluation, Excavation, Field study                | No                 |
| S-035143a     | Matthew Clark                       | 2006 | Archaeological Monitoring Plan for the East Garrison Project, Monterey County, California   | Holman & Associates             | Archaeological, Management/ planning                               | No                 |
| S-035143b     | Matthew R. Clark and Juan Cervantes | 2007 | Archaeological Monitoring for the East Garrison Project, Monterey County, California  | Holman & Associates             | Archaeological, Field study, Management/ planning                  | No                 |
| S-035143c     | Matthew R. Clark                    | 2005 | Archaeological Surface and Subsurface Reconnaissance and Historic Feature Recording for the East Garrison Project Area, Monterey Count, California [original]   | Holman & Associates             | Archaeological, Architectural/ historical, Excavation, Field study | No                 |
| S-035979      | Susan Morley                        | 2009 | Preliminary Cultural Resources Reconnaissance of Assessor's Parcel Number 031-251-004 in the City of Marina, County of Monterey, California   | Achasta Archaeological Services | Archaeological, Field study  | No                 |
| S-036412      | Mary Doane and Gary Breschini       | 2009 | Preliminary Archaeological Reconnaissance for the Marina Middle School, High School, and Joint Use Community Recreational Facilities Project in Marina, Monterey County, California   | Archaeological Consulting       | Archaeological, Field study  | No                 |
| S-036412a     | Mary Doane and Gary S. Breschini    | 2009 | Phase 1 Archaeological Survey Report for the Marina Middle School, High School, and Joint Use Community Recreational Facilities Project in Marina, Monterey County, California  | Archaeological Consulting       | Archaeological, Field study  | No                 |
| S-037693      | Mary Doane and Gary S. Breschini    | 2010 | Phase I Archaeological Survey for the Central Coast California Veterans Cemetery and Eastside Road Infrastructure Projects, Seaside, Monterey County, California  | Archaeological Consulting       | Archaeological, Field study  | Yes                |

***Subject: Cultural Resource Inventory for the CSU Monterey Bay EIR Master Plan Project,  
Monterey County, California***

| Report Number | Authors                             | Year | Title   | Publisher  | Report Type   | Within Project APE |
|---------------|-------------------------------------|------|---|--|---|--------------------|
| S-037725      | Allika Ruby                         | 2010 | Archaeological Survey Report for the Monterey Light Rail Transit Project  | Far Western Anthropological Research Services, Inc.                                  | Archaeological, Field study                           | No                 |
| S-038840      | Mary Doane and Gary S. Breschini    | 2012 | Phase 1 Archaeological Survey for the Fort Ord Dunes State Park Project Near Seaside, Monterey County, California   | Archaeological Consulting  | Archaeological, Field study                           | No                 |
| S-039072      |                                     | 2009 | Cultural Resources Review, Gigling Road and South Boundary Road Improvements, Within Former Fort Ord, Monterey County, California                                     | Basin Research Associates  | Archaeological, Architectural/historical, Field study | No                 |
| S-039246      | Tobin Rodman                        | 2012 | Cultural Resources Constraints Study for the Replacement of the Marina, 6th Street Wood Pole Replacement Project, Monterey County, California, PG&E No. 30787086/7690 | Parus Consulting   | Archaeological, Architectural/historical, Field study | No                 |
| S-040206      | Mary Doane and Gary Breschini       | 2013 | Preliminary Archaeological Reconnaissance for the MRWPCA Salinas Pump Station Capacity Enhancement Project Between Salinas and Marina, Monterey County, California    | Archaeological Consulting  | Archaeological, Field study                           | No                 |
| S-042969      | Carolyn Losee                       | 2012 | Cultural Resources Investigation for AT&T Mobility CNU3562 "W Blanco Road LTE", 3262 Imjin Road, Marina, Monterey County, California 93933 (letter report)            | Archaeological Resources Technology  | Architectural/historical, Field study                 | No                 |
| S-042969a     | Carol Roland-Nawi and Carolyn Losee | 2012 | FCC_2012_1106_005; CNU3562, W Blanco Road TLTE, 3262 Imjin Road, Marina, Collocation  | Office of Historic Preservation; Archaeological Resources Technology                 | OHP Correspondence                                    | No                 |
| S-044195      | Lawrence Moore                      | 2010 | Cultural Resource Inventory, ASR Wells Location, Ord Military Community, Monterey County, CA  | Dept of Public Works, Environmental Division, US Army Garrison, Presidio of Monterey | Archaeological, Architectural/historical, Field study | No                 |
| S-044238      | Aniela Travers                      | 2013 | Cultural Resources Survey, California State University Monterey Bay/CN3776, NWC Eighth Avenue and A Street, Seaside, Monterey County, California, 93955, Unsectioned  | EBI Consulting   | Archaeological, Field study                           | Yes                |
| S-045823      | Mary Doane and Gary S. Breschini    | 2014 | Phase I Archaeology Survey for the Proposed Monterey Peninsula Groundwater Replenishment Project, Northern Monterey County, California                                | Archaeological Consulting  | Archaeological, Field study                           | Yes                |
| S-046930      | Roderic McLean                      | 2014 | FCC Form 620 New Tower ("NT") Submission Packet, Verizon Wireless Imjin and Abrams Facility, 2700 Imjin Parkway, Marina, CA 93933                                     | Bureau Veritas   | Architectural/historical, Management/planning         | No                 |
| S-046930a     |                                     | 2014 | Cultural Resource Assessment Class III Inventory, Verizon Wireless Services, Imjin and Abrams Facility, City of Marina, County of Monterey, California                | LSA Associates, Inc.   | Archaeological, Field study                           | No                 |
| S-047095      | Allika Ruby                         | 2015 | Archaeological Survey Report for the PG&E Salinas #1 and Salinas #2 Pole Replacement Project, Monterey County, California   | Far Western Anthropological Research Group, Inc.                                     | Archaeological, Field study                           | Yes                |



*Subject: Cultural Resource Inventory for the CSU Monterey Bay EIR Master Plan Project, Monterey County, California*

---

| Report Number | Authors                 | Year | Title   | Publisher                       | Report Type                 | Within Project APE |
|---------------|-------------------------|------|---|---------------------------------|-----------------------------|--------------------|
| S-048445      | Dana E. Supernowicz     | 2013 | Archaeological Survey Study of the PG&E Ardennes Project, AT&T Mobility Site No. CNU6074, 207 Ardennes Circle, Seaside, Monterey County, California 93955 | Historic Resource Associates    | Archaeological, Field study | No                 |
| S-048445a     | Milford Wayne Donaldson | 2013 | Collocation Submission Packet; PG&E ARDENNES; AT&T- CNU6074.  | Office Of Historic Preservation | Management/ planning        | No                 |
| S-048445b     | Carol Roland-Navi       | 2014 | FCC_2013_1218_001: CNU6074 (PG&E ARDENNES) 207 ARDENNES CIRCLE, SEASIDE, Collocation  | Office Of Historic Preservation | OHP Correspondence          | No                 |

The following studies occurred within portions of the Project Area.

***S-003418 Cultural Resource Assessment of the Proposed Effluent Disposal System, Fort Ord, Monterey County, California (Peak 1978)***

This study crosses the Project Area in the southwest corner. It relates to an upgrade in the sewage system along the western portion of Fort Ord. No cultural resources were identified.

***S-003441 Appendix D: Archeological Survey, Fort Ord, Monterey County (Unknown 1975)***

This study took place in the northeastern portion of the Project Area. The survey was conducted for a proposed expansion of housing facilities. No cultural resources were encountered.

***S-005210 Predictive Model of Cultural Resources at Fort Ord: A Reconnaissance Cultural Survey of Fort Ord, California (Michael Swernoff of Professional Analysts 1982)***

Professional Analysts surveyed over a thousand acres of the Fort Ord property and analyzed previous surveys and overviews to create a predictive map of cultural sensitivity. The survey was stratified by vegetation type, which included: grassland, live oak savannah, dense brush (manzanita), light brush (sage brush), and coastal strand. Areas of high sensitivity were identified in the eastern and southern portions of the Fort in areas where water drains from high relief areas, there is available surface water, concentrated variability in ecological zone, presence of buckeye trees, and degree of protection from the elements. Additionally, Swernoff reported on four previously recorded historic buildings and one newly recorded historic cairn. Moreover, they report that a single bedrock mortar site, CA-MNT-416, is located in a buffer zone east of Fort Ord.

***S-018372 A Cultural Resources Survey of 783 Hectares, Fort Ord, Monterey County, California (Waite 1995)***

This study was a cultural resources survey sampling of 783 hectares (1,935.4 acres) within the Fort Ord related to the closure of the military base. The survey was stratified by environmental zones, which included: beach strand, active dunes, stabilized dunes (Holocene), stabilized dunes (ancient), and dissected uplands. High probability areas included areas within 100 meters of a water source and a 300-meter wide area along the bluff overlooking the Salinas River on the eastern edge of the Fort Ord. The effort included the recording of a historic site and an examination of two prehistoric sites, which included excavating shovel test pits. Portions of the survey included segments within the eastern half of the Project Area. None of the resources addressed in the report are within the Project Area or one-mile buffer.

***S-22738 Preliminary Archaeological Reconnaissance of the MBEST 18' Water Pipeline Project, Marina, Monterey County, California (Doane and Haversat 2000)***

This study included a survey and records search related to a proposed waterline project in Marina. The survey crosses the Project Area in the northeastern portion. No cultural resources were encountered in the records search or survey for this study.

***S-23023 Preliminary Archaeological Reconnaissance of the 2<sup>nd</sup> Avenue/12<sup>th</sup> Street Project, in the Former Fort Ord, Monterey County, California (Doane and Haversat 2000)***

This study, located along 12<sup>th</sup> Street, 2<sup>nd</sup> Avenue and Lightfighter Drive on the grounds of former Fort Ord, makes up 2/3 of the western boundary of the Project Area on the north end and enters the Project Area approximately 800 meters from the western boundary. This study did not encounter any cultural resources from the survey or record search efforts.

***S-25416 Preliminary Archaeological Reconnaissance for the First Tee Project and Two Separate Recreational Facility Sites in the Former Fort Ord, Monterey County, California (Doane and Haversat 2002)***

This study is related to the construction of a golf course and two recreational facilities on the grounds of the former Fort Ord. The northernmost recreational facility grazes the southern boundary of the Project Area in the western portion. The records search did not indicate any cultural resources within 1 km of the study and no cultural resources were encountered during the survey.

***S-33677a-d Phase 1 Archaeological Reconnaissance for the Marina Coast Water District Regional Urban Water Augmentation Project, Recycled Water Component, Northern Segment, In Marina and Seaside, Monterey County, California (Doane and Haversat 2006 and 2007)***

This study is linked to a waterline project that spans from northeast of the City of Marina through the former Fort Ord to downtown Monterey. It connects reservoirs, pump stations, laterals and several pipelines. This linear study lines several existing streets in the western portion of the Project Area. One historic site was found within the confines of former Fort Ord, but was not affected by their project and does not exist within the Project Area or one-mile buffer. Any other archaeological sites within the concern of the study were located farther to the south, beyond the extent of the former Fort Ord and outside the one-mile buffer of this Project.

***S-33677e Preliminary Archaeological Reconnaissance for the Marina Coast Water District Well 34 Project, In Marina, Monterey County, California (Doane and Breschini 2007)***

This study discusses drilling for a well for the Marina Coast Water District in the East Garrison area of the Ord Community. This portion of the study is outside the Project Area.

***S-35060 Preliminary Archaeological Reconnaissance for the Projects at Main Gate in the Former Fort Ord, Seaside, Monterey County, California (Doane and Breschini 2008)***

This study involves a proposed development project at the Main Gate of the former Fort Ord. The study intersects the Project Area on the southern portion of the western boundary. Neither the records search nor the survey produced any evidence of cultural resources within 1 km of the study area.

***S-37693 Phase 1 Archaeological Survey for the Central Coast California Veterans Cemetery and Eastside Road Infrastructure Projects Seaside, Monterey County, California (Doane and Breschini 2010)***

The study involves an assessment of a cemetery for veterans, as well as a new road alignment and improvements eastward on Inter Garrison Road to Old County Road. The study intersects with the Project Area in the southeastern portion. Records search indicated one historic site (not within the Project Area). Survey yielded the discovery of no additional cultural resources.

***S-44238 Cultural Resources Survey California State University Monterey Bay/CN3776 NWC Eighth Avenue and A Street Seaside, Monterey County, California 93955 Unsectioned (EBI Consulting 2013)***

*Subject: Cultural Resource Inventory for the CSU Monterey Bay EIR Master Plan Project, Monterey County, California*

---

This study is for a proposed telecommunications tower at the intersection of Eighth Avenue and A Street at the former Fort Ord property. The study is within the Project Area in the central region to the north. No cultural resources were encountered in the records search or survey.

***S-45823 Phase 1 Archaeological Survey for the Proposed Monterey Peninsula Groundwater Replenishment Project, Northern Monterey County, California (Doane and Breschini 2014)***

This study is a water resources improvement project, which would inject treated water from a new water treatment plant into the Seaside Groundwater Basin. The study area is vast and involves lands in Marina, Seaside, Monterey and Pacific Grove, as well as unincorporated lands around Marina, Salinas and Castroville. The study bisects the Project Area in the western portion. Although the study contained prehistoric and historic resources, none were located within the Project Area and none encountered during the survey.

***S-47095 Archaeological Survey Report for the PG&E Salinas #1 and Salinas #2 Pole Replacement Project, Monterey County, California (Ruby 2015)***

This study relates to PG&E poles being replaced in Salinas and on the property of former Fort Ord. One pole is within the Project Area and two within the one-mile buffer. Access roads between the poles are also part of the study. No cultural resources discovered during the course of the survey nor in the records search.

## **Native American Consultation**

On behalf of CSUMB, Dudek submitted a Sacred Lands File (SLF) search and request for a list of Native American contacts with NAHC on August 28, 2017 (Attachment 3). NAHC responded on September 6, 2017 with negative results for the SLF search. NAHC provided contacts for 8 separate groups. Pursuant to AB52 requirements, all NAHC-listed California Native American tribes who have requested project notification from CSUMB were contacted.

### ***AB 52 consultation***

A project with an effect that may cause a substantial adverse change in the significance of a tribal cultural resource is a project that may have a significant effect on the environment (Pub. Resources Code, § 21084.2.). CSUMB initiated AB 52 consultation on this project through the following process. Two Native American groups, the Ohlone/Costanoan-Esselen Nation (OCEN) and the Torres Martinez Desert Cahuilla Indians, contacted CSUMB requesting consultation under AB52 for new projects initiated by CSUMB meeting requirements for consultation under CEQA. The Torres Martinez Desert Cahuilla Indians are geographically located in the vicinity of Imperial and

Riverside counties, California. Due to the geographic distance and lack of traditional and cultural affiliation with the geographic area surrounding CSUMB, CSUMB responded to Torres Martinez on July 18, 2017 that AB52 consultation would not be initiated unless additional information supporting cultural affiliation was provided. Also on July 18, 2017, CSUMB sent a letter to OCEN notifying them of the intent to prepare an Environmental Impact Report for the proposed CSUMB Master Plan. The letter described a general overview of the Project and included maps. Attachment 4 presents the record of AB 52 consultation, which is summarized below.

OCEN responded to CSUMB in a letter dated August 4, 2017 requesting consultation and outlining a series of requests as a component of consultation. Their requests included the following: to be provided with copies of reports, to establish a procedure for addressing disturbance to known and unknown sites, and to complete a CHRIS records search at NWIC and with the Native American Heritage Commission (NAHC). CSUMB initiated AB52 consultation with OCEN by a letter dated August 31, 2017. OCEN responded in a letter dated September 11, 2017 requesting no disturbance of cultural lands and implementation of procedures to follow when known or unknown cultural resources are identified, among other points. CSUMB followed up with a letter dated September 5, 2018 providing summary results of the NWIC and NAHC searches and the surface survey. CSUMB met with OCEN on December 17, 2018 and January 29, 2019 to discuss the project.

OCEN brought up several points about cultural sensitivity on the campus and identified various contacts who may have more information about tribal or archaeological cultural resources on the campus. On behalf of CSUMB, Dudek followed up with several of the leads. CSUMB followed up with a letter dated April 18, 2019 summarizing the results of the two meetings, providing OCEN with a copy of the draft cultural report, summarizing supplemental investigations and research completed to attempt to identify TCRs on the campus, and offering to continue consultation with OCEN by holding a field meeting to obtain additional information from OCEN about potential resources. OCEN did not respond to this letter and CSUMB concluded consultation on May 17, 2019. A summary of the additional communications is presented in Attachment 4.

AB 52 requires a TCR to have tangible, geographically defined properties that can be impacted by a project. No known TCRs have been identified through consultation with OCEN. In the future, should one or more TCRs be identified that may be affected, CSUMB will work with tribal representatives that have requested consultation under AB 52 to establish a feasible and appropriate mitigation approach.

### **Cultural Resources Survey**

Dudek archaeologists Ryan Brady, MA, RPA, and Sarah Brewer, BA, performed a survey of the proposed Project Area on November 22, 2017 (Figure 3). The focus of the survey was to characterize existing conditions and identify whether archaeological resources were located at, or

had the potential to be located within, the Project area. The archaeologists applied a mixed-intensity strategy for the survey, using 15-meter transects when possible, and adopting a more opportunistic approach in highly developed areas. More care was given to areas that will be affected by “near-term” projects.

### **1. Student Recreation Center**

Dudek archaeologists inspected the exposed sand north of the parking area, but the southern area was fenced off for construction activities. The trail south of Area 1 was surveyed eastward. This zone was within an oak-pine woodland with ice plant ground cover. The partially-landscaped area south of the construction area was also surveyed. Visibility was good in non-developed areas.

### **2. Student Housing Phase IIB**

Although most of this area was paved, there were some open areas with moderate visibility revealing a sandy substrate. Vegetation in this area included pines, eucalyptus and ice plant.

### **3. Student Housing Phase III**

The south end of this survey area was a paved parking lot. The northwestern portion was also paved or covered in ice plant. Buildings formerly located in this area have been removed. Dudek archaeologists inspected the ground surface in all visible areas. Vegetation in this area included oak, eucalyptus and ice plant.

### **4. Academic IV**

Buildings in the southeastern portion of this survey area were fenced off and in the process of being demolished. Other construction was ongoing and included recently-constructed buildings. The ground surface provided moderate to low visibility.

### **5. Academic V**

The north end of this survey area was fully developed with buildings, grass and a paved parking lot. Ground surface visibility was poor.

### **6. Athletics Field**

The eastern portion of this survey area was heavily disturbed with a fair surface visibility. The western portion was developed with a baseball field, a track, a pool and a parking lot. Some areas are open and show past disturbance.

## **7. Southeast and Northwest New Buildings**

In the southeast block, the northern portion was paved and fenced off. There was thick ice plant in unpaved areas. West of the solar array was an open area with good surface visibility and a high level of disturbance.

The northwestern block was undeveloped with moderate to poor surface visibility. Ice plant covered the ground surface, which was a sandy substrate.

## **8. Outlying Trails and Infrastructure**

In the eastern portion of the Project Area, Dudek archaeologists surveyed a portion of the proposed FORTAG trail from Inter Garrison Road south. The trail was graded with aggregate in areas and was within a disturbed context. Visibility was moderate to poor in the central portion that has been cleared in the past. The thick forested area south of the previously cleared area was not passable.

Dudek archaeologists surveyed all areas of near-term projects and did not identify new archaeological resources in any of the areas surveyed.

## **SUMMARY AND RECOMMENDATIONS**

All cultural resource fieldwork and reporting for this project has been conducted by archaeologists meeting the Secretary of the Interior's Professional Qualifications Standards. A cultural resources records search of the California Historical Resources Information System (CHRIS) at the Northwest Information Center (NWIC) records search found one potential previously recorded prehistoric site within the 19,220 acre former Fort Ord Military Reserve, but no specific locational data was provided in the site record so the exact location remains unknown. This site was recorded as destroyed in 1940 (Pilling 1950). Two other historical archaeological sites and 16 Built Environment resources exist within one mile of the Project Area. A mixed-intensity field survey of the Project Area was conducted on November 22, 2017 and a supplemental survey was conducted on February 6, 2019; the surveys did not identify any unrecorded archaeological resources.

General archaeological sensitivity of the CSUMB campus can be assessed by reviewing the archaeological survey and sensitivity model presented by Swernoff (1982). The study identified high sensitivity for prehistoric resources where:

1. Drainages empty from high relief areas onto the Salinas River floodplain or Toro Creek watershed
2. Surface water is available
3. There is concentrated ecological zone diversity

4. Presence of buckeye trees
5. Protection from the elements

Areas meeting those characteristics are found in the eastern and southern areas of Fort Ord, beyond the current CSUMB boundary.

Dudek has worked with CSUMB to facilitate consultation with Native American tribes who are traditionally and culturally affiliated to the geographic area of the project pursuant to AB 52. This process has included letters sent to Native American tribes who have previously requested notification of projects within this area, a follow-up letter initiating consultation with OCEN, then an additional letter documenting the results of the records search and survey. Further, CSUMB met with OCEN on December 17, 2018 and on January 29, 2019 as part of the government-to-government consultation in order to discuss the project and receive feedback. CSUMB followed up with a letter dated April 18, 2019 summarizing the results of the two meetings, providing OCEN with a copy of the draft cultural report, summarizing supplemental investigations and research completed to attempt to identify TCRs on the campus, and offering to continue consultation with OCEN by holding a field meeting to obtain additional information from OCEN about potential resources. OCEN did not respond to this letter and CSUMB concluded consultation on May 17, 2019.

An appropriate approach to determining potential impacts to TCRs is developed in response to verifying the identified presence of a TCR by a California Native American Tribe through the process of consultation. Government-to-government consultation initiated by CSUMB, acting in good faith and after a reasonable effort, has not resulted in the identification of a TCR within or near the project area. Based on the results of these efforts, the proposed Master Plan Project does not appear to threaten impacts to known archaeological sites or TCRs. Nevertheless, CSUMB will implement the following mitigation measures in the event that unknown resources are uncovered during the course of development.

**Mitigation Measure CULT-1:** CSUMB shall include a standard inadvertent discovery clause in every construction contract for the Project, which requires that in the event that an archaeological resource is discovered during construction (whether or not an archaeologist is present), all soil disturbing work within 100 feet of the find shall cease until a qualified archaeologist can evaluate the find and make a recommendation for how to proceed. For an archaeological resource that is encountered during construction, the campus shall:

- Retain a qualified archaeologist to determine whether the resource has potential to qualify as a historical resource or a unique archaeological resource as outlined in the California Environmental Quality Act (CEQA)(PRC 21083.2).



- If the resource has potential to be a historical resource or a unique archaeological resource, the qualified archaeologist, in consultation with CSUMB, shall prepare a research design and archaeological evaluation plan to assess whether the resource should be considered significant under CEQA criteria.
- If the resource is determined significant, in consultation with CSUMB, a qualified archaeologist will prepare a data recovery plan for retrieving data relevant to the site's significance. The data recovery plan shall be implemented prior to, or during site development (with a 100 foot buffer around the resource). The archaeologist shall also perform appropriate technical analyses, prepare a full written report and file it with the Northwest Information Center, and provide for the permanent curation of recovered materials.

**Mitigation Measure CULT-2:** A Native American and archaeological monitor shall be present for earth-disturbing work in native soils within 750 feet of a documented archaeological resource or TCR, if such resources are discovered and documented in the future. Depth to native soils on particular project sites is typically identified in project-specific geotechnical investigations.

**Mitigation Measure CULT-3:** CSUMB shall include a standard clause in every construction contract for the Project, which requires cultural resource sensitivity training for workers prior to conducting earth disturbance in the vicinity of a documented cultural resource-sensitive area, should one be identified in the future. Additionally, campus staff involved in earth-disturbing work in the vicinity of a documented resource sensitive area will also receive such training.

**Mitigation Measure CULT-4:** Should human remains be discovered at any time, work will halt in that area and procedures set forth in the California Public Resources Code (Section 5097.98) and State Health and Safety Code (Section 7050.5) will be followed, beginning with notification to CSUMB and the County Coroner. If Native American remains are determined to be present, the County Coroner will contact the Native American Heritage Commission to designate a Most Likely Descendent, who will arrange for the dignified disposition and treatment of the remains. OCEN shall be notified of the discovery even if not assigned as MLD.

Should you have any questions relating to this report and its findings please do not hesitate to contact me directly.

Respectfully Submitted,

*Subject: Cultural Resource Inventory for the CSU Monterey Bay EIR Master Plan Project,  
Monterey County, California*

---



Ryan Brady, MA, R.P.A.  
Archaeologist

**DUDEK**

Office: (831) 600-1414

Email: rbrady@dudek.com

cc: Micah Hale, Dudek

Att: *Figure 1. Regional/Vicinity Map*

*Figure 2. Implementation Plan and Near-Term Project Sites*

*Figure 3. Cultural Survey Coverage*

*Attachment 1: National Archaeological Database Information*

*Attachment 2: NWIC Records Search (Confidential)*

*Attachment 3: Native American Heritage Commission Sacred Lands File Search (Confidential)*

*Attachment 4: Record of Native American Consultation (Confidential)*

## REFERENCES CITED

- Basgall, M.E. 1987. Resource Intensification Among Hunter-Gatherers: Acorn Economies in Prehistoric California. *Research in Economic Anthropology* 9:21–52.
- Beardsley, R.K. 1946. The Monterey Custom Flag Pole: Archaeological Findings. *California Historical Society Quarterly* 25(3):204-218
- Bertrando, E. 2004. Evidence and Models for Late Pleistocene Chronology and Settlement Along California’s Central Coast. In *Emerging from the Ice Age: Early Holocene Occupations on the California Central Coast*, edited by Ethan Bertrando and V.A. Levulett, pp. 93–105. San Luis Obispo County Archaeological Society Occasional Papers no. 17.
- Brady, R., J. Farquhar, T. Garlinghouse, and C. Peterson. 2009. *Archaeological Evaluation of CA-MNT-143 for the Asilomar Boardwalk Replacement Project, Asilomar State Beach, Pacific Grove, California*. Albion Environmental, Inc., Santa Cruz. Copies available from the Northwest Information Center, Department of Anthropology, Sonoma State University, Rohnert Park.
- Breschini, G. and T. Haversat. 1992a. Preliminary Excavations at CA-MNT-108, Fisherman’s Wharf, Monterey County, California. In *Archaeological Investigations of Some Significant Sites on the Central Coast of California*, edited by H. Dallas, Jr. and G.S. Breschini, pp. 39–47. Coyote Press Archives of California Prehistory No. 37, Salinas.
- Breschini, G. and T. Haversat. 1992b. Baseline Archaeological Studies at Rancho San Carlos, Carmel Valley, Monterey County, California. Coyote Press Archives of California Prehistory No. 36, Salinas.
- Bryne, S. 2002. *Archaeological Monitoring of the Wilder Ranch Bike Path Construction and Mitigation Related to Archaeological Site CA-SCR-38/123/H*. Garcia and Associates, San Anselmo. Copies available from Northwest Archaeological Information Center, Department of Anthropology, Sonoma State University, Rohnert Park, California.
- Cartier, R. 1993. *The Scotts Valley Site: CA-SCR-177*. The Santa Cruz Archaeological Society, Santa Cruz.
- Dietz, S.A., W.R. Hildebrandt, and T. Jones 1988. *Archaeological Investigations at Elkhorn Slough: CA-MNT-229 A Middle Period Site on the Central California Coast*. Papers in Northern California Anthropology, Number 3.

*Subject: Cultural Resource Inventory for the CSU Monterey Bay EIR Master Plan Project,  
Monterey County, California*

---

Dietz, S.A and T.L. Jackson 1981. *Report of Archaeological Excavations at Nineteen Archaeological Sites for the Stage 1 Pacific Grove-Monterey Consolidation Project Regional Sewerage System*. Coyote Press, Salinas, CA

Erlandson, J.M., M.H. Graham, B.J. Bourque, D. Corbett, J.A. Estes, and R.S. Steneck. 2007. The Kelp Highway Hypothesis: Marine Ecology, the Coastal Migration Theory, and the Peopling of the Americas. *The Journal of Island and Coastal Archaeology* 2(2): 161–174.

Fitzgerald, R.T., J.L. Edwards, J.M. Farquhar, and K. Loeffler. 1995. *Archaeological Test Excavation at CA-MNT-1765, for the Moro Cojo Standard Subdivision Project (SH93001), Monterey County, California*. Biosystems Analysis, Inc., Santa Cruz. Report on file Northwest Information Center, Department of Anthropology, Sonoma State University, Rohnert Park.

Fitzgerald, R.T. and T.L. Jones 1999. The Milling Stone Horizon Revisited: New Perspectives from Northern and Central California. *Journal of California and Great Basin Anthropology* 21:65-93.

Fitzgerald, R.T. and A. Ruby. 1997. *Archaeological Test Excavations at CA-SCR-117, the Davenport Landing Site*. Garcia and Associates, San Anselmo. Report on file Northwest Information Center, Department of Anthropology, Sonoma State University, Rohnert Park.

Gibson, R.O. 1996. *Results of Archaeological Monitoring for Unocal Soil Testing Program along Pipelines near Santa Margarita, San Luis Obispo County, California*. Gibson's Archaeological Consulting, Paso Robles. Report submitted to UNOCAL CERT, San Luis Obispo. Copies available from the Central Coast Information Center, Department of Anthropology, University of California, Santa Barbara.

Hildebrandt, W.R. 2006. *Archaeological Evaluation of the Priest Valley Knoll Sites (CA-MNT-745), Eastern Monterey County, California*. Far Western Anthropological Research Group, Inc., Davis. Copies available from the Northwest Information Center, Department of Anthropology, Sonoma State University, Rohnert Park.

Hildebrandt, W.R., and P. Mikkelsen. 1993. *Archaeological Test Excavations at Fourteen Sites Along Highways 101 and 152, Santa Clara and San Benito Counties, California Volume 1: Prehistory*. Prepared for Caltrans District 4, Oakland. Copies available from Northwest Information Center, Department of Anthropology, Sonoma State University, Rohnert Park.

*Subject: Cultural Resource Inventory for the CSU Monterey Bay EIR Master Plan Project,  
Monterey County, California*

---

- Holm, L., K. Chao and J. Holson. 2013. *Archaeological Assessment for the City of Monterey 2013 Sewer Rehabilitation Project, Monterey County, California PL-2616-21 (Updated July 2013)*. Report on file at the Northwest Information Center, Sonoma State University, Rohnert Park.
- Hylkema, M.G. 1991. *Prehistoric Native American Adaptations Along the Central California Coast of San Mateo and Santa Cruz Counties*. Master's thesis, Department of Anthropology, San Jose State University. University Microfilms, Ann Arbor.
- Jones, T.L. 1993. Big Sur: A Keystone in Central California Culture History. *Pacific Coast Archaeological Quarterly*.
- Jones, T.L. 1995. *Transitions in Prehistoric Diet, Mobility, Exchange, and Social Organization Along California's Big Sur Coast*. Unpublished Ph.D. Dissertation, Department of Anthropology, University of California, Davis.
- Jones, T.L. 2003. *Prehistoric Human Ecology of the Big Sur Coast, California*. Contributions of the University of California Archaeological Research Facility, Berkeley.
- Jones, T.L., G. M. Brown, L.M. Raab, J.L. McVickar, W.G. Spaulding, D.J. Kennett, A. York, and P.L. Walker. 1999. Environmental Imperatives Reconsidered: Demographic Crises in Western North America During the Medieval Climatic Anomaly. *Current Anthropology* 40:137-170.
- Jones, T.L. and J.A. Ferneau 2002a. Prehistory at San Simeon Reef: Archaeological Data Recovery at CA-SLO-179 and -267, San Luis Obispo, California. *San Luis Obispo Archaeological Society Occasional Paper No. 16*.
- Jones, T.L., and J.A. Ferneau. 2002b. Deintensification along the Central Coast. In *Catalysts to Complexity: Late Holocene Societies of the California Coast*, edited by J.M. Erlandson and T.L. Jones, pp. 205-232. Perspectives in California Archaeology, Vol. 6. Cotsen Institute of Archaeology, University of California, Los Angeles.
- Jones, T.L. and J. Haney. 2005. Archaeological Evaluation of CA-MNT-910, -1748/H, -1919, and -2182, Fort Hunter Liggett Military Installation, Monterey County, California. California Polytechnic State University, San Luis Obispo.

*Subject: Cultural Resource Inventory for the CSU Monterey Bay EIR Master Plan Project,  
Monterey County, California*

---

- Jones, D., and W.R. Hildebrandt. 1990. *Archaeological Investigation at Sand Hill Bluff: Portions of Prehistoric Site CA-SCr-7, Santa Cruz County, California*. Far Western Anthropological Research Group, Inc., Davis. Copies available from Northwest Information Center, Department of Anthropology, Sonoma State University, Rohnert Park.
- Jones, D., and W.R. Hildebrandt. 1994. *Archaeological Investigations at Sites CA-SCR-10, CA-SCR-17, CA-SCR-304, and CA-SCR-38/123 for the North Coast Treated Water Main Project, Santa Cruz County, California*. Far Western Anthropological Research Group, Inc. Copies available from Northwest Information Center, Department of Anthropology, Sonoma State University, Rohnert Park.
- Jones, T.L., and D. Jones. 1992. Elkhorn Slough Revisited: Reassessing the Chronology of CA-MNT-229. *Journal of California and Great Basin Anthropology* 14:159-179.
- Jones, T.L., J.F. Porcasi, J.W. Gaeta, and B.F. Coddling. 2008. The Diablo Canyon Fauna: A Coarse-grained Record of Trans-Holocene Foraging from the Central California Mainland Coast. *American Antiquity* 73:289–316.
- Jones, T. L., N. E. Stevens, D. A. Jones, R. T. Fitzgerald, and M. G. Hylkema. 2007. The Central Coast: A Midlatitude Milieu. In *California Prehistory Colonization, Culture, and Complexity*, edited by Terry L. Jones and Kathryn A. Klar, pp: 125-146. Altamira Press, Lanham.
- Jones, T.L., T. Van Bueren, S. Grantham, J. Huddleson, and T.W. Fung. 1996. *Archaeological Test Excavations for the State Highway 1 Widening Project Near Castroville, Monterey County, California*. Office of Cultural Studies, California Department of Transportation. Prepared for Caltrans, District 5, San Luis Obispo. Copies available from Northwest Information Center, Department of Anthropology, Sonoma State University, Rohnert Park.
- Jones, T.L. and G. Waugh 1995. Central California Coastal Prehistory: A View from Little Pico Creek. *Perspectives in California Archaeology* No. 3, Institute of Archaeology, University of California, Los Angeles.
- Jones, T.L. and G. Waugh 1997. Climatic Consequences or Population Pragmatism? A Middle Holocene Prehistory of the Central California Coast. In *Archaeology of the California Coast During the Middle Holocene*, edited by J.M. Erlandson and M.A. Glassow, pp. 111-128. *Perspectives in California Archaeology* 4. Institute of Archaeology, University of California, Los Angeles.

*Subject: Cultural Resource Inventory for the CSU Monterey Bay EIR Master Plan Project,  
Monterey County, California*

---

- Levy, R. 1978. Costanoan. *Handbook of North American Indians*. Vol. 8. Edited by Robert F. Heizer. Smithsonian Institution, Washington.
- Mikkelsen, P., W.R. Hildebrandt and D.A. Jones. 2000. *Prehistoric Adaptations on the Shores of Morro Bay Estuary: Excavations at Site CA-SLO-165, Morro Bay, California*. Occasional Paper No. 14, San Luis Obispo County Archaeological Society, San Luis Obispo, California.
- Milliken, R. J. and J.R. Johnson. 2010. South Coast Ranges Analytical Zone. In *The Contact-Period Native California Community Distribution Model: A Dynamic Digital Atlas and Wiki Encyclopedia 10*. Far Western Anthropological Research Group, Inc., Davis, California. Report submitted to Caltrans District 6, Fresno, California.
- Milliken, R., J. Nelson, W.R. Hildebrandt, and P. Mikkelsen. 1999. *The Moss Landing Hill Site: A Technical Report on Archaeological Studies at CA-MNT-234 in 1991 and 1997-1998*. Far Western Anthropological Research Group, Inc., Davis. Copies available from the Northwest Information Center, Department of Anthropology, Sonoma State University, Rohnert Park.
- Mills, W.W., M.F. Rondeau, and T.L. Jones. 2005. A Fluted Point from Nipomo, San Luis Obispo County, California. *Journal of California and Great Basin Anthropology* 25:214-220.
- Newsome, S.D., D.L. Phillips, B.J. Culleton, T.P. Guilderson, P. Koch. 2004. Dietary Reconstruction of an Early to Middle Holocene Human Population from the Central California Coast: Insights from Advanced Stable Isotope Mixing Models. *Journal of Archaeological Science* 31:1101-1115.
- Pilling, A. R. 1950. Site record for CA-MNT-280 (P-27-000385). On file, Northwest Information Center, Rohnert Park, California.
- Pohorecky, Z.S. 1976. Archaeology of the South Coast Ranges of California. *University of Archaeological Research Facility* 34, Berkeley.
- Rogers, D.B. 1929. *Prehistoric Man of the Santa Barbara Coast*. Museum of Natural History, Santa Barbara.
- Rughe, J. 2016. Fort Ord History. From <http://www.militarymuseum.org/FtOrd.html> accessed Sept. 4, 2018.

*Subject: Cultural Resource Inventory for the CSU Monterey Bay EIR Master Plan Project,  
Monterey County, California*

---

Stine, S. 1994. Extreme and Persistent Drought in California and Patagonia during Medieval Time. *Nature* 369:546-549.

United State Department of Agriculture (USDA), National Resource Conservation Service (NRCS) 2018 Soil Map for Santa Cruz County, California. Accessed online, February 12, 2018. <https://websoilsurvey.sc.egov.usda.gov>

United States Geological Survey (USGS). 1997. Open-file Report 97-489. Geologic Map of Santa Cruz County, California: A Digital Database. Compiled by E. E. Brabb. Electronic document, <https://pubs.usgs.gov/of/1997/of97-489/scruzmap.pdf> accessed February 12, 2018.

Western Regional Climate Center. 2018. Monthly Climate Summary for Fritzsche AAF, California (Fort Ord). Period of Record 04/04/1960 to 11/30/1978. Electronic document: <https://wrcc.dri.edu/summary/Climsmcca.html>. Accessed February 12, 2018.



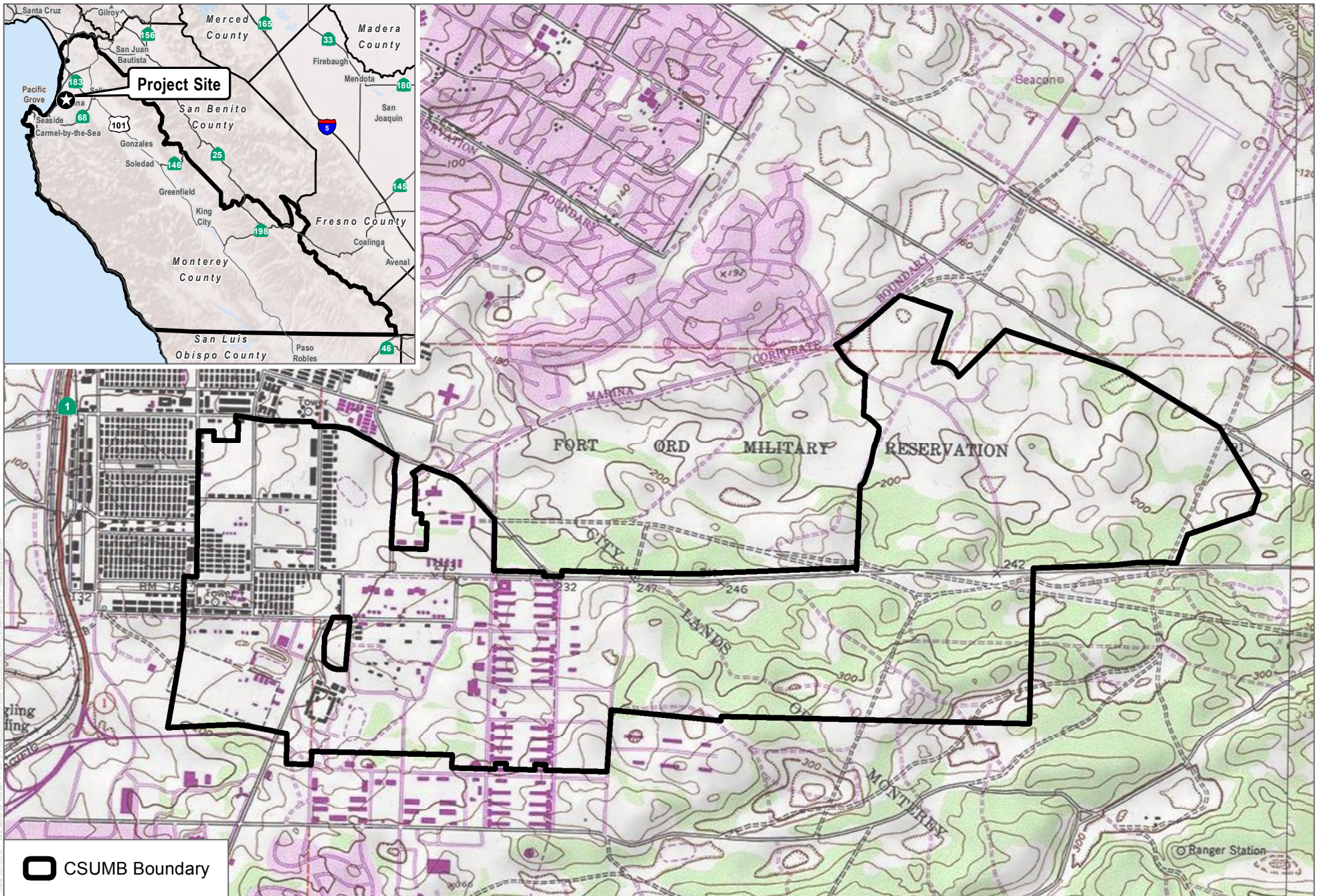

SOURCE: USGS 7.5-Minute Series Marina Quadrangle,  
 Township 14S / Range 2E / Sections 32 & 33, Township 15S / Range 1E / Section 01,  
 Township 15S / Range 2E / Sections 04, 05 & 06

**FIGURE 1**

**Project Location**

**Numbers**

10X Existing Buildings Removed

10X Existing Buildings to Remain

10X Proposed Buildings

Existing Buildings Removed

Near-Term Projects

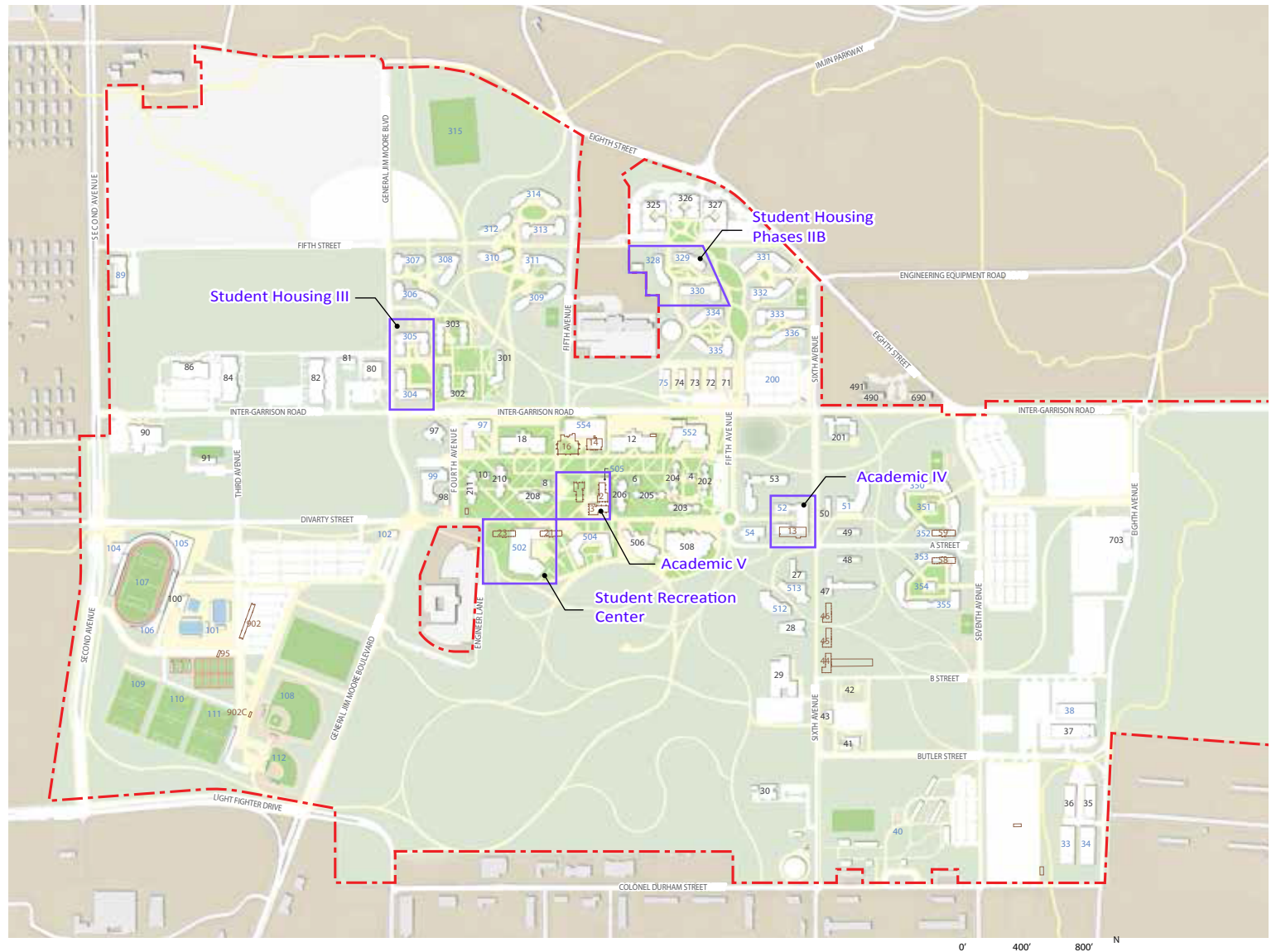

SOURCE: Page / BMS Design Group (2017)

**DUDEK**

**FIGURE 2**  
**Implementation Plan and Near-Term Project Sites**

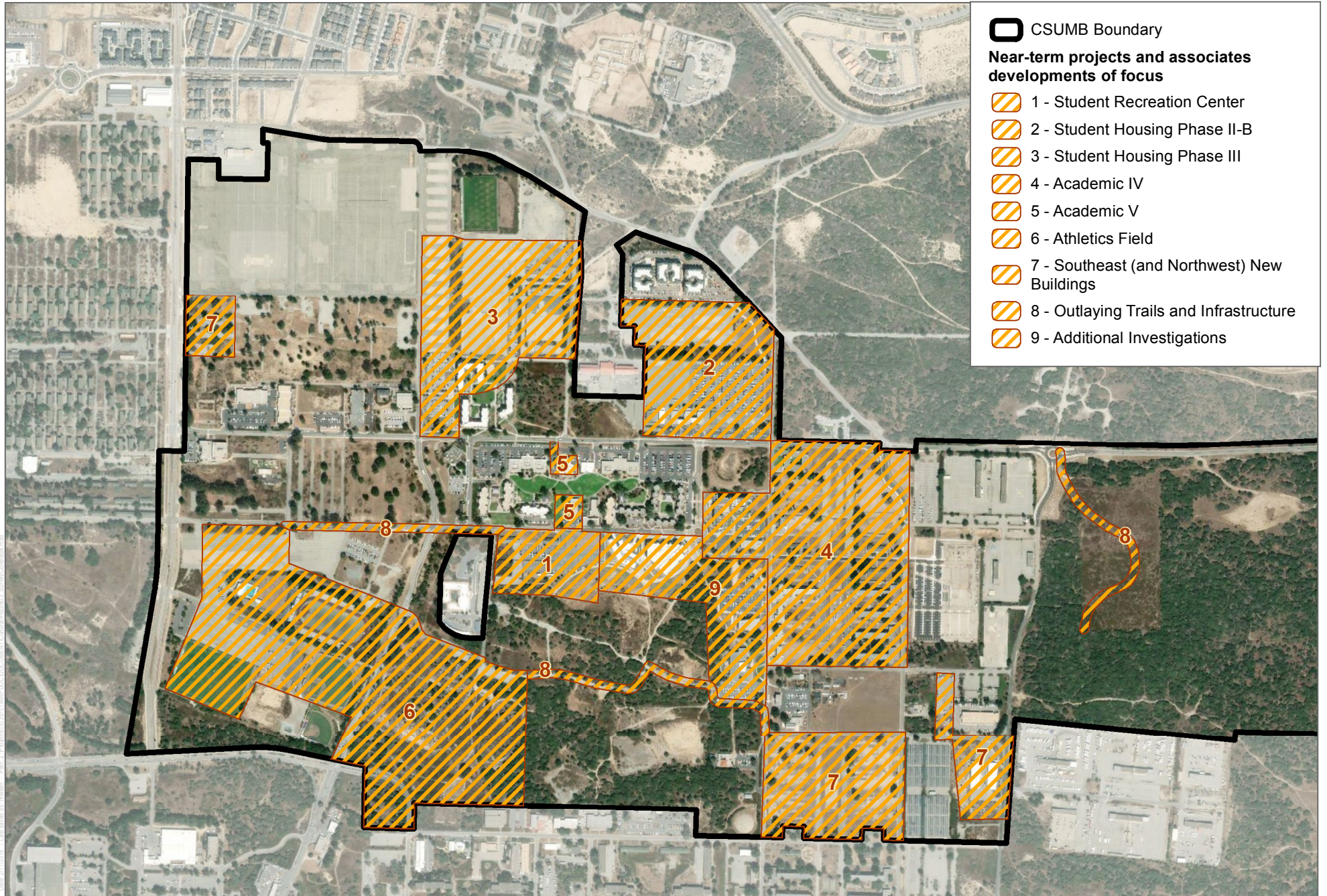

SOURCE: Bing Maps 2019

**FIGURE 3**  
**Cultural Survey Coverage**  
 Cultural Resource Inventory for the CSU Monterey Bay Master Plan EIR



***Attachment 1***  
***National Archaeological Database Information***



# NATIONAL ARCHAEOLOGICAL DATABASE (NADB) INFORMATION

**Authors:** Ryan Brady, MA, RPA and Sarah Brewer, BA

**Firm:** Dudek

**Project Proponent:** California State University Monterey Bay

**Report Date:** January 2019

**Report Title:** Cultural Resource Inventory for the CSU Monterey Bay EIR Master Plan Project, Monterey County, California

**Type of Study:** Archaeological Inventory

**Resources:** P-27-000385

**USGS Quads:** Marina, CA 1:24,000 Salinas, CA 1:24,000; T14S, 15S; R2E, 1E

**Acreage:** 1,396 acres

**Permit Numbers:** Permit Pending

**Keywords:** CSU Monterey Bay, Fort Ord, Marina,





***Attachment 2***  
***NWIC Records Search Results (Confidential)***



***Attachment 3***  
***Native American Heritage Commission Sacred  
Lands File Search (Confidential)***



***Attachment 4***  
***Record of AB 52 Consultation***  
***(Confidential)***

# **APPENDIX F2**

## **Built Environment Inventory and Evaluation Report**

INTENTIONALLY LEFT BLANK

# Built Environment Inventory and Evaluation Report for The California State University, Monterey Bay Master Plan

*Prepared for:*

**California State University, Monterey Bay**

100 Campus Center

Seaside, California 93955

*Contact: Anya Spear, LEED BD+C, AICP*

*Associate Director of Regional Environmental Planning*

*Prepared by:*

*Sarah Corder, MFA; Adrienne Donovan Boyd, MSHP; and Laura Carias, MA*

**DUDEK**

725 Front Street, Suite 400

Santa Cruz, California 95060

SEPTEMBER 2021





# Table of Contents

---

| <b><u>SECTION</u></b>   | <b><u>PAGE NO.</u></b> |
|---|------------------------|
| <b>EXECUTIVE SUMMARY .....</b>  | <b>V</b>               |
| <b>1 INTRODUCTION .....</b>   | <b>1</b>               |
| 1.1 Project Location and Setting.....   | 1                      |
| 1.2 Project Description .....   | 1                      |
| 1.3 Project Team.....   | 5                      |
| 1.4 Regulatory Setting .....  | 11                     |
| 1.5 Master Plan Study Area and Areas of Direct Impact for Built Environment Resources .....             | 18                     |
| <b>2 METHODS .....</b>  | <b>19</b>              |
| 2.1 Records Search and Other Sources .....  | 19                     |
| 2.1.1 California Historical Resource Information System Record Search .....                             | 19                     |
| 2.1.2 Built Environment Resource Database Search.....   | 24                     |
| 2.1.3 Additional Studies.....   | 24                     |
| 2.2 Building Development and Archival Research.....   | 26                     |
| 2.3 Built Environment Field Methods .....   | 27                     |
| <b>3 HISTORIC CONTEXT.....</b>  | <b>29</b>              |
| 3.1 Historical Overview of Monterey County .....  | 29                     |
| 3.2 Historical Overview of Marina .....   | 30                     |
| 3.3 Historical Overview of Seaside .....  | 31                     |
| 3.4 Historical Overview of Fort Ord .....   | 32                     |
| 3.4.1 Camp Gigling to Camp Ord (1917-1940).....   | 32                     |
| 3.4.2 Fort Ord and the 7th Infantry Division (1940-1945).....   | 34                     |
| 3.4.3 Cold War and Vietnam Eras at Fort Ord (1946-1976).....  | 35                     |
| 3.4.4 Built Environment ADI Buildings Constructed During the Cold War and Vietnam Era (1946-1976) ..... | 38                     |
| 3.4.5 The Volunteer Army - and the Base Realignment and Closure (BRAC) (1974-1994) .....                | 49                     |
| 3.5 Notable Fort Ord Architects and Builders .....  | 53                     |
| 3.5.1 Del E. Webb Construction Company .....  | 53                     |
| 3.5.2 Milton T. Pflueger.....   | 53                     |
| 3.5.3 Robert Stanton.....   | 54                     |
| 3.6 Notable Fort Ord Military Personnel .....   | 54                     |
| 3.6.1 General Joseph “Vinegar Joe” Stilwell.....  | 54                     |
| 3.6.2 Lt. James (Jim) E. Moore .....  | 55                     |
| 3.7 Fort Ord Building Typology and Character-Defining Features.....                                     | 55                     |
| 3.7.1 Support Services Buildings .....  | 55                     |
| 3.7.2 Medical Buildings.....  | 57                     |

|          |   |           |
|----------|---|-----------|
| 3.7.3    | Hammerhead Buildings/Barracks .....                                     | 59        |
| 3.7.4    | Recreational Facilities .....   | 60        |
| 3.8      | Historical Overview California State University Monterey Bay .....      | 62        |
| 3.8.1    | Higher Public Education in California .....                             | 62        |
| 3.8.2    | Historical Overview of CSUMB (1991-present) .....                       | 63        |
| <b>4</b> | <b>RESULTS OF IDENTIFICATION EFFORTS AND BUILDING DESCRIPTIONS.....</b> | <b>67</b> |
| <b>5</b> | <b>SIGNIFICANCE EVALUATION FINDINGS .....</b>                           | <b>75</b> |
| <b>6</b> | <b>SUMMARY OF FINDINGS AND MANAGEMENT RECOMMENDATIONS .....</b>         | <b>79</b> |
| 6.1      | Summary of Findings .....   | 79        |
| <b>7</b> | <b>REFERENCES .....</b>   | <b>81</b> |

## APPENDICES

- A Preparer’s Qualifications
- B DPR Forms

## FIGURES

|           |   |    |
|-----------|---|----|
| <b>1</b>  | Project Location.....   | 7  |
| <b>2</b>  | Built Environment Study Area.....   | 9  |
| <b>3</b>  | Impermanent, temporary tents and buildings at Fort Ord c. 1939 (CSUMB 2021: Image 121). .....   | 33 |
| <b>4</b>  | Fort Ord picture showing semi-permanent buildings and tents, 1940 (CSUMB 2021: Image 131). .....  | 34 |
| <b>5</b>  | Fort Ord, after construction of main garrison and infrastructure, such as roads, date unknown (DLIFLC 2021). .....  | 35 |
| <b>6</b>  | Fort Ord, Specialist 4, Abil Abdallah Mughannam at the new Fort Ord barracks in November of 1960 (DLIFLC 2021). .....   | 37 |
| <b>7</b>  | Fort Ord base, aerial image showing the completed barracks, c. 1970. The barracks are described as “Old Permanent Barracks, looking south” (DLIFLC 2021). .....                                 | 38 |
| <b>8</b>  | Fort Ord 1953 architectural drawing of the Permanent Troop Spaces and Supporting Facilities Classrooms (Buildings 21, 23, 58, 59) (CSUMB Facilities 2021). .....                                | 40 |
| <b>9</b>  | Fort Ord 1995 architectural drawing of changes made to some of the buildings that used the Permanent Troop Spaces and Supporting Facilities Classroom building plan (CSUMB Facilities 2021). .. | 40 |
| <b>10</b> | Fort Ord 1963 architectural drawing of the Science Research Lab Annex (Building 13) (CSUMB Facilities 2021). .....  | 42 |
| <b>11</b> | Photograph (c. 1990) of the Science Research Lab Annex (Building 13) after its conversion to the Stone Army Dental Clinic (DLIFLC 2021). .....  | 42 |
| <b>12</b> | Fort Ord 1956 architectural drawing of the Watershed Institute (Building 42) (front elevation) (CSUMB Facilities 2021). .....   | 43 |
| <b>13</b> | Fort Ord 1956 architectural drawing of the Watershed Institute (Building 42) (rear elevation) (CSUMB Facilities 2021). .....  | 43 |

|    |  |    |
|----|--|----|
| 14 | Fort Ord, after construction of new barracks between 1952 and 1954 (The Webb Spinner 1952-54, Vol 8. No. 5:6).....   | 44 |
| 15 | Fort Ord 1952 Conceptual drawing of the new barracks at Fort Ord (The Web Spinner 1952-54, Vol 6. No. 3:1).....  | 45 |
| 16 | Fort Ord architectural site plan of the Hammerhead Buildings/Barracks (CSUMB Facilities 2021).....   | 45 |
| 17 | Fort Ord 1951 conceptual drawing of the Stadium (CSUMB Facilities 2021). ....  | 48 |
| 18 | Fort Ord 1949 architectural drawing the Field House (CSUMB Facilities 2021). ....  | 48 |
| 19 | 1987 Aerial showing the current main campus boundary with intact Fort Ord buildings .....  | 51 |
| 20 | 2021 Aerial showing the current main campus boundary with areas of extensive demolition of Fort Ord buildings and significant changes in paths of circulation..... | 51 |
| 21 | Building 58, Green Hall, View facing southeast at the north elevation (IMG_0566).....  | 56 |
| 22 | Building 13, the Science Research Lab Annex, View facing northwest at the south elevation (IMG_0715). ....   | 57 |
| 23 | Building 44, Pacific Hall, View facing east at the west elevation (IMG_0602). ....   | 59 |
| 24 | Building 902, Freeman Stadium, View facing northeast at the west elevation (IMG_0431).....   | 61 |

**TABLES**

|    |   |    |
|----|---|----|
| 1  | Proposed Master Plan Development .....                                    | 2  |
| 2  | Proposed Master Plan Building Removal.....                                | 4  |
| 3  | Previously Conducted Technical Studies.....                               | 19 |
| 4  | Previously Recorded Built Environment Resources .....                     | 23 |
| 5  | Character-Defining Features: Fort Ord Support Services Buildings.....     | 56 |
| 6  | Character-Defining Features: Fort Ord Medical Buildings .....             | 58 |
| 7  | Character-Defining Features: The Hammerhead Buildings/Barracks .....      | 59 |
| 8  | Character-defining features: Fort Ord Recreational Facilities .....       | 61 |
| 9  | Properties Surveyed .....   | 69 |
| 10 | Individual Significance Findings for CSUMB Buildings within the ADI ..... | 76 |

INTENTIONALLY LEFT BLANK

# Executive Summary

---

As part of cultural resources investigations for the CSUMB Master Plan Environmental Impact Report (EIR), Dudek was retained by California State University, Monterey Bay (CSUMB) to conduct a built environment inventory and evaluation study.

This built environment inventory and evaluation report included a records search of the campus and a one-mile radius around its boundary; an intensive level survey of the campus; archival and building development research for buildings located within the campus boundaries; evaluation of buildings for the National Register of Historic Places (NRHP), California Register of Historical Resources (CRHR), California Historical Landmark (CHL), and local eligibility criteria and integrity requirements; and an assessment of impacts to historical resources in compliance with the California Environmental Quality Act (CEQA) and Public Resources Code (PRC) Sections 5024 and 5024.5 for state-owned resources.

In order to identify potential built environment historical resources that may sustain significant impacts through implementation of the CSUMB Master Plan (Project), a California Historical Resource Information System (CHRIS) record search of the campus and buffer was completed by the Northwest Information Center (NWIC) at Sonoma State University on August 27, 2017. The 2017 records search included a review of the following: Archaeological and non-archaeological resource records and reports on file at NWIC; Office of Historic Preservation (OHP) Historic Properties Directory; OHP Archaeological Determinations of Eligibility; California Inventory of Historical Resources (1976); Historical Maps; Local Inventories; and General Land Office (GLO) and/or rancho Plat Maps.

In addition, all 11 properties located within the CSUMB campus Areas of Direct Impact for Built Environment Resources (ADI) that were constructed at least 45 years ago as of 2021 (i.e., on or before 1976) and proposed for demolition or substantial alteration as part of the Project were photographed, researched, and evaluated in consideration of NRHP, CRHR, CHL, and local designation criteria and integrity requirements, and in consideration of potential impacts to historical resources under CEQA and PRC Sections 5024 and 5024.5.

Dudek formally recorded and evaluated 11 properties over 45 years old located within the ADI proposed for renovation, alteration, or demolition as part of the Project. All 11 of these built environment properties were identified as not eligible for national, state, or local designation. Consequently, all 11 built environment properties evaluated for the purposes of the Project are not considered historical resources under CEQA.

INTENTIONALLY LEFT BLANK

# 1 Introduction

---

Dudek was retained by California State University, Monterey Bay (CSUMB) to conduct a built environment inventory and evaluation study and report for the proposed CSUMB Master Plan (Project) (Figure 1). Only buildings and structures (properties) over 45 years old and proposed for renovation or demolition as part the proposed Project were included in the historic built environment study of the CSUMB campus (campus). This report includes the following components: (1) a California Historical Resources Information System (CHRIS) records search covering the campus and a one-mile radius around its boundary; (2) results of an intensive-level survey of the campus for built environment resources; (3) archival and building development research for properties located within the campus boundaries; (4) the evaluation of properties for the National Register of Historic Places (NRHP); California Register of Historical Resources (CRHR), California Historical Landmark (CHL), and local eligibility criteria and integrity requirements; and (5) consideration of impacts to cultural resources in compliance with the California Environmental Quality Act (CEQA) and Public Resources Code (PRC) Sections 5024 and 5024.5 for state-owned resources. This chapter provides an overview of the Project, qualifications of Dudek staff that prepared this report, regulatory setting, and a description of the Built Environment Study Area (Figure 2).

## 1.1 Project Location and Setting

The campus is located approximately 100 miles south of San Francisco, in Seaside, California, north of the Monterey Peninsula, and near the southern-central portion of Monterey Bay. The campus covers 1,396 acres, which were historically part of the northwestern portion of the U.S. Department of Army Fort Ord Military Reservation (Figure 1). The campus lies within three separate governmental jurisdictions: The City of Marina, the City of Seaside, and unincorporated Monterey County. Primary access to the campus is available from Highway 1, via the main entrance at Lightfighter Drive to the south and from Imjin Parkway to the north. Access is also provided via Second Avenue from the north, General Jim Moore Boulevard from the south, and Inter-Garrison Road and Divarty Street from the east. Inter-Garrison Road connects the East Campus Housing area to the Main Campus.

## 1.2 Project Description

The Project is the proposed California State University, Monterey Bay (CSUMB) Master Plan (proposed Master Plan), including Project Design Features (PDFs) drawn from the CSUMB Master Plan Guidelines (Master Plan Guidelines), and five “near-term” development components to be constructed pursuant to the proposed Master Plan within the next 10 years (collectively, the Project). The Project would provide the basis for the physical development of the CSUMB campus consistent with the vision identified in the Master Plan Guidelines and the mission of the University.

The Project would provide a blueprint for land uses and building and facility space requirements to support an on-campus enrollment of 12,700 full-time-equivalent students (FTES<sup>1</sup>) and 1,776 FTE faculty and staff by the year 2035. Achieving this growth would result in an increase of approximately 6,066 FTES and 752 FTE faculty/staff over existing levels (academic year 2016-2017).

---

<sup>1</sup> Full-time equivalent student (FTES) is the unit of measurement used to convert class load to student enrollment. At CSUMB, one FTES is equal to 15 units. Thus, one FTES is equal to one student enrolled in 15 units or three students each enrolled in 5 units. A related unit of measurement is “headcount.” In the case of one student taking 15 units, the headcount is 1; in the case of three students collectively taking 15 units, the headcount is 3.



The Project also would result in approximately 2.9 million gross square feet (GSF) of total new academic, administration, student life, athletic and recreational, and institutional partnership<sup>2</sup> facilities, and housing development and a net increase of approximately 2.6 million GSF, when considering the demolition of existing buildings (see Table 1). Some of the future building development would include demolition of existing buildings that are currently being used for academic and/or student purposes. The proposed Master Plan anticipates that up to 24 buildings, totaling approximately 256,400 GSF, would be demolished as part of the construction of new buildings (see Table 2).

On-campus housing would be constructed sufficient to continue to accommodate 60 percent of FTES and existing housing would accommodate 65 percent of FTE faculty and staff, with a projected increase of 3,820 student beds and 757 converted residential units for faculty and staff. The Project also would accommodate redevelopment and growth in outdoor athletics and recreation facilities to serve campus needs, with space set aside for additional athletic fields, tennis courts, and pools, as well as for replacement of the existing stadium, field house, and pool house. A stadium and field house renovation project is the subject of separate CEQA review underway in 2021.

As noted above, the Project includes specific development components identified in the proposed Master Plan and expected to be constructed in the next 10 years; these Project components are referred to throughout this EIR as “near-term development components.” These near-term development components include: 1) Student Housing Phase III (600 student housing beds); 2) Academic IV (95,000 GSF of classroom/instructional space); 3) Student Recreation Center (70,000 GSF of recreation space); 4) Student Housing Phase IIB (400 student housing beds); and 5) Academic V (76,700 GSF of classroom/instructional space).

**Table 1. Proposed Master Plan Development**

| Campus Space   | Beds/Units                      | GSF <sup>1</sup> | Implementation |            |
|--|---------------------------------|------------------|----------------|------------|
|  |                                 |                  | Horizon I      | Horizon II |
| <b>EXISTING SPACE (2016-2017)</b>  |                                 |                  |                |            |
| Main Campus Facilities (Non-Residential) <sup>2</sup>                          | —                               | 1,142,777        | NA             |            |
| Student Housing Main Campus  | 2,600 beds                      | 1,171,264        | NA             |            |
| Student Housing East Campus Housing <sup>3</sup>                               | 1,380 beds / 466 units          |                  |                |            |
| Faculty, Staff & Community Partners Housing (East Campus Housing) <sup>4</sup> | 754 units                       | 876,515          | NA             |            |
| <b>Total Existing Space</b>  | <b>3,980 beds / 1,220 units</b> | <b>3,190,556</b> | NA             |            |
| <b>APPROVED BUT NOT YET CONSTRUCTED PROJECT</b>                                |                                 |                  |                |            |
| Monterey Bay Charter School  | —                               | 60,000           | ✓              |            |
| <b>Total Pending or Approved Space</b>   | —                               | <b>60,000</b>    | ✓              |            |
| <b>MASTER PLAN - NEW DEVELOPMENT<sup>5</sup></b>                               |                                 |                  |                |            |
| Academic Space   |                                 | 403,160          |                |            |
| • Academic IV  | —                               | 95,000           | ✓              |            |
| • Academic V   |                                 | 76,704           | ✓              |            |
| • Academic VI  |                                 | 76,704           |                | ✓          |

<sup>2</sup> Institutional Partnerships are projects involving public-public or public-private partnerships and long-term contractual relationships that use or develop CSU real property to further the educational mission of the campus.

**Table 1. Proposed Master Plan Development**

| Campus Space   | Beds/Units                      | GSF1             | Implementation |            |
|--|---------------------------------|------------------|----------------|------------|
|  |                                 |                  | Horizon I      | Horizon II |
| <ul style="list-style-type: none"> <li>Academic VII</li> <li>Academic VIII</li> <li>Greenhouses</li> </ul> |                                 | 76,704           |                | ✓          |
|  |                                 | 76,704           |                | ✓          |
|  |                                 | 1,344            | ✓              |            |
| Institutional Partnerships - Panetta Institute   | —                               | 64,000           | ✓              |            |
| Administration Buildings   | —                               | 77,454           | ✓              |            |
| “Student Life” Buildings   |                                 | 270,764          |                |            |
| <ul style="list-style-type: none"> <li>Childcare Center</li> </ul>   |                                 | 23,000           | ✓              |            |
| <ul style="list-style-type: none"> <li>Student Life Space (Phase I and II)<sup>6</sup></li> </ul>          | —                               | 145,473          | ✓              |            |
| <ul style="list-style-type: none"> <li>Campus Arts &amp; Auditorium</li> </ul>                             |                                 | 82,291           |                | ✓          |
| <ul style="list-style-type: none"> <li>Student Union Phase II</li> </ul>                                   |                                 | 20,000           |                | ✓          |
| Indoor Recreation Buildings and Facilities   |                                 | 165,343          |                |            |
| <ul style="list-style-type: none"> <li>Recreation Center (Phase I and II)</li> </ul>                       | —                               | 70,000           | ✓              |            |
| <ul style="list-style-type: none"> <li>Recreation Center Addition (Phase III)</li> </ul>                   |                                 | 64,574           |                | ✓          |
| <ul style="list-style-type: none"> <li>Wellness Center</li> </ul>  |                                 | 30,769           | ✓              |            |
| Outdoor Athletics & Recreation Support Buildings   | —                               | 59,679           |                |            |
| <ul style="list-style-type: none"> <li>Stadium House</li> </ul>  |                                 | 40,177           | ✓              |            |
| <ul style="list-style-type: none"> <li>Otter Retail Space</li> </ul>                                       |                                 | 10,502           | ✓              |            |
| <ul style="list-style-type: none"> <li>Aquatics Center</li> </ul>  | —                               | 7,000            |                | ✓          |
| <ul style="list-style-type: none"> <li>Field House</li> </ul>  |                                 | 2,000            | ✓              |            |
| Facilities Building  |                                 | 73,590           |                |            |
| <ul style="list-style-type: none"> <li>Facilities Building</li> </ul>                                      | —                               | 23,590           | ✓              |            |
| <ul style="list-style-type: none"> <li>Facilities Storage Buildings</li> </ul>                             |                                 | 50,000           | ✓              |            |
| Housing  | 3,820 beds / 757 units          | 1,760,000        |                |            |
| <ul style="list-style-type: none"> <li>East Campus Housing Conversion<sup>7</sup></li> </ul>               | -1,380 beds / 757 units         | NA               | ✓              |            |
| <ul style="list-style-type: none"> <li>Student Housing Phase IIB</li> </ul>                                | 400 beds                        | 160,000          | ✓              |            |
| <ul style="list-style-type: none"> <li>Student Housing Phase III</li> </ul>                                | 600 beds                        | 200,000          | ✓              |            |
| <ul style="list-style-type: none"> <li>Student Housing Phase IV</li> </ul>                                 | 600 beds                        | 200,000          | ✓              |            |
| <ul style="list-style-type: none"> <li>Student Housing Phase V</li> </ul>                                  | 600 beds                        | 200,000          | ✓              |            |
| <ul style="list-style-type: none"> <li>Student Housing Phase VI</li> </ul>                                 | 600 beds                        | 200,000          | ✓              |            |
| <ul style="list-style-type: none"> <li>Student Housing Phase VII</li> </ul>                                | 600 beds                        | 200,000          |                | ✓          |
| <ul style="list-style-type: none"> <li>Student Housing Phase VIII</li> </ul>                               | 600 beds                        | 200,000          |                | ✓          |
| <ul style="list-style-type: none"> <li>Student Housing Phase IX</li> </ul>                                 | 600 beds                        | 200,000          |                | ✓          |
| <ul style="list-style-type: none"> <li>Student Housing Phase X</li> </ul>                                  | 600 beds                        | 200,000          |                | ✓          |
| <b>Total New Space with Master Plan<sup>7</sup></b>  | <b>3,820 beds / 757 units</b>   | <b>2,873,990</b> |                | NA         |
| <b>Existing Building</b>   | <b>3,980 beds / 1,220 units</b> | <b>3,190,556</b> |                | NA         |
| <b>Approved and Pending Building Projects</b>  | NA                              | <b>60,000</b>    |                | NA         |

**Table 1. Proposed Master Plan Development**

| Campus Space   | Beds/Units                  | GSF1      | Implementation |            |
|--|-----------------------------|-----------|----------------|------------|
|  |                             |           | Horizon I      | Horizon II |
| Total New Building Space with Master Plan <sup>7</sup>       | 3,820 beds / 757units       | 2,873,990 | NA             |            |
| Total Building Space to be Demolished                        | NA                          | -256,366  | NA             |            |
| Net Increase in Building Space with Master Plan <sup>6</sup> | 3,820 beds / 757 units      | 2,617,624 | NA             |            |
| Total Future Building Space                                  | 7,800 Beds /<br>1,220 Units | 5,868,180 | Na             |            |

**Notes:**

1. GSF = gross square feet
2. Excludes existing baseball, softball, soccer and recreation fields and stadiums seating = 596,375 GSF.
3. Of the 466 units in East Campus Housing (Frederick Park I & II) for student housing, 460 units currently house 1,380 student beds and the remaining 6 units are used for offices.
4. Of the 754 units in East Campus Housing (Schoonover Park I & II) for faculty, staff, and Community Housing Partners, 676 units are currently rented or owned.
5. New Master Plan development does not include development on the faculty and staff housing reserve site or the potential athletics expansion area, as development in these areas is not part of the Project. Likewise, Institutional Partnership development beyond the Panetta Institute and the Monterey Bay Charter School is also not part of the Project.
6. To support mixed use development, Student Life space will be allocated within future buildings, as needed.
7. The 757 units for faculty and staff housing would be provided by reallocating and converting existing student housing to faculty and staff housing units and by converting units that are currently not rentable and units occupied by Community Housing Partners. No new faculty and staff housing units would be constructed under the proposed Master Plan.

**Table 2. Proposed Master Plan Building Removal**

| Building # | Building Name                                       | Square Footage (GSF) |
|------------|---|----------------------|
| 1          | Administration                                      | 5,820                |
| 2          | Playa Hall  | 5,829                |
| 3          | Del Mar Hall  | 5,820                |
| 13         | Science Research Lab Annex                          | 12,743               |
| 14         | Otter Express                                       | 7,191                |
| 16         | Dining Commons                                      | 14,080               |
| 21         | Beach Hall  | 5,627                |
| 23         | Tide Hall   | 5,627                |
| 42         | Watershed Institute                                 | 3,772                |
| 44         | Pacific Hall  | 5,000                |
| 45         | Coast Hall  | 5,000                |
| 46         | Harbor Hall   | 5,000                |
| 58         | Green Hall  | 5,627                |
| 59         | Reading Center                                      | 5,627                |
| 70         | Visual & Public Arts - Far East (Potential Removal) | 4,816                |
| 87         | Panetta Institute Storage                           | 2,695                |
| 95         | Soccer Field Restrooms                              | 525                  |
| 100        | Aquatics Center Pump House                          | 1,322                |
| 902        | Field House   | 5,250                |
| 903        | Stadium Track and Field                             | 137,400              |
| 903A       | Stadium Seats North                                 | 5,364                |
| 903B       | Stadium Seats South                                 | 5,364                |
| 903C       | Field Electrical                                    | 150                  |

**Table 2. Proposed Master Plan Building Removal**

| <b>Building #</b>                 | <b>Building Name</b> | <b>Square Footage (GSF)</b> |
|-----------------------------------|----------------------|-----------------------------|
| 904                               | Field Office         | 385                         |
| <b>Total Gross Square Footage</b> |                      | <b>256,366</b>              |

## 1.3 Project Team

The Dudek project team responsible for this report include Historic Built Environment Lead and Task Manager Sarah Corder, MFA, and Dudek Architectural Historians Adrienne Donovan-Boyd, MSHP, and Laura G. Carias, MA. The report was reviewed for quality assurance/quality control by Dudek Senior Architectural Historians Allison Lyons, MSHP, and Kathryn Haley, MA. All authors and reviewers meet the Secretary of the Interior’s Professional Qualification Standards (36 CFR Part 61) for architectural history. Preparer’s qualifications are located in Appendix A.

INTENTIONALLY LEFT BLANK

Figure 1. Project Location

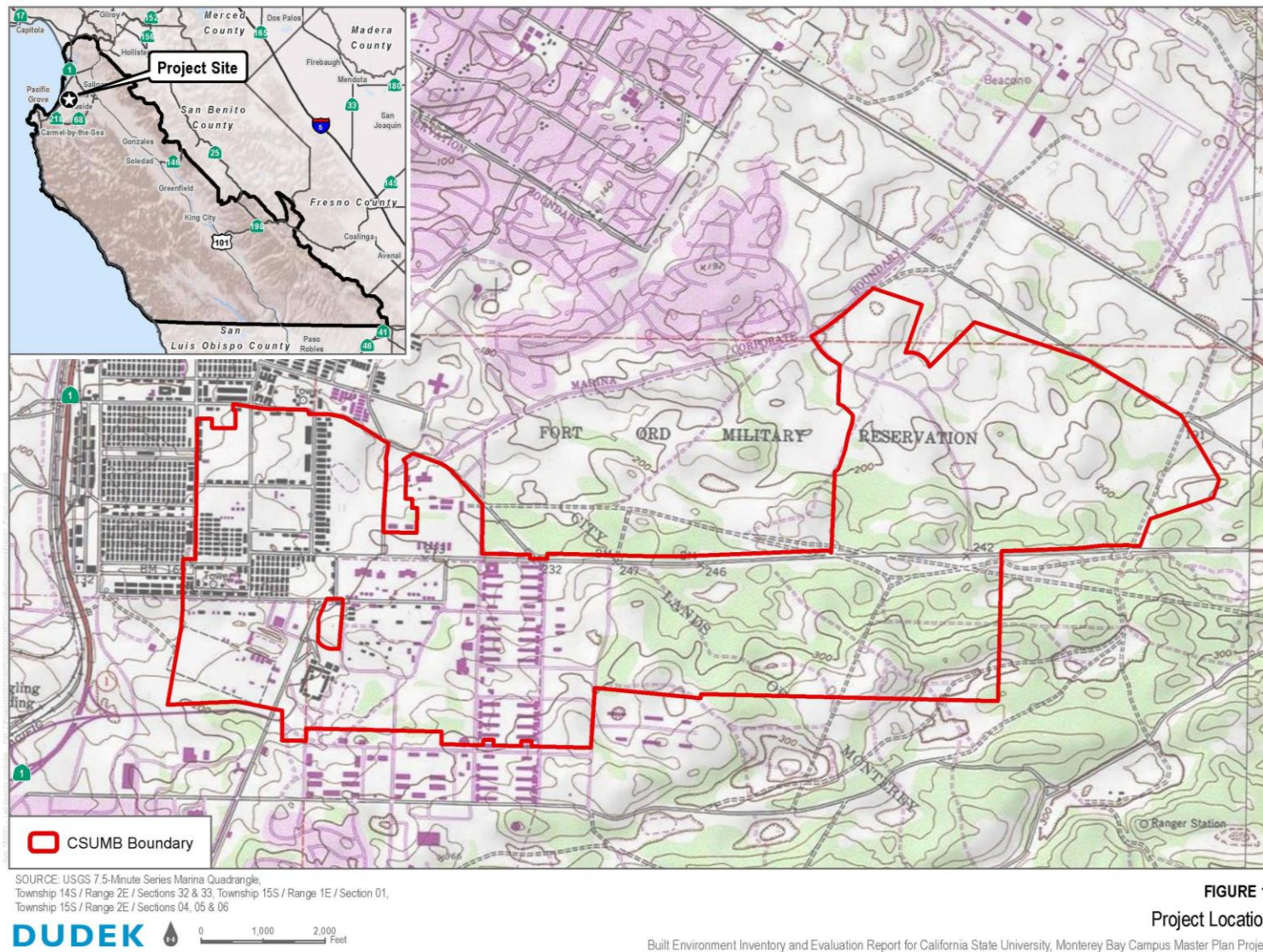

INTENTIONALLY LEFT BLANK

BUILT ENVIRONMENT INVENTORY AND EVALUATION REPORT FOR CALIFORNIA STATE UNIVERSITY,  
 MONTEREY BAY MASTER PLAN

Figure 2. Built Environment Study Area



SOURCE: Bing Vise 2021



FIGURE 2

Built Environment Study Area

Built Environment Inventory and Evaluation Report for California State University, Monterey Bay Campus Master Plan Project



INTENTIONALLY LEFT BLANK

## 1.4 Regulatory Setting

### Federal

#### *National Register of Historic Places*

Although there is no federal nexus for this project, the subject properties were evaluated in consideration of the NRHP designation criteria and integrity requirements to comply with Public Resources Code (PRC) Sections 5024 and 5024.5. The NRHP is the United States' official list of districts, sites, buildings, structures, and objects worthy of preservation. Overseen by the National Park Service under the U.S. Department of the Interior, the NRHP was authorized under the National Historic Preservation Act, as amended. Its listings encompass all National Historic Landmarks, as well as historic areas administered by the National Park Service.

NRHP guidelines for the evaluation of historic significance were developed to be flexible and to recognize the accomplishments of all who have made significant contributions to the nation's history and heritage. Its criteria are designed to guide state and local governments, federal agencies, and others in evaluating potential entries in the NRHP. For a property to be listed in or determined eligible for listing, it must be demonstrated to possess integrity and to meet at least one of the following criteria:

The quality of significance in American history, architecture, archaeology, engineering, and culture is present in districts, sites, buildings, structures, and objects that possess integrity of location, design, setting, materials, workmanship, feeling, and association, and:

- A. That are associated with events that have made a significant contribution to the broad patterns of our history; or
- B. That are associated with the lives of persons significant in our past; or
- C. That embody the distinctive characteristics of a type, period, or method of construction, or that represent the work of a master, or that possess high artistic values, or that represent a significant and distinguishable entity whose components may lack individual distinction; or
- D. That have yielded, or may be likely to yield, information important in prehistory or history.

Integrity is defined in NRHP guidance, "How to Apply the National Register Criteria," as "the ability of a property to convey its significance. To be listed in the NRHP, a property must not only be shown to be significant under the NRHP criteria, but it also must have integrity" (NPS 1995). NRHP guidance further asserts that properties be completed at least 50 years ago to be considered for eligibility. Properties completed fewer than 50 years before evaluation must be proven to be "exceptionally important" (criteria consideration to be considered for listing).

### State

Public Resources Code Sections 5024 and 5024.5

PRC Sections 5024 and 5024.5 provide the following guidance:

- 5024 (a-h): Describes the process of inventorying and evaluating state-owned historical resources in consultation with the State Historic Preservation Officer (SHPO).
- 5024.5 (a-g): Describes the process of identifying adverse effects and development of alternatives and mitigation for state-owned historical resources in consultation with, and as determined by, the SHPO.

### *Review of Projects Affecting State-Owned Historical Resources*

Under PRC Sections 5024(f) and 5024.5, state agencies must provide notification and submit documentation to the SHPO early in the planning process for any project having the potential to affect state-owned historical resources on or eligible for inclusion in the Master List (buildings, structures, landscapes, archaeological sites, and other nonstructural resources). Under PRC Section 5024(f), state agencies request the SHPO's comments on the project.

Under PRC Section 5024.5, it is the SHPO's responsibility to comment on the project and to determine if it may cause an adverse effect (PRC Section 5024.5), defined as a substantial adverse change in the significance of a historical resource (PRC Section 5020.1(q)). In this case, historical resources are defined as resources eligible for or listed in the NRHP and/or resources registered for or eligible for registering as a CHL.

### **California Historical Landmarks**

CHLs are buildings, structures, sites, or places that have been determined to have statewide historical significance by meeting at least one of the criteria listed below (OHP 2019).

- The first, last, only, or most significant of its type in the state or within a large geographic region (Northern, Central, or Southern California).
- Associated with an individual or group having a profound influence on the history of California.
- A prototype of, or an outstanding example of, a period, style, architectural movement or construction or is one of the more notable works or the best surviving work in a region of a pioneer architect, designer or master builder.

The resource also must have written consent of the property owner, be recommended by the State Historical Resources Commission, and be officially designated by the Director of California State Parks. CHLs #770 and above are automatically listed in the CRHR (OHP 2019).

### **California Register of Historical Resources**

In California, the term "historical resource" includes but is not limited to "any object, building, structure, site, area, place, record, or manuscript which is historically or archaeologically significant, or is significant in the architectural, engineering, scientific, economic, agricultural, educational, social, political, military, or cultural annals of California" (California Public Resources Code Section 5020.1(j)). In 1992, the California legislature established the California Register of Historical Resources (CRHR) "to be used by state and local agencies, private groups, and citizens to identify the state's historical resources and to indicate what properties are to be protected, to the extent prudent and feasible, from substantial adverse change" (California Public Resources Code Section 5024.1(a)). The criteria for listing resources on the CRHR were expressly developed to be in accordance with previously established criteria developed for listing in the NRHP, enumerated below. According to California Public Resources Code Section 5024.1(c)(1-4), a resource is considered historically significant if it (i) retains "substantial integrity," and (ii) meets at least one of the following criteria:

1. Is associated with events that have made a significant contribution to the broad patterns of California's history and cultural heritage.
2. Is associated with the lives of persons important in our past.

3. Embodies the distinctive characteristics of a type, period, region, or method of construction, or represents the work of an important creative individual, or possesses high artistic values.
4. Has yielded, or may be likely to yield, information important in prehistory or history.

In order to understand the historic importance of a resource, sufficient time must have passed to obtain a scholarly perspective on the events or individuals associated with the resource. A resource less than 50 years old may be considered for listing in the CRHR if it can be demonstrated that sufficient time has passed to understand its historical importance (see 14 CCR 4852(d)(2)).

The CRHR protects cultural resources by requiring evaluations of the significance of prehistoric and historic resources. The criteria for the CRHR are nearly identical to those for the NRHP, and properties listed or formally designated as eligible for listing in the NRHP are automatically listed in the CRHR, as are the state landmarks and points of interest. The CRHR also includes properties designated under local ordinances or identified through local historical resource surveys.

### **California Environmental Quality Act**

As described further below, the following CEQA statutes and CEQA Guidelines are of relevance to the analysis of archaeological, historic, and tribal cultural resources:

- California Public Resources Code Section 21083.2(g) defines “unique archaeological resource.”
- California Public Resources Code Section 21084.1 and CEQA Guidelines Section 15064.5(a) define “historical resources.” In addition, CEQA Guidelines Section 15064.5(b) defines the phrase “substantial adverse change in the significance of an historical resource.” It also defines the circumstances when a project would materially impair the significance of an historical resource.
- California Public Resources Code Section 21074(a) defines “tribal cultural resources.”
- California Public Resources Code Section 5097.98 and CEQA Guidelines Section 15064.5(e) set forth standards and steps to be employed following the accidental discovery of human remains in any location other than a dedicated ceremony.
- California Public Resources Code Sections 21083.2(b)-(c) and CEQA Guidelines Section 15126.4 provide information regarding the mitigation framework for archaeological and historic resources, including examples of preservation-in-place mitigation measures; preservation-in-place is the preferred manner of mitigating impacts to significant archaeological sites because it maintains the relationship between artifacts and the archaeological context and may also help avoid conflict with religious or cultural values of groups associated with the archaeological site(s).

More specifically, under CEQA, a project may have a significant effect on the environment if it may cause “a substantial adverse change in the significance of an historical resource” (California Public Resources Code Section 21084.1; CEQA Guidelines Section 15064.5(b).) If a site is either listed or eligible for listing in the CRHR, or if it is included in a local register of historic resources or identified as significant in a historical resources survey (meeting the requirements of California Public Resources Code Section 5024.1(q)), it is a “historical resource” and is presumed to be historically or culturally significant for purposes of CEQA (California Public Resources Code Section 21084.1; CEQA Guidelines Section 15064.5(a)). The lead agency is not precluded from determining that a resource is a historical resource even if it does not fall within this presumption (California Public Resources Code Section 21084.1; CEQA Guidelines Section 15064.5(a)).

A “substantial adverse change in the significance of an historical resource” reflecting a significant effect under CEQA means “physical demolition, destruction, relocation, or alteration of the resource or its immediate surroundings such that the significance of an historical resource would be materially impaired” (CEQA Guidelines Section 15064.5(b)(1); California Public Resources Code Section 5020.1(q)). In turn, CEQA Guidelines Section 15064.5(b)(2) states the significance of an historical resource is materially impaired when a project:

1. Demolishes or materially alters in an adverse manner those physical characteristics of an historical resource that convey its historical significance and that justify its inclusion in, or eligibility for, inclusion in the California Register of Historical Resources; or
5. Demolishes or materially alters in an adverse manner those physical characteristics that account for its inclusion in a local register of historical resources pursuant to Section 5020.1(k) of the Public Resources Code or its identification in an historical resources survey meeting the requirements of Section 5024.1(g) of the Public Resources Code, unless the public agency reviewing the effects of the project establishes by a preponderance of evidence that the resource is not historically or culturally significant; or
6. Demolishes or materially alters in an adverse manner those physical characteristics of a historical resource that convey its historical significance and that justify its eligibility for inclusion in the California Register of Historical Resources as determined by a lead agency for purposes of CEQA.

Pursuant to these sections, the CEQA inquiry begins with evaluating whether a project site contains any “historical resources,” then evaluates whether that project will cause a substantial adverse change in the significance of a historical resource such that the resource’s historical significance is materially impaired.

## **Local**

### ***County of Monterey***

#### ***Preservation of Historic Resources Code of the County of Monterey***

Chapter 18.25 of the Monterey County Code of ordinances enumerates the “protection, enhancement, perpetuation, and use of structures and districts of historic, archaeological, architectural, and engineering significance, located within the County (18.25.020 - Intent and Purpose).”

- 18.25.030 – Definitions:

"Cultural resource" means buildings, structures, signs, features, sites, places, areas, or other objects of scientific, aesthetic, educational, cultural, architectural, or historic significance to the residents of the County.”

“Historic district" means an area, which may include public rights-of-way, within the County having special historic and architectural worth and designated as such by the Board of Supervisors pursuant to the provisions of this Chapter. The area may predominantly, though not exclusively, contain historic resources.”

"Historic resource" means any structure, object, fence, site, or portion of a site which has a significant historic, archaeological, architectural, engineering or cultural value, real property or improvement thereon such as a structure, archaeological excavation, or object that is unique or significant because of its location, design, setting, materials, workmanship, or aesthetic feeling and is designated as such by the Board of Supervisors pursuant to the provisions of this Chapter.”

- 18.25.060 - Designation of historic resources and districts:
  - A. Designation of historic resources and districts may be initiated by the Board of Supervisors, the Planning Commission, the Review Board, the Secretary, or upon application of the owner of the property for which designation is requested, or the authorized representative of the owner. No property shall be designated pursuant to this Chapter without the consent of the property owner. Any such proposal shall be filed with the Secretary and may include the following information:
    1. Assessor's parcel number of site of the structure proposed for designation or legal description of the district proposed for designation;
    2. Description detailing the structure or district proposed for designation;
    3. Description of special aesthetic, cultural, architectural, or engineering qualities which justify such designation;
    4. Sketches, drawings, photographs, or other descriptive material;
    5. Statement of condition of structure or district;
    6. Statement of architectural and historic significance of the structure or district; and,
    7. Other information requested by the Secretary or the Historic Resources Review Board.
  - B. All applications by property owners for historical designation shall be filed with the Secretary on forms prescribed by the Secretary and shall be accompanied by all data required pursuant to Subsection A of this Section. Where such application is submitted for designation of an historic district, the application must be subscribed by, or on behalf of, a majority of the property owners in the proposed district.
  - C. No building, alteration, demolition, or removal permits for any improvement, building, or structure relative to any proposal for designation as an historical resource or within an area proposed for designation as an historical district shall be issued between the date on which the proposal was initiated and date the Board of Supervisors takes final action on such proposal, unless a permit pursuant to Chapter 18.26 has been secured.
- 18.25.070 - Review criteria.
  - A. Historical and Cultural Significance.
    1. The resource or district proposed for designation is particularly representative of a distinct historical period, type, style, region, or way of life.
    2. The resource or district proposed for designation is, or contains, a type of building or buildings which was once common but is now rare.
    3. The resource or district proposed for designation was connected with someone renowned.
    4. The resource or district proposed for designation is connected with a business or use which was once common but is now rare.
    5. The resource or district proposed for designation represents the work of a master builder, engineer, designer, artist, or architect whose talent influenced a particular architectural style or way of life.
    6. The resource or district proposed for designation is the site of an important historic event or is associated with events that have made a meaningful contribution to the nation, State, or community.

7. The resource or district proposed for designation has a high potential of yielding information of archaeological interest
- B. Historic, Architectural, and Engineering Significance.
1. The resource or district proposed for designation exemplifies a particular architectural style or way of life important to the County.
  2. The resource or district proposed for designation exemplifies the best remaining architectural type of a community.
  3. The construction materials or engineering methods used in the resource or district proposed for designation embody elements of outstanding attention to architectural or engineering design, detail, material, or craftsmanship.
- C. Community and Geographic Setting.
1. The proposed resource materially benefits the historic character of the community.
  2. The unique location or singular physical characteristic of the resource or district proposed for designation represents an established and familiar visual feature of the community, area, or county.
  3. The district is a geographically definable area, urban or rural possessing a significant concentration or continuity of site, buildings, structures, or objects unified by past events, or aesthetically by plan or physical development.
  4. The preservation of a resource or resources is essential to the integrity of the district.

### ***City of Marina***

This study was completed in consideration of all sections of the City of Marina municipal code related to historical resources.

#### 15.48.020 Definitions:

Historic structure” means any structure that is:

1. Listed individually in the National Register of Historic Places (a listing maintained by the Department of Interior) or preliminarily determined by the Secretary of the Interior as meeting the requirements for individual listing on the National Register;
2. Certified or preliminarily determined by the Secretary of the Interior as contributing to the historical significance of a registered historic district;
3. Individually listed on a state inventory of historic places in states with historic preservation programs which have been approved by the Secretary of Interior;
4. Individually listed on a local inventory of historic places in communities with historic preservation programs that have been certified either: (a) by an approved state program as determined by the Secretary of the Interior or (b) directly by the Secretary of the Interior in states with approved programs.

The city of Marina follows the guidelines set forth by the California Environmental Quality Act (CEQA) of 1970, for governmental agencies at all levels to develop standards and procedures necessary to protect environmental quality, and setting forth regulations for environmental impact reports (EIR).

### ***City of Seaside***

This study was completed in consideration of all sections of the City of Seaside, California - Code of Ordinances related to Historic Preservation (Chapter 17.68). The most recent version of this ordinance was adopted by the City in 2020. Sections most relevant to this study are enumerated in Sections A, B, and C in Chapter 17.68.030 Historic Landmark Designation. In addition, Dudek consulted the most current City of Seaside General Plan (completed in 2004) for additional historic preservation guidance. These sections are provided below.

#### ***17.68.030 Historic Landmark Designation***

The Council may designate an improvement, natural feature, or site as an historic landmark and any area within the City as an historic district in compliance with this section, based on the Council's evaluation of the age of the affected structures, distinguishing characteristics, distinct geographical area, familiar visual feature, significant achievement, and/or other distinctive feature.

- A. **Procedure.** The designation of an historic landmark or district, or the removal of the designation of an historic landmark or district, shall comply with the procedure established by this Zoning Ordinance for amendments in Chapter 17.74, including public notice and a hearing in compliance with state law, and a final decision by the Council.
- B. **Permit issuance during nomination process.** No permit for any improvement or structure within a proposed historic district or relative to a nominated historic landmark shall be issued while the nomination process is pending.
- C. **Placement on historic register.** The nominated district, site, or structure shall be placed on the City's historic register after being officially accepted by the Council, and the designation shall be recorded for each affected parcel in the office of the Monterey County recorder.

#### ***City of Seaside General Plan (2004)***

In addition, the City of Seaside General Plan's Historic Preservation Element contains the following goals and policies relating to cultural resources that are relevant and/or applicable to the Project:

**Historical Resources:** Historically significant sites are located within the community. Stilwell Hall and 35 other structures in the East Garrison area are the only properties in North Seaside that are eligible for the National Register of Historic Places. The City's approved Local Coastal Program Land Use Plan requires that design and architectural guidelines be prepared for buildings and related facilities constructed in the Coastal Zone. The City's goal is to identify all significant archaeological, architectural, and historic resources within Seaside and preserve them in accordance with the California Environmental Quality Act (CEQA) (City of Seaside 2004, p. COS-12)

**Goal COS-5.** Protect high sensitivity archaeological resources, architecturally significant buildings, and historic places (City of Seaside 2004, p. COS-26).

**Policy COS-5.1.** Identify and conserve archeological, architectural, and historic resources within Seaside (City of Seaside 2004, p. COS-26).



**Implementation Plan COS-5.1.1** Assess and Mitigate Impacts to Cultural Resources. Continue to assess development proposals for potential impacts to sensitive historic, archaeological, and paleontological resources pursuant to the California Environmental Quality Act (CEQA) (City of Seaside 2004, p. COS-26).

**Implementation Plan COS-5.1.1a.** For structures that potentially have historic significance, require that a study be conducted by a professional archaeologist or historian to determine the actual significance of the structure and potential impacts of the proposed development in accordance with CEQA Guidelines Section 15064.5. The City may require modification of the project and/or mitigation measures to avoid any impact to a historic structure, when feasible (City of Seaside 2004, p. COS-26).

## 1.5 Master Plan Study Area and Areas of Direct Impact for Built Environment Resources

The Study Area for built environment resources takes into account the boundary of the Master Plan area, which includes the campus. Since much of the proposed Master Plan consists of future projects that are still in early conceptual planning stages, the primary focus of this built environment technical study is on buildings or facilities that are 45 years or older that could be subject to demolition or substantial alteration under the Project.

### **Built Environment ADI-Study Area**

Figure 2 shows the Built Environment ADI within the campus. The Built Environment ADI includes the campus where implementation of the Project may result in impacts to CEQA historical resources. This includes properties (buildings or structures) that were found to be at least 45 years old and were evaluated for significance as part of this study because a proposed Near-Term Project would potentially affect these properties. The ADI consists of the project footprints, which includes areas of demolition, new construction, building renovation, and areas used for staging, if known. The ADI also takes into consideration the maximum extent of potential visual and noise-related impacts that the Project could have on historic built environment resources. Figure 2 shows the locations of the 11 properties evaluated for significance within the campus ADI.

# 2 Methods

The effort to identify previously recorded and/or evaluated built environment properties on the campus included a records search and a review of historical literature; examination of historic maps; archival research; and field surveys. Each of these methods and their results is described below.

## 2.1 Records Search and Other Sources

### 2.1.1 California Historical Resource Information System Record Search

In order to identify cultural resources potentially affected by the Project, a California Historical Resource Information System (CHRIS) record search was completed by Northwest Information Center (NWIC) at Sonoma State University on August 27, 2017. The 2017 records search included the campus and a one-mile buffer. As part of this process Dudek reviewed archaeological and built environment site records and reports on file at NWIC; OHP Historic Properties Directory; OHP Archaeological Determinations of Eligibility; California Inventory of Historical Resources (1976); Historical Maps; Local Inventories; and GLO and/or rancho Plat Maps.

For the purposes of this study, the following records search summary is focused on the built environment. A complete discussion of this records search and results, including archaeological resources and relevant reports, is included in *Cultural Resource Inventory for the CSU Monterey Bay EIR Master Plan Project, Monterey County, California*, a memorandum prepared by Dudek on July 5, 2019 (Brady 2019, pp. 19-27).

#### Previously Conducted Technical Studies

NWIC records indicate that a total of 42 previous cultural resources technical investigations have been conducted within one mile of the campus. Of these, a total of 29 studies cover the built environment. Among the built environment studies, three intersect the campus and 26 studies fall within the one-mile buffer (Table 3). Below Table 3, a short description of each study that fell within the campus boundaries is provided.

**Table 3. Previously Conducted Technical Studies**

| Report ID  | Authors, Publisher                      | Year | Title   |
|--|---|------|---|
| <b><i>Previous Technical Studies Intersecting the campus</i></b>       |   |      |   |
| S-005210   | Michael Swernoff, Professional Analysts | 1982 | A Reconnaissance Cultural Resources Survey of Fort Ord, California.   |
| S-005210a  | Michael Swernoff, Professional Analysts | 1981 | A Reconnaissance Cultural Resources Survey of Fort Ord, California, Draft Report                                  |
| S-018372   | Philip R. Waite, Geo-Marine, Inc.       | 1995 | A Cultural Resources Survey of 783 Hectares, Fort Ord, Monterey County, California                                |
| <b><i>Previous Technical Studies within one mile of the campus</i></b> |   |      |   |
| S-029425   | Scott Billat, EarthTouch, Inc.          | 2004 | Construction of a 70-foot Monopole and New Equipment Shelter, Mars/SF-1036 (resubmittal), 599 DX Road, Marina Ca. |

**Table 3. Previously Conducted Technical Studies**

| Report ID | Authors, Publisher   | Year | Title   |
|-----------|--|------|---|
| S-031953  | Wayne H. Bonner and James M. Keasling, Michael Brandman Associates | 2006 | Cultural Resource Records Search Results and Site Visit for T-Mobile Telecommunications Facility Candidate SF15153 (Metro Marina Monopine/Amateur Radio Club), 599 DX Drive, Marina, Monterey County, California (letter report)                                |
| S-032063  | Architectural Resources Group                                      | 2004 | Fort Ord, East Garrison Historic Resources Assessment   |
| S-032063a | Architectural Resources Group                                      | 2003 | Draft: Fort Ord, East Garrison, Historic Resources Assessment; July 28, 2003  |
| S-032063b | Architectural Resources Group                                      | 2006 | East Garrison Preservation Plan, Fort Ord, Monterey County  |
| S-032063c | Architectural Resources Group                                      | 2004 | Guidelines for Rehabilitating Buildings at the East Garrison, Fort Ord, Monterey County, California   |
| S-032063d | Architectural Resources Group                                      | 2006 | Mothball Plan and Existing Conditions Survey for Fort Ord, East Garrison, Monterey, California  |
| S-033596  | Mary L. Maniery and Cindy L. Baker                                 | 2007 | Cultural Resource Inventory and Evaluation of United States Army Reserve 63D Regional Readiness Command Facilities; Contract No. W912C8-05-P-0052   |
| S-033596a | U.S. Army Reserve and PAR Environmental Services, Inc.             | 2007 | Cultural Resources Inventory and Evaluation of the United States Army Reserve Heroic War Dead USAR Center/Area Maintenance Support Activity 85 (G), Oakland, California; P-01-[010831], 63D Regional Readiness Command Facility CA036, Contract No. W912C8-05-P |
| S-033596b | U.S. Army Reserve and PAR Environmental Services, Inc.             | 2007 | Cultural Resources Inventory and Evaluation of the United States Army Reserve Oakland USAR Center #2, Oakland, California; P-01-01830, 63D Regional Readiness Command Facility CA-125, Contract No. W912C8-05-P-0052  |
| S-033596c | U.S. Army Reserve and PAR Environmental Services, Inc.             | 2007 | Cultural Resources Inventory and Evaluation of the United States Army Reserve PFC Bacciglieri Armed Forces Reserve Center, Concord, California; P-07-002752, 63 D Regional Readiness Command Facility CA007, Contract No. W912C8-P-0052                         |
| S-033596d | U.S. Army Reserve and PAR Environmental Services, Inc.             | 2007 | Cultural Resources Inventory and Evaluation of the United States Army Reserve Col. Hunter Hall USAR Center, San Pablo, California; P-07-002753, 63D Regional Readiness Command Facility CA 070, Contract No. W912C8-05-P-0052                                   |
| S-033596e | U.S. Army Reserve and PAR Environmental Services, Inc.             | 2007 | Cultural Resources Inventory and Evaluation of the United States Army Reserve Fort Ord USAR Center, Marina, California; 63D Regional Readiness Command Facility CA012, Contract No. W912C8-05-P-0052  |
| S-033596f | U.S. Army Reserve and PAR Environmental Services, Inc.             | 2007 | Cultural Resources Inventory and Evaluation of the United States Army Reserve Moss Landing Local Training Area, Moss Landing, California; 63D Regional Readiness Command Facility CA189, Contract No. W912C8-05-P-0052  |

**Table 3. Previously Conducted Technical Studies**

| Report ID | Authors, Publisher  | Year | Title  |
|-----------|---|------|--|
| S-033596g | U.S. Army Reserve and PAR Environmental Services, Inc.  | 2007 | Cultural Resources Inventory and Evaluation of the United States Army Reserve Jones Hall USAR Center, Mountain View, California; P-43-001836, 63D Regional Readiness Command Facility CA031, Contract No. W912C8-05-P-0052 |
| S-033596h | U.S. Army Reserve and PAR Environmental Services, Inc.  | 2007 | Cultural Resources Inventory and Evaluation of the United States Army Reserve Richey Hall USAR Center, San Jose, California; P-43-000728, 63D Regional Readiness Command Facility CA069, Contract No. W912C8-05-P-0052     |
| S-033596i | U.S. Army Reserve and PAR Environmental Services, Inc.  | 2007 | Cultural Resources Inventory and Evaluation of the United States Army Reserve Moffett USAR Center, Mountain View, California; P-43-001837, 63D Regional Readiness Command Facility CA120, Contract No. W912C8-05-P-0052    |
| S-033596j | U.S. Army Reserve and PAR Environmental Services, Inc.  | 2007 | Cultural Resources Inventory and Evaluation of the United States Army Reserve PFC Young USAR Center, Vallejo, California; P-[48-000752], 63D Regional Readiness Command Facility CA-090, Contract No. W912C8-05-P-0052     |
| S-033596k | Milford Wayne Donaldson and James O. Anderson; Office of Historic Preservation and US Army                | 2007 | USA070613A; Inventory and Evaluation of Historic Resources at 63D Regional Readiness Command, US Army Reserve Center in California   |
| S-035143c | Matthew R. Clark, Holman & Associates   | 2005 | Archaeological Surface and Subsurface Reconnaissance and Historic Feature Recording for the East Garrison Project Area, Monterey County, California [original]   |
| S-039072  | Basin Research Associates   | 2009 | Cultural Resources Review, Gigling Road and South Boundary Road Improvements, Within Former Fort Ord, Monterey County, California  |
| S-039246  | Tobin Rodman, Parus Consulting  | 2012 | Cultural Resources Constraints Study for the Replacement of the Marina, 6th Street Wood Pole Replacement Project, Monterey County, California, PG&E No. 30787086/7690  |
| S-042969  | Carolyn Losee, Archaeological Resources Technology  | 2012 | Cultural Resources Investigation for AT&T Mobility CNU3562 "W Blanco Road LTE", 3262 Imjin Road, Marina, Monterey County, California 93933 (letter report)   |
| S-042969a | Carol Roland-Nawi and Carolyn Losee; Office of Historic Preservation; Archaeological Resources Technology | 2012 | FCC_2012_1106_005; CNU3562, W Blanco Road TLTE, 3262 Imjin Road, Marina, Collocation   |

**Table 3. Previously Conducted Technical Studies**

| Report ID | Authors, Publisher   | Year | Title   |
|-----------|--|------|---|
| S-044195  | Lawrence Moore;<br>Dept of Public Works,<br>Environmental Division, US Army Garrison, Presidio of Monterey | 2010 | Cultural Resource Inventory, ASR Wells Location, Ord Military Community, Monterey County, CA                                      |
| S-046930  | Roderic McLean;<br>Bureau Veritas  | 2014 | FCC Form 620 New Tower (“NT”) Submission Packet, Verizon Wireless Imjin and Abrams Facility, 2700 Imjin Parkway, Marina, CA 93933 |

***S-005210: Predictive Model of Cultural Resources at Fort Ord: A Reconnaissance Cultural Survey of Fort Ord, California (Swernoff 1982)***

Professional Analysts conducted a stratified sample survey of Fort Ord in 1982 and analyzed previous surveys and overviews to create a predictive map of cultural resource sensitivity. Areas of high sensitivity for archaeological sites were identified in the eastern and southern portions of Fort Ord. Additionally, Swernoff recorded four historic built environment resources: Whitcher Cemetery, Martinez Hill, Stillwell Hall, and the East Garrison Mess Hall Complex. All were recommended eligible for the NRHP by Swernoff, and the Whitcher Cemetery nomination was recommended to submit to the NRHP as a result of the survey (Swernoff 1982, pp. 8-3 to 9-9).

**S-005210a: A Reconnaissance Cultural Resources Survey of Fort Ord, California, Draft Report**

This report is an unfinalized draft version of the Swernoff 1982 report, described above.

***S-018372: A Cultural Resources Survey of 783 Hectares, Fort Ord, Monterey County, California (Waite 1995)***

This study was a cultural resources survey sampling of 783 hectares (1,935.4 acres) within Fort Ord related to the closure of the military base. The survey was stratified by environmental zones, which included: beach strand, active dunes, stabilized dunes (Holocene), stabilized dunes (ancient), and dissected uplands. High probability areas included areas within 100 meters of a water source and a 300-meter-wide area along the bluff overlooking the Salinas River on the eastern edge of Fort Ord. The effort included the recording of a historic site and an examination of two prehistoric sites, which included excavating shovel test pits. None of the resources addressed in the report are within the campus boundaries or a one-mile buffer.

**Previously Recorded Cultural Resources**

The NWIC records search results did not identify any previously recorded built environment resources within the campus boundaries. The record search also identified sixteen built environment resources within a one-mile radius of the campus, but it was beyond the scope of this project to address them. All built environment resources discovered in the record search are included below in Table 4, including their California Historical Resource Status Codes which indicate their eligibility status.

**Table 4. Previously Recorded Built Environment Resources**

| Primary ID   | Name   | Type      | Age      | Recording event  | California Historical Resource Status Code |
|--|--|-----------|----------|--|--|
| <i>Previously Recorded Resources Intersecting the campus</i>       |  |           |          |  |  |
| None   |  |           |          |  |  |
| <i>Previously Recorded Resources within One Mile of the campus</i> |  |           |          |  |  |
| P-27-002717  | CA-1025A                                     | Structure | Historic | 2001 (Lorna Billat, Earth Touch, Inc.)   | Unknown                                    |
| P-27-002749  | Auto Shop                                    | Building  | Historic | 2003 (Jody R. Stock, Architectural Resources Group);<br>2007 (Ian Alexander, Juan Cervantes, Matthew Clark, Holman & Associates) | Unknown                                    |
| P-27-002880  | Building 2019, latrine, former Fort Ord      | Building  | Historic | 2007 (Matt Bischoff, CSP, Monterey District)   | Unknown                                    |
| P-27-002881  | Building TR9070, office, former Fort Ord     | Building  | Historic | 2007 (Matt Bischoff, CSP, Monterey District)   | Unknown                                    |
| P-27-002882  | Building 2066, warehouse, former Fort Ord    | Building  | Historic | 2007 (Matt Bischoff, CSP, Monterey District)   | Unknown                                    |
| P-27-002883  | Building 2079, former Fort Ord               | Building  | Historic | 2007 (Matt Bischoff, CSP, Monterey District)   | Unknown                                    |
| P-27-002891  | Building 924, metal storage, former Fort Ord | Structure | Historic | 2007 (Matt Bischoff, CSP, Monterey District)   | Unknown                                    |
| P-27-002892  | Building 1A39, office, former Fort Ord       | Structure | Historic | 2007 (Matt Bischoff, CSP, Monterey District)   | Unknown                                    |
| P-27-002893  | Building 1A99, office, former Fort Ord       | Structure | Historic | 2007 (Matt Bischoff, CSP, Monterey District)   | Unknown                                    |
| P-27-002894  | Building 2026Z, storehouse, former Fort Ord  | Building  | Historic | 2007 (Matt Bischoff, CSP, Monterey District)   | Unknown                                    |
| P-27-002895  | Building TR9080, former Fort Ord             | Building  | Historic | 2007 (Matt Bischoff, CSP, Monterey District)   | Unknown                                    |
| P-27-002896  | Building TR9081, former Fort Ord             | Building  | Historic | 2007 (Matt Bischoff, CSP, Monterey District)   | Unknown                                    |
| P-27-002913  | Feature EGP-2                                | Structure | Historic | 2007 (Ian Alexander, Juan Cervantes, Matthew Clark, Holman and Associates)   | Unknown                                    |
| P-27-002915  | Feature EGP-4, WWII Tent Area                | Site      | Historic | 2007 (Matthew Clark, Holman and Associates)  | Unknown                                    |
| P-27-002916  | Feature EGP-5                                | Structure | Historic | 2007 (Matthew Clark, Holman and Associates)  | Unknown                                    |

**Table 4. Previously Recorded Built Environment Resources**

| Primary ID  | Name                           | Type     | Age      | Recording event  | California Historical Resource Status Code |
|-------------|--------------------------------|----------|----------|--|--|
| P-27-003170 | Marina Municipal Airport Tower | Building | Historic | 2012 (Dana E. Supernowicz, Historic Resource Associates) | Unknown                                    |

## 2.1.2 Built Environment Resource Database Search

The Built Environment Resources Directory (BERD) provides information, organized by county, regarding non-archaeological resources in the Office of Historic Preservation’s (OHP) inventory. The BERD inventory only contains information that has been processed through OHP and includes resources reviewed for eligibility to the National Register of Historic Places and the California Historical Landmarks programs through federal and state environmental compliance laws, and resources nominated under federal and state registration programs.

For the purposes of this study, the Monterey County BERD spreadsheet was accessed. In this spreadsheet, multiple resources in the City of Marina and the City of Seaside were noted, including Fort Ord Veterinary Hospital (now Fort Ord Equestrian Center) 1D, 2013, and Fort Ord US Army Reserve Center (6Y). Despite these resources’ close proximity, no historical resources listed in the BERD were noted within the campus.

## 2.1.3 Additional Studies

In addition to studies and site records procured by the CHRIS record search, Dudek also received additional reports from CSUMB and found other reports through various municipal and digital repositories for environmental compliance studies. For the purposes of this study, included below is a brief summary of reports pertaining to the built environment within and immediately adjacent to the campus.

### **Fort Ord, California: Base-Wide Remedial Investigations/Feasibility Study. Volume 1 (1991).**

EA Engineering, Science, and Technology prepared an investigation and feasibility study for the U.S. Army Corps of Engineers (USACE) after the site was placed on the National Priorities List of Hazardous Waste Sites (NPL). In October of 1990, EA Engineering completed a literature review and site inventory as part of their Remedial Investigation/Feasibility Study. The report delineated 21 study zones to review past land use for the purpose of discovering environmental contaminants at Fort Ord. EA Engineering, Science, and Technology also conducted a literature review and provided a history of the site (EA Engineering, Science, and Technology 1991:1-1).

### **Environmental Impact Statement Fort Ord Disposal and Reuse (1993).**

USACE prepared an Environmental Impact Statement to address Fort Ord’s closure and reuse. The document supported creating a 1,500-acre Presidio of Monterey to provide operations support for the remaining Army uses in the area, retaining a 12-acre reserve center on Fort Ord, and disposing of excess property at Fort Ord. The document responds to comments in the following subjects: alternatives, land use, socioeconomics, soils, geology, topography, and seismicity, public services and utilities, water resources, traffic and circulation, air quality,

hazardous and toxic waste site remediations, vegetation, wildlife, and wetland resources, visual resource, new issues, and other concerns. (Fort Ord Disposal and Reuse: EIS. 1993:3-1).

**California Military Base Reuse Task Force: A Strategic Response to Base Reuse Opportunities (1994).**

Governor Pete Wilson appointed the California Military Base Reuse Task Force to explore and mitigate economic, community, and land use issues at military base closures in California. The report outlines barriers and recommendations to potential components of reuse plans including the need to comply with City, County, and other agencies, as well as compliance with CEQA and NEPA in an effort to improve the prospects for a “smooth reuse process, expedited base clean ups, and the protection of natural and cultural resources (California Military Base Reuse Task Force 1994:xxi).

**Final Environmental Impact Report (EIR) Fort Ord, Monterey County, California (1997).**

In June 1997, EMC Planning Group, Inc. and EDAW, Inc. prepared a Fort Ord Reuse Plan Environmental Impact Report for the former Fort Ord Base located in Seaside, Monterey County, California. The EIR was prepared to evaluate the potential impacts to the environment under CEQA that may result from implementing the proposed Fort Ord Reuse Plan. The EIR was prepared to focus on the additional elements needed for CEQA analysis beyond the previously completed studies, Fort Ord Disposal and Reuse Final Environmental Impact Statement (FEIS) and Fort Ord Disposal and Reuse Draft Supplemental Environmental Impact Statement (DSEIS) (EMC Planning Group, Inc Republished 1997:1-2).

**Historic Resources Evaluation Memorandum for Hammerhead Barracks at Fort Ord, Monterey County, California (2019).**

In November 2019, Rincon Consultants, Inc. prepared historic resource evaluations for eight hammerhead buildings at Ford Ord located in Seaside, Monterey County, California. These hammerhead buildings are identical in design, materials, and plan to campus Buildings 44 (Pacific Hall), 45 (Coast Hall), 46 (Harbor Hall), and 47 (Student Services). Rincon recommended that all eight buildings were ineligible for both individual listings in the NRHP, CRHR, or for designation as a City of Seaside Historical Landmarks, or as contributors to a historic district, due to a lack of architectural distinction and lack of important historical associations within the broader context of Cold War military base establishment or a narrower context of military unaccompanied personnel housing (Madsen and Treffers 2019, pp. 13-15).

**Previous Campus Master Plans**

Three prior Campus Master Plans were prepared the campus and adopted by the Board of Trustees of the California State University in 1998, 2004, and 2007. The 2007 Master Plan was updated in 2015.

The 1998 CSUMB Campus Master Plan was the first step by the university to create a “city of learning.” The 1998 Master Plan described the broad steps the university planned to physically guide the development of the campus for the next 30 years. The 1998 Master Plan also addressed the broad physical framework for land use, development intensity, open space, circulation, and linkages to the surrounding community. The document provided a framework to ensure that physical developments to the campus reflect the long-range planning goals (CSUMB 1998).



The most recent 2007 CSUMB Campus Master Plan and EIR considered land uses and space requirements commensurate with enrollment projections for three planning horizons: Planning Horizon I (2005-2014), Planning Horizon II (2015-2024), and Planning Horizon III (beyond 2025) (CSUMB 2007:1-1). The 2007 CSUMB Master Plan projected an on-campus, traditional student enrollment of 8,500 full time equivalent (FTE) students, with an additional 3,500 FTE non-traditional, primarily off-campus students, for a total of 12,000 FTE students at buildout (2025), with 1,900 faculty, staff, and management personnel. There were approximately 6,731 FTE on-campus students in 2015-2016 (CSUMB 2007:1-1).

## 2.2 Building Development and Archival Research

The following text provides a summary of additional background research conducted by Dudek to arrive at a general understanding of the settlement and development of the campus and to gather information on the development of properties evaluated in this study.

### **Chamberlain Library, Defense Language Institute Foreign Language Center**

Dudek obtained access to the Chamberlain Library on June 15, 2021. Dudek staff reviewed documentation relating to the transfer of Fort Ord ownership to the California State University system. This included newspaper clippings, reports, and historic maps. All information obtained from the Chamberlain Library was used in the preparation of the historic context sections of this study.

### **University Archives, California State University Monterey Bay**

Dudek obtained access to CSUMB's archives on June 16, 2021. The archives provided a variety of primary documents, including copies of historic campus maps, campus master plans, and newspaper articles. All information obtained from the CSUMB archives was used in the preparation of the historic context sections of this study.

### **Facilities Plan Room, California State University Monterey Bay**

Dudek obtained access to CSUMB's Facilities Plan Room on June 15-16, 2021. Dudek reviewed the historic as-built drawings and renovation drawings for the campus properties included in this study. Dudek used the information obtained during this visit to develop the construction history of each property and to prepare the historic context sections of this study.

### **Historical Aerial Photographs**

A review of historical aerial photographs was conducted as part of the archival research effort from the following years: 1941, 1956, 1968, 1971, 1981, 1987, 1998, 2005, 2009, 2010, 2012, 2014, 2016, and 2018. (NETR 2021; UCSB 2021).

### **Sanborn Fire Insurance Company Map Review**

Archival research failed to indicate any Sanborn Fire Insurance Company maps for the campus.

## 2.3 Built Environment Field Methods

Dudek Architectural Historian Sarah Corder, MFA conducted an intensive level survey of the campus between June 14 and June 16, 2021. The survey focused on documenting the built environment properties potentially affected by the Project. The survey entailed walking the entire campus and documenting the exterior conditions of all properties proposed for demolition or renovation as part of the Project. Each property was documented with notes and photographs, specifically noting character-defining features, spatial relationships, observed alterations, and examining any historic landscape features on the campus. Dudek documented the fieldwork using field notes, digital photography, close-scale field maps, and aerial photographs. Photographs of the campus were taken with a digital camera. All field notes, photographs, and records related to the current study are on file at Dudek's Santa Cruz, California, office.

INTENTIONALLY LEFT BLANK

# 3 Historic Context

---

The following historic context addresses relevant themes concerning the history and development of CSUMB. It begins with a general overview of Monterey County, the City of Marina, and the City of Seaside and the development of Fort Ord. This is followed by a discussion of CSUMB's development, including a discussion of higher public education in California. The section concludes with a discussion of the historical development periods of the campus including its buildings, structures, architects, and building types.

## 3.1 Historical Overview of Monterey County

One of the earliest known European explorations of the Monterey Bay was a Spanish envoy mission led by Sebastián Vizcaíno in 1602. The purpose of the voyage was to survey the California coastline to locate feasible ports for shipping. Finding Monterey Bay to be commodious, fertile, and extremely favorable for anchorage between Spanish-held Manila and Acapulco, Vizcaíno named the bay "Monterey" after the Conde de Monterey, the present Viceroy in Mexico (Chapman 1920; Hoover et al. 2002). Spanish settlement was limited until the 1770s, when Don Gaspar de Portolá, the Governor of Baja, embarked on a voyage in 1769 to establish military and religious control over the area and established a Presidio to guard the port at Monterey Bay Mission San Carlos Borromeo de Carmelo. The area developed slowly with limited land grants, primarily given to members of the Spanish armed forces (Breschini 1996a; Hoover et al. 2002).

After more than a decade of intermittent rebellion and warfare, New Spain (Mexico and the California territory) won independence from Spain in 1821. In 1822, the Mexican legislative body in California ended isolationist policies designed to protect the Spanish monopoly on trade, and decreed the ports open to foreign merchants. As a result, dynamic trading communities developed along the present-day coastal areas of Monterey County where tallow and hides from the cattle raised in the area were traded for goods such as tea, coffee, spices, and fine leather goods (City 2008). During the Mexican period, land grants were distributed liberally throughout California to increase the population inland from the more settled coastal areas where the Spanish first concentrated their colonization efforts. The City of Monterey continued as the capital of Alta California and the *Californios*, the Mexicans who settled in the region, were given land grants.

The County of Monterey was designated as one of the 27 original counties of California on February 18, 1850, shortly before California officially became a state with the Compromise of 1850. The new state of California recognized the ownership of lands in the state distributed under the Mexican land grants of the previous several decades. As the Gold Rush was picking up steam in 1849, a massive influx of people seeking gold steadily flooded the rural counties of California. When the gold fields became overcrowded and unproductive, many later arrivals sought new sources of wealth altogether. For early arrivals in the relatively flat, fertile acreage of Monterey County, agriculture, cattle rearing, and dairy farming took hold as the leading economic ventures. This mirrored the use of the land in the area by early Spanish and Mexican settlers. Despite the promise of retaining their land, many Mexican families had difficulty proving ownership over their land in the face of new claimants who encroached on their land. Others were forced to sell off portions of their holdings to pay for the legal fees and taxes to maintain ownership (City 2008).

Gold, silver, granite, and lesser quality coal were mined with disappointing results from various locations throughout the County. In the 1870s, sand and gravel was mined from the beaches, with large mining companies securing the rights to haul away a certain quantity of sand per year from private properties along the shore beginning in 1888 (City 2008).

The introduction of the Southern Pacific Railroad (S.P.R.R.) beginning in 1872 with the completion of the Pajaro to Salinas line helped to promote the beauty of the coastal areas of the County for settlement. The S.P.R.R. made the remote areas of the County quickly accessible from San Francisco and other inland, Central Valley locations, which prompted the development of idyllic coastal retreat and vacation communities such as Pacific Grove (1878), Carmel (today, Carmel-By-The-Sea) (1888), and the secluded neighborhoods within the Del Monte Forest (Hoover et al. 2002).

Agriculture and tourism have endured into the present-day as the most substantial contributors to Monterey County's economy which helps to support a population of 434,061 residents. The rich farmland of the Salinas Valley farms in the heart of Monterey County have consistently made agriculture the top provider of employment in the County and have also helped to secure Monterey County as the third largest agricultural County in the State of California. In addition to the picturesque Monterey Bay, the County of Monterey features many tourist destinations of ecological, cultural, and historical value that attract in excess of three million visitors per year (County of Monterey 2021).

## 3.2 Historical Overview of Marina

The land that constitutes the modern-day City of Marina was once part of a 9,000-acre landholding owned by David Jacks and James Bardin dating to the 1860s. The Bardin's sold 2,800 acres of their holding to John Armstrong in 1885. Although Armstrong dubbed the area "Sand Hill Ranch" and used the acreage to grow potatoes, the area of today's Marina remained a largely desolate and undeveloped stretch of sand dunes until the 1910s. He sold 400 acres of his land near the ocean to the San Francisco Sand Company around 1900, who later constructed a sand plant in 1906. Builders utilized sand from the area as a primary source material for the rebuilding of San Francisco after a devastating 1906 earthquake (The Californian 1936; The Californian 1976).

While Southern Pacific railroad cut through the area, development in Marina lagged until about 1915, when San Francisco businessman William Locke-Paddon purchased 1,500 acres of present-day City land and it became known as "Locke-Paddon Colonies", then "Paddonville". Looking to develop his acreage into a townsite, Paddon convinced the Southern Pacific to create a flag stop and he sold five-acre lots for roughly \$75 per acre to stimulate development. Paddon built a community drinking well and created the first school out of a small cottage building in 1916 but found it difficult to attract buyers to his community in the early years. The first post office (also served as a general store) opened in 1919 as the "Marina Post Office", helping to establish Marina as the official town name (The Californian 1936; The Californian 1976).

By 1926, the community had grown to 70 families with surnames like Koenen, Cardoza, Smith, and Maddison among the early settlers. One of the community's oldest organizations, Grange Hall #518, established in 1933. Marina increasingly became a popular gathering place for off-duty soldiers and their families stationed at nearby Fort Ord, in part because of the well-liked Mortimer's restaurant. The town grew steadily after the construction of nearby Fort Ord in 1940 and reached a population of 6,000 by about 1950 (The City of Marina 2021).

During the 1950s, Reservation Road began to emerge as a commercial corridor and the community began to build more suburban-like retail and housing options. Both single-family developments and apartments soon sprung up near Reservation Road. By the mid-1960s the town boasted a new Safeway Supermarket and the "Marina Shopping Center" which was equipped with a bank, coffee shop, dry cleaners, drug store, laundry mat, and other options (The City of Marina 2021). Marina voters approved incorporation on November 5, 1975, by a 20 percent margin, and a

City Hall was established on Hillcrest Avenue. Since incorporation, the City had experience substantial growth with a number of single-family suburban tract developments, new shopping centers, and civic amenities being built in the 1980s. With the closure of Fort Ord in 1993, a major community employer, the City saw a population decline for a few years following its closure (The City of Marina 2021). Despite the brief population decline, the City has since attracted new employers, including aviation businesses at the Marina Municipal Airport and service sector retail jobs, and the population has grown to nearly 23,000 people as of 2020 (U.S. Census 2020).

### 3.3 Historical Overview of Seaside

Seaside, located in Monterey County, began in 1887 when Dr. John L.D. Roberts purchased land a mile to the northwest of the prominent Del Monte Hotel (opened in 1880). Roberts was a physician who had come to California at the age of 24 from New York and saw the development possibilities in creating a new subdivision northeast of Monterey. Roberts “bought 150 acres from his uncle, marketed it as a shoreline resort and in 6 months had repaid his loans, built a house, and expanded his subdivision to the north” (City of Seaside n.d.). The area was originally known as East Monterey. By 1891, the town had a post office, hot springs resort, schools, churches, and a railcar line, and had received the name Seaside (City of Seaside n.d.). The area attracted white, middle-class residents who considered the area a potential resort destination (McKibben 2009a; McKibben 2009b).

In 1910, while Roberts was acting as Monterey County Supervisor, he petitioned to establish the U.S. Army Base Fort Ord on the ranchland north of Seaside. The base quickly grew to house over 20,000 infantry members and civilian workers. With the establishment of Fort Ord, Seaside transformed from a resort destination to a military town. Many original residents left because of the change in the community’s character.

Seaside’s military-driven economy gradually declined with the end of World War I. The decline was compounded by the Great Depression, resulting in low property values. Frequently, people simply claimed a piece of land and built a home without formally purchasing the land. Demographically, the low property values, Dustbowl refugee influx, and military presence contributed to the community becoming one of the most racially diverse areas in the Central Coast (Whaley 2015; McKibben 2009a; McKibben 2009b).

During World War II, Fort Ord grew into one of the U.S. Army’s principal west coast training facilities and the town of Seaside continued to house most of the off-base workers and soldiers. In 1948, the U.S. Army became racially integrated with the signing of Executive Order 9981. Fort Ord became the first integrated training division (MacGregor 1981; McKibben 2009b). As a result, Seaside continued to be a town of ethnic and racial diversity unique in central California. The population of Seaside doubled between 1948 and 1954 from fewer than 10,000 to 21,750 (City of Seaside n.d.).

Seaside initially attempted to incorporate as a city in 1940, but as the process dragged on, half the town’s original acreage was ceded to the City of Monterey and Sand City. In 1954, Seaside finally won its battle and became an independent city. Despite the loss of the original sections of Seaside to neighboring cities, within remaining city boundaries Seaside was able to construct a high school and a City Hall designed by prominent architect Edward Durell Stone (City of Seaside n.d.).

By 1970, Seaside was the most populated city on the Monterey Peninsula, with a population of 35,940. The City had a notable concentration of African-American residents; 20 percent of the population in 1970 was African-American. (McKibben 2009b). By 1980, Seaside’s population was extremely diverse and had no ethnic majority.

The City had the most concentrated population of African-Americans in California between Los Angeles and Oakland. By the 1980s, the area's demographics began to shift with a mass immigration of people from Mexico and Central America. Latinos presently make up the majority of the City's population.

In 1991, the Base Realignment and Closure Commission recommended that Fort Ord be closed. The base was formally decommissioned in 1994. The City was able to sustain the closure of Fort Ord in 1994 and the population remained steady. The majority of the land comprising the base was returned to the State of California for further public use. Seaside continues to develop with recent projects including golf courses, resorts, conference centers, residential and commercial developments, and plans for a mixed-use, transit-oriented downtown (City of Seaside n.d.).

## 3.4 Historical Overview of Fort Ord

The history of Fort Ord has been extensively documented in newspaper articles, websites, academic journals, and books. From its creation in 1917 to its closure in 1994, the base grew to become one of the largest training centers in the country. Its location was also reported to be the most attractive U.S. Army post, with easy access to the ocean and beautiful California weather.

The development periods in the history of Fort Ord were defined by Harold E. Raugh, Jr, a U.S. Army lieutenant colonel and historian with the Department of Defense. Since his retirement, Raugh served as the Chief Historian, for the Defense Logistics Agency, for the Department of Defense and, from 2006-2013, Raugh served as the Command Historian at the Defense Language Institute Foreign Language Center (DLIFLC) and the Presidio of Monterey, California. He received his PhD in history from the University of California, Los Angeles (Walch 2004). Raugh has authored numerous books including, *Fort Ord* (2004); *Presidio of Monterey* (2004); *Operation Joint Endeavor: V Corps in Bosnia-Herzegovina, 1995-1996* (2013); *The Raugh Bibliography of the Indian Mutiny 1857-1859* (2016); and *Wavell in the Middle East, 1939-1941: A study in Generalship*. Raugh defined four periods for the historic development of Fort Ord:

- 1917-1940 Camp Gigling to Camp Ord
- 1940-1945 Fort Ord and the 7th Infantry Division
- 1946-1976 The Cold War and Vietnam Eras
- 1974-1994 The Volunteer Army

These periods correspond to distinct eras in the history of the base and the U.S. Army (Raugh 2004: ii). The following sections provide a summary overview of each of these periods of development and their relevance to the area of Fort Ord now known as the CSUMB campus.

### 3.4.1 Camp Gigling to Camp Ord (1917-1940)

Between 1917 and to 1940, just before the start of World War II, Fort Ord grew from an agricultural field to a bustling Army outpost filled with tents, mess halls, and enlisted soldiers training for foreign conflict.

Fort Ord, located on the Monterey Peninsula, was formally established in 1917 under the name “Fort Gigling.” The land was purchased from David Jacks, a local rancher who, along with the Gigling family, operated a dairy farm on the land (EA Engineering, 1991: 2-1). The site was purchased to create a training ground for field artillery and cavalry troops stationed at the Presidio of Monterey, located about eight miles to the southwest (Military Museum 2016). No formal land improvements or buildings were constructed at the site. The site remained primarily agricultural in use, though it was also used as an area for maneuver training (EA Engineering, 1991: 2-1).

In the late 1930s, after more than a decade of use, several facilities were constructed at the site, including “administrative buildings, barracks, mess halls, tent pads, and a sewage treatment plant” (Military Museum 2016). The work completed from 1938 to 1940 was primarily done by the Civilian Conservation Corps (CCC) and the Works Progress Administration (WPA). The area was named Camp Ord in 1939 and changed to Fort Ord in 1940 (The Californian 1940: 1). Fort Ord was placed under the command of General Joseph “Vinegar Joe” Stilwell. The original site encompassed 3,777 acres (Castle 1990: 4).

Building development during this period was temporary in nature, as the Fort was initially planned to be provisional. Tents of various sizes were erected in neat rows to house troops. In the 1930s, wood buildings were constructed. These buildings were considered impermanent, as they generally used simple wood construction techniques that could be easily moved or deconstructed if necessary.



**Figure 3.** Impermanent, temporary tents and buildings at Fort Ord c. 1939 (CSUMB 2021: Image 121).





**Figure 4.** Fort Ord picture showing semi-permanent buildings and tents, 1940 (CSUMB 2021: Image 131).

### 3.4.2 Fort Ord and the 7th Infantry Division (1940-1945)

The second period of development at Fort Ord was brief, but substantial. The Fort became a semi-permanent base with a massive population influx as operations trained and deployed soldiers for war. This period included the first large-scale development of semi-permanent housing and administration buildings and was the most substantial period of development in Fort Ord's history (Chamberlin Library 2021.).

In 1940, the *Salinas Morning Post* announced contracts for a total of \$2.7 million were awarded to Ford J. Twait and Morrison-Knudsen, Inc., both Los Angeles-based companies, to construct 564 structures on Fort Ord. The Barret & Hilp Company of San Francisco was awarded "\$35,000 to lay down two spur tracks from Southern Pacific lines into the Army reservations" (*Salinas Morning Post*, 1940: 1). The building program was appropriated by Congress to house the 7th Division that was being formed on the base under the command of Gen. Stilwell (*Salinas Morning Post*, 1940: 1). At this time, an additional \$4 million was devoted to making the site a "complete city" with utilities, paving, and sewage. Additionally, the WPA was awarded a \$1.4 million budget to construct buildings at Fort Ord (*Salinas Morning Post*, 1940:1).

By 1941, the Fort had over 28,514 acres of land, 27,000 men, and \$12 million invested to create a training base and staging area for the U.S. Army (Cavanaugh 2000: 9). The WPA and private contractors continued constructing wood frame buildings to accommodate the growing population. The main garrison was constructed between 1940 and the 1960s "starting in the northwest corner of the base and expanding southward and eastward." (Figure 5) (DLIFLC 2021; Military Museum 2016).

During World War II, the Army was changing training tactics. It was actively transitioning the cavalry from horses to tanks and trucks (Castle 1990: 4). Fort Ord also became a training site for amphibious warfare, which was essential for combat missions in the Pacific theater. Fort Ord became home to the amphibious training unit 18th Armored Group, taking advantage of the Fort's proximity to the beaches in Monterey Bay (Panorama, n.d.).

It was during this period that the National Defense Program began requiring Army housing to provide a variety of additional support buildings for soldiers beyond the “screened, framed, and floored tents for officers and men” (The Quartermaster Review 1940). Additional temporary buildings included mess halls, kitchens, lavatories, company supply, and administration buildings, supply and general utilities, medical infirmaries, and recreation facilities (Quartermaster Review 1940:37). Building development in this period was swift and simple. World War II created an immediate need for soldiers, all of whom needed housing. Emergency war construction took place on bases across America. Temporary construction was authorized at “post, camps, and stations where additional regular Army troops are assigned as soon as requirements are determined” and funding became available (The Quartermaster Review 1940: 37). The building program began quickly at Fort Ord. Buildings were constructed of wood, with slight eave overhangs with exposed rafter tails. They were clad in horizontal, wood siding finished with simple corner boards. The majority of the windows were multi-light double-hung wood windows. Most of the buildings appeared to sit on post and pier foundations, which was part of the semi-permanent nature of the construction.



**Figure 5.** Fort Ord, after construction of main garrison and infrastructure, such as roads, date unknown (DLIFLC 2021).

### 3.4.3 Cold War and Vietnam Eras at Fort Ord (1946-1976)

This period of development between 1946 and 1976 was characterized by a massive operation to move the base out of its semi-permanent status and create a permanent outpost for active military personnel who were retained due to ongoing foreign conflicts.

In July of 1948, Harry S Truman signed Executive Order 9981, which officially ended segregation in the armed forces. The order stated that “there shall be equality of treatment and opportunity for all persons in the armed forces without regard to race, color, religion, or national origin” (National Archives Foundation 2021). Fort Ord

became one of the first integrated training divisions in the United States. The Fort was touted as “pioneering to end all segregation” (The Pomona Progress Bulletin 1950: 4). In 1950, the *Pomona Progress Bulletin* reported that black and white soldiers at Fort Ord were “fighting side by side” and all the enlistees “trained together, slept in the same barracks, and eat the same messes” (The Pomona Progress Bulletin 1950: 4).

The end of World War II in 1945 did not bring lasting peace. The tenuous relationship between dominant nations in the communist East and free market West led to the beginning of the Cold War. The Department of Defense maintained a robust fighting force during the Cold War, with more than 900,000 Army personnel retained during the 1950s (ACHP 2006). The ongoing global tensions and the number of active U.S. military personnel created a need for new permanent buildings and expanded military housing at Fort Ord.

In 1949, the Soviet-supported communist government of North Korea invaded American-supported South Korea, initiating the Korean War. Fort Ord was a primary staging area for the training of troops departing for the war (Castle 1990:3). By the 1950s, Fort Ord had become one of the largest basic training camps in the United States. In 1952, the military began a multi-million dollar building program to transform Fort Ord into a permanent post, including the development of permanent troop housing, and the construction of a guard house, stockade, and multiple warehouses. In January of 1952, military authorities announced the new construction program at Fort Ord was underway, with an estimated cost of \$26,650,600. More than half of the funds that were approved by Congress were “earmarked for new permanent troop housing” for more than 7,000 soldiers (The Webb Spinner 1952-54, Vol 6. No. 3:1).

The new troop housing was to be constructed of reinforced concrete, a departure from the wood buildings constructed before and during World War II. The plan called for three types of massive barracks, twenty-two were to house 225 enlisted men each, seven were to accommodate 165 men each, and nine were to house 105 men each (The Webb Spinner 1952-54, Vol 6. No. 3:3). The San Francisco District of the U.S. Army Corps of Engineers oversaw the construction project to completion. An additional \$1,349,700 was earmarked for the expansion of classroom and training facilities at Fort Ord, including a new battalion and regimental headquarters (The Californian 1952a:1 and The Californian 1952b:18). By March of 1952, another phase of the permanent army post transformation began with the construction of a guard house, stockade, warehouse, and other buildings (The Webb Spinner 1952-54, Vol 6. No. 3:1). This addition of permanent buildings continued into the late 1950s, when the Army requested \$124 million to replace all the wood World War II infrastructure at Fort Ord with concrete block and reinforced concrete (Madsen and Treffers 2019:6; San Francisco Examiner 1958:2-4). While many of the wood buildings remain today, this period saw the continuous addition of reinforced concrete permanent buildings across the Fort (Madsen and Treffers 2019:6).

Following the Korean War through the end of the conflict in Vietnam, Fort Ord served as an important training facility. In 1957, Fort Ord was designated as a U.S. Army Training Center for Infantry (Castle 1990: 4). The 7th Infantry Division was based at Fort Ord in 1975 (Cavanaugh 2000: 9). Fort Ord produced thousands of combat-ready troops during the conflict in Vietnam.

With the establishment of Fort Ord as a permanent Army base during this period, there was substantial building construction that led to the modernization of the base and its services. This development is closely related to the history of the current CSUMB campus. All the properties that are included as part of this built environment study were constructed during the Cold War and Vietnam Era period. Building development during this period was a substantial departure from the styles and materials used in the buildings constructed before World War II. Building during the period between 1946 and 1976 used reinforced concrete and concrete masonry unit (CMU). The

buildings tended to be larger than those constructed in previous periods. Other development in this period included support service buildings and several types of medical buildings. Infrastructure was also improved at this time, with the introduction of paved streets and roadways, and the addition of several water tanks, water pumping plants, and warehouse buildings.



**Figure 6.** Fort Ord, Specialist 4, Abil Abdallah Mughannam at the new Fort Ord barracks in November of 1960 (DLIFLC 2021).



**Figure 7.** Fort Ord base, aerial image showing the completed barracks, c. 1970. The barracks are described as “Old Permanent Barracks, looking south” (DLIFLC 2021).

### 3.4.4 Built Environment ADI Buildings Constructed During the Cold War and Vietnam Era (1946-1976)

The following presents a discussion of the properties located within the Built Environment ADI and provides a brief overview of their types, original use, and changes over time. Four categories of building types were identified for the purposes of this study. These are the Support Services Buildings, Medical Buildings, Hammerhead Buildings/Barracks, and Recreational Facilities.

#### Support Services Buildings

Support services buildings at Fort Ord have a variety of uses and functions that have changed over the history of the base. One of the most common type of support services building from this period is classroom buildings. In alignment with the typical planning, design, and materials of buildings constructed during this period of Fort Ord’s history, these buildings are constructed from concrete and CMU and feature side-gabled roofs. Another support services building type is the auto repair buildings that were constructed during this period to support the repair and maintenance of military vehicles. These buildings were more industrial in design, with large openings and metal roll-up doors to support their function.

Beach Hall (21), Tide Hall (23), Green Hall (58), and Reading Center (59), are four support service buildings in the Built Environment ADI. The nearly identical buildings differ slightly due to renovations, but they all began with the same architectural design. The buildings were all constructed in 1954 and were designed by Robert Stanton,

architect for the United States Army Corps of Engineers (CSUMB Facilities 2021). The buildings were described on the architectural plans as “permanent troop spaces and supporting facilities/classrooms” (Figure 8) (CSUMB Facilities 2021). These support services buildings were designed by California architect, Robert Stanton, who designed a variety of residential, commercial, and public buildings in the San Joaquin Valley and Monterey, and Santa Cruz areas.

An auto repair support services building included in this study is Building 70. The building first appears in the 1956 aerial photograph as the east-most building in a group of six similarly sized buildings between 5th Avenue, 6th Avenue, Inter-Garrison Road, and a large parking area. A 1970 site plan of Fort Ord labels these buildings the “Motor Park” (CSUMB Facilities 2021). Archival research did not find any conclusive information on the original use of these buildings. No architectural drawings were available for this building type and the architect is unknown.

After Fort Ord closed in 1994, these support services buildings became part of the CSUMB campus. With the shift to campus use, many of the buildings were altered to fit the needs of CSUMB. Beach Hall and Tide Hall’s building footprints appear unchanged between 1956 and the present, however the circulation pattern of both building’s interior changed during a 1995 remodel when some windows were converted to doors on the north elevation, and a gable roof was added over the primary door (Figure 9) (CSUMB Facilities 2021; NETR 2021). No changes to Green Hall (58) or the Reading Center (59) were noted. Building 70’s footprint does not appear altered, and no additions appear between 1956 and 2016, according to aerial photographs (NETR 2021).

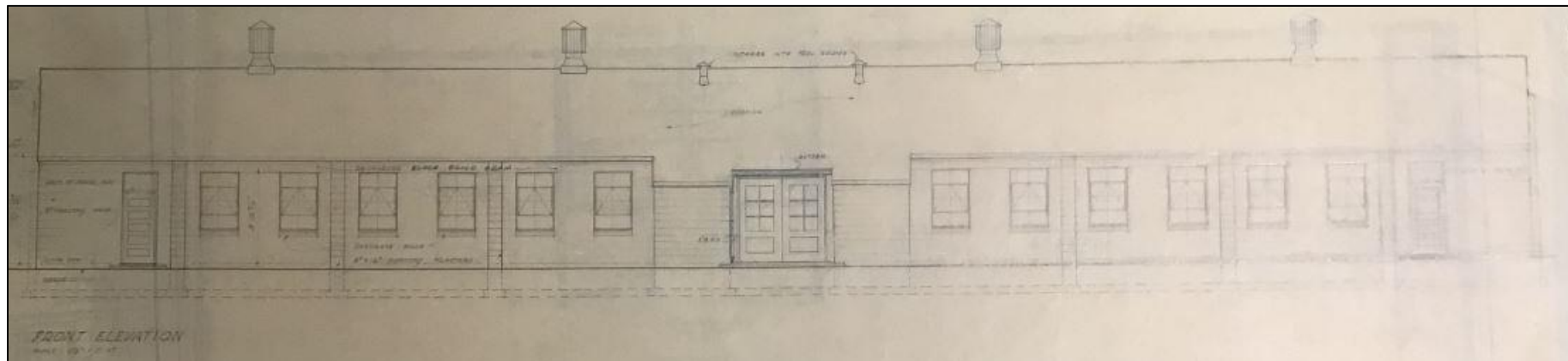

**Figure 8.** Fort Ord 1953 architectural drawing of the Permanent Troop Spaces and Supporting Facilities Classrooms (Buildings 21, 23, 58, 59) (CSUMB Facilities 2021).

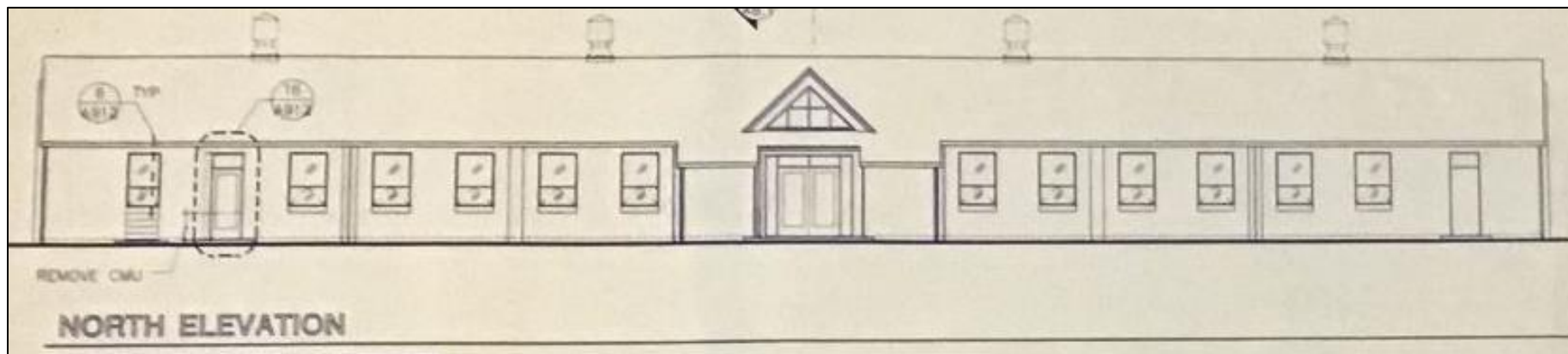

**Figure 9.** Fort Ord 1995 architectural drawing of changes made to some of the buildings that used the Permanent Troop Spaces and Supporting Facilities Classroom building plan (CSUMB Facilities 2021).

## Medical Buildings

Medical buildings at Fort Ord have a variety of uses and functions that changed over the history of the base. One of the most common medical building types during this period were clinic buildings. Examples of clinic buildings that are extant and part of the present-day CSUMB campus study area are the Science Research Lab Annex (13) and Watershed Institute (42) (more detail below). In alignment with the typical planning, design, and materials of buildings constructed during this period of Fort Ord's history, these buildings are constructed with reinforced concrete and CMU and feature flat roofs with multi-light windows with concrete sills. Building 13 was originally a dental clinic and Building 42 was one of the Fort's regimental dispensaries (pharmacies). The buildings were initially designed to have waiting areas near the front entrances, with patient rooms separated from the primary entrance by long hallways.

The Science Research Lab Annex (13), originally a dental clinic, was designed by the San Francisco architectural firm of Milton T. Pflueger in 1963 (CSUMB Facilities 2021). The original plans called for the interior space to have 28 dental chairs. It was the first permanent dental clinic at Fort Ord. Renovation architectural drawings from 1987 show many of the interior walls were demolished to divide the building into two clinics, the Stone Dental Clinic and a Blood Donation Center (Figure 10) (CSUMB Facilities 2021). In 1995, CSUMB facility plans show the building was converted to the university's science building (Figure 11) (CSUMB Facilities 2021).

The Watershed Institute building (42), originally a regimental dispensary, was designed in 1956 by the firm White, Noakes & Neubauer, Architects, and Engineers, located in Washington D. C. (CSUMB Facilities 2021). In 1959, The Californian reported two new regimental dispensaries were approved for construction at Fort Ord. Daniels and House Construction company of Monterey received the contract for \$197,964. Original plans called for the interior space to have a waiting room, clerk and records room, doctor's office, a resting room, examination and treatment room, surgical dressing room, a fan room, the boiler room, and coal storage (Figures 12 and 13). As-built changes were made to the drawings in January of 1960, suggesting the building was constructed by this time (CSUMB Facilities 2021).

After Fort Ord closed in 1994, the buildings became part of the CSUMB campus and both buildings were altered to serve as classroom space designed for academic study and instruction.



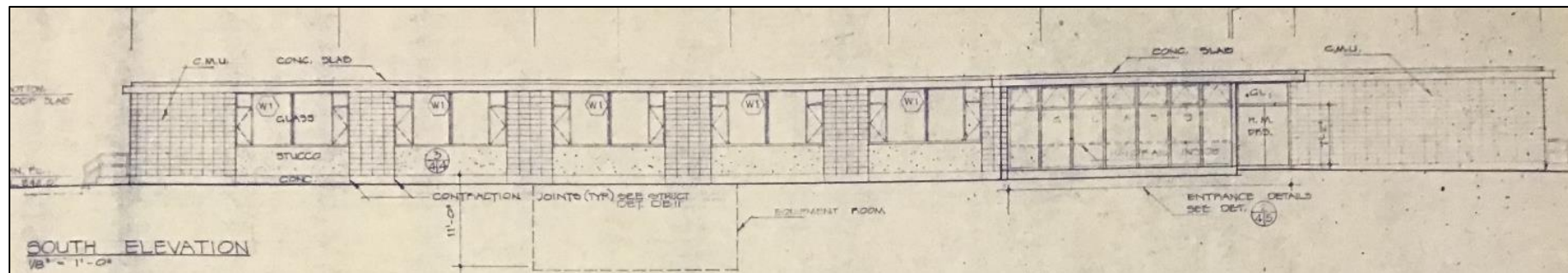

Figure 10. Fort Ord 1963 architectural drawing of the Science Research Lab Annex (Building 13) (CSUMB Facilities 2021).



Figure 11. Photograph (c. 1990) of the Science Research Lab Annex (Building 13) after its conversion to the Stone Army Dental Clinic (DLIFLC 2021).

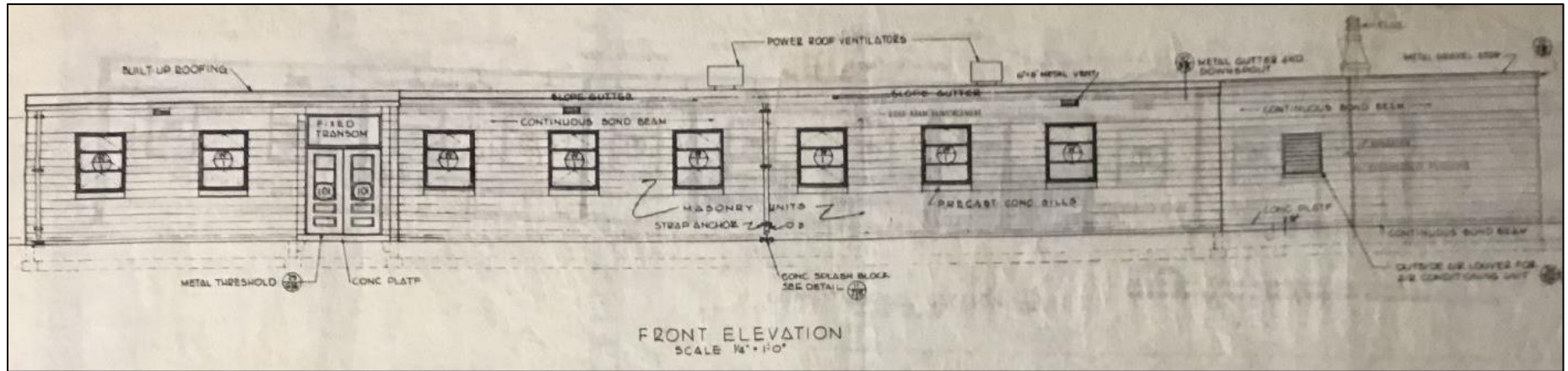

Figure 12. Fort Ord 1956 architectural drawing of the Watershed Institute (Building 42) (front elevation) (CSUMB Facilities 2021).

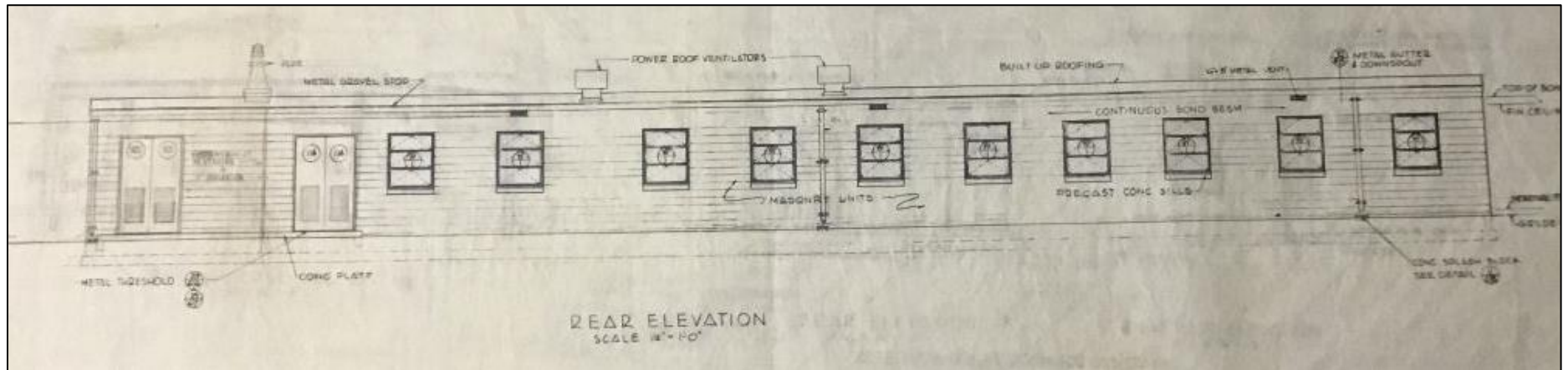

Figure 13. Fort Ord 1956 architectural drawing of the Watershed Institute (Building 42) (rear elevation) (CSUMB Facilities 2021).

## Hammerhead Buildings/Barracks

Three buildings that are part of the CSUMB campus study area, Pacific Hall (44), Coast Hall (45), and Harbor Hall (46), first appear on a 1956 aerial photograph of the site on the western half of the base. They are part of a group of eight other similarly oriented buildings. These buildings were originally designed as new permanent barracks, commonly referred to as the “Hammerhead Buildings,” that were part of the \$26,650,600 construction program awarded by the military in 1952. More than \$17 million of these funds were used to construct 38 three-story barracks. These larger barracks were planned to house entire companies and serve all their needs in one space, with mess halls, lounges, day rooms, orderly rooms, supply rooms, and issue rooms, as well as administrative space (The Californian 1952a).

The Del Webb Construction Company won the work at Fort Ord with a low bid of \$12,614,832 (The Californian 1952b: 18). Groundbreaking for the project took place on February 19, 1952. The barracks were featured in the Del Webb Construction Company’s newsletter, *The Webb Spinner*, in the June/July/August edition. The paper described the new military dormitories as “sleek” (The Web Spinner 1952-54, Vol 6. No. 3:6). The buildings were a departure from the “old, white-painted barracks” constructed 12 years earlier. The new barracks were erected of steel and concrete with large glass areas (Figures 14-16). The concrete construction was praised as both vermin and fire-proof (The Web Spinner 1952-54, Vol 8. No. 5:6).

After Fort Ord closed in 1994, the buildings became part of the CSUMB campus. There were no notable changes to the footprint of the buildings until sometime between 2012 and 2014 when the east, multi-story wings were demolished on Coast Hall (45) and Harbor Hall (46). Pacific Hall’s east multi-story wing was demolished sometime between 2016 and 2021.



**Figure 14.** Fort Ord, after construction of new barracks between 1952 and 1954 (The Webb Spinner 1952-54, Vol 8. No. 5:6).



Figure 15. Fort Ord 1952 Conceptual drawing of the new barracks at Fort Ord (The Web Spinner 1952-54, Vol 6. No. 3:1).

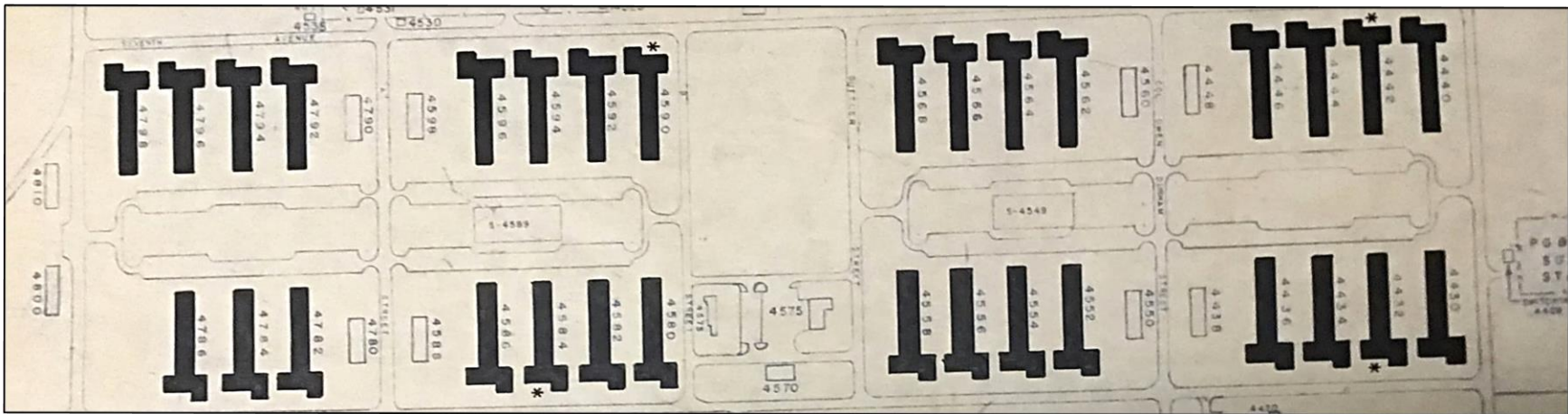

Figure 16. Fort Ord architectural site plan of the Hammerhead Buildings/Barracks (CSUMB Facilities 2021).

## Recreation Facilities

During the Cold War and Vietnam Eras at Fort Ord (1946-1976) recreational opportunities increased substantially on the base. Initially, the U.S. Armed Forces focused solely on training programs that led to the production and establishment of a robust fighting force. Recreation for enlisted soldiers was often provided by civilian groups, not through formal programs run through any branch of the military. This began to change after World War I. The 1940 plan for the development of Fort Ord called for all the buildings necessary to train, house, and care for the infantry, as well as the construction of recreation related facilities such as post exchanges, regimental recreational facilities, moving picture tents, and service clubs (Quartermaster Review 1940: 37). During World War II, the military vastly expanded recreational offerings for enlisted personnel to boost morale and to align with more modern concepts of free-time and leisure (Gates 1957: 99). Morale, it was said, was “just as important as ammunition” and newer, more modern thinking saw recreation as a “vital force in self-development and the art of living” (Gates 1957: 100).

Early recreation activities at the Fort included band concerts, live theater, orchestra shows, and choir performances often organized by the enlisted men (Park 2015: 25). Track and field meets were organized with field days throughout World War II. Boxing was also noted as a popular spectator sport at the base in its early years (Park 2015:25). Fort Ord’s first football team, the Presidio Dons, was organized in October 1940. The team initially practiced and played at nearby Del Monte Polo Field. During World War II, the Fort Ord Athletic and Recreation Officer designed a plan to keep soldiers “fit to fight” by developing a more extensive plan for football, baseball, softball, boxing, and other recreational activities. Soon after, games and tournaments were arranged between Fort Ord teams, nearby military bases, and other organized teams (Gates 1957: 100). After the war ended in 1945, Fort Ord introduced an athletic program that gave service members “an opportunity to take part in any recreational activity they wish” (Park 2015: 33). In 1951, a report completed by the Committee on Religion and Welfare in the Armed Forces found that the availability of “wholesome free time activities” were essential for shaping character, increasing job performance, and for the national support of the Armed Forces” (Gates 1957: 100).

The recreation opportunities available at Fort Ord continued to expand in the post-World War II era with the construction of the stadium and other outdoor athletic fields in the 1950s and 1960s. By 1977, the main garrison area included a wide variety of recreation facilities, including a snack bar, bowling center, softball field, baseball field, service club, library, handball courts, tennis courts, a commissary, the theater, and parade grounds, as well as the Football and Track Stadium (U. S. Army 1977). It was believed that these recreation opportunities created better leaders and would better prepare soldiers for successful civilian lives after their service (Gates 1957: 104).

The Freeman Stadium, originally called Warrior Stadium, is the only Recreation Facility type in the campus study area. Freeman Stadium is made up of the following components: the field, track, bleachers, electrical building, and Field House. This grouping is referred to throughout this report as the “Freeman Stadium.” In January of 1949, the Army prepared plans and specifications for a new Football and Track Stadium (Fresno Bee 1951b:27). The plans were finalized in December 1949 by Fort Ord Engineer Office (CSUMB Facilities 2021). They called for the development of the new stadium at the site of the base’s existing amphitheater, just north of the parade grounds. In January 1951, the Army requested bids for a \$200,000, 6,000-seat, concrete football and track stadium at Fort Ord. The design called for the stadium seating to be reinforced concrete, set into the existing dirt embankment of the base’s amphitheater (Fresno Bee 1951a: 13).

The plan to develop a stadium at Fort Ord was immediately met with criticism, as President Truman had previously ordered a freeze on new government construction projects to direct funds to the Korean War effort. The Army argued that the stadium was planned “long before the present emergency” and would be constructed of non-critical

materials. The planned stadium seating was designed to be constructed of “concrete steel blocks” and concrete slab flooring. In February 1951, it was announced that the stadium would use steel water pipes and cast-iron conduits for construction in an effort to preserve copper (Fresno Bee 1951b:27). Ultimately, the ban on unnecessary construction was ignored, citing the need for recreational facilities to boost morale, and because the growth of Fort Ord was placing a “severe strain on the recreational facilities in the Monterey-Salinas area” (San Francisco Examiner 1951:4). The stadium was considered a necessary facility to “keep pace with the growth of the tent-soldier population” and the athletics field would help to reinforce the Army’s rigorous training program (San Francisco Examiner 1951:4). The contract was awarded to construct the stadium and Field House in March 1951 to F. V. Hampshire Contracting Company of Salinas. They bid \$146,346 for the project. Construction was set to begin soon after the contract was awarded and was planned to be completed by September 1951 (Figures 17 and 18) (The Californian 1951: 1).

After Fort Ord closed in 1994, Warrior Stadium became part of the CSUMB campus. The stadium was rebranded as Freeman Stadium and has not been used for athletic purposes in some time; instead it is used for graduation ceremonies and other gatherings.

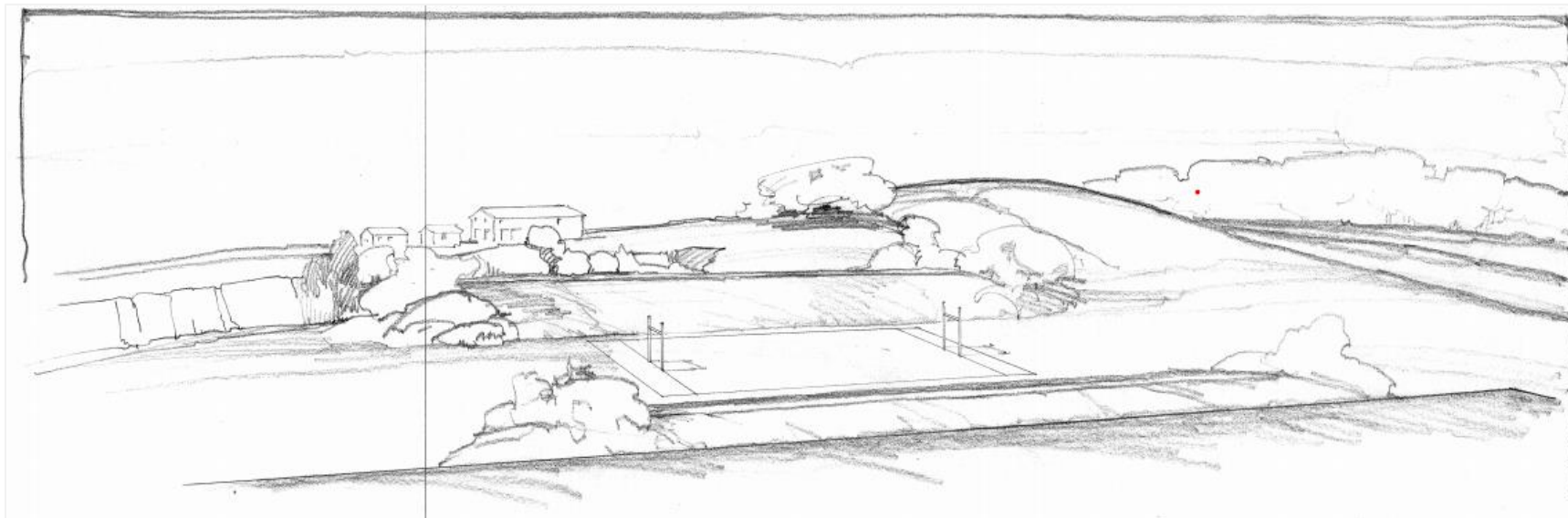

Figure 17. Fort Ord 1951 conceptual drawing of the Stadium (CSUMB Facilities 2021).

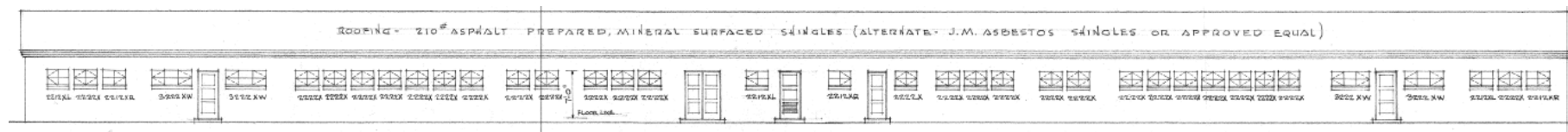

Figure 18. Fort Ord 1949 architectural drawing the Field House (CSUMB Facilities 2021).

### 3.4.5 The Volunteer Army - and the Base Realignment and Closure (BRAC) (1974-1994)

The expiration of the draft authority in 1973 created an all-volunteer Army for the first time since 1948 (Moore 1975: iii). During this era, the Army worked to increase the enlistment men and women, to raise the quality of Army life, and to improve professionalism throughout the rank and file (more 1975: iii). Lieutenant General Harold G. Moore described the program at Fort Ord as one focused on improving conditions, fostering racial harmony, enhancing morale, creating a better training regime to improve life in the Army, and encouraging enlistment (Moore 1975: 119, 121)

With the end of the Cold War in the 1980s, the government implemented programs to increase the efficiency of the Department of Defense. One of these programs included defense installation realignment and closures, including the downsizing of Fort Ord (Cavanaugh 2000: 9). The Base Realignment and Closure (BRAC) Commission determined which military installations would close. BRAC also established the framework for the transfer of ownership. Despite objections by the community to the closure of Fort Ord, the Secretary of Defense announced the closure of Fort Ord in April 1991 (Cavanaugh 2000: 9). The Fort was divided. A portion was retained by the Army, another was kept as a nature preserve, and another was set aside to establish CSUMB. Figures 19 and 20 show the newly established campus boundaries within Fort Ord. The newest installation of the California State University system opened on September 4, 1996 (Cavanaugh 2000: 29). President Bill Clinton was present for the dedication of the campus (Cavanaugh 2000: 28).



INTENTIONALLY LEFT BLANK

Figure 19. 1987 Aerial showing the current main campus boundary with intact Fort Ord buildings



Figure 20. 2021 Aerial showing the current main campus boundary with areas of extensive demolition of Fort Ord buildings and significant changes in paths of circulation



INTENTIONALLY LEFT BLANK

## 3.5 Notable Fort Ord Architects and Builders

### 3.5.1 Del E. Webb Construction Company

The Del E. Webb Company was founded by Delbert Eugene Webb in Phoenix in 1928. The company grew to develop a diverse range of projects across the United States during and was known for large-scale commercial, residential, and institutional projects (Del Webb and Pulte Homes 2021:1). During World War II, the company won many military and Navy contracts for housing projects. They specialized in streamlining massive construction projects across undeveloped land.

After World War II, Webb transitioned into many emerging development markets. In the late 1940s, Webb constructed a casino/hotel in Las Vegas for Benjamin “Bugsy” Siegel. Del Webb went on to become the “largest gaming operator and private employer in Nevada” (Del Webb and Pulte Homes 2021:1). In January of 1960, the Del Webb Corporation opened a community in Phoenix, Arizona aptly named “Sun City”. The community was known for its modestly priced housing and delivered a “highly desirable lifestyle.” Del Webb went on to construct “Sun Cities” in Florida and Southern California (Del Webb and Pulte Homes 2021:1). The company continued to focus on gaming and commercial operations until 1987 when the decision was made to sell these interests and focus on the development of “master-planned, active adult communities” (Del Webb and Pulte Homes 2021:2). By January of 2000, the company had planned and constructed 13 Sun Cities communities, selling more than 80,000 homes. In July 2001, Del Webb Company merged with Pulte Homes Inc. to create the largest homebuilding company in the nation (Del Webb and Pulte Homes 2021:3).

Webb was the lead contractor for several prominent buildings, campuses, and institutions. These included Madison Square Garden in New York City from 1964-1968 (New York, NY) and the Los Angeles County Museum of Art in 1963-1964 (Los Angeles, CA). Several buildings constructed by the company are listed on the NRHP, including many components of the Williams Air Force Base in Arizona (two Ammo Bunkers, the Civil Engineering Maintenance Shop, the Demountable Hangar, the flagpole, the Housing Storage Supply Warehouse, and the Water Pump Station and Water Tower). Additionally, Webb was the contractor for the 1938 addition to the Arizona State Capital Building, Hunts Tomb, and the Phoenix Towers, all in Phoenix, AZ. All three buildings are all listed on the NRHP.

The Del Webb Construction Company received the contract to construct forty-two buildings at Fort Ord in February of 1952. This contract included the construction of the Hammerhead Buildings/Barracks, buildings for the regional headquarters, and regimental supplies buildings (The Web Spinner 1952-54, Vol 6. No. 3:1). The company was also awarded the contract in March of 1952 to construct a guardhouse, stockade, warehouse, and other buildings and a contract to construct the utilities, including fencing, paving, railroads, water systems, water supply and storage (including reservoirs, well houses, equipment, and a water booster pump station), gas distributing system, and sanitary and storm sewer installations. (The Web Spinner 1952-54, Vol 6. No. 4:1; The Web Spinner 1952-54, Vol 6. No. 8:1).

### 3.5.2 Milton T. Pflueger

Milton Theodore Pflueger was born in San Francisco in 1907. From 1925 to 1929, Pflueger worked as a draftsman for the architectural firm Bakewell & Brown. Around 1930, Pflueger began working for his older brother, Timothy Pflueger, who was a partner of architect J. R. Miller (OAC 2021). In 1940, Milton Pflueger went into partnership with his brother Timothy for several years until Timothy Pflueger died in 1946 (PCAD 2021).

Milton Pflueger opened his own firm in the San Francisco Bay area. His more notable projects included: Richmond Memorial Civic Center (Richmond, CA), University of San Francisco Richard A. Gleeson Library (San Francisco, CA), the headquarters building for the Department of Motor Vehicles (Sacramento, CA), the Herbert C. Moffitt Hospital at the University of California Medical Center (San Francisco, CA), Alemany Housing Project (San Francisco, CA), the William F. Herrin laboratories, Herrin Hall, and Florence Moore Hall, all at Stanford University (Stanford, CA), Millberry Union UCSF Medical Center (San Francisco, CA), and Tulare Theater, (Tulare, CA) (OAC 2021 and PCAD 2021). Pflueger's firm is known to have designed the Science Research Annex building in the Built Environment ADI (CSUMB Facilities 2021).

### 3.5.3 Robert Stanton

Robert Stanton was born in Detroit, Michigan in 1900. He served briefly in the U.S. Navy during World War I and then graduated from high school in Los Angeles and went on to complete his education at University of California at Berkeley. After graduation he worked with renowned architect, Wallace Neff. Neff appointed Stanton as project supervisor on several projects and Stanton earned his architecture license in 1934. Stanton moved to Monterey Bay in 1935 and went on to design a variety of residential, commercial, and public buildings in the area. Two of his buildings, the Monterey County Courthouse and the King City High School Auditorium have been listed on the NRHP (Hiller 2007:8-4). Robert Stanton was known to have designed a plan for classroom buildings at Fort Ord that was used for at least four buildings on campus (CSUMB Facilities 2021).

## 3.6 Notable Fort Ord Military Personnel

### 3.6.1 General Joseph "Vinegar Joe" Stilwell

Joseph Warren Stilwell was born in 1883 in Palatka, Florida. He joined the Army and graduated from the United States Military Academy in West Point, New York in 1904 (Encyclopedia Britannica 2021). During World War I, he served as the Deputy Chief of Staff for Intelligence in the IV Corps of the American Expeditionary Forces. He served three times in China and could speak fluent Chinese (Chen n.d.). While serving his third posting in China, he acted as military attaché to the U.S. Legation in Beijing (now Beijing) in north China from 1935 and 1939 (Chen n.d.).

While teaching at the Infantry School at Fort Benning, Georgia, one of Stilwell's students drew a caricature of Stilwell rising out of a vinegar bottle, "portraying his sore personality, and the name 'Vinegar Joe' stuck with him for the rest of his career" (Chen n.d.). He was known to give malevolent nicknames to people he did not like and had a "no-nonsense attitude" (Chen n.d.).

In 1940, Stilwell was the commanding officer of the 7th Division at Fort Ord. While at Fort Ord, he started the Fort's newspaper, *Panorama*. He wanted "a weekly newspaper published by and for the officers and men of Fort Ord/Presidio of Monterey area" (Panorama 1990: 2). Stilwell also established Fort Ord Soldier's Club in 1943 (later renamed the Stilwell Community Center). "The cost was partially funded by enlisted soldiers who voluntarily contributed" (McPherson 1990: 18). The Club was located over the bluffs near the Pacific Ocean and was demolished in 2003 due to erosion.

Stilwell left Fort Ord in 1943 to command the American Troops in the China-Burma-India theater (Castle 1990: 3). He returned to the United States and served as the Sixth Army commander in San Francisco. Stilwell died in 1946 (Encyclopedia Britannica 2021).

### 3.6.2 Lt. James (Jim) E. Moore

James (Jim) E. Moore was born on June 28, 1931. He graduated from United States Military Academy in West Point, New York and was assigned to the 28th Infantry, in Heilbronn, Germany. In 1954, Moore married Joan Marie Phillips, and the couple had seven children. He was stationed at Ft. Bragg, Ft. Benning, and the Alliance Francaise. During the conflict in Vietnam, Moore was awarded both the Silver Star and Vietnamese Cross of Gallantry for his service (Moore Chiusano 2009).

After Vietnam, Moore attended the Army War College and was assigned to J-3 Headquarters, U.S. European Command. Moore was selected to command two Fort Ord brigades, the 3rd BCT Brigade, and the 1st Brigade, 7th Infantry Division (Cavanaugh 2000: preface). He later commanded the 7th Infantry Division. He is credited with saying, “take care of soldiers, and they will take care of the mission” (Moore Chiusano 2009). Moore was awarded the Distinguished Service Medal. He was promoted to lieutenant general in 1985. Moore died in 1999 and the North-South Road at Fort Ord was renamed after him in 2000 (Moore Chiusano 2009).

## 3.7 Fort Ord Building Typology and Character-Defining Features

The following presents a discussion of the building typology found on the campus and provides a detailed account of the specific character-defining features of buildings and structures on site. Four categories of building types were identified for the purposes of this study. These are the Support Services Buildings, Medical Buildings, Hammerhead Buildings/Barracks, and Recreational Facilities. The numbering system used throughout the following discussion represents the current building numbers and building names as shown on the official campus master plan map unless otherwise specified.

### 3.7.1 Support Services Buildings

The Support Services Buildings on the campus were originally constructed in the late 1950s and the early 1960s. The buildings tended to have central entryways that opened into hallways, with classrooms lining the halls. These buildings have a uniform design, like many of the other buildings at Fort Ord. The buildings that fall under this category for the Built Environment ADI include Green Hall (58), the Reading Center (59), Beach Hall (21), and Tide Hall (23).



Figure 21. Building 58, Green Hall, View facing southeast at the north elevation (IMG\_0566).

**Character-Defining Features for the Support Services Buildings**

The Support Services Buildings originally exhibited the following specific character-defining features (Table 5):

**Table 5. Character-Defining Features: Fort Ord Support Services Buildings**

| Character Aspect       | Primary Character-Defining Features  | Character-defining features  |
|------------------------|--|--|
| Shape and Plan         | <ul style="list-style-type: none"> <li>• Simple rectangular form</li> <li>• Single story</li> </ul>  | The overall shape and mass of the building are considered a primary character-defining feature of the support services buildings. The plan should be rectangular in form.  |
| Roof                   | <ul style="list-style-type: none"> <li>• Flat or gable roof</li> <li>• small eave overhangs</li> <li>• No exposed rafters</li> </ul>                                   | Support service buildings from this period have gable roof forms, with slight eave overhangs.  |
| Openings               | <ul style="list-style-type: none"> <li>• Public entrances and circulation patterns</li> </ul>  | Window openings are generally uniform in size and placement, windows are multi-light, and set into concrete openings. Replaced windows are not considered character-defining features as they fall outside the period of significance.   |
| Exterior Ornamentation | <ul style="list-style-type: none"> <li>• Minimal exterior ornamentation</li> </ul>   | The support services buildings were designed to be quickly constructed. They have little to no decorative ornamentation, with windows being set evenly apart and CMU pillars being the only decorative element.  |
| Materials              | <ul style="list-style-type: none"> <li>• Mass-produced and cost-effective materials</li> <li>• Concrete and CMU</li> <li>• Reinforced Concrete construction</li> </ul> | The support services buildings have simple, utilitarian designs. Buildings were constructed using mass-produced and cost-effective building materials that were readily available at the time of construction. For instance, buildings under the support services buildings type were constructed with reinforced concrete and CMU and were minimally decorated. |

Alterations and demolitions over time have compromised the overall architectural integrity of this building type. The most common alterations observed for this building type include the following:

- Replacement windows
- ADA compliance measures such as ramps and doors
- HVAC systems and window units
- Infill of openings
- Addition of front gable over doorways
- Interior renovations

### 3.7.2 Medical Buildings

The Medical Buildings on the campus were originally constructed in the late 1950s and the early 1960s. The Medical Buildings tended to have central entryways that opened into waiting areas, with smaller exam rooms behind reception desks. These buildings did not have a uniform design, unlike many of the other buildings at Fort Ord. The buildings that fall under this category for the campus include The Science Research Lab Annex (13) and the Watershed Institute (42).



**Figure 22.** Building 13, the Science Research Lab Annex, View facing northwest at the south elevation (IMG\_0715).



### Character-Defining Features for the Medical Buildings

The Medical Buildings originally exhibited the following specific character-defining features (Table 6):

**Table 6. Character-Defining Features: Fort Ord Medical Buildings**

| Character Aspect       | Primary Character-Defining Features  | Character-Defining Features   |
|------------------------|--|---|
| Shape and Plan         | <ul style="list-style-type: none"> <li>• Simple rectangular form</li> <li>• Single story</li> </ul>  | The overall shape and mass of the building with a central entrance opening to waiting areas.  |
| Roof                   | <ul style="list-style-type: none"> <li>• Flat roof</li> <li>• Moderate or slight eave openings</li> <li>• No exposed rafters</li> </ul>  | The Medical Buildings have flat roofs, with moderate or slight eave overhangs.  |
| Openings               | <ul style="list-style-type: none"> <li>• Entrances on the ground level</li> <li>• Multi-light windows or modern windows with protruding metal frames set on concrete sills</li> <li>• Public entrances and circulation patterns</li> </ul> | Window openings are uniform in size and placement, windows are multi-light, and set into concrete openings. Replaced windows are not considered character-defining features as they fall outside the period of significance.  |
| Exterior Ornamentation | <ul style="list-style-type: none"> <li>• Minimal exterior ornamentation</li> <li>• Glass windows used as ornamentation</li> </ul>  | The Medical Buildings were often specifically designed to serve specific functions. They have little to no decorative ornamentation, with windows in ribbons, or evenly spaced windows being the only decorative element.   |
| Materials              | <ul style="list-style-type: none"> <li>• Mass-produced and cost-effective materials</li> <li>• Concrete and CMU</li> <li>• Reinforced Concrete construction</li> </ul>   | Medical Buildings have simple, utilitarian designs. Buildings were constructed using mass-produced and cost-effective building materials that were readily available at the time of construction. Buildings under the Medical Building type were constructed with reinforced concrete and CMU and were minimally decorated. |

Alterations and demolitions over time have compromised the overall architectural integrity of this building type. The most common alterations observed for this building type include the following.

- Replacement windows
- ADA compliance measures such as ramps and doors
- HVAC systems and window units
- Infill of openings
- Interior renovations

### 3.7.3 Hammerhead Buildings/Barracks

The Hammerhead Buildings/Barracks were originally constructed between 1952 and 1954, and historically served as a barracks for housing troops. These buildings were commonly called the Hammerhead Buildings because of the “hammer”-like plan. Buildings within the Built Environment ADI that fall under this category include Pacific Hall (44), Coast Hall (45), and Harbor Hall (46).



Figure 23. Building 44, Pacific Hall, View facing east at the west elevation (IMG\_0602).

#### Character-Defining Features of the Hammerhead Buildings

The Hammerhead Buildings/Barracks originally exhibited the following specific character-defining features (Table 7):

Table 7. Character-Defining Features: The Hammerhead Buildings/Barracks

| Character Aspect | Primary Character-Defining Features  | Character-Defining Features  |
|------------------|--|--|
| Shape and Plan   | <ul style="list-style-type: none"> <li>• Hammerhead shape</li> <li>• Single story wing and multi-story wing</li> </ul>     | The overall shape and mass of the building are considered a primary character-defining feature of the Hammerhead Buildings/Barracks. The plan should include a multi-story wing.   |
| Roof             | <ul style="list-style-type: none"> <li>• Flat roof</li> <li>• Wide eave overhangs</li> <li>• No exposed rafters</li> </ul> | The Hammerhead Buildings/Barracks have flat roofs, with moderate eave overhangs.   |
| Openings         | <ul style="list-style-type: none"> <li>• Entrances on the first story</li> <li>• Multi-light windows</li> </ul>            | Window openings are uniform in size and placement, windows are multi-light, and set into concrete openings. Replaced windows are not considered character-defining features as they fall outside the period of significance. |

**Table 7. Character-Defining Features: The Hammerhead Buildings/Barracks**

| Character Aspect       | Primary Character-Defining Features  | Character-Defining Features   |
|------------------------|--|---|
| Exterior Ornamentation | <ul style="list-style-type: none"> <li>• Minimal exterior ornamentation</li> <li>• Glass windows used as ornamentation</li> </ul>                                      | Hammerhead Buildings/Barracks were designed to be quickly constructed. They have little to no decorative ornamentation, with windows in ribbons being the only decorative element.  |
| Materials              | <ul style="list-style-type: none"> <li>• Mass-produced and cost-effective materials</li> <li>• Concrete and CMU</li> <li>• Reinforced concrete construction</li> </ul> | Hammerhead Buildings/Barracks have simple, utilitarian designs. Buildings were constructed using mass-produced and cost-effective building materials that were readily available at the time of construction. For instance, buildings under the Hammerhead type were constructed with reinforced concrete and CMU and were minimally decorated. |

Alterations and demolitions over time have compromised the overall architectural integrity of this building type. The most common alterations observed for this building type include the following.

- Replacement windows
- ADA compliance measures such as ramps and doors
- HVAC systems and window units
- Infill of openings
- Interior renovations

### 3.7.4 Recreational Facilities

The only Recreation Facilities in the Built Environment ADI, Freeman Stadium, was originally constructed in 1951. As previously discussed, the stadium was constructed at the site of Fort Ord’s existing amphitheater, just north of the former parade grounds. The 6,000-seat stadium seating was constructed of reinforced concrete, set into the existing dirt embarkment (Fresno Bee 1951a: 13). The Field House was also constructed of concrete, as a building ban was in effect and concrete was not a restricted material.



Figure 24. Building 902, Freeman Stadium, View facing northeast at the west elevation (IMG\_0431).

#### Character-Defining Features for the Recreational Facilities

The Recreation Facilities originally exhibited the following specific character-defining features (Table 8):

Table 8. Character-defining features: Fort Ord Recreational Facilities

| Character Aspect       | Primary character-defining features   | Character-defining features  |
|------------------------|---|--|
| Shape and Plan         | <ul style="list-style-type: none"> <li>• Arena form</li> <li>• Track</li> <li>• Field</li> <li>• Bleachers</li> <li>• Field House</li> </ul>      | The overall shape and mass of the building as well as circulation and arrangement of the bleachers relative to the field are considered primary character-defining features of Recreational Facilities.                      |
| Roof                   | <ul style="list-style-type: none"> <li>• Various roof forms</li> <li>• Slight eave overhangs</li> </ul>   | Recreational Facilities have varied roof structures, but the retention of the form is a primary character-defining feature   |
| Openings               | <ul style="list-style-type: none"> <li>• Multi-light windows</li> <li>• Concession windows</li> </ul>   | Window openings are uniform in size and placement, windows are multi-light, and set into concrete openings. Replaced windows are not considered character-defining features as they fall outside the period of significance. |
| Exterior Ornamentation | <ul style="list-style-type: none"> <li>• Minimal exterior ornamentation</li> <li>• Glass windows and glass block used as ornamentation</li> </ul> | Recreation Facilities were designed to be the backdrop to athletic competitions and events. They have little to no decorative ornamentation, with evenly spaced windows being the only decorative element.                   |

**Table 8. Character-defining features: Fort Ord Recreational Facilities**

| Character Aspect | Primary character-defining features  | Character-defining features  |
|------------------|--|--|
| Materials        | <ul style="list-style-type: none"> <li>• Mass-produced and cost-effective materials</li> <li>• Concrete and CMU</li> <li>• Reinforced Concrete construction</li> </ul> | Recreation Facilities have simple, utilitarian designs. Buildings were constructed using mass-produced and cost-effective building materials that were readily available at the time of construction. For instance, buildings under the Recreational Facility type were constructed with reinforced concrete and were minimally decorated. |

Alterations and demolitions over time have compromised the overall architectural integrity of this building type. The most common alterations observed for this building type include the following.

- Replacement windows
- Barrel roof additions
- Infill of openings
- HVAC systems and window units
- ADA compliance measures such as ramps and doors

## 3.8 Historical Overview California State University Monterey Bay

### 3.8.1 Higher Public Education in California

The following section discusses the expansion of the State Normal School system in California and the circumstances that caused the early campuses to become the foundation of the Nation’s largest public four-year university system.

The Normal School system began in 18th century Europe as a training school for teachers to establish a standard approach to elementary school curriculum in public institutions. As the notion of consistent teacher-training spread beyond Europe, the first Normal School was established in the United States in Lexington, Massachusetts in 1839 (Encyclopedia Britannica 2002). Nearly twenty years later in 1857, the San Francisco Board of Education established Minns Evening Normal School in San Francisco, named after the school’s first principal, George Minns. It was not only the first Normal School in the state but also the first public institution of higher education in operation within the new State of California (Vasche 1959: 5; CSUC 2021a).

Following a vote of basis by the State Legislature, Minns Evening Normal School became the California State Normal School in 1862. In 1871, the State Legislature voted to relocate the campus from San Francisco to San Jose, where it opened in time for the 1872 term. This campus continues to this day as San Jose State University (CSUC 2021a).

Subsequent State Normal School campuses were established in other cities throughout the State during the remainder of the 19th century, including Los Angeles (1882), Chico (1889), San Diego (1897), and another in San Francisco (1899) (Vasche 1959: 5).

Following the turn of the 20th century, the California State Normal School system established several campuses that offered new educational opportunities. The California Polytechnic School in San Luis Obispo opened as a State-funded, vocational co-ed high school in 1903. The Santa Barbara State Normal School of Manual Arts and Home Economics opened in 1909 as a public institution that adopted the Finnish Sloyd, or education through manual training. The first public junior college opened in Fresno in 1910. Two additional Normal Schools were established during the early 20th century in Fresno (1911) and Arcata (1913) before the State Legislature voted to change all “Normal Schools” in the State system to “Teachers Colleges” in 1921. The State Teachers Colleges were authorized to offer a B.A. of Education in 1923, which was followed by the approval to offer courses beyond teacher training when the Legislature voted to rename “Teachers Colleges” to “State Colleges” in 1935. At this time, the State College system was serving approximately 8,230 students per year (Vasche 1959: 5).

Prompted by massive post-World War II population growth in California, ten (10) new campuses were in place by 1961 when the Donahoe Higher Education Act of 1960 formally established the “California State Colleges” (CSC) system. The newest campuses in Los Angeles (1947), Sacramento (1947), Long Beach (1949), Fullerton (1957), Hayward (1957), Stanislaus (1957), San Fernando Valley (1958), Sonoma (1960), San Bernardino (1960), and Dominguez Hills (1960) helped the burgeoning State system educate roughly 105,900 students annually throughout the state (CSUC 2021a). To construct the facilities necessary to serve the students on the new and expanding CSC campuses, in some cases, the State of California Public Works, Division of Architecture modified standardized designs to fit the needs of individual campuses to save money and expedite construction schedules.

In 1972, the State College System was renamed “The California State University and Colleges” which included criteria by which 14 state campuses were henceforth deemed a ‘University’ while the remaining five retained their designation as a ‘College’. In 1982, the system schools became “The California State University” (CSU) system. Today, the CSU system is one of the widest-ranging public education systems in the United States and presently includes twenty-three (23) participating campuses throughout the state, which serve an estimated 481,000 students every year (Encyclopedia Britannica 2006; CSUC 2021b).

### 3.8.2 Historical Overview of CSUMB (1991-present)

The establishment of CSUMB began in 1991 when news of Ford Ord’s closing was released. Following the announcement of Fort Ord’s closure, plans for a new university were organized through CSU San Jose, with the goal of opening a new CSU campus on the former Fort by August 1995. In May of 1994, the CSU system was given 1,350 acres of former Fort Ord land to establish the CSUMB campus (CSUMB 1998: 19). Administrators set up three temporary facilities in August 1994 and by early 1995 several former military buildings were in the process of rehabilitation for educational use. When the school opened in August, only “two of the twenty-two facilities under renovation were completed, and classes began on the campus and in a nearby vacant elementary school on a temporary basis” (CSUMB 1998: 21). CSUMB was the first university created on what was previously an active military installation. President Bill Clinton was present on September 4, 1995, for the dedication ceremony of the 21st school in the California State University system (CSUMB 1998: 21). In 1995, CSUMB had 633 students with the first phase of construction focusing on renovating military buildings into the key elements of a college campus, including lecture halls and classrooms, faculty offices, dormitories, an auditorium, a student dining hall, a gymnasium, and a library (CSUMB 1998).

The first campus Master Plan was prepared in 1998 and presented the development history of the campus and planned development for the coming years. The 1998 plan stated that two of the three original phases of construction were completed with funding coming from the “military to education” defense conversion project. The plan also stipulated that by the fall of 1997 the campus would have 42 buildings with approximately 500,000 gross square feet of space for campus use (CSUMB 1998).

The college’s first period of development revealed design issues with conversion efforts from a structured and highly organized military design into the interdisciplinary requirement of higher education with an emphasis on freedom of movement (Cavanaugh 2000: 28; CSUMB 1998). The following excerpt from the 1998 plan clearly defines the design challenge presented to the University in the initial phase of campus development:

The campus’s previous use as a military installation serves as the basis for the campus’s community design. The existing buildings, road systems, and landscape spaces were built quickly over specific time periods. Building development is located in clusters over large areas. In addition to the nature and period of development, the political hierarchy of the military is expressed in the organization and placement of the buildings. The building clusters are oriented inward, away from the street, to control their function and use. In imposing this sense of hierarchy, the military formed an environment that, for the University, inherently limit opportunities of use by restricting the social aspects of the built environment that buildings and streets normally offer to a community (CSUMB 1998: 97).

Unlike many colleges in California, CSUMB began with a pre-constructed campus of buildings remaining from the decommissioned military installation. The Army buildings that the university inherited in 1994 were organized in efficient, easy to monitor, gridded developments that were separated by large, paved areas to store military vehicles (Moore 2007: 3-4). The college not only needed to convert buildings constructed for military use into usable education spaces, but they also needed to deformalize the spaces by including roads, landscaping, and pedestrian pathways to make them conducive to be used by students, faculty, and workers (CSUMB 1998; NETR 2021).

Some of the first major modifications to the military buildings occurred as the campus pursued its mobility initiative with a comprehensive ADA compliance plan in the late 1990s. During this time, all of the buildings on the campus were modified for ADA compliance to fulfill a new purpose as an education facility. Such alterations included the installation of ramps and the replacement of original entry and exit points with ADA-accessible doors (CSUMB 1998; CSUMB Plan Room 2021).

This first phase of construction was focused around the Main Quad (Freshman Quad), which became the first significant open space created on campus. Construction was also focused along Sixth Avenue with the renovation of some of the Hammerhead Buildings/Barracks to house academics and support facilities. By 1998, the Main Quad was formalized with curved pedestrian pathways connecting the buildings and surface parking lots along Fifth Avenue. The parking lot to the north of the Main Quad along Inter-Garrison Road retained its same general shape and structure, providing student and faculty parking. This section of the campus became the college’s core and allowed for future planning efforts to utilize it as a centralized location (CSUMB 1998; NETR 2021).

The early 2000s brought additional changes to the college, including the infill of open spaces with the development of North Quad along Inter-Garrison Road and the construction of Chapman Science Academic Center in 2003. These two construction projects followed along the college’s developing main corridors to the southwest of the intersection of Inter-Garrison Road and Sixth Avenue. The Fort Ord buildings, roads, and parking lots east of Sixth Avenue were largely unused, and the school’s development was focused west of Sixth Avenue. With the construction of Chapman

Science Academic Center, a pedestrian zone was developed between 2005 and 2009 connecting A Street to Divarty Street and the Main Quad. A three-street roundabout allowed for an improved flow of traffic and generated a more cohesive campus plan (NETR 2021). These changes facilitated the consolidation of academic spaces in an attempt to generate a reasonable, pedestrian scale circulation pattern (Moore 2007: 4-1). Parking lots from Fort Ord continued to be utilized into the 2000s, north of the Visual and Public Art Center (Building 70) and south of Beach Hall and Tide Hall (Buildings 21 and 23). The large lot on the southern side of Divarty Street by 2007 had undergone a large-scale redevelopment project with the construction of the Tanimura & Antle Family Memorial Library, the Business & Information Technology Building, and the Crescent walkway. This series of redevelopments eliminated half of the parking lot on the southern side of Divarty Street and redirected pedestrian traffic along the large open space to the direct south of the college along the Crescent walkway. The 2007 project reinforced the campus's developing centralized core and worked to further pedestrian corridors (CSUMB 2007; NETR 2021).

Unlike the majority of colleges in California that continue to grow in size based on the influx of new students, CSUMB required a continuous removal of buildings or portions of buildings located onsite. Between 2012 and 2014, the eastern wings of Coast Hall (Building 45) and Harbor Hall (Building 46) were demolished. Exposed openings were enclosed with CMU. Similarly, between 2016 and 2018, the college demolished nine of the Hammerhead Buildings/Barracks between Inter Garrison Road and B Street and the eastern wing of Pacific Hall (Building 44). This section of the college transitioned from a formalized double row of Hammerhead Buildings/Barracks, repeating in design, plan, and spacing arranged around a centered roadway, into a row of academic buildings easily accessed from Sixth Avenue and A Street (NETR 2021). Throughout the 2000s and 2010s, CSUMB constructed new facilities closer to the Main Quad. Over time the rigid military planning was disrupted with pedestrian pathways, replacement of open lots or parking lots with buildings, and the demolition of Fort Ord buildings (Figures 19 and 20).



INTENTIONALLY LEFT BLANK

# 4 Results of Identification Efforts and Building Descriptions

---

As stated in the field methods (Section 2.3), campus buildings not included in the survey included those that have no renovation or demolition proposed under the Project; buildings of recent construction that lack historical associations; buildings less than 45 years old, portable/temporary buildings; or buildings that were recently moved onto the campus from a different location. Furthermore, at this time it does not appear that any of the post-1976 buildings located on the campus rise to the level of exceptional importance required for buildings and structures of the recent past to be considered historically significant.

A total of 11 properties are located within the Built Environment ADI (Figure 2). The properties were constructed between 1951 to 1964 and were documented and evaluated in consideration of NRHP, CRHR, CHL, and local criteria and integrity requirements as part of this study. These properties required recordation and evaluation for historical significance because they are over 45 years old and will potentially be impacted by Near-Term Projects. The tables below provide survey results for the 11 properties, including a photograph of each building/structure, current name, year built (if known), a general physical description of the building/structure, and any alterations identified either through building development research or during the historic built environment resources survey. Dates and details of construction and alterations were confirmed through building development research conducted at the CSUMB Facilities office and archival research.

INTENTIONALLY LEFT BLANK

Table 9. Properties Surveyed



| Building Number | Current Building Name   | Year Built | Descriptions  | Identified Alternations  | Architectural Style | Architect (if known)                                  |
|-----------------|---|------------|---|--|---------------------|---|
| 13              | <b>Science Research Lab Annex</b><br><br>View facing south at the north elevation (IMG_0715) | 1964       | The one-story, utilitarian building with modern stylistic details has a rectangular floor plan with several small projections. The building appears to sit on a concrete slab foundation and the primary construction materials are CMU and cement. The perimeter of the building has simple native landscaping on the east, west, and south elevations. A parking lot is located to the north of the building. The primary elevation faces south with a concrete path leading to the main entrance from A Street. The primary entrance is located offset to the east on the south elevation. The building has a flat roof with small eave overhangs. The main entrance consists of a pair of recently added metal-framed glazed doors, with a large, fixed transom. A fully glazed wall of windows is located to the west of the primary entrance. The exterior walls are varied, with the majority of the building constructed of CMU, with some concrete sections and some floor-to-ceiling windows. Fenestration is irregular and includes horizontal pane 1/1 metal-framed, and metal-framed picture windows, and metal-framed casement windows. An ADA-accessible ramp is located on the north elevation leading to the parking area on the north elevation and a second ADA ramp and entrance are on the east elevation. Metal vents are located below the windows on the north elevation. | <ul style="list-style-type: none"> <li>• 1987 (Fort Ord): Remodel to move the dental clinic to the west side of the building and retrofit east side for proposed blood donor's clinic. Renovations include the demolition of interior walls and finishes, installation of new doors and finishes, construction of loading dock at northwest corner and addition of ramp to parking, new concrete exit porch and stairs.</li> <li>• 1995 (CSUMB): New ramp on east and west elevations, new vents on north elevation, and new window wall added to south elevation, west of primary entrance, new lath, and plaster to match existing on window alteration on north elevation.</li> <li>• 1995 (CSUMB): Change in use from medical/dental building to Science Research Lab</li> </ul> | Utilitarian         | 1964: Milton T. Pflueger Architect, San Francisco, CA |
| 21              | <b>Beach Hall</b><br><br>View facing north at the south elevation (IMG_0302)               | 1954       | The one-story utilitarian building has a rectangular floor plan and a concrete block structural system. The south-facing main elevation is symmetrical. It is covered by a moderately pitched side-gabled roof clad with composition shingles. The south main entrance is located centrally and is flanked by two squared projections and capped by a gabled, glazed dormer. The main entrance consists of recently added metal-framed double-glazed doors with sidelights and topped with a transom. Secondary doors are located to the far east and west ends of the main elevation. Windows are recently added metal-framed, one-over-one, fixed, and awning windows. A single column of cinderblocks is located between every other window on the main and rear north elevation. The fenestration pattern is repeated on the rear elevation. It appears that the westernmost window at the rear elevation was once a door as a pedestrian walkway leads directly up to it. Other alterations include the infill of a centrally located door and windows that flanked it on the rear elevation, added central gabled projection on the main elevation, and recently added main door and all windows.   | <ul style="list-style-type: none"> <li>• Replaced original windows with metal sash fixed and awning windows (1995)</li> <li>• Replaced original windows with recently added glazed double doors, sidelights, and transom window (1995)</li> <li>• Various filled in windows and doors (1995)</li> <li>• Added gable projection on south elevation (1995)</li> <li>• Change of circulation within building as doorways were converted to windows (1995)</li> </ul>  | Utilitarian         | Robert Stanton  |

Table 9. Properties Surveyed



| Building Number | Current Building Name  | Year Built | Descriptions   | Identified Alternations  | Architectural Style | Architect (if known)   |
|-----------------|--|------------|--|--|---------------------|--|
| 23              | <b>Tide Hall</b><br> <p>View facing north at the south elevation (IMG_0292)</p>             | 1954       | The one-story utilitarian building has a rectangular floor plan and a concrete block structural system. The south-facing main elevation is symmetrical. It is covered by a moderately pitched side-gabled roof clad with composition shingles. The main entrance is located centrally and is flanked by two squared projections and capped by a gabled, glazed dormer. The main entrance consists of recently added metal-framed sliding doors. Secondary doors are recently added and located to the far east and west ends of the main elevation. Windows are recently added metal-framed, one-over-one, fixed, and awning windows. Single columns of cinderblocks are located between every other window on the main and rear north elevation. The westernmost and easternmost recently added windows on the rear elevation appear to have been originally been doorways as concrete and asphalt pedestrian walkway lead directly up to it. The fenestration pattern is repeated on the north (rear) elevation. Alterations include the infill of centrally located windows on the rear elevation, conversion of doors to windows on rear elevation, added central gabled projection on the main elevation, and recently added doors. | <ul style="list-style-type: none"> <li>Replaced original windows with metal sash fixed and awning windows (Date Unknown)</li> <li>Various filled in windows and doors (Date Unknown)</li> <li>Added gable projection on south elevation (Date Unknown)</li> <li>Replaced original doors</li> </ul> Change of circulation within building as doorways were converted to windows | Utilitarian         | Robert Stanton   |
| 42              | <b>Watershed Institute</b><br> <p>View facing south at the north elevation (IMG_0683)</p> | c. 1959    | The one-story utilitarian building with modern stylistic details has a primarily rectangular floor plan with a rectangular projection on the west facade. The building appears to sit on a concrete slab foundation and the primary construction material is CMU. The building has a flat roof with small, concrete eave overhangs. The primary elevation faces north with a concrete path leading to the main door from B Street. Planted areas with native landscaping surround the building. A parking lot is located to the south. A concrete path leads from the parking lot to an entrance on the west end of the south elevation. The primary entrance is located offset to the east on the north elevation. The entrance consists of a pair of recently added metal-framed glazed doors, with a large, fixed transom. The north, primary, elevation has six, evenly spaced windows to the east of the entrance and two evenly spaced windows to the west. Fenestration is varied and includes fixed metal-framed picture windows and 1/1 metal. All windowsills appear to be precast concrete.   | <ul style="list-style-type: none"> <li>Several original windows on primary facade replaced with fixed picture windows (Date Unknown)</li> <li>Exterior walls repainted (Date Unknown)</li> <li>Entry doors replaced with modern, ADA-accessible doors (Date Unknown)</li> </ul>  | Utilitarian         | 1956: Noakes & Neubauer, Architects, and Engineers, Washington D. C. |

Table 9. Properties Surveyed



| Building Number | Current Building Name  | Year Built | Descriptions  | Identified Alternations   | Architectural Style | Architect (if known) |
|-----------------|--|------------|---|---|---------------------|----------------------|
| 44              | <p><b>Pacific Hall</b></p>  <p>View facing southeast at the west elevation (IMG_0602)</p> | 1952-1954  | The utilitarian building with modern stylistic details is constructed of board-formed concrete. The single-story building has an L-shaped plan with a flat roof and concrete eave overhangs. The primary, west, elevation has the main entrance at the corner of the "L." Fenestration includes bands of rectangular fixed glass windows in protruding metal frames set on concrete sills. Above the rectangular windows are square metal-framed decorative white panels. The east elevation shows changes to the plan, with a concrete framed door filled with CMUs and a change in exterior cladding. An ADA-accessible ramp leads to a secondary entrance with an arched metal awning on the east facade. The south elevation mirrors other elevations in style and materials. A CMU-filled window opening, and a door repurposed as a window are on the west end of the south elevation. The building appears to sit on a concrete foundation.  | <ul style="list-style-type: none"> <li>• Demolition of east, multi-story wing, and infill of opening with CMU (between 2016 and 2021).</li> <li>• Infill of multiple openings and fenestration changes.</li> <li>• Addition of mosaic mural near primary entrance on west façade (Date Unknown).</li> <li>• Addition of ADA ramps (Date Unknown).</li> <li>• Replacement of original windows throughout.</li> </ul> | Utilitarian         | Unknown              |
| 45              | <p><b>Coast Hall</b></p>  <p>View facing southeast at the west elevation (IMG_0645)</p>  | 1952-1954  | The utilitarian building with modern stylistic details is constructed of board-formed concrete. The single-story building has an L-shaped plan with a flat roof and concrete eave overhangs. The primary, west, elevation has the main entrance at the corner of the "L." Fenestration includes bands of rectangular fixed glass windows in protruding metal frames set on concrete sills. Above the rectangular windows are square metal-framed decorative white panels. Below the windows is a section of concrete block. The east elevation shows changes to the plan, with a concrete framed door filled with CMUs and a change in exterior cladding. ADA-accessible ramps are located on the east and west sides of the building. The south and north elevations mirror other elevations in style and materials. Extensive changes to fenestration and door openings are visible on the south elevation. Several wall sections throughout the building are filled with CMU, showing changes to fenestration, pedestrian entrances, and plan. The building appears to sit on a concrete foundation. | <ul style="list-style-type: none"> <li>• Demolition of east, multi-story wing, and infill of opening with CMU (between 2012 and 2014).</li> <li>• Infill of multiple openings and fenestration changes (between 2016 and 2021)</li> <li>• Addition of ADA ramps (Date Unknown)</li> <li>• Replacement of original windows throughout.</li> </ul>  | Utilitarian         | Unknown              |

Table 9. Properties Surveyed



| Building Number | Current Building Name  | Year Built | Descriptions  | Identified Alternations  | Architectural Style | Architect (if known) |
|-----------------|--|------------|---|--|---------------------|----------------------|
| 46              | Harbor Hall<br> | 1952-1954  | The utilitarian building with modern stylistic details is primarily constructed of board-formed concrete. The single-story building has an L-shaped plan with a flat roof and moderate concrete eave overhangs. The primary, west, elevation has the main entrance at the corner of the "L." Fenestration includes bands of rectangular fixed glass windows in protruding metal frames set on concrete sills. Above the rectangular windows are square metal-framed decorative white panels. The east elevation shows changes to plan, with a concrete framed door filled with CMUs and a change in exterior cladding. An ADA-accessible ramp leads to a secondary entrance with an arched metal awning on the east facade. A below-grade basement is accessed on the east façade with stairs leading north under the ADA ramp. The south and north elevations mirror other elevations in style and materials. A CMU-filled window opening, and a door repurposed as a window are on the west end of the south elevation. The building appears to sit on a concrete foundation. | <ul style="list-style-type: none"> <li>Demolition of east, multi-story wing, and infill of opening with CMU (between 2012 and 2014).</li> <li>Infill of multiple openings and fenestration changes (between 2016 and 2021)</li> <li>Addition of ADA ramps (Date Unknown).</li> <li>Addition of HVAC unit to east side of building.</li> <li>Replacement of original windows throughout.</li> </ul> | Utilitarian         | Unknown              |
| 58              | Green Hall<br> | 1954       | The one-story utilitarian building has a rectangular floor plan and a concrete block structural system. The north-facing main elevation is symmetrical. It is covered by a moderately pitched side-gabled roof clad with composition shingles. The main entrance is located centrally and is flanked by two squared projections. The main entrance consists of a single metal-framed, half-glazed door topped with a transom. Secondary doors are located to the far east and west ends of the main elevation and appear to have been sealed off as doorknobs have been removed. Windows are metal-framed, multi-light awning windows. A single column of cinderblocks is located between every other window on the main and rear south elevation. The fenestration pattern is repeated on the rear elevation. Two central windows have been replaced with recently added windows. Alterations include the sealing doors shut and replacement windows at the rear elevation.  | <ul style="list-style-type: none"> <li>Replacement windows at rear elevation (Date Unknown)</li> </ul>   | Utilitarian         | Robert Stanton       |

Table 9. Properties Surveyed





| Building Number | Current Building Name   | Year Built | Descriptions   | Identified Alternations   | Architectural Style | Architect (if known) |
|-----------------|---|------------|--|---|---------------------|----------------------|
| 59              | <b>Reading Center</b><br> <p>View facing north at the south elevation (IMG_0581)</p>         | 1954       | The one-story utilitarian building has a rectangular floor plan and a concrete block structural system. The south-facing main elevation is symmetrical. It is covered by a moderately pitched side-gabled roof clad with composition shingles. The main entrance is located centrally and is flanked by two squared projections. The main entrance consists of recently added metal-framed double doors with sidelights and transom window. Secondary doors are located to the far east and west ends of the main elevation. These doors are alterations and appear to have been placed within existing windows frames. Windows are recently added, metal-framed, one-over-one, fixed, and awning windows. A single column of cinderblocks is located between every other window on the main and rear north elevation. The fenestration pattern is repeated on the rear elevation. Alterations include the infill of several window frames with doors, replacement windows, and a recently added main door.  | <ul style="list-style-type: none"> <li>Replaced original windows with metal sash fixed and awning windows (Date Unknown)</li> <li>Various filled in windows and doors (Date Unknown)</li> </ul>   | Utilitarian         | Robert Stanton       |
| 70              | <b>Visual and Public Art</b><br> <p>View facing north at the south elevation (IMG_0335)</p> | 1958       | The one-and-a-half-story utilitarian building, with a one-story portion on the north (rear) elevation, is located on the north side of Inter-Garrison Road with a west-facing main elevation. It has a rectangular floor plan and a poured-in-place concrete and steel structural system. The building is capped by a flat roof with slightly overhanging eaves. The main elevation once consisted of five garage doors that have been infilled with anodized aluminum framed, fully glazed bays, glazed doors, and filled in completely except for a row of aluminum-framed fixed windows. The main elevation features a quarter-arch canopy clad in corrugated metal and supported by steel brackets. Windows on the south elevation consist of steel-framed, multi-light, hopper, and awning windows. The fenestration pattern on the east elevation has also been altered as a car garage door and original window frames have been infilled and left with a single row of fixed aluminum sash windows. The one-story portion to the rear retains the original steel sash, multi-light windows. Two large air ducts are located at the rear. | <ul style="list-style-type: none"> <li>Added arched awnings over windows on the south and west elevations (Date Unknown).</li> <li>Infill of multiple garage openings and fenestration changes on the east and west elevations (Date Unknown).</li> <li>Exterior walls repainted (Date Unknown).</li> <li>Addition of HVAC unit to north side of building.</li> <li>Replaced original doors.</li> <li>Replacement of some original windows</li> </ul> | Utilitarian         | Architect Unknown    |



Table 9. Properties Surveyed

| Building Number | Current Building Name   | Year Built | Descriptions  | Identified Alternations  | Architectural Style                                | Architect (if known)  |
|-----------------|---|------------|---|--|--|---|
| 902/903         | <p><b>Hammerhead Buildings/Barracks</b></p>  <p>View facing northeast at the west elevation of the track and Field House. Coated field and bleachers visible on right. (IMG_0437)</p>  <p>View facing northeast at the west elevation Field House (IMG_0425)</p> | 1951       | <p>Freeman Stadium is located at a low grade, with the bleachers following the slope of the hillside. A chain-link fence encloses the field, track, and bleachers, with gates on the west, near the Field House, and on the east side of the field for ADA accessibility. Deciduous and evergreen trees and shrubs are planted around the perimeter of the chain-link fence. Freeman Stadium is made up of the following components: the field, track, bleachers, electrical building, and Field House. Freeman Stadium field is oval, paved, and has a white coating. A paved track encircles the field, but track markings are no longer delineated on the pavement. Concrete, stepped bleachers are located on the north and south side of the track and field. They each measure approximately 342 feet by 48 feet and contain 15, board-formed, concrete bleachers with concrete stairs on both the north and south ends and four sets of stairs evenly spaced throughout the bleachers, creating distinct aiseways. Additional concrete stairs lead from the track on the east and west sides of bleachers. A welded 1½ inch metal railing is located along the perimeter of each section of bleachers with openings at each stairwell. The electrical building is located on a berm west of the track. The small, windowless building is constructed of CMU and sits on a concrete foundation. The building has a low-pitched cement shed roof with small eave overhangs. The two-story, Field House building sits at the west end of the field and track (Figure 1 and 2). The building is rectangular in plan with a side-gable roof sheathed in standing seam metal. The roof has round skylights evenly spaced throughout and small eave overhangs. Three, two-story, barrel roofed sections are evenly spaced on the façade, one of which is a larger central section. Two, smaller, two-story barrel roof sections are located on the north and the southern portions of the building. The concession area is in the central two-story section. This section has square pillars supporting an overhanging barrel roof. The pillars are primarily clad in stucco fiber cement siding panels, with the lower portion clad in manufactured stone veneer. The west elevation has windows located at irregular intervals, all of which appear to be the side-sliding vinyl variety, except for the windows in the barrel roof gable ends, which appear to be fixed, multi-light windows with protruding metal frames.</p> | <ul style="list-style-type: none"> <li>• Minor changes and upgrades were completed in 1953, 1974, 1982, 1987, and 1998.</li> <li>• Major renovations were completed to the Field House in 2006, including the addition of three, barrel roof, two-story additions to the south, center, and north portions of the building, removal of original doors, windows, and substantial changes to fenestration (CSUMB Facilities 2021).</li> <li>• The field was paved in 2018 (Google Earth 2021)</li> </ul> | Altered; no longer reflects an architectural style | <p>Architect: Fort Ord Engineer Office</p> <p>Builder: F. V. Hampshire Contracting Company of Salinas</p> |

# 5 Significance Evaluation Findings

---

A total of 11 properties over 45 years old are located within the campus ADI. Each property was photographed, researched, and recorded on the appropriate DPR forms. Each property was evaluated for historical significance in consideration of NRHP, CRHR, CHL, and local designation criteria and integrity requirements. All of the 11 properties surveyed and evaluated do not appear eligible for inclusion in the NRHP, CRHR, CHL, or local register due to a lack of significant historical associations and compromised integrity.

Table below provides a list of the 11 built environment properties that appear not eligible for listing in the NRHP, CRHR, or CHL as a result of the property significance evaluations. None of the 11 buildings presented in this table are considered historical resources under CEQA or historic resources under PRC 5024 and 5024.5. The summary table below provides the following information: building number(s), current building name, year built, architectural style, property types, significance criteria if applicable, and applicable California Historical Resource Status Code (CHRS code). **Detailed individual property evaluations are provided on the DPR 523 forms, located in Appendix B.** The DPRs provide detailed information on the properties, including applicable NRHP/CRHR/CHL and local eligibility criteria, periods of significance, historic boundary, and character-defining features, if applicable.

**Table 10. Individual Significance Findings for CSUMB Buildings within the ADI**

| Table 10 Number | Campus Building Number(s) | Current Building Name      | Year Built | Architectural Style | Historic Property Type | Current Property Type | Current CHRS Status Code | Eligibility Criteria (if applicable) |
|-----------------|---------------------------|----------------------------|------------|---------------------|------------------------|-----------------------|--------------------------|--------------------------------------|
| 1               | 13                        | Science Research Lab Annex | 1964       | Utilitarian         | Military Building      | Educational Building  | 6Z                       | n/a                                  |
| 2               | 21                        | Beach Hall                 | 1954       | Utilitarian         | Military Building      | Educational Building  | 6Z                       | n/a                                  |
| 3               | 23                        | Tide Hall                  | 1954       | Utilitarian         | Military Building      | Educational Building  | 6Z                       | n/a                                  |
| 4               | 42                        | Watershed Institute        | 1959       | Utilitarian         | Military Building      | Educational Building  | 6Z                       | n/a                                  |
| 5               | 44                        | Pacific Hall               | 1952-1954  | Utilitarian         | Military Building      | Educational Building  | 6Z                       | n/a                                  |
| 6               | 45                        | Coast Hall                 | 1952-1954  | Utilitarian         | Military Building      | Educational Building  | 6Z                       | n/a                                  |
| 7               | 46                        | Harbor Hall                | 1952-1954  | Utilitarian         | Military Building      | Educational Building  | 6Z                       | n/a                                  |
| 8               | 58                        | Green Hall                 | 1954       | Utilitarian         | Military Building      | Educational Building  | 6Z                       | n/a                                  |
| 9               | 59                        | Reading Center             | 1954       | Utilitarian         | Military Building      | Educational Building  | 6Z                       | n/a                                  |
| 10              | 70                        | Visual & Public Arts       | 1958       | Utilitarian         | Military Building      | Educational Building  | 6Z                       | n/a                                  |
| 11              | 902-903C                  | Freeman Stadium            | 1951       | Utilitarian         | Military Building      | Athletic Complex      | 6Z                       | n/a                                  |

While the focus of the built environment study was to determine significance for individual buildings proposed for demolition or renovation in the Master Plan, Dudek's architectural historians also reviewed the CSUMB campus for its potential as a historic district. According to National Register Bulletin 15, a historic district is defined as a resource that "possesses a significant concentration, linkage, or continuity of sites, buildings, structures, or objects united historically or aesthetically by plan or physical development" (USDO I 1995: 5). Unlike other CSU (California State University) campuses, CSUMB was originally a military base known as Fort Ord. The history of Fort Ord dates back to 1917 and continued a growth and development trajectory until it was formally decommissioned in 1994 by the Base Realignment and Closure Commission. At the time of the closure, the land once belonging to the Army was divided, including the section that was set aside for the establishment of CSUMB. For the purposes of evaluating the CSUMB campus and its individual buildings, it was necessary to use the previously defined periods of significance for Fort Ord established by military historian Harold E. Raugh, Jr. listed below:

- Camp Gigling to Camp Ord (1917-1940)
- Fort Ord and the 7th Infantry Division (1940-1945)
- The Cold War and Vietnam Eras (1946-1976)
- The Volunteer Army (1974-1994)

In addition to the currently established military periods of significance, Dudek also evaluated the campus in consideration of the history of the CSU system and the CSUMB development period that began in the 1990s.

Given that all of the properties included within the campus ADI were constructed between 1951 and 1964, their potential for significance as a historic district would fall under the period defined as the Cold War and Vietnam Eras (1946-1976) at Fort Ord. While these buildings are of historic age and were constructed during this important period of development in Fort Ord's history, they no longer retain enough integrity to convey significance as a historic district. One of the most notable elements of integrity that is compromised is the integrity of setting. Significant demolition, changes to circulation patterns, introduction of new buildings, and changes in use, all impact the CSUMB campus's ability to convey significance from its time as an active Cold War and Vietnam Era military installation. Additionally, the subdivision of Fort Ord following its closure has also greatly impacted the integrity of feeling, association, and setting of the Cold War and Vietnam Era portions of the installation. In summary, the portion of Fort Ord that is now the CSUMB campus no longer retains the requisite integrity to convey significance and Dudek finds that there is no potential for the campus to be a historic district at the national, state, or local level.

INTENTIONALLY LEFT BLANK

# 6 Summary of Findings and Management Recommendations

---

## 6.1 Summary of Findings

Dudek formally recorded and evaluated 11 properties located within the Built Environment ADI over 45 years old proposed for renovation, alteration, or demolition as part of the Project. All built environment properties were identified as not eligible for national, state, or local designation. Therefore, it is not necessary to examine potential impacts to these properties resulting from the implementation of the proposed Master Plan. In summary, the Project will not result in significant impacts to CEQA built environment historical resources. The finding for the Project related to built environment historical resources is no impact.

INTENTIONALLY LEFT BLANK

# 7 References

---

- Advisory Council on Historic Preservation (ACHP). 2006. "Draft Program Comment Regarding Cold War Era Unaccompanied Personnel Housing." Federal Register: The Daily Journal of the United States Government. 12 April 2016. Accessed June 30, 2021 Available at: <https://www.federalregister.gov/documents/2006/04/12/06-3509/draft-program-comment-regarding-cold-war-era-unaccompanied-personnel-housing>
- Boland n.d. "Guidelines for Evaluating and Nominating Properties Associated with Significant Persons." National Register Bulletin 32. U.S. Department of the Interior, National Park Service. <https://www.nps.gov/nr/publications/bulletins/nrb32/>.
- Brady, Ryan. 2019. *Cultural Resource Inventory for the CSU Monterey Bay EIR Master Plan Project, Monterey County, California*. Memorandum prepared July 5, 2019 by Dudek for CSU Monterey Bay, Campus Planning and Development.
- Breschini, G. and T. Haversat. 1992a. Preliminary Excavations at CA-MNT-108, Fisherman's Wharf, Monterey County, California. In *Archaeological Investigations of Some Significant Sites on the Central Coast of California*, edited by H. Dallas, Jr. and G.S. Breschini, pp. 39–47. Coyote Press Archives of California Prehistory No. 37, Salinas.
- California Military Base Reuse Task Force, "Report of the California Military Base Reuse Task Force to Governor Pete Wilson: a strategic response to base reuse opportunities" (1994). California Agencies. Paper 71. Accessed July 12, 2021. Available at: [http://digitalcommons.law.ggu.edu/caldocs\\_agencies/71](http://digitalcommons.law.ggu.edu/caldocs_agencies/71)
- Californian, The. 1936. Paddon Tells of Marina's History. July 21, 1936. Page 2. Salinas, California. Accessed September 10, 2021. Available at: <https://www.newspapers.com>
- Californian, The. 1940. "No More Camp Ord! It's Fort Ord Now! Stilwell in Command: Headquarters of General Located on Salinas Side." July 13, 1940. Salinas, California, pg. 1.
- Californian, The. 1951. Stadium Field House—Sixth Army Lets Ord Contract. March 20, 1951. P1. Accessed June 17, 2021. Available at: [Newspapers.com](https://www.newspapers.com).
- Californian, The. 1952a. Proposed New Fort Ord Barracks. January 22, 1952. Page 1. Salinas, California. Accessed June 25, 2021. Available at: <https://www.newspapers.com>
- Californian, The. 1952b Phoenix Arizona Firm. January 22, 1952. Page 18. Salinas, California. Accessed June 25, 2021. Available at: <https://www.newspapers.com>.
- Californian, The. 1959. Work Starts on 3 New Buildings at Fort Ord. January 24, 1952. Page 18. Salinas, California. Accessed June 25, 2021. Available at: <https://www.newspapers.com>
- Californian, The. 1976. Marina's history: \$20 an acre and a promise. July 3, 1976. Page 32. Salinas, California. Accessed September 10, 2021. Available at: <https://www.newspapers.com>
- Castle, Ted. 1990. "The March of Time." Fort Ord Panorama. September 21, 1990.



- Cavanaugh, Joe. 2000. *The Peace Dividend: Defense Conversion Through Higher Education*. The Leon Panetta Institute.
- Chamberlin Library. 2021. Fort Ord Working Papers. CSUMB Special Collections Box 6.42-01. Available at the Chamberlin Library, Seaside, California.
- Chapman, Charles. 1920. "Sebastian Vizcaino: Exploration of California." *The Southwestern Historical Quarterly* 23(4). April 1920. Accessed January 21, 2021. <http://www.jstor.org/stable/27794572>.
- Chen, C. Peter. n.d. "Joseph Stilwell" World War II Database. Accessed online July 1, 2021: [https://ww2db.com/person\\_bio.php?person\\_id=18](https://ww2db.com/person_bio.php?person_id=18)
- City (City of Carmel-By-The-Sea). 2008. *Historic Context Statement Carmel-By-The-Sea*. Prepared for the City of Carmel-By-The-Sea. 1<sup>st</sup> ed. Leslie Heumann and Associates, 1994. 2<sup>nd</sup> ed. Archives and Architecture, 1996. Update, Architectural Resource Group, Inc., 2008.
- City of Marina. n.d. "City of Marina History" Accessed online September 10, 2021: <https://cityofmarina.org/DocumentCenter/View/143/Marina-History?bidId=>
- City of Seaside. 2004. "Conservation/Open Space Element." City of Seaside General Plan. Adopted by City Council resolution 04-59, August 5, 2004. <https://www.ci.seaside.ca.us/DocumentCenter/View/368/Seaside-General-Plan-Full-Text-PDF?bidId=>
- City of Seaside. n.d. "Seaside History" Accessed online July 1, 2021: <https://www.ci.seaside.ca.us/166/Seaside-History>
- County of Monterey. 2021. "At a Glance: Monterey County." County of Monterey Website. Accessed January 18, 2021. <https://www.co.monterey.ca.us/government/departments-i-z/resource-management-agency-rma/economic-development/at-a-glance-county-facts>.
- CSUC (California State University, Chico). 2021a. "State Normal School at Chico." Accessed July 8, 2021. <https://www.csuchico.edu/traditions/history/normal-school.shtml>.
- CSUC. 2021b. "Chico State Teachers College." Accessed July 8, 2021. <https://www.csuchico.edu/traditions/history/teachers-college.shtml>
- CSUMB (California State University, Monterey Bay). 1998. CSUMB Master Plan.
- CSUMB. 2007. CSUMB Master Plan.
- CSUMB Enrollment Facts. N.d. Accessed online: <https://csumb.edu/iar/enrollment-fast-facts-most-recent-term/>
- CSUMB Facilities. 2021. Original As built and renovation architectural drawings on file with CSUMB facilities department. Accessed in person June 15-16, 2021.
- CSUMB. 2021. Images 121 and 131. Fort Ord Images: Historical Photographs and Postcards. Accessed on July 15, 2021. Available: [https://digitalcommons.csUMB.edu/fortord\\_images/](https://digitalcommons.csUMB.edu/fortord_images/)
- Del Webb and Pulte Homes 2021. Del Web History. Accessed July 9, 2021. Available at: [http://media.corporate-ir.net/media\\_files/irol/14/147717/DelWebb/DelWebbHistory.pdf](http://media.corporate-ir.net/media_files/irol/14/147717/DelWebb/DelWebbHistory.pdf)

- DLIFLC (Defense Language Institute Foreign Language Center). 2021. Command History Program. Accessed in person on June 15, 2021 and accessed online database collection online July 2021. Available at: <https://adli.pastperfectonline.com/>
- EA Engineering. 1991. Draft Final Fort Ord, California Base wide Remedial Investigation Feasibility Study. Volume 1 Literature Review and Base Inventory Report. Accessed on July 13, 2021. Available at: <https://www.fortordcleanup.com/documents/search/>
- EMC Planning Group Inc and EDAW, Inc. 1997 (Republished in 2001). Fort Ord Reuse Plan. Accessed July 12, 2021. Available at: [https://www.fora.org/Reports/BRP/BRP\\_v4\\_FinalEIR\\_1997.pdf](https://www.fora.org/Reports/BRP/BRP_v4_FinalEIR_1997.pdf)
- Fort Ord Disposal and Reuse: EIS. 1993. Vol IV Final. Environmental Impact Statement Fort Ord Disposal and Reuse. Accessed July 12, 2021. Available at: [https://www.google.com/books/edition/Fort\\_Ord\\_Disposal\\_and\\_Reuse/CdY3AQAAAMAJ?hl=en&gbpv=1](https://www.google.com/books/edition/Fort_Ord_Disposal_and_Reuse/CdY3AQAAAMAJ?hl=en&gbpv=1)
- Fresno Bee, The. 1951a. "Army Spokesman Are Defending Building of Fort Ord Stadium." January 12, 1951. Page 13. Accessed June 17, 2021.
- Fresno Bee, The. 1951b. "Army Spokesman Are Defending Building of Fort Ord Stadium." February 4, 1951. Page 27. Accessed June 17, 2021. Available at: [Newspapers.com](http://www.newspapers.com).
- Gates, S., & Williams, H. 1957. The Armed Forces. The Annals of the American Academy of Political and Social Science, 313, 99-104. Accessed June 17, 2021. <http://proxy.multcolib.org:2052/stable/1031762>
- Google Earth. 2021. Historic Aerial Imagery Historic Aerial Photographs of CSUMB Campus, 100 Campus Center, Seaside, CA 93955, dating from 1998, 2004, 2005, 2006, 2007, 2009, 2011, 1012, 2013, 2016, 2018, 2019, 2020. <https://earth.google.com/web/>
- Hiller, Peter. 2007. NRHP Nomination Form. Monterey County Court House. National Parks Service. Accessed July 18, 2021. Available at: [https://npgallery.nps.gov/NRHP/GetAsset/NRHP/08000878\\_text](https://npgallery.nps.gov/NRHP/GetAsset/NRHP/08000878_text)
- Hoover, Mildred B., Hero Eugene Rensch, Ethel G. Rensch, and William N. Abeloe. 2002. Historic Spots in California. 5th ed. Stanford, California: Stanford University Press.
- Encyclopedia Britannica. 2016. "Normal school." Encyclopedia Britannica, April 20, 2016. <https://www.britannica.com/topic/normal-school>. Accessed September 16, 2019.
- Encyclopedia Britannica. 2020. "California State University." Encyclopedia Britannica, January 26, 2020. <https://www.britannica.com/topic/California-State-University-system-California>. Accessed September 16, 2019.
- Encyclopedia Britannica. 2021. "Joseph W. Stilwell". Encyclopedia Britannica, March 15, 2021, <https://www.britannica.com/biography/Joseph-W-Stilwell>. Accessed July 7, 2021.
- MacGregor Jr., Morris J. 1981. Integration of the Armed Forces, 1940-1965. Center of Military History, United States Army: Washington, D.C.

- Madsen, Alexandra and Steven Treffers. 2019. *Historic Resources Evaluation Memorandum for Hammerhead Barracks at Fort Ord, Monterey County, California*. Prepared by Rincon Consultants, Inc for City of Seaside, Community and Economic Development Department. November 4, 2019. Accessed June 28, 2021. [https://www.ci.seaside.ca.us/DocumentCenter/View/10674/9\\_App-S--HRE-Memo](https://www.ci.seaside.ca.us/DocumentCenter/View/10674/9_App-S--HRE-Memo)
- McKibben, Carol Lynn and the Seaside History Project. 2009a. *Image of America: Seaside*. Charleston, SC: Arcadia Publishing.
- McKibben, Carol Lynn. 2009b. "Race and Color in A California Coastal Community: The Seaside Story." *BlackPast.org*. Accessed online: <https://www.blackpast.org/african-american-history/race-and-color-california-coastal-community-seaside-story/>.
- McPherson, Stephanie. 1990. "Ord Commanders: Training, community programs have made Ord a dynamic place to work and live." September 21, 1990, pg. 18.
- Military Construction Appropriations (MCA) for 1979: Hearings Before a Subcommittee of the Committee on Appropriations, House of Representatives, Ninety-fifth Congress, Second Session. 1978. United States: U.S. Government Printing Office. Digitized by Google. Accessed June 25, 2021. Available at: [https://www.google.com/books/edition/Military\\_Construction\\_Appropriations\\_for/cv06AAAAMAAJ?hl=en&gbpv=1&dq=Fort+Ord+Dental+clinic&pg=PA109&printsec=frontcover](https://www.google.com/books/edition/Military_Construction_Appropriations_for/cv06AAAAMAAJ?hl=en&gbpv=1&dq=Fort+Ord+Dental+clinic&pg=PA109&printsec=frontcover)
- Military Museum. 2016. "Historic California Posts, Camps, Stations, and Airfields: Fort Ord." Accessed on June 19, 2021. <http://www.militarymuseum.org/FtOrd.html>
- Moore Chiusano, Elizabeth. 2009. James E. Moore, Class of 1954. Grip Hands Memorials. Accessed June 30, 2021. Available at: [http://www.usma1954.org/Grip\\_Hands/memorials/19733jem.htm](http://www.usma1954.org/Grip_Hands/memorials/19733jem.htm)
- Moore Iacofano Goltsman, Inc. 2007. Master Plan, Volume I, Design Plan.
- Moore, Harold G. Lieutenant General. 1975. *Building a Volunteer Army: The Fort Ord Contribution*. Department of the Army. Washington D.C. Accessed June 30, 2021. Available at: [https://history.army.mil/html/books/090/90-3/CMH\\_Pub\\_90-3.pdf](https://history.army.mil/html/books/090/90-3/CMH_Pub_90-3.pdf)
- National Archives Foundation. 2021. Executive Order 9981. Accessed June 29, 2021. Available at: <https://www.archivesfoundation.org/documents/executive-order-9981-ending-segregation-armed-forces/>
- NETR (Nationwide Environmental Title Research LLC). 2021. Historic Aerial Photographs of 100 Campus Center, Seaside, CA 93955 dating from 1956, 1968, 1981, 1998, 2005, 2009, 2010, 2012, 2014, 2016, and 2018. Accessed June 10, 2021. <https://www.historicaerials.com/viewer>
- NPS (National Park Service). 1990. National Register Bulletin: Technical Information on the National Register of Historic Places: Survey, Evaluation, Registration, and Preservation of Cultural Resources. How to Apply the National Register Criteria for Evaluation. <https://www.nps.gov/nr/publications/bulletins/pdfs/nrb15.pdf>.
- NPS. 1995. "How to Apply the National Register Criteria for Evaluation." National Register Bulletin 15. Accessed January 27, 2021. <https://www.nps.gov/nr/publications/bulletins/pdfs/nrb15.pdf>

- OAC (Online Archives of California). 2021. Finding Aid for the Milton Pflueger drawings of the University of California, Berkeley Radiation Laboratory addition, 1961 0000276. <https://oac.cdlib.org/findaid/ark:/13030/c86w9bq9/>.
- OHP (California Office of Historic Preservation). 2019. "California Historical Landmarks." Accessed July 2019. [https://ohp.parks.ca.gov/?page\\_id=21441](https://ohp.parks.ca.gov/?page_id=21441)
- Panorama. 1990. "50 Years and Counting.." September 21, 1990, pg. 2.
- Panorama. n.d. "Ford Ord in World War II." Historic California Posts: Fort Ord. Accessed on June 19, 2021. <http://www.militarymuseum.org/FtOrd.html>
- Park, R. 2015. "Happy and Cheerful in This Fine Camp": Sports, Recreation, and the United States Army at Fort Ord and Camp Roberts, 1940 to 1945. *Journal of Sport History*, 42(1), 21-37. Accessed on June 18, 2021, from <https://www.jstor.org/stable/10.5406/jsporthistory.42.1.21>
- PCAD (Pacific Coast Architecture Database). 2021. Database information for Milton Theodore Pflueger and Timothy Pflueger. Accessed July 7, 2021. <http://pcad.lib.washington.edu>
- Pomona Progress Bulletin. 1950. War Solving Racial Problems. August 24, 1950. Page 4. Accessed June 29, 2021. Available at: Newspapers.com.
- Quartermaster Review, The. 1940. "Army Construction Underway at Camp Ord, California." Volume XX. No 3. November-December. On file at the Chamberlin Library, Ord Military Community.
- Raugh, Harold E. 2004. Fort Ord. Charleston, SC: Arcadia.
- Salinas Morning Post. 1940. "\$2,766,000 in Building Authorized—Ord Contracts Let." August 21, 1940. Salinas, CA. pg. 1.
- San Francisco Examiner. 1951. Fort Ord Will Get Stadium. San Francisco Page 4. · 3 Feb 1951. Pages 1 and 4 A Available on [www.Newspapers.com](http://www.Newspapers.com). Accessed on Jun 11, 2021.
- San Francisco Examiner. 1958. Army Asks OK on \$124,000,000 for Fort Ord Buildings. San Francisco. Section 2. Page. 4. Available on [www.Newspapers.com](http://www.Newspapers.com). Accessed July 18, 2021.
- Swernoff, Michael. 1982. *Predictive Model of Cultural Resources at Fort Ord: A Reconnaissance Cultural Survey of Fort Ord, California*. Prepared under the Direction of the Department of the Army, Sacramento District Corps of Engineers, Contract #DACA05-800-C-0228, by Professional Analysts. Report on file as S-005210 at the CHRIS Northwest Information Center, Sonoma State University, Rohnert Park, CA.
- U.S. Army. 1977. Post Map Main Garrison Area. Fort Ord, California. Drawing number G-950. Accessed in person at the Chamberlain Library on June 15, 2021.
- U.S. Census. US. Census Quick Facts. "Marina, CA". Accessed September 10, 2021: <https://www.census.gov/quickfacts/marinacalifornia>

UCSB (University of California, Santa Barbara). 2021. Historic Aerial Photographs of 100 Campus Center, Seaside, CA 93955 dating from 1941, 1956, 1971, 1987, and 1998. Map & Imagery Laboratory (MIL) UCSB Library, Electronic Resource. Accessed June 10, 2021. [http://mil.library.ucsb.edu/ap\\_indexes/FrameFinder](http://mil.library.ucsb.edu/ap_indexes/FrameFinder).

Vasche, J. Burton. 1959. "The California State Colleges: Their History, Organization, Purposes, and Programs." in California

Waite, Philip R. 1995. *A Cultural Resources Survey of 783 Hectares, Fort Ord, Monterey County, California*. Prepared by Geo-Marine, Inc. for Tri-Services Cultural Resources Research Center, Construction Engineering Research laboratory. Miscellaneous Report of Investigations No. 67. Report on file as S-018372 at the CHRIS Northwest Information Center, Sonoma State University, Rohnert Park, CA.

Walch, Bob. 2004. An Army Historian's Pictorial Take on Fort Ord. Monterey County NOW. Accessed July 12, 2021. Available at: [https://www.montereycountyweekly.com/news/local\\_news/an-army-historian-s-pictorial-take-on-fort-ord/article\\_6e8b0250-9c38-5ca4-a4a4-f93d42d65a11.html](https://www.montereycountyweekly.com/news/local_news/an-army-historian-s-pictorial-take-on-fort-ord/article_6e8b0250-9c38-5ca4-a4a4-f93d42d65a11.html).

Webb Spinner, The. 1952-1954. Webb Spinner Volume for 1952-1954. Del Webb Sun Cities Museum Collection. Accessed June 30, 2021. Accessed at: <https://delwebbsuncitiesmuseum.org/newsletters-webb-spinners/>

Whaley, Derek. 2015. "East Monterey & Seaside." Santa Cruz Trains: Railroads of the Monterey Bay Area. July 20, 2015. Accessed online: <https://www.santacruztrains.com/2015/07/east-monterey-seaside.html>.

# Appendix A

---

## Preparer's Qualifications

# Sarah Corder, MFA

---

## Historic Built Environment Lead

Sarah Corder (*SARE-uh COR-der; she/her*) is an architectural historian with 17 years' experience throughout the United States in all elements of cultural resources management, including project management, intensive-level field investigations, architectural history studies, and historical significance evaluations in consideration of the California Register of Historical Resources (CRHR), the National Register of Historic Places (NRHP), and local-level evaluation criteria. Ms. Corder has conducted hundreds of historical resource evaluations and developed detailed historic context statements for a multitude of property types and architectural styles, including private residential, commercial, industrial, educational, and agricultural properties. She has also provided expertise on numerous projects requiring conformance with the Secretary of the Interior's Standards for the Treatment of Historic Properties.

Ms. Corder meets the Secretary of the Interior's Professional Qualification Standards for both Architectural History and History. She has experience preparing environmental compliance documentation in support of projects that fall under the California Environmental Quality Act (CEQA)/National Environmental Policy Act (NEPA), and Sections 106 and 110 of the National Historic Preservation Act.

## Relevant Experience

**Riverside City College Life Science/Physical Science Reconstruction Project, Riverside Community College District, Riverside, California.** Dudek was retained by the Riverside Community College District to complete a cultural resources technical report for the Life Science/Physical Science Reconstruction Project in the City of Riverside, California. The report included the results of a California Historical Resources Information System (CHRIS) records search; a pedestrian survey of the project site by a qualified architectural historian; building development and archival research; development of an appropriate historic context for the project site; and recordation and evaluation of two (2) educational/institutional properties and one (1) mural over 45 years old for historical significance and integrity in consideration NRHP, CRHR, and local designation criteria and integrity requirements. Responsibilities for the project include archival research, co-authorship of the report, and preparation of Department of Parks and Recreation Series 523 Forms (DPR forms), and quality assurance/quality control of work products. (2020)

**Integrity Assessment and Comparative Analysis for Confidential Education Project, Confidential Client, Santa Barbara, California.** Dudek prepared a memorandum that provides a comparative analysis and detailed account of alterations made to a confidential educational property located in the City of Santa Barbara, California. This analysis was designed to facilitate future significance evaluations with regard to the property's physical integrity and architectural merit. Responsibilities included project management, field survey, archival research, and preparation of the technical memorandum. (2019-2020)

### *Education*

*Savannah College of Art and Design*

*MFA, Historic Preservation, 2004*

*Bridgewater College*

*BA, History, 2002*

### *Professional Affiliations*

*National Trust for*

*Historic Preservation*

*Los Angeles Conservancy*

*California Preservation Foundation*

*Society for Architectural Historians*

**San Francisco State University Master Plan EIR, San Francisco State University, City of San Francisco, California.** Dudek was retained to evaluate all buildings and structures on campus over 45 years old that were proposed for demolition or substantial alteration as part of the proposed Master Plan Program. The study entailed conducting archival and building development research, a records search, detailed impacts assessment, and development of mitigation measures for project conformance with the Secretary of the Interior's Standards for Rehabilitation. Responsibilities included field survey leadership, archival research, evaluation of built environment resources, co-authorship of the technical report, and preparation of DPR forms. (2019)

**Castilleja Master Plan and Conditional Use Permit Project, City of Palo Alto, California.** Dudek was retained by the City of Palo Alto to conduct a cultural resources study for the Castilleja Master Plan and Conditional Use Permit project. The proposed project would allow for an increase in student enrollment and expand the existing campus by demolishing existing buildings, constructing a new building and a new below-grade parking structure, and increasing the amount of open space. The study included a historical significance evaluation of the campus and related buildings and structures for the private all-girls school for grades 6–12. The school has been educating 6th- to 12th-grade girls since 1907 and has been located at the current site since 1910. The school's facilities include administrative buildings, a chapel theater, classrooms, a gymnasium, a pool, an aboveground parking area, a playing area, and a track. All buildings and structures within the proposed project site that were constructed at least 45 years ago were photographed, researched, and evaluated in consideration of CRHR and City designation criteria and integrity requirements. Responsibilities included field survey, background research, preparation of DPR forms for the evaluation of built resources, and co-authorship of the cultural resources report. (2019)

**CSU Chico College Park Demolition Project, CSU Chico, Butte County, California.** Dudek was retained by CSU Chico to complete a cultural resources study for a project that proposes demolition of 10 single-family residences near the CSU Chico campus. The study involved completion of a CHRIS records search; a pedestrian survey of the project area for built-environment resources; archival and building development research for each property; outreach with local libraries, historical societies, and advocacy groups; and a historic context and evaluation of 10 properties for historical significance. Responsibilities included co-authorship of the technical report, evaluation of built environment resources, field survey, archival research, and preparation of DPR forms. (2018)

**Castilleja School Project, City of Palo Alto, California.** Dudek was retained by the City of Palo Alto to conduct a cultural resources study for the Castilleja Master Plan and Conditional Use Permit project. The study included a historical significance evaluation of the campus and related buildings and structures. Responsibilities included field survey, background research, preparation of DPR forms for the evaluation of built resources, and co-authorship of the cultural resources report. (2017)

**CSU Chico Siskiyou Hall Project, CSU Chico, Butte County, California.** Dudek was retained by CSU Chico to complete a historic resources technical report for Siskiyou Hall. The study involved a pedestrian survey of the project area for built-environment resources, conducting archival and building development research, and completing a historic context and evaluation of the property for historical significance. Responsibilities included field survey, contributions to the technical report, and archival research. (2017)

**Fullerton College Facilities Master Plan Program EIR, North Orange County Community College District, City of Fullerton, California.** The district contracted Dudek to evaluate all buildings and structures on campus over 45 years old that were proposed for demolition or substantial alteration as part of the proposed Master Plan Program. The study entailed conducting archival and building development research, a records search, detailed impacts assessment, and development of mitigation measures for project conformance with the Secretary of the Interior's Standards for Rehabilitation. As a result of the significance evaluation, three historic districts and one individually eligible building were identified within the project area. Responsibilities included archival research, field survey, and co-authorship the technical report. (2017)



# Adrienne Donovan Boyd, MSHP

---

## Architectural Historian

Adrienne Donovan-Boyd (*AY-dree-en DON-uh-vin BOID; she/her*) is an architectural historian with significant experience in Oregon and the Pacific Northwest. Ms. Donovan-Boyd has 15 years' experience in all elements of cultural resources management, including intensive- and reconnaissance-level field investigations, architectural history studies, and historical significance evaluations for compliance projects, the National Register of Historic Places (NRHP), and local landmark designations. She is a very skilled researcher, adept at evaluation of historic properties and an experienced author of historical resources evaluation reports, findings of effect documentation for Sections 106 and 110 of the National Historic Preservation Act, historic context statements, and management plans for historic properties. Ms. Donovan-Boyd meets the Secretary of the Interior's Professional Qualification Standards for architectural history and also maintains a strong professional relationship with State Historic Preservation Office staff in Washington and Oregon.

### **Education**

*University of Oregon  
MS, Historic Preservation, 2009*

*Portland State University  
BA, Community Development, 2006*

Ms. Donovan-Boyd has completed numerous projects requiring compliance with the Secretary of the Interior's Standards for the Treatment of Historic Properties. Her recent work at the University of Oregon's The Shire, a John Yeon-designed historic landscape in the Columbia River Gorge National Scenic Area, has focused on completing a cultural landscape report, including preparing a historic context statement, evaluation and analysis, and treatment protocols and procedures. Ms. Donovan-Boyd's National Register Nomination for the mid-century modern Amundsen House in Gresham, Oregon, was recently approved by the State Advisory Committee for Historic Preservation.

## Project Experience

### Cultural Resource Inventory and Evaluation

**Cultural Resources Report, Horning Tree Seed Orchard, Bureau of Land Management, Washington County, Oregon.** Served on an interdisciplinary team. Attended project meetings and contributed archival research, in-field research, geographic information system (GIS) data, and sections of the report including landscape descriptions, historic context section, significance evaluations, and recommendations. The project proposed that the site was eligible at the local and state level for the NRHP. (2020)

**Class III Inventory and Cultural Resources Report, Fish Springs Ranch, NextEra Energy, Washoe County, Nevada.** Served on a multidisciplinary team working on a Class III Inventory for the Fish Springs Ranch property. Contributed to archival research and co-authored the report, including the historic context section, significance evaluations, and recommendations. The project proposed that the historic period buildings remaining were not eligible for the NRHP. (2020)

**Cultural Landscape Report, The Shire, University of Oregon, Skamania County, Washington.** Served on a multidisciplinary team working for the University of Oregon on a Cultural Landscape Inventory for John Yeon's Columbia River Gorge property, The Shire. Contributed archival research, in-field research, GIS data, and sections of the report, including landscape descriptions, historic context section, existing conditions, significance

evaluations, and treatment recommendations. The project proposed that the site was eligible at the local and state level for the NRHP. (2019–2020)

**Cultural Resources Inventory, The Shire First Bay Shoreline Restoration Project, Skamania County, Washington.**

Served as architectural historian for the University of Oregon's project to conduct shoreline and habitat restoration at The Shire property in Skamania County. The project was subject to Section 106 review (lead agency: Federal Emergency Management Agency). Led the aboveground survey, conducted archival research, and co-authored the report with recommended determinations of eligibility and findings of effect. (2018–2019)

**Cultural Resources Services, U.S. Army Corps of Engineers (ACOE) Master Planning IDIQ, Portland District, Oregon.**

Served as architectural historian for the ACOE Portland District's Master Plan and integrated Environmental Assessment for the Mid-Columbia (Bonneville, The Dalles, John Day, and Willow Creek) and Rogue River (Lost Creek, Elk Creek, and Applegate) basin regions. Attended project meetings, conducted site visit reconnaissance surveys within the Lost Creek Project, and prepared the historic properties management plan for the Lost Creek Project. (2018)

**Cultural Resources Investigations, Mouth of the Columbia River South Jetty Rehabilitation Project, Clatsop County, Oregon.**

Served as architectural historian for the ACOE's proposed South Jetty rehabilitation within Fort Stevens State Park. The investigations involved inventorying and evaluating the South Jetty and a historic trails system. Evaluated the identified resources for the NRHP and co-authored the report. (2018)

**Intensive-Level Survey, Port of Portland World War II Hangers, Portland International Airport.** Conducted an intensive-level survey for two World War II Airport Hangers at the Portland International Airport and completed a cultural resource report with recommendations for the potential to list the structures on the NRHP. The hangers were significant for being the last remaining World War II constructed hangers on the Portland Airport Site. (2017)

**Lower Snake River Programmatic Environmental Impact Statement; Washington, Oregon, Idaho; ACOE.**

Researched and reported on historic built environment resources for the cultural resource sections for a programmatic Environmental Impact Statement related to the ACOE sediment management plan. The project area includes the Lower Snake River and four associated sub-basins: Clearwater River, Salmon River, Grande Ronde River, and Hells Canyon Reach of the Snake River. Made eligibility recommendation and co-authored the report. (2014)

**Reconnaissance-Level Inventory, Gresham, Oregon.** Conducted reconnaissance-level surveys for approximately 450 properties in the Centennial and Rockwood neighborhoods in Gresham, Oregon. Properties will be recorded in the Oregon State Historic Preservation Office's Historic Sites Database. (2020–Present)

**Reconnaissance-Level Inventory, Gresham, Oregon.** Conducted two reconnaissance-level surveys for approximately 57 properties in the Mt. Hood neighborhood and approximately 177 properties in the Kelly Creek neighborhood of Gresham, Oregon. Recorded all information in the Oregon State Historic Preservation Office's Historic Sites Database. (2017)

**Intensive-Level Inventory, Enterprise Cemetery, Enterprise, Oregon.** Conducted an intensive-level survey of the Enterprise Cemetery in Enterprise, Oregon. Conducted all field work, authored the report, and completed all necessary archival research to outline the cemetery's historic context. (2017)

**Intensive-Level Inventory, Roslyn, Washington.** Conducted intensive-level surveys of historic properties in Roslyn, Washington, in stages from 2012–2014. Recorded all information in the Washington Department of Archeology and Historic Preservation Office's online WISAARD Database. (2012–2014)

# Laura G. Carias, MA

---

## Architectural Historian

Laura Carias has over fifteen years of experience in the field of historic and cultural resources evaluation, identification, documentation, and preservation. Ms. Carias specializes in historic resources assessments including historic significance evaluations in consideration of the California Register of Historical Resources (CRHR) Register, and the National Register of Historic Places (NRHP), and local-level evaluation criteria. She also has experience in intensive-level field surveys, historic structure reports, design consultation, Historic American Buildings Survey and Historic American Engineering Record documentation, local Mills Act contracts, and local, state and nation landmark designations.

Ms. Carias meets the Secretary of the Interior's Professional Qualification Standards for Architectural History. She has experience preparing environmental compliance documentation in support of projects that fall under the California Environmental Quality Act (CEQA)/National Environmental Policy Act (NEPA), and Sections 106 of the National Historic Preservation Act (NHPA).

### **Education**

*California State University,  
Sacramento  
MA, Public History, 2004  
California State University,  
Dominguez Hills  
BA, History and Chicano Studies,  
2003*

### **Professional Affiliations**

*National Trust for Historic  
Preservation  
Los Angeles Conservancy  
California Preservation Foundation  
Society for Architectural Historians*

## Dudek Project Experience (2020-Present)

**123 Independence Drive Mixed-Use Project, Menlo Park, California. (2021).** Served as architectural historian and co-author of the Historical Resources Evaluation Report (report). The Sobrato Organization retained Dudek to prepare a cultural resources study in support of the 123 Independence Drive Mixed-Use Project located in the City of Menlo Park. The study included a pedestrian survey of the subject properties for buildings and structures over 45 years of age; building development and archival research for the identified properties located within the project site; recordation and evaluation of cultural resources identified within the study area for the National Register of Historic Places (NRHP), California Register of Historical Resources (CRHR), and local eligibility criteria and integrity requirements; and an assessment of potential impacts to historical resources in conformance with CEQA and all applicable local municipal code and planning documents. Responsibilities included site specific background research, co-authoring the historic context covering the development of the site over time and preparation of significance evaluation.

**Historic Built Environment Evaluation Report for the Sycuan Fee to Trust Project, Sycuan Band of the Kumeyaay Nation Reservation, San Diego County, California (2020).** Dudek was retained by the Sycuan Band of the Kumeyaay Nation Reservation (Sycuan) to complete a Historic Properties Inventory and Evaluation Report for the proposed Sycuan Fee to Trust Project (Project), located on the within the vicinity of El Cajon, California in unincorporated San Diego County. The Project proposes a fee-to-trust transfer of five (5) parcels that cumulatively total approximately 40 acres. The transfer of land from Sycuan to the Bureau of Indian Affairs (BIA), the federal lead agency. Responsibilities for the project included: background research and authoring the cultural resources report.

**Mothballing Plan, Fort MacArthur World War I Cantonment Historic District, Los Angeles, California.** Dudek was retained to prepare a mothballing plan for the former military facility known as Fort MacArthur. The purpose of this Mothballing Plan was to document the existing conditions of the contributing buildings and to provide guidance and recommendations that LAUSD can employ for mothballing the district-contributing buildings that are not in active use in a manner consistent with National Park Service (NPS) Preservation Brief No. 31, *Mothballing Historic Buildings*. Responsible for field survey, recordation and documentation of existing conditions, and shared authorship of the Mothballing Plan. (2020-2021)

## Additional Work Experience (2004-2009)

### **Historic American Engineering Record**

#### **San Juan Bautista, California**

Authored Historic American Engineering Record for a former Southern California Edison 1917 substation. Documentation was successfully submitted to the Library of Congress. Prior to DUDEK, Chattel, Inc.

### **Department of Veterans Affairs West Los Angeles, Building 500 Building Replacement Project**

#### **Los Angeles, California**

Authored Finding of Effects report to satisfy Section 106 compliance for the West Los Angeles Veterans Affairs Historic District. The proposed project includes the addition of a new hospital and associated support buildings as well as the demolition of several non-contributing buildings. Prior to DUDEK, Chattel, Inc.

### **Second Church of Christ, Scientist, Historic Structure Report**

#### **Long Beach, California**

Compiled a Historic Structure Report to assist current owner in obtaining much needed funds for rehabilitation of 1914 church with extensive water damage. Prior to DUDEK, Chattel, Inc.

### **Sears Boyle Heights, Los Angeles, Federal Investment Tax Credit**

#### **Los Angeles, California**

Submitted and received conditional approvals on Part II Federal Investment Tax Credit application for former Sears, Roebuck and Company retail store and warehouse in Boyle Heights. Participated in design collaboration on rehabilitation of subject property as a mixed-use property with retail, creative office, and residential space. Prior to DUDEK, Chattel, Inc.

### **1311-1317 North Hayworth Avenue**

#### **West Hollywood, California**

Successfully designated a multi-family residence as a Cultural Resource and entered the property owner into a Mills Act historical property contract. Prior to DUDEK, Chattel, Inc.

### **Los Angeles Unified School District, Lincoln High School Small Learning Community Improvements**

#### **Los Angeles, California**

Historic resources assessment for Lincoln High School as part of the environmental compliance work performed for proposed landscaping and American Disabilities Act (ADA) compliance. Work was completed to confirm historic significance of school and character-defining features and document project conformance with the Secretary's Standards for Rehabilitation in support of Work compliance with California Environmental Quality Act (CEQA). Prior to DUDEK, Sapphos Environmental, Inc.

# Appendix B

---

DPR Forms

State of California & The Resources Agency  
DEPARTMENT OF PARKS AND RECREATION  
**PRIMARY RECORD**

Primary #  
HRI #  
Trinomial  
NRHP Status Code 6Z

Other Listings  
Review Code

Reviewer

Date

Page 1 of 15 \*Resource Name or #: (Assigned by recorder) Science Research Lab Annex

P1. Other Identifier: CSUMB Building 13

\*P2. Location:  Not for Publication  Unrestricted

\*a. County Monterey County and (P2c, P2e, and P2b or P2d. Attach a Location Map as necessary.)

\*b. USGS 7.5' Quad Marina, CA Date 1995 T 15S; R 1E; NW ¼ of SW ¼ of Sec 6; Mount Diablo B.M.

c. Address 3700 6TH Avenue Seaside Zip 93955

d. UTM: (Give more than one for large and/or linear resources) Zone 10S, 607801 mE/ 4057011 mN

e. Other Locational Data: (e.g., parcel #, directions to resource, elevation, decimal degrees, etc., as appropriate)

The Science Research Lab Annex sits north of A Street, between 5<sup>th</sup> Avenue and 6<sup>th</sup> Avenue.

\*P3a. Description: (Describe resource and its major elements. Include design, materials, condition, alterations, size, setting, and boundaries)

The Science Research Lab Annex (CSUMB Building 13) is clustered with other classroom buildings southeast of the Main Quad on the California State University, Monterey Bay (CSUMB) campus. The one-story, utilitarian building with modern stylistic details has a rectangular floor plan with several small projections. The building appears to sit on a concrete slab foundation and the primary construction materials are CMU and cement. The perimeter of the building has simple landscaping on the east, west, and south elevations. A parking lot is located to the north of the building.

See Continuation Sheet.

\*P3b. Resource Attributes: (List attributes and codes) HP15. Educational building, HP34. Military property

P5a. Photograph or Drawing (Photograph required for buildings, structures, and objects.)



\*P4. Resources Present:  Building  
 Structure  Object  Site  District   
Element of District  Other (Isolates, etc.)

P5b. Description of Photo: (view, date, accession #) south  
elevation, view looking  
northwest, Dudek(IMG 0716)

\*P6. Date Constructed/Age and Source:  Historic  Prehistoric  Both  
1963 (CSUMB Facilities)

\*P7. Owner and Address:  
CSUMB, 100 Campus Center,  
Seaside, CA. 93955

\*P8. Recorded by: (Name, affiliation, and address) Sarah Corder,  
Dudek, 725 Front St #400,  
Santa Cruz, CA 95060

\*P9. Date Recorded: 6/14/2021

\*P10. Survey Type: (Describe)  
Intensive level

\*P11. Report Citation: (Cite survey report and other sources or enter none)  
Dudek 2021. Built Environment Inventory and Evaluation Report for California State

University, Monterey Bay

\*Attachments:  NONE  Location Map  Continuation Sheet  Building, Structure, and Object Record  
 Archaeological Record  District Record  Linear Feature Record  Milling Station Record  Rock Art Record  
 Artifact Record  Photograph Record  Other (List): \_\_\_\_\_

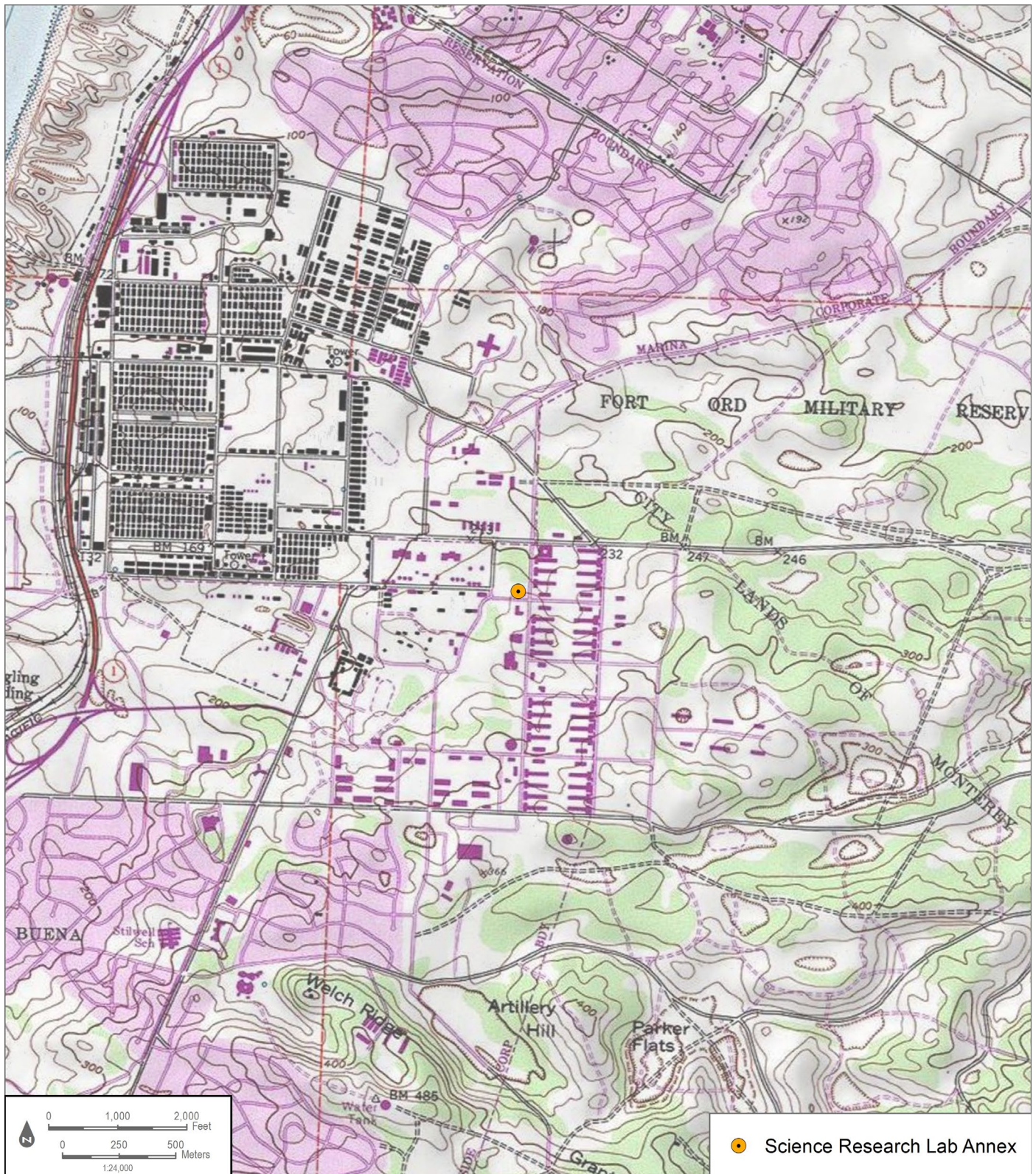

# BUILDING, STRUCTURE, AND OBJECT RECORD

\*Resource Name or # (Assigned by recorder) Science Research Lab Annex \*NRHP Status Code 6Z

Page 3 of 15

B1. Historic Name: Fort Ord Dental Clinic, Stone Dental Clinic

B2. Common Name: Science Research Lab Annex, CSUMB Building 13

B3. Original Use: Military Medical Clinic 4. Present Use: Classroom/Science Lab

\*B5. Architectural Style: Utilitarian

\*B6. Construction History: (Construction date, alterations, and date of alterations)

Designed in 1963 and completed in 1964, the Science Research Lab Annex has been altered since its construction. Renovation and as-built drawings show alterations to the building took place in 1987 and 1995 (CSUMB Facilities 2021). In 1987, Fort Ord remodeled the building to move the dental clinic to the west side of the building and retrofit the east side of the building to accommodate a proposed blood donation clinic. Renovations included the demolition of interior walls and finishes, installation of new doors, the construction of a loading dock at the northwest corner, an addition of a ramp to the parking area, and the construction of a new concrete exit porch and stairs. In 1995, CSUMB installed a ramp on the east and west facades, new vents on the north elevation, a new window wall on the south elevation to the west of primary entrance and completed window alterations on the north elevation. At this time the building's use changed from a medical/dental building to a CSUMB classroom building with science labs (CSUMB Facilities 2021).

\*B7. Moved?  No  Yes  Unknown Date: \_\_\_\_\_ Original Location: \_\_\_\_\_ \*B8. Related Features:

B9a. Architect: Milton T. Pflueger b. Builder: N/A

\*B10. Significance: Theme N/A Area N/A

Period of Significance N/A Property Type N/A Applicable Criteria N/A

(Discuss importance in terms of historical or architectural context as defined by theme, period, and geographic scope. Also address integrity.)

See Continuation Sheet.

B11. Additional Resource Attributes: (List attributes and codes) \_\_\_\_\_

\*B12. References: See Continuation Sheet.

B13. Remarks:

\*B14. Evaluator: Adrienne Donovan-Boyd, MSHP

\*Date of Evaluation: July 20, 2021

(This space reserved for official comments.)

(Sketch Map with north arrow required.)

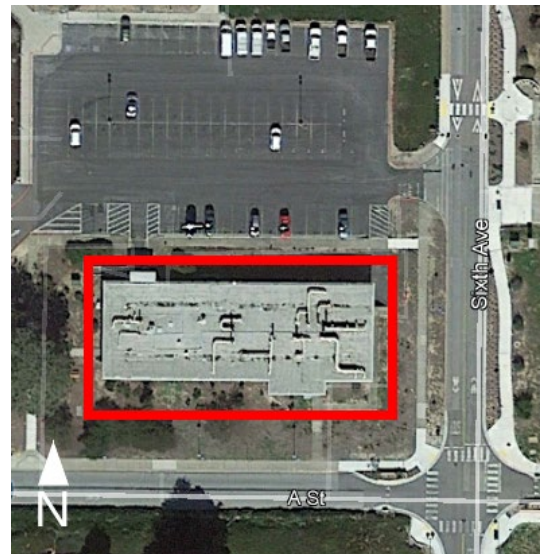



## CONTINUATION SHEET

Property Name: Science Research Lab Annex

Page 4 of 15

### \*P3a. Description (continued):

The primary elevation faces south with a concrete path leading to the main entrance from A Street. The primary entrance is located offset to the east on the south elevation. The building has a flat roof with small eave overhangs. The main entrance consists of a pair of recently added metal-framed glazed doors, with a large, fixed transom. A fully glazed wall of windows is located to the west of the primary entrance. The exterior walls are varied, with the majority of the building constructed of CMU, with some concrete sections and some floor-to-ceiling windows.

Fenestration is irregular and includes horizontal pane 1/1 metal-framed, and metal-framed picture windows, and metal-framed casement windows. An ADA-accessible ramp is located on the north elevation leading to the parking area on the north elevation and a second ADA ramp and entrance are on the east elevation. Metal vents are located below the windows on the north elevation.



Figure 1. Main (south) elevation and entrance, looking northwest (IMG\_0715)

## CONTINUATION SHEET

Property Name: Science Research Lab Annex

Page 5 of 15



Figure 2. North elevation, looking southeast (IMG\_0746)

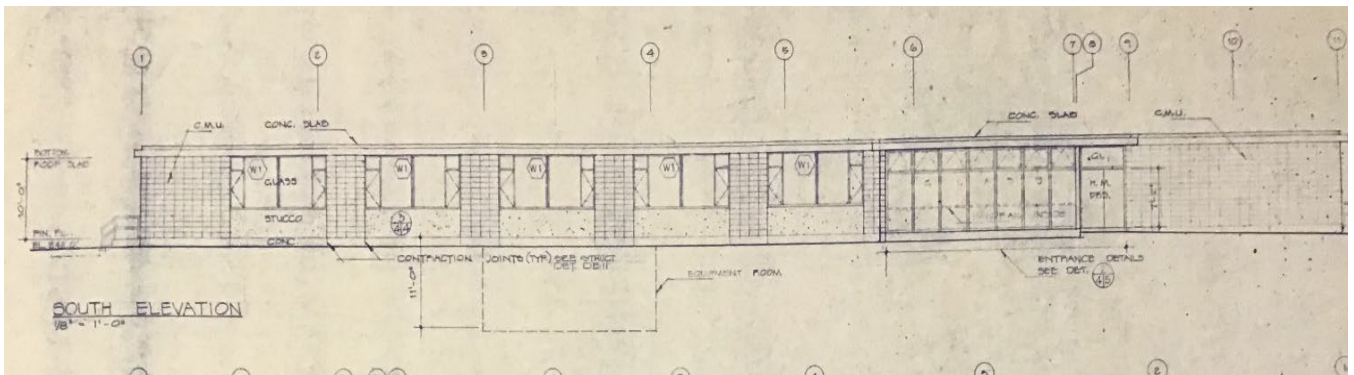

Figure 3. 1963 architectural drawing of the south elevation Science Research Lab Annex (CSUMB Facilities 2021)

### Alterations:

- Remodel to move the dental clinic to the west side of the building and retrofit the east side for the proposed blood donor's clinic. Renovations include the demolition of interior walls and finishes, installation of new doors and finishes, construction of loading dock at northwest corner and addition of ramp to parking, new concrete exit porch and stairs. (1987)
- New ramp on east and west elevations, new vents on north elevation, and new window wall added to south elevation, west of primary entrance, new lath, and plaster to match existing, window alteration on north elevation, replacement of window bank on south elevation (1995)
- Change in use from medical/dental building to Science Research Lab (1995)

## CONTINUATION SHEET

Property Name: Science Research Lab Annex

Page 6 of 15

### \*B10. Significance (continued):

#### Historical Overview of Fort Ord

The history of Fort Ord has been extensively documented in newspaper articles, websites, academic journals, and books. From its creation in 1917 to its closure in 1994, the base grew to become one of the largest training centers in the country. Its location was also reported to be the most attractive U.S. Army post, with easy access to the ocean and beautiful California weather.

The development periods in the history of Fort Ord were defined by Harold E. Raugh, Jr, a U.S. Army lieutenant colonel and historian with the Department of Defense. Since his retirement, Raugh served as the Chief Historian, for the Defense Logistics Agency, for the Department of Defense and, from 2006-2013, Raugh served as the Command Historian at the Defense Language Institute Foreign Language Center (DLIFLC) and the Presidio of Monterey, California. He received his PhD in history from the University of California, Los Angeles (Walch 2004). Raugh has authored numerous books including, *Fort Ord* (2004); *Presidio of Monterey* (2004); *Operation Joint Endeavor: V Corps in Bosnia-Herzegovina, 1995-1996* (2013); *The Raugh Bibliography of the Indian Mutiny 1857-1859* (2016); and *Wavell in the Middle East, 1939-1941: A study in Generalship*. Raugh defined four periods for the historic development of Fort Ord:

- 1917-1940 Camp Gigling to Camp Ord
- 1940-1945 Fort Ord and the 7th Infantry Division
- 1946-1976 The Cold War and Vietnam Eras
- 1974-1994 The Volunteer Army

These periods correspond to distinct eras in the history of the base and the U.S. Army (Raugh 2004: ii). The following sections provide a summary overview of each of these periods of development and their relevance to the area of Fort Ord now known as the CSUMB campus.

The full historic context of Fort Ord is represented in the report, *Built Environment Inventory and Evaluation Report for California State University, Monterey Bay* (Dudek 2021). The following presents only relevant historical and building typology information pertaining to the development of the Science Research Lab Annex.

#### Cold War and Vietnam Eras at Fort Ord (1946-1976)

This period of development between 1946 and 1976 was characterized by a massive operation to move the base out of its semi-permanent status and create a permanent outpost for active military personnel who were retained due to ongoing foreign conflicts.

In July of 1948, Harry S Truman signed Executive Order 9981, which officially ended segregation in the armed forces. The order stated that "there shall be equality of treatment and opportunity for all persons in the armed forces without regard to race, color, religion, or national origin" (National Archives Foundation 2021). Fort Ord became one of the first integrated training divisions in the United States. The Fort was touted as "pioneering to end all segregation" (The Pomona Progress Bulletin 1950: 4). In 1950, the Pomona Progress Bulletin reported that black and white soldiers at Fort Ord were "fighting side by side" and all the enlistees "trained together, slept in the same barracks, and eat the same messes" (The Pomona Progress Bulletin 1950: 4).

The end of World War II in 1945 did not bring lasting peace. The tenuous relationship between dominant nations in the communist East and free market West led to the beginning

## CONTINUATION SHEET

Property Name: Science Research Lab Annex

Page 7 of 15

of the Cold War. The Department of Defense maintained a robust fighting force during the Cold War, with more than 900,000 Army personnel retained during the 1950s (ACHP 2006). The ongoing global tensions and the number of active U.S. military personnel created a need for new permanent buildings and expanded military housing at Fort Ord.

In 1949, the Soviet-supported communist government of North Korea invaded American-supported South Korea, initiating the Korean War. Fort Ord was a primary staging area for the training of troops departing for the war (Castle 1990:3). By the 1950s, Fort Ord had become one of the largest basic training camps in the United States. In 1952, the military began a multi-million dollar building program to transform Fort Ord into a permanent post, including the development of permanent troop housing, and the construction of a guard house, stockade, and multiple warehouses. In January of 1952, military authorities announced the new construction program at Fort Ord was underway, with an estimated cost of \$26,650,600. More than half of the funds that were approved by Congress were "earmarked for new permanent troop housing" for more than 7,000 soldiers (The Webb Spinner 1952-54, Vol 6. No. 3:1).

The new troop housing was to be constructed of reinforced concrete, a departure from the wood buildings constructed before and during World War II. The plan called for three types of massive barracks, twenty-two were to house 225 enlisted men each, seven were to accommodate 165 men each, and nine were to house 105 men each (The Webb Spinner 1952-54, Vol 6. No. 3:3). The San Francisco District of the U.S. Army Corps of Engineers oversaw the construction project to completion. An additional \$1,349,700 was earmarked for the expansion of classroom and training facilities at Fort Ord, including a new battalion and regimental headquarters (The Californian 1952a:1 and The Californian 1952b:18). By March of 1952, another phase of the permanent army post transformation began with the construction of a guard house, stockade, warehouse, and other buildings (The Webb Spinner 1952-54, Vol 6. No. 3:1). This addition of permanent buildings continued into the late 1950s, when the Army requested \$124 million to replace all the wood World War II infrastructure at Fort Ord with concrete block and reinforced concrete (Madsen and Treffers 2019:6; San Francisco Examiner 1958:2-4). While many of the wood buildings remain today, this period saw the continuous addition of reinforced concrete permanent buildings across the Fort (Madsen and Treffers 2019:6).

Following the Korean War through the end of the conflict in Vietnam, Fort Ord served as an important training facility. In 1957, Fort Ord was designated as a U.S. Army Training Center for Infantry (Castle 1990: 4). The 7th Infantry Division was based at Fort Ord in 1975 (Cavanaugh 2000: 9). Fort Ord produced thousands of combat-ready troops during the conflict in Vietnam.

With the establishment of Fort Ord as a permanent Army base during this period, there was substantial building construction that led to the modernization of the base and its services. This development is closely related to the history of the current CSUMB campus. All the properties that are included as part of this built environment study were constructed during the Cold War and Vietnam Era period. Building development during this period was a substantial departure from the styles and materials used in the buildings constructed before World War II. Building during the period between 1946 and 1976 used reinforced concrete and concrete masonry unit (CMU). The buildings tended to be larger than those constructed in previous periods. Other development in this period included support service buildings and several types of medical buildings. Infrastructure was also improved at this time, with the introduction of paved streets and roadways, and the addition of several water tanks, water pumping plants, and warehouse buildings.

## CONTINUATION SHEET

Property Name: Science Research Lab Annex

Page 8 of 15

### **Science Research Lab Annex, 1964**

The Science Research Lab Annex building was designed by the San Francisco architectural firm of Milton T. Pflueger in 1963. The plan lists the building designer as "JRS" and "LBM" and notes the design was prepared under the direction of H.N. Turner (CSUMB Facilities 2021). The building was constructed in 1964. The original plans called for the interior space to have 28 dental chairs and was the first permanent dental clinic at Fort Ord. Additional permanent dental clinics were constructed at Fort Ord in 1964, 1970, and 1977, with additional funds for further clinic space requested in 1979 (MCA 1979:109). Renovation architectural drawings from 1987 show many of the interior walls were demolished to divide the building into two clinics, the Stone Dental Clinic and a blood donation center (CSUMB Facilities 2021). After Fort Ord closed in 1994, the building became part of the CSUMB campus and was altered to serve as classroom space designed for academic study and instruction. CSUMB facility plans show in 1995, the building was converted to a university science building and named the Science Research Lab Annex (CSUMB Facilities 2021).

### **Milton Pflueger**

Milton Theodore Pflueger was born in San Francisco in 1907. From 1925 to 1929, Pflueger worked as a draftsman for the architectural firm Bakewell & Brown. Around 1930, Pflueger began working for his older brother, Timothy Pflueger, who was a partner of architect J. R. Miller (OAC 2021). In 1940, Milton Pflueger went into partnership with his brother Timothy for several years until Timothy Pflueger died in 1946 (PCAD 2021). Milton Pflueger opened his own firm in the San Francisco Bay area. His more notable projects included: Richmond Memorial Civic Center (Richmond, CA), University of San Francisco Richard A. Gleeson Library (San Francisco, CA), the headquarters building for the Department of Motor Vehicles (Sacramento, CA), the Herbert C. Moffitt Hospital at the University of California Medical Center (San Francisco, CA), Alemany Housing Project (San Francisco, CA), the William F. Herrin laboratories, Herrin Hall, and Florence Moore Hall, all at Stanford University (Stanford, CA), Millberry Union UCSF Medical Center (San Francisco, CA), and Tulare Theater, (Tulare, CA) (OAC 2021 and PCAD 2021). Pflueger's firm is known to have designed the Science Research Annex building in the Built Environment ADI (CSUMB Facilities 2021).

### **Fort Ord Building Typology and Character-Defining Features**

Four categories of building types were identified for the purposes of this study. These are the Support Services Buildings, Medical Buildings, Hammerhead Buildings/Barracks, and Recreational Buildings. The following presents a discussion of the Medical building typology, as the Science Research Lab Annex is classified in this category. This section provides an overview and a detailed account of the specific character-defining features of Fort Ord's Cold War and Vietnam Era (1946-1976) medical buildings.

### **Medical Buildings**

Medical buildings constructed during the Cold War and Vietnam Eras (1946-1976) at Fort Ord have a variety of uses and functions that changed over the history of the base. One of the most common medical building types during this period were clinic buildings. In alignment with the typical planning, design, and materials of buildings constructed during this period of Fort Ord's history, these buildings are constructed with reinforced concrete and CMU and feature flat roofs with multi-light windows set on concrete sills. The Medical Buildings tended to have central entryways that opened into waiting areas, with smaller exam rooms behind reception areas. These buildings did not have a uniform design, unlike many of the other buildings at Fort Ord.

**CONTINUATION SHEET**

Property Name: Science Research Lab Annex

Page 9 of 15

**Character-Defining Features for the Medical Buildings**

The Medical Buildings originally exhibited the following specific character-defining features:

| Character Aspect       | Primary Character-Defining Features  | Character-Defining Features   |
|------------------------|--|---|
| Shape and Plan         | <ul style="list-style-type: none"> <li>• Simple rectangular form</li> <li>• Single story</li> </ul>  | The overall shape and mass of the building with a central entrance opening to waiting areas.  |
| Roof                   | <ul style="list-style-type: none"> <li>• Flat roof</li> <li>• Moderate or slight eave openings</li> <li>• No exposed rafters</li> </ul>  | The Medical Buildings have flat roofs, with moderate or slight eave overhangs.  |
| Openings               | <ul style="list-style-type: none"> <li>• Entrances on the ground level</li> <li>• Multi-light windows or modern windows with protruding metal frames set on concrete sills</li> <li>• Public entrances and circulation patterns</li> </ul> | Window openings are uniform in size and placement, windows are multi-light, and set into concrete openings. Replaced windows are not considered character-defining features as they fall outside the period of significance.  |
| Exterior Ornamentation | <ul style="list-style-type: none"> <li>• Minimal exterior ornamentation</li> <li>• Glass windows used as ornamentation</li> </ul>  | The Medical Buildings were often specifically designed to serve specific functions. They have little to no decorative ornamentation, with windows in ribbons, or evenly spaced windows being the only decorative element.   |
| Materials              | <ul style="list-style-type: none"> <li>• Mass-produced and cost-effective materials</li> <li>• Concrete and CMU</li> <li>• Reinforced Concrete construction</li> </ul>   | Medical Buildings have simple, utilitarian designs. Buildings were constructed using mass-produced and cost-effective building materials that were readily available at the time of construction. Buildings under the Medical Building type were constructed with reinforced concrete and CMU and were minimally decorated. |

Alterations and demolitions over time have compromised the overall architectural integrity of this building type. The most common alterations observed for this building type include the following.

- Replacement windows
- ADA compliance measures such as ramps and doors
- HVAC systems and window units
- Infill of openings
- Interior renovations

## CONTINUATION SHEET

Property Name: Science Research Lab Annex

Page 10 of 15

### NRHP/CRHR Designation Criteria

In consideration of the Science Research Lab Annex's history and requisite integrity, Dudek recommends the building not eligible for listing in the NRHP and CRHR based on the following significance evaluation and in consideration of national and state eligibility criteria:

#### **Criterion A/1: That are associated with events that have made a significant contribution to the broad patterns of our history.**

The Science Research Lab Annex was constructed in 1964 during the period defined as the Cold War and Vietnam Eras (1946-1976) at Ford Ord. While this building is of historic age and was constructed during this important period of development in Fort Ord's history, it no longer retains enough integrity to convey its significance. One of the most notable elements of integrity that is compromised is the integrity of setting. Significant demolition, changes to circulation patterns, introduction of new buildings, and changes in use, all impact the campus's ability to convey significance from its time as an active Cold War and Vietnam Era military base. The loss of this overall integrity of setting adversely effects the Science Research Lab Annex, as individual buildings are no longer able to convey their collective history. Additionally, the subdivision of Fort Ord following its closure has also greatly impacted the integrity of feeling, association, and setting of the Cold War and Vietnam Era portions of the installation. In summary, the Science Research Lab Annex, is not able to convey its association with any extraordinary events or events occurring within the context of Cold War and Vietnam military Medical Buildings, the CSUMB Campus, or has an association with the broad patterns of history in Monterey County, the State of California, or the Nation. Dudek recommends the building is not eligible under NRHP/CRHR Criterion A/1.

#### **Criterion B/2: That are associated with the lives of persons significant in our past.**

To be found eligible under B/2 the building must be directly tied to an important person and the place where that individual conducted or produced the work for which he or she is known. Milton T. Pflueger was found to be the architecture firm responsible for the design, but the utilitarian building does not reflect on of his remarkable works. Archival research indicated that the Science Research Lab Annex building, originally called the Fort Ord Dental Clinic, was not directly associated with any other significant person or persons. As such this building is not known to have any historical associations with people important to the nation's or state's past. Due to a lack of identified significant associations with important persons in history, Dudek recommends the building is not eligible under NRHP/CRHR Criterion B/2.

#### **Criterion C/3: That embody the distinctive characteristics of a type, period, or method of construction, or that represent the work of a master, or that possess high artistic values, or that represent a significant and distinguishable entity whose components may lack individual distinction.**

The Science Research Lab Annex was added to Fort Ord in 1964. The building was designed by the Milton T. Pflueger Architectural Firm, of San Francisco, CA. The plan lists the building designer as "JRS" and "LBM" and notes the design was prepared under the direction of H. N. Turner (CSUMB Facilities 2021). Milton Theodore Pflueger lead a notable San Francisco architectural firm. He designed many distinguished buildings during his career, first with his older brother, and then as the head of his own firm.

While Pflueger may be a master architect, the Science Research Lab Annex, designed by his firm, is not one of the firm's notable buildings, nor was it a defining moment in the firm's career. The Science Research Lab Annex is a smaller, utilitarian building, with minimal detailing, and few stylistic features. The building appears to have been designed by "JRS" and "LBM" under the direction of H.N. Turner (CSUMB Facilities 2021). No further information was discovered during archival research about these designers.

## CONTINUATION SHEET

Property Name: Science Research Lab Annex

Page 11 of 15

The building is a ubiquitous building type that lacks high style components to set it apart from other buildings constructed throughout the State of California in the 1960s. Additionally, the Science Research Lab Annex, has undergone numerous alterations and changes to notable character-defining features including many replacement windows, enclosed openings, and changes to circulation patterns and use. Due to a lack of high artistic value, a lack of evidence suggesting this is a notable work of the Milton T. Pflueger Firm, and substantial alterations, Dudek recommends the building is not eligible under NRHP/CRHR Criterion C/3.

**Criterion D/4: That have yielded, or may be likely to yield, information important in prehistory or history.**

There is no evidence to suggest that this building has the potential to yield information important to state or local history. Therefore, Dudek recommends the building is not eligible under NRHP/CRHR Criterion D/4.

**California Historic Landmark Statement of Significance**

In consideration of the Science Research Lab Annex's history and requisite integrity, Dudek recommends the building not eligible for designation as a California Historic Landmark based on the following significance evaluation and in consideration of state eligibility criteria:

**The first, last, only, or most significant of its type in the state or within a large geographic region (Northern, Central, or Southern California).**

The Science Research Lab Annex was designed in 1963 and constructed in 1964. The building was constructed during the Cold War and Vietnam Eras (1946-1976) at Fort Ord. The Science Research Lab Annex appears to have been conceptualized by architects who worked for Milton Theodore Pflueger, a notable San Francisco architect. The building is a ubiquitous building type that lacks high style components to set it apart from other buildings constructed throughout the State of California in the 1960s. Therefore, Dudek recommends the building is not eligible for listing as a CHL under this criterion.

**Associated with an individual or group having a profound influence on the history of California.**

Archival research failed to indicate any significant associations between the Science Research Lab Annex and individuals or groups that profoundly influenced the history of California. The Science Research Lab Annex building was originally the Fort Ord Dental Clinic, to provide a service for military personnel. Milton T. Pflueger was found to be the architecture firm responsible for the design, but the utilitarian building does not reflect a remarkable project for the firm. No other individuals are known to have influenced the construction or use of this building. Therefore, Dudek recommends the building is not eligible for listing as a CHL under this criterion.

**A prototype of, or an outstanding example of, a period, style, architectural movement or construction or is one of the more notable works or the best surviving work in a region of a pioneer architect, designer or master builder.**

The Science Research Lab Annex is neither a prototype or an outstanding example of a period, style, or architectural movement. It is a typical example of utilitarian military design and was constructed well after these designs had become popular in the 1950s. The building was designed to serve a utilitarian purpose. There are no identifying features on the building that would establish the connection to the notable work of a master architect in the State of California. Additionally, the building has been altered and it fails to sufficiently convey its significance. Therefore, Dudek recommends the building is not eligible for listing as a CHL under this criterion.



## CONTINUATION SHEET

Property Name: Science Research Lab Annex

Page 12 of 15

### Local Designation Criteria

Portions of the CSUMB campus are located within the boundaries of two cities, City of Seaside and the City of Marina, both of which evaluate historical resources in accordance with CEQA Guidelines. as presented above. The subject property, as discussed in the NRHP/CRHR/CHL criteria discussion above, does not rise to the necessary level of significance for local, state, or national designation. For these reasons, the subject property is recommended not eligible individually or as a component of a historic district under any of the NRHP/CRHR/CHL/local criteria.

Additionally, portions of the CSUMB campus are located in the County of Monterey and the campus is therefore subject to the regulations set forth in Chapter 18.25 of the Monterey County Code. The subject property, as discussed in the NRHP/CRHR/CHL criteria discussion above, does not rise to the necessary level of significance for state or national designation. For these same reasons, the subject property is also recommended not eligible individually or as a component of a historic district under any of the delineated County of Monterey review criteria categories that are addressed with the NRHP/CRHR/CHL criteria discussed above: A. Historical and Cultural Significance; B. Historic, Architectural, and Engineering Significance; or C. Community and Geographic Setting.

### Integrity Discussion

The Science Research Lab Annex was analyzed against the seven aspects of integrity: location, design, setting, materials, workmanship, feeling, and association. The building retains its integrity of location, as it has not been relocated. However, the integrity of setting has been compromised with the demolition of adjacent buildings, new constructions, and changes in paths of circulation throughout the campus. This change of use, from a Cold War and Vietnam Era military dental clinic to a classroom building for CSUMB also adversely effects the integrity of setting. The integrity of design, materials and workmanship are compromised, as replacement materials have been added throughout the building since its completion in 1964, including replacement of most of the original windows. As a result, the integrity of feeling is not intact, as the building is unable to convey the feeling of a 1960s military dental clinic. As the building does not possess historic significance, there is no historic association. While the building is in good condition, it does not possess integrity to convey significance or its temporal period.

### Summary of Evaluation Findings

Based on the significance evaluations and integrity analysis presented above, the Science Research Lab Annex does not appear to meet the NRHP, CRHR, CHL or local designation criteria. Therefore, Science Research Lab Annex is not considered a historical resource for purposes of CEQA.

## CONTINUATION SHEET

Property Name: Science Research Lab Annex

Page 13 of 15

### \*B12. References (continued):

- ACHP (Advisory Council on Historic Preservation). 2006. "Draft Program Comment Regarding Cold War Era Unaccompanied Personnel Housing." Federal Register: The Daily Journal of the United States Government. 12 April 2016. Accessed June 30, 2021 Available at: <https://www.federalregister.gov/documents/2006/04/12/06-3509/draft-program-comment-regarding-cold-war-era-unaccompanied-personnel-housing>
- Californian, The. 1940. "No More Camp Ord! It's Fort Ord Now! Stilwell in Command: Headquarters of General Located on Salinas Side." July 13, 1940. Salinas, California, pg. 1.
- Californian, The. 1951. Stadium Field House—Sixth Army Lets Ord Contract. March 20, 1951. P1. Accessed June 17, 2021. Available at: [Newspapers.com](http://Newspapers.com).
- Castle, Ted. 1990. "The March of Time." Fort Ord Panorama. September 21, 1990.
- Cavanaugh, Joe. 2000. *The Peace Dividend: Defense Conversion Through Higher Education*. The Leon Panetta Institute.
- Chamberlin Library. 2021. Fort Ord Working Papers. CSUMB Special Collections Box 6.42-01. Available at the Chamberlin Library, Seaside, California.
- CSUC (California State University, Chico). 2021a. "State Normal School at Chico." Accessed July 8, 2021. <https://www.csuchico.edu/traditions/history/normal-school.shtml>.
- CSUC. 2021b. "Chico State Teachers College." Accessed July 8, 2021. <https://www.csuchico.edu/traditions/history/teachers-college.shtml>
- CSUMB Facilities. 2021. Original As built and renovation architectural drawings on file with CSUMB facilities department. Accessed in person June 15-16, 2021.
- DLIFLC (Defense Language Institute Foreign Language Center). 2021. Command History Program. Accessed in person on June 15, 2021 and accessed online database collection online July 2021. Available at: <https://adli.pastperfectonline.com/>
- EA Engineering. 1991. Draft Final Fort Ord, California Base wide Remedial Investigation Feasibility Study. Volume 1 Literature Review and Base Inventory Report. Accessed on July 13, 2021. Available at: <https://www.fortordcleanup.com/documents/search/>
- Fresno Bee, The. 1951a. "Army Spokesman Are Defending Building of Fort Ord Stadium." January 12, 1951. Page 13. Accessed June 17, 2021.
- Fresno Bee, The. 1951b. "Army Spokesman Are Defending Building of Fort Ord Stadium." February 4, 1951. Page 27. Accessed June 17, 2021. Available at: [Newspapers.com](http://Newspapers.com).
- Gates, S., & Williams, H. 1957. The Armed Forces. The Annals of the American Academy of Political and Social Science, 313, 99-104. Accessed June 17, 2021. <http://proxy.multcolib.org:2052/stable/1031762>

## CONTINUATION SHEET

Property Name: Science Research Lab Annex

Page 14 of 15

- MacGregor Jr., Morris J. 1981. Integration of the Armed Forces, 1940-1965. Center of Military History, United States Army: Washington, D.C.
- Madsen, Alexandra and Steven Treffers. 2019. *Historic Resources Evaluation Memorandum for Hammerhead Barracks at Fort Ord, Monterey County, California*. Prepared by Rincon Consultants, Inc for City of Seaside, Community and Economic Development Department. November 4, 2019. Accessed June 28, 2021.  
[https://www.ci.seaside.ca.us/DocumentCenter/View/10674/9\\_App-S---HRE-Memo](https://www.ci.seaside.ca.us/DocumentCenter/View/10674/9_App-S---HRE-Memo)
- Military Museum. 2016. "Historic California Posts, Camps, Stations, and Airfields: Fort Ord." Accessed on June 19, 2021. <http://www.militarymuseum.org/FtOrd.html>
- National Archives Foundation. 2021. Executive Order 9981. Accessed June 29, 2021. Available at: <https://www.archivesfoundation.org/documents/executive-order-9981-ending-segregation-armed-forces/>
- NETR (Nationwide Environmental Title Research LLC). 2021. Historic Aerial Photographs of 100 Campus Center, Seaside, CA 93955 dating from 1956, 1968, 1981, 1998, 2005, 2009, 2010, 2012, 2014, 2016, and 2018. Accessed June 10, 2021.  
<https://www.historicaerials.com/viewer>
- OAC (Online Archives of California). 2021. Finding Aid for the Milton Pflueger drawings of the University of California, Berkeley Radiation Laboratory addition, 1961 0000276. <https://oac.cdlib.org/findaid/ark:/13030/c86w9bq9/>.
- PCAD (Pacific Coast Architecture Database). 2021. Database information for Milton Theodore Pflueger and Timothy Pflueger. Accessed July 7, 2021.  
<http://pcad.lib.washington.edu>
- Panorama. 1990. "50 Years and Counting..." September 21, 1990, pg. 2.
- Panorama. n.d. "Ford Ord in World War II." Historic California Posts: Fort Ord. Accessed on June 19, 2021. <http://www.militarymuseum.org/FtOrd.html>
- Park, R. 2015. "Happy and Cheerful in This Fine Camp": Sports, Recreation, and the United States Army at Fort Ord and Camp Roberts, 1940 to 1945. *Journal of Sport History*, 42(1), 21-37. Accessed on June 18, 2021, from  
<https://www.jstor.org/stable/10.5406/jsporthistory.42.1.21>
- Pomona Progress Bulletin. 1950. War Solving Racial Problems. August 24, 1950. Page 4. Accessed June 29, 2021. Available at: [Newspapers.com](http://www.newspapers.com).
- Quartermaster Review, The. 1940. "Army Construction Underway at Camp Ord, California." Volume XX. No 3. November-December. On file at the Chamberlin Library, Ord Military Community.
- Raugh, Harold E. 2004. Fort Ord. Charleston, SC: Arcadia.
- Salinas Morning Post. 1940. "\$2,766,000 in Building Authorized—Ord Contracts Let." August 21, 1940. Salinas, CA. pg. 1.
- San Francisco Examiner. 1951. Fort Ord Will Get Stadium. San Francisco Page 4. · 3 Feb 1951. Pages 1 and 4 A Available on [www.Newspapers.com](http://www.newspapers.com). Accessed on Jun 11, 2021.

## CONTINUATION SHEET

Property Name: Science Research Lab Annex

Page 15 of 15

San Francisco Examiner. 1958. Army Asks OK on \$124,000,000 for Fort Ord Buildings. San Francisco. Section 2. Page. 4. Available on [www.Newspapers.com](http://www.Newspapers.com). Accessed July 18, 2021.

Vasche, J. Burton. 1959. "The California State Colleges: Their History, Organization, Purposes, and Programs." in California

U.S. Army. 1977. Post Map Main Garrison Area. Fort Ord, California. Drawing number G-950. Accessed in person at the Chamberlain Library on June 15, 2021.

Walch, Bob. 2004. An Army Historian's Pictorial Take on Fort Ord. Monterey County NOW. Accessed July 12, 2021. Available at:  
[https://www.montereycountyweekly.com/news/local\\_news/an-army-historian-s-pictorial-take-on-fort-ord/article\\_6e8b0250-9c38-5ca4-a4a4-f93d42d65a11.html](https://www.montereycountyweekly.com/news/local_news/an-army-historian-s-pictorial-take-on-fort-ord/article_6e8b0250-9c38-5ca4-a4a4-f93d42d65a11.html)

State of California & The Resources Agency  
DEPARTMENT OF PARKS AND RECREATION  
**PRIMARY RECORD**

Primary #  
HRI #  
Trinomial  
NRHP Status Code 6Z

Other Listings  
Review Code

Reviewer

Date

Page 1 of 15 \*Resource Name or #: (Assigned by recorder) Beach Hall

P1. Other Identifier: CSUMB Building 21

\*P2. Location:  Not for Publication  Unrestricted

\*a. County Monterey County and (P2c, P2e, and P2b or P2d. Attach a Location Map as necessary.)

\*b. USGS 7.5' Quad Marina, CA Date 1995 T 15S; R 1E; NE ¼ ■ of SE ¼ ■ of Sec 1; Mount Diablo B.M.

c. Address 3716 First Street Seaside Zip 93955

d. UTM: (Give more than one for large and/or linear resources) Zone 10S, 607323 mE/ 4057010 mN

e. Other Locational Data: (e.g., parcel #, directions to resource, elevation, decimal degrees, etc., as appropriate)

Beach Hall sits south of Divarty Street, east of Engineer Lane.

\*P3a. Description: (Describe resource and its major elements. Include design, materials, condition, alterations, size, setting, and boundaries)

Beach Hall (CSUMB Building 21) is a one-story utilitarian building has a rectangular floor plan and a concrete block structural system. The south-facing main elevation is symmetrical. It is covered by a moderately pitched side-gabled roof clad with composition shingles. The south main entrance is located centrally and is flanked by two squared projections and capped by a gabled, glazed dormer. The main entrance consists of recently added metal-framed double-glazed doors with sidelights and topped with a transom. Secondary doors are located to the far east and west ends of the main elevation.

**Continuation Sheet**

\*P3b. Resource Attributes: (List attributes and codes) HP15. Educational building/HP34 Military property

P5a. Photograph or Drawing (Photograph required for buildings, structures, and objects.)



\*P4. Resources Present:  Building  
 Structure  Object  Site  District   
Element of District  Other (Isolates, etc.)

P5b. Description of Photo: (view, date, accession #) south elevation, view looking north, Dudek (IMG 0302)

\*P6. Date Constructed/Age and Source:  Historic  Prehistoric  Other  
1953 (CSUMB Facilities)

\*P7. Owner and Address:  
CSUMB, 100 Campus Center, Seaside, CA. 93955

\*P8. Recorded by: (Name, affiliation, and address) Sarah Corder, Dudek, 725 Front St #400, Santa Cruz, CA 95060

\*P9. Date Recorded: 6/14/2021

\*P10. Survey Type: (Describe)  
Intensive level

\*P11. Report Citation: (Cite survey report and other sources or enter none)  
Dudek 2021. Built

Environment Inventory and Evaluation Report for California State University, Monterey Bay.

\*Attachments:  NONE  Location Map  Continuation Sheet  Building, Structure, and Object Record  
 Archaeological Record  District Record  Linear Feature Record  Milling Station Record  Rock Art Record  
 Artifact Record  Photograph Record  Other (List): \_\_\_\_\_

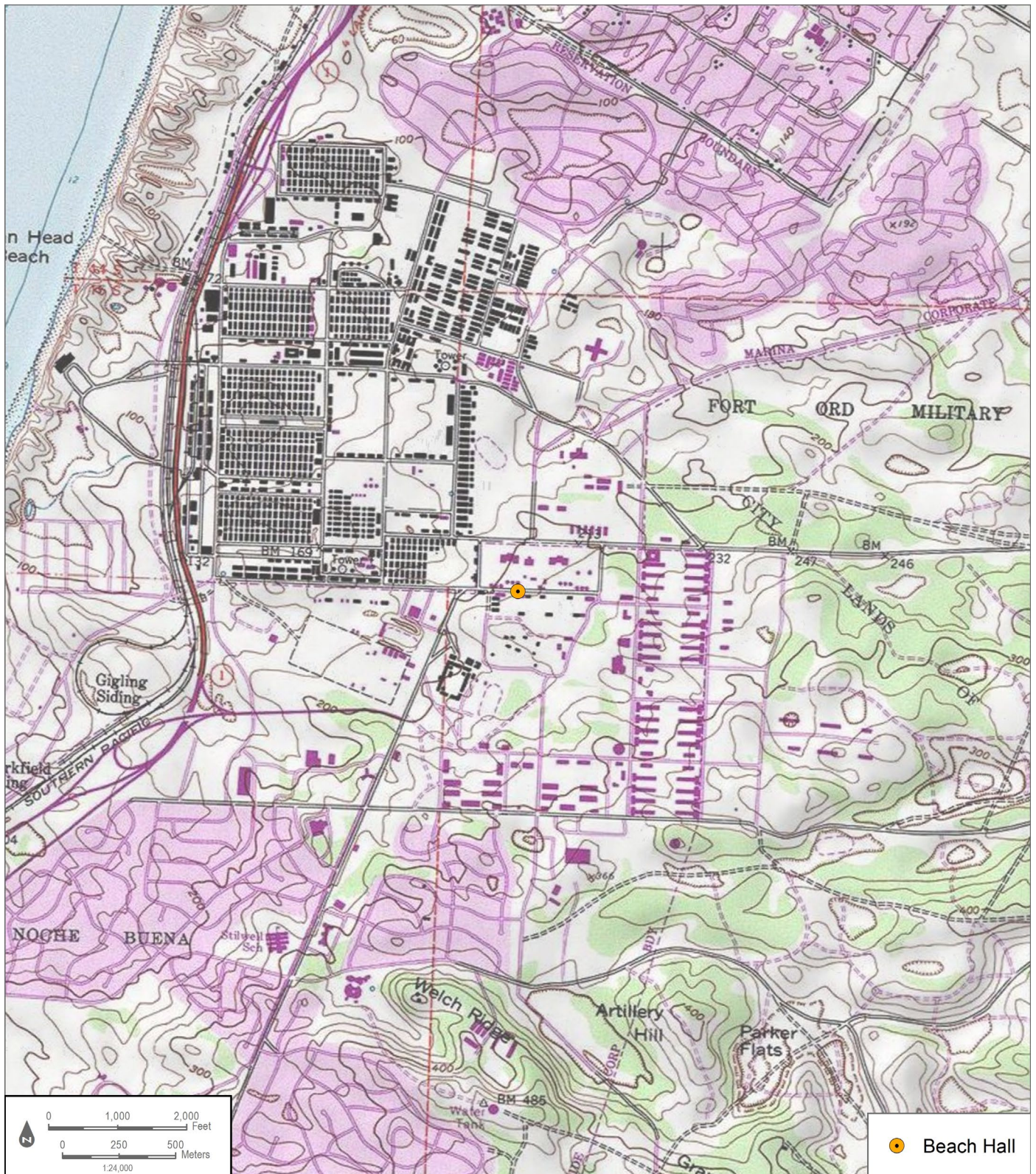

# BUILDING, STRUCTURE, AND OBJECT RECORD

\*Resource Name or # (Assigned by recorder) Beach Hall \*NRHP Status Code 6Z  
Page 3 of 15

B1. Historic Name: Permanent Troop Spaces and Support Facilities Classroom  
B2. Common Name: Beach Hall (CSUMB Building 21)  
B3. Original Use: Military Classroom 4. Present Use: Student Services

\*B5. Architectural Style: Utilitarian

\*B6. Construction History: (Construction date, alterations, and date of alterations)  
Designed in 1953 and completed in 1954, Beach Hall has undergone several alterations. Renovation and as-built drawings show alterations to the Beach Hall took place in 1995. Changes include the addition of gabled roof to south elevation and substantial changes to fenestration (CSUMB Facilities 2021).

\*B7. Moved?  No  Yes  Unknown Date: \_\_\_\_\_ Original Location: \_\_\_\_\_ \*B8. Related Features:

B9a. Architect: Robert Stanton b. Builder: Unknown

\*B10. Significance: Theme N/A Area N/A  
Period of Significance N/A Property Type N/A Applicable Criteria N/A  
(Discuss importance in terms of historical or architectural context as defined by theme, period, and geographic scope. Also address integrity.)

See Continuation Sheet.

B11. Additional Resource Attributes: (List attributes and codes) \_\_\_\_\_

\*B12. References: See Continuation Sheet.

B13. Remarks:

\*B14. Evaluator: Laura Carias, MA

\*Date of Evaluation: July 20, 2021

(This space reserved for official comments.)



## CONTINUATION SHEET

Property Name: Beach Hall

Page 4 of 15

**\*P3a. Description (continued):**

Windows are recently added metal-framed, one-over-one, fixed, and awning windows. A single column of cinderblocks is located between every second window on the main (south) and rear (north) elevation. The fenestration pattern is repeated on the rear elevation. It appears that the westernmost window at the rear elevation was once a door as a pedestrian walkway leads directly up to it. Other alterations include the infill of a centrally located door and windows that flanked it on the rear elevation, added central gabled projection on the main elevation, and recently added main door and all windows.



Figure 1. Main (south) elevation, looking north (IMG\_0302)



## CONTINUATION SHEET

Property Name: Beach Hall

Page 5 of 15



Figure 2. North elevation, looking south (IMG\_0314)

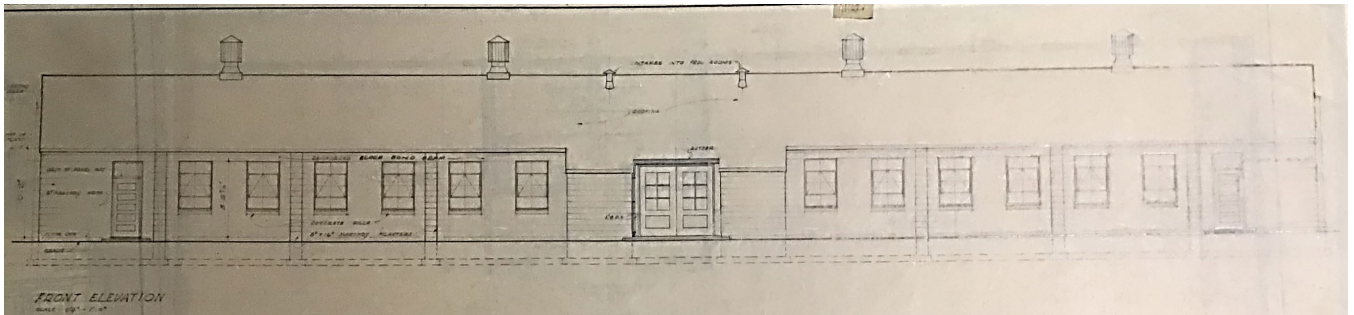

Figure 3. 1953 architectural drawing of the primary elevation of a typical Support Services Building, the design used for Beach Hall (CSUMB Facilities 2021)

### Known and Observed Alterations:

- Replaced original windows with metal sash fixed and awning windows (1995)
- Replaced original windows with contemporary glazed double doors, sidelights and transom window (1995)
- Various filled in windows and doors (1995)
- Added gable projection on south elevation (1995)
- Change of circulation within building as doorways were converted to windows (1995)

## CONTINUATION SHEET

Property Name: Beach Hall

Page 6 of 15

### \*B10. Significance (continued):

#### Historical Overview of Fort Ord

The history of Fort Ord has been extensively documented in newspaper articles, websites, academic journals, and books. From its creation in 1917 to its closure in 1994, the base grew to become one of the largest training centers in the country. Its location was also reported to be the most attractive U.S. Army post, with easy access to the ocean and beautiful California weather.

The development periods in the history of Fort Ord were defined by Harold E. Raugh, Jr, a U.S. Army lieutenant colonel and historian with the Department of Defense. Since his retirement, Raugh served as the Chief Historian, for the Defense Logistics Agency, for the Department of Defense and, from 2006-2013, Raugh served as the Command Historian at the Defense Language Institute Foreign Language Center (DLIFLC) and the Presidio of Monterey, California. He received his PhD in history from the University of California, Los Angeles (Walch 2004). Raugh has authored numerous books including, *Fort Ord* (2004); *Presidio of Monterey* (2004); *Operation Joint Endeavor: V Corps in Bosnia-Herzegovina, 1995-1996* (2013); *The Raugh Bibliography of the Indian Mutiny 1857-1859* (2016); and *Wavell in the Middle East, 1939-1941: A study in Generalship*. Raugh defined four periods for the historic development of Fort Ord:

- 1917-1940 Camp Gigling to Camp Ord
- 1940-1945 Fort Ord and the 7th Infantry Division
- 1946-1976 The Cold War and Vietnam Eras
- 1974-1994 The Volunteer Army

These periods correspond to distinct eras in the history of the base and the U.S. Army (Raugh 2004: ii).

The full historic context of Fort Ord is represented in the report, *Built Environment Inventory and Evaluation Report for California State University, Monterey Bay* (Dudek 2021). The following presents only relevant historical and building typology information pertaining to the development of Beach Hall.

#### Cold War and Vietnam Eras at Fort Ord (1946-1976)

This period of development between 1946 and 1976 was characterized by a massive operation to move the base out of its semi-permanent status and create a permanent outpost for active military personnel who were retained due to ongoing foreign conflicts.

In July of 1948, Harry S Truman signed Executive Order 9981, which officially ended segregation in the armed forces. The order stated that "there shall be equality of treatment and opportunity for all persons in the armed forces without regard to race, color, religion, or national origin" (National Archives Foundation 2021). Fort Ord became one of the first integrated training divisions in the United States. The Fort was touted as "pioneering to end all segregation" (The Pomona Progress Bulletin 1950: 4). In 1950, the Pomona Progress Bulletin reported that black and white soldiers at Fort Ord were "fighting side by side" and all the enlistees "trained together, slept in the same barracks, and eat the same messes" (The Pomona Progress Bulletin 1950: 4).

The end of World War II in 1945 did not bring lasting peace. The tenuous relationship between dominant nations in the communist East and free market West led to the beginning of the Cold War. The Department of Defense maintained a robust fighting force during the Cold War, with more than 900,000 Army personnel retained during the 1950s (ACHP 2006). The ongoing global tensions and the number of active U.S. military personnel created a

## CONTINUATION SHEET

Property Name: Beach Hall

Page 7 of 15

need for new permanent buildings and expanded military housing at Fort Ord.

In 1949, the Soviet-supported communist government of North Korea invaded American-supported South Korea, initiating the Korean War. Fort Ord was a primary staging area for the training of troops departing for the war (Castle 1990:3). By the 1950s, Fort Ord had become one of the largest basic training camps in the United States. In 1952, the military began a multi-million dollar building program to transform Fort Ord into a permanent post, including the development of permanent troop housing, and the construction of a guard house, stockade, and multiple warehouses. In January of 1952, military authorities announced the new construction program at Fort Ord was underway, with an estimated cost of \$26,650,600. More than half of the funds that were approved by Congress were "earmarked for new permanent troop housing" for more than 7,000 soldiers (The Webb Spinner 1952-54, Vol 6. No. 3:1).

The new troop housing was to be constructed of reinforced concrete, a departure from the wood buildings constructed before and during World War II. The plan called for three types of massive barracks, twenty-two were to house 225 enlisted men each, seven were to accommodate 165 men each, and nine were to house 105 men each (The Webb Spinner 1952-54, Vol 6. No. 3:3). The San Francisco District of the U.S. Army Corps of Engineers oversaw the construction project to completion. An additional \$1,349,700 was earmarked for the expansion of classroom and training facilities at Fort Ord, including a new battalion and regimental headquarters (The Californian 1952a:1 and The Californian 1952b:18). By March of 1952, another phase of the permanent army post transformation began with the construction of a guard house, stockade, warehouse, and other buildings (The Webb Spinner 1952-54, Vol 6. No. 3:1). This addition of permanent buildings continued into the late 1950s, when the Army requested \$124 million to replace all the wood World War II infrastructure at Fort Ord with concrete block and reinforced concrete (Madsen and Treffers 2019:6; San Francisco Examiner 1958:2-4). While many of the wood buildings remain today, this period saw the continuous addition of reinforced concrete permanent buildings across the Fort (Madsen and Treffers 2019:6).

Following the Korean War through the end of the conflict in Vietnam, Fort Ord served as an important training facility. In 1957, Fort Ord was designated as a U.S. Army Training Center for Infantry (Castle 1990: 4). The 7th Infantry Division was based at Fort Ord in 1975 (Cavanaugh 2000: 9). Fort Ord produced thousands of combat-ready troops during the conflict in Vietnam.

With the establishment of Fort Ord as a permanent Army base during this period, there was substantial building construction that led to the modernization of the base and its services. This development is closely related to the history of the current CSUMB campus. All the properties that are included as part of this built environment study were constructed during the Cold War and Vietnam Era period. Building development during this period was a substantial departure from the styles and materials used in the buildings constructed before World War II. Building during the period between 1946 and 1976 used reinforced concrete and concrete masonry unit (CMU). The buildings tended to be larger than those constructed in previous periods. Other development in this period included support service buildings and several types of medical buildings. Infrastructure was also improved at this time, with the introduction of paved streets and roadways, and the addition of several water tanks, water pumping plants, and warehouse buildings.

### **Beach Hall, 1954**

Constructed in 1954, Beach Hall (21) was designed by Robert Stanton, Monterey Bay architect (CSUMB Facilities 2021). It was one of several identical buildings described as "permanent troop spaces and supporting facilities/classrooms" designed for Fort Ord

## CONTINUATION SHEET

Property Name: Beach Hall

Page 8 of 15

(CSUMB Facilities 2021). The building first appears in a 1956 aerial photograph as a long, rectangular plan, gable-ended building with a south-facing entrance on the south side of Divarty Street (UCSB 2021). This building floor plan appears unchanged between 1956 and 2005 (NETR 2021). The area surrounding this building appears to have changed, as all the buildings north of Divarty Street to the north were demolished circa 1971-81 (UCSB 2021, NETR 2021). Although parking lots south of Beach Hall appear unchanged since 1956, they have been repaved. Between 2005 and 2009, two buildings to the southwest, along Engineer Lane were demolished (NETR 2021). Between the 2014 and 2016 aerial photographs, the College of Arts, Humanities, and Social Sciences (504) building was erected, due east of Beach Hall (NETR 2021). The circulation pattern in and out of the building was likely changed during a 1995 interior remodel when windows were converted into doors on the north elevation. Before 2005, the gabled addition over the primary entrance was added (NETR 2021). No other changes were noted.

### **Robert Stanton**

Robert Stanton was born in Detroit, Michigan in 1900. He served briefly in the U.S. Navy during World War I and then graduated from high school in Los Angeles and went on to complete his education at University of California at Berkeley. After graduation he worked with renowned architect, Wallace Neff. Neff appointed Stanton as project supervisor on several projects and Stanton earned his architecture license in 1934. Stanton moved to Monterey Bay in 1935 and went on to design a variety of residential, commercial, and public buildings in the area. Two of his buildings, the Monterey County Courthouse and the King City High School Auditorium have been listed on the NRHP (Hiller 2007:8-4). Robert Stanton was known to have designed a plan for classroom buildings at Fort Ord that was used for at least four buildings on campus (CSUMB Facilities 2021).

### **Fort Ord Building Typology and Character-Defining Features**

Four categories of building types were identified for the purposes of this study. These are the Support Services Buildings, Medical Buildings, Hammerhead Buildings/Barracks, and Recreational Buildings. The following presents a discussion of the Support Services building typology, as Beach Hall is classified in this category. This section provides a detailed account of the specific character-defining features of Fort Ord Cold War and Vietnam Era (1946-1976) Support Services buildings.

#### **Building Typology: Support Services Buildings**

Support Services Buildings constructed during the Cold War and Vietnam Eras (1946-1976) at Fort Ord have a variety of uses and functions that changed over the history of the base. The buildings tended to have central entryways that opened into hallways, with classrooms lining the halls. In alignment with the typical planning, design, and materials of buildings from this period of Fort Ord's history, these buildings are constructed with reinforced concrete and CMU and feature gable roofs with multi-light windows with concrete sills. These buildings have a uniform design, like many of the other buildings at Fort Ord.

After Fort Ord closed in 1994, these support services buildings became part of the CSUMB campus. With the shift to campus use, many of the buildings were altered to fit the needs of CSUMB. Beach Hall's building footprint appears unchanged between 1956 and the present, however the circulation pattern of the building's interior changed during a 1995 remodel when some windows were converted to doors on the north elevation, and a gable roof was added over the primary door (CSUMB Facilities 2021; NETR 2021).

#### **Character-Defining Features for the Support Services Buildings**

The Support Services Buildings originally exhibited the following specific character-defining features:

**CONTINUATION SHEET**

Property Name: Beach Hall

Page 9 of 15

| Character Aspect       | Primary Character-Defining Features  | Character-defining features  |
|------------------------|--|--|
| Shape and Plan         | <ul style="list-style-type: none"> <li>• Simple rectangular form</li> <li>• Single story</li> </ul>  | The overall shape and mass of the building are considered a primary character-defining feature of the support services buildings. The plan should be rectangular in form.  |
| Roof                   | <ul style="list-style-type: none"> <li>• Flat or gable roof</li> <li>• small eave overhangs</li> <li>• No exposed rafters</li> </ul>                                   | Support service buildings from this period have gable roof forms, with slight eave overhangs.  |
| Openings               | <ul style="list-style-type: none"> <li>• Public entrances and circulation patterns</li> </ul>  | Window openings are generally uniform in size and placement, windows are multi-light, and set into concrete openings. Replaced windows are not considered character-defining features as they fall outside the period of significance.   |
| Exterior Ornamentation | <ul style="list-style-type: none"> <li>• Minimal exterior ornamentation</li> </ul>   | The support services buildings were designed to be quickly constructed. They have little to no decorative ornamentation, with windows being set evenly apart and CMU pillars being the only decorative element.  |
| Materials              | <ul style="list-style-type: none"> <li>• Mass-produced and cost-effective materials</li> <li>• Concrete and CMU</li> <li>• Reinforced Concrete construction</li> </ul> | The support services buildings have simple, utilitarian designs. Buildings were constructed using mass-produced and cost-effective building materials that were readily available at the time of construction. For instance, buildings under the support services buildings type were constructed with reinforced concrete and CMU and were minimally decorated. |

Alterations and demolitions over time have compromised the overall architectural integrity of this building type. The most common alterations observed for this building type include the following.

- Replacement windows
- ADA compliance measures such as ramps and doors
- HVAC systems and window units
- Infill of openings
- Addition of front gable over doorways
- Interior renovations

**NRHP/CRHR Designation Criteria**

In consideration of the Beach Hall's history and requisite integrity, Dudek recommends the building not eligible for listing in the NRHP and CRHR based on the following significance evaluation and in consideration of national and state eligibility criteria:

**Criterion A/1: That are associated with events that have made a significant contribution to the broad patterns of our history.**

Beach Hall was constructed in 1954 during the period defined as the Cold War and Vietnam Eras (1946-1976) at Ford Ord. While this building is of historic age and was constructed during an important period of development in Fort Ord's history, it no longer retains enough integrity to convey its significance. One of the most notable elements of integrity that is compromised is the integrity of setting. Significant demolition, changes to

## CONTINUATION SHEET

Property Name: Beach Hall

Page 10 of 15

circulation patterns, introduction of new buildings, and changes in use, all impact the building's ability to convey significance from its time as an active Cold War and Vietnam Era military base. The loss of this overall integrity of setting adversely affects Beach Hall, as individual buildings are no longer able to convey their collective history. Additionally, the subdivision of Fort Ord following its closure has also greatly impacted the integrity of feeling, association, and setting of the remaining Cold War and Vietnam Era buildings. Beach Hall is not able to convey its association with any extraordinary events or events occurring within the context of Cold War and Vietnam military support service buildings, the CSUMB Campus, or has an association with the broad patterns of history locally, within the State of California, or the Nation. Therefore, the building is recommended not eligible under NRHP/CRHR Criterion A/1.

**Criterion B/2: That are associated with the lives of persons significant in our past.**

To be found eligible under B/2 Beach Hall must be directly tied to an important person and the place where that individual conducted or produced the work for which he or she is known. No person or persons were shown to be influential or directly associated with the building. As such this building is not known to have any historical associations with people important to the nation's or state's past. Due to a lack of identified significant associations with important persons in history, Dudek recommends the building is not eligible under NRHP/CRHR Criterion B/2.

**Criterion C/3: That embody the distinctive characteristics of a type, period, or method of construction, or that represent the work of a master, or that possess high artistic values, or that represent a significant and distinguishable entity whose components may lack individual distinction.**

Archival research indicates that Beach Hall was constructed in 1954 as one of several classroom/support buildings for Fort Ord. Although designed by architect, Robert Stanton, the building was not constructed in any obvious architectural style. The building is a ubiquitous building type that lacks high style components to set it apart from other buildings constructed in the 1950s. The building has been altered with the addition of a gable at the south main elevation, a majority of the original windows and doors have been replaced, and there have been changes to the fenestration pattern. Due to a lack of high artistic value, a lack of evidence suggesting this is a notable work of Robert Stanton, and because of alterations to character-defining features, Dudek recommends the building is not eligible under NRHP/CRHR Criterion C/3.

**Criterion D/4: That have yielded, or may be likely to yield, information important in prehistory or history.**

There is no evidence to suggest that Beach Hall has the potential to yield information important to state or local history. Therefore, the building is recommended not eligible under NRHP/CRHR Criterion D/4.

**California Historic Landmark Statement of Significance**

In consideration of the building's history and requisite integrity, Dudek recommends the building not eligible for designation as a California Historic Landmark based on the following significance evaluation and in consideration of state eligibility criteria:

**The first, last, only, or most significant of its type in the state or within a large geographic region (Northern, Central, or Southern California).**

Beach Hall was designed in 1953 and constructed in 1954. The building was constructed during the Cold War and Vietnam Eras (1946-1976) at Fort Ord. Beach Hall was designed by Robert Stanton. The building is a ubiquitous building type that lacks high style components to set it apart from other utilitarian buildings constructed throughout the State of California in the 1950s. Therefore, Dudek recommends the building is not eligible for listing as a CHL under this criterion.

## CONTINUATION SHEET

Property Name: Beach Hall

Page 11 of 15

**Associated with an individual or group having a profound influence on the history of California.**

Archival research failed to indicate any significant associations between the Beach Hall and individuals or groups that profoundly influenced the history of California. Beach Hall was one of several support/classroom buildings constructed on the site. Robert Stanton was found to be the building's architect, but the utilitarian building does not reflect one of his remarkable designs. No other individuals are known to have influenced the construction or use of this building. Therefore, Dudek recommends the building is not eligible for listing as a CHL under this criterion.

**A prototype of, or an outstanding example of, a period, style, architectural movement or construction or is one of the more notable works or the best surviving work in a region of a pioneer architect, designer or master builder.**

Beach Hall is neither a prototype or an outstanding example of a period, style, or architectural movement. The building was designed to serve a utilitarian purpose. There are no remaining identifying features on Beach Hall that would establish the building as a notable work of a master architect, or a notable designer or builder working within the military, or in the State of California. Therefore, Dudek recommends the building is not eligible for listing as a CHL under this criterion.

**Local Designation Criteria**

Portions of the CSUMB campus are located within the boundaries of two cities, City of Seaside and the City of Marina, both of which evaluate historical resources in accordance with CEQA Guidelines. as presented above. The subject property, as discussed in the NRHP/CRHR/CHL criteria discussion above, does not rise to the necessary level of significance for local, state, or national designation. For these reasons, the subject property is recommended not eligible individually or as a component of a historic district under any of the NRHP/CRHR/CHL or local criteria.

Additionally, portions of the CSUMB campus are located in the County of Monterey and the campus is therefore subject to the regulations set forth in Chapter 18.25 of the Monterey County Code. The subject property, as discussed in the NRHP/CRHR/CHL criteria discussion above, does not rise to the necessary level of significance for state or national designation. For these same reasons, the subject property is also recommended not eligible individually or as a component of a historic district under any of the delineated County of Monterey review criteria categories that are addressed with the NRHP/CRHR/CHL criteria discussed above: A. Historical and Cultural Significance; B. Historic, Architectural, and Engineering Significance; or C. Community and Geographic Setting.

**Integrity Discussion**

Beach Hall was analyzed against the seven aspects of integrity: location, design, setting, materials, workmanship, feeling, and association. The building retains its integrity of location, as it has not been relocated. The integrity of setting has been compromised with the demolition of adjacent buildings, new constructions, and changes in paths of circulation throughout the campus. This change of use, from a Cold War and Vietnam Era military support services building to an education classroom building for CSUMB also adversely effects the integrity of setting and feeling. Replacement materials have been added throughout the building since its completion in 1954, including new windows, doors, change in fenestration pattern, and addition of roof gable at south elevation over the primary entrance. These alterations have compromised the building's integrity of design, materials, and workmanship. As the building does not possess

## CONTINUATION SHEET

Property Name: Beach Hall

Page 12 of 15

historic significance, there is no historic association. While the building is in good condition, it does not possess integrity to convey significance or its temporal period.

### Summary of Evaluation Findings

Beach Hall retains little historic integrity and lacks historical and architectural significance. Based on the significance evaluations presented above, the Beach Hall does not appear to meet the NRHP, CRHR, CHL or local designation criteria. Therefore, Beach Hall is not considered a historical resource for purposes of CEQA.



## CONTINUATION SHEET

Property Name: Beach Hall

Page 13 of 15

### \*B12. References (continued):

- ACHP (Advisory Council on Historic Preservation). 2006. "Draft Program Comment Regarding Cold War Era Unaccompanied Personnel Housing." Federal Register: The Daily Journal of the United States Government. 12 April 2016. Accessed June 30, 2021 Available at: <https://www.federalregister.gov/documents/2006/04/12/06-3509/draft-program-comment-regarding-cold-war-era-unaccompanied-personnel-housing>
- Californian, The. 1940. "No More Camp Ord! It's Fort Ord Now! Stilwell in Command: Headquarters of General Located on Salinas Side." July 13, 1940. Salinas, California, pg. 1.
- Californian, The. 1951. Stadium Field House—Sixth Army Lets Ord Contract. March 20, 1951. P1. Accessed June 17, 2021. Available at: [Newspapers.com](http://Newspapers.com).
- Castle, Ted. 1990. "The March of Time." Fort Ord Panorama. September 21, 1990.
- Cavanaugh, Joe. 2000. *The Peace Dividend: Defense Conversion Through Higher Education*. The Leon Panetta Institute.
- Chamberlin Library. 2021. Fort Ord Working Papers. CSUMB Special Collections Box 6.42-01. Available at the Chamberlin Library, Seaside, California.
- CSUMB Facilities. 2021. Original As built and renovation architectural drawings on file with CSUMB facilities department. Accessed in person June 15-16, 2021.
- DLIFLC (Defense Language Institute Foreign Language Center). 2021. Command History Program. Accessed in person on June 15, 2021 and accessed online database collection online July 2021. Available at: <https://adli.pastperfectonline.com/>
- EA Engineering. 1991. Draft Final Fort Ord, California Base wide Remedial Investigation Feasibility Study. Volume 1 Literature Review and Base Inventory Report. Accessed on July 13, 2021. Available at: <https://www.fortordcleanup.com/documents/search/>
- Fresno Bee, The. 1951a. "Army Spokesman Are Defending Building of Fort Ord Stadium." January 12, 1951. Page 13. Accessed June 17, 2021.
- Fresno Bee, The. 1951b. "Army Spokesman Are Defending Building of Fort Ord Stadium." February 4, 1951. Page 27. Accessed June 17, 2021. Available at: [Newspapers.com](http://Newspapers.com).
- Gates, S., & Williams, H. 1957. The Armed Forces. The Annals of the American Academy of Political and Social Science, 313, 99-104. Accessed June 17, 2021. <http://proxy.multcolib.org:2052/stable/1031762>
- Hiller, Peter. 2007. NRHP Nomination Form. Monterey County Court House. National Parks Service. Accessed July 18, 2021. Available at: [https://npgallery.nps.gov/NRHP/GetAsset/NRHP/08000878\\_text](https://npgallery.nps.gov/NRHP/GetAsset/NRHP/08000878_text)
- MacGregor Jr., Morris J. 1981. Integration of the Armed Forces, 1940-1965. Center of Military History, United States Army: Washington, D.C.

## CONTINUATION SHEET

Property Name: Beach Hall

Page 14 of 15

- Madsen, Alexandra and Steven Treffers. 2019. *Historic Resources Evaluation Memorandum for Hammerhead Barracks at Fort Ord, Monterey County, California*. Prepared by Rincon Consultants, Inc for City of Seaside, Community and Economic Development Department. November 4, 2019. Accessed June 28, 2021.  
[https://www.ci.seaside.ca.us/DocumentCenter/View/10674/9\\_App-S---HRE-Memo](https://www.ci.seaside.ca.us/DocumentCenter/View/10674/9_App-S---HRE-Memo)
- Military Museum. 2016. "Historic California Posts, Camps, Stations, and Airfields: Fort Ord." Accessed on June 19, 2021. <http://www.militarymuseum.org/FtOrd.html>
- National Archives Foundation. 2021. Executive Order 9981. Accessed June 29, 2021. Available at: <https://www.archivesfoundation.org/documents/executive-order-9981-ending-segregation-armed-forces/>
- NETR (Nationwide Environmental Title Research LLC). 2021. Historic Aerial Photographs of 100 Campus Center, Seaside, CA 93955 dating from 1956, 1968, 1981, 1998, 2005, 2009, 2010, 2012, 2014, 2016, and 2018. Accessed June 10, 2021.  
<https://www.historicaerials.com/viewer>
- Panorama. 1990. "50 Years and Counting..." September 21, 1990, pg. 2.
- Panorama. n.d. "Ford Ord in World War II." Historic California Posts: Fort Ord. Accessed on June 19, 2021. <http://www.militarymuseum.org/FtOrd.html>
- Park, R. 2015. "Happy and Cheerful in This Fine Camp": Sports, Recreation, and the United States Army at Fort Ord and Camp Roberts, 1940 to 1945. *Journal of Sport History*, 42(1), 21-37. Accessed on June 18, 2021, from  
<https://www.jstor.org/stable/10.5406/jsporhistory.42.1.21>
- Pomona Progress Bulletin. 1950. War Solving Racial Problems. August 24, 1950. Page 4. Accessed June 29, 2021. Available at: [Newspapers.com](http://www.newspapers.com).
- Quartermaster Review, The. 1940. "Army Construction Underway at Camp Ord, California." Volume XX. No 3. November-December. On file at the Chamberlin Library, Ord Military Community.
- Raugh, Harold E. 2004. Fort Ord. Charleston, SC: Arcadia.
- Salinas Morning Post. 1940. "\$2,766,000 in Building Authorized—Ord Contracts Let." August 21, 1940. Salinas, CA. pg. 1.
- San Francisco Examiner. 1951. Fort Ord Will Get Stadium. San Francisco Page 4. . 3 Feb 1951. Pages 1 and 4 A Available on [www.Newspapers.com](http://www.newspapers.com). Accessed on Jun 11, 2021.
- San Francisco Examiner. 1958. Army Asks OK on \$124,000,000 for Fort Ord Buildings. San Francisco. Section 2. Page. 4. Available on [www.Newspapers.com](http://www.newspapers.com). Accessed July 18, 2021.
- Vasche, J. Burton. 1959. "The California State Colleges: Their History, Organization, Purposes, and Programs." in California
- U.S. Army. 1977. Post Map Main Garrison Area. Fort Ord, California. Drawing number G-950. Accessed in person at the Chamberlain Library on June 15, 2021.

## CONTINUATION SHEET

Property Name: Beach Hall

Page 15 of 15

Walch, Bob. 2004. An Army Historian's Pictorial Take on Fort Ord. Monterey County NOW. Accessed July 12, 2021. Available at:  
[https://www.montereycountyweekly.com/news/local\\_news/an-army-historian-s-pictorial-take-on-fort-ord/article\\_6e8b0250-9c38-5ca4-a4a4-f93d42d65a11.html](https://www.montereycountyweekly.com/news/local_news/an-army-historian-s-pictorial-take-on-fort-ord/article_6e8b0250-9c38-5ca4-a4a4-f93d42d65a11.html)

Whaley, Derek. 2015. "East Monterey & Seaside." Santa Cruz Trains: Railroads of the Monterey Bay Area. July 20, 2015. Accessed online:  
<https://www.santacruztrains.com/2015/07/east-monterey-seaside.html>.

Webb Spinner, The. 1952-1954. Webb Spinner Volume for 1952-1954. Del Webb Sun Cities Museum Collection. Accessed June 30, 2021. Accessed at:  
<https://delwebbsuncitiesmuseum.org/newsletters-webb-spinners/>

State of California & The Resources Agency  
DEPARTMENT OF PARKS AND RECREATION  
**PRIMARY RECORD**

Primary #  
HRI #  
Trinomial  
NRHP Status Code 6Z

Other Listings  
Review Code

Reviewer

Date

Page 1 of 15 \*Resource Name or #: (Assigned by recorder) Tide Hall

P1. Other Identifier: CSUMB Building 23

\*P2. Location:  Not for Publication  Unrestricted

\*a. County Monterey County and (P2c, P2e, and P2b or P2d. Attach a Location Map as necessary.)

\*b. USGS 7.5' Quad Marina, CA Date 1995 T 15S; R 1E; NE ¼ of SE ¼ of Sec 1; Mount Diablo B.M.

c. Address 3719 Engineer Road Seaside Zip 93955

d. UTM: (Give more than one for large and/or linear resources) Zone 10S 607231 mE/ 4057011 mN

e. Other Locational Data: (e.g., parcel #, directions to resource, elevation, decimal degrees, etc., as appropriate)

Tide Hall sits south of Divarty Street, east of Engineer Lane

\*P3a. Description: (Describe resource and its major elements. Include design, materials, condition, alterations, size, setting, and boundaries)

Tide Hall (CSUMB Building 23) is a one-story utilitarian building that has a rectangular floor plan and a concrete block structural system. The south facing main elevation is symmetrical. It is covered by a moderately pitched side gabled roof clad with composition shingles. The main entrance is located centrally and is flanked by two squared projections and capped by a gabled, glazed dormer. The main entrance consists of contemporary metal framed sliding doors. Secondary doors are contemporary and located on the far east and west ends of the main elevation. Windows are contemporary metal framed, one-over-one, fixed and awning windows.

See Continuation Sheet

\*P3b. Resource Attributes: (List attributes and codes) HP15. Educational building/HP34 Military property

\*P4. Resources Present:  Building

Structure  Object  Site  District  Element of District  Other (Isolates, etc.)

P5b. Description of Photo: (view, date, accession #) south elevation, view looking north, Dudek (IMG 0246).

\*P6. Date Constructed/Age and Source:  Historic  Prehistoric  Both 1953 (CSUMB Facilities)

\*P7. Owner and Address: CSUMB, 100 Campus Center, Seaside, CA. 93955

\*P8. Recorded by: (Name, affiliation, and address) Sarah Corder, Dudek, 725 Front St #400, Santa Cruz, CA 95060

\*P9. Date Recorded: 7/9/2021

\*P10. Survey Type: (Describe) Intensive level

\*P11. Report Citation: (Cite survey report and other sources or enter none) Dudek 2021. Built

P5a. Photograph or Drawing (Photograph required for buildings, structures, and objects.)



Environment Inventory and Evaluation Report for California State University, Monterey Bay.

\*Attachments:  NONE  Location Map  Continuation Sheet  Building, Structure, and Object Record

Archaeological Record  District Record  Linear Feature Record  Milling Station Record  Rock Art Record

Artifact Record  Photograph Record  Other (List): \_\_\_\_\_

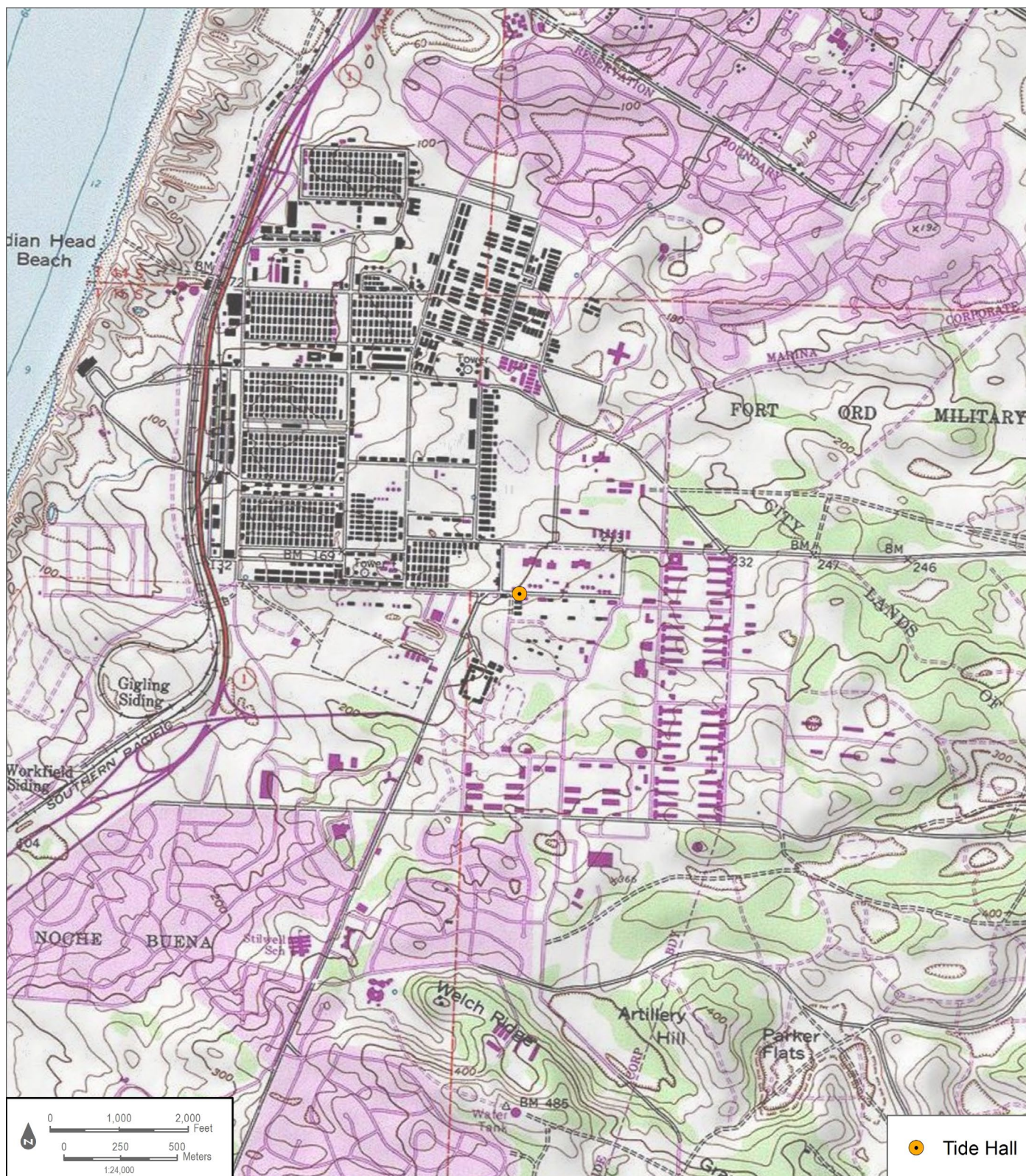

# BUILDING, STRUCTURE, AND OBJECT RECORD

\*Resource Name or # (Assigned by recorder) Tide Hall \*NRHP Status Code 6Z  
Page 3 of 15

B1. Historic Name: Permanent Troop Spaces and Support Facilities Classroom  
B2. Common Name: Tide Hall  
B3. Original Use: Educational building 4. Present Use: Administration

\*B5. Architectural Style: Utilitarian

\*B6. Construction History: (Construction date, alterations, and date of alterations)  
Designed in 1953 and completed in 1954, Tide Hall has undergone several alterations. Renovation and as-built drawings show alterations to the building took place in 1995. Changes include the addition of gabled roof to south elevation and substantial changes to fenestration (CSUMB Facilities 2021).

\*B7. Moved?  No  Yes  Unknown Date: \_\_\_\_\_ Original Location: \_\_\_\_\_ \*B8. Related Features:

B9a. Architect: Robert Stanton b. Builder: Unknown

\*B10. Significance: Theme N/A Area N/A  
Period of Significance N/A Property Type N/A Applicable Criteria N/A  
(Discuss importance in terms of historical or architectural context as defined by theme, period, and geographic scope. Also address integrity.)

See Continuation Sheet.

B11. Additional Resource Attributes: (List attributes and codes) \_\_\_\_\_

\*B12. References: See Continuation Sheet.

B13. Remarks:

\*B14. Evaluator: Laura Carias, MA

\*Date of Evaluation: July 9, 2021

(This space reserved for official comments.)

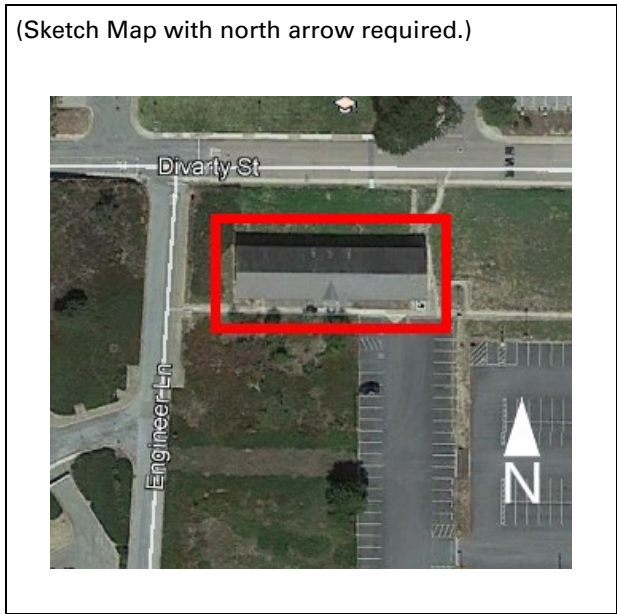

## CONTINUATION SHEET

Property Name: Tide Hall

Page 4 of 15

**\*P3a. Description (continued):**

A single column of cinderblocks is located between every second window on the main (south) and rear (north) elevation. The westernmost and easternmost windows on the rear elevation appear have originally been doorways as concrete and asphalt pedestrian walkways lead directly up to them. Window fenestration is repeated on the north (rear) elevation. Alterations include the infill of a centrally located windows on the rear elevation, conversion of doors to windows on rear elevation, added central gabled projection on main elevation, and replacement doors.



Figure 1. Main (south) elevation, looking north (IMG\_0292)

## CONTINUATION SHEET

Property Name: Tide Hall

Page 5 of 15



Figure 2. North elevation, looking south (IMG\_0314)

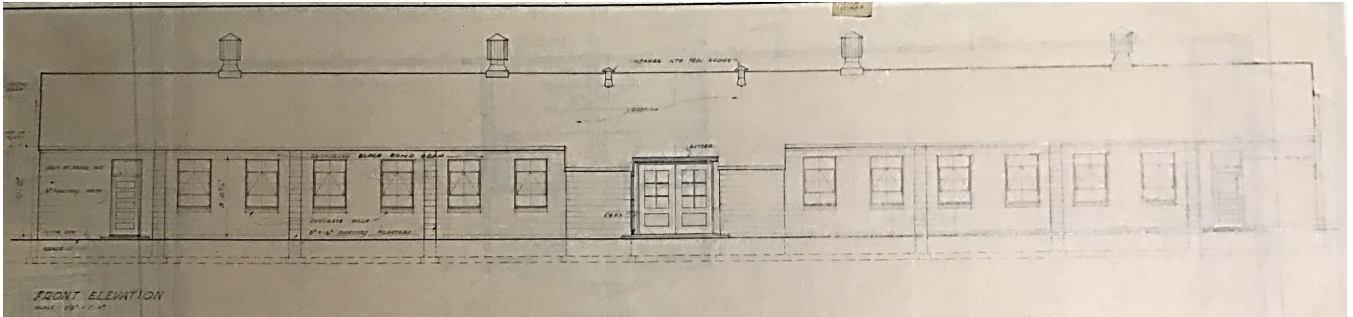

Figure 3. 1953 architectural drawing of a typical Support Services Building, the design used for Tide Hall (CSUMB Facilities 2021)

### Alterations:

- Replaced original windows with metal sash fixed and awning windows (1995)
- Various filled in windows and doors (Date unknown)
- Added gable projection on south elevation (1995)
- Replaced original doors (Date unknown)
- Change of circulation within building as doorways were converted to windows (1995)



## CONTINUATION SHEET

Property Name: Tide Hall

Page 6 of 15

### \*B10. Significance (continued):

#### Historical Overview of Fort Ord

The history of Fort Ord has been extensively documented in newspaper articles, websites, academic journals, and books. From its creation in 1917 to its closure in 1994, the base grew to become one of the largest training centers in the country. Its location was also reported to be the most attractive U.S. Army post, with easy access to the ocean and beautiful California weather.

The development periods in the history of Fort Ord were defined by Harold E. Raugh, Jr, a U.S. Army lieutenant colonel and historian with the Department of Defense. Since his retirement, Raugh served as the Chief Historian, for the Defense Logistics Agency, for the Department of Defense and, from 2006-2013, Raugh served as the Command Historian at the Defense Language Institute Foreign Language Center (DLIFLC) and the Presidio of Monterey, California. He received his PhD in history from the University of California, Los Angeles (Walch 2004). Raugh has authored numerous books including, *Fort Ord* (2004); *Presidio of Monterey* (2004); *Operation Joint Endeavor: V Corps in Bosnia-Herzegovina, 1995-1996* (2013); *The Raugh Bibliography of the Indian Mutiny 1857-1859* (2016); and *Wavell in the Middle East, 1939-1941: A study in Generalship*. Raugh defined four periods for the historic development of Fort Ord:

- 1917-1940 Camp Gigling to Camp Ord
- 1940-1945 Fort Ord and the 7th Infantry Division
- 1946-1976 The Cold War and Vietnam Eras
- 1974-1994 The Volunteer Army

These periods correspond to distinct eras in the history of the base and the U.S. Army (Raugh 2004: ii). The following sections provide a summary overview of each of these periods of development and their relevance to the area of Fort Ord now known as the CSUMB campus.

The full historic context of Fort Ord is represented in the report, *Built Environment Inventory and Evaluation Report for California State University, Monterey Bay* (Dudek 2021). The following presents only relevant historical and building typology information pertaining to the development of Tide Hall.

#### Cold War and Vietnam Eras at Fort Ord (1946-1976)

This period of development between 1946 and 1976 was characterized by a massive operation to move the base out of its semi-permanent status and create a permanent outpost for active military personnel who were retained due to ongoing foreign conflicts.

In July of 1948, Harry S Truman signed Executive Order 9981, which officially ended segregation in the armed forces. The order stated that "there shall be equality of treatment and opportunity for all persons in the armed forces without regard to race, color, religion, or national origin" (National Archives Foundation 2021). Fort Ord became one of the first integrated training divisions in the United States. The Fort was touted as "pioneering to end all segregation" (Pomona Progress Bulletin 1950: 4). In 1950, the Pomona Progress Bulletin reported that black and white soldiers at Fort Ord were "fighting side by side" and all the enlistees "trained together, slept in the same barracks, and eat the same messes" (Pomona Progress Bulletin 1950: 4).

The end of World War II in 1945 did not bring lasting peace. The tenuous relationship between dominant nations in the communist East and free market West led to the beginning of the Cold War. The Department of Defense maintained a robust fighting force during the Cold War, with more than 900,000 Army personnel retained during the 1950s (ACHP 2006).

## CONTINUATION SHEET

Property Name: Tide Hall

Page 7 of 15

The ongoing global tensions and the number of active U.S. military personnel created a need for new permanent buildings and expanded military housing at Fort Ord.

In 1949, the Soviet-supported communist government of North Korea invaded American-supported South Korea, initiating the Korean War. Fort Ord was a primary staging area for the training of troops departing for the war (Castle 1990:3). By the 1950s, Fort Ord had become one of the largest basic training camps in the United States. In 1952, the military began a multi-million dollar building program to transform Fort Ord into a permanent post, including the development of permanent troop housing, and the construction of a guard house, stockade, and multiple warehouses. In January of 1952, military authorities announced the new construction program at Fort Ord was underway, with an estimated cost of \$26,650,600. More than half of the funds that were approved by Congress were "earmarked for new permanent troop housing" for more than 7,000 soldiers (The Webb Spinner 1952-54, Vol 6. No. 3:1).

The new troop housing was to be constructed of reinforced concrete, a departure from the wood buildings constructed before and during World War II. The plan called for three types of massive barracks, twenty-two were to house 225 enlisted men each, seven were to accommodate 165 men each, and nine were to house 105 men each (The Webb Spinner 1952-54, Vol 6. No. 3:3). The San Francisco District of the U.S. Army Corps of Engineers oversaw the construction project to completion. An additional \$1,349,700 was earmarked for the expansion of classroom and training facilities at Fort Ord, including a new battalion and regimental headquarters (The Californian 1952a:1 and The Californian 1952b:18). By March of 1952, another phase of the permanent army post transformation began with the construction of a guard house, stockade, warehouse, and other buildings (The Webb Spinner 1952-54, Vol 6. No. 3:1). This addition of permanent buildings continued into the late 1950s, when the Army requested \$124 million to replace all the wood World War II infrastructure at Fort Ord with concrete block and reinforced concrete (Madsen and Treffers 2019:6; San Francisco Examiner 1958:2-4). While many of the wood buildings remain today, this period saw the continuous addition of reinforced concrete permanent buildings across the Fort (Madsen and Treffers 2019:6).

Following the Korean War through the end of the conflict in Vietnam, Fort Ord served as an important training facility. In 1957, Fort Ord was designated as a U.S. Army Training Center for Infantry (Castle 1990: 4). The 7th Infantry Division was based at Fort Ord in 1975 (Cavanaugh 2000: 9). Fort Ord produced thousands of combat-ready troops during the conflict in Vietnam.

With the establishment of Fort Ord as a permanent Army base during this period, there was substantial building construction that led to the modernization of the base and its services. This development is closely related to the history of the current CSUMB campus. All the properties that are included as part of this built environment study were constructed during the Cold War and Vietnam Era period. Building development during this period was a substantial departure from the styles and materials used in the buildings constructed before World War II. Buildings constructed between 1946 and 1976 primarily used reinforced concrete and concrete masonry unit (CMU) in their design. The buildings tended to be larger than those constructed in previous periods. Other development in this period included support service buildings and several types of medical buildings. Infrastructure was also improved at this time, with the introduction of paved streets and roadways, and the addition of several water tanks, water pumping plants, and warehouse buildings.

### **Tide Hall (23)**

Constructed in 1954, Tide Hall (23) was designed by Robert Stanton a local Monterey Bay

## CONTINUATION SHEET

Property Name: Tide Hall

Page 8 of 15

architect (CSUMB Facilities 2021). It was one of several identical buildings described as “permanent troop spaces and supporting facilities/classrooms” designed for Fort Ord (CSUMB Facilities 2021). The building first appears in a 1956 aerial photograph as a long, rectangular plan, gable-ended building with a south-facing entrance, on the south side of Divarty Street (UCSB 2021). This building appears unchanged between 1956 and 2016, there are major changes to the surrounding area (NETR 2021). All the buildings north of Divarty Street to the north were demolished circa 1971-81 (UCSB 2021, NETR 2021). Between 1981 and 1987, the Veteran’s Administration building appears to the southwest across Engineer’s Lane 81 (NETR 2021, UCSB 2021). Between 2005 and 2009, two buildings immediately south of Tide Hall along Engineer Lane were demolished (NETR 2021). The circulation pattern in and out of the building was likely changed during a 1995 interior remodel when windows were converted into doors on the north elevation (CSUMB Facilities 2021). Before 2005, the gabled addition over the primary entrance was added (NETR 2021). No other changes were noted.

### **Robert Stanton**

Robert Stanton was born in Detroit, Michigan in 1900. He served briefly in the U.S. Navy during World War I and then graduated from high school in Los Angeles and went on to complete his education at University of California at Berkeley. After graduation he worked with renowned architect, Wallace Neff. Neff appointed Stanton as project supervisor on several projects and Stanton earned his architecture license in 1934. Stanton moved to Monterey Bay in 1935 and went on to design a variety of residential, commercial, and public buildings in the area. Two of his buildings, the Monterey County Courthouse and the King City High School Auditorium have been listed on the NRHP (Hiller 2007:8-4). Robert Stanton was known to have designed a plan for classroom buildings at Fort Ord that was used for at least four buildings on campus (CSUMB Facilities 2021).

### **Fort Ord Building Typology**

Four categories of building types were identified for the purposes of this study. These are the Support Services Buildings, Medical Buildings, Hammerhead Buildings/Barracks, and Recreational Buildings. The following presents a discussion of the Support Services building typology, as Tide Hall (23) is classified in this typology. This section provides a detailed account of the specific character-defining features of Fort Ord Cold War and Vietnam Era (1946-1976) Support Services buildings.

### **Building Typology: Support Services Buildings**

Support Services Buildings constructed during the Cold War and Vietnam Eras (1946-1976) at Fort Ord have a variety of uses and functions that changed over the history of the base. In alignment with the typical planning, design, and materials of buildings constructed during this period of Fort Ord’s history, these buildings are constructed with reinforced concrete and CMU and feature moderately pitched gable roofs with multi-light windows with concrete sills. The buildings tended to have central entryways that opened into hallways, with classrooms lining the halls. In alignment with the typical planning, design, and materials of buildings from this period of Fort Ord’s history, these buildings are constructed with reinforced concrete and CMU and feature gable roofs with multi-light windows with concrete sills. These buildings have a uniform design, like many of the other buildings at Fort Ord.

After Fort Ord closed in 1994, these support services buildings became part of the CSUMB campus. With the shift to campus use, many of the buildings were altered to fit the needs of CSUMB. Tide Hall’s building footprints appears unchanged between 1956 and the present, however the circulation pattern of the building’s interior changed during a 1995 remodel when some windows were converted to doors on the north elevation, and a gable roof was added over the primary door (CSUMB Facilities 2021; NETR 2021).

**CONTINUATION SHEET**

Property Name: Tide Hall

Page 9 of 15

**Character-Defining Features for the Support Services Buildings**

The Support Services Buildings originally exhibited the following specific character-defining features:

| Character Aspect       | Primary Character-Defining Features  | Character-defining features  |
|------------------------|--|--|
| Shape and Plan         | <ul style="list-style-type: none"> <li>• Simple rectangular form</li> <li>• Single story</li> </ul>  | The overall shape and mass of the building are considered a primary character-defining feature of the support services buildings. The plan should be rectangular in form.  |
| Roof                   | <ul style="list-style-type: none"> <li>• Flat or gable roof</li> <li>• small eave overhangs</li> <li>• No exposed rafters</li> </ul>                                   | Support service buildings from this period have gable roof forms, with slight eave overhangs.  |
| Openings               | <ul style="list-style-type: none"> <li>• Public entrances and circulation patterns</li> </ul>  | Window openings are generally uniform in size and placement, windows are multi-light, and set into concrete openings. Replaced windows are not considered character-defining features as they fall outside the period of significance.   |
| Exterior Ornamentation | <ul style="list-style-type: none"> <li>• Minimal exterior ornamentation</li> </ul>   | The support services buildings were designed to be quickly constructed. They have little to no decorative ornamentation, with windows being set evenly apart and CMU pillars being the only decorative element.  |
| Materials              | <ul style="list-style-type: none"> <li>• Mass-produced and cost-effective materials</li> <li>• Concrete and CMU</li> <li>• Reinforced Concrete construction</li> </ul> | The support services buildings have simple, utilitarian designs. Buildings were constructed using mass-produced and cost-effective building materials that were readily available at the time of construction. For instance, buildings under the support services buildings type were constructed with reinforced concrete and CMU and were minimally decorated. |

Alterations and demolitions over time have compromised the overall architectural integrity of this building type. The most common alterations observed for this building type include the following:

- Replacement windows
- ADA compliance measures such as ramps and doors
- HVAC systems and window units
- Infill of openings
- Addition of front gable over doorways
- Interior renovations

**NRHP/CRHR Designation Criteria**

In consideration of Tide Hall's history and requisite integrity, Dudek recommends the building not eligible for listing in the NRHP and CRHR based on the following significance evaluation and in consideration of national and state eligibility criteria:

**Criterion A/1: That are associated with events that have made a significant contribution to the broad patterns of our history.**

Tide Hall was constructed in 1954 during the period defined as the Cold War and Vietnam

## CONTINUATION SHEET

Property Name: Tide Hall

Page 10 of 15

Eras (1946-1976) at Ford Ord. While this building is of historic age and was constructed during an important period of development in Fort Ord's history, it no longer retains enough integrity to convey its significance. One of the most notable elements of integrity that is compromised is the integrity of setting. Significant demolition, changes to circulation patterns, introduction of new buildings, and changes in use, all impact the campus's ability to convey significance from its time as an active Cold War and Vietnam Era military base. The loss of this overall integrity of setting adversely affects Tide Hall, as individual buildings are no longer able to convey their collective history. Additionally, the subdivision of Fort Ord following its closure has also greatly impacted the integrity of feeling, association, and setting of the remaining Cold War and Vietnam Era buildings. Tide Hall is not able to convey its association with any extraordinary events or events occurring within the context of Cold War and Vietnam military support service buildings, the CSUMB Campus, or has an association with the broad patterns of history in Monterey County, the State of California, or the Nation. Therefore, the building is recommended not eligible under NRHP/CRHR Criterion A/1.

**Criterion B/2: That are associated with the lives of persons significant in our past.**

To be found eligible under B/2 the building must be directly tied to an important person and the place where that individual conducted or produced the work for which he or she is known. No other single person was shown to be influential or directly associated with the building. As such, this building is not known to have any historical associations with people important to the nation's or state's past. Due to a lack of identified significant associations with important persons in history, Dudek recommends the building is not eligible under NRHP/CRHR Criterion B/2.

**Criterion C/3: That embody the distinctive characteristics of a type, period, or method of construction, or that represent the work of a master, or that possess high artistic values, or that represent a significant and distinguishable entity whose components may lack individual distinction.**

Archival research indicates that Tide Hall was constructed in 1954 as one of several classroom/support buildings for Fort Ord. Although designed by architect, Robert Stanton, the building was not constructed in any obvious architectural style. The building is a ubiquitous building type that lacks high style components to set it apart from other buildings constructed in the 1960s. The building has been altered with the addition of a gable at the south main elevation and the removal of all original windows and doors as well as changes to the fenestration pattern. For these reasons, the building does not possess a high level of architectural merit to be considered for inclusion in the NRHP. For these reasons Dudek recommends Tide Hall is not eligible under NRHP/CRHR Criterion C/3.

**Criterion D/4: That have yielded, or may be likely to yield, information important in prehistory or history.**

There is no evidence to suggest that Tide Hall has the potential to yield information important to state or local history. Therefore, the building is recommended not eligible under NRHP/CRHR Criterion D/4.

**California Historic Landmark Statement of Significance**

In consideration of Tide Hall's history and requisite integrity, Dudek recommends the building is not eligible for designation as a California Historic Landmark based on the following significance evaluation and in consideration of state eligibility criteria:

**The first, last, only, or most significant of its type in the state or within a large geographic region (Northern, Central, or Southern California).**

Tide Hall was designed in 1953 and constructed in 1954. The building was constructed after the initial, core development period of Fort Ord in the 1940s. Tide Hall was

## CONTINUATION SHEET

Property Name: Tide Hall

Page 11 of 15

designed by Robert Stanton. The building is a ubiquitous building type that lacks high style components to set it apart from other utilitarian buildings constructed throughout the State of California in the 1950s. Therefore, Dudek recommends the building is not eligible for listing as a CHL under this criterion.

### **Associated with an individual or group having a profound influence on the history of California.**

Archival research failed to indicate any significant associations between Tide Hall and individuals or groups that profoundly influenced the history of California. Tide Hall was one of several support/classroom buildings constructed on the site. Robert Stanton was found to be the architect responsible for the design, but the utilitarian building does not reflect one of his remarkable designs. No other individuals are known to have influenced the construction or use of this building. Therefore, Dudek recommends the building is not eligible for listing as a CHL under this criterion.

### **A prototype of, or an outstanding example of, a period, style, architectural movement or construction or is one of the more notable works or the best surviving work in a region of a pioneer architect, designer or master builder.**

Tide Hall is neither a prototype or an outstanding example of a period, style, or architectural movement. The building was designed to serve a utilitarian purpose. There are no remaining identifying features on Tide Hall that would establish the building as a notable work of a master architect, or a notable designer or builder working within the military, or in the State of California. Therefore, Dudek recommends the building is not eligible for listing as a CHL under this criterion.

### **Local Designation Criteria**

Portions of the CSUMB campus are located within the boundaries of two cities, City of Seaside and the City of Marina, both of which evaluate historical resources in accordance with CEQA Guidelines. as presented above. The subject property, as discussed in the NRHP/CRHR/CHL criteria discussion above, does not rise to the necessary level of significance for local, state, or national designation. For these reasons, the subject property is recommended not eligible individually or as a component of a historic district under any of the NRHP/CRHR/CHL or local criteria.

Additionally, portions of the CSUMB campus are located in the County of Monterey and the campus is therefore subject to the regulations set forth in Chapter 18.25 of the Monterey County Code. The subject property, as discussed in the NRHP/CRHR/CHL criteria discussion above, does not rise to the necessary level of significance for state or national designation. For these same reasons, the subject property is also recommended not eligible individually or as a component of a historic district under any of the delineated County of Monterey review criteria categories that are addressed with the NRHP/CRHR/CHL criteria discussed above: A. Historical and Cultural Significance; B. Historic, Architectural, and Engineering Significance; or C. Community and Geographic Setting.

### **Integrity Discussion**

Tide Hall was analyzed against the seven aspects of integrity: location, design, setting, materials, workmanship, feeling, and association. The building retains its integrity of location, as it has not been relocated; however, the integrity of setting has been compromised due to the change of use, from a Cold War and Vietnam Era military support services building to an educational classroom building for CSUMB. Changes to the surrounding area have further compromised the integrity of setting and feeling. Replacement materials have been added throughout the building since its completion in 1954, including new doors, changes in the fenestration pattern, and addition of roof gable at south elevation. These alterations have compromised the resource's integrity of

## CONTINUATION SHEET

Property Name: Tide Hall

Page 12 of 15

design, materials, and workmanship. As the building does not possess historic significance, there is no historic association. While the building is in good condition, it does not possess integrity to convey significance or its temporal period.

### Summary of Evaluation Findings

Tide Hall retains little historic integrity and lacks historical and architectural significance. Based on the significance evaluations presented above, Tide Hall does not appear to meet the NRHP, CRHR, CHL or local designation criteria. Therefore, Tide Hall is not considered a historical resource for purposes of CEQA.

## CONTINUATION SHEET

Property Name: Tide Hall

Page 13 of 15

### \*B12. References (continued):

- ACHP (Advisory Council on Historic Preservation). 2006. "Draft Program Comment Regarding Cold War Era Unaccompanied Personnel Housing." Federal Register: The Daily Journal of the United States Government. 12 April 2016. Accessed June 30, 2021 Available at: <https://www.federalregister.gov/documents/2006/04/12/06-3509/draft-program-comment-regarding-cold-war-era-unaccompanied-personnel-housing>
- Californian, The. 1940. "No More Camp Ord! It's Fort Ord Now! Stilwell in Command: Headquarters of General Located on Salinas Side." July 13, 1940. Salinas, California, pg. 1.
- Californian, The. 1951. Stadium Field House—Sixth Army Lets Ord Contract. March 20, 1951. P1. Accessed June 17, 2021. Available at: [Newspapers.com](http://Newspapers.com).
- Castle, Ted. 1990. "The March of Time." Fort Ord Panorama. September 21, 1990.
- Cavanaugh, Joe. 2000. *The Peace Dividend: Defense Conversion Through Higher Education*. The Leon Panetta Institute.
- Chamberlin Library. 2021. Fort Ord Working Papers. CSUMB Special Collections Box 6.42-01. Available at the Chamberlin Library, Seaside, California.
- CSUMB Facilities. 2021. Original As built and renovation architectural drawings on file with CSUMB facilities department. Accessed in person June 15-16, 2021.
- DLIFLC (Defense Language Institute Foreign Language Center). 2021. Command History Program. Accessed in person on June 15, 2021 and accessed online database collection online July 2021. Available at: <https://adli.pastperfectonline.com/>
- EA Engineering. 1991. Draft Final Fort Ord, California Base wide Remedial Investigation Feasibility Study. Volume 1 Literature Review and Base Inventory Report. Accessed on July 13, 2021. Available at: <https://www.fortordcleanup.com/documents/search/>
- Fresno Bee, The. 1951a. "Army Spokesman Are Defending Building of Fort Ord Stadium." January 12, 1951. Page 13. Accessed June 17, 2021.
- Fresno Bee, The. 1951b. "Army Spokesman Are Defending Building of Fort Ord Stadium." February 4, 1951. Page 27. Accessed June 17, 2021. Available at: [Newspapers.com](http://Newspapers.com).
- Gates, S., & Williams, H. 1957. The Armed Forces. The Annals of the American Academy of Political and Social Science, 313, 99-104. Accessed June 17, 2021. <http://proxy.multcolib.org:2052/stable/1031762>
- Hiller, Peter. 2007. NRHP Nomination Form. Monterey County Court House. National Parks Service. Accessed July 18, 2021. Available at: [https://npgallery.nps.gov/NRHP/GetAsset/NRHP/08000878\\_text](https://npgallery.nps.gov/NRHP/GetAsset/NRHP/08000878_text)



## CONTINUATION SHEET

Property Name: Tide Hall

Page 14 of 15

MacGregor Jr., Morris J. 1981. *Integration of the Armed Forces, 1940-1965*. Center of Military History, United States Army: Washington, D.C.

Madsen, Alexandra and Steven Treffers. 2019. *Historic Resources Evaluation Memorandum for Hammerhead Barracks at Fort Ord, Monterey County, California*. Prepared by Rincon Consultants, Inc for City of Seaside, Community and Economic Development Department. November 4, 2019. Accessed June 28, 2021.  
[https://www.ci.seaside.ca.us/DocumentCenter/View/10674/9\\_App-S---HRE-Memo](https://www.ci.seaside.ca.us/DocumentCenter/View/10674/9_App-S---HRE-Memo)

Military Museum. 2016. "Historic California Posts, Camps, Stations, and Airfields: Fort Ord." Accessed on June 19, 2021. <http://www.militarymuseum.org/FtOrd.html>

National Archives Foundation. 2021. Executive Order 9981. Accessed June 29, 2021. Available at: <https://www.archivesfoundation.org/documents/executive-order-9981-ending-segregation-armed-forces/>

NETR (Nationwide Environmental Title Research LLC). 2021. Historic Aerial Photographs of 100 Campus Center, Seaside, CA 93955 dating from 1956, 1968, 1981, 1998, 2005, 2009, 2010, 2012, 2014, 2016, and 2018. Accessed June 10, 2021.  
<https://www.historicaerials.com/viewer>

Panorama. 1990. "50 Years and Counting..." September 21, 1990, pg. 2.

Panorama. n.d. "Ford Ord in World War II." Historic California Posts: Fort Ord. Accessed on June 19, 2021. <http://www.militarymuseum.org/FtOrd.html>

Park, R. 2015. "Happy and Cheerful in This Fine Camp": Sports, Recreation, and the United States Army at Fort Ord and Camp Roberts, 1940 to 1945. *Journal of Sport History*, 42(1), 21-37. Accessed on June 18, 2021, from  
<https://www.jstor.org/stable/10.5406/jsporthistory.42.1.21>

Pomona Progress Bulletin. 1950. War Solving Racial Problems. August 24, 1950. Page 4. Accessed June 29, 2021. Available at: [Newspapers.com](http://www.newspapers.com).

Quartermaster Review, The. 1940. "Army Construction Underway at Camp Ord, California." Volume XX. No 3. November-December. On file at the Chamberlin Library, Ord Military Community.

Raugh, Harold E. 2004. Fort Ord. Charleston, SC: Arcadia.

Salinas Morning Post. 1940. "\$2,766,000 in Building Authorized—Ord Contracts Let." August 21, 1940. Salinas, CA. pg. 1.

San Francisco Examiner. 1951. Fort Ord Will Get Stadium. San Francisco Page 4. · 3 Feb 1951. Pages 1 and 4 A Available on [www.Newspapers.com](http://www.newspapers.com). Accessed on Jun 11, 2021.

San Francisco Examiner. 1958. Army Asks OK on \$124,000,000 for Fort Ord Buildings. San Francisco. Section 2. Page. 4. Available on [www.Newspapers.com](http://www.newspapers.com). Accessed July 18, 2021.

## CONTINUATION SHEET

Property Name: Tide Hall

Page 15 of 15

Vasche, J. Burton. 1959. "The California State Colleges: Their History, Organization, Purposes, and Programs." in California

U.S. Army. 1977. Post Map Main Garrison Area. Fort Ord, California. Drawing number G-950. Accessed in person at the Chamberlain Library on June 15, 2021.

Walch, Bob. 2004. An Army Historian's Pictorial Take on Fort Ord. Monterey County NOW. Accessed July 12, 2021. Available at:  
[https://www.montereycountyweekly.com/news/local\\_news/an-army-historian-s-pictorial-take-on-fort-ord/article\\_6e8b0250-9c38-5ca4-a4a4-f93d42d65a11.html](https://www.montereycountyweekly.com/news/local_news/an-army-historian-s-pictorial-take-on-fort-ord/article_6e8b0250-9c38-5ca4-a4a4-f93d42d65a11.html)

Whaley, Derek. 2015. "East Monterey & Seaside." Santa Cruz Trains: Railroads of the Monterey Bay Area. July 20, 2015. Accessed online:  
<https://www.santacruztrains.com/2015/07/east-monterey-seaside.html>.

Webb Spinner, The. 1952-1954. Webb Spinner Volume for 1952-1954. Del Webb Sun Cities Museum Collection. Accessed June 30, 2021. Accessed at:  
<https://delwebbsuncitiesmuseum.org/newsletters-webb-spinners/>

State of California & The Resources Agency  
DEPARTMENT OF PARKS AND RECREATION  
**PRIMARY RECORD**

Primary #  
HRI #  
Trinomial  
NRHP Status Code 6Z

Other Listings  
Review Code

Reviewer

Date

Page 1 of 15 \*Resource Name or #: (Assigned by recorder) Watershed Institute

P1. Other Identifier: CSUMB Building 42

\*P2. Location:  Not for Publication  Unrestricted

\*a. County Monterey County and (P2c, P2e, and P2b or P2d. Attach a Location Map as necessary.)

\*b. USGS 7.5' Quad Marina, CA Date 1995 T 15S; R 1E; NE  $\frac{1}{4}$   of SW  $\frac{1}{4}$   of Sec 6; Mount Diablo B.M.

c. Address 4573 6th Avenue, Seaside Zip 93955

d. UTM: (Give more than one for large and/or linear resources) Zone 10S, 607912 mE/ 4056703 mN

e. Other Locational Data: (e.g., parcel #, directions to resource, elevation, decimal degrees, etc., as appropriate)

The Watershed Institute (CSUMB Building 42) sits south of B Street, between 6<sup>th</sup> Avenue and 7<sup>th</sup> Avenue.

\*P3a. Description: (Describe resource and its major elements. Include design, materials, condition, alterations, size, setting, and boundaries)

The Watershed Institute (CSUMB Building 42) is located southeast of the Main Quad on the California State University, Monterey Bay (CSUMB) campus. The building is surrounded by simple plantings and to the east of the building are several greenhouses and planting areas, where native plant restoration is taught in an outdoor classroom setting. A parking area is to the south of the building. The one-story utilitarian building with modern stylistic details has a primarily rectangular floor plan with a rectangular projection on the west facade. The building appears to sit on a concrete slab foundation and the primary construction material is CMU.

See Continuation Sheet.

\*P3b. Resource Attributes: (List attributes and codes) HP15. Educational building, HP34. Military property

P5a. Photograph or Drawing (Photograph required for buildings, structures, and objects.)



\*P4. Resources Present:  Building  
 Structure  Object  Site  District   
Element of District  Other (Isolates, etc.)

P5b. Description of Photo: (view, date, accession #) north  
elevation, view looking  
southeast, Dudek  
(IMG 0682)

\*P6. Date Constructed/Age and Source:  Historic  Prehistoric  Both  
1959 (CSUMB Facilities).

\*P7. Owner and Address:  
CSUMB, 100 Campus Center,  
Seaside, CA. 93955

\*P8. Recorded by: (Name, affiliation, and address) Sarah Corder,  
Dudek, 725 Front St #400,  
Santa Cruz, CA 95060

\*P9. Date Recorded: 6/14/2021

\*P10. Survey Type: (Describe)  
Intensive level

\*P11. Report Citation: (Cite survey report and other sources or enter none)

"Dudek 2021. Built Environment Inventory and Evaluation Report for California State University, Monterey Bay.

\*Attachments:  NONE  Location Map  Continuation Sheet  Building, Structure, and Object Record

Archaeological Record  District Record  Linear Feature Record  Milling Station Record  Rock Art Record

Artifact Record  Photograph Record  Other (List): \_\_\_\_\_

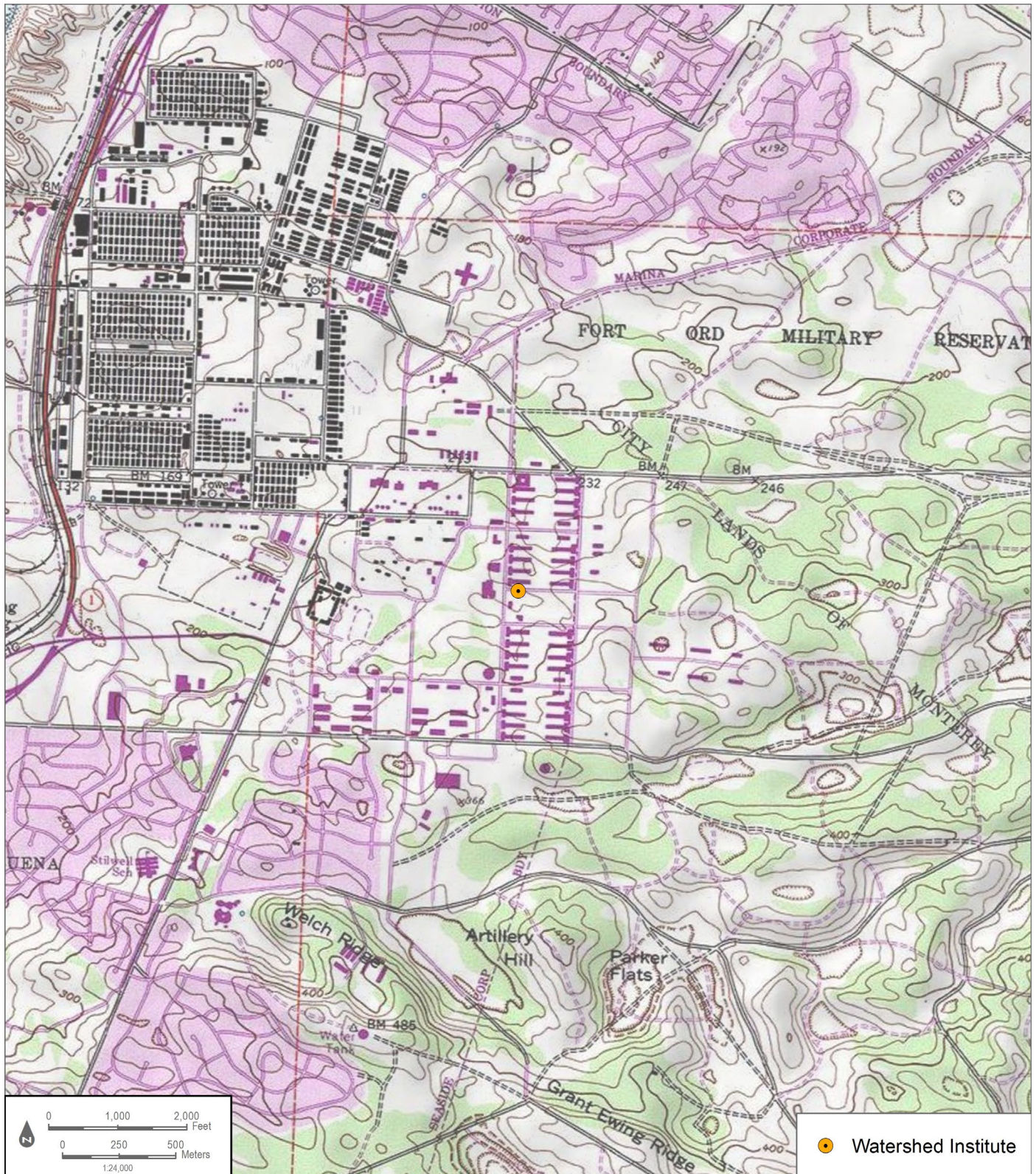

# BUILDING, STRUCTURE, AND OBJECT RECORD

\*Resource Name or # (Assigned by recorder) Watershed Institute \*NRHP Status Code 6Z  
Page 3 of 15

B1. Historic Name: Fort Ord Regimental Dispensary  
B2. Common Name: Watershed Institute  
B3. Original Use: Military Medical Clinic 4. Present Use: Classroom/Science Lab

\*B5. Architectural Style: Mid-Century Modern

\*B6. Construction History: (Construction date, alterations, and date of alterations)

Designed in 1956 and completed in 1959, the Watershed Institute is a utilitarian building with modern detailing. As-built drawings show alterations were made to the original plans by Fort Ord in 1958. The building became the Watershed Institute, an educational classroom building, after 1995, when the CSUMB Campus was established. The building is covered in a mural, likely applied after the building was adapted for the CSUMB. At this time, the entry doors were likely replaced with modern ADA accessible doors and some windows were also replaced with single, fixed panes.

\*B7. Moved?  No  Yes  Unknown Date: \_\_\_\_\_ Original Location: \_\_\_\_\_ \*B8. Related Features:

B9a. Architect: Noakes & Neubauer, Architects and Engineers b. Builder: N/A

\*B10. Significance: Theme N/A Area N/A  
Period of Significance N/A Property Type N/A Applicable Criteria N/A  
(Discuss importance in terms of historical or architectural context as defined by theme, period, and geographic scope. Also address integrity.)

See Continuation Sheet.

B11. Additional Resource Attributes: (List attributes and codes) \_\_\_\_\_

\*B12. References: See Continuation Sheet.

B13. Remarks:

\*B14. Evaluator: Adrienne Donovan-Boyd, MSHP

\*Date of Evaluation: July 20, 2021

(This space reserved for official comments.)



## CONTINUATION SHEET

Property Name: Watershed Institute

Page 4 of 15

### \*P3a. Description (continued):

The building has a flat roof with small, concrete eave overhangs. The primary elevation faces north with a concrete path leading to the main door from B Street. Planted landscaping areas surround the building. A parking lot is located to the south. A concrete path leads from the parking lot to an entrance on the west end of the south elevation. The primary entrance is located offset to the east on the north elevation. The entrance consists of a pair of recently added metal-framed glazed doors, with a large, fixed transom. The north, primary, elevation has six, evenly spaced windows to the east of the entrance and two evenly spaced windows to the west. Fenestration is varied and includes fixed metal-framed picture windows and 1/1 metal. All windowsills appear to be precast concrete.



Figure 1. Main (north) elevation and entrance, looking southeast (IMG\_0681)

# CONTINUATION SHEET

Property Name: Watershed Institute  
Page 5 of 15



Figure 2. West elevation, looking east (IMG\_0675).

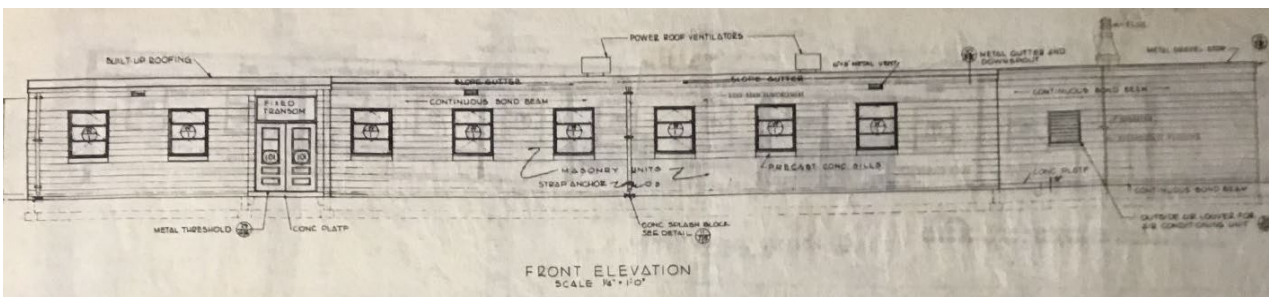

Figure 3. 1956 architectural drawing of the Watershed Institute (CSUMB Facilities 2021)

## CONTINUATION SHEET

Property Name: Watershed Institute

Page 6 of 15

### \*B10. Significance (continued):

#### Historical Overview of Fort Ord

The history of Fort Ord has been extensively documented in newspaper articles, websites, academic journals, and books. From its creation in 1917 to its closure in 1994, the base grew to become one of the largest training centers in the country. Its location was also reported to be the most attractive U.S. Army post, with easy access to the ocean and beautiful California weather.

The development periods in the history of Fort Ord were defined by Harold E. Raugh, Jr, a U.S. Army lieutenant colonel and historian with the Department of Defense. Since his retirement, Raugh served as the Chief Historian, for the Defense Logistics Agency, for the Department of Defense and, from 2006-2013, Raugh served as the Command Historian at the Defense Language Institute Foreign Language Center (DLIFLC) and the Presidio of Monterey, California. He received his PhD in history from the University of California, Los Angeles (Walch 2004). Raugh has authored numerous books including, Fort Ord (2004); Presidio of Monterey (2004); Operation Joint Endeavor: V Corps in Bosnia-Herzegovina, 1995-1996 (2013); The Raugh Bibliography of the Indian Mutiny 1857-1859 (2016); and Wavell in the Middle East, 1939-1941: A study in Generalship. Raugh defined four periods for the historic development of Fort Ord:

1917-1940 Camp Gigling to Camp Ord

1940-1945 Fort Ord and the 7th Infantry Division

1946-1976 The Cold War and Vietnam Eras

1974-1994 The Volunteer Army

These periods correspond to distinct eras in the history of the base and the U.S. Army (Raugh 2004: ii). The following sections provide a summary overview of each of these periods of development and their relevance to the area of Fort Ord now known as the CSUMB campus.

The full historic context of Fort Ord is represented in the report, Built Environment Inventory and Evaluation Report for California State University, Monterey Bay (Dudek 2021). The following presents only relevant historical and building typology information pertaining to the development of the Watershed Institute.

#### Cold War and Vietnam Eras at Fort Ord (1946-1976)

This period of development between 1946 and 1976 was characterized by a massive operation to move the base out of its semi-permanent status and create a permanent outpost for active military personnel who were retained due to ongoing foreign conflicts.

In July of 1948, Harry S Truman signed Executive Order 9981, which officially ended segregation in the armed forces. The order stated that "there shall be equality of treatment and opportunity for all persons in the armed forces without regard to race, color, religion, or national origin" (National Archives Foundation 2021). Fort Ord became one of the first integrated training divisions in the United States. The Fort was touted as "pioneering to end all segregation" (Pomona Progress Bulletin 1950: 4). In 1950, the Pomona Progress Bulletin reported that black and white soldiers at Fort Ord were "fighting side by side" and all the enlistees "trained together, slept in the same barracks, and eat the same messes" (Pomona Progress Bulletin 1950: 4).

The end of World War II in 1945 did not bring lasting peace. The tenuous relationship



## CONTINUATION SHEET

Property Name: Watershed Institute

Page 7 of 15

between dominant nations in the communist East and free market West led to the beginning of the Cold War. The Department of Defense maintained a robust fighting force during the Cold War, with more than 900,000 Army personnel retained during the 1950s (ACHP 2006). The ongoing global tensions and the number of active U.S. military personnel created a need for new permanent buildings and expanded military housing at Fort Ord.

In 1949, the Soviet-supported communist government of North Korea invaded American-supported South Korea, initiating the Korean War. Fort Ord was a primary staging area for the training of troops departing for the war (Castle 1990:3). By the 1950s, Fort Ord had become one of the largest basic training camps in the United States. In 1952, the military began a multi-million dollar building program to transform Fort Ord into a permanent post, including the development of permanent troop housing, and the construction of a guard house, stockade, and multiple warehouses. In January of 1952, military authorities announced the new construction program at Fort Ord was underway, with an estimated cost of \$26,650,600. More than half of the funds that were approved by Congress were "earmarked for new permanent troop housing" for more than 7,000 soldiers (The Webb Spinner 1952-54, Vol 6. No. 3:1).

The new troop housing was to be constructed of reinforced concrete, a departure from the wood buildings constructed before and during World War II. The plan called for three types of massive barracks, twenty-two were to house 225 enlisted men each, seven were to accommodate 165 men each, and nine were to house 105 men each (The Webb Spinner 1952-54, Vol 6. No. 3:3). The San Francisco District of the U.S. Army Corps of Engineers oversaw the construction project to completion. An additional \$1,349,700 was earmarked for the expansion of classroom and training facilities at Fort Ord, including a new battalion and regimental headquarters (The Californian 1952a:1 and The Californian 1952b:18). By March of 1952, another phase of the permanent army post transformation began with the construction of a guard house, stockade, warehouse, and other buildings (The Webb Spinner 1952-54, Vol 6. No. 3:1). This addition of permanent buildings continued into the late 1950s, when the Army requested \$124 million to replace all the wood World War II infrastructure at Fort Ord with concrete block and reinforced concrete (Madsen and Treffers 2019:6; San Francisco Examiner 1958:2-4). While many of the wood buildings remain today, this period saw the continuous addition of reinforced concrete permanent buildings across the Fort (Madsen and Treffers 2019:6).

Following the Korean War through the end of the conflict in Vietnam, Fort Ord served as an important training facility. In 1957, Fort Ord was designated as a U.S. Army Training Center for Infantry (Castle 1990: 4). The 7th Infantry Division was based at Fort Ord in 1975 (Cavanaugh 2000: 9). Fort Ord produced thousands of combat-ready troops during the conflict in Vietnam.

With the establishment of Fort Ord as a permanent Army base during this period, there was substantial building construction that led to the modernization of the base and its services. This development is closely related to the history of the current CSUMB campus. All the properties that are included as part of this built environment study were constructed during the Cold War and Vietnam Era period. Building development during this period was a substantial departure from the styles and materials used in the buildings constructed before World War II. Buildings constructed between 1946 and 1976 primarily used reinforced concrete and concrete masonry unit (CMU) in their design. The buildings tended to be larger than those constructed in previous periods. Other development in this period included support service buildings and several types of medical buildings. Infrastructure was also improved at this time, with the introduction of paved streets and roadways, and the addition of several water tanks, water pumping plants, and warehouse buildings.

## CONTINUATION SHEET

Property Name: Watershed Institute

Page 8 of 15

### **Watershed Institute, 1958**

The Watershed Institute building was designed 1956 by the firm White, Noakes & Neubauer, Architects and Engineers, located in Washington D. C. (Figure 3) (CSUMB Facilities: Building 42 1956). Very little information was found during archival research about this firm, with only one newspaper article found where Noakes & Neubauer were the noted architects for a new wing on a retirement home (The Morning Call 1959: 50). The plans were updated for Fort Ord in 1958. Originally the building served as one of the fort's regimental dispensaries. In 1959, The Californian, reported two new regimental dispensaries were approved for construction at Fort Ord. Daniels and House Construction company of Monterey received the contract for \$197,964. The dispensaries were to include facilities such as pharmacies, surgical dressing examination and waiting rooms. The completion of a new main road and parking area was planned to coincide with the construction of the buildings (The Californian 1959:14). The plan lists the building designer as "J.D.L" and checked by "R. A. P." and notes the design was prepared under the direction of the Chief Engineering Division of Military Contracts (CSUMB Facilities: Building 42 1956). As built changes were made to the drawings in January of 1960, suggesting the building was constructed by this time. Original plans called for the interior space to have a waiting room, clerk and records room, doctor's office, a resting room, examination and treatment room, surgical dressing room, a fan room, the boiler room, and coal storage. (CSUMB Facilities: Building 42 1956). Currently the building is used by the CSUMB as a classroom known as the Watershed Institute.

### **Fort Ord Building Typology and Character-Defining Features**

Four categories of building types were identified for the purposes of this study. These are the Support Services Buildings, Medical Buildings, Hammerhead Buildings/Barracks, and Recreational Buildings. The following presents a discussion of the Medical building typology, as the Watershed Institute is classified in this category. This section provides an overview and a detailed account of the specific character-defining features of Fort Ord's Cold War and Vietnam Era (1946-1976) medical buildings.

### **Medical Buildings**

Medical buildings constructed during the Cold War and Vietnam Eras (1946-1976) at Fort Ord have a variety of uses and functions that changed over the history of the base. One of the most common medical building types during this period were clinic buildings. In alignment with the typical planning, design, and materials of buildings constructed during this period of Fort Ord's history, these buildings are constructed with reinforced concrete and CMU and feature flat roofs with multi-light windows set on concrete sills. The Medical Buildings tended to have central entryways that opened into waiting areas, with smaller exam rooms behind reception areas. These buildings did not have a uniform design, unlike many of the other buildings at Fort Ord.

### **Character-Defining Features of Fort Ord Medical Buildings**

This section provides a detailed account of the specific character-defining features of this type of building and noted alterations that are considered non-character defining features. This section provides a detailed account of the specific character-defining features of Fort Ord's Cold War and Vietnam Era (1946-1976) Medical Buildings.

**CONTINUATION SHEET**

Property Name: Watershed Institute  
 Page 9 of 15

The Medical Buildings originally exhibited the following specific character-defining features:

Character-Defining Features: Fort Ord Medical Buildings

| Character Aspect       | Primary Character-Defining Features  | Character-Defining Features   |
|------------------------|--|---|
| Shape and Plan         | <ul style="list-style-type: none"> <li>• Simple rectangular form</li> <li>• Single story</li> </ul>  | The overall shape and mass of the building with a central entrance opening to waiting areas.  |
| Roof                   | <ul style="list-style-type: none"> <li>• Flat roof</li> <li>• Moderate or slight eave openings</li> <li>• No exposed rafters</li> </ul>  | The Medical Buildings have flat roofs, with moderate or slight eave overhangs.  |
| Openings               | <ul style="list-style-type: none"> <li>• Entrances on the ground level</li> <li>• Multi-light windows or modern windows with protruding metal frames set on concrete sills</li> <li>• Public entrances and circulation patterns</li> </ul> | Window openings are uniform in size and placement, windows are multi-light, and set into concrete openings. Replaced windows are not considered character-defining features as they fall outside the period of significance.  |
| Exterior Ornamentation | <ul style="list-style-type: none"> <li>• Minimal exterior ornamentation</li> <li>• Glass windows used as ornamentation</li> </ul>  | The Medical Buildings were often specifically designed to serve specific functions. They have little to no decorative ornamentation, with windows in ribbons, or evenly spaced windows being the only decorative element.   |
| Materials              | <ul style="list-style-type: none"> <li>• Mass-produced and cost-effective materials</li> <li>• Concrete and CMU</li> <li>• Reinforced Concrete construction</li> </ul>   | Medical Buildings have simple, utilitarian designs. Buildings were constructed using mass-produced and cost-effective building materials that were readily available at the time of construction. Buildings under the Medical Building type were constructed with reinforced concrete and CMU and were minimally decorated. |

Alterations and demolitions over time have compromised the overall architectural integrity of this building type. The most common alterations observed for this building type include the following.

- Replacement windows
- ADA compliance measures such as ramps and doors

## CONTINUATION SHEET

Property Name: Watershed Institute

Page 10 of 15

- HVAC systems and window units
- Infill of openings
- Interior renovations

### NRHP/CRHR Designation Criteria

In consideration of the project site's history and requisite integrity, Dudek recommends the property not eligible for listing in the NRHP and CRHR based on the following significance evaluation and in consideration of national and state eligibility criteria:

#### **Criterion A/1: That are associated with events that have made a significant contribution to the broad patterns of our history.**

The Watershed Institute was constructed in 1959 during the period defined as the Cold War and Vietnam Eras (1946-1976) at Fort Ord. While this building is of historic age and was constructed during this important period of development in Fort Ord's history, it no longer retains enough integrity to convey its significance. One of the most notable elements of integrity that is compromised is the integrity of setting. Significant demolition, changes to circulation patterns, introduction of new buildings, and changes in use, all impact the building's ability to convey significance from its time as an active Cold War and Vietnam Era military medical building. The loss of this overall integrity of setting adversely affects the Watershed Institute, as individual buildings are no longer able to convey their collective history. Additionally, the subdivision of Fort Ord following its closure in 1994 has also greatly impacted the integrity of feeling, association, and setting of the Cold War and Vietnam Era portions of the installation. In summary, the Watershed Institute is not able to convey its association with any extraordinary events or events occurring within the context of Cold War and Vietnam Era medical buildings, the CSUMB Campus, or has an association with the broad patterns of history in Monterey County, the State of California, or the Nation. Therefore, the building is recommended not eligible under NRHP/CRHR Criterion A/1.

#### **Criterion B/2: That are associated with the lives of persons significant in our past.**

To be found eligible under B/2 the property must be directly tied to an important person and the place where that individual conducted or produced the work for which he or she is known. Archival research indicated that the Watershed Institute building, originally one of Fort Ord's regimental dispensaries, was not associated with a single, significant person or persons. As such this property is not known to have any historical associations with people important to the nation's or state's past. Due to a lack of identified significant associations with important persons in history, Dudek recommends the building is not eligible under NRHP/CRHR Criterion B/2.

#### **Criterion C/3: That embody the distinctive characteristics of a type, period, or method of construction, or that represent the work of a master, or that possess high artistic values, or that represent a significant and distinguishable entity whose components may lack individual distinction.**

The Watershed Institute was constructed at Fort Ord in 1959. The building was designed by White, Noakes & Neubauer, Architects and Engineers, Washington D. C. The plan lists the building designer as "J.D.L" and checked by "R.A.P." (CSUMB Facilities 2021 Very little information was found during archival research about the firm of White, Noakes & Neubauer, or any further information about the noted designers. The Watershed Institute building is a smaller, utilitarian building, with minimal detailing, and few stylistic features. No further information was discovered during archival research about these designers. The building is a ubiquitous building type that lacks high style components to set it apart from other buildings constructed during this era. Additionally, the Watershed Institute, has undergone alterations, including changes to fenestration and

## CONTINUATION SHEET

Property Name: Watershed Institute

Page 11 of 15

use. Due to a lack of high artistic value, a lack of evidence suggesting this is the work of a master, and its noted alterations, Dudek recommends the Watershed Institute is recommended not eligible under NRHP/CRHR Criterion C/3.

**Criterion D/4: That have yielded, or may be likely to yield, information important in prehistory or history.**

There is no evidence to suggest that this property has the potential to yield information important to state or local history. Therefore, the property is recommended not eligible under NRHP/CRHR Criterion D/4.

**California Historic Landmark Statement of Significance**

In consideration of the Watershed Institute's history and requisite integrity, Dudek recommends the property not eligible for designation as a California Historic Landmark based on the following significance evaluation and in consideration of state eligibility criteria:

**The first, last, only, or most significant of its type in the state or within a large geographic region (Northern, Central, or Southern California).**

The Watershed Institute was designed in 1956 and constructed in 1959. The building was constructed during the Cold War and Vietnam Eras (1946-1976) at Fort Ord. The building appears to have been conceptualized by architects who worked for White, Noakes & Neubauer, a Washington D.C. based architectural firm. The building is a ubiquitous building type that lacks high style components to set it apart from other buildings constructed throughout the State of California in the 1950s and 1960s. Therefore, the building is recommended not eligible for listing as a CHL under this criterion.

**Associated with an individual or group having a profound influence on the history of California.**

Archival research failed to indicate any significant associations between the Watershed Institute and individuals or groups that profoundly influenced the history of California. The Watershed Institute building was originally a Fort Ord Regimental Dispensary, constructed to provide a service for military personnel. White, Noakes & Neubauer, a Washington D.C. base architectural firm was responsible for the design. Very little information was found during archival research about the firm and no other buildings are known to have been designed by the firm. No other individuals are known to have influenced the construction or use of this building. Therefore, Dudek recommends the building is not eligible for listing as a CHL under this criterion.

**A prototype of, or an outstanding example of, a period, style, architectural movement or construction or is one of the more notable works or the best surviving work in a region of a pioneer architect, designer or master builder.**

The Watershed Institute building is neither a prototype or an outstanding example of a period, style, or architectural movement. It is a typical example of a utilitarian design. The building was designed to serve a utilitarian purpose for the military at Fort Ord. There are no identifying features on the Watershed Institute that would establish the connection to the notable work of a master architect in the State of California. Additionally, the Watershed Institute building has been altered and it fails to sufficiently convey its temporal period. Therefore, Dudek recommends the building is not eligible for listing as a CHL under this criterion.

**Local Designation Criteria**

Portions of the CSUMB campus are located within the boundaries of two cities, City of Seaside and the City of Marina, both of which evaluate historical resources in accordance with CEQA Guidelines. as presented above. The subject property, as discussed in the NRHP/CRHR/CHL criteria discussion above, does not rise to the necessary level of

## CONTINUATION SHEET

Property Name: Watershed Institute

Page 12 of 15

significance for local, state, or national designation. For these reasons, the subject property is recommended not eligible individually or as a component of a historic district under any of the NRHP/CRHR/CHL criteria.

Additionally, portions of the CSUMB campus are located in the County of Monterey and the campus is therefore subject to the regulations set forth in Chapter 18.25 of the Monterey County Code. The subject property, as discussed in the NRHP/CRHR/CHL criteria discussion above, does not rise to the necessary level of significance for state or national designation. For these same reasons, the subject property is also recommended not eligible individually or as a component of a historic district under any of the delineated County of Monterey review criteria categories that are addressed with the NRHP/CRHR/CHL criteria discussed above: A. Historical and Cultural Significance; B. Historic, Architectural, and Engineering Significance; or C. Community and Geographic Setting.

### Integrity Discussion

The Watershed Institute was analyzed against the seven aspects of integrity: location, design, setting, materials, workmanship, feeling, and association. The building retains its integrity of location, as it has not been relocated; however, the integrity of setting has been compromised due to the change of use, from a Cold War and Vietnam Era military support services building to an education classroom building for CSUMB. The building was designed with minimal elements typical of a utilitarian building. Some of the features of the original design, most notably the windows on the primary facade have been lost due to alterations. Therefore, the overall integrity of design has been compromised. A majority of the original materials appear to be intact, and such the building retains some integrity of materials. The techniques used in the construction of the Watershed Institute are still apparent, with the CMU construction and concrete windowsills, accordingly the building has retained some integrity of workmanship. The exterior of the Watershed Institute no longer conveys its original use as a 1950s military regimental dispensary. Therefore, the integrity of feeling has been lost. As the Watershed Institute does not possess historic significance, there is no historic association. While the building is in good condition, it does not possess adequate integrity to convey significance or its temporal period.

### Summary of Evaluation Findings

The Watershed Institute building retains a diminished level of historic integrity and lacks historical and architectural significance. Based on the significance evaluations presented above, the Watershed Institute does not appear to meet the NRHP, CRHR, CHL or local designation criteria. Therefore, Watershed Institute building is not considered a historical resource for purposes of CEQA.

## CONTINUATION SHEET

Property Name: Watershed Institute

Page 13 of 15

### \*B12. References (continued):

- ACHP (Advisory Council on Historic Preservation). 2006. "Draft Program Comment Regarding Cold War Era Unaccompanied Personnel Housing." Federal Register: The Daily Journal of the United States Government. 12 April 2016. Accessed June 30, 2021 Available at: <https://www.federalregister.gov/documents/2006/04/12/06-3509/draft-program-comment-regarding-cold-war-era-unaccompanied-personnel-housing>
- Californian, The. 1940. "No More Camp Ord! It's Fort Ord Now! Stilwell in Command: Headquarters of General Located on Salinas Side." July 13, 1940. Salinas, California, pg. 1.
- Californian, The. 1951. Stadium Field House—Sixth Army Lets Ord Contract. March 20, 1951. P1. Accessed June 17, 2021. Available at: [Newspapers.com](http://Newspapers.com).
- Castle, Ted. 1990. "The March of Time." Fort Ord Panorama. September 21, 1990.
- Cavanaugh, Joe. 2000. *The Peace Dividend: Defense Conversion Through Higher Education*. The Leon Panetta Institute.
- Chamberlin Library. 2021. Fort Ord Working Papers. CSUMB Special Collections Box 6.42-01. Available at the Chamberlin Library, Seaside, California.
- CSUMB Facilities. 2021. Original As built and renovation architectural drawings on file with CSUMB facilities department. Accessed in person June 15-16, 2021.
- DLIFLC (Defense Language Institute Foreign Language Center). 2021. Command History Program. Accessed in person on June 15, 2021 and accessed online database collection online July 2021. Available at: <https://adli.pastperfectonline.com/>
- EA Engineering. 1991. Draft Final Fort Ord, California Base wide Remedial Investigation Feasibility Study. Volume 1 Literature Review and Base Inventory Report. Accessed on July 13, 2021. Available at: <https://www.fortordcleanup.com/documents/search/>
- Fresno Bee, The. 1951a. "Army Spokesman Are Defending Building of Fort Ord Stadium." January 12, 1951. Page 13. Accessed June 17, 2021.
- Fresno Bee, The. 1951b. "Army Spokesman Are Defending Building of Fort Ord Stadium." February 4, 1951. Page 27. Accessed June 17, 2021. Available at: [Newspapers.com](http://Newspapers.com).
- Gates, S., & Williams, H. 1957. The Armed Forces. The Annals of the American Academy of Political and Social Science, 313, 99-104. Accessed June 17, 2021. <http://proxy.multcolib.org:2052/stable/1031762>
- MacGregor Jr., Morris J. 1981. Integration of the Armed Forces, 1940-1965. Center of Military History, United States Army: Washington, D.C.
- Madsen, Alexandra and Steven Treffers. 2019. *Historic Resources Evaluation Memorandum for Hammerhead Barracks at Fort Ord, Monterey County, California*. Prepared by

## CONTINUATION SHEET

Property Name: Watershed Institute

Page 14 of 15

Rincon Consultants, Inc for City of Seaside, Community and Economic Development Department. November 4, 2019. Accessed June 28, 2021.  
[https://www.ci.seaside.ca.us/DocumentCenter/View/10674/9\\_App-S---HRE-Memo](https://www.ci.seaside.ca.us/DocumentCenter/View/10674/9_App-S---HRE-Memo)

Military Museum. 2016. "Historic California Posts, Camps, Stations, and Airfields: Fort Ord." Accessed on June 19, 2021. <http://www.militarymuseum.org/FtOrd.html>

National Archives Foundation. 2021. Executive Order 9981. Accessed June 29, 2021. Available at: <https://www.archivesfoundation.org/documents/executive-order-9981-ending-segregation-armed-forces/>

NETR (Nationwide Environmental Title Research LLC). 2021. Historic Aerial Photographs of 100 Campus Center, Seaside, CA 93955 dating from 1956, 1968, 1981, 1998, 2005, 2009, 2010, 2012, 2014, 2016, and 2018. Accessed June 10, 2021.  
<https://www.historicaerials.com/viewer>

Panorama. 1990. "50 Years and Counting..." September 21, 1990, pg. 2.

Panorama. n.d. "Ford Ord in World War II." Historic California Posts: Fort Ord. Accessed on June 19, 2021. <http://www.militarymuseum.org/FtOrd.html>

Park, R. 2015. "Happy and Cheerful in This Fine Camp": Sports, Recreation, and the United States Army at Fort Ord and Camp Roberts, 1940 to 1945. *Journal of Sport History*, 42(1), 21-37. Accessed on June 18, 2021, from  
<https://www.jstor.org/stable/10.5406/jsporhistory.42.1.21>

Pomona Progress Bulletin. 1950. War Solving Racial Problems. August 24, 1950. Page 4. Accessed June 29, 2021. Available at: [Newspapers.com](http://www.newspapers.com).

Quartermaster Review, The. 1940. "Army Construction Underway at Camp Ord, California." Volume XX. No 3. November-December. On file at the Chamberlin Library, Ord Military Community.

Raugh, Harold E. 2004. Fort Ord. Charleston, SC: Arcadia.

Salinas Morning Post. 1940. "\$2,766,000 in Building Authorized—Ord Contracts Let." August 21, 1940. Salinas, CA. pg. 1.

San Francisco Examiner. 1951. Fort Ord Will Get Stadium. San Francisco Page 4. · 3 Feb 1951. Pages 1 and 4 A Available on [www.Newspapers.com](http://www.newspapers.com). Accessed on Jun 11, 2021.

San Francisco Examiner. 1958. Army Asks OK on \$124,000,000 for Fort Ord Buildings. San Francisco. Section 2. Page. 4. Available on [www.Newspapers.com](http://www.newspapers.com). Accessed July 18, 2021.

Vasche, J. Burton. 1959. "The California State Colleges: Their History, Organization, Purposes, and Programs." in California

U.S. Army. 1977. Post Map Main Garrison Area. Fort Ord, California. Drawing number G-950. Accessed in person at the Chamberlain Library on June 15, 2021.



## CONTINUATION SHEET

Property Name: Watershed Institute

Page 15 of 15

Walch, Bob. 2004. An Army Historian's Pictorial Take on Fort Ord. Monterey County NOW. Accessed July 12, 2021. Available at:  
[https://www.montereycountyweekly.com/news/local\\_news/an-army-historian-s-pictorial-take-on-fort-ord/article\\_6e8b0250-9c38-5ca4-a4a4-f93d42d65a11.html](https://www.montereycountyweekly.com/news/local_news/an-army-historian-s-pictorial-take-on-fort-ord/article_6e8b0250-9c38-5ca4-a4a4-f93d42d65a11.html)

Whaley, Derek. 2015. "East Monterey & Seaside." Santa Cruz Trains: Railroads of the Monterey Bay Area. July 20, 2015. Accessed online:  
<https://www.santacruztrains.com/2015/07/east-monterey-seaside.html>.

Webb Spinner, The. 1952-1954. Webb Spinner Volume for 1952-1954. Del Webb Sun Cities Museum Collection. Accessed June 30, 2021. Accessed at:  
<https://delwebbsuncitiesmuseum.org/newsletters-webb-spinners/>

State of California & The Resources Agency  
DEPARTMENT OF PARKS AND RECREATION  
**PRIMARY RECORD**

Primary #  
HRI #  
Trinomial  
NRHP Status Code 6Z

Other Listings  
Review Code

Reviewer

Date

Page 1 of 15 \*Resource Name or #: (Assigned by recorder) Pacific Hall

P1. Other Identifier CSUMB Building 44

\*P2. Location:  Not for Publication  Unrestricted

\*a. County Monterey County and (P2c, P2e, and P2b or P2d. Attach a Location Map as necessary.)

\*b. USGS 7.5' Quad Marina, CA Date 1995 T 15S; R 1E; NW  $\frac{1}{4}$   of SW  $\frac{1}{4}$   of Sec 6; Mount Diablo **B.M.**

c. Address 4580 6th Avenue, Seaside Zip 93955

d. UTM: (Give more than one for large and/or linear resources) Zone 10S, 607876 mE/ 4056754 mN

e. Other Locational Data: (e.g., parcel #, directions to resource, elevation, decimal degrees, etc., as appropriate)

Pacific Hall sits north of B Street, between 6<sup>th</sup> Avenue and 7<sup>th</sup> Avenue.

\*P3a. Description: (Describe resource and its major elements. Include design, materials, condition, alterations, size, setting, and boundaries)

Pacific Hall (CSUMB Building 44) is a utilitarian building with modern stylistic details. The building is constructed of board-formed concrete. The single-story building has an L-shaped plan with a flat roof and concrete eave overhangs. The primary, west, elevation has the main entrance at the corner of the "L." Fenestration includes bands of rectangular fixed glass windows in protruding metal frames set on concrete sills. Concrete pillars divide the sets of windows.

See Continuation Sheet.

\*P3b. Resource Attributes: (List attributes and codes) HP15. Educational Building, HP34. Military Property

P5a. Photograph or Drawing (Photograph required for buildings, structures, and objects.)



\*P4. Resources Present:  Building  
 Structure  Object  Site  District   
Element of District  Other (Isolates, etc.)

P5b. Description of Photo: (view, date, accession #) West elevation, view looking southeast, Dudek (IMG 0602).

\*P6. Date Constructed/Age and Source:  Historic  Prehistoric  Both 1952-1954 (The Webb Spinner).

\*P7. Owner and Address:  
CSUMB  
100 Campus Center  
Seaside, CA. 93955

\*P8. Recorded by: (Name, affiliation, and address) Sarah Corder Dudek  
725 Front St #400  
Santa Cruz, CA 95060

\*P9. Date Recorded: 6/14/2021

\*P10. Survey Type: (Describe)  
Intensive level

\*P11. Report Citation: (Cite survey report and other sources or enter none) Dudek 2021. Built Environment Inventory and Evaluation Report for California State University, Monterey Bay

\*Attachments:  NONE  Location Map  Continuation Sheet  Building, Structure, and Object Record

Archaeological Record  District Record  Linear Feature Record  Milling Station Record  Rock Art Record

Artifact Record  Photograph Record  Other (List): \_\_\_\_\_

Page 2 of 15 \*Resource Name or # (Assigned by recorder) Pacific Hall  
Map Name: Marina Quadrangle \*Scale: USGS 7.5-minute Series \*Date of map: 1995

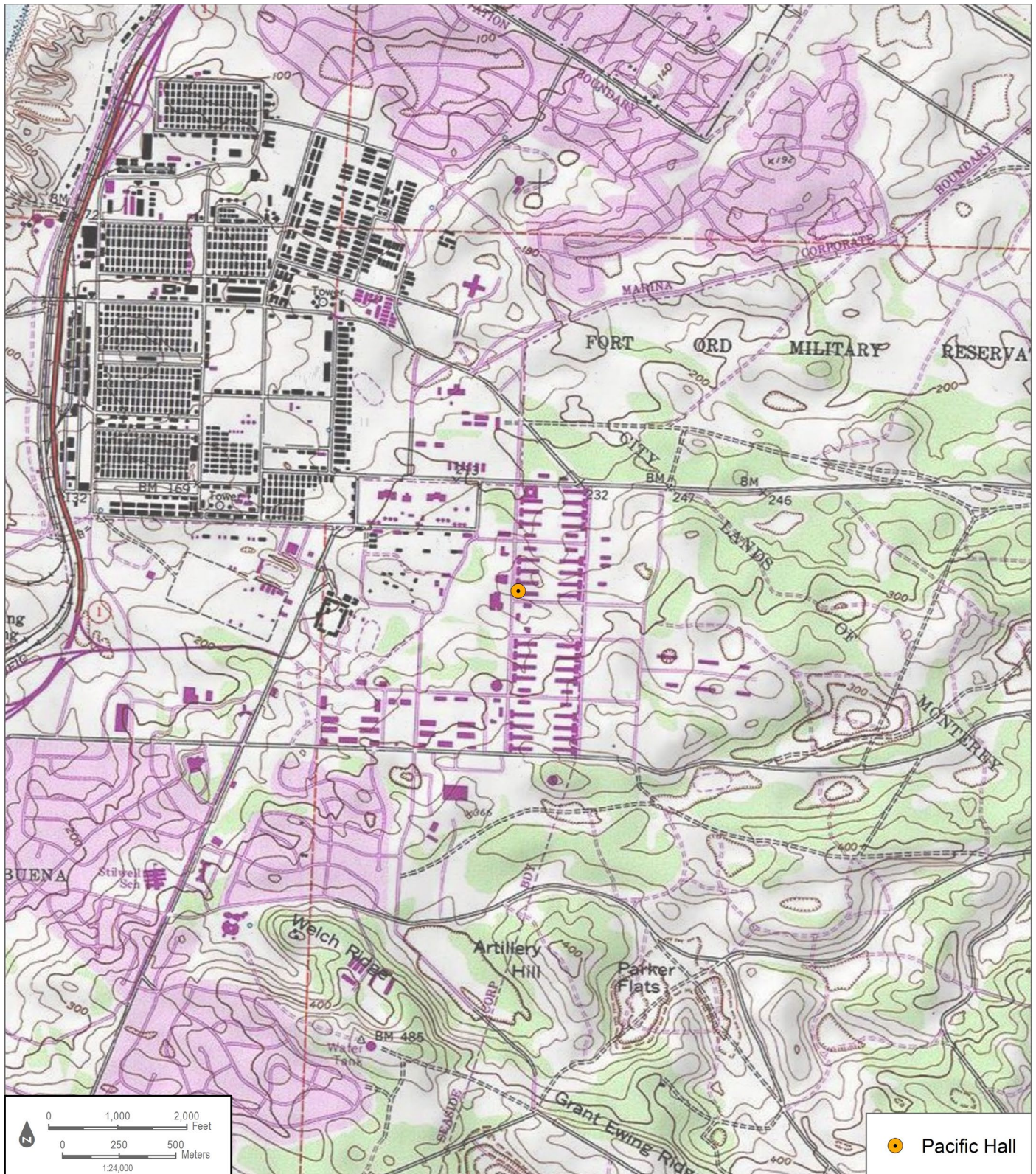

# BUILDING, STRUCTURE, AND OBJECT RECORD

\*Resource Name or # (Assigned by recorder) Pacific Hall \*NRHP Status Code 6Z

Page 3 of 15

B1. Historic Name: Hammerhead Building, Hammerhead Barracks, Fort Ord Barracks

B2. Common Name: Pacific Hall, CSUMB Building 44

B3. Original Use: Military Barracks 4. Present Use: Educational Classroom

\*B5. Architectural Style: Utilitarian

\*B6. Construction History: (Construction date, alterations, and date of alterations)

Designed and constructed between 1952-1954, Pacific Hall (44) is a utilitarian building with modern design elements. Originally the building served as barracks at Fort Ord. At least 38 barracks were constructed by Del Webb Construction Company at a cost of \$12,614,832. Construction started in 1952 (The Californian 1952b:18). When CSUMB acquired the campus, the building became Pacific Hall, and has been in use as a classroom. It is likely the addition of the ADA ramps and the replacement of windows were completed during this transition. Between 2016 and 2021, the east, multi-story wing of the building was demolished and the opening to that wing was filled with CMU (NETR 2021).

\*B7. Moved?  No  Yes  Unknown Date: \_\_\_\_\_ Original Location: \_\_\_\_\_ \*B8. Related Features:

B9a. Architect: unknown b. Builder: Del Webb Construction Company

\*B10. Significance: Theme N/A Area N/A  
Period of Significance N/A Property Type N/A Applicable Criteria N/A

(Discuss importance in terms of historical or architectural context as defined by theme, period, and geographic scope. Also address integrity.)

See Continuation Sheet.

B11. Additional Resource Attributes: (List attributes and codes) \_\_\_\_\_

\*B12. References: See Continuation Sheet.

B13. Remarks:

\*B14. Evaluator: Adrienne Donovan-Boyd, MSHP

\*Date of Evaluation: July 20, 2021

(This space reserved for official comments.)

(Sketch Map with north arrow required.)

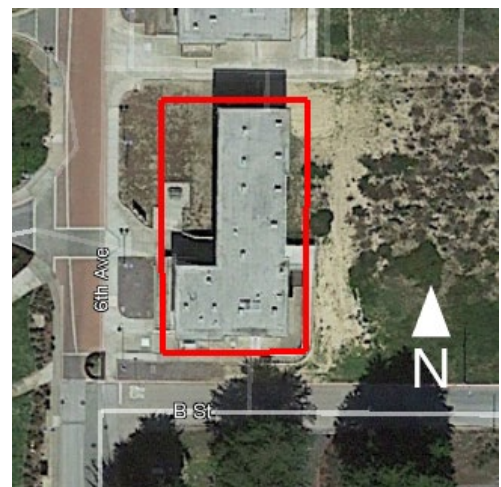

## CONTINUATION SHEET

Property Name: Pacific Hall  
Page 4 of 15

**\*P3a. Description (continued):**

Above the rectangular windows are square metal-framed decorative white panels. The east elevation shows changes to the plan, with a concrete framed door filled with CMUs and a change in exterior cladding. An ADA-accessible ramp leads to a secondary entrance with an arched metal awning on the east facade. The south elevation mirrors other elevations in style and materials. A CMU-filled window opening, and a door repurposed as a window are on the west end of the south elevation. The building appears to sit on a concrete foundation.



Figure 1. Main (west) elevation and north elevation, looking southeast (IMG\_0604)



Figure 2. South elevation, looking north (IMG\_0621)

## CONTINUATION SHEET

Property Name: Pacific Hall  
Page 5 of 15

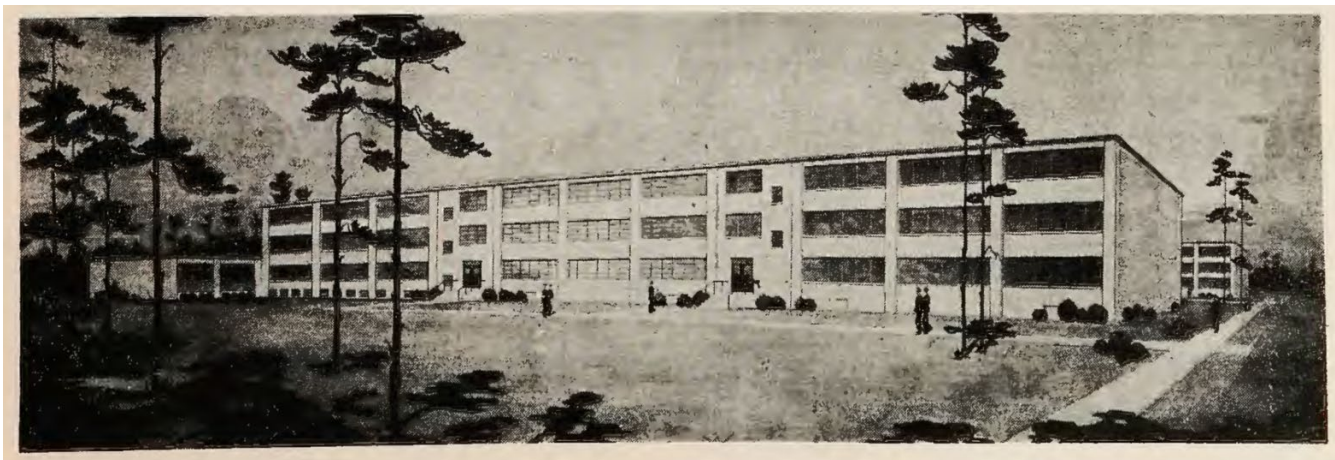

Figure 3. 1952 conceptual drawing of the new barracks to be constructed at Fort Ord  
(The Webb Spinner 1952)

### \*B10. Significance (continued):

#### Historical Overview of Fort Ord

The history of Fort Ord has been extensively documented in newspaper articles, websites, academic journals, and books. From its creation in 1917 to its closure in 1994, the base grew to become one of the largest training centers in the country. Its location was also reported to be the most attractive U.S. Army post, with easy access to the ocean and beautiful California weather.

The development periods in the history of Fort Ord were defined by Harold E. Raugh, Jr, a U.S. Army lieutenant colonel and historian with the Department of Defense. Since his retirement, Raugh served as the Chief Historian, for the Defense Logistics Agency, for the Department of Defense and, from 2006-2013, Raugh served as the Command Historian at the Defense Language Institute Foreign Language Center (DLIFLC) and the Presidio of Monterey, California. He received his PhD in history from the University of California, Los Angeles (Walch 2004). Raugh has authored numerous books including, *Fort Ord* (2004); *Presidio of Monterey* (2004); *Operation Joint Endeavor: V Corps in Bosnia-Herzegovina, 1995-1996* (2013); *The Raugh Bibliography of the Indian Mutiny 1857-1859* (2016); and *Wavell in the Middle East, 1939-1941: A study in Generalship*. Raugh defined four periods for the historic development of Fort Ord:

- 1917-1940 Camp Gigling to Camp Ord
- 1940-1945 Fort Ord and the 7th Infantry Division
- 1946-1976 The Cold War and Vietnam Eras
- 1974-1994 The Volunteer Army

These periods correspond to distinct eras in the history of the base and the U.S. Army (Raugh 2004: ii). The following sections provide a summary overview of each of these periods of development and their relevance to the area of Fort Ord now known as the CSUMB campus.

The full historic context of Fort Ord is represented in the report, *Built Environment Inventory and Evaluation Report for California State University, Monterey Bay* (Dudek

## CONTINUATION SHEET

Property Name: Pacific Hall  
Page 6 of 15

2021). The following presents only relevant historical and building typology information pertaining to the development of Pacific Hall.

### **Cold War and Vietnam Eras at Fort Ord (1946-1976)**

This period of development between 1946 and 1976 was characterized by a massive operation to move the base out of its semi-permanent status and create a permanent outpost for active military personnel who were retained due to ongoing foreign conflicts.

In July of 1948, Harry S Truman signed Executive Order 9981, which officially ended segregation in the armed forces. The order stated that "there shall be equality of treatment and opportunity for all persons in the armed forces without regard to race, color, religion, or national origin" (National Archives Foundation 2021). Fort Ord became one of the first integrated training divisions in the United States. The Fort was touted as "pioneering to end all segregation" (The Pomona Progress Bulletin 1950: 4). In 1950, the Pomona Progress Bulletin reported that black and white soldiers at Fort Ord were "fighting side by side" and all the enlistees "trained together, slept in the same barracks, and eat the same messes" (The Pomona Progress Bulletin 1950: 4).

The end of World War II in 1945 did not bring lasting peace. The tenuous relationship between dominant nations in the communist East and free market West led to the beginning of the Cold War. The Department of Defense maintained a robust fighting force during the Cold War, with more than 900,000 Army personnel retained during the 1950s (ACHP 2006). The ongoing global tensions and the number of active U.S. military personnel created a need for new permanent buildings and expanded military housing at Fort Ord.

In 1949, the Soviet-supported communist government of North Korea invaded American-supported South Korea, initiating the Korean War. Fort Ord was a primary staging area for the training of troops departing for the war (Castle 1990:3). By the 1950s, Fort Ord had become one of the largest basic training camps in the United States. In 1952, the military began a multi-million dollar building program to transform Fort Ord into a permanent post, including the development of permanent troop housing, and the construction of a guard house, stockade, and multiple warehouses. In January of 1952, military authorities announced the new construction program at Fort Ord was underway, with an estimated cost of \$26,650,600. More than half of the funds that were approved by Congress were "earmarked for new permanent troop housing" for more than 7,000 soldiers (The Webb Spinner 1952-54, Vol 6. No. 3:1).

The new troop housing was to be constructed of reinforced concrete, a departure from the wood buildings constructed before and during World War II. The plan called for three types of massive barracks, twenty-two were to house 225 enlisted men each, seven were to accommodate 165 men each, and nine were to house 105 men each (The Webb Spinner 1952-54, Vol 6. No. 3:3). The San Francisco District of the U.S. Army Corps of Engineers oversaw the construction project to completion. An additional \$1,349,700 was earmarked for the expansion of classroom and training facilities at Fort Ord, including a new battalion and regimental headquarters (The Californian 1952a:1 and The Californian 1952b:18). By March of 1952, another phase of the permanent army post transformation began with the construction of a guard house, stockade, warehouse, and other buildings (The Webb Spinner 1952-54, Vol 6. No. 3:1). This addition of permanent buildings continued into the late 1950s, when the Army requested \$124 million to replace all the wood World War II infrastructure at Fort Ord with concrete block and reinforced concrete (Madsen and Treffers 2019:6; San Francisco Examiner 1958:2-4). While many of the wood buildings

## CONTINUATION SHEET

Property Name: Pacific Hall  
Page 7 of 15

remain today, this period saw the continuous addition of reinforced concrete permanent buildings across the Fort (Madsen and Treffers 2019:6).

Following the Korean War through the end of the conflict in Vietnam, Fort Ord served as an important training facility. In 1957, Fort Ord was designated as a U.S. Army Training Center for Infantry (Castle 1990: 4). The 7th Infantry Division was based at Fort Ord in 1975 (Cavanaugh 2000: 9). Fort Ord produced thousands of combat-ready troops during the conflict in Vietnam.

With the establishment of Fort Ord as a permanent Army base during this period, there was substantial building construction that led to the modernization of the base and its services. This development is closely related to the history of the current CSUMB campus. All the properties that are included as part of this built environment study were constructed during the Cold War and Vietnam Era period. Building development during this period was a substantial departure from the styles and materials used in the buildings constructed before World War II. Building during the period between 1946 and 1976 used reinforced concrete and concrete masonry unit (CMU). The buildings tended to be larger than those constructed in previous periods. Other development in this period included support service buildings and several types of medical buildings. Infrastructure was also improved at this time, with the introduction of paved streets and roadways, and the addition of several water tanks, water pumping plants, and warehouse buildings.

### **Pacific Hall, 1952-1954**

Pacific Hall first appears on a 1956 aerial photograph of the site in the western half, of a group of eight other similarly laid out buildings. These buildings were originally designed as new permanent barracks that were part of a \$26,650,000 construction program awarded by the military in 1952. More than \$17 million of these funds were used to construct 38, new, three-story barracks. These larger barracks were planned to house entire companies and serve all their needs in one space, with mess halls, lounges, day rooms, orderly rooms, supply rooms, and issue rooms, as well as administrative space (the Californian 1952a).

The Del Webb Construction Company won the bid for the work at Fort Ord with a low bid of \$12,614,832 (The Californian 1952b: 18). Groundbreaking for the project took place on February 19, 1952. The barracks were featured in Webb's newsletter, *The Webb Spinner*, in the June/July/August edition. The paper touted the new military dormitories as being "sleek" (The Webb Spinner 1954:6). The buildings were a departure from the "old, white-painted barracks" constructed 12 years earlier. The new barracks were erected of steel and concrete and features large glass areas. The concrete construction was lauded as both vermin- and fire-proof (The Webb Spinner 1954:6).

After Fort Ord closed in 1994, the buildings became part of the CSUMB campus. There are no notable changes to the footprint of Pacific Hall until sometime between 2016 and 2021, when the east multi-story wing was demolished.

### **Del Webb Construction Company**

The Del E. Webb Company was founded by Delbert Eugene Webb in Phoenix in 1928. The company grew to develop a diverse range of projects across the United States during and was known for large-scale commercial, residential, and institutional projects (Del Webb and Pulte Homes 2021:1). During World War II, the company won many military and Navy contracts for housing projects. They specialized in streamlining massive construction projects across undeveloped land.

After World War II, Webb transitioned into many emerging development markets. In the



## CONTINUATION SHEET

Property Name: Pacific Hall  
Page 8 of 15

late 1940s, Webb constructed a casino/hotel in Las Vegas for Benjamin "Bugsy" Siegel. Del Webb went on to become the "largest gaming operator and private employer in Nevada" (Del Webb and Pulte Homes 2021:1). In January of 1960, the Del Webb Corporation opened a community in Phoenix, Arizona aptly named "Sun City". The community was known for its modestly priced housing and delivered a "highly desirable lifestyle." Del Webb went on to construct "Sun Cities" in Florida and Southern California (Del Webb and Pulte Homes 2021:1). The company continued to focus on gaming and commercial operations until 1987 when the decision was made to sell these interests and focus on the development of "master-planned, active adult communities" (Del Webb and Pulte Homes 2021:2). By January of 2000, the company had planned and constructed 13 Sun Cities communities, selling more than 80,000 homes. In July 2001, Del Webb Company merged with Pulte Homes Inc. to create the largest homebuilding company in the nation (Del Webb and Pulte Homes 2021:3).

Webb was the lead contractor for several prominent buildings, campuses, and institutions. These included Madison Square Garden in New York City from 1964-1968 (New York, NY) and the Los Angeles County Museum of Art in 1963-1964 (Los Angeles, CA). Several buildings constructed by the company are listed on the NRHP, including many components of the Williams Air Force Base in Arizona (two Ammo Bunkers, the Civil Engineering Maintenance Shop, the Demountable Hangar, the flagpole, the Housing Storage Supply Warehouse, and the Water Pump Station and Water Tower). Additionally, Webb was the contractor for the 1938 addition to the Arizona State Capital Building, Hunts Tomb, and the Phoenix Towers, all in Phoenix, AZ. All three buildings are all listed on the NRHP.

The Del Webb Construction Company received the contract to construct forty-two buildings at Fort Ord in February of 1952. This contract included the construction of the Hammerhead Buildings/Barracks, buildings for the regional headquarters, and regimental supplies buildings (The Web Spinner 1952-54, Vol 6. No. 3:1). The company was also awarded the contract in March of 1952 to construct a guardhouse, stockade, warehouse, and other buildings and a contract to construct the utilities, including fencing, paving, railroads, water systems, water supply and storage (including reservoirs, well houses, equipment, and a water booster pump station), gas distributing system, and sanitary and storm sewer installations. (The Web Spinner 1952-54, Vol 6. No. 4:1; The Web Spinner 1952-54, Vol 6. No. 8:1).

### **Fort Ord Building Typology and Character-Defining Features**

Four categories of building types were identified for the purposes of this study. These are the Support Services Buildings, Medical Buildings, Hammerhead Buildings/Barracks, and Recreational Buildings. The following presents a discussion of the Hammerhead Buildings/Barracks building typology, as Pacific Hall is classified in this category. This section provides a detailed account of the specific character-defining features of Fort Ord Cold War and Vietnam Era (1946-1976) Hammerhead Buildings/Barracks.

### **Hammerhead Buildings/Barracks**

The Hammerhead Buildings/Barracks were constructed to house troops at Fort Ord as it was expanding from a semi-permanent instillation to a permanent base. In alignment with the typical planning, design, and materials of buildings constructed during this period of Fort Ord's history, these buildings are constructed with reinforced concrete and CMU and feature flat roofs with multi-light windows with concrete sills.

Pacific Hall (44) first appears on a 1956 aerial photograph of the site on the western half of the base. It is part of a group of eight other similarly oriented buildings. No changes to the footprint were noted

After Fort Ord closed in 1994, the buildings became part of the CSUMB campus. There were

**CONTINUATION SHEET**

Property Name: Pacific Hall  
 Page 9 of 15

no notable changes to the footprint of the building until sometime between 2016 and 2018 when the east, multi-story wing was demolished on Pacific Hall.

**Character-Defining Features of the Hammerhead Buildings**

The Hammerhead Buildings/Barracks originally exhibited the following specific character-defining features:

| Character Aspect       | Primary Character-Defining Features  | Character-Defining Features   |
|------------------------|--|---|
| Shape and Plan         | <ul style="list-style-type: none"> <li>• Hammerhead shape</li> <li>• Single story wing and multi-story wing</li> </ul>   | The overall shape and mass of the building are considered a primary character-defining feature of the Hammerhead Buildings/Barracks. The plan should include a multi-story wing.  |
| Roof                   | <ul style="list-style-type: none"> <li>• Flat roof</li> <li>• Wide eave overhangs</li> <li>• No exposed rafters</li> </ul>   | The Hammerhead Buildings/Barracks have flat roofs, with moderate eave overhangs.  |
| Openings               | <ul style="list-style-type: none"> <li>• Entrances on the first story</li> <li>• Multi-light windows</li> </ul>  | Window openings are uniform in size and placement, windows are multi-light, and set into concrete openings. Replaced windows are not considered character-defining features as they fall outside the period of significance.  |
| Exterior Ornamentation | <ul style="list-style-type: none"> <li>• Minimal exterior ornamentation</li> <li>• Glass windows used as ornamentation</li> </ul>                                      | Hammerhead Buildings/Barracks were designed to be quickly constructed. They have little to no decorative ornamentation, with windows in ribbons being the only decorative element.  |
| Materials              | <ul style="list-style-type: none"> <li>• Mass-produced and cost-effective materials</li> <li>• Concrete and CMU</li> <li>• Reinforced concrete construction</li> </ul> | Hammerhead Buildings/Barracks have simple, utilitarian designs. Buildings were constructed using mass-produced and cost-effective building materials that were readily available at the time of construction. For instance, buildings under the Hammerhead type were constructed with reinforced concrete and CMU and were minimally decorated. |

Alterations and demolitions over time have compromised the overall architectural integrity of this building type. The most common alterations observed for this building type include the following.

- Replacement windows
- ADA compliance measures such as ramps and doors
- HVAC systems and window units
- Infill of openings
- Interior renovations

## CONTINUATION SHEET

Property Name: Pacific Hall  
Page 10 of 15

### NRHP/CRHR Designation Criteria

In consideration of the Pacific Hall's history and requisite integrity, Dudek recommends the building is not eligible for listing in the NRHP and CRHR based on the following significance evaluation and in consideration of national and state eligibility criteria:

**Criterion A/1: That are associated with events that have made a significant contribution to the broad patterns of our history.**

Pacific Hall was constructed in 1952-1954 during the period defined as the Cold War and Vietnam Eras (1946-1976) at Ford Ord. While this building is of historic age and was constructed during this important period of development in Fort Ord's history, it no longer retains enough integrity to convey its significance. One of the most notable elements of integrity that is compromised is the integrity of setting. Significant demolition, changes to circulation patterns, introduction of new buildings, and changes in use all impact the campus's ability to convey significance from its time as an active Cold War and Vietnam Era military base. The loss of this overall integrity of setting adversely affects Pacific Hall, as individual buildings are no longer able to convey their collective history. Additionally, the subdivision of Fort Ord following its closure has also greatly impacted the integrity of feeling, association, and setting of the Cold War and Vietnam Era portions of the installation. In summary, Pacific Hall, is not able to convey its association with any extraordinary events or events occurring within the context of Cold War and Vietnam military barracks, the CSUMB Campus, or has an association with the broad patterns of history in Monterey County, the State of California, or the Nation. Therefore, the building is recommended not eligible under NRHP/CRHR Criterion A/1.

**Criterion B/2: That are associated with the lives of persons significant in our past.**

To be found eligible under B/2 the building must be directly tied to an important person and the place where that individual conducted or produced the work for which he or she is known. Archival research failed to indicate any historical associations with people important to the nation's or state's past. Due to a lack of identified significant associations with important persons in history, Dudek recommends the building is not eligible under NRHP/CRHR Criterion B/2.

**Criterion C/3: That embody the distinctive characteristics of a type, period, or method of construction, or that represent the work of a master, or that possess high artistic values, or that represent a significant and distinguishable entity whose components may lack individual distinction.**

No original plans or designs for the 1952-1954 barracks were discovered during archival research. Newspaper articles from 1952, announced the contract was awarded to the Del Webb Company, of Phoenix, AZ (the Californian 1952a). The Webb Company was a notable building company that completed contracts for the government, commercial clients, and private individuals during its long period operation, beginning in 1929 and continuing to the present. The Webb Company designed many distinguished buildings including many that are listed on the NRHP. While Webb may be a master builder, Pacific Hall, was constructed during a period when the Webb company was completing many other large-scale projects, many at military bases. The company received many contracts during and after World War II to construct barracks and other military related buildings. The buildings at Fort Ord were common contracts for the company, and they had constructing buildings of this type at other bases.

Pacific Hall is a utilitarian building, with minimal detailing, and few stylistic features. Additionally, the building has undergone numerous, alterations, including changes to fenestration, materials, and the demolition of the east, multi-story wing.

## CONTINUATION SHEET

Property Name: Pacific Hall  
Page 11 of 15

Originally the building housed an entire infantry of troops, the remaining portion of the building is currently used for classroom space. While the building is associated with a master builder, the Del Webb Construction Company, it is not one of their more notable works. Furthermore, the building lacks high artistic value, and has undergone substantial alterations. For these reasons Dudek recommends Pacific Hall is not eligible under NRHP/CRHR Criterion C/3.

**Criterion D/4: That have yielded, or may be likely to yield, information important in prehistory or history.**

There is no evidence to suggest that this building has the potential to yield information important to state or local history. Therefore, the building is recommended not eligible under NRHP/CRHR Criterion D/4.

**California Historic Landmark Statement of Significance**

In consideration of Pacific Hall's history and requisite integrity, Dudek recommends the building is not eligible for designation as a California Historic Landmark based on the following significance evaluation and in consideration of state eligibility criteria:

**The first, last, only, or most significant of its type in the state or within a large geographic region (Northern, Central, or Southern California).**

Pacific Hall was constructed between 1952-1954. The building, along with at least 38 other barracks, were constructed during the fort's transition to a permanent base during the Cold War and Vietnam Eras (1946-1976) at Fort Ord. Pacific Hall was constructed by Del Webb Company, a company based in Phoenix Arizona. The building is a utilitarian building type that lacks high style components to set it apart from other buildings constructed throughout the State of California in the 1950s. Therefore, Dudek recommends Pacific Hall is not eligible for listing as a CHL under this criterion.

**Associated with an individual or group having a profound influence on the history of California.**

Pacific Hall was originally constructed to be one of Fort Ord's barracks, one of 38 such buildings to provide a housing for military personnel. The Del Webb Construction Company, a notable Phoenix, Arizona based company, was responsible for the construction of the building. While Pacific Hall is associated with a master builder with many known projects completed in California, this building is not one of the company's notable works. No other individuals are known to have influenced the construction or use of this building. Therefore, Dudek recommends Pacific Hall is not eligible for listing as a CHL under this criterion.

**A prototype of, or an outstanding example of, a period, style, architectural movement or construction or is one of the more notable works or the best surviving work in a region of a pioneer architect, designer or master builder.**

Pacific Hall is neither a prototype or an outstanding example of a period, style, or architectural movement. It is a typical example of a utilitarian design. The building was designed to serve a utilitarian purpose for the military at Fort Ord. There are no identifying features on Pacific Hall that would establish the connection to the notable work of the Del Webb Construction Company in the State of California. Additionally, Pacific Hall has been substantially altered and the large multi-story wing demolished making it unable to convey its temporal period or its historic context. Therefore, Dudek recommends Pacific Hall is not eligible for listing as a CHL under this criterion.

**Local Designation Criteria**

Portions of the CSUMB campus are located within the boundaries of two cities, City of

## CONTINUATION SHEET

Property Name: Pacific Hall  
Page 12 of 15

Seaside and the City of Marina, both of which evaluate historical resources in accordance with CEQA Guidelines. as presented above. The subject property, as discussed in the NRHP/CRHR/CHL criteria discussion above, does not rise to the necessary level of significance for local, state, or national designation. For these reasons, the subject property is recommended not eligible individually or as a component of a historic district under any of the NRHP/CRHR/CHL criteria.

Additionally, portions of the CSUMB campus are located in the County of Monterey and the campus is therefore subject to the regulations set forth in Chapter 18.25 of the Monterey County Code. The subject property, as discussed in the NRHP/CRHR/CHL criteria discussion above, does not rise to the necessary level of significance for state or national designation. For these same reasons, the subject property is also recommended not eligible individually or as a component of a historic district under any of the delineated County of Monterey review criteria categories that are addressed with the NRHP/CRHR/CHL criteria discussed above: A. Historical and Cultural Significance; B. Historic, Architectural, and Engineering Significance; or C. Community and Geographic Setting.

### Integrity Discussion

Pacific Hall was analyzed against the seven aspects of integrity: location, design, setting, materials, workmanship, feeling, and association. The building retains its integrity of location, as it has not been relocated. The building was designed with minimal elements reflecting an architectural style. Some of the features reflecting the original design, most notably the windows and the demolition of the multi-story wing, have been lost, and the overall integrity of design has been compromised. The integrity of setting has been lost as with the change in use from its original use as barracks at Fort Ord to a classroom building for CSUMB. Therefore, the integrity of setting has been lost. While some of the original materials appear to be intact, the demolition of the multi-story wing and changes to original fenestration have compromised the integrity of materials. The techniques used in the construction of Pacific Hall are still apparent, with the CMU and concrete construction, but the demolition of more than half the building has adversely affected the integrity of workmanship. The exterior of Pacific Hall no longer conveys its original use. Therefore, the integrity of feeling has been lost. As Pacific Hall does not possess historic significance, there is no historic association. The building does not possess adequate integrity to convey significance.

### Summary of Evaluation Findings

Pacific Hall has compromised historic integrity and lacks historical and architectural significance. Based on the significance evaluations presented above, Pacific Hall does not appear to meet the NRHP, CRHR, CHL or local designation criteria. Therefore, Pacific Hall is not considered a historical resource for purposes of CEQA.

## CONTINUATION SHEET

Property Name: Pacific Hall  
Page 13 of 15

### \*B12. References (continued):

- ACHP (Advisory Council on Historic Preservation). 2006. "Draft Program Comment Regarding Cold War Era Unaccompanied Personnel Housing." Federal Register: The Daily Journal of the United States Government. 12 April 2016. Accessed June 30, 2021 Available at: <https://www.federalregister.gov/documents/2006/04/12/06-3509/draft-program-comment-regarding-cold-war-era-unaccompanied-personnel-housing>
- Californian, The. 1940. "No More Camp Ord! It's Fort Ord Now! Stilwell in Command: Headquarters of General Located on Salinas Side." July 13, 1940. Salinas, California, pg. 1.
- Californian, The. 1951. Stadium Field House—Sixth Army Lets Ord Contract. March 20, 1951. P1. Accessed June 17, 2021. Available at: [Newspapers.com](http://Newspapers.com).
- Castle, Ted. 1990. "The March of Time." Fort Ord Panorama. September 21, 1990.
- Cavanaugh, Joe. 2000. *The Peace Dividend: Defense Conversion Through Higher Education*. The Leon Panetta Institute.
- Chamberlin Library. 2021. Fort Ord Working Papers. CSUMB Special Collections Box 6.42-01. Available at the Chamberlin Library, Seaside, California.
- CSUMB Facilities. 2021. Original As built and renovation architectural drawings on file with CSUMB facilities department. Accessed in person June 15-16, 2021.
- Del Webb and Pulte Homes 2021. Del Webb History. Accessed July 9, 2021. Available at: [http://media.corporate-ir.net/media\\_files/irol/14/147717/DelWebb/DelWebbHistory.pdf](http://media.corporate-ir.net/media_files/irol/14/147717/DelWebb/DelWebbHistory.pdf)
- DLIFLC (Defense Language Institute Foreign Language Center). 2021. Command History Program. Accessed in person on June 15, 2021 and accessed online database collection online July 2021. Available at: <https://adli.pastperfectonline.com/>
- EA Engineering. 1991. Draft Final Fort Ord, California Base wide Remedial Investigation Feasibility Study. Volume 1 Literature Review and Base Inventory Report. Accessed on July 13, 2021. Available at: <https://www.fortordcleanup.com/documents/search/>
- Fresno Bee, The. 1951a. "Army Spokesman Are Defending Building of Fort Ord Stadium." January 12, 1951. Page 13. Accessed June 17, 2021.
- Fresno Bee, The. 1951b. "Army Spokesman Are Defending Building of Fort Ord Stadium." February 4, 1951. Page 27. Accessed June 17, 2021. Available at: [Newspapers.com](http://Newspapers.com).
- Gates, S., & Williams, H. 1957. The Armed Forces. The Annals of the American Academy of Political and Social Science, 313, 99-104. Accessed June 17, 2021. <http://proxy.multcolib.org:2052/stable/1031762>

## CONTINUATION SHEET

Property Name: Pacific Hall  
Page 14 of 15

- MacGregor Jr., Morris J. 1981. *Integration of the Armed Forces, 1940-1965*. Center of Military History, United States Army: Washington, D.C.
- Madsen, Alexandra and Steven Treffers. 2019. *Historic Resources Evaluation Memorandum for Hammerhead Barracks at Fort Ord, Monterey County, California*. Prepared by Rincon Consultants, Inc for City of Seaside, Community and Economic Development Department. November 4, 2019. Accessed June 28, 2021.  
[https://www.ci.seaside.ca.us/DocumentCenter/View/10674/9\\_App-S---HRE-Memo](https://www.ci.seaside.ca.us/DocumentCenter/View/10674/9_App-S---HRE-Memo)
- Military Museum. 2016. "Historic California Posts, Camps, Stations, and Airfields: Fort Ord." Accessed on June 19, 2021. <http://www.militarymuseum.org/FtOrd.html>
- National Archives Foundation. 2021. Executive Order 9981. Accessed June 29, 2021. Available at: <https://www.archivesfoundation.org/documents/executive-order-9981-ending-segregation-armed-forces/>
- NETR (Nationwide Environmental Title Research LLC). 2021. Historic Aerial Photographs of 100 Campus Center, Seaside, CA 93955 dating from 1956, 1968, 1981, 1998, 2005, 2009, 2010, 2012, 2014, 2016, and 2018. Accessed June 10, 2021.  
<https://www.historicaerials.com/viewer>
- Panorama. 1990. "50 Years and Counting..." September 21, 1990, pg. 2.
- Panorama. n.d. "Ford Ord in World War II." Historic California Posts: Fort Ord. Accessed on June 19, 2021. <http://www.militarymuseum.org/FtOrd.html>
- Park, R. 2015. "Happy and Cheerful in This Fine Camp": Sports, Recreation, and the United States Army at Fort Ord and Camp Roberts, 1940 to 1945. *Journal of Sport History*, 42(1), 21-37. Accessed on June 18, 2021, from  
<https://www.jstor.org/stable/10.5406/jsporhistory.42.1.21>
- Pomona Progress Bulletin. 1950. War Solving Racial Problems. August 24, 1950. Page 4. Accessed June 29, 2021. Available at: [Newspapers.com](http://www.newspapers.com).
- Quartermaster Review, The. 1940. "Army Construction Underway at Camp Ord, California." Volume XX. No 3. November-December. On file at the Chamberlin Library, Ord Military Community.
- Raugh, Harold E. 2004. Fort Ord. Charleston, SC: Arcadia.
- Salinas Morning Post. 1940. "\$2,766,000 in Building Authorized—Ord Contracts Let." August 21, 1940. Salinas, CA. pg. 1.
- San Francisco Examiner. 1951. Fort Ord Will Get Stadium. San Francisco Page 4. · 3 Feb 1951. Pages 1 and 4 A Available on [www.Newspapers.com](http://www.newspapers.com). Accessed on Jun 11, 2021.
- San Francisco Examiner. 1958. Army Asks OK on \$124,000,000 for Fort Ord Buildings. San Francisco. Section 2. Page. 4. Available on [www.Newspapers.com](http://www.newspapers.com). Accessed July 18, 2021.

## CONTINUATION SHEET

Property Name: Pacific Hall

Page 15 of 15

Vasche, J. Burton. 1959. "The California State Colleges: Their History, Organization, Purposes, and Programs." in California

U.S. Army. 1977. Post Map Main Garrison Area. Fort Ord, California. Drawing number G-950. Accessed in person at the Chamberlain Library on June 15, 2021.

Walch, Bob. 2004. An Army Historian's Pictorial Take on Fort Ord. Monterey County NOW. Accessed July 12, 2021. Available at:  
[https://www.montereycountyweekly.com/news/local\\_news/an-army-historian-s-pictorial-take-on-fort-ord/article\\_6e8b0250-9c38-5ca4-a4a4-f93d42d65a11.html](https://www.montereycountyweekly.com/news/local_news/an-army-historian-s-pictorial-take-on-fort-ord/article_6e8b0250-9c38-5ca4-a4a4-f93d42d65a11.html)

Whaley, Derek. 2015. "East Monterey & Seaside." Santa Cruz Trains: Railroads of the Monterey Bay Area. July 20, 2015. Accessed online:  
<https://www.santacruztrains.com/2015/07/east-monterey-seaside.html>.

Webb Spinner, The. 1952-1954. Webb Spinner Volume for 1952-1954. Del Webb Sun Cities Museum Collection. Accessed June 30, 2021. Accessed at:  
<https://delwebbsuncitiesmuseum.org/newsletters-webb-spinners/>



State of California & The Resources Agency  
 DEPARTMENT OF PARKS AND RECREATION  
**PRIMARY RECORD**

Primary #  
 HRI #  
 Trinomial  
**NRHP Status Code 6Z**

Other Listings  
 Review Code

Reviewer

Date

Page 1 of 16 \*Resource Name or #: (Assigned by recorder) Coast Hall

P1. Other Identifier: CSUMB Building 45

\*P2. Location:  Not for Publication  Unrestricted

\*a. County Monterey County and (P2c, P2e, and P2b or P2d. Attach a Location Map as necessary.)

\*b. USGS 7.5' Quad Marina, CA Date 1995 T 15S; R 2E; NW ¼ of SW ¼ of Sec 6; Mount Diablo B.M.

c. Address 4582 6th Avenue, Seaside Zip 93955

d. UTM: (Give more than one for large and/or linear resources) Zone 10S, 607875 mE/ 4056803 mN

e. Other Locational Data: (e.g., parcel #, directions to resource, elevation, decimal degrees, etc., as appropriate)

Coast Hall sits on 6<sup>th</sup> Avenue, between A Street and B Street.

APN: 031101005000

\*P3a. Description: (Describe resource and its major elements. Include design, materials, condition, alterations, size, setting, and boundaries)

Coast Hall (CSUMB Building 45) is located southeast of the Main Quad on the California State University, Monterey Bay (CSUMB) campus. The utilitarian building with modern stylistic details is constructed of board-formed concrete. The single-story building has an L-shaped plan with a flat roof and concrete eave overhangs. The primary, west, elevation has the main entrance at the corner of the "L." Fenestration includes bands of rectangular fixed glass windows in protruding metal frames set on concrete sills.

**See Continuation Sheet.**

\*P3b. Resource Attributes: (List attributes and codes) HP15. Educational building, HP34. Military property

P5a. Photograph or Drawing (Photograph required for buildings, structures, and objects.)



\*P4. Resources Present:  Building

Structure  Object  Site  District  Element of District  Other (Isolates, etc.)

P5b. Description of Photo: (view, date, accession #) west elevation, view looking southeast, Dudek (IMG 0645)

\*P6. Date Constructed/Age and Source:  Historic  Prehistoric  Both 1952-1954 (The Webb Spinner).

\*P7. Owner and Address:

CSUMB  
100 Campus Center  
Seaside, CA. 93955

\*P8. Recorded by: (Name, affiliation, and address) Sarah Corder, Dudek, 725 Front St #400, Santa Cruz, CA 95060

\*P9. Date Recorded: 6/14/2021

\*P10. Survey Type: (Describe)

Intensive level

\*P11. Report Citation: (Cite survey

report and other sources or enter none) Dudek 2021. Built Environment Inventory and Evaluation Report for California State

\*Attachments:  NONE  Location Map  Continuation Sheet  Building, Structure, and Object Record

Archaeological Record  District Record  Linear Feature Record  Milling Station Record  Rock Art Record

Artifact Record  Photograph Record  Other (List): \_\_\_\_\_



# BUILDING, STRUCTURE, AND OBJECT RECORD

\*Resource Name or # (Assigned by recorder) Coast Hall \*NRHP Status Code 6Z  
Page 3 of 16

B1. Historic Name: Hammerhead Building, Hammerhead Barracks, Fort Ord Barracks  
B2. Common Name: Coast Hall, CSUMB Building 45  
B3. Original Use: Military Barracks 4. Present Use: Educational Classroom

\*B5. Architectural Style: Utilitarian

\*B6. Construction History: (Construction date, alterations, and date of alterations)

Designed and constructed between 1952-1954, Coast Hall is a utilitarian building with modern stylistic details. Originally the building served as barracks at Fort Ord. At least 38 barracks were constructed by Del Webb Construction Company at a cost of \$12,614,832. Construction started in 1952 (The Californian 1952b: 18). When California State University at Monterey Bay (CSUMB) acquired the campus, the building became Coast Hall, an educational classroom building. It is likely the addition of the ADA ramps and the replacement of windows was completed during this transition. Between 2006 and 2012, the east, multi-story wing of the building was demolished and the opening to that wing was filled with CMU.

\*B7. Moved?  No  Yes  Unknown Date: \_\_\_\_\_ Original Location: \_\_\_\_\_ \*B8. Related Features:

B9a. Architect: unknown b. Builder: Del Webb Construction Company

\*B10. Significance: Theme N/A Area N/A  
Period of Significance N/A Property Type N/A Applicable Criteria N/A  
(Discuss importance in terms of historical or architectural context as defined by theme, period, and geographic scope. Also address integrity.)

See Continuation Sheet.

B11. Additional Resource Attributes: (List attributes and codes) \_\_\_\_\_

\*B12. References: See Continuation Sheet.

B13. Remarks:

\*B14. Evaluator: Adrienne Donovan-Boyd, MSHP

\*Date of Evaluation: July 9, 2021

(Sketch Map with north arrow required.)



(This space reserved for official comments.)

## CONTINUATION SHEET

Property Name: Coast Hall  
Page 4 of 16

### \*P3a. Description (continued):

Above the rectangular windows are square metal-framed decorative white panels. Below the windows is a section of concrete block. The east elevation shows changes to the plan, with a concrete framed door filled with CMUs and a change in exterior cladding. ADA-accessible ramps are located on the east and west sides of the building. The south and north elevations mirror other elevations in style and materials. Extensive changes to fenestration and door openings are visible on the south elevation. Several wall sections throughout the building are filled with CMU, showing changes to fenestration, pedestrian entrances, and plan. The building appears to sit on a concrete foundation.

### Alterations:

- Demolition of east, multi-story wing, and infill of opening with CMU (between 2012 and 2014).
- Infill of multiple openings and fenestration changes (between 2016 and 2021)
- Addition of ADA ramps (Date Unknown)
- Replacement of original windows throughout.



Figure 1. Main (west) elevation, looking southeast (IMG\_0644)

## CONTINUATION SHEET

Property Name: Coast Hall  
Page 5 of 16



Figure 2. East elevation, rear entrance, awning, and filled in area that originally connected to the multi-story wing, looking northwest. (IMG\_0639)

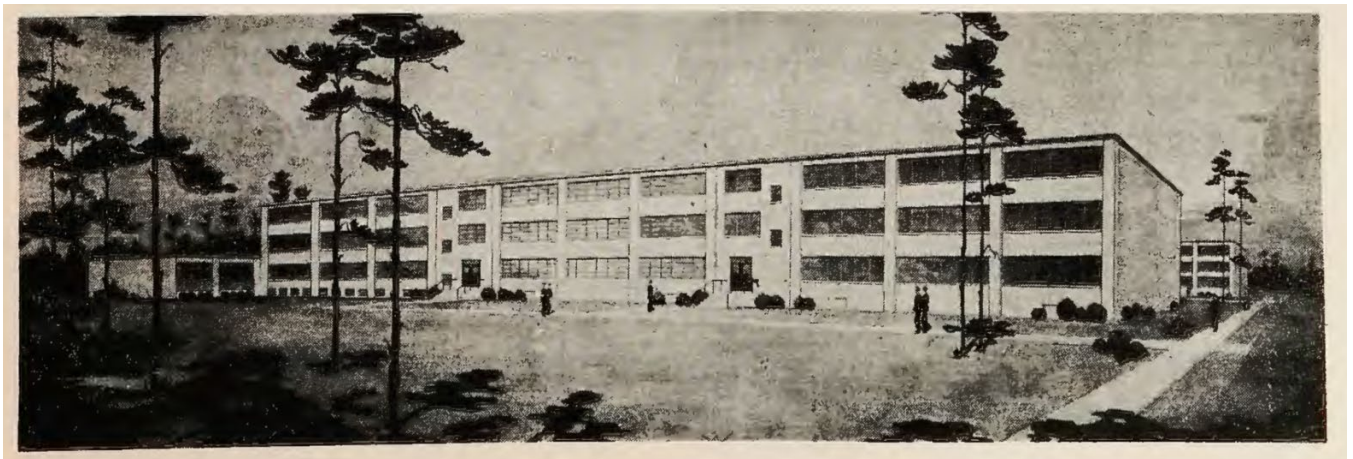

Figure 3. 1952 conceptual drawing of the new barracks to be constructed at Fort Ord. (The Webb Spinner 1952) (DPR Elevation)

## CONTINUATION SHEET

Property Name: Coast Hall  
Page 6 of 16

### \*B10. Significance (continued):

#### Historical Overview of Fort Ord

The history of Fort Ord has been extensively documented in newspaper articles, websites, academic journals, and books. From its creation in 1917 to its closure in 1994, the base grew to become one of the largest training centers in the country. Its location was also reported to be the most attractive U.S. Army post, with easy access to the ocean and beautiful California weather.

The development periods in the history of Fort Ord were defined by Harold E. Raugh, Jr, a U.S. Army lieutenant colonel and historian with the Department of Defense. Since his retirement, Raugh served as the Chief Historian, for the Defense Logistics Agency, for the Department of Defense and, from 2006-2013, Raugh served as the Command Historian at the Defense Language Institute Foreign Language Center (DLIFLC) and the Presidio of Monterey, California. He received his PhD in history from the University of California, Los Angeles (Walch 2004). Raugh has authored numerous books including, *Fort Ord* (2004); *Presidio of Monterey* (2004); *Operation Joint Endeavor: V Corps in Bosnia-Herzegovina, 1995-1996* (2013); *The Raugh Bibliography of the Indian Mutiny 1857-1859* (2016); and *Wavell in the Middle East, 1939-1941: A study in Generalship*. Raugh defined four periods for the historic development of Fort Ord:

- 1917-1940 Camp Gigling to Camp Ord
- 1940-1945 Fort Ord and the 7th Infantry Division
- 1946-1976 The Cold War and Vietnam Eras
- 1974-1994 The Volunteer Army

These periods correspond to distinct eras in the history of the base and the U.S. Army (Raugh 2004: ii). The following sections provide a summary overview of each of these periods of development and their relevance to the area of Fort Ord now known as the CSUMB campus.

The full historic context of Fort Ord is represented in the report, *Built Environment Inventory and Evaluation Report for California State University, Monterey Bay* (Dudek 2021). The following presents only relevant historical and building typology information pertaining to the development of Coast Hall.

#### Cold War and Vietnam Eras at Fort Ord (1946-1976)

This period of development between 1946 and 1976 was characterized by a massive operation to move the base out of its semi-permanent status and create a permanent outpost for active military personnel who were retained due to ongoing foreign conflicts.

In July of 1948, Harry S Truman signed Executive Order 9981, which officially ended segregation in the armed forces. The order stated that "there shall be equality of treatment and opportunity for all persons in the armed forces without regard to race, color, religion, or national origin" (National Archives Foundation 2021). Fort Ord became one of the first integrated training divisions in the United States. The Fort was touted as "pioneering to end all segregation" (The Pomona Progress Bulletin 1950: 4). In 1950, the Pomona Progress Bulletin reported that black and white soldiers at Fort Ord were "fighting side by side" and all the enlistees "trained together, slept in the same barracks, and eat the same messes" (The Pomona Progress Bulletin 1950: 4).

The end of World War II in 1945 did not bring lasting peace. The tenuous relationship between dominant nations in the communist East and free market West led to the beginning

## CONTINUATION SHEET

Property Name: Coast Hall  
Page 7 of 16

of the Cold War. The Department of Defense maintained a robust fighting force during the Cold War, with more than 900,000 Army personnel retained during the 1950s (ACHP 2006). The ongoing global tensions and the number of active U.S. military personnel created a need for new permanent buildings and expanded military housing at Fort Ord.

In 1949, the Soviet-supported communist government of North Korea invaded American-supported South Korea, initiating the Korean War. Fort Ord was a primary staging area for the training of troops departing for the war (Castle 1990:3). By the 1950s, Fort Ord had become one of the largest basic training camps in the United States. In 1952, the military began a multi-million dollar building program to transform Fort Ord into a permanent post, including the development of permanent troop housing, and the construction of a guard house, stockade, and multiple warehouses. In January of 1952, military authorities announced the new construction program at Fort Ord was underway, with an estimated cost of \$26,650,600. More than half of the funds that were approved by Congress were "earmarked for new permanent troop housing" for more than 7,000 soldiers (The Webb Spinner 1952-54, Vol 6. No. 3:1).

The new troop housing was to be constructed of reinforced concrete, a departure from the wood buildings constructed before and during World War II. The plan called for three types of massive barracks, twenty-two were to house 225 enlisted men each, seven were to accommodate 165 men each, and nine were to house 105 men each (The Webb Spinner 1952-54, Vol 6. No. 3:3). The San Francisco District of the U.S. Army Corps of Engineers oversaw the construction project to completion. An additional \$1,349,700 was earmarked for the expansion of classroom and training facilities at Fort Ord, including a new battalion and regimental headquarters (The Californian 1952a:1 and The Californian 1952b:18). By March of 1952, another phase of the permanent army post transformation began with the construction of a guard house, stockade, warehouse, and other buildings (The Webb Spinner 1952-54, Vol 6. No. 3:1). This addition of permanent buildings continued into the late 1950s, when the Army requested \$124 million to replace all the wood World War II infrastructure at Fort Ord with concrete block and reinforced concrete (Madsen and Treffers 2019:6; San Francisco Examiner 1958:2-4). While many of the wood buildings remain today, this period saw the continuous addition of reinforced concrete permanent buildings across the Fort (Madsen and Treffers 2019:6).

Following the Korean War through the end of the conflict in Vietnam, Fort Ord served as an important training facility. In 1957, Fort Ord was designated as a U.S. Army Training Center for Infantry (Castle 1990: 4). The 7th Infantry Division was based at Fort Ord in 1975 (Cavanaugh 2000: 9). Fort Ord produced thousands of combat-ready troops during the conflict in Vietnam.

With the establishment of Fort Ord as a permanent Army base during this period, there was substantial building construction that led to the modernization of the base and its services. This development is closely related to the history of the current CSUMB campus. All the properties that are included as part of this built environment study were constructed during the Cold War and Vietnam Era period. Building development during this period was a substantial departure from the styles and materials used in the buildings constructed before World War II. Building during the period between 1946 and 1976 used reinforced concrete and concrete masonry unit (CMU). The buildings tended to be larger than those constructed in previous periods. Other development in this period included support service buildings and several types of medical buildings. Infrastructure was

## CONTINUATION SHEET

Property Name: Coast Hall  
Page 8 of 16

also improved at this time, with the introduction of paved streets and roadways, and the addition of several water tanks, water pumping plants, and warehouse buildings.

### **Coast Hall, 1952-1954**

Coast Hall (45) first appears on a 1956 aerial photograph of the site in the western half, of a group of eight other similarly laid out buildings. These buildings were originally designed as new permanent barracks that were part of a \$26,650,000 construction program awarded by the military in 1952. More than \$17 million of these funds were used to construct 38, new, three-story barracks. These larger barracks were planned to house entire companies and serve all their needs in one space, with mess halls, lounges, day rooms, orderly rooms, supply rooms, and issue rooms, as well as administrative space (the Californian 1952a).

The Del Webb Construction Company won the bid for the work at Fort Ord with a low bid of \$12,614,832 (The Californian 1952b: 18). Groundbreaking for the project took place on February 19, 1952. The barracks were featured in Webb's newsletter, The Webb Spinner, in the June/July/August edition. The paper touted the new military dormitories as being "sleek" (The Webb Spinner 1954:6). The buildings were a departure from the "old, white-painted barracks" constructed 12 years earlier. The new barracks were erected of steel and concrete and features large glass areas. The concrete construction was lauded as both vermin- and fire-proof (The Webb Spinner 1954:6). After Fort Ord closed in 1994, the buildings became part of the CSUMB campus.

### **Del Webb Construction Company**

The Del Webb Construction Company was founded by Delbert Eugene Webb in Phoenix in 1928. The company would become known for its ability to develop profitable commercial and residential large-scale projects (Del Webb and Pulte Homes 2021:1). Webb was the lead contractor on Madison Square Garden and the L. A. County Museum of Art. During World War II, the company won many military and navy housing projects where the company streamlined development of housing on once barren land. In the late 1940s Webb constructed a casino/hotel in Las Vegas for Benjamin "Bugsy" Siegle. Over time Del Webb became the largest gaming operator and private employer in California.

The Del Webb Corporation opened a community, Sun City, in January of 1960. The community was known for its modestly priced housing and delivering a "highly desirable lifestyle" (Del Webb and Pulte Homes 2021:1). Del Webb went on to construct "Sun Cities" in Florida and Southern California, both of which were sold. The company continued to focus on gaming and commercial operations until 1987, when the decision was made to sell these interests and focus on the development of "master-planned, active adult communities" (Del Webb and Pulte Homes 2021:2). By January of 2000 the company had planned and constructed 13 Sun Cities Communities, selling more than 80,000 homes. In July 2001, Del Webb Company merged with Pulte Homes inc. to create the largest homebuilding company in the Nation (Del Webb and Pulte Homes 2021:3).

Several buildings on the Williams Air Force Base are listed on the NRHP including, two Ammo Bunkers, the Civil Engineering Maintenance Shop, the Demountable Hangar, the flagpole, the Housing Storage Supply Warehouse, and the Water Pump Station and Water Tower. Additionally, the 1938 addition to the Arizona State Capital Building, Hunts Tomb in Phoenix Arizona, and the Phoenix Towers in Phoenix are all individual listed on the NRHP. The Del Webb Construction Company has constructed thousands of buildings across the United States.



## CONTINUATION SHEET

Property Name: Coast Hall  
Page 9 of 16

### Fort Ord Building Typology and Character-Defining Features

Four categories of building types were identified for the purposes of this study. These are the Support Services Buildings, Medical Buildings, Hammerhead Buildings/Barracks, and Recreational Buildings. The following presents a discussion of the Hammerhead Buildings/Barracks building typology, as Coast Hall is classified in this category. This section provides a detailed account of the specific character-defining features of Fort Ord Cold War and Vietnam Era (1946-1976) Hammerhead Buildings/Barracks.

### Hammerhead Buildings/Barracks

The Hammerhead Buildings/Barracks were constructed to house troops at Fort Ord as it was expanding from a semi-permanent installation to a permanent base. In alignment with the typical planning, design, and materials of buildings constructed during this period of Fort Ord's history, these buildings are constructed with reinforced concrete and CMU and feature flat roofs with multi-light windows with concrete sills.

Coast Hall (45) first appears on a 1956 aerial photograph of the site on the western half of the base. It is part of a group of eight other similarly oriented buildings. No changes to the footprint were noted. After Fort Ord closed in 1994, the buildings became part of the CSUMB campus. There were no notable changes to the footprint of the building until sometime between 2016 and 2018 when the east, multi-story wing was demolished on Coast Hall.

### Character-Defining Features of the Hammerhead Buildings

The Hammerhead Buildings/Barracks originally exhibited the following specific character-defining features:

#### Character-Defining Features: The Hammerhead Buildings/Barracks

| Character Aspect       | Primary Character-Defining Features   | Character-Defining Features  |
|------------------------|---|--|
| Shape and Plan         | <ul style="list-style-type: none"> <li>Hammerhead shape</li> <li>Single story wing and multi-story wing</li> </ul>            | The overall shape and mass of the building are considered a primary character-defining feature of the Hammerhead Buildings/Barracks. The plan should include a multi-story wing.   |
| Roof                   | <ul style="list-style-type: none"> <li>Flat roof</li> <li>Wide eave overhangs</li> <li>No exposed rafters</li> </ul>          | The Hammerhead Buildings/Barracks have flat roofs, with moderate eave overhangs.   |
| Openings               | <ul style="list-style-type: none"> <li>Entrances on the first story</li> <li>Multi-light windows</li> </ul>                   | Window openings are uniform in size and placement, windows are multi-light, and set into concrete openings. Replaced windows are not considered character-defining features as they fall outside the period of significance. |
| Exterior Ornamentation | <ul style="list-style-type: none"> <li>Minimal exterior ornamentation</li> <li>Glass windows used as ornamentation</li> </ul> | Hammerhead Buildings/Barracks were designed to be quickly constructed. They have little to no decorative ornamentation, with windows in ribbons being the only decorative element.   |

**CONTINUATION SHEET**

Property Name: Coast Hall  
 Page 10 of 16

|           |  |   |
|-----------|--|---|
| Materials | <ul style="list-style-type: none"> <li>• Mass-produced and cost-effective materials</li> <li>• Concrete and CMU</li> <li>• Reinforced concrete construction</li> </ul> | Hammerhead Buildings/Barracks have simple, utilitarian designs. Buildings were constructed using mass-produced and cost-effective building materials that were readily available at the time of construction. For instance, buildings under the Hammerhead type were constructed with reinforced concrete and CMU and were minimally decorated. |
|-----------|--|---|

Alterations and demolitions over time have compromised the overall architectural integrity of this building type. The most common alterations observed for this building type include the following.

- Replacement windows
- ADA compliance measures such as ramps and doors
- HVAC systems and window units
- Infill of openings
- Interior renovations

**NRHP/CRHR Designation Criteria**

In consideration of the project site's history and requisite integrity, Dudek recommends the property not eligible for listing in the NRHP and CRHR based on the following significance evaluation and in consideration of national and state eligibility criteria:

**Criterion A/1: That are associated with events that have made a significant contribution to the broad patterns of our history.**

Coast Hall was constructed in 1952-1954 during the period defined as the Cold War and Vietnam Eras (1946-1976) at Ford Ord. While this building is of historic age and was constructed during this important period of development in Fort Ord's history, it no longer retains enough integrity to convey its significance. One of the most notable elements of integrity that is compromised is the integrity of setting. Significant demolition, changes to circulation patterns, introduction of new buildings, and changes in use, all impact the campus's ability to convey significance from its time as an active Cold War and Vietnam Era military base. The loss of this overall integrity of setting adversely effects Coast Hall, as individual buildings are no longer able to convey their collective history. Additionally, the subdivision of Fort Ord following its closure has also greatly impacted the integrity of feeling, association, and setting of the Cold War and Vietnam Era portions of the installation. In summary, Coast Hall, is not able to convey its association with any extraordinary events or events occurring within the context of Cold War and Vietnam military barracks, the CSUMB Campus, or has an association with the broad patterns of history in Monterey County, the State of California, or the Nation. Therefore, the building is recommended not eligible under NRHP/CRHR Criterion A/1.

**Criterion B/2: That are associated with the lives of persons significant in our past.**

To be found eligible under B/2 the building must be directly tied to an important person and the place where that individual conducted or produced the work for which he or she is known. Archival research failed to indicate any historical associations with people important to the nation's or state's past. Due to a lack of identified significant associations with important persons in history, the building does not appear eligible under NRHP/CRHR Criterion B/2.

**Criterion C/3: That embody the distinctive characteristics of a type, period, or method**

## CONTINUATION SHEET

Property Name: Coast Hall  
Page 11 of 16

**of construction, or that represent the work of a master, or that possess high artistic values, or that represent a significant and distinguishable entity whose components may lack individual distinction.**

No original plans or designs for the 1952-1954 barracks were discovered during archival research. Newspaper articles from 1952, announced the contract was awarded to the Del Webb Company, of Phoenix, AZ (the Californian 1952a). The Webb Company was a notable building company that completed contracts for the government, commercial clients, and private individuals during its long period operation, beginning in 1929 and continuing to the present. The Webb Company designed many distinguished buildings including many that are listed on the NRHP. While Webb may be a master builder, Coast Hall, was constructed during a period when the Webb company was completing many other large-scale projects, many at military bases. The company received many contracts during World War II to construct barracks and other military related buildings. The buildings at Fort Ord were common contracts for the company, and they had constructed buildings of this type at other bases.

Coast Hall is a utilitarian building, with minimal detailing, and few stylistic features. Additionally, Coast Hall, has undergone numerous, alterations, including changes to fenestration, materials, and the demolition of the east, multi-story wing. Originally the building housed an entire infantry of troops, the remaining portion of the building is currently used for classroom space. While the building is associated with a master builder, the Del Webb Construction Company, it is not one of their more notable works. Additionally, the building lacks high artistic value, and has undergone substantial alterations. For these reasons Coast Hall is recommended not eligible under NRHP/CRHR Criterion C/3.

**Criterion D/4: That have yielded, or may be likely to yield, information important in prehistory or history.**

There is no evidence to suggest that this property has the potential to yield information important to state or local history. Therefore, the property is recommended not eligible under NRHP/CRHR Criterion D/4.

### **California Historic Landmark Statement of Significance**

In consideration of Coast Hall's history and requisite integrity, Dudek recommends the property not eligible for designation as a California Historic Landmark based on the following significance evaluation and in consideration of state eligibility criteria:

**The first, last, only, or most significant of its type in the state or within a large geographic region (Northern, Central, or Southern California).**

Coast Hall was constructed between 1952 and 1954. The building, along with at least 38 other barracks, was constructed after the initial, core development period of Fort Ord in the 1940s. The buildings were constructed during the fort's transition to a permanent base. Coast Hall was constructed by Del Webb Company, a company based in Phoenix Arizona. The building is a utilitarian building type that lacks high style components to set it apart from other buildings constructed throughout the State of California in the 1950s and 1960s. Therefore, Dudek recommends Coast Hall is not eligible for listing as a CHL under this criterion.

**Associated with an individual or group having a profound influence on the history of California.**

Coast Hall was originally constructed to be one of Fort Ord's barracks, one of 38 such buildings to provide a housing for military personnel. The Del Webb Construction Company, a notable Phoenix, Arizona based company, was responsible for the construction of the building. While Coast Hall is associated with a master builder with many known projects

## CONTINUATION SHEET

Property Name: Coast Hall  
Page 12 of 16

completed in California, this building is not one of the company's notable works. No other individuals are known to have influenced the construction or use of this building. Therefore, Dudek recommends Coast Hall is not eligible for listing as a CHL under this criterion.

**A prototype of, or an outstanding example of, a period, style, architectural movement or construction or is one of the more notable works or the best surviving work in a region of a pioneer architect, designer or master builder.**

Coast Hall is neither a prototype or an outstanding example of a period, style, or architectural movement. It is a typical example of a utilitarian design. The building was designed to serve a utilitarian purpose for the military at Fort Ord. There are no identifying features on Coast Hall that would establish the connection to the notable work of the Del Webb Construction Company in the State of California. Additionally, Coast Hall has been substantially altered and the large multi-story wing demolished making it unable to sufficiently convey its temporal period or its historic context. Therefore, Dudek recommends Coast Hall is not eligible for listing as a CHL under this criterion.

### Local Designation Criteria

Portions of the CSUMB campus are located within the boundaries of two cities, City of Seaside and the City of Marina, both of which evaluate historical resources in accordance with CEQA Guidelines. as presented above. The subject property, as discussed in the NRHP/CRHR/CHL criteria discussion above, does not rise to the necessary level of significance for local, state, or national designation. For these reasons, the subject property is recommended not eligible individually or as a component of a historic district under any of the NRHP/CRHR/CHL criteria.

Additionally, portions of the CSUMB campus are located in the County of Monterey and the campus is therefore subject to the regulations set forth in Chapter 18.25 of the Monterey County Code. The subject property, as discussed in the NRHP/CRHR/CHL criteria discussion above, does not rise to the necessary level of significance for state or national designation. For these same reasons, the subject property is also recommended not eligible individually or as a component of a historic district under any of the delineated County of Monterey review criteria categories that are addressed with the NRHP/CRHR/CHL criteria discussed above: A. Historical and Cultural Significance; B. Historic, Architectural, and Engineering Significance; or C. Community and Geographic Setting.

### Integrity Discussion

Coast Hall was analyzed against the seven aspects of integrity: location, design, setting, materials, workmanship, feeling, and association. The building retains its integrity of location, as it has not been relocated. The building was designed with minimal elements reflecting an architectural style. Some of the features reflecting the original design, most notably the windows and the demolition of the multi-story wing, have been lost, and the overall integrity of design has been compromised. The integrity of setting has been lost with the change in use from its original use as barracks at Fort Ord to a classroom building for CSUMB. Therefore, the integrity of setting has been lost. While some of the original materials appear to be intact, the demolition of the multi-story wing and changes to original fenestration have compromised the integrity of materials. The techniques used in the construction of Coast Hall are still apparent, with the CMU and concrete construction, but the demolition of more than half the building has adversely affected the integrity of workmanship. The exterior of Coast Hall no longer conveys its original use. Therefore, the integrity of feeling has been lost. As Coast Hall does not possess historic significance, there is no historic association. The building does not possess adequate integrity to convey significance.

## CONTINUATION SHEET

Property Name: Coast Hall

Page 13 of 16

### Summary of Evaluation Findings

Coast Hall has a compromised level of historic integrity and lacks historical and architectural significance. Based on the significance evaluations presented above, Coast Hall does not appear to meet the NRHP, CRHR, CHL or local designation criteria. Therefore, Coast Hall is not considered a historical resource for purposes of CEQA.

## CONTINUATION SHEET

Property Name: Coast Hall

Page 14 of 16

### \*B12. References (continued):

- ACHP (Advisory Council on Historic Preservation). 2006. "Draft Program Comment Regarding Cold War Era Unaccompanied Personnel Housing." Federal Register: The Daily Journal of the United States Government. 12 April 2016. Accessed June 30, 2021 Available at: <https://www.federalregister.gov/documents/2006/04/12/06-3509/draft-program-comment-regarding-cold-war-era-unaccompanied-personnel-housing>
- Californian, The. 1940. "No More Camp Ord! It's Fort Ord Now! Stilwell in Command: Headquarters of General Located on Salinas Side." July 13, 1940. Salinas, California, pg. 1.
- Californian, The. 1951. Stadium Field House—Sixth Army Lets Ord Contract. March 20, 1951. P1. Accessed June 17, 2021. Available at: [Newspapers.com](http://Newspapers.com).
- Castle, Ted. 1990. "The March of Time." Fort Ord Panorama. September 21, 1990.
- Cavanaugh, Joe. 2000. *The Peace Dividend: Defense Conversion Through Higher Education*. The Leon Panetta Institute.
- Chamberlin Library. 2021. Fort Ord Working Papers. CSUMB Special Collections Box 6.42-01. Available at the Chamberlin Library, Seaside, California.
- CSUMB Facilities. 2021. Original As built and renovation architectural drawings on file with CSUMB facilities department. Accessed in person June 15-16, 2021.
- Del Webb and Pulte Homes 2021. Del Webb History. Accessed July 9, 2021. Available at: [http://media.corporate-ir.net/media\\_files/irol/14/147717/DelWebb/DelWebbHistory.pdf](http://media.corporate-ir.net/media_files/irol/14/147717/DelWebb/DelWebbHistory.pdf)
- DLIFLC (Defense Language Institute Foreign Language Center). 2021. Command History Program. Accessed in person on June 15, 2021 and accessed online database collection online July 2021. Available at: <https://adli.pastperfectonline.com/>
- EA Engineering. 1991. Draft Final Fort Ord, California Base wide Remedial Investigation Feasibility Study. Volume 1 Literature Review and Base Inventory Report. Accessed on July 13, 2021. Available at: <https://www.fortordcleanup.com/documents/search/>
- Fresno Bee, The. 1951a. "Army Spokesman Are Defending Building of Fort Ord Stadium." January 12, 1951. Page 13. Accessed June 17, 2021.
- Fresno Bee, The. 1951b. "Army Spokesman Are Defending Building of Fort Ord Stadium." February 4, 1951. Page 27. Accessed June 17, 2021. Available at: [Newspapers.com](http://Newspapers.com).
- Gates, S., & Williams, H. 1957. The Armed Forces. The Annals of the American Academy of Political and Social Science, 313, 99-104. Accessed June 17, 2021. <http://proxy.multcolib.org:2052/stable/1031762>

## CONTINUATION SHEET

Property Name: Coast Hall

Page 15 of 16

- MacGregor Jr., Morris J. 1981. *Integration of the Armed Forces, 1940-1965*. Center of Military History, United States Army: Washington, D.C.
- Madsen, Alexandra and Steven Treffers. 2019. *Historic Resources Evaluation Memorandum for Hammerhead Barracks at Fort Ord, Monterey County, California*. Prepared by Rincon Consultants, Inc for City of Seaside, Community and Economic Development Department. November 4, 2019. Accessed June 28, 2021.  
[https://www.ci.seaside.ca.us/DocumentCenter/View/10674/9\\_App-S---HRE-Memo](https://www.ci.seaside.ca.us/DocumentCenter/View/10674/9_App-S---HRE-Memo)
- Military Museum. 2016. "Historic California Posts, Camps, Stations, and Airfields: Fort Ord." Accessed on June 19, 2021. <http://www.militarymuseum.org/FtOrd.html>
- National Archives Foundation. 2021. Executive Order 9981. Accessed June 29, 2021. Available at: <https://www.archivesfoundation.org/documents/executive-order-9981-ending-segregation-armed-forces/>
- NETR (Nationwide Environmental Title Research LLC). 2021. Historic Aerial Photographs of 100 Campus Center, Seaside, CA 93955 dating from 1956, 1968, 1981, 1998, 2005, 2009, 2010, 2012, 2014, 2016, and 2018. Accessed June 10, 2021.  
<https://www.historicaerials.com/viewer>
- Panorama. 1990. "50 Years and Counting..." September 21, 1990, pg. 2.
- Panorama. n.d. "Ford Ord in World War II." Historic California Posts: Fort Ord. Accessed on June 19, 2021. <http://www.militarymuseum.org/FtOrd.html>
- Park, R. 2015. "Happy and Cheerful in This Fine Camp": Sports, Recreation, and the United States Army at Fort Ord and Camp Roberts, 1940 to 1945. *Journal of Sport History*, 42(1), 21-37. Accessed on June 18, 2021, from  
<https://www.jstor.org/stable/10.5406/jsporhistory.42.1.21>
- Pomona Progress Bulletin. 1950. War Solving Racial Problems. August 24, 1950. Page 4. Accessed June 29, 2021. Available at: [Newspapers.com](http://www.newspapers.com).
- Quartermaster Review, The. 1940. "Army Construction Underway at Camp Ord, California." Volume XX. No 3. November-December. On file at the Chamberlin Library, Ord Military Community.
- Raugh, Harold E. 2004. Fort Ord. Charleston, SC: Arcadia.
- Salinas Morning Post. 1940. "\$2,766,000 in Building Authorized—Ord Contracts Let." August 21, 1940. Salinas, CA. pg. 1.
- San Francisco Examiner. 1951. Fort Ord Will Get Stadium. San Francisco Page 4. · 3 Feb 1951. Pages 1 and 4 A Available on [www.Newspapers.com](http://www.newspapers.com). Accessed on Jun 11, 2021.
- San Francisco Examiner. 1958. Army Asks OK on \$124,000,000 for Fort Ord Buildings. San Francisco. Section 2. Page. 4. Available on [www.Newspapers.com](http://www.newspapers.com). Accessed July 18, 2021.

## CONTINUATION SHEET

Property Name: Coast Hall

Page 16 of 16

Vasche, J. Burton. 1959. "The California State Colleges: Their History, Organization, Purposes, and Programs." in California

U.S. Army. 1977. Post Map Main Garrison Area. Fort Ord, California. Drawing number G-950. Accessed in person at the Chamberlain Library on June 15, 2021.

Walch, Bob. 2004. An Army Historian's Pictorial Take on Fort Ord. Monterey County NOW. Accessed July 12, 2021. Available at:  
[https://www.montereycountyweekly.com/news/local\\_news/an-army-historian-s-pictorial-take-on-fort-ord/article\\_6e8b0250-9c38-5ca4-a4a4-f93d42d65a11.html](https://www.montereycountyweekly.com/news/local_news/an-army-historian-s-pictorial-take-on-fort-ord/article_6e8b0250-9c38-5ca4-a4a4-f93d42d65a11.html)

Whaley, Derek. 2015. "East Monterey & Seaside." Santa Cruz Trains: Railroads of the Monterey Bay Area. July 20, 2015. Accessed online:  
<https://www.santacruztrains.com/2015/07/east-monterey-seaside.html>.

Webb Spinner, The. 1952-1954. Webb Spinner Volume for 1952-1954. Del Webb Sun Cities Museum Collection. Accessed June 30, 2021. Accessed at:  
<https://delwebbsuncitiesmuseum.org/newsletters-webb-spinners/>



State of California & The Resources Agency  
DEPARTMENT OF PARKS AND RECREATION  
**PRIMARY RECORD**

Primary #  
HRI #  
Trinomial  
NRHP Status Code 6Z

Other Listings  
Review Code

Reviewer

Date

Page 1 of 16 \*Resource Name or #: (Assigned by recorder) Harbor Hall

P1. Other Identifier: CSUMB Building 46

\*P2. Location:  Not for Publication  Unrestricted

\*a. County Monterey County and (P2c, P2e, and P2b or P2d. Attach a Location Map as necessary.)

\*b. USGS 7.5' Quad Marina, CA Date 1995 T 15S; R 2E; NW ¼  of SW ¼  of Sec 6; Mount Diablo B.M.

c. Address 4580 6th Avenue, Seaside Zip 93955

d. UTM: (Give more than one for large and/or linear resources) Zone 10S, 607876 mE/ 4056852 mN

e. Other Locational Data: (e.g., parcel #, directions to resource, elevation, decimal degrees, etc., as appropriate)

Harbor Hall sits north of B Street, between 6<sup>th</sup> Avenue and 7<sup>th</sup> Avenue.

\*P3a. Description: (Describe resource and its major elements. Include design, materials, condition, alterations, size, setting, and boundaries)

Harbor Hall (CSUMB Building 46) is located southeast of the Main Quad on the California State University, Monterey Bay (CSUMB) campus. The utilitarian building with modern stylistic details is primarily constructed of board-formed concrete. The single-story building has an L-shaped plan with a flat roof and moderate concrete eave overhangs. The primary, west, elevation has the main entrance at the corner of the "L." Fenestration includes bands of rectangular fixed glass windows in protruding metal frames set on concrete sills. **See Continuation Sheet.**

\*P3b. Resource Attributes: (List attributes and codes) HP15. Educational building, HP34. Military property

P5a. Photograph or Drawing (Photograph required for buildings, structures, and objects.)



\*P4. Resources Present:  Building  
 Structure  Object  Site  District   
Element of District  Other (Isolates, etc.)

P5b. Description of Photo: (view, date, accession #) West elevation, view looking east, Dudek (IMG 06520)

\*P6. Date Constructed/Age and Source:  Historic  Prehistoric  Both  
1952-1954 (The Webb Spinner).

\*P7. Owner and Address:

CSUMB  
100 Campus Center  
Seaside, CA. 93955

\*P8. Recorded by: (Name, affiliation, and address) Sarah Corder Dudek  
725 Front St #400  
Santa Cruz, CA 95060

\*P9. Date Recorded: 6/14/2021

\*P10. Survey Type: (Describe)  
Intensive level

\*P11. Report Citation: (Cite survey report and other sources or enter none) Dudek 2021. Built Environment Inventory and Evaluation Report for California State Bay.

\*Attachments:  NONE  Location Map  Continuation Sheet  Building, Structure, and Object Record  
 Archaeological Record  District Record  Linear Feature Record  Milling Station Record  Rock Art Record  
 Artifact Record  Photograph Record  Other (List): \_\_\_\_\_

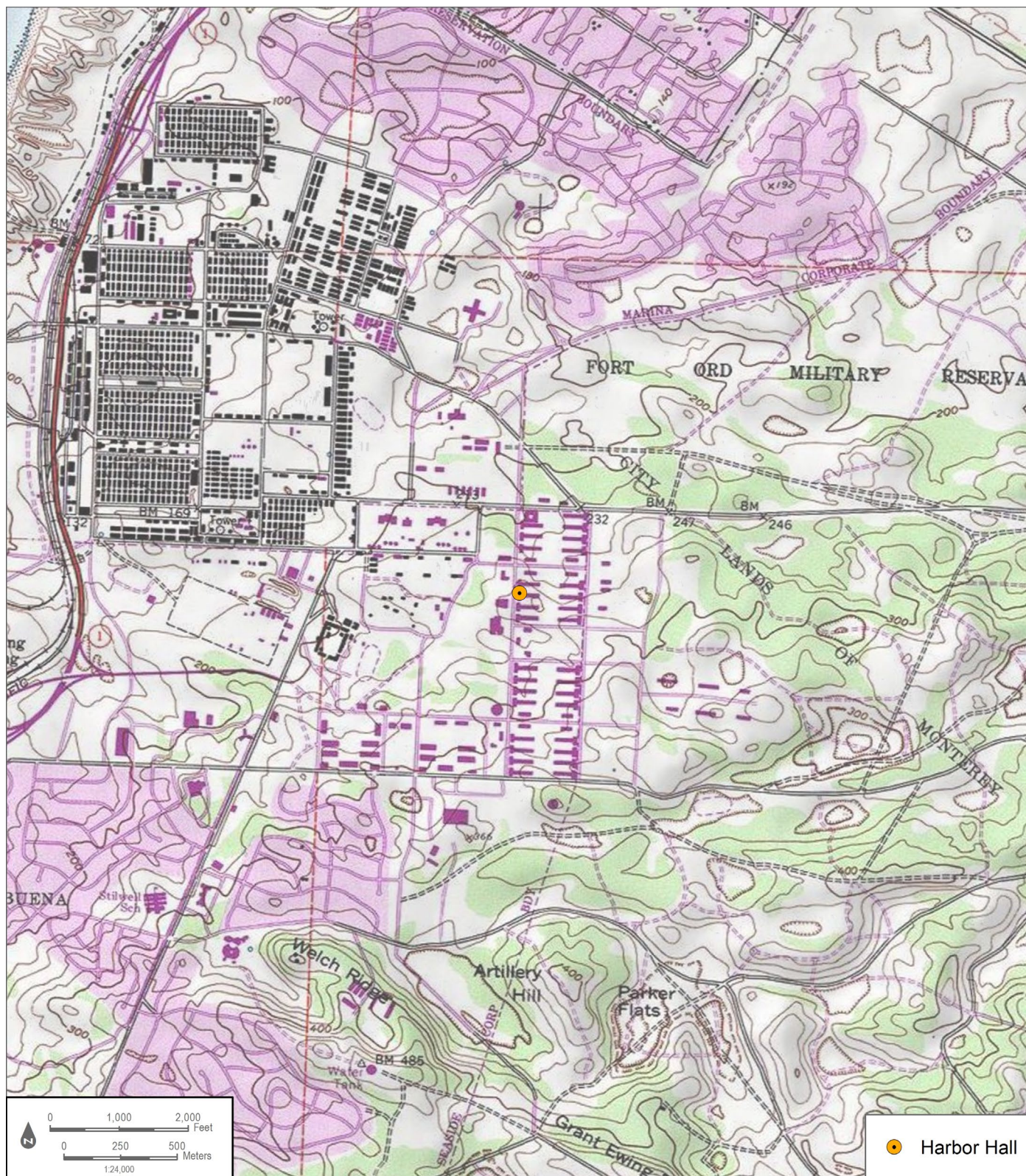

# BUILDING, STRUCTURE, AND OBJECT RECORD

\*Resource Name or # (Assigned by recorder) Harbor Hall \*NRHP Status Code 6Z

Page 3 of 16

B1. Historic Name: Hammerhead Building, Hammerhead Barracks, Fort Ord Barracks

B2. Common Name: Harbor Hall, CSUMB Building 46

B3. Original Use: Military Barracks 4. Present Use: Educational Classroom

\*B5. Architectural Style: Utilitarian

\*B6. Construction History: (Construction date, alterations, and date of alterations)

Constructed in c. 1952, Harbor Hall (46) is a utilitarian building with modern design elements. Originally the building served as barracks at Fort Ord. At least 38 barracks were constructed by Del Webb Construction Company at a cost of \$12,614,832. Construction started in 1952 (The Californian 1952b: 18). When California State University at Monterey Bay (CSUMB) acquired the campus, the building became Harbor Hall, an educational classroom building. It is likely the addition of the ADA ramps and the replacement of windows were completed during this transition. There are no notable changes to Harbor Hall's surroundings until sometime between 1998 and 2005 when a landscaped green space also appears to join Harbor Hall to the Student Services building via their multi-story east wings. Sometime between 2012 and 2014, Harbor Hall's east multi-story wing was demolished.

\*B7. Moved?  No  Yes  Unknown Date: \_\_\_\_\_ Original Location: \_\_\_\_\_ \*B8. Related Features:

B9a. Architect: unknown b. Builder: Del Webb Construction Company

\*B10. Significance: Theme N/A Area N/A  
Period of Significance N/A Property Type N/A Applicable Criteria N/A

(Discuss importance in terms of historical or architectural context as defined by theme, period, and geographic scope. Also address integrity.)

See Continuation Sheet.

B11. Additional Resource Attributes: (List attributes and codes) \_\_\_\_\_

\*B12. References: See Continuation Sheet.

B13. Remarks:

\*B14. Evaluator: Adrienne Donovan-Boyd, MSHP

\*Date of Evaluation: July 20, 2021

(This space reserved for official comments.)

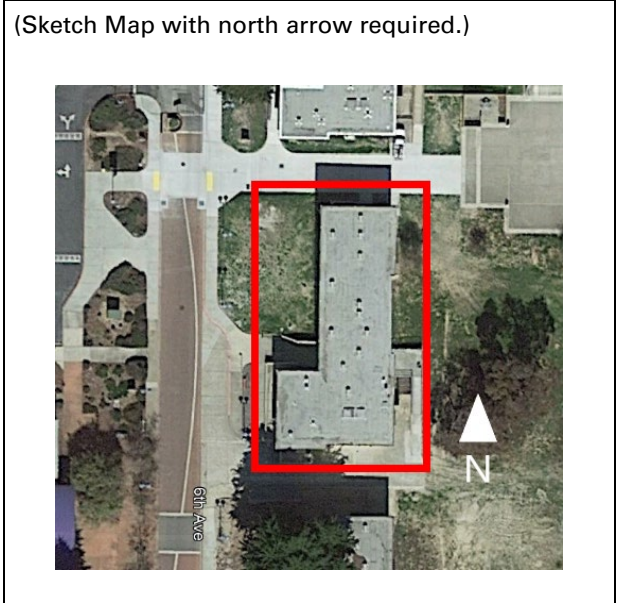

## CONTINUATION SHEET

Property Name: Harbor Hall  
Page 4 of 16

### \*P3a

#### Description (continued):

Above the rectangular windows are square metal-framed decorative white panels. The east elevation shows changes to plan, with a concrete framed door filled with CMUs and a change in exterior cladding. An ADA-accessible ramp leads to a secondary entrance with an arched metal awning on the east facade. A below-grade basement is accessed on the east façade with stairs leading north under the ADA ramp. The south and north elevations mirror other elevations in style and materials. A CMU-filled window opening, and a door repurposed as a window are on the west end of the south elevation. The building appears to sit on a concrete foundation.

#### Alterations:

- Demolition of east, multi-story wing, and infill of opening with CMU (between 2012 and 2014).
- Infill of multiple openings and fenestration changes (between 2016 and 2018)
- Addition of ADA ramps (Date Unknown).
- Addition of HVAC unit to east side of building (Date Unknown).
- Replacement of original windows throughout (Date Unknown).



3

Figure 1. Front entrance detail of Harbor Hall (west elevations), looking southeast, detail of ADA ramps (IMG\_0671)

## CONTINUATION SHEET

Property Name: Harbor Hall  
Page 5 of 16



Figure 2. Main (west) elevation, looking northeast (IMG\_0654)



Figure 3. 1952 conceptual drawing of the new barracks to be constructed at Fort Ord.  
(The Webb Spinner 1952)

### Historical Overview of Fort Ord

The history of Fort Ord has been extensively documented in newspaper articles, websites, academic journals, and books. From its creation in 1917 to its closure in 1994, the base grew to become one of the largest training centers in the country. Its location was also reported to be the most attractive U.S. Army post, with easy access to the ocean and beautiful California weather.

The development periods in the history of Fort Ord were defined by Harold E. Raugh, Jr, a U.S. Army lieutenant colonel and historian with the Department of Defense. Since his

## CONTINUATION SHEET

Property Name: Harbor Hall  
Page 6 of 16

retirement, Raugh served as the Chief Historian, for the Defense Logistics Agency, for the Department of Defense and, from 2006-2013, Raugh served as the Command Historian at the Defense Language Institute Foreign Language Center (DLIFLC) and the Presidio of Monterey, California. He received his PhD in history from the University of California, Los Angeles (Walch 2004). Raugh has authored numerous books including, *Fort Ord* (2004); *Presidio of Monterey* (2004); *Operation Joint Endeavor: V Corps in Bosnia-Herzegovina, 1995-1996* (2013); *The Raugh Bibliography of the Indian Mutiny 1857-1859* (2016); and *Wavell in the Middle East, 1939-1941: A study in Generalship*. Raugh defined four periods for the historic development of Fort Ord:

- 1917-1940 Camp Gigling to Camp Ord
- 1940-1945 Fort Ord and the 7th Infantry Division
- 1946-1976 The Cold War and Vietnam Eras
- 1974-1994 The Volunteer Army

These periods correspond to distinct eras in the history of the base and the U.S. Army (Raugh 2004: ii). The following sections provide a summary overview of each of these periods of development and their relevance to the area of Fort Ord now known as the CSUMB campus.

The full historic context of Fort Ord is represented in the report, *Built Environment Inventory and Evaluation Report for California State University, Monterey Bay* (Dudek 2021). The following presents only relevant historical and building typology information pertaining to the development of Harbor Hall.

### **Cold War and Vietnam Eras at Fort Ord (1946-1976)**

This period of development between 1946 and 1976 was characterized by a massive operation to move the base out of its semi-permanent status and create a permanent outpost for active military personnel who were retained due to ongoing foreign conflicts.

In July of 1948, Harry S Truman signed Executive Order 9981, which officially ended segregation in the armed forces. The order stated that "there shall be equality of treatment and opportunity for all persons in the armed forces without regard to race, color, religion, or national origin" (National Archives Foundation 2021). Fort Ord became one of the first integrated training divisions in the United States. The Fort was touted as "pioneering to end all segregation" (The Pomona Progress Bulletin 1950: 4). In 1950, the *Pomona Progress Bulletin* reported that black and white soldiers at Fort Ord were "fighting side by side" and all the enlistees "trained together, slept in the same barracks, and eat the same messes" (The Pomona Progress Bulletin 1950: 4).

The end of World War II in 1945 did not bring lasting peace. The tenuous relationship between dominant nations in the communist East and free market West led to the beginning of the Cold War. The Department of Defense maintained a robust fighting force during the Cold War, with more than 900,000 Army personnel retained during the 1950s (ACHP 2006). The ongoing global tensions and the number of active U.S. military personnel created a need for new permanent buildings and expanded military housing at Fort Ord.

In 1949, the Soviet-supported communist government of North Korea invaded American-supported South Korea, initiating the Korean War. Fort Ord was a primary staging area for the training of troops departing for the war (Castle 1990:3). By the 1950s, Fort Ord had become one of the largest basic training camps in the United States. In 1952, the military began a multi-million dollar building program to transform Fort Ord into a

## CONTINUATION SHEET

Property Name: Harbor Hall  
Page 7 of 16

permanent post, including the development of permanent troop housing, and the construction of a guard house, stockade, and multiple warehouses. In January of 1952, military authorities announced the new construction program at Fort Ord was underway, with an estimated cost of \$26,650,600. More than half of the funds that were approved by Congress were "earmarked for new permanent troop housing" for more than 7,000 soldiers (The Webb Spinner 1952-54, Vol 6. No. 3:1).

The new troop housing was to be constructed of reinforced concrete, a departure from the wood buildings constructed before and during World War II. The plan called for three types of massive barracks, twenty-two were to house 225 enlisted men each, seven were to accommodate 165 men each, and nine were to house 105 men each (The Webb Spinner 1952-54, Vol 6. No. 3:3). The San Francisco District of the U.S. Army Corps of Engineers oversaw the construction project to completion. An additional \$1,349,700 was earmarked for the expansion of classroom and training facilities at Fort Ord, including a new battalion and regimental headquarters (The Californian 1952a:1 and The Californian 1952b:18). By March of 1952, another phase of the permanent army post transformation began with the construction of a guard house, stockade, warehouse, and other buildings (The Webb Spinner 1952-54, Vol 6. No. 3:1). This addition of permanent buildings continued into the late 1950s, when the Army requested \$124 million to replace all the wood World War II infrastructure at Fort Ord with concrete block and reinforced concrete (Madsen and Treffers 2019:6; San Francisco Examiner 1958:2-4). While many of the wood buildings remain today, this period saw the continuous addition of reinforced concrete permanent buildings across the Fort (Madsen and Treffers 2019:6).

Following the Korean War through the end of the conflict in Vietnam, Fort Ord served as an important training facility. In 1957, Fort Ord was designated as a U.S. Army Training Center for Infantry (Castle 1990: 4). The 7th Infantry Division was based at Fort Ord in 1975 (Cavanaugh 2000: 9). Fort Ord produced thousands of combat-ready troops during the conflict in Vietnam.

With the establishment of Fort Ord as a permanent Army base during this period, there was substantial building construction that led to the modernization of the base and its services. This development is closely related to the history of the current CSUMB campus. All the properties that are included as part of this built environment study were constructed during the Cold War and Vietnam Era period. Building development during this period was a substantial departure from the styles and materials used in the buildings constructed before World War II. Building during the period between 1946 and 1976 used reinforced concrete and concrete masonry unit (CMU). The buildings tended to be larger than those constructed in previous periods. Other development in this period included support service buildings and several types of medical buildings. Infrastructure was also improved at this time, with the introduction of paved streets and roadways, and the addition of several water tanks, water pumping plants, and warehouse buildings.

### **Harbor Hall, 1952-1954**

Harbor Hall (46) first appears on a 1956 aerial photograph of the site in the western half, of a group of eight other similarly laid out buildings. These buildings were originally designed as new permanent barracks that were part of a \$26,650,000 construction program awarded by the military in 1952. More than \$17 million of these funds were used to construct 38, new, three-story barracks. These larger barracks were planned to house entire companies and serve all their needs in one space, with mess halls, lounges, day rooms, orderly rooms, supply rooms, and issue rooms, as well as administrative space (the Californian 1952a).

The Del Webb Construction Company won the bid for the work at Fort Ord with a low bid of

## CONTINUATION SHEET

Property Name: Harbor Hall  
Page 8 of 16

\$12,614,832 (The Californian 1952b: 18). Groundbreaking for the project took place on February 19, 1952. The barracks were featured in Webb's newsletter, The Webb Spinner, in the June/July/August edition. The paper touted the new military dormitories as being "sleek" (The Webb Spinner 1954:6). The buildings were a departure from the "old, white-painted barracks" constructed 12 years earlier. The new barracks were erected of steel and concrete and features large glass areas. The concrete construction was lauded as both vermin- and fire-proof (The Webb Spinner 1954:6).

After Fort Ord closed in 1994, the buildings became part of the CSUMB campus. There are no notable changes to the footprint of Harbor Hall until sometime between 2016 and 2021, when the east multi-story wing was demolished.

### **Del Webb Construction Company**

The Del E. Webb Company was founded by Delbert Eugene Webb in Phoenix in 1928. The company grew to develop a diverse range of projects across the United States during and was known for large-scale commercial, residential, and institutional projects (Del Webb and Pulte Homes 2021:1). During World War II, the company won many military and Navy contracts for housing projects. They specialized in streamlining massive construction projects across undeveloped land.

After World War II, Webb transitioned into many emerging development markets. In the late 1940s, Webb constructed a casino/hotel in Las Vegas for Benjamin "Bugsy" Siegel. Del Webb went on to become the "largest gaming operator and private employer in Nevada" (Del Webb and Pulte Homes 2021:1). In January of 1960, the Del Webb Corporation opened a community in Phoenix, Arizona aptly named "Sun City". The community was known for its modestly priced housing and delivered a "highly desirable lifestyle." Del Webb went on to construct "Sun Cities" in Florida and Southern California (Del Webb and Pulte Homes 2021:1). The company continued to focus on gaming and commercial operations until 1987 when the decision was made to sell these interests and focus on the development of "master-planned, active adult communities" (Del Webb and Pulte Homes 2021:2). By January of 2000, the company had planned and constructed 13 Sun Cities communities, selling more than 80,000 homes. In July 2001, Del Webb Company merged with Pulte Homes Inc. to create the largest homebuilding company in the nation (Del Webb and Pulte Homes 2021:3).

Webb was the lead contractor for several prominent buildings, campuses, and institutions. These included Madison Square Garden in New York City from 1964-1968 (New York, NY) and the Los Angeles County Museum of Art in 1963-1964 (Los Angeles, CA). Several buildings constructed by the company are listed on the NRHP, including many components of the Williams Air Force Base in Arizona (two Ammo Bunkers, the Civil Engineering Maintenance Shop, the Demountable Hangar, the flagpole, the Housing Storage Supply Warehouse, and the Water Pump Station and Water Tower). Additionally, Webb was the contractor for the 1938 addition to the Arizona State Capital Building, Hunts Tomb, and the Phoenix Towers, all in Phoenix, AZ. All three buildings are all listed on the NRHP.

The Del Webb Construction Company received the contract to construct forty-two buildings at Fort Ord in February of 1952. This contract included the construction of the Hammerhead Buildings/Barracks, buildings for the regional headquarters, and regimental supplies buildings (The Web Spinner 1952-54, Vol 6. No. 3:1). The company was also awarded the contract in March of 1952 to construct a guardhouse, stockade, warehouse, and other buildings and a contract to construct the utilities, including fencing, paving, railroads, water systems, water supply and storage (including reservoirs, well houses, equipment, and a water booster pump station), gas distributing system, and sanitary and storm sewer instillations. (The Web Spinner 1952-54, Vol 6. No. 4:1; The Web Spinner 1952-54, Vol 6. No. 8:1).



**CONTINUATION SHEET**

Property Name: Harbor Hall  
 Page 9 of 16

**Fort Ord Building Typology and Character-Defining Features**

Four categories of building types were identified for the purposes of this study. These are the Support Services Buildings, Medical Buildings, Hammerhead Buildings/Barracks, and Recreational Buildings. The following presents a discussion of the Hammerhead Buildings/Barracks building typology, as Harbor Hall is classified in this category. This section provides a detailed account of the specific character-defining features of Fort Ord Cold War and Vietnam Era (1946-1976) Hammerhead Buildings/Barracks.

**Hammerhead Buildings/Barracks**

The Hammerhead Buildings/Barracks were constructed to house troops at Fort Ord as it was expanding from a semi-permanent instillation to a permanent base. In alignment with the typical planning, design, and materials of buildings constructed during this period of Fort Ord’s history, these buildings are constructed with reinforced concrete and CMU and feature flat roofs with multi-light windows with concrete sills.

Harbor Hall (46) first appears on a 1956 aerial photograph of the site on the western half of the base. It is part of a group of eight other similarly oriented buildings. No changes to the footprint were noted After Fort Ord closed in 1994, the buildings became part of the CSUMB campus. There were no notable changes to the footprint of the building until sometime between 2016 and 2018 when the east, multi-story wing was demolished on Harbor Hall.

The Hammerhead Buildings/Barracks originally exhibited the following specific character-defining features:

**Character-Defining Features: The Hammerhead Buildings/Barracks**

| Character Aspect       | Primary Character-Defining Features   | Character-Defining Features  |
|------------------------|---|--|
| Shape and Plan         | <ul style="list-style-type: none"> <li>• Hammerhead shape</li> <li>• Single story wing and multi-story wing</li> </ul>            | The overall shape and mass of the building are considered a primary character-defining feature of the Hammerhead Buildings/Barracks. The plan should include a multi-story wing.   |
| Roof                   | <ul style="list-style-type: none"> <li>• Flat roof</li> <li>• Wide eave overhangs</li> <li>• No exposed rafters</li> </ul>        | The Hammerhead Buildings/Barracks have flat roofs, with moderate eave overhangs.   |
| Openings               | <ul style="list-style-type: none"> <li>• Entrances on the first story</li> <li>• Multi-light windows</li> </ul>                   | Window openings are uniform in size and placement, windows are multi-light, and set into concrete openings. Replaced windows are not considered character-defining features as they fall outside the period of significance. |
| Exterior Ornamentation | <ul style="list-style-type: none"> <li>• Minimal exterior ornamentation</li> <li>• Glass windows used as ornamentation</li> </ul> | Hammerhead Buildings/Barracks were designed to be quickly constructed. They have little to no decorative ornamentation, with windows in ribbons being the only decorative element.   |

## CONTINUATION SHEET

Property Name: Harbor Hall  
Page 10 of 16

|           |  |   |
|-----------|--|---|
| Materials | <ul style="list-style-type: none"><li>• Mass-produced and cost-effective materials</li><li>• Concrete and CMU</li><li>• Reinforced concrete construction</li></ul> | Hammerhead Buildings/Barracks have simple, utilitarian designs. Buildings were constructed using mass-produced and cost-effective building materials that were readily available at the time of construction. For instance, buildings under the Hammerhead type were constructed with reinforced concrete and CMU and were minimally decorated. |
|-----------|--|---|

Alterations and demolitions over time have compromised the overall architectural integrity of this building type. The most common alterations observed for this building type include the following.

- Replacement windows
- ADA compliance measures such as ramps and doors
- HVAC systems and window units
- Infill of openings
- Interior renovations

### NRHP/CRHR Designation Criteria

In consideration of the project site's history and requisite integrity, Dudek recommends the property not eligible for listing in the NRHP and CRHR based on the following significance evaluation and in consideration of national and state eligibility criteria:

#### **Criterion A/1: That are associated with events that have made a significant contribution to the broad patterns of our history.**

Harbor Hall was constructed in 1952-1954 during the period defined as the Cold War and Vietnam Eras (1946-1976) at Ford Ord. While this building is of historic age and was constructed during this important period of development in Fort Ord's history, it no longer retains enough integrity to convey its significance. One of the most notable elements of integrity that is compromised is the integrity of setting. Significant demolition, changes to circulation patterns, introduction of new buildings, and changes in use all impact the campus's ability to convey significance from its time as an active Cold War and Vietnam Era military base. The loss of this overall integrity of setting adversely affects Harbor Hall, as individual buildings are no longer able to convey their collective history. Additionally, the subdivision of Fort Ord following its closure has also greatly impacted the integrity of feeling, association, and setting of the Cold War and Vietnam Era portions of the installation. In summary, Harbor Hall, is not able to convey its association with any extraordinary events or events occurring within the context of Cold War and Vietnam military barracks, the CSUMB Campus, or has an association with the broad patterns of history in Monterey County, the State of California, or the Nation. Therefore, the building is recommended not eligible under NRHP/CRHR Criterion A/1.

#### **Criterion B/2: That are associated with the lives of persons significant in our past.**

To be found eligible under B/2 the property must be directly tied to an important person and the place where that individual conducted or produced the work for which he or she is known. Archival research failed to indicate any historical associations with people

## CONTINUATION SHEET

Property Name: Harbor Hall  
Page 11 of 16

important to the nation's or state's past. Due to a lack of identified significant associations with important persons in history, Dudek recommends the building is not eligible under NRHP/CRHR Criterion B/2.

**Criterion C/3: That embody the distinctive characteristics of a type, period, or method of construction, or that represent the work of a master, or that possess high artistic values, or that represent a significant and distinguishable entity whose components may lack individual distinction.**

No original plans or designs for the c. 1952 Barracks were discovered during archival research. Newspaper articles from 1952, announced the contract was awarded to the Del Webb Company, of Phoenix, AZ (the Californian 1952a). The Webb Company was a notable building company that completed contracts for the government, commercial clients, and private individuals during its long period operation, beginning in 1929 and continuing to the present. The Webb Company designed many distinguished buildings including many that are listed on the NRHP. While Webb may be a master builder, Harbor Hall, was constructed during a period when the Webb company was completing many other large-scale projects, many at military bases. The company received many contracts during World War II to construct barracks and other military related buildings. The buildings at Fort Ord were common contracts for the company, and they had constructed buildings of this type at other bases.

Harbor Hall is a utilitarian building, with minimal detailing, and few stylistic features. Additionally, Harbor Hall, has undergone numerous, alterations, including changes to fenestration, materials, and the demolition of the east, multi-story wing. Originally the building housed an entire infantry of troops, the remaining portion of the building is currently used for classroom space. While the building is associated with a master builder, the Del Webb Construction Company, it is not one of their more notable works. Additionally, the building lacks high artistic value, and has undergone substantial alterations, including the demolition of more than half the building. For these reasons Harbor Hall is recommended not eligible under NRHP/CRHR Criterion C/3.

**Criterion D/4: That have yielded, or may be likely to yield, information important in prehistory or history.**

There is no evidence to suggest that this property has the potential to yield information important to state or local history. Therefore, Harbor Hall is recommended not eligible under NRHP/CRHR Criterion D/4.

### **California Historic Landmark Statement of Significance**

In consideration of Harbor Hall's history and requisite integrity, Dudek recommends the property not eligible for designation as a California Historic Landmark based on the following significance evaluation and in consideration of state eligibility criteria:

**The first, last, only, or most significant of its type in the state or within a large geographic region (Northern, Central, or Southern California).**

Harbor Hall was constructed between 1952-1954. The building, along with at least 38 other barracks, were constructed during the fort's transition to a permanent base during the Cold War and Vietnam Eras (1946-1976) at Ford Ord. The buildings were constructed during the fort's transition to a permanent base. The building is a utilitarian building type that lacks high style components to set it apart from other buildings constructed throughout the State of California in the 1950s. Harbor Hall was constructed by Del Webb Company, a company based in Phoenix Arizona. The building is a utilitarian building type that lacks high style components to set it apart from other buildings constructed throughout the State of California in the 1950s.

**Associated with an individual or group having a profound influence on the history of California.**

## CONTINUATION SHEET

Property Name: Harbor Hall  
Page 12 of 16

Harbor Hall was originally constructed to be one of Fort Ord's barracks, one of 38 such buildings to provide a housing for military personnel. The Del Webb Construction Company, a notable Phoenix, Arizona based company, was responsible for the construction of the building. While Harbor Hall is associated with a master builder with many known projects completed in California, this building is not one of the company's notable works. No other individuals are known to have influenced the construction or use of this building. Therefore, Dudek recommends Harbor Hall is not eligible for listing as a CHL under this criterion.

**A prototype of, or an outstanding example of, a period, style, architectural movement or construction or is one of the more notable works or the best surviving work in a region of a pioneer architect, designer or master builder.**

Harbor Hall is neither a prototype or an outstanding example of a period, style, or architectural movement. It is a typical example of a utilitarian design. The building was designed to serve a utilitarian purpose for the military at Fort Ord. There are no identifying features on Harbor Hall that would establish the connection to the notable work of the Del Webb Construction Company in the State of California. Additionally, Harbor Hall has been substantially altered and the large multi-story wing demolished making it unable to sufficiently convey its temporal period or its historic context. Therefore, the subject property is recommended not eligible for listing as a CHL under this criterion.

### Local Designation Criteria

Portions of the CSUMB campus are located within the boundaries of two cities, City of Seaside and the City of Marina, both of which evaluate historical resources in accordance with CEQA Guidelines. as presented above. The subject property, as discussed in the NRHP/CRHR/CHL criteria discussion above, does not rise to the necessary level of significance for local, state, or national designation. For these reasons, the subject property is recommended not eligible individually or as a component of a historic district under any of the NRHP/CRHR/CHL criteria.

Additionally, portions of the CSUMB campus are located in the County of Monterey and the campus is therefore subject to the regulations set forth in Chapter 18.25 of the Monterey County Code. The subject property, as discussed in the NRHP/CRHR/CHL criteria discussion above, does not rise to the necessary level of significance for state or national designation. For these same reasons, the subject property is also recommended not eligible individually or as a component of a historic district under any of the delineated County of Monterey review criteria categories that are addressed with the NRHP/CRHR/CHL criteria discussed above: A. Historical and Cultural Significance; B. Historic, Architectural, and Engineering Significance; or C. Community and Geographic Setting.

### Integrity Discussion

Harbor Hall was analyzed against the seven aspects of integrity: location, design, setting, materials, workmanship, feeling, and association. The building retains its integrity of location, as it has not been relocated. The building was designed with minimal elements reflecting an architectural style. Some of the features reflecting the original design, most notably the windows and the demolition of the multi-story wing, have been lost, and the overall integrity of design has been diminished. The integrity of setting has been diminished as with the change in use from its original use as barracks at Fort Ord to a classroom building for CSUMB. Therefore, the integrity of setting has been lost. Some of the original materials appear to be intact, but the demolition of the multi-story wing and changes to original fenestration has diminished the integrity of materials. The techniques used in the construction of Harbor Hall are still apparent, with the CMU construction and concrete, accordingly the building has retained some integrity of workmanship. The exterior of Harbor Hall no longer conveys its original

## CONTINUATION SHEET

Property Name: Harbor Hall

Page 13 of 16

use. Therefore, the integrity of feeling has been lost. As Harbor Hall does not possess historic significance, there is no historic association. The building does not possess adequate integrity to convey significance.

### Summary of Evaluation Findings

Harbor Hall retains a diminished level of historic integrity and lacks historical and architectural significance. Based on the significance evaluations presented above, Harbor Hall does not appear to meet the NRHP, CRHR, CHL or local designation criteria. Therefore, Harbor Hall is not considered a historical resource for purposes of CEQA.

## CONTINUATION SHEET

Property Name: Harbor Hall  
Page 14 of 16

### \*B12. References (continued):

- ACHP (Advisory Council on Historic Preservation). 2006. "Draft Program Comment Regarding Cold War Era Unaccompanied Personnel Housing." Federal Register: The Daily Journal of the United States Government. 12 April 2016. Accessed June 30, 2021 Available at: <https://www.federalregister.gov/documents/2006/04/12/06-3509/draft-program-comment-regarding-cold-war-era-unaccompanied-personnel-housing>
- Californian, The. 1940. "No More Camp Ord! It's Fort Ord Now! Stilwell in Command: Headquarters of General Located on Salinas Side." July 13, 1940. Salinas, California, pg. 1.
- Californian, The. 1951. Stadium Field House—Sixth Army Lets Ord Contract. March 20, 1951. P1. Accessed June 17, 2021. Available at: [Newspapers.com](http://Newspapers.com).
- Castle, Ted. 1990. "The March of Time." Fort Ord Panorama. September 21, 1990.
- Cavanaugh, Joe. 2000. *The Peace Dividend: Defense Conversion Through Higher Education*. The Leon Panetta Institute.
- Chamberlin Library. 2021. Fort Ord Working Papers. CSUMB Special Collections Box 6.42-01. Available at the Chamberlin Library, Seaside, California.
- CSUMB Facilities. 2021. Original As built and renovation architectural drawings on file with CSUMB facilities department. Accessed in person June 15-16, 2021.
- Del Webb and Pulte Homes 2021. Del Webb History. Accessed July 9, 2021. Available at: [http://media.corporate-ir.net/media\\_files/irol/14/147717/DelWebb/DelWebbHistory.pdf](http://media.corporate-ir.net/media_files/irol/14/147717/DelWebb/DelWebbHistory.pdf)
- DLIFLC (Defense Language Institute Foreign Language Center). 2021. Command History Program. Accessed in person on June 15, 2021 and accessed online database collection online July 2021. Available at: <https://adli.pastperfectonline.com/>
- EA Engineering. 1991. Draft Final Fort Ord, California Base wide Remedial Investigation Feasibility Study. Volume 1 Literature Review and Base Inventory Report. Accessed on July 13, 2021. Available at: <https://www.fortordcleanup.com/documents/search/>
- Fresno Bee, The. 1951a. "Army Spokesman Are Defending Building of Fort Ord Stadium." January 12, 1951. Page 13. Accessed June 17, 2021.
- Fresno Bee, The. 1951b. "Army Spokesman Are Defending Building of Fort Ord Stadium." February 4, 1951. Page 27. Accessed June 17, 2021. Available at: [Newspapers.com](http://Newspapers.com).
- Gates, S., & Williams, H. 1957. The Armed Forces. The Annals of the American Academy of Political and Social Science, 313, 99-104. Accessed June 17, 2021. <http://proxy.multcolib.org:2052/stable/1031762>

## CONTINUATION SHEET

Property Name: Harbor Hall  
Page 15 of 16

- MacGregor Jr., Morris J. 1981. *Integration of the Armed Forces, 1940-1965*. Center of Military History, United States Army: Washington, D.C.
- Madsen, Alexandra and Steven Treffers. 2019. *Historic Resources Evaluation Memorandum for Hammerhead Barracks at Fort Ord, Monterey County, California*. Prepared by Rincon Consultants, Inc for City of Seaside, Community and Economic Development Department. November 4, 2019. Accessed June 28, 2021.  
[https://www.ci.seaside.ca.us/DocumentCenter/View/10674/9\\_App-S---HRE-Memo](https://www.ci.seaside.ca.us/DocumentCenter/View/10674/9_App-S---HRE-Memo)
- Military Museum. 2016. "Historic California Posts, Camps, Stations, and Airfields: Fort Ord." Accessed on June 19, 2021. <http://www.militarymuseum.org/FtOrd.html>
- National Archives Foundation. 2021. Executive Order 9981. Accessed June 29, 2021. Available at: <https://www.archivesfoundation.org/documents/executive-order-9981-ending-segregation-armed-forces/>
- NETR (Nationwide Environmental Title Research LLC). 2021. Historic Aerial Photographs of 100 Campus Center, Seaside, CA 93955 dating from 1956, 1968, 1981, 1998, 2005, 2009, 2010, 2012, 2014, 2016, and 2018. Accessed June 10, 2021.  
<https://www.historicaerials.com/viewer>
- Panorama. 1990. "50 Years and Counting..." September 21, 1990, pg. 2.
- Panorama. n.d. "Ford Ord in World War II." Historic California Posts: Fort Ord. Accessed on June 19, 2021. <http://www.militarymuseum.org/FtOrd.html>
- Park, R. 2015. "Happy and Cheerful in This Fine Camp": Sports, Recreation, and the United States Army at Fort Ord and Camp Roberts, 1940 to 1945. *Journal of Sport History*, 42(1), 21-37. Accessed on June 18, 2021, from  
<https://www.jstor.org/stable/10.5406/jsporthistory.42.1.21>
- Pomona Progress Bulletin. 1950. War Solving Racial Problems. August 24, 1950. Page 4. Accessed June 29, 2021. Available at: [Newspapers.com](http://www.newspapers.com).
- Quartermaster Review, The. 1940. "Army Construction Underway at Camp Ord, California." Volume XX. No 3. November-December. On file at the Chamberlin Library, Ord Military Community.
- Raugh, Harold E. 2004. Fort Ord. Charleston, SC: Arcadia.
- Salinas Morning Post. 1940. "\$2,766,000 in Building Authorized—Ord Contracts Let." August 21, 1940. Salinas, CA. pg. 1.
- San Francisco Examiner. 1951. Fort Ord Will Get Stadium. San Francisco Page 4. · 3 Feb 1951. Pages 1 and 4 A Available on [www.Newspapers.com](http://www.newspapers.com). Accessed on Jun 11, 2021.
- San Francisco Examiner. 1958. Army Asks OK on \$124,000,000 for Fort Ord Buildings. San Francisco. Section 2. Page. 4. Available on [www.Newspapers.com](http://www.newspapers.com). Accessed July 18, 2021.

## CONTINUATION SHEET

Property Name: Harbor Hall

Page 16 of 16

Vasche, J. Burton. 1959. "The California State Colleges: Their History, Organization, Purposes, and Programs." in California

U.S. Army. 1977. Post Map Main Garrison Area. Fort Ord, California. Drawing number G-950. Accessed in person at the Chamberlain Library on June 15, 2021.

Walch, Bob. 2004. An Army Historian's Pictorial Take on Fort Ord. Monterey County NOW. Accessed July 12, 2021. Available at:  
[https://www.montereycountyweekly.com/news/local\\_news/an-army-historian-s-pictorial-take-on-fort-ord/article\\_6e8b0250-9c38-5ca4-a4a4-f93d42d65a11.html](https://www.montereycountyweekly.com/news/local_news/an-army-historian-s-pictorial-take-on-fort-ord/article_6e8b0250-9c38-5ca4-a4a4-f93d42d65a11.html)

Whaley, Derek. 2015. "East Monterey & Seaside." Santa Cruz Trains: Railroads of the Monterey Bay Area. July 20, 2015. Accessed online:  
<https://www.santacruztrains.com/2015/07/east-monterey-seaside.html>.

Webb Spinner, The. 1952-1954. Webb Spinner Volume for 1952-1954. Del Webb Sun Cities Museum Collection. Accessed June 30, 2021. Accessed at:  
<https://delwebbsuncitiesmuseum.org/newsletters-webb-spinners/>



State of California & The Resources Agency  
DEPARTMENT OF PARKS AND RECREATION  
**PRIMARY RECORD**

Primary #  
HRI #  
Trinomial  
NRHP Status Code 6Z

Other Listings  
Review Code

Reviewer

Date

Page 1 of 14 \*Resource Name or #: (Assigned by recorder) Green Hall

P1. Other Identifier: CSUMB Building 58

\*P2. Location:  Not for Publication  Unrestricted

\*a. County Monterey County and (P2c, P2e, and P2b or P2d. Attach a Location Map as necessary.)

\*b. USGS 7.5' Quad Marina, CA Date 1995 T 15S; R 2E; NE ¼ of SW ¼ of Sec 6; Mount Diablo B.M.

c. Address 4598 7<sup>th</sup> Avenue Seaside Zip 93955

d. UTM: (Give more than one for large and/or linear resources) Zone 10S, 608100 mE/ 4056957 mN

e. Other Locational Data: (e.g., parcel #, directions to resource, elevation, decimal degrees, etc., as appropriate)

Green Hall sits south of A Street, west of 7<sup>th</sup> Avenue.

\*P3a. Description: (Describe resource and its major elements. Include design, materials, condition, alterations, size, setting, and boundaries)

Green Hall (CSUMB Building 58) is a one-story utilitarian building with a rectangular floor plan and a concrete block structural system. The north-facing main elevation is symmetrical. It is covered by a moderately pitched side-gabled roof clad with composition shingles. The main entrance is located centrally and is flanked by two squared projections. The main entrance consists of a single metal-framed, half-glazed door topped with a transom. Secondary doors are located to the far east and west ends of the main elevation and appear to have been sealed off as doorknobs have been removed.

See Continuation Sheet

\*P3b. Resource Attributes: (List attributes and codes) HP15. Educational building/HP34 Military property

P5a. Photograph or Drawing (Photograph required for buildings, structures, and objects.)



\*P4. Resources Present:  Building  
 Structure  Object  Site  District   
Element of District  Other (Isolates, etc.)

P5b. Description of Photo: (view, date, accession #) north elevation, view to the southeast, Dudek (IMG 0566)

\*P6. Date Constructed/Age and Source:  Historic  Prehistoric  Both  
1953 (CSUMB Facilities)

\*P7. Owner and Address:

CSUMB  
100 Campus Center  
Seaside, CA. 93955

\*P8. Recorded by: (Name, affiliation, and address) Sarah Corder

Dudek  
725 Front St #400  
Santa Cruz, CA 95060

\*P9. Date Recorded: 6/14/2021

\*P10. Survey Type: (Describe)  
Intensive level

\*P11. Report Citation: (Cite survey report and other sources or enter none)

Dudek 2021. Built Environment Inventory and Evaluation Report for California State University, Monterey

\*Attachments:  NONE  Location Map  Continuation Sheet  Building, Structure, and Object Record

Archaeological Record  District Record  Linear Feature Record  Milling Station Record  Rock Art Record

Artifact Record  Photograph Record  Other (List): \_\_\_\_\_

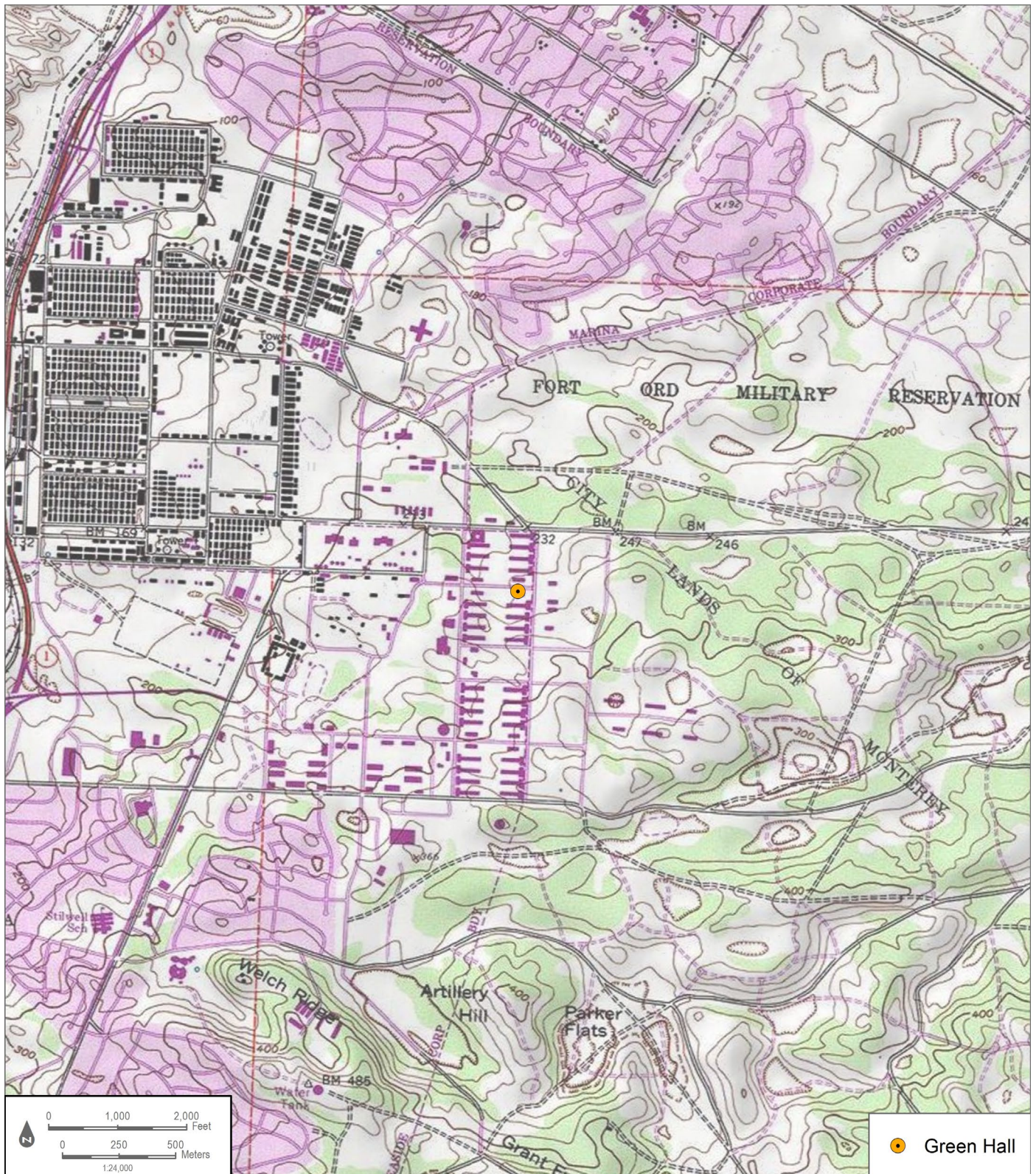

# BUILDING, STRUCTURE, AND OBJECT RECORD

\*Resource Name or # (Assigned by recorder) Green Hall \*NRHP Status Code 6Z  
Page 3 of 14

B1. Historic Name: Permanent Troop Spaces and Support Facilities Classroom  
B2. Common Name: Green Hall (CSUMB Building 58)  
B3. Original Use: Educational building 4. Present Use: Classroom

\*B5. Architectural Style: Utilitarian

\*B6. Construction History: (Construction date, alterations, and date of alterations)  
Designed in 1953 and completed in 1954, Green Hall has undergone several alterations. As-built drawings show alterations to the building took place in 1995. Changes include the replacement of original windows on the south elevation (CSUMB Facilities 2021).

\*B7. Moved?  No  Yes  Unknown Date: \_\_\_\_\_ Original Location: \_\_\_\_\_ \*B8. Related Features:

B9a. Architect: Robert Stanton b. Builder: Unknown

\*B10. Significance: Theme N/A Area N/A  
Period of Significance N/A Property Type N/A Applicable Criteria N/A

(Discuss importance in terms of historical or architectural context as defined by theme, period, and geographic scope. Also address integrity.)

See Continuation Sheet.

B11. Additional Resource Attributes: (List attributes and codes) \_\_\_\_\_

\*B12. References: See Continuation Sheet.

B13. Remarks:

\*B14. Evaluator: Laura Carias, MA

\*Date of Evaluation: July 20, 2021

(This space reserved for official comments.)

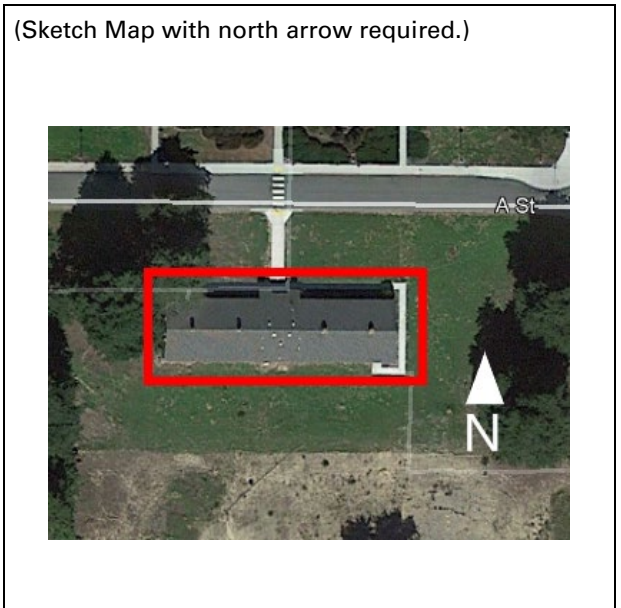

## CONTINUATION SHEET

Property Name: Green Hall

Page 4 of 14

**\*P3a. Description (continued):**

Windows are metal-framed, multi-light awning windows. A single column of cinderblocks is located between every other window on the main and rear south elevation. The fenestration pattern is repeated on the rear elevation. Two central windows have been replaced with recently added windows. Alterations include the sealing doors shut and replacement windows at the rear elevation.



Figure 1. Main (north) elevation, looking southeast (IMG\_0566)



Figure 2. South elevation, looking northwest (IMG\_0576)

**Alterations:**

- Replacement windows at rear elevation (1995)
- Replacement Roof (2005)

## CONTINUATION SHEET

Property Name: Green Hall

Page 5 of 14

### \*B10. Significance (continued):

#### Historical Overview of Fort Ord

The history of Fort Ord has been extensively documented in newspaper articles, websites, academic journals, and books. From its creation in 1917 to its closure in 1994, the base grew to become one of the largest training centers in the country. Its location was also reported to be the most attractive U.S. Army post, with easy access to the ocean and beautiful California weather.

The development periods in the history of Fort Ord were defined by Harold E. Raugh, Jr, a U.S. Army lieutenant colonel and historian with the Department of Defense. Since his retirement, Raugh served as the Chief Historian, for the Defense Logistics Agency, for the Department of Defense and, from 2006-2013, Raugh served as the Command Historian at the Defense Language Institute Foreign Language Center (DLIFLC) and the Presidio of Monterey, California. He received his PhD in history from the University of California, Los Angeles (Walch 2004). Raugh has authored numerous books including, *Fort Ord* (2004); *Presidio of Monterey* (2004); *Operation Joint Endeavor: V Corps in Bosnia-Herzegovina, 1995-1996* (2013); *The Raugh Bibliography of the Indian Mutiny 1857-1859* (2016); and *Wavell in the Middle East, 1939-1941: A study in Generalship*. Raugh defined four periods for the historic development of Fort Ord:

- 1917-1940 Camp Gigling to Camp Ord
- 1940-1945 Fort Ord and the 7th Infantry Division
- 1946-1976 The Cold War and Vietnam Eras
- 1974-1994 The Volunteer Army

These periods correspond to distinct eras in the history of the base and the U.S. Army (Raugh 2004: ii).

The full historic context of Fort Ord is represented in the report, *Built Environment Inventory and Evaluation Report for California State University, Monterey Bay* (Dudek 2021). The following presents only relevant historical and building typology information pertaining to the development of Green Hall.

#### Cold War and Vietnam Eras at Fort Ord (1946-1976)

This period of development between 1946 and 1976 was characterized by a massive operation to move the base out of its semi-permanent status and create a permanent outpost for active military personnel who were retained due to ongoing foreign conflicts.

In July of 1948, Harry S Truman signed Executive Order 9981, which officially ended segregation in the armed forces. The order stated that "there shall be equality of treatment and opportunity for all persons in the armed forces without regard to race, color, religion, or national origin" (National Archives Foundation 2021). Fort Ord became one of the first integrated training divisions in the United States. The Fort was touted as "pioneering to end all segregation" (The Pomona Progress Bulletin 1950: 4). In 1950, the Pomona Progress Bulletin reported that black and white soldiers at Fort Ord were "fighting side by side" and all the enlistees "trained together, slept in the same barracks, and eat the same messes" (The Pomona Progress Bulletin 1950: 4).

The end of World War II in 1945 did not bring lasting peace. The tenuous relationship between dominant nations in the communist East and free market West led to the beginning of the Cold War. The Department of Defense maintained a robust fighting force during the Cold War, with more than 900,000 Army personnel retained during the 1950s (ACHP 2006). The

## CONTINUATION SHEET

Property Name: Green Hall

Page 6 of 14

ongoing global tensions and the number of active U.S. military personnel created a need for new permanent buildings and expanded military housing at Fort Ord.

In 1949, the Soviet-supported communist government of North Korea invaded American-supported South Korea, initiating the Korean War. Fort Ord was a primary staging area for the training of troops departing for the war (Castle 1990:3). By the 1950s, Fort Ord had become one of the largest basic training camps in the United States. In 1952, the military began a multi-million dollar building program to transform Fort Ord into a permanent post, including the development of permanent troop housing, and the construction of a guard house, stockade, and multiple warehouses. In January of 1952, military authorities announced the new construction program at Fort Ord was underway, with an estimated cost of \$26,650,600. More than half of the funds that were approved by Congress were "earmarked for new permanent troop housing" for more than 7,000 soldiers (The Webb Spinner 1952-54, Vol 6. No. 3:1).

The new troop housing was to be constructed of reinforced concrete, a departure from the wood buildings constructed before and during World War II. The plan called for three types of massive barracks, twenty-two were to house 225 enlisted men each, seven were to accommodate 165 men each, and nine were to house 105 men each (The Webb Spinner 1952-54, Vol 6. No. 3:3). The San Francisco District of the U.S. Army Corps of Engineers oversaw the construction project to completion. An additional \$1,349,700 was earmarked for the expansion of classroom and training facilities at Fort Ord, including a new battalion and regimental headquarters (The Californian 1952a:1 and The Californian 1952b:18). By March of 1952, another phase of the permanent army post transformation began with the construction of a guard house, stockade, warehouse, and other buildings (The Webb Spinner 1952-54, Vol 6. No. 3:1). This addition of permanent buildings continued into the late 1950s, when the Army requested \$124 million to replace all the wood World War II infrastructure at Fort Ord with concrete block and reinforced concrete (Madsen and Treffers 2019:6; San Francisco Examiner 1958:2-4). While many of the wood buildings remain today, this period saw the continuous addition of reinforced concrete permanent buildings across the Fort (Madsen and Treffers 2019:6).

Following the Korean War through the end of the conflict in Vietnam, Fort Ord served as an important training facility. In 1957, Fort Ord was designated as a U.S. Army Training Center for Infantry (Castle 1990: 4). The 7th Infantry Division was based at Fort Ord in 1975 (Cavanaugh 2000: 9). Fort Ord produced thousands of combat-ready troops during the conflict in Vietnam.

With the establishment of Fort Ord as a permanent Army base during this period, there was substantial building construction that led to the modernization of the base and its services. This development is closely related to the history of the current CSUMB campus. All the properties that are included as part of this built environment study were constructed during the Cold War and Vietnam Era period. Building development during this period was a substantial departure from the styles and materials used in the buildings constructed before World War II. Building during the period between 1946 and 1976 used reinforced concrete and concrete masonry unit (CMU). The buildings tended to be larger than those constructed in previous periods. Other development in this period included support service buildings and several types of medical buildings. Infrastructure was also improved at this time, with the introduction of paved streets and roadways, and the addition of several water tanks, water pumping plants, and warehouse buildings.

### **Green Hall, 1954**

Constructed in 1954, Green Hall (58) was designed by Robert Stanton, Monterey Bay architect (CSUMB Facilities 2021). It was one of several identical buildings described as "permanent troop spaces and supporting facilities/classrooms" designed for Fort Ord (CSUMB Facilities 2021). It first appears on a 1956 aerial photograph as a long, rectangular plan, gable-ended building on the south side of A Street (UCSB 2021). The

## CONTINUATION SHEET

Property Name: Green Hall

Page 7 of 14

entrance faces north to A Street and is accessed by a formal path from the A Street sidewalk. It is surrounded on all sides by lawn. Replacement windows were installed during a 1995 renovation. The roof was replaced in 2005.

### Robert Stanton

Robert Stanton was born in Detroit, Michigan in 1900. He served briefly in the U.S. Navy during World War I and then graduated from high school in Los Angeles and went on to complete his education at University of California at Berkeley. After graduation he worked with renowned architect, Wallace Neff. Neff appointed Stanton as project supervisor on several projects and Stanton earned his architecture license in 1934. Stanton moved to Monterey Bay in 1935 and went on to design a variety of residential, commercial, and public buildings in the area. Two of his buildings, the Monterey County Courthouse and the King City High School Auditorium have been listed on the NRHP (Hiller 2007:8-4). Robert Stanton was known to have designed a plan for classroom buildings at Fort Ord that was used for at least four buildings on campus (CSUMB Facilities 2021).

### Fort Ord Building Typology and Character-Defining Features

Four categories of building types were identified for the purposes of this study. These are the Support Services Buildings, Medical Buildings, Hammerhead Buildings/Barracks, and Recreational Buildings. The following presents a discussion of the Support Services building typology, as Green Hall (58) is classified in this category. This section provides a detailed account of the specific character-defining features of Fort Ord Cold War and Vietnam Era (1946-1976) Support Services buildings.

### Support Services Buildings

Support Services Buildings constructed during the Cold War and Vietnam Eras (1946-1976) at Fort Ord have a variety of uses and functions that changed over the history of the base. The buildings tended to have central entryways that opened into hallways, with classrooms lining the halls. In alignment with the typical planning, design, and materials of buildings from this period of Fort Ord's history, these buildings are constructed with reinforced concrete and CMU and feature gable roofs with multi-light windows with concrete sills. These buildings have a uniform design, like many of the other buildings at Fort Ord.

After Fort Ord closed in 1994, these support services buildings became part of the CSUMB campus. With the shift to campus use, many of the buildings were altered to fit the needs of CSUMB. No changes to the plan of Green Hall were noted.

### Character-Defining Features for the Support Services Buildings

The Support Services Buildings originally exhibited the following specific character-defining features:

#### Character-Defining Features: Fort Ord Support Services Buildings

| Character Aspect | Primary Character-Defining Features  | Character-defining features   |
|------------------|--|---|
| Shape and Plan   | <ul style="list-style-type: none"><li>Simple rectangular form</li><li>Single story</li></ul> | The overall shape and mass of the building are considered a primary character-defining feature of the support services buildings. The plan should be rectangular in form. |

**CONTINUATION SHEET**

Property Name: Green Hall

Page 8 of 14

|                        |  |  |
|------------------------|--|--|
| Roof                   | <ul style="list-style-type: none"> <li>Flat or gable roof</li> <li>small eave overhangs</li> <li>No exposed rafters</li> </ul>                                   | Support service buildings from this period have gable roof forms, with slight eave overhangs.  |
| Openings               | <ul style="list-style-type: none"> <li>Public entrances and circulation patterns</li> </ul>  | Window openings are generally uniform in size and placement, windows are multi-light, and set into concrete openings. Replaced windows are not considered character-defining features as they fall outside the period of significance.   |
| Exterior Ornamentation | <ul style="list-style-type: none"> <li>Minimal exterior ornamentation</li> </ul>   | The support services buildings were designed to be quickly constructed. They have little to no decorative ornamentation, with windows being set evenly apart and CMU pillars being the only decorative element.  |
| Materials              | <ul style="list-style-type: none"> <li>Mass-produced and cost-effective materials</li> <li>Concrete and CMU</li> <li>Reinforced Concrete construction</li> </ul> | The support services buildings have simple, utilitarian designs. Buildings were constructed using mass-produced and cost-effective building materials that were readily available at the time of construction. For instance, buildings under the support services buildings type were constructed with reinforced concrete and CMU and were minimally decorated. |

Alterations and demolitions over time have compromised the overall architectural integrity of this building type. The most common alterations observed for this building type include the following.

- Replacement windows
- ADA compliance measures such as ramps and doors
- HVAC systems and window units
- Infill of openings
- Addition of front gable over doorways
- Interior renovations

**NRHP/CRHR Designation Criteria**

In consideration of the project site's history and requisite integrity, Dudek recommends the building not eligible for listing in the NRHP and CRHR based on the following significance evaluation and in consideration of national and state eligibility criteria:

**Criterion A/1: That are associated with events that have made a significant contribution to the broad patterns of our history.**

Green Hall was constructed in 1951 during the period defined as the Cold War and Vietnam Eras (1946-1976) at Ford Ord. While this building is of historic age and was constructed during an important period of development in Fort Ord's history, it no longer retains enough integrity to convey its significance. One of the most notable elements of integrity that is compromised is the integrity of setting. Significant demolition, changes to circulation patterns, introduction of new buildings, and changes in use, all impact the campus's ability to convey significance from its time as an active Cold War and Vietnam Era military base. The loss of this overall integrity of setting adversely effects Green



## CONTINUATION SHEET

Property Name: Green Hall

Page 9 of 14

Hall, as individual buildings are no longer able to convey their collective history. Additionally, the subdivision of Fort Ord following its closure has also greatly impacted the integrity of feeling, association, and setting of the remaining Cold War and Vietnam Era buildings. Green Hall is not able to convey its association with any extraordinary events or events occurring within the context of Cold War and Vietnam military support service buildings, the CSUMB Campus, or has an association with the broad patterns of history in Monterey County, the State of California, or the Nation. Therefore, the building is recommended not eligible under NRHP/CRHR Criterion A/1.

**Criterion B/2: That are associated with the lives of persons significant in our past.**

To be found eligible under B/2 the building must be directly tied to an important person and the place where that individual conducted or produced the work for which he or she is known. Archival research found no significant or influential directly associated with the building. As such this building is not known to have any historical associations with people important to the nation's or state's past. Due to a lack of identified significant associations with important persons in history, Dudek recommends the building is not eligible under NRHP/CRHR Criterion B/2.

**Criterion C/3: That embody the distinctive characteristics of a type, period, or method of construction, or that represent the work of a master, or that possess high artistic values, or that represent a significant and distinguishable entity whose components may lack individual distinction.**

Archival research indicates that Green Hall was constructed in 1954 as one of several classroom/support buildings for Fort Ord. Although designed by architect, Robert Stanton, the building was not constructed in any obvious architectural style. The building is a ubiquitous building type that lacks high style components to set it apart from other buildings constructed in the 1950s. No further information on Stanton was identified during archival research. The building has been altered with the replacement of many of the original windows. Due to a lack of high artistic value, a lack of evidence suggesting this is a notable work of the Robert Stanton Firm, Dudek recommends the building is not eligible under NRHP/CRHR Criterion C/3.

**Criterion D/4: That have yielded, or may be likely to yield, information important in prehistory or history.**

There is no evidence to suggest that Green Hall has the potential to yield information important to state or local history. Therefore, Dudek recommends the building is not eligible under NRHP/CRHR Criterion D/4.

**California Historic Landmark Statement of Significance**

In consideration of Green Hall's history and requisite integrity, Dudek recommends the building not eligible for designation as a California Historic Landmark based on the following significance evaluation and in consideration of state eligibility criteria:

**The first, last, only, or most significant of its type in the state or within a large geographic region (Northern, Central, or Southern California).**

Green Hall was designed in 1953 and constructed in 1954. The building was constructed during the Cold War and Vietnam Eras (1946-1976) at Fort Ord. Green Hall was designed by Robert Stanton. The building is a ubiquitous building type that lacks high style components to set it apart from other utilitarian buildings constructed throughout the State of California in the 1950s. Therefore, Dudek recommends the building is not eligible for listing as a CHL under this criterion.

## CONTINUATION SHEET

Property Name: Green Hall

Page 10 of 14

**Associated with an individual or group having a profound influence on the history of California.**

Archival research failed to indicate any significant associations between the Green Hall and individuals or groups that profoundly influenced the history of California. Green Hall was one of several support/classroom buildings constructed on site. Robert Stanton was found to be the architect responsible for the design, but the utilitarian building does not reflect a remarkable design of his. No other individuals are known to have influenced the construction or use of this building. Therefore, Dudek recommends the building is not eligible for listing as a CHL under this criterion.

**A prototype of, or an outstanding example of, a period, style, architectural movement or construction or is one of the more notable works or the best surviving work in a region of a pioneer architect, designer or master builder.**

Green Hall is neither a prototype or an outstanding example of a period, style, or architectural movement. The building was designed to serve a utilitarian purpose. There are no identifying features on Green Hall that would establish the building as a notable work of a master architect, or a notable designer or builder working within the military, or in the State of California. Therefore, Dudek recommends the building is not eligible for listing as a CHL under this criterion.

**Local Designation Criteria**

Portions of the CSUMB campus are located within the boundaries of two cities, City of Seaside and the City of Marina, both of which evaluate historical resources in accordance with CEQA Guidelines. as presented above. The subject property, as discussed in the NRHP/CRHR/CHL criteria discussion above, does not rise to the necessary level of significance for local, state, or national designation. For these reasons, the subject property is recommended not eligible individually or as a component of a historic district under any of the NRHP/CRHR/CHL criteria.

Additionally, portions of the CSUMB campus are also located in the County of Monterey and it is therefore subject to the regulations set forth in Chapter 18.25 of the Monterey County Code. The subject property, as discussed in the NRHP/CRHR/CHL criteria discussion above, does not rise to the necessary level of significance for state or national designation. For these same reasons, the subject property is also recommended not eligible individually or as a component of a historic district under any of the delineated County of Monterey review criteria categories that are addressed with the NRHP/CRHR/CHL criteria discussed above: A. Historical and Cultural Significance; B. Historic, Architectural, and Engineering Significance; or C. Community and Geographic Setting.

**Integrity Discussion**

Green Hall was analyzed against the seven aspects of integrity: location, design, setting, materials, workmanship, feeling, and association. The building retains its integrity of location, as it has not been relocated. However, the integrity of setting has been compromised with the demolition of adjacent buildings, new constructions, and changes in paths of circulation throughout the campus. This change of use, from a Cold War and Vietnam Era military support services building to a classroom building for CSUMB adversely effects the integrity of setting. A few windows have been replaced and a door closed off since its completion in 1954. These alterations have compromised the resource's integrity of design, materials, and workmanship. As a result, the integrity of feeling is not intact, as the building is unable to convey the feeling of a 1950s military support services building. As the building does not possess historic significance, there is no historic association. While the building is in good condition, it does not possess integrity to convey significance or its temporal period.

## CONTINUATION SHEET

Property Name: Green Hall

Page 11 of 14

### Summary of Evaluation Findings

Green Hall retains little historic integrity and lacks historical and architectural significance. Based on the significance evaluations presented above, Green Hall does not appear to meet the NRHP, CRHR, CHL or local designation criteria. Therefore, Green Hall is not considered a historical resource for purposes of CEQA.

## CONTINUATION SHEET

Property Name: Green Hall

Page 12 of 14

### \*B12. References (continued):

ACHP (Advisory Council on Historic Preservation). 2006. "Draft Program Comment Regarding Cold War Era Unaccompanied Personnel Housing." Federal Register: The Daily Journal of the United States Government. 12 April 2016. Accessed June 30, 2021 Available at: <https://www.federalregister.gov/documents/2006/04/12/06-3509/draft-program-comment-regarding-cold-war-era-unaccompanied-personnel-housing>

Californian, The. 1940. "No More Camp Ord! It's Fort Ord Now! Stilwell in Command: Headquarters of General Located on Salinas Side." July 13, 1940. Salinas, California, pg. 1.

Californian, The. 1951. Stadium Field House—Sixth Army Lets Ord Contract. March 20, 1951. P1. Accessed June 17, 2021. Available at: [Newspapers.com](http://Newspapers.com).

Castle, Ted. 1990. "The March of Time." Fort Ord Panorama. September 21, 1990.

Cavanaugh, Joe. 2000. *The Peace Dividend: Defense Conversion Through Higher Education*. The Leon Panetta Institute.

Chamberlin Library. 2021. Fort Ord Working Papers. CSUMB Special Collections Box 6.42-01. Available at the Chamberlin Library, Seaside, California.

CSUMB Facilities. 2021. Original As built and renovation architectural drawings on file with CSUMB facilities department. Accessed in person June 15-16, 2021.

DLIFLC (Defense Language Institute Foreign Language Center). 2021. Command History Program. Accessed in person on June 15, 2021 and accessed online database collection online July 2021. Available at: <https://adli.pastperfectonline.com/>

EA Engineering. 1991. Draft Final Fort Ord, California Base wide Remedial Investigation Feasibility Study. Volume 1 Literature Review and Base Inventory Report. Accessed on July 13, 2021. Available at: <https://www.fortordcleanup.com/documents/search/>

Fresno Bee, The. 1951a. "Army Spokesman Are Defending Building of Fort Ord Stadium." January 12, 1951. Page 13. Accessed June 17, 2021.

Fresno Bee, The. 1951b. "Army Spokesman Are Defending Building of Fort Ord Stadium." February 4, 1951. Page 27. Accessed June 17, 2021. Available at: [Newspapers.com](http://Newspapers.com).

Gates, S., & Williams, H. 1957. The Armed Forces. The Annals of the American Academy of Political and Social Science, 313, 99-104. Accessed June 17, 2021. <http://proxy.multcolib.org:2052/stable/1031762>

Hiller, Peter. 2007. NRHP Nomination Form. Monterey County Court House. National Parks Service. Accessed July 18, 2021. Available at: [https://npgallery.nps.gov/NRHP/GetAsset/NRHP/08000878\\_text](https://npgallery.nps.gov/NRHP/GetAsset/NRHP/08000878_text)

## CONTINUATION SHEET

Property Name: Green Hall

Page 13 of 14

- MacGregor Jr., Morris J. 1981. *Integration of the Armed Forces, 1940-1965*. Center of Military History, United States Army: Washington, D.C.
- Madsen, Alexandra and Steven Treffers. 2019. *Historic Resources Evaluation Memorandum for Hammerhead Barracks at Fort Ord, Monterey County, California*. Prepared by Rincon Consultants, Inc for City of Seaside, Community and Economic Development Department. November 4, 2019. Accessed June 28, 2021.  
[https://www.ci.seaside.ca.us/DocumentCenter/View/10674/9\\_App-S---HRE-Memo](https://www.ci.seaside.ca.us/DocumentCenter/View/10674/9_App-S---HRE-Memo)
- Military Museum. 2016. "Historic California Posts, Camps, Stations, and Airfields: Fort Ord." Accessed on June 19, 2021. <http://www.militarymuseum.org/FtOrd.html>
- National Archives Foundation. 2021. Executive Order 9981. Accessed June 29, 2021. Available at: <https://www.archivesfoundation.org/documents/executive-order-9981-ending-segregation-armed-forces/>
- NETR (Nationwide Environmental Title Research LLC). 2021. Historic Aerial Photographs of 100 Campus Center, Seaside, CA 93955 dating from 1956, 1968, 1981, 1998, 2005, 2009, 2010, 2012, 2014, 2016, and 2018. Accessed June 10, 2021.  
<https://www.historicaerials.com/viewer>
- Panorama. 1990. "50 Years and Counting..." September 21, 1990, pg. 2.
- Panorama. n.d. "Ford Ord in World War II." Historic California Posts: Fort Ord. Accessed on June 19, 2021. <http://www.militarymuseum.org/FtOrd.html>
- Park, R. 2015. "Happy and Cheerful in This Fine Camp": Sports, Recreation, and the United States Army at Fort Ord and Camp Roberts, 1940 to 1945. *Journal of Sport History*, 42(1), 21-37. Accessed on June 18, 2021, from  
<https://www.jstor.org/stable/10.5406/jsporthistory.42.1.21>
- Pomona Progress Bulletin. 1950. War Solving Racial Problems. August 24, 1950. Page 4. Accessed June 29, 2021. Available at: [Newspapers.com](http://www.newspapers.com).
- Quartermaster Review, The. 1940. "Army Construction Underway at Camp Ord, California." Volume XX. No 3. November-December. On file at the Chamberlin Library, Ord Military Community.
- Raugh, Harold E. 2004. Fort Ord. Charleston, SC: Arcadia.
- Salinas Morning Post. 1940. "\$2,766,000 in Building Authorized—Ord Contracts Let." August 21, 1940. Salinas, CA. pg. 1.
- San Francisco Examiner. 1951. Fort Ord Will Get Stadium. San Francisco Page 4. · 3 Feb 1951. Pages 1 and 4 A Available on [www.Newspapers.com](http://www.newspapers.com). Accessed on Jun 11, 2021.
- San Francisco Examiner. 1958. Army Asks OK on \$124,000,000 for Fort Ord Buildings. San Francisco. Section 2. Page. 4. Available on [www.Newspapers.com](http://www.newspapers.com). Accessed July 18, 2021.

## CONTINUATION SHEET

Property Name: Green Hall

Page 14 of 14

Vasche, J. Burton. 1959. "The California State Colleges: Their History, Organization, Purposes, and Programs." in California

U.S. Army. 1977. Post Map Main Garrison Area. Fort Ord, California. Drawing number G-950. Accessed in person at the Chamberlain Library on June 15, 2021.

Walch, Bob. 2004. An Army Historian's Pictorial Take on Fort Ord. Monterey County NOW. Accessed July 12, 2021. Available at:  
[https://www.montereycountyweekly.com/news/local\\_news/an-army-historian-s-pictorial-take-on-fort-ord/article\\_6e8b0250-9c38-5ca4-a4a4-f93d42d65a11.html](https://www.montereycountyweekly.com/news/local_news/an-army-historian-s-pictorial-take-on-fort-ord/article_6e8b0250-9c38-5ca4-a4a4-f93d42d65a11.html)

Whaley, Derek. 2015. "East Monterey & Seaside." Santa Cruz Trains: Railroads of the Monterey Bay Area. July 20, 2015. Accessed online:  
<https://www.santacruztrains.com/2015/07/east-monterey-seaside.html>.

Webb Spinner, The. 1952-1954. Webb Spinner Volume for 1952-1954. Del Webb Sun Cities Museum Collection. Accessed June 30, 2021. Accessed at:  
<https://delwebbsuncitiesmuseum.org/newsletters-webb-spinners/>

State of California & The Resources Agency  
DEPARTMENT OF PARKS AND RECREATION  
**PRIMARY RECORD**

Primary #  
HRI #  
Trinomial  
NRHP Status Code 6Z

Other Listings  
Review Code

Reviewer

Date

Page 1 of 15 \*Resource Name or #: (Assigned by recorder) Reading Center

P1. Other Identifier: CSUMB Building 59

\*P2. Location:  Not for Publication  Unrestricted

\*a. County Monterey County and (P2c, P2e, and P2b or P2d. Attach a Location Map as necessary.)

\*b. USGS 7.5' Quad Marina, CA Date 1995 T 15S; R 2E; NE  $\frac{1}{4}$   of SW  $\frac{1}{4}$   of Sec 6; Mount Diablo B.M.

c. Address 4790 7<sup>th</sup> Avenue Seaside Zip 93955

d. UTM: (Give more than one for large and/or linear resources) Zone 10S, 608102 mE/ 4057011 mN

e. Other Locational Data: (e.g., parcel #, directions to resource, elevation, decimal degrees, etc., as appropriate)

The Reading Center sits north of A Street, west of 7<sup>th</sup> Avenue.

\*P3a. Description: (Describe resource and its major elements. Include design, materials, condition, alterations, size, setting, and boundaries)

The Reading Center (CSUMB Building 59) is a one-story utilitarian building with a rectangular floor plan and a concrete block structural system. The south-facing main elevation is symmetrical. It is covered by a moderately pitched side-gabled roof clad with composition shingles. The main entrance is located centrally and is flanked by two squared projections. The main entrance consists of recently added metal-framed double doors with sidelights and transom window.

See Continuation Sheet

\*P3b. Resource Attributes: (List attributes and codes) HP15. Educational building/HP34 Military property

P5a. Photograph or Drawing (Photograph required for buildings, structures, and objects.)



\*P4. Resources Present:  Building  
 Structure  Object  Site  District   
Element of District  Other (Isolates, etc.)

P5b. Description of Photo: (view, date, accession #) south elevation, view looking north, Dudek (IMG 0581)

\*P6. Date Constructed/Age and Source:  Historic  Prehistoric  Both  
1953 (CSUMB Facilities)

\*P7. Owner and Address:  
CSUMB, 100 Campus Center, Seaside, CA. 93955

\*P8. Recorded by: (Name, affiliation, and address) Sarah Corder  
Dudek  
725 Front St #400  
Santa Cruz, CA 95060

\*P9. Date Recorded: 6/14/2021

\*P10. Survey Type: (Describe)  
Intensive level

\*P11. Report Citation: (Cite survey report and other sources or enter none) Dudek 2021. Built Environment Inventory and Evaluation Report for California State University, Monterey

\*Attachments:  NONE  Location Map  Continuation Sheet  Building, Structure, and Object Record

Archaeological Record  District Record  Linear Feature Record  Milling Station Record  Rock Art Record

Artifact Record  Photograph Record  Other (List): \_\_\_\_\_

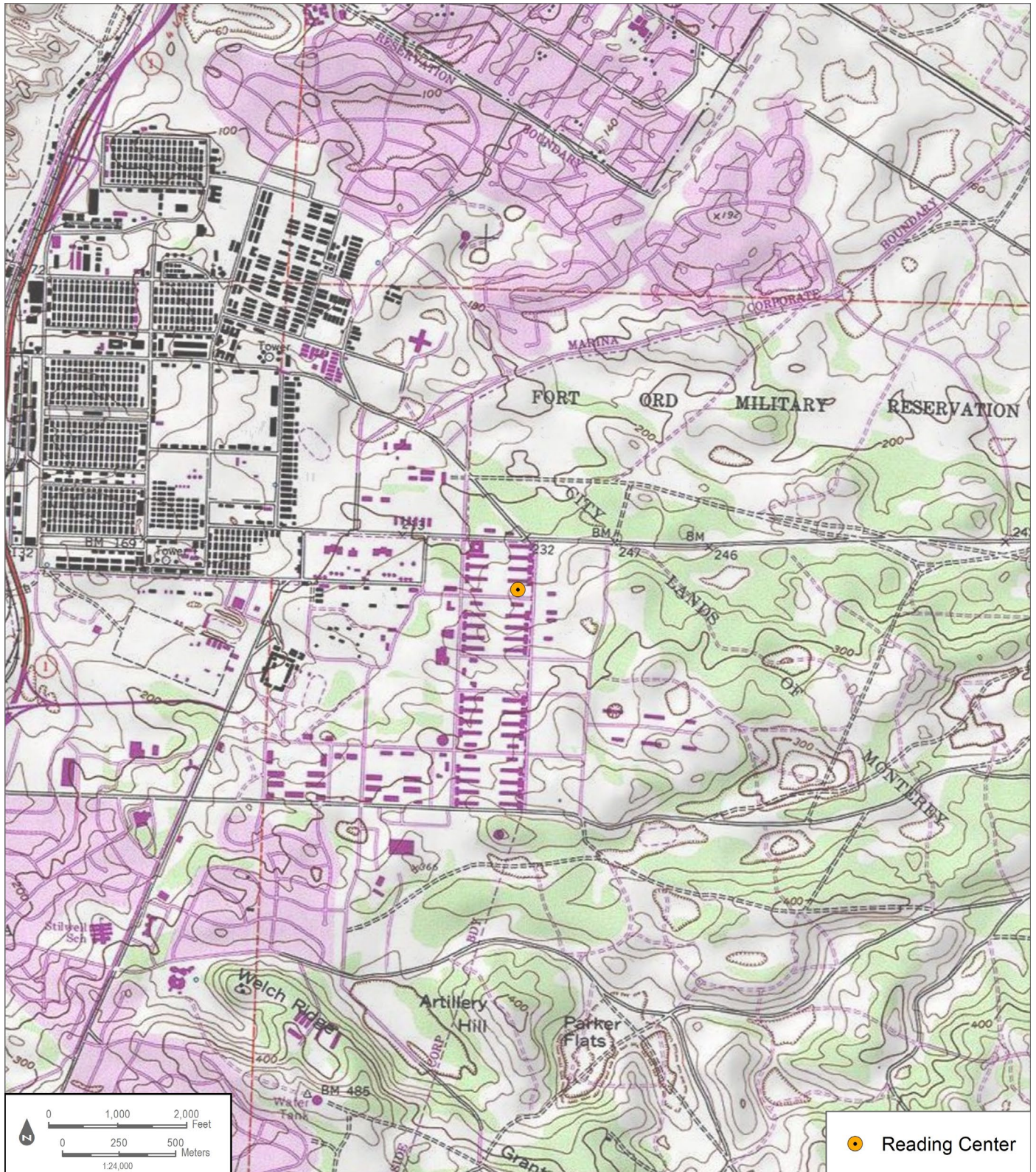



# BUILDING, STRUCTURE, AND OBJECT RECORD

\*Resource Name or # (Assigned by recorder) Reading Center \*NRHP Status Code 6Z  
Page 3 of 15

B1. Historic Name: Permanent Troop Spaces and Support Facilities Classroom  
B2. Common Name: Reading Center, CSUMB Building 59  
B3. Original Use: Educational building 4. Present Use: Administration

\*B5. Architectural Style: Utilitarian

\*B6. Construction History: (Construction date, alterations, and date of alterations)  
The Reading Center was designed in 1953 and completed in 1954. As-built drawings show alterations to the subject property took place in 1995. Changes include the replacement of original windows and various infilled windows and doors (CSUMB Facilities 2021).

\*B7. Moved?  No  Yes  Unknown Date: \_\_\_\_\_ Original Location: \_\_\_\_\_ \*B8. Related Features:

B9a. Architect: Robert Stanton b. Builder: Unknown

\*B10. Significance: Theme N/A Area N/A  
Period of Significance N/A Property Type N/A Applicable Criteria N/A

(Discuss importance in terms of historical or architectural context as defined by theme, period, and geographic scope. Also address integrity.)

See Continuation Sheet.

B11. Additional Resource Attributes: (List attributes and codes) \_\_\_\_\_

\*B12. References: See Continuation Sheet.

B13. Remarks:

\*B14. Evaluator: Laura Carias, MA

\*Date of Evaluation: July 20, 2021

(This space reserved for official comments.)

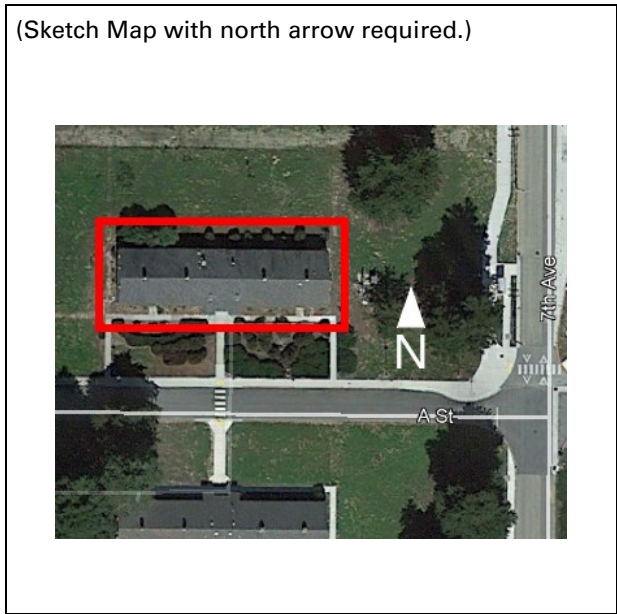

## CONTINUATION SHEET

Property Name: Reading Center

Page 4 of 15

**\*P3a. Description (continued):**

Secondary doors are located to the far east and west ends of the main elevation. These doors are alterations and appear to have been placed within existing window frames. Windows are recently added, metal-framed, one-over-one, fixed, and awning windows. A single column of cinderblocks is located between every second window on the main and rear north elevation. The fenestration pattern is repeated on the rear elevation. Alterations include the infill of several window frames with doors, replacement windows, and a recently added main door.



Figure 1. Main (south) elevation, looking north (IMG\_0581)

## CONTINUATION SHEET

Property Name: Reading Center

Page 5 of 15



Figure 2. north elevation, looking southwest (IMG\_0598)

### Alterations:

- Replaced original windows with metal sash fixed and awning windows (1995)
- Various filled in windows and doors (1995)

## CONTINUATION SHEET

Property Name: Reading Center

Page 6 of 15

### \*B10. Significance (continued):

#### Historical Overview of Fort Ord

The history of Fort Ord has been extensively documented in newspaper articles, websites, academic journals, and books. From its creation in 1917 to its closure in 1994, the base grew to become one of the largest training centers in the country. Its location was also reported to be the most attractive U.S. Army post, with easy access to the ocean and beautiful California weather.

The development periods in the history of Fort Ord were defined by Harold E. Raugh, Jr, a U.S. Army lieutenant colonel and historian with the Department of Defense. Since his retirement, Raugh served as the Chief Historian, for the Defense Logistics Agency, for the Department of Defense and, from 2006-2013, Raugh served as the Command Historian at the Defense Language Institute Foreign Language Center (DLIFLC) and the Presidio of Monterey, California. He received his PhD in history from the University of California, Los Angeles (Walch 2004). Raugh has authored numerous books including, *Fort Ord* (2004); *Presidio of Monterey* (2004); *Operation Joint Endeavor: V Corps in Bosnia-Herzegovina, 1995-1996* (2013); *The Raugh Bibliography of the Indian Mutiny 1857-1859* (2016); and *Wavell in the Middle East, 1939-1941: A study in Generalship*. Raugh defined four periods for the historic development of Fort Ord:

- 1917-1940 Camp Gigling to Camp Ord
- 1940-1945 Fort Ord and the 7th Infantry Division
- 1946-1976 The Cold War and Vietnam Eras
- 1974-1994 The Volunteer Army

These periods correspond to distinct eras in the history of the base and the U.S. Army (Raugh 2004: ii).

The full historic context of Fort Ord is represented in the report, *Built Environment Inventory and Evaluation Report for California State University, Monterey Bay* (Dudek 2021). The following presents only relevant historical and building typology information pertaining to the development of the Reading Center.

#### Cold War and Vietnam Eras at Fort Ord (1946-1976)

This period of development between 1946 and 1976 was characterized by a massive operation to move the base out of its semi-permanent status and create a permanent outpost for active military personnel who were retained due to ongoing foreign conflicts.

In July of 1948, Harry S Truman signed Executive Order 9981, which officially ended segregation in the armed forces. The order stated that "there shall be equality of treatment and opportunity for all persons in the armed forces without regard to race, color, religion, or national origin" (National Archives Foundation 2021). Fort Ord became one of the first integrated training divisions in the United States. The Fort was touted as "pioneering to end all segregation" (The Pomona Progress Bulletin 1950: 4). In 1950, the *Pomona Progress Bulletin* reported that black and white soldiers at Fort Ord were "fighting side by side" and all the enlistees "trained together, slept in the same barracks, and eat the same messes" (The Pomona Progress Bulletin 1950: 4).

The end of World War II in 1945 did not bring lasting peace. The tenuous relationship between dominant nations in the communist East and free market West led to the beginning of the Cold War. The Department of Defense maintained a robust fighting force during the Cold War, with more than 900,000 Army personnel retained during the 1950s (ACHP 2006).

## CONTINUATION SHEET

Property Name: Reading Center

Page 7 of 15

The ongoing global tensions and the number of active U.S. military personnel created a need for new permanent buildings and expanded military housing at Fort Ord.

In 1949, the Soviet-supported communist government of North Korea invaded American-supported South Korea, initiating the Korean War. Fort Ord was a primary staging area for the training of troops departing for the war (Castle 1990:3). By the 1950s, Fort Ord had become one of the largest basic training camps in the United States. In 1952, the military began a multi-million dollar building program to transform Fort Ord into a permanent post, including the development of permanent troop housing, and the construction of a guard house, stockade, and multiple warehouses. In January of 1952, military authorities announced the new construction program at Fort Ord was underway, with an estimated cost of \$26,650,600. More than half of the funds that were approved by Congress were "earmarked for new permanent troop housing" for more than 7,000 soldiers (The Webb Spinner 1952-54, Vol 6. No. 3:1).

The new troop housing was to be constructed of reinforced concrete, a departure from the wood buildings constructed before and during World War II. The plan called for three types of massive barracks, twenty-two were to house 225 enlisted men each, seven were to accommodate 165 men each, and nine were to house 105 men each (The Webb Spinner 1952-54, Vol 6. No. 3:3). The San Francisco District of the U.S. Army Corps of Engineers oversaw the construction project to completion. An additional \$1,349,700 was earmarked for the expansion of classroom and training facilities at Fort Ord, including a new battalion and regimental headquarters (The Californian 1952a:1 and The Californian 1952b:18). By March of 1952, another phase of the permanent army post transformation began with the construction of a guard house, stockade, warehouse, and other buildings (The Webb Spinner 1952-54, Vol 6. No. 3:1). This addition of permanent buildings continued into the late 1950s, when the Army requested \$124 million to replace all the wood World War II infrastructure at Fort Ord with concrete block and reinforced concrete (Madsen and Treffers 2019:6; San Francisco Examiner 1958:2-4). While many of the wood buildings remain today, this period saw the continuous addition of reinforced concrete permanent buildings across the Fort (Madsen and Treffers 2019:6).

Following the Korean War through the end of the conflict in Vietnam, Fort Ord served as an important training facility. In 1957, Fort Ord was designated as a U.S. Army Training Center for Infantry (Castle 1990: 4). The 7th Infantry Division was based at Fort Ord in 1975 (Cavanaugh 2000: 9). Fort Ord produced thousands of combat-ready troops during the conflict in Vietnam.

With the establishment of Fort Ord as a permanent Army base during this period, there was substantial building construction that led to the modernization of the base and its services. This development is closely related to the history of the current CSUMB campus. All the properties that are included as part of this built environment study were constructed during the Cold War and Vietnam Era period. Building development during this period was a substantial departure from the styles and materials used in the buildings constructed before World War II. Building during the period between 1946 and 1976 used reinforced concrete and concrete masonry unit (CMU). The buildings tended to be larger than those constructed in previous periods. Other development in this period included support service buildings and several types of medical buildings. Infrastructure was also improved at this time, with the introduction of paved streets and roadways, and the addition of several water tanks, water pumping plants, and warehouse buildings.

### **Reading Center, 1954**

Constructed in 1954, the Reading Center (59) was designed by Robert Stanton, Monterey Bay architect (CSUMB Facilities 2021). It was one of several identical buildings described as "permanent troop spaces and supporting facilities/classrooms" designed for Fort Ord (CSUMB Facilities 1953). It first appears in the 1956 aerial photograph as a long, rectangular

## CONTINUATION SHEET

Property Name: Reading Center

Page 8 of 15

plan, gable-ended building on the north side of A Street (UCSB 1956). The entrance faces south to A Street and is accessed by a formal path from the A Street sidewalk. It is surrounded on all sides by lawn. The Reading Center (59) is mirrored in plan, size, and position by Green Hall (58) south of A Street. It appears south of a group of four buildings similar in plan to Pacific Hall (44), Coast Hall (45) and Harbor Hall (46), however buildings in this group begin to be demolished in 2010, and demolition is complete by 2021. No changes to the Reading Center over time were noted.

### **Robert Stanton**

Robert Stanton was born in Detroit, Michigan in 1900. He served briefly in the U.S. Navy during World War I and then graduated from high school in Los Angeles and went on to complete his education at University of California at Berkeley. After graduation he worked with renowned architect, Wallace Neff. Neff appointed Stanton as project supervisor on several projects and Stanton earned his architecture license in 1934. Stanton moved to Monterey Bay in 1935 and went on to design a variety of residential, commercial, and public buildings in the area. Two of his buildings, the Monterey County Courthouse and the King City High School Auditorium have been listed on the NRHP (Hiller 2007:8-4). Robert Stanton was known to have designed a plan for classroom buildings at Fort Ord that was used for at least four buildings on campus (CSUMB Facilities 2021).

### **Fort Ord Building Typology**

Four categories of building types were identified for the purposes of this study. These are the Support Services Buildings, Medical Buildings, Hammerhead Buildings/Barracks, and Recreational Buildings. The following presents a discussion of the Support Services building typology, as the Reading Center (59) is classified in this typology. This section provides a detailed account of the specific character-defining features of Fort Ord Cold War and Vietnam Era (1946-1976) Support Services buildings.

### **Support Services Buildings**

Support Services Buildings constructed during the Cold War and Vietnam Eras (1946-1976) at Fort Ord have a variety of uses and functions that changed over the history of the base. The buildings tended to have central entryways that opened into hallways, with classrooms lining the halls. In alignment with the typical planning, design, and materials of buildings from this period of Fort Ord's history, these buildings are constructed with reinforced concrete and CMU and feature gable roofs with multi-light windows with concrete sills. These buildings have a uniform design, like many of the other buildings at Fort Ord.

After Fort Ord closed in 1994, these support services buildings became part of the CSUMB campus. With the shift to campus use, many of the buildings were altered to fit the needs of CSUMB. No changes to the Reading Center were noted.

### **Character-Defining Features for the Support Services Buildings**

The Support Services Buildings originally exhibited the following specific character-defining features:

## CONTINUATION SHEET

Property Name: Reading Center

Page 9 of 15

### Character-Defining Features: Fort Ord Support Services Buildings

| Character Aspect       | Primary Character-Defining Features  | Character-defining features  |
|------------------------|--|--|
| Shape and Plan         | <ul style="list-style-type: none"> <li>Simple rectangular form</li> <li>Single story</li> </ul>  | The overall shape and mass of the building are considered a primary character-defining feature of the support services buildings. The plan should be rectangular in form.  |
| Roof                   | <ul style="list-style-type: none"> <li>Flat or gable roof</li> <li>small eave overhangs</li> <li>No exposed rafters</li> </ul>                                   | Support service buildings from this period have gable roof forms, with slight eave overhangs.  |
| Openings               | <ul style="list-style-type: none"> <li>Public entrances and circulation patterns</li> </ul>  | Window openings are generally uniform in size and placement, windows are multi-light, and set into concrete openings. Replaced windows are not considered character-defining features as they fall outside the period of significance.   |
| Exterior Ornamentation | <ul style="list-style-type: none"> <li>Minimal exterior ornamentation</li> </ul>   | The support services buildings were designed to be quickly constructed. They have little to no decorative ornamentation, with windows being set evenly apart and CMU pillars being the only decorative element.  |
| Materials              | <ul style="list-style-type: none"> <li>Mass-produced and cost-effective materials</li> <li>Concrete and CMU</li> <li>Reinforced Concrete construction</li> </ul> | The support services buildings have simple, utilitarian designs. Buildings were constructed using mass-produced and cost-effective building materials that were readily available at the time of construction. For instance, buildings under the support services buildings type were constructed with reinforced concrete and CMU and were minimally decorated. |

Alterations and demolitions over time have compromised the overall architectural integrity of this building type. The most common alterations observed for this building type include the following.

- Replacement windows
- ADA compliance measures such as ramps and doors
- HVAC systems and window units
- Infill of openings
- Addition of front gable over doorways
- Interior renovations

#### NRHP/CRHR Designation Criteria

In consideration of the project site's history and requisite integrity, Dudek recommends the property not eligible for listing in the NRHP and CRHR based on the following significance evaluation and in consideration of national and state eligibility criteria:

## CONTINUATION SHEET

Property Name: Reading Center

Page 10 of 15

**Criterion A/1: That are associated with events that have made a significant contribution to the broad patterns of our history.**

The Reading Center was designed in 1953 and constructed in 1954 during the period defined as the Cold War and Vietnam Eras (1946-1976) at Ford Ord. While this building is of historic age and was constructed during an important period of development in Fort Ord's history, it no longer retains enough integrity to convey its significance. One of the most notable elements of integrity that is compromised is the integrity of setting. Significant demolition, changes to circulation patterns, introduction of new buildings, and changes in use, all impact the building's ability to convey significance from its time as an active Cold War and Vietnam Era military base. The loss of this overall integrity of setting adversely affects Beach Hall, as individual buildings are no longer able to convey their collective history. Additionally, the subdivision of Fort Ord following its closure has also greatly impacted the integrity of feeling, association, and setting of the remaining Cold War and Vietnam Era buildings. Beach Hall is not able to convey its association with any extraordinary events or events occurring within the context of Cold War and Vietnam military support service buildings, the CSUMB Campus, or has an association with the broad patterns of history in Monterey County, the State of California, or the Nation. Therefore, the building is recommended not eligible under NRHP/CRHR Criterion A/1.

**Criterion B/2: That are associated with the lives of persons significant in our past.**

To be found eligible under B/2 the property must be directly tied to an important person and the place where that individual conducted or produced the work for which he or she is known. Archival research found no significant or influential people directly associated with the building. As such this property is not known to have any historical associations with people important to the nation's or state's past. Due to a lack of identified significant associations with important persons in history, Dudek recommends the building is not eligible under NRHP/CRHR Criterion B/2.

**Criterion C/3: That embody the distinctive characteristics of a type, period, or method of construction, or that represent the work of a master, or that possess high artistic values, or that represent a significant and distinguishable entity whose components may lack individual distinction.**

Archival research indicates that the Reading Center was constructed in 1954 as one of several classroom/support buildings for Fort Ord. Although designed by architect, Robert Stanton, the building was not constructed in any obvious architectural style. The building is a ubiquitous building type that lacks high style components to set it apart from other buildings constructed in the 1950s. The building has been altered by the removal of original windows and doors and there have been changes to the fenestration pattern. Due to a lack of high artistic value, a lack of evidence suggesting this is a notable work of Robert Stanton, and because of the alterations to character-defining features, Dudek recommends the building is not eligible under NRHP/CRHR Criterion C/3.

**Criterion D/4: That have yielded, or may be likely to yield, information important in prehistory or history.**

There is no evidence to suggest that this property has the potential to yield information important to state or local history. Therefore, the property is recommended not eligible under NRHP/CRHR Criterion D/4.

**California Historic Landmark Statement of Significance**

In consideration of the subject property's history and requisite integrity, Dudek



## CONTINUATION SHEET

Property Name: Reading Center

Page 11 of 15

recommends the property not eligible for designation as a California Historic Landmark based on the following significance evaluation and in consideration of state eligibility criteria:

**The first, last, only, or most significant of its type in the state or within a large geographic region (Northern, Central, or Southern California).**

The Reading Center was designed in 1953 and constructed in 1954. The building was constructed after the initial, core development period of Fort Ord in the 1940s. Beach Hall was designed by Robert Stanton. The building is a ubiquitous building type that lacks high style components to set it apart from other utilitarian buildings constructed throughout the State of California in the 1950s. Therefore, the subject property is recommended not eligible for listing as a CHL under this criterion.

**Associated with an individual or group having a profound influence on the history of California.**

Archival research failed to indicate any significant associations between the subject property and individuals or groups that profoundly influenced the history of California. The Reading Center was one of several support/classroom buildings constructed on site. Robert Stanton was found to be the architect responsible for the design, but the utilitarian building does not reflect a remarkable design. No other individuals are known to have influenced the construction or use of this building. Therefore, the subject property is recommended not eligible for listing as a CHL under this criterion.

**A prototype of, or an outstanding example of, a period, style, architectural movement or construction or is one of the more notable works or the best surviving work in a region of a pioneer architect, designer or master builder.**

The Reading Center is neither a prototype or an outstanding example of a period, style, or architectural movement. The building was designed to serve a utilitarian purpose. There are no remaining identifying features on the Reading Center that would establish the building as a notable work of a master architect, or a notable designer or builder working within the military, or in the State of California. Therefore, the subject property is recommended not eligible for listing as a CHL under this criterion.

**Local Designation Criteria**

Portions of the CSUMB campus are located within the boundaries of two cities, City of Seaside and the City of Marina, both of which evaluate historical resources in accordance with CEQA Guidelines. as presented above. The subject property, as discussed in the NRHP/CRHR/CHL criteria discussion above, does not rise to the necessary level of significance for local, state, or national designation. For these reasons, the subject property is recommended not eligible individually or as a component of a historic district under any of the NRHP/CRHR/CHL criteria.

Additionally, portions of the CSUMB campus are located in the County of Monterey and it is therefore subject to the regulations set forth in Chapter 18.25 of the Monterey County Code. The subject property, as discussed in the NRHP/CRHR/CHL criteria discussion above, does not rise to the necessary level of significance for state or national designation. For these same reasons, the subject property is also recommended not eligible individually or as a component of a historic district under any of the delineated County of Monterey review criteria categories that are addressed with the NRHP/CRHR/CHL criteria discussed above: A. Historical and Cultural Significance; B. Historic, Architectural, and Engineering Significance; or C. Community and Geographic Setting.

## CONTINUATION SHEET

Property Name: Reading Center

Page 12 of 15

### Integrity Discussion

The Reading Center retains its integrity of location. Windows have been replaced and various windows and doors have been closed off since its completion in 1954. These alterations have diminished the resource's integrity of design, materials, and workmanship. Although the Reading Center is still used as a support building, the site, once a bustling army base, is now home to a California State University campus. These changes to the surrounding area have diminished the integrity of setting, feeling, and association. The changes to original materials prohibit the building from conveying its significance or its temporal period.

### Summary of Evaluation Findings

The Reading Center retains little historic integrity and lacks historical and architectural significance. Based on the significance evaluations presented above, the Reading Center does not appear to meet the NRHP, CRHR, CHL or local designation criteria. Therefore, the Reading Center is not considered a historical resource for purposes of CEQA.

## CONTINUATION SHEET

Property Name: Reading Center

Page 13 of 15

### \*B12. References (continued):

- ACHP (Advisory Council on Historic Preservation). 2006. "Draft Program Comment Regarding Cold War Era Unaccompanied Personnel Housing." Federal Register: The Daily Journal of the United States Government. 12 April 2016. Accessed June 30, 2021 Available at: <https://www.federalregister.gov/documents/2006/04/12/06-3509/draft-program-comment-regarding-cold-war-era-unaccompanied-personnel-housing>
- Californian, The. 1940. "No More Camp Ord! It's Fort Ord Now! Stilwell in Command: Headquarters of General Located on Salinas Side." July 13, 1940. Salinas, California, pg. 1.
- Californian, The. 1951. Stadium Field House—Sixth Army Lets Ord Contract. March 20, 1951. P1. Accessed June 17, 2021. Available at: [Newspapers.com](http://Newspapers.com).
- Castle, Ted. 1990. "The March of Time." Fort Ord Panorama. September 21, 1990.
- Cavanaugh, Joe. 2000. *The Peace Dividend: Defense Conversion Through Higher Education*. The Leon Panetta Institute.
- Chamberlin Library. 2021. Fort Ord Working Papers. CSUMB Special Collections Box 6.42-01. Available at the Chamberlin Library, Seaside, California.
- CSUC (California State University, Chico). 2021a. "State Normal School at Chico." Accessed July 8, 2021. <https://www.csuchico.edu/traditions/history/normal-school.shtml>.
- CSUC. 2021b. "Chico State Teachers College." Accessed July 8, 2021. <https://www.csuchico.edu/traditions/history/teachers-college.shtml>
- CSUMB Facilities. 2021. Original As built and renovation architectural drawings on file with CSUMB facilities department. Accessed in person June 15-16, 2021.
- DLIFLC (Defense Language Institute Foreign Language Center). 2021. Command History Program. Accessed in person on June 15, 2021 and accessed online database collection online July 2021. Available at: <https://adli.pastperfectonline.com/>
- EA Engineering. 1991. Draft Final Fort Ord, California Base wide Remedial Investigation Feasibility Study. Volume 1 Literature Review and Base Inventory Report. Accessed on July 13, 2021. Available at: <https://www.fortordcleanup.com/documents/search/>
- Fresno Bee, The. 1951a. "Army Spokesman Are Defending Building of Fort Ord Stadium." January 12, 1951. Page 13. Accessed June 17, 2021.
- Fresno Bee, The. 1951b. "Army Spokesman Are Defending Building of Fort Ord Stadium." February 4, 1951. Page 27. Accessed June 17, 2021. Available at: [Newspapers.com](http://Newspapers.com).
- Gates, S., & Williams, H. 1957. The Armed Forces. The Annals of the American Academy of Political and Social Science, 313, 99-104. Accessed June 17, 2021. <http://proxy.multcolib.org:2052/stable/1031762>

## CONTINUATION SHEET

Property Name: Reading Center

Page 14 of 15

- MacGregor Jr., Morris J. 1981. *Integration of the Armed Forces, 1940-1965*. Center of Military History, United States Army: Washington, D.C.
- Madsen, Alexandra and Steven Treffers. 2019. *Historic Resources Evaluation Memorandum for Hammerhead Barracks at Fort Ord, Monterey County, California*. Prepared by Rincon Consultants, Inc for City of Seaside, Community and Economic Development Department. November 4, 2019. Accessed June 28, 2021.  
[https://www.ci.seaside.ca.us/DocumentCenter/View/10674/9\\_App-S---HRE-Memo](https://www.ci.seaside.ca.us/DocumentCenter/View/10674/9_App-S---HRE-Memo)
- Military Museum. 2016. "Historic California Posts, Camps, Stations, and Airfields: Fort Ord." Accessed on June 19, 2021. <http://www.militarymuseum.org/FtOrd.html>
- National Archives Foundation. 2021. Executive Order 9981. Accessed June 29, 2021. Available at: <https://www.archivesfoundation.org/documents/executive-order-9981-ending-segregation-armed-forces/>
- NETR (Nationwide Environmental Title Research LLC). 2021. Historic Aerial Photographs of 100 Campus Center, Seaside, CA 93955 dating from 1956, 1968, 1981, 1998, 2005, 2009, 2010, 2012, 2014, 2016, and 2018. Accessed June 10, 2021.  
<https://www.historicaerials.com/viewer>
- OAC (Online Archives of California). 2021. Finding Aid for the Milton Pflueger drawings of the University of California, Berkeley Radiation Laboratory addition, 1961 0000276. <https://oac.cdlib.org/findaid/ark:/13030/c86w9bq9/>.
- PCAD (Pacific Coast Architecture Database). 2021. Database information for Milton Theodore Pflueger and Timothy Pflueger. Accessed July 7, 2021.  
<http://pcad.lib.washington.edu>
- Panorama. 1990. "50 Years and Counting..." September 21, 1990, pg. 2.
- Panorama. n.d. "Ford Ord in World War II." Historic California Posts: Fort Ord. Accessed on June 19, 2021. <http://www.militarymuseum.org/FtOrd.html>
- Park, R. 2015. "Happy and Cheerful in This Fine Camp": Sports, Recreation, and the United States Army at Fort Ord and Camp Roberts, 1940 to 1945. *Journal of Sport History*, 42(1), 21-37. Accessed on June 18, 2021, from  
<https://www.jstor.org/stable/10.5406/jsporhistory.42.1.21>
- Pomona Progress Bulletin. 1950. War Solving Racial Problems. August 24, 1950. Page 4. Accessed June 29, 2021. Available at: [Newspapers.com](http://Newspapers.com).
- Quartermaster Review, The. 1940. "Army Construction Underway at Camp Ord, California." Volume XX. No 3. November-December. On file at the Chamberlin Library, Ord Military Community.
- Raugh, Harold E. 2004. Fort Ord. Charleston, SC: Arcadia.
- Salinas Morning Post. 1940. "\$2,766,000 in Building Authorized—Ord Contracts Let." August 21, 1940. Salinas, CA. pg. 1.
- San Francisco Examiner. 1951. Fort Ord Will Get Stadium. San Francisco Page 4. · 3 Feb 1951. Pages 1 and 4 A Available on [www.Newspapers.com](http://www.Newspapers.com). Accessed on Jun 11, 2021.

## CONTINUATION SHEET

Property Name: Reading Center

Page 15 of 15

San Francisco Examiner. 1958. Army Asks OK on \$124,000,000 for Fort Ord Buildings. San Francisco. Section 2. Page. 4. Available on [www.Newspapers.com](http://www.Newspapers.com). Accessed July 18, 2021.

Vasche, J. Burton. 1959. "The California State Colleges: Their History, Organization, Purposes, and Programs." in California

U.S. Army. 1977. Post Map Main Garrison Area. Fort Ord, California. Drawing number G-950. Accessed in person at the Chamberlain Library on June 15, 2021.

Walch, Bob. 2004. An Army Historian's Pictorial Take on Fort Ord. Monterey County NOW. Accessed July 12, 2021. Available at:  
[https://www.montereycountyweekly.com/news/local\\_news/an-army-historian-s-pictorial-take-on-fort-ord/article\\_6e8b0250-9c38-5ca4-a4a4-f93d42d65a11.html](https://www.montereycountyweekly.com/news/local_news/an-army-historian-s-pictorial-take-on-fort-ord/article_6e8b0250-9c38-5ca4-a4a4-f93d42d65a11.html)

State of California & The Resources Agency  
DEPARTMENT OF PARKS AND RECREATION  
**PRIMARY RECORD**

Primary #  
HRI #  
Trinomial  
NRHP Status Code 6Z

Other Listings  
Review Code

Reviewer

Date

Page 1 of 15 \*Resource Name or #: (Assigned by recorder) Visual & Public Arts

P1. Other Identifier: CSUMB Building 70

\*P2. Location:  Not for Publication  Unrestricted

\*a. County Monterey County and (P2c, P2e, and P2b or P2d. Attach a Location Map as necessary.)

\*b. USGS 7.5' Quad Marina, CA Date 1995 T 15S; R 2E; SW ¼ of NW ¼ of Sec 6; Mount Diablo B.M.

c. Address 4855 3<sup>rd</sup> Avenue Seaside Zip 93955

d. UTM: (Give more than one for large and/or linear resources) Zone 10S, 607703 mE/ 4057310 mN

e. Other Locational Data: (e.g., parcel #, directions to resource, elevation, decimal degrees, etc., as appropriate)

The Visual & Public Art building sits north of 3<sup>rd</sup> Avenue and west of 6<sup>th</sup> Avenue

\*P3a. Description: (Describe resource and its major elements. Include design, materials, condition, alterations, size, setting, and boundaries)

The Visual & Public Arts building (CSUMB Building 70) sits north east of the Main Quad on the California State University Monterey Bay Campus (CSUMB). The one-and-a-half-story utilitarian building, with a one-story portion on the north (rear) elevation, is located on the north side of Inter-Garrison Road with a west-facing main elevation. It has a rectangular floor plan and a poured-in-place concrete and steel structural system. The building is capped by a flat roof with slightly overhanging eaves. The main elevation once consisted of five garage doors that have been infilled with anodized aluminum framed, fully glazed bays, glazed doors, and filled in completely except for a row of aluminum-framed fixed windows. **See Continuation Sheet**

P5a. Photograph or Drawing (Photograph required for buildings, structures, and objects.)



\*P3b. Resource Attributes: (List attributes and codes) HP15.

Educational building/HP34  
Military property

\*P4. Resources Present:  Building  
 Structure  Object  Site  District   
Element of District  Other (Isolates, etc.)

P5b. Description of Photo: (view, date, accession #) south elevation, view looking north, Dudek, (IMG 0334)

\*P6. Date Constructed/Age and Source:  Historic  Prehistoric  Both  
c. 1950 (NETR 2021)

\*P7. Owner and Address:  
CSUMB,  
100 Campus Center  
Seaside, CA. 93955

\*P8. Recorded by: (Name, affiliation, and address) Sarah Corder  
Dudek  
725 Front St #400  
Santa Cruz, CA 95060

\*P9. Date Recorded: 7/9/2021

\*P10. Survey Type: (Describe)

Intensive level

\*P11. Report Citation: (Cite survey report and other sources or enter none) Dudek 2021. Built Environment Inventory and Evaluation Report for California State University, Monterey Bay

\*Attachments:  NONE  Location Map  Continuation Sheet  Building, Structure, and Object Record

Archaeological Record  District Record  Linear Feature Record  Milling Station Record  Rock Art Record

Artifact Record  Photograph Record  Other (List): \_\_\_\_\_

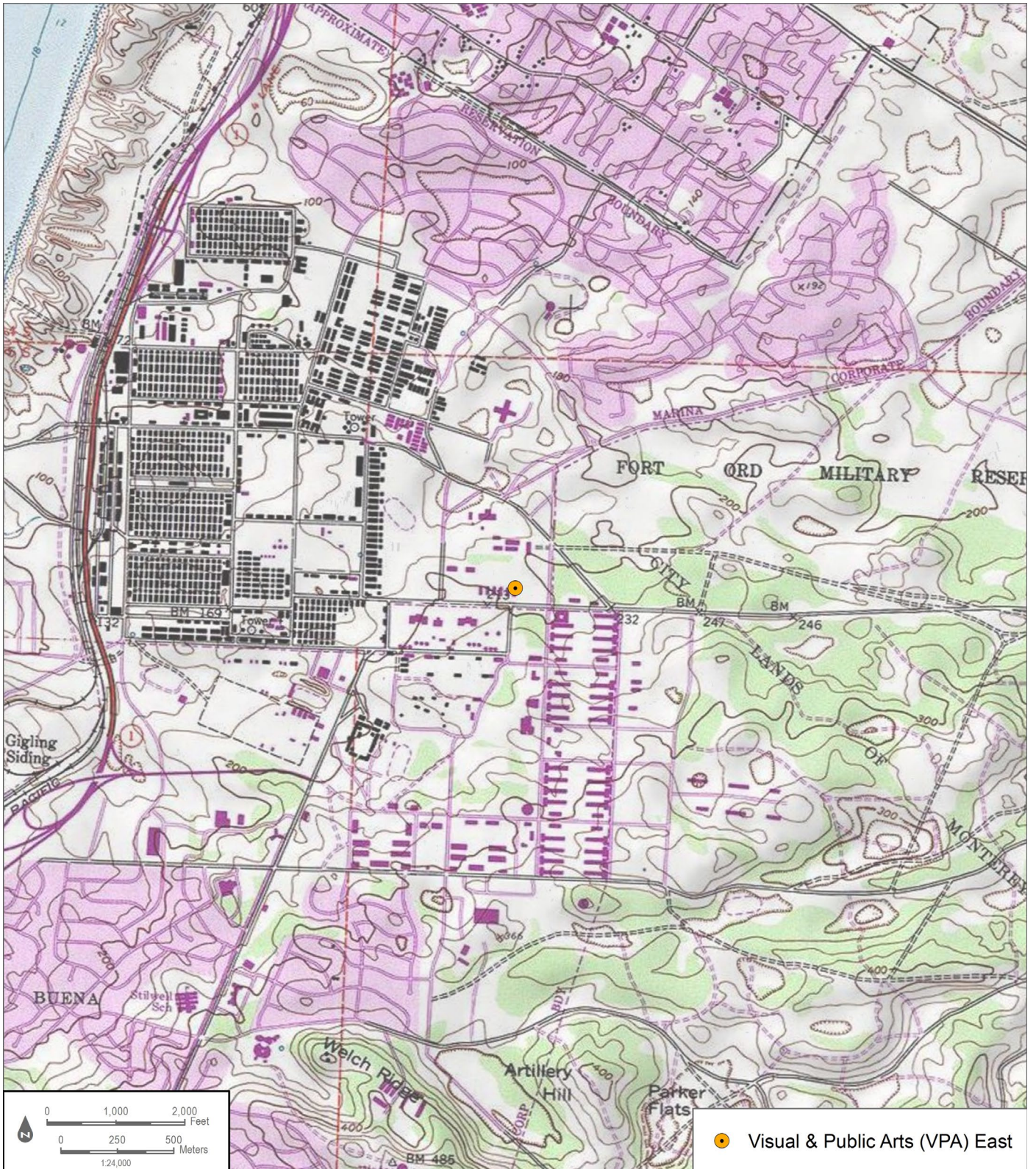

● Visual & Public Arts (VPA) East

# BUILDING, STRUCTURE, AND OBJECT RECORD

\*Resource Name or # (Assigned by recorder) Visual and Public Arts Building \*NRHP Status Code 6Z  
Page 3 of 15

B1. Historic Name: Fort Ord Motor Park  
B2. Common Name Visual and Public Arts Building, CSUMB Building 70  
B3. Original Use: Motor Park 4. Present Use: Classroom

\*B5. Architectural Style: Utilitarian

\*B6. Construction History: (Construction date, alterations, and date of alterations)  
Built in circa 1950 the Visual and Public Arts Building has undergone several alterations since it's construction. No architectural drawings were located for this building. Observed alterations include the addition of arched awnings over the windows on the south and west elevations, the infill of multiple garage openings and fenestration changes on the east and west elevations, painting of the exterior, the addition of HVAC unit to north side of building, and the replacement of the original doors and some original windows.

\*B7. Moved?  No  Yes  Unknown Date: \_\_\_\_\_ Original Location: \_\_\_\_\_ \*B8. Related Features:

B9a. Architect: Unknown b. Builder: Unknown

\*B10. Significance: Theme N/A Area N/A  
Period of Significance N/A Property Type N/A Applicable Criteria N/A  
(Discuss importance in terms of historical or architectural context as defined by theme, period, and geographic scope. Also address integrity.)

See Continuation Sheet.

B11. Additional Resource Attributes: (List attributes and codes) \_\_\_\_\_

\*B12. References: See Continuation Sheet.

B13. Remarks:

\*B14. Evaluator: Laura Carias, MA  
\*Date of Evaluation: July 20, 2021

(This space reserved for official comments.)

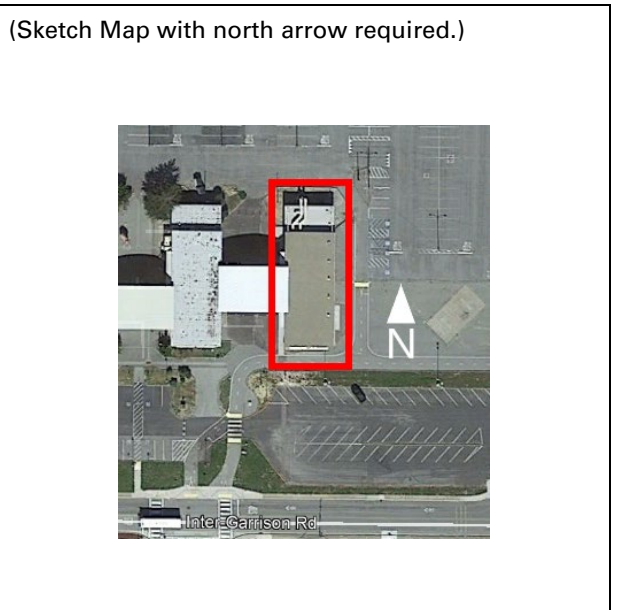



## CONTINUATION SHEET

Property Name: Visual and Public Arts 70

Page 4 of 15

**\*P3a. Description (continued):**

The main elevation features a quarter-arch canopy clad in corrugated metal and supported by steel brackets. Windows on the south elevation consist of steel-framed, multi-light, hopper, and awning windows. The fenestration pattern on the east elevation has also been altered as a garage door and original window frames have been infilled and left with a single row of fixed aluminum sash windows. The one-story portion to the rear retains the original steel sash, multi-light windows. Two large air ducts are located at the rear.



Figure 1. Main (south) elevation, looking north (IMG\_0335)

## CONTINUATION SHEET

Property Name: Visual and Public Arts 70

Page 5 of 15



Figure 2. North (right) and east (left) elevations, looking southwest (IMG\_0348)

### Alterations:

- Added arched awnings over windows on the south and west elevations (Date Unknown).
- Infill of multiple garage openings and fenestration changes on the east and west elevations (Date Unknown).
- Exterior walls repainted (Date Unknown).
- Addition of HVAC unit to north side of building (Date Unknown).
- Replacement of original doors (Date Unknown).
- Replacement of some original windows (Date Unknown).

## CONTINUATION SHEET

Property Name: Visual and Public Arts 70

Page 6 of 15

### \*B10. Significance (continued):

#### Historical Overview of Fort Ord

The history of Fort Ord has been extensively documented in newspaper articles, websites, academic journals, and books. From its creation in 1917 to its closure in 1994, the base grew to become one of the largest training centers in the country. Its location was also reported to be the most attractive U.S. Army post, with easy access to the ocean and beautiful California weather.

The development periods in the history of Fort Ord were defined by Harold E. Raugh, Jr, a U.S. Army lieutenant colonel and historian with the Department of Defense. Since his retirement, Raugh served as the Chief Historian, for the Defense Logistics Agency, for the Department of Defense and, from 2006-2013, Raugh served as the Command Historian at the Defense Language Institute Foreign Language Center (DLIFLC) and the Presidio of Monterey, California. He received his PhD in history from the University of California, Los Angeles (Walch 2004). Raugh has authored numerous books including, Fort Ord (2004); Presidio of Monterey (2004); Operation Joint Endeavor: V Corps in Bosnia-Herzegovina, 1995-1996 (2013); The Raugh Bibliography of the Indian Mutiny 1857-1859 (2016); and Wavell in the Middle East, 1939-1941: A study in Generalship. Raugh defined four periods for the historic development of Fort Ord:

- 1917-1940 Camp Gigling to Camp Ord
- 1940-1945 Fort Ord and the 7th Infantry Division
- 1946-1976 The Cold War and Vietnam Eras
- 1974-1994 The Volunteer Army

These periods correspond to distinct eras in the history of the base and the U.S. Army (Raugh 2004: ii). The following sections provide a summary overview of each of these periods of development and their relevance to the area of Fort Ord now known as the CSUMB campus.

The full historic context of Fort Ord is represented in the report, Built Environment Inventory and Evaluation Report for California State University, Monterey Bay (Dudek 2021). The following presents only relevant historical and building typology information pertaining to the development of the Visual and Public Art building.

#### Cold War and Vietnam Eras at Fort Ord (1946-1976)

This period of development between 1946 and 1976 was characterized by a massive operation to move the base out of its semi-permanent status and create a permanent outpost for active military personnel who were retained due to ongoing foreign conflicts.

In July of 1948, Harry S Truman signed Executive Order 9981, which officially ended segregation in the armed forces. The order stated that "there shall be equality of treatment and opportunity for all persons in the armed forces without regard to race, color, religion, or national origin" (National Archives Foundation 2021). Fort Ord became one of the first integrated training divisions in the United States. The Fort was touted as "pioneering to end all segregation" (The Pomona Progress Bulletin 1950: 4). In 1950, the Pomona Progress Bulletin reported that black and white soldiers at Fort Ord were "fighting side by side" and all the enlistees "trained together, slept in the same barracks, and eat the same messes" (The Pomona Progress Bulletin 1950: 4).

The end of World War II in 1945 did not bring lasting peace. The tenuous relationship between dominant nations in the communist East and free market West led to the beginning

## CONTINUATION SHEET

Property Name: Visual and Public Arts 70

Page 7 of 15

of the Cold War. The Department of Defense maintained a robust fighting force during the Cold War, with more than 900,000 Army personnel retained during the 1950s (ACHP 2006). The ongoing global tensions and the number of active U.S. military personnel created a need for new permanent buildings and expanded military housing at Fort Ord.

In 1949, the Soviet-supported communist government of North Korea invaded American-supported South Korea, initiating the Korean War. Fort Ord was a primary staging area for the training of troops departing for the war (Castle 1990:3). By the 1950s, Fort Ord had become one of the largest basic training camps in the United States. In 1952, the military began a multi-million dollar building program to transform Fort Ord into a permanent post, including the development of permanent troop housing, and the construction of a guard house, stockade, and multiple warehouses. In January of 1952, military authorities announced the new construction program at Fort Ord was underway, with an estimated cost of \$26,650,600. More than half of the funds that were approved by Congress were "earmarked for new permanent troop housing" for more than 7,000 soldiers (The Webb Spinner 1952-54, Vol 6. No. 3:1).

The new troop housing was to be constructed of reinforced concrete, a departure from the wood buildings constructed before and during World War II. The plan called for three types of massive barracks, twenty-two were to house 225 enlisted men each, seven were to accommodate 165 men each, and nine were to house 105 men each (The Webb Spinner 1952-54, Vol 6. No. 3:3). The San Francisco District of the U.S. Army Corps of Engineers oversaw the construction project to completion. An additional \$1,349,700 was earmarked for the expansion of classroom and training facilities at Fort Ord, including a new battalion and regimental headquarters (The Californian 1952a:1 and The Californian 1952b:18). By March of 1952, another phase of the permanent army post transformation began with the construction of a guard house, stockade, warehouse, and other buildings (The Webb Spinner 1952-54, Vol 6. No. 3:1). This addition of permanent buildings continued into the late 1950s, when the Army requested \$124 million to replace all the wood World War II infrastructure at Fort Ord with concrete block and reinforced concrete (Madsen and Treffers 2019:6; San Francisco Examiner 1958:2-4). While many of the wood buildings remain today, this period saw the continuous addition of reinforced concrete permanent buildings across the Fort (Madsen and Treffers 2019:6).

Following the Korean War through the end of the conflict in Vietnam, Fort Ord served as an important training facility. In 1957, Fort Ord was designated as a U.S. Army Training Center for Infantry (Castle 1990: 4). The 7th Infantry Division was based at Fort Ord in 1975 (Cavanaugh 2000: 9). Fort Ord produced thousands of combat-ready troops during the conflict in Vietnam.

With the establishment of Fort Ord as a permanent Army base during this period, there was substantial building construction that led to the modernization of the base and its services. This development is closely related to the history of the current CSUMB campus. All the properties that are included as part of this built environment study were constructed during the Cold War and Vietnam Era period. Building development during this period was a substantial departure from the styles and materials used in the buildings constructed before World War II. Building during the period between 1946 and 1976 used reinforced concrete and concrete masonry unit (CMU). The buildings tended to be larger than those constructed in previous periods. Other development in this period included support service buildings and several types of medical buildings. Infrastructure was also improved at this time, with the introduction of paved streets and roadways, and the addition of several water tanks, water pumping plants, and warehouse buildings.

**CONTINUATION SHEET**

Property Name: Visual and Public Arts 70  
 Page 8 of 15

**Visual & Public Arts Building - Far East (70)**

The Visual & Public Arts building (70) first appears in the 1956 aerial photograph as the east-most building in a group of six similarly sized buildings between 5th Avenue, 6th Avenue, north of Inter-Garrison Road and south of a large parking area. This building group included Visual & Public Arts - East (71), Visual & Public Arts - Center (72), Visual & Public Arts - West (73), and the Central Plant buildings (74 - two buildings). The Visual & Public Arts building (70) does not appear to be enlarged between 1956 and 2016, according to aerial photographs. Between 1987 and 1998, two arched breezeway structures appear between the Visual & Public Arts - East (71), Visual & Public Arts - Center (72), and Visual & Public Arts - West (73) buildings. Sometime after 2016, one of the two Central Plant buildings (74) is demolished.

**Fort Ord Building Typology**

Four categories of building types were identified for the purposes of this study. These are the Support Services Buildings, Medical Buildings, Hammerhead Buildings/Barracks, and Recreational Buildings. The following presents a discussion of the Support Services building typology, as the Visual and Public Arts building (70) is classified as this type. This section provides a detailed account of the specific character-defining features of Fort Ord Cold War and Vietnam Era (1946-1976) Support Services buildings.

**Building Typology: Support Services Buildings**

Support Services Buildings constructed during the Cold War and Vietnam Eras (1946-1976) at Fort Ord have a variety of uses and functions that changed over the history of the base. In alignment with the typical planning, design, and materials of buildings constructed during this period of Fort Ord's history, these buildings are constructed with reinforced concrete and CMU and feature flat or gable roofs with multi-light windows with concrete sills. These buildings tended to have a uniform design, like many of the other buildings at Fort Ord.

After Fort Ord closed in 1994, these support services buildings became part of the CSUMB campus. With the shift to campus use, many of the buildings were altered to fit the needs of CSUMB. The Visual and Public Arts building footprints appears unchanged between 1956 and the present (NETR 2021).

**Character-Defining Features for the Support Services Buildings**

The Support Services Buildings originally exhibited the following specific character-defining features:

| Character Aspect | Primary Character-Defining Features  | Character-defining features   |
|------------------|--|---|
| Shape and Plan   | <ul style="list-style-type: none"> <li>Simple rectangular form</li> <li>Single story</li> </ul>                                | The overall shape and mass of the building are considered a primary character-defining feature of the support services buildings. The plan should be rectangular in form. |
| Roof             | <ul style="list-style-type: none"> <li>Flat or gable roof</li> <li>small eave overhangs</li> <li>No exposed rafters</li> </ul> | Support service buildings from this period have gable roof forms, with slight eave overhangs.   |
| Openings         | <ul style="list-style-type: none"> <li>Public entrances and circulation patterns</li> </ul>                                    | Window openings are generally uniform in size and placement, windows are multi-light, and set into concrete openings. Replaced windows                                    |

**CONTINUATION SHEET**

Property Name: Visual and Public Arts 70

Page 9 of 15

|                        |  |  |
|------------------------|--|--|
|                        |  | are not considered character-defining features as they fall outside the period of significance.  |
| Exterior Ornamentation | <ul style="list-style-type: none"> <li>Minimal exterior ornamentation</li> </ul>   | The support services buildings were designed to be quickly constructed. They have little to no decorative ornamentation, with windows being set evenly apart and CMU pillars being the only decorative element.  |
| Materials              | <ul style="list-style-type: none"> <li>Mass-produced and cost-effective materials</li> <li>Concrete and CMU</li> <li>Reinforced Concrete construction</li> </ul> | The support services buildings have simple, utilitarian designs. Buildings were constructed using mass-produced and cost-effective building materials that were readily available at the time of construction. For instance, buildings under the support services buildings type were constructed with reinforced concrete and CMU and were minimally decorated. |

Alterations and demolitions over time have compromised the overall architectural integrity of this building type. The most common alterations observed for this building type include the following.

- Replacement windows
- ADA compliance measures such as ramps and doors
- HVAC systems and window units
- Infill of openings
- Addition of front gable over doorways
- Interior renovations

**NRHP/CRHR Designation Criteria**

In consideration of the Visual and Public Arts building's history and requisite integrity, Dudek recommends the building not eligible for listing in the NRHP and CRHR based on the following significance evaluation and in consideration of national and state eligibility criteria:

**Criterion A/1: That are associated with events that have made a significant contribution to the broad patterns of our history.**

The Visual and Public Arts building was constructed in c 1950 during the period defined as the Cold War and Vietnam Eras (1946-1976) at Ford Ord. While this building is of historic age and was constructed during an important period of development in Fort Ord's history, it no longer retains enough integrity to convey its significance. One of the most notable elements of integrity that is compromised is the integrity of setting. Significant demolition, changes to circulation patterns, introduction of new buildings, and changes in use, all impact the campus's ability to convey significance from its time as an active Cold War and Vietnam Era military base. The loss of this overall integrity of setting adversely effects the Visual and Public Arts building, as individual buildings are no longer able to convey their collective history. Additionally, the subdivision of Fort Ord following its closure has also greatly impacted the integrity of feeling, association, and setting of the remaining Cold War and Vietnam Era buildings. The Visual and Public Arts building is not able to convey its association with any extraordinary

## CONTINUATION SHEET

Property Name: Visual and Public Arts 70

Page 10 of 15

events or events occurring within the context of Cold War and Vietnam military support service buildings, the CSUMB Campus, or has an association with the broad patterns of history in Monterey County, the State of California, or the Nation. Therefore, the building is recommended not eligible under NRHP/CRHR Criterion A/1.

**Criterion B/2: That are associated with the lives of persons significant in our past.**

To be found eligible under B/2 the building must be directly tied to an important person and the place where that individual conducted or produced the work for which he or she is known. Archival research did not find any notable persons associated with the Visual and Public Arts building. As such, this building is not known to have any historical associations with people important to the nation's or state's past. Due to a lack of identified significant associations with important persons in history, Dudek recommends the building is not eligible under NRHP/CRHR Criterion B/2.

**Criterion C/3: That embody the distinctive characteristics of a type, period, or method of construction, or that represent the work of a master, or that possess high artistic values, or that represent a significant and distinguishable entity whose components may lack individual distinction.**

Archival research indicates that the Visual and Public Arts building was constructed in c. 1950 as a motor park for Fort Ord. The building was not constructed in any obvious architectural style and is a ubiquitous building type that lacks high style components to set it apart from other buildings constructed in the 1950s. The building has been altered with the alteration of the fenestration pattern on the east elevation, the infill of a garage door, and the infill of the original window frames. For these reasons, the building does not possess a high level of architectural merit to be considered for inclusion in the NRHP. For these reasons Dudek recommends the Visual and Public Arts building is not eligible under NRHP/CRHR Criterion C/3.

**Criterion D/4: That have yielded, or may be likely to yield, information important in prehistory or history.**

There is no evidence to suggest that the Visual and Public Arts building has the potential to yield information important to state or local history. Therefore, the building is recommended not eligible under NRHP/CRHR Criterion D/4.

**California Historic Landmark Statement of Significance**

In consideration of the Visual and Public Arts building history and requisite integrity, Dudek recommends the building is not eligible for designation as a California Historic Landmark based on the following significance evaluation and in consideration of state eligibility criteria:

**The first, last, only, or most significant of its type in the state or within a large geographic region (Northern, Central, or Southern California).**

The Visual and Public Arts building was designed circa 1950. The building was constructed during the Cold War and Vietnam Eras (1946-1976) at Fort Ord. The Visual and Public Arts building is a utilitarian building type that lacks high style components to set it apart from other buildings constructed throughout the State of California in the 1950s. Therefore, Dudek recommends the building is not eligible for listing as a CHL under this criterion.

**Associated with an individual or group having a profound influence on the history of California.**

Archival research failed to indicate any significant associations between the Visual and Public Arts building and individuals or groups that profoundly influenced the history of California. The Visual and Public Arts building was one of several

## CONTINUATION SHEET

Property Name: Visual and Public Arts 70

Page 11 of 15

support/classroom buildings constructed on the site. No architect or other individuals are known to have influenced the construction or use of this building. Therefore, Dudek recommends the Visual and Public Arts building is not eligible for listing as a CHL under this criterion.

**A prototype of, or an outstanding example of, a period, style, architectural movement or construction or is one of the more notable works or the best surviving work in a region of a pioneer architect, designer or master builder.**

The Visual and Public Arts building is neither a prototype or an outstanding example of a period, style, or architectural movement. The building was designed to serve a utilitarian purpose as Fort Ord's Motor Park. There are no remaining identifying features on the Visual and Public Arts building that would establish the building as a notable work of a master architect, or a notable designer or builder working within the military, or in the State of California. Therefore, Dudek recommends the building is not eligible for listing as a CHL under this criterion.

### Local Designation Criteria

Portions of the CSUMB campus are located within the boundaries of two cities, City of Seaside and the City of Marina, both of which evaluate historical resources in accordance with CEQA Guidelines. as presented above. The subject property, as discussed in the NRHP/CRHR/CHL criteria discussion above, does not rise to the necessary level of significance for local, state, or national designation. For these reasons, the subject property is recommended not eligible individually or as a component of a historic district under any of the NRHP/CRHR/CHL criteria.

Additionally, portions of the CSUMB campus are located in the County of Monterey and the campus is therefore subject to the regulations set forth in Chapter 18.25 of the Monterey County Code. The subject property, as discussed in the NRHP/CRHR/CHL criteria discussion above, does not rise to the necessary level of significance for state or national designation. For these same reasons, the subject property is also recommended not eligible individually or as a component of a historic district under any of the delineated County of Monterey review criteria categories that are addressed with the NRHP/CRHR/CHL criteria discussed above: A. Historical and Cultural Significance; B. Historic, Architectural, and Engineering Significance; or C. Community and Geographic Setting.

### Integrity Discussion

The Visual and Public Arts building was analyzed against the seven aspects of integrity: location, design, setting, materials, workmanship, feeling, and association. The building retains its integrity of location, as it has not been relocated; however, the integrity of setting has been compromised due to the change of use, from a Cold War and Vietnam Era military support services building to an educational classroom building for CSUMB. Changes to the surrounding area have further compromised the integrity of setting and feeling. Replacement materials have been added throughout the building since its completion in circa 1950, changes in the fenestration pattern and the infill of several openings. These alterations have compromised the resource's integrity of design, materials, and workmanship. As the building does not possess historic significance, there is no historic association. While the building is in good condition, it does not possess integrity to convey significance or its temporal period.

### Summary of Evaluation Findings

The Visual and Public Arts building retains little historic integrity and lacks historical and architectural significance. Based on the significance evaluations presented above, the Visual and Public Arts building does not appear to meet the NRHP,



## CONTINUATION SHEET

Property Name: Visual and Public Arts 70

Page 12 of 15

CRHR, CHL or local designation criteria. Therefore, the Visual and Public Arts building is not considered a historical resource for purposes of CEQA.

## CONTINUATION SHEET

Property Name: Visual and Public Arts 70

Page 13 of 15

### \*B12. References (continued):

ACHP (Advisory Council on Historic Preservation). 2006. "Draft Program Comment Regarding Cold War Era Unaccompanied Personnel Housing." Federal Register: The Daily Journal of the United States Government. 12 April 2016. Accessed June 30, 2021 Available at: <https://www.federalregister.gov/documents/2006/04/12/06-3509/draft-program-comment-regarding-cold-war-era-unaccompanied-personnel-housing>

Californian, The. 1940. "No More Camp Ord! It's Fort Ord Now! Stilwell in Command: Headquarters of General Located on Salinas Side." July 13, 1940. Salinas, California, pg. 1.

Californian, The. 1951. Stadium Field House—Sixth Army Lets Ord Contract. March 20, 1951. P1. Accessed June 17, 2021. Available at: [Newspapers.com](http://Newspapers.com).

Castle, Ted. 1990. "The March of Time." Fort Ord Panorama. September 21, 1990.

Cavanaugh, Joe. 2000. *The Peace Dividend: Defense Conversion Through Higher Education*. The Leon Panetta Institute.

Chamberlin Library. 2021. Fort Ord Working Papers. CSUMB Special Collections Box 6.42-01. Available at the Chamberlin Library, Seaside, California.

CSUMB Facilities. 2021. Original As built and renovation architectural drawings on file with CSUMB facilities department. Accessed in person June 15-16, 2021.

DLIFLC (Defense Language Institute Foreign Language Center). 2021. Command History Program. Accessed in person on June 15, 2021 and accessed online database collection online July 2021. Available at: <https://adli.pastperfectonline.com/>

EA Engineering. 1991. Draft Final Fort Ord, California Base wide Remedial Investigation Feasibility Study. Volume 1 Literature Review and Base Inventory Report. Accessed on July 13, 2021. Available at: <https://www.fortordcleanup.com/documents/search/>

Fresno Bee, The. 1951a. "Army Spokesman Are Defending Building of Fort Ord Stadium." January 12, 1951. Page 13. Accessed June 17, 2021.

Fresno Bee, The. 1951b. "Army Spokesman Are Defending Building of Fort Ord Stadium." February 4, 1951. Page 27. Accessed June 17, 2021. Available at: [Newspapers.com](http://Newspapers.com).

Gates, S., & Williams, H. 1957. The Armed Forces. The Annals of the American Academy of Political and Social Science, 313, 99-104. Accessed June 17, 2021. <http://proxy.multcolib.org:2052/stable/1031762>

MacGregor Jr., Morris J. 1981. Integration of the Armed Forces, 1940-1965. Center of Military History, United States Army: Washington, D.C.

Madsen, Alexandra and Steven Treffers. 2019. *Historic Resources Evaluation Memorandum for Hammerhead Barracks at Fort Ord, Monterey County, California*. Prepared by

## CONTINUATION SHEET

Property Name: Visual and Public Arts 70

Page 14 of 15

Rincon Consultants, Inc for City of Seaside, Community and Economic Development Department. November 4, 2019. Accessed June 28, 2021.  
[https://www.ci.seaside.ca.us/DocumentCenter/View/10674/9\\_App-S---HRE-Memo](https://www.ci.seaside.ca.us/DocumentCenter/View/10674/9_App-S---HRE-Memo)

Military Museum. 2016. "Historic California Posts, Camps, Stations, and Airfields: Fort Ord." Accessed on June 19, 2021. <http://www.militarymuseum.org/FtOrd.html>

National Archives Foundation. 2021. Executive Order 9981. Accessed June 29, 2021. Available at: <https://www.archivesfoundation.org/documents/executive-order-9981-ending-segregation-armed-forces/>

NETR (Nationwide Environmental Title Research LLC). 2021. Historic Aerial Photographs of 100 Campus Center, Seaside, CA 93955 dating from 1956, 1968, 1981, 1998, 2005, 2009, 2010, 2012, 2014, 2016, and 2018. Accessed June 10, 2021.  
<https://www.historicaerials.com/viewer>

Panorama. 1990. "50 Years and Counting..." September 21, 1990, pg. 2.

Panorama. n.d. "Ford Ord in World War II." Historic California Posts: Fort Ord. Accessed on June 19, 2021. <http://www.militarymuseum.org/FtOrd.html>

Park, R. 2015. "Happy and Cheerful in This Fine Camp": Sports, Recreation, and the United States Army at Fort Ord and Camp Roberts, 1940 to 1945. *Journal of Sport History*, 42(1), 21-37. Accessed on June 18, 2021, from  
<https://www.jstor.org/stable/10.5406/jsporhistory.42.1.21>

Pomona Progress Bulletin. 1950. War Solving Racial Problems. August 24, 1950. Page 4. Accessed June 29, 2021. Available at: [Newspapers.com](http://www.newspapers.com).

Quartermaster Review, The. 1940. "Army Construction Underway at Camp Ord, California." Volume XX. No 3. November-December. On file at the Chamberlin Library, Ord Military Community.

Raugh, Harold E. 2004. Fort Ord. Charleston, SC: Arcadia.

Salinas Morning Post. 1940. "\$2,766,000 in Building Authorized—Ord Contracts Let." August 21, 1940. Salinas, CA. pg. 1.

San Francisco Examiner. 1951. Fort Ord Will Get Stadium. San Francisco Page 4. · 3 Feb 1951. Pages 1 and 4 A Available on [www.Newspapers.com](http://www.newspapers.com). Accessed on Jun 11, 2021.

San Francisco Examiner. 1958. Army Asks OK on \$124,000,000 for Fort Ord Buildings. San Francisco. Section 2. Page. 4. Available on [www.Newspapers.com](http://www.newspapers.com). Accessed July 18, 2021.

Vasche, J. Burton. 1959. "The California State Colleges: Their History, Organization, Purposes, and Programs." in California

U.S. Army. 1977. Post Map Main Garrison Area. Fort Ord, California. Drawing number G-950. Accessed in person at the Chamberlain Library on June 15, 2021.

## CONTINUATION SHEET

Property Name: Visual and Public Arts 70

Page 15 of 15

Walch, Bob. 2004. An Army Historian's Pictorial Take on Fort Ord. Monterey County NOW. Accessed July 12, 2021. Available at:  
[https://www.montereycountyweekly.com/news/local\\_news/an-army-historian-s-pictorial-take-on-fort-ord/article\\_6e8b0250-9c38-5ca4-a4a4-f93d42d65a11.html](https://www.montereycountyweekly.com/news/local_news/an-army-historian-s-pictorial-take-on-fort-ord/article_6e8b0250-9c38-5ca4-a4a4-f93d42d65a11.html)

Whaley, Derek. 2015. "East Monterey & Seaside." Santa Cruz Trains: Railroads of the Monterey Bay Area. July 20, 2015. Accessed online:  
<https://www.santacruztrains.com/2015/07/east-monterey-seaside.html>.

Webb Spinner, The. 1952-1954. Webb Spinner Volume for 1952-1954. Del Webb Sun Cities Museum Collection. Accessed June 30, 2021. Accessed at:  
<https://delwebbsuncitiesmuseum.org/newsletters-webb-spinners/>

State of California & The Resources Agency  
DEPARTMENT OF PARKS AND RECREATION  
**PRIMARY RECORD**

Primary #  
HRI #  
Trinomial  
NRHP Status Code 6Z

Other Listings  
Review Code

Reviewer

Date

Page 1 of 18 \*Resource Name or #: (Assigned by recorder) Freeman Stadium

P1. Other Identifier: CSUMB Building 902/903

\*P2. Location:  Not for Publication  Unrestricted

\*a. County Monterey County and (P2c, P2e, and P2b or P2d. Attach a Location Map as necessary.)

\*b. USGS 7.5' Quad Marina, CA Date 1995 T 15S; R 1E; NE  $\frac{1}{4}$   of SE  $\frac{1}{4}$   of Sec 1; Mount Diablo B.M.

c. Address 4111 2nd Ave Seaside Zip 93955

d. UTM: (Give more than one for large and/or linear resources) Zone 10S, 606812 mE/ 4056806 mN

e. Other Locational Data: (e.g., parcel #, directions to resource, elevation, decimal degrees, etc., as appropriate)

Freeman Stadium sits south of Divarty Street, between 2nd Avenue and General Jim Moore Boulevard.

\*P3a. Description: (Describe resource and its major elements. Include design, materials, condition, alterations, size, setting, and boundaries)

Freeman Stadium (CSUMB Building 902/903) sits south of Divarty Street, between 2nd Avenue and General Jim Moore Boulevard. The stadium is clustered with other outdoor athletic facilities northeast of the Otter Sports Complex on the California State University, Monterey Bay (CSUMB) campus. Freeman Stadium is located at a low grade, with the bleachers following the slope of the hillside. A chain-link fence encloses the field, track, and bleachers, with gates on the west, near the Field House, and on the east side of the field for ADA accessibility. Deciduous and evergreen trees and shrubs are planted around the perimeter of the chain-link fence. **See Continuation Sheet.**

\*P3b. Resource Attributes: (List attributes and codes) HP42. Stadium/Sports Field/HP34 Military property

P5a. Photograph or Drawing (Photograph required for buildings, structures, and objects.)



\*P4. Resources Present:  Building  
 Structure  Object  Site  District   
Element of District  Other (Isolates, etc.)

P5b. Description of Photo: (view, date, accession #) East elevation, view looking west, Dudek (IMG 0477)

\*P6. Date Constructed/Age and Source:  Historic  Prehistoric  Both  
1951 (The Californian)

\*P7. Owner and Address:  
CSUMB, 100 Campus Center, Seaside, CA. 93955

\*P8. Recorded by: (Name, affiliation, and address) Sarah Corder, Dudek, 725 Front St #400, Santa Cruz, CA 95060

\*P9. Date Recorded: 6/14/2021

\*P10. Survey Type: (Describe)  
Intensive level

\*P11. Report Citation: (Cite survey report and other sources or enter none)  
Dudek 2021. Built

Environment Inventory and Evaluation Report for California State University, Monterey Bay

\*Attachments:  NONE  Location Map  Continuation Sheet  Building, Structure, and Object Record  
 Archaeological Record  District Record  Linear Feature Record  Milling Station Record  Rock Art Record  
 Artifact Record  Photograph Record  Other (List): \_\_\_\_\_

Page 2 of 18 \*Resource Name or # (Assigned by recorder) Freeman Stadium  
Map Name: Marina Quadrangle \*Scale: USGS 7.5-minute Series \*Date of map: 1995



# BUILDING, STRUCTURE, AND OBJECT RECORD

\*Resource Name or # (Assigned by recorder) Freeman Stadium \*NRHP Status Code 6Z  
Page 3 of 18

B1. Historic Name: Warriors Stadium  
B2. Common Name: Freeman Stadium  
B3. Original Use: Stadium/Sports Field 4. Present Use: Outdoor Field/Athletic Complex  
\*B5. Architectural Style: Altered Beyond Recognition

\*B6. Construction History: (Construction date, alterations, and date of alterations)  
Designed in 1949 and completed in 1951, Freeman Stadium has been altered beyond recognition since its construction. Renovation and as-built drawings show alterations to the subject property took place in 1953, 1974, 1982, 1987, 1998, and 2006. Minor changes and upgrades were completed in 1953, 1974, 1982, 1987, and 1998. Major renovations were completed to the Field House in 2006, including the addition of three, barrel roof, two-story additions to the south, center, and north portions of the building, removal of original doors, windows, and substantial changes to fenestration (CSUMB Facilities 2021). The field was paved in 2018 (NETR 2021)

\*B7. Moved?  No  Yes  Unknown Date: \_\_\_\_\_ Original Location: \_\_\_\_\_ \*B8. Related Features:

B9a. Architect: Fort Ord Engineering Office b. Builder: F. V. Hampshire Contracting Company

\*B10. Significance: Theme N/A Area N/A  
Period of Significance N/A Property Type N/A Applicable Criteria N/A  
(Discuss importance in terms of historical or architectural context as defined by theme, period, and geographic scope. Also address integrity.)

See Continuation Sheet.

B11. Additional Resource Attributes: (List attributes and codes) \_\_\_\_\_

\*B12. References: See Continuation Sheet.

B13. Remarks:

\*B14. Evaluator: Adrienne Donovan-Boyd, MSHP

\*Date of Evaluation: July 20, 2021

(This space reserved for official comments.)

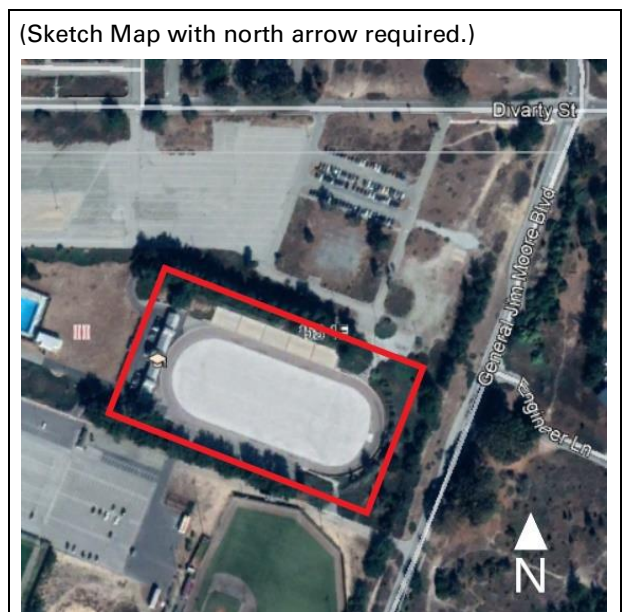

## CONTINUATION SHEET

Property Name: Freeman Stadium

Page 4 of 18

### \*P3a. Description (continued):

Freeman Stadium is made up of the following components: the field, track, bleachers, electrical building, and Field House. Freeman Stadium field is oval, paved, and has a white coating. A paved track encircles the field, but track markings are no longer delineated on the pavement. Concrete, stepped bleachers are located on the north and south side of the track and field. They each measure approximately 342 feet by 48 feet and contain 15, board-formed, concrete bleachers with concrete stairs on both the north and south ends and four sets of stairs evenly spaced throughout the bleachers, creating distinct aisleways. Additional concrete stairs lead from the track on the east and west sides of bleachers. A welded 1½ inch metal railing is located along the perimeter of each section of bleachers with openings at each stairwell.

The electrical building is located on a berm west of the track. The small, windowless building is constructed of CMU and sits on a concrete foundation. The building has a low-pitched cement shed roof with small eave overhangs.

The two-story, Field House building sits at the west end of the field and track. The building is rectangular in plan with a side-gable roof sheathed in standing seam metal. The roof has round skylights evenly spaced throughout and small eave overhangs. Three, two-story, barrel roofed sections are evenly spaced on the façade, one of which is a larger central section. Two, smaller, two-story barrel roof sections are located on the north and the southern portions of the building. The concession area is in the central two-story section. This section has square pillars supporting an overhanging barrel roof. The pillars are primarily clad in stucco fiber cement siding panels, with the lower portion clad in manufactured stone veneer. The west elevation has windows located at irregular intervals, all of which appear to be the side-sliding vinyl variety, except for the windows in the barrel roof gable ends, which appear to be fixed, multi-light windows with protruding metal frames.



Figure 1. Main (west) elevation, looking northeast (IMG\_0431)



# CONTINUATION SHEET

Property Name: Freeman Stadium

Page 5 of 18



Figure 2. East elevation, looking west (IMG\_0477)

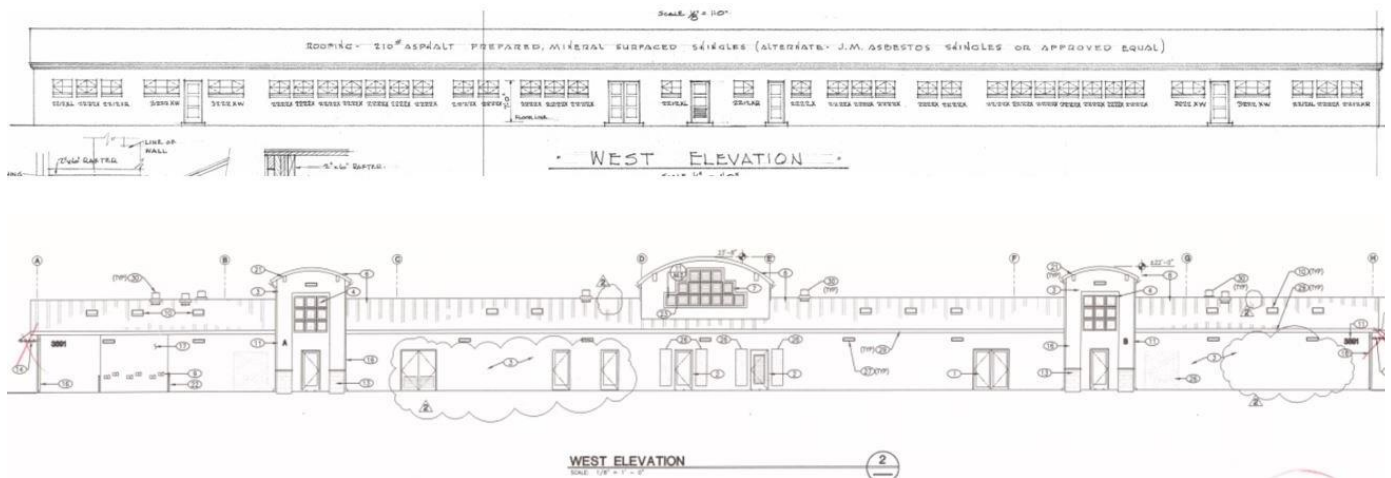

Figure 3. 1949 As-Built Drawing (top) 2006 Renovation Drawing (bottom) (DPR Elevations)

## CONTINUATION SHEET

Property Name: Freeman Stadium

Page 6 of 18



Figure 4. South bleachers, looking southeast (IMG\_0434)



Figure 5. Electrical building, looking east (IMG\_0452)

## CONTINUATION SHEET

Property Name: Freeman Stadium

Page 7 of 18



Figure 6. Track detail, looking northwest, Field House in background (IMG\_0437)

### \*B10. Significance (continued):

#### Historical Overview of Fort Ord

The history of Fort Ord has been extensively documented in newspaper articles, websites, academic journals, and books. From its creation in 1917 to its closure in 1994, the base grew to become one of the largest training centers in the country. Its location was also reported to be the most attractive U.S. Army post, with easy access to the ocean and beautiful California weather.

The development periods in the history of Fort Ord were defined by Harold E. Raugh, Jr, a U.S. Army lieutenant colonel and historian with the Department of Defense. Since his retirement, Raugh served as the Chief Historian, for the Defense Logistics Agency, for the Department of Defense and, from 2006-2013, Raugh served as the Command Historian at the Defense Language Institute Foreign Language Center (DLIFLC) and the Presidio of Monterey, California. He received his PhD in history from the University of California, Los Angeles (Walch 2004). Raugh has authored numerous books including, Fort Ord (2004); Presidio of Monterey (2004); Operation Joint Endeavor: V Corps in Bosnia-Herzegovina, 1995-1996 (2013); The Raugh Bibliography of the Indian Mutiny 1857-1859 (2016); and Wavell in the Middle East, 1939-1941: A study in Generalship. Raugh defined four periods for the historic development of Fort Ord:

- 1917-1940 Camp Gigling to Camp Ord
- 1940-1945 Fort Ord and the 7th Infantry Division
- 1946-1976 The Cold War and Vietnam Eras
- 1974-1994 The Volunteer Army

These periods correspond to distinct eras in the history of the base and the U.S. Army (Raugh 2004: ii). The following sections provide a summary overview of each of these periods of development and their relevance to the area of Fort Ord now known as the CSUMB campus.

## CONTINUATION SHEET

Property Name: Freeman Stadium

Page 8 of 18

The full historic context of Fort Ord is represented in the report, Built Environment Inventory and Evaluation Report for California State University, Monterey Bay (Dudek 2021). The following presents only relevant historical and building typology information pertaining to the development of Freeman Stadium.

### **Cold War and Vietnam Eras at Fort Ord (1946-1976)**

This period of development between 1946 and 1976 was characterized by a massive operation to move the base out of its semi-permanent status and create a permanent outpost for active military personnel who were retained due to ongoing foreign conflicts.

In July of 1948, Harry S Truman signed Executive Order 9981, which officially ended segregation in the armed forces. The order stated that "there shall be equality of treatment and opportunity for all persons in the armed forces without regard to race, color, religion, or national origin" (National Archives Foundation 2021). Fort Ord became one of the first integrated training divisions in the United States. The Fort was touted as "pioneering to end all segregation" (The Pomona Progress Bulletin 1950: 4). In 1950, the Pomona Progress Bulletin reported that black and white soldiers at Fort Ord were "fighting side by side" and all the enlistees "trained together, slept in the same barracks, and eat the same messes" (The Pomona Progress Bulletin 1950: 4).

The end of World War II in 1945 did not bring lasting peace. The tenuous relationship between dominant nations in the communist East and free market West led to the beginning of the Cold War. The Department of Defense maintained a robust fighting force during the Cold War, with more than 900,000 Army personnel retained during the 1950s (ACHP 2006). The ongoing global tensions and the number of active U.S. military personnel created a need for new permanent buildings and expanded military housing at Fort Ord.

In 1949, the Soviet-supported communist government of North Korea invaded American-supported South Korea, initiating the Korean War. Fort Ord was a primary staging area for the training of troops departing for the war (Castle 1990:3). By the 1950s, Fort Ord had become one of the largest basic training camps in the United States. In 1952, the military began a multi-million dollar building program to transform Fort Ord into a permanent post, including the development of permanent troop housing, and the construction of a guard house, stockade, and multiple warehouses. In January of 1952, military authorities announced the new construction program at Fort Ord was underway, with an estimated cost of \$26,650,600. More than half of the funds that were approved by Congress were "earmarked for new permanent troop housing" for more than 7,000 soldiers (The Webb Spinner 1952-54, Vol 6. No. 3:1).

The new troop housing was to be constructed of reinforced concrete, a departure from the wood buildings constructed before and during World War II. The plan called for three types of massive barracks, twenty-two were to house 225 enlisted men each, seven were to accommodate 165 men each, and nine were to house 105 men each (The Webb Spinner 1952-54, Vol 6. No. 3:3). The San Francisco District of the U.S. Army Corps of Engineers oversaw the construction project to completion. An additional \$1,349,700 was earmarked for the expansion of classroom and training facilities at Fort Ord, including a new battalion and regimental headquarters (The Californian 1952a:1 and The Californian 1952b:18). By March of 1952, another phase of the permanent army post transformation began with the construction of a guard house, stockade, warehouse, and other buildings (The Webb Spinner 1952-54, Vol 6. No. 3:1). This addition of permanent buildings continued into the late 1950s, when the Army requested \$124 million to replace all the wood World War II infrastructure at Fort Ord with concrete block and reinforced concrete (Madsen and Treffers 2019:6; San Francisco Examiner 1958:2-4). While many of the wood buildings remain today, this period saw the continuous addition of reinforced concrete permanent buildings across the Fort (Madsen and Treffers 2019:6).

## CONTINUATION SHEET

Property Name: Freeman Stadium

Page 9 of 18

Following the Korean War through the end of the conflict in Vietnam, Fort Ord served as an important training facility. In 1957, Fort Ord was designated as a U.S. Army Training Center for Infantry (Castle 1990: 4). The 7th Infantry Division was based at Fort Ord in 1975 (Cavanaugh 2000: 9). Fort Ord produced thousands of combat-ready troops during the conflict in Vietnam.

With the establishment of Fort Ord as a permanent Army base during this period, there was substantial building construction that led to the modernization of the base and its services. This development is closely related to the history of the current CSUMB campus. All the properties that are included as part of this built environment study were constructed during the Cold War and Vietnam Era period. Building development during this period was a substantial departure from the styles and materials used in the buildings constructed before World War II. Building during the period between 1946 and 1976 used reinforced concrete and concrete masonry unit (CMU). The buildings tended to be larger than those constructed in previous periods. Other development in this period included support service buildings and several types of medical buildings. Infrastructure was also improved at this time, with the introduction of paved streets and roadways, and the addition of several water tanks, water pumping plants, and warehouse buildings.

### **Recreation Opportunities at Fort Ord**

During the Cold War and Vietnam Eras at Fort Ord (1946-1976) recreational opportunities increased substantially on the base. Initially, the U.S. Armed Forces focused solely on training programs that led to the production and establishment of a robust fighting force. Recreation for enlisted soldiers was often provided by civilian groups, not through formal programs run through any branch of the military. This began to change after World War I. The 1940 plan for the development of Fort Ord called for all the buildings necessary to train, house, and care for the infantry, as well as the construction of recreation related facilities such as post exchanges, regimental recreational facilities, moving picture tents, and service clubs (Quartermaster Review 1940: 37). During World War II, the military vastly expanded recreational offerings for enlisted personnel to boost morale and to align with more modern concepts of free-time and leisure (Gates 1957: 99). Morale, it was said, was "just as important as ammunition" and newer, more modern thinking saw recreation as a "vital force in self-development and the art of living" (Gates 1957: 100).

Early recreation activities at the Fort included band concerts, live theater, orchestra shows, and choir performances often organized by the enlisted men (Park 2015: 25). Track and field meets were organized with field days throughout World War II. Boxing was also noted as a popular spectator sport at the base in its early years (Park 2015:25). Fort Ord's first football team, the Presidio Dons, was organized in October 1940. The team initially practiced and played at nearby Del Monte Polo Field. During World War II, the Fort Ord Athletic and Recreation Officer designed a plan to keep soldiers "fit to fight" by developing a more extensive plan for football, baseball, softball, boxing, and other recreational activities. Soon after, games and tournaments were arranged between Fort Ord teams, nearby military bases, and other organized teams (Gates 1957: 100). After the war ended in 1945, Fort Ord introduced an athletic program that gave service members "an opportunity to take part in any recreational activity they wish" (Park 2015: 33). In 1951, a report completed by the Committee on Religion and Welfare in the Armed Forces found that the availability of "wholesome free time activities" were essential for shaping character, increasing job performance, and for the national support of the Armed Forces" (Gates 1957: 100).

The recreation opportunities available at Fort Ord continued to expand in the post-World War II era with the construction of the stadium and other outdoor athletic fields in the 1950s and 1960s. By 1977, the main garrison area included a wide variety of recreation

## CONTINUATION SHEET

Property Name: Freeman Stadium

Page 10 of 18

facilities, including a snack bar, bowling center, softball field, baseball field, service club, library, handball courts, tennis courts, a commissary, the theater, and parade grounds, as well as the Football and Track Stadium (U. S. Army 1977). It was believed that these recreation opportunities created better leaders and would better prepare soldiers for successful civilian lives after their service (Gates 1957: 104).

The Freeman Stadium, originally called the Warrior Stadium, is the only Recreation Facility type in the campus study area. Freeman Stadium is made up of the following components: the field, track, bleachers, electrical building, and Field House. This grouping is referred to throughout this report as the "Freeman Stadium." In January of 1949, the Army prepared plans and specifications for a new Football and Track Stadium (Fresno Bee 1951b:27). The plans were finalized in December 1949 by Fort Ord Engineer Office (CSUMB Facilities 2021). They called for the development of the new stadium at the site of the base's existing amphitheater, just north of the parade grounds. In January 1951, the Army requested bids for a \$200,000, 6,000-seat, concrete football and track stadium at Fort Ord. The design called for the stadium seating to be reinforced concrete, set into the existing dirt embankment of the base's amphitheater (Fresno Bee 1951a: 13).

The plan to develop a stadium at Fort Ord was immediately met with criticism, as President Truman had previously ordered a freeze on new government construction projects to direct funds to the Korean War effort. The Army argued that the stadium was planned "long before the present emergency" and would be constructed of non-critical materials. The planned stadium seating was designed to be constructed of "concrete steel blocks" and concrete slab flooring. In February 1951, it was announced that the stadium would use steel water pipes and cast-iron conduits for construction in an effort to preserve copper (Fresno Bee 1951b:27). Ultimately, the ban on unnecessary construction was ignored, citing the need for recreational facilities to boost morale, and because the growth of Fort Ord was placing a "severe strain on the recreational facilities in the Monterey-Salinas area" (San Francisco Examiner 1951:4). The stadium was considered a necessary facility to "keep pace with the growth of the tent-soldier population" and the athletics field would help to reinforce the Army's rigorous training program (San Francisco Examiner 1951:4). The contract was awarded to construct the stadium and Field House in March 1951 to F. V. Hampshire Contracting Company of Salinas. They bid \$146,346 for the project. Construction was set to begin soon after the contract was awarded and was planned to be completed by September 1951 (Figures 17 and 18) (The Californian 1951: 1).

After Fort Ord closed in 1994, Warrior Stadium became part of the CSUMB campus. The stadium was rebranded as Freeman Stadium and has not been used for athletic purposes in some time; instead it is used for graduation ceremonies and other gatherings.

### **Fort Ord Football: The Warriors**

The first football team at Fort Ord were named the Presidio Dons was organized in 1940. The team held practices at nearby fields and appeared to play other branches of the military. After the new stadium was constructed in 1951, the team's name changed to the Warriors and games were being played regularly between military units, but also against other college teams. By November of 1953 the Fort Ord's semi-professional football team made up of service members stationed at Fort Ord, were playing games in the newly completed "Warriors Stadium" (Sacramento Bee 1953:33). During the 1953 season, the Warriors played both the Los Angeles Rams and the San Francisco Forty Niners. The team was so well respected that in the 1950s, coaches from various colleges would visit Fort Ord at the end of the season in an effort to recruit players for college football (Hollaway 2021). The Warriors were the top-ranked service team in the country in the mid-1950s (Sports Press 2012). In 1953, Don Heinrich, who twice earned the All-American rating while quarterbacking for the Washington Huskies, and Ollie Matson, who played for the Chicago Cardinals and went on to play for the Los Angeles Rams were both playing for

## CONTINUATION SHEET

Property Name: Freeman Stadium

Page 11 of 18

the Warriors during their tour of duty (Seattle Times 1953:73). The Fort Ord Warriors continued to have All Star and professional bound players through the 1950s and 1960s keeping them in the top of the ratings and making football one of Fort Ord's most prominent sports.

### **Freeman Stadium, 1951**

In January of 1949, the Army prepared plans and specifications for a new Football and Track Stadium (Fresno Bee 1951b:27). The plans were finalized in December of 1949, by the Fort Ord Engineer Office (CSUMB Facilities 1949). They called for the development of the new stadium at the site of the base's existing amphitheater, just north of the parade grounds. In January of 1951, the Army put out a call for bids for the \$200,000, 6,000-seat, concrete football and track stadium at Fort Ord. The design called for the stadium seating to be reinforced concrete, set into the existing dirt embarkment of the base's amphitheater (Fresno Bee 1951a:13).

The plan to develop a stadium at Fort Ord was immediately met with criticism, as President Truman had previously ordered a federal freeze on new government construction to aid the Korean War effort. The Army argued that the stadium was planned "long before the present emergency" and would be constructed of non-critical materials. The planned stadium seating was designed to be constructed of "concrete steel blocks" and concrete slab flooring. They announced in February of 1951, in an effort to preserve copper, the stadium would use steel water pipes and cast-iron conduits for construction (Fresno Bee 1951b:27). Ultimately, the ban on unnecessary building was ignored, citing the need for recreational facilities to boost morale, and because the growth of Fort Ord was placing a "severe strain on the recreational facilities in the Monterey-Salinas area" (San Francisco Examiner 1951:4). The stadium was considered a necessary facility to "keep pace with the growth of the tent-soldier population" and the athletics field would help to reinforce the Army's rigorous training program (San Francisco Examiner 1951:4).

The contract was awarded to construct the stadium and Field House in March of 1951 to F. V. Hampshire Contracting Company of Salinas. They bid \$146,346 for the project. Construction was set to begin soon after the contract was awarded and was planned to be completed by September of 1951 (The Californian 1951:1).

### **Fort Ord Building Typology**

Four categories of building types were identified for the purposes of this study. These are the Support Services Buildings, Medical Buildings, Hammerhead Buildings/Barracks, and Recreational Facilities. The following presents a discussion of the Recreation Facilities typology, as Freeman Stadium is classified in this typology. This section provides a detailed account of the specific character-defining features of Fort Ord Cold War and Vietnam Era (1946-1976) Recreation Buildings.

### **Building Typology: Recreational Facilities**

During the Cold War and Vietnam Eras at Fort Ord (1946-1976) recreational opportunities increased substantially on the base. In alignment with the typical planning, design, and materials of buildings constructed during this period of Fort Ord's history, these buildings are constructed with reinforced concrete and CMU and feature multi-light windows with concrete sills.

The only Recreation Facility in the Built Environment ADI, Freeman Stadium, was originally constructed in 1951. The stadium was constructed at the site of Fort Ord's existing amphitheater, just north of the parade grounds. The 6,000-seat stadium seating was constructed of reinforced concrete, set into the existing dirt embarkment (Fresno Bee 1951a: 13). The Field House was also constructed of concrete, as a building ban was in effect and concrete was not a restricted material. After Fort Ord closed in 1994, Warrior Stadium became part of the CSUMB campus. The stadium was rebranded as Freeman

**CONTINUATION SHEET**

Property Name: Freeman Stadium

Page 12 of 18

Stadium and has not been used for athletic purposes in some time, instead it is used for graduation ceremonies and other gatherings.

**Character-Defining Features for the Recreational Facilities**

The Recreation Facilities originally exhibited the following specific character-defining features:

| Character Aspect       | Primary character-defining features  | Character-defining features  |
|------------------------|--|--|
| Shape and Plan         | <ul style="list-style-type: none"> <li>• Arena form</li> <li>• Track</li> <li>• Field</li> <li>• Bleachers</li> <li>• Field House</li> </ul>                           | The overall shape and mass of the facility as well as circulation and arrangement of the bleachers relative to the field are considered primary character-defining features of Recreational Facilities.  |
| Roof                   | <ul style="list-style-type: none"> <li>• Various roof forms</li> <li>• Slight eave overhangs</li> </ul>  | Recreational Facilities have varied roof structures, but the retention of the form is a primary character-defining feature   |
| Openings               | <ul style="list-style-type: none"> <li>• Multi-light windows</li> <li>• Concession windows</li> </ul>  | Window openings are uniform in size and placement, windows are multi-light, and set into concrete openings. Replaced windows are not considered character-defining features as they fall outside the period of significance.   |
| Exterior Ornamentation | <ul style="list-style-type: none"> <li>• Minimal exterior ornamentation</li> <li>• Glass windows and glass block used as ornamentation</li> </ul>                      | Recreation Facilities were designed to be the backdrop to athletic competitions and events. They have little to no decorative ornamentation, with evenly spaced windows being the only decorative element.   |
| Materials              | <ul style="list-style-type: none"> <li>• Mass-produced and cost-effective materials</li> <li>• Concrete and CMU</li> <li>• Reinforced Concrete construction</li> </ul> | Recreation Facilities have simple, utilitarian designs. Buildings were constructed using mass-produced and cost-effective building materials that were readily available at the time of construction. For instance, buildings under the Recreational Facility type were constructed with reinforced concrete and were minimally decorated. |

Alterations and demolitions over time have compromised the overall architectural integrity of this building type. The most common alterations observed for Recreational Facilities typology include the following:



## CONTINUATION SHEET

Property Name: Freeman Stadium

Page 13 of 18

- Replacement windows
- Barrel roof additions
- Infill of openings
- HVAC systems and window units
- ADA compliance measures such as ramps and doors

### NRHP/CRHR Designation Criteria

In consideration of the project site's history and requisite integrity, Dudek recommends the property not eligible for listing in the NRHP and CRHR based on the following significance evaluation and in consideration of national and state eligibility criteria:

#### **Criterion A/1: That are associated with events that have made a significant contribution to the broad patterns of our history.**

Built in 1951, Freeman Stadium and associated buildings, were constructed for use by the fort's football team, the Warriors. The stadium was constructed after the core construction period of the base during a period when the military was working to increase recreational facilities and opportunities for service members. The initial base plan did not call for a stadium, with early practices and scrimmages taking place at nearby facilities. Both the increasing popularity of football and the desire to provide more avenues for athletic recreation, created a need for an on-site stadium at Fort Ord. This nationwide interest in sports and recreation resulted in numerous improvements to recreation facilities on army bases across America. While Freeman Stadium does reflect the post-war investment in recreation, that investment and subsequent infrastructure was not limited to or unique to Fort Ord. Utilitarian stadiums, such as these, were not uncommon. Freeman Stadium is not able to convey its association with any extraordinary events or events occurring within the context of Cold War and Vietnam military recreation buildings, the CSUMB Campus, or has an association with the broad patterns of history in Monterey County, the State of California, or the Nation. Therefore, the Dudek recommends the stadium is not eligible under NRHP/CRHR Criterion A/1.

#### **Criterion B/2: That are associated with the lives of persons significant in our past.**

To be found eligible under B/2 the property must be directly tied to an important person and the place where that individual conducted or produced the work for which he or she is known. Archival research indicated that Freeman Stadium, originally called the Warriors Stadium, was originally named after Fort Ord's football team, the Warriors. No single person was shown to be influential or directly associated with the stadium. As such this property is not known to have any historical associations with people important to the nation's or state's past. Due to a lack of identified significant associations with important persons in history, Dudek recommends the building is not eligible under NRHP/CRHR Criterion B/2.

#### **Criterion C/3: That embody the distinctive characteristics of a type, period, or method of construction, or that represent the work of a master, or that possess high artistic values, or that represent a significant and distinguishable entity whose components may lack individual distinction.**

Freeman Stadium was added to the Fort Ord in 1951. By 1952 the stadium included the track, football field, bleachers, electrical building, and the Field House. Research indicates that the stadium was designed using the amphitheater on the site and was designed by the Fort Ord Post Engineer Office.

## CONTINUATION SHEET

Property Name: Freeman Stadium

Page 14 of 18

The original design for the stadium, bleachers, and Field House were completed by architects and/or engineers who were employed by the Fort Ord Engineering Office. The building drawings identify "ROWE" as the individual who drew the plans and shows the plans were checked by an individual with the initials "M.O.R". No further information on these individuals was identified during archival research. The drawings were approved by Lt. Col. Post Engineer Menon W. Whitsitt. No further information was uncovered during archival research about Whitsitt, or the other's listed on the plan. None of the research identified a significant architect for Freeman Stadium, as such, no master architect is found to be associated with the design.

Lastly, stadiums are a ubiquitous type of recreational facility. Archival research did not identify Freeman Stadium as being distinctive in its type, period, and method of construction. There is no artistic value to the present paved track or paved field. The concrete stadium bleachers are a simple, utilitarian design. The field and track have been altered beyond recognition with numerous additions and replacement of original materials including new surfacing on the track and the paving and surfacing of the field. Additionally, the Field House, has undergone numerous, extensive alterations, including substantial changes to the plan, exterior cladding, and fenestration. Due to a lack of high artistic value, a lack of evidence suggesting Freeman Stadium is associated with a master architect, and substantial alterations, Dudek recommends the stadium is not eligible under NRHP/CRHR Criterion C/3.

**Criterion D/4: That have yielded, or may be likely to yield, information important in prehistory or history.**

There is no evidence to suggest that Freeman Stadium has the potential to yield information important to state or local history. Therefore, Dudek recommends the stadium is not eligible under NRHP/CRHR Criterion D/4.

**California Historic Landmark Statement of Significance**

In consideration of the Freeman Stadium's history and requisite integrity, Dudek recommends the property not eligible for designation as a California Historic Landmark based on the following significance evaluation and in consideration of state eligibility criteria:

**The first, last, only, or most significant of its type in the state or within a large geographic region (Northern, Central, or Southern California).**

Freeman Stadium was designed in 1949 and constructed in 1951. The stadium and associated buildings were constructed after the initial, core development period of Fort Ord in the 1940s. The stadium was conceptualized by architects employed through the Fort Ord Engineering office and is a ubiquitous building type that lacks high style components to set it apart from other stadiums constructed throughout the State of California in the 1950s. Therefore, Dudek recommends the stadium is not eligible for listing as a CHL under this criterion.

**Associated with an individual or group having a profound influence on the history of California.**

Archival research failed to indicate any significant associations between the subject property and individuals or groups that profoundly influenced the history of California. Freeman Stadium was developed by the military, and no single individual was found to have influenced design, construction, or use of the building. Therefore, Dudek recommends the stadium is not eligible for listing as a CHL under this criterion.

**A prototype of, or an outstanding example of, a period, style, architectural movement or construction or is one of the more notable works or the best surviving work in a region of a pioneer architect, designer or master builder.**

Freeman Stadium is neither a prototype or an outstanding example of a period, style, or

## CONTINUATION SHEET

Property Name: Freeman Stadium

Page 15 of 18

architectural movement. The stadium has been altered beyond recognition and it fails to convey either its style or its temporal period. It is a typical example of a sports arena, designed to serve a utilitarian purpose. There are no remaining identifying features on the Field House that would establish the building as a notable work of a master architect, or a notable designer or builder working within the military, or in the State of California. Therefore, Dudek recommends the stadium is not eligible for listing as a CHL under this criterion.

### Local Designation Criteria

Portions of the CSUMB campus are located within the boundaries of two cities, City of Seaside and the City of Marina, both of which evaluate historical resources in accordance with CEQA Guidelines. as presented above. The subject property, as discussed in the NRHP/CRHR/CHL criteria discussion above, does not rise to the necessary level of significance for local, state, or national designation. For these reasons, the subject property is recommended not eligible individually or as a component of a historic district under any of the NRHP/CRHR/CHL criteria.

Additionally, portions of the CSUMB campus are located in the County of Monterey and the campus is therefore subject to the regulations set forth in Chapter 18.25 of the Monterey County Code. The subject property, as discussed in the NRHP/CRHR/CHL criteria discussion above, does not rise to the necessary level of significance for state or national designation. For these same reasons, the subject property is also recommended not eligible individually or as a component of a historic district under any of the delineated County of Monterey review criteria categories that are addressed with the NRHP/CRHR/CHL criteria discussed above: A. Historical and Cultural Significance; B. Historic, Architectural, and Engineering Significance; or C. Community and Geographic Setting.

### Integrity Discussion

Freeman Stadium was analyzed against the seven aspects of integrity: location, design, setting, materials, workmanship, feeling, and association. The stadium retains its integrity of location, as it has not been relocated. However, the integrity of setting has been compromised with the demolition of adjacent buildings, new constructions, and changes in paths of circulation throughout the campus. Replacement materials have been added throughout the stadium since its completion in 1951, including new track materials, the paving of the field, removal of the goal posts, and extensive alterations and material changes to the Field House. These alterations have diminished the resource's integrity of design, materials, and workmanship. The stadium is no longer used as a football stadium and the site, once a bustling army base, is now home to a California State University campus. These changes to the surrounding area and the change of use, from a sports arena to an outdoor auditorium, have compromised the integrity of setting, feeling, and association. The changes to original materials and the change in original use prohibit the stadium from conveying significance or its temporal period.

### Summary of Evaluation Findings

Freeman Stadium retains little to no historic integrity and lacks historical and architectural significance. Based on the significance evaluations presented above, Freeman Stadium does not appear to meet the NRHP, CRHR, CHL or local designation criteria. Therefore, Freeman Stadium is not considered a historical resource for purposes of CEQA.

## CONTINUATION SHEET

Property Name: Freeman Stadium

Page 16 of 18

### \*B12. References (continued):

- ACHP (Advisory Council on Historic Preservation). 2006. "Draft Program Comment Regarding Cold War Era Unaccompanied Personnel Housing." Federal Register: The Daily Journal of the United States Government. 12 April 2016. Accessed June 30, 2021 Available at: <https://www.federalregister.gov/documents/2006/04/12/06-3509/draft-program-comment-regarding-cold-war-era-unaccompanied-personnel-housing>
- Californian, The. 1940. "No More Camp Ord! It's Fort Ord Now! Stilwell in Command: Headquarters of General Located on Salinas Side." July 13, 1940. Salinas, California, pg. 1.
- Californian, The. 1951. Stadium Field House—Sixth Army Lets Ord Contract. March 20, 1951. P1. Accessed June 17, 2021. Available at: [Newspapers.com](http://Newspapers.com).
- Castle, Ted. 1990. "The March of Time." Fort Ord Panorama. September 21, 1990.
- Cavanaugh, Joe. 2000. *The Peace Dividend: Defense Conversion Through Higher Education*. The Leon Panetta Institute.
- Chamberlin Library. 2021. Fort Ord Working Papers. CSUMB Special Collections Box 6.42-01. Available at the Chamberlin Library, Seaside, California.
- CSUMB Facilities. 2021. Original As built and renovation architectural drawings on file with CSUMB facilities department. Accessed in person June 15-16, 2021.
- DLIFLC (Defense Language Institute Foreign Language Center). 2021. Command History Program. Accessed in person on June 15, 2021 and accessed online database collection online July 2021. Available at: <https://adli.pastperfectonline.com/>
- EA Engineering. 1991. Draft Final Fort Ord, California Base wide Remedial Investigation Feasibility Study. Volume 1 Literature Review and Base Inventory Report. Accessed on July 13, 2021. Available at: <https://www.fortordcleanup.com/documents/search/>
- Fresno Bee, The. 1951a. "Army Spokesman Are Defending Building of Fort Ord Stadium." January 12, 1951. Page 13. Accessed June 17, 2021.
- Fresno Bee, The. 1951b. "Army Spokesman Are Defending Building of Fort Ord Stadium." February 4, 1951. Page 27. Accessed June 17, 2021. Available at: [Newspapers.com](http://Newspapers.com).
- Gates, S., & Williams, H. 1957. The Armed Forces. The Annals of the American Academy of Political and Social Science, 313, 99-104. Accessed June 17, 2021. <http://proxy.multcolib.org:2052/stable/1031762>
- Hollaway, Chuck. 2021. Chuck Hollaway Chronicles. Accessed June 18, 2021. <http://www.chuckhollaway.com/part-2>.
- MacGregor Jr., Morris J. 1981. Integration of the Armed Forces, 1940-1965. Center of Military History, United States Army: Washington, D.C.

## CONTINUATION SHEET

Property Name: Freeman Stadium

Page 17 of 18

- Madsen, Alexandra and Steven Treffers. 2019. *Historic Resources Evaluation Memorandum for Hammerhead Barracks at Fort Ord, Monterey County, California*. Prepared by Rincon Consultants, Inc for City of Seaside, Community and Economic Development Department. November 4, 2019. Accessed June 28, 2021.  
[https://www.ci.seaside.ca.us/DocumentCenter/View/10674/9\\_App-S---HRE-Memo](https://www.ci.seaside.ca.us/DocumentCenter/View/10674/9_App-S---HRE-Memo)
- Military Museum. 2016. "Historic California Posts, Camps, Stations, and Airfields: Fort Ord." Accessed on June 19, 2021. <http://www.militarymuseum.org/FtOrd.html>
- National Archives Foundation. 2021. Executive Order 9981. Accessed June 29, 2021. Available at: <https://www.archivesfoundation.org/documents/executive-order-9981-ending-segregation-armed-forces/>
- NETR (Nationwide Environmental Title Research LLC). 2021. Historic Aerial Photographs of 100 Campus Center, Seaside, CA 93955 dating from 1956, 1968, 1981, 1998, 2005, 2009, 2010, 2012, 2014, 2016, and 2018. Accessed June 10, 2021.  
<https://www.historicaerials.com/viewer>
- Panorama. 1990. "50 Years and Counting..." September 21, 1990, pg. 2.
- Panorama. n.d. "Ford Ord in World War II." Historic California Posts: Fort Ord. Accessed on June 19, 2021. <http://www.militarymuseum.org/FtOrd.html>
- Park, R. 2015. "Happy and Cheerful in This Fine Camp": Sports, Recreation, and the United States Army at Fort Ord and Camp Roberts, 1940 to 1945. *Journal of Sport History*, 42(1), 21-37. Accessed on June 18, 2021, from  
<https://www.jstor.org/stable/10.5406/jsporthistory.42.1.21>
- Pomona Progress Bulletin. 1950. War Solving Racial Problems. August 24, 1950. Page 4. Accessed June 29, 2021. Available at: [Newspapers.com](http://www.newspapers.com).
- Quartermaster Review, The. 1940. "Army Construction Underway at Camp Ord, California." Volume XX. No 3. November-December. On file at the Chamberlin Library, Ord Military Community.
- Raugh, Harold E. 2004. Fort Ord. Charleston, SC: Arcadia.
- Salinas Morning Post. 1940. "\$2,766,000 in Building Authorized—Ord Contracts Let." August 21, 1940. Salinas, CA. pg. 1.
- San Francisco Examiner. 1951. Fort Ord Will Get Stadium. San Francisco Page 4. · 3 Feb 1951. Pages 1 and 4 A Available on [www.Newspapers.com](http://www.newspapers.com). Accessed on Jun 11, 2021.
- San Francisco Examiner. 1958. Army Asks OK on \$124,000,000 for Fort Ord Buildings. San Francisco. Section 2. Page. 4. Available on [www.Newspapers.com](http://www.newspapers.com). Accessed July 18, 2021.
- Seattle Times. 1953. "Fort Ord Will Be Ramblers' Next Foe" Sunday November 15, 1953. Seattle, Washington. Accessed on June 18, 2021. [www.Newsbank.com](http://www.newsbank.com).

## CONTINUATION SHEET

Property Name: Freeman Stadium

Page 18 of 18

SportspressNW. 2012. Wayback Machine: 'Deadeye' Don Heinrich. Accessed on June 18, 2021. Available at: <http://sportspressnw.com/2140579/2012/wayback-machine-deadeye-don-heinrich>.

Vasche, J. Burton. 1959. "The California State Colleges: Their History, Organization, Purposes, and Programs." in California

U.S. Army. 1977. Post Map Main Garrison Area. Fort Ord, California. Drawing number G-950. Accessed in person at the Chamberlain Library on June 15, 2021.

Walch, Bob. 2004. An Army Historian's Pictorial Take on Fort Ord. Monterey County NOW. Accessed July 12, 2021. Available at: [https://www.montereycountyweekly.com/news/local\\_news/an-army-historian-s-pictorial-take-on-fort-ord/article\\_6e8b0250-9c38-5ca4-a4a4-f93d42d65a11.html](https://www.montereycountyweekly.com/news/local_news/an-army-historian-s-pictorial-take-on-fort-ord/article_6e8b0250-9c38-5ca4-a4a4-f93d42d65a11.html)

Whaley, Derek. 2015. "East Monterey & Seaside." Santa Cruz Trains: Railroads of the Monterey Bay Area. July 20, 2015. Accessed online: <https://www.santacruztrains.com/2015/07/east-monterey-seaside.html>.

Webb Spinner, The. 1952-1954. Webb Spinner Volume for 1952-1954. Del Webb Sun Cities Museum Collection. Accessed June 30, 2021. Accessed at: <https://delwebbsuncitiesmuseum.org/newsletters-webb-spinners/>

# **APPENDIX G**

## **Noise Measurements and Calculations**

INTENTIONALLY LEFT BLANK



# FIELD NOISE MEASUREMENT DATA

PROJECT C.SUMB CAMPUS MASTER PLAN PROJECT # 10357  
 SITE ID ST-1  
 SITE ADDRESS \_\_\_\_\_ OBSERVER(S) DAVID ORTEGA  
 START DATE 5/23/19 END DATE 5/23/19  
 START TIME 1005 END TIME 1025

**METEOROLOGICAL CONDITIONS**  
 TEMP 62 F HUMIDITY 70 % R.H. WIND ALM LIGHT MODERATE  
 WINDSPD 2 MPH DIR. N NE S SE S SW W NW VARIABLE STEADY GUSTY  
 SKY SUNNY CLEAR OVERCAST PRTL CLDY FOG RAIN

**ACOUSTIC MEASUREMENTS**  
 MEAS. INSTRUMENT Piccolo II TYPE 1 2 SERIAL # P0218020900  
 CALIBRATOR \_\_\_\_\_ SERIAL # \_\_\_\_\_  
 CALIBRATION CHECK PRE-MEASUREMENT 94 dBA SPL POST-MEASUREMENT \_\_\_\_\_ dBA SPL WINDSCRN Yes

**SETTINGS** A-WTD SLOW FAST FRONTAL RANDOM ANSI OTHER: \_\_\_\_\_

| REC. # | BEGIN       | END         | Leq         | Lmax        | Lmin        | L90         | L50         | L10         | OTHER (SPECIFY METRIC) |
|--------|-------------|-------------|-------------|-------------|-------------|-------------|-------------|-------------|------------------------|
|        | <u>1005</u> | <u>1025</u> | <u>55.7</u> | <u>74.2</u> | <u>45.4</u> | <u>49.2</u> | <u>52.6</u> | <u>59.1</u> |                        |
|        |             |             |             |             |             |             |             |             |                        |
|        |             |             |             |             |             |             |             |             |                        |
|        |             |             |             |             |             |             |             |             |                        |

COMMENTS \_\_\_\_\_

**SOURCE INFO AND TRAFFIC COUNTS**  
 PRIMARY NOISE SOURCE TRAFFIC AIRCRAFT RAIL INDUSTRIAL OTHER: \_\_\_\_\_  
 ROADWAY TYPE: ARTERIAL DIST. TO RDWY C/L OR EOP: 10 Feet

TRAFFIC COUNT DURATION: 20 MIN SPEED 35 mph MIN SPEED \_\_\_\_\_  
 DIST. TO RDWY C/L OR EOP: 10 Feet

| COUNT 1<br>(OR RDWY 1) | DIRECTION | NB/EB     |       | SB/WB |       | IF COUNTING BOTH DIRECTIONS AS ONE, CHECK HERE | COUNT 2<br>(OR RDWY 2) | NB/EB |       | SB/WB |  |
|------------------------|-----------|-----------|-------|-------|-------|--|------------------------|-------|-------|-------|--|
|                        |           | NB/EB     | SB/WB | NB/EB | SB/WB |  |                        | NB/EB | SB/WB |       |  |
|                        | AUTOS     | <u>75</u> |       |       |       | <u>X</u>                                       |                        |       |       |       |  |
|                        | MED TRKS  | <u>1</u>  |       |       |       |  |                        |       |       |       |  |
|                        | HVY TRKS  | <u>1</u>  |       |       |       |  |                        |       |       |       |  |
|                        | BUSES     | <u>0</u>  |       |       |       |  |                        |       |       |       |  |
|                        | MOTRCLS   | <u>0</u>  |       |       |       |  |                        |       |       |       |  |

SPEEDS ESTIMATED BY: RADAR / DRIVING THE PACE  
 POSTED SPEED LIMIT SIGNS SAY: 35 mph

OTHER NOISE SOURCES (BACKGROUND): DIST. AIRCRAFT RUSTLING LEAVES DIST. BARKING DOGS BIRDS DIST. INDUSTRIAL  
 DIST. KIDS PLAYING DIST. CONVRSTNS / YELLING DIST. TRAFFIC (LIST RDWYS BELOW) DISTD GARDENERS/LANDSCAPING NOISE  
 OTHER: \_\_\_\_\_

**DESCRIPTION / SKETCH**  
 TERRAIN HARD SOFT MIXED FLAT OTHER: \_\_\_\_\_  
 PHOTOS Tri-pod base is 6 inches higher than road (on top of curb)  
 OTHER COMMENTS / SKETCH \_\_\_\_\_

# FIELD NOISE MEASUREMENT DATA

|   |                                 |
|---|---------------------------------|
| PROJECT <u>CSUMB CAMPUS MASTER PLAN</u> | PROJECT # <u>10357</u>          |
| SITE ID <u>ST-2</u>                     |                                 |
| SITE ADDRESS _____                      | OBSERVER(S) <u>DAVID ORTEGA</u> |
| START DATE <u>5/23/19</u>               | END DATE <u>5/23/19</u>         |
| START TIME <u>1052</u>                  | END TIME <u>1112</u>            |

**METEOROLOGICAL CONDITIONS**

TEMP 62 F HUMIDITY 70 % R.H. WIND CALM LIGHT MODERATE  
WINDSPD 2 MPH DIR. N NE S SE S SW W NW VARIABLE STEADY GUSTY  
SKY SUNNY CLEAR OVRCAST PRTLY CLDY FOG RAIN

**ACOUSTIC MEASUREMENTS**

MEAS. INSTRUMENT PICCOLO II TYPE 1 (2) SERIAL # P0218020906  
CALIBRATOR \_\_\_\_\_ SERIAL # \_\_\_\_\_  
CALIBRATION CHECK PRE-MEASUREMENT 94 dBA SPL POST-MEASUREMENT \_\_\_\_\_ dBA SPL WINDSCRN Yes

SETTINGS (A-WTD) (SLOW) FAST FRONTAL RANDOM ANSI OTHER: \_\_\_\_\_

| REC. # | BEGIN       | END         | Leq         | Lmax        | Lmin        | L90       | L50         | L10         | OTHER (SPECIFY METRIC) |
|--------|-------------|-------------|-------------|-------------|-------------|-----------|-------------|-------------|------------------------|
|        | <u>1052</u> | <u>1112</u> | <u>58.1</u> | <u>83.3</u> | <u>36.2</u> | <u>40</u> | <u>47.7</u> | <u>60.8</u> |                        |
|        |             |             |             |             |             |           |             |             |                        |
|        |             |             |             |             |             |           |             |             |                        |
|        |             |             |             |             |             |           |             |             |                        |
|        |             |             |             |             |             |           |             |             |                        |

COMMENTS \_\_\_\_\_

**SOURCE INFO AND TRAFFIC COUNTS**

PRIMARY NOISE SOURCE TRAFFIC AIRCRAFT RAIL INDUSTRIAL OTHER: \_\_\_\_\_  
ROADWAY TYPE: COLLECTOR DIST. TO RDWY C/L OR EDP: 5 Feet

TRAFFIC COUNT DURATION: 20 MIN SPEED 30 mph

|                     | MIN       |       | SPEED |       | IF COUNTING BOTH DIRECTIONS AS ONE, CHECK HERE | MIN   |       | SPEED |       |
|---------------------|-----------|-------|-------|-------|--|-------|-------|-------|-------|
|                     | NB/EB     | SB/WB | NB/EB | SB/WB |  | NB/EB | SB/WB | NB/EB | SB/WB |
| COUNT 1 (OR RDWY 1) |           |       |       |       |  |       |       |       |       |
| AUTOS               | <u>33</u> |       |       |       |  |       |       |       |       |
| MED TRKS            | <u>6</u>  |       |       |       |  |       |       |       |       |
| HVY TRKS            | <u>2</u>  |       |       |       |  |       |       |       |       |
| BUSES               | <u>1</u>  |       |       |       |  |       |       |       |       |
| MOTRCLS             | <u>0</u>  |       |       |       | <u>X</u>                                       |       |       |       |       |
| COUNT 2 (OR RDWY 2) |           |       |       |       |  |       |       |       |       |

SPEEDS ESTIMATED BY: RADAR / DRIVING THE PACE  
POSTED SPEED LIMIT SIGNS SAY: \_\_\_\_\_

OTHER NOISE SOURCES (BACKGROUND): DIST. AIRCRAFT RUSTLING LEAVES DIST. BARKING DOGS BIRDS DIST. INDUSTRIAL  
DIST. KIDS PLAYING DIST. CONVRSTNS / YELLING DIST. TRAFFIC (LIST RDWYS BELOW) DISTD GARDENERS/LANDSCAPING NOISE  
OTHER: \_\_\_\_\_

**DESCRIPTION / SKETCH**

TERRAIN (HARD) SOFT MIXED FLAT OTHER: \_\_\_\_\_  
PHOTOS Tri-pod base is 6 inches higher than road (on top of curb)  
OTHER COMMENTS / SKETCH \_\_\_\_\_

# FIELD NOISE MEASUREMENT DATA

PROJECT CSUMB CAMPUS MASTER PLAN PROJECT # 10357  
 SITE ID ST-3  
 SITE ADDRESS \_\_\_\_\_ OBSERVER(S) DAVID ORTEGA  
 START DATE 5/23/19 END DATE 5/23/19  
 START TIME 1143 END TIME 1203

**METEOROLOGICAL CONDITIONS**  
 TEMP 62 F HUMIDITY 70 % R.H. WIND CALM LIGHT MODERATE  
 WINDSPD 2 MPH DIR. N NE S SE S SW W NW VARIABLE STEADY GUSTY  
 SKY SUNNY CLEAR OVRCAST PRTLY CLDY FOG RAIN

**ACOUSTIC MEASUREMENTS**  
 MEAS. INSTRUMENT Piccolo II TYPE 1 2 SERIAL # P0218020900  
 CALIBRATOR \_\_\_\_\_ SERIAL # \_\_\_\_\_  
 CALIBRATION CHECK PRE-MEASUREMENT 94 dBA SPL POST-MEASUREMENT \_\_\_\_\_ dBA SPL WINDSCRN YES

SETTINGS A-WTD SLOW FAST FRONTAL RANDOM ANSI OTHER: \_\_\_\_\_

| REC. # | BEGIN       | END         | Leq         | Lmax        | Lmin      | L90       | L50         | L10         | OTHER (SPECIFY METRIC) |
|--------|-------------|-------------|-------------|-------------|-----------|-----------|-------------|-------------|------------------------|
|        | <u>1143</u> | <u>1203</u> | <u>53.8</u> | <u>69.9</u> | <u>39</u> | <u>44</u> | <u>49.1</u> | <u>58.8</u> |                        |
|        |             |             |             |             |           |           |             |             |                        |
|        |             |             |             |             |           |           |             |             |                        |
|        |             |             |             |             |           |           |             |             |                        |

COMMENTS \_\_\_\_\_

**SOURCE INFO AND TRAFFIC COUNTS**  
 PRIMARY NOISE SOURCE TRAFFIC AIRCRAFT RAIL INDUSTRIAL OTHER: \_\_\_\_\_  
 ROADWAY TYPE: COLLECTOR DIST. TO RDWY C/L OR EOP: 10 Feet

TRAFFIC COUNT DURATION: 20 MIN SPEED 25 mph

| COUNT 1<br>(OR RDWY 1) | DIRECTION |       | MIN | SPEED | IF COUNTING BOTH DIRECTIONS AS ONE, CHECK HERE | COUNT 2<br>(OR RDWY 2) |       |
|------------------------|-----------|-------|-----|-------|--|------------------------|-------|
|                        | NB/EB     | SB/WB |     |       |  | NB/EB                  | SB/WB |
| AUTOS                  | <u>41</u> |       |     |       | <u>X</u>                                       |                        |       |
| MED TRKS               | <u>4</u>  |       |     |       |  |                        |       |
| HVY TRKS               | <u>1</u>  |       |     |       |  |                        |       |
| BUSES                  | <u>0</u>  |       |     |       |  |                        |       |
| MOTRCLS                | <u>0</u>  |       |     |       |  |                        |       |

SPEEDS ESTIMATED BY: RADAR / DRIVING THE PACE  
 POSTED SPEED LIMIT SIGNS SAY: 25 mph

OTHER NOISE SOURCES (BACKGROUND): DIST. AIRCRAFT RUSTLING LEAVES DIST. BARKING DOGS BIRDS DIST. INDUSTRIAL  
 DIST. KIDS PLAYING DIST. CONVRSTNS / YELLING DIST. TRAFFIC (LIST RDWYS BELOW) DISTD GARDENERS/LANDSCAPING NOISE  
 OTHER: Construction vehicle beeping in distant background

**DESCRIPTION / SKETCH**  
 TERRAIN HARD SOFT MIXED FLAT OTHER: \_\_\_\_\_  
 PHOTOS Tri-pod base is 6 inches higher than road (on top of curb)  
 OTHER COMMENTS / SKETCH \_\_\_\_\_

# FIELD NOISE MEASUREMENT DATA

|   |                                 |
|---|---------------------------------|
| PROJECT <u>CSUMB CAMPUS MASTER PLAN</u> | PROJECT # <u>10357</u>          |
| SITE ID <u>ST-4</u>                     |                                 |
| SITE ADDRESS _____                      | OBSERVER(S) <u>DAVID ORTEGA</u> |
| START DATE <u>5/23/19</u>               | END DATE <u>5/23/19</u>         |
| START TIME <u>1224</u>                  | END TIME <u>1244</u>            |

**METEOROLOGICAL CONDITIONS**

TEMP 62 F      HUMIDITY 70 % R.H.      WIND CALM LIGHT      MODERATE  
WINDSPD 2 MPH      DIR. N NE S SE S SW W NW      VARIABLE STEADY GUSTY  
SKY SUNNY CLEAR OVRCAST      PRTLY CLDY      FOG      RAIN

**ACOUSTIC MEASUREMENTS**

MEAS. INSTRUMENT Piccolo II      TYPE 1 2      SERIAL # P0218020900  
CALIBRATOR \_\_\_\_\_      SERIAL # \_\_\_\_\_  
CALIBRATION CHECK      PRE-MEASUREMENT 94 dBA SPL      POST-MEASUREMENT \_\_\_\_\_ dBA SPL      WINDSCRN yes

SETTINGS      A-WTD SLOW      FAST      FRONTAL      RANDOM      ANSI      OTHER: \_\_\_\_\_

| REC. # | BEGIN       | END         | Leq         | Lmax        | Lmin        | L90         | L50       | L10         | OTHER (SPECIFY METRIC) |
|--------|-------------|-------------|-------------|-------------|-------------|-------------|-----------|-------------|------------------------|
| _____  | <u>1224</u> | <u>1244</u> | <u>53.6</u> | <u>71.5</u> | <u>33.9</u> | <u>40.1</u> | <u>48</u> | <u>58.2</u> | _____                  |
| _____  | _____       | _____       | _____       | _____       | _____       | _____       | _____     | _____       | _____                  |
| _____  | _____       | _____       | _____       | _____       | _____       | _____       | _____     | _____       | _____                  |
| _____  | _____       | _____       | _____       | _____       | _____       | _____       | _____     | _____       | _____                  |

COMMENTS \_\_\_\_\_

**SOURCE INFO AND TRAFFIC COUNTS**

PRIMARY NOISE SOURCE TRAFFIC      AIRCRAFT      RAIL      INDUSTRIAL      OTHER: \_\_\_\_\_  
ROADWAY TYPE: COLLECTOR      DIST. TO RDWY C/L OR EOP      10 Feet

TRAFFIC COUNT DURATION: 20 MIN      SPEED 25 mph

| COUNT 1<br>(OR RDWY 1) | DIRECTION | NB/EB     |       | SB/WB |       | IF COUNTING BOTH DIRECTIONS AS ONE, CHECK HERE | COUNT 2<br>(OR RDWY 2) | NB/EB |       | SB/WB |       |
|------------------------|-----------|-----------|-------|-------|-------|--|------------------------|-------|-------|-------|-------|
|                        |           | NB/EB     | SB/WB | NB/EB | SB/WB |  |                        | NB/EB | SB/WB |       |       |
|                        | AUTOS     | <u>63</u> | _____ | _____ | _____ | <u>X</u>                                       |                        | _____ | _____ | _____ | _____ |
|                        | MED TRKS  | <u>1</u>  | _____ | _____ | _____ | _____  |                        | _____ | _____ | _____ | _____ |
|                        | HVY TRKS  | <u>0</u>  | _____ | _____ | _____ | _____  |                        | _____ | _____ | _____ | _____ |
|                        | BUSES     | <u>1</u>  | _____ | _____ | _____ | _____  |                        | _____ | _____ | _____ | _____ |
|                        | MOTRCLS   | <u>0</u>  | _____ | _____ | _____ | _____  |                        | _____ | _____ | _____ | _____ |

SPEEDS ESTIMATED BY: RADAR / DRIVING THE PACE  
POSTED SPEED LIMIT SIGNS SAY: 25 mph

OTHER NOISE SOURCES (BACKGROUND): DIST. AIRCRAFT      RUSTLING LEAVES      DIST. BARKING DOGS BIRDS      DIST. INDUSTRIAL  
DIST. KIDS PLAYING      DIST. CONVRSTNS / YELLING      DIST. TRAFFIC (LIST RDWYS BELOW)      DISTD GARDENERS/LANDSCAPING NOISE  
OTHER: \_\_\_\_\_

**DESCRIPTION / SKETCH**

TERRAIN      HARD      SOFT      MIXED      FLAT      OTHER: \_\_\_\_\_  
PHOTOS Tri-pod base is 6 inches higher than road (on top of curb)  
OTHER COMMENTS / SKETCH

The sketch shows a road layout on a grid. A road curves from the bottom left towards the top right. A 'Round-about' is indicated by a circle and arrows. A vertical line segment is labeled '10 ft'. A compass rose is in the bottom left corner.

# FIELD NOISE MEASUREMENT DATA

PROJECT CSUMB CAMPUS MASTER PLAN PROJECT # 10357  
 SITE ID ST-5  
 SITE ADDRESS \_\_\_\_\_ OBSERVER(S) DAVID ORTEGA  
 START DATE 5/23/19 END DATE 5/23/19  
 START TIME 1312 END TIME 1332

**METEOROLOGICAL CONDITIONS**  
 TEMP 62 F HUMIDITY 70 % R.H. WIND ALM LIGHT MODERATE  
 WINDSPD 2 MPH DIR. N NE S SE S SW W NW VARIABLE STEADY GUSTY  
 SKY SUNNY CLEAR OVRCAST PRTLY CLDY FOG RAIN

**ACOUSTIC MEASUREMENTS**  
 MEAS. INSTRUMENT Piccolo II TYPE 1 2 SERIAL # P0218020900  
 CALIBRATOR \_\_\_\_\_ SERIAL # \_\_\_\_\_  
 CALIBRATION CHECK PRE-MEASUREMENT 94 dBA SPL POST-MEASUREMENT \_\_\_\_\_ dBA SPL WINDSCRN Yes

SETTINGS A-WTD SLOW FAST FRONTAL RANDOM ANSI OTHER: \_\_\_\_\_

| REC. # | BEGIN       | END         | Leq         | Lmax        | Lmin        | L90         | L50         | L10         | OTHER (SPECIFY METRIC) |
|--------|-------------|-------------|-------------|-------------|-------------|-------------|-------------|-------------|------------------------|
|        | <u>1312</u> | <u>1332</u> | <u>59.2</u> | <u>75.6</u> | <u>48.5</u> | <u>52.2</u> | <u>55.9</u> | <u>62.8</u> |                        |
|        |             |             |             |             |             |             |             |             |                        |
|        |             |             |             |             |             |             |             |             |                        |
|        |             |             |             |             |             |             |             |             |                        |

COMMENTS \_\_\_\_\_

**SOURCE INFO AND TRAFFIC COUNTS**  
 PRIMARY NOISE SOURCE TRAFFIC AIRCRAFT RAIL INDUSTRIAL OTHER: \_\_\_\_\_  
 ROADWAY TYPE: ARTERIAL DIST. TO RDWY C/L OR EOP 5 feet

| TRAFFIC COUNT DURATION: <u>20</u> MIN | SPEED <u>35 mph</u> |       | MIN   |       | SPEED |       |
|---------------------------------------|---------------------|-------|-------|-------|-------|-------|
|                                       | NB/EB               | SB/WB | NB/EB | SB/WB | NB/EB | SB/WB |
| COUNT 1 (OR RDWY 1)                   |                     |       |       |       |       |       |
| DIRECTION                             | NB/EB               | SB/WB | NB/EB | SB/WB | NB/EB | SB/WB |
| AUTOS                                 | <u>97</u>           |       |       |       |       |       |
| MED TRKS                              | <u>5</u>            |       |       |       |       |       |
| HVY TRKS                              | <u>2</u>            |       |       |       |       |       |
| BUSES                                 | <u>0</u>            |       |       |       |       |       |
| MOTRCLS                               | <u>0</u>            |       |       |       |       |       |
|                                       |                     |       |       |       |       |       |

IF COUNTING BOTH DIRECTIONS AS ONE, CHECK HERE X

SPEEDS ESTIMATED BY: RADAR / DRIVING THE PACE  
 POSTED SPEED LIMIT SIGNS SAY: 35 mph

OTHER NOISE SOURCES (BACKGROUND): DIST. AIRCRAFT RUSTLING LEAVES DIST. BARKING DOGS BIRDS DIST. INDUSTRIAL  
 DIST. KIDS PLAYING DIST. CONVRSTNS / YELLING DIST. TRAFFIC (LIST RDWYS BELOW) DISTD GARDENERS/LANDSCAPING NOISE  
 OTHER: \_\_\_\_\_

**DESCRIPTION / SKETCH**  
 TERRAIN HARD SOFT MIXED FLAT OTHER: \_\_\_\_\_  
 PHOTOS Tri-pod base is 6 inches higher than road (on top of curb)  
 OTHER COMMENTS / SKETCH

# FIELD NOISE MEASUREMENT DATA

|   |                                 |
|---|---------------------------------|
| PROJECT <u>CSUMB CAMPUS MASTER PLAN</u> | PROJECT # <u>10357</u>          |
| SITE ID <u>ST-6</u>                     |                                 |
| SITE ADDRESS _____                      | OBSERVER(S) <u>DAVID ORTEGA</u> |
| START DATE <u>5/23/19</u>               | END DATE <u>5/23/19</u>         |
| START TIME <u>1355</u>                  | END TIME <u>1415</u>            |

**METEOROLOGICAL CONDITIONS**

|                        |                                 |  |
|------------------------|---------------------------------|--|
| TEMP <u>62</u> F       | HUMIDITY <u>70</u> % R.H.       | WIND <u>CALM</u> <u>LIGHT</u> MODERATE |
| WINDSPD <u>2</u> MPH   | DIR. <u>N</u> NE S SE S SW W NW | VARIABLE STEADY GUSTY                  |
| SKY <u>SUNNY CLEAR</u> | <u>OVRCAST</u> PRTL CLDY FOG    | RAIN                                   |

**ACOUSTIC MEASUREMENTS**

MEAS. INSTRUMENT Piccolo II TYPE 1 2 SERIAL # P028020900

CALIBRATOR \_\_\_\_\_ SERIAL # \_\_\_\_\_

CALIBRATION CHECK PRE-MEASUREMENT 94 dBA SPL POST-MEASUREMENT \_\_\_\_\_ dBA SPL WINDSCRN yes

SETTINGS A-WTD SLOW FAST FRONTAL RANDOM ANSI OTHER: \_\_\_\_\_

| REC. # | BEGIN       | END         | Leq         | Lmax        | Lmin        | L90         | L50       | L10         | OTHER (SPECIFY METRIC) |
|--------|-------------|-------------|-------------|-------------|-------------|-------------|-----------|-------------|------------------------|
|        | <u>1355</u> | <u>1415</u> | <u>55.9</u> | <u>75.3</u> | <u>38.3</u> | <u>44.4</u> | <u>50</u> | <u>59.5</u> |                        |
|        |             |             |             |             |             |             |           |             |                        |
|        |             |             |             |             |             |             |           |             |                        |
|        |             |             |             |             |             |             |           |             |                        |
|        |             |             |             |             |             |             |           |             |                        |

COMMENTS \_\_\_\_\_

**SOURCE INFO AND TRAFFIC COUNTS**

PRIMARY NOISE SOURCE TRAFFIC AIRCRAFT RAIL INDUSTRIAL OTHER: \_\_\_\_\_

ROADWAY TYPE: COLLECTOR DIST. TO RDWY C/L OR EOP 1 Foot

TRAFFIC COUNT DURATION: 20 MIN SPEED 35 mph

|          | DIRECTION | COUNT 1 (OR RDWY 1) |       | COUNT 2 (OR RDWY 2) |       | IF COUNTING BOTH DIRECTIONS AS ONE, CHECK HERE |
|----------|-----------|---------------------|-------|---------------------|-------|--|
|          |           | NB/EB               | SB/WB | NB/EB               | SB/WB |  |
| AUTOS    |           | <u>35</u>           |       |                     |       | <u>X</u>                                       |
| MED TRKS |           | <u>0</u>            |       |                     |       |  |
| HVY TRKS |           | <u>0</u>            |       |                     |       |  |
| BUSES    |           | <u>0</u>            |       |                     |       |  |
| MOTRCLS  |           | <u>0</u>            |       |                     |       |  |

SPEEDS ESTIMATED BY: RADAR / DRIVING THE PACE  
POSTED SPEED LIMIT SIGNS SAY: 35 mph

OTHER NOISE SOURCES (BACKGROUND): DIST. AIRCRAFT RUSTLING LEAVES DIST. BARKING DOGS BIRDS DIST. INDUSTRIAL  
DIST. KIDS PLAYING DIST. CONVRSTNS / YELLING DIST. TRAFFIC (LIST RDWYS BELOW) DISTD GARDENERS/LANDSCAPING NOISE  
OTHER: \_\_\_\_\_

**DESCRIPTION / SKETCH**

TERRAIN HARD SOFT MIXED FLAT OTHER: \_\_\_\_\_

PHOTOS Tri-pod base is 6 inches higher than road (on top of curb)

OTHER COMMENTS / SKETCH

# FIELD NOISE MEASUREMENT DATA

|   |                                 |
|---|---------------------------------|
| PROJECT <u>CSUMB CAMPUS MASTER PLAN</u> | PROJECT # <u>10357</u>          |
| SITE ID <u>ST-7</u>                     |                                 |
| SITE ADDRESS _____                      | OBSERVER(S) <u>DAVID ORTEGA</u> |
| START DATE <u>5/23/19</u>               | END DATE <u>5/23/19</u>         |
| START TIME <u>1430</u>                  | END TIME <u>1450</u>            |

**METEOROLOGICAL CONDITIONS**

TEMP 62 F HUMIDITY 70 % R.H. WIND CALM LIGHT MODERATE  
WINDSPD 2 MPH DIR. N NE S SE S SW W NW VARIABLE STEADY GUSTY  
SKY SUNNY CLEAR OVRCAST PRTLY CLDY FOG RAIN

**ACOUSTIC MEASUREMENTS**

MEAS. INSTRUMENT PICCOLO II TYPE 1 2 SERIAL # P0218020900  
CALIBRATOR \_\_\_\_\_ SERIAL # \_\_\_\_\_  
CALIBRATION CHECK PRE-MEASUREMENT 94 dBA SPL POST-MEASUREMENT \_\_\_\_\_ dBA SPL WINDSCRN yes

SETTINGS A-WTD SLOW FAST FRONTAL RANDOM ANSI OTHER: \_\_\_\_\_

| REC. # | BEGIN       | END         | Leq         | Lmax        | Lmin        | L90         | L50         | L10         | OTHER (SPECIFY METRIC) |
|--------|-------------|-------------|-------------|-------------|-------------|-------------|-------------|-------------|------------------------|
|        | <u>1430</u> | <u>1450</u> | <u>63.5</u> | <u>87.7</u> | <u>38.8</u> | <u>50.3</u> | <u>56.6</u> | <u>66.1</u> |                        |
|        |             |             |             |             |             |             |             |             |                        |
|        |             |             |             |             |             |             |             |             |                        |
|        |             |             |             |             |             |             |             |             |                        |
|        |             |             |             |             |             |             |             |             |                        |

COMMENTS \_\_\_\_\_

**SOURCE INFO AND TRAFFIC COUNTS**

PRIMARY NOISE SOURCE TRAFFIC AIRCRAFT RAIL INDUSTRIAL OTHER: \_\_\_\_\_  
ROADWAY TYPE: COLLECTOR DIST. TO RDWY C/L OR EOP: 3 Feet

TRAFFIC COUNT DURATION: 20 MIN SPEED 35 mph MIN SPEED \_\_\_\_\_  
COUNT 1 (OR RDWY 1) DIRECTION NB/EB SB/WB NB/EB SB/WB IF COUNTING BOTH DIRECTIONS AS ONE, CHECK HERE COUNT 2 (OR RDWY 2)

| COUNT 1 (OR RDWY 1) | DIRECTION |       | SPEED |       | IF COUNTING BOTH DIRECTIONS AS ONE, CHECK HERE | COUNT 2 (OR RDWY 2) |       |
|---------------------|-----------|-------|-------|-------|--|---------------------|-------|
|                     | NB/EB     | SB/WB | NB/EB | SB/WB |  | NB/EB               | SB/WB |
| AUTOS               | <u>87</u> |       |       |       |  |                     |       |
| MED TRKS            | <u>5</u>  |       |       |       |  |                     |       |
| HVY TRKS            | <u>0</u>  |       |       |       |  |                     |       |
| BUSES               | <u>0</u>  |       |       |       |  |                     |       |
| MOTRCLS             | <u>0</u>  |       |       |       | <u>X</u>                                       |                     |       |

SPEEDS ESTIMATED BY: RADAR / DRIVING THE PACE  
POSTED SPEED LIMIT SIGNS SAY: 35 mph

OTHER NOISE SOURCES (BACKGROUND): DIST. AIRCRAFT RUSTLING LEAVES DIST. BARKING DOGS BIRDS DIST. INDUSTRIAL  
DIST. KIDS PLAYING DIST. CONVRSTNS / YELLING DIST. TRAFFIC (LIST RDWYS BELOW) DISTD GARDENERS/LANDSCAPING NOISE  
OTHER: Facility across the street had a buzzing gate that would sound when vehicles entered and left the facility

**DESCRIPTION / SKETCH**

TERRAIN HARD SOFT MIXED FLAT OTHER: \_\_\_\_\_  
PHOTOS Tri-pod base is 6 inches higher than road (on top of curb)  
OTHER COMMENTS / SKETCH

# FIELD NOISE MEASUREMENT DATA

PROJECT CSUMB CAMPUS MASTER PLAN PROJECT # 10357  
 SITE ID ST-8  
 SITE ADDRESS \_\_\_\_\_ OBSERVER(S) DAVID ORTEGA  
 START DATE 5/23/19 END DATE 5/23/19  
 START TIME 1505 END TIME 1525

**METEOROLOGICAL CONDITIONS**  
 TEMP 62 F HUMIDITY 70 % R.H. WIND CALM LIGHT MODERATE  
 WINDSPD 2 MPH DIR. N NE S SE S SW W NW VARIABLE STEADY GUSTY  
 SKY SUNNY CLEAR OVRCAST PRTLY CLDY FOG RAIN

**ACOUSTIC MEASUREMENTS**  
 MEAS. INSTRUMENT Piccolo II TYPE 1 2 SERIAL # P0218020900  
 CALIBRATOR \_\_\_\_\_ SERIAL # \_\_\_\_\_  
 CALIBRATION CHECK PRE-MEASUREMENT 94 dBA SPL POST-MEASUREMENT \_\_\_\_\_ dBA SPL WINDSCRN YES

SETTINGS A-WTD SLOW FAST FRONTAL RANDOM ANSI OTHER: \_\_\_\_\_

| REC. # | BEGIN       | END         | Leq         | Lmax        | Lmin        | L90         | L50         | L10         | OTHER (SPECIFY METRIC) |
|--------|-------------|-------------|-------------|-------------|-------------|-------------|-------------|-------------|------------------------|
|        | <u>1505</u> | <u>1525</u> | <u>67.5</u> | <u>90.9</u> | <u>44.7</u> | <u>54.2</u> | <u>62.7</u> | <u>70.9</u> |                        |
|        |             |             |             |             |             |             |             |             |                        |
|        |             |             |             |             |             |             |             |             |                        |
|        |             |             |             |             |             |             |             |             |                        |

COMMENTS \_\_\_\_\_

**SOURCE INFO AND TRAFFIC COUNTS**  
 PRIMARY NOISE SOURCE TRAFFIC AIRCRAFT RAIL INDUSTRIAL OTHER: \_\_\_\_\_  
 ROADWAY TYPE: COLLECTOR DIST. TO RDWY C/L OR EOP: 3 Feet

TRAFFIC COUNT DURATION: 20 MIN SPEED ~40 mph  
 MIN SPEED

| COUNT 1<br>(OR RDWY 1) | DIRECTION  |       | SPEED | IF COUNTING BOTH DIRECTIONS AS ONE, CHECK HERE | COUNT 2<br>(OR RDWY 2) | DIRECTION |       | SPEED |
|------------------------|------------|-------|-------|--|------------------------|-----------|-------|-------|
|                        | NB/EB      | SB/WB |       |  |                        | NB/EB     | SB/WB |       |
| AUTOS                  | <u>153</u> |       |       |  |                        |           |       |       |
| MED TRKS               | <u>1</u>   |       |       |  |                        |           |       |       |
| HVY TRKS               | <u>0</u>   |       |       |  |                        |           |       |       |
| BUSES                  | <u>1</u>   |       |       |  |                        |           |       |       |
| MOTRCLS                | <u>1</u>   |       |       | <u>X</u>                                       |                        |           |       |       |

SPEEDS ESTIMATED BY: RADAR DRIVING THE PACE  
 POSTED SPEED LIMIT SIGNS SAY: \_\_\_\_\_

OTHER NOISE SOURCES (BACKGROUND): DIST. AIRCRAFT RUSTLING LEAVES DIST. BARKING DOGS BIRDS DIST. INDUSTRIAL  
 DIST. KIDS PLAYING DIST. CONVRSTNS / YELLING DIST. TRAFFIC (LIST RDWYS BELOW) DISTD GARDENERS/LANDSCAPING NOISE  
 OTHER: \_\_\_\_\_

**DESCRIPTION / SKETCH**  
 TERRAIN HARD SOFT MIXED FLAT OTHER: \_\_\_\_\_  
 PHOTOS Tri-pod base is 6 inches higher than road (on top of curb)  
 OTHER COMMENTS / SKETCH



To User: bordered cells are inputs, unbordered cells have formulae

noise level limit for construction phase, per FTA at residences = **80**  
 allowable hours over which Leq is to be averaged (example: 8 per FTA guidance) = **8**

| Construction Phase                     | Equipment                  | Total Equipment Qty | AUF % (from FHWA RCNM) | Reference Lmax @ 50 ft. from FHWA RCNM | Client Equipment Description, Data Source and/or Notes | Source to NSR Distance (ft.) | Distance-Adjusted Lmax | Allowable Operation Time (hours) | Allowable Operation Time (minutes) | Predicted 8-hour Leq |
|--|----------------------------|---------------------|------------------------|--|--|------------------------------|------------------------|----------------------------------|------------------------------------|----------------------|
| Demolition                             | Concrete Saw               | 1                   | 20                     | 90                                     |  | 125                          | 82.0                   | 8                                | 480                                | 75                   |
|  | Dozer                      | 1                   | 40                     | 82                                     |  | 125                          | 74.0                   | 8                                | 480                                | 70                   |
|  | Backhoe                    | 2                   | 40                     | 78                                     |  | 125                          | 70.0                   | 8                                | 480                                | 69                   |
|  | Front End Loader           | 1                   | 40                     | 79                                     |  | 125                          | 71.0                   | 8                                | 480                                | 67                   |
| Total for Demolition Phase:            |                            |                     |                        |  |  |                              |                        |                                  |                                    | 77.4                 |
| Site Preparation                       | Grader                     | 1                   | 40                     | 85                                     |  | 125                          | 77.0                   | 8                                | 480                                | 73                   |
|  | Scraper                    | 1                   | 40                     | 84                                     |  | 125                          | 76.0                   | 8                                | 480                                | 72                   |
|  | Front End Loader           | 1                   | 40                     | 79                                     |  | 125                          | 71.0                   | 8                                | 480                                | 67                   |
| Total for Site Preparation Phase:      |                            |                     |                        |  |  |                              |                        |                                  |                                    | 76.2                 |
| Grading                                | Grader                     | 1                   | 40                     | 85                                     |  | 125                          | 77.0                   | 8                                | 480                                | 73                   |
|  | Dozer                      | 1                   | 40                     | 82                                     |  | 125                          | 74.0                   | 8                                | 480                                | 70                   |
|  | Tractor                    | 1                   | 40                     | 84                                     |  | 125                          | 76.0                   | 8                                | 480                                | 72                   |
|  | Backhoe                    | 1                   | 40                     | 78                                     |  | 125                          | 70.0                   | 8                                | 480                                | 66                   |
|  | Slurry Trenching Machine   | 1                   | 50                     | 80                                     |  | 125                          | 72.0                   | 8                                | 480                                | 69                   |
| Total for Grading Phase:               |                            |                     |                        |  |  |                              |                        |                                  |                                    | 77.7                 |
| Building Construction                  | Crane                      | 1                   | 16                     | 81                                     |  | 262                          | 66.6                   | 8                                | 480                                | 59                   |
|  | Man Lift                   | 2                   | 20                     | 75                                     | Forklifts  | 262                          | 60.6                   | 8                                | 480                                | 57                   |
|  | Generator                  | 1                   | 50                     | 72                                     |  | 262                          | 57.6                   | 8                                | 480                                | 55                   |
|  | Tractor                    | 1                   | 40                     | 84                                     |  | 262                          | 69.6                   | 6                                | 360                                | 64                   |
|  | Welder / Torch             | 3                   | 40                     | 73                                     |  | 262                          | 58.6                   | 8                                | 480                                | 59                   |
| Total for Building Construction Phase: |                            |                     |                        |  |  |                              |                        |                                  |                                    | 67.1                 |
| Paving                                 | Concrete Mixer Truck       | 1                   | 40                     | 79                                     |  | 125                          | 71.0                   | 8                                | 480                                | 67                   |
|  | Paver                      | 1                   | 50                     | 77                                     |  | 125                          | 69.0                   | 8                                | 480                                | 66                   |
|  | All Other Equipment > 5 HP | 1                   | 50                     | 85                                     |  | 125                          | 77.0                   | 8                                | 480                                | 74                   |
|  | Roller                     | 2                   | 20                     | 80                                     |  | 125                          | 72.0                   | 8                                | 480                                | 68                   |
|  | Tractor                    | 1                   | 40                     | 84                                     |  | 125                          | 76.0                   | 8                                | 480                                | 72                   |
| Total for Paving Phase:                |                            |                     |                        |  |  |                              |                        |                                  |                                    | 77.5                 |
| Architectural Coating                  | Compressor (Air)           | 1                   | 40                     | 78                                     |  | 262                          | 63.6                   | 8                                | 480                                | 60                   |
| Total for Architectural Coating Phase: |                            |                     |                        |  |  |                              |                        |                                  |                                    | 59.6                 |

To User: bordered cells are inputs, unbordered cells have formulae

noise level limit for construction phase, per FTA at residences = **80**  
 allowable hours over which Leq is to be averaged (example: 8 per FTA guidance) = **8**

| Construction Phase                     | Equipment                  | Total Equipment Qty | AUF % (from FHWA RCNM) | Reference Lmax @ 50 ft. from FHWA RCNM | Client Equipment Description, Data Source and/or Notes | Source to NSR Distance (ft.) | Distance-Adjusted Lmax | Allowable Operation Time (hours) | Allowable Operation Time (minutes) | Predicted 8-hour Leq |
|--|----------------------------|---------------------|------------------------|--|--|------------------------------|------------------------|----------------------------------|------------------------------------|----------------------|
| Demolition                             | Concrete Saw               | 1                   | 20                     | 90                                     |  | 30                           | 94.4                   | 8                                | 480                                | 87                   |
|  | Dozer                      | 1                   | 40                     | 82                                     |  | 30                           | 86.4                   | 8                                | 480                                | 82                   |
|  | Backhoe                    | 2                   | 40                     | 78                                     |  | 30                           | 82.4                   | 8                                | 480                                | 81                   |
|  | Front End Loader           | 1                   | 40                     | 79                                     |  | 30                           | 83.4                   | 8                                | 480                                | 79                   |
| Total for Demolition Phase:            |                            |                     |                        |  |  |                              |                        |                                  |                                    | <b>89.8</b>          |
| Site Preparation                       | Grader                     | 1                   | 40                     | 85                                     |  | 30                           | 89.4                   | 8                                | 480                                | 85                   |
|  | Dozer                      | 1                   | 40                     | 82                                     |  | 30                           | 86.4                   | 8                                | 480                                | 82                   |
|  | Front End Loader           | 1                   | 40                     | 79                                     |  | 30                           | 83.4                   | 8                                | 480                                | 79                   |
| Total for Site Preparation Phase:      |                            |                     |                        |  |  |                              |                        |                                  |                                    | <b>87.9</b>          |
| Grading                                | Grader                     | 1                   | 40                     | 85                                     |  | 30                           | 89.4                   | 8                                | 480                                | 85                   |
|  | Dozer                      | 1                   | 40                     | 82                                     |  | 30                           | 86.4                   | 8                                | 480                                | 82                   |
|  | Tractor                    | 1                   | 40                     | 84                                     |  | 30                           | 88.4                   | 8                                | 480                                | 84                   |
|  | Backhoe                    | 1                   | 40                     | 78                                     |  | 30                           | 82.4                   | 8                                | 480                                | 78                   |
|  | Slurry Trenching Machine   | 1                   | 50                     | 80                                     |  | 30                           | 84.4                   | 8                                | 480                                | 81                   |
| Total for Grading Phase:               |                            |                     |                        |  |  |                              |                        |                                  |                                    | <b>90.1</b>          |
| Building Construction                  | Crane                      | 1                   | 16                     | 81                                     |  | 136                          | 72.3                   | 8                                | 480                                | 64                   |
|  | Man Lift                   | 1                   | 20                     | 75                                     | Forklifts  | 136                          | 66.3                   | 8                                | 480                                | 59                   |
|  | Generator                  | 1                   | 50                     | 72                                     |  | 136                          | 63.3                   | 8                                | 480                                | 60                   |
|  | Tractor                    | 1                   | 40                     | 84                                     |  | 136                          | 75.3                   | 8                                | 480                                | 71                   |
|  | Welder / Torch             | 3                   | 40                     | 73                                     |  | 136                          | 64.3                   | 8                                | 480                                | 65                   |
| Total for Building Construction Phase: |                            |                     |                        |  |  |                              |                        |                                  |                                    | <b>73.3</b>          |
| Paving                                 | Concrete Mixer Truck       | 1                   | 40                     | 79                                     |  | 30                           | 83.4                   | 8                                | 480                                | 79                   |
|  | Paver                      | 1                   | 50                     | 77                                     |  | 30                           | 81.4                   | 8                                | 480                                | 78                   |
|  | All Other Equipment > 5 HP | 1                   | 50                     | 85                                     |  | 30                           | 89.4                   | 8                                | 480                                | 86                   |
|  | Roller                     | 1                   | 20                     | 80                                     |  | 30                           | 84.4                   | 8                                | 480                                | 77                   |
|  | Tractor                    | 1                   | 40                     | 84                                     |  | 30                           | 88.4                   | 8                                | 480                                | 84                   |
| Total for Paving Phase:                |                            |                     |                        |  |  |                              |                        |                                  |                                    | <b>89.7</b>          |
| Architectural Coating                  | Compressor (Air)           | 1                   | 40                     | 78                                     |  | 136                          | 69.3                   | 8                                | 480                                | 65                   |
| Total for Architectural Coating Phase: |                            |                     |                        |  |  |                              |                        |                                  |                                    | <b>65.3</b>          |

To User: bordered cells are inputs, unbordered cells have formulae

noise level limit for construction phase, per FTA at residences = **80**  
 allowable hours over which Leq is to be averaged (example: 8 per FTA guidance) = **8**

| Construction Phase                     | Equipment                  | Total Equipment Qty | AUF % (from FHWA RCNM) | Reference Lmax @ 50 ft. from FHWA RCNM | Client Equipment Description, Data Source and/or Notes | Source to NSR Distance (ft.) | Distance-Adjusted Lmax | Allowable Operation Time (hours) | Allowable Operation Time (minutes) | Predicted 8-hour Leq |
|--|----------------------------|---------------------|------------------------|--|--|------------------------------|------------------------|----------------------------------|------------------------------------|----------------------|
| Demolition                             | Concrete Saw               | 1                   | 20                     | 90                                     |  | 75                           | 86.5                   | 8                                | 480                                | 79                   |
|  | Dozer                      | 1                   | 40                     | 82                                     |  | 75                           | 78.5                   | 8                                | 480                                | 74                   |
|  | Backhoe                    | 2                   | 40                     | 78                                     |  | 75                           | 74.5                   | 8                                | 480                                | 74                   |
|  | Front End Loader           | 1                   | 40                     | 79                                     |  | 75                           | 75.5                   | 8                                | 480                                | 71                   |
| Total for Demolition Phase:            |                            |                     |                        |  |  |                              |                        |                                  |                                    | <b>81.9</b>          |
| Site Preparation                       | Grader                     | 1                   | 40                     | 85                                     |  | 75                           | 81.5                   | 8                                | 480                                | 77                   |
|  | Dozer                      | 1                   | 40                     | 82                                     |  | 75                           | 78.5                   | 8                                | 480                                | 74                   |
|  | Front End Loader           | 1                   | 40                     | 79                                     |  | 75                           | 75.5                   | 8                                | 480                                | 71                   |
| Total for Site Preparation Phase:      |                            |                     |                        |  |  |                              |                        |                                  |                                    | <b>79.9</b>          |
| Grading                                | Grader                     | 1                   | 40                     | 85                                     |  | 75                           | 81.5                   | 8                                | 480                                | 77                   |
|  | Dozer                      | 1                   | 40                     | 82                                     |  | 75                           | 78.5                   | 8                                | 480                                | 74                   |
|  | Tractor                    | 1                   | 40                     | 84                                     |  | 75                           | 80.5                   | 8                                | 480                                | 76                   |
|  | Backhoe                    | 1                   | 40                     | 78                                     |  | 75                           | 74.5                   | 8                                | 480                                | 70                   |
|  | Slurry Trenching Machine   | 1                   | 50                     | 80                                     |  | 75                           | 76.5                   | 8                                | 480                                | 73                   |
| Total for Grading Phase:               |                            |                     |                        |  |  |                              |                        |                                  |                                    | <b>82.1</b>          |
| Building Construction                  | Crane                      | 1                   | 16                     | 81                                     |  | 233                          | 67.6                   | 8                                | 480                                | 60                   |
|  | Man Lift                   | 1                   | 20                     | 75                                     | Forklifts  | 233                          | 61.6                   | 8                                | 480                                | 55                   |
|  | Generator                  | 1                   | 50                     | 72                                     |  | 233                          | 58.6                   | 8                                | 480                                | 56                   |
|  | Tractor                    | 1                   | 40                     | 84                                     |  | 233                          | 70.6                   | 6                                | 360                                | 65                   |
|  | Welder / Torch             | 3                   | 40                     | 73                                     |  | 233                          | 59.6                   | 8                                | 480                                | 60                   |
| Total for Building Construction Phase: |                            |                     |                        |  |  |                              |                        |                                  |                                    | <b>67.9</b>          |
| Paving                                 | Concrete Mixer Truck       | 1                   | 40                     | 79                                     |  | 75                           | 75.5                   | 8                                | 480                                | 71                   |
|  | Paver                      | 1                   | 50                     | 77                                     |  | 75                           | 73.5                   | 8                                | 480                                | 70                   |
|  | All Other Equipment > 5 HP | 1                   | 50                     | 85                                     |  | 75                           | 81.5                   | 8                                | 480                                | 78                   |
|  | Roller                     | 1                   | 20                     | 80                                     |  | 75                           | 76.5                   | 8                                | 480                                | 69                   |
|  | Tractor                    | 1                   | 40                     | 84                                     |  | 75                           | 80.5                   | 8                                | 480                                | 76                   |
| Total for Paving Phase:                |                            |                     |                        |  |  |                              |                        |                                  |                                    | <b>81.7</b>          |
| Architectural Coating                  | Compressor (Air)           | 1                   | 40                     | 78                                     |  | 233                          | 64.6                   | 8                                | 480                                | 61                   |
| Total for Architectural Coating Phase: |                            |                     |                        |  |  |                              |                        |                                  |                                    | <b>60.7</b>          |

To User: bordered cells are inputs, unbordered cells have formulae

noise level limit for construction phase, per FTA at residences = **80**  
 allowable hours over which Leq is to be averaged (example: 8 per FTA guidance) = **8**

| Construction Phase                     | Equipment                  | Total Equipment Qty | AUF % (from FHWA RCNM) | Reference Lmax @ 50 ft. from FHWA RCNM | Client Equipment Description, Data Source and/or Notes | Source to NSR Distance (ft.) | Distance-Adjusted Lmax | Allowable Operation Time (hours) | Allowable Operation Time (minutes) | Predicted 8-hour Leq |
|--|----------------------------|---------------------|------------------------|--|--|------------------------------|------------------------|----------------------------------|------------------------------------|----------------------|
| Demolition                             | Concrete Saw               | 1                   | 20                     | 90                                     |  | 40                           | 91.9                   | 8                                | 480                                | 85                   |
|  | Dozer                      | 1                   | 40                     | 82                                     |  | 40                           | 83.9                   | 8                                | 480                                | 80                   |
|  | Backhoe                    | 2                   | 40                     | 78                                     |  | 40                           | 79.9                   | 8                                | 480                                | 79                   |
|  | Front End Loader           | 1                   | 40                     | 79                                     |  | 40                           | 80.9                   | 8                                | 480                                | 77                   |
| Total for Demolition Phase:            |                            |                     |                        |  |  |                              |                        |                                  |                                    | <b>87.3</b>          |
| Site Preparation                       | Grader                     | 1                   | 40                     | 85                                     |  | 40                           | 86.9                   | 8                                | 480                                | 83                   |
|  | Scraper                    | 1                   | 40                     | 84                                     |  | 40                           | 85.9                   | 8                                | 480                                | 82                   |
|  | Front End Loader           | 1                   | 40                     | 79                                     |  | 40                           | 80.9                   | 8                                | 480                                | 77                   |
| Total for Site Preparation Phase:      |                            |                     |                        |  |  |                              |                        |                                  |                                    | <b>86.1</b>          |
| Grading                                | Grader                     | 1                   | 40                     | 85                                     |  | 40                           | 86.9                   | 8                                | 480                                | 83                   |
|  | Dozer                      | 1                   | 40                     | 82                                     |  | 40                           | 83.9                   | 8                                | 480                                | 80                   |
|  | Tractor                    | 1                   | 40                     | 84                                     |  | 40                           | 85.9                   | 8                                | 480                                | 82                   |
|  | Backhoe                    | 1                   | 40                     | 78                                     |  | 40                           | 79.9                   | 8                                | 480                                | 76                   |
|  | Slurry Trenching Machine   | 1                   | 50                     | 80                                     |  | 40                           | 81.9                   | 8                                | 480                                | 79                   |
| Total for Grading Phase:               |                            |                     |                        |  |  |                              |                        |                                  |                                    | <b>87.6</b>          |
| Building Construction                  | Crane                      | 1                   | 16                     | 81                                     |  | 134                          | 72.4                   | 8                                | 480                                | 64                   |
|  | Man Lift                   | 2                   | 20                     | 75                                     | Forklifts  | 134                          | 66.4                   | 8                                | 480                                | 62                   |
|  | Generator                  | 1                   | 50                     | 72                                     |  | 134                          | 63.4                   | 8                                | 480                                | 60                   |
|  | Tractor                    | 1                   | 40                     | 84                                     |  | 134                          | 75.4                   | 6                                | 360                                | 70                   |
|  | Welder / Torch             | 3                   | 40                     | 73                                     |  | 134                          | 64.4                   | 8                                | 480                                | 65                   |
| Total for Building Construction Phase: |                            |                     |                        |  |  |                              |                        |                                  |                                    | <b>72.9</b>          |
| Paving                                 | Concrete Mixer Truck       | 1                   | 40                     | 79                                     |  | 40                           | 80.9                   | 8                                | 480                                | 77                   |
|  | Paver                      | 1                   | 50                     | 77                                     |  | 40                           | 78.9                   | 8                                | 480                                | 76                   |
|  | All Other Equipment > 5 HP | 1                   | 50                     | 85                                     |  | 40                           | 86.9                   | 8                                | 480                                | 84                   |
|  | Roller                     | 2                   | 20                     | 80                                     |  | 40                           | 81.9                   | 8                                | 480                                | 78                   |
|  | Tractor                    | 1                   | 40                     | 84                                     |  | 40                           | 85.9                   | 8                                | 480                                | 82                   |
| Total for Paving Phase:                |                            |                     |                        |  |  |                              |                        |                                  |                                    | <b>87.4</b>          |
| Architectural Coating                  | Compressor (Air)           | 1                   | 40                     | 78                                     |  | 134                          | 69.4                   | 6                                | 360                                | 64                   |
| Total for Architectural Coating Phase: |                            |                     |                        |  |  |                              |                        |                                  |                                    | <b>64.2</b>          |

To User: bordered cells are inputs, unbordered cells have formulae

noise level limit for construction phase, per FTA at residences = **85**  
 allowable hours over which Leq is to be averaged (example: 8 per FTA guidance) = **8**

| Construction Phase                     | Equipment                  | Total Equipment Qty | AUF % (from FHWA RCNM) | Reference Lmax @ 50 ft. from FHWA RCNM | Client Equipment Description, Data Source and/or Notes | Source to NSR Distance (ft.) | Distance-Adjusted Lmax | Allowable Operation Time (hours) | Allowable Operation Time (minutes) | Predicted 8-hour Leq |
|--|----------------------------|---------------------|------------------------|--|--|------------------------------|------------------------|----------------------------------|------------------------------------|----------------------|
| Demolition                             | Concrete Saw               | 1                   | 20                     | 90                                     |  | 80                           | 85.9                   | 8                                | 480                                | 79                   |
|  | Dozer                      | 1                   | 40                     | 82                                     |  | 80                           | 77.9                   | 8                                | 480                                | 74                   |
|  | Backhoe                    | 2                   | 40                     | 78                                     |  | 80                           | 73.9                   | 8                                | 480                                | 73                   |
|  | Front End Loader           | 1                   | 40                     | 79                                     |  | 80                           | 74.9                   | 8                                | 480                                | 71                   |
| Total for Demolition Phase:            |                            |                     |                        |  |  |                              |                        |                                  |                                    | <b>81.3</b>          |
| Site Preparation                       | Grader                     | 1                   | 40                     | 85                                     |  | 80                           | 80.9                   | 8                                | 480                                | 77                   |
|  | Scraper                    | 1                   | 40                     | 84                                     |  | 80                           | 79.9                   | 8                                | 480                                | 76                   |
|  | Front End Loader           | 1                   | 40                     | 79                                     |  | 80                           | 74.9                   | 8                                | 480                                | 71                   |
| Total for Site Preparation Phase:      |                            |                     |                        |  |  |                              |                        |                                  |                                    | <b>80.0</b>          |
| Grading                                | Grader                     | 1                   | 40                     | 85                                     |  | 80                           | 80.9                   | 8                                | 480                                | 77                   |
|  | Dozer                      | 1                   | 40                     | 82                                     |  | 80                           | 77.9                   | 8                                | 480                                | 74                   |
|  | Tractor                    | 1                   | 40                     | 84                                     |  | 80                           | 79.9                   | 8                                | 480                                | 76                   |
|  | Backhoe                    | 1                   | 40                     | 78                                     |  | 80                           | 73.9                   | 8                                | 480                                | 70                   |
|  | Slurry Trenching Machine   | 1                   | 50                     | 80                                     |  | 80                           | 75.9                   | 8                                | 480                                | 73                   |
| Total for Grading Phase:               |                            |                     |                        |  |  |                              |                        |                                  |                                    | <b>81.5</b>          |
| Building Construction                  | Crane                      | 1                   | 16                     | 81                                     |  | 173                          | 70.2                   | 8                                | 480                                | 62                   |
|  | Man Lift                   | 2                   | 20                     | 75                                     | Forklifts  | 173                          | 64.2                   | 8                                | 480                                | 60                   |
|  | Generator                  | 1                   | 50                     | 72                                     |  | 173                          | 61.2                   | 8                                | 480                                | 58                   |
|  | Tractor                    | 1                   | 40                     | 84                                     |  | 173                          | 73.2                   | 8                                | 480                                | 69                   |
|  | Welder / Torch             | 3                   | 40                     | 73                                     |  | 173                          | 62.2                   | 8                                | 480                                | 63                   |
| Total for Building Construction Phase: |                            |                     |                        |  |  |                              |                        |                                  |                                    | <b>71.4</b>          |
| Paving                                 | Concrete Mixer Truck       | 1                   | 40                     | 79                                     |  | 80                           | 74.9                   | 8                                | 480                                | 71                   |
|  | Paver                      | 1                   | 50                     | 77                                     |  | 80                           | 72.9                   | 8                                | 480                                | 70                   |
|  | All Other Equipment > 5 HP | 1                   | 50                     | 85                                     |  | 80                           | 80.9                   | 8                                | 480                                | 78                   |
|  | Roller                     | 2                   | 20                     | 80                                     |  | 80                           | 75.9                   | 8                                | 480                                | 72                   |
|  | Tractor                    | 1                   | 40                     | 84                                     |  | 80                           | 79.9                   | 8                                | 480                                | 76                   |
| Total for Paving Phase:                |                            |                     |                        |  |  |                              |                        |                                  |                                    | <b>81.4</b>          |

|                                  |    |     |     |     |      |      |      |      |
|----------------------------------|----|-----|-----|-----|------|------|------|------|
| 1/1-octave band center frequency | 63 | 125 | 250 | 500 | 1000 | 2000 | 4000 | 8000 |
| A-weighting adjustments          | 26 | 13  | 9   | 3   | 0    | -1   | -1   | 1    |

|  |      |                                  |    |    |    |    |    |    |    |
|--|------|----------------------------------|----|----|----|----|----|----|----|
|  |      | specific sound power levels (dB) |    |    |    |    |    |    |    |
| largest of values for the two fan diameter ranges, per <u>ENC</u> (Bies & Hansen 1996) --> | plug | 36                               | 38 | 36 | 34 | 33 | 28 | 20 | 12 |
| largest of values for the two fan diameter ranges, per <u>ENC</u> (Bies & Hansen 1996) --> | tube | 41                               | 41 | 47 | 46 | 44 | 43 | 37 | 35 |
| largest of values for the two fan diameter ranges, per <u>ENC</u> (Bies & Hansen 1996) --> | prop | 56                               | 57 | 56 | 55 | 55 | 52 | 48 | 46 |

AHUs (plenum-type return fan only, no condenser units [assume in-building chilled water or DX plant]):

| Phase  | Building Tag              | GSF    | m <sup>2</sup> | facility function       | CFM pksf | m <sup>3</sup> /s per 1,000 |               | fanteype = plug, tube, or prop | unweighted PWL        |               |     |     |     |      |      |      | OA dB | Q (cfm) | Distance to Nearest Receptor (feet) | Hourly dBA Leq |      |
|--|---------------------------|--------|----------------|-------------------------|----------|-----------------------------|---------------|--------------------------------|-----------------------|---------------|-----|-----|-----|------|------|------|-------|---------|-------------------------------------|----------------|------|
|  |                           |        |                |                         |          | m <sup>2</sup>              | Pressure (Pa) |                                | Q (m <sup>3</sup> /s) | 63            | 125 | 250 | 500 | 1000 | 2000 | 4000 |       |         |                                     |                | 8000 |
| <i>return air fans in building rooftop AHUs:</i> |                           |        |                |                         |          |                             |               |                                |                       |               |     |     |     |      |      |      |       |         |                                     |                |      |
|  | Student Housing Phase IIB | 160000 | 14872          | dormitory               | 100      | 0.51                        | 625           | 8                              | plug                  | 86            | 88  | 86  | 84  | 83   | 78   | 70   | 62    | 93      | 16000                               |                |      |
|  | Student Housing Phase III | 240000 | 22308          | dormitory               | 100      | 0.51                        | 625           | 11                             | plug                  | 87            | 89  | 87  | 85  | 84   | 79   | 71   | 63    | 94      | 24000                               |                |      |
|  | Student Recreation Center | 70000  | 6507           | sporting spectator area | 1125     | 5.71                        | 625           | 37                             | plug                  | 93            | 95  | 93  | 91  | 90   | 85   | 77   | 69    | 100     | 79000                               |                |      |
|  | Academic V                | 76700  | 7129           | classroom               | 250      | 1.27                        | 625           | 9                              | plug                  | 86            | 88  | 86  | 84  | 83   | 78   | 70   | 62    | 93      | 20000                               |                |      |
|  | Academic IV               | 72200  | 6711           | classroom               | 250      | 1.27                        | 625           | 9                              | plug                  | 86            | 88  | 86  | 84  | 83   | 78   | 70   | 62    | 93      | 19000                               |                |      |
|  |                           |        |                |                         |          |                             |               |                                |                       | A-weighted dB |     |     |     |      |      |      |       | OA      |                                     |                |      |
|  |                           |        |                |                         |          |                             |               |                                |                       | 60            | 75  | 77  | 81  | 83   | 79   | 71   | 61    | 87      |                                     | 233            | 42   |
|  |                           |        |                |                         |          |                             |               |                                |                       | 61            | 76  | 78  | 82  | 84   | 80   | 72   | 62    | 88      |                                     | 136            | 48   |
|  |                           |        |                |                         |          |                             |               |                                |                       | 67            | 82  | 84  | 88  | 90   | 86   | 78   | 68    | 94      |                                     | 262            | 48   |
|  |                           |        |                |                         |          |                             |               |                                |                       | 60            | 75  | 77  | 81  | 83   | 79   | 71   | 61    | 87      |                                     | 134            | 47   |
|  |                           |        |                |                         |          |                             |               |                                |                       | 60            | 75  | 77  | 81  | 83   | 79   | 71   | 61    | 87      |                                     | 173            | 45   |

# **APPENDIX H**

## **Revised Transportation Analysis**

INTENTIONALLY LEFT BLANK





Prepared by

**FEHR & PEERS**

160 W Santa Clara St #675  
San Jose, CA 95113  
408.278.1700

*May 2022*

# **California State University Monterey Bay Master Plan**

## Transportation Analysis

Prepared for  
**California State University, Monterey Bay  
and DUDEK**

Transportation Analysis

# California State University, Monterey Bay Master Plan

Prepared for:  
California State University, Monterey Bay  
and  
Dudek

May 2022

SJ17-1728

FEHR  PEERS

**Note to reader: Strike through and double underline text indicates text changes from November 2021. Additional information added to an appendix is noted with "Added to report since November 2021."**



## Table of Contents

|   |           |
|---|-----------|
| <b>EXECUTIVE SUMMARY .....</b>  | <b>i</b>  |
| Project Description.....  | i         |
| CEQA Impacts and Mitigation Measures.....   | iv        |
| Operations Analysis Results.....  | vi        |
| <b>1. INTRODUCTION AND PROJECT DESCRIPTION .....</b>                              | <b>1</b>  |
| Purpose.....  | 1         |
| Project Description.....  | 6         |
| Recent Changes to CEQA Transportation Analysis .....                              | 13        |
| SB 743 VMT Assessment Methods Decisions.....                                      | 13        |
| Operations Analysis Study Area and Scenarios (For Information Purposes Only)..... | 18        |
| Report Organization .....   | 22        |
| <b>EXISTING CONDITIONS AND RELEVANT PLANS .....</b>                               | <b>24</b> |
| <b>2. EXISTING CONDITIONS.....</b>  | <b>25</b> |
| Existing Campus Parking and Transportation Demand Management .....                | 25        |
| Existing Street System.....   | 29        |
| Existing Truck Routes .....   | 31        |
| Existing Pedestrian Facilities.....   | 32        |
| Existing Bicycle Facilities .....   | 34        |
| Existing Transit Service .....  | 37        |
| Existing Intersection Operations.....   | 42        |
| Existing Freeway Segment Operations.....  | 50        |
| Existing Freeway Ramp Operations .....  | 51        |
| Field Observations.....   | 52        |
| <b>3. SUMMARY OF RELEVANT REGIONAL CIRCULATION AND TRANSPORTATION PLANS.....</b>  | <b>56</b> |
| AMBAG Regional Transportation Plan .....  | 56        |
| Seaside General Plan .....  | 57        |
| Marina General Plan .....   | 60        |
| Monterey County General Plan.....   | 61        |

|           |  |            |
|-----------|--|------------|
|           | TAMC Congestion Management Program .....   | 63         |
|           | 2018 Monterey County Active Transportation Plan.....   | 63         |
|           | Fort Ord Reuse Authority Act.....  | 64         |
|           | Monterey-Salinas Transit Designing for Transit .....   | 65         |
|           | <b>CEQA SIGNIFICANCE CRITERIA, VMT ANALYSIS METHODS, IMPACTS AND MITIGATION.....</b>                     | <b>66</b>  |
| <b>4.</b> | <b>SIGNIFICANCE CRITERIA AND VMT ANALYSIS METHODS.....</b>   | <b>67</b>  |
|           | Significance Criteria .....  | 67         |
|           | Traffic Forecasting Methods.....   | 71         |
| <b>5.</b> | <b>CEQA SIGNIFICANT IMPACTS AND MITIGATION.....</b>  | <b>77</b>  |
|           | Plan Conflicts Analysis .....  | 77         |
|           | SB 743 VMT Analysis .....  | 85         |
|           | Hazards Evaluation Analysis .....  | 87         |
|           | Emergency Access Analysis .....  | 87         |
|           | Construction Impact Analysis .....   | 87         |
|           | <b>PARKING MANAGEMENT AND TDM.....</b>   | <b>89</b>  |
| <b>6.</b> | <b>PARKING MANAGEMENT AND TDM.....</b>   | <b>90</b>  |
|           | Main Campus Parking Evaluation.....  | 90         |
|           | Main Campus Inbound AM peak Hour Mode Share .....  | 96         |
|           | Project PDFs to reduce Project Vehicle Trips and VMT .....   | 98         |
|           | <b>OPERATIONS ANALYSIS (FOR INFORMATION PURPOSES ONLY) .....</b>   | <b>102</b> |
| <b>7.</b> | <b>OPERATIONS ANALYSIS AND PROJECT TRAFFIC FORECASTING METHODS (FOR INFORMATION PURPOSES ONLY) .....</b> | <b>103</b> |
|           | Traffic Analysis Methods.....  | 103        |
|           | Project Traffic Volumes.....   | 107        |
| <b>8.</b> | <b>EXISTING WITH PROJECT CONDITIONS (FOR INFORMATION PURPOSES ONLY) .....</b>                            | <b>116</b> |
|           | Existing with Project Intersection Levels of Service.....  | 116        |
|           | Existing with Project Freeway Levels of Service .....  | 117        |
|           | Existing with Project Ramp Analysis.....   | 119        |

|            |  |            |
|------------|--|------------|
| <b>9.</b>  | <b>CUMULATIVE WITHOUT EASTSIDE PARKWAY CONDITIONS (FOR INFORMATION PURPOSES ONLY) .....</b>                      | <b>121</b> |
|            | Cumulative without and with Project and without Eastside Parkway Conditions Traffic Volumes                      | 121        |
|            | Cumulative without and with Project and without Eastside Parkway Conditions Roadway Improvements .....           | 121        |
|            | Cumulative without and with Project and without Eastside Parkway Conditions Intersection Levels of Service ..... | 126        |
|            | Cumulative without and with Project and without Eastside Parkway Conditions Freeway Levels of Service .....      | 126        |
|            | Cumulative without and with Project and without Eastside Parkway Conditions Ramp Levels of Service .....         | 129        |
| <b>10.</b> | <b>CUMULATIVE WITH EASTSIDE PARKWAY CONDITIONS (FOR INFORMATION PURPOSES ONLY) .....</b>                         | <b>131</b> |
|            | Cumulative without and with Project and with Eastside Parkway Conditions Roadway Improvements .....              | 131        |
|            | Cumulative without and with Project and with Eastside Parkway Conditions Intersection Levels of Service .....    | 132        |
|            | Cumulative without and with Project and with Eastside Parkway Conditions Freeway Levels of Service .....         | 133        |
|            | Cumulative without and with Project and with Eastside Parkway Conditions Ramp Levels of Service .....            | 135        |
| <b>11.</b> | <b>TRANSPORTATION FACILITY DEFICIENCIES AND POTENTIAL IMPROVEMENTS (FOR INFORMATION PURPOSES ONLY) .....</b>     | <b>137</b> |
|            | Deficiencies Criteria .....  | 137        |
|            | Deficiencies Analysis and Potential Improvements .....   | 138        |

## **Appendices**

- Appendix A: CSUMB Master Plan EIR – Trip Generation Evaluation Methods and Estimates
- Appendix B: California State University, Monterey Bay Master Plan EIR – Transportation Study Area Locations
- Appendix C: Existing Parking Inventory
- Appendix D: Existing Traffic Counts
- Appendix E: Intersection Level of Service Calculations
- Appendix F: Association of Monterey Bay Area Governments Travel Model Validation
- Appendix G: VMT Analysis for Greenhouse Gases and VMT Forecasting Outline
- Appendix H: CSUMB Draft Parking Supply Scenarios
- Appendix I: Parking Demand and Supply Calculations
- Appendix J: California State University, Monterey Bay Housing and Parking Management Guidelines
- Appendix K: Intersection Volume Figures
- Appendix L: Intersection Level of Service Tables
- Appendix M: Freeway Analysis
- Appendix N: Intersection Signal Warrant Analysis
- Appendix O: Intersection with Improvements Level of Service Calculations



## List of Figures

|           |   |     |
|-----------|---|-----|
| Figure 1  | Project Location .....  | 3   |
| Figure 2  | Project Location and Study Intersections .....                              | 4   |
| Figure 3  | Project Location and Study Freeway Segments .....                           | 5   |
| Figure 4  | CSUMB Proposed Bicycle Network .....  | 10  |
| Figure 5  | CSUMB Proposed Pedestrian Network.....                                      | 11  |
| Figure 6  | CSUMB Campus Streets and Parking Lots.....                                  | 12  |
| Figure 7  | Academic Parking Occupancy from 7:00 AM to 7:00 PM .....                    | 27  |
| Figure 8  | Residential Parking Occupancy from 7:00 AM to 7:00 PM.....                  | 27  |
| Figure 9  | Existing CSUMB and Regionally Planned Pedestrian Facilities.....            | 33  |
| Figure 10 | Existing CSUMB and Regionally Planned Bicycle Facilities .....              | 35  |
| Figure 11 | Existing Transit Service to CSUMB.....                                      | 41  |
| Figure 12 | Existing Conditions Peak Hour Traffic Volumes and Lane Configurations ..... | 47  |
| Figure 13 | Signalized Intersection Level of Service Examples .....                     | 104 |
| Figure 14 | Parking Area Ingress/Egress Routes for External Trips.....                  | 114 |
| Figure 15 | Parking Area Ingress/Egress Routes for Internal Trips .....                 | 115 |

## List of Tables

|  |     |
|--|-----|
| Table ES-1: CSUMB Population Type By Housing Location .....  | ii  |
| Table ES-2: Intersection Deficiency and Improvement Summary.....   | vii |
| Table ES-3: Freeway Segment Deficiency and Improvement Summary.....  | x   |
| Table 1: CSUMB Population Type By Housing Location .....   | 7   |
| Table 2: Existing Parking Spaces.....  | 26  |
| Table 3: Existing Parking Demand Rates .....   | 26  |
| Table 4: Existing Weekday MST Transit Service Summary .....  | 39  |
| Table 5: Average Weekday MST Boarding Factors .....  | 40  |
| Table 6: Existing Intersection Levels of Service.....  | 43  |
| Table 7: Existing Freeway Segment Levels Of Service.....   | 50  |
| Table 8: Existing Ramp AM Peak Hour Volumes and Capacities.....  | 51  |
| Table 9: Existing Ramp PM Peak-Hour Volumes and Capacities.....  | 52  |
| Table 10: Existing CSU TISM VMT Significance Thresholds.....   | 67  |
| Table 11: Project Generated VMT Threshold Based on Existing Conditions for Monterey County .....   | 70  |
| Table 12: Project’s Effect on VMT (Boundary VMT) Threshold based on Cumulative Conditions for Monterey County.....                                       | 70  |
| Table 13: Roadway Improvements for Cumulative Conditions .....   | 73  |
| Table 14: Service Populations .....  | 76  |
| Table 15: Main Campus Transit Ridership Summary .....  | 79  |
| Table 16: East Campus Transit Ridership Summary .....  | 79  |
| Table 17: Weekday Peak Hour Bus Route Capacity Analysis.....   | 80  |
| Table 18: Project Generated VMT for SB 743 VMT Assessment.....   | 86  |
| Table 19: Project’s Effect on VMT (Boundary VMT) for SB 743 VMT Assessment.....  | 87  |
| Table 20: Future Academic Parking Supply By Parking Zone – Base Scenario.....  | 93  |
| Table 21: Future Residential Parking Supply By Parking Zone – Base Scenario .....  | 93  |
| Table 22: Existing and Future (Base Scenario) Parking Supply Summary.....  | 94  |
| Table 23: Future Parking Supply By Parking Zone (Land Area Allocation and Base Scenarios) .....  | 94  |
| Table 24: Future Parking Supply Summary (Future Parking Supply Base Scenario, Land Area Allocation Parking Supply Scenario, and Master Plan Vision)..... | 95  |
| Table 25: AM Peak Period Inbound Person Mode Share for All CSUMB Students, Faculty and Staff .....   | 96  |
| Table 26: AM peak period Inbound Person Mode Share for CSUMB Students, Faculty and Staff Residents of East Campus And Off-Campus .....                   | 98  |





|           |  |     |
|-----------|--|-----|
| Table 27: | Signalized Intersection Level of Service Definitions .....   | 105 |
| Table 28: | Unsignalized Intersection and Roundabout Level of Service Definitions .....  | 106 |
| Table 29: | Freeway Segment Level of Service Definitions .....   | 107 |
| Table 30: | Existing Conditions Vehicle Trip Generation for CSUMB Campus.....  | 109 |
| Table 31: | CSUMB Campus Vehicle Trip Generation for Project Conditions .....  | 110 |
| Table 32: | CSUMB Campus Vehicle Trip Generation Results .....   | 111 |
| Table 33: | Distribution of CSUMB External Vehicle Trips to Nearby Communities (AMBAG Model) .....                                   | 112 |
| Table 34: | CSUMB Main Campus Total Daily Vehicle Trips.....   | 113 |
| Table 35: | Existing without and with Project Conditions Freeway Segment LOS .....   | 118 |
| Table 36: | Existing without and with Project Conditions Ramp AM Peak Hour Volumes and Capacities                                    | 119 |
| Table 37: | Existing without and with Project Conditions Ramp PM Peak Hour Volumes and Capacities                                    | 120 |
| Table 38: | Cumulative without and with Project and without Eastside Parkway Conditions Intersection Improvements.....               | 122 |
| Table 39: | Cumulative without and with Project Conditions Freeway Segment Level of Service.....                                     | 128 |
| Table 40: | Cumulative without and with Project Conditions Ramp AM Peak Hour Volumes and Capacities .....                            | 129 |
| Table 41: | Cumulative without and with Project Conditions Ramp PM Peak Hour Volumes and Capacities .....                            | 130 |
| Table 42: | Cumulative without and with Project and with Eastside Parkway Conditions Freeway Segment Level of Service.....           | 134 |
| Table 43: | Cumulative without and with Project, and with Eastside Parkway Conditions Ramp AM Peak Hour Volumes and Capacities ..... | 135 |
| Table 44: | Cumulative without and with Project, and with Eastside Parkway Conditions Ramp PM Peak Hour Volumes and Capacities ..... | 136 |
| Table 45: | Existing with Project Conditions Intersection Improvements Summary .....   | 140 |
| Table 46: | Cumulative with Project and without Eastside Parkway Conditions Intersection Improvements Summary.....                   | 146 |
| Table 47: | Roundabout Improvements Intersection Level of Service .....  | 149 |
| Table 48: | Cumulative with Project and with Eastside Parkway Conditions Intersection Improvements Summary.....                      | 152 |

## EXECUTIVE SUMMARY

This report presents the results of the transportation analysis (TA) conducted for the *California State University, Monterey Bay (CSUMB) Master Plan*, also referred to as the Project. The purposes of the TA are two-fold:

- To present the transportation analysis for compliance with the California Environmental Quality Act (CEQA), including analysis of the Project’s vehicle miles traveled (VMT), the identification of significant impacts and mitigation, where applicable, for inclusion in the Environmental Impact Report (EIR),<sup>1</sup> and
- To present a traffic operations analysis for informational purposes only, intended to inform the reader of potential roadway operational deficiencies<sup>2</sup> resulting from the addition of Project traffic, and potential transportation improvements to reduce the identified deficient operations.

The analysis presented in this report was conducted based on the *California State University Transportation Impact Study Manual* (2019) to evaluate the effects of the Project on the transportation system on and near the campus.

## PROJECT DESCRIPTION

The Project consists of the proposed CSUMB Master Plan, including Project Design Features (PDFs), as described in the Project Description (Chapter 3) of the CSUMB Master Plan Draft Environmental Impact Report (EIR) (Master Plan Draft EIR). Project elements that would affect the transportation system include the proposed increase in student enrollment and associated increase in faculty and staff; the added on-campus housing for students, faculty, and staff; and a Main Campus street and parking system that facilitates and prioritizes walking, bicycling, and transit use over vehicle travel.

---

<sup>1</sup> VMT refers to “Vehicle Miles Traveled,” a metric that accounts for the number of vehicle trips generated plus the length or distance of those trips. This report uses total VMT and boundary VMT metrics for specific geographic areas, which are defined in **Chapter 4**.

<sup>2</sup> Deficiencies are the Project’s potential effects to the study area’s transportation system and determined by the criteria described in **Chapter 11**.



## CAMPUS POPULATION

Upon buildout, the Project would accommodate an increase in campus enrollment from the existing 6,634 full-time equivalent (FTE) students<sup>3</sup> and 1,024 FTE faculty/staff,<sup>4</sup> to 12,700 FTE students and 1,776 FTE faculty/staff. Based on academic year 2016-17, achieving this growth would result in an increase of approximately 6,066 FTE students and 752 FTE faculty/staff over existing levels.

## LAND USE/CAMPUS HOUSING

Upon buildout, the Project is forecast to house at least 60 percent of enrolled students and 65 percent of faculty and staff on campus (refer to PDF-LU-5 and PDF-LU-6, as described in Chapter 3, Project Description, of the Master Plan Draft EIR).

**Table ES-1** summarizes the number of students, faculty, and staff presently residing on- and off-campus (Existing Conditions), and the number forecasted to reside on- and off-campus under Project Conditions when FTE student enrollment and FTE faculty/staff employment reach a total of 14,476.

**TABLE ES-1: CSUMB POPULATION TYPE BY HOUSING LOCATION**

| Population Component                                       | Existing Conditions<br>(FTE Students or Faculty/Staff) <sup>1</sup> | Project Conditions<br>(FTE Students or Faculty/Staff) <sup>1</sup> | Change<br>(Project – Existing) <sup>2</sup> |
|--|---|--|---|
| Student Population   | 6,634   | 12,700   | +6,066                                      |
| Faculty/Staff Population                                   | 1,024   | 1,776  | +752  |
| Student, Faculty, and Staff Population (Campus Population) | 7,658   | 14,476   | +6,818                                      |
| Campus Population with Community Housing Partners          | 7,938   | 14,542   | +6,604                                      |

Notes:

1. FTE = Full-time equivalent students or faculty and staff
2. Change (Project - Existing) = Project Conditions column – Existing Conditions column.

Source: Fehr & Peers, 2019.

<sup>3</sup> Full-time equivalent (FTE) is the unit of measurement used to convert class load to student enrollment. At CSUMB, one FTE is equal to 15 units. Thus, one FTE student is equal to one student enrolled in 15 units or three students each enrolled in 5 units. A related unit of measurement is “headcount.” In the case of one student taking 15 units, the headcount is 1; in the case of three students collectively taking 15 units, the headcount is 3.

<sup>4</sup> According to CSUMB Institutional Assessment and Research, 1 FTE faculty/staff = full-time faculty or staff headcount + part time faculty or staff headcount then divided by 3. The faculty and staff category also includes affiliates, which are companies that have been contracted by the University Corporation at Monterey Bay or “Corporation” to provide services that the auxiliary has been asked to provide by the university (e.g., dining, bookstore, etc.), and the affiliate’s employees work full-time on campus in that capacity. They are also referred to as contractors. The auxiliary includes staff of the Corporation, Student Union, and Foundation.



As shown on **Table ES-1**, the total on-campus housed population (i.e., the number of students, faculty, and staff residing in either Main Campus or East Campus housing) is forecasted to increase from the existing 58 percent (4,443 of 7,658) to 61 percent (8,774 of 14,476). In terms of actual on-campus housing facilities, the Project would provide housing to accommodate an increase in student population from approximately 6,634 to 12,700 FTEs, and an increase in employees (i.e., faculty and staff) from approximately 1,024 to 1,776 FTEs.

## CAMPUS TRANSPORTATION NETWORK

The Project includes modifications to existing campus parking and transportation facilities in order to create a more pedestrian- and bicycle-oriented campus core. Specific elements of the key PDFs identified in Chapter 3 of the Master Plan Draft EIR that influence existing and future vehicle traffic in and near the CSUMB campus include:

- Parking will be consolidated and relocated to select areas on the periphery of the campus core (PDF-MO-1[c]).
- Vehicle access will be limited to CSUMB students, faculty, and staff vehicles on General Jim Moore Boulevard between Eighth Street and Fifth Street (PDF-MO-3).
- Vehicle travel through the campus core will be restricted to shuttles, transit vehicles, service vehicles, and emergency vehicles at Inter-Garrison Road between General Jim Moore Boulevard and Sixth Avenue, Divarty Street between General Jim Moore Boulevard and Seventh Avenue, Fourth Avenue between Divarty Street and Inter-Garrison Road, Fifth Avenue between Divarty Street and Inter-Garrison, A Street between Divarty Street and Seventh Avenue, Sixth Avenue between B Street and north of Divarty Street, and Butler Street between Sixth Avenue and Seventh Avenue (PDF-MO-3).
- Seventh Avenue between Colonel Durham Street and Butler Street will be converted to one-way for vehicles traveling north from Colonel Durham Street to Inter-Garrison Road (PDF-MO-3).

## PARKING MANAGEMENT AND TRANSPORTATION DEMAND MANAGEMENT

In addition to consolidating and relocating existing campus parking lots, parking management (PDF-MO-1[c]) would be aligned with the expansion of the existing transportation demand management (TDM) strategies (PDF-MO-1), as indicated in the PDFs in Chapter 3 of the Master Plan Draft EIR, to make parking more efficient and remove non-essential lots from the campus core. The TDM plan would address parking management and complement other multimodal infrastructure investments (PDF-MO-2), vehicle restrictions (PDF-MO-3), transit mobility (PDF-MO7 to -11), and active mode (bicycle and pedestrian) mobility (PDF-MO-12 and -13).



The trip generation and parking demand analysis presented in this report uses observed data (refer to **Appendix A**) and assumes the existing Parking Management and Transportation Demand Management (TDM) measures remain in place on the CSUMB campus, and those measures continue to be as effective in reducing vehicle trip-making and encouraging the use of other modes based on observed existing travel characteristics. The analysis furthermore assumes no increased effectiveness or growth in TDM and parking measures despite plans to expand these programs (refer to **Chapter 6** for TDM and parking demand reduction potential).

## CEQA IMPACTS AND MITIGATION MEASURES

Recent legislation in California, Senate Bill (SB) 743, has changed the metric by which significant transportation impacts under CEQA are assessed from level of service, or LOS, to vehicle miles traveled, or “VMT.” In response to this recent legislation, the CSU Office of the Chancellor recently issued the *2019 California State University Transportation Impact Study Manual (2019 CSU TISM)*. The *2019 CSU TISM* establishes the following significance criteria for use in an environmental impact analysis in identifying a project’s potentially significant transportation-related impacts:

- **Plan Conflict:** The Project would conflict with a program, plan, ordinance, or policy addressing the circulation system, including transit, roadway, bicycle, and pedestrian facilities.
- **VMT Impacts:** The Project would result in a VMT-related impact in accordance with the CSU’s project-level or cumulative VMT Significance Thresholds.
- **Hazard Impact:** The Project would substantially increase hazards due to a geometric design feature (e.g., sharp curves or dangerous intersections) or incompatible uses (e.g., farm equipment).
- **Emergency Access Impact:** The Project would result in inadequate emergency vehicle access.

Each of these is further described below.

### PLAN CONFLICTS

The Project’s consistency was evaluated against the relevant circulation and transportation plans considered. This evaluation is summarized by travel mode below.

- **Existing or planned transit systems** will not be significantly impacted by the Project. The Project does not propose changes to the transit system that will impact the *2040 Metropolitan Transportation Plan / Sustainable Communities Strategy (2018)* goals of expanding the role transit plays in meeting the region’s mobility needs such as investments in bus rapid transit, expansion of local services, and planned rail projects. Internal circulation changes will support core regional transit travel within the Campus. The Project is not anticipated to create demand for public transit



above the existing capacity, and therefore, the Project would not have an adverse effect on transit ridership and facilities, and no additional improvements would be required.

- **Existing or planned roadway facilities** will not be significantly impacted by the Project. The Project proposes to design Campus parking lots and local streets to promote a “park once” policy that limits vehicle circulation on local streets on or near the CSUMB campus. Parallel transportation improvements will serve the shifts in regional and local traffic through the CSUMB campus. The street modifications also would support a more walkable, bikeable, and transit-oriented Main Campus core.
- **Existing or planned bicycle facilities** will not be significantly impacted by the Project. The Project will not conflict with existing or planned bicycle facilities. The Project proposes to increase bicycle connections between the existing and planned facilities.
- **Existing or planned pedestrian facilities** will not be significantly impacted by the Project. The Project would enhance pedestrian circulation within the Main Campus core and connections to adjacent land uses, a beneficial effect on pedestrian circulation and access. Therefore, the Project would not interfere with existing or planned pedestrian facilities or conflict with applicable non-automotive transportation plans, guidelines, policies, or standards.

## VEHICLE MILES TRAVELED (VMT)

The VMT impact analysis presented in this report considers the Project’s direct impacts relative to Project-generated VMT per service population, as well the Project’s long-term effect on VMT using boundary VMT per service population evaluated under Cumulative Conditions.

### Project Generated VMT (Project Analysis)

The significance threshold for determining the Project generated VMT impact is a Total VMT per service population rate of 23.91, which is 15 percent below the Existing Conditions VMT per service population for Monterey County of 28.12. Under the Existing with Project Conditions, the CSUMB campus total VMT per service population rate of 20.30 is below the applicable threshold of 23.91. Therefore, the CSUMB campus total VMT per service population rate would not exceed the applicable thresholds under Existing with Project Conditions and the impact is less than significant.

### Projects Effect on VMT (Cumulative Analysis)

This analysis evaluated whether the Project would result in an increase in the countywide boundary VMT per service population from “Cumulative Conditions” to “Cumulative with Project and without Eastside Parkway Conditions” or “Cumulative with Project and with Eastside Parkway Conditions.” The regional impact threshold for the Project’s effect on VMT is the Monterey County Cumulative Conditions boundary VMT per service population of 14.07.



The Project's effect on VMT under Cumulative with Project and without Eastside Parkway Conditions of 13.98 is below the threshold of 14.07. Therefore, the Project would not exceed the applicable thresholds relative to the Project's effect on VMT under Cumulative with Project and without Eastside Parkway Conditions and the impact is less than significant.

Under conditions assuming the Eastside Parkway is in place, the Project's effect on VMT under Cumulative with Project and with Eastside Parkway Conditions of 13.98 is below the threshold of 14.07. Therefore, the Project would not exceed the applicable thresholds under this scenario and the impact is less than significant.

## HAZARDS

The Project would have a significant impact if it would substantially increase hazards due to a roadway geometric design feature (e.g., sharp curves or dangerous intersections) or incompatible uses (e.g., farm equipment). While the Project does include modifications that will change the design of parking lots and local streets and intersections, these modifications would not create hazards such as sharp curves or include otherwise dangerous features. Therefore, the impact is less than significant.

## EMERGENCY ACCESS

For this analysis, a significant impact would occur if the Project or an element of the Project would result in inadequate emergency access. Future parking facilities and streets will be designed to accommodate emergency vehicles. Emergency and service vehicles will continue to have access to the campus and ability to circulate through streets restricted to other vehicles. Therefore, the impact is less than significant.

## OPERATIONS ANALYSIS RESULTS

Operational deficiencies and improvements of intersections and freeway segments within the Project study area were analyzed not to determine environmental impacts within the meaning of CEQA but rather for informational purposes. Deficiency criteria presented in the California State University *Transportation Impact Study Manual* (2012) are used to identify the Project's deficiencies with a refinement to the freeway deficiency criteria: the criteria used is based on Caltrans guidance.

## INTERSECTIONS

Intersections with deficiencies and improvements are summarized below in **Table ES-2**, along with a determination as to whether the intersection deficiency is addressed by the improvement.



**TABLE ES-2: INTERSECTION DEFICIENCY AND IMPROVEMENT SUMMARY**

| Intersection <sup>1</sup>                                      | Deficiency Identified?           |   |  | Improvement  | Deficiency Addressed?            |   |  |
|--|----------------------------------|---|--|--|----------------------------------|---|--|
|  | Existing with Project Conditions | Cumulative with Project and without Eastside Parkway Conditions | Cumulative with Project and with Eastside Parkway Conditions |  | Existing with Project Conditions | Cumulative with Project and without Eastside Parkway Conditions | Cumulative with Project and with Eastside Parkway Conditions |
| 3 SR 1 Southbound Ramps and Imjin Parkway (Cal)                | Yes                              | Yes   | Yes  | Add WBL. Convert off-ramp to loop ramp equivalent.   | Yes                              | Yes   | Yes  |
| 5 Second Avenue and Imjin Parkway (M)                          | No                               | Yes   | Yes  | Add third NBL, second NBR. Add third WBL, two WBT, and convert shared WBT/R to WBR. Add second SBL, second SBT, convert shared SBT/R to SBR. Add second EBL, third EBT, convert shared EBT/R to two SBR.   | N/A                              | Yes   | Yes  |
| 10 Imjin Road and Imjin Parkway (M)                            | No                               | Yes   | No   | Add second WBL   | N/A                              | Yes   | N/A  |
| 12 Reservation Road and Imjin Parkway (M)                      | No                               | Yes   | Yes  | Add third SBT  | N/A                              | <b>No</b>   | Yes  |
| 14 Inter-Garrison Road and Reservation Road (MC)               | No                               | Yes   | Yes  | Add second NBL   | N/A                              | Yes   | <b>No</b>  |
| 16 Second Avenue and Eighth Street (M)                         | Yes                              | No  | No   | Signalize intersection and optimize signal timings.  | Yes                              | N/A   | N/A  |
| 21 <u>Eighth Street/Seventh Avenue and Inter-Garrison Road</u> | <u>Yes</u>                       | <u>No</u>   | <u>No</u>  | <u>Add EB and WB left-turn pockets. Convert shared NBL/T/R to 1 left turn lane, 1 through lane and 1 right turn lane. Convert shared SBT/L and channelized NBR to 1 left turn lane, and 1 shared through-right lane. Signalize intersection and optimize signal timings.</u> | <u>Yes</u>                       | <u>N/A</u>  | <u>N/A</u>   |





**TABLE ES-2: INTERSECTION DEFICIENCY AND IMPROVEMENT SUMMARY**

| Intersection <sup>1</sup>                                      | Deficiency Identified?           |   |  | Improvement   | Deficiency Addressed?            |   |  |
|--|----------------------------------|---|--|---|----------------------------------|---|--|
|  | Existing with Project Conditions | Cumulative with Project and without Eastside Parkway Conditions | Cumulative with Project and with Eastside Parkway Conditions |   | Existing with Project Conditions | Cumulative with Project and without Eastside Parkway Conditions | Cumulative with Project and with Eastside Parkway Conditions |
| 22 Eighth Avenue and Inter-Garrison Road (CSUMB)               | Yes                              | Yes   | Yes  | <u>Option 1</u> - Signalize, optimize signal timings, and add two WBL   | Yes                              | <b>No</b>   | Yes  |
|  |                                  |   |  | <u>Option 2</u> - Add second circulating lane to roundabout and add WBL   | Yes                              | <b>No</b>   | Yes  |
| 23 Abrams Drive and Inter-Garrison Road (MC)                   | Yes                              | Yes   | No   | Existing Conditions Improvement: Signalize intersection, optimize signal timings, and add SBL<br>Cumulative Conditions Improvement: Add second EBL      | Yes                              | Yes   | N/A  |
| 25 Inter-Garrison Road Connection and Inter-Garrison Road (MC) | No                               | Yes   | Yes  | Signalize intersection optimize cycle length and splits   | N/A                              | Yes   | <b>No</b>  |
| 28 Davis Road and Reservation Road (MC)                        | No                               | Yes   | Yes  | Add second EBL  | N/A                              | <b>No</b>   | <b>No</b>  |
| 29 Second Avenue and Divarty Street (M)                        | Yes                              | No  | No   | Convert NBR and SBR to shared NBT/R and SBT/R   | Yes                              | N/A   | N/A  |
| 33 General Jim Moore Boulevard and Lightfighter (S)            | No                               | Yes   | Yes  | <u>Option 1</u> - Add third NBL, second NBT. Add SBR and overlap phase. Add second EBL. Add second WBL and second WBT. Optimize cycle length and splits | N/A                              | Yes   | Yes  |
|  |                                  |   |  | <u>Option 2</u> - Roundabout design   | N/A                              | Yes   | Yes  |



**TABLE ES-2: INTERSECTION DEFICIENCY AND IMPROVEMENT SUMMARY**

| Intersection <sup>1</sup>                            | Deficiency Identified?           |   |  | Improvement   | Deficiency Addressed?            |   |  |
|--|----------------------------------|---|--|---|----------------------------------|---|--|
|  | Existing with Project Conditions | Cumulative with Project and without Eastside Parkway Conditions | Cumulative with Project and with Eastside Parkway Conditions |   | Existing with Project Conditions | Cumulative with Project and without Eastside Parkway Conditions | Cumulative with Project and with Eastside Parkway Conditions |
| 39 General Jim Moore Boulevard and Gigling Road (S)  | No                               | Yes   | Yes  | Option 1 - Add second WBL                                   | N/A                              | Yes   | Yes  |
|  |                                  |   |  | Option 2 - Roundabout design                                | N/A                              | Yes   | Yes  |
| 46 General Jim Moore Boulevard and Normandy Road (S) | No                               | No  | Yes  | Add third NBT, third SBT, optimized cycle length and splits | N/A                              | N/A   | <b>No</b>  |
| 47 General Jim Moore Boulevard and Coe Avenue (S)    | Yes                              | Yes   | No   | Signalize intersection and optimize signal timings          | Yes                              | Yes   | N/A  |

Notes:

1. Intersection jurisdiction and associated LOS threshold applied.
  - i. City of Marina = M
  - ii. City of Seaside = S
  - iii. California State University, Monterey Bay = CSUMB
  - iv. Monterey County = MC
  - v. Caltrans = Cal

Source: Fehr & Peers, 2019.



## FREEWAY SEGMENTS

Freeway segment deficiencies are summarized in **Table ES-3** below. These deficiencies on SR 1 would remain, as there is no assurance that funding will be available for the one planned improvement (widening SR 1 to six lanes from Fremont Boulevard-Del Monte Boulevard to Canyon Del Rey Boulevard), and there are no other planned widening improvements that would address the remainder of the deficiencies. Therefore, there are no feasible improvements available and the deficiencies in **Table ES-3** would remain.

**TABLE ES-3: FREEWAY SEGMENT DEFICIENCY AND IMPROVEMENT SUMMARY**

| Freeway Segment  | Deficiency Identified?           |   |  |
|--|----------------------------------|---|--|
|  | Existing with Project Conditions | Cumulative with Project and without Eastside Parkway Conditions | Cumulative with Project and with Eastside Parkway Conditions |
| Northbound SR 1 between Lightfighter Drive and Fremont Boulevard-Del Monte Boulevard | No                               | Yes   | Yes  |
| Southbound SR 1 between Lightfighter Drive and Fremont Boulevard-Del Monte Boulevard | Yes                              | Yes   | No   |
| Northbound SR 1 between Fremont Boulevard-Del Monte Boulevard and Canyon Del Rey     | Yes                              | Yes   | Yes  |
| Southbound SR 1 between Fremont Boulevard-Del Monte Boulevard and Canyon Del Rey     | Yes                              | Yes   | Yes  |

Source: Fehr & Peers, 2019.

## FREEWAY RAMPS

Freeway ramps analysis was conducted for the Existing with Project Condition and Cumulative with Project and without and with Eastside Parkway Conditions to assess changes in peak hour ramp volumes with the addition of Project traffic and its effects on freeway and local street operations. The freeway study ramps include the on- and off-ramps at SR 1 and Imjin Parkway, and SR 1 and Lightfighter Drive. The volumes for all the with Project conditions scenarios are expected to increase at each of the ramps without exceeding the ramp capacities, with the exception of the SR 1 and Imjin Parkway southbound on-ramp and the SR 1 and Imjin Parkway northbound off-ramp; therefore, no deficiencies were identified. Volumes are expected to decrease for the SR 1 and Imjin Parkway southbound on-ramp and the SR 1 and Imjin Parkway northbound off-ramp. Decreases in volumes under the with Project conditions are due to the displacement and reassignment of traffic when the Project volume is added to the roadway network.



# 1. INTRODUCTION AND PROJECT DESCRIPTION

This report presents the results of the Transportation Analysis (TA) conducted for the proposed *California State University, Monterey Bay (CSUMB) Master Plan* (the "Project"). The Project consists of the proposed Master Plan and Project Design Features (PDFs), as described in Chapter 3, Project Description, of the Master Plan Draft EIR. The trip generation and parking demand analysis presented in this report assumes the existing Parking Management and Transportation Demand Management (TDM) measures remain in place on the CSUMB campus, and those measures continue to be as effective in reducing vehicle trip-making and encouraging the use of other modes based on observed existing travel characteristics. It furthermore assumes no increased effectiveness or growth in TDM and parking measures despite plans to expand these programs (refer to **Chapter 6** for TDM and parking demand reduction potential). Therefore, this TA bases Project trip generation, parking demand, and roadway operations changes on observed data to the greatest extent possible.

The CSUMB Main Campus is located within the geographic boundaries of the cities of Marina, Seaside, and Monterey County, and is generally bounded by Eighth Street, Inter-Garrison Road, Eighth Avenue, Colonel Durham Street, Lightfighter Drive, and Second Avenue. The East Campus open space and housing is located east of Eighth Avenue on either side of Inter-Garrison Road. **Figure 1** shows the location of the Project site (Main Campus and East Campus) and the surrounding transportation network. **Figure 2** shows the Project site with study intersections. **Figure 3** shows the Project site (Main Campus and East Campus) and the surrounding transportation network with the freeway study segments.

This chapter discusses the report purpose, Project description, recent changes in the California Environmental Quality Act (CEQA) regarding transportation analyses, the study area/analysis scenarios/methods used in the operations analysis and the criteria used to identify deficiencies, and report organization.

## PURPOSE

The primary purpose of this report is:

- To present the transportation analysis for compliance with the CEQA, including analysis of the Project's vehicle miles traveled (VMT), the identification of significant impacts and recommended mitigation, where applicable, for inclusion in the Environmental Impact Report (EIR),<sup>5</sup> and

---

<sup>5</sup> VMT refers to "Vehicle Miles Traveled," a metric that accounts for the number of vehicle trips generated plus the length or distance of those trips. This report uses total VMT and boundary VMT metrics for specific geographic areas, which are defined in **Chapter 4**.



- To present a traffic operations analysis for informational purposes only, intended to inform the reader of potential roadway operational deficiencies<sup>6</sup> resulting from the addition of Project traffic, and potential transportation improvements to reduce the identified deficient operations.

This TA addresses the Project's effects on the roadway system and on the nearby bicycle, pedestrian, and transit networks. Project effects on the environment were evaluated following the CEQA Guidelines and the *California State University Transportation Impact Study Manual (2019)*, which provides guidance on how to evaluate the effects of projects on the transportation system on and near a CSU campus. Guidance from the City of Marina, City of Seaside, Monterey County, and Caltrans was also considered.

---

<sup>6</sup> Deficiencies are the Project's potential effects to the study area's transportation system and determined by the criteria described in **Chapter 11**.



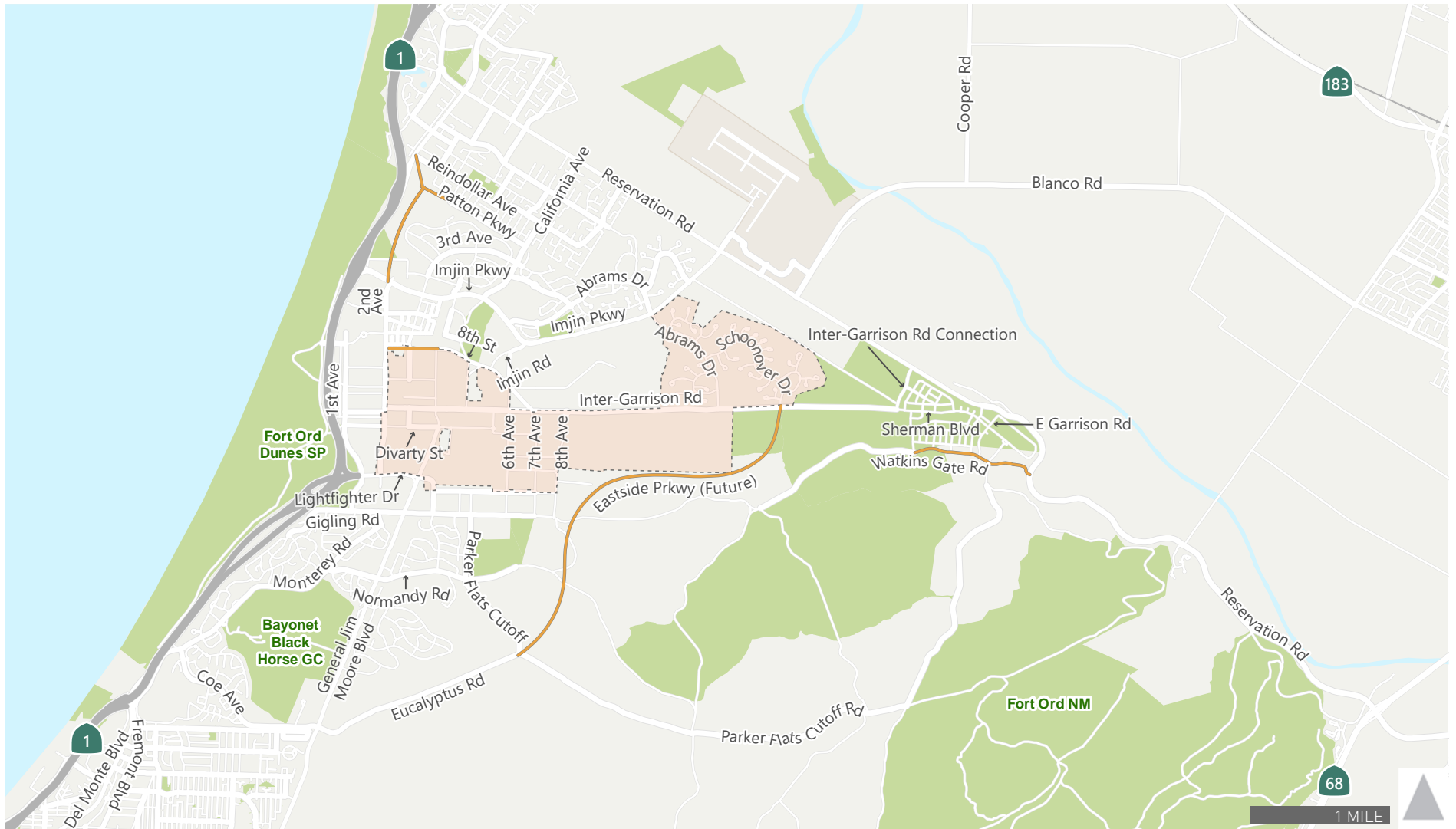



-  California State University Monterey Bay Campus
-  New/Extended Roadway



Figure 1  
Project Location



- California State University Monterey Bay Campus
- # Study Intersection
- # Future Intersection
- New/Extended Roadway

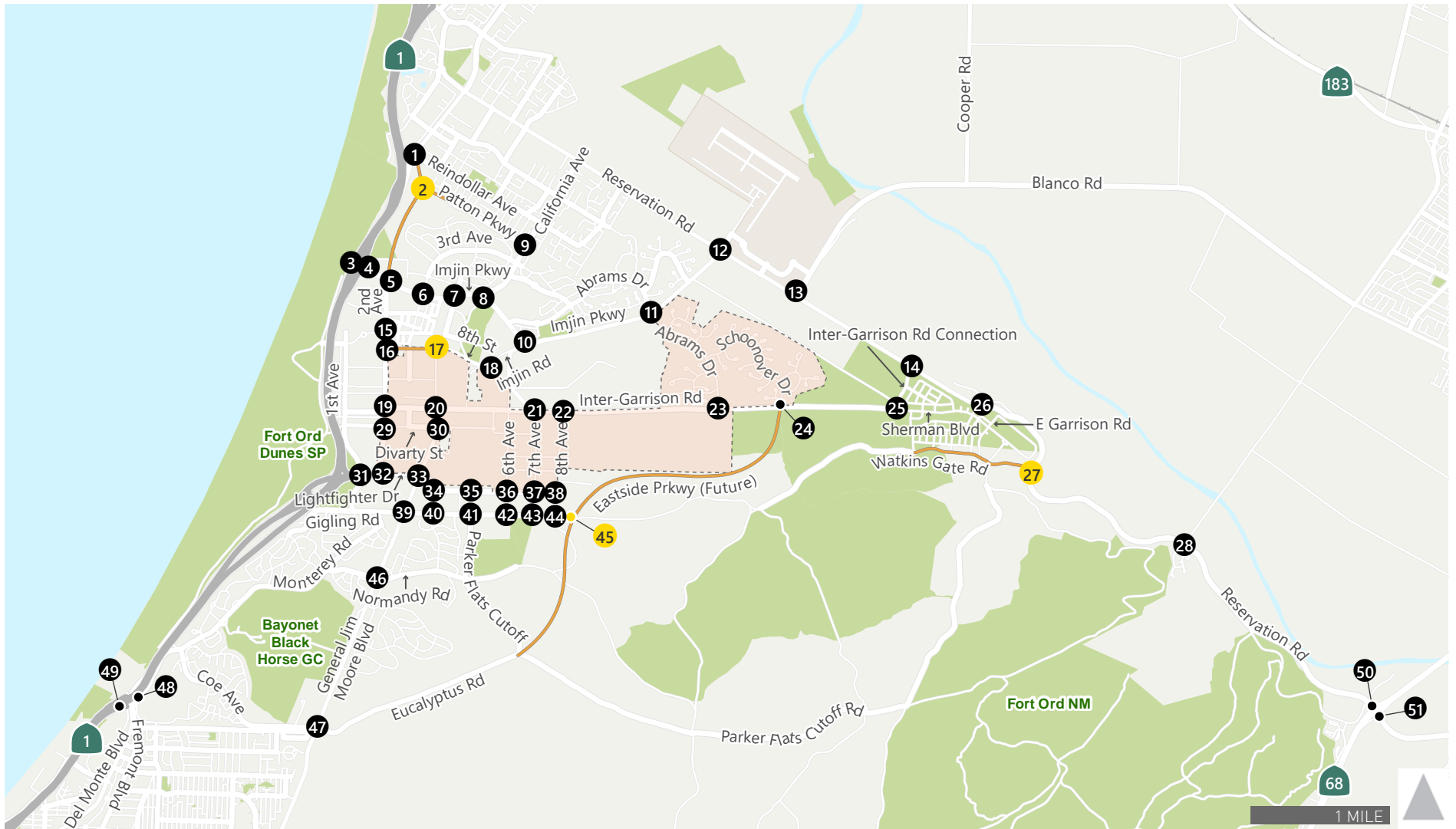

Figure 2  
Project Location and Study Intersections

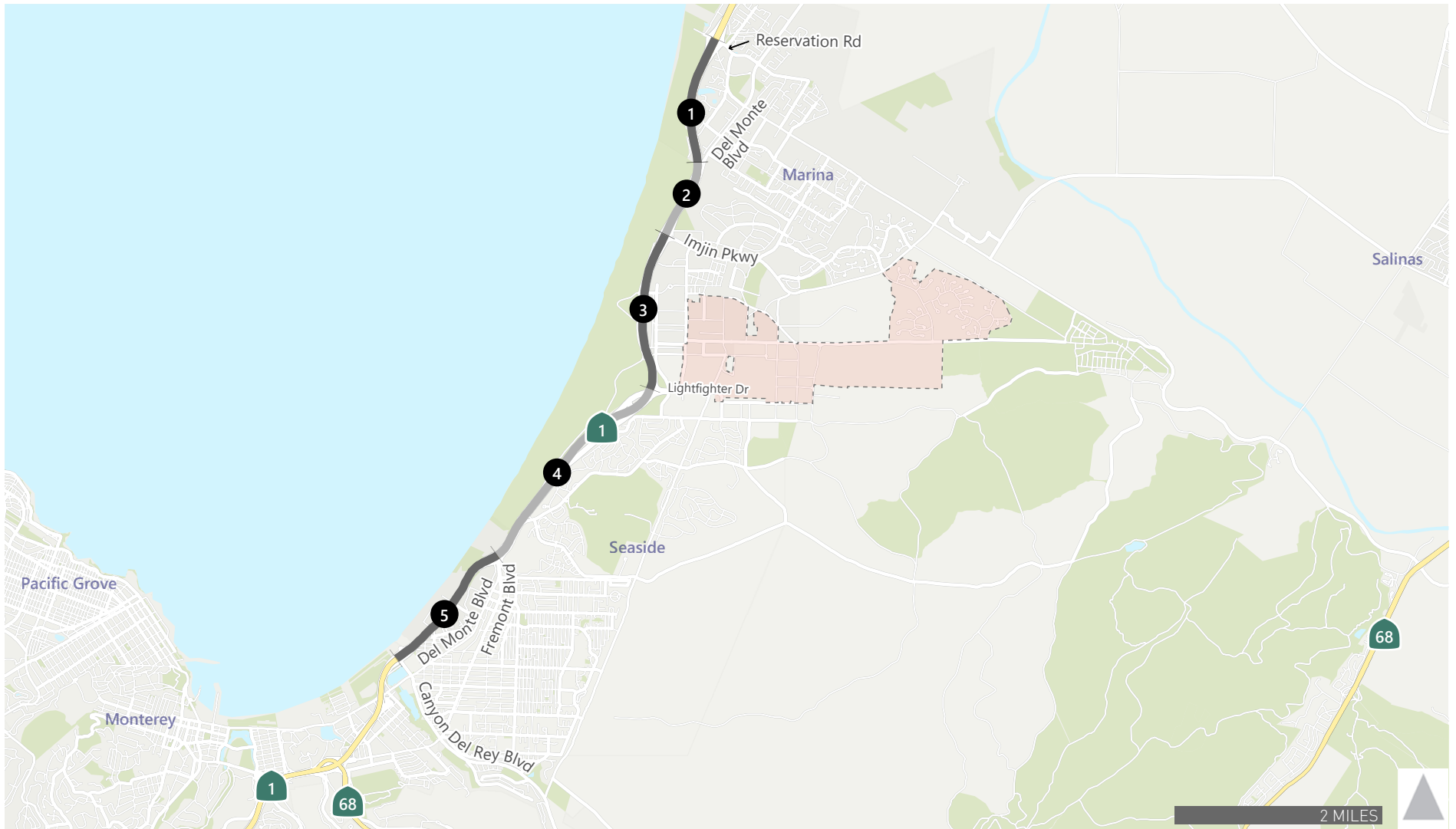



-  Study Freeway Segments
-  California State University Monterey Bay Campus



Figure 3  
 Project Location and Study Freeway Segments



## PROJECT DESCRIPTION

The Project is the proposed CSUMB Master Plan, including Project Design Features (PDFs), as described in Project Description (Chapter 3), of the CSUMB Master Plan Draft Environmental Impact Report (Master Plan Draft EIR). Project elements that would affect the transportation system include the proposed increase in student enrollment and associated increase in faculty and staff; the added on-campus housing for students, faculty, and staff; and a Main Campus street and parking system that facilitates and prioritizes walking, bicycling, and transit use over vehicle travel. Each of these Project elements is described below.

## CAMPUS POPULATION

Upon buildout, the Project would accommodate an increase in campus enrollment from the existing (based on academic year 2016-2017) 6,634 full-time equivalent (FTE) students<sup>7</sup> and 1,024 FTE faculty/staff,<sup>8</sup> to 12,700 FTE students and 1,776 FTE faculty/staff. Achieving this growth would result in an increase of approximately 6,066 FTE students and 752 FTE faculty/staff over existing levels.

## LAND USE/CAMPUS HOUSING

Upon buildout, the Project is forecast to house at least 60 percent of enrolled students and 65 percent of faculty and staff on campus (refer to PDF-LU-5 and PDF-LU-6, as described in Chapter 3 of the proposed CSUMB Master Plan Draft EIR [Master Plan Draft EIR]). Based on current and projected future conditions, at Project buildout the percentage of students housed on-campus is expected to be similar to the existing percentage, although the absolute number of students housed on campus will increase with planned enrollment growth, while the percentage of faculty and staff housed on campus is expected to increase as the result of the Project. Refer to *California State University, Monterey Bay Proposed Master Plan Housing Memorandum* (**Attachment A** of the trip generation memorandum in **Appendix A** of this TA report).

**Table 1** summarizes the number and percentage of students, faculty, and staff presently residing on- and off-campus (Existing Conditions), and the number forecasted to reside on- and off-campus under Project Conditions when FTE student enrollment and FTE faculty/staff employment reach a total of 14,476.

---

<sup>7</sup> Full-time equivalent (FTE) is the unit of measurement used to convert class load to student enrollment. At CSUMB, one FTE is equal to 15 units. Thus, one FTE student is equal to one student enrolled in 15 units or three students each enrolled in 5 units. A related unit of measurement is "headcount." In the case of one student taking 15 units, the headcount is 1; in the case of three students collectively taking 15 units, the headcount is 3.

<sup>8</sup> According to CSUMB Institutional Assessment and Research, 1 FTE faculty/staff = full-time faculty or staff headcount + part time faculty or staff headcount then divided by 3. The faculty and staff category also includes affiliates, which are companies that have been contracted by the University Corporation at Monterey Bay or "Corporation" to provide services that the auxiliary has been asked to provide by the university (e.g., dining, bookstore, etc.), and the affiliate's employees work full-time on campus in that capacity. They are also referred to as contractors. The auxiliary includes staff of the Corporation, Student Union, and Foundation.



**TABLE 1: CSUMB POPULATION TYPE BY HOUSING LOCATION**

| Housing Location  | Existing Conditions<br>(FTE Students or Faculty/Staff) <sup>1</sup> | Project Conditions<br>(FTE Students or Faculty Staff) <sup>1</sup> | Change<br>(Project – Existing) <sup>2</sup> |
|---|---|--|---|
| <b>Student Population</b>   |   |  |   |
| Main Campus   | 2,600<br>(39.2%)  | 7,620 <sup>3</sup><br>(60.0%)                                      | +5,020                                      |
| East Campus <sup>4</sup>  | 1,380<br>(20.8%)  | 0<br>(0%)  | -1,380                                      |
| Off-Campus  | 2,654<br>(40.0%)  | 5,080<br>(40.0%)   | +2,426                                      |
| <i>Subtotal [A]</i>   | <i>6,634</i><br><i>(100%)</i>                                       | <i>12,700</i><br><i>(100%)</i>                                     | <i>+6,066</i>                               |
| <b>Faculty/Staff Population</b>                                   |   |  |   |
| East Campus <sup>4</sup>  | 463<br>(45.2%)  | 1,154 <sup>3</sup><br>(65.0%)                                      | +691  |
| Off-Campus  | 561<br>(54.8%)  | 622<br>(35.0%)   | +61   |
| <i>Subtotal [B]</i>   | <i>1,024</i><br><i>(100%)</i>                                       | <i>1,776</i><br><i>(100%)</i>                                      | <i>+752</i>                                 |
| <b>Student, Faculty, and Staff Population (Campus Population)</b> |   |  |   |
| Main Campus and East Campus<br>(Students, Faculty and Staff)      | 4,443<br>(58.0%)  | 8,774<br>(60.6%)   | +4,331                                      |
| Off-Campus<br>(Students, Faculty and Staff)                       | 3,215<br>(42.0%)  | 5,702<br>(39.4%)   | +2,487                                      |
| <b>Total<br/>[A + B = C]</b>                                      | <b>7,658<br/>(100%)</b>   | <b>14,476<br/>(100%)</b>   | <b>+6,818</b>                               |
| <b>Campus Population with Community Housing Partners</b>          |   |  |   |
| East Campus<br>(Community Housing Partners) [D]                   | 280   | 66   | -214  |
| <b>Total [C+D = E]</b>  | <b>7,938</b>  | <b>14,542</b>  | <b>+6,604</b>                               |

Notes:

1. FTE = Full-time equivalent students, faculty/staff or community housing partners.
2. Change (Project – Existing) = Project Conditions column – Existing Conditions column.
3. The transportation trip generation analysis uses a campus population that, meets but does not exceed the 60 percent student housing goal and the 65 faculty and staff housing goal under Project Conditions.
4. Under Existing Conditions 1,380 students, 463 faculty/staff, and 280 community housing partners live in the East Campus housing. Under Project Conditions 1,154 faculty/staff and 66 community housing partners live in the East Campus housing unless housing is needed by for campus employees.

Source: Fehr & Peers, 2019.



As shown in **Table 1**, the total population housed on-campus (i.e., the number of students, faculty, and staff residing in either Main Campus or East Campus housing) is forecasted to increase from the existing 58 percent (4,443 of 7,658) to 61 percent (8,774 of 14,476).<sup>9</sup>

## CAMPUS TRANSPORTATION NETWORK

The Project includes physical modifications to existing campus parking and transportation facilities to create a more pedestrian and bicycle-oriented campus core. Specific elements (refer to **Figure 6**) of the key PDFs in Chapter 3 of the Master Plan Draft EIR that influence existing and future vehicle traffic in and near the CSUMB campus include the following:

- Parking will be consolidated and relocated to select areas on the periphery of the campus core (PDF-MO-1[c]).
- Vehicle access will be limited to CSUMB students, faculty, and staff vehicles on General Jim Moore Boulevard between Eighth Street and Fifth Street (PDF-MO-3).
- Vehicle travel through the campus core will be restricted to shuttles, transit vehicles, service vehicles, and emergency vehicles at the following locations (PDF-MO-3):
  - Inter-Garrison Road between General Jim Moore Boulevard and Sixth Avenue
  - Divarty Street between General Jim Moore Boulevard and Seventh Avenue
  - Fourth Avenue between Divarty Street and Inter-Garrison Road
  - Fifth Avenue between Divarty Street and Inter-Garrison Road
  - A Street between Divarty Street and Seventh Avenue
  - Sixth Avenue between B Street and north of Divarty Street
  - Butler Street between Sixth Avenue and Seventh Avenue
- Seventh Avenue between Colonel Durham Street and Butler Street will be converted to one-way for vehicles traveling north from Colonel Durham Street to Inter-Garrison Road.

CSUMB proposed on campus bicycle and pedestrian networks are presented in **Figure 4** and **Figure 5**.

---

<sup>9</sup> As space permits, Community Housing Partners will also reside in the East Campus housing; Community Housing Partners are made up of affiliates (a subcategory of CSUMB staff), educational partners and military partners. While Community Housing Partners live on-campus, they are not associated with on-campus housing for students, faculty, and staff, and therefore are not included in the student, faculty, and staff population total but are included in the entire campus population total in **Table 1**.



## TRANSPORTATION DEMAND MANAGEMENT AND PARKING MANAGEMENT

In addition to consolidating and relocating existing campus parking lots, parking management (PDF-MO-1[c]) would be aligned with the expansion of the existing transportation demand management (TDM) strategies (PDF-MO-1), as indicated in Chapter 3 of the Master Plan Draft EIR, to make parking more efficient and remove non-essential lots from the campus core. Parking for academic or residential lots would be consolidated as new development occurs. Continued use of a limited number of special-use parking stalls would be provided throughout campus to accommodate service vehicles, deliveries, loading and unloading activities, and trash pick-up. Appropriate numbers of accessible stalls would be allocated campus wide as required by state code. The TDM plan would address parking management and complement other multimodal infrastructure investments (PDF-MO-2), vehicle restrictions (PDF-MO-3), transit mobility (PDF-MO7 to 11), and active mode (bicycle and pedestrian) mobility (PDF-MO-12 and 13). The list of existing Parking Management and TDM strategies are listed in the Existing Conditions chapter (**Chapter 2**).



Figure 7.10:

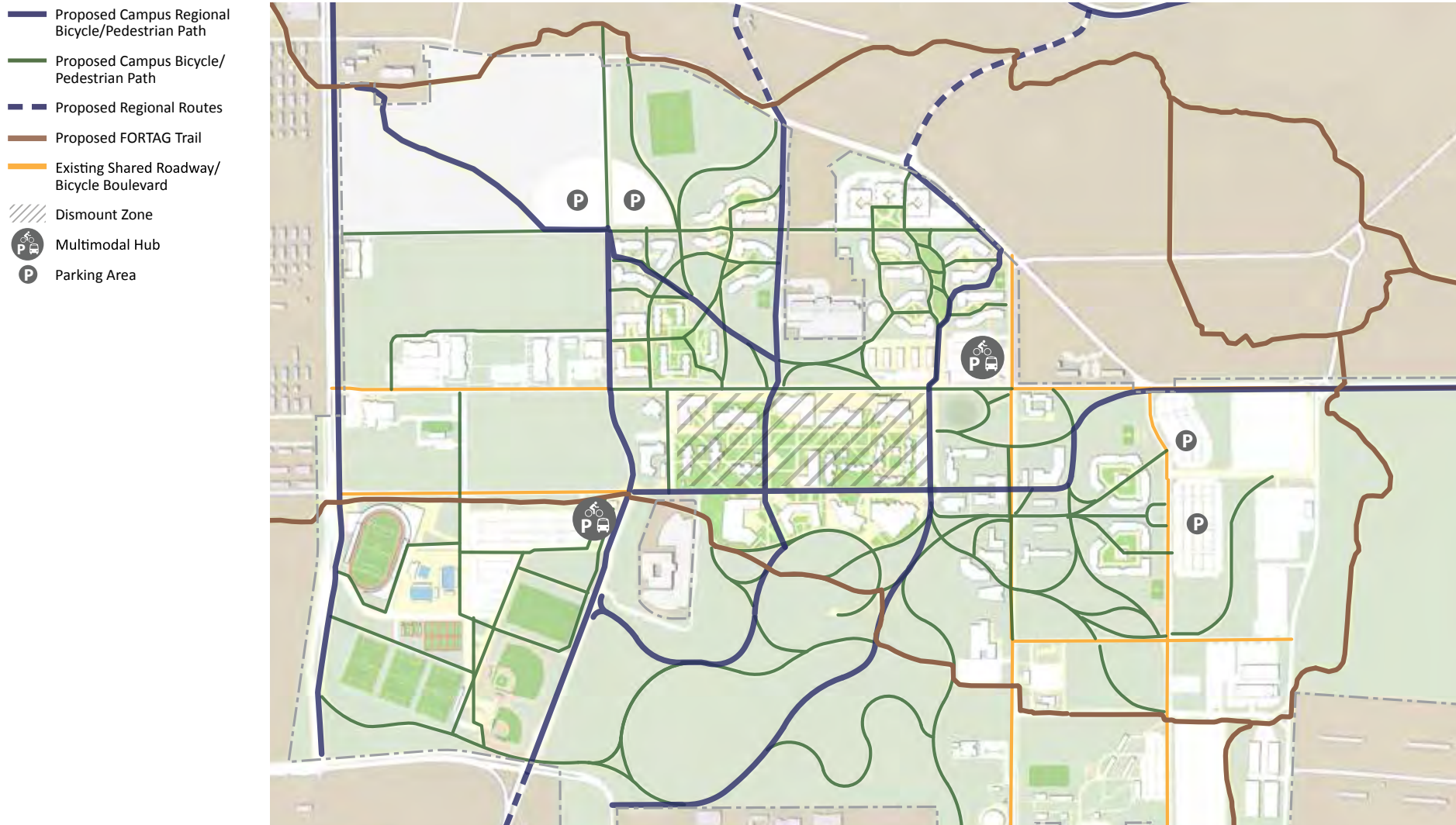

Source: Page / BMS Design Group (2017)

SOURCE: Page / BMS Design Group (2017)



CSU Monterey Bay Master Plan EIR

CSU MONTEREY BAY CAMPUS MASTER PLAN

**FIGURE 3-11  
Bicycle Circulation Plan**

Figure 4

**CSUMB Proposed Bicycle Network**

Figure 7.12:

- Proposed FORTAG Trail
- - - Bicycle/Pedestrian Path
- Sidewalk or Walkway
- Grades < 5%
- Multimodal Hub
- Parking Area

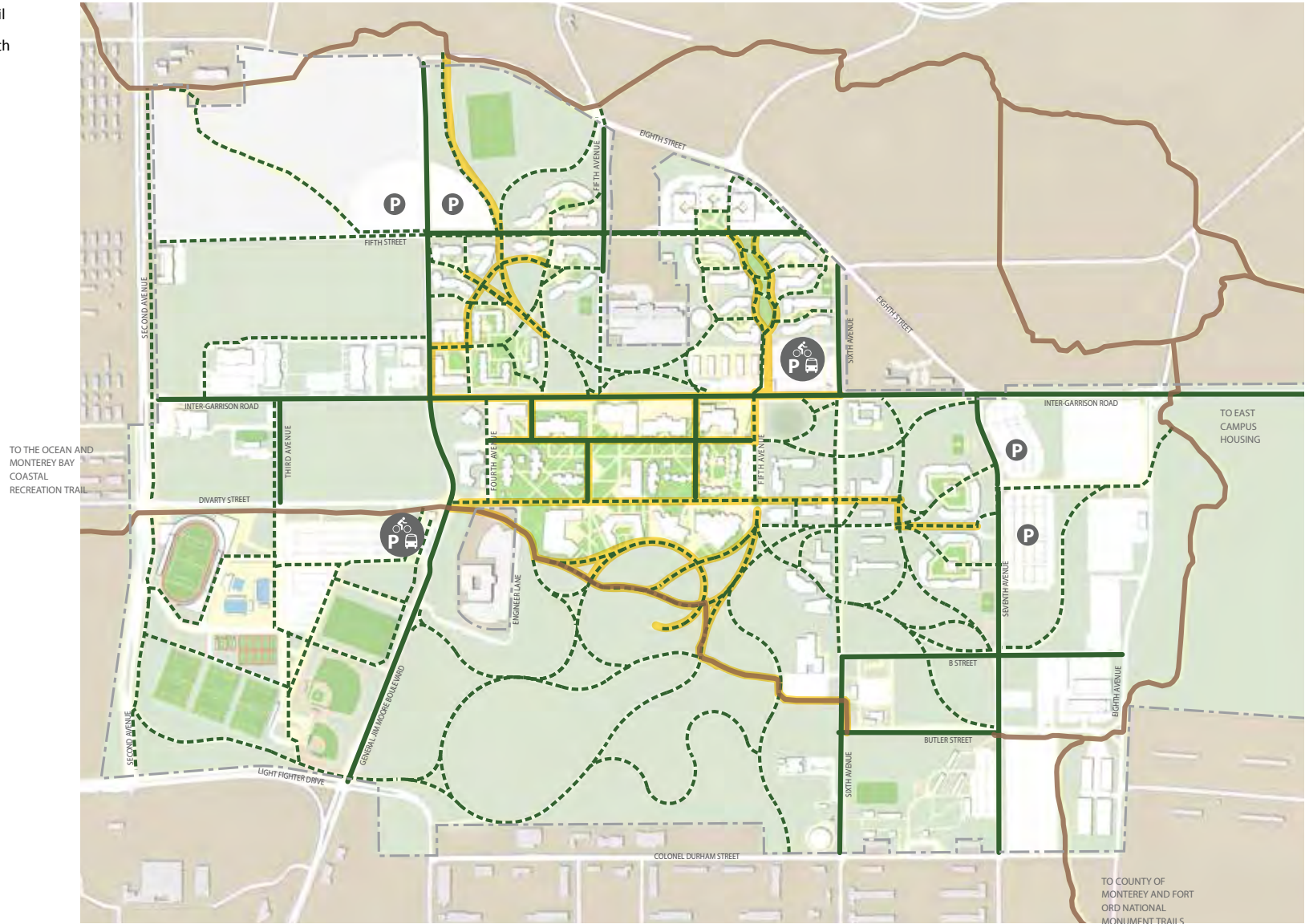

Source: Page / BMS Design Group (2017)

SOURCE: Page / BMS Design Group (2017)

**CSU MONTEREY BAY CAMPUS MASTER PLAN**  
**FIGURE 3-12**  
**Pedestrian Circulation Plan**

Figure 5

CSU Monterey Bay Master Plan EIR

**CSUMB Proposed Pedestrian Network**



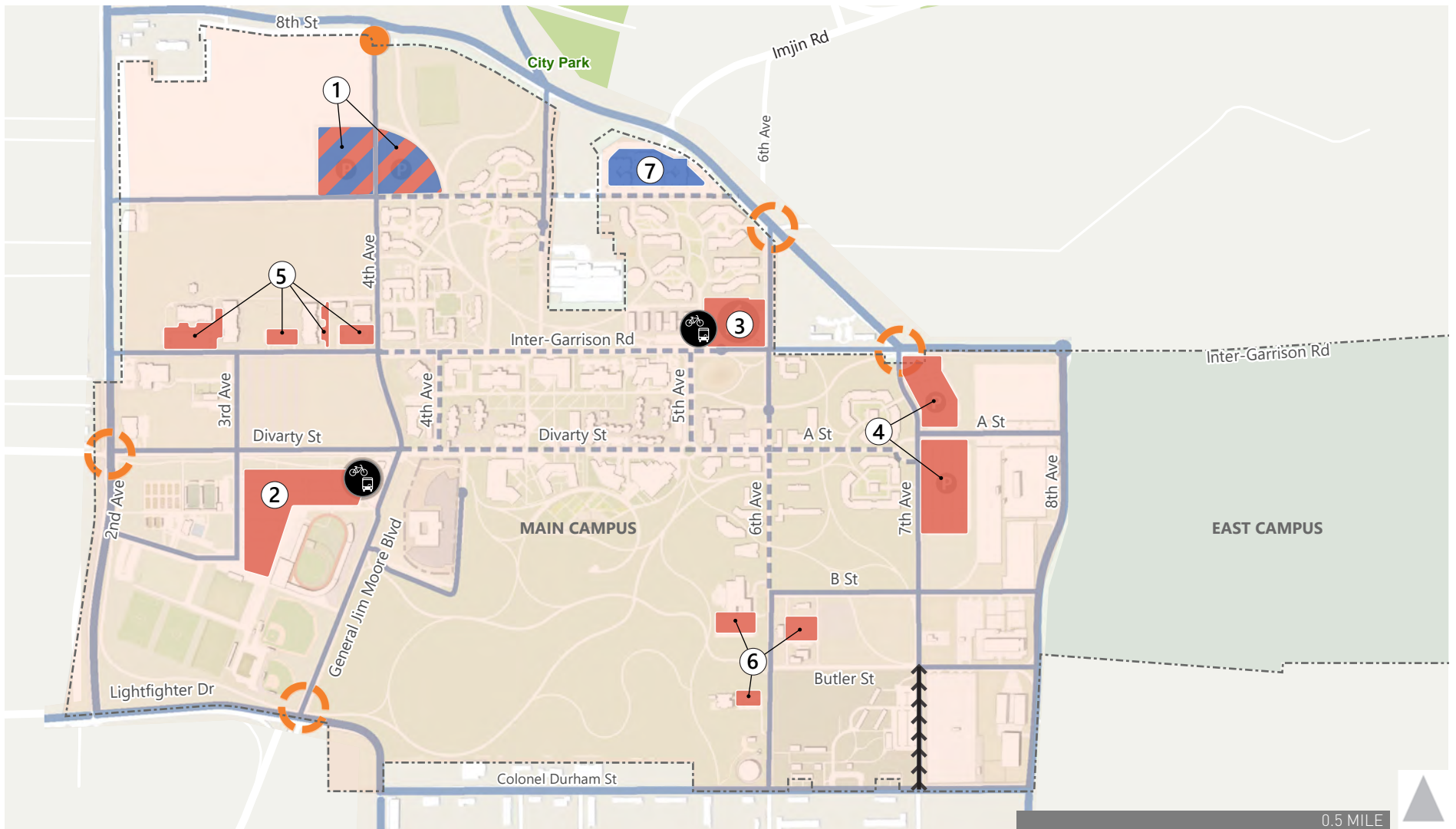

California State University Monterey Bay Main Campus  
 California State University Monterey Bay East Campus

Peripheral Circulation Street  
 Campus Vehicular Street  
 Campus Restricted Access Street  
 (Shuttle, Transit, Service and Emergency)  
 Oneway Street  
 Campus Entry  
 Gated Entry  
 (Restricted to CSUMB students, faculty and staff)

Academic Parking Area  
 Residential Parking Area  
 Academic and Residential Parking Area  
 Multimodal Hub



Figure 6  
 CSUMB Campus Streets and Parking Lots

## RECENT CHANGES TO CEQA TRANSPORTATION ANALYSIS

Senate Bill (SB) 743, signed by Governor Jerry Brown in 2013, changed the way transportation impacts are identified under CEQA. Specifically, the legislation directed the State of California's Office of Planning and Research (OPR) to look at different metrics for identifying transportation impacts and make corresponding revisions to the CEQA Guidelines. Following several years of draft proposals and related public comments, OPR settled upon VMT<sup>10</sup> as the preferred metric for assessing passenger vehicle-related impacts, and issued revised CEQA Guidelines in December 2018, along with a *Technical Advisory on Evaluating Transportation Impacts in CEQA* (December 2018) to assist practitioners in implementing the CEQA Guidelines revisions to use VMT as the new metric.

Under the revised Guidelines, vehicle level of service (LOS) is no longer used as a determinant of significant environmental impacts, and an analysis of a project's impacts relative to VMT is the new metric against which significant impacts are to be assessed. In response to this methodological change in required transportation analysis, the CSU Chancellors Office prepared the recently issued *2019 California State University Transportation Impact Study Manual (CSU TISM)*, which supersedes the *2012 CSU TISM*. The *2019 CSU TISM* provides guidance for the preparation of CEQA-compliant transportation impact analysis pursuant to SB 743 and is the operative TISM for the analysis presented here.

## SB 743 VMT ASSESSMENT METHODS DECISIONS

As discussed below, the comprehensive VMT analysis (i.e., VMT including all vehicle trips, vehicle types, and trip purposes without separation by land use) presented in this report considers the Project's direct impacts, as well as a cumulative analysis that considers the Project's long-term effect on VMT.<sup>11</sup> The VMT analysis methods and thresholds used for this analysis go beyond the *Technical Advisory on Evaluating Transportation Impacts in CEQA* (December 2018) due to the unique characteristics of a university campus development project, which are not specifically addressed in the Technical Advisory. This is due to several reasons, including the Technical Advisory's focus on how to streamline or avoid VMT impact review for

---

<sup>10</sup> VMT refers to "Vehicle Miles Traveled," a metric that accounts for the number of vehicle trips generated plus the length or travel distance of those trips. This report uses the total VMT and boundary VMT metrics for specific geographic areas. The VMT metrics are defined in **Chapter 4**. VMT is an accessibility performance metric that evaluates the changes in land use patterns, regional transportation systems, and other built environment characteristics. This is different from the previous performance metric, vehicle level of service, which measures vehicle mobility.

<sup>11</sup> This is in contrast with the OPR Technical Advisory recommendation to use Partial VMT for transportation impact analysis (Governor's Office of Planning and Research, *Technical Advisory: On Evaluating Transportation Impacts in CEQA*, pages 15 and 16). Using Partial VMT for Project generated VMT screening may not tell the full story of the project's benefits. For example, mixed-use projects help reduce VMT by shortening vehicle trip lengths or reducing vehicle trips because of the convenience of walking, bicycling, or using transit between project destinations. A comprehensive VMT analysis is a more complete evaluation.





projects the state considers to be desirable based on their type and location (i.e., infill projects near transit) and that include the most common land uses (i.e., office, industrial, residential, and retail).

Accordingly, after careful evaluation of the OPR Technical Advisory relative to a campus setting, the CSU Chancellor's Office prepared the *2019 CSU TISM* to provide guidance for CEQA compliant transportation impact analysis pursuant to SB 743 for all CSU campuses. The *2019 CSU TISM* was prepared by transportation engineers and support staff with a strong understanding of CEQA practice and focus on consistency and compliance with CEQA Guidelines.

The OPR Technical Advisory provides a blueprint for organizing key decisions regarding SB 743 methods: the decisions listed later in this section follow the basic structure of the *OPR Technical Advisory*. The *OPR Technical Advisory* recommends considering a project's short-term, long-term, and cumulative effects on VMT but provides limited recommendations on how to prepare a comprehensive VMT analysis for projects. The CSU Chancellor's Office and resulting *2019 CSU TISM* considers the substantial evidence presented in the OPR Technical Advisory to make key decisions about the VMT forecasting model, VMT accounting methods, calculation of the baseline and cumulative regional VMT estimates, and VMT thresholds required for a comprehensive analysis. Below are substantial evidence examples with specific citations of:

- using all Project generated VMT and Project's Effect on VMT (refer to the **Retail Projects** quote below),
- not truncating trip lengths based on model or political boundaries (refer to the **Consideration for All Projects** quote below), and
- accounting for the cumulative effects of a project (refer to **Cumulative Impacts** quote) used to create the *2019 CSU TISM*.

The quotes are listed below with highlights added to the most relevant portion of the quote.

**Retail Projects.** *Generally, lead agencies should analyze the effects of a retail project by assessing the change in total VMT<sup>11</sup> because retail projects typically reroute travel from other retail destinations. A retail project might lead to increases or decreases in VMT, depending on previously existing retail travel patterns.* (Quote from page 5 of the *Technical Advisory on Evaluating Transportation Impacts in CEQA*, December 2018; footnote 11 in this quote is a reference to see Appendix 1 of the OPR Technical Advisory, which discusses evaluation of Total VMT).

**Considerations for All Projects.** *Lead agencies should not truncate any VMT analysis because of jurisdictional or other boundaries, for example, by failing to count the portion of a trip that falls outside the jurisdiction or by discounting the VMT from a trip that crosses a jurisdictional boundary. CEQA requires environmental analyses to reflect a "good faith effort at full disclosure." (CEQA Guidelines, § 15151.) Thus, where methodologies exist that can estimate the full extent of vehicle travel from a project, the lead agency should apply them to do so. Where those VMT effects will grow over time,*



*analyses should consider both a project's short-term and long-term effects on VMT.* (Quote from page 6 of the *Technical Advisory: On Evaluating Transportation Impacts in CEQA*, December 2018).

**Cumulative Impacts.** *A project's cumulative impacts are based on an assessment of whether the "incremental effects of an individual project are considerable when viewed in connection with the effects of past projects, the effects of other current projects, and the effects of probable future projects." (Pub. Resources Code, § 21083, subd. (b)(2); see CEQA Guidelines, § 15064, subd. (h)(1).)* (Quote from page 6 of the *Technical Advisor: On Evaluating Transportation Impacts in CEQA*, December 2018).

The inclusion of Project's effect on VMT for retail projects in the OPR Technical Advisory is one of the reasons that the analysis presented here includes all trip purposes and vehicle types without separation of VMT by land use, and an evaluation of Project's Effects on VMT (i.e., Project generated VMT per service population and boundary VMT).

The expectations of a CEQA impact analysis to provide a complete picture of the VMT effects on the environment are highlighted within the CEQA Guidelines in the following sections.

- **CEQA Guidelines – Expectations for Environmental Impact Analysis**
  - § 15003 (F) = fullest possible protection of the environment...
  - § 15003 (I) = adequacy, completeness, and good-faith effort at full disclosure...
  - § 15125 (C) = EIR must demonstrate that the significant environmental impacts of the proposed project were adequately investigated...
  - § 15144 = an agency must use its best efforts to find out and disclose...
  - § 15151 = sufficient analysis to allow a decision which intelligently takes account of environmental consequences...

All of these suggest completeness (and accuracy) is important and have largely been recognized by the courts as the context for judging an adequate analysis. Furthermore, to understand the effects of a project, VMT inputs for air quality, greenhouse gas (GHG) emissions, and energy consumption already require a comprehensive analysis of 'project generated' and 'project's effect on VMT' using local or regional travel forecasting models:

- Project generated VMT per service population (Direct Impacts): The sum of the "VMT from" and "VMT to" and within a local jurisdiction under baseline conditions divided by the sum of the number of residents, employees, and students in the local jurisdiction.
- Project's effect on VMT per service population (Cumulative Impacts): An evaluation of the change in travel between without and with project conditions on all roadways within the local jurisdiction under Cumulative Conditions divided by the sum of the number of residents, employees, and students in the local jurisdiction.



Both 'project generated VMT' and the 'project's effect on VMT' are recommended in the *2019 CSU TISM* to fully account for VMT effects that may include changes to VMT generation from neighboring land uses. The importance of a comprehensive analysis using all VMT per service population and that considers the project's effect on VMT is that land use projects can influence the routing of existing trips and the VMT generation of surrounding land uses. Combined with the expectations established in the CEQA Guidelines and CEQA case law, ignoring the project's effect on VMT may result in an inadequate analysis.

With this in mind, implementation of an SB 743 VMT assessment requires that certain methodology decisions must be made prior to the assessment. The necessary decisions and selected tools used in this assessment are as follows (consistent with the *2019 CSU TISM*):

- Select a VMT calculation tool
  - Use the Association of Monterey Bay Area Governments (AMBAG) regional travel forecasting model.
- Select the VMT accounting method(s)
  - Total (Project generated)<sup>12</sup> VMT per service population (for Direct Impacts): The sum of the "VMT from" and "VMT to" and within a specific geographic area divided by the service population, which is the sum of the number of residents, employees, and students in the county.
  - Project's effect on VMT per service population (for Cumulative Impacts): An evaluation of the change in travel between without and with Project Conditions on all roadways within Monterey County under Cumulative Conditions divided by the sum of the number of residents, employees, and students in the county.
- Calculate the baseline and cumulative regional VMT estimates
  - The analysis presented here uses VMT from all trip purposes and vehicle types without separation of VMT by land use for Monterey County with a baseline set as Existing Conditions VMT generated by Monterey County and cumulative set as VMT on all roadways in Monterey County under Cumulative without Project Conditions. (Refer to the descriptions of Project generated VMT (Project Analysis) and Project's effect on VMT (Cumulative Analysis) presented in **Chapters 4** and **5** for more details.)

---

<sup>12</sup> For projects requiring a full VMT assessment, the *2019 California State University Transportation Impact Study Manual* describes the need to evaluate the project-generated VMT per service population. This analysis uses the total VMT metric. The Project's VMT is the difference between the CSUMB campus total VMT under Existing with Project Conditions and Existing Conditions. This approach of identifying the Project's total VMT is to capture the effects of increasing on-campus housing and shifting of student housing from East Campus Housing to Main Campus.



- Set VMT threshold(s)
  - The threshold to be applied in assessing Project-specific impacts is 15 percent below the existing total VMT per service population rate for Monterey County.<sup>13</sup> (Refer to **Table 10** for additional details about this threshold)
  - The threshold to be applied in assessing cumulative impacts (Project's effect on VMT) is no change in the cumulative conditions (future) boundary VMT per service population (without and with Eastside Parkway) for Monterey County. (Refer to **Table 10** for additional details about this threshold)

As to direct impacts, total VMT per service population is the metric used to evaluate how the CSUMB campus VMT rate changes (increases or decreases) between the "without Project" and "with Project" scenarios, considering both VMT increases due to growth and VMT reductions due to changes in travel behavior.<sup>14</sup> The "with Project" scenario results are divided by the number of full-time equivalent (FTE) students, FTE faculty, and staff (the change in service population due to the Project) to normalize the results; that is, to account for the differences in travel behavior among the different campus population types.<sup>15</sup> Total VMT per service population is used to evaluate changes in the VMT rate due to the Project (i.e., the direct impacts); however, it does not evaluate a Project's effect on VMT on the entire roadway system,<sup>16</sup> which is evaluated as part of the cumulative analysis.

Regarding the cumulative analysis, the CSUMB campus land use changes are relatively small in the context of Monterey County's residential population and employment; therefore, it is likely that the Project's effect on VMT (cumulative impact) would be localized, such as shifting some existing trips to/from other neighborhoods close to the CSUMB campus. Furthermore, the Project is likely to cause existing pass-through traffic to shift to alternate routes as more CSUMB campus-generated traffic occurs on the local streets within and near the CSUMB campus. Therefore, the Project's effect on VMT, as evaluated by the cumulative effects of the Project's land use and transportation changes, compares the changes in boundary

---

<sup>13</sup> The CSU has selected the 15 percent reduction relative to Monterey County based on the OPR *Technical Advisory*, which states "... OPR recommends that a per capita or per employee VMT that is 15 percent below that of existing development may be a reasonable threshold." (Quote from page 10 of the *Technical Advisory on Evaluating Transportation Impacts in CEQA*, December 2018).

<sup>14</sup> The trip generation approach and technical methods are unique because of the size of the CSUMB campus, the unique travel behavior of each portion of the CSUMB population, and varied housing locations of the CSUMB population. Rather than calculating the net increase in project VMT due to the net increase in land use intensity like most projects, the total VMT is prepared for the entire campus under Existing Conditions and Existing with Project Conditions to capture the effects of adding student on-campus housing to the Main Campus and shifting of student housing from East Campus to Main Campus, and increasing the portion of faculty and staff living in the East Campus.

<sup>15</sup> For this analysis, service population is defined as the sum of all employees, residents, and students (Kindergarten through University).

<sup>16</sup> An often-cited example of how a project can affect VMT is the addition of a grocery store in a food desert. Residents of a neighborhood without a grocery store have to travel a great distance to an existing grocery store. Adding a grocery store to that neighborhood will shorten many of the grocery shopping trips and reduce the VMT to/from the neighborhood. This concept is likely to occur with the addition of campus housing.



VMT per service population<sup>17</sup> between the Cumulative and Cumulative with Project conditions, including with and without Eastside Parkway Conditions. Each scenario is described in detail later in this chapter.

For the reasons listed above, the analysis presented in this report focuses on the VMT for all trip purposes and vehicle types without separation of VMT by land use. For the project analysis, the Project generated VMT threshold was developed using the Existing Conditions total VMT for Monterey County because a substantial majority of the campus population (nearly 90 percent of students, faculty, and staff) lives within Monterey County. As a result, most of the CSUMB campus total VMT would be within Monterey County and, therefore, impacts assessed against the Monterey County baseline is the most appropriate assessment of a project's direct impact. Like the Project-generated VMT baseline rate, the boundary VMT baseline uses the Monterey County boundary VMT to evaluate the Project's effects on VMT because the Project effects are likely to be localized near the CSUMB campus and within Monterey County.

## OPERATIONS ANALYSIS STUDY AREA AND SCENARIOS (FOR INFORMATION PURPOSES ONLY)

### PROJECT STUDY AREA

The study area for the transportation operations analysis presented in this report was determined by using Project traffic volume estimates to identify intersections and freeway segments where the Project may contribute to deficient operations. The outer edges of the study area were defined first, followed by major intersections along local access routes to the campus that could potentially experience deficient operations with the addition of Project traffic and redistribution of traffic. Please refer to the memorandum *California State University, Monterey Bay (CSUMB) Master Plan EIR – Transportation Study Area Locations* in **Appendix A** of this report for additional details regarding the process used to determine the study area. The intersections and freeway segments within the study area are described below.

#### Study Intersections

A total of 51 intersections, as shown on **Figure 2** and listed here, were selected as study locations in consultation with CSUMB staff and reviewing agencies; the corresponding jurisdiction is noted in parentheses.

1. Del Monte Boulevard and Reindollar Avenue (City of Marina [M])
2. Second Avenue Extension and Patton Parkway (Future Intersection) (M)
3. State Route (SR) 1 Southbound Ramps and Imjin Parkway (Caltrans [Cal])

---

<sup>17</sup> Boundary VMT captures all VMT on a roadway network within a specified geographic area, including local trips plus interregional travel, that does not have an origin or destination within the area.



4. SR 1 Northbound Ramps and Imjin Parkway (Cal)
5. Second Avenue and Imjin Parkway (M)
6. Third Avenue and Imjin Parkway (M)
7. Fourth Avenue and Imjin Parkway (M)
8. California Avenue and Imjin Parkway (M)
9. California Avenue and Patton Parkway (M)
10. Imjin Road and Imjin Parkway (M)
11. Abrams Drive and Imjin Parkway (M)
12. Reservation Road and Imjin Parkway (M)
13. Blanco Road and Reservation Road (Monterey County [MC])
14. Inter-Garrison Road Connection and Reservation Road (MC)
15. Second Avenue and Ninth Street (M)
16. Second Avenue and Eighth Street (M)
17. Fourth Avenue and Eighth Street (Future Intersection) (M / CSUMB)
18. Imjin Road and Eighth Street (M)
19. Second Avenue and Inter-Garrison Road (M)
20. General Jim Moore Boulevard and Inter-Garrison Road (M / CSUMB)
21. Eighth Street/Seventh Avenue and Inter-Garrison Road (MC / M / CSUMB)
22. Eighth Avenue and Inter-Garrison Road (CSUMB)
23. Abrams Drive and Inter-Garrison Road (MC / CSUMB)
24. Schoonover Road and Inter-Garrison Road (MC)
25. Inter-Garrison Road Connection and Inter-Garrison Road (MC)
26. East Garrison Road and Reservation Road (MC)
27. Reservation Road and Watkins Gate Road (MC)
28. Davis Road and Reservation Road (MC)
29. Second Avenue and Divarty Street (M / CSUMB)
30. General Jim Moore Boulevard and Divarty Street (M / CSUMB)
31. First Avenue and Lightfighter Drive (City of Seaside [S])
32. Second Avenue and Lightfighter Drive (S)
33. General Jim Moore Boulevard and Lightfighter Drive (S)
34. Malmedy Road and Colonel Durham Street (S)
35. Parker Flatts Cut Off Road and Colonel Durham Street (S)
36. Sixth Avenue and Colonel Durham Street (S)



37. Seventh Avenue and Colonel Durham Street (S)
38. Eighth Avenue and Colonel Durham Street (MC)
39. General Jim Moore Boulevard and Gigling Road (S)
40. Malmedy Road and Gigling Road (S)
41. Parker Flatts Cut Off Road and Gigling Road (S)
42. Sixth Avenue and Gigling Road (S)
43. Seventh Avenue and Gigling Road (S)
44. Eighth Avenue and Gigling Road (MC)
45. Eastside Parkway and Gigling Road (MC)
46. General Jim Moore Boulevard and Normandy Road (S)
47. General Jim Moore Boulevard and Coe Avenue (S)
48. Fremont Boulevard-Southbound SR 1 Off-Ramp and Monterey Road (Cal / Sand City)
49. California Avenue and Monterey Road-Northbound SR 1 Off-Ramp (Cal / S)
50. Reservation Road and State Route 68 Westbound Ramps (Cal / MC)
51. Reservation Road and State Route 68 Eastbound Ramps (Cal / MC)

### Freeway Segments and Ramps

The freeway segments identified for analysis are those at which the Project is expected to add traffic equal to or greater than two percent of the freeway segment's capacity. Based on this criterion, the following ten freeway segments were selected:

1. State Route 1 between Reservation Road and Del Monte Boulevard (2 segments)
2. State Route 1 between Del Monte Boulevard and Imjin Parkway (2 segments)
3. State Route 1 between Imjin Parkway and Lightfighter Drive (2 segments)
4. State Route 1 between Lightfighter Drive and Fremont Boulevard-Del Monte Boulevard (2 segments)
5. State Route 1 between Fremont Boulevard-Del Monte Boulevard and Canyon Del Rey Boulevard (2 segments)

In addition to the above segments, the study area includes the following eight freeway on- and off-ramps:

1. State Route 1 and Imjin Parkway Interchange Ramps (4 ramps)
2. State Route 1 and Lightfighter Drive Interchange Ramps (4 ramps)



## ANALYSIS SCENARIOS

The operations of the study intersections, freeway segments, and freeway ramps are evaluated during the weekday morning (AM) and weekday evening (PM) peak hours for the scenarios listed below. These scenarios include a description of the study area conditions at the time the Draft EIR Notice of Preparation was issued (Existing Conditions); Project changes to the existing transportation conditions for all travel modes in the study area (Existing with Project Conditions); and a description of the long-term cumulative setting, approximately 20 years in the future (Cumulative without Project and without Eastside Parkway Conditions and Cumulative with Project and without Eastside Parkway Conditions). Given the uncertainty of the Eastside Parkway project, two cumulative scenarios relating to Eastside Parkway are provided (Cumulative without and with Project and without Eastside Parkway Conditions, and Cumulative without and with Project and with Eastside Parkway Conditions).

- Scenario 1:** *Existing Conditions* – Existing traffic conditions based on existing volumes.
- Scenario 2:** *Existing with Project Conditions* – Scenario 1 volumes plus the combined effects of the CSUMB Master Plan including increased campus population and modifications to existing campus parking and transportation facilities.
- Scenario 3:** *Cumulative without Project and without Eastside Parkway Conditions* – Year 2035 cumulative traffic volumes based on forecasts from the AMBAG regional travel model without Eastside Parkway.<sup>18</sup>
- Scenario 4:** *Cumulative with Project and without Eastside Parkway Conditions* – Scenario 3 volumes plus effects of the CSUMB Master Plan including increased campus population and modifications to existing campus parking and transportation facilities.
- Scenario 5:** *Cumulative without Project and with Eastside Parkway Conditions* – Year 2035 cumulative traffic volumes based on forecasts from the AMBAG regional travel model with Eastside Parkway.
- Scenario 6:** *Cumulative with Project and with Eastside Parkway Conditions* – Scenario 5 volumes plus the combined effects of the CSUMB Master Plan including increased campus population and modifications to existing campus parking and transportation facilities.

---

<sup>18</sup> As of this writing, the Eastside Parkway project does not have an identified funding source, nor has a final alignment been determined. Refer to **Figure 2** for alignment studied.





## REPORT ORGANIZATION

This report is divided into five sections and 11 chapters:

- **Existing Conditions and Relevant Plans**
  - **Chapter 2 – Existing Conditions** describes the existing campus parking and transportation demand management and the transportation system near the Project site, including the surrounding roadway network, AM and PM peak hour driveway and intersection turning movement volumes, existing bicycle, pedestrian, and transit facilities, intersection levels of service, freeway segment levels of service, and ramp operations.
  - **Chapter 3 – Summary of Relevant Circulation and Transportation Plans** provides background information to be used for the plan consistency evaluation.
- **CEQA Significance Criteria, VMT Analysis Methods, Impacts and Mitigation**
  - **Chapter 4 – Significance Criteria and Analysis Methods** lists the significance criteria used for the environmental impact analysis. This chapter also discusses the traffic forecasting methods used to estimate total VMT per service population rate and the Project's effect on VMT using boundary VMT per service population.
  - **Chapter 5 – CEQA Impacts and Mitigation** evaluates the Project's impacts on the overall transportation system via the VMT analyses and to transit, bicycle, and pedestrian systems, and identifies mitigation measures, if warranted, to address significant impacts of the Project.
- **Parking Management and TDM**
  - **Chapter 6 – Parking Management and TDM** describes the parking supply and mode share assumptions used in the transportation analysis, which establishes the business as usual condition for the future Parking Management and TDM Plan. To assist with refining the proposed PDFs and implementation of the Master Plan, the Main Campus Parking Evaluation and Main Campus Inbound AM peak Hour Mode Share Evaluation was conducted using the parking demand and mode share data collected for this report.
- **Operations Analysis (For Information Purposes Only)**
  - *Chapter 7 – Operations Analysis and Project Traffic Forecasting Methods (For Information Purposes Only)* describes the traffic analysis methods and traffic volumes used for the operations analysis chapters.
  - *Chapter 8 – Existing with Project Conditions (For Information Purposes Only)* addresses intersection and freeway operations for Existing with Project Conditions. The relevant Project information and Project trip generation, distribution, and assignment is also discussed in this chapter.



- *Chapter 9 – Cumulative without Eastside Parkway Conditions (For Information Purposes Only)* addresses the cumulative intersection and freeway operations for conditions without and with the Project and without the Eastside Parkway.
- *Chapter 10 – Cumulative with Eastside Parkway Conditions (For Information Purposes Only)* addresses the cumulative intersection and freeway operations for conditions without and with the Project and with the Eastside Parkway.
- *Chapter 11 – Transportation Deficiencies and Improvements (For Information Purposes Only)* describes the Project’s effects on intersection and freeway operations, and identifies improvements to address deficiencies caused by the Project. This chapter also includes an evaluation of potential secondary effects to bicycle and pedestrian facilities associated with the roadway system improvements.





## 2. EXISTING CONDITIONS

This chapter describes the Existing Conditions associated with roadways, truck routes, pedestrian facilities, bicycle facilities, and transit service near the Project site. It also presents existing vehicle volumes, and operations for the study intersections and freeway segments.

### EXISTING CAMPUS PARKING AND TRANSPORTATION DEMAND MANAGEMENT

This section describes the existing parking conditions and transportation demand management (TDM) program currently in effect on the campus. The parking uses are described as academic parking and residential parking:

- Academic parking serves students (residing on- and off-campus), staff, employees, and visitors, and is not restricted to on-campus residents as is residential parking, described below. Academic parking also includes handicapped, electric vehicle, and motorcycle parking that serves all populations.
- Residential parking is parking reserved for on-campus residents only. Residential parking includes handicapped, electric vehicle, and motorcycle parking reserved for on-campus residents.

### EXISTING PARKING INVENTORY AND DEMAND SURVEY

To assess the existing level of parking demand on-campus and the related available inventory, a parking occupancy survey was conducted over a three-day period for the academic and residential parking areas located within the Main Campus on typical non-holiday days (Tuesday, November 28, 2017; Wednesday, November 29, 2017; and Thursday, November 30, 2017). This parking occupancy survey also provided a parking inventory of the existing parking lots on the campus. The details of the survey results are provided in **Appendix C**.

Under Existing Conditions, the campus has 40 parking lots with a total of 4,721 academic and residential spaces. **Table 2** presents a summary of the number of existing parking spaces on the CSUMB Main Campus.



**TABLE 2: EXISTING PARKING SPACES**

| Parking Type | Spaces <sup>1</sup> |
|--------------|---------------------|
| Academic     | 3,730               |
| Residential  | 991                 |
| <b>Total</b> | <b>4,721</b>        |

Notes:

1. Residential lots include both North Quad and Promontory Housing lots. Students who live in the Main Quad park in Academic lots.

Source: CSUMB data received May 2018. Fehr & Peers, 2019.

**Table 3** presents the core campus peak parking demand rates, which are estimated as the total parking utilized on the campus divided by the existing campus population, for the academic and residential parking lots based on the survey results. For the academic parking lots, the peak parking occupancy period occurred at 11:00 AM at a demand rate of 0.31 parking spaces per FTE; for the residential parking lots the peak parking occupancy period occurred at 7:00 AM at a demand rate of 0.20 parking spaces per student. Academic and residential parking occupancy percentages depict the amount of existing parking utilized compared to the amount of existing parking available on the campus, and are shown for every half-hour from 7:00 AM to 7:00 PM in **Figure 7** and **Figure 8**.

**TABLE 3: EXISTING PARKING DEMAND RATES**

| Item                         | Academic        | Residential              |
|------------------------------|-----------------|--------------------------|
| Existing Peak Parking Demand | 2,396 spaces    | 525 spaces               |
| Existing Population          | 7,658 FTE       | 2,600 residents          |
| Existing Parking Demand Rate | 0.31 spaces/FTE | 0.20 spaces per resident |

Notes:

1. FTE = Full-time equivalent students, faculty, and staff

Source: CSUMB data received May 2018. Fehr & Peers, 2019.



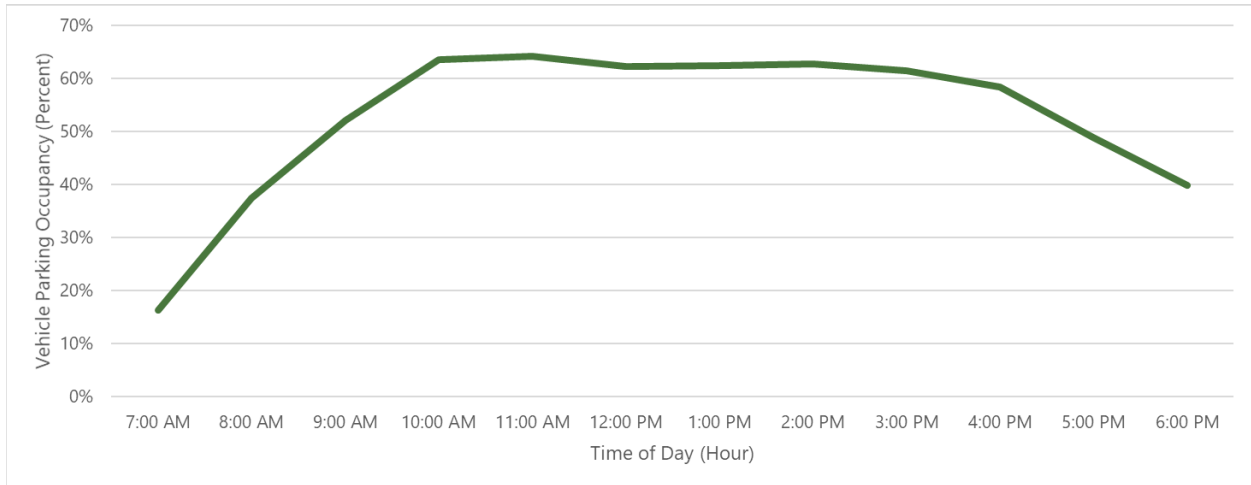

**Figure 7 Academic Parking Occupancy from 7:00 AM to 7:00 PM**

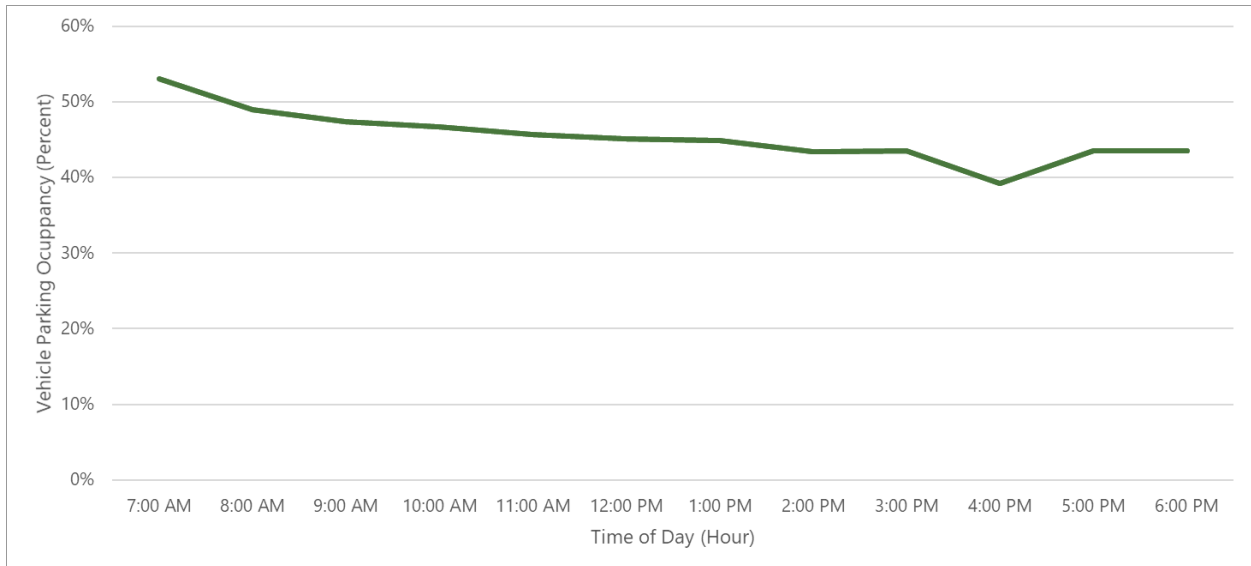

**Figure 8 Residential Parking Occupancy from 7:00 AM to 7:00 PM**

In terms of the direct observations, the peak observed academic parking demand for the entire campus was 2,396 vehicles, or 64 percent occupied, at 11:00 AM. The peak observed residential parking demand for the entire campus was 525 vehicles, or 53 percent occupied, at 7:00 AM. The overall academic and residential demand of 2,921 vehicles is lower than existing parking supply of 4,721 parking spaces and represents an overall occupancy rate of approximately 62 percent. Assuming a circulation factor of five percent, the estimated existing parking supply based on the existing demand would be 3,068 parking spaces, which is 1,653 spaces fewer than the actual existing parking supply.



## EXISTING TRANSPORTATION DEMAND MANAGEMENT PROGRAM

The existing CSUMB TDM program complements the on-campus housing of students, faculty, and staff and enhances the quality of pedestrian, bicycle, and transit facilities on campus. Housing and high-quality transportation infrastructure helps to promote walking, bicycling, and transit use, which reduces vehicle trips to/from the campus. CSUMB's Master Plan Guidelines include the following existing TDM strategies intended to provide residents and off-campus students, faculty, and staff with transportation options that can reduce vehicle trip generation:

- Otter Cycle Center – on-campus bicycle repair shop that also offers bicycle rentals and other services to facilitate bicycle ridership.
- Bicycle Storage and Amenities – several hundred bicycle racks have been installed on campus outside of residence halls and popular academic, recreation and administrative buildings. Additionally, a secure bicycle bunker storage room has been installed, as well as two 'fix-it' stations that provide 24/7 access to bicycle repair tools and air pumps. Bicycle registration is also available through the University Police Department to simplify that process. Three skateboard storage racks also have been installed in the popular destinations on campus.
- Paid Parking – to discourage non-CSUMB related vehicle trips the campus manages parking on campus via a parking permit fee structure presently based upon campus, community, or vehicle type and parking timeframes. The fees have increased several times over the last two decades to more accurately match the true cost of providing managed parking.
- Monterey-Salinas Transit (MST) – the campus has entered into an agreement with MST that is annually renewed and provides universal access on the MST bus network for all active CSUMB ID card holders, three supplemental campus-serving and subsidized bus routes, and funding for a shared transit marketing student intern.
- Emergency Ride Home Program – campus community members can sign up for a program run by Transportation Agency for Monterey County (TAMC) that reimburses taxi or ridesharing trips home in emergency situations for commuters who use alternative means of transportation.
- Carsharing and Ridesharing – CSUMB hosts four cars for carsharing. These are cars stationed on the campus available for use by carshare members on the campus. Additionally, CSUMB students, faculty and staff can use Go831, a regional ride share program.
- Transportation Services Website – Information for most of the available TDM strategies is included on a campus website to facilitate information dissemination.
- Delivery Vehicle Limitations – to discourage delivery vehicle trips, drivers providing frequent delivery services to campus, such as office supply deliveries, have been instructed to limit their deliveries to campus to no more than three days per week.



- Bicyclist/Pedestrian Malls – to encourage pedestrian and bicycle use, a section of Divarty Street and a section of Sixth Avenue are closed to regular vehicular traffic to accommodate pedestrians and bicyclists.
- Traffic Calming – to discourage automobile use and provide increased safety, speed humps and flashing beacon crosswalk devices have been installed on several campus roadways to reduce vehicle speeds, particularly near high traffic pedestrian crosswalks.

## EXISTING STREET SYSTEM

Regional access to the CSUMB Main Campus is provided by State Route (SR) 1. Primary local access to the CSUMB campus is provided by Imjin Road from the north, Inter-Garrison Road from the west and east, and General Jim Moore Boulevard from the south. The Main Campus entrance at Lightfighter Drive and General Jim Moore Boulevard is marked by a gateway entrance sign. Traffic from Seaside or the Monterey Peninsula access the campus from the General Jim Moore Boulevard entrance; traffic from Salinas or Marina accesses the campus via either the Second Avenue, Imjin Road, or Inter-Garrison Road entrances; and traffic from Santa Cruz County access the campus entrances at either Inter-Garrison and Second Avenue or Imjin Road. These roadways are described below and illustrated in **Figure 1**.

*State Route 1 (SR 1)* is a state highway within Monterey County, providing access to Watsonville and Santa Cruz to the north via Seaside, Marina, and Castroville, and to San Luis Obispo to the south via Monterey and Carmel. Through its connection to SR 156 in Castroville, SR 1 also provides access to US 101 and the greater San Francisco Bay Area. Through Marina and Seaside, SR 1 has a posted speed limit of 65 miles per hour (mph), and provides four lanes north of the Del Monte Boulevard interchange, six lanes south of Del Monte Boulevard interchange to the Fremont Boulevard/Del Monte Boulevard interchange, and returns to four lanes south of the Fremont Boulevard/Del Monte Boulevard interchange. SR 1 average daily traffic (ADT) counts range between 51,560 to 96,960 for the segments between Del Monte Boulevard and Canyon Del Rey Boulevard, with the highest ADT between Imjin Parkway and Del Monte Boulevard.

*Reservation Road* is a major arterial extending from the Pacific Ocean at Marina State Park west of Dunes Drive, through the City of Marina. East of Del Monte Boulevard, Reservation Road is a four-lane divided street. At East Garrison Road, east of Imjin Parkway, it narrows to a two-lane rural highway. Reservation Road is under the jurisdiction of the City of Marina west of Blanco Road and the County of Monterey east of Blanco Road. The ADT on Reservation Road ranges between 6,220 to 26,570 vehicles with the lowest ADT south of Blanco Road, and the highest ADT between Imjin Road and Blanco Road.

*Imjin Parkway* is an arterial street within the City of Marina limits. Imjin Parkway is a two-lane road at its interchange with SR 1 and a four-lane divided street with left-turn channelization east of the northbound SR 1 ramps and two lanes east of Imjin Road. Imjin Parkway has bike lanes on each side of the street starting east of Second Avenue with the eastbound bike lane ending at Reservation Road. The speed limit on Imjin Parkway is





45 mph. Imjin Parkway has an ADT of 22,500 east of Second Avenue and an ADT of 28,220 west of Second Avenue toward SR 1.

*California Avenue/Fifth Avenue* is a two-lane arterial from central Marina to Imjin Parkway, and a local street south of Imjin Parkway ending at Inter-Garrison Road. California Avenue connects Reservation Road with Imjin Parkway and CSUMB. Bicycle lanes are provided along California Avenue/Fifth Avenue between Imjin Parkway and Reservation Road. The speed limit on California Avenue is 25 mph. The ADT on California Avenue north of Imjin Parkway is 5,900.

*Eighth Street* is a two-lane arterial from First Avenue to Inter-Garrison Road that is currently closed (future extension is planned) between Third Avenue and Fifth Avenue. The speed limit along Eighth Street is 35 mph.

*Inter-Garrison Road* extends from Second Avenue to Reservation Road as a two-lane arterial. The extension of Inter-Garrison Road (referred to as the Inter-Garrison Road Connection in this analysis) to Reservation Road, completed in 2013, provides a regional connection from the Marina-Salinas area to SR 1. The speed limit on Inter-Garrison Road is 35 mph between Eighth Avenue and Schoonover Road and 25 mph between Second Avenue and Eighth Avenue. Inter-Garrison Road has an ADT of 8,450 between Eighth Avenue and Abrams Drive, and an ADT of 2,630 between Second Avenue and Third Avenue.

*Lightfighter Drive* starts from the SR 1 ramps as an east-west street that continues as the north-south street Malmedy Road at the intersection of Colonel Durham Street. From the SR 1 interchange to General Jim Moore Boulevard, the street is a four-lane divided major arterial with a speed limit of 40 mph. East of General Jim Moore Boulevard, Lightfighter Drive is a two-lane minor arterial with a speed limit of 25 mph. West of General Jim Moore Boulevard, the ADT on Lightfighter range between 13,250 and 15,000 vehicles.

*Divarty Street* is a two-lane local street from First Avenue to Fifth Avenue providing access to the core of the CSUMB campus. The speed limit along Divarty Street is 25 mph.

*Colonel Durham Street* is a two-lane local street that extends between Lightfighter Drive/Malmedy Road to the west and Eighth Avenue to the east. The street has pedestrian facilities along one or both sides west of Sixth Avenue, and although it is a local street, the speed limit is 35 mph along its entirety.

*Gigling Road* is a two-lane arterial that starts just east of SR 1 at Noumea Road and extends to Eighth Avenue. Gigling Road has a speed limit of 30 mph and an ADT of 6,300 vehicles.

*Second Avenue* connects Lightfighter Drive in Seaside with Imjin Parkway in Marina, along the western edge of CSUMB. Second Avenue is a north-south arterial street in Marina and Seaside with four lanes from Imjin Parkway to Tenth Street, two lanes from Tenth Street to Divarty Street, and returns to four lanes south of Divarty Street. Second Avenue has right-turn and left-turn channelization on the entire stretch of the street, and bike lanes north of Divarty Street to Imjin Parkway. The speed limit on Second Avenue is 35 mph. The lowest ADT on



Second Avenue is 2,500 vehicles south of Divarty Street. Second Avenue's ADT is highest north of Fifth Street, with ADT of 6,330 vehicles.

*General Jim Moore Boulevard* is a four-lane arterial that extends from Canyon del Rey Boulevard to Lightfighter Drive in Seaside. Once it enters the campus at Lightfighter Drive, the street becomes a two-lane arterial to Fifth Street with a posted speed limit of 25 mph on campus. The ADT on General Jim Moore Boulevard ranges between 5,230 to 9,600 vehicles, with the lowest ADT north of Lightfighter Drive (on campus) and highest ADT between Lightfighter Drive and Gigling Road (south of campus).

*Sixth Avenue* is a north-south local street that extends from Gigling Road to Eighth Street. The two-lane connector has restricted access from CSUMB's Student Services building, 250 feet south of A Street to B Street.

*Seventh Avenue* is a north-south two-lane local street that extends from Gigling Road to the south to Eighth Street/Inter-Garrison Road to the north.

*Eighth Avenue* is a north-south two-lane local street that extends from Gigling Road on the south to Inter-Garrison Road at in the north.

*Abrams Drive* is a two-lane connector between Imjin Parkway and Inter-Garrison Road, with a posted speed limit of 30 mph and ADT of 5,050. Abrams Drive is the main street through East Campus Housing and connects to Bunker Hill Drive, Manassas Drive, and Schoonover Road.

*Schoonover Road* is a two-lane connector between Abrams Drive and Inter-Garrison Road with a posted speed limit of 25 mph. The street travels through the eastern side of the East Campus Housing.

## EXISTING TRUCK ROUTES

SR 1 is identified as part of the regional truck network. The freeway is intended to move goods efficiently within the cities of Marina and Seaside, between outlying agricultural uses, and packing/distribution centers. Additionally, the freeway serves to separate truck traffic from local streets where the larger vehicles may conflict with other uses.

Both the City of Marina and City of Seaside designate and describe streets that permit commercial vehicles exceeding three tons as truck routes with appropriate signage. Neither city has an existing truck route network, but in the Circulation Element of the Seaside General Plan, the City identified establishing a truck route network as an ongoing goal to reduce impacts on residential neighborhoods. In the City of Marina, commercial trucks are prohibited from entering local residential streets and collectors except for the purpose of local deliveries.



## EXISTING PEDESTRIAN FACILITIES

The CSUMB campus has a variety of pedestrian accommodations, such as sidewalks, pedestrian malls, and trails. Some portions of the campus, such as existing pedestrian malls on Divarty Street and Sixth Avenue which are street segments reserved for primarily pedestrian use with limited transit and service vehicle usage, have a high-quality walking environment with many destinations within a close walking distance, while other areas of campus lack sidewalks. **Figure 9** shows the locations of existing sidewalks and sidewalk gaps on and near the CSUMB campus.

Arterial roads such as Lightfighter Drive, Second Avenue and Gigling Road have sidewalks on one or both sides of the street. Several local streets within and near the campus do not have sidewalks, creating gaps in the pedestrian network.

While CSUMB has made improvements to the on-campus pedestrian network, a limited number of direct, accessible, and protected pedestrian connections are in place through parking lots and to the existing sidewalk network. Additionally, there are no existing sidewalks along Inter-Garrison Road connecting the Main Campus to the East Campus Housing area east of Eighth Avenue. In many areas, the natural topography exceeds a five percent grade, making the construction of Americans with Disabilities Act (ADA)-accessible pathways difficult along some streets such as Fifth Avenue, Sixth Avenue, and portions of Inter-Garrison Road. Distances between major destinations that are more than a 10-minute walk, coupled with a mild yet windy and foggy coastal climate, can deter pedestrian movement.



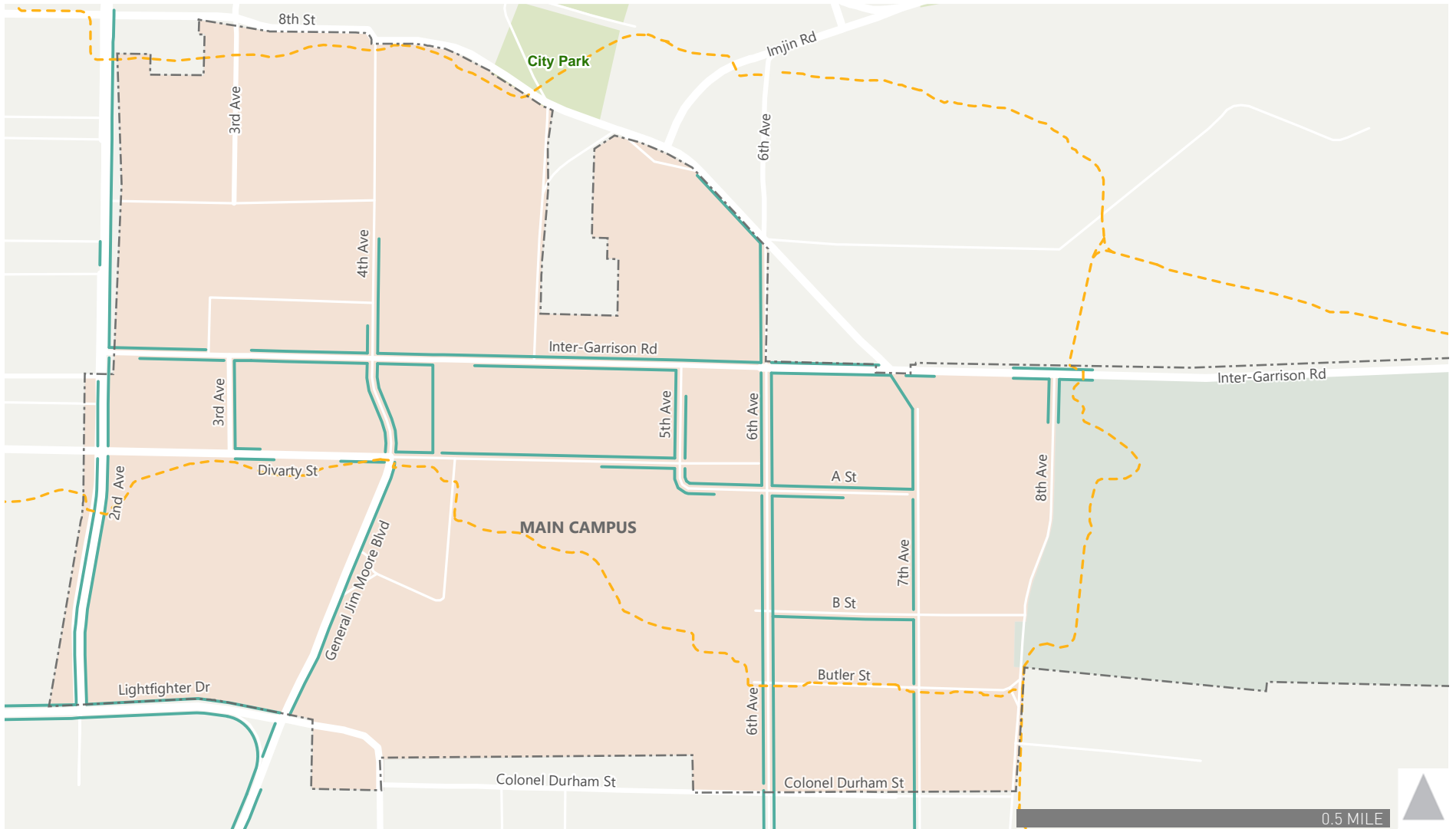

- California State University Monterey Bay Main Campus
- California State University Monterey Bay East Campus

- Existing Pedestrian Network**
- Existing Sidewalk

- Planned Pedestrian Network**
- Fort Ord Regional Trail & Greenway (FORTAG) Preferred Alignment



Figure 9  
Existing CSUMB and Regionally Planned Pedestrian Facilities

## EXISTING BICYCLE FACILITIES

There are several existing bicycle facilities on the CSUMB campus and in surrounding areas, comprised of bike routes or boulevards, bike lanes, and separated bike paths or trails. On campus and surrounding the campus, there are 3.8 miles of bike boulevards, which are low-speed and low-volume streets designated with pavement markings for shared bicycle use with motor vehicles, and other bike facilities along roadways. The campus has parking for 580 bicycles, which includes 36 secure indoor spots within the Bike Bunker parking facility, which are typically well-utilized during the academic year.

**Figure 10** shows the existing and regionally planned bicycle facilities as described in the *2011 Transportation Agency for Monterey County (TAMC) Bicycle and Pedestrian Master Plan, 2016 for a Regional Urban Design Guidelines* and *2018 Monterey County Active Transportation Plan*.

Bikeway planning and design in California typically relies on guidelines and design standards established by the California Department of Transportation (Caltrans) in the *Highway Design Manual* (Caltrans 2020). The *Highway Design Manual* provides for three distinct types of bikeway facilities that are applicable to the campus, as described below and shown in the accompanying figures.

- Class I Bikeways (Shared-Use Paths) provide a completely separate right-of-way and are designated for the exclusive use of bicycles and pedestrians, with vehicle and pedestrian crossflow minimized. The campus recently constructed its first separated bike path, or a Class I facility, between the Promontory housing and Inter-Garrison Road. On the campus periphery, separated bicycle paths exist on the east side of Second Avenue between Lightfighter Drive and Imjin Parkway and off campus, along Imjin Parkway between Second Avenue and Imjin Road, at which point it transitions to an in-road shared bicycle route.

### SHARED-USE PATH (CLASS I)

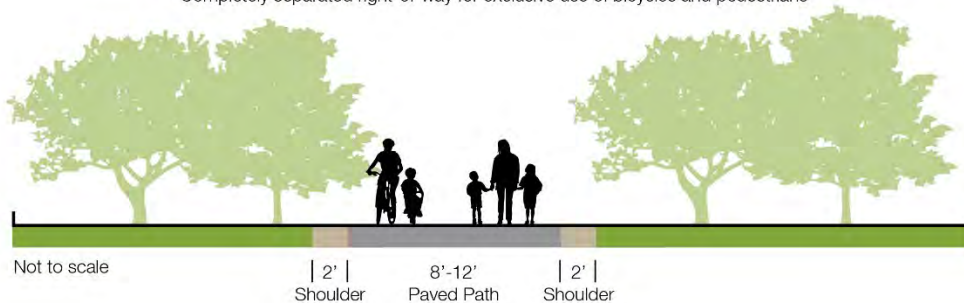

Completely separated right-of-way for exclusive use of bicycles and pedestrians

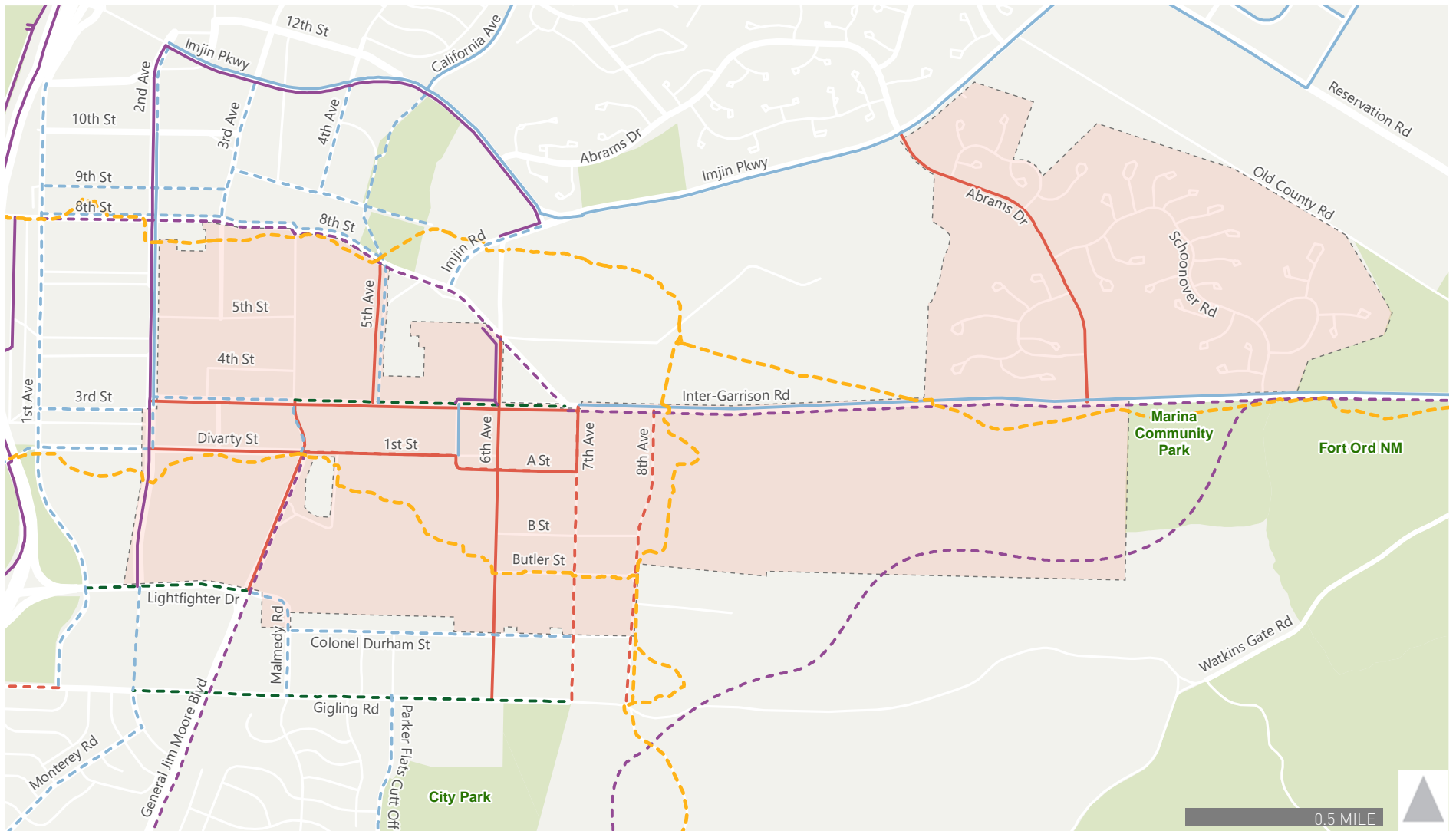



 California State University Monterey Bay Campus

**Existing Bicycle Facilities**

-  Class I - Shared Use Path
-  Class II - Bicycle Lane
-  Class III - Bicycle Route

**Planned Bicycle Facilities**

-  Fort Ord Regional Trail & Greenway (FORTAG) Preferred Alignment
-  Class I - Shared Use Path
-  Class II - Bicycle Lane
-  Class III - Bicycle Route
-  Class IV - Cycle Track/Separated Bikeway

Figure 10  
Existing CSUMB and Regionally Planned Bicycle Facilities



- Class II Bikeways (Bicycle Lanes) are dedicated lanes for bicyclists generally adjacent to the outer vehicle travel lanes, that have special lane markings, pavement legends, and signage. Bicycle lanes are at least five (5) feet wide. Bicycle lanes, also known as Class II facilities, are provided on Second Avenue, General Jim Moore Boulevard from Lightfighter Drive to Inter-Garrison Road, Fifth Avenue from Divarty Street to Inter-Garrison Road and Inter-Garrison Road from Seventh Avenue to Schoonover Drive.

## BICYCLE LANE (CLASS II)

On-street striped lane for one-way bike travel

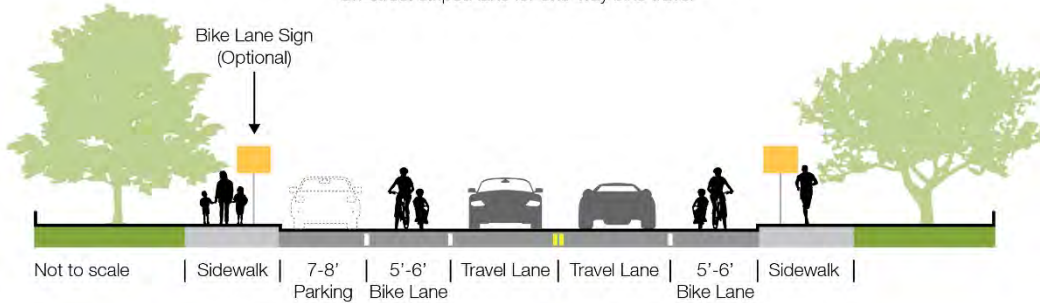

- Class III Bikeways (Bike Boulevards/Bicycle Routes) are designated by signs or pavement markings for shared use with motor vehicles but have no separated bike right-of-way or lane striping. On-campus bike routes, known as Class III facilities, include approximately 3.8 miles of bicycle boulevards on the following road segments: Divarty Street from Second Avenue to A Street, A Street from Divarty to Seventh Avenue, Seventh Avenue from Inter-Garrison Road Colonel Durham Street, and Inter-Garrison Road from Seventh Avenue to Second Avenue.

## BICYCLE ROUTE (CLASS III)

Shared on-street facility

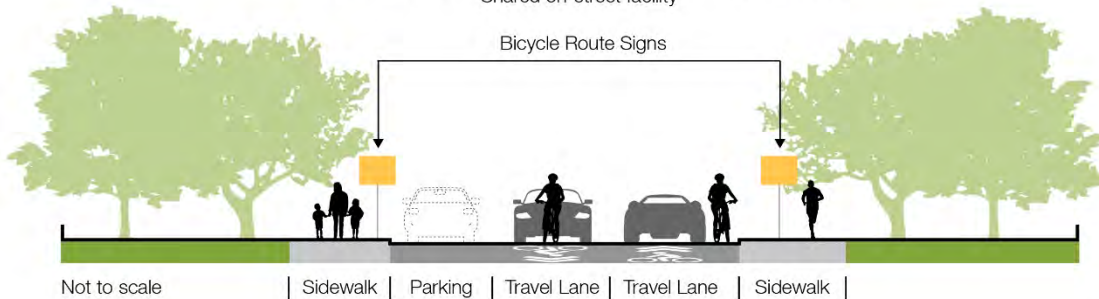

- Class IV Bikeways (Cycle Tracks or “Separated” Bikeways) provide a right-of-way designated exclusively for bicycle travel within a roadway and are protected from other vehicle traffic by physical barriers, including, but not limited to, grade separations, flexible posts, inflexible vertical barriers such as raised curbs or parked cars. None of the existing facilities in the study area classify as Class IV bikeways.

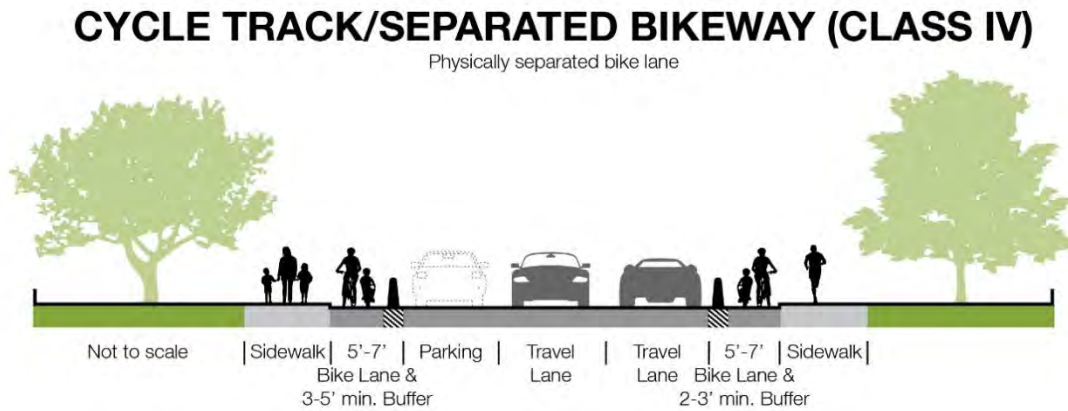

## EXISTING TRANSIT SERVICE

The public transit system that connects the CSUMB campus to the greater Monterey and Salinas area is operated by the Monterey-Salinas Transit District (MST). Students, staff, and faculty receive free boarding and unlimited access on all MST regular bus routes with their CSUMB Otter ID card. Eight bus routes serve stops in or along the boundary of the CSUMB campus throughout the academic year: Routes 12, 16, 18, 19, 25, 26, 67, and 74. **Figure 11** shows the map of the transit services that run through the academic year, and **Table 4** describes weekday bus route information and route access from CSUMB to major points of interest throughout the region.

Seven bus routes travel along Fourth Avenue and connect with a main stop that is centrally located adjacent to CSUMB's Alumni and Visitor Center and west of the Main Campus. Routes serve a total of 21 on-campus bus stops – 11 stops in the Main Campus and 10 stops in the East Campus. A majority of the stops are located along Inter-Garrison Road, Second Avenue, and Sixth Avenue. Routes 16, 19, 25, 26, and 74 travel through the campus and provide service to the stops located at the East Campus Housing.

Students, faculty, and staff with physical disabilities have access to the MST para-transit program, RIDES. This service operates on a point-to-point basis with no restrictions on purpose of the trip and appointments are required to guarantee service. The para-transit service accommodates travel to and from locations that are up to three-quarters of a mile from any of MST's regular bus routes and the service is available during the hours of operation of MST's regular fixed-route bus service. CSUMB also offers a wheelchair accessible cart that is





available for University Departments/Group tours, campus-wide orientations, and major events such as Commencement.

## BUS ROUTE BOARDINGS

The boarding factors for all bus routes described in **Table 4**, including the number of buses, the capacity of each bus, and the number of passenger boardings (general and CSUMB) per bus, are provided for the AM and PM peak hours in **Table 5** (except Route 19 with a daily factor). Boarding factor is defined as the average number of passenger boardings relative to average bus capacity.

As shown on the table, Routes 12, 16, 18, and 74 run vehicles with a capacity between 46 to 59 passengers, and Routes 19, 25, and 26 run vehicles with a capacity of 21 passengers. Students make up more than 50 percent of the ridership on an average day for Routes 16, 19, 25, and 26. Route 16, which runs from The Dunes development at Second Avenue through the Main Campus and East Campus to the Marina Transit Exchange, has an estimated average boarding factor of 0.20 in the AM peak hour and 0.24 in the PM peak hour, with students making up 0.10 and 0.14 of those boarding factors, respectively. Route 19, which runs on Fridays and weekends, has a daily boarding factor of 0.29, with students making up most of that boarding factor (0.23). Routes 25 and 26, which primarily serve the campus, have estimated average weekday boarding factors greater than 0.20, with students making up most or all of the boardings. Route 74 has the highest boarding factor of 0.59 in the AM peak hour. Students make up a small percentage of the passengers of Route 74.



**TABLE 4: EXISTING WEEKDAY MST TRANSIT SERVICE SUMMARY**

| Route           | Description                          | From                          | To                        | Hours of Operation  | Average Weekday Headway   | Average Weekday Boardings <sup>1</sup> | CSUMB Weekday Boardings <sup>1</sup> |
|-----------------|--------------------------------------|-------------------------------|---------------------------|---|---|--|--------------------------------------|
| 12              | The Dunes - NPS                      | CSUMB Alumni & Visitor Center | Naval Postgraduate School | 6:45 AM to 5:40 PM  | Limited <sup>2</sup>  | 37                                     | 10%                                  |
| 16              | Marina – The Dunes                   | CSUMB Alumni & Visitor Center | Marina Transit Exchange   | 5:35 AM to 10:30 PM   | Every 60 Minutes  | 376                                    | 60%                                  |
| 18              | Monterey – The Dunes                 | CSUMB Alumni & Visitor Center | Monterey Transit Plaza    | 6:00 AM to 10:40 PM   | Every 60 Minutes  | 383                                    | 43%                                  |
| 19              | Del Monte Center – CSUMB East Campus | CSUMB Alumni & Visitor Center | Del Monte Center          | Fridays & Saturdays: 1:00 PM to 2:55 AM<br>Sundays: 6:00 PM to 11:50 PM | Every 60 Minutes before 7:00 PM<br>Every 120 minutes after 7:00 PM <sup>3</sup> | 66                                     | 80%                                  |
| 25              | CSUMB – Salinas                      | CSUMB Alumni & Visitor Center | Salinas Transit Center    | 6:20 AM to 10:35 PM   | Every 60 Minutes  | 120                                    | 80%                                  |
| 26              | CSUMB – East Campus Express          | CSUMB Alumni & Visitor Center | East Campus               | 6:30 AM to 12:25 AM   | Every 20 minutes  | 390                                    | 98%                                  |
| 67 <sup>4</sup> | Presidio – Marina                    | Otter Sports Center           | Reservation & Beach       | Fridays: 2:15 PM to 10:10 PM<br>Weekends: 10:15 AM to 10:10 PM          | Every 120 minutes <sup>5</sup>  | -                                      | -                                    |
| 74 <sup>6</sup> | Presidio – Toro Park                 | CSUMB Alumni & Visitor Center | Portola and Anza          | 6:30 AM to 6:00 PM  | Limited <sup>2</sup>  | 89                                     | 3%                                   |

Notes:

1. Boardings collected for the CSUMB Spring 2017 Semester, from January 23, 2017 to May 12, 2017. Boardings based on average Tuesday to Thursday boardings for all routes except Route 19. Average boardings for Route 19 based on Friday and Saturday data.
  2. Headways for Route 12 range between 60 to 120 minutes. Route 74 runs one route in each direction in the morning and one evening route towards Toro Park.
  3. Route 19 only operates on Fridays and weekends, and headways are shown for Fridays and Saturdays, since the hours of operation are limited for Sunday.
  4. Route 67 service started operating in September 2017.
  5. Route 67 runs every 60 minutes on weekends.
  6. Regular service does not make a scheduled stop at CSUMB Alumni and Visitor Center. Express Service in the evening does not make a stop at CSUMB Alumni and Visitor Center.
- Source: Calculations based on boarding data provided by MST in August 2017. Route descriptions and hours of operation are based on printable map and schedules downloaded from MST.org in December 2017.



**TABLE 5: AVERAGE WEEKDAY MST BOARDING FACTORS**

| Route <sup>1</sup> | Peak Hour <sup>2</sup> | Average Number of Peak Period Buses [A] | Bus Capacity [B] <sup>1</sup> | Total Peak Hour Capacity [(A * B) / 2 = C] | Average Peak Hour Boardings [D] <sup>2</sup> | Average Peak Hour CSUMB Boardings [E] <sup>2</sup> | Boarding Factor [D/C = F] | CSUMB Boarding Factor [E/C = G] |
|--------------------|------------------------|---|-------------------------------|--|--|--|---------------------------|---------------------------------|
| 12                 | AM                     | 5                                       | 49                            | 123  | 8  | 1  | 0.07                      | 0.01                            |
|                    | PM                     | 3                                       | 49                            | 74   | 6  | 1  | 0.08                      | 0.02                            |
| 16                 | AM                     | 5                                       | 47                            | 118  | 23   | 12   | 0.20                      | 0.10                            |
|                    | PM                     | 5                                       | 47                            | 118  | 28   | 16   | 0.24                      | 0.14                            |
| 18                 | AM                     | 5                                       | 47                            | 118  | 22   | 7  | 0.19                      | 0.06                            |
|                    | PM                     | 5                                       | 47                            | 118  | 33   | 17   | 0.28                      | 0.14                            |
| 19                 | Daily <sup>3</sup>     | 11                                      | 21                            | 231  | 66   | 53   | 0.29                      | 0.23                            |
| 25                 | AM                     | 3                                       | 21                            | 32   | 8  | 6  | 0.25                      | 0.19                            |
|                    | PM                     | 3                                       | 21                            | 32   | 7  | 6  | 0.22                      | 0.19                            |
| 26                 | AM                     | 10                                      | 21                            | 105  | 22   | 22   | 0.21                      | 0.21                            |
|                    | PM                     | 10                                      | 21                            | 105  | 29   | 29   | 0.28                      | 0.28                            |
| 74                 | AM                     | 2                                       | 56                            | 56   | 33   | 1  | 0.59                      | 0.02                            |
|                    | PM                     | 1                                       | 56                            | 56   | 7  | 1  | 0.13                      | 0.02                            |

Notes:

1. Bus capacity includes sitting and standing capacity.
2. Calculations based on Spring 2017 Tuesday through Thursday peak period ridership data provided by MST. Peak hour boardings were calculated by dividing the peak period capacity by two.
3. Route 19 only operates on Fridays and weekends. Boarding factor for Route 19 is based on average ridership on Friday and Saturday, since hours of operation are limited on Sundays.

Source: Calculations based on Spring 2017 Tuesday through Thursday peak period and daily ridership data provided by MST in August 2017.



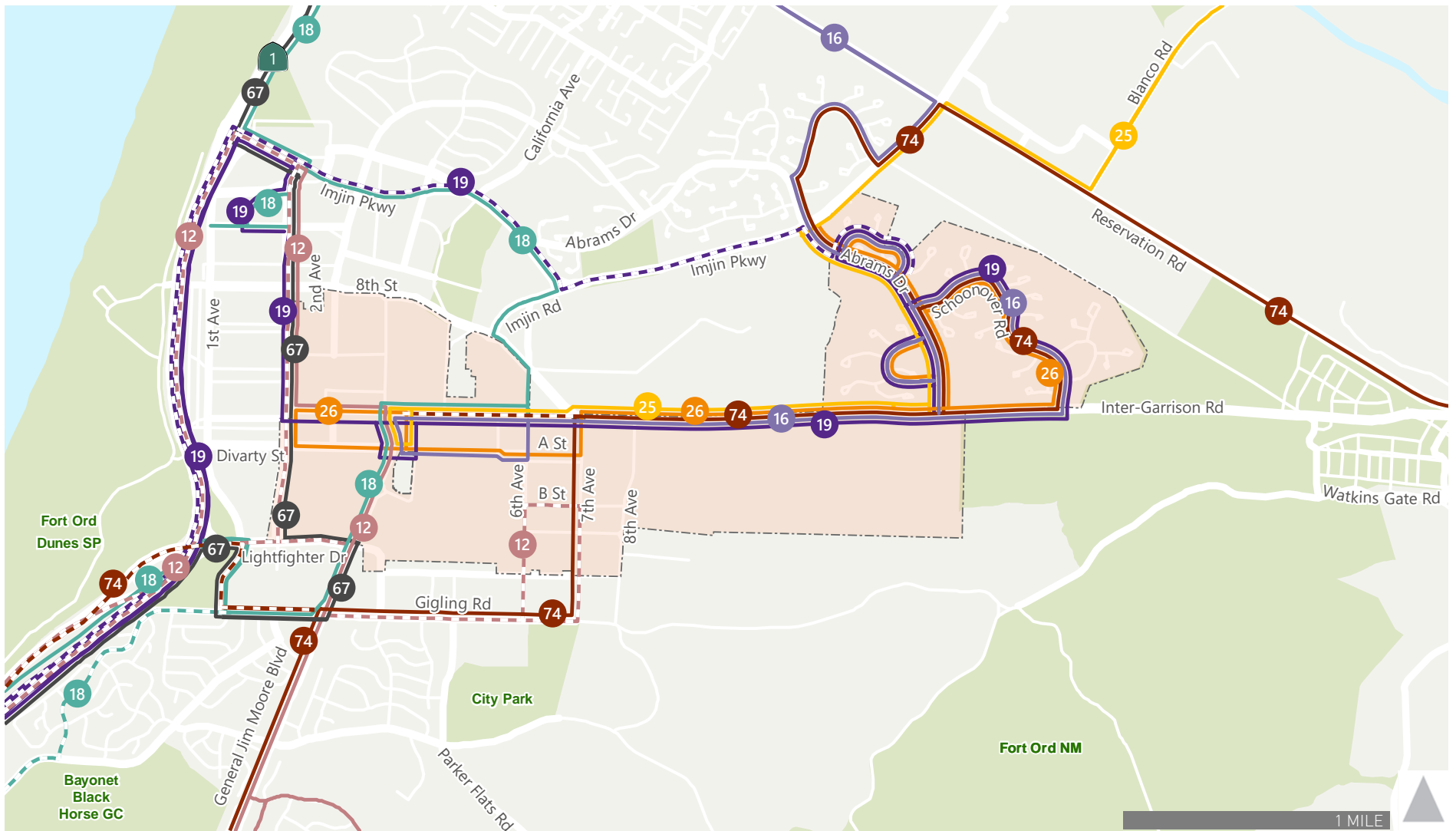

Note: Transit Routes shown for Academic Year, 2017

California State University Monterey Bay Campus

**Monterey-Salinas Transit (MST)**

- Regular Service Routes
- - - Express/Select Trips

**Headways**

- 20 minutes: 26
- 60 minutes: 16, 18, 19, 25
- 120 minutes: 67
- Limited: 12, 74



Figure 11  
Existing Transit Service to CSUMB

## EXISTING INTERSECTION OPERATIONS

Intersection traffic operations were evaluated during a typical mid-week day during the morning (7:00 to 9:00 AM) and evening (4:00 to 6:00 PM) peak periods at the 51 study intersections. For the study intersections, the single hour with the highest traffic volumes during each count period was identified. In addition, counts of pedestrian and bicycle volumes were collected during the morning (AM) and evening (PM) peak periods at the study intersections. All counts were collected in May 2017 and April 2018 while CSU and local schools were in session; the data is shown in **Appendix D**.

**Table 6** shows the existing level of service at each study intersection. (refer to **Chapter 7** for a description of the level of service (LOS) analysis method and relevant LOS standards for each jurisdiction.) **Appendix E** contains the analysis sheets documenting the intersection level of service calculations. The intersection volumes are shown in **Figure 12**.

The following intersections, with applicable peak hour noted, exceed their applicable level of service standard of the local jurisdiction under Existing Conditions (i.e., without Project, Conditions):

- Int 3. SR 1 Southbound Ramps and Imjin Parkway (AM peak hour)
- Int 4. SR 1 Northbound Ramps and Imjin Parkway (PM peak hour)
- Int 6. Third Avenue and Imjin Parkway (AM and PM peak hour)
- Int 7. Fourth Avenue and Imjin Parkway (AM and PM peak hour)
- Int 16. Second Avenue and Eighth Street (AM peak hour)
- Int 23. Abrams Drive and Inter-Garrison Road (AM peak hour)
- Int 47. General Jim Moore Boulevard and Coe Avenue (AM peak hour)
- Int 48. Fremont Boulevard/Southbound SR 1 Off-Ramp and Monterey Road (AM and PM peak hour)



**TABLE 6: EXISTING INTERSECTION LEVELS OF SERVICE**

| #  | Intersection  | Count Date | Intersection Control <sup>1</sup> | Jurisdiction (LOS Standard) <sup>2</sup> | Peak Hour <sup>3</sup> | Delay <sup>4</sup>                            | LOS <sup>5</sup>      |
|----|---|------------|-----------------------------------|--|------------------------|---|-----------------------|
| 1  | Del Monte Boulevard and Reindollar Avenue           | 4/25/2018  | Signalized                        | M (D)                                    | AM<br>PM               | 11.6<br>8.9                                   | B<br>A                |
| 2  | Second Avenue Extension and Patton Parkway          | Future     | Signalized                        | M (D)                                    | AM<br>PM               | Future Intersection                           |                       |
| 3  | SR 1 Southbound Ramps and Imjin Parkway             | 5/3/2017   | Signalized                        | for a (C)                                | AM<br>PM               | <b>36.6</b><br>17.2                           | <b>D</b><br>B         |
| 4  | SR 1 Northbound Ramps and Imjin Parkway             | 5/3/2017   | Signalized                        |  | AM<br>PM               | 0.0 (0.1)<br><b>0.2 (26.7)</b>                | A (A)<br><b>A (D)</b> |
| 5  | Second Avenue and Imjin Parkway                     | 4/27/2017  | Signalized                        | M (D)                                    | AM<br>PM               | 12.5<br>16.3                                  | B<br>B                |
| 6  | Third Avenue and Imjin Parkway                      | 4/27/2017  | SSS                               | M (D)                                    | AM<br>PM               | 3.7 ( <b>103.6</b> )<br>1.3 ( <b>43.2</b> )   | <b>A (F)</b><br>A (E) |
| 7  | Fourth Avenue and Imjin Parkway                     | 5/3/2017   | SSS                               | M (D)                                    | AM<br>PM               | 0.4 ( <b>88.9</b> )<br>1.4 ( <b>&gt;120</b> ) | A (F)<br>A (F)        |
| 8  | California Avenue and Imjin Parkway                 | 4/27/2017  | Signalized                        | M (D)                                    | AM<br>PM               | 20.2<br>10.0                                  | C<br>A                |
| 9  | California Avenue and Patton Parkway                | 4/25/2018  | SSS                               | M (D)                                    | AM<br>PM               | 1.4 (17.4)<br>0.4 (10.4)                      | A (C)<br>A (B)        |
| 10 | Imjin Road and Imjin Parkway                        | 4/27/2017  | Signalized                        | M (D)                                    | AM<br>PM               | 7.4<br>7.6                                    | A<br>A                |
| 11 | Abrams Drive and Imjin Parkway                      | 4/27/2017  | Signalized                        | M (D)                                    | AM<br>PM               | 14.5<br>17.4                                  | B<br>B                |
| 12 | Reservation Road and Imjin Parkway                  | 4/27/2017  | Signalized                        | M (D)                                    | AM<br>PM               | 22.5<br>32.9                                  | C<br>C                |
| 13 | Blanco Road and Reservation Road                    | 4/25/2018  | Signalized                        | MC (D)                                   | AM<br>PM               | 13.1<br>11.0                                  | B<br>B                |
| 14 | Inter-Garrison Road Connection and Reservation Road | 4/27/2017  | Signalized                        | MC (D)                                   | AM<br>PM <sup>7</sup>  | 10.4<br>10.2                                  | B<br>B                |
| 15 | Second Avenue and Ninth Street                      | 4/27/2017  | AWSC                              | M (D)                                    | AM<br>PM               | 21.9<br>11.4                                  | C<br>B                |
| 16 | Second Avenue and Eighth Street                     | 4/27/2017  | AWSC                              | M (D)                                    | AM<br>PM               | <b>56.3</b><br>12.8                           | <b>F</b><br>B         |
| 17 | Fourth Avenue and Eighth Street                     | Future     | AWSC                              | M / CSUMB (D)                            | AM<br>PM               | Project Intersection <sup>6</sup>             |                       |
| 18 | Imjin Road and Eighth Street                        | 4/27/2017  | AWSC                              | M (D)                                    | AM <sup>7</sup><br>PM  | 17.9<br>9.3                                   | C<br>A                |
| 19 | Second Avenue and Inter-Garrison Road               | 4/27/2017  | AWSC                              | M (D)                                    | AM<br>PM               | 26.5<br>9.8                                   | D<br>A                |



**TABLE 6: EXISTING INTERSECTION LEVELS OF SERVICE**

| #  | Intersection   | Count Date | Intersection Control <sup>1</sup> | Jurisdiction (LOS Standard) <sup>2</sup> | Peak Hour <sup>3</sup>             | Delay <sup>4</sup>       | LOS <sup>5</sup> |
|----|--|------------|-----------------------------------|--|------------------------------------|--------------------------|------------------|
| 20 | General Jim Moore Boulevard and Inter-Garrison Road    | 4/25/2018  | AWSC                              | M/ CSUMB (D)                             | AM <sup>7</sup><br>PM <sup>7</sup> | 8.5<br>9.9               | A<br>A           |
| 21 | Eighth Street/Seventh Avenue and Inter-Garrison Road   | 4/25/2018  | AWSC                              | MC / M / CSUMB (D)                       | AM <sup>7</sup><br>PM              | 12.9<br>8.9              | B<br>A           |
| 22 | Eighth Avenue and Inter-Garrison Road                  | 4/25/2018  | Roundabout                        | CSUMB (D)                                | AM <sup>7</sup><br>PM              | 32.1<br>8.6              | D<br>A           |
| 23 | Abrams Drive and Inter-Garrison Road                   | 4/27/2017  | AWSC                              | MC / CSUMB (D)                           | AM <sup>7</sup><br>PM              | <b>60.3</b><br>12.8      | <b>F</b><br>B    |
| 24 | Schoonover Road and Inter-Garrison Road                | 4/27/2017  | AWSC                              | MC (D)                                   | AM <sup>7</sup><br>PM              | 20.8<br>11.1             | C<br>B           |
| 25 | Inter-Garrison Road Connection and Inter-Garrison Road | 4/27/2017  | AWSC                              | MC (D)                                   | AM <sup>7</sup><br>PM              | 11.8<br>11.1             | B<br>B           |
| 26 | East Garrison Road and Reservation Road                | 4/25/2018  | Signalized                        | MC (D)                                   | AM<br>PM                           | 5.0<br>5.6               | A<br>A           |
| 27 | Reservation Road and Watkins Gate Road                 | Future     | Signalized                        | MC (D)                                   | AM<br>PM                           | Future Intersection      |                  |
| 28 | Davis Road and Reservation Road                        | 4/25/2018  | Signalized                        | MC (D)                                   | AM<br>PM                           | 18.2<br>15.9             | B<br>B           |
| 29 | Second Avenue and Divarty Street                       | 4/27/2017  | AWSC                              | M / CSUMB (D)                            | AM<br>PM                           | 31.1<br>9.4              | D<br>A           |
| 30 | General Jim Moore Boulevard and Divarty Street         | 4/27/2017  | AWSC                              | M / CSUMB (D)                            | AM<br>PM <sup>7</sup>              | 9.1<br>10.2              | A<br>B           |
| 31 | First Avenue and Lightfighter Drive                    | 4/27/2017  | Signalized                        | S (C)                                    | AM <sup>7</sup><br>PM              | 4.0<br>3.4               | A<br>A           |
| 32 | Second Avenue and Lightfighter Drive                   | 4/27/2017  | Signalized                        | S (C)                                    | AM<br>PM                           | 18.3<br>14.2             | B<br>B           |
| 33 | General Jim Moore Boulevard and Lightfighter Drive     | 4/27/2017  | Signalized                        | S (C)                                    | AM<br>PM                           | 20.0<br>22.6             | B<br>C           |
| 34 | Malmedy Road and Colonel Durham Street                 | 4/25/2018  | AWSC                              | S (C)                                    | AM <sup>7</sup><br>PM              | 9.9<br>8.3               | A<br>A           |
| 35 | Parker Flatts Cut Off Road and Colonel Durham Street   | 4/25/2018  | SSS                               | S (C)                                    | AM <sup>7</sup><br>PM <sup>7</sup> | 0.4 (10.9)<br>1.1 (10.1) | A (B)<br>A (B)   |
| 36 | Sixth Avenue and Colonel Durham Street                 | 4/25/2018  | AWSC                              | S (C)                                    | AM <sup>7</sup><br>PM <sup>7</sup> | 8.9<br>7.8               | A<br>A           |
| 37 | Seventh Avenue and Colonel Durham Street               | 4/25/2018  | SSS                               | S (C)                                    | AM <sup>7</sup><br>PM <sup>7</sup> | 6.6 (12.3)<br>7 (10.5)   | A (B)<br>A (B)   |
| 38 | Eighth Avenue and Colonel Durham Street                | 4/25/2018  | SSS                               | MC (D)                                   | AM<br>PM                           | 0.6 (14.5)<br>2 (13.9)   | A (B)<br>A (B)   |



**TABLE 6: EXISTING INTERSECTION LEVELS OF SERVICE**

| #  | Intersection   | Count Date | Intersection Control <sup>1</sup> | Jurisdiction (LOS Standard) <sup>2</sup> | Peak Hour <sup>3</sup> | Delay <sup>4</sup>         | LOS <sup>5</sup>     |
|----|--|------------|-----------------------------------|--|------------------------|----------------------------|----------------------|
| 39 | General Jim Moore Boulevard and Gigling Road                   | 4/27/2017  | Signalized                        | S (C)                                    | AM<br>PM               | 25.9<br>14.8               | C<br>B               |
| 40 | Malmedy Road and Gigling Road                                  | 4/25/2018  | SSS                               | S (C)                                    | AM<br>PM               | 3.7 (24.9)<br>2.0 (18.0)   | A (C)<br>A (C)       |
| 41 | Parker Flatts Cut Off Road and Gigling Road                    | 4/25/2018  | SSS                               | S (C)                                    | AM <sup>7</sup><br>PM  | 2.0 (23.6)<br>2.8 (17.6)   | A (C)<br>A (C)       |
| 42 | Sixth Avenue and Gigling Road                                  | 4/25/2018  | AWSC                              | S (C)                                    | AM<br>PM               | 13.3<br>10.2               | B<br>B               |
| 43 | Seventh Avenue and Gigling Road                                | 4/25/2018  | SSS                               | S (C)                                    | AM<br>PM               | 2.1 (12.7)<br>0.9 (9.0)    | A (B)<br>A (A)       |
| 44 | Eighth Avenue and Gigling Road                                 | 4/25/2018  | AWSC                              | MC (D)                                   | AM <sup>7</sup><br>PM  | 9.9<br>10.3                | A<br>B               |
| 45 | Eastside Parkway and Gigling Road                              | Future     | AWSC                              | MC (D)                                   | AM<br>PM               | Future Intersection        |                      |
| 46 | General Jim Moore Boulevard and Normandy Road                  | 4/25/2018  | Signalized                        | S (C)                                    | AM<br>PM               | 22.0<br>9.9                | C<br>A               |
| 47 | General Jim Moore Boulevard and Coe Avenue                     | 4/25/2018  | AWSC                              | S (C)                                    | AM<br>PM               | <b>92.2</b><br>18.4        | <b>F</b><br>C        |
| 48 | Fremont Boulevard - Southbound SR 1 Off-Ramp and Monterey Road | 4/25/2018  | Signalized                        | for a / Sand City (C)                    | AM<br>PM               | <b>65.8</b><br><b>50.5</b> | <b>E</b><br><b>D</b> |
| 49 | California Avenue—and Monterey Road - Northbound SR 1 Off-Ramp | 4/25/2018  | Signalized                        | Cal / S (C)                              | AM<br>PM               | 12.1<br>24.5               | B<br>C               |
| 50 | Reservation Road and State Route 68 Westbound Ramps            | 4/25/2018  | Signalized                        | Cal / MC (C)                             | AM<br>PM               | 13.6<br>33.0               | B<br>C               |
| 51 | Reservation Road and State Route 68 Eastbound Ramps            | 4/25/2018  | Signalized                        | Cal / MC (C)                             | AM<br>PM               | 11.4<br>12.2               | B<br>B               |

Notes: **Bold text** indicates intersection operates at unacceptable level of service.

- SSS = Side Street Stop Controlled, AWSC = All Way Stop Controlled, Signalized = Signalized intersection
- Intersection jurisdiction and associated LOS threshold applied.
  - City of Marina = M
  - City of Seaside = S
  - California State University, Monterey Bay = CSUMB
  - Monterey County = MC
  - Caltrans = Cal
- AM = AM peak hour, PM = PM peak hour.
- Whole intersection weighted average control delay expressed in seconds per vehicle calculated using methods described in the 2010 *Highway Capacity Manual* for signalized intersections and all-way stop-controlled intersections. For side-street stop-controlled intersections, average control delay and total delay for the worst movement are reported as "average control delay (worst movement total delay)."





5. LOS = Level of Service. LOS calculations conducted using the Synchro 10 analysis software packages, which apply the methods described in the 2010 *Highway Capacity Manual*. For side-street stop-controlled intersections, average control LOS and total LOS for the worst movement are reported as "average control LOS (worst movement total LOS)."
  6. Fourth Avenue and Eighth Street is currently closed by both the City of Marina and CSUMB. The Project proposes to make this a limited access gated entry, restricted to through traffic; therefore, the intersection is considered open in the with Project scenarios. The intersection is also proposed to be open in the future; therefore, open in the Cumulative without Project scenarios.
  7. For these intersections, the peak hour factor is below 0.85; therefore, the delay is calculated based on the peak of the peak 15 minutes, which results in delay calculations that vary from general peak hour observations.
- Source: Fehr & Peers, 2019.



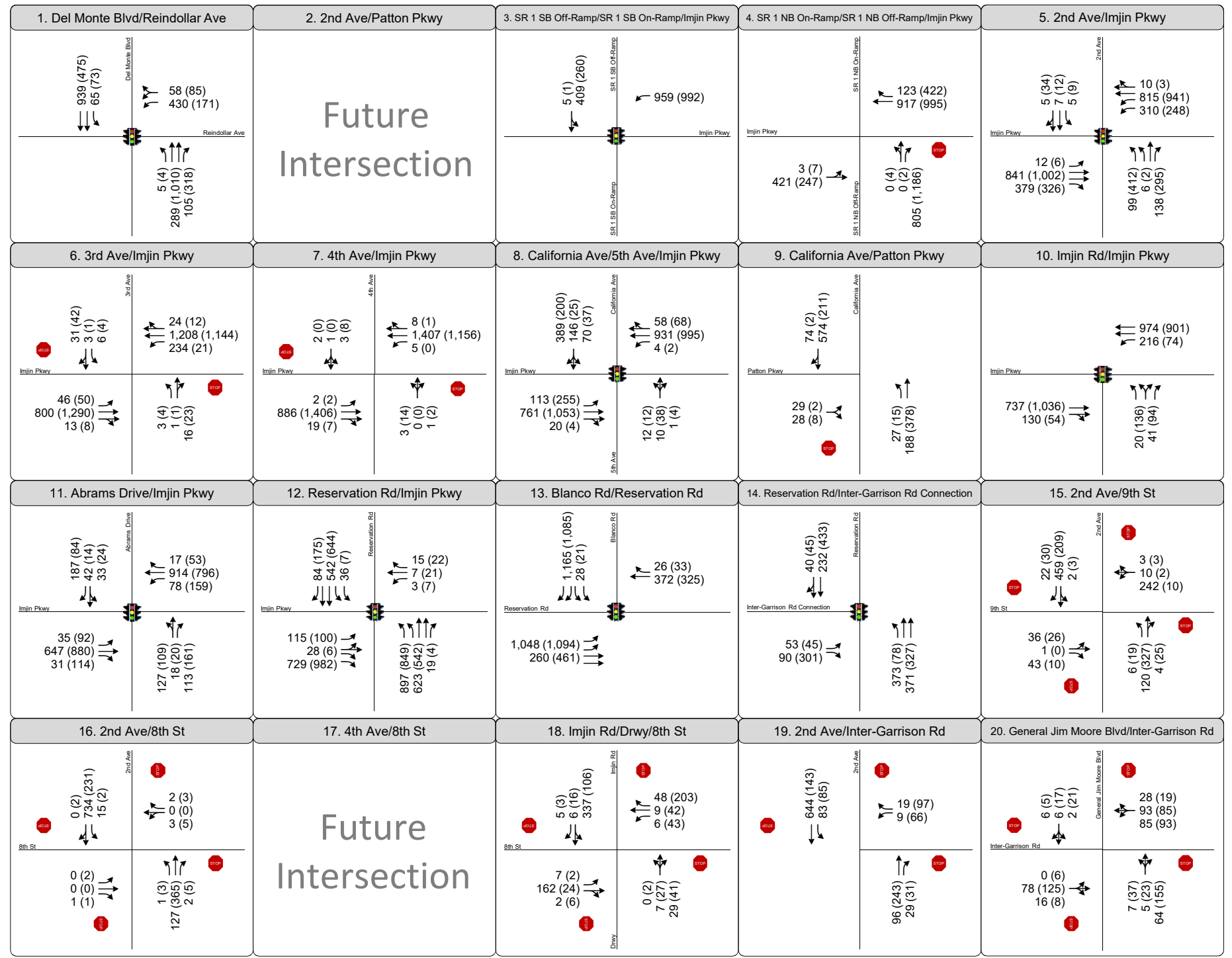
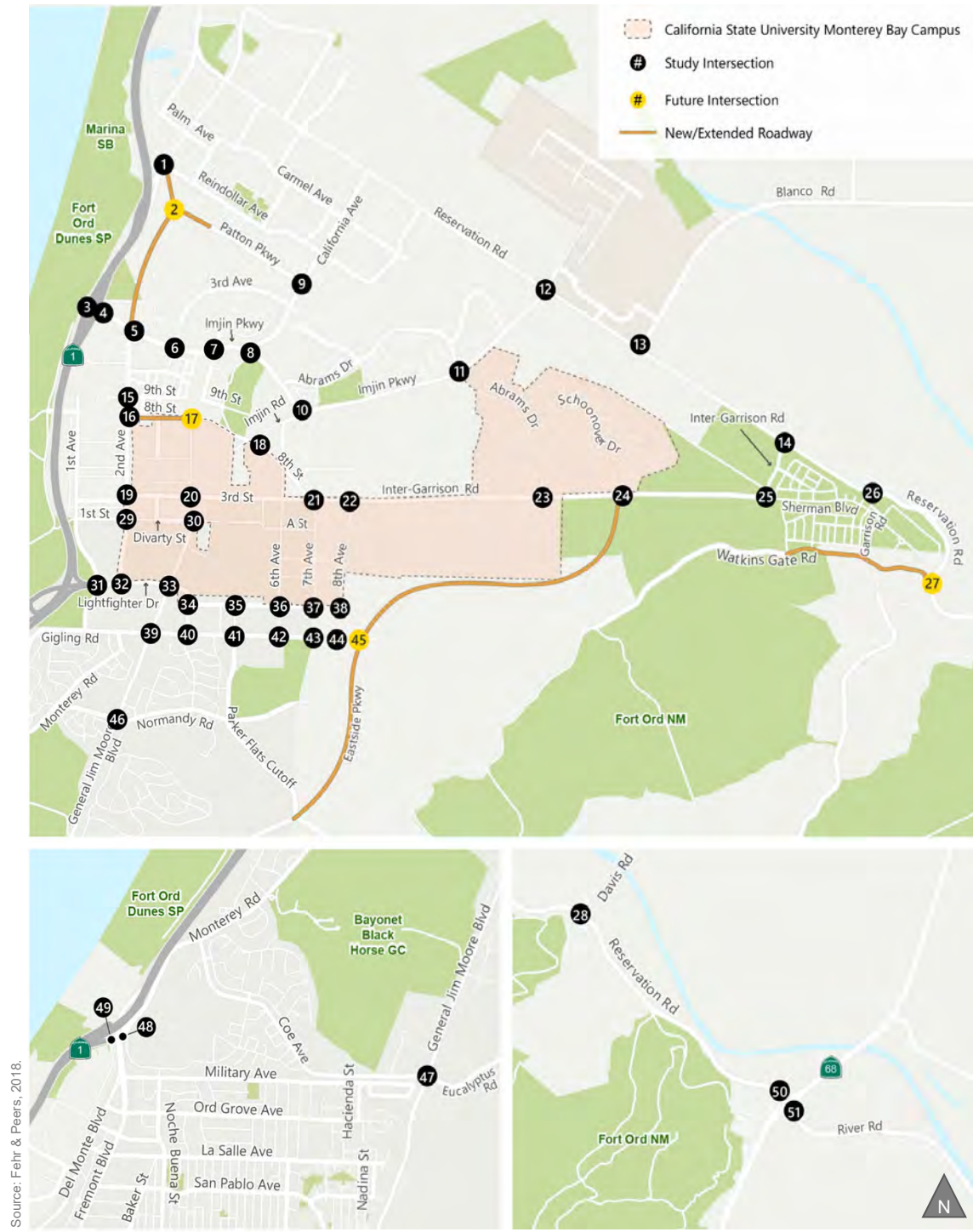

- LEGEND**
- AM (PM) Peak Hour Traffic Volume
  - Lane Configuration
  - Stop Sign Controlled
  - Signalized
  - Roundabout

Figure 12a  
Study Intersection Peak Hour Traffic Volumes and Lane Configurations  
Existing Conditions



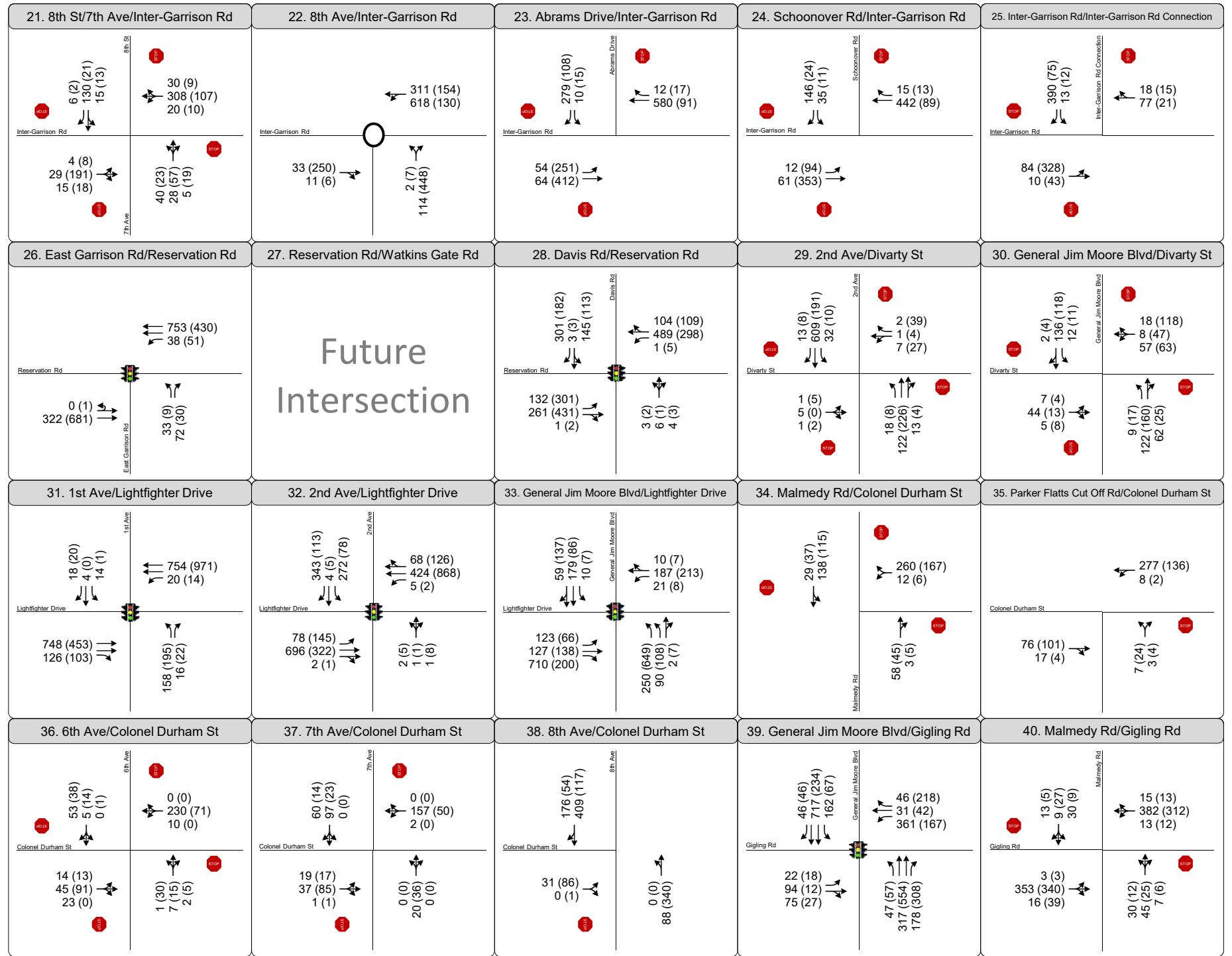
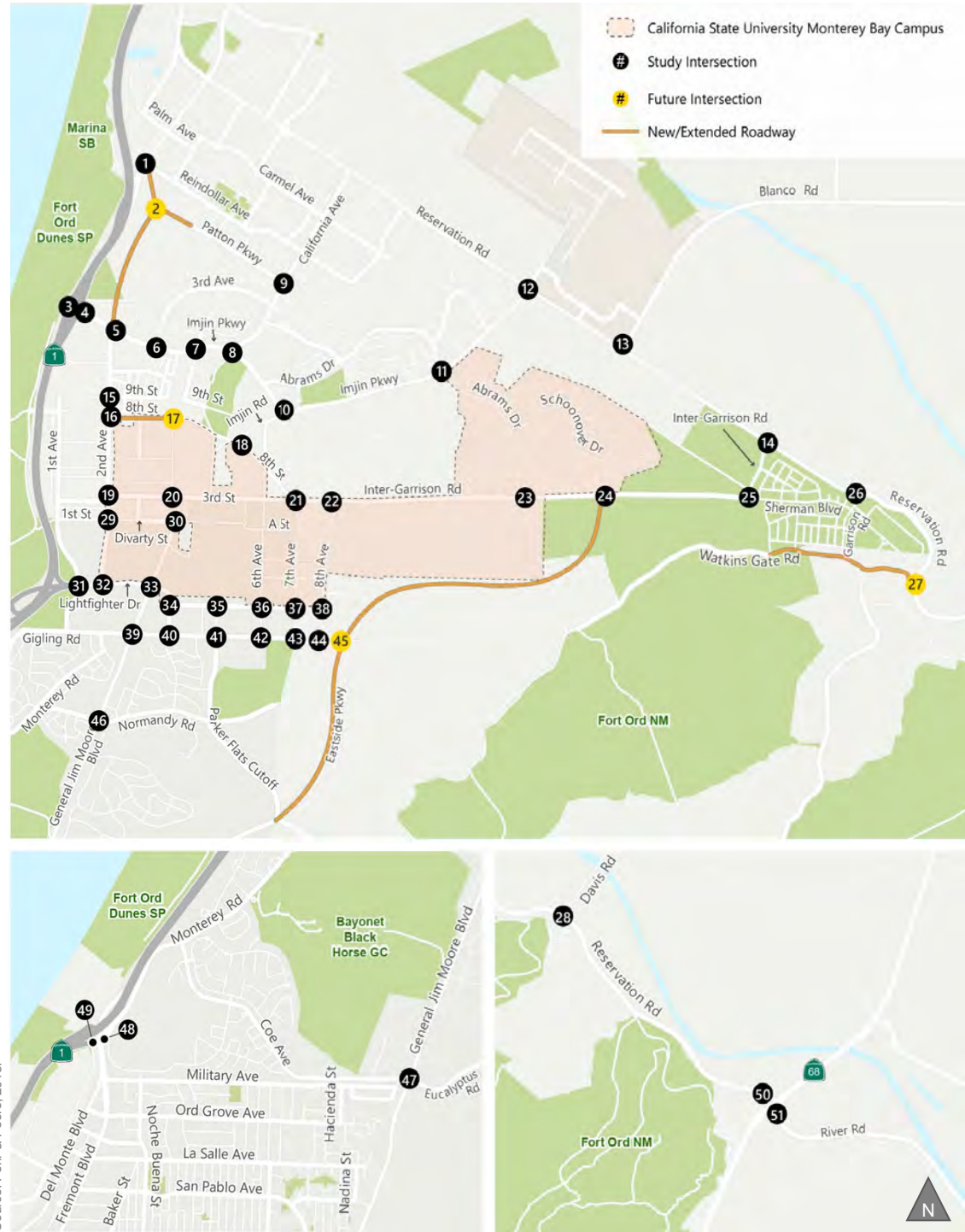

**LEGEND**

- AM (PM) Peak Hour Traffic Volume
- Lane Configuration
- Stop Sign Controlled
- Signalized
- Roundabout

Figure 12b  
Study Intersection Peak Hour Traffic Volumes and Lane Configurations  
Existing Conditions



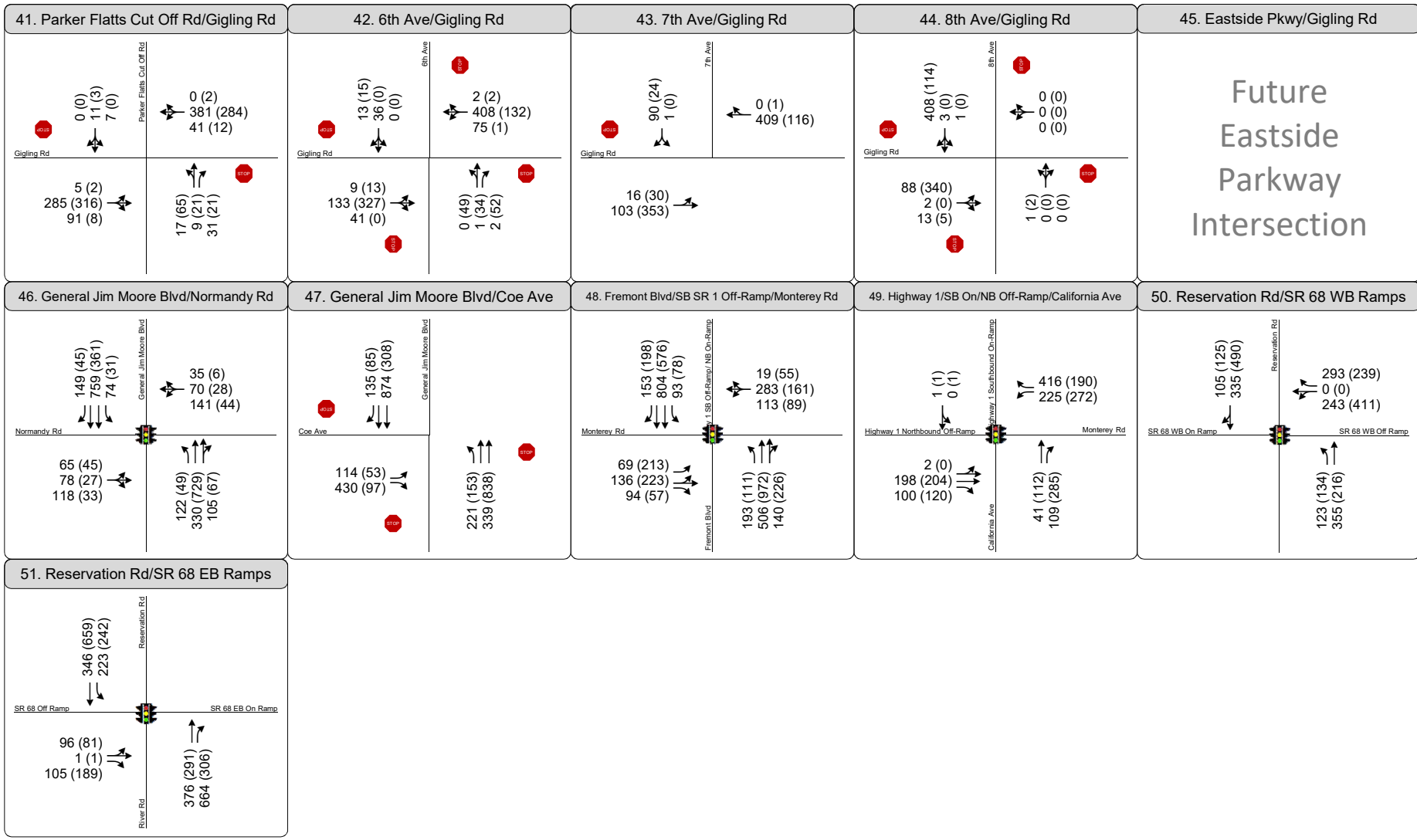
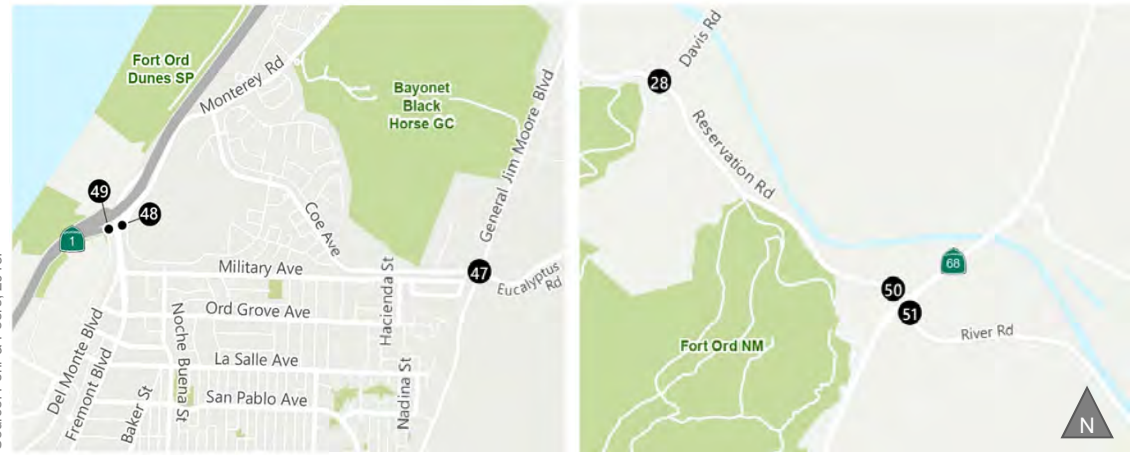
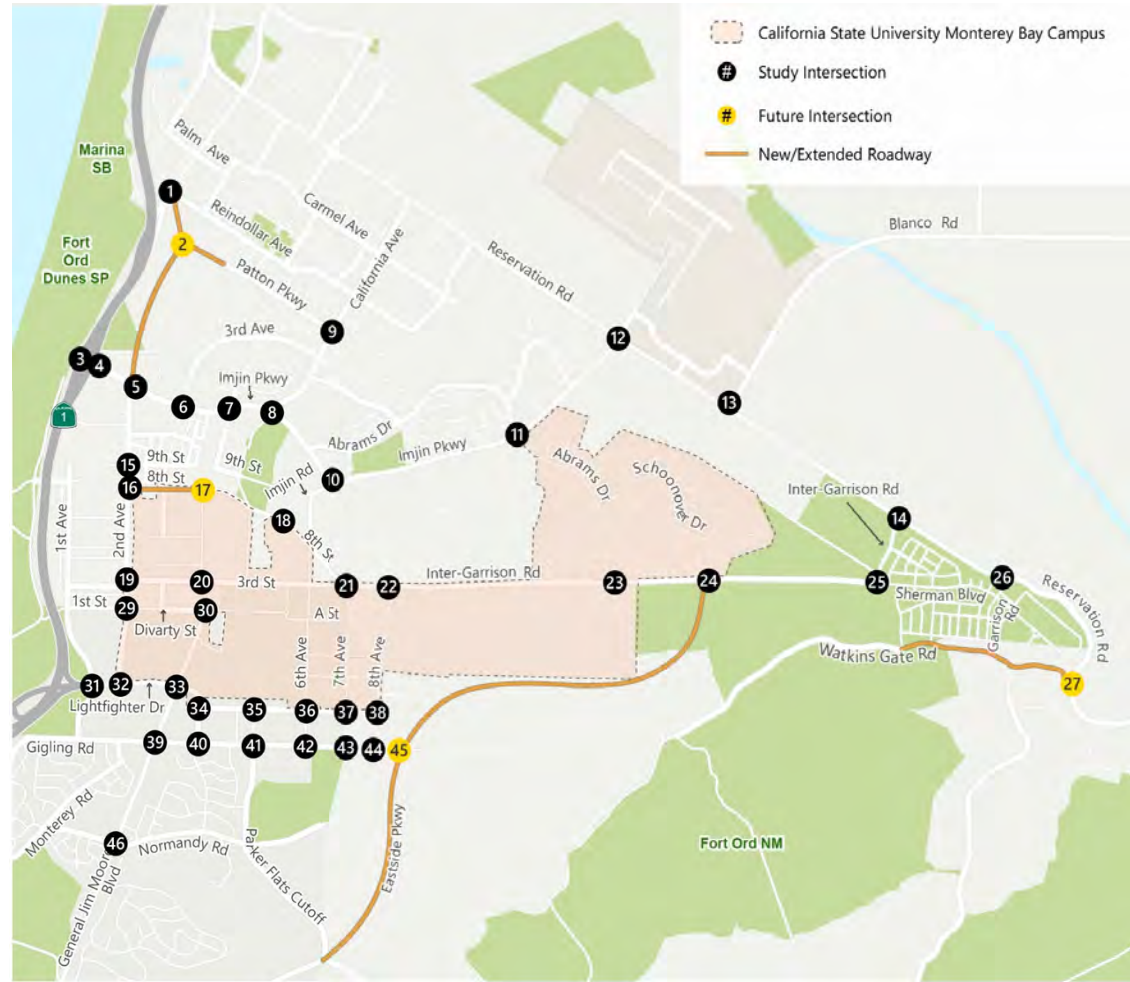

- LEGEND**
- AM (PM) Peak Hour Traffic Volume
  - Lane Configuration
  - Stop Sign Controlled
  - Signalized
  - Roundabout



Figure 12c  
Study Intersection Peak Hour Traffic Volumes and Lane Configurations  
Existing Conditions

## EXISTING FREEWAY SEGMENT OPERATIONS

The existing morning (AM) and evening (PM) peak hour freeway segment levels of service were evaluated using the method described in **Chapter 7**. Traffic volume observations were recorded at five locations along SR 1. **Table 7** shows the existing freeway segment levels of service. The following freeway segments exceed the Caltrans level of service standard (that is, they operate at LOS D or worse under Existing Conditions):

- Southbound SR 1 between Reservation Road and Canyon Del Rey Boulevard during the AM peak hour (all 5 southbound SR 1 segments)
- Northbound SR 1 between Imjin Parkway and Lightfighter Drive during the PM peak hour
- Northbound SR 1 between Fremont Boulevard-Del Monte Boulevard and Canyon Del Rey Boulevard the PM peak hour

**TABLE 7: EXISTING FREEWAY SEGMENT LEVELS OF SERVICE**

| Freeway Segment  | Peak Hour <sup>1</sup> | Mixed Lanes | Volume       | Density <sup>2,3</sup> | Level of Service <sup>4</sup> |
|--|------------------------|-------------|--------------|------------------------|-------------------------------|
| <b>State Route 1 – Southbound</b>                                  |                        |             |              |                        |                               |
| Reservation Road and Del Monte Boulevard                           | AM                     | 2           | <b>2,705</b> | <b>29.1</b>            | <b>D</b>                      |
|  | PM                     |             | 1,418        | 11.3                   | B                             |
| Del Monte Boulevard and Imjin Parkway                              | AM                     | 3           | <b>4,055</b> | <b>26.7</b>            | <b>D</b>                      |
|  | PM                     |             | 2,088        | 11.3                   | B                             |
| Imjin Parkway and Lightfighter Drive                               | AM                     | 3           | <b>4,560</b> | <b>30.1</b>            | <b>D</b>                      |
|  | PM                     |             | 2,859        | 15.5                   | B                             |
| Lightfighter Drive and Fremont Boulevard-Del Monte Boulevard       | AM                     | 3           | <b>4,778</b> | <b>30.5</b>            | <b>D</b>                      |
|  | PM                     |             | 3,177        | 16.9                   | B                             |
| Fremont Boulevard-Del Monte Boulevard and Canyon Del Rey           | AM                     | 2           | <b>3,843</b> | <b>34.7</b>            | <b>D</b>                      |
|  | PM                     |             | 2,629        | 21.2                   | C                             |
| <b>State Route 1 – Northbound</b>                                  |                        |             |              |                        |                               |
| Reservation Road and Del Monte Boulevard                           | AM                     | 2           | 1,172        | 9.6                    | A                             |
|  | PM                     |             | 2,671        | 21.2                   | C                             |
| Del Monte Boulevard and Imjin Parkway                              | AM                     | 3           | 1,725        | 9.9                    | A                             |
|  | PM                     |             | 4,231        | 22.8                   | C                             |
| Imjin Parkway and Lightfighter Drive                               | AM                     | 3           | 2,397        | 13.6                   | B                             |
|  | PM                     |             | <b>4,906</b> | <b>26.7</b>            | <b>D</b>                      |
| Lightfighter Drive and Fremont Boulevard-Del Monte Boulevard       | AM                     | 3           | 2,708        | 15.2                   | B                             |
|  | PM                     |             | 4,728        | 25.2                   | C                             |
| Fremont Boulevard-Del Monte Boulevard and Canyon Del Rey Boulevard | AM                     | 2           | 2,355        | 20.1                   | C                             |
|  | PM                     |             | <b>3,745</b> | <b>32.1</b>            | <b>D</b>                      |

Notes:

1. AM = AM peak hour, PM = PM peak hour.
2. Measured in passenger cars per mile per lane. Mixed = Mixed-Flow Lanes.
3. If volume/capacity ratio is greater than 1 density is not applicable.
4. Level of service based on density.

**Bold** text indicates below the applicable level of service standard (LOS D for Caltrans designated facilities).

Source: Fehr & Peers, 2019.



## EXISTING FREEWAY RAMP OPERATIONS

The ramp operations were evaluated by comparing the AM and PM peak hour volumes to the ramp capacities. The existing AM and PM peak hour ramp volumes at the SR 1 interchanges at the Imjin Parkway and Lightfighter Drive interchanges are shown and compared in **Table 8** and **Table 9**, respectively. As shown in the tables, all the study ramps operate below capacity during the AM and PM peak periods under Existing Conditions.

**TABLE 8: EXISTING RAMP AM PEAK HOUR VOLUMES AND CAPACITIES**

| Location                    | Direction | Ramp Type <sup>1</sup> | Lanes | Capacity <sup>1</sup> | Existing Volume (vehicles per hour) |
|-----------------------------|-----------|------------------------|-------|-----------------------|-------------------------------------|
| SR 1 and Imjin Parkway      | NB        | Diagonal On-Ramp       | 1     | 1,500                 | 126                                 |
|                             | SB        | Diagonal On-Ramp       | 1     | 1,500                 | 964                                 |
|                             | NB        | Diagonal Off-Ramp      | 2     | 3,000                 | 805                                 |
|                             | SB        | Diagonal Off-Ramp      | 1     | 1,500                 | 414                                 |
| SR 1 and Lightfighter Drive | NB        | Diagonal On-Ramp       | 1     | 1,500                 | 197                                 |
|                             | SB        | Diagonal On-Ramp       | 2     | 3,000                 | 739                                 |
|                             | NB        | Diagonal Off-Ramp      | 2     | 3,000                 | 460                                 |
|                             | SB        | Loop Off-Ramp          | 1     | 1,200                 | 431                                 |

Notes:

1. Peak hour ramp capacity is 1,500 veh/hr/ln (vehicles per hour per lane) and 1,200 veh/hr/ln for diagonal and loop ramps, respectively.

**Bold** text indicates volumes above capacity.

Source: Fehr & Peers, 2019.



**TABLE 9: EXISTING RAMP PM PEAK-HOUR VOLUMES AND CAPACITIES**

| Location                    | Direction | Ramp Type <sup>1</sup> | Lanes | Capacity <sup>1</sup> | Existing Volume (vehicles per hour) |
|-----------------------------|-----------|------------------------|-------|-----------------------|-------------------------------------|
| SR 1 and Imjin Parkway      | NB        | Diagonal On-Ramp       | 1     | 1,500                 | 431                                 |
|                             | SB        | Diagonal On-Ramp       | 1     | 1,500                 | 993                                 |
|                             | NB        | Diagonal Off-Ramp      | 2     | 3,000                 | 1,192                               |
|                             | SB        | Diagonal Off-Ramp      | 1     | 1,500                 | 261                                 |
| SR 1 and Lightfighter Drive | NB        | Diagonal On-Ramp       | 1     | 1,500                 | 661                                 |
|                             | SB        | Diagonal On-Ramp       | 2     | 3,000                 | 538                                 |
|                             | NB        | Diagonal Off-Ramp      | 2     | 3,000                 | 384                                 |
|                             | SB        | Loop Off-Ramp          | 1     | 1,200                 | 167                                 |

Notes:

1. Peak hour ramp capacity is 1,500 veh/hr/ln (vehicles per hour per lane) and 1,200 veh/hr/ln for diagonal and loop ramps, respectively.

**Bold** text indicates volumes above capacity.

Source: Fehr & Peers, 2019.

## FIELD OBSERVATIONS

Field observations were conducted in May 2017 and May 2018 to observe vehicle operations on the local street and freeway systems, and overall circulation of pedestrians and bicycles around the study intersections. Observations were conducted at each study intersection to confirm lane geometries and operational characteristics, including cycle lengths where possible. Field observations are described for the following key access corridors: Imjin Parkway, Inter-Garrison Road, Lightfighter Drive, and Second Avenue.

### Imjin Parkway:

- At SR 1 Interchange: During the AM and PM peak periods, the queue of westbound left-turning vehicles at the SR 1 southbound on-ramp extended to the upstream signalized intersections of SR 1 Northbound Ramps / Imjin Parkway and Second Avenue / Imjin Parkway.
- At Second Avenue: During the AM peak period, queuing on the westbound through approach extended approximately 500 feet upstream from the intersection.
- At Abrams Drive: During the PM peak period, congestion was observed to be heavier in the eastbound direction of Imjin Parkway. Queuing at the Abrams Drive intersection extended west past Third Avenue.
- At Reservation Road: During both peak periods, queues of northbound left-turning vehicles extended past the storage length of the left-turn lanes, approximately 400 feet from the



intersection. Queuing for these left-turn lanes extended farther in the AM period and did not clear after one cycle.

- Along Imjin Parkway: During the AM and PM peak periods, a few people were observed bicycling and walking along Imjin Parkway, and were mostly observed crossing the Second Avenue intersection and Abrams Drive Intersection. Along Imjin Parkway, cyclists were observed using the shared-use path.

#### **Inter-Garrison Road:**

- At stop-controlled intersections during both peak periods, little queuing was observed at intersections with no congestion.
- At Eighth Avenue: Two cyclists were observed traveling on the roadway through the roundabout in lieu of using the shared-use path around the intersection. During the AM peak hour, high westbound left-turn volumes resulted in delays to the westbound approach and the overall intersection delay and LOS as shown in **Table 6**. Little to no queuing was observed during off-peak periods as left turn volumes were lower than during the peak period as shown in counts in **Appendix D**.
- Along Inter-Garrison Road: Most pedestrians were observed closer to campus east of Eighth Avenue. During the PM peak period around class dismissal times, westbound traffic experienced longer queues, specifically around intersections at the Main Campus entrance/exit.

#### **Lightfighter Drive:**

- At First Avenue: During both AM and PM peak periods, the westbound through vehicles experienced the greatest queuing with queues extending to approximately 150 feet. All queues cleared after one traffic signal cycle.
- At General Jim Moore Boulevard: During the AM and PM peak periods, queues of eastbound through vehicles extended approximately 100 feet and would clear after one cycle. During the PM peak period, northbound left-turning vehicles mainly utilized the outside left-turn lane.

#### **Reservation Road:**

- At Blanco Road: During the AM and PM peak periods, observed queues were longest along the westbound left-turn lanes with a maximum of 8 vehicles in each lane in the AM peak period and 18 vehicles in each lane in the PM peak period. The majority of the traffic signal cycle length is utilized by the westbound left and through movement, which allows the westbound left-turn lanes to clear in one cycle. During both peak periods, southbound queuing was limited to a few vehicles, with maximum queue lengths of 75 feet for the left-turn lane. Vehicle queuing for the eastbound approach was substantial in the PM peak hour with a maximum queue of 12 vehicles, translating to nearly a 450-foot queue length.





- At Inter-Garrison Road: Minimal vehicle queuing, approximately 50 feet in length, was observed along Inter-Garrison Road.
- At East Garrison Road: Minimal vehicle queuing, approximately 50 feet in length, was observed along East Garrison Road.
- At Davis Road: Minimal vehicle queuing was observed in the AM and PM peak periods. The longest queues, approximately 125 feet of queued vehicles, were mainly observed along Davis Road on the southbound approach.
- At SR 68 Ramps: A majority of the queuing was observed southbound on Reservation Road at the SR 68 westbound ramps. The queuing in the AM peak period caused a few vehicles to extend past the Portola Drive intersection north of the SR 68 ramps, with a length of approximately 250 feet. During the PM peak period, queues were observed to extend farther back to approximately 375 feet, which blocked the entrance into Portola Drive.
- Along Reservation Road: Minimal to no pedestrian and bicycle activity was observed along Reservation Road.

#### **Second Avenue:**

- Most pedestrians were observed crossing and using the shared-use path along Second Avenue. During the PM peak period, pedestrians were mainly observed traveling north on Second Avenue from the campus.

#### **Colonel Durham Street:**

- No vehicle queuing or frequent pedestrian activity was observed.

#### **Gigling Road:**

- At Parker Flats Cut-Off Road: During the PM peak period, the northbound left-turn vehicles experienced queuing and the length was about 50 feet.
- At Sixth Avenue: During the AM peak period, the westbound through vehicles experienced the most queuing with queues extending over 300 feet from the stop sign. During the PM peak period, queuing occurred in both the eastbound and westbound through directions with queue lengths of about 50 feet.
- At Eighth Avenue: During both the AM and PM peak periods, most pedestrians and cyclists were observed traveling southbound to the trail entrance.
- At General Jim Moore Boulevard: During the AM and PM peak periods, limited queuing was observed at the intersection.
- Along Gigling Road: Minimal pedestrian and bicycle activity was observed along Gigling Road.



### **SR 1 ramps at Monterey Road/ Fremont Boulevard and Monterey Road/ California Avenue:**

- At Fremont Boulevard/ Monterey Road: During the AM and PM peak periods, queues greater than 10 vehicles (250 feet) were mostly observed along the southbound SR 1 off-ramp and northbound Fremont Boulevard on-ramp. Some queues along Monterey Road, both eastbound and westbound, extended between 5 and 10 vehicles (125 feet to 250 feet) and would not clear in one cycle. During the PM peak period, queues from the Monterey Road eastbound approach would queue back to the California Road intersection.
- At California Avenue/ Monterey Road: Queues along Monterey Road were observed to queue back into the northbound right-turn lane along California Avenue for approximately 250 feet. These queues were not served in one cycle.
- At Fremont Boulevard/ Monterey Road and California Avenue/ Monterey Road: More pedestrians were observed along the northbound approach crosswalk, mostly students from the nearby high school traveling between the shopping center and the high school.
- At California Avenue/ Monterey Road: A few pedestrians were observed crossing Monterey Road at the westbound approach, which does not have a crosswalk, to reach the Monterey Peninsula Recreation Trail entrance on the northern end of the intersection. Bicyclists were observed traveling to and from the trail, using either the travel way or crosswalks.

Along the other roadways, light to moderate congestion was observed along the major approaches, and few vehicles were observed using the local streets. Northbound and southbound traffic south of the campus flowed with minimal delay and queuing. During the peak periods, queuing and delay were observed primarily on Imjin Parkway and at intersections closer to State Route 1. At intersections with geometries similar to Eighth Street and Fifth Avenue, vehicles were observed using the intersections as typical stop-controlled T-intersections. In general, the observations indicated that all study intersections, except as noted above, are operating at or near the calculated level of service.



### 3. SUMMARY OF RELEVANT REGIONAL CIRCULATION AND TRANSPORTATION PLANS

This chapter provides background information regarding circulation and transportation plans employed in the plan consistency evaluation later in this report. While CSUMB is not subject to local and regional plans because CSU is a state agency, this chapter summarizes the key transportation plans, goals, and policies and related plan transportation networks, to support the evaluation of Project conflicts with such plans and policies in **Chapter 5** of this report.

#### AMBAG REGIONAL TRANSPORTATION PLAN

The Association of Monterey Bay Area Governments (AMBAG) is the Metropolitan Planning Organization (MPO) for the three-county region (Monterey County, San Benito County, and Santa Cruz County). As the MPO, AMBAG is responsible for preparing the regional transportation plan and sustainable community strategy plan titled Monterey Bay 2040 Moving Forward/2040 Metropolitan Transportation Plan and Sustainable Communities Strategy (2040 MTP/SCS), both published in June 2018. The 2040 MTP/SCS is a 20-year planning document, updated every three years with the following goals and policy objectives:

- Access and Mobility – Provide convenient, accessible, and reliable travel options while maximizing productivity for all people and goods in the region.
- Economic Vitality – Raise the region’s standard of living by enhancing the performance of the transportation system.
- Environment – Promote environmental sustainability and protect the natural environment.
- Healthy Communities – Protect the health of our residents; foster efficient development patterns that optimize travel, housing, and employment choices and encourage active transportation.
- Social Equity – Provide an equitable level of transportation services to all segments of the population.
- System Preservation and Safety – Preserve and ensure a sustainable and safe regional transportation system.

Based on these goals and policies, a financially constrained transportation network (i.e., one recognizing current financial limitations) was prepared by AMBAG to establish the planned improvements that best meet the goals and policy objectives and available funding projections.



## SEASIDE GENERAL PLAN

### SEASIDE GENERAL PLAN (2004)

The 2004 Seaside General Plan includes goals to provide and maintain the City of Seaside's transportation network and ensure that its transportation network is integrated with the regional transportation system (City of Seaside 2004). The general plan also includes multimodal goals to promote additional transit usage and adequate parking. Key transportation goals and policies from the 2004 Seaside General Plan relevant to the analysis presented here include:

#### Key Goals:

- *Goal C-1:* Provide and maintain a City circulation system that promotes safety and satisfies the demand created by new development and redevelopment in Seaside.
- *Goal C-2:* Provide a local circulation system that is integrated with the larger regional transportation system to ensure the economic well-being of the community.
- *Goal C-3:* Promote the increased use of multimodal transportation.
- *Goal C-4:* Ensure adequate parking is provided throughout Seaside.

#### Key Policies:

- *Policy C-1.1:* Design roadway capacities and ensure transportation facilities that adequately serve planned land uses.
- *Policy C-1.2:* Improve the Seaside circulation system in concert with public and private land development and redevelopment projects to maintain the City standard of Level of Service "C".
- *Policy C-1.3:* Coordinate improvements to and maintenance of the City circulation system with other major transportation and infrastructure improvement programs.
- *Policy C-1.4:* Provide adequate access to the University, golf courses, and other uses in North Seaside.
- *Policy C-1.5:* Use traffic calming methods within residential and mixed use areas where necessary to create a pedestrian-friendly circulation system.
- *Policy C-1.6:* Apply creative approaches to increase safety and reduce congestion in areas with unique problems, such as: neighborhoods with narrow, one-way streets; areas around schools; neighborhoods with non-essential alleys, businesses with drive-through access; and other special situations.
- *Policy C-1.7:* Reduce impacts on residential neighborhoods from truck traffic and related noise.
- *Policy C-2.1:* Coordinate planning, construction and maintenance of development projects and circulation improvements with adjacent jurisdictions and transportation agencies.
- *Policy C-2.2:* Support programs that help reduce congestion and encourage alternative modes of transportation.



- *Policy C-2.3:* Support development that is compatible with increased operations at the Monterey Peninsula Airport.
- *Policy C-3.1:* Support the provision and expansion of regional transit services and support facilities to serve the City.
- *Policy 3.2:* Work with MST to provide special transit services to meet community needs.
- *Policy C-3.3:* Promote mixed use, higher density residential, and employment-generating development in areas where public transit is convenient and desirable.
- *Policy C-3.4:* Support alternative modes of transportation that encourage physical activity, such as biking and walking.
- *Policy C-4.1:* Require off-street parking in new development and redevelopment projects.
- *Policy C-4.2:* Support the development of well-designed and aesthetically pleasing parking facilities in areas where current parking deficiencies exist or where substantial traffic generating uses are planned.
- *Policy C-4.3:* Ensure well-landscaped parking lots that facilitate pedestrian movement and screen unattractive structures.

## SEASIDE DRAFT GENERAL PLAN UPDATE

In addition to the existing general plan approved in 2005, the City of Seaside is currently preparing its next general plan, the 2040 General Plan, *Seaside 2040*, which includes a vision for a multimodal network of complete streets (City of Seaside 2017). The 2040 General Plan is in draft form and has not yet been adopted by the City Council; therefore, the information contained in the draft plan is advisory only. Goal LUD-23 in the *Seaside 2040* Land Use & Community Design section highlights the desire to transform the City's northern area into a "mixed-use, economically-vibrant Campus Town that serves the student population and leverages its geographic adjacency to CSUMB." The area is intended to be high-density with a multimodal focus to improve access and connections for all modes to CSUMB.

Additionally, the 2040 General Plan presents different modal priorities than the currently adopted 2005 General Plan. The 2005 General Plan includes a level of service (LOS) policy that requires the City of Seaside to maintain a LOS C standard during peak hours. Using this LOS C standard requires the construction of larger intersections, which can have a negative effect on pedestrian and bicycle access and comfort. Thus, the draft 2040 General Plan (November 2017) goals include policies that focus on creating accessible, complete streets for all users of the street system and paths. Key transportation goals and policies relevant to the analysis presented here from the 2040 General Plan include:



### Key Goals:

- *Goal M-1:* A citywide network of “complete streets” that meets the needs of all users, including bicyclists, children, persons with disabilities, motorists, movers of commercial goods, pedestrians, public transportation, and seniors.
- *Goal M-2:* Mobility options that serve the multi-modal access and travel needs generated by new development in a manner suitable to the local context.
- *Goal M-5:* A citywide bicycle network that connects residential, commercial, educational, and recreational uses, and earns Seaside the reputation of a bicycle-friendly city.
- *Goal M-6:* Transit service that is frequent and convenient, and maximizes ridership potential for residents, employees, and visitors.
- *Goal M-7:* A safe transportation system that eliminates traffic-related fatalities and reduces non-fatal injury collisions.
- *Goal M-9:* Minimize the impact of motor vehicle parking on residential neighborhoods.
- *Goal M-10:* Environmentally sustainable transportation.
- *Goal M-11:* Integrate Seaside’s circulation system with the larger regional transportation system to ensure the economic well-being of the community.

### Key Policies:

- *Planning for all modes and transportation/ land use integration.* Design streets holistically, using a complete streets approach, which considers pedestrians, bicyclists, motorists, transit users, and other modes together to adequately serve future land uses.
- *Coordination with new development.* Improve the Seaside circulation system in concert with public and private land development and redevelopment projects.
- *Traffic calming.* Consider the implementation of traffic calming measures to reduce speeding and make streets user-friendly for all modes of transportation, including pedestrians and bicyclists.
- *Multi-modal connectivity.* Promote pedestrian and bicycle improvements that improve connectivity between existing and new development.
- *Pedestrian amenities.* Require new development and redevelopment to increase connectivity through direct and safe pedestrian connections to public amenities, neighborhoods, shopping, and employment destinations throughout the City.
- *Bikeway network completion.* Strive to complete the citywide bicycle network to create a full network of bicycle facilities throughout Seaside.
- *Transit Priority Corridors.* Provide measures to reduce delay to transit vehicles on priority transit corridors, such as queue-jump lanes and/or bus signal prioritization, where feasible, on transit priority street segments.



- *Transit amenities.* Support right-of-way design and amenities consistent with local transit goals to make it easier to get to transit services and improve transit as a viable alternative to driving.
- *Transit stop maintenance is provided.* Work with local and regional transit agencies to ensure that transit stops are maintained in a safe, clean, and attractive condition to encourage transit ridership.
- *Safety Improvements.* Provide safety improvements, and prioritize pedestrian circulation over other travel modes, along high-injury and high-fatality streets and intersections.
- *Safety and traffic calming.* Use traffic calming methods within residential and mixed-use areas, where necessary, to create a pedestrian-friendly circulation system.
- *Safety for all modes.* Ensure that planned non-transportation capital improvement projects, on or near a roadway, consider safety for all modes of travel during construction and upon completion.
- *Transportation demand management (TDM).* Promote TDM measures for new development. Measures may include subsidized transit passes, car share spaces, unbundled parking, and secured bicycle parking. Allow the City to provide incentives to new projects that provide TDM measures.
- *TAMC and countywide planning efforts.* Continue to support the overall vision, goals, objectives, and policies as a partner in TAMC. The City recognizes the regional significance of connecting bicycle and pedestrian facilities, sharing consistent guidelines, needs, and preferences within the City and the greater Monterey County.
- *Regional transit.* Continue to support and encourage development of TAMC's planned regional transit projects and coordinate service and facilities for new development and redeveloped parts of the City.

## MARINA GENERAL PLAN

The Marina General Plan was adopted on October 31, 2000 and updated with amendments through August 4, 2010 (City of Marina 2010). The Marina General Plan lays out broad goals and specific policies on land use, community design, circulation, housing, public facilities, open space, recreation, conservation, noise, seismic and safety considerations, and historic preservation. The following are the primary policies of the Marina General Plan from the Transportation Element that are relevant to the analysis presented here:

- *Policy 3.3.2:* Reduce the length and travel time of work trips generated by local residents by maximizing opportunities for residents to work within the community.
- *Policy 3.3.4:* Reduce the number and length of vehicular trips and limit overall traffic congestion by promoting land use patterns which allow for multipurpose trips and trip deferral during peak travel times.



- *Policy 3.3.5:* The City of Marina shall ensure that walking and bicycling routes are integral parts of street design and form a safe and preferred transportation network. Protect existing and future residential areas from through-traffic that creates safety, noise, and pollution problems.
- *Policy 3.3.7:* The City of Marina shall coordinate with surrounding jurisdictions and agencies, such as TAMC, Caltrans, California Department of Parks and Recreation, Monterey Peninsula Regional Park District, CSUMB, AMBAG, FORA, BLM, City of Seaside, and Monterey County to pursue projects that develop new pedestrian and bicycle routes and that improve and maintain existing pedestrian and bicycle routes. New routes shall be linked to existing routes wherever possible.
- *Policy 3.3.8:* Link existing and future areas of the City with an integrated system of roads, transit, footpaths, and bikeways that connect neighborhoods, commercial areas, schools, parks, and other major community-serving destinations.
- *Policy 3.3.9:* Where necessary and feasible, accept some traffic congestion to achieve other community goals, such as encouraging the integrity of neighborhoods and the use of alternative means of travel.
- *Policy 3.3.10:* Make all transportation decisions within a broad policy context that considers visual, environmental, economic, and social objectives rather than being solely responsive to existing or projected traffic problems.

## MONTEREY COUNTY GENERAL PLAN

The Monterey County General Plan released on October 26, 2010, presents a long-range vision for the County, looking forward 25 years into the future (County of Monterey, 2010). The transportation goals and polices in the Circulation Element relevant to the analysis presented here are listed below:

- Goal C-1 – Achieve an acceptable level of service by 2030.
  - Policy C-1.1 – The acceptable level of service of County roads and intersection shall be Level of Service D, except as follows:
    - Acceptable level of service for County roads in Community areas may be reduced below LOS D through the Community Plan process.
    - County roads operating at LOS D or below at the time of adopting this General Plan shall not be allowed to be degraded further except in Community areas where the Lower LOS may be approved through the Community Plan process.
    - Area Plans prepared for County Planning Areas may establish an acceptable level of service for County roads other than LOS D. The benefits which justify less than LOS D shall be identified in the Area Plan. Where an Area Plan does not establish a separate LOS, the standard LOS D shall apply.





- Goal C-2 – Optimize the use of the County’s transportation facilities.
  - Policy C-2.4 – A reduction of the number of vehicle miles traveled per person shall be encouraged.
  - Policy C-2.6 – Bicycle and automobile storage facilities shall be encouraged in conjunction with public transportation facilities.
- Goal C-3 – Minimize the negative impacts of transportation in the County.
  - Policy C-3.1 – Transportation modes shall be planned, and strategies developed to protect air quality; reduce noise; reduce the consumption of fossil fuels; and minimize the acquisition of land for roadway construction.
- Goal C-4 – Provide a public road and highway network for the efficient and safe movements of people and commodities.
  - Policy C-4.2 – All new roads and interior circulation systems shall be designed, developed, and maintained according to adopted County standards or allowed through specific agreements and plans.
  - Policy C-4.5 – New public local and collector roads shall be located and designed to minimize disruption of existing development, discourage through auto traffic, and provide for bicycle and pedestrian traffic within the right-of-way.
  - Policy C-4.7 – Where appropriate and sufficient public right-of-way is available, bicycle paths shall be separated from major roads and highways and be provided between adjacent communities.
- Goal C-5 – Maintain and enhance a system of scenic roads and highways through areas of scenic beauty without imposing undue restrictions on private property or constricting the normal flow of traffic.
  - Policy C-5.5 – Agencies involved in officially designating State Scenic Highways and/or County Scenic Roads shall coordinate their efforts for the integrated design and implementation of such designations.
- Goal C-6 – Promote viable transportation options.
  - Policy C-6.3 – The County shall encourage new development to concentrate along major transportation corridors and near cities to make transit services to these areas more feasible.
  - Policy C-6.8 – The County shall encourage coordination between all social service transportation providers.
- Goal C-8 – Encourage a rail system that offers efficient and economical transport of people and commodities.
- Goal C-9 – Promote a safe, convenient bicycle transportation system integrated as part of the public roadway system.



- Policy C-9.2 – Construction of expansion of roadways within major transportation corridors shall consider improved bike routes.
- Policy C-9.5 – Visitor-serving facilities shall provide adequate bicycle access and secure bicycle parking facilities.

## TAMC CONGESTION MANAGEMENT PROGRAM

Transportation Agency for Monterey County (TAMC) is the designated Congestion Management Agency for Monterey County. In 1990, the state passed legislation requiring CMAs like TAMC to implement a Congestion Management Program (CMP). The CMP provides level of service and performance standards, trip reduction techniques, development of deficiency programs, transportation system management, and capital improvement programming for the purpose of minimizing regional traffic impacts of development. As a designated CMA, TAMC reviews land use development proposals in order to ensure that traffic impacts of land use development are mitigated. TAMC also undertakes traffic counting regionally, and projects traffic impacts on regional roadways based on adopted general plans and other land use planning documents.

## 2018 MONTEREY COUNTY ACTIVE TRANSPORTATION PLAN

The 2018 Transportation Agency for Monterey County Active Transportation Plan is an update of the 2011 Bicycle and Pedestrian Master Plan, which identified all existing and planned bicycle and pedestrian facilities in Monterey County. The Plan identifies remaining gaps in the bicycle and pedestrian network and opportunity areas for innovative bicycle facility design, such as a planned separated bikeway (Class IV) improvement along Inter-Garrison Road. These pedestrian and bicycle planned improvements, including the planned Inter-Garrison Road improvement, are shown on **Figure 9** and **Figure 10**. The ATP has added more emphasis on “low-stress networks” that serve people of all ages and abilities, such as separate bike paths, protected bike lanes, bicycle boulevards, and bike protection at intersections. Goals set out in the Plan relevant to the analysis presented here include:

- Increasing the proportion of active transportation trips throughout Monterey County.
- Improve bicycle and pedestrian safety.
- Remove gaps and enhance bicycle and pedestrian network connectivity.
- Provide improved bicycle and pedestrian access to diverse areas and populations in Monterey County.
- Increase awareness of the environmental and public health benefits of bicycling and walking for transportation and recreation.
- Improve the quality of the bike and pedestrian network through innovative design and maintenance of existing facilities.



## FORT ORD REUSE AUTHORITY ACT

The Fort Ord Reuse Authority Act was implemented to facilitate the transfer and reuse of the Fort Ord military base, and established Fort Ord Reuse Authority (FORA) as the entity responsible for planning, financing, and carrying out the transfer and reuse of the base in a cooperative, coordinated, balanced, and decisive manner (Cal. Gov. Code § 6765 for a seq.). Founded in 1994, FORA was responsible for oversight of the Monterey Bay area economic recovery following the closure and reuse planning of the former Fort Ord military base. Pursuant to the Act, FORA's legislatively defined mission was complete as of June 30, 2020 and FORA has been dissolved per the FORA resolution No. 18-11.

The FORA Resolution No. 18-11 approved a Transition Plan that was submitted to the Monterey County Local Agency Formation Commission and that assigns assets and liabilities, designates responsible successor agencies, and provides a schedule for the remaining obligations (FORA 2018). The Transition Plan calls for the cities of Marina, Seaside, Monterey and Del Rey Oaks, and the County of Monterey to follow the Reuse Plan policies and programs and states that "...the implementation of the on-site Fort Ord transportation network and transit policies and programs are essential to the long-term success of the economic recovery of the reuse." The Resolution further states that after FORA's ultimate dissolution, any changes to the policies and programs of the Reuse Plan or any part thereof will be made by the respective land use jurisdictions only after full compliance with all applicable laws, including but not limited to CEQA.

After the official closure of Fort Ord in 1994, FORA adopted the Fort Ord Reuse Plan (Reuse Plan) in 1997 (FORA 1997). The Reuse Plan provided a framework for the reuse of more than 45 square miles of the former Fort Ord army base. The Reuse Plan identified transportation improvements to create a balanced transportation system, including pedestrian ways, bikeways, transit, and streets to provide for the safe and efficient movement of people. Responsibility for the remaining capital improvements in the Reuse Plan has been transitioned to the local agencies for implementation. The remaining capital improvements enhance regional access alternatives, provide additional local access routes, and enhance the internal circulation system to reduce through trips on facilities in the higher density or other sensitive areas.

The FORA Regional Urban Design Guidelines (RUDG), adopted on June 10, 2016, established standards for road design, setbacks, building height, landscaping, signage, and other matters of visual importance (FORA 2016). RUDG emphasizes the application and importance of the complete streets and connected street network, as well as providing well-designed transit facilities that improve the rider experience and economic vitality. To realize and support the complete streets concept, the following objectives are identified within the guidelines:

- Encouraging appropriate development scale and pattern to a village environment
- Minimizing street scale to facilitate pedestrian movement while providing adequate circulation and parking opportunities
- Minimizing street width to provide comfortable pedestrian environment



## MONTEREY-SALINAS TRANSIT DESIGNING FOR TRANSIT

MST developed the Designing for Transit manual in November 2006 to provide guidance to decision-makers, developers, and community members on planning for safe and efficient transit (MST 2020). This includes guidance on considerations and statements other agencies should consider in their general plans and planning. MST advises these policy statements should be considered in General Plans to achieve a multimodal transportation network:

- Integrate land use and circulation plans to create an urban environment that supports a multimodal transportation system;
- Prioritize future development and redevelopment projects that are accessible using the existing multimodal transportation network;
- Direct development to areas with a confluence of transportation facilities (sidewalks, bike paths, park & rides, and transit centers); and
- Limit development in areas accessible by only a single transportation mode.





## 4. SIGNIFICANCE CRITERIA AND VMT ANALYSIS METHODS

As previously noted, recent legislation in California, Senate Bill 743, changed the metric by which transportation-related significant impacts are to be assessed from LOS to VMT under CEQA. While lead agencies have until July 2020 to implement this change, they are free to do so prior to that date, as has been the case with multiple jurisdictions throughout the state.

In response to this recent legislation, the CSU Chancellor’s Office recently issued the *2019 California State University Transportation Impact Study Manual (2019 CSU TISM)*. The *2019 CSU TISM* provides guidance for the preparation of CEQA compliant transportation impact analysis pursuant to SB 743 and is the operative TISM for the analysis presented here. The detailed impact criteria for VMT and other transportation-related items are described below followed by the VMT forecasting methods.

An analysis of the Project’s potential impacts is presented in **Chapter 5**.

### SIGNIFICANCE CRITERIA

Consistent with the revised CEQA Guidelines, the *2019 CSU TISM* establishes updated significance criteria to be used for environmental impact analysis. The project would result in a significant impact if it meets any of the significance criteria below:

- Plan Conflict: The Project would conflict with a program, plan, ordinance, or policy addressing the circulation system, including transit, roadway, bicycle, and pedestrian facilities.
- VMT Impacts: The Project would result in a VMT-related impact as described below in **Table 10**.
- Hazard Impact: The Project would substantially increase hazards due to a geometric design feature (e.g., sharp curves or dangerous intersections) or incompatible uses (e.g., farm equipment).
- Emergency Access Impact: The Project would result in inadequate emergency vehicle access.

**TABLE 10: EXISTING CSU TISM VMT SIGNIFICANCE THRESHOLDS**

| Impact Categories  | CSU Significance Thresholds   | Calculated Numeric Thresholds for Project  |
|--------------------|---|--|
| Project Impacts    | The threshold to be applied in assessing Project-specific impacts is 15% below the existing total VMT per service population rate of Monterey County.                   | The Project would result in a significant project-specific impact if the CSUMB campus total VMT per service population under Existing with Project Conditions is greater than 23.91. |
| Cumulative Impacts | The threshold to be applied in assessing cumulative impacts is no change in the cumulative conditions (future) boundary VMT per service population for Monterey County. | The Project would result in a significant cumulative impact if it causes the cumulative countywide daily boundary VMT per service population to be greater than 14.07.               |

Source: CSU 2019.



Each of these impact criteria is discussed further below.

## PLAN CONFLICTS

As described in the *2019 CSU TISM*, a Project may cause a significant impact if:

- The Project would conflict with a program, plan, ordinance, or policy addressing the circulation system, including transit, roadway, bicycle, and pedestrian facilities.

To determine the Project's consistency with relevant transportation programs, plans, ordinances or policies, the following significance thresholds were applied to each respective mode of travel – transit, roadways, bicycle facilities and pedestrians as listed below.

### Transit

Analysis of transit-related impacts encompasses two components: (1) transit capacity, and (2) the Project's consistency with local transit plans. For transit capacity, a significant impact would occur if the Project creates demand for public transit above the capacity which is provided or planned.

To determine the Project's consistency with local transit plans, significant impacts would occur if the Project or any part of the Project:

- Disrupts existing transit services or facilities;<sup>19</sup> or
- Conflicts with an existing or planned transit facility; or
- Conflicts with transit policies adopted by the City of Seaside, Monterey County, Fort Ord Reuse Authority, Transportation Agency for Monterey County, or Monterey-Salinas Transit for their respective facilities in the study area.

### Roadways

To determine the Project's consistency with local roadway plans, significant impacts would occur if the Project or any part of the Project:

- Disrupts existing or planned roadway facilities or conflicts with applicable program, plan, ordinance, or policy.

---

<sup>19</sup> This includes disruptions caused by the Project relative to transit street operations and transit stops/shelters; or impacts to transit operations from traffic improvements proposed or resulting from the Project.



### Bicycle Facilities

To determine the Project's consistency with local bicycle plans, significant impacts would occur if the Project or any part of the Project:

- Disrupts existing or planned bicycle facilities or conflicts with applicable bicycle plans, guidelines, policies, or standards.

### Pedestrian Facilities

Analysis of pedestrian impacts encompasses two components: (1) on-campus pedestrian connections, and (2) the Project's consistency with applicable programs, plans, ordinances, or policies. Significant pedestrian impacts would occur if the Project or any part of the Project

- Fails to provide safe pedestrian connections between campus buildings and adjacent streets and transit facilities; or
- Disrupts existing or planned pedestrian facilities or conflicts with applicable programs, plans, ordinances, or policies.

## VMT THRESHOLDS AND IMPACT CRITERIA

As discussed in **Chapter 1**, the VMT impact analysis presented in this report considers the Project's direct impacts relative to Project generated VMT using the total VMT per service population metric, as well as a cumulative analysis, which considers the Project's long-term effect on VMT using boundary VMT per service population. Each analysis is addressed separately below.

### Project Generated VMT (Project Analysis)

The significance threshold for determining the project's direct impact is a Total VMT per service population rate that is 15 percent below the Existing Conditions total VMT per service population for Monterey County. The OPR *Technical Advisory* suggests a similar threshold for residential and office land uses (i.e., 15 percent below VMT in a geographic area). Per the *2019 CSU TISM*, the CSU has selected the 15 percent reduction relative to Monterey County based on the OPR *Technical Advisory* and the fact that most of the students, faculty, and staff live within Monterey County. As a result, most of the CSUMB campus total VMT would be within Monterey County and, therefore, impacts assessed against the Monterey County baseline is the most appropriate measure of the Project's direct impact. Thus, the threshold applied in this analysis is 15% below the existing VMT of 28.12, which as shown in **Table 10**, is the existing total VMT per service population of Monterey County, or 23.91 (Monterey County total VMT per Service Population of 28.12 x 85% = 23.91).





**TABLE 11: PROJECT GENERATED VMT THRESHOLD BASED ON EXISTING CONDITIONS FOR MONTEREY COUNTY**

| Item   | Amount       |
|--|--------------|
| Monterey County Total Vehicle Miles Traveled (A) <sup>1</sup>          | 19,158,300   |
| Monterey County Service Population (B) <sup>1,2</sup>                  | 681,200      |
| Monterey County Total VMT per Service Population (A/B = C)             | 28.12        |
| Monterey County Total VMT per Service Population Threshold (C*85% = D) | <b>23.91</b> |

Notes:

1. Rounded service population and VMT to nearest 100.
2. Service population is defined as the sum of all employees, residents, and students (Kindergarten through University).

Source: Fehr & Peers, 2019.

Therefore, the Project would cause a significant Project generated VMT impact if

- The Project would result in a significant project-specific impact if the CSUMB campus total VMT per service population under Existing with Project Conditions is greater than 23.91.

### Project's Effect on VMT (Cumulative Analysis)

The impact threshold for the Project's effect on VMT, or the Project's cumulative impact, is the Monterey County Boundary VMT per Service Population, or 14.07 (refer to **Table 12** for illustration of how the 14.07 is calculated). Like the Project generated VMT baseline using the total VMT per service population rate of Monterey County, the boundary VMT baseline uses the Monterey County boundary VMT to evaluate the Project's effects on VMT because the Project effects are likely to be localized near the CSUMB campus and within Monterey County.

**TABLE 12: PROJECT'S EFFECT ON VMT (BOUNDARY VMT) THRESHOLD BASED ON CUMULATIVE CONDITIONS FOR MONTEREY COUNTY**

| Item  | Amount       |
|---|--------------|
| Monterey County Boundary Vehicle Miles Traveled (A) <sup>1</sup>  | 11,268,400   |
| Monterey County Service Population (B) <sup>1,2</sup>             | 800,900      |
| Monterey County Boundary VMT per Service Population (A/B = EC)    | 14.07        |
| Monterey County Boundary VMT per Service Population Threshold (C) | <b>14.07</b> |

Notes:

1. Rounded service population and VMT to nearest 100.
2. Service population is defined as the sum of all employees, residents, and students (Kindergarten to University)

Source: Fehr & Peers, 2019.



Therefore, the Project's effect on VMT would be significant if

- The Project would result in a significant cumulative impact if it causes the cumulative countywide daily boundary VMT per service population to be greater than 14.07.

## HAZARD IMPACT

The Project would have a significant impact regarding hazards if

- The Project would substantially increase hazards due to a geometric design feature (e.g., sharp curves or dangerous intersections) or incompatible uses (e.g., farm equipment).

## EMERGENCY ACCESS IMPACT

Ease of access and travel time are critical for first responders when traveling in emergency vehicles. Obstructions in the roadway, detours, and excessive delays due to congestion are among the factors that can affect emergency response time. A significant impact would occur if

- The Project would result in inadequate emergency access.

## TRAFFIC FORECASTING METHODS

The AMBAG regional travel forecasting model was used to develop daily VMT and traffic forecasts for the CSUMB campus and the Project study area. VMT forecasts were prepared for the SB 743 VMT assessment, as well as for use as inputs for the greenhouse gas (GHG) analysis.

## AMBAG MODEL DOCUMENTATION

A description of the base year model validation and future year travel model assumptions is included in **Appendix B**. The future year travel model is used to develop forecasts for Cumulative Conditions and includes traffic from projects presently under construction, approved (but not yet constructed and/or occupied) developments, pending developments, and projected growth to Year 2035. Planned and funded roadway and intersection improvements associated with the approved projects and the Fort Ord Reuse Authority (FORA) Capital Improvement Program, City of Marina, and the *2040 Metropolitan Transportation Plan / Sustainable Communities Strategy (2018)* are included. Refer to **Table 13** for the jurisdictional source and descriptions of roadway improvements within the study area.



Intersection and freeway forecasts were developed using guidelines published in National Cooperative Highway Research Program (NCHRP) Report 765<sup>20</sup> for converting raw model results into forecasted volumes. This method, known as the difference forecast method, is based on existing counts and the difference between the model's baseline and future volumes. This method normalizes the model projections based on the accuracy of the model validation and the existing roadway volumes.

---

<sup>20</sup> National Cooperative Highway Research Program (NCHRP). *Report 765: Analytical Travel Forecasting Approaches for Project-Level Planning and Design*, Washington, D.C.: National Academy Press, 2014.



**TABLE 13: ROADWAY IMPROVEMENTS FOR CUMULATIVE CONDITIONS**

| Project Number <sup>1</sup>                       | Name                         | Description  | Sources <sup>2</sup> |                   |                  | Notes  |
|---|------------------------------|--|----------------------|-------------------|------------------|--|
|   |                              |  | City <sup>3</sup>    | FORA <sup>4</sup> | RTP <sup>5</sup> |  |
| <b>City of Marina Capital Improvement Program</b> |                              |  |                      |                   |                  |  |
| R 05  | Second Avenue Extension      | Extend Second Avenue as a 2-lane arterial between Imjin Parkway and Reindollar Avenue  | X                    | X                 |                  |  |
| R 34  | Eighth Street                | Upgrade/construct Eighth Street as a 2-lane arterial from Second Avenue to Inter-Garrison Road                                     | X                    | X                 |                  |  |
| R 37  | Patton Parkway Extension     | Extension of Patton Parkway from Del Monte Boulevard to Crescent Street  | X                    | X                 |                  |  |
| R 61  | Second Avenue Widening       | Widen Second Avenue from Tenth street to Inter-Garrison Road. Remove Class II bike lanes and restripe for two lanes each direction | X                    |                   |                  | Project is planned, funding projected between 2020 and 2035. |
| <b>Fort Ord Reuse Authority (FORA)</b>            |                              |  |                      |                   |                  |  |
| FO 6  | Inter-Garrison Road Widening | Widen Inter-Garrison Road to a 4-lane arterial from Eastside Parkway to Reservation Road   |                      | X                 |                  | Partially completed between Sherman Blvd to Reservation Road |
| FO 7  | Gigling Road                 | Widen Gigling Road to a 4-lane arterial from General Jim Moore Boulevard to Future Eastside Parkway near Eighth Avenue             |                      | X                 |                  |  |
| <b>AMBAG Regional Transportation Plan (RTP)</b>   |                              |  |                      |                   |                  |  |
| MON-MAR001-MA                                     | Reservation Road Widening    | Widen Reservation Road to 4 lanes between East Garrison Gate and Davis Road  |                      | X                 | X                |  |
| MON-MAR001-MA                                     | Imjin Parkway Widening       | Widen Imjin Parkway to four lanes from Imjin Road to Reservation Road  | X                    |                   | X                |  |

Notes:

1. Project ID Number based on leading agency from source document.
2. Projects appearing in multiple source lists are described and denoted by source.
3. Listed in City of Marina's 5 Year Capital Improvement Project List, Revised March 2016.
4. Listed in Fort Ord Reuse Authority's Capital Improvement Program Fiscal Year 2017/18 through 2027/28, and Fort Ord Reuse Authority Fee Reallocation Study: Deficiency Analysis and Fee Reallocation (2017).
5. Listed in the 2040 Metropolitan Transportation Plan / Sustainable Communities Strategy (2018).

Source: Fehr & Peers, 2019.



## VMT ESTIMATION PROCESS FOR THE SB 743 ASSESSMENT

### Total VMT per Service Population Estimation Method

The total VMT is the VMT from all vehicle trips for all trip purposes and types caused by the residential population, employment population, and student population in a specific area. It is calculated by summing the "VMT within," "VMT from," and "VMT to" a specified area, as follows:

$$\text{Total VMT} = (II + IX) + (II + XI) = 2 * II + IX + XI$$

- Internal-internal (*II*): The full length of all trips made entirely within the specified geographic area limits.
- Internal-external (*IX*): The full length of all trips with an origin within the specified geographic area and destination outside of the area.
- External-internal (*XI*): The full length of all trips with an origin outside of the specified geographic area and destination within the area.

The intra-zonal VMT and VMT between traffic analysis zones, or TAZs, that are in the specified geographic study area causes some double counting, which is an expected result when summing the trip end based VMT. To ensure a VMT rate is expressed properly (i.e., that the numerator and denominator include the generators of both trip ends of the VMT), the total VMT is divided by the service population (residential population, employment population, plus student population), the generators of both trip ends of the VMT. The VMT estimates are also presented on a per service population basis to account for both the effects of population and/or employment growth and the effects of changes in personal travel behavior. For example, population growth may cause an increase in VMT, while travelers changing their behavior by using different travel modes or decreasing their vehicle trip lengths (such as a higher percentage of students living campus) would cause decreases in VMT.

### Project's Effect on VMT Estimation Method (Using Boundary VMT)

As noted earlier, the Project's effect on VMT, or cumulative impact, is evaluated using the boundary VMT, which captures all VMT on the roadway network within a specified geographic area, including local trips plus interregional travel that does not have an origin or destination within the area. The geographical boundary method only considers traffic within the physical limits of the selected study area and does not include the impact of vehicles once they travel outside the area limits. The use of boundary VMT provides a complete evaluation of the potential effects of the Project because it captures the combined effect of new VMT, shifting existing VMT to/from other neighborhoods, and/or shifts in existing traffic to alternate travel routes or modes. The boundary VMT is also divided by the service population (sum of residents, employees, and students) to account for the effects of population and/or employment growth and the effects of changes in personal travel behavior within the specified geographic area.



## SERVICE POPULATIONS

Service population is the sum of the number of employees, residents, and students within the designated geographic area. **Table 14** shows the service populations for the CSUMB campus and Monterey County for the analysis scenarios:

- Existing Conditions – Baseline total VMT per service population and boundary VMT per service population based on existing land use and transportation network.
- Existing with Project Conditions – Existing Conditions with the combined effects of the CSUMB Master Plan including increased campus population and modifications to existing campus parking and transportation facilities on total VMT per service population.
- Cumulative Conditions – Year 2035 boundary VMT per service population based on forecasts from the AMBAG regional travel model without Eastside Parkway.
- Cumulative with Project and without Eastside Parkway Conditions– Cumulative Conditions boundary VMT per service population with the combined effects of the CSUMB Master Plan including increased campus population and modifications to existing campus parking and transportation facilities.



**TABLE 14: SERVICE POPULATIONS**

|   | <b>Existing Conditions</b> | <b>Existing with Project Conditions</b> | <b>Cumulative Conditions</b> | <b>Cumulative with Project and without Eastside Parkway Conditions</b> |
|---|----------------------------|---|------------------------------|--|
| <b>CSUMB Campus</b>                               |                            |   |                              |  |
| Employees (A) <sup>1,2</sup>                      | 1,030                      | 1,780                                   | 1,030                        | 1,780  |
| Residents (B) <sup>1,3</sup>                      | 280                        | 70                                      | 280                          | 70   |
| Students (C) <sup>1,4</sup>                       | 6,640                      | 12,700                                  | 6,640                        | 12,700   |
| Service Population (A + B + C = D) <sup>1,5</sup> | 7,950                      | 14,550                                  | 7,950                        | 14,550   |
| <b>Monterey County</b>                            |                            |   |                              |  |
| Employees (E) <sup>1,2</sup>                      | 183,660                    | 184,410                                 | 228,780                      | 229,530  |
| Residents (F) <sup>1,3</sup>                      | 384,830                    | 384,620                                 | 444,350                      | 444,140  |
| Students (G) <sup>1,4</sup>                       | 112,690                    | 124,820                                 | 127,680                      | 139,810  |
| Service Population (E + F + G = H) <sup>1,5</sup> | 681,180                    | 693,850                                 | 800,810                      | 813,480  |

Notes:

1. Rounded service population to nearest 10.
2. Employees are the sum of employees working at the CSUMB Campus or in Monterey County per the AMBAG travel demand model.
3. Residents (defined as the Community Housing Partners living on the East Campus) are the sum of residents living on the CSUMB Campus or in Monterey County per the AMBAG travel demand model. As shown in Table 1, the Community Housing Partner residential population is expected to decrease as CSUMB accommodates more faculty and staff in the East Campus housing.
4. Students are the sum of students (Kindergarten to University) on the CSUMB Campus or Monterey County per the AMBAG travel demand model. Students on the CSUMB Campus are defined as university students.
5. Service population is defined as the sum of all employees, residents, and students (Kindergarten to University).

Source: Fehr & Peers, 2019.



## 5. CEQA SIGNIFICANT IMPACTS AND MITIGATION

This chapter discusses potential Project impacts per the significance criteria described in **Chapter 4**. The determination of a significant impact related to the transportation network is based on the evaluation of key plans, policies, and goals described in **Chapter 3** of this report. Plan conflict impacts were evaluated by comparing the Project Conditions to applicable programs, plans, ordinances, or policies addressing the circulation system, including transit, roadways, bicycle, and pedestrian facilities. Both direct (Project generated) and cumulative (Project's effect) VMT impacts were evaluated. Direct VMT impacts were evaluated using total VMT per service population rate under Existing with Project Conditions. Cumulative VMT impacts were evaluated using boundary VMT under Cumulative with Project and without Eastside Parkway Conditions, and Cumulative with Project and with Eastside Parkway Conditions. Hazards due to design features and emergency access impacts were evaluated under Project Conditions.

### PLAN CONFLICTS ANALYSIS

Conflicts with the relevant transportation plans, as described in **Chapter 3**, were addressed by travel mode as discussed below.

#### TRANSIT EVALUATION

Existing access for regional MST bus routes is provided primarily via Inter-Garrison Road, Imjin Road, and General Jim Moore Boulevard. Currently, regional routes mainly circulate through Inter-Garrison, Divarty Street, East Campus, and General Jim Moore Boulevard. It is reasonable to expect that as long as there is adequate demand, existing transit circulation would be maintained in the future, including through the future restricted access segments of Inter-Garrison Road and Divarty Street. Since these restricted access segments are primarily designed to preserve bicycle and pedestrian circulation near the core campus, regional transit travel would be limited as much as possible to core routes, and shuttles would primarily travel along the periphery of the Main Campus.

As part of the Project, additional shuttles are proposed to support the regional transit passing through the campus, as well as residents living in Main Campus and East Campus. Existing shuttles run as MST routes and primarily travel along Inter-Garrison Road, Divarty Street, and East Campus. In the future, these additional shuttles are proposed to circulate in a larger loop serving the East Campus, North Main Campus Housing, the multimodal hubs, and parking areas by traveling along the future Fifth Street, Sixth Street, Inter-Garrison Road, Divarty Street, and General Jim Moore.

The Project does not propose changes to the transit system that would impact the *2040 Metropolitan Transportation Plan / Sustainable Communities Strategy (2018)* goals of expanding the role transit plays in meeting the region's mobility needs such as investments in bus rapid transit, expansion of local services,





and planned rail projects. Internal circulation changes would support core regional transit travel within the Campus.

Project transit ridership is estimated using the existing mode splits for each population type by housing location. Assuming the public transit service levels and the destinations accessible by transit (e.g., portion of jobs and other land use destinations) remain similar between Existing Conditions and Existing with Project Conditions, and assuming no parking management strategies are implemented that would encourage transit ridership, for the reasons explained below, it is reasonable to expect that transit travel behavior (e.g., percent transit mode share for each population type and residential location) would generally remain the same as Existing Conditions. Therefore, the existing transit mode share by population type was used in calculating the Project transit ridership.

The reason for this determination is because switching from the disaggregated mode share splits for each population type and residential location to the CSUMB Main Campus transit mode share, the analysis shows there actually would be a decrease in the transit mode share over time as students are moved from East Campus to Main Campus and, therefore, would be less reliant on transit. Based on the CSUMB person trip survey, the transit mode share currently is less than 10 percent of the Campus population travel. As more housing is built on campus and students are moved from East Campus to Main Campus, the share of travel by walking and bicycling is expected to increase and the transit mode share is expected to drop to less than 5 percent (refer to mode share summary in **Chapter 6**).

However, while the transit mode share expressed as a percentage could decrease, the total number of transit riders is likely to increase as CSUMB increases its implementation of effective Parking Management and TDM strategies, which would result in an increase in the transit mode share under future conditions. Relatedly, because the provision of transit service is reactive to increased demand for transit ridership, transit service can be increased via increased bus frequency and additional routes, if justified.

As shown in **Table 15**, Main Campus transit ridership is expected to increase as the Project proposes to house more students on the Main Campus. The student population has higher existing transit ridership rates compared to faculty and staff. Since the same travel behaviors are assumed in the future, increasing the student population on the Main Campus would correspondingly increase Project ridership on the Main Campus.



**TABLE 15: MAIN CAMPUS TRANSIT RIDERSHIP SUMMARY**

| Data Source                           | Existing Ridership |    | Project Ridership |     |
|---------------------------------------|--------------------|----|-------------------|-----|
|                                       | AM                 | PM | AM                | PM  |
| Mode Share/Trip Gen Data <sup>1</sup> | 31                 | 23 | 67                | 49  |
| MST Data <sup>2</sup>                 | 27                 | 41 | N/A               | N/A |

Notes:

1. Peak hour ridership calculated using mode share data from person trip surveys (inbound - AM, outbound - PM), and campus population type by housing location.
2. Peak hour ridership data from Spring 2017 MST data for all Routes excluding Route 26.

Source: Fehr & Peers, June 2019; MST, August 2017.

In comparison, as shown on **Table 16**, transit ridership would decrease in the East Campus. As summarized in **Appendix A**, the current East Campus faculty and staff transit mode share is 2.9 percent and the East Campus student transit mode share is 32.8 percent. Relocation of student residents to the Main Campus and increasing the number of faculty and staff residents on the East Campus would therefore lower East Campus Project transit ridership overall, because faculty and staff use transit less frequently than students. The transit ridership numbers shown in **Table 16** are based on a condition where there are no additional parking management strategies or limitations in place to discourage use of single occupant vehicles. As previously noted, future parking management strategies could cause transit ridership to increase, thereby potentially exceeding future projected ridership rates. Should this occur, it is expected that future transit service would be implemented to serve the future ridership demand.

**TABLE 16: EAST CAMPUS TRANSIT RIDERSHIP SUMMARY**

| Data Source                           | Existing Ridership |    | Project Ridership <sup>3</sup> |     |
|---------------------------------------|--------------------|----|--------------------------------|-----|
|                                       | AM                 | PM | AM                             | PM  |
| Mode Share/Trip Gen Data <sup>1</sup> | 66                 | 51 | 18                             | 15  |
| MST Data <sup>2</sup>                 | 22                 | 29 | N/A                            | N/A |

Notes:

1. Peak hour ridership calculated using mode share data from person trip surveys (inbound - AM, outbound - PM), and campus population type by housing location.
2. Peak hour ridership data from Spring 2017 MST data for Route 26, which travels between East Campus and Main Campus.
3. Future ridership conservatively based on current conditions, assuming no increase in on-campus housing, parking policies or additional transit connectivity to encourage ridership.

Source: Fehr & Peers, June 2019; MST, August 2017.

A bus capacity analysis was conducted for the weekday AM and PM peak hours when the Project's estimated public transit ridership is the highest. This analysis assumes that public transit service levels and the destinations accessible by transit (e.g., portion of jobs and other land use destinations) are similar between Existing Conditions and Existing with Project Conditions. Therefore, Project transit riders are estimated to



use each route in similar proportions as Existing Conditions. The estimated Project peak hour boardings per route are presented in **Table 17**. The Existing plus Project peak hour boardings were then divided by the route’s vehicle capacity to determine if the Project would cause the ridership-to-capacity ratio to exceed 1.0 and therefore create demand for public transit above the capacity provided under Existing Conditions.

**TABLE 17: WEEKDAY PEAK HOUR BUS ROUTE CAPACITY ANALYSIS**

| Route <sup>1</sup> | Peak Hour | Peak Hour Capacity [A] <sup>1</sup> | Average Existing Peak Hour Boarding <sup>2</sup> | Project Peak Hour Boarding <sup>3</sup> | Total Boarding [B] | Over Capacity? (B/A > 1?) |
|--------------------|-----------|-------------------------------------|--|---|--------------------|---------------------------|
| <b>Main Campus</b> |           |                                     |  |   |                    |                           |
| 12                 | AM        | 123                                 | 8  | 2                                       | 10                 | No                        |
|                    | PM        | 74                                  | 6  | 1                                       | 7                  | No                        |
| 16                 | AM        | 118                                 | 23   | 30                                      | 53                 | No                        |
|                    | PM        | 118                                 | 28   | 19                                      | 47                 | No                        |
| 18                 | AM        | 118                                 | 22   | 17                                      | 39                 | No                        |
|                    | PM        | 118                                 | 33   | 21                                      | 54                 | No                        |
| 25                 | AM        | 32                                  | 8  | 15                                      | 23                 | No                        |
|                    | PM        | 32                                  | 7  | 7                                       | 14                 | No                        |
| 74                 | AM        | 56                                  | 33   | 2                                       | 35                 | No                        |
|                    | PM        | 56                                  | 7  | 1                                       | 8                  | No                        |
| <b>East Campus</b> |           |                                     |  |   |                    |                           |
| 26                 | AM        | 105                                 | 22   | 18                                      | 40                 | No                        |
|                    | PM        | 105                                 | 29   | 15                                      | 44                 | No                        |

Notes:

1. Bus capacity is a product of the average number of buses serving the route during the weekday AM and PM peak hours and sitting and standing capacity. Peak hour capacity was calculated by dividing the peak period capacity by two.
2. Calculations based on Spring 2017 Tuesday through Thursday peak period ridership data provided by MST. Peak hour boardings were calculated by dividing the peak period capacity by two.
3. Plan transit ridership per route estimated based on the proportion of ridership for the route.

Source: Fehr & Peers, 2019.

As shown in Table 17, the Project is not anticipated to create demand for public transit above the existing available capacity and, therefore, the impact of the Project on transit ridership and facilities would be less than significant, and no mitigation or additional improvements would be required.

Moreover, the additional shuttles proposed by the Project to circulate within the campus would not affect existing or planned transit facilities and would not reduce existing or planned capacity. These proposed



shuttles would add capacity that could serve estimated Project ridership from the Main Campus and East Campus described above.

Consistent with the *2040 Metropolitan Transportation Plan / Sustainable Communities Strategy (2018)*, the existing transit circulation would be maintained in the future, including through the future restricted access segments of Inter-Garrison Road and Divarty Road. The changes to the vehicle circulation system as part of the Project would not be expected to interfere with existing transit facilities nor conflict with planned transit facilities and services or conflict with adopted transit plans, guidelines, policies, or standards. Additionally, the Project is supportive of the transit use and goals summarized in **Chapter 3**. Therefore, the impact relative to disruption of existing or planned transit facilities or conflicts with transit program, plan, ordinance, or policy would be less than significant.

## ROADWAY EVALUATION

The Project includes modifications to existing campus parking and street facilities to create a more pedestrian and bicycle-oriented campus core. These modifications will cause existing and future local and regional traffic to circulate differently on-campus and in some cases divert traffic to adjacent streets. The expected influence on existing and future traffic for each of the key PDFs is to be implemented as part of the Project, as described in the Project Description, Chapter 3 of the Master Plan Draft EIR, are listed below:

- Parking will be consolidated and relocated to select areas on the periphery of the campus core (PDF-MO-1[c]):
  - Traffic Volume Change: Less CSUMB vehicle traffic within the Main Campus core. Increased volumes of CSUMB vehicles along the outer streets of the Main Campus.
- Vehicle access will be limited to CSUMB students, faculty, and staff vehicles on General Jim Moore Boulevard between Eighth Street and Fifth Street (PDF-MO-3):
  - Traffic Volume Change: Shifting of non-CSUMB vehicles to parallel streets of Second Avenue and Eighth Street and direct access to new parking lots for CSUMB vehicles along General Jim Moore Boulevard.
- Vehicle travel through the campus core will be restricted to shuttles, transit vehicles, service vehicles, and emergency vehicles by limiting access at the following locations (PDF-MO-3):
  - Inter-Garrison Road between General Jim Moore Boulevard and Sixth Avenue
  - Divarty Street between General Jim Moore Boulevard and Seventh Avenue
  - Fourth Avenue between Divarty Street and Inter-Garrison Road
  - Fifth Avenue between Divarty Street and Inter-Garrison Road
  - A Street between Divarty Street and Seventh Avenue
  - Sixth Avenue between B Street and north of Divarty Street
  - Butler Street between Sixth Avenue and Seventh Avenue



- Traffic Volume Change: Shifting of existing and future vehicle traffic to nearby roadway facilities including Second Avenue, Eighth Street (future street extension between Third Avenue and Fifth Avenue), Imjin Parkway, Eighth Street, Colonel Durham Street, and Gigling Road.
- Seventh Avenue between Colonel Durham Street and Butler Street will be converted to one-way for vehicles traveling north from Colonel Durham Street to Inter-Garrison Road (PDF-MO-3).
  - Traffic Volume Change: Shifting of outbound traffic to Eighth Avenue. (A complement to limiting vehicle access within the Main Campus core.)

Overall, the Project would not conflict with existing or planned roadway facilities because the proposed roadway changes are limited to on-campus roads. Moreover, while the Project would result in a shift of vehicle traffic from the campus core to nearby roads, the Project also includes a “park once” policy that would limit vehicle circulation on local streets on or near the CSUMB campus. Parallel transportation improvements (such as the Eighth Street extension and Gigling Road to Inter-Garrison Road) would serve the shifts in local and regional traffic that otherwise would travel through the CSUMB campus. The street modifications also would support a more walkable, bikeable and transit oriented Main Campus core. The Project would not be expected to interfere with existing roadway facilities, conflict with planned roadway facilities, or conflict with adopted transportation plans, guidelines, policies, or standards. Therefore, the impact relative to disruption of existing or planned roadways or conflicts with program, plan, ordinance, or policy would be less than significant.

## BICYCLE EVALUATION

The Project is expected to generate demand for bicycle lanes, bicycle routes, and off-street shared use paths between the Campus and adjacent land uses, and travel to/from areas within the entire Campus. The Project proposes to improve bicycle access along Inter-Garrison Road and Divarty Street by restricting vehicles along segments of these roadways next to the campus core. Inter-Garrison Road has bicycle lanes (Class II) from the East Campus to Main Campus. The Project proposes to improve bicycle travel throughout the Main Campus through the following steps:

- Replacing the existing Class II facilities (bike lanes) on Inter-Garrison Road between Fourth Avenue and Sixth Avenue with Class I facilities (bike paths).
- Installing a Class I bicycle path facility in place of the existing Class III bicycle route facility along the future restricted access segment of Divarty Street between General Jim Moore Boulevard to Seventh Avenue.
- Installing a Class I bicycle path along the segment of General Jim Moore Boulevard that transverses the Main Campus from Lightfighter Road to Divarty Street that would serve as a main bicycle north-south route.
- Providing a network of Class 1 trails linking the campus together.



The proposed campus bicycle and pedestrian networks are shown on **Figure 4** and **Figure 5**, respectively.

To further facilitate bicycle and pedestrian travel, smaller interior parking lots would be removed, which would allow for increased internal campus facilities, such as campus bicycle and pedestrian paths and trails to aid pedestrian and bicycle circulation. These internal bicycle and pedestrian paths are proposed near housing and other campus buildings that would connect to the proposed bicycle facilities on roadways described above, and existing and planned facilities and trails, including the planned Fort Ord Regional Trail and Greenway (FORTAG) shown on **Figure 10**.

The FORTAG is a planned 30-mile network of regional trails that will connect Seaside, Marina, and CSUMB, and will extend to the existing Monterey Bay Sanctuary Scenic Trail that is parallel to SR 1. The FORTAG trail is planned to go through the Main Campus and along Butler Street, Eighth Street, and Divarty Street within the Campus. The trail would also intersect with Inter-Garrison Road, General Jim Moore Boulevard, and Second Avenue within and around the Main Campus. The Project's consolidation of parking to satellite parking areas would not interfere with the FORTAG trail's alignment and would remove driveways of smaller existing parking lots near the Main Campus, reducing the number of conflict points for the trail. The Project would not interfere with the FORTAG trail's planned route, and proposes bicycle facilities that would provide connections to the trail.

Overall, the Project's bicycle enhancements on the Main Campus core align with the *Monterey County Active Transportation Plan (ATP) 2018*, except for the planned improvement along a portion of Inter-Garrison Road. Under existing conditions, Inter-Garrison Road is a bike route (Class III bikeway) from Second Avenue to Seventh Avenue and has bike lanes (Class II bikeway) from Seventh Avenue to Inter-Garrison Road Connection. Under the *ATP 2018*, Inter-Garrison Road is planned as a cycle track or separated bikeway (Class IV bikeway) from General Jim Moore Boulevard to Eighth Street/Seventh Avenue. As shown on **Figure 4** and **Figure 10**, the Project proposes to restrict vehicle travel and construct a shared-use path (Class I bikeway) along Inter-Garrison Road between General Jim Moore Boulevard and Sixth Avenue. The specifics of this Project improvement differ somewhat from what is proposed in the *ATP 2018*; although, the Project's improvement would provide a path for exclusive use of bicycle and pedestrians. Thus, the path provides bicyclists a similar exclusive travel facility as would a cycle track and, as a result achieves the same purpose and, therefore, is consistent with the *ATP 2018*.

The Project improvements of adding new internal bicycle paths and on-road bicycle facilities connecting to existing and planned bicycle facilities align with the overall goals and policies of the plans described in **Chapter 3**, such as the *Monterey County ATP 2018*, which aims to improve bicycle connectivity by eliminating gaps, improving the quality of the bicycle network, and supporting complete streets for all users, including bicyclists. The Project improvements would not disrupt or conflict with the intent of planned bicycle facilities consistent with relevant plan goals and policies, and would not conflict with applicable programs, plans, ordinances, or policies related to bicycle facilities. Therefore, the bicycle-related impact would be less than significant.



## PEDESTRIAN EVALUATION

The Project proposes to increase housing within the Main Campus and relocate parking areas outside of the Main Campus core. These changes are expected to generate demand for sidewalks and off-street shared use paths. As can be presented on **Figure 9**, there are gaps in the existing sidewalks on and around the campus. As shown on **Figure 5**, the Project would expand the pedestrian network on the campus and to adjacent land uses by adding multi-use greenways, pedestrian pathways, and closing existing sidewalk gaps. The Project also proposes to establish additional pedestrian malls such as Divarty Street and Inter-Garrison Road as described in **Chapter 1**.

The Project site plan was evaluated for internal circulation between the residential housing, academic and recreational uses, and transit stops. As part of the Project, Divarty Street would be further developed as a pedestrian mall with restricted vehicle travel. Along with Divarty Street, Inter-Garrison Road would also be limited to only pedestrian, bicycle, and transit travel. These restricted access roadways will allow for improved pedestrian circulation within the central core of the Main Campus. Along with restricting vehicles from traveling along the core of the campus, smaller interior parking lots will be removed, and parking would be located mainly on the periphery of the campus to help minimize pedestrian and vehicle conflicts.

Bus stops are mainly concentrated around the core of the campus along Inter-Garrison Road, Divarty Street, and Sixth Avenue, which would be limited to only pedestrian, bicycle, and transit travel. Pedestrians will continue to have access to the campus core bus stops.

The Project includes expanding the pedestrian network by adding multi-use greenways and pedestrian pathways. These pathways would link the core campus to residential areas in the north end of the Main Campus and the athletics and recreation district in the southern end of the Main Campus.

The pedestrian goals and policies of the plans summarized in **Chapter 3** include increasing trail connections to parks and open space, supporting pedestrian movements, improving pedestrian safety, and removing gaps in the pedestrian network. The Project improvements, such as increased trail connections to existing and planned trails, expanding multi-use greenways and pathways, reducing vehicle circulation through the core of the campus, and closing gaps in the pedestrian network, align with these goals and policies. The Project would not interfere with existing or planned pedestrian facilities nor conflict with applicable non-vehicle transportation plans, guidelines, policies, or standards and, instead, would enhance pedestrian circulation within the Main Campus core and connections to adjacent land uses, which is a beneficial effect on the pedestrian circulation and access. Therefore, the Project would not conflict with pedestrian-related plans and any impact would be less than significant.



## SB 743 VMT ANALYSIS

This section presents an analysis of the Project's impacts relative to VMT, including the daily VMT estimates for the SB 743 VMT assessment; data for the greenhouse gas (GHG) analysis can be found in **Appendix G**. **Appendix G** also includes a VMT forecasting outline using the AMBAG regional travel model.

The total VMT and boundary VMT were estimated using the AMBAG travel model. The total VMT per service population rate is used to evaluate the direct effects of the Project under Existing with Project Conditions, while the boundary VMT is used under Cumulative with Project Conditions to evaluate the Project's effect on VMT – an evaluation of cumulative impacts. The results of the Project generated VMT (using total VMT per service population rates) and Project's effect (using boundary VMT per service population ratios) on VMT impact analyses are presented in **Table 18** and **Table 19**, respectively. Each analysis is separately addressed below.

### PROJECT GENERATED VMT

As shown in **Table 18**, the CSUMB campus total VMT would increase in absolute terms between Existing Conditions (178,500 total vehicle miles traveled) and Existing with Project Conditions (295,500 total vehicle miles traveled), which is expected due to the planned Campus population increase and the associated increase in related vehicle travel.

However, on a per service population basis, which is the metric relative to assessing impacts under CEQA, VMT would *decrease* by approximately 10 percent between Existing Conditions (22.31) and Existing with Project Conditions (20.24). This decrease would result due to the increase in on-campus housing and modifications to the Campus street system, both attributes of the Project. Other VMT reducing components of the Project include student life buildings, indoor recreation buildings and facilities, outdoor athletics, and recreation support buildings.

As to whether the CSUMB campus total VMT per service population rate under Existing with Project Conditions would result in a significant impact within the meaning of CEQA, **Table 18** presents the CSUMB campus total VMT per service population of 20.24. This is less than the applicable threshold of 23.91. Therefore, the CSUMB campus total VMT rate impact would be less than significant.

Please refer to the sections titled SB 743 VMT Assessment Method Decisions in **Chapter 1** and the Significance Criteria and VMT Analysis Methods in **Chapter 4**, for explanation of the methods utilized to calculate the total VMT and the total VMT per service population rate, and the basis upon which significant impacts are assessed under CEQA.





**TABLE 18: PROJECT GENERATED VMT FOR SB 743 VMT ASSESSMENT**

|   | Existing Conditions   | Existing with Project Conditions |
|---|---|----------------------------------|
| <b>CSUMB Campus</b>                           |   |                                  |
| Total Vehicle Miles Traveled (A) <sup>1</sup> | 178,500   | 295,500                          |
| Service Population (B) <sup>1,2</sup>         | 8,000   | 14,600                           |
| Total VMT per Service Population (A/B = C)    | 22.31   | 20.24                            |
| <b>Impact Assessment</b>                      |   |                                  |
|   | Total VMT per Service Population Threshold<br>(Impact Conclusion) | 23.91<br>(Less Than Significant) |

Notes:

1. Rounded service population and VMT to nearest 100.
2. Service population is defined as the sum of all employees, residents, and students (Kindergarten to University).

Source: Fehr & Peers, 2019.

## PROJECT'S EFFECT ON VMT

The results of the analysis addressing the Project's effect on VMT under Cumulative with Project and *without* Eastside Parkway Conditions are presented in **Table 19**. Under Cumulative with Project and without Eastside Parkway Conditions the Monterey County boundary VMT per service population<sup>21</sup> of 13.98 is less than the applicable threshold of 14.07. Therefore, the impact of the Project's effect on VMT under Cumulative without Eastside Parkway Conditions would be less than significant.

The results of the analysis addressing the Project's effect on VMT under Cumulative with Project and *with* Eastside Parkway Conditions are also presented in **Table 19**. Under Cumulative with Project and with Eastside Parkway Conditions the Monterey County boundary VMT per service population of 13.96 is less than the applicable threshold of 14.07. Therefore, the impact of the Project's effect on VMT under Cumulative with Project and with Eastside Parkway Conditions would be less than significant.

Please refer to the sections titled SB 743 VMT Assessment Method Decisions in **Chapter 1** and the Significance Criteria and VMT Analysis Methods in **Chapter 4**, for explanation of the methods utilized to calculate the boundary VMT and the basis upon which significant impacts are assessed under CEQA.

<sup>21</sup> Service population is defined as the sum of all employees, residents, and students (Kindergarten to University)



**TABLE 19: PROJECT’S EFFECT ON VMT (BOUNDARY VMT) FOR SB 743 VMT ASSESSMENT**

|   | Existing Conditions | Cumulative Conditions   | Cumulative with Project and without Eastside Parkway Conditions | Cumulative with Project and with Eastside Parkway Conditions |
|---|---------------------|---|---|--|
| <b>Monterey County</b>                  |                     |   |   |  |
| Vehicle Miles Traveled (D) <sup>1</sup> | 9,011,700           | 11,268,400  | 11,372,800  | 11,353,400   |
| Service Population (E) <sup>1,2</sup>   | 681,200             | 800,900   | 813,500   | 813,500  |
| VMT per Service Population (D/E = F)    | 13.23               | 14.07   | 13.98   | 13.96  |
| <b>Impact Assessment</b>                |                     |   |   |  |
|   |                     | VMT per Service Population Threshold (14.07)<br>(Impact Conclusion) | 14.07<br>(Less Than Significant)                                | 14.07<br>(Less Than Significant)                             |

Notes:

1. Rounded service population and VMT to nearest 100.
2. Service population is defined as the sum of all employees, residents, and students (Kindergarten to University).

Source: Fehr & Peers, 2019.

## HAZARDS EVALUATION ANALYSIS

The Project includes modifications to existing campus parking and transportation facilities to create a more pedestrian and bicycle-oriented campus core. These modifications would change the design of parking lots and local streets and intersections, but they would not create hazards such as sharp curves or include otherwise dangerous transportation-facility design features. Therefore, the Project impact related to hazards would be less than significant.

## EMERGENCY ACCESS ANALYSIS

While most vehicle traffic under the Project will have limited access to the Main Campus core, emergency vehicles will have unlimited access to Campus streets restricted to pedestrians, bicyclists, transit vehicles and service vehicles. Additionally, future parking facilities and streets will be designed to accommodate emergency vehicles. As such, emergency and service vehicles will continue to have unlimited access to the campus that will be improved by the design of future parking facilities and streets. Therefore, the Project impact related to emergency access would be less than significant.

## CONSTRUCTION IMPACT ANALYSIS

Construction activities include those associated with site preparation, and building and other infrastructure construction.



Site preparation includes all of the activities required to allow construction on the Project site. Major components of site preparation would involve removal of the existing parking lots, excavation and grading of the site, and construction of necessary infrastructure. A variety of equipment would be required for the site preparation stage including bulldozers, grading machines, cranes, and dump trucks, which would be responsible for the removal and deposition of cut and fill material on the site.

Building construction involves the assembly of the buildings. Major elements of building construction could include driving piles to support the building foundation, assembling the concrete reinforcing bars as the building frame, pouring concrete, and completing the building accessories such as elevators. Additional infrastructure construction includes streets and parking lots.

As discussed in **Chapter 7**, at buildout the Project would generate approximately 12,510 average daily trips (ADT), with approximately 1,000 of those trips coming in the morning and evening peak hours. Construction operations would generate substantially fewer trips on a daily basis (less than 1,300 ADT) and, thus, the volume of construction traffic would be less than Project traffic. To address construction traffic, PDF-MO-14 (cited below) requires that the Project contractors implement construction traffic control plans that comply with California Department of Transportation (Caltrans) Standard Specifications and include, among other components, appropriate traffic control devices, such as signage and temporary roadway closures, if necessary. With implementation of the plan, safe access to the pedestrian, bicycle, transit, and street facilities would be maintained while construction activities associated with Project proceed.

*PDF-MO-14: Avoid Construction Conflicts – When construction projects require significant work within existing roadways CSUMB will require the design team and/or the project contractor and their qualified registered Civil Engineer to implement a construction traffic control plan. This requirement will be incorporated into construction bid packages. The plans will conform with the current version of the State of California Department of Transportation Standard Specifications, where applicable, and will be reviewed and approved by CSUMB prior to implementation. The traffic control plan will include any detour plans and/or temporary traffic control devices warranted, per the current version of the California Manual on Uniform Traffic Controls Devices to provide for public safety, maintenance of access, temporary roadway closures, if needed, and construction-area signage. CSUMB shall inform emergency services of any roadway or lane closures and alternative travel routes to ensure adequate access for emergency vehicles when construction projects would result in temporary lane or roadway closures.*

Therefore, traffic-related impacts associated with Project construction would be less than significant with implementation of PDF-MO-14.





## 6. PARKING MANAGEMENT AND TDM

This chapter defines the parking supply and mode share assumptions used in the transportation analysis based on observed data (refer to **Appendix A** to **Appendix C**). This chapter provides additional detail about the parking supply and mode share to show the range of parking supply scenarios and potential VMT reductions due to additional parking management and TDM strategies. This parking supply analysis is also used to inform the campus traffic assignment to the new campus parking lots shown in the Operations Analysis section of this report (refer to **Chapter 7** to **11**). Furthermore, this parking and TDM evaluation provides a clear baseline to compare the effectiveness of the Parking Management and TDM Plan strategies to be implemented in the future. This chapter concludes with suggested refinements to the PDFs that could reduce project trips and/or VMT.

### MAIN CAMPUS PARKING EVALUATION

PDF-MO-1(c) would manage the parking supply, consolidate and relocate parking lots to the edge of the Main Campus, remove non-essential parking lots from the campus core, and facilitate a “park once” policy.

This parking evaluation builds upon the *CSUMB Draft Parking Supply Scenarios* (Fehr & Peers, August 2015) included in **Appendix H**, which presented three parking supply scenarios with various parking pricing and parking management strategies. The 2015 parking supply scenarios analysis was a high-level analysis focused on parking supply using descriptive parking data provided by campus staff; it did not include existing parking occupancy or peak parking demand data as this analysis does. This parking analysis uses existing parking data to estimate future parking supply and identify potential parking management strategies that could be incorporated into a Parking Management Plan. Three scenarios are discussed:

1. **Future Parking Supply Base Scenario** – This business-as-usual scenario would result in a parking supply of 6,374 parking spaces at the consolidated parking lots. This scenario assumes the future parking supply accommodates future population at the current parking demand rate and implements the existing level of parking policies and parking management program.
2. **Land Area Allocation Parking Supply Scenario** – This scenario is based on the Master Plan land use map (PDF-LU-1) allocation for parking and would result in a parking supply of 5,651 parking spaces at the consolidated parking lots.
3. **Master Plan Vision to Maintain Existing Parking Supply Scenario** – This scenario would maintain the parking supply of 4,721 parking spaces at the consolidated parking lots and would require parking management to reduce the parking demand by implementing parking strategies such as increased parking pricing and permit restrictions for freshmen and sophomores. This scenario was chosen by the campus as part of the public Master Planning process and could be achieved by implementation of a Parking Management Plan and TDM measures per PDF-MO-1. The existing parking supply is described in the CSUMB Master Plan Guidelines as having an over-



supply of parking for the existing campus enrollment. As the campus consolidates parking to satellite parking areas along the edge of the Main Campus, as shown in **Figure 6**, the parking supply is assumed to remain constant. By placing the parking areas along the edge of the Main Campus near the gated entry and campus entries, most vehicle traffic will circulate on Eighth Avenue, Eighth Street, Gigling Road, Second Avenue, and General Jim Moore Boulevard. Parking areas closer to the campus core will include “Multimodal Hubs.”

Below is a description of current academic parking, residential parking, and multimodal hubs used in the parking analysis:

- **Academic parking** areas serve all populations, which includes off-campus students, Main Campus student residents, faculty/staff, visitors, and community housing partners.
- **Residential parking** areas only serve students living on the Main Campus.
- **Multimodal hubs** are located at the academic parking areas at Inter-Garrison Road/Sixth Avenue and Divarty Street/General Jim Moore Boulevard. The multimodal hubs will be designed to serve several transportation modes, including carpool vehicles, pick-up/drop-off activities, transit vehicles, bicyclists, and other populations on campus.

The following is a description of the proposed seven parking areas (refer to **Figure 6**) for the parking area locations):

- Parking Area 1 - Academic and Residential Parking: Located along General Jim Moore Boulevard north of Fifth Street.
- Parking Area 2 - Academic Parking: Located on the southwest corner of the Divarty Street and General Jim Moore Boulevard intersection. This parking area will have a multimodal hub.
- Parking Area 3 - Academic Parking: Located on the northwest corner of the intersection of Inter-Garrison Road and Sixth Avenue. This parking area will have a multimodal hub.
- Parking Area 4 - Academic Parking: Located north and south of A Street between Sixth Avenue and Seventh Avenue.
- Parking Area 5 - Academic Parking: Parking lot for faculty and staff located along the northern side of Inter-Garrison Road west of General Jim Moore Boulevard.
- Parking Area 6 - Academic Parking: Parking lot for faculty and staff located along Sixth Avenue between B Street and Butler Street.
- Parking Area 7 - Residential Parking: Parking lot for student residents located at Promontory Housing, and at the intersection of Eighth Street and Imjin Road.

The Master Plan Guidelines and PDF-MO-1(c) include a requirement to develop a Parking Management Plan that defines measures to manage the parking demand to maintain the existing parking supply for the next phase of campus growth. The following section provides parking supply estimates based on the



parking demand data collected for this report and also the land area allocation from the Master Plan Circulation plan. Therefore, the analysis establishes a base condition using existing travel characteristics (observed travel behavior data), which do not include future enhanced parking management and/or TDM programs, to provide a clear baseline to compare the effectiveness of the Parking Management and TDM Plan strategies to be implemented in the future. The results confirm that the CSUMB campus will have the available space to park vehicles and that the campus can provide a parking supply to accommodate a desired parking demand with the appropriate parking management strategies.

## PARKING DEMAND SURVEY AND PARKING SUPPLY ESTIMATES

### Existing Parking Demand

The future campus parking supply for the Project was estimated using existing parking inventory and parking occupancy data collected by Mott McDonald in the Fall of 2017. The existing parking inventory and occupancy data is presented in **Chapter 2**. Existing parking demand rates were determined for two types of parking: academic and residential.<sup>22</sup> Existing academic parking demand rates were calculated by determining peak parking demand of existing parking lots not restricted to on-campus residents and dividing that demand by the existing student, faculty, and staff population presented in **Table 1**. Existing residential parking demand rates were calculated by determining peak parking demand of existing parking lots restricted to only on-campus residents and dividing that demand by the existing Main Campus residential population presented in **Table 1**. The existing academic and residential parking demand rates are summarized in **Table 3**, and calculations are presented in **Table I-1** and **Table I-2** of **Appendix I**. As presented in **Table 3**, the existing academic parking demand rate is 0.31 spaces per FTE, which is greater than the parking demand rate for residential parking (0.20 spaces per on-campus resident).

### Future Parking Demand and Parking Supply Analysis

The parking area locations, estimated size of the parking lots provided by CSUMB, and vehicle occupancy (drive-alone, carpool, or transit) were used in this transportation analysis to develop the on-campus vehicle trip distribution and assignment (refer to **Chapter 7**) and this information was used as a starting point to project the future parking supply. Conservatively, the future academic and residential parking supply base scenario was estimated using the existing parking demand rates as presented in **Chapter 1**, the campus population and a circulation factor<sup>23</sup> of five percent.

---

<sup>22</sup> Academic parking is defined as general parking utilized by students, faculty, and staff that are not restricted to only on-campus residents. Residential parking is parking reserved for on-campus residents.

<sup>23</sup> The existing parking demand rate is the accumulation of vehicles parked on-campus at the peak of the day on a per FTE basis. The parking supply is the total number of available spaces available, regardless of whether they are occupied or not. To ensure there are some available spaces for circulating vehicles a parking circulation factor of 5 percent is applied to the parking demand to estimate the campus parking supply.



The future academic parking supply was determined using the total student, faculty, and staff population of 14,476 FTEs as both off- and on-campus residents are expected to also use parking spaces for academic daily use. The number of future parking spaces needed per parking area was determined by multiplying the percentage of trips traveling to the six academic parking areas. This trip and parking space distribution, and parking supply per parking zone are presented in **Table 20**.

**TABLE 20: FUTURE ACADEMIC PARKING SUPPLY BY PARKING ZONE – BASE SCENARIO**

| Parking Area   | Percent of Total Trips | Future Academic Parking Supply (parking spaces) |
|----------------|------------------------|---|
| Parking Area 1 | 25%                    | 1,190   |
| Parking Area 2 | 15%                    | 714   |
| Parking Area 3 | 16%                    | 760   |
| Parking Area 4 | 29%                    | 1,380   |
| Parking Area 5 | 7%                     | 333   |
| Parking Area 6 | 8%                     | 381   |
| <b>Total</b>   | <b>100%</b>            | <b>4,758</b>                                    |

Source: CSUMB, June 2018. Fehr & Peers, 2019.

The future residential parking supply was determined based on the proposed Main Campus residential population of 7,620 students. It is assumed that the Main Campus residential parking supply would be restricted to Main Campus residents and assumes there will be no future parking permit restrictions for on-campus student residents. This establishes a baseline for measuring the effectiveness of parking management and TDM plan strategies. The distribution of residential parking spaces between the two residential parking areas was assumed to be based on proximity to student housing. As the Promontory housing is part of the campus, the Promontory parking area supply was included and assumed to be the same as the existing, 382 spaces. The remaining residential parking spaces are expected to be co-located with the General Parking area along General Jim Moore Boulevard north of Fifth Street (Parking Area 1), which includes both academic and residential parking uses. **Table 21** summarizes the parking supply for the residential uses on campus.

**TABLE 21: FUTURE RESIDENTIAL PARKING SUPPLY BY PARKING ZONE – BASE SCENARIO**

| Parking Area   | Percent of Total Trips | Future Residential Parking (parking spaces) |
|----------------|------------------------|---|
| Parking Area 1 | 76%                    | 1,234                                       |
| Parking Area 7 | 24%                    | 382   |
| <b>Total</b>   | <b>100%</b>            | <b>1,616</b>                                |

Source: CSUMB, June 2018. Fehr & Peers, 2019.





As shown on **Table 22**, the future academic parking supply is estimated to be 4,758 spaces and the projected future residential parking supply would need to be 1,616 spaces assuming existing parking management and TDM measures. Thus, a total future supply of 6,374 spaces would be needed, which is 1,653 more than the existing inventory.

**TABLE 22: EXISTING AND FUTURE (BASE SCENARIO) PARKING SUPPLY SUMMARY**

| Parking Type | Existing (parking spaces) | Future Parking Supply Base Scenario (parking spaces) |
|--------------|---------------------------|--|
| Academic     | 3,730                     | 4,758  |
| Residential  | 991                       | 1,616  |
| <b>Total</b> | <b>4,721</b>              | <b>6,374</b>   |

Source: CSUMB data received May 2018. Fehr & Peers, 2019.

The future parking supply was estimated based on the Draft EIR Figure 3-7 parking land area allocation (acres). It was then assumed there would be 125 parking spaces per acre. This estimated future parking supply based on land area produces 5,651 parking spaces and is summarized by parking area below in **Table 23**. The future parking supply estimated by campus population growth under the Base Scenario is presented for comparison purposes.

**TABLE 23: FUTURE PARKING SUPPLY BY PARKING ZONE (LAND AREA ALLOCATION AND BASE SCENARIOS)**

| Parking Area   | Land Area Allocation Parking Supply Scenario (parking spaces) <sup>1</sup> | Future Parking Supply Base Scenario (parking spaces) <sup>2</sup> |
|----------------|--|---|
| Parking Area 1 | 1,250  | 2,424   |
| Parking Area 2 | 1,188  | 714   |
| Parking Area 3 | 463  | 760   |
| Parking Area 4 | 1,450  | 1,380   |
| Parking Area 5 | 500  | 333   |
| Parking Area 6 | 375  | 381   |
| Parking Area 7 | 425  | 382   |
| <b>Total</b>   | <b>5,651</b>   | <b>6,374</b>  |

Notes:

1. Land Area Allocation Parking Supply Scenario estimated by the CSUMB Master Plan land area allocation provided by CSUMB in June 2018.
2. Future Parking Supply Base Scenario estimated by campus population growth in a business as usual case based on methodology described in **Chapter 7** and tables shown in **Appendix I**.

Source: CSUMB, June 2018. Fehr & Peers, 2019.



The future parking supply base scenario which is estimated based on campus population growth would be 723 spaces greater than the land area allocation parking supply scenario based on the Master Plan land use map (PDF-LU-1).<sup>24</sup> Since the existing and proposed student housing would be located close to Parking Area 1 and a quarter of Project off-campus travel is expected to travel to Parking Area 1, the “needed” future parking supply at Parking Area 1 is expected to be higher than the other parking areas and, therefore, potentially more of the nearby land would need to be dedicated to provide parking.

**Table 24** shows the summary of the academic and residential parking supply for the three scenarios.

**TABLE 24: FUTURE PARKING SUPPLY SUMMARY (FUTURE PARKING SUPPLY BASE SCENARIO, LAND AREA ALLOCATION PARKING SUPPLY SCENARIO, AND MASTER PLAN VISION)**

| Parking Type | Future Parking Supply Base Scenario | Land Area Allocation Parking Supply Scenario | Master Plan Vision - Maintain Existing Parking Supply Scenario |
|--------------|-------------------------------------|--|--|
| Academic     | 4,758                               | 4,451  | 3,730  |
| Residential  | 1,616                               | 1,200  | 991  |
| <b>Total</b> | <b>6,374</b>                        | <b>5,651</b>                                 | <b>4,721</b>   |

Source: CSUMB data received May 2018. Fehr & Peers, 2019.

CSUMB would manage the future parking supply by implementing parking and Transportation Demand Management programs and policies that focus on reducing the academic and residential parking demand, per PDF-MO-1. CSUMB campus is developing parking and TDM guidelines, *California State University, Monterey Bay Housing and Parking Management Guidelines, 2021 (Appendix J)*, to inform parking management and TDM programs and policies as part of PDF-MO-1. This guideline introduces the requirement for freshman and sophomores and 90 percent of internal program students to live in on-campus housing, and restricting freshman and sophomores from parking on campus and purchasing parking permits. Several parking pricing and management strategies that could be considered as part of this guideline and incorporated into the development of the parking management plan and TDM programs and policies as part of PDF-MO-1 include the following:

- Adjusting the cost of parking permits – This strategy could include higher cost for on-campus resident parking permits, tiered parking pricing based on the distance to the Main Campus core, and/or a tiered pricing from limited days (1-day, 2-day, etc.). These parking strategies would reduce the residential and academic parking demand.
- Establishing designated parking locations by academic program – This parking management strategy would help manage the academic parking demand.

<sup>24</sup> 6,374 parking spaces – 5,651 parking spaces = 723 parking spaces



- Restrict East Campus parking on the Main Campus – This parking management strategy would help manage staff and faculty demand of academic parking on the Main Campus.

## MAIN CAMPUS INBOUND AM PEAK HOUR MODE SHARE

As a part of the TA, CSUMB conducted a person travel survey to gather data on existing mode shares. The results were used to estimate the future (with Project) mode shares. The results show that the CSUMB Main Campus would achieve a combined drive alone and shared ride mode share of 46.5 percent by housing more than half of the CSUMB population on-campus, and there is an opportunity for an enhanced TDM plan to reduce the drive alone usage for students, faculty, and staff living off-campus.

The CSUMB Person Travel Survey was conducted in Fall 2017 to better understand the travel choices of CSUMB students, faculty, and staff (refer to **Appendix A** for the sample person travel survey and the trip generation and mode share results). The Existing Conditions and estimated Project Conditions AM peak period inbound person mode shares for CSUMB students, faculty, and staff living on-campus, in East Campus or off-campus are shown in **Table 25**. Under Existing Conditions, the combined drive-alone and shared ride mode share is 62.5 percent while under Project Conditions the combined drive-alone and shared ride mode share is estimated to be less than 47 percent.

**TABLE 25: AM PEAK PERIOD INBOUND PERSON MODE SHARE FOR ALL CSUMB STUDENTS, FACULTY AND STAFF**

| Mode                     | Existing Conditions <sup>3</sup> | Project Conditions <sup>4</sup> |
|--------------------------|----------------------------------|---------------------------------|
| Drive Alone <sup>1</sup> | 53.8%                            | 41.2%                           |
| Shared Ride <sup>2</sup> | 8.7%                             | 5.3%                            |
| <b>Sub-Total</b>         | <b>62.5%</b>                     | <b>46.5%</b>                    |
| Transit                  | 9.6%                             | 4.6%                            |
| Walk                     | 24.2%                            | 40.7%                           |
| Bicycle                  | 3.1%                             | 7.3%                            |
| Other                    | 0.6%                             | 0.9%                            |

Notes:

1. Drive alone includes motorcycles.
2. Shared ride includes carpooling, vanpooling, drop-off, transportation network companies like Uber and Lyft, and taxis.
3. Existing Conditions mode share summarized from **Tables C-8** and **C-9** of the *CSUMB Master Plan EIR – Trip Generation Evaluation Methods and Estimates* memorandum in **Appendix E** of this TA.
4. Project Conditions mode share accounts for 75 percent reduction in Main Campus student internal vehicle trips due to the change in parking locations. Weighted average AM peak period inbound person mode share of CSUMB students, faculty, and staff using Project Conditions campus populations estimates summarized in **Table 1** and person mode share data from **Table C-7** (of the *CSUMB Master Plan EIR – Trip Generation Evaluation Methods and Estimates* memorandum in **Appendix A** of this TA) except student Main Campus mode share is adjusted as follows: from 12.4% to 3.1% for Drive-Alone; from 6.0% to 1.5% for Shared Ride; 4.6% transit; from 70.3% to 77.3% for walk; from 5.1% to 12% for bicycle; and 1.5 % for other to account for Satellite Campus parking locations.
5. Mode share goal expressed in Figure 7.7 of the *CSUMB Master Plan* (June 2017). This mode share applies to off-campus residents.

Source: Fehr & Peers, 2019.



Under Project Conditions, Main Campus student internal vehicle trip generation rates would be reduced due to two factors, both of which disincentivize vehicle use on campus. The first is that parking will be consolidated and relocated to select areas on the periphery of the campus core, less convenient locations for Main Campus students. Second, new infill student housing will be sited close to the academic core. Both of these changes are expected to shift student travel from vehicles to more convenient on-campus transit, bicycling, walking, and other non-vehicular modes of travel. Correspondingly, the Main Campus student internal vehicle trip generation rates were reduced by 75 percent, which was estimated from existing Main Campus student characteristics from the CSUMB Person Travel Survey. As shown in **Table 25**, the AM peak period inbound drive-alone and shared-ride mode share to Main Campus under Existing Conditions (62.5 percent) would be reduced under Project Conditions (46.5 percent).

The above discussion combines the travel behavior of on-campus and off-campus residents. As shown in the *CSUMB Master Plan EIR – Trip Generation Evaluation Methods and Estimates* memorandum in **Appendix A** of this TA, student, faculty, and staff residents living on-campus drive far less than those living off-campus. Most off-campus student, faculty, and staff residents drive to the CSUMB Main Campus (refer to **Table 26**). The AM inbound drive-alone and shared-ride mode share to Main Campus under Existing Conditions (85.0 percent) would increase under Project Conditions (93.1 percent). This increase is due to faculty and staff who would be housed here driving more to the Main Campus as compared to students who currently live in East Campus housing. As a point of reference, the average combined work trip mode share for Monterey County or Santa Cruz County is 80 percent to 95 percent drive-alone and shared-ride (refer to the *CSUMB Master Plan EIR – Trip Generation Evaluation Methods and Estimates* memorandum in **Appendix A** of this TA). The parking management and TDM programs to be developed as part of PDF-MO-1 could help reduce the vehicle trips generated by students, faculty, and staff living at the East Campus or Off-Campus under Project Conditions by 5 to 10 percentage points.



**TABLE 26: AM PEAK PERIOD INBOUND PERSON MODE SHARE FOR CSUMB STUDENTS, FACULTY AND STAFF RESIDENTS OF EAST CAMPUS AND OFF-CAMPUS**

| Mode                     | Existing Conditions <sup>3</sup> | Project Conditions <sup>4</sup> |
|--------------------------|----------------------------------|---------------------------------|
| Drive Alone <sup>1</sup> | 75.0%                            | 83.6%                           |
| Shared Ride <sup>2</sup> | 10.0%                            | 9.5%                            |
| <b>Sub-Total</b>         | <b>85.0%</b>                     | <b>93.1%</b>                    |
| Transit                  | 12.2%                            | 4.5%                            |
| Walk                     | 0.5%                             | 0.3%                            |
| Bicycle                  | 2.1%                             | 2.0%                            |
| Other                    | 0.1%                             | 0.1%                            |

Notes:

1. Drive alone includes motorcycles.
2. Shared ride includes carpooling, vanpooling, drop-off, transportation network companies like Uber and Lyft, and taxis.
3. Existing Conditions and Project Conditions mode share summarized from **Tables C-9** and **C-11** of the *CSUMB Master Plan EIR – Trip Generation Evaluation Methods and Estimates* memorandum in **Appendix A** of this TA.
4. Weighted average AM peak period inbound person mode share of CSUMB students, faculty, and staff using Project Conditions campus populations estimates summarized in **Table 1** and person mode share data from **Table C-7** (of the *CSUMB Master Plan EIR – Trip Generation Evaluation Methods and Estimates* memorandum in **Appendix A** of this TA). Person mode share includes East Campus and Off-Campus residents.

Source: Fehr & Peers, 2019.

## PROJECT PDFS TO REDUCE PROJECT VEHICLE TRIPS AND VMT

While the Project would not result in significant impacts relative to vehicle travel as determined by the previously presented impact analysis, the CSUMB intends to further develop and implement Parking Management and TDM policies per PDF-MO-1 that would further reduce vehicle trips and VMT. Revisions of the Project PDFs to include the following would assist in achieving these goals (PDF-MO-1 to PDF-MO-6 shown).

**PDF-MO-1:** TDM Plan – *The campus will continue to implement, enhance, and expand TDM strategies to reduce single-occupant vehicle trips as part of a formal TDM Plan. The TDM Plan will include the following components:*

- TDM Strategies - *Expand upon existing alternative transportation programs (carshare, universal transit pass, late night CSUMB-specific Line 19 downtown Monterey shuttle, Otter Cycle Center, bike rentals, bike repair, guided bike tours, and bike counter bike/scooter share programs) by using strategies taken from the CSU Transportation Demand Management (TDM) Manual (2019,2012) as a guide for project and program development.*
- Commuter Travel An Incentives Program - *Reduce commuter dependency on single-occupancy vehicle travel. Establish and promote an incentives-based commuter program*



to encourage students, faculty and staff commuters to carpool and take ~~alternative~~**active and transit** modes of travel to campus.

- c. Parking Management - ~~Develop parking management~~ Implement strategies and measures to **reduce parking demand**, including the following:
- Consolidate ~~general~~**academic** and/or residential parking on the periphery of the campus **and remove non-essential parking lots from the campus core** per Figure 3-9. (See also PDF-MO-2 for information about multimodal hubs.)
  - **Maintain the existing parking supply of 4,721 parking spaces at the consolidated lots by**
  - **implementing strategies, including, but not limited to, increased parking prices**
  - **and Restrict the number of permits restrictions for allocated to fFreshmen and sSophomores.**
  - Establish residential parking in proximity to new student residential development.
  - Establish parking permit programs/restrictions and lot assignments that discourage movement of vehicles between campus parking **locations (i.e., establish "park once" policy), Main and East Campus housing**, and encourage ~~alternative~~**active and transit** modes of travel.
  - ~~Establish~~ Designated parking stalls **in preferred locations** for the promotion of carpooling, vanpooling, ridesharing and low and zero emission vehicles.
  - Allow limited special parking stalls throughout campus to accommodate accessible and service vehicles, deliveries, loading and unloading activities.
- d. Transit Services - Analyze unmet transit needs and expand transit services in collaboration with MST and other local agencies as needed to provide the level of off-campus connections, inter-campus circulation and para-transportation identified in the TDM plan. (See also PDF-MO-7 through PDF-MO-11 for more information about transit services.)
- e. Bicycle and Pedestrian Improvements – Identify, prioritize, and design bicycle and pedestrian improvements **and create a separated trail network as shown in the Master Plan Guidelines** using connecting landscape features where appropriate. Implement improvements as part of nearby capital projects, where possible. Provide a maintenance plan that creates a system for maintaining pavement quality, signage, bicycle racks and painted markings. (See also PDF-MO-12 and PDF-MO-13 below.)



- f. Monitoring - ~~Maintain an annual~~**Conduct periodic** campus-wide travel surveys to collect data on **Main-Campus CSUMB student and faculty/staff** transportation behavior, experiences, ~~and,~~ mode preferences, and ~~to monitor,~~ mode ~~shares~~**split**.
- g. TDM Program Administration - Expand and manage TDM services and programs. Establish new staff position(s) to coordinate TDM services and programs, and encourage office administration roles to take on advocacy roles for these programs within their offices. Establish an annual budget for non-capital transportation facilities maintenance and upgrades, planning, and TDM programs.

PDF-MO-2: Multimodal Infrastructure - Expand the campus ~~transportation system~~ multimodal **transportation system** infrastructure and programs. Establish two multimodal hubs, consistent with Figure 3-9, to provide centralized arrival points on campus from the four campus entries. The multimodal hubs will prioritize regional transit connections, shuttle service, carsharing, and visitors.

PDF-MO-3: Vehicle Restrictions - Establish restrictions to general vehicle travel through the campus core and locate vehicle circulation and parking on the campus periphery consistent with Figure 3-9. Establish consistent place-making roadway barriers, signs and landscaping to communicate restricted access roadway entrances. Eliminate the use of bollards, k-rails or industrial looking measures to restrict vehicle access. Maintain traffic speeds at safe levels for all road users and implement traffic calming measures where vehicle behavior routinely exceeds safe levels.

PDF-MO-4: Campus Entries - Create four major entries with signs which lead to two key arrival areas, including: Divarty Street and General Jim Moore Boulevard on the west side (Peninsula Gateway) and Inter-Garrison Road and Sixth Avenue on the east side (Valley Gateway) (see Figure 3-9).

PDF-MO-5: Wayfinding - Expand and maintain a comprehensive regional wayfinding sign sequence, in coordination with state and local agencies, from the primary campus entrances, to campus parking locations.

PDF-MO-6: Design Standards - Pursue universally accessible design throughout campus.

PDF-MO-14: Avoid Construction Conflicts - When construction projects require significant work within existing roadways CSUMB will require the design team and/or the project contractor and their qualified registered Civil Engineer to implement a construction traffic control plan. This requirement will be incorporated into construction bid packages. The plans will conform with the current version of the State of California Department of Transportation Standard Specifications, where applicable, and will be reviewed and approved by CSUMB prior to



*implementation. The traffic control plan will include any detour plans and/or temporary traffic control devices warranted, per the current version of the California Manual on Uniform Traffic Controls Devices to provide for public safety, maintenance of access, temporary roadway closures, if needed, and construction-area signage. CSUMB shall inform emergency services of any roadway or lane closures and alternative travel routes to ensure adequate access for emergency vehicles when construction projects would result in temporary lane or roadway closures.*







## 7. OPERATIONS ANALYSIS AND PROJECT TRAFFIC FORECASTING METHODS (FOR INFORMATIONAL PURPOSES ONLY)

The following analysis is presented for informational purposes only; that is, for purposes of CEQA analysis, impacts relating to vehicle travel are assessed based on VMT consistent with the requirements of the recently revised CEQA Guidelines (refer to **Chapter 5**). The analyses presented here are used to evaluate the traffic operations of study intersections, freeway segments, and freeway ramps within the context of level of service (LOS), which is no longer the metric used in assessing impacts relative to CEQA.

### TRAFFIC ANALYSIS METHODS

The operations of roadway facilities are presented here within the context of LOS, a qualitative description of vehicular traffic flow based on factors such as speed, travel time, delay, and freedom to maneuver. Six levels are defined from LOS A, which reflects free-flow conditions where there is very little interaction between vehicles, to LOS F, where the vehicle demand exceeds the capacity and high levels of vehicle delay result. LOS E represents “at-capacity” operations. When traffic volumes exceed the capacity at an intersection, vehicles may wait through multiple signal cycles before traveling through the intersection; these operations are designated as LOS F. Examples of the various levels of service for a signalized intersection are illustrated in **Figure 13**.

### SIGNALIZED INTERSECTIONS

For purposes of this analysis, the LOS method for signalized intersections is based on average control vehicular delay, as described in Chapter 18 of the *2010 Highway Capacity Manual (HCM)* by the Transportation Research Board. Control delay includes initial deceleration delay, queue move-up time, stopped delay, and final acceleration delay. The average control delay for signalized intersections is calculated using the Synchro analysis software and is correlated to a LOS designation as shown in **Table 27**.

When conducting a LOS analysis, CSUMB uses a LOS D standard for local streets, as presented in the *California State University Transportation Impact Study Manual* (2012). Local streets in Marina and Monterey County have a LOS D standard, while Seaside has established a LOS C standard, and Caltrans uses a LOS C/D standard.



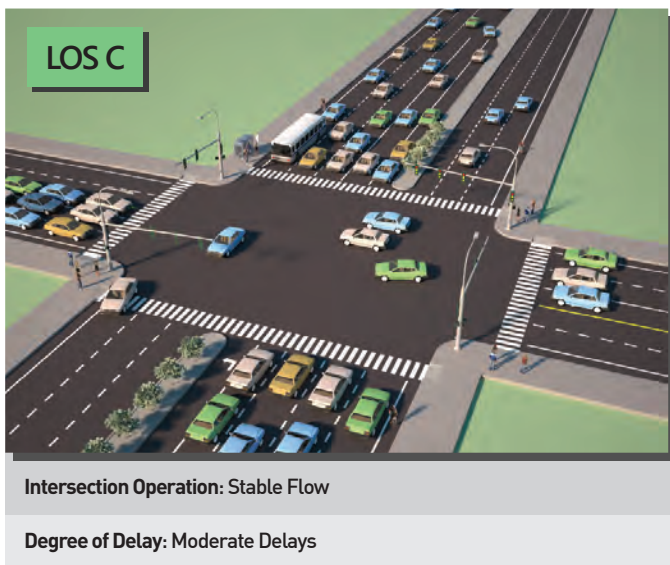
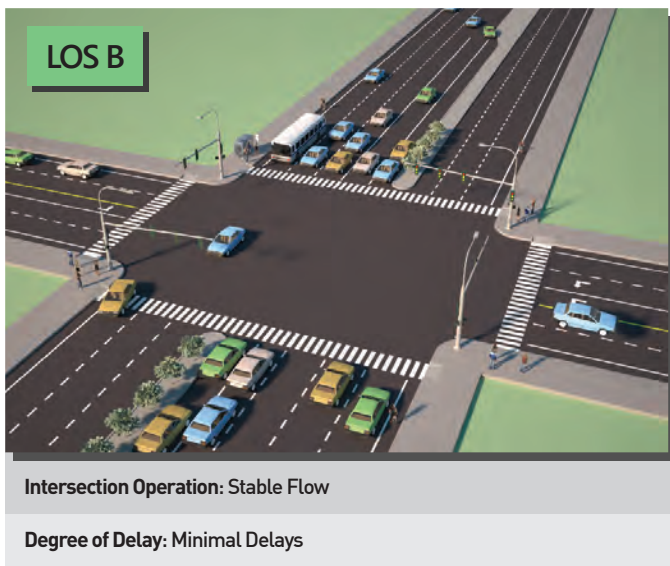

Figure 13  
 Signalized Intersection Level of Service Examples

**TABLE 27: SIGNALIZED INTERSECTION LEVEL OF SERVICE DEFINITIONS**

| Level of Service | Description  | Average Control Delay Per Vehicle (Seconds) |
|------------------|--|---|
| A                | Operations with very low delay occurring with favorable progression and/or short cycle lengths.  | ≤ 10.0                                      |
| B                | Operations with low delay occurring with good progression and/or short cycle lengths.  | > 10.0 to 20.0                              |
| C                | Operations with average delays resulting from fair progression and/or longer cycle lengths. Individual cycle failures begin to appear.   | > 20.0 to 35.0                              |
| D                | Operations with longer delays due to a combination of unfavorable progression, long cycle lengths, and/or high volume-to-capacity (V/C) ratios. Many vehicles stop and individual cycle failures are noticeable. | > 35.0 to 55.0                              |
| E                | Operations with long delays indicating poor progression, long cycle lengths, and high V/C ratios. Individual cycle failures are frequent occurrences.  | > 55.0 to 80.0                              |
| F                | Operations with delays unacceptable to most drivers occurring due to over saturation, poor progression, or very long cycle lengths.  | > 80.0                                      |

Source: *Highway Capacity Manual*, Transportation Research Board, 2010.

## UNSIGNALIZED INTERSECTIONS AND ROUNDABOUTS

Operations of the unsignalized study area intersections and roundabouts were evaluated using the methods contained in Chapters 19, 20, and 21 of the *2010 HCM* and calculated using Synchro analysis software. LOS ratings for stop-sign controlled intersections are based on the average control delay expressed in seconds per vehicle. At two-way or side-street-stop controlled intersections, control delay is calculated for each movement, not for the intersection as a whole. For approaches composed of a single lane, control delay is computed as the average of all movements in that lane. For all-way stop-controlled and roundabout locations, a weighted average delay for the entire intersection is presented. **Table 28** summarizes the relationship between delay and LOS for unsignalized intersections and roundabouts.

CSUMB does not have an adopted LOS policy for unsignalized intersections; however, CSUMB strives to maintain LOS D, which is a LOS standard that has been used in other traffic studies on the CSUMB campus. A typical improvement for unsignalized intersections is to install traffic signals. However, unsignalized intersections that operate at LOS E, or have critical movements that operate at LOS E, may not meet warrants established for the consideration of signalization. Therefore, for this analysis, a LOS F operation and fulfilling the peak hour signal warrant is the threshold for an intersection improvement. For two-way stop-controlled intersections, this analysis also determines the need for improvements based on turn movement operations



(such as queues overflowing the storage capacity) as well as peak hour traffic signal warrant analyses described below from the *California Manual on Uniform Traffic Control Devices (CA MUTCD)*.<sup>1</sup>

### Warrant 3 – Peak hour vehicle volume

This warrant determines if the minor street traffic suffers undue delay when entering or crossing the major street for a minimum of one hour of an average day. This is based on the major street left-turn volume, the higher-volume minor-street approach volume, and calculated delay for vehicles on the higher-volume minor-street approach.

**TABLE 28: UNSIGNALIZED INTERSECTION AND ROUNDABOUT LEVEL OF SERVICE DEFINITIONS**

| Level of Service | Description  | Average Control Delay Per Vehicle (Seconds) |
|------------------|--|---|
| A                | Little or no delays  | ≤ 10.0                                      |
| B                | Short traffic delays                                       | > 10.0 to 15.0                              |
| C                | Average traffic delays                                     | > 15.0 to 25.0                              |
| D                | Long traffic delays  | > 25.0 to 35.0                              |
| E                | Very long traffic delays                                   | > 35.0 to 50.0                              |
| F                | Extreme traffic delays with intersection capacity exceeded | > 50.0                                      |

Source: *Highway Capacity Manual*, Transportation Research Board, 2010.

## FREEWAY SEGMENTS

Freeway mainline segments were analyzed using the methods described in Chapter 11 of *HCM 2010*. This method takes into consideration peak hour traffic volumes, free-flow speeds, percentage of heavy vehicles, and number of travel lanes. These factors are used to determine the vehicle density, measured in passenger cars per mile per lane. The ranges of densities for freeway segment levels of service are shown in **Table 29**. The Caltrans standard for the freeway segments is LOS C/D threshold.

<sup>1</sup> Signal warrant analysis is intended to examine the general correlation between the planned level of future development and the need to install new traffic signals. It estimates future development-generated traffic compared to a sub-set of the standard traffic signal warrants recommended in the 2014 *California Manual on Uniform Traffic Control Devices (CA MUTCD)* guidelines. While satisfying one or more of these warrants could justify the installation of a signal at an intersection, this analysis should not serve as the only basis for deciding whether and when to install a signal. To reach such a decision, the full set of warrants should be investigated by an experienced engineer based on field-measured rather than forecast traffic data and a thorough study of traffic and roadway conditions. Furthermore, the decision to install a signal should not be based solely upon the warrants, since the installation of signals may lead to certain types of collisions.



**TABLE 29: FREEWAY SEGMENT LEVEL OF SERVICE DEFINITIONS**

| Level of Service | Density (passenger cars per mile per lane) |
|------------------|--|
| A                | ≤ 11                                       |
| B                | 11.1 to 18.0                               |
| C                | 18.1 to 26.0                               |
| D                | 26.1 to 46.0                               |
| E                | 46.1 to 58.0                               |
| F                | > 58.0                                     |

Source: Highway Capacity Manual, Transportation Research Board, 2010.

## FREEWAY ON- AND OFF-RAMPS

To identify the need for an additional freeway on- or off-ramp lane, maximum peak-hour capacity of 1,500 vehicles per hour per lane (veh/hr/ln) and 1,200 veh/hr/ln was used in analyzing direct and loop freeway ramps, respectively. These are planning-level thresholds and are intended to identify potential operational issues.

## PROJECT TRAFFIC VOLUMES

For the purpose of this analysis, the amount of traffic associated with the Project was estimated using a three-step process:

1. **Trip Generation** – The *number* of vehicles that would be entering/exiting the Project site with the increased campus population was estimated. (Refer to the *California State University, Monterey Bay Master Plan EIR – Trip Generation Evaluation Methods and Estimates* memorandum in **Appendix A** for a detailed description of the trip generation analysis).
2. **Trip Distribution** – The *directions* that vehicles would use to approach and depart the Project site were projected using the AMBAG travel model.
3. **Trip Assignment** – The number of vehicles that would be generated by the Project was then *assigned* to specific streets and intersection turning movements based on the AMBAG travel model and forecasting methods.

Each of these steps in the process is further described in the following sub-sections.

## TRIP GENERATION

The trip generation approach and technical methods were tailored for the Project because of the size of the CSUMB campus, the unique travel behavior of each portion of the CSUMB population, and varied housing



locations of the CSUMB population. In establishing conditions tailored for the Project, the project trip generation is based on observed CSUMB travel characteristics and the assumption that the existing Parking Management and TDM measures would remain in place on the CSUMB campus, and those measures continue to be effective in reducing vehicle trip making and encourage the use of other modes of travel. Rather than calculating the net increase in Project vehicle trips due to the net increase in land uses like most projects, trip generation was prepared for the entire campus under both Existing Conditions and Project Conditions to capture the effects of increasing on-campus housing and shifting of student housing from East Campus to Main Campus. Specifically, the net new Project traffic is the difference in the Project Conditions and Existing Conditions CSUMB campus trip generation. As shown in the analysis, housing an average of 61 percent of the future campus population (students, faculty, and staff) on-campus increases the:

- Likelihood of trips staying within the campus (internal trips); and
- Likelihood of trips shifting to other modes (walking, bicycling, micro-mobility<sup>1</sup>, and transit) for both on and off-campus travel.

A detailed discussion of the CSUMB trip generation can be found in the *California State University, Monterey Bay Master Plan EIR – Trip Generation Evaluation Methods and Estimates* memorandum (refer to **Appendix A**). Total vehicle trip generation for the CSUMB campus under Existing Conditions and Project Conditions are presented in **Table 30** and **Table 31**, respectively. As shown, the total trip generation estimates are provided for the Main Campus and East Campus separately, as well as total numbers for the entire campus. Adjustments to account for internal trips are also illustrated.

---

<sup>1</sup> Micro-mobility is an emerging mode of travel that is characterized by new electric lightweight utility vehicles such as e-scooters and e-bikes.



**TABLE 30: EXISTING CONDITIONS VEHICLE TRIP GENERATION FOR CSUMB CAMPUS**

| Location Type   | Trip Type <sup>1</sup> | Daily         | AM Peak Hour |              |             | PM Peak Hours |             |             |
|---|------------------------|---------------|--------------|--------------|-------------|---------------|-------------|-------------|
|   |                        |               | Total        | In           | Out         | Total         | In          | Out         |
| <b>Main Campus</b>                                    |                        |               |              |              |             |               |             |             |
| Promontory Housing Internal Trips <sup>2</sup>        | E                      | 142           | 12           | 11           | 1           | 8             | 1           | 7           |
| Main Campus Internal Trips <sup>3</sup>               | D                      | 669           | 272          | 148          | 124         | 140           | 63          | 77          |
| Main Campus External Trips                            | A                      | 10,029        | 919          | 633          | 286         | 1,005         | 432         | 573         |
| Main Campus Trips with East Campus                    | C                      | 2,171         | 317          | 263          | 54          | 307           | 93          | 214         |
| <b>Main Campus Total [A] A+C+D+E</b>                  |                        | <b>13,011</b> | <b>1,520</b> | <b>1,055</b> | <b>465</b>  | <b>1,460</b>  | <b>589</b>  | <b>871</b>  |
| <b>East Campus</b>                                    |                        |               |              |              |             |               |             |             |
| East Campus Trips with Main Campus                    | C                      | 2,171         | 317          | 54           | 263         | 307           | 214         | 93          |
| East Campus External Trips                            | B                      | 7,846         | 482          | 80           | 402         | 452           | 270         | 182         |
| <b>East Campus Total [B] B+C</b>                      |                        | <b>10,017</b> | <b>799</b>   | <b>134</b>   | <b>665</b>  | <b>759</b>    | <b>484</b>  | <b>275</b>  |
| <b>Internal Trip Adjustment</b>                       |                        |               |              |              |             |               |             |             |
| Promontory Housing Internal Trips                     | E                      | -142          | -12          | -11          | -1          | -8            | -1          | -7          |
| Main Campus Internal Trips <sup>3</sup>               | D                      | -669          | -272         | -148         | -124        | -140          | -63         | -77         |
| Main Campus Trips with East Campus                    | C                      | -2,171        | -317         | -263         | -54         | -307          | -93         | -214        |
| East Campus Trips with Main Campus                    | C                      | -2,171        | -317         | -54          | -263        | -307          | -214        | -93         |
| <b>Trip Adjustment [C] C+D+E</b>                      |                        | <b>-5,153</b> | <b>-918</b>  | <b>-476</b>  | <b>-442</b> | <b>-762</b>   | <b>-371</b> | <b>-391</b> |
| <b>External Campus Trip Total [A+B+C]<sup>4</sup></b> | <b>A+B</b>             | <b>17,875</b> | <b>1,401</b> | <b>713</b>   | <b>688</b>  | <b>1,457</b>  | <b>702</b>  | <b>755</b>  |

Notes:

1. Trip type shown on Figure 1 in **Appendix A**.
  2. Promontory Housing is an existing residential building for on-campus student residents and is located on Eighth Street in the Main Campus.
  3. Main Campus Internal Trips = Main Campus Students and Campus Supporting Trips.
  4. The campus trip generation is the sum of all Main Campus and East Campus external vehicle trips generated by students, faculty, staff, and visitors.
- Source: Fehr & Peers, 2019.

As shown in **Table 30**, for the purpose of the analysis presented here, existing external vehicle trip generation is calculated as approximately 17,875<sup>1</sup> daily vehicle trips, 1,401 AM peak-hour trips (713 inbound and 688 outbound) and 1,457 PM peak-hour trips (702 inbound and 755 outbound).

As shown in **Table 31**, under Project Conditions the campus external vehicle trip generation would increase to approximately 30,385 daily vehicle trips, 2,290 AM peak-hour trips (1,188 inbound and 1,102 outbound) and 2,495 PM peak-hour trips (1,203 inbound and 1,292 outbound).

<sup>1</sup> This excludes vehicle through trips not associated with the CSUMB campus.





**TABLE 31: CSUMB CAMPUS VEHICLE TRIP GENERATION FOR PROJECT CONDITIONS**

| Trip Type   | Trip Type <sup>1</sup> | Daily         | AM Peak Hour  |              |              | PM Peak Hours |              |              |
|---|------------------------|---------------|---------------|--------------|--------------|---------------|--------------|--------------|
|   |                        |               | Total         | In           | Out          | Total         | In           | Out          |
| <b>Main Campus</b>                                    |                        |               |               |              |              |               |              |              |
| Promontory Housing Internal Trips                     | E                      | 40            | 3             | 3            | 0            | 2             | 0            | 2            |
| Main Campus Internal Trips <sup>2</sup>               | D                      | 970           | 495           | 261          | 234          | 253           | 120          | 133          |
| Main Campus External Trips                            | A                      | 23,953        | 1,722         | 1,093        | 629          | 2,089         | 926          | 1,163        |
| Main Campus Trips with East Campus                    | C                      | 1,867         | 434           | 361          | 73           | 488           | 152          | 336          |
| <b>Main Campus Total [A]</b>                          | <b>A+C+D+E</b>         | <b>26,830</b> | <b>2,654</b>  | <b>1,718</b> | <b>936</b>   | <b>2,832</b>  | <b>1,198</b> | <b>1,634</b> |
| <b>East Campus</b>                                    |                        |               |               |              |              |               |              |              |
| East Campus Trips with Main Campus                    | C                      | 1,867         | 434           | 73           | 361          | 488           | 336          | 152          |
| East Campus External Trips                            | B                      | 6,432         | 568           | 95           | 473          | 406           | 277          | 129          |
| <b>East Campus Total [B]</b>                          | <b>B+C</b>             | <b>8,299</b>  | <b>1,002</b>  | <b>168</b>   | <b>834</b>   | <b>894</b>    | <b>613</b>   | <b>281</b>   |
| <b>Internal Trip Adjustment</b>                       |                        |               |               |              |              |               |              |              |
| Promontory Housing Internal Trips                     | E                      | -40           | -3            | -3           | -0           | -2            | -0           | -2           |
| Main Campus Internal Trips <sup>2</sup>               | D                      | -970          | -495          | -261         | -234         | -253          | -120         | -133         |
| Main Campus Trips with East Campus                    | C                      | -1,867        | -434          | -361         | -73          | -488          | -152         | -336         |
| East Campus Trips with Main Campus                    | C                      | -1,867        | -434          | -73          | -361         | -488          | -336         | -152         |
| <b>Trip Adjustment [C]</b>                            | <b>C+D+E</b>           | <b>-4,744</b> | <b>-1,366</b> | <b>-698</b>  | <b>-668</b>  | <b>-1,231</b> | <b>-608</b>  | <b>-623</b>  |
| <b>External Campus Trip Total [A+B+C]<sup>3</sup></b> | <b>A+B</b>             | <b>30,385</b> | <b>2,290</b>  | <b>1,188</b> | <b>1,102</b> | <b>2,495</b>  | <b>1,203</b> | <b>1,292</b> |

Notes:

1. Trip type shown on Figure 1 in **Appendix A**.
2. Main Campus Internal Trips = Main Campus Students and Campus Supporting Trips.
3. The campus trip generation is the sum of all Main Campus and East Campus external vehicle trips generated by students, faculty, staff, and visitors.

Source: Fehr & Peers, 2019.

The amount of Project traffic that would be added to the road network is estimated by subtracting campus-related trip generation under Existing Conditions from campus-related trip generation under Project Conditions. As shown in **Table 32**, based on this calculation, the Project would generate a total of 12,510 additional external daily trips, including 889 additional external AM peak hour trips and 1,038 additional external PM peak hour trips.

By housing a large percentage of students, faculty, and staff on-campus, and consolidating parking to the periphery, the Project would convert a large number of potential off-campus-based trips to on-campus generated trips, thereby reducing the number of external campus trips both to and from campus. Related, because of the increasing in the number of students living on-campus, the number of Project-generated external trips made by on-campus students for purposes such as recreational activities, off-campus dining, visiting family and friends, etc. would increase in absolute terms over existing levels.



**TABLE 32: CSUMB CAMPUS VEHICLE TRIP GENERATION RESULTS**

| Scenario                               | Daily         | AM peak Hour |            |            | PM Peak Hours |            |            |
|--|---------------|--------------|------------|------------|---------------|------------|------------|
|  |               | Total        | In         | Out        | Total         | In         | Out        |
| Existing Conditions [A]                | 17,875        | 1,401        | 713        | 688        | 1,457         | 702        | 755        |
| Project Conditions [B]                 | 30,385        | 2,290        | 1,188      | 1,102      | 2,495         | 1,203      | 1,292      |
| <b>Additional External Trips [B-A]</b> | <b>12,510</b> | <b>889</b>   | <b>475</b> | <b>414</b> | <b>1,038</b>  | <b>501</b> | <b>537</b> |

Source: Fehr & Peers, 2019.

## TRIP DISTRIBUTION

Campus vehicle trips are generated by students, faculty, staff, community housing partners, campus support (trips made by police staff, maintenance, landscapers, custodians staff, etc.), and visitors traveling to/from the CSUMB campus. The AMBAG travel model was used to distribute the vehicle trips from the CSUMB campus to nearby communities for each analysis scenario (Existing Conditions, Existing with Project Conditions, Cumulative Conditions without Project, and Cumulative with Project Conditions). The distribution of Project traffic is described in detail in **Appendix F** and **Chapter 9**, and considered: 1) regional land use destinations outside of the Campus, and 2) ease and convenience of access to nearby freeways and regional streets.

The distribution of vehicle traffic going to/coming from the nearby communities of Castroville (and farther north), Marina, Salinas, Seaside, and Monterey to the CSUMB Campus is presented in **Table 33**. The distribution, as used in determine the study area, is summarized for the inbound direction during the AM peak hour and the outbound direction for the PM peak hour under Existing with Project Conditions and Cumulative with Project Conditions; the distribution of CSUMB campus traffic is similar during the AM and PM peak hours under each scenario.

As shown on **Table 33**, vehicle trips to/from the north account for 25 to 29 percent of all vehicle trips. The communities south of the CSUMB campus account for 36 to 39 percent of vehicle trips. Finally, communities east of the CSUMB campus (Salinas) account for 34 to 37 percent of the vehicle trips.



**TABLE 33: DISTRIBUTION OF CSUMB EXTERNAL VEHICLE TRIPS TO NEARBY COMMUNITIES  
(AMBAG MODEL)**

| Direction             | Existing with Project Conditions |                        | Cumulative with Project Conditions |                        |
|-----------------------|----------------------------------|------------------------|------------------------------------|------------------------|
|                       | AM Inbound Peak Hour             | PM Outbound Peak Hours | AM Inbound Peak Hour               | PM Outbound Peak Hours |
| <b>North</b>          |                                  |                        |                                    |                        |
| Castroville and North | 18%                              | 17%                    | 20%                                | 17%                    |
| Marina                | 9%                               | 8%                     | 9%                                 | 10%                    |
| <b>North Total</b>    | <b>27%</b>                       | <b>25%</b>             | <b>29%</b>                         | <b>27%</b>             |
| <b>East</b>           |                                  |                        |                                    |                        |
| Salinas               | 37%                              | 37%                    | 34%                                | 34%                    |
| <b>East Total</b>     | <b>37%</b>                       | <b>37%</b>             | <b>34%</b>                         | <b>34%</b>             |
| <b>South</b>          |                                  |                        |                                    |                        |
| Seaside               | 13%                              | 15%                    | 14%                                | 16%                    |
| Monterey and West     | 23%                              | 23%                    | 23%                                | 23%                    |
| <b>South Total</b>    | <b>36%</b>                       | <b>38%</b>             | <b>37%</b>                         | <b>39%</b>             |

Source: Fehr & Peers, 2019.

### Distribution to Main Campus Parking Areas

In this analysis it was assumed that once vehicles arrive on the Main Campus, drivers could use any one of the seven parking areas shown in **Figure 6**. The Project trips are distributed to these seven parking areas based on the parking area's proximity to the nearby communities, possible routings, estimated size of the parking areas provided by CSUMB, and vehicle occupancy (drive-alone, carpool or transit). The resulting distribution to each parking area is shown in **Table 34** and additional details and assumptions are provided in **Appendix I**.



**TABLE 34: CSUMB MAIN CAMPUS TOTAL DAILY VEHICLE TRIPS**

| Parking Areas <sup>1</sup>  | Number and Percent of Total Trips |
|---|-----------------------------------|
| 1. General Parking (General Jim Moore/Fifth-Eighth)                     | 6,961<br>(26%)                    |
| 2. Multimodal Hub/Visitor & Carpool Parking (General Jim Moore/Divarty) | 3,994<br>(15%)                    |
| 3. Multimodal Hub/Visitor & Carpool Parking<br>(Sixth/Inter-Garrison)   | 3,698<br>(14%)                    |
| 4. General Parking (Seventh/A Street)                                   | 7,413<br>(28%)                    |
| 5. Inter-Garrison Road between Second & General Jim Moore Boulevard     | 1,240<br>(5%)                     |
| 6. Sixth Street between B and Colonel Durham Street                     | 1,912<br>(7%)                     |
| 7. Promontory   | 1,612<br>(6%)                     |
| <b>Total</b>  | <b>26,830<br/>(100%)</b>          |

Notes:

1. Further details on the Parking Areas are provided in **Chapter 6** section of the report and **Appendix I**.

Source: Fehr & Peers, 2019.

## TRIP ASSIGNMENT

The trips generated by the Project were assigned to the roadway system based on the directions of approach and departure and the distribution to the on-campus parking lots. On-campus vehicle trip assignment was based on the vehicle paths shown in **Figure 14** and **Figure 15**. These parking area routes were determined in consideration of existing travel routes to/from the campus and proposed changes to the on-campus vehicle street system described in **Chapter 1**.



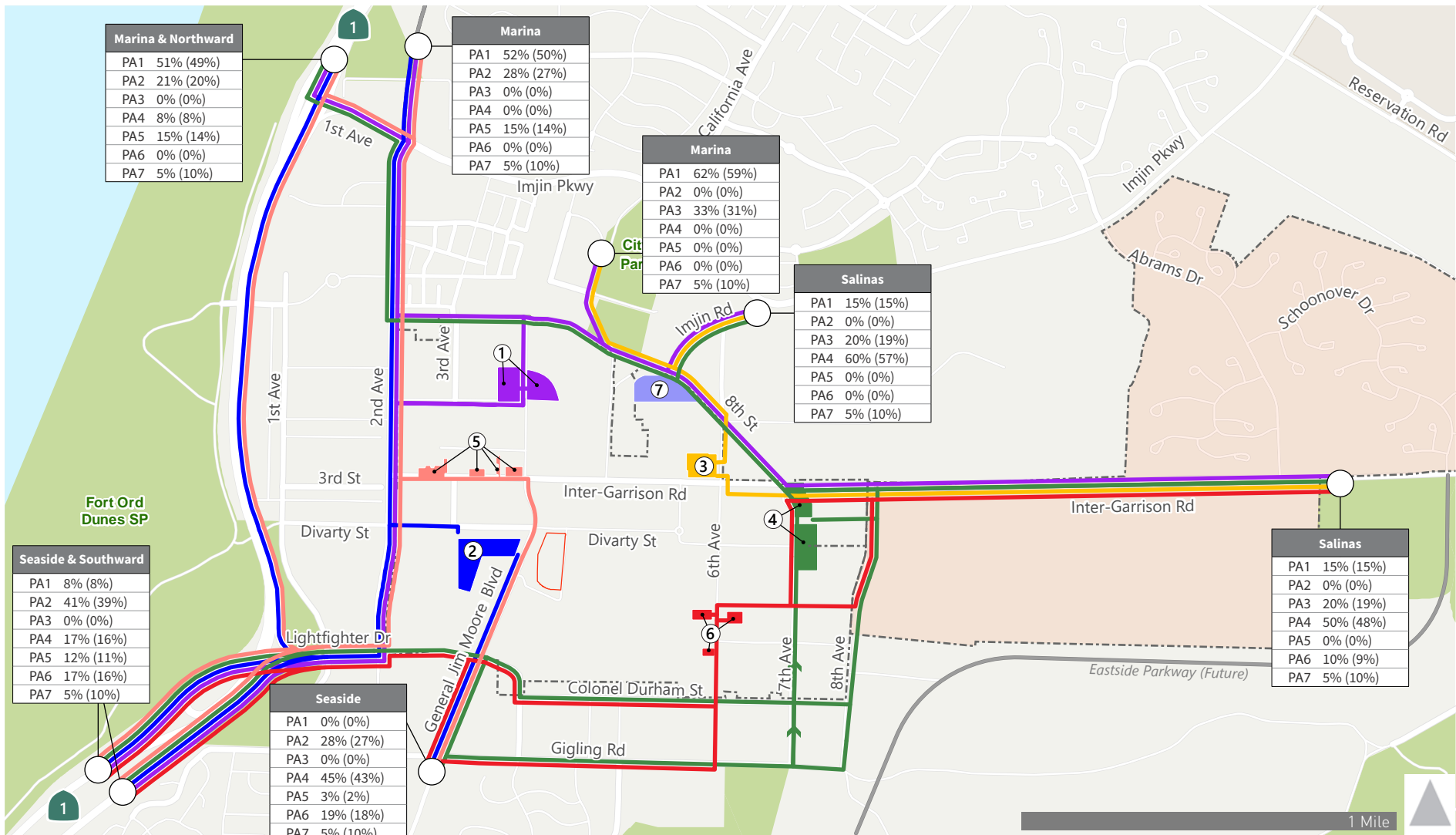

- California State University Monterey Bay Campus
- New/Extended Roadway
- Restricted Access Streets

**Parking Area Route**

- From/to Parking Area 1
- From/to Parking Area 2
- From/to Parking Area 3
- From/to Parking Area 4
- From/to Parking Area 5
- From/to Parking Area 6

**Route Distribution**

|     |        |
|-----|--------|
| PA1 | AM(PM) |
| PA2 | AM(PM) |
| PA3 | AM(PM) |
| PA4 | AM(PM) |
| PA5 | AM(PM) |
| PA6 | AM(PM) |

Figure 14

Parking Area Ingress/Egress Routes for External Trips

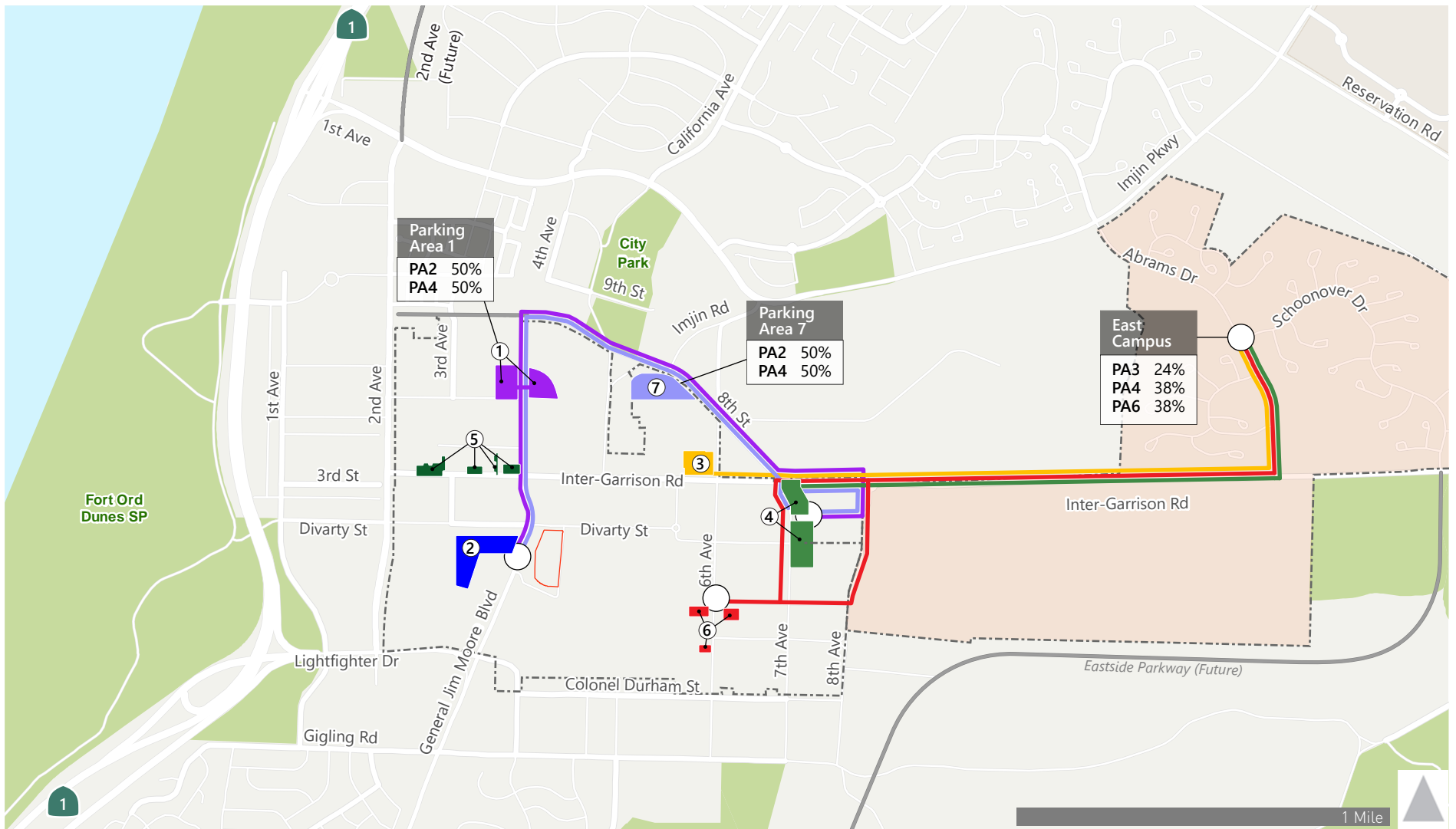

California State University Monterey Bay Campus

New/Extended Roadway

\* Multi-modal Hub

\*\* Staff/Faculty Parking

**Parking Area Route**

From/to Parking Area 1

From/to Parking Area 2

From/to Parking Area 3

From/to Parking Area 4

From/to Parking Area 5

From/to Parking Area 6

From/to Parking Area 7



Figure 15

Parking Area Ingress/Egress Routes for Internal Trips

## 8. EXISTING WITH PROJECT CONDITIONS (FOR INFORMATION PURPOSES ONLY)

This chapter evaluates the effects of the Project on the surrounding roadway system under Existing with Project Conditions and with the results of the level of service calculations. Existing with Project Conditions are defined as Existing Conditions with the addition of vehicle traffic generated by the Project and modifications to the existing campus parking and transportation facilities. Intersection and freeway segment deficiencies under this scenario are then identified by comparing the level of service results under Existing with Project Conditions to those under Existing Conditions.

### EXISTING WITH PROJECT INTERSECTION LEVELS OF SERVICE

Level of service calculations were conducted to evaluate intersection operations under Existing with Project Conditions. The intersection volumes are shown in **Appendix K** and the results of the LOS analysis are summarized in **Table L-2** of **Appendix L**. The results for Existing Conditions are included for comparison purposes. The deficiency criteria in **Chapter 11** are used to identify deficiencies in the roadway system. The corresponding LOS calculation sheets are included in **Appendix E**.

The deficiencies identified in the with Project Condition on the surrounding transportation system, and recommended measures to improve deficiencies, are described in **Chapter 11**.

### SIGNAL WARRANT ANALYSIS

For the purpose of this TA, the peak-hour signal warrant was evaluated for unsignalized intersections that operate below their designated LOS threshold under Existing with Project Conditions. The results of the peak-hour warrant analysis presented in **Table N-1** in **Appendix N** indicates the following intersections, which exceed their designated LOS threshold, would meet peak hour warrants:

- Int 16. Second Avenue and Eighth Street (AM and PM peak hour)
- Int 21. Eighth Street/Seventh Avenue and Inter-Garrison Road (PM peak hour)
- Int 22. Eighth Avenue and Inter-Garrison Road (AM and PM peak hour)
- Int 23. Abrams Drive and Inter-Garrison Road (AM and PM peak hour)
- Int 29. Second Avenue and Divarty Street (PM peak hour)
- Int 47. General Jim Moore Boulevard and Coe Avenue (AM and PM peak hour)

Although at the SR 1 Northbound Ramps and Imjin Parkway (Int. 4), the worst movement delay (northbound approach) exceeds the local jurisdiction's designated LOS threshold, the intersection does not meet the peak hour signal warrant as the minor street right turn volumes would be considered negligible. The right



turn volumes from the SR 1 Northbound off-ramp continue onto Imjin Parkway through an added lane without conflict to the eastbound through traffic entering the intersection on a separate receiving lane; therefore, based on guidance from CA MUTCD shown below the northbound approach is evaluated as a one-lane approach with only the northbound through and left turn traffic.

#### **Section 4C.01.10**

Similar engineering judgment and rationale should be applied to a street approach with one through/left-turn lane plus a right-turn lane. In this case, the degree of conflict of minor-street right-turn traffic with traffic on the major street should be considered. Thus, right-turn traffic should not be included in the minor-street volume if the movement enters the major street with minimal conflict. The approach should be evaluated as a one-lane approach with only the traffic volume in the through/left-turn lane considered.

## **EXISTING WITH PROJECT FREEWAY LEVELS OF SERVICE**

Freeway segments of SR 1 were analyzed with the added Project traffic (refer to **Appendix M**). Results of the analysis identifying the segments exceeding Caltrans' standard are presented in **Table 35**. Measured against the Caltrans level of service standard, the following freeway segments exceed the level of service standard (that is, they operate at LOS D or worse):

- Southbound SR 1 between Reservation Road and Canyon Del Rey Boulevard during the AM peak hour (all 5 southbound SR 1 segments)
- Northbound SR 1 between Imjin Parkway and Lightfighter Drive during the PM peak hour
- Northbound SR 1 between Fremont Boulevard-Del Monte Boulevard and Canyon Del Rey during the PM peak hour

Freeway segment deficiencies and improvements are addressed in **Chapter 11**.





**TABLE 35: EXISTING WITHOUT AND WITH PROJECT CONDITIONS FREEWAY SEGMENT LOS**

| Freeway Segment  | Peak Hour <sup>1</sup> | Capacity | Existing without Project |                        |                  | Existing with Project |                        |                  | Project Percent of Capacity |
|--|------------------------|----------|--------------------------|------------------------|------------------|-----------------------|------------------------|------------------|-----------------------------|
|  |                        |          | Volume                   | Density <sup>2,3</sup> | LOS <sup>4</sup> | Volume                | Density <sup>2,3</sup> | LOS <sup>4</sup> |                             |
| <b>State Route 1 – Southbound</b>                                  |                        |          |                          |                        |                  |                       |                        |                  |                             |
| Reservation Road and Del Monte Boulevard                           | AM                     | 4,700    | <b>2,705</b>             | <b>29.1</b>            | <b>D</b>         | <b>2,790</b>          | <b>30.4</b>            | <b>D</b>         | <b>1.6%</b>                 |
|  | PM                     |          | 1,418                    | 11.3                   | B                | 1,420                 | 11.3                   | B                | 1.5%                        |
| Del Monte Boulevard and Imjin Parkway                              | AM                     | 7,050    | <b>4,055</b>             | <b>26.7</b>            | <b>D</b>         | <b>4,150</b>          | <b>27.5</b>            | <b>D</b>         | <b>1.4%</b>                 |
|  | PM                     |          | 2,088                    | 11.3                   | B                | 2,110                 | 11.5                   | B                | 1.3%                        |
| Imjin Parkway and Lightfighter Drive                               | AM                     | 7,050    | <b>4,560</b>             | <b>30.1</b>            | <b>D</b>         | <b>4,530</b>          | <b>29.8</b>            | <b>D</b>         | <b>0.9%</b>                 |
|  | PM                     |          | 2,859                    | 15.5                   | B                | 2,820                 | 15.3                   | B                | 0.2%                        |
| Lightfighter Drive and Fremont Boulevard-Del Monte Boulevard       | AM                     | 7,050    | <b>4,778</b>             | <b>30.5</b>            | <b>D</b>         | <b>4,850</b>          | <b>31.2</b>            | <b>D</b>         | <b>2.1%</b>                 |
|  | PM                     |          | 3,177                    | 16.9                   | B                | 3,720                 | 17.4                   | B                | 1.9%                        |
| Fremont Boulevard-Del Monte Boulevard and Canyon Del Rey           | AM                     | 4,700    | <b>3,843</b>             | <b>34.7</b>            | <b>D</b>         | <b>3,890</b>          | <b>35.4</b>            | <b>E</b>         | <b>2.2%</b>                 |
|  | PM                     |          | 2,629                    | 21.2                   | C                | 2,700                 | 21.7                   | C                | 2.3%                        |
| <b>State Route 1 – Northbound</b>                                  |                        |          |                          |                        |                  |                       |                        |                  |                             |
| Reservation Road and Del Monte Boulevard                           | AM                     | 4,700    | 1,172                    | 9.6                    | A                | 1,230                 | 10.1                   | A                | 1.3%                        |
|  | PM                     |          | 2,671                    | 21.2                   | C                | 2,790                 | 22.1                   | C                | 1.9%                        |
| Del Monte Boulevard and Imjin Parkway                              | AM                     | 7,050    | 1,725                    | 9.9                    | A                | 1,790                 | 10.3                   | A                | 1.0%                        |
|  | PM                     |          | 4,231                    | 22.8                   | C                | 4,360                 | 23.6                   | C                | 1.6%                        |
| Imjin Parkway and Lightfighter Drive                               | AM                     | 7,050    | 2,397                    | 13.6                   | B                | 2,410                 | 13.7                   | B                | 0.3%                        |
|  | PM                     |          | <b>4,906</b>             | <b>26.7</b>            | <b>D</b>         | <b>4,880</b>          | <b>26.5</b>            | <b>D</b>         | <b>0.9%</b>                 |
| Lightfighter Drive and Fremont Boulevard-Del Monte Boulevard       | AM                     | 7,050    | 2,708                    | 15.2                   | B                | 2,810                 | 15.7                   | B                | 1.7%                        |
|  | PM                     |          | 4,728                    | 25.2                   | C                | 4,840                 | 26.0                   | C                | 2.3%                        |
| Fremont Boulevard-Del Monte Boulevard and Canyon Del Rey Boulevard | AM                     | 4,700    | 2,355                    | 20.1                   | C                | 2,440                 | 20.8                   | C                | 1.7%                        |
|  | PM                     |          | <b>3,745</b>             | <b>32.1</b>            | <b>D</b>         | <b>3,820</b>          | <b>33.1</b>            | <b>D</b>         | <b>3.5%</b> <sup>5</sup>    |

Notes: **Bold** text indicates below the applicable level of service standard (LOS D for Caltrans designated facilities). **Bold and highlighted text** indicates freeway segment deficiency as described in **Chapter 11**.

1. AM = AM peak hour, PM = PM peak hour.
2. Measured in passenger cars per mile per lane. Mixed = Mixed-Flow Lanes.
3. If volume/capacity ratio is greater than 1, density is not applicable.
4. Level of service (LOS) based on density.
5. The vehicle demand for the PM outbound peak hour direction of the next freeway segment (CA-1 between Canyon Del Rey and Casa Verde Way) is less than the project percent capacity. Therefore, the last freeway segment to be studied south of CSUMB campus is between Fremont Boulevard-Del Monte Boulevard and Canyon Del Rey Boulevard.

Source: Fehr & Peers, 2019.



## EXISTING WITH PROJECT RAMP ANALYSIS

A freeway ramp analysis was conducted to assess changes in peak hour ramp volumes with the addition of Project traffic and its effects on freeway and local street operations. Ramp capacity is an operational consideration that is managed over time by Caltrans and local jurisdictions.

Freeway ramp segments to/from State Route 1 were analyzed during the AM and PM peak hours with added Project traffic. Results of the analysis identifying the ramps with volumes that exceed the ramp capacity are presented in **Table 36** and **Table 37**. Most of the ramp volumes increase in the Existing with Project Conditions, with the exception of the SR 1 and Imjin Parkway southbound on-ramp during both peak hours, and the SR 1 and Imjin Parkway northbound off-ramp during the PM peak hour. Decreases in volumes under Existing with Project Conditions are due to the displacement and reassignment of existing traffic when the Project volume is added to the roadway network.

As shown in **Table 36** and **Table 37**, under Existing with Project Conditions, all ramp volumes will be less than the ramp capacity during the AM and PM peak hours.

**TABLE 36: EXISTING WITHOUT AND WITH PROJECT CONDITIONS RAMP AM PEAK HOUR VOLUMES AND CAPACITIES**

| Location                    | Direction | Ramp Type         | Lanes | Capacity <sup>1</sup> | Existing without Project (vehicles per hour) | Existing with Project (vehicles per hour) |
|-----------------------------|-----------|-------------------|-------|-----------------------|--|---|
| SR 1 and Imjin Parkway      | NB        | Diagonal On-Ramp  | 1     | 1,500                 | 126  | 200                                       |
|                             | SB        | Diagonal On-Ramp  | 1     | 1,500                 | 964  | 950                                       |
|                             | NB        | Diagonal Off-Ramp | 2     | 3,000                 | 805  | 830                                       |
|                             | SB        | Diagonal Off-Ramp | 1     | 1,500                 | 414  | 530                                       |
| SR 1 and Lightfighter Drive | NB        | Diagonal On-Ramp  | 1     | 1,500                 | 197  | 220                                       |
|                             | SB        | Diagonal On-Ramp  | 2     | 3,000                 | 739  | 850                                       |
|                             | NB        | Diagonal Off-Ramp | 2     | 3,000                 | 460  | 570                                       |
|                             | SB        | Loop Off-Ramp     | 1     | 1,200                 | 431  | 440                                       |

Notes: **Bold** text indicates volumes above capacity.

1. Peak hour ramp capacity is 1,500 veh/hr/ln (vehicles per hour per lane) and 1,200 veh/hr/ln for diagonal and loop ramps, respectively.

Source: Fehr & Peers, 2019.



**TABLE 37: EXISTING WITHOUT AND WITH PROJECT CONDITIONS RAMP PM PEAK HOUR  
VOLUMES AND CAPACITIES**

| Location                    | Direction | Ramp Type <sup>1</sup> | Lanes | Capacity <sup>1</sup> | Existing without Project<br>(vehicles per hour) | Existing with Project<br>(vehicles per hour) |
|-----------------------------|-----------|------------------------|-------|-----------------------|---|--|
| SR 1 and Imjin Parkway      | NB        | Diagonal On-Ramp       | 1     | 1,500                 | 431   | 570  |
|                             | SB        | Diagonal On-Ramp       | 1     | 1,500                 | 993   | 980  |
|                             | NB        | Diagonal Off-Ramp      | 2     | 3,000                 | 1,192   | 1,170  |
|                             | SB        | Diagonal Off-Ramp      | 1     | 1,500                 | 261   | 300  |
| SR 1 and Lightfighter Drive | NB        | Diagonal On-Ramp       | 1     | 1,500                 | 661   | 670  |
|                             | SB        | Diagonal On-Ramp       | 2     | 3,000                 | 538   | 680  |
|                             | NB        | Diagonal Off-Ramp      | 2     | 3,000                 | 384   | 540  |
|                             | SB        | Loop Off-Ramp          | 1     | 1,200                 | 167   | 180  |

Notes: **Bold** text indicates volumes above capacity.

1. Peak hour ramp capacity is 1,500 veh/hr/ln (vehicles per hour per lane) and 1,200 veh/hr/ln for diagonal and loop ramps, respectively.

Source: Fehr & Peers, 2019.



## 9. CUMULATIVE WITHOUT EASTSIDE PARKWAY CONDITIONS (FOR INFORMATION PURPOSES ONLY)

This chapter evaluates the effects of the Project on the surrounding roadway system under Cumulative without and with the Project Conditions and with the results of the level of service calculations. Cumulative traffic volumes are based on 2035 forecasts from the AMBAG travel model, including the land uses, and transportation network infrastructure described in the AMBAG constrained transportation list and modifications described in the *Association of Monterey Bay Area Governments Travel Model Validation* memorandum included in **Appendix F**. The peak hour vehicle trip estimates into and out of CSUMB are based on the Project vehicle trip estimates discussed in **Chapter 3**.

### CUMULATIVE WITHOUT AND WITH PROJECT AND WITHOUT EASTSIDE PARKWAY CONDITIONS TRAFFIC VOLUMES

Cumulative without and with Project off-campus vehicle assignment was determined by the AMBAG travel model. On-campus vehicle trip assignment was refined using the Existing Conditions and Project Conditions trip generation described in **Chapter 3** and vehicle paths shown on **Figure 14** and **Figure 15**. Future model land use changes are described in **Appendix F** and roadway network changes are described below.

### CUMULATIVE WITHOUT AND WITH PROJECT AND WITHOUT EASTSIDE PARKWAY CONDITIONS ROADWAY IMPROVEMENTS

The Cumulative without and with Project analysis adds cumulative volumes to the existing transportation network plus funded street improvements planned by the FORA<sup>1</sup>, City of Marina, and the *2040 Metropolitan Transportation Plan / Sustainable Communities Strategy (2018)*. Intersection improvements incorporated into the Cumulative Conditions analysis are based on the funded roadways improvements described in **Table 13**: and presented in **Table 38**. The Cumulative with Project analysis also includes Project transportation facility changes to the campus as described in **Chapter 1** and shown on **Figure 6**.

---

<sup>1</sup> FORA will sunset on June 30, 2020, and transportation facilities in the FORA CIP is being assigned to the local jurisdiction.



**TABLE 38: CUMULATIVE WITHOUT AND WITH PROJECT AND WITHOUT EASTSIDE PARKWAY CONDITIONS INTERSECTION IMPROVEMENTS**

| Project Number <sup>1</sup>                       | Project Name             | Project Description  | Sources <sup>2</sup> |                   |                  | Intersection                               | Geometry Changes   | Intersection Control Changes |
|---|--------------------------|--|----------------------|-------------------|------------------|--|--|------------------------------|
|   |                          |  | City <sup>3</sup>    | FORA <sup>4</sup> | RTP <sup>5</sup> |  |  |                              |
| <b>City of Marina Capital Improvement Program</b> |                          |  |                      |                   |                  |  |  |                              |
| R 05  | Second Avenue Extension  | Extend Second Avenue as a 2-lane arterial between Imjin Parkway and Reindollar Avenue          | X                    | X                 | 2                | Patton Parkway and Second Avenue Extension | 3-way signalized intersection (NB, SB, and EB legs), one lane in each direction with left turn pockets with 120 feet of vehicle storage  | Signalized <sup>6</sup>      |
| R 34  | Eighth Street            | Upgrade/construct Eighth Street as a 2-lane arterial from Second Avenue to Inter-Garrison Road | X                    | X                 | 16               | Eighth Street and Second Avenue            | Refer to Improvement R 61  | Signalized                   |
|   |                          |  |                      |                   | 18               | Eighth Street and Imjin Road               | SB: change from a shared through-left and right turn to one lane entering the roundabout<br>EB: change from a shared through-left and right turn to one lane entering the roundabout<br>WB: change from a shared through-left and right turn to one lane entering the roundabout | Roundabout                   |
| R 37  | Patton Parkway Extension | Extension of Patton Parkway from Del Monte Boulevard to Crescent Street                        | X                    | X                 | 2                | Patton Parkway and Second Avenue Extension | Refer to Improvement R 05  | Refer to Improvement 1       |



**TABLE 38: CUMULATIVE WITHOUT AND WITH PROJECT AND WITHOUT EASTSIDE PARKWAY CONDITIONS INTERSECTION IMPROVEMENTS**

| Project Number <sup>1</sup> | Project Name           | Project Description  | Sources <sup>2</sup> |                   |                  | Intersection | Geometry Changes                      | Intersection Control Changes   |            |
|-----------------------------|------------------------|--|----------------------|-------------------|------------------|--------------|---------------------------------------|--|------------|
|                             |                        |  | City <sup>3</sup>    | FORA <sup>4</sup> | RTP <sup>5</sup> |              |                                       |  |            |
| R 61 & TI 18                | Second Avenue Widening | Widen Second Avenue from Tenth Street to Inter-Garrison Road. Remove Class II bike lanes and restripe for two lanes each direction | X                    |                   |                  | 15           | Ninth Street and Second Avenue        | SB: change from a shared through-left and 1 right turn to 1 left, 1 through, 1 shared through-right<br>NB: change from 1 left turn and 1 through-right to 1 left, 1 through and 1 a shared through-right | Signalized |
|                             |                        |  |                      |                   |                  | 16           | Eighth Street and Second Avenue       | SB: Change to 2 through lanes and 1 left turn lane<br>NB: Change to 1 through lane and 1 shared through-right  | Signalized |
|                             |                        |  |                      |                   |                  | 19           | Inter-Garrison Road and Second Avenue | SB: from 1 left turn and 1 through to 1 left, 2 through lanes<br>NB: from 1 through and 1 right turn lanes to 1 through and 1 shared through-right lanes   | Signalized |
| TI 06                       | Traffic Intersection   | Intersection Improvement   | X                    |                   |                  | 6            | Imjin Parkway and Third Avenue        | No geometry changes  | Signalized |
| TI 09                       | Traffic Intersection   | Intersection Improvement   | X                    |                   |                  | 7            | Imjin Parkway and Fourth Avenue       | No geometry changes  | Signalized |
| TI 27                       | Traffic Intersection   | Intersection Improvement   | X                    |                   |                  | 11           | Imjin Parkway and Abrams Drive        | Install double left turn lanes on Imjin Pkwy, left and right turn lanes on Abrams Drive  | Signalized |
| TI 44                       | Traffic Intersection   | Intersection Improvement   | X                    |                   |                  | 23           | Inter-Garrison Road and Abrams Drive  | Second SB left-turn.   | Signalized |



**TABLE 38: CUMULATIVE WITHOUT AND WITH PROJECT AND WITHOUT EASTSIDE PARKWAY CONDITIONS INTERSECTION IMPROVEMENTS**

| Project Number <sup>1</sup>                     | Project Name                 | Project Description   | Sources <sup>2</sup> |                   |                  | Intersection   | Geometry Changes   | Intersection Control Changes  |      |
|---|------------------------------|---|----------------------|-------------------|------------------|--|--|---|------|
|   |                              |   | City <sup>3</sup>    | FORA <sup>4</sup> | RTP <sup>5</sup> |  |  |   |      |
| TI 42 & TI 43                                   | Traffic Intersection         | Intersection Improvement  | X                    |                   | 21               | Inter-Garrison Road and Eighth Street/Seventh Avenue         | Add EB and WB left-turn pockets<br><u>NB: 1 left turn lane, 1 through lane and 1 right turn lane</u><br><u>SB: 1 left turn lane, and 1 shared through-right lane</u> | Signalized  |      |
| TI 45   | Traffic Intersection         | Intersection Improvement  | X                    |                   | 29               | Divarty Street and Second Avenue                             | No geometry changes  | Signalized  |      |
| <b>Fort Ord Reuse Authority (FORA)</b>          |                              |   |                      |                   |                  |  |  |   |      |
| FO 6  | Inter-Garrison Road Widening | Widen Inter-Garrison Road to a 4-lane arterial from Eastside Parkway to Reservation Road                        |                      | X                 | 25               | Inter-Garrison Road and Inter-Garrison Road Connection       | WB: 1 shared through-right<br>EB: 1 left turn lane and 1 through lane  | AWSC  |      |
| FO 7  | Gigling Road                 | Widen Gigling Road to a 4-lane arterial from General Jim Moore Boulevard to Eastside Parkway near Eighth Avenue |                      | X                 | 39-44            | Gigling from General Jim Moore Boulevard to Eastside Parkway | Add a through lane both EB/WB on Gigling   | Signalized  |      |
| <b>AMBAG Regional Transportation Plan (RTP)</b> |                              |   |                      |                   |                  |  |  |   |      |
| MON-MAR001-MA                                   | Reservation Road Widening    | Widen Reservation Road to 4 lanes between East Garrison Gate and Davis Road                                     |                      | X                 | X                | 27   | Watkins Gate Road and Reservation Road   | NB: from one shared left/through/right lane to 1 through, 1 through-right and 1 left turn lane<br>SB: from one shared left/through/right lane to 1 through, 1 through-right and 1 left turn lane<br>EB: 1 left turn and 1 right turn lane | None |



**TABLE 38: CUMULATIVE WITHOUT AND WITH PROJECT AND WITHOUT EASTSIDE PARKWAY CONDITIONS INTERSECTION IMPROVEMENTS**

| Project Number <sup>1</sup> | Project Name           | Project Description   | Sources <sup>2</sup> |                   |                  | Intersection                          | Geometry Changes  | Intersection Control Changes |
|-----------------------------|------------------------|---|----------------------|-------------------|------------------|---------------------------------------|---|------------------------------|
|                             |                        |   | City <sup>3</sup>    | FORA <sup>4</sup> | RTP <sup>5</sup> |                                       |   |                              |
|                             |                        |   |                      |                   |                  | 28 Reservation Road and Davis Road    | SB: from 1 left turn lane and a through lane to 1 left turn lane, 1 through lane, and 1 shared through-right<br>NB: from 1 left turn lane and a through lane to 1 left turn lane, 1 shared through-right<br>EB and WB remain the same | None                         |
| MON-MAR001-MA               | Imjin Parkway Widening | Widen Imjin Parkway to four lanes from Imjin Road to Reservation Road | X                    |                   | X                | 11 Imjin Parkway and Abrams Drive     | EB and WB: Install 1 left turn lane, 1 through lane, and 1 shared through-right<br>NB and SB: left and right turn lanes on Abrams Drive   | None                         |
|                             |                        |   |                      |                   |                  | 12 Imjin Parkway and Reservation Road | EB: Change to 2 left turn lanes, 1 through lane, and 2 right turn lanes   | None                         |

Notes:

1. Project ID Number based on leading agency from source document.
2. Projects appearing in multiple source lists are described and denoted by source.
3. Listed in City of Marina's 5 Year Capital Improvement Project List, Revised March 2016.
4. Listed in Fort Ord Reuse Authority's Capital Improvement Program Fiscal Year 2017/18 through 2027/28, and Fort Ord Reuse Authority Fee Reallocation Study: Deficiency Analysis and Fee Reallocation (2017).
5. Listed in the 2040 Metropolitan Transportation Plan / Sustainable Communities Strategy (2018).
6. Improvement from source does not define control.

Source: Fehr & Peers, 2019.





## CUMULATIVE WITHOUT AND WITH PROJECT AND WITHOUT EASTSIDE PARKWAY CONDITIONS INTERSECTION LEVELS OF SERVICE

Level of service calculations were conducted to evaluate intersection operations under Cumulative without Project and without Eastside Parkway Conditions and Cumulative with Project and without Eastside Parkway Conditions. The intersection volumes are shown in **Appendix D** and results of the LOS analysis are summarized in **Table L-3** of **Appendix L**. The deficiency criteria in **Chapter 11** are used to identify deficiencies in the transportation system. The corresponding LOS calculation sheets are included in **Appendix E**.

The deficiencies identified in the with Project Condition on the surrounding transportation system, and potential improvements, are described in **Chapter 11**.

### SIGNAL WARRANT ANALYSIS

For the purpose of this TA, the peak-hour signal warrant was also evaluated for unsignalized intersections that operate below their designated LOS threshold under Cumulative with Project and without Eastside Parkway Conditions. The results of the peak-hour warrant analysis presented in **Table N-1** in **Appendix N** indicates the following intersections, which exceed their designated LOS threshold, would meet peak hour warrants:

- Int 22. Eighth Avenue and Inter-Garrison Road (AM and PM peak hour)
- Int 25. Inter-Garrison Road Connection and Inter-Garrison Road (AM and PM peak hour)
- Int 47. General Jim Moore Boulevard and Coe Avenue (AM and PM peak hour)

As described in **Signal Warrant Analysis** section of **Chapter 3**, SR 1 Northbound Ramps and Imjin Parkway (Int. 4) worst movement delay (minor street delay), northbound approach delay, is below the LOS threshold, though the intersection does not meet the peak hour signal warrant as the minor street northbound right traffic would not conflict with the major street eastbound through traffic.

## CUMULATIVE WITHOUT AND WITH PROJECT AND WITHOUT EASTSIDE PARKWAY CONDITIONS FREEWAY LEVELS OF SERVICE

Freeway segments of SR 1 were analyzed during the AM and PM peak hours to calculate the amount of Project traffic projected to be added (refer to **Appendix M**). Results of the analysis identifying the segments exceeding Caltrans' standard are presented in **Table 39**. Measured against the Caltrans level of service standard, the following freeway segments would exceed the level of service standard (that is, they operate at LOS D or worse):



- Southbound SR 1 between Reservation Road and Canyon Del Rey Boulevard during the AM peak hour (all 5 southbound SR 1 segments)
- Southbound SR 1 between Fremont Boulevard-Del Monte Boulevard and Canyon Del Rey during the PM peak hour
- Northbound SR 1 between Del Monte Boulevard and Imjin Parkway during the PM peak hour
- Northbound SR 1 between Imjin Parkway and Canyon Del Rey Boulevard the PM peak hour
- Northbound SR 1 between Fremont Boulevard-Del Monte Boulevard and Canyon Del Rey during the AM peak hour

Freeway segment deficiencies and potential improvements are addressed in **Chapter 11**.



**TABLE 39: CUMULATIVE WITHOUT AND WITH PROJECT CONDITIONS FREEWAY SEGMENT LEVEL**

| Freeway Segment  | Peak Hour <sup>1</sup> | Capacity | Cumulative without Project |                        |                  | Cumulative with Project |                        |                  | Project Percent of Capacity |
|--|------------------------|----------|----------------------------|------------------------|------------------|-------------------------|------------------------|------------------|-----------------------------|
|  |                        |          | Volume                     | Density <sup>2,3</sup> | LOS <sup>4</sup> | Volume                  | Density <sup>2,3</sup> | LOS <sup>4</sup> |                             |
| <b>State Route 1 – Southbound</b>                                  |                        |          |                            |                        |                  |                         |                        |                  |                             |
| Reservation Road and Del Monte Boulevard                           | AM                     | 4,700    | <b>3,480</b>               | <b>44.7</b>            | <b>E</b>         | <b>3,560</b>            | <b>N/A<sup>4</sup></b> | <b>F</b>         | <b>1.9%</b>                 |
|  | PM                     |          | 1,830                      | 14.6                   | B                | 1,870                   | 14.9                   | B                | 1.7%                        |
| Del Monte Boulevard and Imjin Parkway                              | AM                     | 7,050    | <b>5,060</b>               | <b>36.9</b>            | <b>E</b>         | <b>5,150</b>            | <b>38.0</b>            | <b>E</b>         | <b>1.5%</b>                 |
|  | PM                     |          | 3,200                      | 17.4                   | B                | 2,920                   | 15.9                   | B                | 1.4%                        |
| Imjin Parkway and Lightfighter Drive                               | AM                     | 7,050    | <b>5,230</b>               | <b>37.3</b>            | <b>E</b>         | <b>5,250</b>            | <b>37.6</b>            | <b>E</b>         | <b>0.9%</b>                 |
|  | PM                     |          | 3,490                      | 19.0                   | C                | 3,450                   | 18.7                   | C                | 0.2%                        |
| Lightfighter Drive and Fremont Boulevard-Del Monte Boulevard       | AM                     | 7,050    | <b>5,450</b>               | <b>37.6</b>            | <b>E</b>         | <b>5,550</b>            | <b>38.9</b>            | <b>E</b>         | <b>2.1%</b>                 |
|  | PM                     |          | 3,920                      | 20.8                   | C                | 4,010                   | 21.3                   | C                | 1.9%                        |
| Fremont Boulevard-Del Monte Boulevard and Canyon Del Rey           | AM                     | 4,700    | <b>4,470</b>               | -                      | <b>F</b>         | <b>4,540</b>            | <b>N/A<sup>4</sup></b> | <b>F</b>         | <b>2.5%</b>                 |
|  | PM                     |          | 3,170                      | 25.9                   | C                | <b>3,240</b>            | <b>26.6</b>            | <b>D</b>         | <b>2.3%</b>                 |
| <b>State Route 1 – Northbound</b>                                  |                        |          |                            |                        |                  |                         |                        |                  |                             |
| Reservation Road and Del Monte Boulevard                           | AM                     | 4,700    | 1,500                      | 12.3                   | B                | 1,520                   | 12.4                   | B                | 1.4%                        |
|  | PM                     |          | 2,970                      | 23.7                   | C                | 3,050                   | 24.4                   | C                | 2.2%                        |
| Del Monte Boulevard and Imjin Parkway                              | AM                     | 7,050    | 2,410                      | 13.8                   | B                | 2,440                   | 14.0                   | B                | 1.1%                        |
|  | PM                     |          | <b>4,850</b>               | <b>26.7</b>            | <b>D</b>         | <b>4,940</b>            | <b>27.3</b>            | <b>D</b>         | <b>0.9%</b>                 |
| Imjin Parkway and Lightfighter Drive                               | AM                     | 7,050    | 3,070                      | 17.5                   | B                | 3,070                   | 17.5                   | B                | 0.3%                        |
|  | PM                     |          | <b>5,530</b>               | <b>31.3</b>            | <b>D</b>         | <b>5,520</b>            | <b>31.2</b>            | <b>D</b>         | <b>1.8%</b>                 |
| Lightfighter Drive and Fremont Boulevard-Del Monte Boulevard       | AM                     | 7,050    | 3,480                      | 19.5                   | C                | 3,580                   | 20.0                   | C                | 1.7%                        |
|  | PM                     |          | <b>5,380</b>               | <b>29.7</b>            | <b>D</b>         | <b>5,470</b>            | <b>30.4</b>            | <b>D</b>         | <b>2.3%</b>                 |
| Fremont Boulevard-Del Monte Boulevard and Canyon Del Rey Boulevard | AM                     | 4,700    | 2,970                      | 25.7                   | C                | <b>3,040</b>            | <b>26.4</b>            | <b>D</b>         | <b>2.0%</b>                 |
|  | PM                     |          | <b>4,290</b>               | <b>40.5</b>            | <b>E</b>         | <b>4,350</b>            | <b>41.6</b>            | <b>E</b>         | <b>2.6%<sup>5</sup></b>     |

Notes: **Bold** text indicates below the applicable level of service standard (LOS D for Caltrans designated facilities). **Bold and highlighted text** indicates freeway segment deficiency as described in **Chapter 11**.

1. AM = AM peak hour, PM = PM peak hour.
2. Measured in passenger cars per mile per lane. Mixed = Mixed-Flow Lanes.
3. If volume/capacity ratio is greater than 1, density is not applicable.
4. Level of service (LOS) based on density.
5. The vehicle demand for the PM outbound peak hour direction of the next freeway segment (CA-1 between Canyon Del Rey and Casa Verde Way) is less than the project percent capacity. Therefore, the last freeway segment to be studied south of CSUMB campus is between Fremont Boulevard-Del Monte Boulevard and Canyon Del Rey Boulevard.

Source: Fehr & Peers, 2019.



## CUMULATIVE WITHOUT AND WITH PROJECT AND WITHOUT EASTSIDE PARKWAY CONDITIONS RAMP LEVELS OF SERVICE

A freeway ramp analysis was conducted for Cumulative conditions to assess changes in peak hour ramp volumes with the addition of Project traffic and its effects on freeway and local street operations.

Freeway ramp segments to/from State Route 1 were analyzed during the AM and PM peak hours to calculate the amount of Project traffic projected to be added. Results of the analysis identifying the segments that exceed the ramp capacity are presented in **Table 40** and **Table 41**. All of the ramp volumes would increase under Cumulative with Project and without Eastside Parkway Conditions, with the exception of the SR 1 and Imjin Parkway southbound on-ramp in the PM peak hour, and the SR 1 and Imjin Parkway northbound off-ramp during AM peak hour. Decreases in volume under Cumulative with Project and without Eastside Parkway Conditions are due to the displacement and reassignment of cumulative traffic when the Project volume is added to the roadway network.

As shown on **Table 40** and **Table 41**, under Cumulative with Project and without Eastside Parkway Conditions, all ramp volumes would be less than the ramp capacity during the AM and PM peak hours.

**TABLE 40: CUMULATIVE WITHOUT AND WITH PROJECT CONDITIONS RAMP AM PEAK HOUR VOLUMES AND CAPACITIES**

| Location                    | Direction | Ramp Type         | Lanes | Capacity <sup>1</sup> | Cumulative without Project<br>(vehicles per hour) | Cumulative with Project<br>(vehicles per hour) |
|-----------------------------|-----------|-------------------|-------|-----------------------|---|--|
| SR 1 and Imjin Parkway      | NB        | Diagonal On-Ramp  | 1     | 1,500                 | 430   | 460  |
|                             | SB        | Diagonal On-Ramp  | 1     | 1,500                 | 1,180   | 1,190  |
|                             | NB        | Diagonal Off-Ramp | 2     | 3,000                 | 1,080   | 1,080  |
|                             | SB        | Diagonal Off-Ramp | 1     | 1,500                 | 920   | 990  |
| SR 1 and Lightfighter Drive | NB        | Diagonal On-Ramp  | 1     | 1,500                 | 380   | 400  |
|                             | SB        | Diagonal On-Ramp  | 2     | 3,000                 | 600   | 700  |
|                             | NB        | Diagonal Off-Ramp | 2     | 3,000                 | 750   | 860  |
|                             | SB        | Loop Off-Ramp     | 1     | 1,200                 | 520   | 540  |

Notes: **Bold** text indicates volumes above capacity.

1. Peak hour ramp capacity is 1,500 veh/hr/ln (vehicles per hour per lane) and 1,200 veh/hr/ln for diagonal and loop ramps, respectively.

Source: Fehr & Peers, 2019.



**TABLE 41: CUMULATIVE WITHOUT AND WITH PROJECT CONDITIONS RAMP PM PEAK HOUR VOLUMES AND CAPACITIES**

| Location                    | Direction | Ramp Type <sup>1</sup> | Lanes | Capacity <sup>1</sup> | Cumulative without Project<br>(vehicles per hour) | Cumulative with Project<br>(vehicles per hour) |
|-----------------------------|-----------|------------------------|-------|-----------------------|---|--|
| SR 1 and Imjin Parkway      | NB        | Diagonal On-Ramp       | 1     | 1,500                 | 860   | 940  |
|                             | SB        | Diagonal On-Ramp       | 1     | 1,500                 | 1,270   | 1,250  |
|                             | NB        | Diagonal Off-Ramp      | 2     | 3,000                 | 1,590   | 1,580  |
|                             | SB        | Diagonal Off-Ramp      | 1     | 1,500                 | 590   | 670  |
| SR 1 and Lightfighter Drive | NB        | Diagonal On-Ramp       | 1     | 1,500                 | 770   | 800  |
|                             | SB        | Diagonal On-Ramp       | 2     | 3,000                 | 800   | 930  |
|                             | NB        | Diagonal Off-Ramp      | 2     | 3,000                 | 520   | 650  |
|                             | SB        | Loop Off-Ramp          | 1     | 1,200                 | 320   | 310  |

Notes: **Bold** text indicates volumes above capacity.

1. Peak hour ramp capacity is 1,500 veh/hr/ln (vehicles per hour per lane) and 1,200 veh/hr/ln for diagonal and loop ramps, respectively.

Source: Fehr & Peers, 2019.



## 10. CUMULATIVE WITH EASTSIDE PARKWAY CONDITIONS (FOR INFORMATION PURPOSES ONLY)

This chapter presents the results of the level of service calculations under Cumulative with and without Project, and with the assumption that the Eastside Parkway is constructed. Eastside Parkway is the future two lane arterial connection that would connect General Jim Moore Boulevard and Inter-Garrison Road. At the time of this analysis FORA was responsible for providing the necessary funding for the roadway connection although, as of this writing, when FORA sunsets (June 30, 2020), the local jurisdiction will have the sole responsibility to arrange for the funding of all required road mitigation measures from such Jurisdiction's own resources. TAMC will assume responsibility for collecting Regional Impact Development fees to fund impacts to regional roads resulting from development projects on underlying Jurisdiction's property. Thus, a specific source of funding for future roads has not been identified or when such funding would be available, nor has a final Eastside Parkway project alignment been determined. Currently, FORA is leading the first phase of the environmental review of the roadway project. Cumulative traffic volumes are based on forecasts from the AMBAG travel model, including the land uses and transportation network infrastructure described in **Chapter 9**, plus the Eastside Parkway assumed to be constructed between Inter-Garrison Road and General Jim Moore Boulevard. The peak hour vehicle trip estimates into and out of CSUMB are based on the Project vehicle trip estimates discussed in **Chapter 7**.

### CUMULATIVE WITHOUT AND WITH PROJECT AND WITH EASTSIDE PARKWAY CONDITIONS ROADWAY IMPROVEMENTS

The Cumulative without and with Project with Eastside Parkway scenario was evaluated to determine the effects of adding Eastside Parkway and its associated improvements to the results previously presented in **Chapter 9**. As noted above, Eastside Parkway is the planned future two lane arterial connection that would connect General Jim Moore Boulevard and Inter-Garrison Road. The connection would begin at General Jim Moore Boulevard and Coe Avenue (Int. 47) as a continuation of Eucalyptus Road to the east and end at Schoonover Road and Inter-Garrison Road (Int 24). Based on information presently available, the following intersection improvements were assumed part of the Eastside Parkway roadway improvements:

- Int 24. Schoonover Road and Inter-Garrison Road: Signalized intersection. Addition of a northbound approach with a left turn lane, through lane, and right turn lane. Addition of an eastbound shared right/through lane and southbound shared left/through lane.
- Int 45. Eastside Parkway and Gigling Road: Open signalized intersection with Gigling Road. Addition of a northbound approach with a left turn lane and shared right/through lane. Addition of a southbound approach with a left turn lane, through lane, and right turn lane.



- Int 47. General Jim Moore Boulevard and Coe Avenue: Addition of a westbound leg with one left turn lane, one through lane, and one right turn lane. Opening of the southbound left turn lanes, northbound right turn lane, and eastbound through lane. Signalization of the intersection.

The Cumulative with Project and with Eastside Parkway analysis also includes the transportation facility changes to the campus that would be built as part of the Project, as described in **Chapter 1**, and shown on **Figure 2**.

## CUMULATIVE WITHOUT AND WITH PROJECT AND WITH EASTSIDE PARKWAY CONDITIONS INTERSECTION LEVELS OF SERVICE

The following intersections that would exceed the applicable LOS threshold under the Cumulative with Project and without Eastside Parkway Conditions (refer to **Chapter 9** and **Appendix L**) would not exceed the applicable level of service threshold in the Cumulative with Project and with Eastside Parkway Conditions (refer to **Table L-4** in **Appendix L**):

- Int 10. Imjin Road and Imjin Parkway (PM peak hour),
- Int 17. Fourth Avenue and Eighth Street (AM peak hour),
- Int 23. Abrams Drive and Inter-Garrison Road (AM and PM peak hour), and
- Int 37. Seventh Avenue and Colonel Durham Street (PM peak hour).

For travel between Seaside and SR 1 from/to Salinas and eastward, the addition of Eastside Parkway is expected to result in a traffic shift from other east-west roadways such as Imjin parkway, Inter-Garrison Road, Eighth Street, and Colonel Durham Street, onto Eastside Parkway. The shift of traffic that would result from this new connector would result in increased travel along Reservation Road to access Eastside Parkway from Inter-Garrison Road. As a result of the redistribution of traffic, the following intersection, which meets the applicable level of service thresholds under the Cumulative with Project and without Eastside Parkway Conditions, would exceed the threshold under Cumulative with Project and with Eastside Parkway Conditions:

- Int 27. Reservation Road and Watkins Gate Road

## SIGNAL WARRANT ANALYSIS

The addition of Eastside Parkway as a part of planned improvements would change the intersections that exceed their designated LOS threshold and meet peak hour warrants under Cumulative with Project without Eastside Parkway Conditions. That is, the same intersections operating below their designated LOS threshold and meeting peak hour warrants under the Cumulative with Project without Eastside Parkway Conditions would remain unchanged under the Cumulative with Project and with Eastside Parkway Conditions.



## CUMULATIVE WITHOUT AND WITH PROJECT AND WITH EASTSIDE PARKWAY CONDITIONS FREEWAY LEVELS OF SERVICE

Freeway segments of SR 1 were analyzed during the AM and PM peak hours to calculate the effect of Eastside Parkway on the Cumulative without and with Project Conditions. The results of the analysis are presented in **Table 39**. As shown on the table, overall, the same southbound segments would operate below the level of service standard. In the northbound direction, the following segments that exceed the level of service standard in the Cumulative with Project and without Eastside Parkway Condition would not exceed the level of service standard in the Cumulative with Project and with Eastside Parkway Condition:

- Del Monte Boulevard and Imjin Parkway
- Imjin Parkway and Lightfighter Drive

The reason for the improved operations on the above two segments is because, as previously noted, the addition of Eastside Parkway would result in shifts of traffic in the area. This includes a shift of the traffic traveling northward/eastward of the Campus, exiting SR 1 earlier, and using Eastside Parkway to access these destinations. Volume shifts as described would reduce volumes on these segments of SR 1 and, therefore, improve operations in the Cumulative without and with Project and with Eastside Parkway versus the Cumulative without and with Project, and without Eastside Parkway.





**TABLE 42: CUMULATIVE WITHOUT AND WITH PROJECT AND WITH EASTSIDE PARKWAY  
CONDITIONS FREEWAY SEGMENT LEVEL OF SERVICE**

| Freeway Segment  | Peak Hour <sup>1</sup> | Capacity | Cumulative without Project and with Eastside Parkway |                        |                  | Cumulative with Project and with Eastside Parkway |                        |                  | Project Percent of Capacity |
|--|------------------------|----------|--|------------------------|------------------|---|------------------------|------------------|-----------------------------|
|  |                        |          | Volume   | Density <sup>2,3</sup> | LOS <sup>4</sup> | Volume  | Density <sup>2,3</sup> | LOS <sup>4</sup> |                             |
| <b>State Route 1 – Southbound</b>                                  |                        |          |  |                        |                  |   |                        |                  |                             |
| Reservation Road and Del Monte Boulevard                           | AM                     | 4,700    | <b>3,460</b>   | <b>44.2</b>            | <b>E</b>         | <b>3,497</b>                                      | <b>N/A<sup>4</sup></b> | <b>F</b>         | <b>1.9%</b>                 |
|  | PM                     |          | 1,870  | 14.9                   | B                | 1,890   | 15.1                   | B                | 1.7%                        |
| Del Monte Boulevard and Imjin Parkway                              | AM                     | 7,050    | <b>5,050</b>   | <b>36.7</b>            | <b>E</b>         | <b>4,633</b>                                      | <b>32.0</b>            | <b>D</b>         | <b>1.5%</b>                 |
|  | PM                     |          | 2,910  | 15.8                   | B                | 2,940   | 16.0                   | B                | 1.4%                        |
| Imjin Parkway and Lightfighter Drive                               | AM                     | 7,050    | <b>5,080</b>   | <b>35.5</b>            | <b>E</b>         | <b>4,767</b>                                      | <b>32.1</b>            | <b>D</b>         | <b>0.9%</b>                 |
|  | PM                     |          | 3,380  | 18.4                   | C                | 3,340   | 18.1                   | C                | 0.2%                        |
| Lightfighter Drive and Fremont Boulevard-Del Monte Boulevard       | AM                     | 7,050    | <b>5,490</b>   | <b>38.1</b>            | <b>E</b>         | <b>5,153</b>                                      | <b>34.2</b>            | <b>D</b>         | <b>1.9%</b>                 |
|  | PM                     |          | 3,940  | 20.9                   | C                | 4,030   | 21.4                   | C                | 1.3%                        |
| Fremont Boulevard-Del Monte Boulevard and Canyon Del Rey           | AM                     | 4,700    | <b>4,540</b>   | -                      | <b>F</b>         | <b>4,747</b>                                      | <b>N/A<sup>4</sup></b> | <b>F</b>         | <b>2.5%</b>                 |
|  | PM                     |          | <b>3,230</b>   | <b>26.5</b>            | <b>D</b>         | <b>3,300</b>                                      | <b>27.2</b>            | <b>D</b>         | <b>2.3%</b>                 |
| <b>State Route 1 – Northbound</b>                                  |                        |          |  |                        |                  |   |                        |                  |                             |
| Reservation Road and Del Monte Boulevard                           | AM                     | 4,700    | 1,480  | 12.1                   | B                | 1,520   | 12.4                   | B                | 1.4%                        |
|  | PM                     |          | 2,740  | 21.7                   | C                | 3,086   | 24.7                   | C                | 2.2%                        |
| Del Monte Boulevard and Imjin Parkway                              | AM                     | 7,050    | 2,400  | 13.8                   | B                | 2,450   | 14.1                   | B                | 1.1%                        |
|  | PM                     |          | 4,510  | 24.5                   | C                | 4,207   | 22.7                   | C                | 1.8%                        |
| Imjin Parkway and Lightfighter Drive                               | AM                     | 7,050    | 2,950  | 16.8                   | B                | 2,950   | 16.8                   | B                | 0.3%                        |
|  | PM                     |          | 4,570  | 24.6                   | C                | 4,524   | 24.3                   | C                | 0.9%                        |
| Lightfighter Drive and Fremont Boulevard-Del Monte Boulevard       | AM                     | 7,050    | 3,440  | 19.2                   | C                | 3,550   | 19.9                   | C                | 1.7%                        |
|  | PM                     |          | 4,720  | 25.2                   | C                | <b>5,167</b>                                      | <b>28.2</b>            | <b>D</b>         | <b>2.2%</b>                 |
| Fremont Boulevard-Del Monte Boulevard and Canyon Del Rey Boulevard | AM                     | 4,700    | <b>3,000</b>   | <b>26.0</b>            | <b>D</b>         | <b>3,070</b>                                      | <b>26.7</b>            | <b>D</b>         | <b>1.9%</b>                 |
|  | PM                     |          | <b>3,570</b>   | <b>30.0</b>            | <b>D</b>         | <b>4,648</b>                                      | <b>N/A<sup>4</sup></b> | <b>F</b>         | <b>2.6%</b>                 |

Notes: **Bold** text indicates below the applicable level of service standard (LOS D for Caltrans designated facilities). **Bold and highlighted text** indicates freeway segment deficiency as described in **Chapter 11**.

1. AM = AM peak hour, PM = PM peak hour.
2. Measured in passenger cars per mile per lane. Mixed = Mixed-Flow Lanes.
3. If volume/capacity ratio is greater than 1, density is not applicable.
4. Level of service (LOS) based on density.
5. The vehicle demand for the PM outbound peak hour direction of the next freeway segment (CA-1 between Canyon Del Rey and Casa Verde Way) is less than the project percent of capacity.

Source: Fehr & Peers, 2019.



## CUMULATIVE WITHOUT AND WITH PROJECT AND WITH EASTSIDE PARKWAY CONDITIONS RAMP LEVELS OF SERVICE

Similar to the Cumulative with Project and without Eastside Parkway Conditions, under Cumulative with Project and with Eastside Parkway Conditions, all ramp volumes would be less than the ramp capacity during the AM and PM peak hours. Cumulative without and with Project and with Eastside Parkway Conditions would result in a shift of ramp volumes from the Imjin Parkway southbound on-ramp and northbound on-ramp to the same ramps at Lightfighter. As described above for the **Freeway Level of Service** section, the addition of Eastside Parkway would affect the travel between SR 1 to/from northward/eastward of the Campus.

**TABLE 43: CUMULATIVE WITHOUT AND WITH PROJECT, AND WITH EASTSIDE PARKWAY CONDITIONS RAMP AM PEAK HOUR VOLUMES AND CAPACITIES**

| Location                    | Direction | Ramp Type         | Lanes | Capacity <sup>1</sup> | Cumulative without Project with Eastside Parkway (vehicles per hour) | Cumulative with Project with Eastside Parkway (vehicles per hour) |
|-----------------------------|-----------|-------------------|-------|-----------------------|--|---|
| SR 1 and Imjin Parkway      | NB        | Diagonal On-Ramp  | 1     | 1,500                 | 430  | 490   |
|                             | SB        | Diagonal On-Ramp  | 1     | 1,500                 | 1,050  | 1,050   |
|                             | NB        | Diagonal Off-Ramp | 2     | 3,000                 | 970  | 980   |
|                             | SB        | Diagonal Off-Ramp | 1     | 1,500                 | 930  | 1,010   |
| SR 1 and Lightfighter Drive | NB        | Diagonal On-Ramp  | 1     | 1,500                 | 380  | 380   |
|                             | SB        | Diagonal On-Ramp  | 2     | 3,000                 | 760  | 870   |
|                             | NB        | Diagonal Off-Ramp | 2     | 3,000                 | 820  | 930   |
|                             | SB        | Loop Off-Ramp     | 1     | 1,200                 | 510  | 530   |

Notes: **Bold** text indicates volumes above capacity.

1. Peak hour ramp capacity is 1,500 veh/hr/ln (vehicles per hour per lane) and 1,200 veh/hr/ln for diagonal and loop ramps, respectively.

Source: Fehr & Peers, 2019.



**TABLE 44: CUMULATIVE WITHOUT AND WITH PROJECT, AND WITH EASTSIDE PARKWAY CONDITIONS RAMP PM PEAK HOUR VOLUMES AND CAPACITIES**

| Location                    | Direction | Ramp Type <sup>1</sup> | Lanes | Capacity <sup>1</sup> | Cumulative without Project with Eastside Parkway (vehicles per hour) | Cumulative with Project with Eastside Parkway (vehicles per hour) |
|-----------------------------|-----------|------------------------|-------|-----------------------|--|---|
| SR 1 and Imjin Parkway      | NB        | Diagonal On-Ramp       | 1     | 1,500                 | 860  | 970   |
|                             | SB        | Diagonal On-Ramp       | 1     | 1,500                 | 1,210  | 1,180   |
|                             | NB        | Diagonal Off-Ramp      | 2     | 3,000                 | 1,200  | 1,230   |
|                             | SB        | Diagonal Off-Ramp      | 1     | 1,500                 | 690  | 730   |
| SR 1 and Lightfighter Drive | NB        | Diagonal On-Ramp       | 1     | 1,500                 | 770  | 770   |
|                             | SB        | Diagonal On-Ramp       | 2     | 3,000                 | 890  | 1,020   |
|                             | NB        | Diagonal Off-Ramp      | 2     | 3,000                 | 960  | 1,070   |
|                             | SB        | Loop Off-Ramp          | 1     | 1,200                 | 290  | 290   |

Notes: **Bold** text indicates volumes above capacity.

1. Peak hour ramp capacity is 1,500 veh/hr/ln (vehicles per hour per lane) and 1,200 veh/hr/ln for diagonal and loop ramps, respectively.

Source: Fehr & Peers, 2019.



## 11. TRANSPORTATION FACILITY DEFICIENCIES AND POTENTIAL IMPROVEMENTS (FOR INFORMATION PURPOSES ONLY)

This chapter discusses the Project's potential effects to the study intersections and study freeway segments. First, the deficiency criteria are described. Next, the deficiencies and potential improvements are presented for each transportation facility type (intersections and freeway segments).

### DEFICIENCIES CRITERIA

The deficiency criteria presented in the California State University *Transportation Impact Study Manual* (2012) are used to identify the Project's deficiencies, with a refinement to the freeway deficiency criteria in that criteria based on Caltrans guidance and removal of the construction deficiency criteria.

The deficiencies attributable to the Project were determined by comparing the results of the level of service calculations under Existing with Project Conditions to the results under Existing Conditions without Project to determine Project's effects on existing conditions. In the case of cumulative impacts, the Cumulative with Project and without Eastside Parkway Conditions was compared to the Cumulative without Project and without Eastside Parkway Conditions to determine whether the Project's contribution to that deficiency is cumulatively considerable. Cumulative without and with Project, and with the Eastside Parkway Conditions were similarly evaluated to determine the effects of Eastside Parkway on Cumulative with Project and without Eastside Parkway Conditions.

Below are the deficiency criteria as applied to the Project.

### OFF-SITE TRAFFIC OPERATIONS

- A roadway segment or signalized intersection operates at LOS D or better under a no project scenario and the addition of project trips causes overall traffic operations on the facility to operate at LOS E or F. Roadway segment operations criteria are further refined below based on Caltrans guidance from Chapter 11 of the *HCM 2010*.
- A roadway segment or signalized intersection operates at LOS E or F under a no project scenario and the project adds both 10 or more peak hour trips and 5 seconds or more of peak hour delay, during the same peak hour. Roadway segment operations criteria are further refined below based on Caltrans guidance from Chapter 11 of the *HCM 2010*.
- If a signalized intersection operates at a very poor LOS F (control delay of 120 seconds or more), the significance criterion shall be an increase in v/c ratio of 0.02 or more.



- Operational deficiencies on freeway segments in study area within Monterey County were determined to occur when the addition of Project traffic causes:
  - Peak hour freeway segment operations to deteriorate from an acceptable level (LOS C/D threshold or better) under the without Project conditions to an unacceptable level (LOS D or worse) under with Project conditions; or
  - There is an increase in traffic of more than two percent of the capacity on a segment that operates unacceptably under without Project Conditions.
- Deficiencies are said to occur when the with Project scenario results in the average intersection delay for an all-way stop-controlled intersection, or the worst movement/approach for a side-street stop-controlled intersection, to degrade to LOS F and the intersection satisfies the peak hour traffic signal warrant from the *California Manual of Uniform Traffic Control Devices* (MUTCD) (2014).<sup>29</sup>

## DEFICIENCIES ANALYSIS AND POTENTIAL IMPROVEMENTS

The following section summarizes the deficiencies and potential improvements for intersections, freeway segments and freeway ramps. Each section includes a discussion of deficiencies under Existing with Project Conditions, Cumulative with Project and without Eastside Parkway Conditions, and Cumulative with Project and with Eastside Parkway Conditions.

### INTERSECTION LEVEL OF SERVICE

The following physical improvements would improve the identified intersection deficiencies by increasing capacity. The improved intersection LOS calculations are presented in **Appendix O**.

#### Existing with Project Conditions

Under Existing with Project Conditions, implementation of the Project would increase motor vehicle traffic and congestion, resulting in operational deficiencies at the following intersections. The localized improvements identified below would incrementally improve intersection operations and, in some cases, improve street connectivity. The intersections with operation deficiencies and corresponding improvements are further described below.

---

<sup>29</sup> The peak-hour signal warrant analysis should not serve as the only basis for deciding whether and when to install a traffic signal. To reach such a decision, the full set of warrants should be investigated based on a thorough study of traffic and roadway conditions by an experienced engineer. The decision to install a signal should not be based solely upon the warrants, since the installation of signals can lead to certain types of collisions. The responsible state or local agency should undertake regular monitoring of actual traffic conditions and accident data and timely re-evaluation of the full set of warrants in order to prioritize and program intersections for signalization.



**Intersection 3: SR 1 Southbound Ramps and Imjin Parkway (Caltrans):** Adding a second westbound left turn lane and converting the southbound off-ramp to a loop off-ramp would improve intersection operations and queuing. This would address the deficiency at this intersection.

**Intersection 16: Second Avenue and Eighth Street (Marina):** Adding a second southbound through lane; converting the northbound left lane to a shared left-through lane; and converting the northbound through lane and northbound right lane to a shared northbound through-right would improve intersection operations and queuing. These southbound changes match the future southbound geometry planned as part of the City of Marina's 5 Year Capital Improvement Project List. This intersection meets peak hour signal warrant in the Existing with Project Conditions; therefore, the improvements evaluated include signalization and optimization of the cycle length and splits. This would address the deficiency at this intersection.

**Intersection 21: Eighth Street/Seventh Avenue and Inter-Garrison Road (Monterey County/CSUMB):** Adding eastbound and westbound left-turn pockets, converting the shared northbound left, through and right turn lane to a left turn lane, a through lane, and a right turn lane, and converting the shared southbound through-left lane and the right turn lane to a left turn lane, and a shared through-right lane to improve intersection operations and queuing. These geometry and signalized improvements are planned as part of the City of Marina's 5 Year Capital Improvement Project List. This intersection meets peak hour signal warrant in the Existing with Project Conditions; therefore, the improvements evaluated include signalization and optimization of the cycle length and splits. This improvement would address the deficiency at this intersection.

**Intersection 22: Eighth Avenue and Inter-Garrison Road (Monterey County/CSUMB):** Two improvement options have been identified:

- Option 1 – Signalization of intersection: This intersection meets peak hour signal warrant in the Existing with Project Conditions; therefore, the improvements evaluated for Option 1 include signalization and optimization of the cycle length and splits. This would improve the intersection operations to an acceptable level of service.
- Option 2 – Add second inside turning lane in roundabout and add a westbound left approaching lane: This option enhances intersection operations of the existing roundabout. Adding a second inside turning lane, a dedicated westbound left lane, and a second receiving leg on the south leg would improve the intersection operations and queuing during the AM peak hour. This improvement would address the deficiency at this intersection.

**Intersection 23: Abrams Drive and Inter-Garrison Road (CSUMB/Monterey County):** Adding a second southbound left lane would improve intersection operations and queuing. This intersection meets peak hour signal warrant in the Existing with Project Conditions; therefore, the improvements evaluated include signalization and optimization of the cycle length and splits. This improvement would address the deficiency at this intersection.



**Intersection 29: Second Avenue and Divarty Street (Marina/CSUMB):** Adding a through lane to both the northbound and southbound directions, converting the northbound right lane to a shared northbound through-right, and converting the southbound right lane to a shared southbound through-right lane would improve intersection operations and queuing. These changes match the future geometry planned at this intersection. This would address the deficiency at this intersection.

**Intersection 47: General Jim Moore Boulevard and Coe Avenue (Seaside):** This intersection meets the peak hour signal warrant. Signalizing the intersection and optimizing the cycle length and splits would improve intersection operations and queuing. This would address the deficiency at this intersection.

**Table 45** shows the peak hour delays and LOS results for without and with potential improvements for each of the intersections with a level of service deficiency under Existing with Project Conditions. As shown on the table, with implementation of the improvements, operations at each intersection would improve, and the Project's impacts would be reduced below the local jurisdiction's thresholds at the six intersections.

**TABLE 45: EXISTING WITH PROJECT CONDITIONS INTERSECTION IMPROVEMENTS SUMMARY**

| Intersection | Improvements <sup>3</sup>  | Peak Hour <sup>1</sup> | Intersection Operations                         |                  |  |                  |   |                  |
|--------------|--|------------------------|---|------------------|--|------------------|---|------------------|
|              |  |                        | Without Project Conditions Without Improvements |                  | With Project Conditions Without Improvements |                  | With Project Conditions With Improvements |                  |
|              |  |                        | Delay   | LOS <sup>2</sup> | Delay  | LOS <sup>2</sup> | Delay                                     | LOS <sup>2</sup> |
| 3            | SR 1 Southbound Ramps and Imjin Parkway <sup>4</sup>                 | AM                     | 36.6  | D                | 61.3   | E                | - <sup>4</sup>                            | A                |
|              |  | PM                     | 17.2  | B                | 19.6   | B                | - <sup>4</sup>                            | A                |
| 16           | Second Avenue and Eighth Street                                      | AM                     | 56.3  | F                | >120   | F                | 8.2                                       | A                |
|              |  | PM                     | 12.8  | B                | 23.3   | C                | 6.2                                       | A                |
| 21           | <u>Eighth Street/Seventh Avenue and Inter-Garrison Road</u>          | AM                     | 12.9  | B                | 98.4   | F                | 16.9                                      | B                |
|              |  | PM                     | 8.9   | A                | 51.6   | F                | 16.0                                      | B                |
| 22           | Option 1 - Signalize, optimize signal timings                        | AM                     | 32.1  | D                | 114.3  | F                | 1.4                                       | A                |
|              |  | PM                     | 8.6   | A                | 25.9   | E                | 9.9                                       | A                |
|              | Option 2 - Add second circulating lane to the roundabout and Add WBL | AM                     | 32.1  | D                | 114.3  | F                | 14.7                                      | B                |
|              |  | PM                     | 8.6   | A                | 25.9   | D                | 23.0                                      | C                |
| 23           | Abrams Drive and Inter-Garrison Road                                 | AM                     | 60.3  | F                | >120   | F                | 21.3                                      | C                |
|              |  | PM                     | 12.8  | B                | 78.8   | F                | 3.9                                       | A                |
| 29           | Second Avenue and Divarty Street                                     | AM                     | 31.1  | D                | >120   | F                | 9.2                                       | A                |
|              |  | PM                     | 9.4   | A                | 50.9   | F                | 10.1                                      | B                |



**TABLE 45: EXISTING WITH PROJECT CONDITIONS INTERSECTION IMPROVEMENTS SUMMARY**

| Intersection                                  | Improvements <sup>3</sup>                          | Peak Hour <sup>1</sup> | Intersection Operations                         |                  |  |                  |   |                  |
|---|--|------------------------|---|------------------|--|------------------|---|------------------|
|   |  |                        | Without Project Conditions Without Improvements |                  | With Project Conditions Without Improvements |                  | With Project Conditions With Improvements |                  |
|   |  |                        | Delay   | LOS <sup>2</sup> | Delay  | LOS <sup>2</sup> | Delay                                     | LOS <sup>2</sup> |
| 47 General Jim Moore Boulevard and Coe Avenue | Signalize intersection and optimize signal timings | AM                     | <b>92.2</b>                                     | <b>F</b>         | <b>103.2</b>                                 | <b>F</b>         | 12.6                                      | B                |
|   |  | PM                     | 18.4  | C                | 23.0   | C                | 6.0                                       | A                |

Notes: **Bold text** indicates intersection operates at unacceptable level of service. **Bold and highlighted text** indicates an intersection deficiency.

\*Indicates unsignalized intersection.

1. AM = AM peak hour, PM = PM peak hour.
2. LOS = Level of Service. The method described in the *Highway Capacity Manual (HCM)* (Transportation Research Board) was used to prepare the LOS calculations for the signalized study intersections. This method analyzes intersection operations based on average control delay per vehicle. Control delay includes the initial deceleration delay, queue move-up time, stopped delay, and final acceleration delay. The average control delay is calculated using Synchro analysis software and is correlated to a LOS designation
3. EB = Eastbound, WB = Westbound, NB = Northbound, SB = Southbound; T = Through, L = Left-turn, R = Right-turn, LTR = Shared Left-Through-Right Lane, TR = Shared Through-Right Lane, TL = Shared Through-Left Lane.
4. The draft improvement would remove potential conflicting turn movements at this intersection, which removes vehicle control delay at this intersection.

Source: Fehr & Peers, 2019.

### Cumulative with Project and without Eastside Parkway Conditions

Under Cumulative with Project and without Eastside Parkway Conditions, implementation of the Project would increase motor vehicle traffic and congestion, resulting in operational deficiencies at the following intersections. The localized improvements identified below would incrementally improve intersection operations and, in some cases, improve street connectivity. The intersections with operation deficiencies and corresponding improvements are further described below.

**Intersection 3: SR 1 Southbound Ramps and Imjin Parkway (Caltrans):** Adding a second westbound left turn lane and converting the southbound off-ramp into a loop off-ramp would address the deficiency at this intersection.

**Intersection 5: Second Avenue and Imjin Parkway (Marina):** Reconfigure the intersection to follow improvements identified in *The Dunes at Monterey Bay EIR (2005)*. These improvements include:

- Adding a third northbound left lane and a second northbound right lane.
- Adding a third westbound left lane, two westbound through lanes, and converting a shared westbound through-right lane to a westbound right lane.





- Adding a second southbound left lane, a second southbound through lane, and converting a shared southbound through-right lane to a southbound right lane.
- Adding a second eastbound left lane, a third eastbound through lane, and converting a shared eastbound through-right lane to two eastbound right lanes.
- Converting a shared westbound through-right lane to a westbound right lane, a shared southbound through-right lane to a southbound right lane, and a shared eastbound through-right lane to two eastbound right lanes.

These improvements would address the deficiency at this intersection; however, an important design consideration is the secondary effects to pedestrian and bicyclist operations. The widening would affect the crossing length and time bicyclists and pedestrians spend in front of vehicles. The improvement to widen the northbound approach for additional turning lanes would require widening beyond restriping, which would affect the available right of way for a future parallel separated shared use path.

**Intersection 10: Imjin Road and Imjin Parkway (Marina):** Adding a second westbound left lane would improve intersection operations and queuing. This would address the deficiency at this intersection.

**Intersection 12: Reservation Road and Imjin Parkway (Marina):** Adding a third southbound through lane would improve intersection operations and queuing. However, this would not improve the intersection operations to an acceptable level of service. To improve the intersection operations, additional widening, such as adding a northbound through lane, could be considered. Though, this creates a secondary effect on bicyclists and pedestrians as widening an intersection that already has a large footprint would have a detrimental effect on bicyclists and pedestrians because adding lanes increases the distance bicyclists and pedestrians must cross to navigate the intersection, increasing their exposure to vehicles.

**Intersection 14: Inter-Garrison Road and Reservation Road (Monterey County):** Adding a second northbound left lane would improve intersection operations and queuing. This would address the deficiency at this intersection.

**Intersection 22: Eighth Avenue and Inter-Garrison Road (Monterey County/CSUMB):** The following potential improvements were evaluated:

- Option 1 – Signalization of intersection: Adding a second northbound left lane, two westbound left lanes, and converting the shared westbound through-left lane to a westbound through lane only would improve intersection operations and queuing. However, this would not improve the intersection operations to an acceptable level of service. Therefore, the deficiency remains under Cumulative with Project and without Eastside Parkway Conditions. Although further widening could be considered as an improvement, an important design consideration is the secondary effects to pedestrian and bicyclist operations; therefore, no other improvements are feasible due to the increased secondary effect to pedestrian and bicyclist operations.



- Option 2 – Add second inside turning lane in roundabout and add a westbound left approaching lane: Adding a second inside turning lane to the roundabout, a dedicated westbound left lane, and a second receiving lane to the south leg would improve intersection operations and queuing. However, this would not improve the intersection operations to an acceptable level of service. Therefore, the deficiency remains under Cumulative with Project and without Eastside Parkway Conditions.

Although further widening could be considered as an improvement, an important design consideration for multi-lane roundabouts is the bicycle and pedestrian crossings across two approach/departure lanes. Refer to further discussion of the impact of multi-lane roundabouts to bicyclists and pedestrians in the **Secondary Effects of Intersection Improvements** section.

**Intersection 23: Abrams Drive and Inter-Garrison Road (Monterey County):** Adding a second eastbound left lane would improve intersection operations and queuing. This would address the deficiency at this intersection.

**Intersection 25: Inter-Garrison Road Connection and Inter-Garrison Road (Marina):** Signalizing the intersection and optimizing the cycle length and splits would improve intersection operations and queuing. This intersection met peak hour signal warrants. These improvements would address the deficiency at this intersection.

**Intersection 28: Davis Road and Reservation Road (Monterey County):** Adding a second eastbound left lane would improve intersection operations and queuing. This physical improvement would address the deficiency at this intersection in the AM peak hour; though, the intersection would remain deficient in the PM peak hour.

**Intersection 33: General Jim Moore Boulevard and Lightfighter Road (Seaside):** The following improvements were evaluated:

- Option 1 – Lane geometry improvements: Reconfiguring the intersection to follow the improvements identified in *The Dunes at Monterey Bay EIR (2005)* would address the deficiency at this intersection. The subject improvements include:
  - Adding a third northbound left lane and a second northbound through lane.
  - Adding a southbound right lane with overlap phase.
  - Adding a second eastbound left lane.
  - Adding a second westbound left lane, and a second westbound through lane.
  - Cycle length and splits are optimized.

As previously noted, increasing vehicle capacity by widening streets generally has a detrimental effect on bicyclists and pedestrians because adding lanes increases the distance bicyclists and pedestrians must cross to navigate the intersection, increasing their exposure to vehicles. With



intersection improvements for approaches on Lightfighter Drive, there would be secondary effect on bicyclist and pedestrian travel along the existing crossings and planned Class IV bicycle facilities for Lightfighter Drive as level of comfort for pedestrians and bicyclists decreases with widening of streets. Please refer to the discussion of potential secondary effects resulting from implementation of the road improvements below.

- Option 2 – Roundabout: A two-lane roundabout is proposed at this intersection under the Campus Town Specific Plan and is in line with the goals of the new *Seaside 2040 General Plan*. A roundabout was also tested to improve the deficiencies at this intersection and was found to address the deficiency. Delays were found to be slightly less than Option 1 (signalized intersection).

As previously noted, an important design consideration for multi-lane roundabouts is the bicycle and pedestrian crossings across two approach/departure lanes. Refer to further discussion of the impact of multi-lane roundabouts to bicyclists and pedestrians in the **Secondary Effects of Intersection Improvements** section.

**Intersection 39: General Jim Moore Boulevard and Gigling Road (Seaside):** Two improvement options at this intersection are possible.

- Option 1 – Lane geometry improvement: Adding a second westbound left lane would improve intersection operations and queueing. This would address the deficiency at this intersection.

As previously noted, increasing vehicle capacity by widening streets generally has a detrimental effect on bicyclists and pedestrians because adding lanes increases the distance bicyclists and pedestrians must cross to navigate the intersection, increasing their exposure to vehicles. With intersection improvements for approaches on Gigling Road, the secondary effect on planned bicycle facilities for Gigling Road would continue as level of comfort for bicyclists decreases with widening of streets. Please refer to the discussion of potential secondary effects resulting from implementation of the road improvements below.

- Option 2 – Roundabout: A two-lane roundabout is proposed at this intersection under the Campus Town Specific Plan and is in line with the goals of the new *Seaside 2040 General Plan*. A roundabout was tested to improve the deficiencies at this intersection due to the CSUMB expansion and was found to address the deficiency. Delays were found to be slightly less than Option 1 (signalized intersection).

As previously noted, an important design consideration for multi-lane roundabouts is the bicycle and pedestrian crossings across two approach/departure lanes. Specifically, multi-lane roundabouts without controlled pedestrian and bicycling crossings have an inherent “double threat” to pedestrians and bicyclists. For example, a visually impaired pedestrian needs adequate guidance (design features and/or control devices) to know when to enter the street as vehicles and bicyclist yield to the pedestrian. Therefore, each double lane approach/departure should include sufficient design features (staged crossing one lane at a time, bypass lanes) and control devices (signalization,



yield control, etc.) to accommodate all users, especially visually impaired pedestrians and elderly users.

**Intersection 47: General Jim Moore Boulevard and Coe Avenue (Seaside):** Signalizing the intersection and optimizing the cycle length and splits would improve intersection operations and queuing. This intersection met peak hour signal warrants. These improvements would address the deficiency at this intersection.

Improvements are summarized in **Table 46**. As shown on the table, with implementation of the improvements, operations at each intersection would improve, and deficiencies attributed to the Project would be reduced below the local jurisdiction's thresholds at nine of the 12 intersections; the three exceptions are: Reservation Road and Imjin Parkway (Int. 12); Eighth Avenue and Inter-Garrison Road (Int. 22); and Davis Road and Reservation Road (Int. 28), which would each continue to exceed the applicable LOS threshold, even with implementation of the improvements. **Appendix O** shows the delays, LOS results for without and with improvements for all study intersections with a level of service deficiency under Cumulative with Project and without Eastside Parkway Conditions.



**TABLE 46: CUMULATIVE WITH PROJECT AND WITHOUT EASTSIDE PARKWAY CONDITIONS  
INTERSECTION IMPROVEMENTS SUMMARY**

| Intersection  | Improvements <sup>3</sup>   | Peak Hour <sup>1</sup> | Intersection Operations                         |                  |  |                  |   |                  |
|---|---|------------------------|---|------------------|--|------------------|---|------------------|
|   |   |                        | Without Project Conditions Without Improvements |                  | With Project Conditions Without Improvements |                  | With Project Conditions With Improvements |                  |
|   |   |                        | Delay   | LOS <sup>2</sup> | Delay  | LOS <sup>2</sup> | Delay                                     | LOS <sup>2</sup> |
| 3 SR 1 Southbound Ramps and Imjin Parkway <sup>4</sup>    | Add WBL. Convert off-ramp to loop ramp equivalent   | AM                     | >120  | F                | >120   | F                | - <sup>4</sup>                            | A                |
|   |   | PM                     | >120  | F                | >120   | F                | - <sup>4</sup>                            | A                |
| 5 Second Avenue and Imjin Parkway                         | Add third NBL, second NBR. Add third WBL, two WBTR, and convert shared WBTR to WBR. Add second SBL, second SBT, convert shared SBTR to SBR. Add second EBL, third EBT, convert shared EBTR to two SBR | AM                     | 51.2  | D                | 59.9   | F                | 20.7                                      | C                |
|   |   | PM                     | 73.6  | E                | 81.2   | F                | 24.7                                      | C                |
| 10 Imjin Road and Imjin Parkway                           | Add second WBL  | AM                     | 14.4  | B                | 28.3   | C                | 13.5                                      | B                |
|   |   | PM                     | 24.7  | C                | 62.2   | E                | 30.3                                      | C                |
| 12 Reservation Road and Imjin Parkway                     | Add third SBT   | AM                     | 43.8  | D                | 48.4   | D                | 37.2                                      | D                |
|   |   | PM                     | 107.0   | F                | 119.7  | F                | 96.2                                      | F                |
| 14 Inter-Garrison Road and Reservation Road               | Add second NBL  | AM                     | 22.1  | C                | 43.3   | D                | 13.9                                      | B                |
|   |   | PM                     | 41.8  | D                | 80.4   | F                | 43.8                                      | D                |
| 22 Eighth Avenue and Inter-Garrison Road                  | Option 1 - Signalize, optimize signal timings, and add two WBL<br>Option 2 - Add second circulating lane to roundabout and add WBL  | AM                     | 107.6   | F                | >120   | F                | 64.6                                      | E                |
|   |   | PM                     | 28.5  | D                | 114.3  | F                | 97.9                                      | F                |
| 23 Abrams Drive and Inter-Garrison Road                   | Add second EBL  | AM                     | 33.4  | C                | 76.9   | E                | 42.7                                      | D                |
|   |   | PM                     | 32.6  | C                | 74.1   | E                | 12.5                                      | B                |
| 25 Inter-Garrison Road Connection and Inter-Garrison Road | Signalize intersection optimize cycle length and splits   | AM                     | 39.9  | E                | 80.7   | F                | 24.1                                      | C                |
|   |   | PM                     | 17.3  | C                | 34.5   | D                | 16.7                                      | B                |
| 28 Davis Road and Reservation Road                        | Add second EBL  | AM                     | 88.8  | F                | >120   | F                | 52.1                                      | D                |
|   |   | PM                     | >120  | F                | >120   | F                | 96.6                                      | F                |



**TABLE 46: CUMULATIVE WITH PROJECT AND WITHOUT EASTSIDE PARKWAY CONDITIONS INTERSECTION IMPROVEMENTS SUMMARY**

| Intersection                                       | Improvements <sup>3</sup>   | Peak Hour <sup>1</sup> | Intersection Operations                         |                  |  |                  |   |                  |
|--|---|------------------------|---|------------------|--|------------------|---|------------------|
|  |   |                        | Without Project Conditions Without Improvements |                  | With Project Conditions Without Improvements |                  | With Project Conditions With Improvements |                  |
|  |   |                        | Delay   | LOS <sup>2</sup> | Delay  | LOS <sup>2</sup> | Delay                                     | LOS <sup>2</sup> |
| 33<br>General Jim Moore Boulevard and Lightfighter | <u>Option 1</u> - Add third NBL, second NBT. Add SBR and overlap phase. Add second EBL. Add second WBL and second WBT. Optimize cycle length and splits | AM                     | 33.7  | C                | <b>79.6</b>                                  | <b>E</b>         | 17.8                                      | B                |
|  |   | PM                     | 24.4  | C                | 29.1   | C                | 27.6                                      | C                |
|  |   | AM                     | 33.7  | C                | <b>79.6</b>                                  | <b>E</b>         | 13.7                                      | B                |
|  |   | PM                     | 24.4  | C                | 29.1   | C                | 12.2                                      | B                |
|  |   | AM                     | 30.6  | C                | <b>51.8</b>                                  | <b>D</b>         | 23.3                                      | C                |
|  |   | PM                     | 22.5  | C                | <b>56.0</b>                                  | <b>E</b>         | 36.9                                      | D                |
| 39<br>General Jim Moore Boulevard and Gigling Road | <u>Option 2</u> - Roundabout design   | AM                     | 30.6  | C                | <b>51.8</b>                                  | <b>D</b>         | 24.8                                      | C                |
|  |   | PM                     | 22.5  | C                | <b>56.0</b>                                  | <b>E</b>         | 14.0                                      | B                |
| 47<br>General Jim Moore Boulevard and Coe Avenue   | Signalize intersection and optimize signal timings  | AM                     | <b>113.7</b>                                    | <b>F</b>         | <b>&gt;120</b>                               | <b>F</b>         | 21.7                                      | C                |
|  |   | PM                     | <b>30.4</b>                                     | <b>D</b>         | <b>35.2</b>                                  | <b>E</b>         | 6.0                                       | A                |

Notes: **Bold text** indicates intersection operates at unacceptable level of service. **Bold and highlighted text** indicates an intersection deficiency.

\*Indicates unsignalized intersection.

1. AM = AM peak hour, PM = PM peak hour.

2. LOS = Level of Service. The method described in the *Highway Capacity Manual* (HCM) (Transportation Research Board) was used to prepare the LOS calculations for the signalized study intersections. This method analyzes intersection operations based on average control delay per vehicle. Control delay includes the initial deceleration delay, queue move-up time, stopped delay, and final acceleration delay. The average control delay is calculated using Synchro analysis software and is correlated to a LOS designation

3. EB = Eastbound, WB = Westbound, NB = Northbound, SB = Southbound; T = Through, L = Left-turn, R = Right-turn, LTR = Shared Left-Through-Right Lane, TR = Shared Through-Right Lane, TL = Shared Through-Left Lane.

4. The draft improvement would remove potential conflicting turn movements at this intersection, which removes vehicle control delay at this intersection.

Source: Fehr & Peers, 2019.

### Cumulative with Project and without Eastside Parkway Conditions – Planned Roundabouts Improvements

The *Draft Seaside 2040 General Plan and the Campus Town Specific Plan* proposes roundabouts for General Jim Moore Boulevard and Lightfighter Drive (Int. 33) and General Jim Moore Boulevard and Gigling Road (Int. 39). Along with these proposed roundabouts, there are two roundabouts proposed as part of the



concepts for the Imjin Parkway widening, which is a planned regional transportation plan improvement. The roundabouts associated with the Imjin Parkway widening would be constructed at Imjin Road and Imjin Parkway (Int. 10), and Abrams Drive and Imjin Parkway (Int. 11). The planned roundabout configurations are described below. These planned roundabout improvements were evaluated in the Cumulative without and with Project and without Eastside Parkway Conditions to determine if the desired improvements serve the future traffic, including the Project. **Table 47** summarizes the delays and LOS results with the roundabout improvements for Cumulative with Project and without Eastside Parkway Conditions.

- Int 10. Imjin Parkway widening at Imjin Road and Imjin Parkway:
  - Two-Lane Roundabout
  - Northbound: Two entry lanes (left lane and right turn lane) and one exit lane
  - Eastbound Leg: Two entry lanes (shared through-left and shared through-right lane) and two exit lanes
  - Westbound: Two entry lanes (shared through-left and through lane) and two exit lanes
- Int 11. Abrams Drive and Imjin Parkway:
  - Two-Lane Roundabout
  - Northbound: One entry through-left lane and bypass right turn lane, and one exit lane
  - Eastbound Leg: Two entry lanes (shared through-left and shared through-right lane) and two exit lanes
  - Southbound: One entry through-left lane and bypass right turn lane, and one exit lane
  - Westbound Leg: Two entry lanes (shared through-left and shared through-right lane) and two exit lanes
- Int 33. General Jim Moore Boulevard and Lightfighter Drive:
  - Two-Lane Roundabout
  - Northbound: Two entry lanes (left lane and shared left-through-right lane) and two exit lanes
  - Eastbound Leg: Two entry lanes (shared left-through-right lane and right lane) and two exit lanes
  - Southbound: Two entry lanes (shared through-left and shared through-right lane) and two exit lanes
  - Westbound Leg: Two entry lanes (shared through-left and shared through-right lane) and two exit lanes
- Int 39. General Jim Moore Boulevard and Gigling Road:
  - Two-Lane Roundabout
  - Northbound: Two entry lanes (shared through-left and shared through-right lane) and two exit lanes



- o Eastbound Leg: Two entry lanes (shared through-left and shared through-right lane) and two exit lanes
- o Southbound: Two entry lanes (shared through-left and shared through-right lane) and two exit lanes
- o Westbound Leg: Two entry lanes (shared through-left and shared through-right lane) and two exit lanes

The roundabout improvements would increase the delay of the Imjin Parkway intersections and would result in deficient operations in the PM peak hour at Abrams Drive and Imjin Parkway (Int. 11), which was not previously identified as a deficient intersection in the analysis above. The roundabout improvements for the General Jim Moore Boulevard intersections would result in reduced delay. The roundabout improvements are also presented above for General Jim Moore Boulevard and Lightfighter Drive (Int. 33) and General Jim Moore Boulevard and Gigling Road (Int. 39) to address the intersection deficiencies.

**TABLE 47: ROUNDABOUT IMPROVEMENTS INTERSECTION LEVEL OF SERVICE**

| #  | Intersection                                       | Intersection Control | Jurisdiction (LOS Standard) <sup>1</sup> | Peak Hour <sup>2</sup> | Cumulative without Project without Roundabout Improvement |                  | Cumulative with Project without Roundabout Improvement |                  | Cumulative with Project with Roundabout Improvement |                  |
|----|--|----------------------|--|------------------------|---|------------------|--|------------------|---|------------------|
|    |  |                      |  |                        | Delay <sup>3</sup>  | LOS <sup>4</sup> | Delay <sup>3</sup>                                     | LOS <sup>4</sup> | Delay <sup>3</sup>                                  | LOS <sup>4</sup> |
| 10 | Imjin Road and Imjin Parkway                       | Roundabout           | M (D)                                    | AM                     | 14.4  | B                | 28.3   | C                | 28.7  | D                |
|    |  |                      |  | PM                     | 24.7  | C                | <b>62.2</b>  | <b>E</b>         | <b>85.2</b>   | <b>F</b>         |
| 11 | Abrams Drive and Imjin Parkway                     | Roundabout           | M (D)                                    | AM                     | 15.3  | B                | 20.9   | C                | 26.5  | D                |
|    |  |                      |  | PM                     | 17.4  | B                | 23.9   | C                | <b>71.2</b>   | <b>F</b>         |
| 33 | General Jim Moore Boulevard and Lightfighter Drive | Roundabout           | S (C)                                    | AM                     | 33.7  | C                | <b>79.6</b>  | <b>E</b>         | 13.7  | B                |
|    |  |                      |  | PM                     | 24.4  | C                | 29.1   | C                | 12.2  | B                |
| 39 | General Jim Moore Boulevard and Gigling Road       | Roundabout           | S (C)                                    | AM                     | 30.6  | C                | <b>51.8</b>  | <b>D</b>         | 24.8  | C                |
|    |  |                      |  | PM                     | 22.5  | C                | <b>56.0</b>  | <b>E</b>         | 14.0  | B                |

Notes: **Bold text** indicates intersection operates at unacceptable level of service. **Bold and highlighted text** indicates an intersection deficiency.

\*Indicates unsignalized intersection.

1. Intersection jurisdiction and associated LOS threshold applied.

i. City of Marina = M





- ii. City of Seaside = S
2. AM = AM peak hour, PM = PM peak hour.
3. LOS = Level of Service. The method described in the *Highway Capacity Manual* (HCM) (Transportation Research Board) was used to prepare the LOS calculations for the signalized study intersections. This method analyzes intersection operations based on average control delay per vehicle. Control delay includes the initial deceleration delay, queue move-up time, stopped delay, and final acceleration delay. The average control delay is calculated using Synchro analysis software and is correlated to a LOS designation  
Source: Fehr & Peers, 2019.

### Cumulative with Project and with Eastside Parkway Conditions

Under the Cumulative with Project and with Eastside Parkway Conditions, implementation of the Project would increase motor vehicle traffic and congestion, resulting in operational deficiencies at the following intersections. The localized improvements identified below would incrementally improve intersection operations and, in some cases, improve street connectivity. The intersections with operation deficiencies and corresponding improvements are further described below.

However, because all but one of the improvements under this “with Eastside Parkway” scenario were previously described under the “without Eastside Parkway” scenario presented above, no further description of these improvements is necessary and reference to the preceding section is provided; description is provided only as to those improvements not previously described.

**Intersection 3: SR 1 Southbound Ramps and Imjin Parkway (Caltrans):** Refer to prior discussion under Cumulative with Project and without Eastside Parkway Conditions.

**Intersection 5: Second Avenue and Imjin Parkway (Marina):** Refer to prior discussion under Cumulative with Project and without Eastside Parkway Conditions.

**Intersection 12: Reservation Road and Imjin Parkway (Marina):** Refer to prior discussion under Cumulative with Project and without Eastside Parkway Conditions.

**Intersection 14: Inter-Garrison Road and Reservation Road (Monterey County):** Refer to prior discussion under Cumulative with Project and without Eastside Parkway Conditions.

**Intersection 22: Eighth Avenue and Inter-Garrison Road (Monterey County/CSUMB):** Two improvement options have been identified:

- Option 1 – Signalization of intersection: This intersection meets peak hour signal warrant in the Cumulative with Project and with Eastside Parkway Conditions; therefore, the improvements evaluated for Option 1 include signalization and optimization of the cycle length and splits. This would address the deficiency at the intersection.
- Option 2 – Add second inside turning lane in roundabout and add a westbound left approaching lane: This option explores improvements that consider enhance the operations of the intersection



assuming the intersection remains as a roundabout. Adding a second inside turning lane, a dedicated westbound left lane, and a second receiving leg on the south leg would make a significant improvement to the intersection operations and queuing during both the AM and PM peak hours. This would address the deficiency at the intersection.

**Intersection 25: East Garrison Road and Reservation Road (Monterey County):** Refer to prior discussion under Cumulative with Project and without Eastside Parkway Conditions.

**Intersection 28: Davis Road and Reservation Road (Monterey County):** Refer to prior discussion under Cumulative with Project and without Eastside Parkway Conditions.

**Intersection 33: General Jim Moore Boulevard and Lightfighter Road (Seaside):** Refer to prior discussion under Cumulative with Project and without Eastside Parkway Conditions.

**Intersection 39: General Jim Moore Boulevard and Gigling Road (Seaside):** Refer to prior discussion under Cumulative with Project and without Eastside Parkway Conditions.

**Intersection 46: General Jim Moore Boulevard and Normandy Road (Seaside):** Reconfigure the intersection based on the improvements identified in *The Dunes at Monterey Bay EIR (2005)*. These improvements include:

- Adding a third northbound through lane and third southbound through lane
- Optimizing traffic signal cycle length and splits

**Appendix O** shows the delays, LOS, and changes in critical volume-to-capacity ratio and delay used to identify deficiencies at the study intersections under the Cumulative with Project and with Eastside Parkway Conditions. Improvements are described below and summarized in **Table 48**. As shown on the table, with implementation of the improvements, operations at each intersection would improve, and deficiencies attributed to the Project would be reduced below the local jurisdiction's thresholds at six of the ten intersections; the three exceptions are: Inter-Garrison Road and Reservation Road (Int. 14); East Garrison Road and Reservation Road (Int. 25); Davis Road and Reservation Road (Int. 28); and General Jim Moore Boulevard and Normandy Road (Int. 46), which would each continue to exceed the applicable LOS threshold, even with implementation of the improvements.



**TABLE 48: CUMULATIVE WITH PROJECT AND WITH EASTSIDE PARKWAY CONDITIONS  
INTERSECTION IMPROVEMENTS SUMMARY**

| Intersection   | Improvements <sup>3</sup>  | Peak Hour <sup>1</sup> | Intersection Operations                         |                  |  |                  |   |                  |
|--|--|------------------------|---|------------------|--|------------------|---|------------------|
|  |  |                        | Without Project Conditions Without Improvements |                  | With Project Conditions Without Improvements |                  | With Project Conditions With Improvements |                  |
|  |  |                        | Delay   | LOS <sup>2</sup> | Delay  | LOS <sup>2</sup> | Delay                                     | LOS <sup>2</sup> |
| 3 SR 1 Southbound Ramps and Imjin Parkway <sup>4</sup> | Refer to Cumulative with Project Improvement in <b>Table 46.</b>   | AM                     | >120  | F                | >120   | F                | - <sup>4</sup>                            | A                |
|  |  | PM                     | >120  | F                | >120   | F                | - <sup>4</sup>                            | A                |
| 5 Second Avenue and Imjin Parkway                      | Refer to Cumulative with Project and without Eastside Parkway Conditions Improvement in <b>Table 46.</b>                   | AM                     | 55.3  | E                | 60.8   | E                | 20.2                                      | C                |
|  |  | PM                     | 54.8  | D                | 65.6   | E                | 21.6                                      | C                |
| 12 Reservation road and Imjin Parkway                  | Refer to Cumulative with Project and without Eastside Parkway Conditions Improvement in <b>Table 46.</b>                   | AM                     | 25.7  | C                | 26.1   | C                | 23.6                                      | C                |
|  |  | PM                     | 55.6  | E                | 61.5   | E                | 49.9                                      | D                |
| 14 Inter-Garrison Road and Reservation Road            | Refer to Cumulative with Project and without Eastside Parkway Conditions Improvement in <b>Table 46.</b>                   | AM                     | 117.8   | F                | >120   | F                | 16.3                                      | B                |
|  |  | PM                     | >120  | F                | >120   | F                | 66.6                                      | E                |
| 22 Eighth Avenue and Inter-Garrison Road               | <u>Option 1</u> – Refer to Cumulative with Project and without Eastside Parkway Conditions Improvement in <b>Table 46.</b> | AM                     | 50.5  | F                | >120   | F                | 12.7                                      | B                |
|  |  | PM                     | 14.7  | B                | 33.9   | D                | 11.3                                      | B                |
|  |  | AM                     | 50.5  | F                | >120   | F                | 12.2                                      | B                |
|  |  | PM                     | 14.7  | B                | 33.9   | D                | 14.1                                      | B                |
| 25 East Garrison Road and Reservation Road             | Refer to Cumulative with Project and without Eastside Parkway Conditions Improvement in <b>Table 46.</b>                   | AM                     | >120  | F                | >120   | F                | 56.8                                      | E                |
|  |  | PM                     | >120  | F                | >120   | F                | 51.3                                      | D                |
| 28 Davis Road and Reservation Road                     | Refer to Cumulative with Project and without Eastside Parkway Conditions Improvement in <b>Table 46.</b>                   | AM                     | >120  | F                | >120   | F                | 77.7                                      | E                |
|  |  | PM                     | >120  | F                | >120   | F                | >120                                      | F                |



**TABLE 48: CUMULATIVE WITH PROJECT AND WITH EASTSIDE PARKWAY CONDITIONS INTERSECTION IMPROVEMENTS SUMMARY**

| Intersection                                     | Improvements <sup>3</sup>  | Peak Hour <sup>1</sup> | Intersection Operations                         |                  |  |                  |   |                  |
|--|--|------------------------|---|------------------|--|------------------|---|------------------|
|  |  |                        | Without Project Conditions Without Improvements |                  | With Project Conditions Without Improvements |                  | With Project Conditions With Improvements |                  |
|  |  |                        | Delay   | LOS <sup>2</sup> | Delay  | LOS <sup>2</sup> | Delay                                     | LOS <sup>2</sup> |
| 33 General Jim Moore Boulevard and Lightfighter  | Option 1 – Refer to Cumulative with Project and without Eastside Parkway Conditions Improvement in Table 46. | AM                     | 71.6  | E                | >120   | F                | 19.2                                      | B                |
|  |  | PM                     | 33.0  | C                | 43.6   | D                | 18.4                                      | B                |
|  |  | AM                     | 71.6  | E                | >120   | F                | 15.1                                      | C                |
|  |  | PM                     | 33.0  | C                | 43.6   | D                | 12.2                                      | B                |
| 39 General Jim Moore Boulevard and Gigling Road  | Option 1 – Refer to Cumulative with Project and without Eastside Parkway Conditions Improvement in Table 46. | AM                     | 38.5  | D                | 65.3   | E                | 17.9                                      | B                |
|  |  | PM                     | 114.7   | F                | >120   | F                | 17.2                                      | B                |
|  |  | AM                     | 38.5  | D                | 65.3   | E                | 24.6                                      | C                |
|  |  | PM                     | 114.7   | F                | >120   | F                | 32.4                                      | D                |
| 46 General Jim Moore Boulevard and Normandy Road | Add third NBT, third SBT, optimized cycle length and splits  | AM                     | 65.3  | E                | 70.4   | E                | 59.4                                      | E                |
|  |  | PM                     | 18.7  | B                | 20.4   | C                | 13.6                                      | B                |

Notes: **Bold text** indicates intersection operates at unacceptable level of service. **Bold and highlighted text** indicates an intersection deficiency.

\*Indicates unsignalized intersection.

1. AM = AM peak hour, PM = PM peak hour.

2. LOS = Level of Service. The method described in the *Highway Capacity Manual* (HCM) (Transportation Research Board) was used to prepare the LOS calculations for the signalized study intersections. This method analyzes intersection operations based on average control delay per vehicle. Control delay includes the initial deceleration delay, queue move-up time, stopped delay, and final acceleration delay. The average control delay is calculated using Synchro analysis software and is correlated to a LOS designation

3. EB = Eastbound, WB = Westbound, NB = Northbound, SB = Southbound; T = Through, L = Left-turn, R = Right-turn, LTR = Shared Left-Through-Right Lane, TR = Shared Through-Right Lane, TL = Shared Through-Left Lane.

4. The draft improvement would remove potential conflicting turn movements at this intersection, which removes vehicle control delay at this intersection.

Source: Fehr & Peers, 2019.



Although the improvements would not improve operations at the intersection to an acceptable LOS, the improvements would reduce the intersection AM peak hour delay below the Cumulative without Project with Eastside Parkway scenario results and address the deficiency.

While the improvements would reduce the Project's identified deficiency, an important design consideration is the secondary impacts to pedestrian and bicyclist operations. The road widening would affect the crossing length and time bicyclists and pedestrians spend in front of vehicles. The intersection improvement to further widen the northbound and southbound approach for additional turning lanes would require widening beyond restriping, which would affect the available right of way used of existing and proposed Class I shared use path along General Jim Moore Boulevard. Please refer to the discussion of potential secondary effects resulting from implementation of the road improvements below.

## FREEWAY SEGMENTS

Deficiencies for freeway segments were determined based on the criteria described in the **Deficiencies Criteria** section of this chapter.

### Existing with Project Conditions

For the Existing with Project Conditions, the Project would result in deficiencies at the following segments:

- Southbound SR 1 between Lightfighter Drive and Fremont Boulevard-Del Monte Boulevard during the AM peak hour
- Southbound SR 1 between Fremont Boulevard-Del Monte Boulevard and Canyon Del Rey during the AM Peak hour
- Northbound SR 1 between Fremont Boulevard-Del Monte Boulevard and Canyon Del Rey during the PM Peak hour

### Cumulative with Project and without Eastside Parkway Conditions

For the Cumulative with Project and without Eastside Parkway Conditions, the Project's effect on traffic would be cumulatively considerable, thereby resulting in deficiencies at the following segments:

- Southbound SR 1 between Lightfighter Drive and Fremont Boulevard-Del Monte Boulevard during the AM peak hour
- Southbound SR 1 between Fremont Boulevard-Del Monte Boulevard and Canyon Del Rey during the AM Peak hour and PM peak hour
- Northbound SR 1 between Lightfighter Drive and Fremont Boulevard-Del Monte Boulevard during the PM peak hour



- Northbound SR 1 between Fremont Boulevard-Del Monte Boulevard and Canyon Del Rey during the PM Peak hour

### **Cumulative with Project and with Eastside Parkway Conditions**

Similar to the Cumulative with Project and without Eastside Parkway Conditions, the Cumulative with Project and with Eastside Parkway Conditions would have the same freeway deficiencies, except at the southbound segment between Lightfighter Drive and Fremont Boulevard-Del Monte Boulevard in the AM peak hour. The addition of the Eastside Parkway would result in shifts of traffic that could result in a reduced number of Project traffic traveling along this segment of SR 1, thereby eliminating the deficiency at this location.

### **Freeway Improvements**

As part of the *2040 Metropolitan Transportation Plan / Sustainable Communities Strategy* (2018), there is a planned improvement to widen SR 1 to six lanes from Fremont Boulevard-Del Monte Boulevard to Canyon Del Rey Boulevard. This planned improvement would increase capacity and could improve operations along a segment that performs deficiently with the addition of Project traffic and PDFs; thus, addressing the deficiencies on the northbound and southbound SR 1 segments between Fremont Boulevard-Del Monte Boulevard and Canyon Del Rey Boulevard. However, since there is no assurance that the funding will be available, the deficiency would remain as there is no other feasible mitigation.

There are no planned widening improvements for SR 1 north of Fremont Boulevard-Del Monte Boulevard that would address the between Lightfighter Drive and Fremont Boulevard-Del Monte Boulevard. As part of the TAMC 2014 Regional Transportation Plan, the proposed improvements for transit capacity along SR 1 and widening of interchanges of SR 1 would not widen or directly increase vehicle capacity along SR 1. As such, there is no feasible improvement available, and the deficiency would remain.

## **SECONDARY EFFECTS OF INTERSECTION IMPROVEMENTS**

As discussed above, various types of intersection improvements could address the identified deficiencies. These improvements vary in size and type, including reconfiguring intersection approaches, adding lanes, and other types of improvements. Secondary effects associated with widening intersections for vehicle movements include effects relating to pedestrians and bicyclists; that is, the need for additional right of way, removal of trees, relocation of utilities, lengthening of crosswalks, and/or modification of signal phasing could increase the crossing distance/time for pedestrians and bicyclists, thereby resulting in potential safety related impacts.

Where dual right-turn lanes are proposed, they could result in a double threat condition for pedestrians and bicyclists. The double threat for pedestrians and bicyclist may be reduced by implementing a no right-turn on red for movements that have two right-turn lanes. However, despite the implementation of the no



right-turn on red, there continues to be a secondary impact to pedestrians and bicyclists caused by the increased crossing distance on all legs of the intersection.

Widening of a roundabout as discussed for Eighth Avenue and Inter-Garrison Road (Int. 22) would result in the need for additional right of way and widening of approaches and exiting lanes. The widening of approaches and exiting lanes would lengthen crosswalks. Although a separated shared use path is provided for bicyclists through the roundabout, there continues to be a secondary impact to bicyclists caused by increased crossing distances and widening affecting the width and length of the separated shared use path unless a tunnel or bridge are constructed. An important design consideration for multi-lane roundabouts is the bicycle and pedestrian crossings across two approach/departure lanes. Specifically, multi-lane roundabouts without controlled pedestrian and bicycling crossings could have an inherent “double threat” to pedestrians and bicyclists. For example, a visually impaired pedestrian needs adequate guidance (design features and/or control devices) to know when to enter the street as vehicles and bicyclist yield to the pedestrian. Therefore, each double lane approach/departure should include sufficient design features (staged crossing one lane at a time, bypass lanes) and control devices (signalization, yield control, etc.) to accommodate all users, especially visually impaired pedestrians and elderly users.



**APPENDIX A: CSUMB MASTER PLAN EIR – TRIP GENERATION  
EVALUATION METHODS AND ESTIMATES**







## MEMORANDUM

Date: November 9, 2021

To: Anya Spear and Matt McCluney, California State University Monterey Bay  
Steve Lohr and Dawn Theodora, California State University Office of the Chancellor  
Ann Sansevero, Dudek

From: Daniel Rubins, Jane Bierstedt, and Matt Haynes, Fehr & Peers

**Subject: California State University Monterey Bay Master Plan EIR – Trip Generation Evaluation Methods and Estimates**

*SJ17-1728*

---

This memorandum describes the trip generation for the proposed California State University Monterey Bay (CSUMB) Master Plan, including Project Design Features (PDFs) drawn from the CSUMB Master Plan Guidelines (the Project).

### MEMORANDUM ORGANIZATION

This technically oriented memorandum provides an overview of the Project relative to transportation related matters with four sections: (1) project description, (2) technical methods, (3) trip generation estimates, and 4) summary. The purpose of each section is described below.

- Project Description: This section describes the populations under Existing Conditions and Project Conditions for the CSUMB Main Campus and East Campus that are the basis of this trip generation analysis.
- Technical Methods: The trip generation approach and technical methods are unique because of the size of the CSUMB campus, the unique travel behavior of each portion of the CSUMB population, and varied housing locations of the CSUMB population. Rather than calculating the net increase in project vehicle trips due to the net increase in land use intensity like most projects, the trip generation is prepared for the entire campus (see **Figure 1** for CSUMB campus boundary encompassing Main Campus, East Campus Open Space and East Campus) under Existing Conditions and Project Conditions to capture the



effects of adding student on-campus housing to the Main Campus and shifting of student housing from East Campus to Main Campus, and increasing the portion of faculty and staff living in the East Campus. Specifically, the net new project traffic is the difference between the Project Conditions and Existing Conditions CSUMB campus trip generation. As shown in the analysis, housing a greater percentage of students, faculty and staff on-campus increases the:

- Likelihood of trips staying within the campus (internal trips); and
- Likelihood of trips shifting to other modes (walking, bicycling, micro-mobility, and transit) for both on- and off-campus travel.

This section has three subsections:

- Trip Types and Assumptions: This section describes and illustrates the five trip types studied for the CSUMB Campus and the boundaries used for the trip generation analysis. It also discusses key assumptions and definitions.
- Existing Trip Generation and Travel Characteristics: The Existing Conditions trip generation estimates for the Main Campus and East Campus are based on the *CSUMB Person Trip Travel Survey* conducted by CSUMB staff and analyzed by Fehr & Peers, Main Campus cordon trips from the annual *CSUMB 2016-2017 Traffic Generation* report (Mott MacDonald, November 2017), and the East Campus vehicle cordon counts conducted by Fehr & Peers. This section summarizes the person trip generation, vehicle trip generation and mode share data for those traveling between East Campus and Main Campus, and between Main Campus and off-Campus.
- Trip Generation Rates: This section summarizes the trip generation rates for two vehicle cordons and three sub-cordons. This section also summarizes by reference to an attachment the Existing Conditions and Project Conditions vehicle trip generation rates for the three campus population types (students, faculty and staff) on an FTE basis.
- Trip Generation Estimates: The vehicle trip generation for the CSUMB campus under Existing Conditions and Project Conditions is presented in this section. The total trip generation estimates are provided for the Main Campus and East Campus, as well as total numbers for the entire campus.



- Summary: The memorandum concludes with a summary of the net increase in trip generation between Existing Conditions and Project Conditions. This is the amount of added project traffic that will be evaluated in the transportation analysis (TA).

## PROJECT DESCRIPTION

The Project is the CSUMB Master Plan. Project elements that affect the transportation system include the proposed increase in enrollment, the on-campus housing for students, faculty, and staff, and a Main Campus street and parking system that facilitates and prioritizes walking, bicycling, and transit use over vehicle travel. Upon buildout, the Project would accommodate an increase in campus enrollment from the existing 6,634 full time equivalent students (FTES)<sup>1</sup> and 1,024 full time equivalent faculty/staff (FTEF),<sup>2</sup> to 12,700 FTES and 1,776 FTEF. Under Project Conditions, it is projected that the Project would house at least 60 percent of enrolled students and 65 percent of faculty and staff on campus (PDF-LU-5 and PDF-LU-6, as described in Chapter 3 of the proposed CSUMB Master Plan Draft EIR). As explained in the *California State University, Monterey Bay Proposed Master Plan Housing Memorandum* (see **Attachment A**), the Project Conditions on-campus student housing rate is similar to the existing on-campus student rates, and the Project Conditions on-campus faculty and staff housing rate is expected to increase based on various policies, programs and procedures to be implemented over the coming years.

**Table 1** summarizes the number and percentage of students, faculty, and staff presently residing on- and off-campus (Existing Conditions), and the number forecasted to reside on- and off-campus under Project Conditions when FTES enrollment and FTEF employment total reaches 14,476.

---

<sup>1</sup> Full-time equivalent (FTE) is the unit of measurement used to convert class load to student enrollment. At CSUMB, one FTE is equal to 15 units. Thus, one FTE is equal to one student enrolled in 15 units or three students each enrolled in 5 units. A related unit of measurement is "headcount." In the case of one student taking 15 units, the headcount is 1; in the case of three students collectively taking 15 units, the headcount is 3.

<sup>2</sup> According to CSUMB Institutional Assessment and Research, 1 FTE = full time faculty or staff headcount + part time faculty or staff headcount divided by 3. The faculty and staff category also includes affiliates, which are companies that have been contracted by the Corporation to provide services that the auxiliary has been asked to provide by the university (e.g., dining, bookstore, etc.), and the affiliate's employee works full-time on campus in that capacity. They are also referred to as contractors. The Auxiliary includes staff of the Corporation, Student Union and Foundation.



**TABLE 1: CSUMB POPULATION TYPE BY HOUSING LOCATION**

| Housing Location  | Existing Conditions (FTES or FTEF) <sup>1</sup> | Project Conditions (FTES or FTEF) <sup>1</sup> | Change (Project – Existing) <sup>2</sup> |
|---|---|--|--|
| <b>Student Population</b>   |   |  |  |
| Main Campus   | 2,600<br>(39.2%)                                | 7,620 <sup>3</sup><br>(60.0%)                  | +5,200                                   |
| East Campus <sup>4</sup>  | 1,380<br>(20.8%)                                | 0<br>(0%)                                      | -1,380                                   |
| Off-Campus  | 2,654<br>(40.0%)                                | 5,080<br>(40.0%)                               | +2,426                                   |
| <i>Subtotal [A]</i>   | <i>6,634</i><br><i>(100%)</i>                   | <i>12,700</i><br><i>(100%)</i>                 | <i>+6,066</i>                            |
| <b>Faculty/Staff Population</b>                                   |   |  |  |
| East Campus <sup>4</sup>  | 463<br>(45.2%)                                  | 1,154 <sup>3</sup><br>(65.0%)                  | +691                                     |
| Off-Campus  | 561<br>(54.8%)                                  | 622<br>(35.0%)                                 | +61                                      |
| <i>Subtotal [B]</i>   | <i>1,024</i><br><i>(100%)</i>                   | <i>1,776</i><br><i>(100%)</i>                  | <i>+752</i>                              |
| <b>Student, Faculty, and Staff Population (Campus Population)</b> |   |  |  |
| Main Campus and East Campus<br>(Students, Faculty and Staff)      | 4,443<br>(58.0%)                                | 8,774<br>(60.6%)                               | +4,331                                   |
| Off-Campus<br>(Students, Faculty and Staff)                       | 3,215<br>(42.0%)                                | 5,702<br>(39.4%)                               | +2,487                                   |
| <b>Total [A + B = C]</b>  | <b>7,658</b><br><b>(100%)</b>                   | <b>14,476</b><br><b>(100%)</b>                 | <b>+6,818</b>                            |
| <b>Campus Population with Community Housing Partners</b>          |   |  |  |
| East Campus<br>(Community Housing Partners) [D]                   | 280   | 66   | -214                                     |
| <b>Total [C+D = E]</b>  | <b>7,938</b>                                    | <b>14,542</b>                                  | <b>+6,604</b>                            |

Notes:

1. FTES = Full time equivalent students; FTEF = Full time equivalent faculty/staff.
2. Change (Project - Existing) = Project Conditions column – Existing Conditions column.
3. The transportation trip generation analysis uses a campus population that, meets but does not exceed the 60 percent student housing goal and the 65 faculty and staff housing goal under Project Conditions.
4. Under Existing Conditions 1,380 students, 463 faculty/staff, and 280 community housing partners live in the East Campus housing. Under Project Conditions 1,154 faculty/staff and 66 community housing partners live in the East Campus housing unless housing is needed by for campus employees.

Source: Fehr & Peers, 2019.



The total on-campus housed population (i.e., the number of students, faculty, and staff residing in either Main Campus or East Campus housing) is forecasted to increase from the existing 58 percent (4,443 of 7,658) to 61 percent (8,774 of 14,476). As space permits, community housing partners<sup>3</sup> will also reside in the East Campus housing. While community housing partners live on-campus, they are not associated with on-campus housing for students, faculty and staff, and therefore are not included in the student, faculty, and staff population total but are included in the entire campus population total in **Table 1**.

In terms of actual on-campus housing facilities, the Project would provide housing to accommodate an increase in campus population from the existing approximately 6,634 FTES to 12,700 FTES, and an increase in employees (i.e., faculty and staff) from approximately 1,024 FTEF to 1,776 FTEF.<sup>4</sup>

## TECHNICAL METHODS

The addition of students, faculty, and staff as part of the Project will increase the overall campus person and vehicle trip generation. The following sections provided a detailed accounting of the trip generation estimates by trip type, CSUMB campus population, and housing location.

### TRIP TYPES AND ASSUMPTIONS

Because of the large size of the CSUMB campus, some vehicle trips will start and end within the campus and, as such, are designated internal trips (e.g., vehicle trips between the Main Campus and East Campus or trips within Main Campus). These internal vehicle trips are considered part of the on-campus transportation analysis, and do not affect the operations of off-campus intersections and freeway segments. Only trips that travel off campus (external trips) are used to evaluate the Project's effects on external intersections and freeway segments.

To properly estimate trip generation for the entire campus, five types of vehicle trips were defined based on their origins and destinations: 1) External trips between Main Campus and Off Campus (designated below as "A" trip type), 2) External trips between East Campus and Off Campus ("B" trip type), 3) Internal trips between Main Campus and East Campus ("C" trip type), 4) Internal trips within Main Campus ("D" trip type), and 5) Internal trips between The Promontory and Main Campus ("E" trip type).

---

<sup>3</sup> Community housing partners are made up of affiliates (a subcategory of CSUMB staff), educational partners and military partners, and public sector employees working in the Monterey area.

<sup>4</sup> Existing student, faculty and staff quantities based on 2016 baseline figures provided by CSUMB staff.



The five trip types are illustrated in **Figure 1** and described below:

- **A – External Trips between Main Campus and Off Campus:**
  - This trip type is made, for example, by students living on-campus and going off-campus, students, faculty/staff living off-campus traveling to campus, as well as campus supporting/visitor trips (by visitors, deliveries, transit, and other supporting activities) that enter or exit the CSUMB Main Campus cordon. These include trips to/from Seaside, Marina, Salinas, and other nearby communities.
- **B – External Trips between East Campus and Off Campus:**
  - This trip type is made, for example, by students and faculty/staff living on East Campus that travel off-campus. This includes trips between East Campus and Seaside, Marina, Salinas, and other nearby communities.
- **C – Internal Trips between Main Campus and East Campus:**
  - This trip type is made, for example, by students and faculty/staff that travel between CSUMB's Main Campus and East Campus. These trips are internal campus trips because both trip ends are located within the entire campus cordon.
- **D – Internal Trips within Main Campus:**
  - This trip type is made, for example, by students, and campus support vehicles that travel within CSUMB's Main Campus. These trip pairs are internal campus trips because both trip ends are located within the Main campus cordon.
- **E – Internal Trips between The Promontory and Main Campus:**
  - This trip type is made, for example, by students and campus support vehicles that travel between The Promontory residential buildings and CSUMB's Main Campus. These trips are internal campus trips because both trip ends are located within the Main Campus cordon.

The Project trip generation estimates are based on existing CSUMB travel data observed at each cordon (or boundary defining a portion of the campus): 1) the Main Campus Cordon, 2) East Campus Cordon, 3) the entire CSUMB campus, 4) East Campus Sub-Cordon for Students, and 5) East Campus Sub-Cordon for faculty, staff and community housing partners (see **Figure 1** for the location of each cordon).



SJ17\_1728\_Fig01\_CSUMB Trip Pairs\_v5.ai

- California State University Monterey Bay Campus
- Main Campus Cordon
- East Campus Cordon
- Agency Boundary
- A. External Trips between Main Campus and Off-Campus
- B. External Trips between East Campus and Off-Campus
- C. Internal Trips between Main Campus and East Campus
- D. Internal Trips within Main Campus
- E. Internal Trips between The Promontory and Main Campus
- Promontory Housing Sub-Cordon Location
- East Campus Sub-Cordon for Students
- East Campus Sub-Cordon for Faculty, Staff, and Community Housing Partners



Figure 1  
CSUMB Cordons and Trip Types



The Main Campus trip generation is the sum of Main Campus internal vehicle trips and Main Campus Cordon vehicle trips (e.g., vehicle trips to/from Promontory, East Campus, and off-campus locations). East Campus Cordon count/total trip generation is the sum of the East Campus internal vehicle trips with Main Campus and East Campus external trips. This trip generation format is used throughout the memo.

In addition to the trip types, and campus cordon locations described above, the following concepts are intended to assist the reader in understanding the trip generation methods and analysis assumptions presented in the subsequent sections:

- The CSUMB campus population is the sum of full-time equivalent students, faculty, and staff. The entire campus population is the sum of full-time equivalent students, faculty, staff and Community Housing Partners.
- The CSUMB trip generation estimates do not include pass-through traffic (e.g., vehicles that use campus streets to travel through the university to other destinations without stopping).
- The CSUMB External Campus Trip Total is the sum of all Type A and B vehicle trips generated by students, faculty, staff, community housing partners plus campus supporting vehicle trips (e.g., deliveries, maintenance, etc.) and visitor trips.
- The Existing Main Campus Trip Generation is based on the Main Campus daily vehicle cordon count from the annual *CSUMB 2016-2017 Traffic Generation* memorandum, and most of the daily and peak hour vehicle data comes from the *CSUMB Person Trip Travel Survey*, and the inbound/outbound split are from either the annual *CSUMB 2016-2017 Traffic Generation*, the *CSUMB Person Trip Travel Survey*, or a combination of the two data sources.
- The Existing Main Campus Trip Generation for this analysis includes all Main Campus trips (Trip Types A, C, D, and E). In comparison, the Annual Monitoring Cordon Total Trips from the annual *CSUMB 2016-2017 Traffic Generation* memorandum includes only a portion of these trips by excluding a portion of the vehicle trips from the Promontory student housing and internal supporting vehicle trips. Thus, the daily vehicle trip generation reported for this Main Campus Cordon Trips is greater than and defined differently than the Annual Monitoring Cordon Total Trips.
- The Existing East Campus Cordon Total for this analysis includes all East Campus trips (Trip Types B and C) and is based on the East Campus Cordon counts collected in the Fall of 2017 and includes the daily and peak hour data collected from the *CSUMB Person Trip Travel Survey*.





- The Project trip generation estimates presented in this memorandum assume the existing Transportation Demand Management (TDM) and Parking Management measures remain in place on the CSUMB campus, and those measures continue to be as effective in reducing vehicle trip-making and encouraging the use of other modes. It furthermore assumes no growth in TDM and parking measures despite plans to expand these programs.
- On-campus housing vehicle trip rates are less than off-campus vehicle trip rates. Therefore, as the portion of the CSUMB population living on-campus increases, the per person vehicle trip generation rate will decrease.
- Main Campus students, campus supporting vehicle trips (e.g., deliveries, maintenance, etc.) and visitor vehicle trips are included in the trip estimates as one group because of the limited fidelity in the available travel data.

## EXISTING TRIP GENERATION AND TRAVEL CHARACTERISTICS

The vehicle trip generation estimates for Existing Conditions are based on the data sources listed below and discussed in greater detail in this section:

1. Person and Vehicle Trip Generation Data: *CSUMB Person Trip Travel Survey* conducted by CSUMB staff and analyzed by Fehr & Peers (Fall 2017);
2. Main Campus Cordon Trips: Main Campus cordon trips from the annual *CSUMB 2016-2017 Traffic Generation* report (Mott MacDonald, November 2017); and
3. East Campus Cordon Trips: East Campus Vehicle Cordon Count collected along the boundary of this portion of the campus (conducted November 2017 by Fehr & Peers).

These studies provide information on the travel behavior of students, faculty and staff living off-campus, living on the Main Campus, and living on the East Campus. Additional detail regarding the person and vehicle trip generation data, Main Campus Cordon Trips, and East Campus Cordon Trips are described in more detail below. The reader may find it useful to refer back to **Figure 1** for specific trip type or campus location definitions.

- Person and Vehicle Trip Generation Travel Data: The *CSUMB Person Trip Travel Survey (Attachment B)* includes questions of the Main Campus population to determine travel choices to/from the Main Campus, primary mode of travel, arrival and departure time on each day of the week, frequency of travel, and the frequency of vehicle use. The 2,410 responses were summarized to determine the person trip generation, vehicle trip generation and primary mode share data for those traveling between East Campus and



Main Campus, and between Main Campus and off-Campus (**Attachment C**). **Tables C-1** through **C-4** summarize the directional personal and vehicle trip rates from the Survey responses. The person and vehicle trips rates in **Tables C-5** and **C-6** were used for the peak commute direction (inbound in the morning peak hour and outbound in the evening peak hour) as described later in the memo.

Most CSUMB students, faculty, and staff residing off-campus travel to/from the campus by passenger vehicle. As shown in **Tables C-7** and **C-8** off-campus residents (see the fourth and last columns from the left in **Table C-7**) have a higher combined drive-alone and shared-ride mode share than the average work trip mode share for Monterey or Santa Cruz counties (see the third through sixth columns from the left in **Table C-8**). In contrast, on-campus residents have a lower drive-alone and shared ride mode share than either County's combined work drive-alone or shared ride mode share.

The drive-alone mode share for the Main Campus, with on- and off-campus students, is approximately 54 percent; the number is approximately 75 percent when excluding on-campus student residents (see **Table C-9**). Thus, including the on-campus student residents has a notable influence on the inbound morning peak hour mode share and illustrates the benefit on-campus housing has on shifting travel behavior from the personal vehicle to walking, bicycling and transit.

Existing Conditions vehicle trip generation rates for the Main Campus and East Campus were derived from the cordon trip counts. The Main Campus cordon trips are a calculated value per the steps described below. East Campus Cordon count comes from the counts collected along the boundary of this portion of the campus. The vehicle trip rates are further divided by campus population using the person trip travel survey trip rates referenced previously and provided in **Attachment C**.

- Main Campus Cordon Vehicle Trips: The Main Campus Cordon Trips is a calculated value that uses several data sources using the following steps.
  - Step 1 – Summary of Daily Trip Generation from Annual Trip Generation report: This step establishes daily trip generation using the Main Campus and Promontory daily trip generation estimate from the annual *CSUMB 2016-2017 Traffic*



*Generation* report. The Main Campus daily vehicle trip generation<sup>5</sup> is sourced from the annual *CSUMB 2016-2017 Traffic Generation* report. As shown in **Table 2**, the annual monitor cordon trips of 10,545 daily vehicles (see line 1), Promontory trip count of 1,518 (sum of external (see line 2) and internal (see line 3) trips), and internal campus supporting trips of 948 (line 4) are added together to estimate the Main Campus trip generation of 13,011 daily vehicles (line 5). The internal trips in the annual *CSUMB 2016-2017 Traffic Generation* report were derived from visual CSUMB permit surveys, external delivery travel data provided by CSUMB staff.

**TABLE 2: CSUMB MAIN CAMPUS DAILY VEHICLE TRIP GENERATION AND CORDON COUNTS**

|          | <b>Location (Population Type)</b>                 | <b>Trip Types<sup>1</sup></b> | <b>Daily Vehicle Trips</b> |
|----------|---|-------------------------------|----------------------------|
| 1        | Annual Monitoring Cordon Total Trips <sup>2</sup> | A+C                           | 10,545                     |
| 2        | Promontory External Trips <sup>3</sup>            | A                             | +661                       |
| 3        | Promontory Internal Trips <sup>4</sup>            | E                             | +857                       |
| 4        | Main Campus Internal Trips <sup>5</sup>           | D                             | +948                       |
| <b>5</b> | <b>Main Campus Trip Generation</b>                | <b>A+C+D+E</b>                | <b>13,011</b>              |

Notes:

FTE = Full time equivalent.

1. Trip pairs shown on Figure 1.

2. From Total CSUMB Int-Ext/Ext-Int Trips line in Exhibit 3 of the annual *CSUMB 2016-2017 Traffic Generation* memorandum.

3. From footnote 7 of Exhibit 3 of the annual *CSUMB 2016-2017 Traffic Generation* memorandum.

4. From Internal Trips line of Exhibit 3 of the annual *CSUMB 2016-2017 Traffic Generation* memorandum.

5. Calculated based on daily vehicle trip generation rate summarized in Attachment C-6 for Main Campus students. This value is calculated as follow: 142 daily vehicle trips = 0.188 daily vehicle trips per student x 756 promontory students.

Source: Fehr & Peers, 2019.

- Step 2 – Daily Trip Generation Using for CSUMB Environmental Analysis: This step allocates the CSUMB Main Campus Trip Generation of 13,011 daily vehicle trips from step 1 based on the daily vehicle trip rates derived from the *CSUMB Person Trip Travel Survey* (see **Attachment C Table C-6**), and the Promontory parking lot driveway data from the annual *CSUMB 2016-2017 Traffic Generation* report (see **Attachment D**). The daily vehicle trips for each location and population type are

---

<sup>5</sup> The Main Campus trip generation is the sum of all external vehicle trips generated by students, faculty, staff, visitors, and campus supporting personnel such as security and maintenance staff vehicles such as deliveries.



shown in **Table 3** (see notes for the daily trip rate source). For this trip generation analysis, the Main Campus Supporting Internal Trips (Trip Type D), and the Main Campus Supporting Trips and Visitor Trips (Trip Type A) are the remaining vehicle trips after applying the daily trip rates to the other housing location and population type. By using the person and vehicle trip generation data, the estimate of internal student and supporting trips is less than stated in the annual *CSUMB 2016-2017 Traffic Generation* report.

**TABLE 3: CSUMB DAILY MAIN CAMPUS TRIP GENERATION BY LOCATION AND POPULATION TYPE**

| Location (Population Type)   | Trip Types <sup>1</sup> | Population Size (FTE) | Daily Trip Rate (Vehicle Trips per FTE) <sup>2</sup> | Daily Vehicle Trips |
|--|-------------------------|-----------------------|--|---------------------|
| Main Campus Housing (Students) <sup>3</sup>                                | A                       | 1,844                 | 2.079  | 3,832               |
| Promontory Housing (Students) <sup>3</sup>                                 | A                       | 756                   | 2.079  | 1,572               |
| Off-Campus Housing (Students) <sup>2</sup>                                 | A                       | 2,654                 | 1.285  | 3,411               |
| Off-Campus Housing (Faculty and Staff) <sup>2</sup>                        | A                       | 561                   | 1.602  | 899                 |
| East Campus Housing (Students) <sup>2</sup>                                | C                       | 1,380                 | 1.030  | 1,422               |
| East Campus Housing (Faculty and Staff) <sup>2</sup>                       | C                       | 463                   | 1.618  | 749                 |
| Main Campus Housing Internal Trips (Students) <sup>2</sup>                 | D                       | 1,844                 | 0.188  | 348                 |
| Promontory Housing Internal Trips (Students) <sup>2</sup>                  | E                       | 756                   | 0.188  | 142                 |
| Main Campus Supporting Internal Trips (Campus Population) <sup>4</sup>     | D                       | 7,658                 | 0.042  | 321                 |
| Campus Supporting Trips and Visitor Trips (Campus Population) <sup>4</sup> | A                       | 7,658                 | 0.041  | 315                 |
| <b>Main Campus Trip Generation</b>   | <b>A+C<br/>+D+E</b>     | <b>7,658</b>          | <b>1.699</b>   | <b>13,011</b>       |

Notes:

FTE = Full time equivalent.

1. Trip pairs shown on Figure 1.

2. Calculated based on daily vehicle trip rate from **Attachment C Table C-6**.

3. Calculated vehicle trip rate for Main Campus and Promontory Housing vehicle trip rate based on daily Promontory driveway count minus Promontory internal vehicle trips. This value is calculated as (1,714 Promontory vehicle trips – 142 Promontory housing vehicle trips)/756 Promontory Students = 2.079 vehicle trips per FTES.

4. Campus Supporting Internal Trips, and Campus Supporting Trips and Visitor Trips are the remaining daily vehicle trips (split approximately evenly) to sum to the Main Campus Trip Generation.

Source: Fehr & Peers, 2019.

The internal student and campus supporting trips are excluded from the Main Campus Trip Generation to derive the daily Main Campus Cordon Trips. **Table 4**



shows the 142 internal Promontory vehicle trips (see line 2) and 669 daily internal student and campus supporting vehicle trips (see line 3) that are removed. The resulting Main Campus Cordon Trips (12,200) is the number of daily vehicle trips that leave the Main Campus cordon boundary (see line 4).

**TABLE 4: CSUMB MAIN CAMPUS CORDON TRIPS**

| Location (Population Type)                                      | Trip Types <sup>1</sup> | Daily Vehicle Trips |
|---|-------------------------|---------------------|
| <b>1 Main Campus Trip Generation</b>                            | <b>A+C+D+E</b>          | <b>13,011</b>       |
| 2 Promontory Internal Trips <sup>2</sup>                        | E                       | -142                |
| 3 Main Campus Students and Campus Supporting Trips <sup>3</sup> | D                       | -669                |
| <b>4 Main Campus Cordon Trips</b>                               | <b>A+C</b>              | <b>12,200</b>       |

Notes:

FTE = Full time equivalent.

1. Trip pairs shown on Figure 1.

2. Promontory Internal Trips = 756 Promontory Students \* 0.188 vehicle trips per FTES = 142 vehicle trips.

3. Main Campus Supporting Internal Trips (321 daily vehicle trips) and Main Campus Housing Internal Trips (348 daily vehicle trips) = Main Campus Students and Campus Supporting Trips (669 daily vehicle trips).

Source: Fehr & Peers, 2019.

- Step 3 – Peak Hour Trip Generation: The number of morning and evening peak hour vehicle trips were determined by factoring the daily Main Campus Trip Generation by the ratios of peak hour trips to daily trips. The Main Campus trip generation of 1,520 morning peak hour vehicle trips is approximately 11.7% of the 13,011 daily trips. While the Main Campus trip generation of 1,460 evening peak hour vehicle trips is approximately 11.2% of the 13,011 daily trips.
- Step 4 – Peak Hour Directional Trip Generation: This step estimates the inbound and outbound splits are based on the vehicle trip rates shown in **Attachment D Table D-2**. These peak hour directional trip rates are derived from sources such as the vehicle trip rates derived from the *CSUMB Person Trip Travel Survey*, the annual *CSUMB 2016-2017 Traffic Generation* report, the Promontory parking lot driveway data from the annual *CSUMB 2016-2017 Traffic Generation* report (see **Attachment D**), and the East Campus Cordon Trips. The result is a 69%/31% in/out split during the morning peak hour and a 40%/60% in/out split during the evening peak hour. The results are similar to the in/out splits from the Institute of Transportation Engineers (ITE) *Trip Generation Manual* 10<sup>th</sup> Edition for University/College land use code 550 (78%/22% in/out split during the morning peak hour and 32%/66% in/out split during the evening peak hour). The results are summarized in **Table 5**.



The split of inbound, outbound and internal trip estimates are shown in **Table 5** and are the result of using the trip rates described in **Attachment E**. The reader can review the Existing Conditions trip generation estimates by population type in **Attachment F**. The internal trips are summarized on line 3 of **Table F-1**, the Main Campus Cordon Count Trips is on line 10 of **Table F-1**, and the Main Campus Trip Generation is shown on line 14 of **Table F-1**. As shown in **Table 5**, the Main Campus Cordon Count is estimated by subtracting the Main Campus Internal Trips from the Main Campus Trip Generation.

**TABLE 5: EXISTING CSUMB MAIN CAMPUS PEAK HOUR VEHICLE TRIP GENERATION AND CORDON COUNTS**

| Location<br>(Population Type)                                   | Population<br>Size (FTE) | Trip<br>Type <sup>1</sup> | Daily  | AM Peak Hour |       |      | PM Peak Hour |     |     |
|---|--------------------------|---------------------------|--------|--------------|-------|------|--------------|-----|-----|
|   |                          |                           |        | Total        | In    | Out  | Total        | In  | Out |
| <b>Vehicle Trip Generation</b>                                  |                          |                           |        |              |       |      |              |     |     |
| Main Campus Trip<br>Generation (Students,<br>Faculty and Staff) | 7,658                    | A+C+<br>D+E               | 13,011 | 1,520        | 1,055 | 465  | 1,460        | 589 | 871 |
| Main Campus Internal<br>Student and Campus<br>Supporting Trips  | 7,658                    | D+E                       | -811   | -284         | -159  | -125 | -148         | -64 | -84 |
| <b>Vehicle Cordon</b>   |                          |                           |        |              |       |      |              |     |     |
| Main Campus Cordon<br>(Students, Faculty and<br>Staff)          | 7,658                    | A+C                       | 12,200 | 1,236        | 896   | 340  | 1,312        | 525 | 787 |
| <b>Vehicle Sub-Cordon</b>                                       |                          |                           |        |              |       |      |              |     |     |
| Promontory Housing  | 756                      | A+E                       | 1,714  | 56           | 17    | 39   | 113          | 53  | 60  |

Notes:

FTE = Full time equivalent.

1. Trip types shown on Figure 1.

Source: Fehr & Peers, 2019.

- East Campus Cordon Trips: The East Campus Cordon Count study collected vehicle counts from collected from the three East Campus neighborhoods (e.g., Frederick Park I, Frederick Park II, and Schoonover Park). Counts were collected Tuesday through Wednesday during the week of November 7<sup>th</sup> and Tuesday through Thursday during the week of November 14<sup>th</sup>, 2017. The count results are summarized in **Table 6**.

Unlike the calculated Main Campus Cordon Counts, the East Campus Cordon count data is directly related to the observed vehicle trips from either students or



faculty/staff/community housing partners. Since students live in Frederick Parks I & II neighborhoods and faculty/staff and community housing partners live in Schoonover Park, it is clear which population type is generating trips.

**TABLE 6: EXISTING CSUMB EAST CAMPUS CORDON VEHICLE COUNTS**

| Location<br>(Population Type)  | Population<br>Size (FTE) | Trip<br>Type <sup>1</sup> | Daily  | AM Peak Hour |     |     | PM Peak Hour |     |     |
|--|--------------------------|---------------------------|--------|--------------|-----|-----|--------------|-----|-----|
|  |                          |                           |        | Total        | In  | Out | Total        | In  | Out |
| <b>Vehicle Cordon</b>  |                          |                           |        |              |     |     |              |     |     |
| East Campus Cordon<br>(Students, Faculty, Staff<br>and Community<br>Housing Partners) <sup>2</sup> | 2,123                    | B+C                       | 10,017 | 799          | 134 | 665 | 759          | 484 | 275 |
| <b>Vehicle Sub-Cordon</b>  |                          |                           |        |              |     |     |              |     |     |
| East Campus Sub-<br>Cordon (Faculty, Staff<br>and Community<br>Housing Partners) <sup>2,3</sup>    | 743                      | B+C                       | 4,667  | 519          | 86  | 433 | 444          | 305 | 139 |
| East Campus Sub-<br>Cordon (Students) <sup>2,4</sup>   | 1,380                    | B+C                       | 5,350  | 280          | 48  | 232 | 315          | 179 | 136 |

Notes:

FTE = Full time equivalent.

1. Trip types shown on Figure 1.
2. Under Existing Conditions, 1,380 students, 463 faculty/staff, and 280 community housing partners (affiliate agency and other government employees) live in the East Campus housing.
3. East Campus Cordon count for faculty, staff, and community housing partners living along Schoonover Road.
4. East Campus Cordon count for students living along Bunker Hill and Manassas Drive.

Source: Fehr & Peers, 2019.

## TRIP GENERATION RATES

As previously noted, the existing campus vehicle trip generation rates were calculated based on the *CSUMB Person Trip Travel Survey* data, the annual *CSUMB 2016-2017 Traffic Generation* report data (which includes Main Campus cordon trips and the driveway counts taken at the Promontory student housing and reported in the annual *CSUMB 2016-2017 Traffic Generation* report), and the East Campus vehicle cordon counts conducted by Fehr & Peers.

**Table 7** shows the trip rates at two vehicle cordon locations and three sub-cordon locations, which are calculated by dividing the vehicle cordon trip generation summarized in **Tables 5** and **6** by the respective population sizes.



**TABLE 7: EXISTING CONDITIONS CSUMB CAMPUS CORDON  
 VEHICLE TRIP GENERATION RATES<sup>1</sup>**

| Location<br>(Population Type)  | Population<br>Size (FTE) | Trip<br>Type <sup>2</sup> | Daily | AM Peak Hour |      |      | PM Peak Hour |      |      |
|--|--------------------------|---------------------------|-------|--------------|------|------|--------------|------|------|
|  |                          |                           |       | Total        | In   | Out  | Total        | In   | Out  |
| <b>Vehicle Cordon</b>  |                          |                           |       |              |      |      |              |      |      |
| Main Campus Cordon<br>(Students, Faculty and Staff)  | 7,658                    | A+C                       | 1.59  | 0.16         | 0.12 | 0.04 | 0.17         | 0.07 | 0.10 |
| East Campus Cordon<br>(Students, Faculty, Staff and Community Housing Partners) <sup>2</sup> | 2,122                    | B+C                       | 4.72  | 0.38         | 0.06 | 0.32 | 0.36         | 0.23 | 0.13 |
| <b>Vehicle Sub-Cordon</b>  |                          |                           |       |              |      |      |              |      |      |
| Promontory Housing   | 756                      | A+E                       | 2.27  | 0.07         | 0.02 | 0.05 | 0.15         | 0.07 | 0.08 |
| East Campus Sub-Cordon (Faculty, Staff and Community Housing Partners) <sup>2,3</sup>        | 743                      | B+C                       | 6.28  | 0.70         | 0.12 | 0.58 | 0.60         | 0.41 | 0.19 |
| East Campus Sub-Cordon (Students) <sup>2,4</sup>   | 1,380                    | B+C                       | 3.88  | 0.20         | 0.03 | 0.17 | 0.23         | 0.13 | 0.10 |

Notes:

FTE = Full time equivalent.

1. Vehicle trip generation rates represent vehicles per FTE. For presentation purposes, these rates are rounded to the nearest hundredth.
2. Trip type shown on Figure 1.
3. Under Existing Conditions, 1,380 students, 463 faculty/staff, and 280 community housing partners live in the East Campus housing.
4. East Campus Cordon count for faculty, staff, and community housing partners living along Schoonover Road.
5. East Campus Cordon count for students living along Bunker Hill and Manassas Drive.

Source: Fehr & Peers, 2019.

The Existing Conditions and Project Conditions trip generation rates were calculated separately by location and for the various campus population types and housing location, which show vehicle trips per FTE in **Attachment E**. **Attachment E** also presents a description of each of the CSUMB trip types.

Under Project Conditions, the Main Campus student internal vehicle trip generation rates would be reduced due to two factors, both of which disincentives vehicle use on campus. The first is that parking will be consolidated and relocated to select areas on the periphery of the campus core, a non-convenient location for Main Campus students. Second, new infilled student housing will be close to the academic core. Both of these changes are expected to shift student travel from vehicles





to more convenient on-campus transit, bicycling, walking and other non-vehicle modes of travel. The Main Campus student internal vehicle trip generation rates were reduced by 75 percent.

**Attachment F** presents the Existing Conditions vehicle trip generation for CSUMB by population type and housing location.

## **TRIP GENERATION ESTIMATES**

Total vehicle trip generation for the CSUMB campus under both Existing Conditions and Project Conditions are presented in **Tables 8** and **9**, respectively. The total trip generation estimates are provided for the Main Campus and East Campus separately, as well as total numbers for the entire campus.

As shown in **Table 8**, under Existing Conditions the Campus external vehicle trip generation is approximately 17,875 daily vehicle trips, 1,401 morning peak-hour trips (713 inbound and 688 outbound) and 1,457 evening peak-hour trips (702 inbound and 755 outbound). A detailed Existing Conditions trip generation table is included as **Attachment E**. The trip estimates are presented by campus population and housing location.



**TABLE 8: EXISTING CONDITIONS VEHICLE TRIP GENERATION FOR CSUMB CAMPUS**

| Location Type   | Trip Type <sup>1</sup> | Daily         | Morning Peak Hour |              |             | Evening Peak Hours |             |             |
|---|------------------------|---------------|-------------------|--------------|-------------|--------------------|-------------|-------------|
|   |                        |               | Total             | In           | Out         | Total              | In          | Out         |
| <b>Main Campus</b>                                    |                        |               |                   |              |             |                    |             |             |
| Promontory Housing Internal Trips                     | E                      | 142           | 12                | 11           | 1           | 8                  | 1           | 7           |
| Main Campus Internal Trips <sup>2</sup>               | D                      | 669           | 272               | 148          | 124         | 140                | 63          | 77          |
| Main Campus External Trips                            | A                      | 10,029        | 919               | 633          | 286         | 1,005              | 432         | 573         |
| Main Campus Trips with East Campus                    | C                      | 2,171         | 317               | 263          | 54          | 307                | 93          | 214         |
| <b>Main Campus Total [A]</b>                          | <b>A+C+D+E</b>         | <b>13,011</b> | <b>1,520</b>      | <b>1,055</b> | <b>465</b>  | <b>1,460</b>       | <b>589</b>  | <b>871</b>  |
| <b>East Campus</b>                                    |                        |               |                   |              |             |                    |             |             |
| East Campus Trips with Main Campus                    | C                      | 2,171         | 317               | 54           | 263         | 307                | 214         | 93          |
| East Campus External Trips                            | B                      | 7,846         | 482               | 80           | 402         | 452                | 270         | 182         |
| <b>East Campus Total [B]</b>                          | <b>B+C</b>             | <b>10,017</b> | <b>799</b>        | <b>134</b>   | <b>665</b>  | <b>759</b>         | <b>484</b>  | <b>275</b>  |
| <b>Internal Trip Adjustment</b>                       |                        |               |                   |              |             |                    |             |             |
| Promontory Housing Internal Trips                     | E                      | -142          | -12               | -11          | -1          | -8                 | -1          | -7          |
| Main Campus Internal Trips <sup>2</sup>               | D                      | -669          | -272              | -148         | -124        | -140               | -63         | -77         |
| Main Campus Trips with East Campus                    | C                      | -2,171        | -317              | -263         | -54         | -307               | -93         | -214        |
| East Campus Trips with Main Campus                    | C                      | -2,171        | -317              | -54          | -263        | -307               | -214        | -93         |
| <b>Trip Adjustment [C]</b>                            | <b>C+D+E</b>           | <b>-5,153</b> | <b>-918</b>       | <b>-476</b>  | <b>-442</b> | <b>-762</b>        | <b>-371</b> | <b>-391</b> |
| <b>External Campus Trip Total [A+B+C]<sup>3</sup></b> | <b>A+B</b>             | <b>17,875</b> | <b>1,401</b>      | <b>713</b>   | <b>688</b>  | <b>1,457</b>       | <b>702</b>  | <b>755</b>  |

Notes:

1. Trip type shown on Figure 1.
  2. Main Campus Internal Trips = Main Campus Students and Campus Supporting Trips.
  3. The campus trip generation is the sum of all Main Campus and East Campus external vehicle trips generated by students, faculty, staff, and visitors.
- Source: Fehr & Peers, 2019.



As shown in **Table 9**, under Project Conditions the campus external vehicle trip generation would be approximately 30,385 daily vehicle trips, 2,290 morning peak-hour trips (1,188 inbound and 1,102 outbound) and 2,495 evening peak-hour trips (1,203 inbound and 1,292 outbound). A detailed Project Conditions trip generation table is included as **Attachment F**. The trip estimates are presented by person type and housing location.

**TABLE 9: CSUMB CAMPUS VEHICLE TRIP GENERATION FOR PROJECT CONDITIONS**

| Trip Type   | Trip Type <sup>1</sup> | Daily         | Morning Peak Hour |              |              | Evening Peak Hours |              |              |
|---|------------------------|---------------|-------------------|--------------|--------------|--------------------|--------------|--------------|
|   |                        |               | Total             | In           | Out          | Total              | In           | Out          |
| <b>Main Campus</b>                                    |                        |               |                   |              |              |                    |              |              |
| Promontory Housing Internal Trips                     | E                      | 40            | 3                 | 3            | 0            | 2                  | 0            | 2            |
| Main Campus Internal Trips <sup>2</sup>               | D                      | 970           | 495               | 261          | 234          | 253                | 120          | 133          |
| Main Campus External Trips                            | A                      | 23,953        | 1,722             | 1,093        | 629          | 2,089              | 926          | 1,163        |
| Main Campus Trips with East Campus                    | C                      | 1,867         | 434               | 361          | 73           | 488                | 152          | 336          |
| <b>Main Campus Total [A]</b>                          | <b>A+C+D+E</b>         | <b>26,830</b> | <b>2,654</b>      | <b>1,718</b> | <b>936</b>   | <b>2,832</b>       | <b>1,198</b> | <b>1,634</b> |
| <b>East Campus</b>                                    |                        |               |                   |              |              |                    |              |              |
| East Campus Trips with Main Campus                    | C                      | 1,867         | 434               | 73           | 361          | 488                | 336          | 152          |
| East Campus External Trips                            | B                      | 6,432         | 568               | 95           | 473          | 406                | 277          | 129          |
| <b>East Campus Total [B]</b>                          | <b>B+C</b>             | <b>8,299</b>  | <b>1,002</b>      | <b>168</b>   | <b>834</b>   | <b>894</b>         | <b>613</b>   | <b>281</b>   |
| <b>Internal Trip Adjustment</b>                       |                        |               |                   |              |              |                    |              |              |
| Promontory Housing Internal Trips                     | E                      | -40           | -3                | -3           | -0           | -2                 | -0           | -2           |
| Main Campus Internal Trips <sup>2</sup>               | D                      | -970          | -495              | -261         | -234         | -253               | -120         | -133         |
| Main Campus Trips with East Campus                    | C                      | -1,867        | -434              | -361         | -73          | -488               | -152         | -336         |
| East Campus Trips with Main Campus                    | C                      | -1,867        | -434              | -73          | -361         | -488               | -336         | -152         |
| <b>Trip Adjustment [C]</b>                            | <b>C+D+E</b>           | <b>-4,744</b> | <b>-1,366</b>     | <b>-698</b>  | <b>-668</b>  | <b>-1,231</b>      | <b>-608</b>  | <b>-623</b>  |
| <b>External Campus Trip Total [A+B+C]<sup>3</sup></b> | <b>A+B</b>             | <b>30,385</b> | <b>2,290</b>      | <b>1,188</b> | <b>1,102</b> | <b>2,495</b>       | <b>1,203</b> | <b>1,292</b> |

Notes:

1. Trip type shown on Figure 1.
2. Main Campus Internal Trips = Main Campus Students and Campus Supporting Trips.
3. The campus trip generation is the sum of all Main Campus and East Campus external vehicle trips generated by students, faculty, staff, and visitors.

Source: Fehr & Peers, 2019.

The amount of added traffic generated by the Project is estimated by subtracting the trip generation for Existing Conditions from the trip generation for Project Conditions. As shown in **Table 10**, the Project would generate 12,510 additional external daily trips, 889 additional external morning peak hour trips and 1,038 additional external evening peak hour trips.



## SUMMARY

By housing a large portion of students, faculty, and staff on-campus, and consolidating parking to the periphery, CSUMB would convert many potential off-campus-based trips to on-campus generated trips, thereby reducing both the number of external campus trips to and from campus. Relatedly, by increasing the number of on-campus students, the number of CSUMB external trips made by on-campus students for purposes such as recreational activities, off-campus dining, visiting family and friends, etc. would increase in absolute terms over existing levels.

By comparing **Tables 8** and **9** we can see the net change in vehicle trips due to the Main Campus population growth, the additional on-campus student housing, and faculty and staff moving into residential units currently occupied by students and community housing partners in the East Campus housing. Thus, the net increase in trip generation between Existing Conditions and Project Conditions is the Project increment studied in the transportation analysis. As noted earlier in the document, this trip generation estimate assumes the existing Transportation Demand Management (TDM) and Parking Management measures remain in place on the CSUMB campus, and those measures continue to be as effective in reducing vehicle trip-making and encouraging the use of other modes. **Table 10** presents the net increase in external campus trips between Existing Conditions and Project Conditions.

**TABLE 10: CSUMB CAMPUS VEHICLE TRIP GENERATION RESULTS**

| Scenario                               | Daily         | Morning Peak Hour |            |            | Evening Peak Hours |            |            |
|--|---------------|-------------------|------------|------------|--------------------|------------|------------|
|  |               | Total             | In         | Out        | Total              | In         | Out        |
| Existing Conditions [A]                | 17,875        | 1,401             | 713        | 688        | 1,457              | 702        | 755        |
| Project Conditions [B]                 | 30,385        | 2,290             | 1,188      | 1,102      | 2,495              | 1,203      | 1,292      |
| <b>Additional External Trips [B-A]</b> | <b>12,510</b> | <b>889</b>        | <b>475</b> | <b>414</b> | <b>1,038</b>       | <b>501</b> | <b>537</b> |

Source: Fehr & Peers, 2019.

## ATTACHMENTS

- Attachment A: California State University, Monterey Bay Proposed Master Plan Housing Memorandum
- Attachment B: CSUMB Person Trip Travel Survey
- Attachment C: CSUMB Person Trip Travel Survey Trip Rates and Primary Mode of Travel Results
- Attachment D: Promontory Driveway Count and Vehicle Trip Rates
- Attachment E: Trip Type Descriptions and Existing and Project Conditions Trip Generation Rates
- Attachment F: Existing and Project Conditions Vehicle Trip Generation for CSUMB by Population Type and Housing Location

**Attachment A:**  
**California State University, Monterey Bay**  
**Proposed Master Plan Housing**  
**Memorandum**

**Refer to Appendix C-1 of the CSUMB Master Plan EIR**

**Attachment B:**  
**CSUMB Person Trip Travel Survey**



# California State University MONTEREY BAY

## Fall 2017 Travel Survey

Dear Campus Community,

This short survey is intended to support campus planning efforts to improve our transportation systems. The results will also contribute data to the Comprehensive Master Plan.

Individual information collected in this survey will remain confidential. Only aggregated data will be made public.

\* 1. What is your primary affiliation with CSUMB?

- Student
- Faculty
- Staff (state or corporation)
- Other (please specify)

\* 2. Where do you currently reside?

- Main Campus Housing (Main Quad, North Quad or Promontory)
- East Campus Housing (Frederick's Park or Schoonover Park)
- Other (off-campus)



# California State University MONTEREY BAY

Fall 2017 Travel Survey

\* 3. Please enter the ZIP code where you currently live?

\* 4. What is your primary mode of travel to Main Campus?

- Drive alone
- Motorcycle
- Carpool or Vanpool
- Dropped Off - by family or friends
- Dropped Off - by transportation company (taxi, Uber, Lyft, etc.)
- Bus
- Bicycle
- Walk
- Skateboard
- Other (please specify)





# California State University MONTEREY BAY

## Fall 2017 Travel Survey

\* 5. Do you have a valid CSUMB Main Campus parking permit?

- Yes.
- No.
- No, but I do pay for daily meter rate at least once a week on average.

\* 6. How many miles per gallon (mpg) does the vehicle you drive (or ride in) to Main Campus typically achieve?

- I don't know
- Less than 19 mpg
- 19-44 mpg
- Hybrid Vehicle and/or 45 mpg or higher
- All Electric Vehicle. If so, Level I, II or III?

\* 7. Where do you typically park on Main Campus?

- In a lot off the Main Quad (lots 1, 12, 16, 18, 205 or 208)
- Across Divarty St., Inter-Garrison Rd., Fourth Ave. or Fifth Ave. from the Main Quad (lots 19, 23, 71, 72, 97, 98, 508)
- Near North Quad or Promontory (lots 300, 301, Promontory)
- Near Campus Police, Otter Sports Center or Athletics area (lots 80, 82, 84, 86, 90, 91, 100, 106, 107, 902, 903)
- Near World Theater, Student Services or University Center (lots 13, 28, 29, 30, 42, 45, 201, 490)
- Off campus on periphery roadways

\* 8. How often do you use your vehicle to drive between Main Campus locations during the day?

- 5 to 7 days a week
- 3 to 5 days a week
- 1 to 2 days a week
- 1 to 2 days a month
- Never

\* 9. How often do you use your vehicle to leave and return to Main Campus throughout the day? (Not counting your commute)

- Several times a day
- Nearly once a day
- A few days a week
- A few days a month
- Rarely
- Never



# California State University MONTEREY BAY

## Fall 2017 Travel Survey

\* 10. During a typical week, how many days do you travel to Main Campus?

- 0
- 1
- 2
- 3
- 4
- 5
- 6
- 7

\* 11. What is your typical travel time to Main Campus using your primary mode from where you currently live?

- 1-10 mins
- 10-15 mins
- 15-30 mins
- 30-60 mins
- More than 60 mins

\* 12. Please select what time you typically ARRIVE on Main Campus each day?

|      | Monday | Tuesday | Wednesday | Thursday | Friday | Saturday |
|------|--------|---------|-----------|----------|--------|----------|
| Date |        |         |           |          |        |          |
| /    |        |         |           |          |        |          |
| Time |        |         |           |          |        |          |

\* 13. Please select what time you typically DEPART Main Campus each day?

|      | Monday | Tuesday | Wednesday | Thursday | Friday | Saturday |
|------|--------|---------|-----------|----------|--------|----------|
| Date |        |         |           |          |        |          |
| /    |        |         |           |          |        |          |
| Time |        |         |           |          |        |          |



California State University  
**MONTEREY BAY**

Fall 2017 Travel Survey

\* 14. Do you live within a 5 min walk of a bus stop?

- Yes
- No
- I don't know

\* 15. Do you live within a 30 min walk or bike of Main Campus?

- Yes
- No
- I don't know

\* 16. How often do you ride the bus to Main Campus?

- Every weekday
- A few days a week
- A few days a month
- On the rare occasion I need to
- I do not ride the bus



# California State University MONTEREY BAY

## Fall 2017 Travel Survey

\* 17. What factors are most important to you in choosing your means of transportation to Main Campus?  
(select your top 3)

- Environmental impact
- Amount of things I need to carry
- Cost
- Accessibility
- Stress reduction
- Ability to do other things while commuting
- Travel time or schedule
- Comfort and safety
- Other (please specify)

\* 18. If you usually drive alone to Main Campus, what is preventing you from using a commute alternative such as carpooling, riding transit, bicycling or walking? (select your top 3)

- I don't know what other options would work for me
- Transit does not route near my home
- Transit schedules do not work for me
- Need to make stops on my commute
- Can not get home in emergency
- Difficult to find others to carpool
- Use my car on the job
- Prefer to drive my car
- Child or family care responsibilities
- Work/Class at irregular or unpredictable hours
- Inadequate bicycle or pedestrian routes/paths
- I do not have access to a bicycle
- I don't usually drive alone
- Other (please specify)



# California State University MONTEREY BAY

## Fall 2017 Travel Survey

\* 19. If you usually drive alone to Main Campus, which commute alternative would you be willing to try out one or more days per week?

- Carpool/Vanpool
- Drop-off (by family, friend or transport company)
- Bus
- Bicycle or skateboard
- Walk
- Other (please specify)

\* 20. If you usually drive alone to Main Campus, which of the following incentives and services would encourage you to use a commute alternative, such as carpool, public transit or bicycle? (select your top 3)

- ANY: A safer, cleaner and better lit route
- ANY: A Commute Club, with incentives for participating members only
- ANY: Employee rebate benefits for not driving to campus
- ANY: More information provided on each commute alternative option
- CARPOOL or LOW EMISSION VEHICLE/EV: Reduced parking permit price and/or designated parking stalls for carpool or low emission vehicle/electric vehicle
- BUS: Altered bus schedule or increased frequency
- BUS: Closer bus stop to residence/campus destination
- BIKE: Access to free or discounted bicycle (rental or bikeshare)
- BIKE: Free or discounted bicycle gear (locks and helmets)
- BIKE: More shower and/or changing room facilities on campus
- BIKE: More covered and secure bicycle parking on campus
- None, I do not wish to carpool, bus, bike or walk to campus
- Other (please specify)

\* 21. Which campus transportation programs are unfamiliar to you? Select all that apply.

- MST bus service with your OtterCard
- Electric Vehicle Charging Stations
- Zipcar
- Otter Cycle Center (bike rentals, repair shop, bike bunker indoor parking and community rides)
- Bike locker rentals (Residence Hall Association)
- Emergency Ride Home program (TAMC)
- N/A

\* 22. Which campus transportation programs have you used at least once? Select all that apply.

- MST bus service with your OtterCard
- Electric Vehicle Charging Stations
- Zipcar
- Otter Cycle Center (bike rentals, repair shop, bike bunker indoor parking and community rides)
- Bike locker rentals (Residence Hall Association)
- Emergency Ride Home program (TAMC)
- N/A

THANK YOU!

Your feedback is critical for the further development of campus transportation infrastructure and programs.

If you have questions regarding any of the services you read about in this survey, please visit [csumb.edu/transportation](http://csumb.edu/transportation)

**Attachment C:**  
**CSUMB Person Trip Travel Survey Trip Rates  
and Primary Mode of Travel Results**



**TABLE C-1: CSUMB PERSON TRAVEL SURVEY – INBOUND DIRECTION FOR PERSON TRIP OBSERVATIONS FOR MAIN CAMPUS**

| Trip Pair                                 | Student     |             |            |               | Faculty and Staff |             |            |               | Total [A+B]<br>D+E +C+A |
|---|-------------|-------------|------------|---------------|-------------------|-------------|------------|---------------|-------------------------|
|   | Main Campus | East Campus | Off-Campus | Sub-total [A] | Main Campus       | East Campus | Off-Campus | Sub-total [B] |                         |
|   | D+E         | C           | A          | D+E +C+A      | N/A               | C           | A          | C+A           |                         |
| <b>Response Rate Summary</b>              |             |             |            |               |                   |             |            |               |                         |
| Survey Responses                          | 711         | 332         | 1,122      | 2,165         | N/A               | 115         | 136        | 251           | 2,416                   |
| Current Population                        | 2,600       | 1,380       | 2,654      | 6,634         | N/A               | 463         | 561        | 1,024         | 7,658                   |
| Response Rate                             | 27%         | 24%         | 42%        | 33%           | N/A               | 25%         | 24%        | 25%           | 32%                     |
| <b>Observations by Time-of-Day</b>        |             |             |            |               |                   |             |            |               |                         |
| 12:00 am – 5:59 am                        | 29          | 2           | 2          | 33            | 0                 | 0           | 0          | 0             | 33                      |
| 6:00 am – 6:59 am                         | 7           | 7           | 13         | 27            | 0                 | 7           | 5          | 12            | 39                      |
| 7:00 am – 7:59 am                         | 54          | 48          | 157        | 259           | 0                 | 40          | 46         | 86            | 345                     |
| 8:00 am – 8:59 am                         | 81          | 41          | 116        | 238           | 0                 | 42          | 46         | 88            | 326                     |
| 9:00 am – 9:59 am                         | 73          | 74          | 167        | 314           | 0                 | 9           | 12         | 21            | 335                     |
| 10:00 am – 11:59 am                       | 82          | 45          | 122        | 249           | 0                 | 5           | 7          | 12            | 261                     |
| 12:00 pm – 2:59 pm                        | 74          | 32          | 111        | 217           | 0                 | 1           | 1          | 2             | 219                     |
| 3:00 pm – 5:59 pm                         | 20          | 28          | 99         | 147           | 0                 | 1           | 1          | 2             | 149                     |
| 6:00 pm – 11:59 pm                        | 12          | 6           | 31         | 49            | 0                 | 1           | 0          | 1             | 50                      |
| <b>Observation Summary by Time Period</b> |             |             |            |               |                   |             |            |               |                         |
| Daily Observations                        | 432         | 283         | 818        | 1,533         | 0                 | 106         | 118        | 224           | 1,757                   |
| AM Peak Hour <sup>1</sup>                 | 68          | 45          | 137        | 250           | 0                 | 41          | 46         | 87            | 337                     |
| PM Peak Hour <sup>2</sup>                 | 9           | 13          | 45         | 67            | 0                 | 0           | 0          | 0             | 67                      |
| <b>Person Trip Rates by Time Period</b>   |             |             |            |               |                   |             |            |               |                         |
| Daily Observations                        | 0.61        | 0.85        | 0.73       | 0.71          | NA                | 0.92        | 0.87       | 0.89          | 0.73                    |
| AM Peak Hour                              | 0.09        | 0.13        | 0.12       | 0.12          | NA                | 0.36        | 0.34       | 0.35          | 0.14                    |
| PM Peak Hour                              | 0.01        | 0.04        | 0.04       | 0.03          | NA                | 0.00        | 0.00       | 0.00          | 0.03                    |

Notes:

1. AM Peak Hour observations are an average of responses for 7:00 – 7:59 am and 8:00 – 8:59 am.
2. PM Peak Hour observations are factored using a peak period to peak hour factor from the evening outbound observations. Since the survey only has hourly data for the peak direction (outbound), we used the peak hour (5:00 – 6:00 pm) trip value (273) divided by the peak period (3:00 – 6:00 pm) trip value (612) which results in a peak period to peak hour factor of  $273/612 = 0.45$ . See Table C-2 for values.

Source: Fehr & Peers, 2019.

**TABLE C-2: CSUMB PERSON TRAVEL SURVEY – OUTBOUND DIRECTION FOR PERSON TRIP OBSERVATIONS FOR MAIN CAMPUS**

| Trip Pair                                 | Student     |             |            |               | Faculty and Staff |             |            |               | Total [A+B]<br>D+E<br>+C+A |
|---|-------------|-------------|------------|---------------|-------------------|-------------|------------|---------------|----------------------------|
|   | Main Campus | East Campus | Off-Campus | Sub-total [A] | Main Campus       | East Campus | Off-Campus | Sub-total [B] |                            |
|   | D+E         | C           | A          | D+E<br>+C+A   | N/A               | C           | A          | C+A           |                            |
| <b>Response Rate Summary</b>              |             |             |            |               |                   |             |            |               |                            |
| Survey Responses                          | 711         | 332         | 1,122      | 2,165         | N/A               | 115         | 136        | 251           | 2,416                      |
| Current Population                        | 2,600       | 1,380       | 2,654      | 6,634         | N/A               | 463         | 561        | 1,024         | 7,658                      |
| Response Rate                             | 27%         | 24%         | 42%        | 33%           | N/A               | 25%         | 24%        | 25%           | 32%                        |
| <b>Observations by Time-of-Day</b>        |             |             |            |               |                   |             |            |               |                            |
| 12:00pm - 2:59 pm                         | 71          | 39          | 158        | 268           | 0                 | 4           | 1          | 5             | 273                        |
| 3:00 pm - 3:59 pm                         | 28          | 27          | 67         | 122           | 0                 | 3           | 3          | 6             | 128                        |
| 4:00 pm - 4:59 pm                         | 37          | 40          | 92         | 169           | 0                 | 15          | 27         | 42            | 211                        |
| 5:00 pm - 5:59 pm                         | 44          | 28          | 78         | 150           | 0                 | 61          | 62         | 123           | 273                        |
| 6:00 pm - 6:59 pm                         | 51          | 38          | 101        | 190           | 0                 | 11          | 15         | 26            | 216                        |
| 7:00 pm - 7:59 pm                         | 41          | 20          | 72         | 133           | 0                 | 6           | 3          | 9             | 142                        |
| 8:00 pm - 11:59 pm                        | 97          | 71          | 185        | 353           | 0                 | 4           | 6          | 10            | 363                        |
| 12:00 am - 5:59 am                        | 9           | 4           | 9          | 22            | 0                 | 0           | 0          | 0             | 22                         |
| 6:00 am - 9:59 am                         | 13          | 5           | 15         | 33            | 0                 | 0           | 0          | 0             | 33                         |
| 10:00 am - 11:59 am                       | 19          | 11          | 36         | 66            | 0                 | 0           | 1          | 1             | 67                         |
| <b>Observation Summary by Time Period</b> |             |             |            |               |                   |             |            |               |                            |
| Daily Observations                        | 410         | 283         | 813        | 1,506         | 0                 | 104         | 118        | 222           | 1,728                      |
| AM Peak Hour <sup>1</sup>                 | 4           | 2           | 5          | 11            | 0                 | 0           | 0          | 0             | 11                         |
| PM Peak Hour <sup>2</sup>                 | 69          | 46          | 129        | 244           | 0                 | 5           | 5          | 10            | 254                        |
| <b>Person Trip Rates by Time Period</b>   |             |             |            |               |                   |             |            |               |                            |
| Daily Observations                        | 0.58        | 0.85        | 0.72       | 0.70          | NA                | 0.90        | 0.87       | 0.88          | 0.72                       |
| AM Peak Hour                              | 0.01        | 0.00        | 0.00       | 0.01          | NA                | 0.00        | 0.00       | 0.00          | 0.00                       |
| PM Peak Hour                              | 0.07        | 0.10        | 0.08       | 0.08          | NA                | 0.31        | 0.28       | 0.30          | 0.10                       |

Notes:

1. AM Peak Hour represents 7:00 am – 7:59 am. AM Peak Hour observations are factored using a peak period to peak hour factor from the morning observations. Since the survey only has hourly data for the peak direction (inbound), we used the peak hour (7:00 – 7:59 am) trip value (345) divided by the peak period (6:00 – 10:00 am) trip value (1,045) which results in a peak period to peak hour factor of 345/1,045 = 0.33. See Table C-1 for values.
2. PM Peak Hour observations are an average of responses for 5:00 – 5:59 pm and 6:00 – 6:59 pm.

Source: Fehr & Peers, 2019.

**TABLE C-3: CSUMB PERSON TRAVEL SURVEY – INBOUND DIRECTION FOR VEHICLE TRIP OBSERVATIONS FOR MAIN CAMPUS**

| Trip Pair                                 | Student     |             |            |               | Faculty and Staff |             |            | Sub-total [B] | Total [A+B] |
|---|-------------|-------------|------------|---------------|-------------------|-------------|------------|---------------|-------------|
|   | Main Campus | East Campus | Off-Campus | Sub-total [A] | Main Campus       | East Campus | Off-Campus |               |             |
|   | D+E         | C           | A          | D+E +C+A      | N/A               | C           | A          | C+A           | D+E+C +A    |
| <b>Response Rate Summary</b>              |             |             |            |               |                   |             |            |               |             |
| Survey Responses                          | 711         | 332         | 1,122      | 2,165         | N/A               | 115         | 136        | 251           | 2,416       |
| Current Population                        | 2,600       | 1,380       | 2,654      | 6,634         | N/A               | 463         | 561        | 1,024         | 7,658       |
| Response Rate                             | 27%         | 24%         | 42%        | 33%           | N/A               | 25%         | 24%        | 25%           | 32%         |
| <b>Observations by Time-of-Day</b>        |             |             |            |               |                   |             |            |               |             |
| 12:00 am – 5:59 am                        | 5           | 1           | 2          | 8             | 0                 | 0           | 0          | 0             | 8           |
| 6:00 am – 6:59 am                         | 2           | 5           | 11         | 18            | 0                 | 7           | 5          | 12            | 30          |
| 7:00 am – 7:59 am                         | 8           | 32          | 139        | 179           | 0                 | 38          | 40         | 78            | 257         |
| 8:00 am – 8:59 am                         | 13          | 25          | 99         | 137           | 0                 | 34          | 43         | 77            | 214         |
| 9:00 am – 9:59 am                         | 13          | 41          | 146        | 200           | 0                 | 8           | 12         | 20            | 220         |
| 10:00 am – 11:59 am                       | 10          | 24          | 104        | 138           | 0                 | 5           | 7          | 12            | 150         |
| 12:00 pm – 2:59 pm                        | 11          | 19          | 95         | 125           | 0                 | 1           | 1          | 2             | 127         |
| 3:00 pm – 5:59 pm                         | 3           | 17          | 92         | 112           | 0                 | 1           | 1          | 2             | 114         |
| 6:00 pm – 11:59 pm                        | 3           | 5           | 28         | 36            | 0                 | 1           | 0          | 1             | 37          |
| <b>Observation Summary by Time Period</b> |             |             |            |               |                   |             |            |               |             |
| Daily Observations                        | 68          | 169         | 716        | 953           | 0                 | 95          | 109        | 204           | 1,157       |
| AM Peak Hour <sup>1</sup>                 | 13          | 33          | 123        | 169           | 0                 | 21          | 28         | 49            | 219         |
| PM Peak Hour <sup>2</sup>                 | 1           | 8           | 42         | 51            | 0                 | 0           | 0          | 0             | 51          |
| <b>Vehicle Trip Rates by Time Period</b>  |             |             |            |               |                   |             |            |               |             |
| Daily Observations                        | 0.10        | 0.51        | 0.64       | 0.44          | NA                | 0.83        | 0.80       | 0.81          | 0.48        |
| AM Peak Hour                              | 0.01        | 0.09        | 0.11       | 0.07          | NA                | 0.31        | 0.31       | 0.31          | 0.10        |
| PM Peak Hour                              | 0.00        | 0.02        | 0.04       | 0.02          | NA                | 0.00        | 0.00       | 0.00          | 0.02        |

Notes:

1. AM Peak Hour observations are an average of responses for 7:00 – 7:59 am and 8:00 am – 8:59 am.
2. PM Peak Hour observations are factored using a peak period to peak hour factor from the evening outbound observations. Since the survey only has hourly data for the peak direction (outbound), we used the peak hour (5:00 – 6:00 pm) trip value (194) divided by the peak period (3:00 – 6:00 pm) trip value (424) which results in a peak period to peak hour factor of  $194/424 = 0.46$ . See Table C-4 for values.

Source: Fehr & Peers, 2019.

**TABLE C-4: CSUMB PERSON TRAVEL SURVEY – OUTBOUND DIRECTION FOR VEHICLE TRIP  
OBSERVATIONS FOR MAIN CAMPUS**

| Trip Pair                                 |             |             |            |                           | Faculty and Staff |             |            | Sub-total [B]<br>C+A | Total [A+B]<br>D+E +C+A |
|---|-------------|-------------|------------|---------------------------|-------------------|-------------|------------|----------------------|-------------------------|
|   | Main Campus | East Campus | Off-Campus | Sub-total [A]<br>D+E +C+A | Main Campus       | East Campus | Off-Campus |                      |                         |
|   | D+E         | C           | A          |                           | N/A               | C           | A          |                      |                         |
| <b>Response Rate Summary</b>              |             |             |            |                           |                   |             |            |                      |                         |
| Survey Responses                          | 711         | 332         | 1,122      | 2,165                     | N/A               | 115         | 136        | 251                  | 2,416                   |
| Current Population                        | 2,600       | 1,380       | 2,654      | 6,634                     | N/A               | 463         | 561        | 1,024                | 7,658                   |
| Response Rate                             | 27%         | 24%         | 42%        | 33%                       | N/A               | 25%         | 24%        | 25%                  | 32%                     |
| <b>Observations by Time-of-Day</b>        |             |             |            |                           |                   |             |            |                      |                         |
| 12:00pm - 2:59 pm                         | 10          | 26          | 148        | 184                       | 0                 | 2           | 2          | 4                    | 188                     |
| 3:00 pm - 3:59 pm                         | 6           | 16          | 60         | 82                        | 0                 | 2           | 3          | 5                    | 87                      |
| 4:00 pm - 4:59 pm                         | 7           | 24          | 77         | 108                       | 0                 | 12          | 23         | 35                   | 143                     |
| 5:00 pm - 5:59 pm                         | 6           | 16          | 65         | 87                        | 0                 | 55          | 52         | 107                  | 194                     |
| 6:00 pm - 6:59 pm                         | 7           | 22          | 87         | 116                       | 0                 | 12          | 19         | 31                   | 147                     |
| 7:00 pm - 7:59 pm                         | 9           | 14          | 68         | 91                        | 0                 | 6           | 4          | 10                   | 101                     |
| 8:00 pm - 11:59 pm                        | 13          | 36          | 157        | 206                       | 0                 | 2           | 5          | 7                    | 213                     |
| 12:00 am - 5:59 am                        | 3           | 6           | 17         | 26                        | 0                 | 0           | 0          | 0                    | 26                      |
| 6:00 am - 9:59 am                         | 1           | 3           | 15         | 19                        | 0                 | 0           | 0          | 0                    | 19                      |
| 10:00 am - 11:59 am                       | 4           | 10          | 32         | 46                        | 0                 | 0           | 1          | 1                    | 47                      |
| <b>Observation Summary by Time Period</b> |             |             |            |                           |                   |             |            |                      |                         |
| Daily Observations                        | 66          | 173         | 726        | 965                       | 0                 | 91          | 109        | 200                  | 1,165                   |
| AM Peak Hour <sup>1</sup>                 | 0           | 1           | 5          | 6                         | 0                 | 0           | 0          | 0                    | 6                       |
| PM Peak Hour <sup>2</sup>                 | 7           | 19          | 76         | 102                       | 0                 | 34          | 36         | 70                   | 172                     |
| <b>Vehicle Trip Rates by Time Period</b>  |             |             |            |                           |                   |             |            |                      |                         |
| Daily Observations                        | 0.09        | 0.52        | 0.65       | 0.45                      | NA                | 0.79        | 0.80       | 0.80                 | 0.48                    |
| AM Peak Hour                              | 0.00        | 0.00        | 0.00       | 0.00                      | NA                | 0.00        | 0.00       | 0.00                 | 0.00                    |
| PM Peak Hour                              | 0.01        | 0.06        | 0.07       | 0.05                      | NA                | 0.29        | 0.26       | 0.27                 | 0.07                    |

Notes:

1. AM Peak Hour represents 7:00 am – 7:59 am. AM Peak Hour observations are factored using a peak period to peak hour factor from the morning observations. Since the survey only has hourly data for the peak direction (inbound), we used the peak hour (7:00 – 7:59 am) trip value (257) divided by the peak period (6:00 – 10:00 am) trip value (721) which results in a peak period to peak hour factor of 257/721 = 0.36. See Table C-3 for values.
2. PM Peak Hour observations are an average of responses for 5:00 – 5:59 pm and 6:00 – 6:59 pm.

Source: Fehr & Peers, 2019.

**TABLE C-5: CSUMB PERSON TRAVEL SURVEY - PERSON TRIP GENERATION RATES TO/FROM MAIN CAMPUS<sup>1</sup>**

| Housing Location         | Trip Pair <sup>2</sup> | Daily | AM Peak Hour |                  |      | PM Peak Hour |      |      |
|--------------------------|------------------------|-------|--------------|------------------|------|--------------|------|------|
|                          |                        |       | Total        | In               | Out  | Total        | In   | Out  |
| <b>Students</b>          |                        |       |              |                  |      |              |      |      |
| Main Campus <sup>3</sup> | D+E                    | 1.19  | 0.10         | 0.09             | 0.01 | 0.08         | 0.01 | 0.07 |
| East Campus              | C                      | 1.70  | 0.13         | 0.13             | 0.00 | 0.14         | 0.04 | 0.10 |
| Off-Campus               | A                      | 1.45  | 0.12         | 0.12             | 0.00 | 0.12         | 0.04 | 0.08 |
| <b>Faculty and Staff</b> |                        |       |              |                  |      |              |      |      |
| Main Campus              |                        |       |              | N/A <sup>4</sup> |      |              |      |      |
| East Campus              | C                      | 1.82  | 0.36         | 0.36             | 0.00 | 0.31         | 0.00 | 0.31 |
| Off-Campus               | A                      | 1.74  | 0.34         | 0.34             | 0.00 | 0.28         | 0.00 | 0.28 |

Notes:

1. For presentation purposes, person trip generation rates are rounded up to the nearest hundredth.
2. Trip pairs shown on Figure 1.
3. Main campus student trips are internal to the Main Campus Cordon.
4. Faculty and staff are not housed on the Main Campus.

Source: Fehr & Peers, 2019.

**TABLE C-6: CSUMB PERSON TRAVEL SURVEY - VEHICLE TRIP GENERATION RATES TO/FROM MAIN CAMPUS<sup>1</sup>**

| Housing Location         | Trip Pair <sup>2</sup> | Daily | AM Peak Hour |                  |      | PM Peak Hour |      |      |
|--------------------------|------------------------|-------|--------------|------------------|------|--------------|------|------|
|                          |                        |       | Total        | In               | Out  | Total        | In   | Out  |
| <b>Students</b>          |                        |       |              |                  |      |              |      |      |
| Main Campus <sup>3</sup> | D+E                    | 0.19  | 0.02         | 0.02             | 0.00 | 0.01         | 0.00 | 0.01 |
| East Campus              | C                      | 1.03  | 0.09         | 0.09             | 0.00 | 0.08         | 0.02 | 0.06 |
| Off-Campus               | A                      | 1.29  | 0.11         | 0.11             | 0.00 | 0.11         | 0.04 | 0.07 |
| <b>Faculty and Staff</b> |                        |       |              |                  |      |              |      |      |
| Main Campus              |                        |       |              | N/A <sup>4</sup> |      |              |      |      |
| East Campus              | C                      | 1.62  | 0.31         | 0.31             | 0.00 | 0.29         | 0.00 | 0.29 |
| Off-Campus               | A                      | 1.60  | 0.31         | 0.31             | 0.00 | 0.26         | 0.00 | 0.26 |

Notes:

1. For presentation purposes the vehicle trip rates are rounded to the nearest hundredth.
2. Trip pairs shown on Figure 1.
3. Main campus student trips are internal to the Main Campus Cordon.
4. Faculty and staff are not housed on the Main Campus.

Source: Fehr & Peers, 2019.

**TABLE C-7: CSUMB PERSON TRAVEL SURVEY - PRIMARY MODE OF TRAVEL TO MAIN CAMPUS OBSERVATIONS**

| Housing Location   | Main Campus | Student     |            | Main Campus | Faculty and Staff |            |
|--------------------|-------------|-------------|------------|-------------|-------------------|------------|
|                    |             | East Campus | Off-Campus |             | East Campus       | Off-Campus |
| Survey Responses   | 711         | 332         | 1,122      | N/A         | 115               | 136        |
| Current Population | 2,600       | 1,380       | 2,654      | N/A         | 463               | 561        |
| Drive Alone        | 12.5%       | 52.5%       | 82.9%      | N/A         | 85.3%             | 85.3%      |
| Shared Ride        | 6.0%        | 10.8%       | 10.6%      | N/A         | 4.3%              | 10.3%      |
| Transit            | 4.6%        | 32.8%       | 4.8%       | N/A         | 4.3%              | 2.9%       |
| Walk               | 70.3%       | 0.9%        | 0.4%       | N/A         | 0.0%              | 0.0%       |
| Bicycle            | 5.1%        | 3.0%        | 1.1%       | N/A         | 6.1%              | 1.5%       |
| Other              | 1.5%        | 0.0%        | 0.2%       | N/A         | 0.0%              | 0.0%       |

Source: Fehr & Peers, 2019.

**TABLE C-8: PRIMARY MODE OF TRAVEL COMPARISON**

| Mode                     | CSUMB 2017 Existing Mode Share <sup>3</sup> | 2011-2015 American Community Survey (ACS) <sup>4</sup> |                   | 2012 California Household Travel Survey (CHTS) <sup>4</sup> |                   |
|--------------------------|---|--|-------------------|---|-------------------|
|                          |   | Monterey County  | Santa Cruz County | Monterey County   | Santa Cruz County |
| Drive Alone <sup>1</sup> | 53.8%                                       | 70.7%  | 70.5%             | 77.4%   | 75.2%             |
| Shared Ride <sup>2</sup> | 8.7%  | 11.9%  | 9.4%              | 16.0%   | 13.5%             |
| Transit                  | 9.6%  | 2.1%   | 2.9%              | 2.2%  | 2.2%              |
| Walk                     | 24.2%                                       | 3.1%   | 3.9%              | 1.2%  | 5.0%              |
| Bicycle                  | 3.1%  | 0.8%   | 3.8%              | 3.2%  | 4.1%              |
| Other                    | 0.6%  | 11.4%  | 9.5%              | 0.0%  | 0.0%              |

## Notes:

1. Drive alone includes motorcycles
2. Shared ride includes carpooling, vanpooling, drop-off, Transportation Network Companies like Uber and Lyft, and taxis.
3. Weighted average morning inbound person mode share of CSUMB students, faculty, and staff. Mode share includes Main Campus, East Campus and Off-Campus residents from the *CSUMB Person Trip Travel Survey* data.
4. Home-based work trips only.

Source: Fehr &amp; Peers, 2019.

**TABLE C-9: PRIMARY MODE OF TRAVEL TO MAIN CAMPUS FOR CSUMB POPULATION**

| Housing Location  | Student     |             |            | Faculty and Staff |             |            | Main Campus Mode Split | Main Campus Mode Split without Main Campus Residents |
|-------------------|-------------|-------------|------------|-------------------|-------------|------------|------------------------|--|
|                   | Main Campus | East Campus | Off-Campus | Main Campus       | East Campus | Off-Campus |                        |  |
| Campus Population | 2,600       | 1,380       | 2,654      | N/A               | 463         | 561        | 7,658<br>(100%)        | 5,058<br>(100%)                                      |
| Drive Alone       | 322         | 725         | 2,200      | N/A               | 395         | 479        | 4,121<br>(53.8%)       | 3,798<br>(75.1%)                                     |
| Shared Ride       | 156         | 149         | 281        | N/A               | 20          | 58         | 664<br>(8.7%)          | 508<br>(10.0%)                                       |
| Transit           | 120         | 453         | 127        | N/A               | 20          | 16         | 736<br>(9.6%)          | 616<br>(12.2%)                                       |
| Walk              | 1,830       | 12          | 11         | N/A               | 0           | 0          | 1,853<br>(24.2%)       | 23<br>(0.5%)   |
| Bicycle           | 133         | 41          | 29         | N/A               | 28          | 8          | 240<br>(3.1%)          | 107<br>(2.1%)  |
| Other             | 39          | 0           | 5          | N/A               | 0           | 0          | 44<br>(0.5%)           | 6<br>(0.1%)  |

Note:

1. Person trips by mode by campus population is calculated by multiplying the mode split shown in Table C-7 by the campus population. The person trips are rounded to the nearest whole number.
2. Main Campus Mode Split is the sum of all student and faculty/staff columns divided by the main campus population.

Source: Fehr & Peers, 2019.



**Attachment D:**  
**Promontory Driveway Counts and Vehicle**  
**Trip Rates**

**TABLE D-1: PROMONTORY DRIVEWAY COUNT AND VEHICLE TRIP RATES**

| Location<br>(Population Type)                                | Trip<br>Pair <sup>2</sup> | Daily  | AM Peak Hour |        |        | PM Peak Hour |        |        |
|--|---------------------------|--------|--------------|--------|--------|--------------|--------|--------|
|  |                           |        | Total        | In     | Out    | Total        | In     | Out    |
| <b>Vehicle Trips</b>   |                           |        |              |        |        |              |        |        |
| Driveway Count <sup>2</sup>                                  | A + E                     | 1,714  | 56           | 17     | 39     | 113          | 53     | 60     |
| Promontory Housing<br>Internal Trips (Students) <sup>3</sup> | E                         | 142    | 12           | 11     | 1      | 8            | 1      | 7      |
| Promontory Housing<br>Trips (Students) <sup>4</sup>          | A                         | 1,571  | 24           | 10     | 14     | 54           | 26     | 29     |
| <b>Vehicle Trip Rates<sup>5</sup></b>                        |                           |        |              |        |        |              |        |        |
| Driveway Count   | A + E                     | 2.2672 | 0.0741       | 0.0225 | 0.0516 | 0.01494      | 0.0701 | 0.0793 |
| Promontory Housing<br>Internal Trips (Students)              | E                         | 0.1885 | 0.0153       | 0.0148 | 0.0005 | 0.0110       | 0.0019 | 0.0091 |
| Promontory Housing<br>Trips (Students)                       | A                         | 2.0787 | 0.0588       | 0.0077 | 0.0511 | 0.1384       | 0.0682 | 0.0702 |

Notes:

1. Trip pairs shown on Figure 1.
2. Promontory housing driveway count from the annual *CSUMB 2016-2017 Traffic Generation* report.
3. Promontory housing internal trips estimated using the vehicle trip rates summarized in Attachment C (of this memo) Table C-6 titled CSUMB Person Travel Survey – Vehicle Trip Generation Rates to/from Main Campus. Rates from Main Campus line under the Students subheading.
4. Promontory Housing Trips are the remaining vehicle trips when the Promontory Housing Internal Trips (Students) are subtracted from the driveway count.
5. For presentation purposes, person trip generation rates are rounded up to the nearest hundred thousandth. Rates derived by dividing the vehicle counts by 756 Full-Time Equivalent Students (FTES).

Source: Fehr & Peers, 2019.

# **Attachment E:**

## **Trip Type Descriptions and Existing and Project Conditions Trip Generation Rates**

**ATTACHMENT E-1: CSUMB TRIP TYPE INFORMATION**

| Row Number                        | Population Type  | Housing Location or Origin   | Existing Population | Project Population | Trip Type | Description  |
|-----------------------------------|--|------------------------------|---------------------|--------------------|-----------|--|
| <b>Main Campus Internal Trips</b> |  |                              |                     |                    |           |  |
| 1                                 | Promontory Housing Students                                | Promontory Housing           | 756                 | 756                | E         | These are trips made by students living in The Promontory Housing, driving to Main Campus. These trips may include Promontory housed students driving to class, the gym, or other on-campus uses.  |
| 2                                 | Main Campus Students and Campus Supporting Trips           | Main Campus (non-Promontory) | 7,658               | 14,476             | D         | These are trips made by students living on Main Campus, driving to another part of Main Campus (non-Promontory Housing). These trips may include students driving to class, the gym, or other on-campus uses. Plus, trips made by campus support staff including campus security, maintenance, shuttle buses, etc. These trips circulate within the Main Campus. |
| <b>Main Campus External Trips</b> |  |                              |                     |                    |           |  |
| 4                                 | Promontory Housing Students                                | Promontory Housing           | 756                 | 756                | A         | These trips are made by students living in Promontory Housing but traveling to off-campus for purposes such as off-campus dining, recreational events, visiting off-campus friends and family, etc.  |
| 5                                 | East Campus Students                                       | East Campus                  | 1,380               | 0                  | C         | These trips are made by students living on East Campus but traveling to/from but traveling to off-campus for purposes such as off-campus dining, recreational events, visiting off-campus friends and family, etc.   |
| 6                                 | East Campus Faculty/Staff                                  | East Campus                  | 463                 | 1,154              | C         | These trips are made by faculty/staff living on East Campus but traveling to/from but traveling to off-campus for purposes such as off-campus dining, recreational events, visiting off-campus friends and family, etc.  |
| 7                                 | Off-Campus Students  | Off-Campus                   | 2,654               | 5,080              | A         | These trips are made by students coming from their off-campus residences to Main Campus for class and other campus related activities.   |
| 8                                 | Off-Campus Faculty/Staff                                   | Off-Campus                   | 463                 | 1,154              | A         | These trips are made by students coming from their off-campus residences to Main Campus for class and other campus related activities.   |
| 9                                 | Main Campus Students, Campus Supporting Trips and Visitors | Off-Campus                   | 7,658               | 14,476             | A         | These trips are made by students living on Main Campus but traveling to off-campus for purposes such as off-campus dining, recreational events, visiting off-campus friends and family, etc. Plus campus supporting trips coming from off-campus, and visitors.  |
| <b>East Campus Internal Trips</b> |  |                              |                     |                    |           |  |
| 15                                | East Campus Students                                       | East Campus                  | 1,380               | 0                  | C         | These trips are made by students living on East Campus but traveling to/from Main Campus. These trips may include students driving to class, the gym, or other on-campus uses.   |
| 16                                | East Campus Faculty/Staff                                  | East Campus                  | 463                 | 1,154              | C         | These trips are made by faculty/staff living on East Campus but traveling to/from Main Campus. These trips may include students driving to class, the gym, or other on-campus uses.  |
| <b>East Campus External Trips</b> |  |                              |                     |                    |           |  |
| 18                                | East Campus Students                                       | East Campus                  | 1,380               | 0                  | B         | These trips are made by students living on East Campus but traveling to off-campus for purposes such as off-campus dining, recreational events, visiting off-campus friends and family, etc.   |
| 19                                | East Campus Faculty/Staff                                  | East Campus                  | 463                 | 1,154              | B         | These trips are made by faculty/staff living on East Campus but traveling to off-campus for purposes such as off-campus dining, recreational events, visiting off-campus friends and family, etc.  |
| 20                                | East Campus Community Housing Partners                     | East Campus                  | 280                 | 66                 | B         | These trips are made by community partners living on East Campus but traveling to off-campus for purposes such as work, personnel events, visiting friends and family, etc.  |

Source: Fehr & Peers, 2018.

**TABLE E-2: EXISTING CONDITIONS VEHICLE TRIP RATES**

| Row Number                                   | Population Type   | Housing Location  | Unit       | Size         | Trip Type <sup>1</sup> | Daily        | AM Peak Hour |              |              | PM Peak Hour |              |              |
|--|---|---|------------|--------------|------------------------|--------------|--------------|--------------|--------------|--------------|--------------|--------------|
|  |   |   |            |              |                        |              | Total        | In           | Out          | Total        | In           | Out          |
| <b>Main Campus</b>                           |   |   |            |              |                        |              |              |              |              |              |              |              |
| Main Campus Internal Trips                   |   |   |            |              |                        |              |              |              |              |              |              |              |
| 1  | Students  | Promontory Housing  | FTE        | 756          | E                      | 0.188        | 0.016        | 0.015        | 0.001        | 0.010        | 0.001        | 0.009        |
| 2  | CSUMB Campus Population                                     | Main Campus Students and Campus Supporting Trips            | FTE        | 7,658        | D                      | 0.087        | 0.035        | 0.019        | 0.016        | 0.018        | 0.008        | 0.010        |
| 3  | <i>Internal Trips [A]</i>                                   |   | <i>FTE</i> | <i>7,658</i> | <i>D + E</i>           | <i>0.106</i> | <i>0.037</i> | <i>0.021</i> | <i>0.016</i> | <i>0.019</i> | <i>0.008</i> | <i>0.011</i> |
| Main Campus External Trips                   |   |   |            |              |                        |              |              |              |              |              |              |              |
| 4  | Students  | Promontory Housing  | FTE        | 756          | A                      | 2.079        | 0.058        | 0.008        | 0.050        | 0.139        | 0.069        | 0.070        |
| 5  | Students  | East Campus Housing   | FTE        | 1,380        | C                      | 1.030        | 0.104        | 0.086        | 0.018        | 0.080        | 0.023        | 0.057        |
| 6  | Faculty/Staff   | East Campus Housing   | FTE        | 463          | C                      | 1.618        | 0.376        | 0.313        | 0.063        | 0.424        | 0.132        | 0.292        |
| 7  | Students  | Off-Campus Housing  | FTE        | 2,654        | A                      | 1.285        | 0.111        | 0.106        | 0.005        | 0.106        | 0.038        | 0.068        |
| 8  | Faculty/Staff   | Off-Campus Housing  | FTE        | 561          | A                      | 1.602        | 0.419        | 0.305        | 0.114        | 0.442        | 0.182        | 0.260        |
| 9  | CSUMB Campus Population                                     | Main Campus Students, Campus Supporting Trips, and Visitors | FTE        | 7,658        | A                      | 0.542        | 0.045        | 0.023        | 0.022        | 0.048        | 0.023        | 0.025        |
| 10   | <i>Main Campus Cordon Trips [B]</i>                         |   | <i>FTE</i> | <i>7,658</i> | <i>A + C</i>           | <i>1.593</i> | <i>0.161</i> | <i>0.117</i> | <i>0.044</i> | <i>0.172</i> | <i>0.069</i> | <i>0.103</i> |
| East Campus Housing TDM Reductions           |   |   |            |              |                        |              |              |              |              |              |              |              |
| 11   | Student East Campus Housing TDM Reduction for Students      |   | FTE        | 1,380        | C                      | 0.000        | 0.000        | 0.000        | 0.000        | 0.000        | 0.000        | 0.000        |
| 12   | Student East Campus Housing TDM Reduction for Faculty/Staff |   | FTE        | 463          | C                      | 0.000        | 0.000        | 0.000        | 0.000        | 0.000        | 0.000        | 0.000        |
| 13   | <i>East Campus Housing TDM Reduction [C]</i>                |   | <i>FTE</i> | <i>1,843</i> | <i>C</i>               | <i>0.000</i> | <i>0.000</i> | <i>0.000</i> | <i>0.000</i> | <i>0.000</i> | <i>0.000</i> | <i>0.000</i> |
| 14   | <b>Main Campus Trip Generation [A + B - C = D]</b>          |   | <b>FTE</b> | <b>7,658</b> | <b>A+C+D+E</b>         | <b>1.699</b> | <b>0.199</b> | <b>0.138</b> | <b>0.061</b> | <b>0.191</b> | <b>0.077</b> | <b>0.114</b> |
| <b>East Campus</b>                           |   |   |            |              |                        |              |              |              |              |              |              |              |
| East Campus Internal Trips                   |   |   |            |              |                        |              |              |              |              |              |              |              |
| 15   | Students  | East Campus Housing   | FTE        | 1,380        | C                      | 1.030        | 0.104        | 0.018        | 0.086        | 0.080        | 0.057        | 0.023        |
| 16   | Faculty/Staff   | East Campus Housing   | FTE        | 463          | C                      | 1.618        | 0.376        | 0.063        | 0.313        | 0.423        | 0.292        | 0.132        |
| 17   | <i>Internal Trips with Main Campus [F]</i>                  |   | <i>FTE</i> | <i>1,843</i> | <i>C</i>               | <i>1.178</i> | <i>0.172</i> | <i>0.029</i> | <i>0.143</i> | <i>0.167</i> | <i>0.116</i> | <i>0.051</i> |
| East Campus External Trips                   |   |   |            |              |                        |              |              |              |              |              |              |              |
| 18   | Students  | East Campus Housing   | FTE        | 1,380        | B                      | 2.846        | 0.100        | 0.017        | 0.083        | 0.148        | 0.073        | 0.075        |
| 19   | Faculty/Staff   | East Campus Housing   | FTE        | 463          | B                      | 5.274        | 0.465        | 0.078        | 0.387        | 0.335        | 0.229        | 0.106        |
| 20   | Community Housing Partners                                  | East Campus Housing   | FTE        | 280          | B                      | 5.275        | 0.464        | 0.075        | 0.389        | 0.336        | 0.232        | 0.104        |
| 21   | <i>External Trips [E]</i>                                   |   | <i>FTE</i> | <i>2,123</i> | <i>B</i>               | <i>3.696</i> | <i>0.227</i> | <i>0.038</i> | <i>0.189</i> | <i>0.213</i> | <i>0.127</i> | <i>0.086</i> |
| East Campus Housing TDM Reductions           |   |   |            |              |                        |              |              |              |              |              |              |              |
| 22   | Student East Campus Housing TDM Reduction for Students      |   | FTE        | 1,380        | C                      | 0.000        | 0.000        | 0.000        | 0.000        | 0.000        | 0.000        | 0.000        |
| 23   | Student East Campus Housing TDM Reduction for Faculty/Staff |   | FTE        | 463          | C                      | 0.000        | 0.000        | 0.000        | 0.000        | 0.000        | 0.000        | 0.000        |
| 24   | <i>East Campus Housing TDM Reduction [G]</i>                |   | <i>FTE</i> | <i>1,843</i> | <i>C</i>               | <i>0.000</i> | <i>0.000</i> | <i>0.000</i> | <i>0.000</i> | <i>0.000</i> | <i>0.000</i> | <i>0.000</i> |
| 25   | <b>East Campus Cordon Trips [F + E - G = H]</b>             |   | <b>FTE</b> | <b>1,843</b> | <b>B+C</b>             | <b>4.718</b> | <b>0.376</b> | <b>0.063</b> | <b>0.313</b> | <b>0.358</b> | <b>0.228</b> | <b>0.130</b> |
| <b>Off Campus</b>                            |   |   |            |              |                        |              |              |              |              |              |              |              |
| Off-Campus Housing TDM Reductions            |   |   |            |              |                        |              |              |              |              |              |              |              |
| 26   | Off-Campus Housing TDM Reduction for Students               |   | FTE        | 2,654        | A                      | 0.000        | 0.000        | 0.000        | 0.000        | 0.000        | 0.000        | 0.000        |
| 27   | Off-Campus Housing TDM Reduction for Faculty/Staff          |   | FTE        | 561          | A                      | 0.000        | 0.000        | 0.000        | 0.000        | 0.000        | 0.000        | 0.000        |
| 28   | <b>Off-Campus Housing TDM Reduction [I]</b>                 |   | <b>FTE</b> | <b>3,215</b> | <b>A</b>               | <b>0.000</b> | <b>0.000</b> | <b>0.000</b> | <b>0.000</b> | <b>0.000</b> | <b>0.000</b> | <b>0.000</b> |
| <b>CSUMB Campus Internal Trip Adjustment</b> |   |   |            |              |                        |              |              |              |              |              |              |              |
| Main Campus Internal Trips Adjustment        |   |   |            |              |                        |              |              |              |              |              |              |              |
| 29   | Students  | Promontory Housing  | FTE        | 756          | E                      | 0.188        | 0.016        | 0.015        | 0.001        | 0.010        | 0.001        | 0.009        |
| 30   | CSUMB Campus Population                                     | Main Campus Students and Campus Supporting Trips            | FTE        | 7,658        | D                      | 0.087        | 0.035        | 0.019        | 0.016        | 0.018        | 0.008        | 0.010        |
| 31   | Students  | East Campus Housing   | FTE        | 1,380        | C                      | 1.030        | 0.104        | 0.086        | 0.018        | 0.080        | 0.023        | 0.057        |
| 32   | Faculty/Staff   | East Campus Housing   | FTE        | 463          | C                      | 1.618        | 0.376        | 0.313        | 0.063        | 0.424        | 0.132        | 0.292        |
| 33   | <i>Internal Trips Adjustment [J]</i>                        |   | <i>FTE</i> | <i>7,658</i> | <i>C + D + E</i>       | <i>0.389</i> | <i>0.078</i> | <i>0.055</i> | <i>0.023</i> | <i>0.060</i> | <i>0.021</i> | <i>0.039</i> |
| East Campus Internal Trips Adjustment        |   |   |            |              |                        |              |              |              |              |              |              |              |
| 34   | Students  | East Campus Housing   | FTE        | 1,380        | C                      | 1.030        | 0.104        | 0.018        | 0.086        | 0.080        | 0.057        | 0.023        |
| 35   | Faculty/Staff   | East Campus Housing   | FTE        | 463          | C                      | 1.618        | 0.376        | 0.063        | 0.313        | 0.424        | 0.292        | 0.132        |
| 36   | <i>Internal Trips with Main Campus [F]</i>                  |   | <i>FTE</i> | <i>1,843</i> | <i>C</i>               | <i>1.178</i> | <i>0.172</i> | <i>0.029</i> | <i>0.143</i> | <i>0.166</i> | <i>0.116</i> | <i>0.050</i> |
| 37   | <b>Internal Trip Adjustment Total [J + F = L]</b>           |   | <b>FTE</b> | <b>1,843</b> | <b>C</b>               | <b>2.796</b> | <b>0.498</b> | <b>0.258</b> | <b>0.240</b> | <b>0.413</b> | <b>0.201</b> | <b>0.212</b> |
| <b>CSUMB Campus External Trips Total</b>     |   |   |            |              |                        |              |              |              |              |              |              |              |
| 38   | <b>External Campus Trip Total [D + H - I - L = M]</b>       |   | <b>FTE</b> | <b>7,938</b> | <b>A+B</b>             | <b>2.252</b> | <b>0.177</b> | <b>0.090</b> | <b>0.087</b> | <b>0.183</b> | <b>0.088</b> | <b>0.095</b> |

Notes:

FTE = Full time equivalent.

1. Vehicle trip generation rates represent vehicles per FTE. For presentation purposes, these rates are rounded to the nearest thousandth.

2. Trip type shown on Figure 1.

Source: Fehr & Peers, 2019.

**TABLE E-3: PROJECT CONDITIONS VEHICLE TRIP GENERATION RATES**

| Row Number                                   | Population Type   | Housing Location  | Unit       | Size          | Trip Type <sup>1</sup> | Daily | AM Peak Hour |       |       | PM Peak Hour |       |       |
|--|---|---|------------|---------------|------------------------|-------|--------------|-------|-------|--------------|-------|-------|
|  |   |   |            |               |                        |       | Total        | In    | Out   | Total        | In    | Out   |
| <b>Main Campus</b>                           |   |   |            |               |                        |       |              |       |       |              |       |       |
| Main Campus Internal Trips                   |   |   |            |               |                        |       |              |       |       |              |       |       |
| 1  | Students  | Promontory Housing  | FTE        | 756           | E                      | 0.053 | 0.004        | 0.004 | 0.000 | 0.003        | 0.000 | 0.003 |
| 2  | CSUMB Campus Population                                     | Main Campus Students and Campus Supporting Trips            | FTE        | 14,476        | D                      | 0.067 | 0.034        | 0.018 | 0.016 | 0.017        | 0.008 | 0.009 |
| 3  | <i>Internal Trips [A]</i>                                   |   | <i>FTE</i> | <i>14,476</i> | <i>D + E</i>           | 0.070 | 0.034        | 0.018 | 0.016 | 0.018        | 0.009 | 0.009 |
| Main Campus External Trips                   |   |   |            |               |                        |       |              |       |       |              |       |       |
| 4  | Students  | Promontory Housing  | FTE        | 756           | A                      | 2.079 | 0.058        | 0.008 | 0.050 | 0.139        | 0.069 | 0.070 |
| 5  | Students  | East Campus Housing   | FTE        | 0             | C                      |       |              |       |       |              |       |       |
| 6  | Faculty/Staff   | East Campus Housing   | FTE        | 1,154         | C                      | 1.618 | 0.376        | 0.313 | 0.063 | 0.423        | 0.132 | 0.291 |
| 7  | Students  | Off-Campus Housing  | FTE        | 5,080         | A                      | 1.285 | 0.111        | 0.106 | 0.005 | 0.106        | 0.038 | 0.068 |
| 8  | Faculty/Staff   | Off-Campus Housing  | FTE        | 622           | A                      | 1.601 | 0.420        | 0.305 | 0.115 | 0.442        | 0.182 | 0.260 |
| 9  | CSUMB Campus Population                                     | Main Campus Students, Campus Supporting Trips, and Visitors | FTE        | 14,476        | A                      | 1.026 | 0.059        | 0.025 | 0.034 | 0.081        | 0.039 | 0.042 |
| 10   | <i>Main Campus Cordon Trips [B]</i>                         |   | <i>FTE</i> | <i>14,476</i> | <i>A + C</i>           | 1.784 | 0.149        | 0.100 | 0.049 | 0.178        | 0.074 | 0.104 |
| East Campus Housing TDM Reductions           |   |   |            |               |                        |       |              |       |       |              |       |       |
| 11   | Student East Campus Housing TDM Reduction for Students      |   | FTE        | 0             | C                      |       |              |       |       |              |       |       |
| 12   | Student East Campus Housing TDM Reduction for Faculty/Staff |   | FTE        | 1,154         | C                      | 0.000 | 0.000        | 0.000 | 0.000 | 0.000        | 0.000 | 0.000 |
| 13   | <i>East Campus Housing TDM Reduction [C]</i>                |   | <i>FTE</i> | <i>1,154</i>  | <i>C</i>               | 0.000 | 0.000        | 0.000 | 0.000 | 0.000        | 0.000 | 0.000 |
| 14   | <b>Main Campus Trip Generation [A + B - C = D]</b>          |   | <b>FTE</b> | <b>14,476</b> | <b>A+C+D+E</b>         | 1.853 | 0.183        | 0.119 | 0.064 | 0.196        | 0.083 | 0.113 |
| <b>East Campus</b>                           |   |   |            |               |                        |       |              |       |       |              |       |       |
| East Campus Internal Trips                   |   |   |            |               |                        |       |              |       |       |              |       |       |
| 15   | Students  | East Campus Housing   | FTE        | 0             | C                      |       |              |       |       |              |       |       |
| 16   | Faculty/Staff   | East Campus Housing   | FTE        | 1,154         | C                      | 1.618 | 0.376        | 0.063 | 0.313 | 0.423        | 0.291 | 0.132 |
| 17   | <i>Internal Trips with Main Campus [F]</i>                  |   | <i>FTE</i> | <i>1,154</i>  | <i>C</i>               | 1.618 | 0.376        | 0.063 | 0.313 | 0.423        | 0.291 | 0.132 |
| East Campus External Trips                   |   |   |            |               |                        |       |              |       |       |              |       |       |
| 18   | Students  | East Campus Housing   | FTE        | 0             | B                      |       |              |       |       |              |       |       |
| 19   | Faculty/Staff   | East Campus Housing   | FTE        | 1,154         | B                      | 5.272 | 0.465        | 0.078 | 0.387 | 0.333        | 0.227 | 0.106 |
| 20   | Community Housing Partners                                  | East Campus Housing   | FTE        | 66            | B                      | 5.273 | 0.470        | 0.076 | 0.394 | 0.333        | 0.227 | 0.106 |
| 21   | <i>External Trips [E]</i>                                   |   | <i>FTE</i> | <i>1,220</i>  | <i>B</i>               | 5.274 | 0.466        | 0.078 | 0.388 | 0.334        | 0.228 | 0.106 |
| East Campus Housing TDM Reductions           |   |   |            |               |                        |       |              |       |       |              |       |       |
| 22   | Student East Campus Housing TDM Reduction for Students      |   | FTE        | 0             | C                      |       |              |       |       |              |       |       |
| 23   | Student East Campus Housing TDM Reduction for Faculty/Staff |   | FTE        | 1,154         | C                      | 0     | 0            | 0     | 0     | 0            | 0     | 0     |
| 24   | <i>East Campus Housing TDM Reduction [G]</i>                |   | <i>FTE</i> | <i>1,154</i>  | <i>C</i>               | 0     | 0            | 0     | 0     | 0            | 0     | 0     |
| 25   | <b>East Campus Cordon Trips [F + E - G = H]</b>             |   | <b>FTE</b> | <b>1,154</b>  | <b>B+C</b>             | 6.802 | 0.821        | 0.138 | 0.683 | 0.733        | 0.503 | 0.230 |
| <b>Off Campus</b>                            |   |   |            |               |                        |       |              |       |       |              |       |       |
| Off-Campus Housing TDM Reductions            |   |   |            |               |                        |       |              |       |       |              |       |       |
| 26   | Off-Campus Housing TDM Reduction for Students               |   | FTE        | 5,080         | A                      | 0.000 | 0.000        | 0.000 | 0.000 | 0.000        | 0.000 | 0.000 |
| 27   | Off-Campus Housing TDM Reduction for Faculty/Staff          |   | FTE        | 622           | A                      | 0.000 | 0.000        | 0.000 | 0.000 | 0.000        | 0.000 | 0.000 |
| 28   | <b>Off-Campus Housing TDM Reduction [I]</b>                 |   | <b>FTE</b> | <b>5,702</b>  | <b>A</b>               | 0.000 | 0.000        | 0.000 | 0.000 | 0.000        | 0.000 | 0.000 |
| <b>CSUMB Campus Internal Trip Adjustment</b> |   |   |            |               |                        |       |              |       |       |              |       |       |
| Main Campus Internal Trips Adjustment        |   |   |            |               |                        |       |              |       |       |              |       |       |
| 29   | Students  | Promontory Housing  | FTE        | 756           | E                      | 0.053 | 0.004        | 0.004 | 0.000 | 0.003        | 0.000 | 0.003 |
| 30   | CSUMB Campus Population                                     | Main Campus Students and Campus Supporting Trips            | FTE        | 14,476        | D                      | 0.067 | 0.034        | 0.018 | 0.016 | 0.017        | 0.008 | 0.009 |
| 31   | Students  | East Campus Housing   | FTE        | 0             | C                      |       |              |       |       |              |       |       |
| 32   | Faculty/Staff   | East Campus Housing   | FTE        | 1,154         | C                      | 1.618 | 0.376        | 0.313 | 0.063 | 0.423        | 0.132 | 0.291 |
| 33   | <i>Internal Trips Adjustment [J]</i>                        |   | <i>FTE</i> | <i>14,476</i> | <i>C + D + E</i>       | 0.199 | 0.064        | 0.043 | 0.021 | 0.051        | 0.018 | 0.033 |
| East Campus Internal Trips Adjustment        |   |   |            |               |                        |       |              |       |       |              |       |       |
| 34   | Students  | East Campus Housing   | FTE        | 0             | C                      |       |              |       |       |              |       |       |
| 35   | Faculty/Staff   | East Campus Housing   | FTE        | 1,154         | C                      | 1.618 | 0.376        | 0.063 | 0.313 | 0.423        | 0.291 | 0.132 |
| 36   | <i>Internal Trips with Main Campus [F]</i>                  |   | <i>FTE</i> | <i>1,154</i>  | <i>C</i>               | 1.618 | 0.376        | 0.063 | 0.313 | 0.423        | 0.291 | 0.132 |
| 37   | <b>Internal Trip Adjustment Total [J + F = L]</b>           |   | <b>FTE</b> | <b>15,630</b> | <b>C</b>               | 0.304 | 0.087        | 0.045 | 0.042 | 0.079        | 0.039 | 0.040 |
| <b>CSUMB Campus External Trips Total</b>     |   |   |            |               |                        |       |              |       |       |              |       |       |
| 38   | <b>External Campus Trip Total [D + H - I - L = M]</b>       |   | <b>FTE</b> | <b>14,542</b> | <b>A+B</b>             | 2.089 | 0.157        | 0.082 | 0.075 | 0.172        | 0.083 | 0.089 |

Notes:

FTE = Full time equivalent.

1. Vehicle trip generation rates represent vehicles per FTE. For presentation purposes, these rates are rounded to the nearest thousandth.

2. Trip type shown on Figure 1.

Source: Fehr & Peers, 2019.

**Attachment F:**  
**Existing and Project Conditions Vehicle Trip  
Generation for CSUMB by Population Type  
and Housing Location**

**ATTACHMENT F-1: EXISTING CONDITIONS VEHICLE TRIP GENERATION FOR CSUMB BY POPULATION TYPE AND HOUSING LOCATION**

| Row Number                                   | Population Type   | Housing Location   | Unit       | Size         | Trip Type <sup>1</sup> | Daily         | AM Peak Hour |              |            | PM Peak Hour |            |            |
|--|---|--|------------|--------------|------------------------|---------------|--------------|--------------|------------|--------------|------------|------------|
|  |   |  |            |              |                        |               | Total        | In           | Out        | Total        | In         | Out        |
| <b>Main Campus</b>                           |   |  |            |              |                        |               |              |              |            |              |            |            |
| Main Campus Internal Trips                   |   |  |            |              |                        |               |              |              |            |              |            |            |
| 1  | Students  | Promontory Housing   | FTE        | 756          | E                      | 142           | 12           | 11           | 1          | 8            | 1          | 7          |
| 2  | CSUMB Campus Population                                     | Main Campus Students and Campus Supporting Trips                 | FTE        | 7,658        | D                      | 669           | 272          | 148          | 124        | 140          | 63         | 77         |
| 3  | <i>Internal Trips [A]</i>                                   |  | <i>FTE</i> | <i>7,658</i> | <i>D + E</i>           | <i>811</i>    | <i>284</i>   | <i>159</i>   | <i>125</i> | <i>148</i>   | <i>64</i>  | <i>84</i>  |
| Main Campus External Trips                   |   |  |            |              |                        |               |              |              |            |              |            |            |
| 4  | Students  | Promontory Housing   | FTE        | 756          | A                      | 1,572         | 44           | 6            | 38         | 105          | 52         | 53         |
| 5  | Students  | East Campus Housing  | FTE        | 1,380        | C                      | 1,422         | 143          | 118          | 25         | 111          | 32         | 79         |
| 6  | Faculty/Staff   | East Campus Housing  | FTE        | 463          | C                      | 749           | 174          | 145          | 29         | 196          | 61         | 135        |
| 7  | Students  | Off-Campus Housing   | FTE        | 2,654        | A                      | 3,411         | 294          | 281          | 13         | 280          | 100        | 180        |
| 8  | Faculty/Staff   | Off-Campus Housing   | FTE        | 561          | A                      | 899           | 235          | 171          | 64         | 248          | 102        | 146        |
| 9  | CSUMB Campus Population                                     | Main Campus Students, Campus Supporting Trips, and Visitor Trips | FTE        | 7,658        | A                      | 4,147         | 346          | 175          | 171        | 372          | 178        | 194        |
| 10   | <i>Main Campus Cordon Trips [B]</i>                         |  | <i>FTE</i> | <i>7,658</i> | <i>A + C</i>           | <i>12,200</i> | <i>1,236</i> | <i>896</i>   | <i>340</i> | <i>1,312</i> | <i>525</i> | <i>787</i> |
| East Campus Housing TDM Reductions           |   |  |            |              |                        |               |              |              |            |              |            |            |
| 11   | Student East Campus Housing TDM Reduction for Students      |  | FTE        | 1,380        | C                      | 0             | 0            | 0            | 0          | 0            | 0          | 0          |
| 12   | Student East Campus Housing TDM Reduction for Faculty/Staff |  | FTE        | 463          | C                      | 0             | 0            | 0            | 0          | 0            | 0          | 0          |
| 13   | <i>East Campus Housing TDM Reduction [C]</i>                |  | <i>FTE</i> | <i>1,843</i> | <i>C</i>               | <i>0</i>      | <i>0</i>     | <i>0</i>     | <i>0</i>   | <i>0</i>     | <i>0</i>   | <i>0</i>   |
| 14   | <b>Main Campus Trip Generation [A + B - C = D]</b>          |  | <b>FTE</b> | <b>7,658</b> | <b>A+C+D+E</b>         | <b>13,011</b> | <b>1,520</b> | <b>1,055</b> | <b>465</b> | <b>1,460</b> | <b>589</b> | <b>871</b> |
| <b>East Campus</b>                           |   |  |            |              |                        |               |              |              |            |              |            |            |
| East Campus Internal Trips                   |   |  |            |              |                        |               |              |              |            |              |            |            |
| 15   | Students  | East Campus Housing  | FTE        | 1,380        | C                      | 1,422         | 143          | 25           | 118        | 111          | 79         | 32         |
| 16   | Faculty/Staff   | East Campus Housing  | FTE        | 463          | C                      | 749           | 174          | 29           | 145        | 196          | 135        | 61         |
| 17   | <i>Internal Trips with Main Campus [F]</i>                  |  | <i>FTE</i> | <i>1,843</i> | <i>C</i>               | <i>2,171</i>  | <i>317</i>   | <i>54</i>    | <i>263</i> | <i>307</i>   | <i>214</i> | <i>93</i>  |
| East Campus External Trips                   |   |  |            |              |                        |               |              |              |            |              |            |            |
| 18   | Students  | East Campus Housing  | FTE        | 1,380        | B                      | 3,928         | 137          | 23           | 114        | 204          | 100        | 104        |
| 19   | Faculty/Staff   | East Campus Housing  | FTE        | 463          | B                      | 2,441         | 215          | 36           | 179        | 154          | 105        | 49         |
| 20   | Community Housing Partners                                  | East Campus Housing  | FTE        | 280          | B                      | 1,477         | 130          | 21           | 109        | 94           | 65         | 29         |
| 21   | <i>External Trips [E]</i>                                   |  | <i>FTE</i> | <i>2,123</i> | <i>B</i>               | <i>7,846</i>  | <i>482</i>   | <i>80</i>    | <i>402</i> | <i>452</i>   | <i>270</i> | <i>182</i> |
| East Campus Housing TDM Reductions           |   |  |            |              |                        |               |              |              |            |              |            |            |
| 22   | Student East Campus Housing TDM Reduction for Students      |  | FTE        | 1,380        | C                      | 0             | 0            | 0            | 0          | 0            | 0          | 0          |
| 23   | Student East Campus Housing TDM Reduction for Faculty/Staff |  | FTE        | 463          | C                      | 0             | 0            | 0            | 0          | 0            | 0          | 0          |
| 24   | <i>East Campus Housing TDM Reduction [G]</i>                |  | <i>FTE</i> | <i>1,843</i> | <i>C</i>               | <i>0</i>      | <i>0</i>     | <i>0</i>     | <i>0</i>   | <i>0</i>     | <i>0</i>   | <i>0</i>   |
| 25   | <b>East Campus Cordon Trips [F + E - G = H]</b>             |  | <b>FTE</b> | <b>2,123</b> | <b>B+C</b>             | <b>10,017</b> | <b>799</b>   | <b>134</b>   | <b>665</b> | <b>759</b>   | <b>484</b> | <b>275</b> |
| <b>Off Campus</b>                            |   |  |            |              |                        |               |              |              |            |              |            |            |
| Off-Campus Housing TDM Reductions            |   |  |            |              |                        |               |              |              |            |              |            |            |
| 26   | Off-Campus Housing TDM Reduction for Students               |  | FTE        | 2,654        | A                      | 0             | 0            | 0            | 0          | 0            | 0          | 0          |
| 27   | Off-Campus Housing TDM Reduction for Faculty/Staff          |  | FTE        | 561          | A                      | 0             | 0            | 0            | 0          | 0            | 0          | 0          |
| 28   | <b>Off-Campus Housing TDM Reduction [I]</b>                 |  | <b>FTE</b> | <b>3,215</b> | <b>A</b>               | <b>0</b>      | <b>0</b>     | <b>0</b>     | <b>0</b>   | <b>0</b>     | <b>0</b>   | <b>0</b>   |
| <b>CSUMB Campus Internal Trip Adjustment</b> |   |  |            |              |                        |               |              |              |            |              |            |            |
| Main Campus Internal Trips Adjustment        |   |  |            |              |                        |               |              |              |            |              |            |            |
| 29   | Students  | Promontory Housing   | FTE        | 756          | E                      | 142           | 12           | 11           | 1          | 8            | 1          | 7          |
| 30   | CSUMB Campus Population                                     | Main Campus Students and Campus Supporting Trips                 | FTE        | 7,658        | D                      | 669           | 272          | 148          | 124        | 140          | 63         | 77         |
| 31   | Students  | East Campus Housing  | FTE        | 1,380        | C                      | 1,422         | 143          | 118          | 25         | 111          | 32         | 79         |
| 32   | Faculty/Staff   | East Campus Housing  | FTE        | 463          | C                      | 749           | 174          | 145          | 29         | 196          | 61         | 135        |
| 33   | <i>Internal Trips Adjustment [J]</i>                        |  | <i>FTE</i> | <i>7,658</i> | <i>C + D + E</i>       | <i>2,982</i>  | <i>601</i>   | <i>422</i>   | <i>179</i> | <i>455</i>   | <i>157</i> | <i>298</i> |
| East Campus Internal Trips Adjustment        |   |  |            |              |                        |               |              |              |            |              |            |            |
| 34   | Students  | East Campus Housing  | FTE        | 1,380        | C                      | 1,422         | 143          | 25           | 118        | 111          | 79         | 32         |
| 35   | Faculty/Staff   | East Campus Housing  | FTE        | 463          | C                      | 749           | 174          | 29           | 145        | 196          | 135        | 61         |
| 36   | <i>Internal Trips with Main Campus [F]</i>                  |  | <i>FTE</i> | <i>1,843</i> | <i>C</i>               | <i>2,171</i>  | <i>317</i>   | <i>54</i>    | <i>263</i> | <i>307</i>   | <i>214</i> | <i>93</i>  |
| 37   | <b>Internal Trip Adjustment Total [J + F = L]</b>           |  | <b>FTE</b> | <b>1,843</b> | <b>C</b>               | <b>5,153</b>  | <b>918</b>   | <b>476</b>   | <b>442</b> | <b>762</b>   | <b>371</b> | <b>391</b> |
| <b>CSUMB Campus External Trips Total</b>     |   |  |            |              |                        |               |              |              |            |              |            |            |
| 38   | <b>External Campus Trip Total [D + H - I - L = M]</b>       |  | <b>FTE</b> | <b>7,938</b> | <b>A+B</b>             | <b>17,875</b> | <b>1,401</b> | <b>713</b>   | <b>688</b> | <b>1,457</b> | <b>702</b> | <b>755</b> |

Notes:

FTE = Full time equivalent.

1. Trip type shown on Figure 1.

Source: Fehr & Peers, 2019.



**ATTACHMENT F-2: PROJECT CONDITIONS VEHICLE TRIP GENERATION FOR CSUMB BY POPULATION TYPE AND HOUSING LOCATION**

| Row Number                                   | Population Type   | Housing Location  | Unit       | Size          | Trip Type <sup>1</sup> | Daily         | AM Peak Hour |              |              | PM Peak Hour |              |              |
|--|---|---|------------|---------------|------------------------|---------------|--------------|--------------|--------------|--------------|--------------|--------------|
|  |   |   |            |               |                        |               | Total        | In           | Out          | Total        | In           | Out          |
| <b>Main Campus</b>                           |   |   |            |               |                        |               |              |              |              |              |              |              |
| Main Campus Internal Trips                   |   |   |            |               |                        |               |              |              |              |              |              |              |
| 1  | Students  | Promontory Housing  | FTE        | 756           | E                      | 40            | 3            | 3            | 0            | 2            | 0            | 2            |
| 2  | CSUMB Campus Population                                     | Main Campus Students and Campus Supporting Trips            | FTE        | 14,476        | D                      | 970           | 495          | 261          | 234          | 253          | 120          | 133          |
| 3  | <i>Internal Trips [A]</i>                                   |   | <i>FTE</i> | <i>14,476</i> | <i>D + E</i>           | <i>1,010</i>  | <i>498</i>   | <i>264</i>   | <i>234</i>   | <i>255</i>   | <i>120</i>   | <i>135</i>   |
| Main Campus External Trips                   |   |   |            |               |                        |               |              |              |              |              |              |              |
| 4  | Students  | Promontory Housing  | FTE        | 756           | A                      | 1,572         | 44           | 6            | 38           | 105          | 52           | 53           |
| 5  | Students  | East Campus Housing   | FTE        | 0             | C                      | 0             | 0            | 0            | 0            | 0            | 0            | 0            |
| 6  | Faculty/Staff   | East Campus Housing   | FTE        | 1,154         | C                      | 1,867         | 434          | 361          | 73           | 488          | 152          | 336          |
| 7  | Students  | Off-Campus Housing  | FTE        | 5,080         | A                      | 6,528         | 563          | 538          | 25           | 538          | 193          | 345          |
| 8  | Faculty/Staff   | Off-Campus Housing  | FTE        | 622           | A                      | 996           | 261          | 190          | 71           | 275          | 113          | 162          |
| 9  | CSUMB Campus Population                                     | Main Campus Students, Campus Supporting Trips, and Visitors | FTE        | 14,476        | A                      | 14,857        | 854          | 359          | 495          | 1,171        | 568          | 603          |
| 10   | <i>Main Campus Cordon Trips [B]</i>                         |   | <i>FTE</i> | <i>14,476</i> | <i>A + C</i>           | <i>25,820</i> | <i>2,156</i> | <i>1,454</i> | <i>702</i>   | <i>2,577</i> | <i>1,078</i> | <i>1,499</i> |
| East Campus Housing TDM Reductions           |   |   |            |               |                        |               |              |              |              |              |              |              |
| 11   | Student East Campus Housing TDM Reduction for Students      |   | FTE        | 0             | C                      | 0             | 0            | 0            | 0            | 0            | 0            | 0            |
| 12   | Student East Campus Housing TDM Reduction for Faculty/Staff |   | FTE        | 1,154         | C                      | 0             | 0            | 0            | 0            | 0            | 0            | 0            |
| 13   | <i>East Campus Housing TDM Reduction [C]</i>                |   | <i>FTE</i> | <i>1,154</i>  | <i>C</i>               | <i>0</i>      | <i>0</i>     | <i>0</i>     | <i>0</i>     | <i>0</i>     | <i>0</i>     | <i>0</i>     |
| 14   | <b>Main Campus Trip Generation [A + B - C = D]</b>          |   | <b>FTE</b> | <b>14,476</b> | <b>A+C+D+E</b>         | <b>26,830</b> | <b>2,654</b> | <b>1,718</b> | <b>936</b>   | <b>2,832</b> | <b>1,198</b> | <b>1,634</b> |
| <b>East Campus</b>                           |   |   |            |               |                        |               |              |              |              |              |              |              |
| East Campus Internal Trips                   |   |   |            |               |                        |               |              |              |              |              |              |              |
| 15   | Students  | East Campus Housing   | FTE        | 0             | C                      | 0             | 0            | 0            | 0            | 0            | 0            | 0            |
| 16   | Faculty/Staff   | East Campus Housing   | FTE        | 1,154         | C                      | 1,867         | 434          | 73           | 361          | 488          | 336          | 152          |
| 17   | <i>Internal Trips with Main Campus [F]</i>                  |   | <i>FTE</i> | <i>1,154</i>  | <i>C</i>               | <i>1,867</i>  | <i>434</i>   | <i>73</i>    | <i>361</i>   | <i>488</i>   | <i>336</i>   | <i>152</i>   |
| East Campus External Trips                   |   |   |            |               |                        |               |              |              |              |              |              |              |
| 18   | Students  | East Campus Housing   | FTE        | 0             | B                      | 0             | 0            | 0            | 0            | 0            | 0            | 0            |
| 19   | Faculty/Staff   | East Campus Housing   | FTE        | 1,154         | B                      | 6,084         | 537          | 90           | 447          | 384          | 262          | 122          |
| 20   | Community Housing Partners                                  | East Campus Housing   | FTE        | 66            | B                      | 348           | 31           | 5            | 26           | 22           | 15           | 7            |
| 21   | <i>External Trips [E]</i>                                   |   | <i>FTE</i> | <i>1,220</i>  | <i>B</i>               | <i>6,432</i>  | <i>568</i>   | <i>95</i>    | <i>473</i>   | <i>406</i>   | <i>277</i>   | <i>129</i>   |
| East Campus Housing TDM Reductions           |   |   |            |               |                        |               |              |              |              |              |              |              |
| 22   | Student East Campus Housing TDM Reduction for Students      |   | FTE        | 0             | C                      | 0             | 0            | 0            | 0            | 0            | 0            | 0            |
| 23   | Student East Campus Housing TDM Reduction for Faculty/Staff |   | FTE        | 1,154         | C                      | 0             | 0            | 0            | 0            | 0            | 0            | 0            |
| 24   | <i>East Campus Housing TDM Reduction [G]</i>                |   | <i>FTE</i> | <i>1,154</i>  | <i>C</i>               | <i>0</i>      | <i>0</i>     | <i>0</i>     | <i>0</i>     | <i>0</i>     | <i>0</i>     | <i>0</i>     |
| 25   | <b>East Campus Cordon Trips [F + E - G = H]</b>             |   | <b>FTE</b> | <b>1,220</b>  | <b>B+C</b>             | <b>8,299</b>  | <b>1,002</b> | <b>168</b>   | <b>834</b>   | <b>894</b>   | <b>613</b>   | <b>281</b>   |
| <b>Off Campus</b>                            |   |   |            |               |                        |               |              |              |              |              |              |              |
| Off-Campus Housing TDM Reductions            |   |   |            |               |                        |               |              |              |              |              |              |              |
| 26   | Off-Campus Housing TDM Reduction for Students               |   | FTE        | 5,080         | A                      | 0             | 0            | 0            | 0            | 0            | 0            | 0            |
| 27   | Off-Campus Housing TDM Reduction for Faculty/Staff          |   | FTE        | 622           | A                      | 0             | 0            | 0            | 0            | 0            | 0            | 0            |
| 28   | <b>Off-Campus Housing TDM Reduction [I]</b>                 |   | <b>FTE</b> | <b>5,702</b>  | <b>A</b>               | <b>0</b>      | <b>0</b>     | <b>0</b>     | <b>0</b>     | <b>0</b>     | <b>0</b>     | <b>0</b>     |
| <b>CSUMB Campus Internal Trip Adjustment</b> |   |   |            |               |                        |               |              |              |              |              |              |              |
| Main Campus Internal Trips Adjustment        |   |   |            |               |                        |               |              |              |              |              |              |              |
| 29   | Students  | Promontory Housing  | FTE        | 756           | E                      | 40            | 3            | 3            | 0            | 2            | 0            | 2            |
| 30   | CSUMB Campus Population                                     | Main Campus Students and Campus Supporting Trips            | FTE        | 14,476        | D                      | 970           | 495          | 261          | 234          | 253          | 120          | 133          |
| 31   | Students  | East Campus Housing   | FTE        | 0             | C                      | 0             | 0            | 0            | 0            | 0            | 0            | 0            |
| 32   | Faculty/Staff   | East Campus Housing   | FTE        | 1,154         | C                      | 1,867         | 434          | 361          | 73           | 488          | 152          | 336          |
| 33   | <i>Internal Trips Adjustment [J]</i>                        |   | <i>FTE</i> | <i>14,476</i> | <i>C + D + E</i>       | <i>2,877</i>  | <i>932</i>   | <i>625</i>   | <i>307</i>   | <i>743</i>   | <i>272</i>   | <i>471</i>   |
| East Campus Internal Trips Adjustment        |   |   |            |               |                        |               |              |              |              |              |              |              |
| 34   | Students  | East Campus Housing   | FTE        | 0             | C                      | 0             | 0            | 0            | 0            | 0            | 0            | 0            |
| 35   | Faculty/Staff   | East Campus Housing   | FTE        | 1,154         | C                      | 1,867         | 434          | 73           | 361          | 488          | 336          | 152          |
| 36   | <i>Internal Trips with Main Campus [F]</i>                  |   | <i>FTE</i> | <i>1,154</i>  | <i>C</i>               | <i>1,867</i>  | <i>434</i>   | <i>73</i>    | <i>361</i>   | <i>488</i>   | <i>336</i>   | <i>152</i>   |
| 37   | <b>Internal Trip Adjustment Total [J + F = L]</b>           |   | <b>FTE</b> | <b>15,630</b> | <b>C</b>               | <b>4,744</b>  | <b>1,366</b> | <b>698</b>   | <b>668</b>   | <b>1231</b>  | <b>608</b>   | <b>623</b>   |
| <b>CSUMB Campus External Trips Total</b>     |   |   |            |               |                        |               |              |              |              |              |              |              |
| 38   | <b>External Campus Trip Total [D + H - I - L = M]</b>       |   | <b>FTE</b> | <b>14,542</b> | <b>A+B</b>             | <b>30,385</b> | <b>2,290</b> | <b>1,188</b> | <b>1,102</b> | <b>2,495</b> | <b>1,203</b> | <b>1,292</b> |

Notes:

FTE = Full time equivalent.

1. Trip type shown on Figure 1.

Source: Fehr & Peers, 2019.

**APPENDIX B: CALIFORNIA STATE UNIVERSITY, MONTEREY BAY  
MASTER PLAN EIR – TRANSPORTATION STUDY AREA LOCATIONS**





## MEMORANDUM

Date: June 10, 2019

To: Anya Spear and Matt McCluney, California State University Monterey Bay  
Steve Lohr and Dawn Theodora, California State University Office of the Chancellor  
Ann Sansevero, Dudek

From: Daniel Rubins and Matt Haynes, Fehr & Peers

**Subject: California State University Monterey Bay 2019 Master Plan EIR –  
Transportation Study Area Locations**

*SJ17-1728*

---

This memorandum describes how the final study area for the proposed California State University Monterey Bay (CSUMB) Master Plan EIR transportation analysis was determined. Specifically, it describes how the Project traffic volume estimates were used to identify those intersections and freeway segments at which the Project would result in a deficient operation. The memorandum first defines the likely outer edges of the study area. Second, it selects the major intersections along the local access routes to the campus that may be experience deficient operations with the proposed Project based on estimated Project trips and related road distribution and assignment. Local access routes include the on-campus vehicle street system, parking location changes, and the amount of traffic that would be added to the transportation network as a result of implementation of the proposed Project. The memo concludes with a list of the study intersections and freeway segments.

### PROJECT DESCRIPTION

The Project is the CSUMB Master Plan. Project elements that affect the transportation system include the proposed increase in enrollment, the on-campus housing for students, faculty, and staff, and a Main Campus street and parking system that facilitates and prioritizes walking, bicycling, and transit use over vehicle travel. Upon buildout, the Project would accommodate an increase in campus enrollment from the existing 6,634 full time equivalent students (FTES)<sup>1</sup> and 1,024 full time

---

<sup>1</sup> Full-time equivalent (FTE) is the unit of measurement used to convert class load to student enrollment. At CSUMB, one FTE is equal to 15 units. Thus, one FTE is equal to one student enrolled in 15 units or three students each enrolled in 5 units. A related unit of measurement is "headcount." In the case of one student taking 15 units, the headcount is 1; in the case of three students collectively taking 15 units, the headcount is 3.



equivalent faculty/staff (FTEF),<sup>2</sup> to 12,700 FTES and 1,776 FTEF. Under Project Conditions, it is projected that the Project would house at least 60 percent of enrolled students and 65 percent of faculty and staff on campus (PDF-LU-5 and PDF-LU-6, as described in Chapter 3 of the proposed CSUMB Master Plan Draft EIR). As explained in the *Draft California State University Monterey Bay Proposed Master Plan Housing Memorandum* (see **Attachment A** of the *California State University Monterey Bay Master Plan EIR – Trip Generation Evaluation Methods and Estimates* memorandum), the Project Conditions on-campus student housing rate is similar to the existing on-campus student rates, and the Project Conditions on-campus faculty and staff housing rate is expected to increase based on various policies, programs and procedures to be implemented over the coming years.

**Table 1** summarizes the number and percentage of students, faculty, and staff presently residing on- and off-campus (Existing Conditions), and the number forecasted to reside on- and off-campus under Project Conditions when FTES enrollment and FTEF employment total reaches 14,476.

The total on-campus housed population (i.e., the number of students, faculty, and staff residing in either Main Campus or East Campus housing) is forecasted to increase from the existing 58 percent (4,443 of 7,658) to 61 percent (8,774 of 14,476). As space permits, community housing partners<sup>3</sup> will also reside in the East Campus housing. While community housing partners live on-campus, they are not associated with on-campus housing for students, faculty and staff, and therefore are not included in the student, faculty, and staff population total but are included in the entire campus population total in **Table 1**.

In terms of actual on-campus housing facilities, the Project would provide housing to accommodate an increase in campus population from the existing approximately 6,634 FTES to 12,700 FTES, and an increase in employees (i.e., faculty and staff) from approximately 1,024 FTEF to 1,776 FTEF.<sup>4</sup>

---

<sup>2</sup> According to CSUMB Institutional Assessment and Research, 1 FTE = full time faculty or staff headcount + part time faculty or staff headcount divided by 3. The faculty and staff category also includes affiliates, which are companies that have been contracted by the Corporation to provide services that the auxiliary has been asked to provide by the university (e.g. dining, bookstore, etc.), and the affiliate's employee works full-time on campus in that capacity. They are also referred to as contractors. The Auxiliary includes staff of the Corporation, Student Union and Foundation.

<sup>3</sup> Community housing partners are made up of affiliates (a subcategory of CSUMB staff), educational partners and military partners, and public sector employees working in the Monterey area.

<sup>4</sup> Existing student, faculty and staff quantities based on 2016 baseline figures provided by CSUMB staff.



**TABLE 1: CSUMB POPULATION TYPE BY HOUSING LOCATION**

| Housing Location  | Existing Conditions (FTES or FTEF) <sup>1</sup> | Project Conditions (FTES or FTEF) <sup>1</sup> | Change (Project – Existing) <sup>2</sup> |
|---|---|--|--|
| <b>Student Population</b>   |   |  |  |
| Main Campus   | 2,600<br>(39.2%)                                | 7,620<br>(60.0%)                               | +5,200                                   |
| East Campus <sup>4</sup>  | 1,380<br>(20.8%)                                | 0<br>(0%)                                      | -1,380                                   |
| Off-Campus  | 2,654<br>(40.0%)                                | 5,080<br>(40.0%)                               | +2,426                                   |
| <i>Subtotal [A]</i>   | <i>6,634</i><br><i>(100%)</i>                   | <i>12,700</i><br><i>(100%)</i>                 | <i>+6,066</i>                            |
| <b>Faculty/Staff Population</b>                                   |   |  |  |
| East Campus <sup>3</sup>  | 463<br>(45.2%)                                  | 1,154<br>(65.0%)                               | +691                                     |
| Off-Campus  | 561<br>(54.8%)                                  | 622<br>(35.0%)                                 | +61                                      |
| <i>Subtotal [B]</i>   | <i>1,024</i><br><i>(100%)</i>                   | <i>1,776</i><br><i>(100%)</i>                  | <i>+752</i>                              |
| <b>Student, Faculty, and Staff Population (Campus Population)</b> |   |  |  |
| Main Campus and East Campus<br>(Students, Faculty and Staff)      | 4,443<br>(58.0%)                                | 8,774<br>(60.6%)                               | +4,331                                   |
| Off-Campus<br>(Students, Faculty and Staff)                       | 3,215<br>(42.0%)                                | 5,702<br>(39.4%)                               | +2,487                                   |
| <b>Total<br/>[A + B = C]</b>                                      | <b>7,658<br/>(100%)</b>                         | <b>14,476<br/>(100%)</b>                       | <b>+6,818</b>                            |
| <b>Campus Population with Community Housing Partners</b>          |   |  |  |
| East Campus<br>(Community Housing Partners) [D]                   | 280   | 66   | -214                                     |
| <b>Total [C+D = E]</b>  | <b>7,938</b>                                    | <b>14,542</b>                                  | <b>+6,604</b>                            |

Notes:

1. FTES = Full time equivalent students; FTEF = Full time equivalent faculty/staff.
2. Change (Project - Existing) = Project Conditions column – Existing Conditions column.
3. The transportation trip generation analysis uses a campus population that, meets but does not exceed the 60 percent student housing goal and the 65 faculty and staff housing goal under Project Conditions.
4. Under Existing Conditions 1,380 students, 463 faculty/staff, and 280 community housing partners live in the East Campus housing. Under Project Conditions 1,154 faculty/staff and 66 community housing partners live in the East Campus housing unless housing is needed by for campus employees.

Source: Fehr & Peers, 2019.



## PROJECT TRAFFIC VOLUMES

The amount of automobile traffic that would be generated by the proposed Project, and the distribution of that traffic on the area roadways, was estimated using a three-step process:

1. **Trip Generation** – The *number* of vehicles that would enter/exit the Project site with the increased campus population was estimated. (See the *California State University Monterey Bay Master Plan EIR – Trip Generation Evaluation Methods and Estimates* memorandum for a detailed description of the trip generation analysis).
2. **Trip Distribution** – The *direction* that vehicles would use to approach and depart the Project site was projected using the AMBAG travel model.
3. **Trip Assignment** – The number of vehicles that would be generated by the Project was then *assigned* to specific roadway segments using the AMBAG travel model and forecasting methods.

Each of these steps in the process is further described in the following sections.

## VEHICLE TRIP GENERATION ESTIMATES

Below is a condensed discussion of the trip generation presented in the *California State University Monterey Bay Master Plan EIR – Trip Generation Evaluation Methods and Estimates* memorandum. The trip generation approach and technical methods are unique because of the size of the CSUMB campus, the unique travel behavior of each portion of the CSUMB population, and varied housing locations of the CSUMB population. Rather than calculating the net increase in project vehicle trips due to the net increase in land use like most projects; the trip generation is prepared for the entire campus under Existing Conditions and Project Conditions to capture the effects of adding on-campus housing and shifting of student housing from East Campus to Main Campus. Specifically, the net new project traffic is the difference in the Project Conditions and Existing Conditions CSUMB campus trip generation. As shown in the analysis, housing an average of 60 percent of the future campus population (students, faculty and staff) on-campus increases the:

- Likelihood of trips staying within the campus (internal trips); and
- Likelihood of trips shifting to other modes (walking, bicycling, micro-mobility<sup>5</sup>, and transit) for both on and off-campus travel.

Total vehicle trip generation for the CSUMB campus under both Existing Conditions and Project Conditions are presented in **Tables 2** and **3**. As shown, the total trip generation estimates are

---

<sup>5</sup> Micro-mobility is an emerging mode of travel that is characterized by new electric lightweight utility vehicles such as e-scooters, and e-bikes.



provided for the Main Campus and East Campus separately, as well as total numbers for the entire campus.

**TABLE 2: EXISTING CONDITIONS VEHICLE TRIP GENERATION FOR CSUMB CAMPUS**

| Location Type                                       | Trip Type <sup>1</sup> | Daily         | Morning Peak Hour |              |             | Evening Peak Hours |             |             |
|---|------------------------|---------------|-------------------|--------------|-------------|--------------------|-------------|-------------|
|   |                        |               | Total             | In           | Out         | Total              | In          | Out         |
| <b>Main Campus</b>                                  |                        |               |                   |              |             |                    |             |             |
| Promontory Housing Internal Trips                   | E                      | 142           | 12                | 11           | 1           | 8                  | 1           | 7           |
| Main Campus Internal Trips <sup>2</sup>             | D                      | 669           | 272               | 148          | 124         | 140                | 63          | 77          |
| Main Campus External Trips                          | A                      | 10,029        | 919               | 633          | 286         | 1,005              | 432         | 573         |
| Main Campus Trips with East Campus                  | C                      | 2,171         | 317               | 263          | 54          | 307                | 93          | 214         |
| <b>Main Campus Total [A]</b>                        | <b>A+C+D+E</b>         | <b>13,011</b> | <b>1,520</b>      | <b>1,055</b> | <b>465</b>  | <b>1,460</b>       | <b>589</b>  | <b>871</b>  |
| <b>East Campus</b>                                  |                        |               |                   |              |             |                    |             |             |
| East Campus Trips with Main Campus                  | C                      | 2,171         | 317               | 54           | 263         | 307                | 214         | 93          |
| East Campus External Trips                          | B                      | 7,846         | 482               | 80           | 402         | 452                | 270         | 182         |
| <b>East Campus Total [B]</b>                        | <b>B+C</b>             | <b>10,017</b> | <b>799</b>        | <b>134</b>   | <b>665</b>  | <b>759</b>         | <b>484</b>  | <b>275</b>  |
| <b>Internal Trip Adjustment</b>                     |                        |               |                   |              |             |                    |             |             |
| Promontory Housing Internal Trips                   | E                      | -142          | -12               | -11          | -1          | -8                 | -1          | -7          |
| Main Campus Internal Trips <sup>2</sup>             | D                      | -669          | -272              | -148         | -124        | -140               | -63         | -77         |
| Main Campus Trips with East Campus                  | C                      | -2,171        | -317              | -263         | -54         | -307               | -93         | -214        |
| East Campus Trips with Main Campus                  | C                      | -2,171        | -317              | -54          | -263        | -307               | -214        | -93         |
| <b>Trip Adjustment [C]</b>                          | <b>C+D+E</b>           | <b>-5,153</b> | <b>-918</b>       | <b>-476</b>  | <b>-442</b> | <b>-762</b>        | <b>-371</b> | <b>-391</b> |
| <b>External Campus Trip Total [A+B]<sup>3</sup></b> | <b>A+B</b>             | <b>17,875</b> | <b>1,401</b>      | <b>713</b>   | <b>688</b>  | <b>1,457</b>       | <b>702</b>  | <b>755</b>  |

Notes:

1. Trip type shown on Figure 1.
2. Main Campus Internal Trips = Main Campus Students and Campus Supporting Trips.
3. The campus trip generation is the sum of all Main Campus and East Campus external vehicle trips generated by students, faculty, staff, and visitors.  
 Source: Fehr & Peers, 2019.

As shown in **Table 2**, under Existing Conditions the Campus external vehicle trip generation is approximately 17,875<sup>6</sup> daily vehicle trips, 1,401 morning peak-hour trips (713 inbound and 688 outbound) and 1,457 evening peak-hour trips (702 inbound and 755 outbound).

As shown in **Table 3**, under Project Conditions the campus external vehicle trip generation would be approximately 30,385 daily vehicle trips, 2,290 morning peak-hour trips (1,188 inbound and 1,102 outbound) and 2,495 evening peak-hour trips (1,203 inbound and 1,292 outbound).

<sup>6</sup> This excludes vehicle through trips not associated with the CSUMB campus.



**TABLE 3: CSUMB CAMPUS VEHICLE TRIP GENERATION FOR PROJECT CONDITIONS**

| Trip Type   | Trip Type <sup>1</sup> | Daily         | Morning Peak Hour |              |              | Evening Peak Hours |              |              |
|---|------------------------|---------------|-------------------|--------------|--------------|--------------------|--------------|--------------|
|   |                        |               | Total             | In           | Out          | Total              | In           | Out          |
| <b>Main Campus</b>                                  |                        |               |                   |              |              |                    |              |              |
| Promontory Housing Internal Trips                   | E                      | 40            | 3                 | 3            | 0            | 2                  | 0            | 2            |
| Main Campus Internal Trips <sup>2</sup>             | D                      | 970           | 495               | 261          | 234          | 253                | 120          | 133          |
| Main Campus External Trips                          | A                      | 23,953        | 1,722             | 1,093        | 629          | 2,089              | 926          | 1,163        |
| Main Campus Trips with East Campus                  | C                      | 1,867         | 434               | 361          | 73           | 488                | 152          | 336          |
| <b>Main Campus Total [A]</b>                        | <b>A+C+D+E</b>         | <b>26,830</b> | <b>2,654</b>      | <b>1,718</b> | <b>936</b>   | <b>2,832</b>       | <b>1,198</b> | <b>1,634</b> |
| <b>East Campus</b>                                  |                        |               |                   |              |              |                    |              |              |
| East Campus Trips with Main Campus                  | C                      | 1,867         | 434               | 73           | 361          | 488                | 336          | 152          |
| East Campus External Trips                          | B                      | 6,432         | 568               | 95           | 473          | 406                | 277          | 129          |
| <b>East Campus Total [B]</b>                        | <b>B+C</b>             | <b>8,299</b>  | <b>1,002</b>      | <b>168</b>   | <b>834</b>   | <b>894</b>         | <b>613</b>   | <b>281</b>   |
| <b>Internal Trip Adjustment</b>                     |                        |               |                   |              |              |                    |              |              |
| Promontory Housing Internal Trips                   | E                      | -40           | -3                | -3           | -0           | -2                 | -0           | -2           |
| Main Campus Internal Trips <sup>2</sup>             | D                      | -970          | -495              | -261         | -234         | -253               | -120         | -133         |
| Main Campus Trips with East Campus                  | C                      | -1,867        | -434              | -361         | -73          | -488               | -152         | -336         |
| East Campus Trips with Main Campus                  | C                      | -1,867        | -434              | -73          | -361         | -488               | -336         | -152         |
| <b>Trip Adjustment [C]</b>                          | <b>C+D+E</b>           | <b>-4,744</b> | <b>-1,366</b>     | <b>-698</b>  | <b>-668</b>  | <b>-1,231</b>      | <b>-608</b>  | <b>-623</b>  |
| <b>External Campus Trip Total [A+B]<sup>2</sup></b> | <b>A+B</b>             | <b>30,385</b> | <b>2,290</b>      | <b>1,188</b> | <b>1,102</b> | <b>2,495</b>       | <b>1,203</b> | <b>1,292</b> |

Notes:

1. Trip type shown on Figure 1.
2. Main Campus Internal Trips = Main Campus Students and Campus Supporting Trips.
3. The campus trip generation is the sum of all Main Campus and East Campus external vehicle trips generated by students, faculty, staff, and visitors.

Source: Fehr & Peers, 2019.

As shown in **Table 4**, the Project (i.e., Project Conditions) would generate 12,510 additional external daily trips, 889 additional external morning peak hour trips and 1,039 additional external evening peak hour trips.

By housing a large portion of students, faculty, and staff on-campus, and consolidating parking to the periphery. CSUMB would convert many potential off-campus-based trips to on-campus generated trips, thereby reducing both the number of external campus trips to and from campus. Relatedly, by increasing the number of on-campus students, the number of CSUMB external trips made by on-campus students for purposes such as recreational activities, off-campus dining, visiting family and friends, etc. would increase in absolute terms over existing levels.

By comparing **Tables 2** and **3** we can see the net change in vehicle trips due to the Main Campus population growth, the additional on-campus student housing, and faculty and staff moving into residential units currently occupied by students and community housing partners in the East Campus housing. Thus, the net increase in trip generation between Existing Conditions and Project





Conditions is the project increment that will be studied in the transportation analysis. **Table 4** presents the net increase in external campus trips between Existing and Project Conditions.

**TABLE 4: CSUMB CAMPUS VEHICLE TRIP GENERATION RESULTS**

| Scenario                                    | Daily         | Morning Peak Hour |            |            | Evening Peak Hours |            |            |
|---|---------------|-------------------|------------|------------|--------------------|------------|------------|
|   |               | Total             | In         | Out        | Total              | In         | Out        |
| Existing Conditions [A]                     | 17,875        | 1,401             | 713        | 688        | 1,457              | 702        | 755        |
| Project Conditions [B]                      | 30,385        | 2,290             | 1,188      | 1,102      | 2,495              | 1,205      | 1,292      |
| <b><i>Additional Campus Trips [B-A]</i></b> | <b>12,510</b> | <b>889</b>        | <b>475</b> | <b>414</b> | <b>1,039</b>       | <b>501</b> | <b>537</b> |

Source: Fehr & Peers, 2019.

## VEHICLE TRIP DISTRIBUTION ESTIMATES

Campus vehicle trips are generated by students, faculty, staff, community housing partners, campus support (trips made by security staff, maintenance staff, etc.), and visitors traveling to/from the CSUMB campus. The AMBAG travel model was used to distribute the vehicle trips from the CSUMB campus to nearby communities for each analysis scenario (Existing Conditions, Existing with Project Conditions, Cumulative Conditions, and Cumulative with Project Conditions). The distribution of project traffic considered: 1) regional land use destinations outside of the Campus, and 2) ease and convenience of access to nearby freeways and regional streets.

The distribution of vehicle trips going to/coming from nearby communities of Castroville (and north), Marina, Salinas, Seaside, and Monterey to the CSUMB Campus is presented in **Table 5**. The distribution is summarized for the inbound and outbound during the morning peak hour and the evening peak hour under Existing with Project Conditions and Cumulative with Project Conditions. The distribution of CSUMB campus traffic is similar during the morning and evening peak hours under Existing with Project Conditions and Cumulative with Project Conditions. Vehicle trips to/from the north account for 25 to 29 percent of vehicle trips, with the majority traveling to/from Castroville and north. The communities south of the CSUMB campus account for 36% to 39% of vehicle trips. Finally, communities east of the CSUMB campus (Salinas) account for 34 to 37 percent of the vehicle trips.



**TABLE 5: DISTRIBUTION OF CSUMB EXTERNAL VEHICLE TRIPS TO NEARBY COMMUNITIES (AMBAG MODEL)**

| Resident Location     | Existing with Project Conditions |                             | Cumulative with Project Conditions |                             |
|-----------------------|----------------------------------|-----------------------------|------------------------------------|-----------------------------|
|                       | Morning Inbound Peak Hour        | Evening Outbound Peak Hours | Morning Inbound Peak Hour          | Evening Outbound Peak Hours |
| <b>North</b>          |                                  |                             |                                    |                             |
| Castroville and North | 18%                              | 17%                         | 20%                                | 17%                         |
| Marina                | 9%                               | 8%                          | 9%                                 | 10%                         |
| <b>North Total</b>    | <b>27%</b>                       | <b>25%</b>                  | <b>29%</b>                         | <b>27%</b>                  |
| <b>East</b>           |                                  |                             |                                    |                             |
| Salinas               | 37%                              | 37%                         | 34%                                | 34%                         |
| <b>East Total</b>     | <b>37%</b>                       | <b>37%</b>                  | <b>34%</b>                         | <b>34%</b>                  |
| <b>South</b>          |                                  |                             |                                    |                             |
| Seaside               | 13%                              | 15%                         | 14%                                | 16%                         |
| Monterey and West     | 23%                              | 23%                         | 23%                                | 23%                         |
| <b>South Total</b>    | <b>36%</b>                       | <b>38%</b>                  | <b>37%</b>                         | <b>39%</b>                  |

Source: Fehr & Peers, 2019.

### Comparison of Project Trip Distribution

The following sources were reviewed to determine the accuracy of the Project trip distribution patterns derived from the AMBAG travel model:

- CSUMB Student Resident Zip Code Data (specific to students only) – The CSUMB student zip code data was provided by CSUMB staff and includes on-campus and off-campus student resident location by zip code.
- CSUMB Person Trip Travel Survey Zip Code Data (includes students, as well as faculty and staff) – The *CSUMB Person Trip Travel Survey* was conducted in Fall 2017 and included questions to assist in understanding travel choices to/from the Main Campus, including mode of travel and where (zip code) the respondent currently resides. This data set includes on-campus and off-campus student, faculty, and staff resident location by zip code provided by survey respondents.

Fehr & Peers reviewed the CSUMB Student Resident Zip Code data, which, as noted above, is limited to student resident locations. However, this data set represents only a sample of the student resident locations because some students provide only their parents resident location and not the student’s resident location while attending CSUMB; in other words, the survey responses with resident locations listed outside of the proximity of the CSUMB campus were not considered as part of the trip distribution analysis.



As shown in **Table 6**, the distribution of CSUMB student residence locations is similar for both data sets and at least half of the campus population lives on campus. That is, even though the CSUMB student resident zip code data considered as part of the analysis are limited to the student portion of the campus population, both data sets have a similar distribution for resident locations as to students. Furthermore, each data set shows that the majority of the campus population lives on-campus. To compare to the distribution in **Table 5**, the CSUMB zip code and person survey zip code data derived distributions were prepared for off-campus residents only (see **Table 7**).

**TABLE 6: DISTRIBUTION OF CSUMB CAMPUS POPULATION TO NEARBY COMMUNITIES**

| <b>Resident Location</b> | <b>Student Only</b><br>(from CSUMB Zip Code data) | <b>Student Only</b><br>(from Person Trip Travel Survey) | <b>CSUMB Faculty/Staff</b><br>(from Person Trip Travel Survey) | <b>CSUMB Student &amp; Faculty/Staff</b><br>(from Person Trip Travel Survey) |
|--------------------------|---|---|--|--|
| <b>North</b>             |   |   |  |  |
| Castroville and North    | 13%   | 10%   | 10%  | 10%  |
| Marina                   | 8%  | 9%  | 6%   | 9%   |
| <b>North Total</b>       | <b>21%</b>  | <b>19%</b>  | <b>16%</b>   | <b>19%</b>   |
| <b>East</b>              |   |   |  |  |
| Salinas                  | 14%   | 14%   | 13%  | 14%  |
| <b>East Total</b>        | <b>14%</b>  | <b>14%</b>  | <b>13%</b>   | <b>14%</b>   |
| <b>South</b>             |   |   |  |  |
| Seaside                  | 8%  | 8%  | 5%   | 8%   |
| Monterey and West        | 8%  | 6%  | 17%  | 7%   |
| <b>South Total</b>       | <b>16%</b>  | <b>14%</b>  | <b>22%</b>   | <b>15%</b>   |
| <b>On-Campus</b>         |   |   |  |  |
| On-Campus (Main or East) | 49%   | 53%   | 49%  | 52%  |
| <b>On-Campus Total</b>   | <b>49%</b>  | <b>53%</b>  | <b>49%</b>   | <b>52%</b>   |

Source: Fehr & Peers, 2019.

The trip distribution data from the AMBAG travel model was compared to the data collected from the CSUMB Student Resident Zip Code Data and the *CSUMB Person Trip Travel Survey* data representing student, faculty, and staff resident locations. As a first step, the distribution of on-campus and off-campus students, faculty and staff were reviewed for consistency of distribution pattern between data sets. Based on the *CSUMB Person Trip Travel Survey* data, the distribution of vehicle trips going to/coming from different areas of Monterey, Santa Cruz, and Santa Clara counties to the CSUMB campus is presented in **Table 7**.



**TABLE 7: DISTRIBUTION OF CSUMB OFF-CAMPUS POPULATION TO NEARBY COMMUNITIES**

| <b>Resident Location</b> | <b>Student Only</b><br>(from CSUMB Zip Code data) | <b>Student Only</b><br>(from Person Trip Travel Survey) | <b>CSUMB Faculty/Staff</b><br>(from Person Trip Travel Survey) | <b>CSUMB Student &amp; Faculty/Staff</b><br>(from Person Trip Travel Survey) |
|--------------------------|---|---|--|--|
| <b>North</b>             |   |   |  |  |
| Castroville and North    | 26%   | 21%   | 19%  | 21%  |
| Marina                   | 16%   | 19%   | 13%  | 18%  |
| <b>North Total</b>       | <b>42%</b>  | <b>40%</b>  | <b>32%</b>   | <b>39%</b>   |
| <b>East</b>              |   |   |  |  |
| Salinas                  | 28%   | 30%   | 25%  | 30%  |
| <b>East Total</b>        | <b>28%</b>  | <b>30%</b>  | <b>25%</b>   | <b>30%</b>   |
| <b>South</b>             |   |   |  |  |
| Seaside                  | 15%   | 17%   | 9%   | 16%  |
| Monterey and West        | 15%   | 13%   | 34%  | 15%  |
| <b>South Total</b>       | <b>30%</b>  | <b>30%</b>  | <b>43%</b>   | <b>31%</b>   |

Source: Fehr & Peers, 2019.

The distribution of CSUMB external vehicle trips to nearby communities in **Table 5** (from the AMBAG travel mode) is similar (within 10 percentage points) to the distributions of CSUMB Students and Faculty/Staff (from the *CSUMB Person Trip Travel Survey* data) shown in **Table 7**. Thus, the project trip distribution percentages derived from the AMBAG travel model are appropriate for use with this analysis.

## VEHICLE TRIP ASSIGNMENT ESTIMATES

Once the trip generation and distribution were determined, the AMBAG travel model was used to assign the project trips from the CSUMB campus to the transportation network during the morning and evening peak hour under Existing with Project Conditions and Cumulative with Project Conditions.

## SELECTING THE STUDY AREA

The California State University *Transportation Impact Study (TIS) Manual* (November 2012) provides the following guidance for defining the study area (pages 11 and 12):

- *The study area should extend to a sufficient distance from the project site to identify all potentially significant impacts, as supported by substantial evidence.*



- *If the project is of statewide, areawide, or regional significance as defined in Section 21092.5 of the 2017 CEQA Guidelines, then the study area should consider major local arterials and public transit within a maximum of 5 miles of the project site, and freeways, highways and rail transit service within a maximum of 10 miles of the project site.*
- *Additional facilities may be studied based on circumstances unique to the site. CSU should confirm whether TIS preparers may consult with the host City or County early regarding any additional study locations based on local or site-specific issues.*

Using the above guidance, the intersection study area boundary for the proposed Project would extend up to 10 miles from the CSUMB campus and encompass the following locations, with the corresponding geographic location noted in parentheses:

- Highway 1 between Reservation Road and Del Monte Boulevard (County: Castroville and North)
- California Avenue between Third Avenue and Patton Parkway (Marina)
- Del Monte Boulevard between Reindollar Avenue and Cypress Avenue (Marina)
- Blanco Road between Reservation Road and Cooper Road (County: South of Salinas)
- Davis Road between Reservation Road and Foster Road (County: South of Salinas)
- Highway 68 between Reservation Road and Spreckels Avenue (County: South of Salinas)
- Fremont Boulevard south of Highway 1 (Seaside)
- California Avenue south of Highway 1 (Seaside)
- Canyon Del Rey Boulevard south of Highway 1 (Seaside)
- General Jim Moore Boulevard between Coe Avenue and San Pablo Avenue (Seaside)
- Highway 1 between Canyon Del Rey Boulevard and Del Monte Boulevard (County: Monterey and West)

To confirm that the study area boundary is an appropriate distance to diffuse Project traffic such that project traffic would not cause a potential significant impact to the roadway or freeway system beyond the proposed study area, we reviewed the day-to-day variation of roadway and freeway counts within the identified area. This was done by comparing the directional (inbound or outbound) peak hour vehicle trips at the boundary locations listed above to the day-to-day variation of the roadway counts. Using this method, if Project traffic is greater than the day-to-day variation, then the study area boundary may need to be extended beyond the proposed study area boundary described above. Project traffic that is less than the day-to-day variation of a roadway, means that the project traffic is disbursed enough to have little influence on the roadway operation and thus would be unlikely to cause a potentially significant impact. Stated differently, project traffic less than the average day-to-day variation would not be discernable by an observer on the side of the road.



Near the CSUMB campus, the local street system has an average day-to-day variation<sup>7</sup> of approximately 13 percent during the morning peak hour and 12 percent during the evening peak hour (see **Attachment B** for the day-to-day variation calculated from six roadway segments over two to five days). The freeway system has a day-to-day variation of approximately 2 percent in the morning peak hour and 5 percent in the evening peak hour (see **Attachment B**). Therefore, for this analysis, if the Project traffic would contribute more than 10 percent of the peak hour roadway capacity or more than 2 percent of the peak hour freeway capacity, then the study area would need to be expanded to include those roadways/freeways. Often study intersections are selected based on a 10 trip per lane rule or similar rule of thumb. Expressing the percentage of roadway capacity in vehicle trips per lane units, study intersections are proposed to be analyzed if the Project traffic contributes more than 40 to 50 peak hour project vehicle trips per turn lane to an intersection<sup>8</sup> and freeway segments are selected with more than 2 percent of the peak hour freeway capacity (for example, 2 percent of capacity of a 2-lane freeway would be 44 peak hour vehicle trips).

**Attachment A** shows the evaluation of the study boundary for the eleven locations listed above. From left to right the table defines the nearby community, roadways, roadway classification, two-way total roadway capacity, and peak direction roadway assignment distribution from the AMBAG travel model. The evaluation is done by comparing the evening outbound peak hour vehicle trips<sup>9</sup> (see column A in **Attachment A**) to the evening outbound peak hour direction roadway segment threshold (see column B in **Attachment A**) to determine if the study area needs to be expanded beyond that area identified above (see column C in **Attachment A**). The comparison confirms that the study area does not need to be expanded to ensure that all potentially significant Project impacts are identified.

With the study area boundary defined, the major study area intersections and freeway segments were selected based on the CSUMB Project vehicle trips added to the transportation network at locations that meet one or more of the criteria presented in **Table 8**. Criteria 1 and 2 are based on the evaluation of the day-to-day roadway variation described above, and Criteria 3 and 4 are based on the anticipated changes in the transportation street network.

---

<sup>7</sup> Vehicle variation is estimated by comparing day-to-day counts to each other. The difference between the maximum and minimum vehicle volume is defined as the vehicle variation.

<sup>8</sup> As an example, General Jim Moore Boulevard between Coe Avenue and San Pablo Avenue has a total roadway link vehicle capacity of 3,740 vehicles per peak hour per direction. This street segment has two northbound and two southbound lanes. Major intersections along this street will be selected if the project traffic adds more than 187 vehicles (10 percent \* 2 lanes \* 935 vehicles per hour per lane) in either the northbound or southbound direction. The approach geometry along General Jim Moore Boulevard is a left turn lane, two through lanes and a right turn lane. Dividing the 187 vehicles by 4 turn lanes would result in approximately 47 vehicles per turn lane.

<sup>9</sup> The assigned project trips at each boundary location is based on the distribution of project trips summarized in **Table 3** and refined based on the "select zone" assignment analysis using the AMBAG travel model to determine the relative attractiveness of each route. The segment thresholds in terms of vehicle trips were determined by multiplying the roadway/freeway segment capacity by the appropriate day-to-day vehicle volume variation threshold.



**TABLE 8: STUDY AREA CRITERIA**

| Criteria  | Intersections along Streets and Corridors that Meet Criteria   |
|---|--|
| <p>Criterion 1: Major intersections (typically arterial to arterial intersections) along local streets and regional corridors segments that provide access to/from the CSUMB Campus within the study area boundary.</p>   | <p>The major study intersections along the following local streets and regional corridors within the study area boundary meet Criterion 1:</p> <ul style="list-style-type: none"> <li>• Imjin Parkway between Highway 1 and Reservation Road</li> <li>• Reservation Road between Imjin Parkway and State Route 68</li> <li>• Inter-Garrison Road between Reservation Road and 8th Avenue</li> <li>• Lightfighter Drive between Highway 1 and General Jim Moore</li> <li>• Second Avenue between Reindollar Avenue (future) and Imjin Parkway</li> <li>• General Jim Moore between Lightfighter Drive and Eucalyptus Road</li> </ul>  |
| <p>Criterion 2: Project traffic would contribute more than 2 percent of peak hour capacity on freeway segments that provide access to/from the CSUMB Campus.</p>  | <p>Highway 1 segments between State Route 68 and Reservation Road met Criterion 2.</p>   |
| <p>Criterion 3: Local street intersections on or near the Main Campus that may experience changed vehicle patterns due to the closure of Inter-Garrison Road, the one-way re-configuration of 7th Avenue between Colonel Durham Street and Butler Street, or the re-location of Main Campus parking lots to satellite parking lots.<sup>1</sup></p> | <p>The following are nearby and on-campus intersections serving the last mile of access and/or on-campus circulation that meet Criterion 3:</p> <ul style="list-style-type: none"> <li>• Second Avenue between Imjin Parkway and Lightfighter Drive</li> <li>• General Jim More between Eighth Street and Lightfighter Drive</li> <li>• Eighth Avenue between Inter-Garrison Road and Gigling Road</li> <li>• Eight Street between Second Avenue and Inter-Garrison Road</li> <li>• Inter-Garrison Road between Second Avenue and Eighth Avenue</li> <li>• Divarty Street between Second Avenue and Sixth Avenue</li> <li>• Colonel Durham Street between General Jim Moore Boulevard and Eighth Avenue</li> <li>• Gigling Road between General Jim Moore Boulevard and Eighth Avenue</li> </ul> |
| <p>Criterion 4: Local street intersections on or near the Main Campus that may experience changed vehicle patterns due to the Eastside Parkway extension.<sup>1</sup></p>   | <p>The following local street intersections along the following streets meet Criterion 4:</p> <ul style="list-style-type: none"> <li>• Inter-Garrison Road between Second Avenue and Schoonover Drive</li> <li>• Lightfighter Drive between Highway 1 and General Jim Moore Boulevard</li> <li>• Colonel Durham Street between General Jim Moore Boulevard and Eight Avenue</li> <li>• Gigling Road between General Jim Moore Boulevard and Eighth Avenue</li> <li>• Second Avenue between Inter-Garrison Road and Lightfighter Drive</li> <li>• General Jim Moore between Inter-Garrison Road and Eucalyptus Road</li> <li>• Eighth Avenue between Inter-Garrison Road and Gigling Road</li> <li>• Eastside Parkway extension from Inter-Garrison Road to Eucalyptus Road</li> </ul>            |

Notes:

1. The re-distribution of existing traffic due to changes to on-campus vehicle street system and parking locations, and Eastside Parkway extension have the potential to shift traffic. Criteria 3 and 4 were used to identify locations where traffic shifts may cause impacts to the transportation system.

Source: Fehr & Peers, 2019.



## Study Area Intersections

The resulting list of study area intersections creates a study area generally bounded by Reservation Road to the north, Davis Road to the east, Coe Avenue to the south, and Highway 1 to the west.

The list of study intersections is provided in **Table 9** and illustrated in **Figure 1**.

The intersections requested by reviewing agencies (Caltrans, Monterey County, Fort Ord Reuse Authority, City of Seaside, and City of Marina) and included in the final study area intersection list are highlighted in **Table 9** with an asterisk (\*). The only agency requested intersection not included in the final study area intersection list is Normandy Road and Malmedy Road because this route is slower and less direct than traveling via General Jim Moore Boulevard and Gigling Road to/from the CSUMB campus and this intersection does not meet the intersection selection criteria described earlier. In other words, the slower and less direct route is unlikely to experience project traffic.





**TABLE 9: STUDY AREA INTERSECTIONS**

|    |  |    |  |
|----|--|----|--|
| 1  | Del Monte Boulevard and Reindollar Avenue              | 27 | Reservation Road and Watkins Gate Road                         |
| 2  | Second Avenue Extension and Patton Parkway             | 28 | Davis Road and Reservation Road                                |
| 3  | SR 1 Southbound Ramps and Imjin Parkway                | 29 | Second Avenue and Divarty Street                               |
| 4  | SR 1 Northbound Ramps and Imjin Parkway                | 30 | General Jim Moore Boulevard and Divarty Street                 |
| 5  | Second Avenue and Imjin Parkway                        | 31 | First Avenue and Lightfighter Drive                            |
| 6  | Third Avenue and Imjin Parkway                         | 32 | Second Avenue and Lightfighter Drive                           |
| 7  | Fourth Avenue and Imjin Parkway                        | 33 | General Jim Moore Boulevard and Lightfighter Drive             |
| 8  | California Avenue and Imjin Parkway                    | 34 | Malmedy Road and Colonel Durham Street                         |
| 9  | California Avenue and Patton Parkway                   | 35 | Parker Flatts Cut Off Road and Colonel Durham Street           |
| 10 | Imjin Road and Imjin Parkway                           | 36 | Sixth Avenue and Colonel Durham Street                         |
| 11 | Abrams Drive and Imjin Parkway                         | 37 | Seventh Avenue and Colonel Durham Street                       |
| 12 | Reservation Road and Imjin Parkway                     | 38 | Eighth Avenue and Colonel Durham Street                        |
| 13 | Blanco Road and Reservation Road                       | 39 | General Jim Moore Boulevard and Gigling Road                   |
| 14 | Inter-Garrison Road Connection and Reservation Road    | 40 | Malmedy Road and Gigling Road                                  |
| 15 | Second Avenue and Ninth Street                         | 41 | Parker Flatts Cut Off Road and Gigling Road                    |
| 16 | Second Avenue and Eighth Street                        | 42 | Sixth Avenue and Gigling Road                                  |
| 17 | Fourth Avenue and Eighth Street                        | 43 | Seventh Avenue and Gigling Road                                |
| 18 | Imjin Road and Eighth Street                           | 44 | Eight Avenue and Gigling Road                                  |
| 19 | Second Avenue and Inter-Garrison Road                  | 45 | Eastside Parkway and Gigling Road                              |
| 20 | General Jim Moore Boulevard and Inter-Garrison Road    | 46 | General Jim Moore Boulevard and Normandy Road                  |
| 21 | Eighth Street/Seventh Avenue and Inter-Garrison Road   | 47 | General Jim Moore Boulevard and Coe Avenue                     |
| 22 | Eighth Avenue and Inter-Garrison Road                  | 48 | Fremont Boulevard - Southbound SR 1 Off-Ramp and Monterey Road |
| 23 | Abrams Drive and Inter-Garrison Road                   | 49 | California Avenue and Monterey Road - Northbound SR 1 Off-Ramp |
| 24 | Schoonover Road and Inter-Garrison Road                | 50 | Reservation Road and State Route 68 Westbound Ramps            |
| 25 | Inter-Garrison Road Connection and Inter-Garrison Road | 51 | Reservation Road and State Route 68 Eastbound Ramps            |
| 26 | East Garrison Road and Reservation Road                |    |  |



## STUDY AREA FREEWAY SEGMENTS

A similar approach was used for the determination of study area freeway segments. In reviewing available counts near the CSUMB campus, the freeway system has a day-to-day variation of two percent during the morning peak hour and five percent during the evening peak hour in the peak direction (see **Attachment B**). Freeway segments along Highway 1 to which the Project would add more than two percent traffic would be studied. The final list of study area freeway segments is presented below.

1. Highway 1 between Reservation Road and Del Monte Boulevard (2 segments)
2. Highway 1 between Del Monte Boulevard and Imjin Parkway (2 segments)
3. Highway 1 between Imjin Parkway and Lightfighter Drive (2 segments)
4. Highway 1 between Lightfighter Drive and Fremont Boulevard-Del Monte Boulevard (2 segments)
5. Highway 1 between Fremont Boulevard-Del Monte Boulevard and Canyon Del Rey Boulevard (2 segments)

In addition, the following freeway ramps at the two nearest interchanges closest to the CSUMB campus are studied.

1. Highway 1 and Imjin Parkway Interchange Ramps (4 ramps)
2. Highway 1 and Lightfighter Drive Interchange Ramps (4 ramps)

## ATTACHMENTS

- Figure 1: Project Location and Study Area Intersections  
Attachment A: Evaluation of Study Area Boundary  
Attachment B: Roadway Day-to-Day Variation

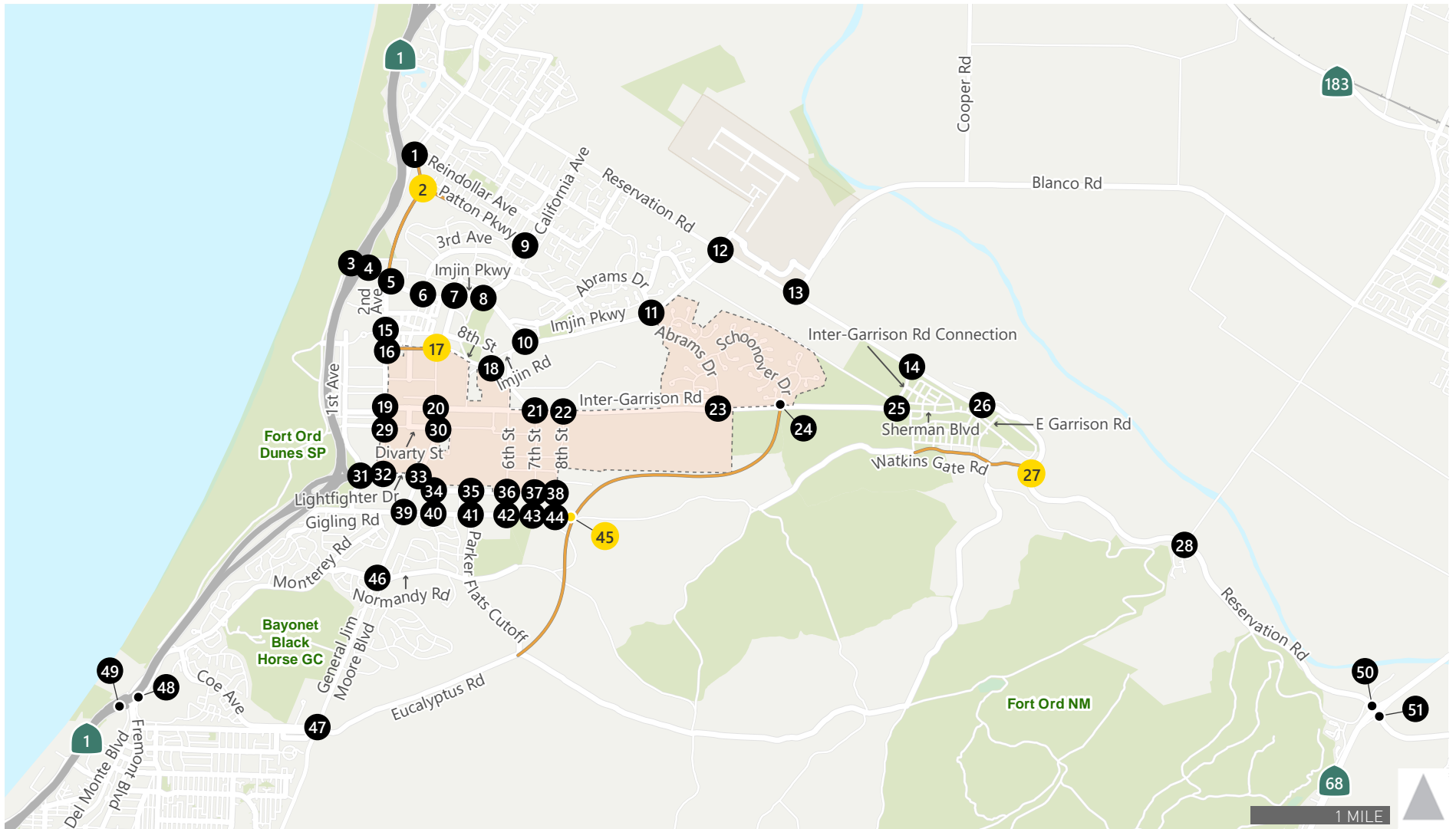

- California State University Monterey Bay Campus
- Study Intersection
- Future Intersection
- New/Extended Roadway



Figure 1  
Project Location and Study Intersections

**ATTACHMENT A: Evaluation of Study Boundary**

| Nearby Community          | Roadways  | Roadway Classification    | Roadway Capacity (vehicles, both directions) <sup>1</sup> | Peak Direction Roadway Assignment Distribution <sup>2</sup> | A: Evening Outbound Peak Hour Vehicle Trips <sup>3</sup> | B: Evening Outbound Peak Hour Direction Roadway Segment Threshold <sup>4</sup> | Distance from CSUMB Campus <sup>5</sup> | C: Study Further (Yes/No) <sup>6</sup> |
|---------------------------|---|---------------------------|---|---|--|--|---|--|
| <b>North</b>              |   |                           |   |   |  |  |   |  |
| Castroville and Northward | CA-1 between Reservation Road and Del Monte Boulevard               | 2-Lane Freeway            | 4,010   | 17%   | 81   | 80   | 6 miles                                 | No <sup>7</sup>                        |
| Marina                    | California Avenue between 3rd Avenue and Patton Parkway             | 2-Lane Arterial           | 1,870   | 4%  | 21   | 94   | 2.5 miles                               | No                                     |
|                           | Del Monte Boulevard between Reindollar Avenue and Cypress Avenue    | 4-Lane Arterial, Divided  | 3,740   | 4%  | 18   | 188  | 4 miles                                 | No                                     |
| <b>East</b>               |   |                           |   |   |  |  |   |  |
| Salinas                   | Blanco Road between Reservation Road and Cooper Road                | Minor 2-Lane Highway      | 1,740   | 11%   | 54   | 87   | 5 miles                                 | No                                     |
|                           | Davis Road between Reservation Road and Foster Road                 | Minor 2-Lane Highway      | 3,480   | 25%   | 116  | 174  | 8 miles                                 | No                                     |
|                           | Highway 68 between Reservation Road and Spreckels Avenue            | 4-Lane, Multilane Highway | 1,825   | 0%  | 1  | 182  | 10 miles                                | No                                     |
| <b>South</b>              |   |                           |   |   |  |  |   |  |
| Seaside                   | Fremont Boulevard just south of CA-1                                | 4-Lane Arterial, Divided  | 3,740   | 4%  | 19   | 188  | 4 miles                                 | No                                     |
|                           | California Avenue just south of CA-1                                | 2-Lane Arterial           | 1,870   | 0%  | 2  | 94   | 4 miles                                 | No                                     |
|                           | Canyon Del Rey Boulevard just south of CA-1                         | 4-Lane Arterial, Divided  | 3,740   | 3%  | 13   | 188  | 5 miles                                 | No                                     |
|                           | General Jim Moore Boulevard between Coe Avenue and San Pablo Avenue | 4-Lane Arterial, Divided  | 3,740   | 8%  | 37   | 188  | 3 miles                                 | No                                     |
| Monterey and Westward     | CA-1 between Canyon Del Rey Boulevard and Del Monte Boulevard       | 2-Lane Freeway            | 4,010   | 23%   | 108  | 80   | 5 miles                                 | No <sup>8</sup>                        |
| <b>Totals</b>             |   |                           |   | <b>100%</b>   | <b>470</b>   |  |   |  |

Notes:

- Roadway capacity for CA US-1 and Highway 68 segments represent peak direction capacity only.
- Peak Direction Roadway Assignment Distribution obtained from the AMBAG Travel Model.
- Evening Outbound Peak Hour Direction Project Trips of the project boundary (470 vehicles).
- Non-freeway roadway segment threshold calculated by multiplying the roadways' peak direction capacity by the capacity threshold (ten percent) as described in the memorandum. Freeway segment threshold calculated by multiplying the freeways' peak direction capacity by the capacity threshold (two percent) as described in the memorandum.
- Distance measured along roadway.
- If column A value is less than column B value, then column C equals No. Otherwise, Column C equals Yes unless noted by a footnote.
- The vehicle demand for the evening outbound peak hour direction of the next freeway segment (CA-1 between Del Monte Boulevard and Nashau Road) is 76 vehicles which is less than the Evening Outbound Peak Hour Direction Roadway Segment Threshold. Therefore the last freeway segment to be studied north of the CSUMB campus is between Reservation Road and Del Monte Boulevard.
- The vehicle demand for the evening outbound peak hour direction of the next freeway segment (CA-1 between Del Monte Boulevard and Casa Verde Way) is 67 vehicles which is less than the Evening Outbound Peak Hour Direction Roadway Segment Threshold. Therefore the last freeway segment to be studied south of the CSUMB campus is between Canyon Del Rey Boulevard and Del Monte Boulevard.

Source: Fehr & Peers, 2019.

## ATTACHMENT B: ROADWAY DAY-TO-DAY VARIATION

### AM Peak Hour: Peak Direction Highway Volumes<sup>1</sup>

| AM Peak Hour Minimum | AM Peak Hour Maximum | AM Peak Hour Average | Difference in Peak Hour Max and Min | Percent Variation |
|----------------------|----------------------|----------------------|-------------------------------------|-------------------|
| 24,014               | 24,563               | 24,289               | 549                                 | 2%                |

### AM Peak Hour: Two-Way Local Roads and Streets Volumes<sup>2</sup>

| AM Peak Hour Minimum | AM Peak Hour Maximum | AM Peak Hour Average | Difference in Peak Hour Max and Min | Percent Variation |
|----------------------|----------------------|----------------------|-------------------------------------|-------------------|
| 27,093               | 30,756               | 28,911               | 3,663                               | 13%               |

### AM Peak Hour: Two-Way Local Roads and Streets Around 5-mile Distance from CSUMB<sup>3</sup>

| AM Peak Hour Minimum | AM Peak Hour Maximum | AM Peak Hour Average | Difference in Peak Hour Max and Min | Percent Variation |
|----------------------|----------------------|----------------------|-------------------------------------|-------------------|
| 4,317                | 4,768                | 4,543                | 451                                 | 10%               |

### PM Peak Hour: Peak Direction Highway Volumes<sup>1</sup>

| PM Peak Hour Minimum | PM Peak Hour Maximum | PM Peak Hour Average | Difference in Peak Hour Max and Min | Percent Variation |
|----------------------|----------------------|----------------------|-------------------------------------|-------------------|
| 26,263               | 27,579               | 26,921               | 1,316                               | 5%                |

### PM Peak Hour: Two-Way Local Roads and Streets Volumes<sup>2</sup>

| PM Peak Hour Minimum | PM Peak Hour Maximum | PM Peak Hour Average | Difference in Peak Hour Max and Min | Percent Variation |
|----------------------|----------------------|----------------------|-------------------------------------|-------------------|
| 25,098               | 28,334               | 26,702               | 3,236                               | 12%               |

### PM Peak Hour: Two-Way Local Roads and Streets Around 5-mile Distance from CSUMB<sup>3</sup>

| PM Peak Hour Minimum | PM Peak Hour Maximum | PM Peak Hour Average | Difference in Peak Hour Max and Min | Percent Variation |
|----------------------|----------------------|----------------------|-------------------------------------|-------------------|
| 4,455                | 5,274                | 4,821                | 819                                 | 17%               |

Notes:

1. Peak direction is towards CSUMB Campus in the morning and away from CSUMB Campus in the evening. The day-to-day variation is based on Highway 1 freeway segments between SR 68 and Reservation Road.

2. Total variation based on 34 roadway segments with the project study area generally bounded by Reservation Road to the north, Davis Road to the east, Coe Avenue to the south, and Highway 1 to the west.

3. Total variation based on 6 roadway segments including Del Monte Boulevard between Beach Road and Reservation Road, General Jim Moore between Coe Avenue and San Pablo Avenue, Reservation Road between Robin Drive and Del Monte Boulevard, Reservation Road between Salinas Avenue and Imjin Parkway, Reservation Road between Inter-Garrison Road and East Garrison Road, and Coe Avenue between Buttercup Boulevard and Malmedy Road.

Source: Fehr & Peers, May 2018.

## **APPENDIX C: EXISTING PARKING INVENTORY**



Table C1: CSUMB Park Inventory

| Latitude    | Longitude    | IDAX ID | Lot Number           | Total Spaces |
|-------------|--------------|---------|----------------------|--------------|
| 36.65086354 | -121.8088451 | 1       | 106                  | 106          |
| 36.65052353 | -121.8076757 | 2       | Otter Soccer Parking | 64           |
| 36.650091   | -121.8063748 | 3       | 107                  | 152          |
| 36.65139344 | -121.8077997 | 4       | 100                  | 24           |
| 36.6511562  | -121.8060918 | 5       | 902                  | 16           |
| 36.65234941 | -121.8041915 | 6       | 903                  | 92           |
| 36.65383418 | -121.8068013 | 7       | 91                   | 29           |
| 36.65456472 | -121.8063399 | 8       | 84                   | 12           |
| 36.65449156 | -121.8087526 | 9       | 90                   | 50           |
| 36.65533721 | -121.807217  | 10      | 86                   | 174          |
| 36.65508438 | -121.8053944 | 11      | 82 West              | 87           |
| 36.65541253 | -121.8035169 | 12      | 82 East              | 44           |
| 36.65513387 | -121.8033265 | 13      | 80                   | 67           |
| 36.6557751  | -121.8021972 | 14      | 300                  | 224          |
| 36.65719633 | -121.7996505 | 15      | 301                  | 385          |
| 36.65829693 | -121.7959504 | 16      | Promontory           | 382          |
| 36.65566536 | -121.7945194 | 17      | 71                   | 707          |
| 36.65497572 | -121.7957311 | 18      | 72                   | 45           |
| 36.65515109 | -121.7917112 | 19      | 490                  | 72           |
| 36.65377716 | -121.7892864 | 20      | 7th Ave - Temp       | 0            |
| 36.65167049 | -121.7887312 | 21      | 59                   | 862          |
| 36.64899728 | -121.7878689 | 22      | 37                   | 86           |
| 36.64824624 | -121.7876362 | 23      | 35                   | 11           |
| 36.64925497 | -121.7926633 | 24      | 42                   | 96           |
| 36.64795734 | -121.7942532 | 25      | 30                   | 45           |
| 36.64944219 | -121.7942445 | 26      | 29                   | 122          |
| 36.65140151 | -121.7941439 | 27      | 28                   | 168          |
| 36.65295946 | -121.7939327 | 28      | 13                   | 82           |
| 36.65429037 | -121.7961314 | 29      | 12 - Temp            | 0            |
| 36.65439527 | -121.7975208 | 30      | 16                   | 46           |
| 36.65431511 | -121.800148  | 31      | 18                   | 188          |
| 36.65409563 | -121.8016487 | 32      | 97                   | 72           |
| 36.65306221 | -121.7995895 | 33      | 208                  | 32           |
| 36.65192711 | -121.7998332 | 34      | 23                   | 0            |
| 36.65239864 | -121.7998114 | 35      | 508                  | 96           |
| 36.65311816 | -121.7986775 | 36      | 1                    | 31           |
| 36.6530337  | -121.7970722 | 37      | 205                  | 19           |
| 36.65300304 | -121.8015448 | 38      | 98                   | 3            |
| 36.65421721 | -121.793181  | 39      | 201                  | 6            |
| 36.65343627 | -121.7955527 | 40      | 202                  | 24           |

Key

- existing parking for future lot 4
- residential parking

|              |             |
|--------------|-------------|
| <b>Total</b> | <b>4721</b> |
|--------------|-------------|

Source: CSUMB data received May 2018

**APPENDIX D: EXISTING TRAFFIC COUNTS**







# Traffic Data Service

San Jose, CA  
 (408) 622-4787  
 tdsbay@cs.com

File Name : 1AM FINAL  
 Site Code : 00000001  
 Start Date : 5/3/2017  
 Page No : 2

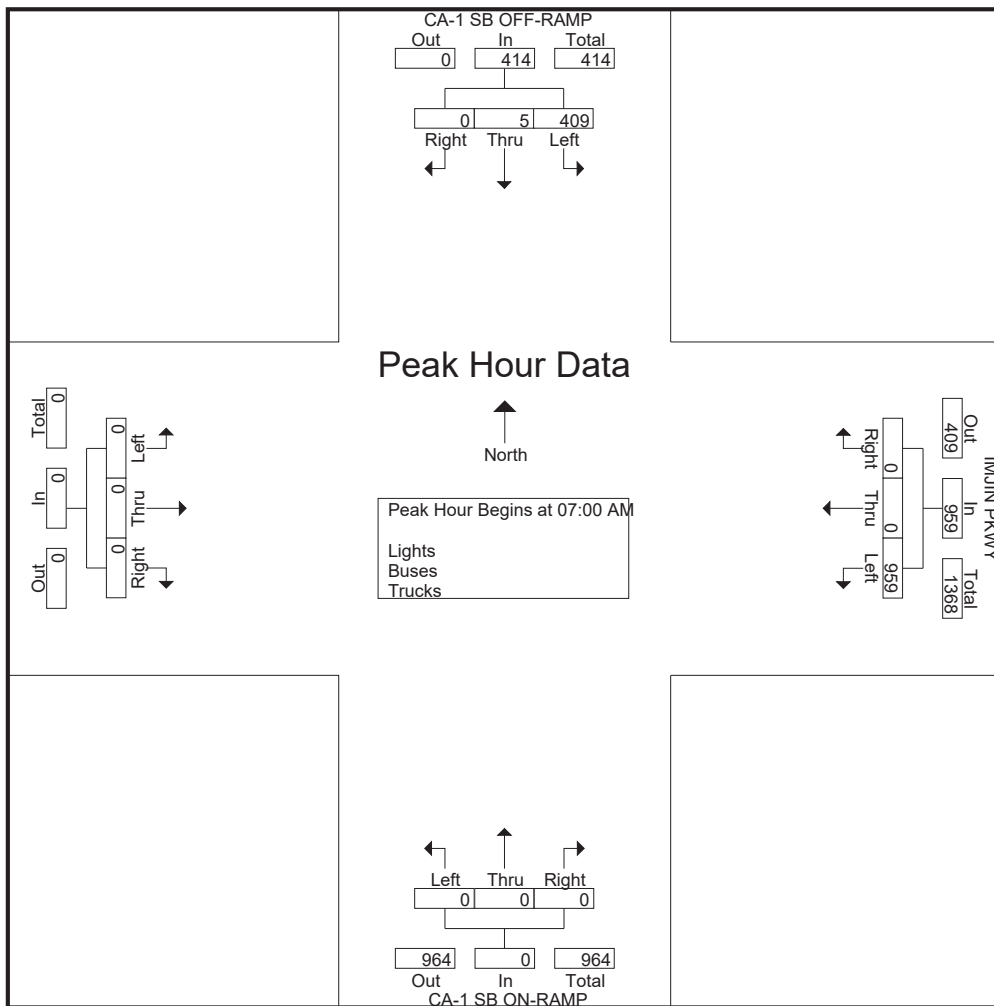

# Traffic Data Service

San Jose, CA  
 (408) 622-4787  
 tdsbay@cs.com

File Name : 1AM FINAL  
 Site Code : 00000001  
 Start Date : 5/3/2017  
 Page No : 1

Groups Printed- Bikes

| Start Time  | CA-1 SB OFF-RAMP<br>Southbound |      |      |      |            | IMJIN PKWY<br>Westbound |      |      |      |            | CA-1 SB ON-RAMP<br>Northbound |      |      |      |            | Eastbound |      |      |      |            | Int. Total |
|-------------|--------------------------------|------|------|------|------------|-------------------------|------|------|------|------------|-------------------------------|------|------|------|------------|-----------|------|------|------|------------|------------|
|             | Right                          | Thru | Left | Peds | App. Total | Right                   | Thru | Left | Peds | App. Total | Right                         | Thru | Left | Peds | App. Total | Right     | Thru | Left | Peds | App. Total |            |
| 07:00 AM    | 0                              | 0    | 0    | 0    | 0          | 0                       | 0    | 0    | 0    | 0          | 0                             | 0    | 0    | 0    | 0          | 0         | 0    | 0    | 0    | 0          | 0          |
| 07:15 AM    | 0                              | 0    | 0    | 0    | 0          | 0                       | 0    | 0    | 0    | 0          | 0                             | 0    | 0    | 0    | 0          | 0         | 0    | 0    | 0    | 0          | 0          |
| 07:30 AM    | 0                              | 0    | 0    | 0    | 0          | 0                       | 0    | 0    | 0    | 0          | 0                             | 0    | 0    | 0    | 0          | 0         | 0    | 0    | 0    | 0          | 0          |
| 07:45 AM    | 0                              | 0    | 0    | 0    | 0          | 0                       | 0    | 0    | 0    | 0          | 0                             | 0    | 0    | 0    | 0          | 0         | 0    | 0    | 0    | 0          | 0          |
| Total       | 0                              | 0    | 0    | 0    | 0          | 0                       | 0    | 0    | 0    | 0          | 0                             | 0    | 0    | 0    | 0          | 0         | 0    | 0    | 0    | 0          | 0          |
| 08:00 AM    | 0                              | 0    | 0    | 0    | 0          | 0                       | 0    | 0    | 0    | 0          | 0                             | 0    | 0    | 0    | 0          | 0         | 0    | 0    | 0    | 0          | 0          |
| 08:15 AM    | 0                              | 0    | 0    | 0    | 0          | 0                       | 0    | 0    | 0    | 0          | 0                             | 0    | 0    | 0    | 0          | 0         | 0    | 0    | 0    | 0          | 0          |
| 08:30 AM    | 0                              | 0    | 0    | 0    | 0          | 0                       | 0    | 0    | 0    | 0          | 0                             | 0    | 0    | 0    | 0          | 0         | 0    | 0    | 0    | 0          | 0          |
| 08:45 AM    | 0                              | 0    | 0    | 0    | 0          | 0                       | 0    | 0    | 0    | 0          | 0                             | 0    | 0    | 0    | 0          | 0         | 0    | 0    | 0    | 0          | 0          |
| Total       | 0                              | 0    | 0    | 0    | 0          | 0                       | 0    | 0    | 0    | 0          | 0                             | 0    | 0    | 0    | 0          | 0         | 0    | 0    | 0    | 0          | 0          |
| Grand Total | 0                              | 0    | 0    | 0    | 0          | 0                       | 0    | 0    | 0    | 0          | 0                             | 0    | 0    | 0    | 0          | 0         | 0    | 0    | 0    | 0          | 0          |
| Apprch %    | 0                              | 0    | 0    | 0    |            | 0                       | 0    | 0    | 0    |            | 0                             | 0    | 0    | 0    |            | 0         | 0    | 0    | 0    |            |            |
| Total %     |                                |      |      |      |            |                         |      |      |      |            |                               |      |      |      |            |           |      |      |      |            |            |

| Start Time   | CA-1 SB OFF-RAMP<br>Southbound |      |      |            | IMJIN PKWY<br>Westbound |      |      |            | CA-1 SB ON-RAMP<br>Northbound |      |      |            | Eastbound |      |      |            | Int. Total |
|--------------|--------------------------------|------|------|------------|-------------------------|------|------|------------|-------------------------------|------|------|------------|-----------|------|------|------------|------------|
|              | Right                          | Thru | Left | App. Total | Right                   | Thru | Left | App. Total | Right                         | Thru | Left | App. Total | Right     | Thru | Left | App. Total |            |
| 07:00 AM     | 0                              | 0    | 0    | 0          | 0                       | 0    | 0    | 0          | 0                             | 0    | 0    | 0          | 0         | 0    | 0    | 0          | 0          |
| 07:15 AM     | 0                              | 0    | 0    | 0          | 0                       | 0    | 0    | 0          | 0                             | 0    | 0    | 0          | 0         | 0    | 0    | 0          | 0          |
| 07:30 AM     | 0                              | 0    | 0    | 0          | 0                       | 0    | 0    | 0          | 0                             | 0    | 0    | 0          | 0         | 0    | 0    | 0          | 0          |
| 07:45 AM     | 0                              | 0    | 0    | 0          | 0                       | 0    | 0    | 0          | 0                             | 0    | 0    | 0          | 0         | 0    | 0    | 0          | 0          |
| Total Volume | 0                              | 0    | 0    | 0          | 0                       | 0    | 0    | 0          | 0                             | 0    | 0    | 0          | 0         | 0    | 0    | 0          | 0          |
| % App. Total | 0                              | 0    | 0    |            | 0                       | 0    | 0    |            | 0                             | 0    | 0    |            | 0         | 0    | 0    |            |            |
| PHF          | .000                           | .000 | .000 | .000       | .000                    | .000 | .000 | .000       | .000                          | .000 | .000 | .000       | .000      | .000 | .000 | .000       | .000       |

Peak Hour Analysis From 07:00 AM to 08:45 AM - Peak 1 of 1

Peak Hour for Entire Intersection Begins at 07:00 AM

# Traffic Data Service

San Jose, CA  
 (408) 622-4787  
 tdsbay@cs.com

File Name : 1AM FINAL  
 Site Code : 00000001  
 Start Date : 5/3/2017  
 Page No : 2

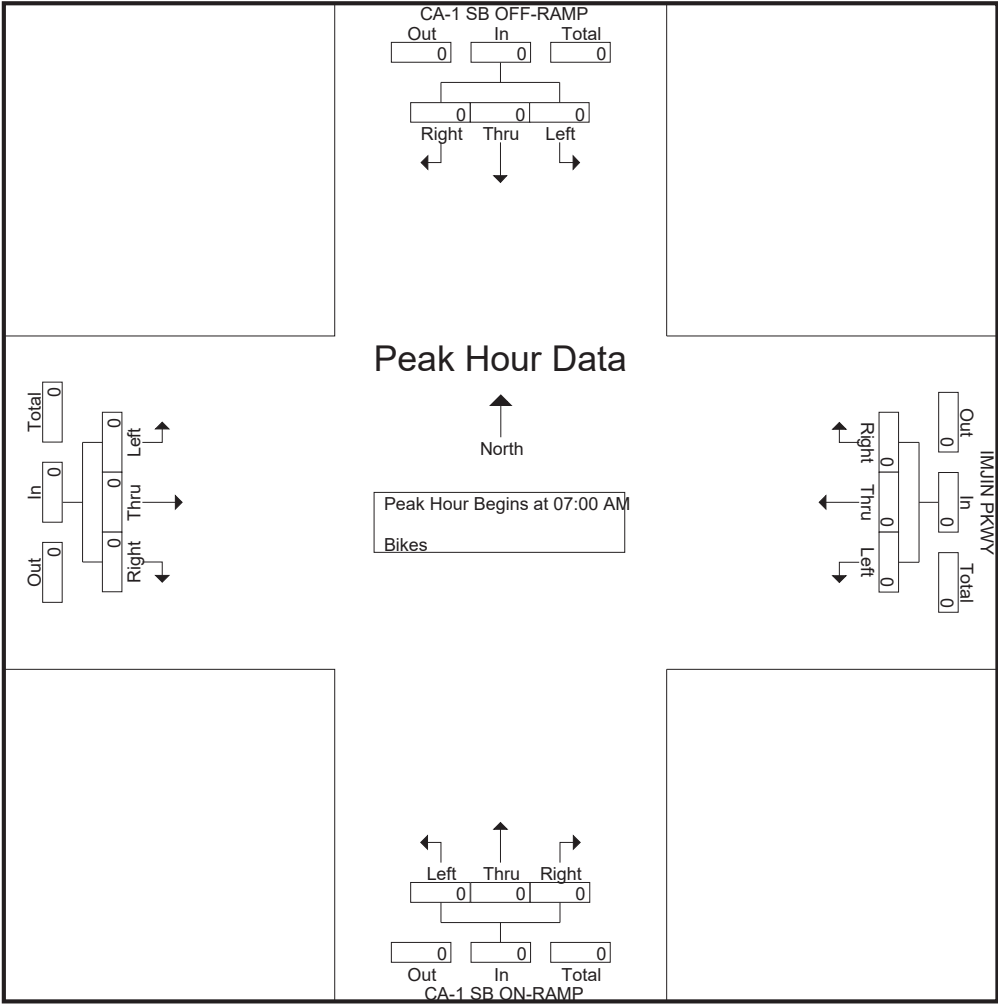



# Traffic Data Service

San Jose, CA  
 (408) 622-4787  
 tdsbay@cs.com

File Name : 1PM FINAL  
 Site Code : 00000001  
 Start Date : 5/3/2017  
 Page No : 2

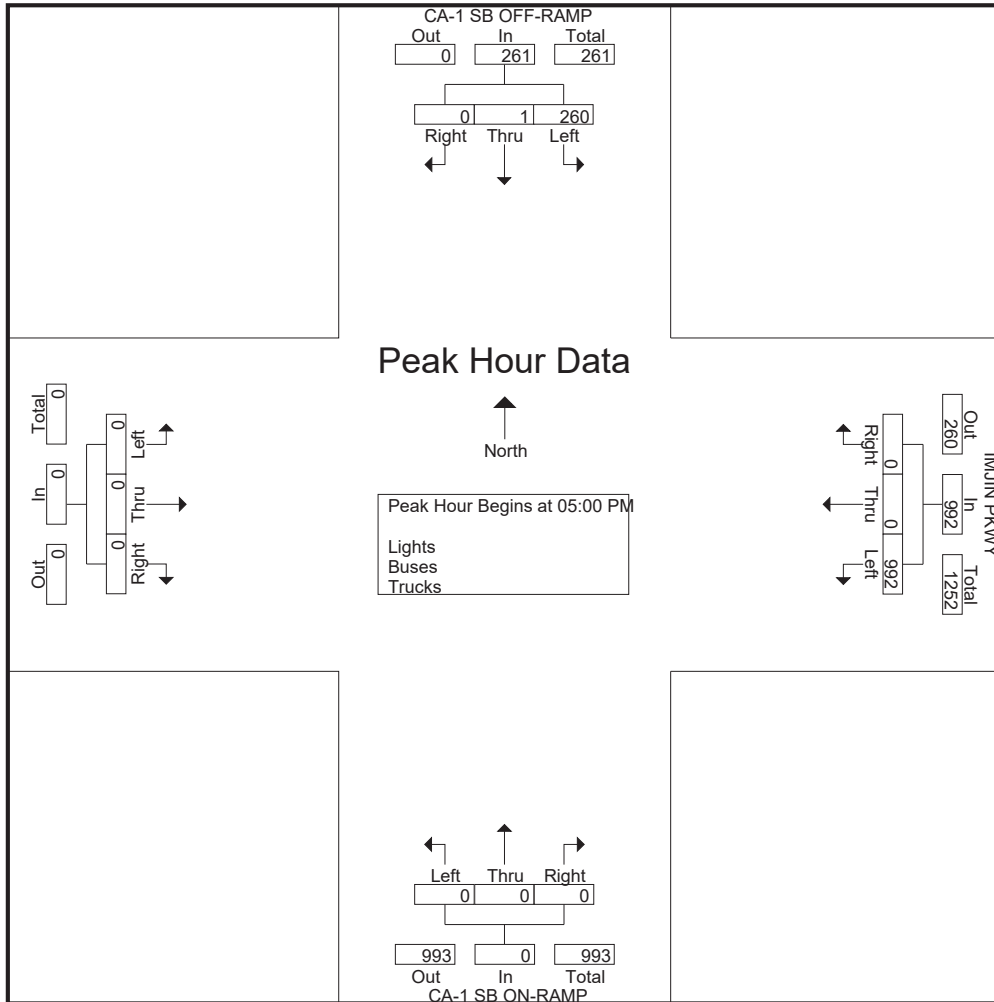

# Traffic Data Service

San Jose, CA  
 (408) 622-4787  
 tdsbay@cs.com

File Name : 1PM FINAL  
 Site Code : 00000001  
 Start Date : 5/3/2017  
 Page No : 1

Groups Printed- Bikes

| Start Time  | CA-1 SB OFF-RAMP<br>Southbound |      |      |      |            | IMJIN PKWY<br>Westbound |      |      |      |            | CA-1 SB ON-RAMP<br>Northbound |      |      |      |            | Eastbound |      |      |      |            | Int. Total |
|-------------|--------------------------------|------|------|------|------------|-------------------------|------|------|------|------------|-------------------------------|------|------|------|------------|-----------|------|------|------|------------|------------|
|             | Right                          | Thru | Left | Peds | App. Total | Right                   | Thru | Left | Peds | App. Total | Right                         | Thru | Left | Peds | App. Total | Right     | Thru | Left | Peds | App. Total |            |
| 04:00 PM    | 0                              | 0    | 0    | 0    | 0          | 0                       | 0    | 0    | 0    | 0          | 0                             | 0    | 0    | 0    | 0          | 0         | 0    | 0    | 0    | 0          | 0          |
| 04:15 PM    | 0                              | 0    | 0    | 0    | 0          | 0                       | 0    | 0    | 0    | 0          | 0                             | 0    | 0    | 0    | 0          | 0         | 0    | 0    | 0    | 0          | 0          |
| 04:30 PM    | 0                              | 0    | 0    | 0    | 0          | 0                       | 0    | 0    | 0    | 0          | 0                             | 0    | 0    | 0    | 0          | 0         | 0    | 0    | 0    | 0          | 0          |
| 04:45 PM    | 0                              | 0    | 0    | 0    | 0          | 0                       | 0    | 0    | 0    | 0          | 0                             | 0    | 0    | 0    | 0          | 0         | 0    | 0    | 0    | 0          | 0          |
| Total       | 0                              | 0    | 0    | 0    | 0          | 0                       | 0    | 0    | 0    | 0          | 0                             | 0    | 0    | 0    | 0          | 0         | 0    | 0    | 0    | 0          | 0          |
| 05:00 PM    | 0                              | 0    | 0    | 0    | 0          | 0                       | 0    | 0    | 0    | 0          | 0                             | 0    | 0    | 0    | 0          | 0         | 0    | 0    | 0    | 0          | 0          |
| 05:15 PM    | 0                              | 0    | 0    | 0    | 0          | 0                       | 0    | 0    | 0    | 0          | 0                             | 0    | 0    | 0    | 0          | 0         | 0    | 0    | 0    | 0          | 0          |
| 05:30 PM    | 0                              | 0    | 0    | 0    | 0          | 0                       | 0    | 0    | 0    | 0          | 0                             | 0    | 0    | 0    | 0          | 0         | 0    | 0    | 0    | 0          | 0          |
| 05:45 PM    | 0                              | 0    | 0    | 0    | 0          | 0                       | 0    | 0    | 0    | 0          | 0                             | 0    | 0    | 0    | 0          | 0         | 0    | 0    | 0    | 0          | 0          |
| Total       | 0                              | 0    | 0    | 0    | 0          | 0                       | 0    | 0    | 0    | 0          | 0                             | 0    | 0    | 0    | 0          | 0         | 0    | 0    | 0    | 0          | 0          |
| Grand Total | 0                              | 0    | 0    | 0    | 0          | 0                       | 0    | 0    | 0    | 0          | 0                             | 0    | 0    | 0    | 0          | 0         | 0    | 0    | 0    | 0          | 0          |
| Apprch %    | 0                              | 0    | 0    | 0    |            | 0                       | 0    | 0    | 0    |            | 0                             | 0    | 0    | 0    |            | 0         | 0    | 0    | 0    |            |            |
| Total %     |                                |      |      |      |            |                         |      |      |      |            |                               |      |      |      |            |           |      |      |      |            |            |

| Start Time   | CA-1 SB OFF-RAMP<br>Southbound |      |      |            | IMJIN PKWY<br>Westbound |      |      |            | CA-1 SB ON-RAMP<br>Northbound |      |      |            | Eastbound |      |      |            | Int. Total |
|--------------|--------------------------------|------|------|------------|-------------------------|------|------|------------|-------------------------------|------|------|------------|-----------|------|------|------------|------------|
|              | Right                          | Thru | Left | App. Total | Right                   | Thru | Left | App. Total | Right                         | Thru | Left | App. Total | Right     | Thru | Left | App. Total |            |
| 04:00 PM     | 0                              | 0    | 0    | 0          | 0                       | 0    | 0    | 0          | 0                             | 0    | 0    | 0          | 0         | 0    | 0    | 0          |            |
| 04:15 PM     | 0                              | 0    | 0    | 0          | 0                       | 0    | 0    | 0          | 0                             | 0    | 0    | 0          | 0         | 0    | 0    | 0          |            |
| 04:30 PM     | 0                              | 0    | 0    | 0          | 0                       | 0    | 0    | 0          | 0                             | 0    | 0    | 0          | 0         | 0    | 0    | 0          |            |
| 04:45 PM     | 0                              | 0    | 0    | 0          | 0                       | 0    | 0    | 0          | 0                             | 0    | 0    | 0          | 0         | 0    | 0    | 0          |            |
| Total Volume | 0                              | 0    | 0    | 0          | 0                       | 0    | 0    | 0          | 0                             | 0    | 0    | 0          | 0         | 0    | 0    | 0          |            |
| % App. Total | 0                              | 0    | 0    |            | 0                       | 0    | 0    |            | 0                             | 0    | 0    |            | 0         | 0    | 0    |            |            |
| PHF          | .000                           | .000 | .000 | .000       | .000                    | .000 | .000 | .000       | .000                          | .000 | .000 | .000       | .000      | .000 | .000 | .000       |            |

Peak Hour Analysis From 04:00 PM to 05:45 PM - Peak 1 of 1  
 Peak Hour for Entire Intersection Begins at 04:00 PM

# Traffic Data Service

San Jose, CA  
 (408) 622-4787  
 tdsbay@cs.com

File Name : 1PM FINAL  
 Site Code : 00000001  
 Start Date : 5/3/2017  
 Page No : 2

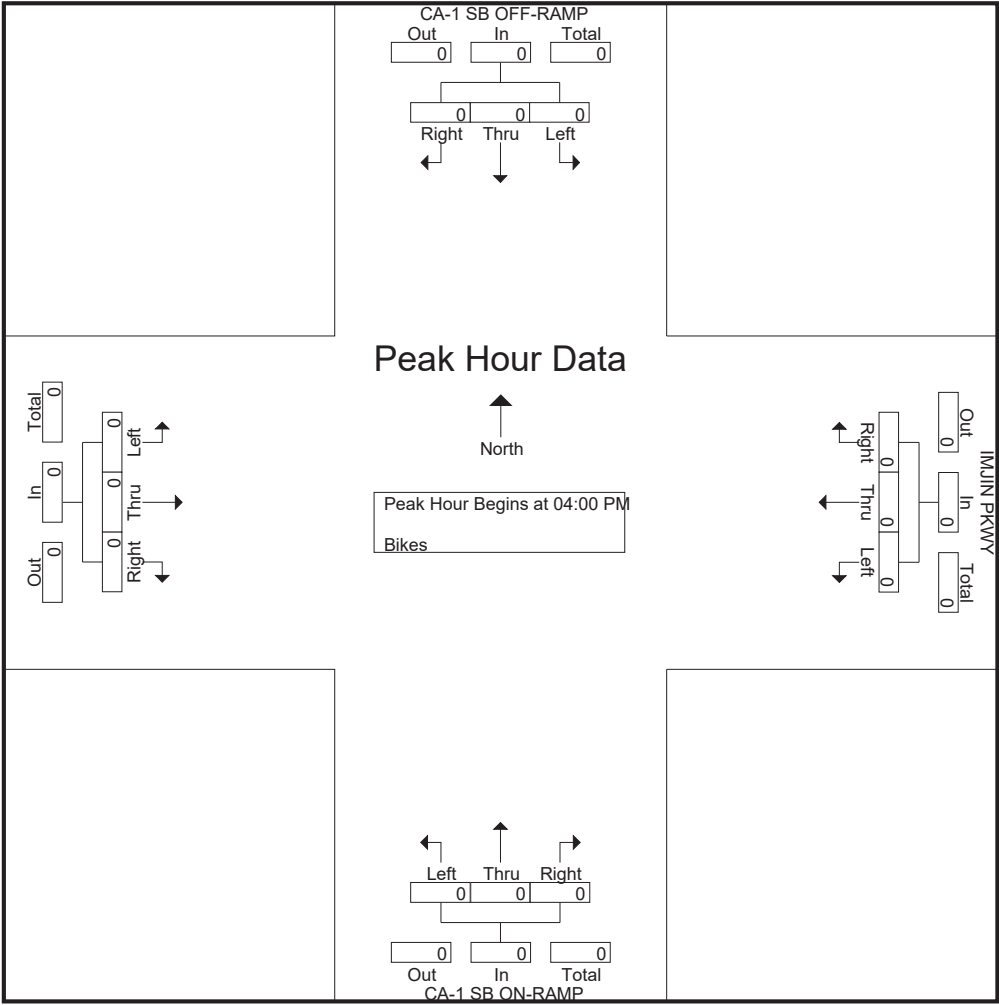



# Traffic Data Service

San Jose, CA  
(408) 622-4787  
tdsbay@cs.com

File Name : 2AM FINAL  
Site Code : 00000002  
Start Date : 5/3/2017  
Page No : 1

Groups Printed- Lights - Buses - Trucks

| Start Time  | CA-1 NB ON-RAMP<br>Southbound |      |      |      |            | IMJIN PKWY<br>Westbound |      |      |      |            | CA-1 NB OFF-RAMP<br>Northbound |      |      |      |            | IMJIN PKWY<br>Eastbound |      |      |      |            | Int. Total |
|-------------|-------------------------------|------|------|------|------------|-------------------------|------|------|------|------------|--------------------------------|------|------|------|------------|-------------------------|------|------|------|------------|------------|
|             | Right                         | Thru | Left | Peds | App. Total | Right                   | Thru | Left | Peds | App. Total | Right                          | Thru | Left | Peds | App. Total | Right                   | Thru | Left | Peds | App. Total |            |
| 07:00 AM    | 0                             | 0    | 0    | 0    | 0          | 28                      | 301  | 0    | 0    | 329        | 149                            | 0    | 0    | 0    | 149        | 0                       | 67   | 1    | 0    | 68         | 546        |
| 07:15 AM    | 0                             | 0    | 0    | 0    | 0          | 27                      | 253  | 0    | 0    | 280        | 201                            | 0    | 0    | 0    | 201        | 0                       | 81   | 1    | 0    | 82         | 563        |
| 07:30 AM    | 0                             | 0    | 0    | 1    | 1          | 28                      | 191  | 0    | 0    | 219        | 244                            | 0    | 0    | 0    | 244        | 0                       | 113  | 0    | 0    | 113        | 577        |
| 07:45 AM    | 0                             | 0    | 0    | 2    | 2          | 40                      | 172  | 0    | 0    | 212        | 211                            | 0    | 0    | 0    | 211        | 0                       | 160  | 1    | 0    | 161        | 586        |
| Total       | 0                             | 0    | 0    | 3    | 3          | 123                     | 917  | 0    | 0    | 1040       | 805                            | 0    | 0    | 0    | 805        | 0                       | 421  | 3    | 0    | 424        | 2272       |
| 08:00 AM    | 0                             | 0    | 0    | 0    | 0          | 38                      | 189  | 0    | 0    | 227        | 225                            | 1    | 0    | 0    | 226        | 0                       | 80   | 1    | 0    | 81         | 534        |
| 08:15 AM    | 0                             | 0    | 0    | 0    | 0          | 40                      | 205  | 0    | 0    | 245        | 195                            | 0    | 1    | 0    | 196        | 0                       | 74   | 0    | 0    | 74         | 515        |
| 08:30 AM    | 0                             | 0    | 0    | 0    | 0          | 44                      | 239  | 0    | 0    | 283        | 139                            | 0    | 0    | 0    | 139        | 0                       | 42   | 3    | 0    | 45         | 467        |
| 08:45 AM    | 0                             | 0    | 0    | 0    | 0          | 42                      | 228  | 0    | 0    | 270        | 146                            | 1    | 0    | 0    | 147        | 0                       | 58   | 3    | 0    | 61         | 478        |
| Total       | 0                             | 0    | 0    | 0    | 0          | 164                     | 861  | 0    | 0    | 1025       | 705                            | 2    | 1    | 0    | 708        | 0                       | 254  | 7    | 0    | 261        | 1994       |
| Grand Total | 0                             | 0    | 0    | 3    | 3          | 287                     | 1778 | 0    | 0    | 2065       | 1510                           | 2    | 1    | 0    | 1513       | 0                       | 675  | 10   | 0    | 685        | 4266       |
| Apprch %    | 0                             | 0    | 0    | 100  |            | 13.9                    | 86.1 | 0    | 0    |            | 99.8                           | 0.1  | 0.1  | 0    |            | 0                       | 98.5 | 1.5  | 0    |            |            |
| Total %     | 0                             | 0    | 0    | 0.1  | 0.1        | 6.7                     | 41.7 | 0    | 0    | 48.4       | 35.4                           | 0    | 0    | 0    | 35.5       | 0                       | 15.8 | 0.2  | 0    | 16.1       |            |
| Lights      | 0                             | 0    | 0    | 3    | 3          | 257                     | 1730 | 0    | 0    | 1987       | 1475                           | 2    | 1    | 0    | 1478       | 0                       | 655  | 10   | 0    | 665        | 4133       |
| % Lights    | 0                             | 0    | 0    | 100  | 100        | 89.5                    | 97.3 | 0    | 0    | 96.2       | 97.7                           | 100  | 100  | 0    | 97.7       | 0                       | 97   | 100  | 0    | 97.1       | 96.9       |
| Buses       | 0                             | 0    | 0    | 0    | 0          | 5                       | 10   | 0    | 0    | 15         | 9                              | 0    | 0    | 0    | 9          | 0                       | 2    | 0    | 0    | 2          | 26         |
| % Buses     | 0                             | 0    | 0    | 0    | 0          | 1.7                     | 0.6  | 0    | 0    | 0.7        | 0.6                            | 0    | 0    | 0    | 0.6        | 0                       | 0.3  | 0    | 0    | 0.3        | 0.6        |
| Trucks      | 0                             | 0    | 0    | 0    | 0          | 25                      | 38   | 0    | 0    | 63         | 26                             | 0    | 0    | 0    | 26         | 0                       | 18   | 0    | 0    | 18         | 107        |
| % Trucks    | 0                             | 0    | 0    | 0    | 0          | 8.7                     | 2.1  | 0    | 0    | 3.1        | 1.7                            | 0    | 0    | 0    | 1.7        | 0                       | 2.7  | 0    | 0    | 2.6        | 2.5        |

| Start Time   | CA-1 NB ON-RAMP<br>Southbound |      |      |            | IMJIN PKWY<br>Westbound |            |      |            | CA-1 NB OFF-RAMP<br>Northbound |      |      |            | IMJIN PKWY<br>Eastbound |            |          |            | Int. Total |
|--|-------------------------------|------|------|------------|-------------------------|------------|------|------------|--------------------------------|------|------|------------|-------------------------|------------|----------|------------|------------|
|  | Right                         | Thru | Left | App. Total | Right                   | Thru       | Left | App. Total | Right                          | Thru | Left | App. Total | Right                   | Thru       | Left     | App. Total |            |
| Peak Hour Analysis From 07:00 AM to 08:45 AM - Peak 1 of 1 |                               |      |      |            |                         |            |      |            |                                |      |      |            |                         |            |          |            |            |
| Peak Hour for Entire Intersection Begins at 07:00 AM       |                               |      |      |            |                         |            |      |            |                                |      |      |            |                         |            |          |            |            |
| 07:00 AM   | 0                             | 0    | 0    | 0          | 28                      | <b>301</b> | 0    | <b>329</b> | 149                            | 0    | 0    | 149        | 0                       | 67         | <b>1</b> | 68         | 546        |
| 07:15 AM   | 0                             | 0    | 0    | 0          | 27                      | 253        | 0    | 280        | 201                            | 0    | 0    | 201        | 0                       | 81         | 1        | 82         | 563        |
| 07:30 AM   | 0                             | 0    | 0    | 0          | 28                      | 191        | 0    | 219        | <b>244</b>                     | 0    | 0    | <b>244</b> | 0                       | 113        | 0        | 113        | 576        |
| 07:45 AM   | 0                             | 0    | 0    | 0          | <b>40</b>               | 172        | 0    | 212        | 211                            | 0    | 0    | 211        | 0                       | <b>160</b> | <b>1</b> | <b>161</b> | <b>584</b> |
| Total Volume   | 0                             | 0    | 0    | 0          | 123                     | 917        | 0    | 1040       | 805                            | 0    | 0    | 805        | 0                       | 421        | 3        | 424        | 2269       |
| % App. Total   | 0                             | 0    | 0    | 0          | 11.8                    | 88.2       | 0    |            | 100                            | 0    | 0    |            | 0                       | 99.3       | 0.7      |            |            |
| PHF  | .000                          | .000 | .000 | .000       | .769                    | .762       | .000 | .790       | .825                           | .000 | .000 | .825       | .000                    | .658       | .750     | .658       | .971       |

# Traffic Data Service

San Jose, CA  
 (408) 622-4787  
 tdsbay@cs.com

File Name : 2AM FINAL  
 Site Code : 00000002  
 Start Date : 5/3/2017  
 Page No : 2

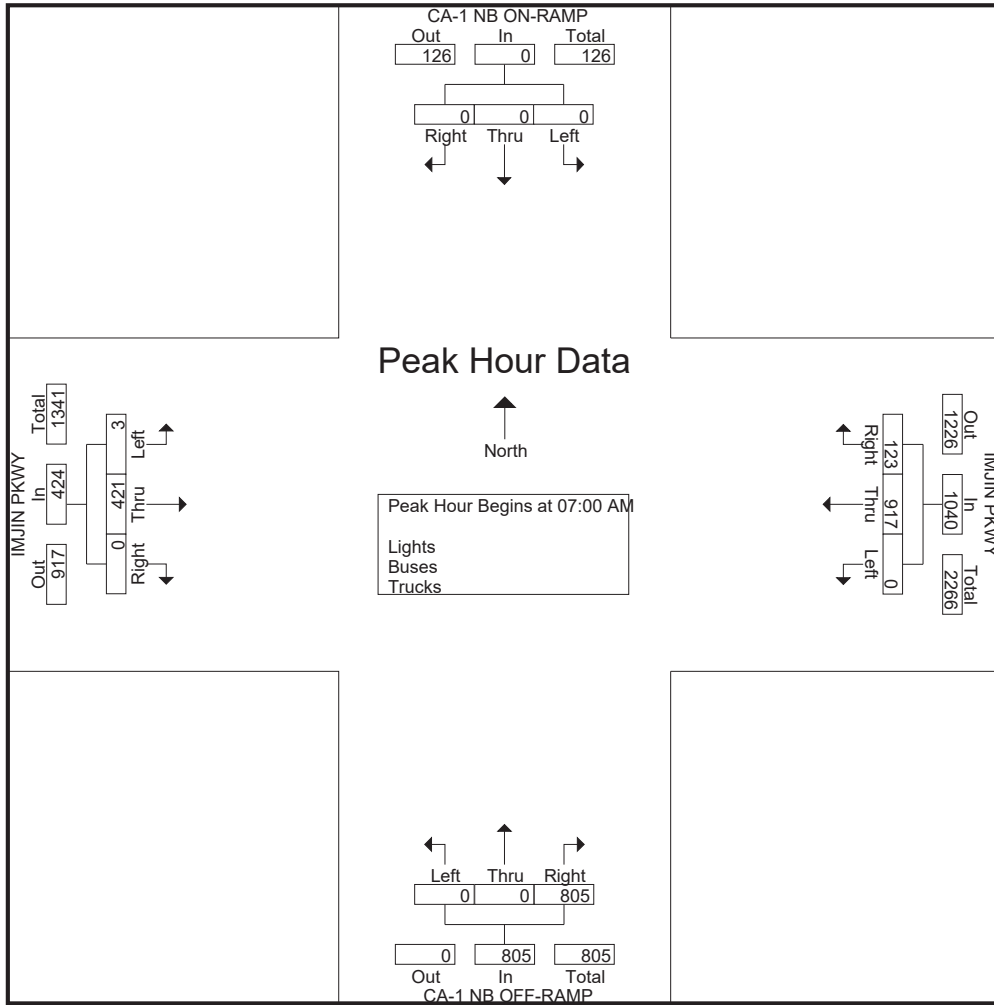

# Traffic Data Service

San Jose, CA  
 (408) 622-4787  
 tdsbay@cs.com

File Name : 2AM FINAL  
 Site Code : 00000002  
 Start Date : 5/3/2017  
 Page No : 1

## Groups Printed- Bikes

| Start Time  | CA-1 NB ON-RAMP<br>Southbound |      |      |      |            | IMJIN PKWY<br>Westbound |      |      |      |            | CA-1 NB OFF-RAMP<br>Northbound |      |      |      |            | IMJIN PKWY<br>Eastbound |      |      |      |            | Int. Total |
|-------------|-------------------------------|------|------|------|------------|-------------------------|------|------|------|------------|--------------------------------|------|------|------|------------|-------------------------|------|------|------|------------|------------|
|             | Right                         | Thru | Left | Peds | App. Total | Right                   | Thru | Left | Peds | App. Total | Right                          | Thru | Left | Peds | App. Total | Right                   | Thru | Left | Peds | App. Total |            |
| 07:00 AM    | 0                             | 0    | 0    | 0    | 0          | 0                       | 0    | 0    | 0    | 0          | 0                              | 0    | 0    | 0    | 0          | 0                       | 0    | 0    | 0    | 0          | 0          |
| 07:15 AM    | 0                             | 0    | 0    | 0    | 0          | 0                       | 0    | 0    | 0    | 0          | 0                              | 0    | 0    | 0    | 0          | 0                       | 0    | 0    | 0    | 0          | 0          |
| 07:30 AM    | 0                             | 0    | 0    | 0    | 0          | 0                       | 1    | 0    | 0    | 1          | 0                              | 0    | 0    | 0    | 0          | 0                       | 0    | 0    | 0    | 0          | 1          |
| 07:45 AM    | 0                             | 0    | 0    | 0    | 0          | 0                       | 0    | 0    | 0    | 0          | 0                              | 0    | 0    | 0    | 0          | 0                       | 0    | 0    | 0    | 0          | 0          |
| Total       | 0                             | 0    | 0    | 0    | 0          | 0                       | 1    | 0    | 0    | 1          | 0                              | 0    | 0    | 0    | 0          | 0                       | 0    | 0    | 0    | 0          | 1          |
| 08:00 AM    | 0                             | 0    | 0    | 0    | 0          | 0                       | 0    | 0    | 0    | 0          | 0                              | 0    | 0    | 0    | 0          | 0                       | 0    | 0    | 0    | 0          | 0          |
| 08:15 AM    | 0                             | 0    | 0    | 0    | 0          | 0                       | 0    | 0    | 0    | 0          | 0                              | 0    | 0    | 0    | 0          | 0                       | 0    | 0    | 0    | 0          | 0          |
| 08:30 AM    | 0                             | 0    | 0    | 0    | 0          | 0                       | 0    | 0    | 0    | 0          | 0                              | 0    | 0    | 0    | 0          | 0                       | 0    | 0    | 0    | 0          | 0          |
| 08:45 AM    | 0                             | 0    | 0    | 0    | 0          | 0                       | 0    | 0    | 0    | 0          | 0                              | 0    | 0    | 0    | 0          | 0                       | 0    | 0    | 0    | 0          | 0          |
| Total       | 0                             | 0    | 0    | 0    | 0          | 0                       | 0    | 0    | 0    | 0          | 0                              | 0    | 0    | 0    | 0          | 0                       | 0    | 0    | 0    | 0          | 0          |
| Grand Total | 0                             | 0    | 0    | 0    | 0          | 0                       | 1    | 0    | 0    | 1          | 0                              | 0    | 0    | 0    | 0          | 0                       | 0    | 0    | 0    | 0          | 1          |
| Apprch %    | 0                             | 0    | 0    | 0    | 0          | 0                       | 100  | 0    | 0    | 100        | 0                              | 0    | 0    | 0    | 0          | 0                       | 0    | 0    | 0    | 0          | 0          |
| Total %     | 0                             | 0    | 0    | 0    | 0          | 0                       | 100  | 0    | 0    | 100        | 0                              | 0    | 0    | 0    | 0          | 0                       | 0    | 0    | 0    | 0          | 0          |

| Start Time   | CA-1 NB ON-RAMP<br>Southbound |      |      |      |            | IMJIN PKWY<br>Westbound |      |      |      |            | CA-1 NB OFF-RAMP<br>Northbound |      |      |      |            | IMJIN PKWY<br>Eastbound |      |      |      |            | Int. Total |
|--------------|-------------------------------|------|------|------|------------|-------------------------|------|------|------|------------|--------------------------------|------|------|------|------------|-------------------------|------|------|------|------------|------------|
|              | Right                         | Thru | Left | Peds | App. Total | Right                   | Thru | Left | Peds | App. Total | Right                          | Thru | Left | Peds | App. Total | Right                   | Thru | Left | Peds | App. Total |            |
| 07:00 AM     | 0                             | 0    | 0    | 0    | 0          | 0                       | 0    | 0    | 0    | 0          | 0                              | 0    | 0    | 0    | 0          | 0                       | 0    | 0    | 0    | 0          | 0          |
| 07:15 AM     | 0                             | 0    | 0    | 0    | 0          | 0                       | 0    | 0    | 0    | 0          | 0                              | 0    | 0    | 0    | 0          | 0                       | 0    | 0    | 0    | 0          | 0          |
| 07:30 AM     | 0                             | 0    | 0    | 0    | 0          | 0                       | 1    | 0    | 0    | 1          | 0                              | 0    | 0    | 0    | 0          | 0                       | 0    | 0    | 0    | 0          | 1          |
| 07:45 AM     | 0                             | 0    | 0    | 0    | 0          | 0                       | 0    | 0    | 0    | 0          | 0                              | 0    | 0    | 0    | 0          | 0                       | 0    | 0    | 0    | 0          | 0          |
| Total Volume | 0                             | 0    | 0    | 0    | 0          | 0                       | 1    | 0    | 0    | 1          | 0                              | 0    | 0    | 0    | 0          | 0                       | 0    | 0    | 0    | 0          | 1          |
| % App. Total | 0                             | 0    | 0    | 0    | 0          | 0                       | 100  | 0    | 0    | 100        | 0                              | 0    | 0    | 0    | 0          | 0                       | 0    | 0    | 0    | 0          | 0          |
| PHF          | .000                          | .000 | .000 | .000 | .000       | .000                    | .250 | .000 | .250 | .250       | .000                           | .000 | .000 | .000 | .000       | .000                    | .000 | .000 | .000 | .000       | .250       |

Peak Hour Analysis From 07:00 AM to 08:45 AM - Peak 1 of 1  
 Peak Hour for Entire Intersection Begins at 07:00 AM

# Traffic Data Service

San Jose, CA  
 (408) 622-4787  
 tdsbay@cs.com

File Name : 2AM FINAL  
 Site Code : 00000002  
 Start Date : 5/3/2017  
 Page No : 2

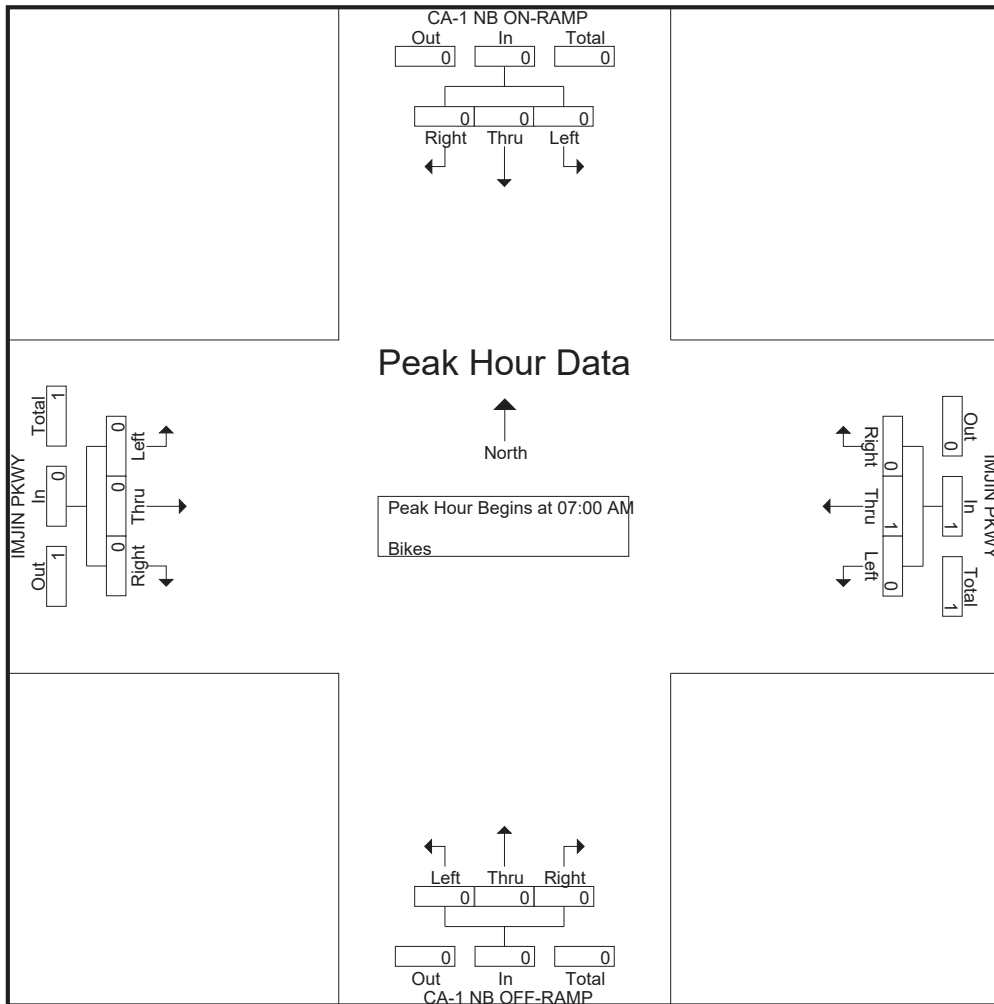

# Traffic Data Service

San Jose, CA  
(408) 622-4787  
tdsbay@cs.com

File Name : 2PM FINAL  
Site Code : 00000002  
Start Date : 5/3/2017  
Page No : 1

Groups Printed- Lights - Buses - Trucks

| Start Time   | CA-1 NB ON-RAMP<br>Southbound |      |      |      |            | IMJIN PKWY<br>Westbound |      |      |      |            | CA-1 NB OFF-RAMP<br>Northbound |      |      |      |            | IMJIN PKWY<br>Eastbound |      |      |      |            | Int. Total |
|--------------|-------------------------------|------|------|------|------------|-------------------------|------|------|------|------------|--------------------------------|------|------|------|------------|-------------------------|------|------|------|------------|------------|
|              | Right                         | Thru | Left | Peds | App. Total | Right                   | Thru | Left | Peds | App. Total | Right                          | Thru | Left | Peds | App. Total | Right                   | Thru | Left | Peds | App. Total |            |
| 04:00 PM     | 0                             | 0    | 0    | 2    | 2          | 96                      | 218  | 0    | 0    | 314        | 296                            | 1    | 3    | 0    | 300        | 0                       | 66   | 1    | 0    | 67         | 683        |
| 04:15 PM     | 0                             | 0    | 0    | 0    | 0          | 109                     | 237  | 0    | 0    | 346        | 297                            | 0    | 1    | 0    | 298        | 0                       | 56   | 2    | 0    | 58         | 702        |
| 04:30 PM     | 0                             | 0    | 0    | 0    | 0          | 96                      | 247  | 0    | 0    | 343        | 304                            | 0    | 1    | 0    | 305        | 0                       | 59   | 2    | 0    | 61         | 709        |
| 04:45 PM     | 0                             | 0    | 0    | 0    | 0          | 96                      | 243  | 0    | 0    | 339        | 291                            | 1    | 2    | 0    | 294        | 0                       | 63   | 3    | 0    | 66         | 699        |
| <b>Total</b> | 0                             | 0    | 0    | 2    | 2          | 397                     | 945  | 0    | 0    | 1342       | 1188                           | 2    | 7    | 0    | 1197       | 0                       | 244  | 8    | 0    | 252        | 2793       |
| 05:00 PM     | 0                             | 0    | 0    | 0    | 0          | 114                     | 245  | 0    | 0    | 359        | 291                            | 0    | 1    | 0    | 292        | 0                       | 56   | 2    | 0    | 58         | 709        |
| 05:15 PM     | 0                             | 0    | 0    | 0    | 0          | 101                     | 237  | 0    | 0    | 338        | 302                            | 0    | 1    | 0    | 303        | 0                       | 56   | 1    | 0    | 57         | 698        |
| 05:30 PM     | 0                             | 0    | 0    | 1    | 1          | 111                     | 270  | 0    | 0    | 381        | 302                            | 1    | 0    | 0    | 303        | 0                       | 72   | 1    | 0    | 73         | 758        |
| 05:45 PM     | 0                             | 0    | 0    | 0    | 0          | 90                      | 214  | 0    | 0    | 304        | 299                            | 0    | 1    | 0    | 300        | 0                       | 72   | 1    | 0    | 73         | 677        |
| <b>Total</b> | 0                             | 0    | 0    | 1    | 1          | 416                     | 966  | 0    | 0    | 1382       | 1194                           | 1    | 3    | 0    | 1198       | 0                       | 256  | 5    | 0    | 261        | 2842       |
| Grand Total  | 0                             | 0    | 0    | 3    | 3          | 813                     | 1911 | 0    | 0    | 2724       | 2382                           | 3    | 10   | 0    | 2395       | 0                       | 500  | 13   | 0    | 513        | 5635       |
| Apprch %     | 0                             | 0    | 0    | 100  |            | 29.8                    | 70.2 | 0    | 0    |            | 99.5                           | 0.1  | 0.4  | 0    |            | 0                       | 97.5 | 2.5  | 0    |            |            |
| Total %      | 0                             | 0    | 0    | 0.1  | 0.1        | 14.4                    | 33.9 | 0    | 0    | 48.3       | 42.3                           | 0.1  | 0.2  | 0    | 42.5       | 0                       | 8.9  | 0.2  | 0    | 9.1        |            |
| Lights       | 0                             | 0    | 0    | 3    | 3          | 805                     | 1887 | 0    | 0    | 2692       | 2354                           | 3    | 10   | 0    | 2367       | 0                       | 493  | 12   | 0    | 505        | 5567       |
| % Lights     | 0                             | 0    | 0    | 100  | 100        | 99                      | 98.7 | 0    | 0    | 98.8       | 98.8                           | 100  | 100  | 0    | 98.8       | 0                       | 98.6 | 92.3 | 0    | 98.4       | 98.8       |
| Buses        | 0                             | 0    | 0    | 0    | 0          | 2                       | 6    | 0    | 0    | 8          | 8                              | 0    | 0    | 0    | 8          | 0                       | 3    | 0    | 0    | 3          | 19         |
| % Buses      | 0                             | 0    | 0    | 0    | 0          | 0.2                     | 0.3  | 0    | 0    | 0.3        | 0.3                            | 0    | 0    | 0    | 0.3        | 0                       | 0.6  | 0    | 0    | 0.6        | 0.3        |
| Trucks       | 0                             | 0    | 0    | 0    | 0          | 6                       | 18   | 0    | 0    | 24         | 20                             | 0    | 0    | 0    | 20         | 0                       | 4    | 1    | 0    | 5          | 49         |
| % Trucks     | 0                             | 0    | 0    | 0    | 0          | 0.7                     | 0.9  | 0    | 0    | 0.9        | 0.8                            | 0    | 0    | 0    | 0.8        | 0                       | 0.8  | 7.7  | 0    | 1          | 0.9        |

| Start Time   | CA-1 NB ON-RAMP<br>Southbound |      |      |            | IMJIN PKWY<br>Westbound |            |      |            | CA-1 NB OFF-RAMP<br>Northbound |      |      |            | IMJIN PKWY<br>Eastbound |           |      |            | Int. Total |
|--|-------------------------------|------|------|------------|-------------------------|------------|------|------------|--------------------------------|------|------|------------|-------------------------|-----------|------|------------|------------|
|  | Right                         | Thru | Left | App. Total | Right                   | Thru       | Left | App. Total | Right                          | Thru | Left | App. Total | Right                   | Thru      | Left | App. Total |            |
| Peak Hour Analysis From 04:00 PM to 05:45 PM - Peak 1 of 1 |                               |      |      |            |                         |            |      |            |                                |      |      |            |                         |           |      |            |            |
| Peak Hour for Entire Intersection Begins at 04:45 PM       |                               |      |      |            |                         |            |      |            |                                |      |      |            |                         |           |      |            |            |
| 04:45 PM   | 0                             | 0    | 0    | 0          | 96                      | 243        | 0    | 339        | 291                            | 1    | 2    | 294        | 0                       | 63        | 3    | 66         | 699        |
| 05:00 PM   | 0                             | 0    | 0    | 0          | 114                     | 245        | 0    | 359        | 291                            | 0    | 1    | 292        | 0                       | 56        | 2    | 58         | 709        |
| 05:15 PM   | 0                             | 0    | 0    | 0          | 101                     | 237        | 0    | 338        | <b>302</b>                     | 0    | 1    | <b>303</b> | 0                       | 56        | 1    | 57         | 698        |
| 05:30 PM   | 0                             | 0    | 0    | 0          | 111                     | <b>270</b> | 0    | <b>381</b> | 302                            | 1    | 0    | 303        | 0                       | <b>72</b> | 1    | <b>73</b>  | <b>757</b> |
| Total Volume   | 0                             | 0    | 0    | 0          | 422                     | 995        | 0    | 1417       | 1186                           | 2    | 4    | 1192       | 0                       | 247       | 7    | 254        | 2863       |
| % App. Total   | 0                             | 0    | 0    | 0          | 29.8                    | 70.2       | 0    |            | 99.5                           | 0.2  | 0.3  |            | 0                       | 97.2      | 2.8  |            |            |
| PHF  | .000                          | .000 | .000 | .000       | .925                    | .921       | .000 | .930       | .982                           | .500 | .500 | .983       | .000                    | .858      | .583 | .870       | .946       |

# Traffic Data Service

San Jose, CA  
 (408) 622-4787  
 tdsbay@cs.com

File Name : 2PM FINAL  
 Site Code : 00000002  
 Start Date : 5/3/2017  
 Page No : 2

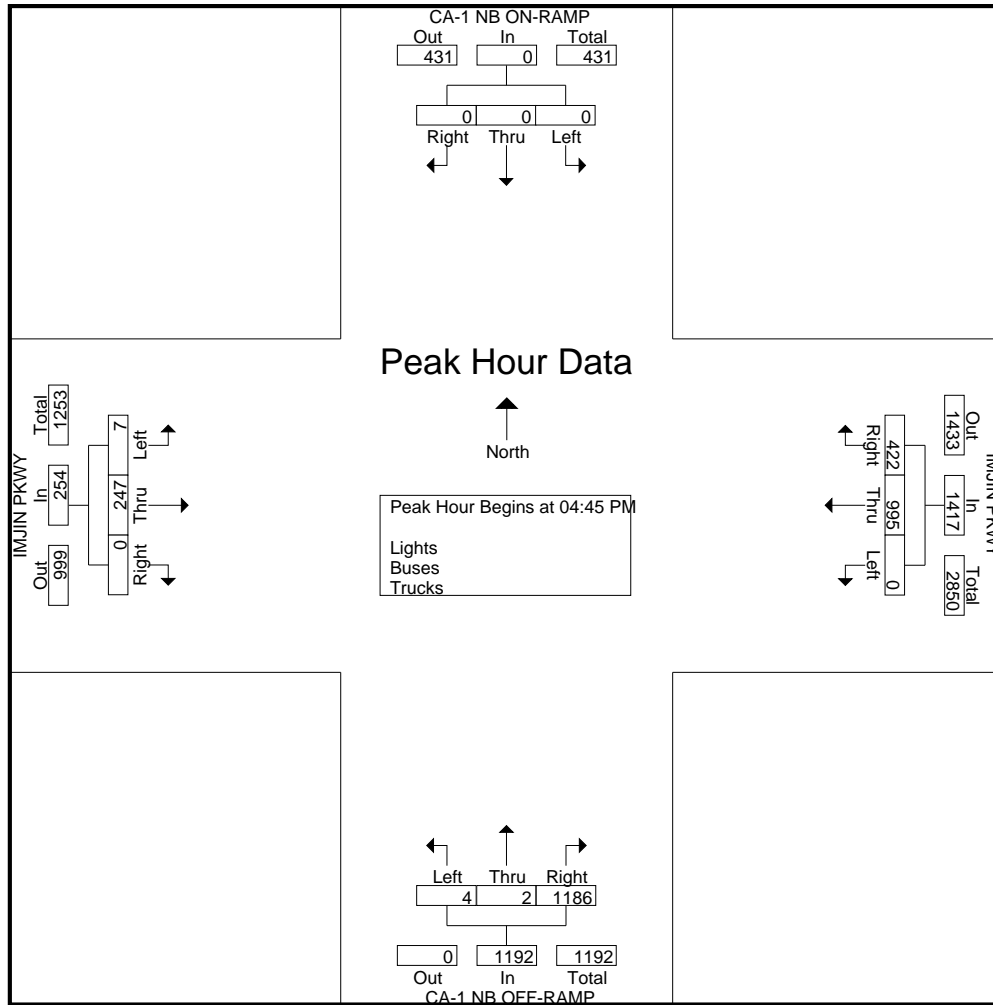

# Traffic Data Service

San Jose, CA  
 (408) 622-4787  
 tdsbay@cs.com

File Name : 2PM FINAL  
 Site Code : 00000002  
 Start Date : 5/3/2017  
 Page No : 1

## Groups Printed- Bikes

| Start Time  | CA-1 NB ON-RAMP<br>Southbound |      |      |      |            | IMJIN PKWY<br>Westbound |      |      |      |            | CA-1 NB OFF-RAMP<br>Northbound |      |      |      |            | IMJIN PKWY<br>Eastbound |      |      |      |            | Int. Total |
|-------------|-------------------------------|------|------|------|------------|-------------------------|------|------|------|------------|--------------------------------|------|------|------|------------|-------------------------|------|------|------|------------|------------|
|             | Right                         | Thru | Left | Peds | App. Total | Right                   | Thru | Left | Peds | App. Total | Right                          | Thru | Left | Peds | App. Total | Right                   | Thru | Left | Peds | App. Total |            |
| 04:00 PM    | 0                             | 0    | 0    | 0    | 0          | 0                       | 1    | 0    | 0    | 1          | 0                              | 0    | 0    | 0    | 0          | 0                       | 0    | 0    | 0    | 0          | 1          |
| 04:15 PM    | 0                             | 0    | 0    | 0    | 0          | 0                       | 0    | 0    | 0    | 0          | 0                              | 0    | 0    | 0    | 0          | 0                       | 0    | 0    | 0    | 0          | 0          |
| 04:30 PM    | 0                             | 0    | 0    | 0    | 0          | 0                       | 0    | 0    | 0    | 0          | 0                              | 0    | 0    | 0    | 0          | 0                       | 0    | 0    | 0    | 0          | 0          |
| 04:45 PM    | 0                             | 0    | 0    | 0    | 0          | 0                       | 1    | 0    | 0    | 1          | 0                              | 0    | 0    | 0    | 0          | 0                       | 0    | 0    | 0    | 0          | 1          |
| Total       | 0                             | 0    | 0    | 0    | 0          | 0                       | 2    | 0    | 0    | 2          | 0                              | 0    | 0    | 0    | 0          | 0                       | 0    | 0    | 0    | 0          | 2          |
| 05:00 PM    | 0                             | 0    | 0    | 0    | 0          | 0                       | 0    | 0    | 0    | 0          | 0                              | 0    | 0    | 0    | 0          | 0                       | 0    | 0    | 0    | 0          | 0          |
| 05:15 PM    | 0                             | 0    | 0    | 0    | 0          | 0                       | 0    | 0    | 0    | 0          | 0                              | 0    | 0    | 0    | 0          | 0                       | 0    | 0    | 0    | 0          | 0          |
| 05:30 PM    | 0                             | 0    | 0    | 0    | 0          | 0                       | 0    | 0    | 0    | 0          | 0                              | 0    | 0    | 0    | 0          | 0                       | 0    | 0    | 0    | 0          | 0          |
| 05:45 PM    | 0                             | 0    | 0    | 0    | 0          | 0                       | 0    | 0    | 0    | 0          | 0                              | 0    | 0    | 0    | 0          | 0                       | 0    | 0    | 0    | 0          | 0          |
| Total       | 0                             | 0    | 0    | 0    | 0          | 0                       | 0    | 0    | 0    | 0          | 0                              | 0    | 0    | 0    | 0          | 0                       | 0    | 0    | 0    | 0          | 0          |
| Grand Total | 0                             | 0    | 0    | 0    | 0          | 0                       | 2    | 0    | 0    | 2          | 0                              | 0    | 0    | 0    | 0          | 0                       | 0    | 0    | 0    | 0          | 2          |
| Apprch %    | 0                             | 0    | 0    | 0    | 0          | 0                       | 100  | 0    | 0    | 100        | 0                              | 0    | 0    | 0    | 0          | 0                       | 0    | 0    | 0    | 0          | 0          |
| Total %     | 0                             | 0    | 0    | 0    | 0          | 0                       | 100  | 0    | 0    | 100        | 0                              | 0    | 0    | 0    | 0          | 0                       | 0    | 0    | 0    | 0          | 0          |

| Start Time   | CA-1 NB ON-RAMP<br>Southbound |      |      |            | IMJIN PKWY<br>Westbound |      |      |            | CA-1 NB OFF-RAMP<br>Northbound |      |      |            | IMJIN PKWY<br>Eastbound |      |      |            | Int. Total |
|--|-------------------------------|------|------|------------|-------------------------|------|------|------------|--------------------------------|------|------|------------|-------------------------|------|------|------------|------------|
|  | Right                         | Thru | Left | App. Total | Right                   | Thru | Left | App. Total | Right                          | Thru | Left | App. Total | Right                   | Thru | Left | App. Total |            |
| Peak Hour Analysis From 04:00 PM to 05:45 PM - Peak 1 of 1 |                               |      |      |            |                         |      |      |            |                                |      |      |            |                         |      |      |            |            |
| Peak Hour for Entire Intersection Begins at 04:00 PM       |                               |      |      |            |                         |      |      |            |                                |      |      |            |                         |      |      |            |            |
| 04:00 PM   | 0                             | 0    | 0    | 0          | 0                       | 1    | 0    | 1          | 0                              | 0    | 0    | 0          | 0                       | 0    | 0    | 0          | 1          |
| 04:15 PM   | 0                             | 0    | 0    | 0          | 0                       | 0    | 0    | 0          | 0                              | 0    | 0    | 0          | 0                       | 0    | 0    | 0          | 0          |
| 04:30 PM   | 0                             | 0    | 0    | 0          | 0                       | 0    | 0    | 0          | 0                              | 0    | 0    | 0          | 0                       | 0    | 0    | 0          | 0          |
| 04:45 PM   | 0                             | 0    | 0    | 0          | 0                       | 1    | 0    | 1          | 0                              | 0    | 0    | 0          | 0                       | 0    | 0    | 0          | 1          |
| Total Volume   | 0                             | 0    | 0    | 0          | 0                       | 2    | 0    | 2          | 0                              | 0    | 0    | 0          | 0                       | 0    | 0    | 0          | 2          |
| % App. Total   | 0                             | 0    | 0    | 0          | 0                       | 100  | 0    | 100        | 0                              | 0    | 0    | 0          | 0                       | 0    | 0    | 0          | 0          |
| PHF  | .000                          | .000 | .000 | .000       | .000                    | .500 | .000 | .500       | .000                           | .000 | .000 | .000       | .000                    | .000 | .000 | .000       | .500       |

# Traffic Data Service

San Jose, CA  
 (408) 622-4787  
 tdsbay@cs.com

File Name : 2PM FINAL  
 Site Code : 00000002  
 Start Date : 5/3/2017  
 Page No : 2

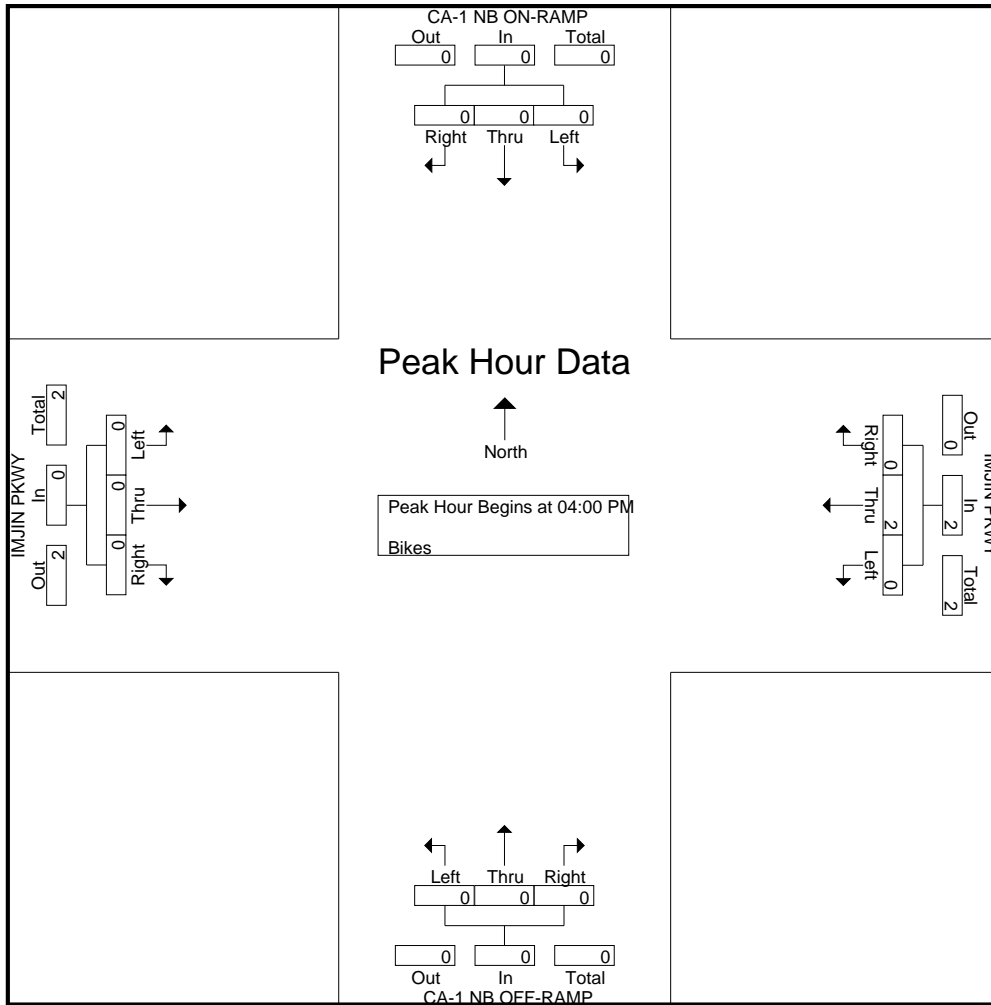



# Traffic Data Service

San Jose, CA  
 (408) 622-4787  
 tdsbay@cs.com

File Name : 3AM FINAL  
 Site Code : 00000003  
 Start Date : 4/27/2017  
 Page No : 1

## Groups Printed- Lights - Buses - Trucks

| Start Time   | 2ND AVE Southbound |          |          |          |            | IMJIN PKWY Westbound |            |            |          |             | 2ND AVE Northbound |          |            |          |            | IMJIN PKWY Eastbound |            |           |          |             | Int. Total  |
|--------------|--------------------|----------|----------|----------|------------|----------------------|------------|------------|----------|-------------|--------------------|----------|------------|----------|------------|----------------------|------------|-----------|----------|-------------|-------------|
|              | Right              | Thru     | Left     | Peds     | App. Total | Right                | Thru       | Left       | Peds     | App. Total  | Right              | Thru     | Left       | Peds     | App. Total | Right                | Thru       | Left      | Peds     | App. Total  |             |
| 07:00 AM     | 0                  | 0        | 0        | 0        | 0          | 1                    | 303        | 51         | 0        | 355         | 15                 | 1        | 15         | 0        | 31         | 28                   | 132        | 5         | 0        | 165         | 551         |
| 07:15 AM     | 2                  | 1        | 0        | 0        | 3          | 1                    | 251        | 81         | 1        | 334         | 14                 | 1        | 18         | 0        | 33         | 74                   | 173        | 0         | 1        | 248         | 618         |
| 07:30 AM     | 1                  | 3        | 2        | 0        | 6          | 3                    | 219        | 91         | 1        | 314         | 31                 | 2        | 11         | 0        | 44         | 74                   | 210        | 4         | 0        | 288         | 652         |
| 07:45 AM     | 2                  | 1        | 2        | 0        | 5          | 2                    | 201        | 84         | 0        | 287         | 43                 | 2        | 27         | 0        | 72         | 82                   | 219        | 2         | 1        | 304         | 668         |
| <b>Total</b> | <b>5</b>           | <b>5</b> | <b>4</b> | <b>0</b> | <b>14</b>  | <b>7</b>             | <b>974</b> | <b>307</b> | <b>2</b> | <b>1290</b> | <b>103</b>         | <b>6</b> | <b>71</b>  | <b>0</b> | <b>180</b> | <b>258</b>           | <b>734</b> | <b>11</b> | <b>2</b> | <b>1005</b> | <b>2489</b> |
| 08:00 AM     | 1                  | 2        | 1        | 0        | 4          | 1                    | 184        | 71         | 0        | 256         | 39                 | 1        | 30         | 0        | 70         | 117                  | 208        | 3         | 0        | 328         | 658         |
| 08:15 AM     | 1                  | 1        | 0        | 0        | 2          | 4                    | 211        | 64         | 0        | 279         | 25                 | 1        | 31         | 0        | 57         | 106                  | 204        | 3         | 0        | 313         | 651         |
| 08:30 AM     | 2                  | 1        | 3        | 0        | 6          | 1                    | 247        | 66         | 0        | 314         | 28                 | 3        | 32         | 0        | 63         | 73                   | 154        | 2         | 0        | 229         | 612         |
| 08:45 AM     | 2                  | 0        | 1        | 2        | 5          | 0                    | 231        | 54         | 0        | 285         | 26                 | 0        | 36         | 0        | 62         | 56                   | 145        | 6         | 2        | 209         | 561         |
| <b>Total</b> | <b>6</b>           | <b>4</b> | <b>5</b> | <b>2</b> | <b>17</b>  | <b>6</b>             | <b>873</b> | <b>255</b> | <b>0</b> | <b>1134</b> | <b>118</b>         | <b>5</b> | <b>129</b> | <b>0</b> | <b>252</b> | <b>352</b>           | <b>711</b> | <b>14</b> | <b>2</b> | <b>1079</b> | <b>2482</b> |
| Grand Total  | 11                 | 9        | 9        | 2        | 31         | 13                   | 1847       | 562        | 2        | 2424        | 221                | 11       | 200        | 0        | 432        | 610                  | 1445       | 25        | 4        | 2084        | 4971        |
| Apprch %     | 35.5               | 29       | 29       | 6.5      |            | 0.5                  | 76.2       | 23.2       | 0.1      |             | 51.2               | 2.5      | 46.3       | 0        |            | 29.3                 | 69.3       | 1.2       | 0.2      |             |             |
| Total %      | 0.2                | 0.2      | 0.2      | 0        | 0.6        | 0.3                  | 37.2       | 11.3       | 0        | 48.8        | 4.4                | 0.2      | 4          | 0        | 8.7        | 12.3                 | 29.1       | 0.5       | 0.1      | 41.9        |             |
| Lights       | 10                 | 9        | 9        | 2        | 30         | 13                   | 1793       | 549        | 2        | 2357        | 214                | 11       | 186        | 0        | 411        | 594                  | 1418       | 25        | 4        | 2041        | 4839        |
| % Lights     | 90.9               | 100      | 100      | 100      | 96.8       | 100                  | 97.1       | 97.7       | 100      | 97.2        | 96.8               | 100      | 93         | 0        | 95.1       | 97.4                 | 98.1       | 100       | 100      | 97.9        | 97.3        |
| Buses        | 0                  | 0        | 0        | 0        | 0          | 0                    | 6          | 8          | 0        | 14          | 4                  | 0        | 4          | 0        | 8          | 4                    | 9          | 0         | 0        | 13          | 35          |
| % Buses      | 0                  | 0        | 0        | 0        | 0          | 0                    | 0.3        | 1.4        | 0        | 0.6         | 1.8                | 0        | 2          | 0        | 1.9        | 0.7                  | 0.6        | 0         | 0        | 0.6         | 0.7         |
| Trucks       | 1                  | 0        | 0        | 0        | 1          | 0                    | 48         | 5          | 0        | 53          | 3                  | 0        | 10         | 0        | 13         | 12                   | 18         | 0         | 0        | 30          | 97          |
| % Trucks     | 9.1                | 0        | 0        | 0        | 3.2        | 0                    | 2.6        | 0.9        | 0        | 2.2         | 1.4                | 0        | 5          | 0        | 3          | 2                    | 1.2        | 0         | 0        | 1.4         | 2           |

| Start Time   | 2ND AVE Southbound |      |      |            | IMJIN PKWY Westbound |      |      |            | 2ND AVE Northbound |      |      |            | IMJIN PKWY Eastbound |      |      |            | Int. Total |
|--|--------------------|------|------|------------|----------------------|------|------|------------|--------------------|------|------|------------|----------------------|------|------|------------|------------|
|  | Right              | Thru | Left | App. Total | Right                | Thru | Left | App. Total | Right              | Thru | Left | App. Total | Right                | Thru | Left | App. Total |            |
| Peak Hour Analysis From 07:00 AM to 08:45 AM - Peak 1 of 1 |                    |      |      |            |                      |      |      |            |                    |      |      |            |                      |      |      |            |            |
| Peak Hour for Entire Intersection Begins at 07:30 AM       |                    |      |      |            |                      |      |      |            |                    |      |      |            |                      |      |      |            |            |
| 07:30 AM   | 1                  | 3    | 2    | 6          | 3                    | 219  | 91   | 313        | 31                 | 2    | 11   | 44         | 74                   | 210  | 4    | 288        | 651        |
| 07:45 AM   | 2                  | 1    | 2    | 5          | 2                    | 201  | 84   | 287        | 43                 | 2    | 27   | 72         | 82                   | 219  | 2    | 303        | 667        |
| 08:00 AM   | 1                  | 2    | 1    | 4          | 1                    | 184  | 71   | 256        | 39                 | 1    | 30   | 70         | 117                  | 208  | 3    | 328        | 658        |
| 08:15 AM   | 1                  | 1    | 0    | 2          | 4                    | 211  | 64   | 279        | 25                 | 1    | 31   | 57         | 106                  | 204  | 3    | 313        | 651        |
| Total Volume   | 5                  | 7    | 5    | 17         | 10                   | 815  | 310  | 1135       | 138                | 6    | 99   | 243        | 379                  | 841  | 12   | 1232       | 2627       |
| % App. Total   | 29.4               | 41.2 | 29.4 |            | 0.9                  | 71.8 | 27.3 |            | 56.8               | 2.5  | 40.7 |            | 30.8                 | 68.3 | 1    |            |            |
| PHF  | .625               | .583 | .625 | .708       | .625                 | .930 | .852 | .907       | .802               | .750 | .798 | .844       | .810                 | .960 | .750 | .939       | .985       |

# Traffic Data Service

San Jose, CA  
 (408) 622-4787  
 tdsbay@cs.com

File Name : 3AM FINAL  
 Site Code : 00000003  
 Start Date : 4/27/2017  
 Page No : 2

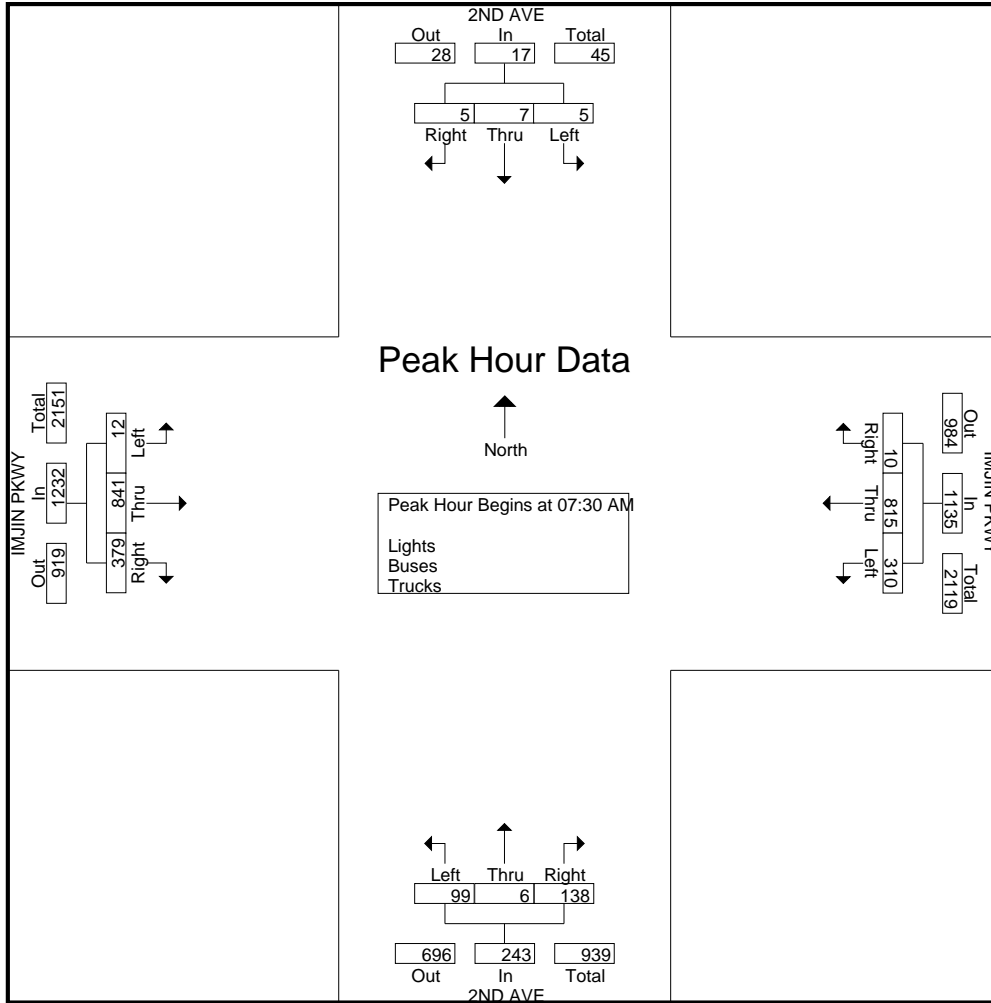

# Traffic Data Service

San Jose, CA  
 (408) 622-4787  
 tdsbay@cs.com

File Name : 3AM FINAL  
 Site Code : 00000003  
 Start Date : 4/27/2017  
 Page No : 1

Groups Printed- Bikes

| Start Time   | 2ND AVE Southbound |      |      |      |            | IMJIN PKWY Westbound |      |      |      |            | 2ND AVE Northbound |      |      |      |            | IMJIN PKWY Eastbound |      |      |      |            | Int. Total |   |
|--------------|--------------------|------|------|------|------------|----------------------|------|------|------|------------|--------------------|------|------|------|------------|----------------------|------|------|------|------------|------------|---|
|              | Right              | Thru | Left | Peds | App. Total | Right                | Thru | Left | Peds | App. Total | Right              | Thru | Left | Peds | App. Total | Right                | Thru | Left | Peds | App. Total |            |   |
| 07:00 AM     | 0                  | 0    | 0    | 0    | 0          | 0                    | 0    | 0    | 0    | 0          | 0                  | 0    | 0    | 0    | 0          | 0                    | 0    | 0    | 0    | 0          | 0          | 0 |
| 07:15 AM     | 0                  | 0    | 0    | 0    | 0          | 0                    | 0    | 0    | 0    | 0          | 0                  | 0    | 0    | 0    | 0          | 0                    | 0    | 0    | 0    | 0          | 0          | 0 |
| 07:30 AM     | 0                  | 0    | 0    | 0    | 0          | 0                    | 0    | 0    | 0    | 0          | 0                  | 0    | 0    | 0    | 0          | 0                    | 0    | 0    | 0    | 0          | 0          | 0 |
| 07:45 AM     | 0                  | 0    | 0    | 0    | 0          | 0                    | 0    | 0    | 0    | 0          | 0                  | 0    | 0    | 0    | 0          | 0                    | 0    | 0    | 0    | 0          | 0          | 0 |
| <b>Total</b> | 0                  | 0    | 0    | 0    | 0          | 0                    | 0    | 0    | 0    | 0          | 0                  | 0    | 0    | 0    | 0          | 0                    | 0    | 0    | 0    | 0          | 0          | 0 |
| 08:00 AM     | 0                  | 0    | 0    | 0    | 0          | 0                    | 0    | 0    | 0    | 0          | 0                  | 0    | 1    | 0    | 1          | 0                    | 0    | 0    | 0    | 0          | 0          | 1 |
| 08:15 AM     | 0                  | 0    | 0    | 0    | 0          | 0                    | 0    | 0    | 0    | 0          | 0                  | 0    | 0    | 0    | 0          | 0                    | 0    | 0    | 0    | 0          | 0          | 0 |
| 08:30 AM     | 0                  | 0    | 0    | 0    | 0          | 0                    | 0    | 0    | 0    | 0          | 0                  | 0    | 0    | 0    | 0          | 0                    | 0    | 0    | 0    | 0          | 0          | 0 |
| 08:45 AM     | 0                  | 0    | 0    | 0    | 0          | 0                    | 0    | 0    | 0    | 0          | 0                  | 0    | 0    | 0    | 0          | 0                    | 0    | 0    | 0    | 0          | 0          | 0 |
| <b>Total</b> | 0                  | 0    | 0    | 0    | 0          | 0                    | 0    | 0    | 0    | 0          | 0                  | 0    | 1    | 0    | 1          | 0                    | 0    | 0    | 0    | 0          | 0          | 1 |
| Grand Total  | 0                  | 0    | 0    | 0    | 0          | 0                    | 0    | 0    | 0    | 0          | 0                  | 0    | 1    | 0    | 1          | 0                    | 0    | 0    | 0    | 0          | 0          | 1 |
| Apprch %     | 0                  | 0    | 0    | 0    | 0          | 0                    | 0    | 0    | 0    | 0          | 0                  | 0    | 100  | 0    | 100        | 0                    | 0    | 0    | 0    | 0          | 0          | 0 |
| Total %      | 0                  | 0    | 0    | 0    | 0          | 0                    | 0    | 0    | 0    | 0          | 0                  | 0    | 100  | 0    | 100        | 0                    | 0    | 0    | 0    | 0          | 0          | 0 |

| Start Time   | 2ND AVE Southbound |      |      |      |            | IMJIN PKWY Westbound |      |      |      |            | 2ND AVE Northbound |      |      |      |            | IMJIN PKWY Eastbound |      |      |      |            | Int. Total |      |
|--|--------------------|------|------|------|------------|----------------------|------|------|------|------------|--------------------|------|------|------|------------|----------------------|------|------|------|------------|------------|------|
|  | Right              | Thru | Left | Peds | App. Total | Right                | Thru | Left | Peds | App. Total | Right              | Thru | Left | Peds | App. Total | Right                | Thru | Left | Peds | App. Total |            |      |
| Peak Hour Analysis From 07:00 AM to 08:45 AM - Peak 1 of 1 |                    |      |      |      |            |                      |      |      |      |            |                    |      |      |      |            |                      |      |      |      |            |            |      |
| Peak Hour for Entire Intersection Begins at 07:15 AM       |                    |      |      |      |            |                      |      |      |      |            |                    |      |      |      |            |                      |      |      |      |            |            |      |
| 07:15 AM   | 0                  | 0    | 0    | 0    | 0          | 0                    | 0    | 0    | 0    | 0          | 0                  | 0    | 0    | 0    | 0          | 0                    | 0    | 0    | 0    | 0          | 0          | 0    |
| 07:30 AM   | 0                  | 0    | 0    | 0    | 0          | 0                    | 0    | 0    | 0    | 0          | 0                  | 0    | 0    | 0    | 0          | 0                    | 0    | 0    | 0    | 0          | 0          | 0    |
| 07:45 AM   | 0                  | 0    | 0    | 0    | 0          | 0                    | 0    | 0    | 0    | 0          | 0                  | 0    | 0    | 0    | 0          | 0                    | 0    | 0    | 0    | 0          | 0          | 0    |
| 08:00 AM   | 0                  | 0    | 0    | 0    | 0          | 0                    | 0    | 0    | 0    | 0          | 0                  | 0    | 1    | 0    | 1          | 0                    | 0    | 0    | 0    | 0          | 0          | 1    |
| Total Volume   | 0                  | 0    | 0    | 0    | 0          | 0                    | 0    | 0    | 0    | 0          | 0                  | 0    | 1    | 0    | 1          | 0                    | 0    | 0    | 0    | 0          | 0          | 1    |
| % App. Total   | 0                  | 0    | 0    | 0    | 0          | 0                    | 0    | 0    | 0    | 0          | 0                  | 0    | 100  | 0    | 100        | 0                    | 0    | 0    | 0    | 0          | 0          | 0    |
| PHF  | .000               | .000 | .000 | .000 | .000       | .000                 | .000 | .000 | .000 | .000       | .000               | .000 | .250 | .250 | .250       | .000                 | .000 | .000 | .000 | .000       | .000       | .250 |

# Traffic Data Service

San Jose, CA  
 (408) 622-4787  
 tdsbay@cs.com

File Name : 3AM FINAL  
 Site Code : 00000003  
 Start Date : 4/27/2017  
 Page No : 2

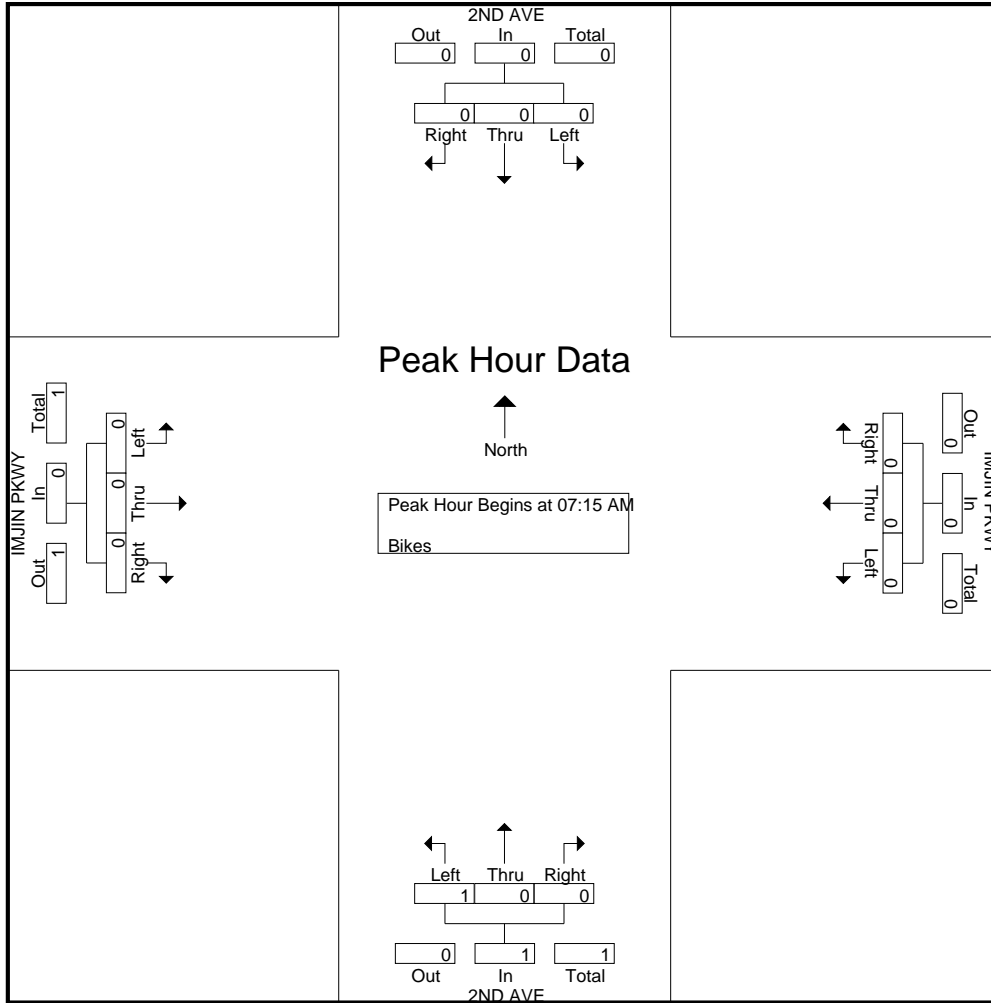

# Traffic Data Service

San Jose, CA  
 (408) 622-4787  
 tdsbay@cs.com

File Name : 3PM FINAL  
 Site Code : 00000003  
 Start Date : 4/27/2017  
 Page No : 1

## Groups Printed- Lights - Buses - Trucks

| Start Time  | 2ND AVE Southbound |      |      |      |            | IMJIN PKWY Westbound |      |      |      |            | 2ND AVE Northbound |      |      |      |            | IMJIN PKWY Eastbound |      |      |      |            | Int. Total |
|-------------|--------------------|------|------|------|------------|----------------------|------|------|------|------------|--------------------|------|------|------|------------|----------------------|------|------|------|------------|------------|
|             | Right              | Thru | Left | Peds | App. Total | Right                | Thru | Left | Peds | App. Total | Right              | Thru | Left | Peds | App. Total | Right                | Thru | Left | Peds | App. Total |            |
| 04:00 PM    | 24                 | 5    | 5    | 2    | 36         | 2                    | 189  | 57   | 0    | 248        | 71                 | 0    | 93   | 0    | 164        | 85                   | 223  | 0    | 2    | 310        | 758        |
| 04:15 PM    | 5                  | 1    | 2    | 0    | 8          | 0                    | 204  | 47   | 1    | 252        | 49                 | 1    | 115  | 0    | 165        | 86                   | 261  | 2    | 0    | 349        | 774        |
| 04:30 PM    | 7                  | 0    | 1    | 0    | 8          | 0                    | 209  | 55   | 0    | 264        | 72                 | 1    | 124  | 0    | 197        | 95                   | 248  | 1    | 1    | 345        | 814        |
| 04:45 PM    | 7                  | 0    | 2    | 1    | 10         | 3                    | 224  | 67   | 0    | 294        | 81                 | 0    | 79   | 0    | 160        | 81                   | 252  | 1    | 2    | 336        | 800        |
| Total       | 43                 | 6    | 10   | 3    | 62         | 5                    | 826  | 226  | 1    | 1058       | 273                | 2    | 411  | 0    | 686        | 347                  | 984  | 4    | 5    | 1340       | 3146       |
| 05:00 PM    | 12                 | 1    | 5    | 2    | 20         | 0                    | 227  | 46   | 0    | 273        | 77                 | 0    | 111  | 1    | 189        | 72                   | 261  | 0    | 3    | 336        | 818        |
| 05:15 PM    | 10                 | 3    | 1    | 2    | 16         | 0                    | 236  | 70   | 0    | 306        | 86                 | 2    | 104  | 0    | 192        | 85                   | 253  | 3    | 1    | 342        | 856        |
| 05:30 PM    | 5                  | 5    | 0    | 0    | 10         | 1                    | 256  | 67   | 1    | 325        | 63                 | 0    | 95   | 0    | 158        | 84                   | 247  | 0    | 1    | 332        | 825        |
| 05:45 PM    | 7                  | 3    | 3    | 1    | 14         | 2                    | 222  | 65   | 0    | 289        | 69                 | 0    | 102  | 0    | 171        | 85                   | 241  | 3    | 2    | 331        | 805        |
| Total       | 34                 | 12   | 9    | 5    | 60         | 3                    | 941  | 248  | 1    | 1193       | 295                | 2    | 412  | 1    | 710        | 326                  | 1002 | 6    | 7    | 1341       | 3304       |
| Grand Total | 77                 | 18   | 19   | 8    | 122        | 8                    | 1767 | 474  | 2    | 2251       | 568                | 4    | 823  | 1    | 1396       | 673                  | 1986 | 10   | 12   | 2681       | 6450       |
| Apprch %    | 63.1               | 14.8 | 15.6 | 6.6  |            | 0.4                  | 78.5 | 21.1 | 0.1  |            | 40.7               | 0.3  | 59   | 0.1  |            | 25.1                 | 74.1 | 0.4  | 0.4  |            |            |
| Total %     | 1.2                | 0.3  | 0.3  | 0.1  | 1.9        | 0.1                  | 27.4 | 7.3  | 0    | 34.9       | 8.8                | 0.1  | 12.8 | 0    | 21.6       | 10.4                 | 30.8 | 0.2  | 0.2  | 41.6       |            |
| Lights      | 77                 | 18   | 19   | 8    | 122        | 8                    | 1742 | 465  | 2    | 2217       | 563                | 4    | 820  | 1    | 1388       | 668                  | 1965 | 10   | 12   | 2655       | 6382       |
| % Lights    | 100                | 100  | 100  | 100  | 100        | 100                  | 98.6 | 98.1 | 100  | 98.5       | 99.1               | 100  | 99.6 | 100  | 99.4       | 99.3                 | 98.9 | 100  | 100  | 99         | 98.9       |
| Buses       | 0                  | 0    | 0    | 0    | 0          | 0                    | 0    | 12   | 8    | 20         | 3                  | 0    | 2    | 0    | 5          | 4                    | 1    | 0    | 0    | 5          | 30         |
| % Buses     | 0                  | 0    | 0    | 0    | 0          | 0                    | 0.7  | 1.7  | 0    | 0.9        | 0.5                | 0    | 0.2  | 0    | 0.4        | 0.6                  | 0.1  | 0    | 0    | 0.2        | 0.5        |
| Trucks      | 0                  | 0    | 0    | 0    | 0          | 0                    | 13   | 1    | 0    | 14         | 2                  | 0    | 1    | 0    | 3          | 1                    | 20   | 0    | 0    | 21         | 38         |
| % Trucks    | 0                  | 0    | 0    | 0    | 0          | 0                    | 0.7  | 0.2  | 0    | 0.6        | 0.4                | 0    | 0.1  | 0    | 0.2        | 0.1                  | 1    | 0    | 0    | 0.8        | 0.6        |

| Start Time   | 2ND AVE Southbound |      |      |            | IMJIN PKWY Westbound |      |      |            | 2ND AVE Northbound |      |      |            | IMJIN PKWY Eastbound |      |      |            | Int. Total |
|--|--------------------|------|------|------------|----------------------|------|------|------------|--------------------|------|------|------------|----------------------|------|------|------------|------------|
|  | Right              | Thru | Left | App. Total | Right                | Thru | Left | App. Total | Right              | Thru | Left | App. Total | Right                | Thru | Left | App. Total |            |
| Peak Hour Analysis From 04:00 PM to 05:45 PM - Peak 1 of 1 |                    |      |      |            |                      |      |      |            |                    |      |      |            |                      |      |      |            |            |
| Peak Hour for Entire Intersection Begins at 05:00 PM       |                    |      |      |            |                      |      |      |            |                    |      |      |            |                      |      |      |            |            |
| 05:00 PM   | 12                 | 1    | 5    | 18         | 0                    | 227  | 46   | 273        | 77                 | 0    | 111  | 188        | 72                   | 261  | 0    | 333        | 812        |
| 05:15 PM   | 10                 | 3    | 1    | 14         | 0                    | 236  | 70   | 306        | 86                 | 2    | 104  | 192        | 85                   | 253  | 3    | 341        | 853        |
| 05:30 PM   | 5                  | 5    | 0    | 10         | 1                    | 256  | 67   | 324        | 63                 | 0    | 95   | 158        | 84                   | 247  | 0    | 331        | 823        |
| 05:45 PM   | 7                  | 3    | 3    | 13         | 2                    | 222  | 65   | 289        | 69                 | 0    | 102  | 171        | 85                   | 241  | 3    | 329        | 802        |
| Total Volume   | 34                 | 12   | 9    | 55         | 3                    | 941  | 248  | 1192       | 295                | 2    | 412  | 709        | 326                  | 1002 | 6    | 1334       | 3290       |
| % App. Total   | 61.8               | 21.8 | 16.4 |            | 0.3                  | 78.9 | 20.8 |            | 41.6               | 0.3  | 58.1 |            | 24.4                 | 75.1 | 0.4  |            |            |
| PHF  | .708               | .600 | .450 | .764       | .375                 | .919 | .886 | .920       | .858               | .250 | .928 | .923       | .959                 | .960 | .500 | .978       | .964       |

# Traffic Data Service

San Jose, CA  
 (408) 622-4787  
 tdsbay@cs.com

File Name : 3PM FINAL  
 Site Code : 00000003  
 Start Date : 4/27/2017  
 Page No : 2

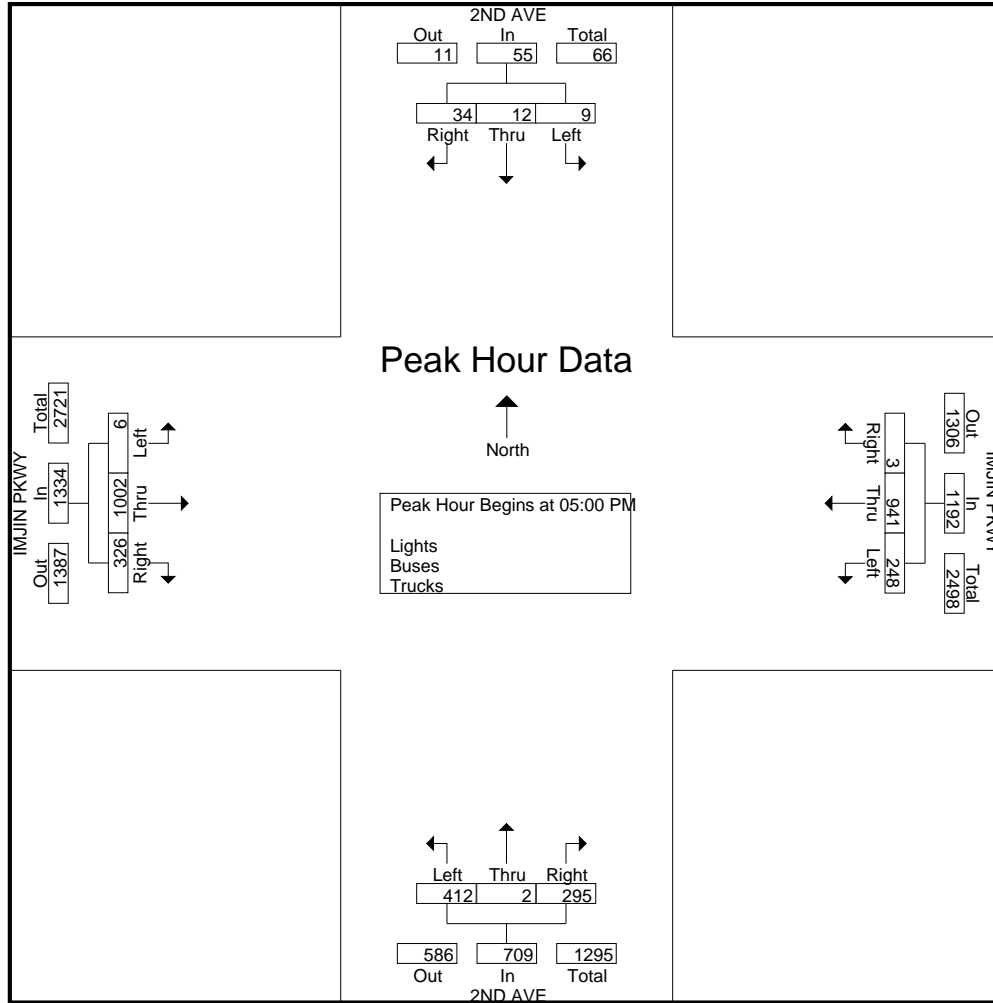

# Traffic Data Service

San Jose, CA  
 (408) 622-4787  
 tdsbay@cs.com

File Name : 3PM FINAL  
 Site Code : 00000003  
 Start Date : 4/27/2017  
 Page No : 1

Groups Printed- Bikes

| Start Time  | 2ND AVE Southbound |      |      |      |            | IMJIN PKWY Westbound |      |      |      |            | 2ND AVE Northbound |      |      |      |            | IMJIN PKWY Eastbound |      |      |      |            | Int. Total |   |
|-------------|--------------------|------|------|------|------------|----------------------|------|------|------|------------|--------------------|------|------|------|------------|----------------------|------|------|------|------------|------------|---|
|             | Right              | Thru | Left | Peds | App. Total | Right                | Thru | Left | Peds | App. Total | Right              | Thru | Left | Peds | App. Total | Right                | Thru | Left | Peds | App. Total |            |   |
| 04:00 PM    | 0                  | 0    | 0    | 0    | 0          | 0                    | 0    | 0    | 0    | 0          | 0                  | 0    | 0    | 0    | 0          | 0                    | 0    | 0    | 0    | 0          | 0          | 0 |
| 04:15 PM    | 0                  | 0    | 0    | 0    | 0          | 0                    | 0    | 0    | 0    | 0          | 0                  | 0    | 0    | 0    | 0          | 0                    | 0    | 0    | 0    | 0          | 0          | 0 |
| 04:30 PM    | 0                  | 0    | 0    | 0    | 0          | 0                    | 0    | 0    | 0    | 0          | 0                  | 0    | 0    | 0    | 0          | 0                    | 0    | 0    | 0    | 0          | 0          | 0 |
| 04:45 PM    | 0                  | 0    | 0    | 0    | 0          | 0                    | 0    | 0    | 0    | 0          | 0                  | 0    | 0    | 0    | 0          | 0                    | 0    | 0    | 0    | 0          | 0          | 0 |
| Total       | 0                  | 0    | 0    | 0    | 0          | 0                    | 0    | 0    | 0    | 0          | 0                  | 0    | 0    | 0    | 0          | 0                    | 0    | 0    | 0    | 0          | 0          | 0 |
| 05:00 PM    | 0                  | 0    | 0    | 0    | 0          | 0                    | 0    | 0    | 0    | 0          | 0                  | 0    | 0    | 0    | 0          | 0                    | 0    | 0    | 0    | 0          | 0          | 0 |
| 05:15 PM    | 0                  | 0    | 0    | 0    | 0          | 0                    | 0    | 0    | 0    | 0          | 0                  | 0    | 0    | 0    | 0          | 0                    | 0    | 0    | 0    | 0          | 0          | 0 |
| 05:30 PM    | 0                  | 0    | 0    | 0    | 0          | 0                    | 0    | 0    | 0    | 0          | 0                  | 0    | 0    | 0    | 0          | 0                    | 0    | 0    | 0    | 0          | 0          | 0 |
| 05:45 PM    | 0                  | 0    | 0    | 0    | 0          | 0                    | 0    | 0    | 0    | 0          | 0                  | 0    | 0    | 0    | 0          | 0                    | 0    | 0    | 0    | 0          | 0          | 0 |
| Total       | 0                  | 0    | 0    | 0    | 0          | 0                    | 0    | 0    | 0    | 0          | 0                  | 0    | 0    | 0    | 0          | 0                    | 0    | 0    | 0    | 0          | 0          | 0 |
| Grand Total | 0                  | 0    | 0    | 0    | 0          | 0                    | 0    | 0    | 0    | 0          | 0                  | 0    | 0    | 0    | 0          | 0                    | 0    | 0    | 0    | 0          | 0          | 0 |
| Apprch %    | 0                  | 0    | 0    | 0    |            | 0                    | 0    | 0    | 0    |            | 0                  | 0    | 0    | 0    |            | 0                    | 0    | 0    | 0    |            |            |   |
| Total %     |                    |      |      |      |            |                      |      |      |      |            |                    |      |      |      |            |                      |      |      |      |            |            |   |

| Start Time   | 2ND AVE Southbound |      |      |            | IMJIN PKWY Westbound |      |      |            | 2ND AVE Northbound |      |      |            | IMJIN PKWY Eastbound |      |      |            | Int. Total |      |
|--|--------------------|------|------|------------|----------------------|------|------|------------|--------------------|------|------|------------|----------------------|------|------|------------|------------|------|
|  | Right              | Thru | Left | App. Total | Right                | Thru | Left | App. Total | Right              | Thru | Left | App. Total | Right                | Thru | Left | App. Total |            |      |
| Peak Hour Analysis From 04:00 PM to 05:45 PM - Peak 1 of 1 |                    |      |      |            |                      |      |      |            |                    |      |      |            |                      |      |      |            |            |      |
| Peak Hour for Entire Intersection Begins at 04:00 PM       |                    |      |      |            |                      |      |      |            |                    |      |      |            |                      |      |      |            |            |      |
| 04:00 PM   | 0                  | 0    | 0    | 0          | 0                    | 0    | 0    | 0          | 0                  | 0    | 0    | 0          | 0                    | 0    | 0    | 0          | 0          | 0    |
| 04:15 PM   | 0                  | 0    | 0    | 0          | 0                    | 0    | 0    | 0          | 0                  | 0    | 0    | 0          | 0                    | 0    | 0    | 0          | 0          | 0    |
| 04:30 PM   | 0                  | 0    | 0    | 0          | 0                    | 0    | 0    | 0          | 0                  | 0    | 0    | 0          | 0                    | 0    | 0    | 0          | 0          | 0    |
| 04:45 PM   | 0                  | 0    | 0    | 0          | 0                    | 0    | 0    | 0          | 0                  | 0    | 0    | 0          | 0                    | 0    | 0    | 0          | 0          | 0    |
| Total Volume   | 0                  | 0    | 0    | 0          | 0                    | 0    | 0    | 0          | 0                  | 0    | 0    | 0          | 0                    | 0    | 0    | 0          | 0          | 0    |
| % App. Total   | 0                  | 0    | 0    |            | 0                    | 0    | 0    |            | 0                  | 0    | 0    |            | 0                    | 0    | 0    |            |            |      |
| PHF  | .000               | .000 | .000 | .000       | .000                 | .000 | .000 | .000       | .000               | .000 | .000 | .000       | .000                 | .000 | .000 | .000       | .000       | .000 |

# Traffic Data Service

San Jose, CA  
(408) 622-4787  
tdsbay@cs.com

File Name : 3PM FINAL  
Site Code : 00000003  
Start Date : 4/27/2017  
Page No : 2

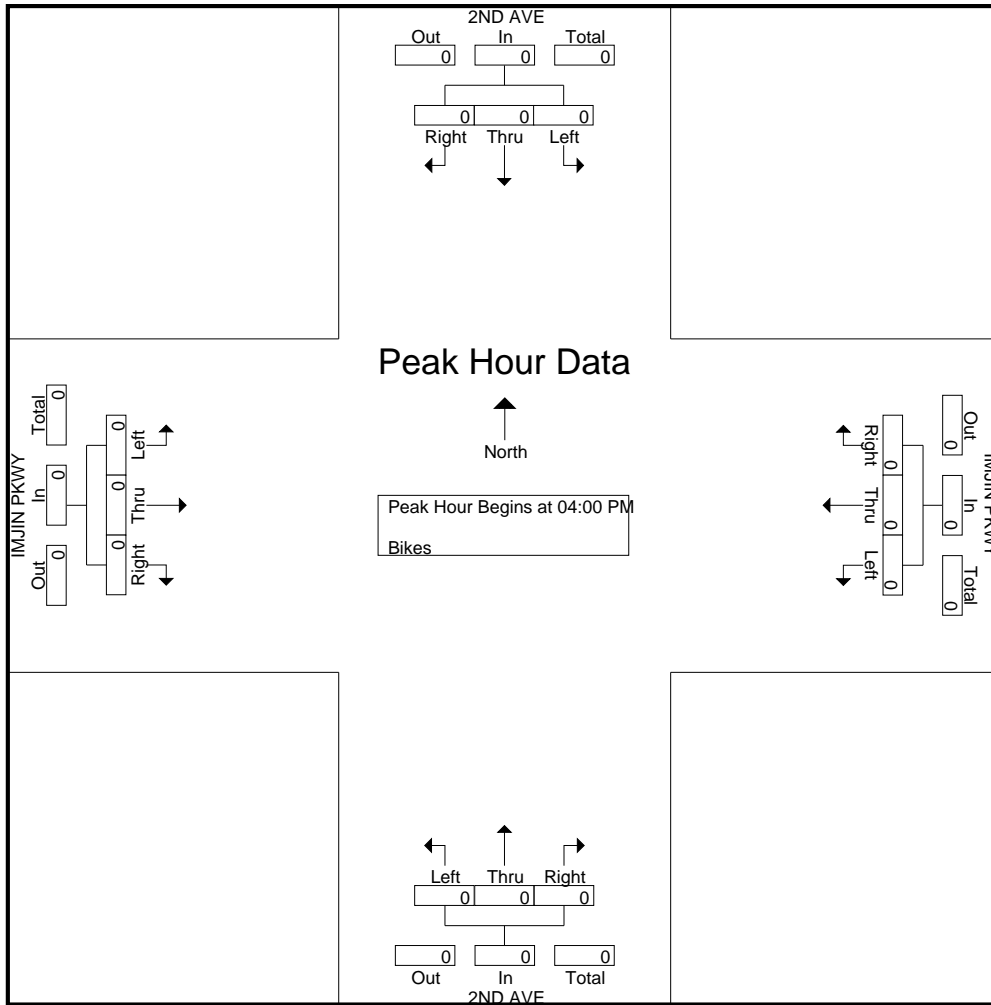



# Traffic Data Service

San Jose, CA  
 (408) 622-4787  
 tdsbay@cs.com

File Name : 4AM FINAL  
 Site Code : 00000004  
 Start Date : 4/27/2017  
 Page No : 1

## Groups Printed- Lights - Buses - Trucks

| Start Time   | 3RD AVE Southbound |          |          |          |            | IMJIN PKWY Westbound |             |            |          |             | 3RD AVE Northbound |          |          |          |            | IMJIN PKWY Eastbound |            |           |          |            | Int. Total  |
|--------------|--------------------|----------|----------|----------|------------|----------------------|-------------|------------|----------|-------------|--------------------|----------|----------|----------|------------|----------------------|------------|-----------|----------|------------|-------------|
|              | Right              | Thru     | Left     | Peds     | App. Total | Right                | Thru        | Left       | Peds     | App. Total  | Right              | Thru     | Left     | Peds     | App. Total | Right                | Thru       | Left      | Peds     | App. Total |             |
| 07:00 AM     | 1                  | 0        | 0        | 0        | 1          | 1                    | 364         | 24         | 0        | 389         | 2                  | 1        | 0        | 0        | 3          | 0                    | 151        | 6         | 0        | 157        | 550         |
| 07:15 AM     | 10                 | 1        | 1        | 0        | 12         | 4                    | 324         | 69         | 0        | 397         | 2                  | 0        | 1        | 0        | 3          | 2                    | 187        | 7         | 0        | 196        | 608         |
| 07:30 AM     | 8                  | 1        | 1        | 1        | 11         | 14                   | 255         | 81         | 0        | 350         | 8                  | 0        | 0        | 1        | 9          | 6                    | 228        | 20        | 2        | 256        | 626         |
| 07:45 AM     | 12                 | 1        | 4        | 0        | 17         | 5                    | 265         | 60         | 0        | 330         | 4                  | 0        | 2        | 0        | 6          | 5                    | 234        | 13        | 0        | 252        | 605         |
| <b>Total</b> | <b>31</b>          | <b>3</b> | <b>6</b> | <b>1</b> | <b>41</b>  | <b>24</b>            | <b>1208</b> | <b>234</b> | <b>0</b> | <b>1466</b> | <b>16</b>          | <b>1</b> | <b>3</b> | <b>1</b> | <b>21</b>  | <b>13</b>            | <b>800</b> | <b>46</b> | <b>2</b> | <b>861</b> | <b>2389</b> |
| 08:00 AM     | 4                  | 0        | 1        | 1        | 6          | 3                    | 255         | 17         | 0        | 275         | 5                  | 0        | 1        | 0        | 6          | 4                    | 242        | 12        | 0        | 258        | 545         |
| 08:15 AM     | 2                  | 0        | 3        | 0        | 5          | 3                    | 294         | 13         | 0        | 310         | 2                  | 0        | 1        | 0        | 3          | 0                    | 217        | 15        | 0        | 232        | 550         |
| 08:30 AM     | 4                  | 0        | 0        | 0        | 4          | 2                    | 301         | 7          | 0        | 310         | 3                  | 0        | 0        | 0        | 3          | 4                    | 179        | 8         | 1        | 192        | 509         |
| 08:45 AM     | 0                  | 0        | 0        | 0        | 0          | 5                    | 264         | 9          | 0        | 278         | 2                  | 2        | 1        | 0        | 5          | 1                    | 160        | 5         | 0        | 166        | 449         |
| <b>Total</b> | <b>10</b>          | <b>0</b> | <b>4</b> | <b>1</b> | <b>15</b>  | <b>13</b>            | <b>1114</b> | <b>46</b>  | <b>0</b> | <b>1173</b> | <b>12</b>          | <b>2</b> | <b>3</b> | <b>0</b> | <b>17</b>  | <b>9</b>             | <b>798</b> | <b>40</b> | <b>1</b> | <b>848</b> | <b>2053</b> |
| Grand Total  | 41                 | 3        | 10       | 2        | 56         | 37                   | 2322        | 280        | 0        | 2639        | 28                 | 3        | 6        | 1        | 38         | 22                   | 1598       | 86        | 3        | 1709       | 4442        |
| Apprch %     | 73.2               | 5.4      | 17.9     | 3.6      |            | 1.4                  | 88          | 10.6       | 0        |             | 73.7               | 7.9      | 15.8     | 2.6      |            | 1.3                  | 93.5       | 5         | 0.2      |            |             |
| Total %      | 0.9                | 0.1      | 0.2      | 0        | 1.3        | 0.8                  | 52.3        | 6.3        | 0        | 59.4        | 0.6                | 0.1      | 0.1      | 0        | 0.9        | 0.5                  | 36         | 1.9       | 0.1      | 38.5       |             |
| Lights       | 39                 | 3        | 10       | 2        | 54         | 36                   | 2252        | 279        | 0        | 2567        | 28                 | 3        | 4        | 1        | 36         | 22                   | 1563       | 85        | 3        | 1673       | 4330        |
| % Lights     | 95.1               | 100      | 100      | 100      | 96.4       | 97.3                 | 97          | 99.6       | 0        | 97.3        | 100                | 100      | 66.7     | 100      | 94.7       | 100                  | 97.8       | 98.8      | 100      | 97.9       | 97.5        |
| Buses        | 2                  | 0        | 0        | 0        | 2          | 1                    | 12          | 1          | 0        | 14          | 0                  | 0        | 0        | 0        | 0          | 0                    | 12         | 1         | 0        | 13         | 29          |
| % Buses      | 4.9                | 0        | 0        | 0        | 3.6        | 2.7                  | 0.5         | 0.4        | 0        | 0.5         | 0                  | 0        | 0        | 0        | 0          | 0                    | 0.8        | 1.2       | 0        | 0.8        | 0.7         |
| Trucks       | 0                  | 0        | 0        | 0        | 0          | 0                    | 58          | 0          | 0        | 58          | 0                  | 0        | 2        | 0        | 2          | 0                    | 23         | 0         | 0        | 23         | 83          |
| % Trucks     | 0                  | 0        | 0        | 0        | 0          | 0                    | 2.5         | 0          | 0        | 2.2         | 0                  | 0        | 33.3     | 0        | 5.3        | 0                    | 1.4        | 0         | 0        | 1.3        | 1.9         |

| Start Time   | 3RD AVE Southbound |      |      |            | IMJIN PKWY Westbound |            |      |            | 3RD AVE Northbound |      |      |            | IMJIN PKWY Eastbound |      |      |            | Int. Total |
|--|--------------------|------|------|------------|----------------------|------------|------|------------|--------------------|------|------|------------|----------------------|------|------|------------|------------|
|  | Right              | Thru | Left | App. Total | Right                | Thru       | Left | App. Total | Right              | Thru | Left | App. Total | Right                | Thru | Left | App. Total |            |
| Peak Hour Analysis From 07:00 AM to 08:45 AM - Peak 1 of 1 |                    |      |      |            |                      |            |      |            |                    |      |      |            |                      |      |      |            |            |
| Peak Hour for Entire Intersection Begins at 07:00 AM       |                    |      |      |            |                      |            |      |            |                    |      |      |            |                      |      |      |            |            |
| 07:00 AM   | 1                  | 0    | 0    | 1          | 1                    | <b>364</b> | 24   | 389        | 2                  | 1    | 0    | 3          | 0                    | 151  | 6    | 157        | 550        |
| 07:15 AM   | 10                 | 1    | 1    | 12         | 4                    | 324        | 69   | 397        | 2                  | 0    | 1    | 3          | 2                    | 187  | 7    | 196        | 608        |
| 07:30 AM   | 8                  | 1    | 1    | 10         | 14                   | 255        | 81   | 350        | 8                  | 0    | 0    | 8          | 6                    | 228  | 20   | 254        | 622        |
| 07:45 AM   | 12                 | 1    | 4    | 17         | 5                    | 265        | 60   | 330        | 4                  | 0    | 2    | 6          | 5                    | 234  | 13   | 252        | 605        |
| Total Volume   | 31                 | 3    | 6    | 40         | 24                   | 1208       | 234  | 1466       | 16                 | 1    | 3    | 20         | 13                   | 800  | 46   | 859        | 2385       |
| % App. Total   | 77.5               | 7.5  | 15   |            | 1.6                  | 82.4       | 16   |            | 80                 | 5    | 15   |            | 1.5                  | 93.1 | 5.4  |            |            |
| PHF  | .646               | .750 | .375 | .588       | .429                 | .830       | .722 | .923       | .500               | .250 | .375 | .625       | .542                 | .855 | .575 | .845       | .959       |

# Traffic Data Service

San Jose, CA  
 (408) 622-4787  
 tdsbay@cs.com

File Name : 4AM FINAL  
 Site Code : 00000004  
 Start Date : 4/27/2017  
 Page No : 2

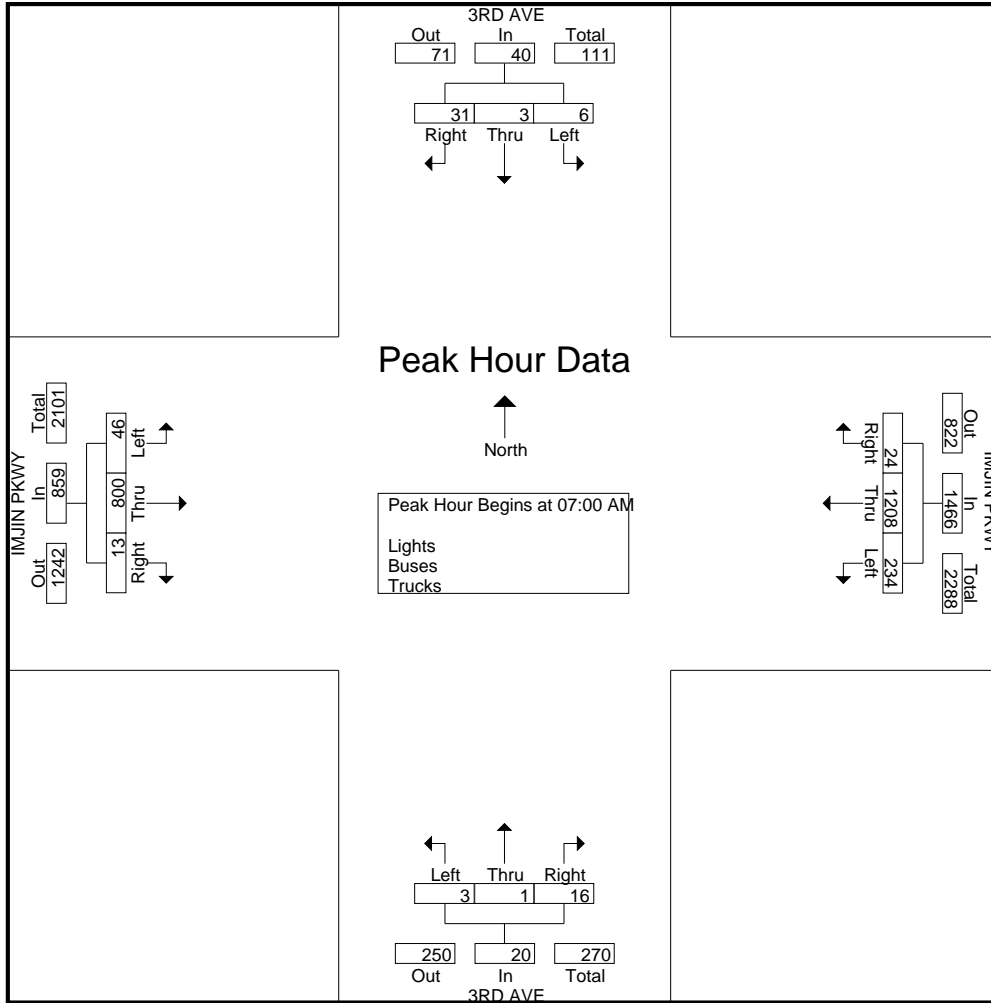

# Traffic Data Service

San Jose, CA  
 (408) 622-4787  
 tdsbay@cs.com

File Name : 4AM FINAL  
 Site Code : 00000004  
 Start Date : 4/27/2017  
 Page No : 1

Groups Printed- Bikes

| Start Time  | 3RD AVE Southbound |      |      |      |            | IMJIN PKWY Westbound |      |      |      |            | 3RD AVE Northbound |      |      |      |            | IMJIN PKWY Eastbound |      |      |      |            | Int. Total |
|-------------|--------------------|------|------|------|------------|----------------------|------|------|------|------------|--------------------|------|------|------|------------|----------------------|------|------|------|------------|------------|
|             | Right              | Thru | Left | Peds | App. Total | Right                | Thru | Left | Peds | App. Total | Right              | Thru | Left | Peds | App. Total | Right                | Thru | Left | Peds | App. Total |            |
| 07:00 AM    | 0                  | 0    | 0    | 0    | 0          | 0                    | 0    | 0    | 0    | 0          | 0                  | 0    | 0    | 0    | 0          | 0                    | 0    | 0    | 0    | 0          | 0          |
| 07:15 AM    | 0                  | 0    | 0    | 0    | 0          | 0                    | 0    | 0    | 0    | 0          | 0                  | 0    | 0    | 0    | 0          | 0                    | 0    | 0    | 0    | 0          | 0          |
| 07:30 AM    | 0                  | 0    | 0    | 0    | 0          | 0                    | 0    | 0    | 0    | 0          | 0                  | 0    | 0    | 0    | 0          | 0                    | 0    | 0    | 0    | 0          | 0          |
| 07:45 AM    | 0                  | 0    | 0    | 0    | 0          | 0                    | 0    | 0    | 0    | 0          | 0                  | 0    | 0    | 0    | 0          | 0                    | 0    | 0    | 0    | 0          | 0          |
| Total       | 0                  | 0    | 0    | 0    | 0          | 0                    | 0    | 0    | 0    | 0          | 0                  | 0    | 0    | 0    | 0          | 0                    | 0    | 0    | 0    | 0          | 0          |
| 08:00 AM    | 0                  | 0    | 0    | 0    | 0          | 0                    | 0    | 0    | 0    | 0          | 0                  | 0    | 0    | 0    | 0          | 0                    | 0    | 0    | 0    | 0          | 0          |
| 08:15 AM    | 0                  | 0    | 0    | 0    | 0          | 0                    | 0    | 0    | 0    | 0          | 0                  | 0    | 0    | 0    | 0          | 0                    | 0    | 0    | 0    | 0          | 0          |
| 08:30 AM    | 0                  | 0    | 0    | 0    | 0          | 0                    | 0    | 0    | 0    | 0          | 0                  | 0    | 0    | 0    | 0          | 0                    | 0    | 0    | 0    | 0          | 0          |
| 08:45 AM    | 0                  | 0    | 0    | 0    | 0          | 0                    | 0    | 0    | 0    | 0          | 0                  | 0    | 0    | 0    | 0          | 0                    | 0    | 0    | 0    | 0          | 0          |
| Total       | 0                  | 0    | 0    | 0    | 0          | 0                    | 0    | 0    | 0    | 0          | 0                  | 0    | 0    | 0    | 0          | 0                    | 0    | 0    | 0    | 0          | 0          |
| Grand Total | 0                  | 0    | 0    | 0    | 0          | 0                    | 0    | 0    | 0    | 0          | 0                  | 0    | 0    | 0    | 0          | 0                    | 0    | 0    | 0    | 0          | 0          |
| Apprch %    | 0                  | 0    | 0    | 0    |            | 0                    | 0    | 0    | 0    |            | 0                  | 0    | 0    | 0    |            | 0                    | 0    | 0    | 0    |            |            |
| Total %     |                    |      |      |      |            |                      |      |      |      |            |                    |      |      |      |            |                      |      |      |      |            |            |

| Start Time   | 3RD AVE Southbound |      |      |            | IMJIN PKWY Westbound |      |      |            | 3RD AVE Northbound |      |      |            | IMJIN PKWY Eastbound |      |      |            | Int. Total |
|--|--------------------|------|------|------------|----------------------|------|------|------------|--------------------|------|------|------------|----------------------|------|------|------------|------------|
|  | Right              | Thru | Left | App. Total | Right                | Thru | Left | App. Total | Right              | Thru | Left | App. Total | Right                | Thru | Left | App. Total |            |
| Peak Hour Analysis From 07:00 AM to 08:45 AM - Peak 1 of 1 |                    |      |      |            |                      |      |      |            |                    |      |      |            |                      |      |      |            |            |
| Peak Hour for Entire Intersection Begins at 07:00 AM       |                    |      |      |            |                      |      |      |            |                    |      |      |            |                      |      |      |            |            |
| 07:00 AM   | 0                  | 0    | 0    | 0          | 0                    | 0    | 0    | 0          | 0                  | 0    | 0    | 0          | 0                    | 0    | 0    | 0          |            |
| 07:15 AM   | 0                  | 0    | 0    | 0          | 0                    | 0    | 0    | 0          | 0                  | 0    | 0    | 0          | 0                    | 0    | 0    | 0          |            |
| 07:30 AM   | 0                  | 0    | 0    | 0          | 0                    | 0    | 0    | 0          | 0                  | 0    | 0    | 0          | 0                    | 0    | 0    | 0          |            |
| 07:45 AM   | 0                  | 0    | 0    | 0          | 0                    | 0    | 0    | 0          | 0                  | 0    | 0    | 0          | 0                    | 0    | 0    | 0          |            |
| Total Volume   | 0                  | 0    | 0    | 0          | 0                    | 0    | 0    | 0          | 0                  | 0    | 0    | 0          | 0                    | 0    | 0    | 0          |            |
| % App. Total   | 0                  | 0    | 0    |            | 0                    | 0    | 0    |            | 0                  | 0    | 0    |            | 0                    | 0    | 0    |            |            |
| PHF  | .000               | .000 | .000 | .000       | .000                 | .000 | .000 | .000       | .000               | .000 | .000 | .000       | .000                 | .000 | .000 | .000       |            |

# Traffic Data Service

San Jose, CA  
(408) 622-4787  
tdsbay@cs.com

File Name : 4AM FINAL  
Site Code : 00000004  
Start Date : 4/27/2017  
Page No : 2

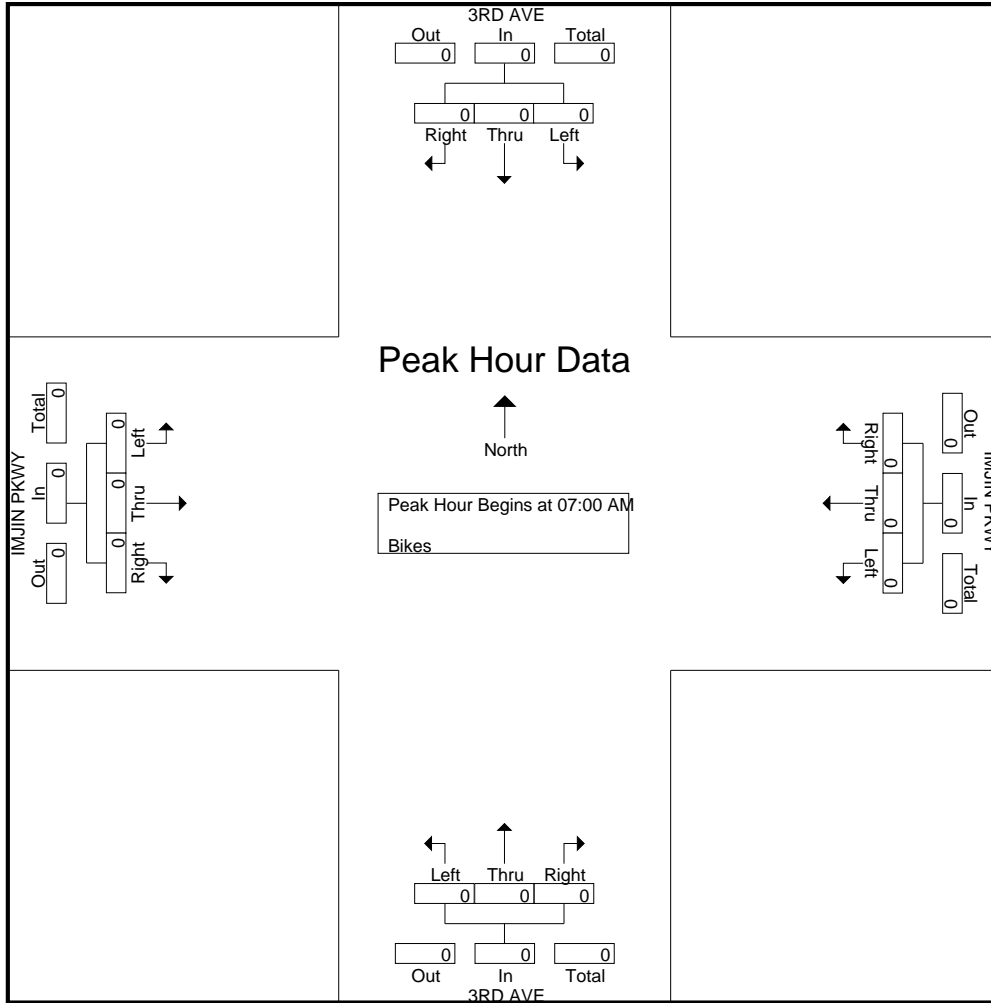

# Traffic Data Service

San Jose, CA  
 (408) 622-4787  
 tdsbay@cs.com

File Name : 4PM FINAL  
 Site Code : 00000004  
 Start Date : 4/27/2017  
 Page No : 1

Groups Printed- Lights - Buses - Trucks

| Start Time   | 3RD AVE Southbound |          |          |          |            | IMJIN PKWY Westbound |             |           |          |             | 3RD AVE Northbound |          |          |          |            | IMJIN PKWY Eastbound |             |           |          |             | Int. Total  |
|--------------|--------------------|----------|----------|----------|------------|----------------------|-------------|-----------|----------|-------------|--------------------|----------|----------|----------|------------|----------------------|-------------|-----------|----------|-------------|-------------|
|              | Right              | Thru     | Left     | Peds     | App. Total | Right                | Thru        | Left      | Peds     | App. Total  | Right              | Thru     | Left     | Peds     | App. Total | Right                | Thru        | Left      | Peds     | App. Total  |             |
| 04:00 PM     | 2                  | 0        | 1        | 0        | 3          | 0                    | 239         | 4         | 0        | 243         | 7                  | 0        | 1        | 3        | 11         | 2                    | 305         | 5         | 0        | 312         | 569         |
| 04:15 PM     | 6                  | 0        | 1        | 0        | 7          | 0                    | 237         | 1         | 0        | 238         | 8                  | 0        | 0        | 0        | 8          | 0                    | 318         | 7         | 0        | 325         | 578         |
| 04:30 PM     | 8                  | 0        | 0        | 2        | 10         | 1                    | 271         | 2         | 0        | 274         | 7                  | 0        | 2        | 0        | 9          | 3                    | 287         | 7         | 0        | 297         | 590         |
| 04:45 PM     | 13                 | 0        | 2        | 0        | 15         | 5                    | 263         | 6         | 0        | 274         | 5                  | 1        | 1        | 1        | 8          | 3                    | 319         | 15        | 0        | 337         | 634         |
| <b>Total</b> | <b>29</b>          | <b>0</b> | <b>4</b> | <b>2</b> | <b>35</b>  | <b>6</b>             | <b>1010</b> | <b>13</b> | <b>0</b> | <b>1029</b> | <b>27</b>          | <b>1</b> | <b>4</b> | <b>4</b> | <b>36</b>  | <b>8</b>             | <b>1229</b> | <b>34</b> | <b>0</b> | <b>1271</b> | <b>2371</b> |
| 05:00 PM     | 17                 | 0        | 1        | 0        | 18         | 2                    | 276         | 5         | 1        | 284         | 5                  | 0        | 0        | 1        | 6          | 4                    | 323         | 19        | 0        | 346         | 654         |
| 05:15 PM     | 6                  | 0        | 0        | 0        | 6          | 4                    | 303         | 6         | 0        | 313         | 7                  | 0        | 2        | 0        | 9          | 0                    | 331         | 4         | 0        | 335         | 663         |
| 05:30 PM     | 6                  | 1        | 1        | 1        | 9          | 1                    | 302         | 4         | 0        | 307         | 6                  | 0        | 1        | 0        | 7          | 1                    | 317         | 12        | 0        | 330         | 653         |
| 05:45 PM     | 12                 | 1        | 3        | 0        | 16         | 5                    | 283         | 3         | 0        | 291         | 7                  | 0        | 1        | 0        | 8          | 0                    | 300         | 9         | 0        | 309         | 624         |
| <b>Total</b> | <b>41</b>          | <b>2</b> | <b>5</b> | <b>1</b> | <b>49</b>  | <b>12</b>            | <b>1164</b> | <b>18</b> | <b>1</b> | <b>1195</b> | <b>25</b>          | <b>0</b> | <b>4</b> | <b>1</b> | <b>30</b>  | <b>5</b>             | <b>1271</b> | <b>44</b> | <b>0</b> | <b>1320</b> | <b>2594</b> |
| Grand Total  | 70                 | 2        | 9        | 3        | 84         | 18                   | 2174        | 31        | 1        | 2224        | 52                 | 1        | 8        | 5        | 66         | 13                   | 2500        | 78        | 0        | 2591        | 4965        |
| Apprch %     | 83.3               | 2.4      | 10.7     | 3.6      |            | 0.8                  | 97.8        | 1.4       | 0        |             | 78.8               | 1.5      | 12.1     | 7.6      |            | 0.5                  | 96.5        | 3         | 0        |             |             |
| Total %      | 1.4                | 0        | 0.2      | 0.1      | 1.7        | 0.4                  | 43.8        | 0.6       | 0        | 44.8        | 1                  | 0        | 0.2      | 0.1      | 1.3        | 0.3                  | 50.4        | 1.6       | 0        | 52.2        |             |
| Lights       | 69                 | 2        | 9        | 3        | 83         | 18                   | 2137        | 31        | 1        | 2187        | 52                 | 1        | 8        | 5        | 66         | 13                   | 2478        | 78        | 0        | 2569        | 4905        |
| % Lights     | 98.6               | 100      | 100      | 100      | 98.8       | 100                  | 98.3        | 100       | 100      | 98.3        | 100                | 100      | 100      | 100      | 100        | 100                  | 99.1        | 100       | 0        | 99.2        | 98.8        |
| Buses        | 1                  | 0        | 0        | 0        | 1          | 0                    | 17          | 0         | 0        | 17          | 0                  | 0        | 0        | 0        | 0          | 0                    | 5           | 0         | 0        | 5           | 23          |
| % Buses      | 1.4                | 0        | 0        | 0        | 1.2        | 0                    | 0.8         | 0         | 0        | 0.8         | 0                  | 0        | 0        | 0        | 0          | 0                    | 0.2         | 0         | 0        | 0.2         | 0.5         |
| Trucks       | 0                  | 0        | 0        | 0        | 0          | 0                    | 20          | 0         | 0        | 20          | 0                  | 0        | 0        | 0        | 0          | 0                    | 17          | 0         | 0        | 17          | 37          |
| % Trucks     | 0                  | 0        | 0        | 0        | 0          | 0                    | 0.9         | 0         | 0        | 0.9         | 0                  | 0        | 0        | 0        | 0          | 0                    | 0.7         | 0         | 0        | 0.7         | 0.7         |

| Start Time   | 3RD AVE Southbound |      |      |            | IMJIN PKWY Westbound |      |      |            | 3RD AVE Northbound |      |      |            | IMJIN PKWY Eastbound |      |      |            | Int. Total |
|--|--------------------|------|------|------------|----------------------|------|------|------------|--------------------|------|------|------------|----------------------|------|------|------------|------------|
|  | Right              | Thru | Left | App. Total | Right                | Thru | Left | App. Total | Right              | Thru | Left | App. Total | Right                | Thru | Left | App. Total |            |
| Peak Hour Analysis From 04:00 PM to 05:45 PM - Peak 1 of 1 |                    |      |      |            |                      |      |      |            |                    |      |      |            |                      |      |      |            |            |
| Peak Hour for Entire Intersection Begins at 04:45 PM       |                    |      |      |            |                      |      |      |            |                    |      |      |            |                      |      |      |            |            |
| 04:45 PM   | 13                 | 0    | 2    | 15         | 5                    | 263  | 6    | 274        | 5                  | 1    | 1    | 7          | 3                    | 319  | 15   | 337        | 633        |
| 05:00 PM   | 17                 | 0    | 1    | 18         | 2                    | 276  | 5    | 283        | 5                  | 0    | 0    | 5          | 4                    | 323  | 19   | 346        | 652        |
| 05:15 PM   | 6                  | 0    | 0    | 6          | 4                    | 303  | 6    | 313        | 7                  | 0    | 2    | 9          | 0                    | 331  | 4    | 335        | 663        |
| 05:30 PM   | 6                  | 1    | 1    | 8          | 1                    | 302  | 4    | 307        | 6                  | 0    | 1    | 7          | 1                    | 317  | 12   | 330        | 652        |
| Total Volume   | 42                 | 1    | 4    | 47         | 12                   | 1144 | 21   | 1177       | 23                 | 1    | 4    | 28         | 8                    | 1290 | 50   | 1348       | 2600       |
| % App. Total   | 89.4               | 2.1  | 8.5  |            | 1                    | 97.2 | 1.8  |            | 82.1               | 3.6  | 14.3 |            | 0.6                  | 95.7 | 3.7  |            |            |
| PHF  | .618               | .250 | .500 | .653       | .600                 | .944 | .875 | .940       | .821               | .250 | .500 | .778       | .500                 | .974 | .658 | .974       | .980       |

# Traffic Data Service

San Jose, CA  
 (408) 622-4787  
 tdsbay@cs.com

File Name : 4PM FINAL  
 Site Code : 00000004  
 Start Date : 4/27/2017  
 Page No : 2

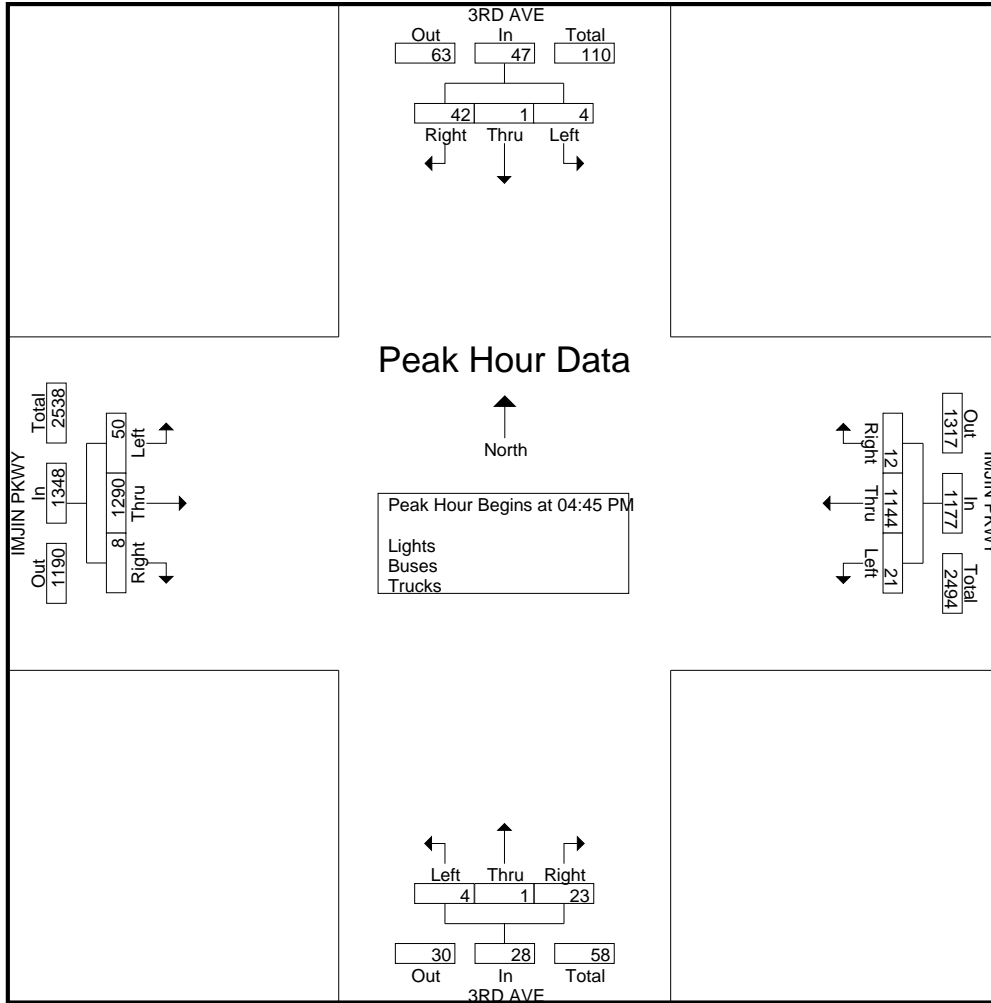

# Traffic Data Service

San Jose, CA  
 (408) 622-4787  
 tdsbay@cs.com

File Name : 4PM FINAL  
 Site Code : 00000004  
 Start Date : 4/27/2017  
 Page No : 1

Groups Printed- Bikes

| Start Time   | 3RD AVE Southbound |      |      |      |            | IMJIN PKWY Westbound |      |      |      |            | 3RD AVE Northbound |      |      |      |            | IMJIN PKWY Eastbound |      |      |      |            | Int. Total |     |
|--------------|--------------------|------|------|------|------------|----------------------|------|------|------|------------|--------------------|------|------|------|------------|----------------------|------|------|------|------------|------------|-----|
|              | Right              | Thru | Left | Peds | App. Total | Right                | Thru | Left | Peds | App. Total | Right              | Thru | Left | Peds | App. Total | Right                | Thru | Left | Peds | App. Total |            |     |
| 04:00 PM     | 0                  | 0    | 0    | 0    | 0          | 0                    | 0    | 0    | 0    | 0          | 0                  | 0    | 0    | 0    | 0          | 0                    | 0    | 0    | 0    | 0          | 0          | 0   |
| 04:15 PM     | 0                  | 0    | 0    | 0    | 0          | 0                    | 0    | 0    | 0    | 0          | 0                  | 0    | 0    | 0    | 0          | 0                    | 0    | 0    | 0    | 0          | 0          | 0   |
| 04:30 PM     | 0                  | 0    | 0    | 0    | 0          | 0                    | 0    | 0    | 0    | 0          | 0                  | 0    | 0    | 0    | 0          | 0                    | 0    | 0    | 0    | 0          | 0          | 0   |
| 04:45 PM     | 0                  | 0    | 0    | 0    | 0          | 0                    | 0    | 0    | 0    | 0          | 0                  | 0    | 0    | 0    | 0          | 0                    | 0    | 0    | 0    | 0          | 0          | 0   |
| <b>Total</b> | 0                  | 0    | 0    | 0    | 0          | 0                    | 0    | 0    | 0    | 0          | 0                  | 0    | 0    | 0    | 0          | 0                    | 0    | 0    | 0    | 0          | 0          | 0   |
| 05:00 PM     | 0                  | 0    | 0    | 0    | 0          | 0                    | 0    | 1    | 0    | 1          | 0                  | 0    | 0    | 0    | 0          | 0                    | 0    | 0    | 0    | 0          | 0          | 1   |
| 05:15 PM     | 0                  | 0    | 0    | 0    | 0          | 0                    | 0    | 0    | 0    | 0          | 0                  | 0    | 0    | 0    | 0          | 0                    | 0    | 0    | 0    | 0          | 0          | 0   |
| 05:30 PM     | 0                  | 0    | 0    | 0    | 0          | 0                    | 0    | 0    | 0    | 0          | 1                  | 0    | 0    | 0    | 1          | 0                    | 1    | 0    | 0    | 1          | 1          | 2   |
| 05:45 PM     | 0                  | 0    | 0    | 0    | 0          | 0                    | 0    | 0    | 0    | 0          | 0                  | 0    | 0    | 0    | 0          | 0                    | 1    | 0    | 0    | 1          | 1          | 1   |
| <b>Total</b> | 0                  | 0    | 0    | 0    | 0          | 0                    | 0    | 1    | 0    | 1          | 1                  | 0    | 0    | 0    | 1          | 0                    | 2    | 0    | 0    | 2          | 2          | 4   |
| Grand Total  | 0                  | 0    | 0    | 0    | 0          | 0                    | 0    | 1    | 0    | 1          | 1                  | 0    | 0    | 0    | 1          | 0                    | 2    | 0    | 0    | 2          | 2          | 4   |
| Apprch %     | 0                  | 0    | 0    | 0    | 0          | 0                    | 0    | 100  | 0    | 100        | 100                | 0    | 0    | 0    | 100        | 0                    | 100  | 0    | 0    | 100        | 0          | 100 |
| Total %      | 0                  | 0    | 0    | 0    | 0          | 0                    | 0    | 25   | 0    | 25         | 25                 | 0    | 0    | 0    | 25         | 0                    | 50   | 0    | 0    | 50         | 0          | 50  |

| Start Time   | 3RD AVE Southbound |      |      |      |            | IMJIN PKWY Westbound |      |      |      |            | 3RD AVE Northbound |      |      |      |            | IMJIN PKWY Eastbound |      |      |      |            | Int. Total |      |
|--|--------------------|------|------|------|------------|----------------------|------|------|------|------------|--------------------|------|------|------|------------|----------------------|------|------|------|------------|------------|------|
|  | Right              | Thru | Left | Peds | App. Total | Right                | Thru | Left | Peds | App. Total | Right              | Thru | Left | Peds | App. Total | Right                | Thru | Left | Peds | App. Total |            |      |
| Peak Hour Analysis From 04:00 PM to 05:45 PM - Peak 1 of 1 |                    |      |      |      |            |                      |      |      |      |            |                    |      |      |      |            |                      |      |      |      |            |            |      |
| Peak Hour for Entire Intersection Begins at 05:00 PM       |                    |      |      |      |            |                      |      |      |      |            |                    |      |      |      |            |                      |      |      |      |            |            |      |
| 05:00 PM   | 0                  | 0    | 0    | 0    | 0          | 0                    | 0    | 1    | 0    | 1          | 0                  | 0    | 0    | 0    | 0          | 0                    | 0    | 0    | 0    | 0          | 0          | 1    |
| 05:15 PM   | 0                  | 0    | 0    | 0    | 0          | 0                    | 0    | 0    | 0    | 0          | 0                  | 0    | 0    | 0    | 0          | 0                    | 0    | 0    | 0    | 0          | 0          | 0    |
| 05:30 PM   | 0                  | 0    | 0    | 0    | 0          | 0                    | 0    | 0    | 0    | 0          | 1                  | 0    | 0    | 0    | 1          | 0                    | 1    | 0    | 0    | 1          | 1          | 2    |
| 05:45 PM   | 0                  | 0    | 0    | 0    | 0          | 0                    | 0    | 0    | 0    | 0          | 0                  | 0    | 0    | 0    | 0          | 0                    | 1    | 0    | 0    | 1          | 1          | 1    |
| Total Volume   | 0                  | 0    | 0    | 0    | 0          | 0                    | 0    | 1    | 0    | 1          | 1                  | 0    | 0    | 0    | 1          | 0                    | 2    | 0    | 0    | 2          | 2          | 4    |
| % App. Total   | 0                  | 0    | 0    | 0    | 0          | 0                    | 0    | 100  | 0    | 100        | 100                | 0    | 0    | 0    | 100        | 0                    | 100  | 0    | 0    | 100        | 0          | 100  |
| PHF  | .000               | .000 | .000 | .000 | .000       | .000                 | .000 | .250 | .000 | .250       | .250               | .000 | .000 | .000 | .250       | .000                 | .500 | .000 | .000 | .500       | .000       | .500 |

# Traffic Data Service

San Jose, CA  
 (408) 622-4787  
 tdsbay@cs.com

File Name : 4PM FINAL  
 Site Code : 00000004  
 Start Date : 4/27/2017  
 Page No : 2

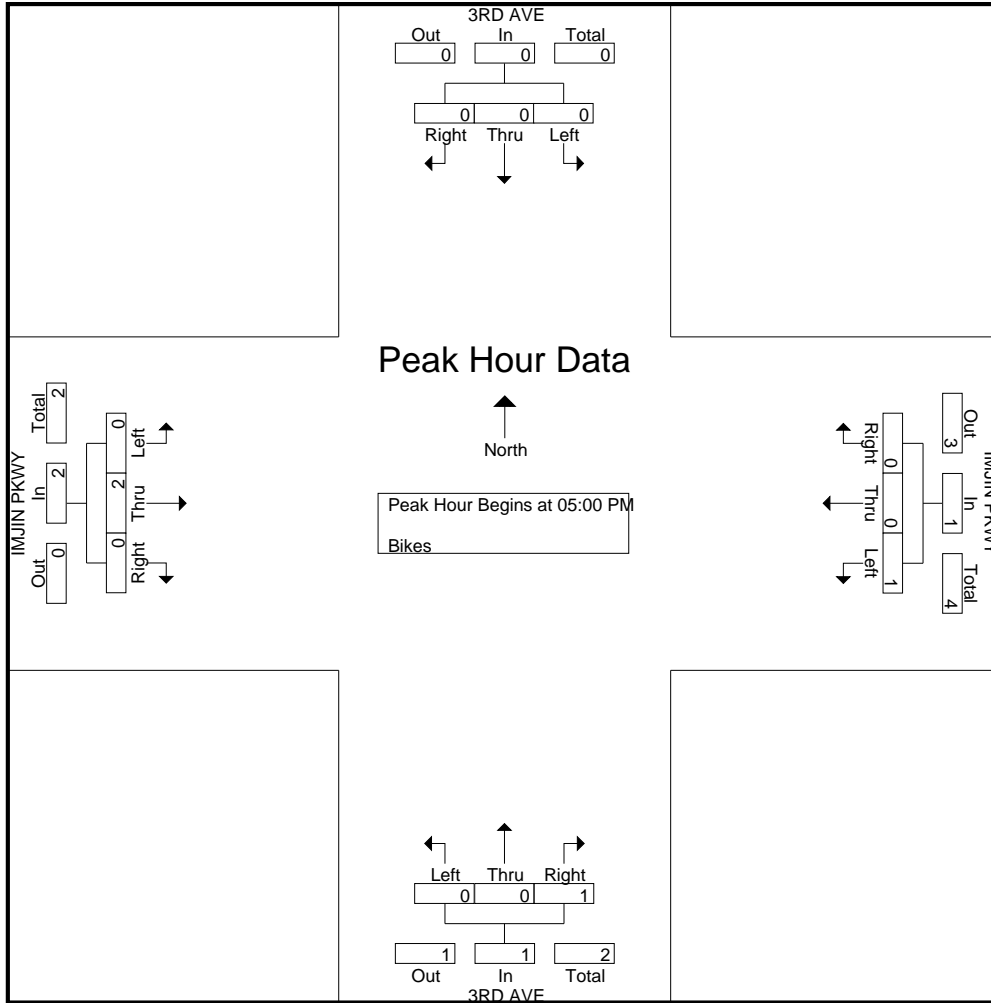



# Traffic Data Service

San Jose, CA  
 (408) 622-4787  
 tdsbay@cs.com

File Name : 5AM FINAL  
 Site Code : 00000005  
 Start Date : 5/3/2017  
 Page No : 1

Groups Printed- Lights - Buses - Trucks

| Start Time  | GENERAL JIM MOORE BLVD Southbound |      |      |      |            | IMJIN PKWY Westbound |      |      |      |            | GENERAL JIM MOORE BLVD Northbound |      |      |      |            | IMJIN PKWY Eastbound |      |      |      |            | Int. Total |
|-------------|-----------------------------------|------|------|------|------------|----------------------|------|------|------|------------|-----------------------------------|------|------|------|------------|----------------------|------|------|------|------------|------------|
|             | Right                             | Thru | Left | Peds | App. Total | Right                | Thru | Left | Peds | App. Total | Right                             | Thru | Left | Peds | App. Total | Right                | Thru | Left | Peds | App. Total |            |
| 07:00 AM    | 0                                 | 0    | 0    | 0    | 0          | 1                    | 394  | 2    | 0    | 397        | 1                                 | 0    | 1    | 0    | 2          | 5                    | 147  | 0    | 0    | 152        | 551        |
| 07:15 AM    | 2                                 | 0    | 0    | 0    | 2          | 2                    | 390  | 0    | 0    | 392        | 0                                 | 0    | 0    | 1    | 1          | 7                    | 194  | 2    | 0    | 203        | 598        |
| 07:30 AM    | 0                                 | 0    | 3    | 1    | 4          | 2                    | 330  | 0    | 0    | 332        | 0                                 | 0    | 1    | 0    | 1          | 5                    | 268  | 0    | 0    | 273        | 610        |
| 07:45 AM    | 0                                 | 1    | 0    | 0    | 1          | 3                    | 293  | 3    | 0    | 299        | 0                                 | 0    | 1    | 0    | 1          | 2                    | 277  | 0    | 0    | 279        | 580        |
| Total       | 2                                 | 1    | 3    | 1    | 7          | 8                    | 1407 | 5    | 0    | 1420       | 1                                 | 0    | 3    | 1    | 5          | 19                   | 886  | 2    | 0    | 907        | 2339       |
| 08:00 AM    | 0                                 | 0    | 0    | 0    | 0          | 7                    | 267  | 0    | 0    | 274        | 1                                 | 0    | 2    | 0    | 3          | 3                    | 213  | 0    | 0    | 216        | 493        |
| 08:15 AM    | 0                                 | 0    | 0    | 0    | 0          | 4                    | 289  | 0    | 0    | 293        | 0                                 | 0    | 1    | 0    | 1          | 3                    | 197  | 1    | 0    | 201        | 495        |
| 08:30 AM    | 0                                 | 1    | 0    | 0    | 1          | 4                    | 295  | 0    | 0    | 299        | 0                                 | 0    | 0    | 0    | 0          | 3                    | 153  | 1    | 0    | 157        | 457        |
| 08:45 AM    | 0                                 | 0    | 0    | 1    | 1          | 1                    | 285  | 0    | 0    | 286        | 0                                 | 0    | 2    | 1    | 3          | 2                    | 152  | 2    | 0    | 156        | 446        |
| Total       | 0                                 | 1    | 0    | 1    | 2          | 16                   | 1136 | 0    | 0    | 1152       | 1                                 | 0    | 5    | 1    | 7          | 11                   | 715  | 4    | 0    | 730        | 1891       |
| Grand Total | 2                                 | 2    | 3    | 2    | 9          | 24                   | 2543 | 5    | 0    | 2572       | 2                                 | 0    | 8    | 2    | 12         | 30                   | 1601 | 6    | 0    | 1637       | 4230       |
| Apprch %    | 22.2                              | 22.2 | 33.3 | 22.2 |            | 0.9                  | 98.9 | 0.2  | 0    |            | 16.7                              | 0    | 66.7 | 16.7 |            | 1.8                  | 97.8 | 0.4  | 0    |            |            |
| Total %     | 0                                 | 0    | 0.1  | 0    | 0.2        | 0.6                  | 60.1 | 0.1  | 0    | 60.8       | 0                                 | 0    | 0.2  | 0    | 0.3        | 0.7                  | 37.8 | 0.1  | 0    | 38.7       |            |
| Lights      | 2                                 | 2    | 3    | 2    | 9          | 24                   | 2471 | 5    | 0    | 2500       | 2                                 | 0    | 4    | 2    | 8          | 22                   | 1564 | 6    | 0    | 1592       | 4109       |
| % Lights    | 100                               | 100  | 100  | 100  | 100        | 100                  | 97.2 | 100  | 0    | 97.2       | 100                               | 0    | 50   | 100  | 66.7       | 73.3                 | 97.7 | 100  | 0    | 97.3       | 97.1       |
| Buses       | 0                                 | 0    | 0    | 0    | 0          | 0                    | 16   | 0    | 0    | 16         | 0                                 | 0    | 0    | 0    | 0          | 0                    | 12   | 0    | 0    | 12         | 28         |
| % Buses     | 0                                 | 0    | 0    | 0    | 0          | 0                    | 0.6  | 0    | 0    | 0.6        | 0                                 | 0    | 0    | 0    | 0          | 0                    | 0.7  | 0    | 0    | 0.7        | 0.7        |
| Trucks      | 0                                 | 0    | 0    | 0    | 0          | 0                    | 56   | 0    | 0    | 56         | 0                                 | 0    | 4    | 0    | 4          | 8                    | 25   | 0    | 0    | 33         | 93         |
| % Trucks    | 0                                 | 0    | 0    | 0    | 0          | 0                    | 2.2  | 0    | 0    | 2.2        | 0                                 | 0    | 50   | 0    | 33.3       | 26.7                 | 1.6  | 0    | 0    | 2          | 2.2        |

| Start Time   | GENERAL JIM MOORE BLVD Southbound |      |      |      |            | IMJIN PKWY Westbound |            |      |            |            | GENERAL JIM MOORE BLVD Northbound |      |      |      |            | IMJIN PKWY Eastbound |      |            |            |            | Int. Total |
|--------------|-----------------------------------|------|------|------|------------|----------------------|------------|------|------------|------------|-----------------------------------|------|------|------|------------|----------------------|------|------------|------------|------------|------------|
|              | Right                             | Thru | Left | Peds | App. Total | Right                | Thru       | Left | Peds       | App. Total | Right                             | Thru | Left | Peds | App. Total | Right                | Thru | Left       | Peds       | App. Total |            |
| 07:00 AM     | 0                                 | 0    | 0    | 0    | 0          | 1                    | <b>394</b> | 2    | <b>397</b> | 1          | 0                                 | 1    | 2    | 5    | 147        | 0                    | 0    | 152        | 551        |            |            |
| 07:15 AM     | 2                                 | 0    | 0    | 0    | 2          | 2                    | 390        | 0    | 392        | 0          | 0                                 | 0    | 0    | 7    | 194        | 2                    | 0    | 203        | 597        |            |            |
| 07:30 AM     | 0                                 | 0    | 3    | 1    | 4          | 2                    | 330        | 0    | 332        | 0          | 0                                 | 1    | 1    | 5    | 268        | 0                    | 0    | 273        | <b>609</b> |            |            |
| 07:45 AM     | 0                                 | 1    | 0    | 0    | 1          | 3                    | 293        | 3    | 299        | 0          | 0                                 | 1    | 1    | 2    | <b>277</b> | 0                    | 0    | <b>279</b> | 580        |            |            |
| Total Volume | 2                                 | 1    | 3    | 1    | 7          | 8                    | 1407       | 5    | 1420       | 1          | 0                                 | 3    | 4    | 19   | 886        | 2                    | 0    | 907        | 2337       |            |            |
| % App. Total | 33.3                              | 16.7 | 50   | 22.2 |            | 0.6                  | 99.1       | 0.4  |            | 25         | 0                                 | 75   |      | 2.1  | 97.7       | 0.2                  |      |            |            |            |            |
| PHF          | .250                              | .250 | .250 | .250 | .500       | .667                 | .893       | .417 | .894       | .250       | .000                              | .750 | .500 | .679 | .800       | .250                 | .813 | .959       |            |            |            |

Peak Hour Analysis From 07:00 AM to 08:45 AM - Peak 1 of 1

Peak Hour for Entire Intersection Begins at 07:00 AM

# Traffic Data Service

San Jose, CA  
 (408) 622-4787  
 tdsbay@cs.com

File Name : 5AM FINAL  
 Site Code : 00000005  
 Start Date : 5/3/2017  
 Page No : 2

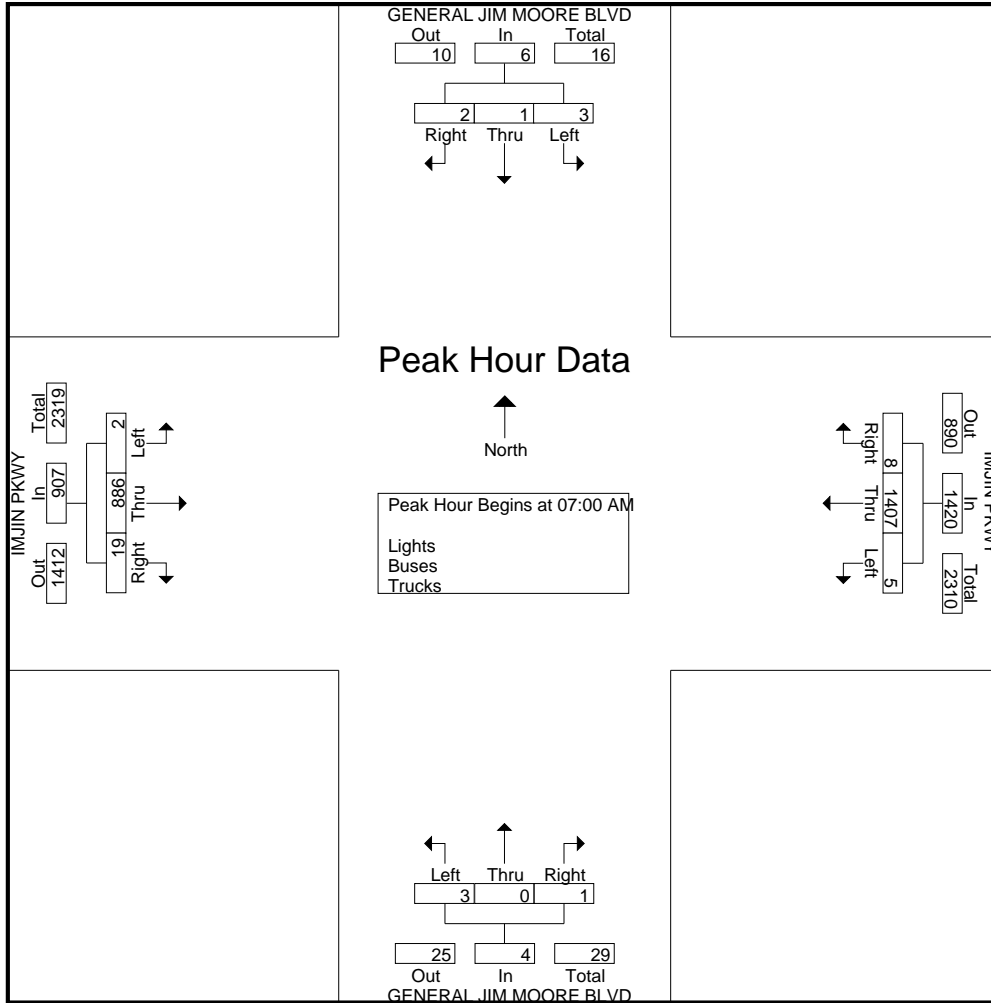



# Traffic Data Service

San Jose, CA  
(408) 622-4787  
tdsbay@cs.com

File Name : 5AM FINAL  
Site Code : 00000005  
Start Date : 5/3/2017  
Page No : 2

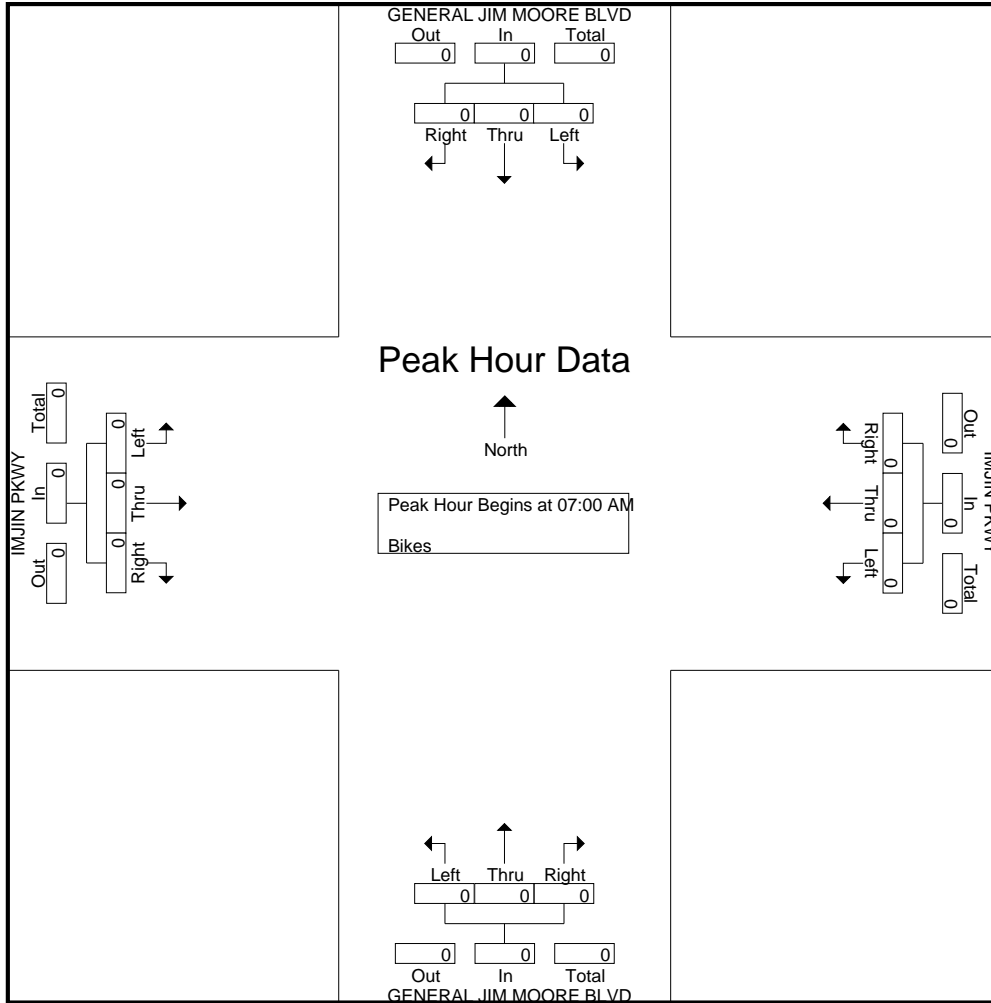

# Traffic Data Service

San Jose, CA  
 (408) 622-4787  
 tdsbay@cs.com

File Name : 5PM FINAL  
 Site Code : 00000005  
 Start Date : 5/3/2017  
 Page No : 1

Groups Printed- Lights - Buses - Trucks

| Start Time  | GENERAL JIM MOORE BLVD Southbound |      |      |      |            | IMJIN PKWY Westbound |      |      |      |            | GENERAL JIM MOORE BLVD Northbound |      |      |      |            | IMJIN PKWY Eastbound |      |      |      |            | Int. Total |
|-------------|-----------------------------------|------|------|------|------------|----------------------|------|------|------|------------|-----------------------------------|------|------|------|------------|----------------------|------|------|------|------------|------------|
|             | Right                             | Thru | Left | Peds | App. Total | Right                | Thru | Left | Peds | App. Total | Right                             | Thru | Left | Peds | App. Total | Right                | Thru | Left | Peds | App. Total |            |
| 04:00 PM    | 1                                 | 0    | 2    | 0    | 3          | 5                    | 242  | 0    | 0    | 247        | 5                                 | 0    | 12   | 0    | 17         | 1                    | 290  | 1    | 0    | 292        | 559        |
| 04:15 PM    | 2                                 | 0    | 3    | 0    | 5          | 1                    | 258  | 2    | 1    | 262        | 1                                 | 0    | 4    | 2    | 7          | 2                    | 359  | 2    | 0    | 363        | 637        |
| 04:30 PM    | 0                                 | 0    | 0    | 0    | 0          | 1                    | 271  | 0    | 0    | 272        | 0                                 | 0    | 4    | 0    | 4          | 6                    | 336  | 0    | 0    | 342        | 618        |
| 04:45 PM    | 4                                 | 0    | 2    | 1    | 7          | 0                    | 271  | 0    | 0    | 271        | 0                                 | 0    | 2    | 0    | 2          | 0                    | 320  | 0    | 0    | 320        | 600        |
| Total       | 7                                 | 0    | 7    | 1    | 15         | 7                    | 1042 | 2    | 1    | 1052       | 6                                 | 0    | 22   | 2    | 30         | 9                    | 1305 | 3    | 0    | 1317       | 2414       |
| 05:00 PM    | 0                                 | 0    | 5    | 0    | 5          | 1                    | 299  | 0    | 0    | 300        | 2                                 | 0    | 6    | 0    | 8          | 2                    | 352  | 0    | 0    | 354        | 667        |
| 05:15 PM    | 0                                 | 0    | 2    | 0    | 2          | 0                    | 273  | 0    | 0    | 273        | 0                                 | 0    | 2    | 0    | 2          | 3                    | 371  | 1    | 0    | 375        | 652        |
| 05:30 PM    | 0                                 | 0    | 0    | 0    | 0          | 0                    | 307  | 0    | 0    | 307        | 0                                 | 0    | 3    | 2    | 5          | 1                    | 339  | 0    | 0    | 340        | 652        |
| 05:45 PM    | 0                                 | 0    | 1    | 0    | 1          | 0                    | 277  | 0    | 0    | 277        | 0                                 | 0    | 3    | 0    | 3          | 1                    | 344  | 1    | 0    | 346        | 627        |
| Total       | 0                                 | 0    | 8    | 0    | 8          | 1                    | 1156 | 0    | 0    | 1157       | 2                                 | 0    | 14   | 2    | 18         | 7                    | 1406 | 2    | 0    | 1415       | 2598       |
| Grand Total | 7                                 | 0    | 15   | 1    | 23         | 8                    | 2198 | 2    | 1    | 2209       | 8                                 | 0    | 36   | 4    | 48         | 16                   | 2711 | 5    | 0    | 2732       | 5012       |
| Apprch %    | 30.4                              | 0    | 65.2 | 4.3  |            | 0.4                  | 99.5 | 0.1  | 0    |            | 16.7                              | 0    | 75   | 8.3  |            | 0.6                  | 99.2 | 0.2  | 0    |            |            |
| Total %     | 0.1                               | 0    | 0.3  | 0    | 0.5        | 0.2                  | 43.9 | 0    | 0    | 44.1       | 0.2                               | 0    | 0.7  | 0.1  | 1          | 0.3                  | 54.1 | 0.1  | 0    | 54.5       |            |
| Lights      | 4                                 | 0    | 15   | 1    | 20         | 8                    | 2170 | 2    | 1    | 2181       | 8                                 | 0    | 35   | 4    | 47         | 12                   | 2681 | 5    | 0    | 2698       | 4946       |
| % Lights    | 57.1                              | 0    | 100  | 100  | 87         | 100                  | 98.7 | 100  | 100  | 98.7       | 100                               | 0    | 97.2 | 100  | 97.9       | 75                   | 98.9 | 100  | 0    | 98.8       | 98.7       |
| Buses       | 0                                 | 0    | 0    | 0    | 0          | 0                    | 10   | 0    | 0    | 10         | 0                                 | 0    | 0    | 0    | 0          | 0                    | 7    | 0    | 0    | 7          | 17         |
| % Buses     | 0                                 | 0    | 0    | 0    | 0          | 0                    | 0.5  | 0    | 0    | 0.5        | 0                                 | 0    | 0    | 0    | 0          | 0                    | 0.3  | 0    | 0    | 0.3        | 0.3        |
| Trucks      | 3                                 | 0    | 0    | 0    | 3          | 0                    | 18   | 0    | 0    | 18         | 0                                 | 0    | 1    | 0    | 1          | 4                    | 23   | 0    | 0    | 27         | 49         |
| % Trucks    | 42.9                              | 0    | 0    | 0    | 13         | 0                    | 0.8  | 0    | 0    | 0.8        | 0                                 | 0    | 2.8  | 0    | 2.1        | 25                   | 0.8  | 0    | 0    | 1          | 1          |

| Start Time   | GENERAL JIM MOORE BLVD Southbound |      |      |      |            | IMJIN PKWY Westbound |      |      |      |            | GENERAL JIM MOORE BLVD Northbound |      |      |      |            | IMJIN PKWY Eastbound |      |      |      |            | Int. Total |
|--------------|-----------------------------------|------|------|------|------------|----------------------|------|------|------|------------|-----------------------------------|------|------|------|------------|----------------------|------|------|------|------------|------------|
|              | Right                             | Thru | Left | Peds | App. Total | Right                | Thru | Left | Peds | App. Total | Right                             | Thru | Left | Peds | App. Total | Right                | Thru | Left | Peds | App. Total |            |
| 05:00 PM     | 0                                 | 0    | 5    | 0    | 5          | 1                    | 299  | 0    | 0    | 300        | 2                                 | 0    | 6    | 0    | 8          | 2                    | 352  | 0    | 0    | 354        | 667        |
| 05:15 PM     | 0                                 | 0    | 2    | 0    | 2          | 0                    | 273  | 0    | 0    | 273        | 0                                 | 0    | 2    | 0    | 2          | 3                    | 371  | 1    | 0    | 375        | 652        |
| 05:30 PM     | 0                                 | 0    | 0    | 0    | 0          | 0                    | 307  | 0    | 0    | 307        | 0                                 | 0    | 3    | 0    | 3          | 1                    | 339  | 0    | 0    | 340        | 650        |
| 05:45 PM     | 0                                 | 0    | 1    | 0    | 1          | 0                    | 277  | 0    | 0    | 277        | 0                                 | 0    | 3    | 0    | 3          | 1                    | 344  | 1    | 0    | 346        | 627        |
| Total Volume | 0                                 | 0    | 8    | 0    | 8          | 1                    | 1156 | 0    | 0    | 1157       | 2                                 | 0    | 14   | 0    | 16         | 7                    | 1406 | 2    | 0    | 1415       | 2596       |
| % App. Total | 0                                 | 0    | 100  | 0    |            | 0.1                  | 99.9 | 0    | 0    |            | 12.5                              | 0    | 87.5 | 0    |            | 0.5                  | 99.4 | 0.1  | 0    |            |            |
| PHF          | .000                              | .000 | .400 | .400 |            | .250                 | .941 | .000 | .942 |            | .250                              | .000 | .583 | .500 |            | .583                 | .947 | .500 | .943 |            | .973       |

Peak Hour Analysis From 04:00 PM to 05:45 PM - Peak 1 of 1

Peak Hour for Entire Intersection Begins at 05:00 PM

# Traffic Data Service

San Jose, CA  
 (408) 622-4787  
 tdsbay@cs.com

File Name : 5PM FINAL  
 Site Code : 00000005  
 Start Date : 5/3/2017  
 Page No : 2

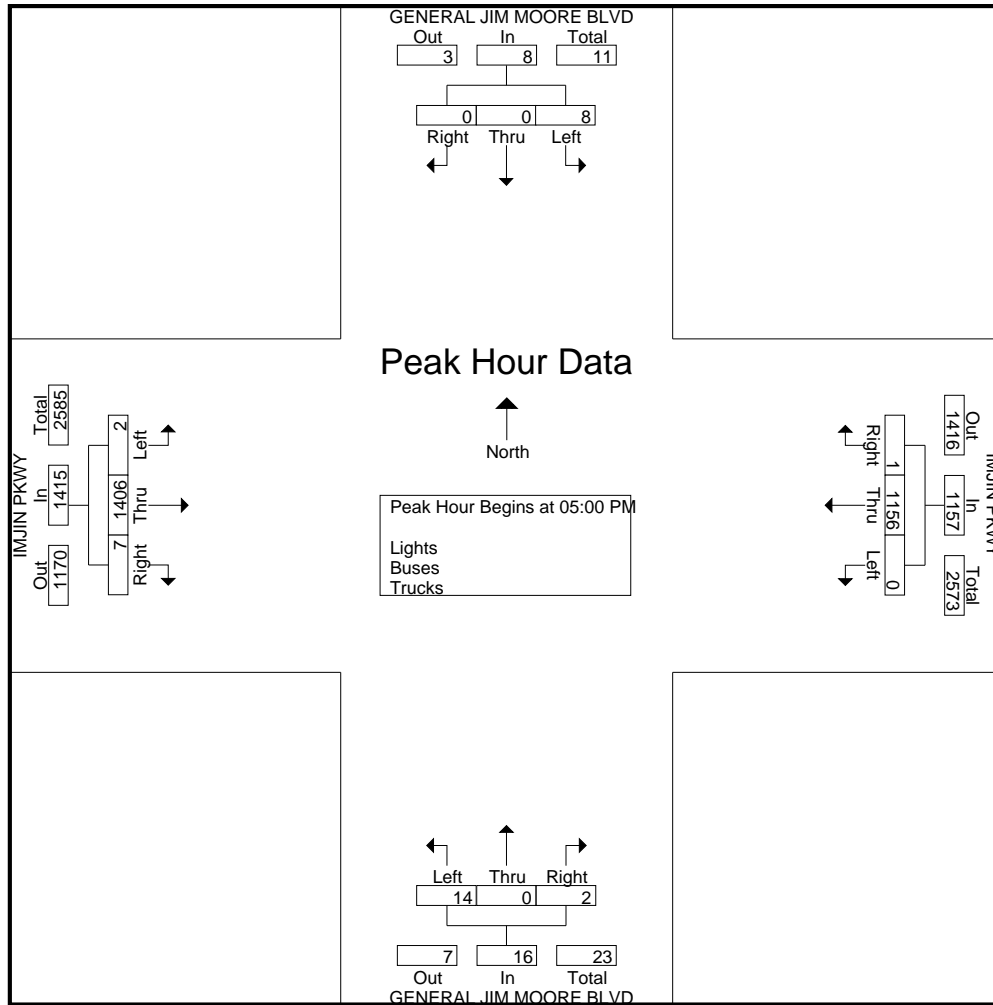

# Traffic Data Service

San Jose, CA  
 (408) 622-4787  
 tdsbay@cs.com

File Name : 5PM FINAL  
 Site Code : 00000005  
 Start Date : 5/3/2017  
 Page No : 1

Groups Printed- Bikes

| Start Time  | GENERAL JIM MOORE BLVD Southbound |      |      |      |            | IMJIN PKWY Westbound |      |      |      |            | GENERAL JIM MOORE BLVD Northbound |      |      |      |            | IMJIN PKWY Eastbound |      |      |      |            | Int. Total |   |   |   |   |   |
|-------------|-----------------------------------|------|------|------|------------|----------------------|------|------|------|------------|-----------------------------------|------|------|------|------------|----------------------|------|------|------|------------|------------|---|---|---|---|---|
|             | Right                             | Thru | Left | Peds | App. Total | Right                | Thru | Left | Peds | App. Total | Right                             | Thru | Left | Peds | App. Total | Right                | Thru | Left | Peds | App. Total |            |   |   |   |   |   |
| 04:00 PM    | 0                                 | 0    | 0    | 0    | 0          | 0                    | 1    | 0    | 0    | 1          | 0                                 | 0    | 0    | 0    | 0          | 0                    | 0    | 0    | 0    | 0          | 0          | 0 | 0 | 0 | 0 | 1 |
| 04:15 PM    | 0                                 | 0    | 0    | 0    | 0          | 0                    | 0    | 0    | 0    | 0          | 0                                 | 0    | 0    | 0    | 0          | 0                    | 0    | 0    | 0    | 0          | 0          | 0 | 0 | 0 | 0 | 0 |
| 04:30 PM    | 0                                 | 0    | 0    | 0    | 0          | 0                    | 0    | 0    | 0    | 0          | 0                                 | 0    | 0    | 0    | 0          | 0                    | 0    | 0    | 0    | 0          | 0          | 0 | 0 | 0 | 0 | 0 |
| 04:45 PM    | 0                                 | 0    | 0    | 0    | 0          | 0                    | 0    | 0    | 0    | 0          | 0                                 | 0    | 0    | 0    | 0          | 0                    | 0    | 0    | 0    | 0          | 0          | 0 | 0 | 0 | 0 | 0 |
| Total       | 0                                 | 0    | 0    | 0    | 0          | 0                    | 1    | 0    | 0    | 1          | 0                                 | 0    | 0    | 0    | 0          | 0                    | 0    | 0    | 0    | 0          | 0          | 0 | 0 | 0 | 0 | 1 |
| 05:00 PM    | 0                                 | 0    | 0    | 0    | 0          | 0                    | 0    | 0    | 0    | 0          | 0                                 | 0    | 0    | 0    | 0          | 0                    | 0    | 0    | 0    | 0          | 0          | 0 | 0 | 0 | 0 | 0 |
| 05:15 PM    | 0                                 | 0    | 0    | 0    | 0          | 0                    | 0    | 0    | 0    | 0          | 0                                 | 0    | 0    | 0    | 0          | 0                    | 0    | 0    | 0    | 0          | 0          | 0 | 0 | 0 | 0 | 0 |
| 05:30 PM    | 0                                 | 0    | 0    | 0    | 0          | 0                    | 0    | 0    | 0    | 0          | 0                                 | 0    | 0    | 0    | 0          | 0                    | 0    | 0    | 0    | 0          | 0          | 0 | 0 | 0 | 0 | 0 |
| 05:45 PM    | 0                                 | 0    | 0    | 0    | 0          | 0                    | 1    | 0    | 0    | 1          | 0                                 | 0    | 0    | 0    | 0          | 0                    | 0    | 0    | 0    | 0          | 0          | 0 | 0 | 0 | 0 | 1 |
| Total       | 0                                 | 0    | 0    | 0    | 0          | 0                    | 1    | 0    | 0    | 1          | 0                                 | 0    | 0    | 0    | 0          | 0                    | 0    | 0    | 0    | 0          | 0          | 0 | 0 | 0 | 0 | 1 |
| Grand Total | 0                                 | 0    | 0    | 0    | 0          | 0                    | 2    | 0    | 0    | 2          | 0                                 | 0    | 0    | 0    | 0          | 0                    | 0    | 0    | 0    | 0          | 0          | 0 | 0 | 0 | 0 | 2 |
| Apprch %    | 0                                 | 0    | 0    | 0    | 0          | 0                    | 100  | 0    | 0    | 100        | 0                                 | 0    | 0    | 0    | 0          | 0                    | 0    | 0    | 0    | 0          | 0          | 0 | 0 | 0 | 0 |   |
| Total %     | 0                                 | 0    | 0    | 0    | 0          | 0                    | 100  | 0    | 0    | 100        | 0                                 | 0    | 0    | 0    | 0          | 0                    | 0    | 0    | 0    | 0          | 0          | 0 | 0 | 0 | 0 |   |

| Start Time   | GENERAL JIM MOORE BLVD Southbound |      |      |      |            | IMJIN PKWY Westbound |      |      |      |            | GENERAL JIM MOORE BLVD Northbound |      |      |      |            | IMJIN PKWY Eastbound |      |      |      |            | Int. Total |      |      |      |      |   |
|--|-----------------------------------|------|------|------|------------|----------------------|------|------|------|------------|-----------------------------------|------|------|------|------------|----------------------|------|------|------|------------|------------|------|------|------|------|---|
|  | Right                             | Thru | Left | Peds | App. Total | Right                | Thru | Left | Peds | App. Total | Right                             | Thru | Left | Peds | App. Total | Right                | Thru | Left | Peds | App. Total |            |      |      |      |      |   |
| Peak Hour Analysis From 04:00 PM to 05:45 PM - Peak 1 of 1 |                                   |      |      |      |            |                      |      |      |      |            |                                   |      |      |      |            |                      |      |      |      |            |            |      |      |      |      |   |
| Peak Hour for Entire Intersection Begins at 04:00 PM       |                                   |      |      |      |            |                      |      |      |      |            |                                   |      |      |      |            |                      |      |      |      |            |            |      |      |      |      |   |
| 04:00 PM   | 0                                 | 0    | 0    | 0    | 0          | 0                    | 1    | 0    | 0    | 1          | 0                                 | 0    | 0    | 0    | 0          | 0                    | 0    | 0    | 0    | 0          | 0          | 0    | 0    | 0    | 0    | 1 |
| 04:15 PM   | 0                                 | 0    | 0    | 0    | 0          | 0                    | 0    | 0    | 0    | 0          | 0                                 | 0    | 0    | 0    | 0          | 0                    | 0    | 0    | 0    | 0          | 0          | 0    | 0    | 0    | 0    | 0 |
| 04:30 PM   | 0                                 | 0    | 0    | 0    | 0          | 0                    | 0    | 0    | 0    | 0          | 0                                 | 0    | 0    | 0    | 0          | 0                    | 0    | 0    | 0    | 0          | 0          | 0    | 0    | 0    | 0    | 0 |
| 04:45 PM   | 0                                 | 0    | 0    | 0    | 0          | 0                    | 0    | 0    | 0    | 0          | 0                                 | 0    | 0    | 0    | 0          | 0                    | 0    | 0    | 0    | 0          | 0          | 0    | 0    | 0    | 0    | 0 |
| Total Volume   | 0                                 | 0    | 0    | 0    | 0          | 0                    | 1    | 0    | 0    | 1          | 0                                 | 0    | 0    | 0    | 0          | 0                    | 0    | 0    | 0    | 0          | 0          | 0    | 0    | 0    | 0    | 1 |
| % App. Total   | 0                                 | 0    | 0    | 0    | 0          | 0                    | 100  | 0    | 0    | 100        | 0                                 | 0    | 0    | 0    | 0          | 0                    | 0    | 0    | 0    | 0          | 0          | 0    | 0    | 0    | 0    |   |
| PHF  | .000                              | .000 | .000 | .000 | .000       | .000                 | .250 | .000 | .000 | .250       | .000                              | .000 | .000 | .000 | .000       | .000                 | .000 | .000 | .000 | .000       | .000       | .000 | .000 | .000 | .250 |   |

# Traffic Data Service

San Jose, CA  
 (408) 622-4787  
 tdsbay@cs.com

File Name : 5PM FINAL  
 Site Code : 00000005  
 Start Date : 5/3/2017  
 Page No : 2

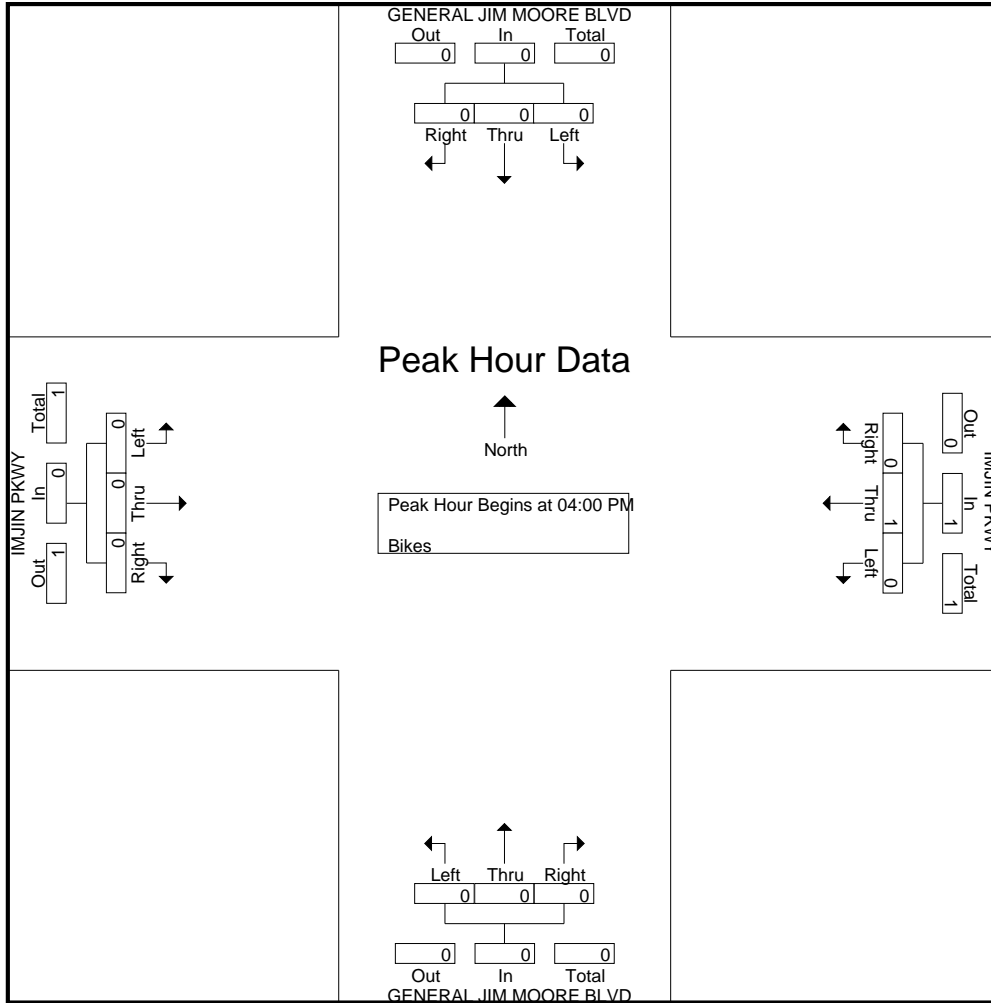



# Traffic Data Service

San Jose, CA  
 (408) 622-4787  
 tdsbay@cs.com

File Name : 6AM FINAL  
 Site Code : 00000006  
 Start Date : 4/27/2017  
 Page No : 1

Groups Printed- Lights - Buses - Trucks

| Start Time  | CALIFORNIA AVE<br>Southbound |      |      |      |            | IMJIN PKWY<br>Westbound |      |      |      |            | CALIFORNIA DR<br>Northbound |      |      |      |            | IMJIN PKWY<br>Eastbound |      |      |      |            | Int. Total |
|-------------|------------------------------|------|------|------|------------|-------------------------|------|------|------|------------|-----------------------------|------|------|------|------------|-------------------------|------|------|------|------------|------------|
|             | Right                        | Thru | Left | Peds | App. Total | Right                   | Thru | Left | Peds | App. Total | Right                       | Thru | Left | Peds | App. Total | Right                   | Thru | Left | Peds | App. Total |            |
| 07:00 AM    | 93                           | 8    | 8    | 0    | 109        | 8                       | 278  | 0    | 0    | 286        | 0                           | 4    | 9    | 0    | 13         | 3                       | 131  | 13   | 0    | 147        | 555        |
| 07:15 AM    | 107                          | 30   | 10   | 0    | 147        | 9                       | 284  | 0    | 0    | 293        | 0                           | 1    | 4    | 0    | 5          | 3                       | 146  | 25   | 1    | 175        | 620        |
| 07:30 AM    | 102                          | 46   | 18   | 0    | 166        | 17                      | 236  | 2    | 0    | 255        | 0                           | 1    | 2    | 0    | 3          | 3                       | 210  | 28   | 1    | 242        | 666        |
| 07:45 AM    | 102                          | 42   | 29   | 0    | 173        | 21                      | 198  | 1    | 0    | 220        | 1                           | 5    | 3    | 0    | 9          | 8                       | 192  | 39   | 0    | 239        | 641        |
| Total       | 404                          | 126  | 65   | 0    | 595        | 55                      | 996  | 3    | 0    | 1054       | 1                           | 11   | 18   | 0    | 30         | 17                      | 679  | 105  | 2    | 803        | 2482       |
| 08:00 AM    | 78                           | 28   | 13   | 0    | 119        | 11                      | 213  | 1    | 0    | 225        | 0                           | 3    | 3    | 0    | 6          | 6                       | 213  | 21   | 0    | 240        | 590        |
| 08:15 AM    | 65                           | 15   | 9    | 0    | 89         | 7                       | 250  | 1    | 0    | 258        | 1                           | 2    | 2    | 0    | 5          | 5                       | 187  | 21   | 0    | 213        | 565        |
| 08:30 AM    | 62                           | 7    | 12   | 0    | 81         | 4                       | 252  | 0    | 0    | 256        | 0                           | 1    | 5    | 0    | 6          | 1                       | 161  | 14   | 1    | 177        | 520        |
| 08:45 AM    | 63                           | 4    | 10   | 0    | 77         | 9                       | 215  | 1    | 0    | 225        | 0                           | 2    | 1    | 0    | 3          | 2                       | 138  | 17   | 1    | 158        | 463        |
| Total       | 268                          | 54   | 44   | 0    | 366        | 31                      | 930  | 3    | 0    | 964        | 1                           | 8    | 11   | 0    | 20         | 14                      | 699  | 73   | 2    | 788        | 2138       |
| Grand Total | 672                          | 180  | 109  | 0    | 961        | 86                      | 1926 | 6    | 0    | 2018       | 2                           | 19   | 29   | 0    | 50         | 31                      | 1378 | 178  | 4    | 1591       | 4620       |
| Apprch %    | 69.9                         | 18.7 | 11.3 | 0    |            | 4.3                     | 95.4 | 0.3  | 0    |            | 4                           | 38   | 58   | 0    |            | 1.9                     | 86.6 | 11.2 | 0.3  |            |            |
| Total %     | 14.5                         | 3.9  | 2.4  | 0    | 20.8       | 1.9                     | 41.7 | 0.1  | 0    | 43.7       | 0                           | 0.4  | 0.6  | 0    | 1.1        | 0.7                     | 29.8 | 3.9  | 0.1  | 34.4       |            |
| Lights      | 665                          | 177  | 108  | 0    | 950        | 82                      | 1871 | 6    | 0    | 1959       | 2                           | 19   | 20   | 0    | 41         | 31                      | 1354 | 175  | 4    | 1564       | 4514       |
| % Lights    | 99                           | 98.3 | 99.1 | 0    | 98.9       | 95.3                    | 97.1 | 100  | 0    | 97.1       | 100                         | 100  | 69   | 0    | 82         | 100                     | 98.3 | 98.3 | 100  | 98.3       | 97.7       |
| Buses       | 4                            | 2    | 0    | 0    | 6          | 3                       | 12   | 0    | 0    | 15         | 0                           | 0    | 1    | 0    | 1          | 0                       | 10   | 3    | 0    | 13         | 35         |
| % Buses     | 0.6                          | 1.1  | 0    | 0    | 0.6        | 3.5                     | 0.6  | 0    | 0    | 0.7        | 0                           | 0    | 3.4  | 0    | 2          | 0                       | 0.7  | 1.7  | 0    | 0.8        | 0.8        |
| Trucks      | 3                            | 1    | 1    | 0    | 5          | 1                       | 43   | 0    | 0    | 44         | 0                           | 0    | 8    | 0    | 8          | 0                       | 14   | 0    | 0    | 14         | 71         |
| % Trucks    | 0.4                          | 0.6  | 0.9  | 0    | 0.5        | 1.2                     | 2.2  | 0    | 0    | 2.2        | 0                           | 0    | 27.6 | 0    | 16         | 0                       | 1    | 0    | 0    | 0.9        | 1.5        |

| Start Time   | CALIFORNIA AVE<br>Southbound |      |      |            | IMJIN PKWY<br>Westbound |      |      |            | CALIFORNIA DR<br>Northbound |      |      |            | IMJIN PKWY<br>Eastbound |      |      |            | Int. Total |
|--|------------------------------|------|------|------------|-------------------------|------|------|------------|-----------------------------|------|------|------------|-------------------------|------|------|------------|------------|
|  | Right                        | Thru | Left | App. Total | Right                   | Thru | Left | App. Total | Right                       | Thru | Left | App. Total | Right                   | Thru | Left | App. Total |            |
| Peak Hour Analysis From 07:00 AM to 08:45 AM - Peak 1 of 1 |                              |      |      |            |                         |      |      |            |                             |      |      |            |                         |      |      |            |            |
| Peak Hour for Entire Intersection Begins at 07:15 AM       |                              |      |      |            |                         |      |      |            |                             |      |      |            |                         |      |      |            |            |
| 07:15 AM   | 107                          | 30   | 10   | 147        | 9                       | 284  | 0    | 293        | 0                           | 1    | 4    | 5          | 3                       | 146  | 25   | 174        | 619        |
| 07:30 AM   | 102                          | 46   | 18   | 166        | 17                      | 236  | 2    | 255        | 0                           | 1    | 2    | 3          | 3                       | 210  | 28   | 241        | 665        |
| 07:45 AM   | 102                          | 42   | 29   | 173        | 21                      | 198  | 1    | 220        | 1                           | 5    | 3    | 9          | 8                       | 192  | 39   | 239        | 641        |
| 08:00 AM   | 78                           | 28   | 13   | 119        | 11                      | 213  | 1    | 225        | 0                           | 3    | 3    | 6          | 6                       | 213  | 21   | 240        | 590        |
| Total Volume   | 389                          | 146  | 70   | 605        | 58                      | 931  | 4    | 993        | 1                           | 10   | 12   | 23         | 20                      | 761  | 113  | 894        | 2515       |
| % App. Total   | 64.3                         | 24.1 | 11.6 |            | 5.8                     | 93.8 | 0.4  |            | 4.3                         | 43.5 | 52.2 |            | 2.2                     | 85.1 | 12.6 |            |            |
| PHF  | .909                         | .793 | .603 | .874       | .690                    | .820 | .500 | .847       | .250                        | .500 | .750 | .639       | .625                    | .893 | .724 | .927       | .945       |

# Traffic Data Service

San Jose, CA  
 (408) 622-4787  
 tdsbay@cs.com

File Name : 6AM FINAL  
 Site Code : 00000006  
 Start Date : 4/27/2017  
 Page No : 2

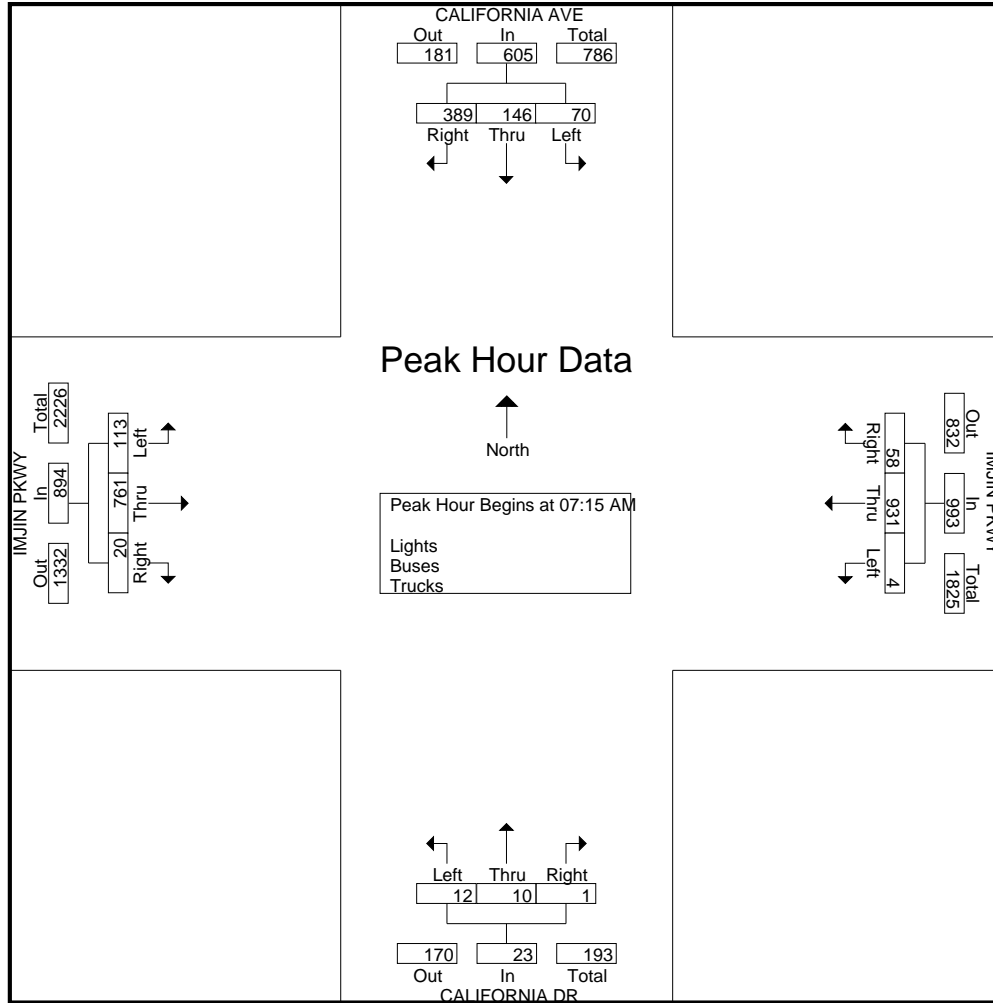

# Traffic Data Service

San Jose, CA  
 (408) 622-4787  
 tdsbay@cs.com

File Name : 6AM FINAL  
 Site Code : 00000006  
 Start Date : 4/27/2017  
 Page No : 1

Groups Printed- Bikes

| Start Time   | CALIFORNIA AVE<br>Southbound |          |          |          |            | IMJIN PKWY<br>Westbound |          |          |          |            | CALIFORNIA DR<br>Northbound |          |          |          |            | IMJIN PKWY<br>Eastbound |          |          |          |            | Int. Total |
|--------------|------------------------------|----------|----------|----------|------------|-------------------------|----------|----------|----------|------------|-----------------------------|----------|----------|----------|------------|-------------------------|----------|----------|----------|------------|------------|
|              | Right                        | Thru     | Left     | Peds     | App. Total | Right                   | Thru     | Left     | Peds     | App. Total | Right                       | Thru     | Left     | Peds     | App. Total | Right                   | Thru     | Left     | Peds     | App. Total |            |
| 07:00 AM     | 0                            | 1        | 0        | 0        | 1          | 0                       | 0        | 0        | 0        | 0          | 0                           | 0        | 0        | 0        | 0          | 0                       | 0        | 0        | 0        | 0          | 0          |
| 07:15 AM     | 1                            | 0        | 0        | 0        | 1          | 0                       | 0        | 0        | 0        | 0          | 0                           | 1        | 0        | 0        | 1          | 0                       | 0        | 0        | 0        | 0          | 0          |
| 07:30 AM     | 0                            | 0        | 0        | 0        | 0          | 0                       | 0        | 0        | 0        | 0          | 0                           | 0        | 0        | 0        | 0          | 0                       | 1        | 0        | 0        | 1          | 1          |
| 07:45 AM     | 0                            | 0        | 0        | 0        | 0          | 0                       | 0        | 0        | 0        | 0          | 0                           | 0        | 0        | 0        | 0          | 0                       | 0        | 0        | 0        | 0          | 0          |
| <b>Total</b> | <b>1</b>                     | <b>1</b> | <b>0</b> | <b>0</b> | <b>2</b>   | <b>0</b>                | <b>0</b> | <b>0</b> | <b>0</b> | <b>0</b>   | <b>0</b>                    | <b>1</b> | <b>0</b> | <b>0</b> | <b>1</b>   | <b>0</b>                | <b>1</b> | <b>0</b> | <b>0</b> | <b>1</b>   | <b>4</b>   |
| 08:00 AM     | 0                            | 0        | 0        | 0        | 0          | 0                       | 0        | 0        | 0        | 0          | 0                           | 0        | 0        | 0        | 0          | 0                       | 0        | 0        | 0        | 0          | 0          |
| 08:15 AM     | 0                            | 0        | 0        | 0        | 0          | 0                       | 0        | 0        | 0        | 0          | 0                           | 0        | 0        | 0        | 0          | 0                       | 0        | 0        | 0        | 0          | 0          |
| 08:30 AM     | 0                            | 0        | 0        | 0        | 0          | 0                       | 0        | 0        | 0        | 0          | 0                           | 0        | 0        | 0        | 0          | 0                       | 3        | 0        | 0        | 3          | 3          |
| 08:45 AM     | 0                            | 0        | 0        | 0        | 0          | 0                       | 0        | 0        | 0        | 0          | 0                           | 0        | 0        | 0        | 0          | 0                       | 1        | 0        | 0        | 1          | 1          |
| <b>Total</b> | <b>0</b>                     | <b>0</b> | <b>0</b> | <b>0</b> | <b>0</b>   | <b>0</b>                | <b>0</b> | <b>0</b> | <b>0</b> | <b>0</b>   | <b>0</b>                    | <b>0</b> | <b>0</b> | <b>0</b> | <b>0</b>   | <b>0</b>                | <b>4</b> | <b>0</b> | <b>0</b> | <b>4</b>   | <b>4</b>   |
| Grand Total  | 1                            | 1        | 0        | 0        | 2          | 0                       | 0        | 0        | 0        | 0          | 0                           | 1        | 0        | 0        | 1          | 0                       | 5        | 0        | 0        | 5          | 8          |
| Apprch %     | 50                           | 50       | 0        | 0        |            | 0                       | 0        | 0        | 0        |            | 0                           | 100      | 0        | 0        |            | 0                       | 100      | 0        | 0        |            |            |
| Total %      | 12.5                         | 12.5     | 0        | 0        | 25         | 0                       | 0        | 0        | 0        | 0          | 0                           | 12.5     | 0        | 0        | 12.5       | 0                       | 62.5     | 0        | 0        | 62.5       |            |

| Start Time   | CALIFORNIA AVE<br>Southbound |      |      |            | IMJIN PKWY<br>Westbound |      |      |            | CALIFORNIA DR<br>Northbound |      |      |            | IMJIN PKWY<br>Eastbound |      |      |            | Int. Total |
|--|------------------------------|------|------|------------|-------------------------|------|------|------------|-----------------------------|------|------|------------|-------------------------|------|------|------------|------------|
|  | Right                        | Thru | Left | App. Total | Right                   | Thru | Left | App. Total | Right                       | Thru | Left | App. Total | Right                   | Thru | Left | App. Total |            |
| Peak Hour Analysis From 07:00 AM to 08:45 AM - Peak 1 of 1 |                              |      |      |            |                         |      |      |            |                             |      |      |            |                         |      |      |            |            |
| Peak Hour for Entire Intersection Begins at 07:00 AM       |                              |      |      |            |                         |      |      |            |                             |      |      |            |                         |      |      |            |            |
| 07:00 AM   | 0                            | 1    | 0    | 1          | 0                       | 0    | 0    | 0          | 0                           | 0    | 0    | 0          | 0                       | 0    | 0    | 0          | 1          |
| 07:15 AM   | 1                            | 0    | 0    | 1          | 0                       | 0    | 0    | 0          | 0                           | 1    | 0    | 1          | 0                       | 0    | 0    | 0          | 2          |
| 07:30 AM   | 0                            | 0    | 0    | 0          | 0                       | 0    | 0    | 0          | 0                           | 0    | 0    | 0          | 0                       | 1    | 0    | 1          | 1          |
| 07:45 AM   | 0                            | 0    | 0    | 0          | 0                       | 0    | 0    | 0          | 0                           | 0    | 0    | 0          | 0                       | 0    | 0    | 0          | 0          |
| Total Volume   | 1                            | 1    | 0    | 2          | 0                       | 0    | 0    | 0          | 0                           | 1    | 0    | 1          | 0                       | 1    | 0    | 1          | 4          |
| % App. Total   | 50                           | 50   | 0    |            | 0                       | 0    | 0    |            | 0                           | 100  | 0    |            | 0                       | 100  | 0    |            |            |
| PHF  | .250                         | .250 | .000 | .500       | .000                    | .000 | .000 | .000       | .000                        | .250 | .000 | .250       | .000                    | .250 | .000 | .250       | .500       |

# Traffic Data Service

San Jose, CA  
 (408) 622-4787  
 tdsbay@cs.com

File Name : 6AM FINAL  
 Site Code : 00000006  
 Start Date : 4/27/2017  
 Page No : 2

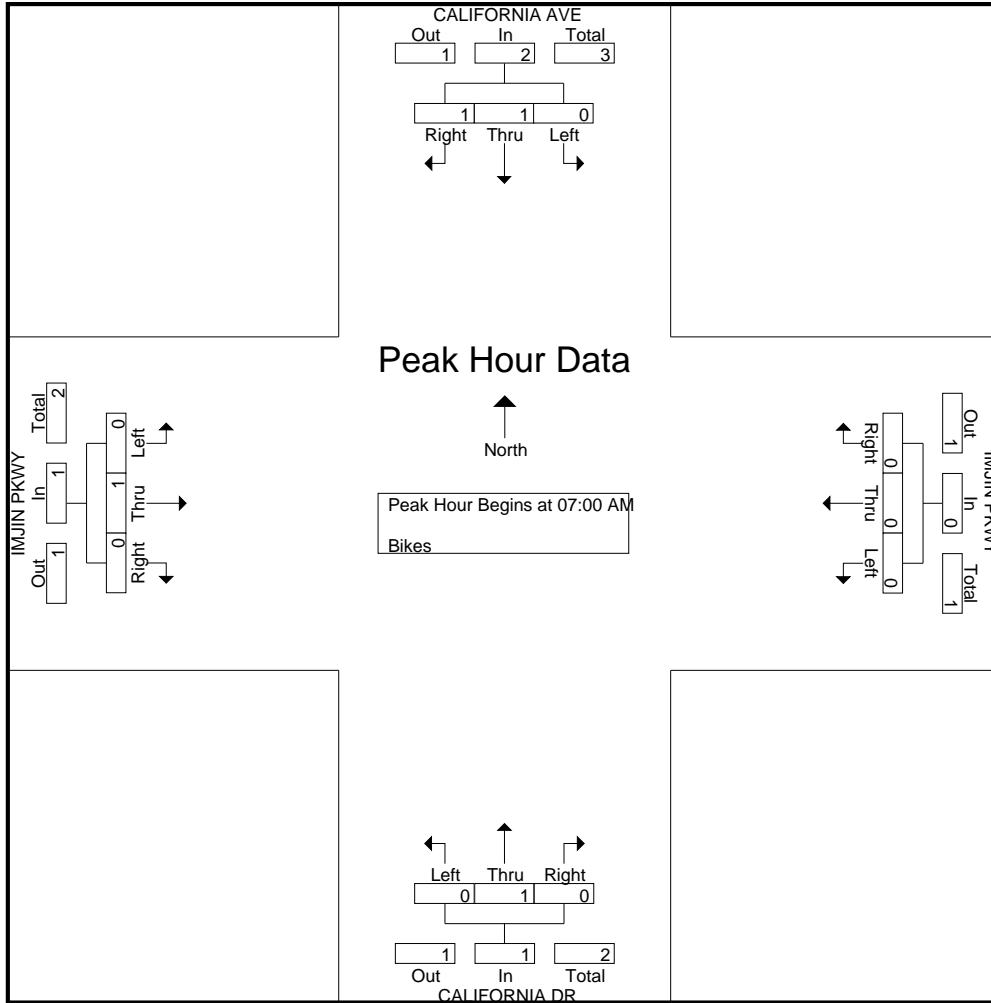

# Traffic Data Service

San Jose, CA  
(408) 622-4787  
tdsbay@cs.com

File Name : 6PM FINAL  
Site Code : 00000006  
Start Date : 4/27/2017  
Page No : 1

Groups Printed- Lights - Buses - Trucks

| Start Time   | CALIFORNIA AVE<br>Southbound |      |      |      |            | IMJIN PKWY<br>Westbound |      |      |      |            | CALIFORNIA DR<br>Northbound |      |      |      |            | IMJIN PKWY<br>Eastbound |      |      |      |            | Int. Total |
|--------------|------------------------------|------|------|------|------------|-------------------------|------|------|------|------------|-----------------------------|------|------|------|------------|-------------------------|------|------|------|------------|------------|
|              | Right                        | Thru | Left | Peds | App. Total | Right                   | Thru | Left | Peds | App. Total | Right                       | Thru | Left | Peds | App. Total | Right                   | Thru | Left | Peds | App. Total |            |
| 04:00 PM     | 40                           | 9    | 6    | 0    | 55         | 9                       | 205  | 1    | 0    | 215        | 1                           | 6    | 5    | 1    | 13         | 1                       | 256  | 54   | 0    | 311        | 594        |
| 04:15 PM     | 34                           | 6    | 9    | 0    | 49         | 11                      | 210  | 0    | 0    | 221        | 1                           | 8    | 1    | 0    | 10         | 1                       | 274  | 58   | 2    | 335        | 615        |
| 04:30 PM     | 42                           | 5    | 5    | 0    | 52         | 7                       | 224  | 1    | 0    | 232        | 3                           | 8    | 3    | 0    | 14         | 2                       | 243  | 60   | 0    | 305        | 603        |
| 04:45 PM     | 51                           | 3    | 7    | 1    | 62         | 16                      | 203  | 1    | 0    | 220        | 0                           | 7    | 4    | 0    | 11         | 1                       | 253  | 58   | 0    | 312        | 605        |
| <b>Total</b> | 167                          | 23   | 27   | 1    | 218        | 43                      | 842  | 3    | 0    | 888        | 5                           | 29   | 13   | 1    | 48         | 5                       | 1026 | 230  | 2    | 1263       | 2417       |
| 05:00 PM     | 54                           | 8    | 11   | 0    | 73         | 19                      | 240  | 0    | 0    | 259        | 2                           | 9    | 1    | 1    | 13         | 1                       | 285  | 65   | 0    | 351        | 696        |
| 05:15 PM     | 42                           | 4    | 5    | 0    | 51         | 20                      | 268  | 0    | 0    | 288        | 1                           | 10   | 5    | 1    | 17         | 0                       | 267  | 69   | 1    | 337        | 693        |
| 05:30 PM     | 56                           | 5    | 9    | 0    | 70         | 23                      | 250  | 2    | 1    | 276        | 1                           | 10   | 2    | 1    | 14         | 2                       | 253  | 57   | 0    | 312        | 672        |
| 05:45 PM     | 48                           | 8    | 12   | 0    | 68         | 6                       | 237  | 0    | 0    | 243        | 0                           | 9    | 4    | 0    | 13         | 1                       | 248  | 64   | 0    | 313        | 637        |
| <b>Total</b> | 200                          | 25   | 37   | 0    | 262        | 68                      | 995  | 2    | 1    | 1066       | 4                           | 38   | 12   | 3    | 57         | 4                       | 1053 | 255  | 1    | 1313       | 2698       |
| Grand Total  | 367                          | 48   | 64   | 1    | 480        | 111                     | 1837 | 5    | 1    | 1954       | 9                           | 67   | 25   | 4    | 105        | 9                       | 2079 | 485  | 3    | 2576       | 5115       |
| Apprch %     | 76.5                         | 10   | 13.3 | 0.2  |            | 5.7                     | 94   | 0.3  | 0.1  |            | 8.6                         | 63.8 | 23.8 | 3.8  |            | 0.3                     | 80.7 | 18.8 | 0.1  |            |            |
| Total %      | 7.2                          | 0.9  | 1.3  | 0    | 9.4        | 2.2                     | 35.9 | 0.1  | 0    | 38.2       | 0.2                         | 1.3  | 0.5  | 0.1  | 2.1        | 0.2                     | 40.6 | 9.5  | 0.1  | 50.4       |            |
| Lights       | 359                          | 47   | 64   | 1    | 471        | 110                     | 1803 | 5    | 1    | 1919       | 9                           | 67   | 25   | 4    | 105        | 9                       | 2049 | 481  | 3    | 2542       | 5037       |
| % Lights     | 97.8                         | 97.9 | 100  | 100  | 98.1       | 99.1                    | 98.1 | 100  | 100  | 98.2       | 100                         | 100  | 100  | 100  | 100        | 100                     | 98.6 | 99.2 | 100  | 98.7       | 98.5       |
| Buses        | 4                            | 1    | 0    | 0    | 5          | 0                       | 16   | 0    | 0    | 16         | 0                           | 0    | 0    | 0    | 0          | 0                       | 3    | 0    | 0    | 3          | 24         |
| % Buses      | 1.1                          | 2.1  | 0    | 0    | 1          | 0                       | 0.9  | 0    | 0    | 0.8        | 0                           | 0    | 0    | 0    | 0          | 0                       | 0.1  | 0    | 0    | 0.1        | 0.5        |
| Trucks       | 4                            | 0    | 0    | 0    | 4          | 1                       | 18   | 0    | 0    | 19         | 0                           | 0    | 0    | 0    | 0          | 0                       | 27   | 4    | 0    | 31         | 54         |
| % Trucks     | 1.1                          | 0    | 0    | 0    | 0.8        | 0.9                     | 1    | 0    | 0    | 1          | 0                           | 0    | 0    | 0    | 0          | 0                       | 1.3  | 0.8  | 0    | 1.2        | 1.1        |

| Start Time   | CALIFORNIA AVE<br>Southbound |          |           |      |            | IMJIN PKWY<br>Westbound |            |          |      |            | CALIFORNIA DR<br>Northbound |           |          |           |            | IMJIN PKWY<br>Eastbound |            |           |            |            | Int. Total |
|--|------------------------------|----------|-----------|------|------------|-------------------------|------------|----------|------|------------|-----------------------------|-----------|----------|-----------|------------|-------------------------|------------|-----------|------------|------------|------------|
|  | Right                        | Thru     | Left      | Peds | App. Total | Right                   | Thru       | Left     | Peds | App. Total | Right                       | Thru      | Left     | Peds      | App. Total | Right                   | Thru       | Left      | Peds       | App. Total |            |
| Peak Hour Analysis From 04:00 PM to 05:45 PM - Peak 1 of 1 |                              |          |           |      |            |                         |            |          |      |            |                             |           |          |           |            |                         |            |           |            |            |            |
| Peak Hour for Entire Intersection Begins at 05:00 PM       |                              |          |           |      |            |                         |            |          |      |            |                             |           |          |           |            |                         |            |           |            |            |            |
| 05:00 PM   | 54                           | <b>8</b> | 11        |      | <b>73</b>  | 19                      | 240        | 0        | 0    | 259        | <b>2</b>                    | 9         | 1        | 1         | 12         | 1                       | <b>285</b> | 65        | <b>351</b> | <b>695</b> |            |
| 05:15 PM   | 42                           | 4        | 5         |      | 51         | 20                      | <b>268</b> | 0        | 0    | <b>288</b> | 1                           | <b>10</b> | <b>5</b> | <b>16</b> |            | 0                       | 267        | <b>69</b> | 336        | 691        |            |
| 05:30 PM   | <b>56</b>                    | 5        | 9         |      | 70         | <b>23</b>               | 250        | <b>2</b> | 1    | 275        | 1                           | 10        | 2        | 13        |            | <b>2</b>                | 253        | 57        | 312        | 670        |            |
| 05:45 PM   | 48                           | 8        | <b>12</b> |      | 68         | 6                       | 237        | 0        | 0    | 243        | 0                           | 9         | 4        | 13        |            | 1                       | 248        | 64        | 313        | 637        |            |
| Total Volume   | 200                          | 25       | 37        |      | 262        | 68                      | 995        | 2        | 1    | 1065       | 4                           | 38        | 12       | 54        |            | 4                       | 1053       | 255       | 1312       | 2693       |            |
| % App. Total   | 76.3                         | 9.5      | 14.1      |      |            | 6.4                     | 93.4       | 0.2      |      |            | 7.4                         | 70.4      | 22.2     |           |            | 0.3                     | 80.3       | 19.4      |            |            |            |
| PHF  | .893                         | .781     | .771      |      | .897       | .739                    | .928       | .250     | .924 |            | .500                        | .950      | .600     | .844      |            | .500                    | .924       | .924      | .934       | .969       |            |

# Traffic Data Service

San Jose, CA  
 (408) 622-4787  
 tdsbay@cs.com

File Name : 6PM FINAL  
 Site Code : 00000006  
 Start Date : 4/27/2017  
 Page No : 2

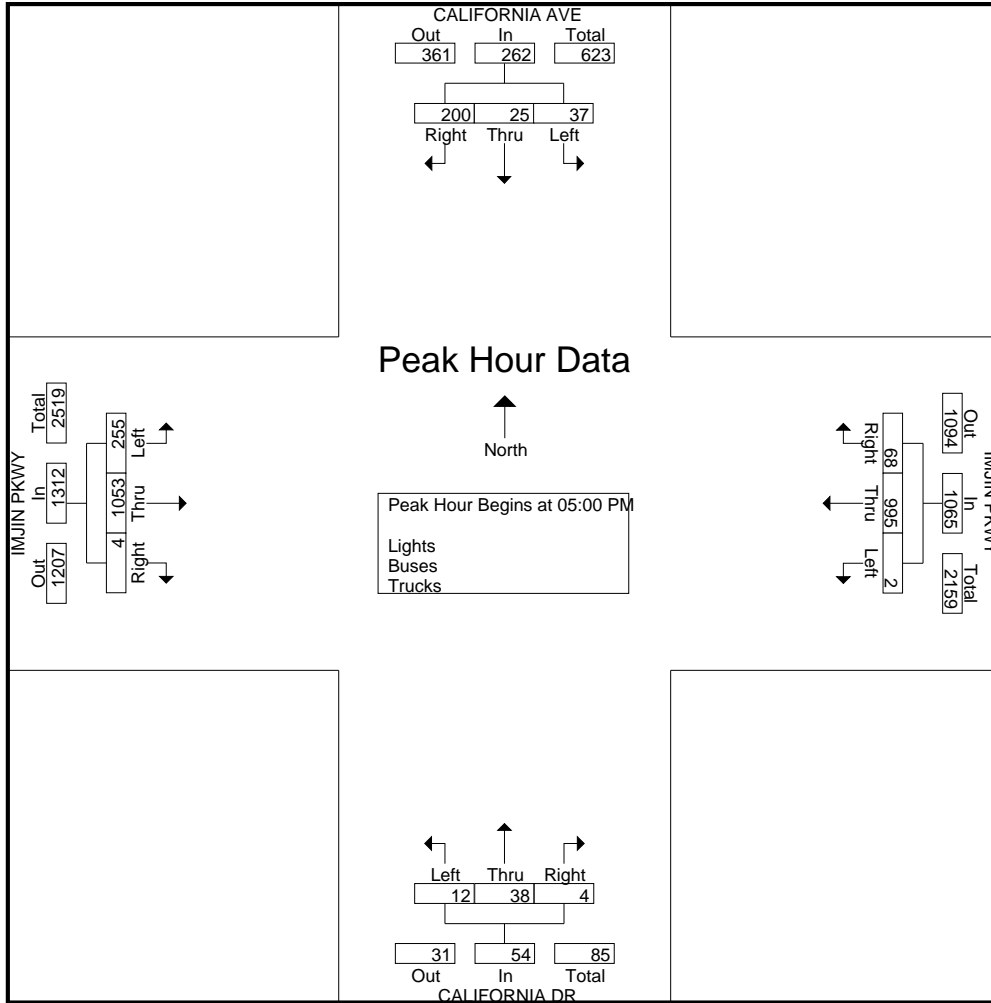

# Traffic Data Service

San Jose, CA  
 (408) 622-4787  
 tdsbay@cs.com

File Name : 6PM FINAL  
 Site Code : 00000006  
 Start Date : 4/27/2017  
 Page No : 1

Groups Printed- Bikes

| Start Time  | CALIFORNIA AVE<br>Southbound |      |      |      |            | IMJIN PKWY<br>Westbound |      |      |      |            | CALIFORNIA DR<br>Northbound |      |      |      |            | IMJIN PKWY<br>Eastbound |      |      |      |            | Int. Total |
|-------------|------------------------------|------|------|------|------------|-------------------------|------|------|------|------------|-----------------------------|------|------|------|------------|-------------------------|------|------|------|------------|------------|
|             | Right                        | Thru | Left | Peds | App. Total | Right                   | Thru | Left | Peds | App. Total | Right                       | Thru | Left | Peds | App. Total | Right                   | Thru | Left | Peds | App. Total |            |
| 04:00 PM    | 0                            | 0    | 0    | 0    | 0          | 0                       | 0    | 0    | 0    | 0          | 0                           | 0    | 0    | 0    | 0          | 0                       | 0    | 0    | 0    | 0          | 0          |
| 04:15 PM    | 0                            | 0    | 0    | 0    | 0          | 0                       | 1    | 0    | 0    | 1          | 0                           | 0    | 0    | 0    | 0          | 0                       | 0    | 0    | 0    | 0          | 0          |
| 04:30 PM    | 0                            | 0    | 0    | 0    | 0          | 0                       | 0    | 0    | 0    | 0          | 0                           | 0    | 0    | 0    | 0          | 0                       | 0    | 0    | 0    | 0          | 0          |
| 04:45 PM    | 0                            | 0    | 0    | 0    | 0          | 0                       | 0    | 0    | 0    | 0          | 0                           | 0    | 0    | 0    | 0          | 0                       | 0    | 0    | 0    | 0          | 0          |
| Total       | 0                            | 0    | 0    | 0    | 0          | 0                       | 1    | 0    | 0    | 1          | 0                           | 0    | 0    | 0    | 0          | 0                       | 0    | 0    | 0    | 0          | 1          |
| 05:00 PM    | 0                            | 0    | 0    | 0    | 0          | 0                       | 0    | 0    | 0    | 0          | 0                           | 0    | 0    | 0    | 0          | 0                       | 0    | 0    | 0    | 0          | 0          |
| 05:15 PM    | 0                            | 0    | 0    | 0    | 0          | 0                       | 0    | 0    | 0    | 0          | 0                           | 0    | 0    | 0    | 0          | 0                       | 0    | 0    | 0    | 0          | 0          |
| 05:30 PM    | 0                            | 0    | 0    | 0    | 0          | 0                       | 0    | 0    | 0    | 0          | 0                           | 0    | 0    | 0    | 0          | 0                       | 0    | 0    | 0    | 0          | 0          |
| 05:45 PM    | 0                            | 1    | 0    | 0    | 1          | 0                       | 0    | 0    | 0    | 0          | 0                           | 0    | 0    | 0    | 0          | 0                       | 0    | 0    | 0    | 0          | 1          |
| Total       | 0                            | 1    | 0    | 0    | 1          | 0                       | 0    | 0    | 0    | 0          | 0                           | 0    | 0    | 0    | 0          | 0                       | 0    | 0    | 0    | 0          | 1          |
| Grand Total | 0                            | 1    | 0    | 0    | 1          | 0                       | 1    | 0    | 0    | 1          | 0                           | 0    | 0    | 0    | 0          | 0                       | 0    | 0    | 0    | 0          | 2          |
| Apprch %    | 0                            | 100  | 0    | 0    |            | 0                       | 100  | 0    | 0    |            | 0                           | 0    | 0    | 0    |            | 0                       | 0    | 0    | 0    |            |            |
| Total %     | 0                            | 50   | 0    | 0    | 50         | 0                       | 50   | 0    | 0    | 50         | 0                           | 0    | 0    | 0    | 0          | 0                       | 0    | 0    | 0    | 0          |            |

| Start Time   | CALIFORNIA AVE<br>Southbound |      |      |            | IMJIN PKWY<br>Westbound |      |      |            | CALIFORNIA DR<br>Northbound |      |      |            | IMJIN PKWY<br>Eastbound |      |      |            | Int. Total |
|--|------------------------------|------|------|------------|-------------------------|------|------|------------|-----------------------------|------|------|------------|-------------------------|------|------|------------|------------|
|  | Right                        | Thru | Left | App. Total | Right                   | Thru | Left | App. Total | Right                       | Thru | Left | App. Total | Right                   | Thru | Left | App. Total |            |
| Peak Hour Analysis From 04:00 PM to 05:45 PM - Peak 1 of 1 |                              |      |      |            |                         |      |      |            |                             |      |      |            |                         |      |      |            |            |
| Peak Hour for Entire Intersection Begins at 04:00 PM       |                              |      |      |            |                         |      |      |            |                             |      |      |            |                         |      |      |            |            |
| 04:00 PM   | 0                            | 0    | 0    | 0          | 0                       | 0    | 0    | 0          | 0                           | 0    | 0    | 0          | 0                       | 0    | 0    | 0          | 0          |
| 04:15 PM   | 0                            | 0    | 0    | 0          | 0                       | 1    | 0    | 1          | 0                           | 0    | 0    | 0          | 0                       | 0    | 0    | 0          | 1          |
| 04:30 PM   | 0                            | 0    | 0    | 0          | 0                       | 0    | 0    | 0          | 0                           | 0    | 0    | 0          | 0                       | 0    | 0    | 0          | 0          |
| 04:45 PM   | 0                            | 0    | 0    | 0          | 0                       | 0    | 0    | 0          | 0                           | 0    | 0    | 0          | 0                       | 0    | 0    | 0          | 0          |
| Total Volume   | 0                            | 0    | 0    | 0          | 0                       | 1    | 0    | 1          | 0                           | 0    | 0    | 0          | 0                       | 0    | 0    | 0          | 1          |
| % App. Total   | 0                            | 0    | 0    |            | 0                       | 100  | 0    |            | 0                           | 0    | 0    |            | 0                       | 0    | 0    |            |            |
| PHF  | .000                         | .000 | .000 | .000       | .000                    | .250 | .000 | .250       | .000                        | .000 | .000 | .000       | .000                    | .000 | .000 | .000       | .250       |

# Traffic Data Service

San Jose, CA  
(408) 622-4787  
tdsbay@cs.com

File Name : 6PM FINAL  
Site Code : 00000006  
Start Date : 4/27/2017  
Page No : 2

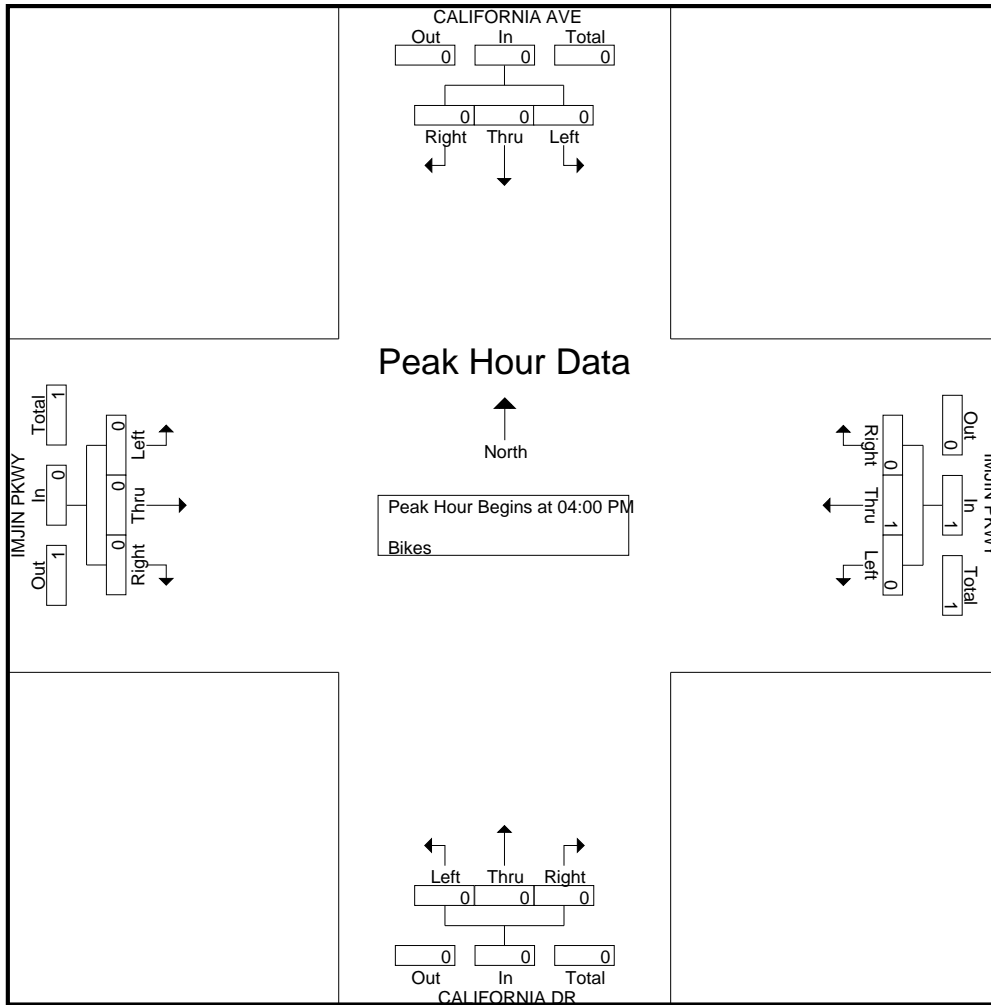



# Traffic Data Service

San Jose, CA  
 (408) 622-4787  
 tdsbay@cs.com

File Name : 7AM FINAL  
 Site Code : 00000007  
 Start Date : 4/27/2017  
 Page No : 1

## Groups Printed- Lights - Buses - Trucks

| Start Time  | Southbound |      |      |      |            | IMJIN PKWY Westbound |      |      |      |            | IMJIN RD Northbound |      |      |      |            | IMJIN PKWY Eastbound |      |      |      |            | Int. Total |
|-------------|------------|------|------|------|------------|----------------------|------|------|------|------------|---------------------|------|------|------|------------|----------------------|------|------|------|------------|------------|
|             | Right      | Thru | Left | Peds | App. Total | Right                | Thru | Left | Peds | App. Total | Right               | Thru | Left | Peds | App. Total | Right                | Thru | Left | Peds | App. Total |            |
| 07:00 AM    | 0          | 0    | 0    | 0    | 0          | 0                    | 296  | 18   | 0    | 314        | 6                   | 0    | 2    | 0    | 8          | 11                   | 124  | 0    | 0    | 135        | 457        |
| 07:15 AM    | 0          | 0    | 0    | 0    | 0          | 0                    | 299  | 47   | 0    | 346        | 4                   | 0    | 3    | 0    | 7          | 16                   | 121  | 0    | 0    | 137        | 490        |
| 07:30 AM    | 0          | 0    | 0    | 0    | 0          | 0                    | 257  | 72   | 0    | 329        | 11                  | 0    | 4    | 2    | 17         | 31                   | 179  | 0    | 0    | 210        | 556        |
| 07:45 AM    | 0          | 0    | 0    | 0    | 0          | 0                    | 248  | 65   | 0    | 313        | 7                   | 0    | 4    | 0    | 11         | 39                   | 196  | 0    | 0    | 235        | 559        |
| Total       | 0          | 0    | 0    | 0    | 0          | 0                    | 1100 | 202  | 0    | 1302       | 28                  | 0    | 13   | 2    | 43         | 97                   | 620  | 0    | 0    | 717        | 2062       |
| 08:00 AM    | 0          | 0    | 0    | 0    | 0          | 0                    | 209  | 44   | 0    | 253        | 13                  | 0    | 5    | 0    | 18         | 28                   | 183  | 0    | 0    | 211        | 482        |
| 08:15 AM    | 0          | 0    | 0    | 0    | 0          | 0                    | 260  | 35   | 0    | 295        | 10                  | 0    | 7    | 0    | 17         | 32                   | 179  | 0    | 0    | 211        | 523        |
| 08:30 AM    | 0          | 0    | 0    | 0    | 0          | 0                    | 251  | 30   | 0    | 281        | 10                  | 0    | 3    | 0    | 13         | 18                   | 161  | 0    | 0    | 179        | 473        |
| 08:45 AM    | 0          | 0    | 0    | 0    | 0          | 0                    | 208  | 27   | 0    | 235        | 8                   | 0    | 13   | 0    | 21         | 17                   | 134  | 0    | 0    | 151        | 407        |
| Total       | 0          | 0    | 0    | 0    | 0          | 0                    | 928  | 136  | 0    | 1064       | 41                  | 0    | 28   | 0    | 69         | 95                   | 657  | 0    | 0    | 752        | 1885       |
| Grand Total | 0          | 0    | 0    | 0    | 0          | 0                    | 2028 | 338  | 0    | 2366       | 69                  | 0    | 41   | 2    | 112        | 192                  | 1277 | 0    | 0    | 1469       | 3947       |
| Apprch %    | 0          | 0    | 0    | 0    | 0          | 0                    | 85.7 | 14.3 | 0    | 2366       | 61.6                | 0    | 36.6 | 1.8  | 112        | 13.1                 | 86.9 | 0    | 0    | 1469       | 3947       |
| Total %     | 0          | 0    | 0    | 0    | 0          | 0                    | 51.4 | 8.6  | 0    | 59.9       | 1.7                 | 0    | 1    | 0.1  | 2.8        | 4.9                  | 32.4 | 0    | 0    | 37.2       |            |
| Lights      | 0          | 0    | 0    | 0    | 0          | 0                    | 1977 | 332  | 0    | 2309       | 68                  | 0    | 32   | 2    | 102        | 188                  | 1250 | 0    | 0    | 1438       | 3849       |
| % Lights    | 0          | 0    | 0    | 0    | 0          | 0                    | 97.5 | 98.2 | 0    | 97.6       | 98.6                | 0    | 78   | 100  | 91.1       | 97.9                 | 97.9 | 0    | 0    | 97.9       | 97.5       |
| Buses       | 0          | 0    | 0    | 0    | 0          | 0                    | 9    | 1    | 0    | 10         | 0                   | 0    | 5    | 0    | 5          | 1                    | 9    | 0    | 0    | 10         | 25         |
| % Buses     | 0          | 0    | 0    | 0    | 0          | 0                    | 0.4  | 0.3  | 0    | 0.4        | 0                   | 0    | 12.2 | 0    | 4.5        | 0.5                  | 0.7  | 0    | 0    | 0.7        | 0.6        |
| Trucks      | 0          | 0    | 0    | 0    | 0          | 0                    | 42   | 5    | 0    | 47         | 1                   | 0    | 4    | 0    | 5          | 3                    | 18   | 0    | 0    | 21         | 73         |
| % Trucks    | 0          | 0    | 0    | 0    | 0          | 0                    | 2.1  | 1.5  | 0    | 2          | 1.4                 | 0    | 9.8  | 0    | 4.5        | 1.6                  | 1.4  | 0    | 0    | 1.4        | 1.8        |

| Start Time   | Southbound |      |      |      |            | IMJIN PKWY Westbound |            |           |            |            | IMJIN RD Northbound |          |           |           |            | IMJIN PKWY Eastbound |      |            |            |            | Int. Total |
|--|------------|------|------|------|------------|----------------------|------------|-----------|------------|------------|---------------------|----------|-----------|-----------|------------|----------------------|------|------------|------------|------------|------------|
|  | Right      | Thru | Left | Peds | App. Total | Right                | Thru       | Left      | Peds       | App. Total | Right               | Thru     | Left      | Peds      | App. Total | Right                | Thru | Left       | Peds       | App. Total |            |
| Peak Hour Analysis From 07:00 AM to 08:45 AM - Peak 1 of 1 |            |      |      |      |            |                      |            |           |            |            |                     |          |           |           |            |                      |      |            |            |            |            |
| Peak Hour for Entire Intersection Begins at 07:30 AM       |            |      |      |      |            |                      |            |           |            |            |                     |          |           |           |            |                      |      |            |            |            |            |
| 07:30 AM   | 0          | 0    | 0    | 0    | 0          | 0                    | 257        | <b>72</b> | <b>329</b> | 11         | 0                   | 4        | 15        | 31        | 179        | 0                    | 0    | 210        | 554        |            |            |
| 07:45 AM   | 0          | 0    | 0    | 0    | 0          | 0                    | 248        | 65        | 313        | 7          | 0                   | 4        | 11        | <b>39</b> | <b>196</b> | 0                    | 0    | <b>235</b> | <b>559</b> |            |            |
| 08:00 AM   | 0          | 0    | 0    | 0    | 0          | 0                    | 209        | 44        | 253        | <b>13</b>  | 0                   | 5        | <b>18</b> | 28        | 183        | 0                    | 0    | 211        | 482        |            |            |
| 08:15 AM   | 0          | 0    | 0    | 0    | 0          | 0                    | <b>260</b> | 35        | 295        | 10         | 0                   | <b>7</b> | 17        | 32        | 179        | 0                    | 0    | 211        | 523        |            |            |
| Total Volume   | 0          | 0    | 0    | 0    | 0          | 0                    | 974        | 216       | 1190       | 41         | 0                   | 20       | 61        | 130       | 737        | 0                    | 0    | 867        | 2118       |            |            |
| % App. Total   | 0          | 0    | 0    | 0    | 0          | 0                    | 81.8       | 18.2      |            | 67.2       | 0                   | 32.8     |           | 15        | 85         | 0                    | 0    |            |            |            |            |
| PHF  | .000       | .000 | .000 | .000 | .000       | .000                 | .937       | .750      | .904       | .788       | .000                | .714     | .847      | .833      | .940       | .000                 | .922 | .947       |            |            |            |

# Traffic Data Service

San Jose, CA  
 (408) 622-4787  
 tdsbay@cs.com

File Name : 7AM FINAL  
 Site Code : 00000007  
 Start Date : 4/27/2017  
 Page No : 2

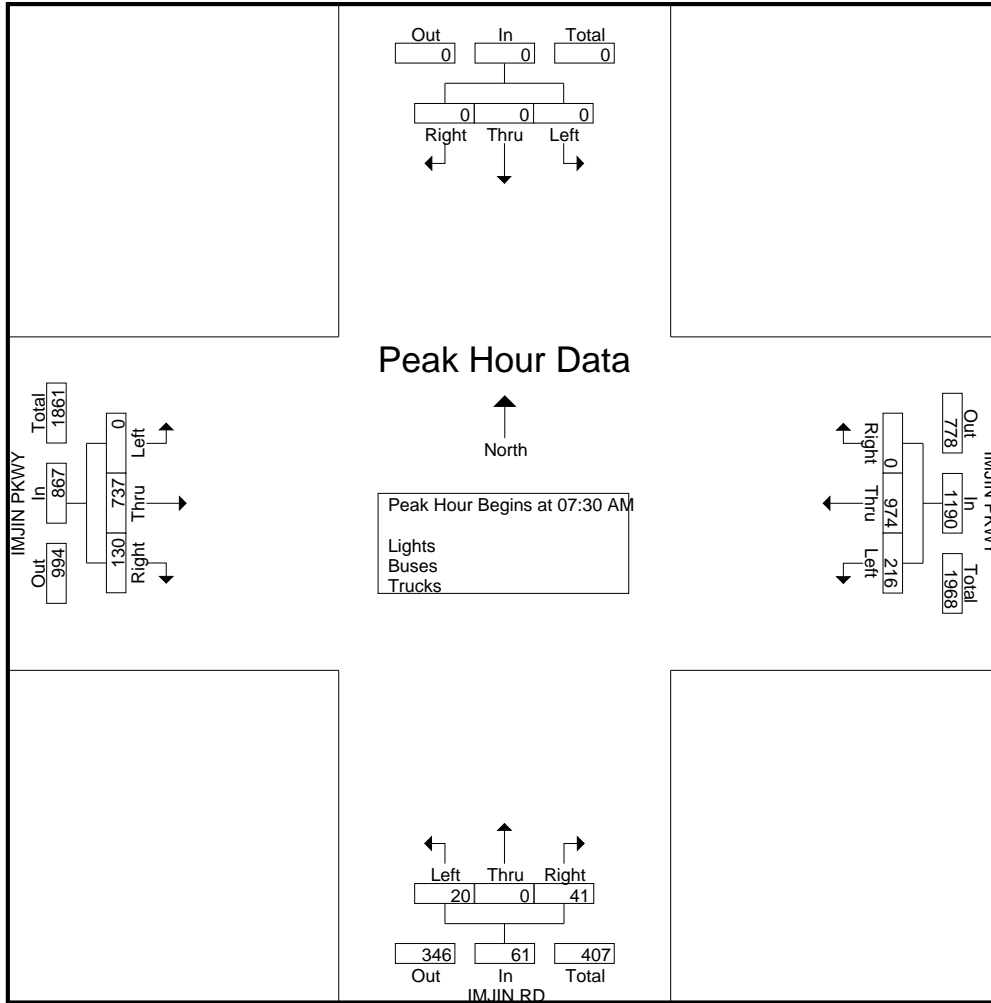

# Traffic Data Service

San Jose, CA  
 (408) 622-4787  
 tdsbay@cs.com

File Name : 7AM FINAL  
 Site Code : 00000007  
 Start Date : 4/27/2017  
 Page No : 1

Groups Printed- Bikes

| Start Time  | Southbound |      |      |      |            | IMJIN PKWY Westbound |      |      |      |            | IMJIN RD Northbound |      |      |      |            | IMJIN PKWY Eastbound |      |      |      |            | Int. Total |
|-------------|------------|------|------|------|------------|----------------------|------|------|------|------------|---------------------|------|------|------|------------|----------------------|------|------|------|------------|------------|
|             | Right      | Thru | Left | Peds | App. Total | Right                | Thru | Left | Peds | App. Total | Right               | Thru | Left | Peds | App. Total | Right                | Thru | Left | Peds | App. Total |            |
| 07:00 AM    | 0          | 0    | 0    | 0    | 0          | 0                    | 0    | 0    | 0    | 0          | 0                   | 0    | 0    | 0    | 0          | 0                    | 0    | 0    | 0    | 0          | 0          |
| 07:15 AM    | 0          | 0    | 0    | 0    | 0          | 0                    | 0    | 0    | 0    | 0          | 0                   | 0    | 0    | 0    | 0          | 0                    | 0    | 0    | 0    | 0          | 0          |
| 07:30 AM    | 0          | 0    | 0    | 0    | 0          | 0                    | 0    | 0    | 0    | 0          | 0                   | 0    | 0    | 0    | 0          | 0                    | 0    | 0    | 0    | 0          | 0          |
| 07:45 AM    | 0          | 0    | 0    | 0    | 0          | 0                    | 0    | 0    | 0    | 0          | 0                   | 0    | 0    | 0    | 0          | 0                    | 0    | 0    | 0    | 0          | 0          |
| Total       | 0          | 0    | 0    | 0    | 0          | 0                    | 0    | 0    | 0    | 0          | 0                   | 0    | 0    | 0    | 0          | 0                    | 0    | 0    | 0    | 0          | 0          |
| 08:00 AM    | 0          | 0    | 0    | 0    | 0          | 0                    | 0    | 0    | 0    | 0          | 0                   | 0    | 0    | 0    | 0          | 0                    | 0    | 0    | 0    | 0          | 0          |
| 08:15 AM    | 0          | 0    | 0    | 0    | 0          | 0                    | 0    | 0    | 0    | 0          | 0                   | 0    | 0    | 0    | 0          | 0                    | 0    | 0    | 0    | 0          | 0          |
| 08:30 AM    | 0          | 0    | 0    | 0    | 0          | 0                    | 0    | 0    | 0    | 0          | 0                   | 0    | 0    | 0    | 0          | 0                    | 0    | 0    | 0    | 0          | 0          |
| 08:45 AM    | 0          | 0    | 0    | 0    | 0          | 0                    | 0    | 0    | 0    | 0          | 0                   | 0    | 0    | 0    | 0          | 0                    | 0    | 0    | 0    | 0          | 0          |
| Total       | 0          | 0    | 0    | 0    | 0          | 0                    | 0    | 0    | 0    | 0          | 0                   | 0    | 0    | 0    | 0          | 0                    | 0    | 0    | 0    | 0          | 0          |
| Grand Total | 0          | 0    | 0    | 0    | 0          | 0                    | 0    | 0    | 0    | 0          | 0                   | 0    | 0    | 0    | 0          | 0                    | 0    | 0    | 0    | 0          | 0          |
| Apprch %    | 0          | 0    | 0    | 0    |            | 0                    | 0    | 0    | 0    |            | 0                   | 0    | 0    | 0    |            | 0                    | 0    | 0    | 0    |            |            |
| Total %     |            |      |      |      |            |                      |      |      |      |            |                     |      |      |      |            |                      |      |      |      |            |            |

| Start Time   | Southbound |      |      |      |            | IMJIN PKWY Westbound |      |      |      |            | IMJIN RD Northbound |      |      |      |            | IMJIN PKWY Eastbound |      |      |      |            | Int. Total |
|--------------|------------|------|------|------|------------|----------------------|------|------|------|------------|---------------------|------|------|------|------------|----------------------|------|------|------|------------|------------|
|              | Right      | Thru | Left | Peds | App. Total | Right                | Thru | Left | Peds | App. Total | Right               | Thru | Left | Peds | App. Total | Right                | Thru | Left | Peds | App. Total |            |
| 07:00 AM     | 0          | 0    | 0    | 0    | 0          | 0                    | 0    | 0    | 0    | 0          | 0                   | 0    | 0    | 0    | 0          | 0                    | 0    | 0    | 0    | 0          | 0          |
| 07:15 AM     | 0          | 0    | 0    | 0    | 0          | 0                    | 0    | 0    | 0    | 0          | 0                   | 0    | 0    | 0    | 0          | 0                    | 0    | 0    | 0    | 0          | 0          |
| 07:30 AM     | 0          | 0    | 0    | 0    | 0          | 0                    | 0    | 0    | 0    | 0          | 0                   | 0    | 0    | 0    | 0          | 0                    | 0    | 0    | 0    | 0          | 0          |
| 07:45 AM     | 0          | 0    | 0    | 0    | 0          | 0                    | 0    | 0    | 0    | 0          | 0                   | 0    | 0    | 0    | 0          | 0                    | 0    | 0    | 0    | 0          | 0          |
| Total Volume | 0          | 0    | 0    | 0    | 0          | 0                    | 0    | 0    | 0    | 0          | 0                   | 0    | 0    | 0    | 0          | 0                    | 0    | 0    | 0    | 0          | 0          |
| % App. Total | 0          | 0    | 0    | 0    |            | 0                    | 0    | 0    | 0    |            | 0                   | 0    | 0    | 0    |            | 0                    | 0    | 0    | 0    |            |            |
| PHF          | .000       | .000 | .000 | .000 | .000       | .000                 | .000 | .000 | .000 | .000       | .000                | .000 | .000 | .000 | .000       | .000                 | .000 | .000 | .000 | .000       | .000       |

Peak Hour Analysis From 07:00 AM to 08:45 AM - Peak 1 of 1  
 Peak Hour for Entire Intersection Begins at 07:00 AM

# Traffic Data Service

San Jose, CA  
(408) 622-4787  
tdsbay@cs.com

File Name : 7AM FINAL  
Site Code : 00000007  
Start Date : 4/27/2017  
Page No : 2

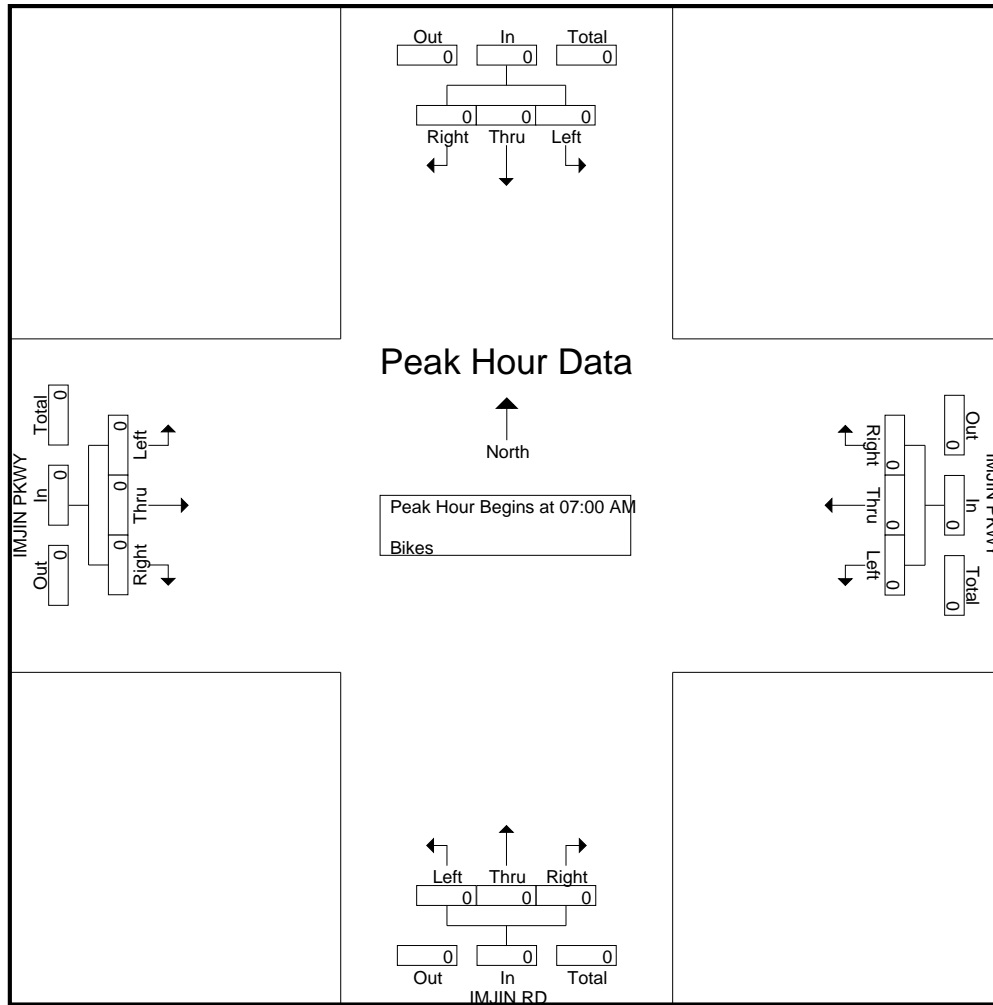

# Traffic Data Service

San Jose, CA  
 (408) 622-4787  
 tdsbay@cs.com

File Name : 7PM FINAL  
 Site Code : 00000007  
 Start Date : 4/27/2017  
 Page No : 1

## Groups Printed- Lights - Buses - Trucks

| Start Time  | Southbound |      |      |      |            | IMJIN PKWY Westbound |      |      |      |            | IMJIN RD Northbound |      |      |      |            | IMJIN PKWY Eastbound |      |      |      |            | Int. Total |
|-------------|------------|------|------|------|------------|----------------------|------|------|------|------------|---------------------|------|------|------|------------|----------------------|------|------|------|------------|------------|
|             | Right      | Thru | Left | Peds | App. Total | Right                | Thru | Left | Peds | App. Total | Right               | Thru | Left | Peds | App. Total | Right                | Thru | Left | Peds | App. Total |            |
| 04:00 PM    | 0          | 0    | 0    | 0    | 0          | 0                    | 194  | 23   | 0    | 217        | 29                  | 0    | 27   | 1    | 57         | 11                   | 254  | 0    | 0    | 265        | 539        |
| 04:15 PM    | 0          | 0    | 0    | 0    | 0          | 0                    | 197  | 11   | 0    | 208        | 12                  | 0    | 19   | 0    | 31         | 5                    | 271  | 0    | 0    | 276        | 515        |
| 04:30 PM    | 0          | 0    | 0    | 0    | 0          | 0                    | 213  | 15   | 0    | 228        | 23                  | 0    | 16   | 0    | 39         | 13                   | 242  | 0    | 0    | 255        | 522        |
| 04:45 PM    | 0          | 0    | 0    | 0    | 0          | 0                    | 211  | 18   | 0    | 229        | 24                  | 0    | 29   | 0    | 53         | 10                   | 254  | 0    | 0    | 264        | 546        |
| Total       | 0          | 0    | 0    | 0    | 0          | 0                    | 815  | 67   | 0    | 882        | 88                  | 0    | 91   | 1    | 180        | 39                   | 1021 | 0    | 0    | 1060       | 2122       |
| 05:00 PM    | 0          | 0    | 0    | 0    | 0          | 0                    | 219  | 12   | 0    | 231        | 21                  | 0    | 34   | 0    | 55         | 14                   | 268  | 0    | 0    | 282        | 568        |
| 05:15 PM    | 0          | 0    | 0    | 0    | 0          | 0                    | 258  | 20   | 0    | 278        | 28                  | 0    | 31   | 0    | 59         | 11                   | 257  | 0    | 0    | 268        | 605        |
| 05:30 PM    | 0          | 0    | 0    | 0    | 0          | 0                    | 219  | 22   | 0    | 241        | 25                  | 0    | 43   | 0    | 68         | 10                   | 256  | 0    | 0    | 266        | 575        |
| 05:45 PM    | 0          | 0    | 0    | 0    | 0          | 0                    | 205  | 20   | 0    | 225        | 20                  | 0    | 28   | 0    | 48         | 19                   | 255  | 0    | 0    | 274        | 547        |
| Total       | 0          | 0    | 0    | 0    | 0          | 0                    | 901  | 74   | 0    | 975        | 94                  | 0    | 136  | 0    | 230        | 54                   | 1036 | 0    | 0    | 1090       | 2295       |
| Grand Total | 0          | 0    | 0    | 0    | 0          | 0                    | 1716 | 141  | 0    | 1857       | 182                 | 0    | 227  | 1    | 410        | 93                   | 2057 | 0    | 0    | 2150       | 4417       |
| Apprch %    | 0          | 0    | 0    | 0    | 0          | 0                    | 92.4 | 7.6  | 0    |            | 44.4                | 0    | 55.4 | 0.2  |            | 4.3                  | 95.7 | 0    | 0    |            |            |
| Total %     | 0          | 0    | 0    | 0    | 0          | 0                    | 38.8 | 3.2  | 0    | 42         | 4.1                 | 0    | 5.1  | 0    | 9.3        | 2.1                  | 46.6 | 0    | 0    | 48.7       |            |
| Lights      | 0          | 0    | 0    | 0    | 0          | 0                    | 1691 | 140  | 0    | 1831       | 181                 | 0    | 221  | 1    | 403        | 92                   | 2033 | 0    | 0    | 2125       | 4359       |
| % Lights    | 0          | 0    | 0    | 0    | 0          | 0                    | 98.5 | 99.3 | 0    | 98.6       | 99.5                | 0    | 97.4 | 100  | 98.3       | 98.9                 | 98.8 | 0    | 0    | 98.8       | 98.7       |
| Buses       | 0          | 0    | 0    | 0    | 0          | 0                    | 8    | 0    | 0    | 8          | 0                   | 0    | 5    | 0    | 5          | 0                    | 4    | 0    | 0    | 4          | 17         |
| % Buses     | 0          | 0    | 0    | 0    | 0          | 0                    | 0.5  | 0    | 0    | 0.4        | 0                   | 0    | 2.2  | 0    | 1.2        | 0                    | 0.2  | 0    | 0    | 0.2        | 0.4        |
| Trucks      | 0          | 0    | 0    | 0    | 0          | 0                    | 17   | 1    | 0    | 18         | 1                   | 0    | 1    | 0    | 2          | 1                    | 20   | 0    | 0    | 21         | 41         |
| % Trucks    | 0          | 0    | 0    | 0    | 0          | 0                    | 1    | 0.7  | 0    | 1          | 0.5                 | 0    | 0.4  | 0    | 0.5        | 1.1                  | 1    | 0    | 0    | 1          | 0.9        |

| Start Time   | Southbound |      |      |            | IMJIN PKWY Westbound |            |           |            | IMJIN RD Northbound |      |           |            | IMJIN PKWY Eastbound |            |      |            | Int. Total |
|--|------------|------|------|------------|----------------------|------------|-----------|------------|---------------------|------|-----------|------------|----------------------|------------|------|------------|------------|
|  | Right      | Thru | Left | App. Total | Right                | Thru       | Left      | App. Total | Right               | Thru | Left      | App. Total | Right                | Thru       | Left | App. Total |            |
| Peak Hour Analysis From 04:00 PM to 05:45 PM - Peak 1 of 1 |            |      |      |            |                      |            |           |            |                     |      |           |            |                      |            |      |            |            |
| Peak Hour for Entire Intersection Begins at 05:00 PM       |            |      |      |            |                      |            |           |            |                     |      |           |            |                      |            |      |            |            |
| 05:00 PM   | 0          | 0    | 0    | 0          | 0                    | 219        | 12        | 231        | 21                  | 0    | 34        | 55         | 14                   | <b>268</b> | 0    | <b>282</b> | 568        |
| 05:15 PM   | 0          | 0    | 0    | 0          | 0                    | <b>258</b> | 20        | <b>278</b> | <b>28</b>           | 0    | 31        | 59         | 11                   | 257        | 0    | 268        | <b>605</b> |
| 05:30 PM   | 0          | 0    | 0    | 0          | 0                    | 219        | <b>22</b> | 241        | 25                  | 0    | <b>43</b> | <b>68</b>  | 10                   | 256        | 0    | 266        | 575        |
| 05:45 PM   | 0          | 0    | 0    | 0          | 0                    | 205        | 20        | 225        | 20                  | 0    | 28        | 48         | <b>19</b>            | 255        | 0    | 274        | 547        |
| Total Volume   | 0          | 0    | 0    | 0          | 0                    | 901        | 74        | 975        | 94                  | 0    | 136       | 230        | 54                   | 1036       | 0    | 1090       | 2295       |
| % App. Total   | 0          | 0    | 0    | 0          | 0                    | 92.4       | 7.6       |            | 40.9                | 0    | 59.1      |            | 5                    | 95         | 0    |            |            |
| PHF  | .000       | .000 | .000 | .000       | .000                 | .873       | .841      | .877       | .839                | .000 | .791      | .846       | .711                 | .966       | .000 | .966       | .948       |

# Traffic Data Service

San Jose, CA  
 (408) 622-4787  
 tdsbay@cs.com

File Name : 7PM FINAL  
 Site Code : 00000007  
 Start Date : 4/27/2017  
 Page No : 2

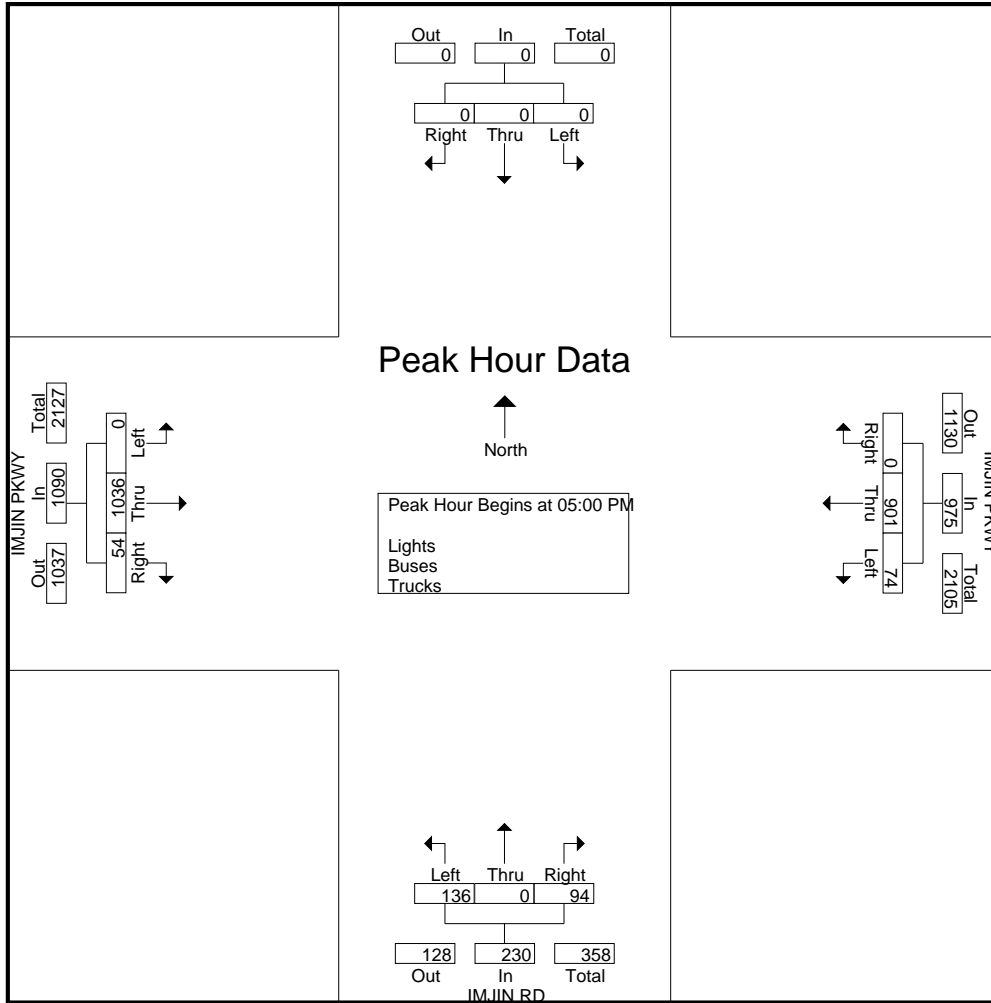

# Traffic Data Service

San Jose, CA  
(408) 622-4787  
tdsbay@cs.com

File Name : 7PM FINAL  
Site Code : 00000007  
Start Date : 4/27/2017  
Page No : 1

Groups Printed- Bikes

| Start Time   | Southbound |      |      |      |            | IMJIN PKWY Westbound |      |      |      |            | IMJIN RD Northbound |      |      |      |            | IMJIN PKWY Eastbound |      |      |      |            | Int. Total |
|--------------|------------|------|------|------|------------|----------------------|------|------|------|------------|---------------------|------|------|------|------------|----------------------|------|------|------|------------|------------|
|              | Right      | Thru | Left | Peds | App. Total | Right                | Thru | Left | Peds | App. Total | Right               | Thru | Left | Peds | App. Total | Right                | Thru | Left | Peds | App. Total |            |
| 04:00 PM     | 0          | 0    | 0    | 0    | 0          | 0                    | 0    | 0    | 0    | 0          | 0                   | 0    | 0    | 0    | 0          | 0                    | 0    | 0    | 0    | 0          | 0          |
| 04:15 PM     | 0          | 0    | 0    | 0    | 0          | 0                    | 1    | 0    | 0    | 1          | 1                   | 0    | 0    | 0    | 1          | 0                    | 0    | 0    | 0    | 0          | 2          |
| 04:30 PM     | 0          | 0    | 0    | 0    | 0          | 0                    | 0    | 0    | 0    | 0          | 0                   | 0    | 0    | 0    | 0          | 0                    | 0    | 0    | 0    | 0          | 0          |
| 04:45 PM     | 0          | 0    | 0    | 0    | 0          | 0                    | 0    | 0    | 0    | 0          | 0                   | 0    | 0    | 0    | 0          | 0                    | 0    | 0    | 0    | 0          | 0          |
| <b>Total</b> | 0          | 0    | 0    | 0    | 0          | 0                    | 1    | 0    | 0    | 1          | 1                   | 0    | 0    | 0    | 1          | 0                    | 0    | 0    | 0    | 0          | 2          |
| 05:00 PM     | 0          | 0    | 0    | 0    | 0          | 0                    | 1    | 0    | 0    | 1          | 0                   | 0    | 0    | 0    | 0          | 0                    | 0    | 0    | 0    | 0          | 1          |
| 05:15 PM     | 0          | 0    | 0    | 0    | 0          | 0                    | 1    | 0    | 0    | 1          | 0                   | 0    | 0    | 0    | 0          | 0                    | 0    | 0    | 0    | 0          | 1          |
| 05:30 PM     | 0          | 0    | 0    | 0    | 0          | 0                    | 0    | 0    | 0    | 0          | 0                   | 0    | 0    | 0    | 0          | 0                    | 0    | 0    | 0    | 0          | 0          |
| 05:45 PM     | 0          | 0    | 0    | 0    | 0          | 0                    | 0    | 0    | 0    | 0          | 0                   | 0    | 0    | 0    | 0          | 0                    | 0    | 0    | 0    | 0          | 0          |
| <b>Total</b> | 0          | 0    | 0    | 0    | 0          | 0                    | 2    | 0    | 0    | 2          | 0                   | 0    | 0    | 0    | 0          | 0                    | 0    | 0    | 0    | 0          | 2          |
| Grand Total  | 0          | 0    | 0    | 0    | 0          | 0                    | 3    | 0    | 0    | 3          | 1                   | 0    | 0    | 0    | 1          | 0                    | 0    | 0    | 0    | 0          | 4          |
| Apprch %     | 0          | 0    | 0    | 0    | 0          | 0                    | 100  | 0    | 0    | 100        | 100                 | 0    | 0    | 0    | 100        | 0                    | 0    | 0    | 0    | 0          |            |
| Total %      | 0          | 0    | 0    | 0    | 0          | 0                    | 75   | 0    | 0    | 75         | 25                  | 0    | 0    | 0    | 25         | 0                    | 0    | 0    | 0    | 0          |            |

| Start Time   | Southbound |      |      |      |            | IMJIN PKWY Westbound |      |      |      |            | IMJIN RD Northbound |      |      |      |            | IMJIN PKWY Eastbound |      |      |      |            | Int. Total |
|--|------------|------|------|------|------------|----------------------|------|------|------|------------|---------------------|------|------|------|------------|----------------------|------|------|------|------------|------------|
|  | Right      | Thru | Left | Peds | App. Total | Right                | Thru | Left | Peds | App. Total | Right               | Thru | Left | Peds | App. Total | Right                | Thru | Left | Peds | App. Total |            |
| Peak Hour Analysis From 04:00 PM to 05:45 PM - Peak 1 of 1 |            |      |      |      |            |                      |      |      |      |            |                     |      |      |      |            |                      |      |      |      |            |            |
| Peak Hour for Entire Intersection Begins at 04:15 PM       |            |      |      |      |            |                      |      |      |      |            |                     |      |      |      |            |                      |      |      |      |            |            |
| 04:15 PM   | 0          | 0    | 0    | 0    | 0          | 0                    | 1    | 0    | 0    | 1          | 1                   | 0    | 0    | 0    | 1          | 0                    | 0    | 0    | 0    | 0          | 2          |
| 04:30 PM   | 0          | 0    | 0    | 0    | 0          | 0                    | 0    | 0    | 0    | 0          | 0                   | 0    | 0    | 0    | 0          | 0                    | 0    | 0    | 0    | 0          | 0          |
| 04:45 PM   | 0          | 0    | 0    | 0    | 0          | 0                    | 0    | 0    | 0    | 0          | 0                   | 0    | 0    | 0    | 0          | 0                    | 0    | 0    | 0    | 0          | 0          |
| 05:00 PM   | 0          | 0    | 0    | 0    | 0          | 0                    | 1    | 0    | 0    | 1          | 0                   | 0    | 0    | 0    | 0          | 0                    | 0    | 0    | 0    | 0          | 1          |
| Total Volume   | 0          | 0    | 0    | 0    | 0          | 0                    | 2    | 0    | 0    | 2          | 1                   | 0    | 0    | 0    | 1          | 0                    | 0    | 0    | 0    | 0          | 3          |
| % App. Total   | 0          | 0    | 0    | 0    | 0          | 0                    | 100  | 0    | 0    | 100        | 100                 | 0    | 0    | 0    | 100        | 0                    | 0    | 0    | 0    | 0          |            |
| PHF  | .000       | .000 | .000 | .000 | .000       | .000                 | .500 | .000 | .000 | .500       | .250                | .000 | .000 | .000 | .250       | .000                 | .000 | .000 | .000 | .000       | .375       |

# Traffic Data Service

San Jose, CA  
 (408) 622-4787  
 tdsbay@cs.com

File Name : 7PM FINAL  
 Site Code : 00000007  
 Start Date : 4/27/2017  
 Page No : 2

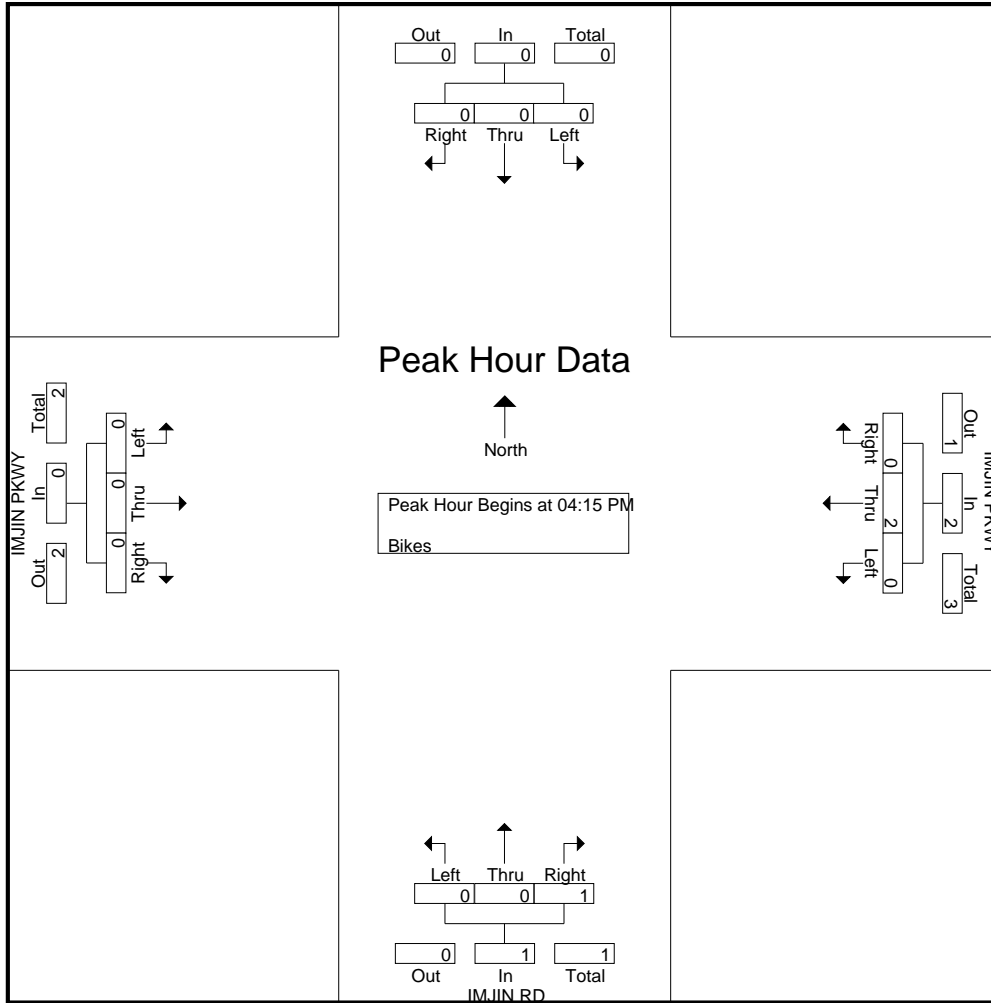



# Traffic Data Service

San Jose, CA  
(408) 622-4787  
tdsbay@cs.com

File Name : 8AM FINAL  
Site Code : 00000008  
Start Date : 4/27/2017  
Page No : 1

Groups Printed- Lights - Buses - Trucks

| Start Time   | ABRAMS DR Southbound |      |      |      |            | IMJIN PKWY Westbound |      |      |      |            | ABRAMS DR Northbound |      |      |      |            | IMJIN PKWY Eastbound |      |      |      |            | Int. Total |
|--------------|----------------------|------|------|------|------------|----------------------|------|------|------|------------|----------------------|------|------|------|------------|----------------------|------|------|------|------------|------------|
|              | Right                | Thru | Left | Peds | App. Total | Right                | Thru | Left | Peds | App. Total | Right                | Thru | Left | Peds | App. Total | Right                | Thru | Left | Peds | App. Total |            |
| 07:00 AM     | 45                   | 9    | 6    | 0    | 60         | 4                    | 226  | 11   | 0    | 241        | 13                   | 4    | 34   | 0    | 51         | 6                    | 116  | 2    | 2    | 126        | 478        |
| 07:15 AM     | 64                   | 15   | 11   | 0    | 90         | 2                    | 249  | 13   | 0    | 264        | 27                   | 5    | 36   | 1    | 69         | 6                    | 135  | 4    | 1    | 146        | 569        |
| 07:30 AM     | 55                   | 18   | 12   | 0    | 85         | 3                    | 225  | 21   | 0    | 249        | 36                   | 3    | 39   | 0    | 78         | 6                    | 175  | 7    | 0    | 188        | 600        |
| 07:45 AM     | 43                   | 3    | 8    | 0    | 54         | 5                    | 242  | 20   | 0    | 267        | 29                   | 4    | 27   | 0    | 60         | 11                   | 169  | 14   | 0    | 194        | 575        |
| <b>Total</b> | 207                  | 45   | 37   | 0    | 289        | 14                   | 942  | 65   | 0    | 1021       | 105                  | 16   | 136  | 1    | 258        | 29                   | 595  | 27   | 3    | 654        | 2222       |
| 08:00 AM     | 25                   | 6    | 2    | 0    | 33         | 7                    | 198  | 24   | 0    | 229        | 21                   | 6    | 25   | 0    | 52         | 8                    | 168  | 10   | 0    | 186        | 500        |
| 08:15 AM     | 23                   | 3    | 5    | 0    | 31         | 5                    | 245  | 16   | 0    | 266        | 21                   | 5    | 23   | 0    | 49         | 4                    | 169  | 12   | 0    | 185        | 531        |
| 08:30 AM     | 21                   | 5    | 10   | 0    | 36         | 7                    | 239  | 15   | 0    | 261        | 16                   | 5    | 23   | 0    | 44         | 5                    | 155  | 13   | 0    | 173        | 514        |
| 08:45 AM     | 14                   | 0    | 4    | 0    | 18         | 7                    | 186  | 11   | 0    | 204        | 19                   | 3    | 21   | 0    | 43         | 6                    | 124  | 6    | 0    | 136        | 401        |
| <b>Total</b> | 83                   | 14   | 21   | 0    | 118        | 26                   | 868  | 66   | 0    | 960        | 77                   | 19   | 92   | 0    | 188        | 23                   | 616  | 41   | 0    | 680        | 1946       |
| Grand Total  | 290                  | 59   | 58   | 0    | 407        | 40                   | 1810 | 131  | 0    | 1981       | 182                  | 35   | 228  | 1    | 446        | 52                   | 1211 | 68   | 3    | 1334       | 4168       |
| Apprch %     | 71.3                 | 14.5 | 14.3 | 0    |            | 2                    | 91.4 | 6.6  | 0    |            | 40.8                 | 7.8  | 51.1 | 0.2  |            | 3.9                  | 90.8 | 5.1  | 0.2  |            |            |
| Total %      | 7                    | 1.4  | 1.4  | 0    | 9.8        | 1                    | 43.4 | 3.1  | 0    | 47.5       | 4.4                  | 0.8  | 5.5  | 0    | 10.7       | 1.2                  | 29.1 | 1.6  | 0.1  | 32         |            |
| Lights       | 285                  | 57   | 57   | 0    | 399        | 40                   | 1763 | 123  | 0    | 1926       | 177                  | 27   | 224  | 1    | 429        | 50                   | 1184 | 68   | 3    | 1305       | 4059       |
| % Lights     | 98.3                 | 96.6 | 98.3 | 0    | 98         | 100                  | 97.4 | 93.9 | 0    | 97.2       | 97.3                 | 77.1 | 98.2 | 100  | 96.2       | 96.2                 | 97.8 | 100  | 100  | 97.8       | 97.4       |
| Buses        | 5                    | 1    | 1    | 0    | 7          | 0                    | 6    | 4    | 0    | 10         | 3                    | 6    | 1    | 0    | 10         | 2                    | 7    | 0    | 0    | 9          | 36         |
| % Buses      | 1.7                  | 1.7  | 1.7  | 0    | 1.7        | 0                    | 0.3  | 3.1  | 0    | 0.5        | 1.6                  | 17.1 | 0.4  | 0    | 2.2        | 3.8                  | 0.6  | 0    | 0    | 0.7        | 0.9        |
| Trucks       | 0                    | 1    | 0    | 0    | 1          | 0                    | 41   | 4    | 0    | 45         | 2                    | 2    | 3    | 0    | 7          | 0                    | 20   | 0    | 0    | 20         | 73         |
| % Trucks     | 0                    | 1.7  | 0    | 0    | 0.2        | 0                    | 2.3  | 3.1  | 0    | 2.3        | 1.1                  | 5.7  | 1.3  | 0    | 1.6        | 0                    | 1.7  | 0    | 0    | 1.5        | 1.8        |

| Start Time   | ABRAMS DR Southbound |           |           |      | App. Total | IMJIN PKWY Westbound |            |           |      | App. Total | ABRAMS DR Northbound |          |           |      | App. Total | IMJIN PKWY Eastbound |            |           |      | Int. Total |            |
|--|----------------------|-----------|-----------|------|------------|----------------------|------------|-----------|------|------------|----------------------|----------|-----------|------|------------|----------------------|------------|-----------|------|------------|------------|
|  | Right                | Thru      | Left      | Peds |            | Right                | Thru       | Left      | Peds |            | Right                | Thru     | Left      | Peds |            | Right                | Thru       | Left      | Peds |            |            |
| Peak Hour Analysis From 07:00 AM to 08:45 AM - Peak 1 of 1 |                      |           |           |      |            |                      |            |           |      |            |                      |          |           |      |            |                      |            |           |      |            |            |
| Peak Hour for Entire Intersection Begins at 07:15 AM       |                      |           |           |      |            |                      |            |           |      |            |                      |          |           |      |            |                      |            |           |      |            |            |
| 07:15 AM   | <b>64</b>            | 15        | 11        |      | <b>90</b>  | 2                    | <b>249</b> | 13        |      | 264        | 27                   | 5        | 36        |      | 68         | 6                    | 135        | 4         |      | 145        | 567        |
| 07:30 AM   | 55                   | <b>18</b> | <b>12</b> |      | 85         | 3                    | 225        | 21        |      | 249        | <b>36</b>            | 3        | <b>39</b> |      | <b>78</b>  | 6                    | <b>175</b> | 7         |      | 188        | <b>600</b> |
| 07:45 AM   | 43                   | 3         | 8         |      | 54         | 5                    | 242        | 20        |      | <b>267</b> | 29                   | 4        | 27        |      | 60         | <b>11</b>            | 169        | <b>14</b> |      | <b>194</b> | 575        |
| 08:00 AM   | 25                   | 6         | 2         |      | 33         | <b>7</b>             | 198        | <b>24</b> |      | 229        | 21                   | <b>6</b> | 25        |      | 52         | 8                    | 168        | 10        |      | 186        | 500        |
| Total Volume   | 187                  | 42        | 33        |      | 262        | 17                   | 914        | 78        |      | 1009       | 113                  | 18       | 127       |      | 258        | 31                   | 647        | 35        |      | 713        | 2242       |
| % App. Total   | 71.4                 | 16        | 12.6      |      |            | 1.7                  | 90.6       | 7.7       |      |            | 43.8                 | 7        | 49.2      |      |            | 4.3                  | 90.7       | 4.9       |      |            |            |
| PHF  | .730                 | .583      | .688      |      | .728       | .607                 | .918       | .813      |      | .945       | .785                 | .750     | .814      |      | .827       | .705                 | .924       | .625      |      | .919       | .934       |

# Traffic Data Service

San Jose, CA  
 (408) 622-4787  
 tdsbay@cs.com

File Name : 8AM FINAL  
 Site Code : 00000008  
 Start Date : 4/27/2017  
 Page No : 2

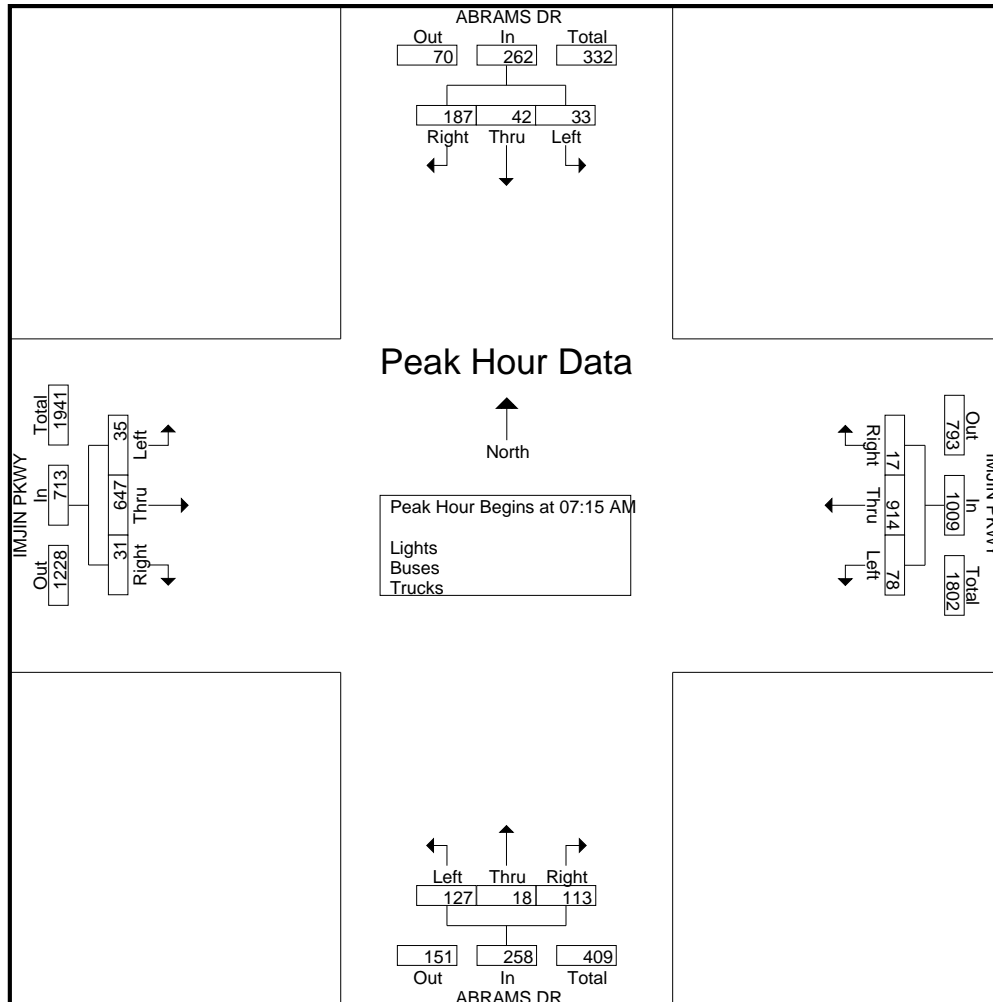

# Traffic Data Service

San Jose, CA  
 (408) 622-4787  
 tdsbay@cs.com

File Name : 8AM FINAL  
 Site Code : 00000008  
 Start Date : 4/27/2017  
 Page No : 1

Groups Printed- Bikes

| Start Time   | ABRAMS DR Southbound |      |      |      |            | IMJIN PKWY Westbound |      |      |      |            | ABRAMS DR Northbound |      |      |      |            | IMJIN PKWY Eastbound |      |      |      |            | Int. Total |
|--------------|----------------------|------|------|------|------------|----------------------|------|------|------|------------|----------------------|------|------|------|------------|----------------------|------|------|------|------------|------------|
|              | Right                | Thru | Left | Peds | App. Total | Right                | Thru | Left | Peds | App. Total | Right                | Thru | Left | Peds | App. Total | Right                | Thru | Left | Peds | App. Total |            |
| 07:00 AM     | 0                    | 0    | 0    | 0    | 0          | 0                    | 0    | 0    | 0    | 0          | 0                    | 0    | 0    | 0    | 0          | 0                    | 0    | 0    | 0    | 0          | 0          |
| 07:15 AM     | 0                    | 0    | 0    | 0    | 0          | 1                    | 0    | 0    | 0    | 1          | 0                    | 0    | 0    | 0    | 0          | 0                    | 0    | 0    | 0    | 0          | 0          |
| 07:30 AM     | 0                    | 0    | 0    | 0    | 0          | 0                    | 0    | 0    | 0    | 0          | 0                    | 0    | 0    | 0    | 0          | 0                    | 0    | 0    | 0    | 0          | 0          |
| 07:45 AM     | 0                    | 0    | 0    | 0    | 0          | 0                    | 0    | 0    | 0    | 0          | 0                    | 0    | 0    | 0    | 0          | 0                    | 0    | 0    | 0    | 0          | 0          |
| <b>Total</b> | 0                    | 0    | 0    | 0    | 0          | 1                    | 0    | 0    | 0    | 1          | 0                    | 0    | 0    | 0    | 0          | 0                    | 0    | 0    | 0    | 0          | 1          |
| 08:00 AM     | 0                    | 0    | 0    | 0    | 0          | 0                    | 0    | 0    | 0    | 0          | 1                    | 0    | 0    | 0    | 1          | 0                    | 0    | 0    | 0    | 0          | 1          |
| 08:15 AM     | 0                    | 0    | 0    | 0    | 0          | 0                    | 0    | 0    | 0    | 0          | 0                    | 0    | 0    | 0    | 0          | 0                    | 0    | 0    | 0    | 0          | 0          |
| 08:30 AM     | 0                    | 0    | 0    | 0    | 0          | 0                    | 0    | 0    | 0    | 0          | 0                    | 0    | 0    | 0    | 0          | 0                    | 0    | 0    | 0    | 0          | 0          |
| 08:45 AM     | 0                    | 0    | 0    | 0    | 0          | 0                    | 0    | 0    | 0    | 0          | 0                    | 0    | 0    | 0    | 0          | 0                    | 0    | 0    | 0    | 0          | 0          |
| <b>Total</b> | 0                    | 0    | 0    | 0    | 0          | 0                    | 0    | 0    | 0    | 0          | 1                    | 0    | 0    | 0    | 1          | 0                    | 0    | 0    | 0    | 0          | 1          |
| Grand Total  | 0                    | 0    | 0    | 0    | 0          | 1                    | 0    | 0    | 0    | 1          | 1                    | 0    | 0    | 0    | 1          | 0                    | 0    | 0    | 0    | 0          | 2          |
| Apprch %     | 0                    | 0    | 0    | 0    | 0          | 100                  | 0    | 0    | 0    | 100        | 100                  | 0    | 0    | 0    | 100        | 0                    | 0    | 0    | 0    | 0          |            |
| Total %      | 0                    | 0    | 0    | 0    | 0          | 50                   | 0    | 0    | 0    | 50         | 50                   | 0    | 0    | 0    | 50         | 0                    | 0    | 0    | 0    | 0          |            |

| Start Time   | ABRAMS DR Southbound |      |      |            | IMJIN PKWY Westbound |      |      |            | ABRAMS DR Northbound |      |      |            | IMJIN PKWY Eastbound |      |      |            | Int. Total |
|--|----------------------|------|------|------------|----------------------|------|------|------------|----------------------|------|------|------------|----------------------|------|------|------------|------------|
|  | Right                | Thru | Left | App. Total | Right                | Thru | Left | App. Total | Right                | Thru | Left | App. Total | Right                | Thru | Left | App. Total |            |
| Peak Hour Analysis From 07:00 AM to 08:45 AM - Peak 1 of 1 |                      |      |      |            |                      |      |      |            |                      |      |      |            |                      |      |      |            |            |
| Peak Hour for Entire Intersection Begins at 07:15 AM       |                      |      |      |            |                      |      |      |            |                      |      |      |            |                      |      |      |            |            |
| 07:15 AM   | 0                    | 0    | 0    | 0          | 1                    | 0    | 0    | 1          | 0                    | 0    | 0    | 0          | 0                    | 0    | 0    | 0          | 1          |
| 07:30 AM   | 0                    | 0    | 0    | 0          | 0                    | 0    | 0    | 0          | 0                    | 0    | 0    | 0          | 0                    | 0    | 0    | 0          | 0          |
| 07:45 AM   | 0                    | 0    | 0    | 0          | 0                    | 0    | 0    | 0          | 0                    | 0    | 0    | 0          | 0                    | 0    | 0    | 0          | 0          |
| 08:00 AM   | 0                    | 0    | 0    | 0          | 0                    | 0    | 0    | 0          | 1                    | 0    | 0    | 1          | 0                    | 0    | 0    | 0          | 1          |
| Total Volume   | 0                    | 0    | 0    | 0          | 1                    | 0    | 0    | 1          | 1                    | 0    | 0    | 1          | 0                    | 0    | 0    | 0          | 2          |
| % App. Total   | 0                    | 0    | 0    | 0          | 100                  | 0    | 0    | 100        | 100                  | 0    | 0    | 100        | 0                    | 0    | 0    | 0          |            |
| PHF  | .000                 | .000 | .000 | .000       | .250                 | .000 | .000 | .250       | .250                 | .000 | .000 | .250       | .000                 | .000 | .000 | .000       | .500       |

# Traffic Data Service

San Jose, CA  
 (408) 622-4787  
 tdsbay@cs.com

File Name : 8AM FINAL  
 Site Code : 00000008  
 Start Date : 4/27/2017  
 Page No : 2

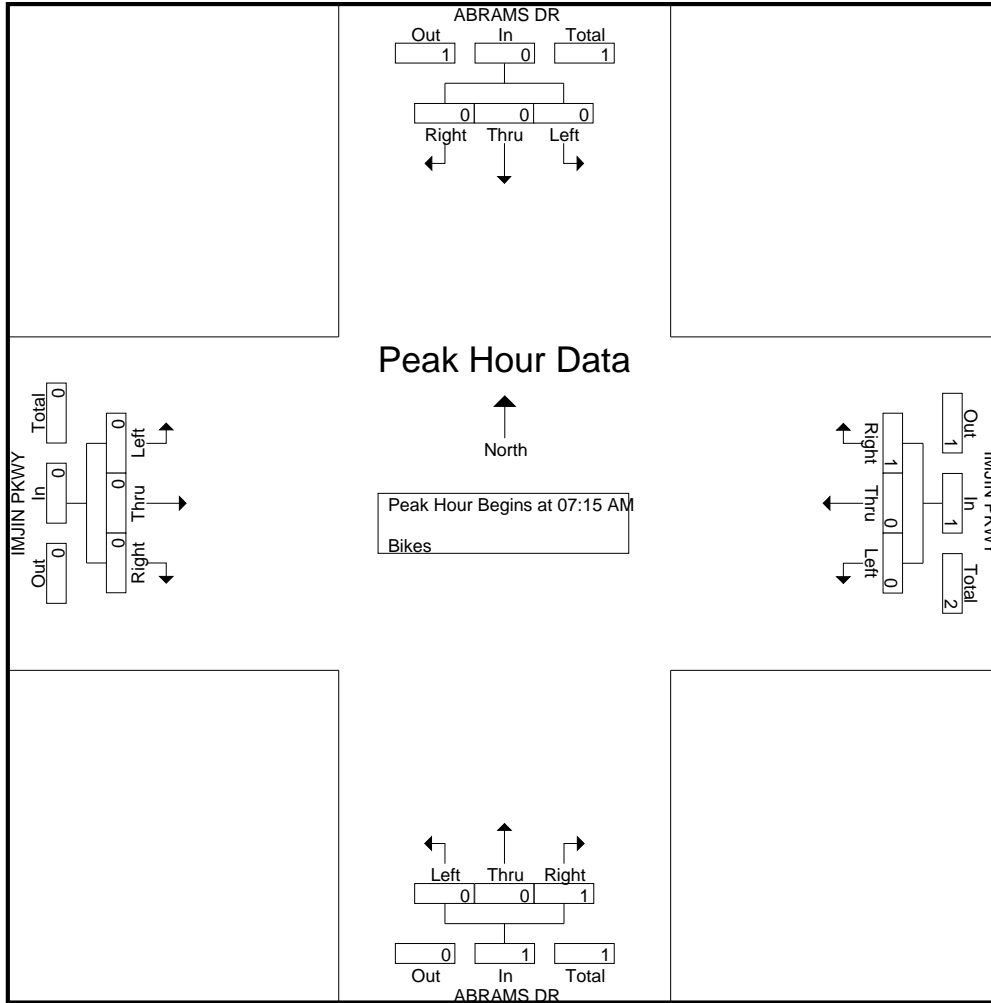

# Traffic Data Service

San Jose, CA  
 (408) 622-4787  
 tdsbay@cs.com

File Name : 8PM FINAL  
 Site Code : 00000008  
 Start Date : 4/27/2017  
 Page No : 1

## Groups Printed- Lights - Buses - Trucks

| Start Time  | ABRAMS DR Southbound |      |      |      |            | IMJIN PKWY Westbound |      |      |      |            | ABRAMS DR Northbound |      |      |      |            | IMJIN PKWY Eastbound |      |      |      |            | Int. Total |
|-------------|----------------------|------|------|------|------------|----------------------|------|------|------|------------|----------------------|------|------|------|------------|----------------------|------|------|------|------------|------------|
|             | Right                | Thru | Left | Peds | App. Total | Right                | Thru | Left | Peds | App. Total | Right                | Thru | Left | Peds | App. Total | Right                | Thru | Left | Peds | App. Total |            |
| 04:00 PM    | 19                   | 2    | 7    | 1    | 29         | 13                   | 163  | 37   | 0    | 213        | 43                   | 0    | 30   | 0    | 73         | 25                   | 219  | 19   | 0    | 263        | 578        |
| 04:15 PM    | 17                   | 2    | 7    | 1    | 27         | 9                    | 149  | 23   | 0    | 181        | 23                   | 1    | 31   | 0    | 55         | 29                   | 253  | 19   | 2    | 303        | 566        |
| 04:30 PM    | 20                   | 1    | 9    | 0    | 30         | 9                    | 187  | 31   | 0    | 227        | 34                   | 10   | 25   | 0    | 69         | 21                   | 222  | 15   | 1    | 259        | 585        |
| 04:45 PM    | 23                   | 2    | 8    | 0    | 33         | 9                    | 179  | 25   | 0    | 213        | 44                   | 4    | 22   | 0    | 70         | 19                   | 230  | 22   | 0    | 271        | 587        |
| Total       | 79                   | 7    | 31   | 2    | 119        | 40                   | 678  | 116  | 0    | 834        | 144                  | 15   | 108  | 0    | 267        | 94                   | 924  | 75   | 3    | 1096       | 2316       |
| 05:00 PM    | 16                   | 4    | 3    | 0    | 23         | 16                   | 193  | 36   | 0    | 245        | 34                   | 6    | 30   | 0    | 70         | 30                   | 219  | 25   | 1    | 275        | 613        |
| 05:15 PM    | 17                   | 2    | 5    | 0    | 24         | 9                    | 247  | 28   | 0    | 284        | 43                   | 3    | 24   | 0    | 70         | 25                   | 244  | 25   | 0    | 294        | 672        |
| 05:30 PM    | 30                   | 5    | 6    | 0    | 41         | 14                   | 188  | 51   | 0    | 253        | 39                   | 7    | 25   | 0    | 71         | 31                   | 206  | 23   | 0    | 260        | 625        |
| 05:45 PM    | 21                   | 3    | 10   | 0    | 34         | 14                   | 168  | 44   | 0    | 226        | 45                   | 4    | 30   | 0    | 79         | 28                   | 211  | 19   | 0    | 258        | 597        |
| Total       | 84                   | 14   | 24   | 0    | 122        | 53                   | 796  | 159  | 0    | 1008       | 161                  | 20   | 109  | 0    | 290        | 114                  | 880  | 92   | 1    | 1087       | 2507       |
| Grand Total | 163                  | 21   | 55   | 2    | 241        | 93                   | 1474 | 275  | 0    | 1842       | 305                  | 35   | 217  | 0    | 557        | 208                  | 1804 | 167  | 4    | 2183       | 4823       |
| Apprch %    | 67.6                 | 8.7  | 22.8 | 0.8  |            | 5                    | 80   | 14.9 | 0    |            | 54.8                 | 6.3  | 39   | 0    |            | 9.5                  | 82.6 | 7.7  | 0.2  |            |            |
| Total %     | 3.4                  | 0.4  | 1.1  | 0    | 5          | 1.9                  | 30.6 | 5.7  | 0    | 38.2       | 6.3                  | 0.7  | 4.5  | 0    | 11.5       | 4.3                  | 37.4 | 3.5  | 0.1  | 45.3       |            |
| Lights      | 162                  | 17   | 55   | 2    | 236        | 93                   | 1454 | 272  | 0    | 1819       | 301                  | 33   | 209  | 0    | 543        | 206                  | 1778 | 167  | 4    | 2155       | 4753       |
| % Lights    | 99.4                 | 81   | 100  | 100  | 97.9       | 100                  | 98.6 | 98.9 | 0    | 98.8       | 98.7                 | 94.3 | 96.3 | 0    | 97.5       | 99                   | 98.6 | 100  | 100  | 98.7       | 98.5       |
| Buses       | 1                    | 4    | 0    | 0    | 5          | 0                    | 6    | 2    | 0    | 8          | 2                    | 2    | 1    | 0    | 5          | 1                    | 4    | 0    | 0    | 5          | 23         |
| % Buses     | 0.6                  | 19   | 0    | 0    | 2.1        | 0                    | 0.4  | 0.7  | 0    | 0.4        | 0.7                  | 5.7  | 0.5  | 0    | 0.9        | 0.5                  | 0.2  | 0    | 0    | 0.2        | 0.5        |
| Trucks      | 0                    | 0    | 0    | 0    | 0          | 0                    | 14   | 1    | 0    | 15         | 2                    | 0    | 7    | 0    | 9          | 1                    | 22   | 0    | 0    | 23         | 47         |
| % Trucks    | 0                    | 0    | 0    | 0    | 0          | 0                    | 0.9  | 0.4  | 0    | 0.8        | 0.7                  | 0    | 3.2  | 0    | 1.6        | 0.5                  | 1.2  | 0    | 0    | 1.1        | 1          |

| Start Time   | ABRAMS DR Southbound |      |      |            | IMJIN PKWY Westbound |      |      |            | ABRAMS DR Northbound |      |      |            | IMJIN PKWY Eastbound |      |      |            | Int. Total |
|--|----------------------|------|------|------------|----------------------|------|------|------------|----------------------|------|------|------------|----------------------|------|------|------------|------------|
|  | Right                | Thru | Left | App. Total | Right                | Thru | Left | App. Total | Right                | Thru | Left | App. Total | Right                | Thru | Left | App. Total |            |
| Peak Hour Analysis From 04:00 PM to 05:45 PM - Peak 1 of 1 |                      |      |      |            |                      |      |      |            |                      |      |      |            |                      |      |      |            |            |
| Peak Hour for Entire Intersection Begins at 05:00 PM       |                      |      |      |            |                      |      |      |            |                      |      |      |            |                      |      |      |            |            |
| 05:00 PM   | 16                   | 4    | 3    | 23         | 16                   | 193  | 36   | 245        | 34                   | 6    | 30   | 70         | 30                   | 219  | 25   | 274        | 612        |
| 05:15 PM   | 17                   | 2    | 5    | 24         | 9                    | 247  | 28   | 284        | 43                   | 3    | 24   | 70         | 25                   | 244  | 25   | 294        | 672        |
| 05:30 PM   | 30                   | 5    | 6    | 41         | 14                   | 188  | 51   | 253        | 39                   | 7    | 25   | 71         | 31                   | 206  | 23   | 260        | 625        |
| 05:45 PM   | 21                   | 3    | 10   | 34         | 14                   | 168  | 44   | 226        | 45                   | 4    | 30   | 79         | 28                   | 211  | 19   | 258        | 597        |
| Total Volume   | 84                   | 14   | 24   | 122        | 53                   | 796  | 159  | 1008       | 161                  | 20   | 109  | 290        | 114                  | 880  | 92   | 1086       | 2506       |
| % App. Total   | 68.9                 | 11.5 | 19.7 |            | 5.3                  | 79   | 15.8 |            | 55.5                 | 6.9  | 37.6 |            | 10.5                 | 81   | 8.5  |            |            |
| PHF  | .700                 | .700 | .600 | .744       | .828                 | .806 | .779 | .887       | .894                 | .714 | .908 | .918       | .919                 | .902 | .920 | .923       | .932       |

# Traffic Data Service

San Jose, CA  
 (408) 622-4787  
 tdsbay@cs.com

File Name : 8PM FINAL  
 Site Code : 00000008  
 Start Date : 4/27/2017  
 Page No : 2

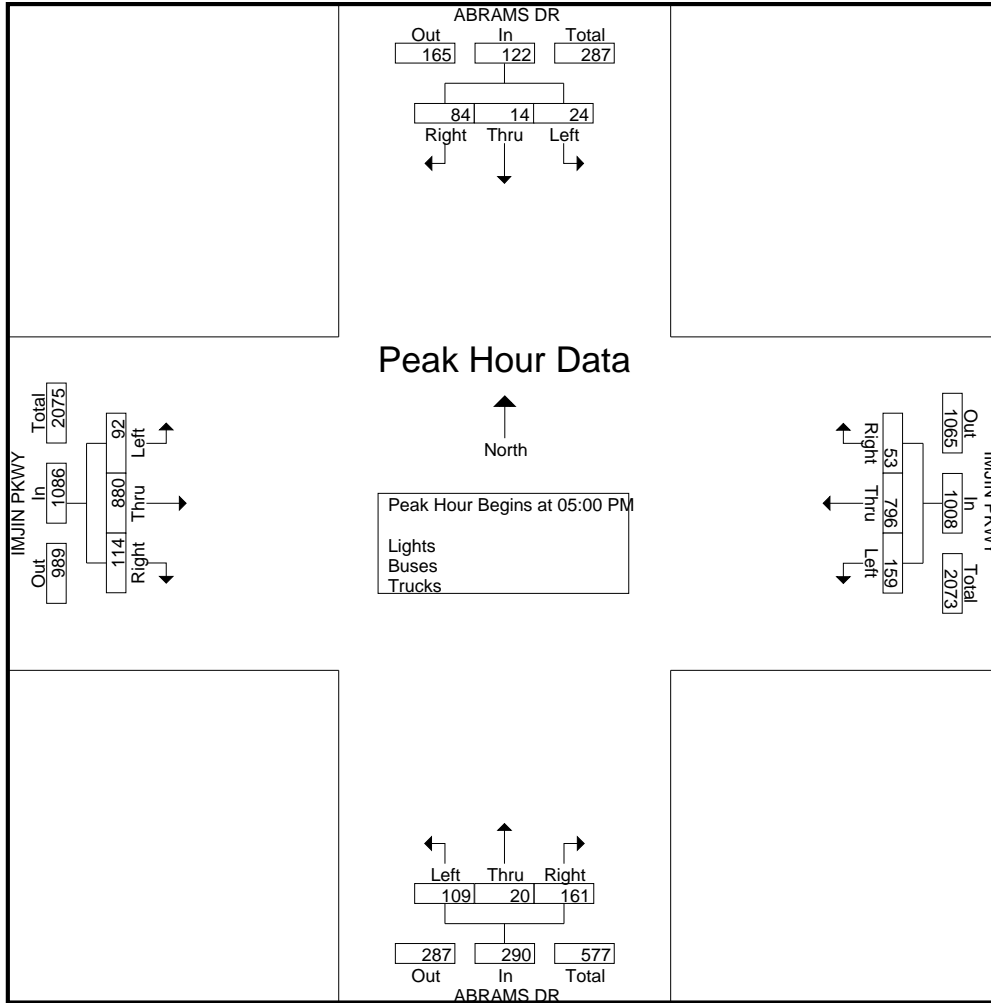

# Traffic Data Service

San Jose, CA  
 (408) 622-4787  
 tdsbay@cs.com

File Name : 8PM FINAL  
 Site Code : 00000008  
 Start Date : 4/27/2017  
 Page No : 1

Groups Printed- Bikes

| Start Time  | ABRAMS DR Southbound |      |      |      |            | IMJIN PKWY Westbound |      |      |      |            | ABRAMS DR Northbound |      |      |      |            | IMJIN PKWY Eastbound |      |      |      |            | Int. Total |   |
|-------------|----------------------|------|------|------|------------|----------------------|------|------|------|------------|----------------------|------|------|------|------------|----------------------|------|------|------|------------|------------|---|
|             | Right                | Thru | Left | Peds | App. Total | Right                | Thru | Left | Peds | App. Total | Right                | Thru | Left | Peds | App. Total | Right                | Thru | Left | Peds | App. Total |            |   |
| 04:00 PM    | 0                    | 0    | 0    | 0    | 0          | 0                    | 0    | 0    | 0    | 0          | 0                    | 0    | 0    | 0    | 0          | 0                    | 0    | 0    | 0    | 0          | 0          | 0 |
| 04:15 PM    | 0                    | 0    | 0    | 0    | 0          | 0                    | 0    | 0    | 0    | 0          | 0                    | 0    | 0    | 0    | 0          | 0                    | 0    | 0    | 0    | 0          | 0          | 0 |
| 04:30 PM    | 0                    | 0    | 0    | 0    | 0          | 0                    | 0    | 0    | 0    | 0          | 0                    | 0    | 0    | 0    | 0          | 0                    | 0    | 0    | 0    | 0          | 0          | 0 |
| 04:45 PM    | 0                    | 0    | 0    | 0    | 0          | 0                    | 0    | 0    | 0    | 0          | 0                    | 0    | 0    | 0    | 0          | 0                    | 0    | 0    | 0    | 0          | 0          | 0 |
| Total       | 0                    | 0    | 0    | 0    | 0          | 0                    | 0    | 0    | 0    | 0          | 0                    | 0    | 0    | 0    | 0          | 0                    | 0    | 0    | 0    | 0          | 0          | 0 |
| 05:00 PM    | 0                    | 0    | 0    | 0    | 0          | 0                    | 0    | 0    | 0    | 0          | 0                    | 0    | 0    | 0    | 0          | 0                    | 0    | 0    | 0    | 0          | 0          | 0 |
| 05:15 PM    | 0                    | 0    | 0    | 0    | 0          | 0                    | 0    | 1    | 0    | 1          | 0                    | 1    | 0    | 0    | 1          | 0                    | 0    | 0    | 0    | 0          | 0          | 2 |
| 05:30 PM    | 0                    | 0    | 0    | 0    | 0          | 0                    | 0    | 0    | 0    | 0          | 0                    | 0    | 0    | 0    | 0          | 0                    | 0    | 0    | 0    | 0          | 0          | 0 |
| 05:45 PM    | 0                    | 0    | 0    | 0    | 0          | 0                    | 0    | 1    | 0    | 1          | 0                    | 0    | 0    | 0    | 0          | 0                    | 0    | 0    | 0    | 0          | 0          | 1 |
| Total       | 0                    | 0    | 0    | 0    | 0          | 0                    | 0    | 2    | 0    | 2          | 0                    | 1    | 0    | 0    | 1          | 0                    | 0    | 0    | 0    | 0          | 0          | 3 |
| Grand Total | 0                    | 0    | 0    | 0    | 0          | 0                    | 0    | 2    | 0    | 2          | 0                    | 1    | 0    | 0    | 1          | 0                    | 0    | 0    | 0    | 0          | 0          | 3 |
| Apprch %    | 0                    | 0    | 0    | 0    |            | 0                    | 0    | 100  | 0    |            | 0                    | 100  | 0    | 0    |            | 0                    | 0    | 0    | 0    |            |            |   |
| Total %     | 0                    | 0    | 0    | 0    |            | 0                    | 0    | 66.7 | 0    | 66.7       | 0                    | 33.3 | 0    | 0    | 33.3       | 0                    | 0    | 0    | 0    |            |            |   |

| Start Time   | ABRAMS DR Southbound |      |      |      |            | IMJIN PKWY Westbound |      |      |      |            | ABRAMS DR Northbound |      |      |      |            | IMJIN PKWY Eastbound |      |      |      |            | Int. Total |      |
|--------------|----------------------|------|------|------|------------|----------------------|------|------|------|------------|----------------------|------|------|------|------------|----------------------|------|------|------|------------|------------|------|
|              | Right                | Thru | Left | Peds | App. Total | Right                | Thru | Left | Peds | App. Total | Right                | Thru | Left | Peds | App. Total | Right                | Thru | Left | Peds | App. Total |            |      |
| 05:00 PM     | 0                    | 0    | 0    | 0    | 0          | 0                    | 0    | 0    | 0    | 0          | 0                    | 0    | 0    | 0    | 0          | 0                    | 0    | 0    | 0    | 0          | 0          | 0    |
| 05:15 PM     | 0                    | 0    | 0    | 0    | 0          | 0                    | 0    | 1    | 0    | 1          | 0                    | 1    | 0    | 0    | 1          | 0                    | 0    | 0    | 0    | 0          | 0          | 2    |
| 05:30 PM     | 0                    | 0    | 0    | 0    | 0          | 0                    | 0    | 0    | 0    | 0          | 0                    | 0    | 0    | 0    | 0          | 0                    | 0    | 0    | 0    | 0          | 0          | 0    |
| 05:45 PM     | 0                    | 0    | 0    | 0    | 0          | 0                    | 0    | 1    | 0    | 1          | 0                    | 0    | 0    | 0    | 0          | 0                    | 0    | 0    | 0    | 0          | 0          | 1    |
| Total Volume | 0                    | 0    | 0    | 0    | 0          | 0                    | 0    | 2    | 0    | 2          | 0                    | 1    | 0    | 0    | 1          | 0                    | 0    | 0    | 0    | 0          | 0          | 3    |
| % App. Total | 0                    | 0    | 0    | 0    |            | 0                    | 0    | 100  | 0    |            | 0                    | 100  | 0    | 0    |            | 0                    | 0    | 0    | 0    |            |            |      |
| PHF          | .000                 | .000 | .000 | .000 |            | .000                 | .000 | .500 | .000 | .500       | .000                 | .250 | .000 | .000 | .250       | .000                 | .000 | .000 | .000 |            |            | .375 |

Peak Hour Analysis From 04:00 PM to 05:45 PM - Peak 1 of 1  
 Peak Hour for Entire Intersection Begins at 05:00 PM

# Traffic Data Service

San Jose, CA  
 (408) 622-4787  
 tdsbay@cs.com

File Name : 8PM FINAL  
 Site Code : 00000008  
 Start Date : 4/27/2017  
 Page No : 2

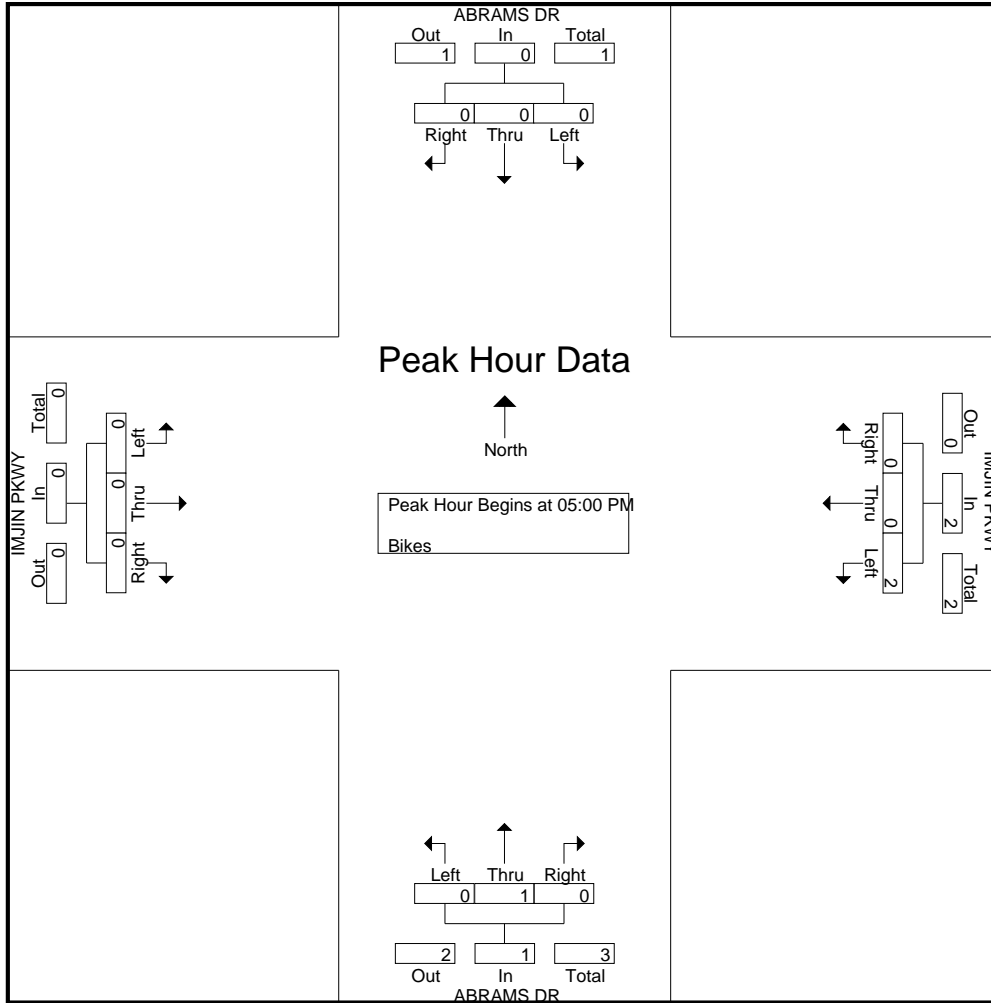



# Traffic Data Service

San Jose, CA  
(408) 622-4787  
tdsbay@cs.com

File Name : 9AM FINAL  
Site Code : 00000009  
Start Date : 4/27/2017  
Page No : 1

## Groups Printed- Lights - Buses - Trucks

| Start Time  | IMJIN RD Southbound |      |      |      |            | RESERVATION RD Westbound |      |      |      |            | IMJIN PKWY Northbound |      |      |      |            | RESERVATION RD Eastbound |      |      |      |            | Int. Total |
|-------------|---------------------|------|------|------|------------|--------------------------|------|------|------|------------|-----------------------|------|------|------|------------|--------------------------|------|------|------|------------|------------|
|             | Right               | Thru | Left | Peds | App. Total | Right                    | Thru | Left | Peds | App. Total | Right                 | Thru | Left | Peds | App. Total | Right                    | Thru | Left | Peds | App. Total |            |
| 07:00 AM    | 1                   | 2    | 0    | 0    | 3          | 5                        | 175  | 265  | 0    | 445        | 110                   | 4    | 10   | 0    | 124        | 12                       | 93   | 1    | 0    | 106        | 678        |
| 07:15 AM    | 5                   | 1    | 1    | 0    | 7          | 4                        | 185  | 260  | 0    | 449        | 171                   | 13   | 20   | 0    | 204        | 11                       | 107  | 5    | 1    | 124        | 784        |
| 07:30 AM    | 2                   | 1    | 1    | 0    | 4          | 3                        | 166  | 233  | 0    | 402        | 190                   | 3    | 33   | 1    | 227        | 20                       | 176  | 9    | 0    | 205        | 838        |
| 07:45 AM    | 4                   | 1    | 0    | 0    | 5          | 7                        | 150  | 198  | 0    | 355        | 198                   | 8    | 48   | 0    | 254        | 22                       | 139  | 11   | 0    | 172        | 786        |
| Total       | 12                  | 5    | 2    | 0    | 19         | 19                       | 676  | 956  | 0    | 1651       | 669                   | 28   | 111  | 1    | 809        | 65                       | 515  | 26   | 1    | 607        | 3086       |
| 08:00 AM    | 4                   | 4    | 1    | 0    | 9          | 5                        | 122  | 206  | 0    | 333        | 170                   | 4    | 14   | 2    | 190        | 31                       | 120  | 11   | 0    | 162        | 694        |
| 08:15 AM    | 2                   | 5    | 1    | 0    | 8          | 5                        | 125  | 250  | 0    | 380        | 174                   | 7    | 17   | 0    | 198        | 17                       | 95   | 10   | 0    | 122        | 708        |
| 08:30 AM    | 0                   | 1    | 0    | 0    | 1          | 5                        | 89   | 220  | 0    | 314        | 167                   | 10   | 15   | 0    | 192        | 19                       | 96   | 13   | 0    | 128        | 635        |
| 08:45 AM    | 2                   | 4    | 2    | 0    | 8          | 7                        | 96   | 183  | 0    | 286        | 119                   | 14   | 10   | 1    | 144        | 11                       | 95   | 8    | 0    | 114        | 552        |
| Total       | 8                   | 14   | 4    | 0    | 26         | 22                       | 432  | 859  | 0    | 1313       | 630                   | 35   | 56   | 3    | 724        | 78                       | 406  | 42   | 0    | 526        | 2589       |
| Grand Total | 20                  | 19   | 6    | 0    | 45         | 41                       | 1108 | 1815 | 0    | 2964       | 1299                  | 63   | 167  | 4    | 1533       | 143                      | 921  | 68   | 1    | 1133       | 5675       |
| Apprch %    | 44.4                | 42.2 | 13.3 | 0    |            | 1.4                      | 37.4 | 61.2 | 0    |            | 84.7                  | 4.1  | 10.9 | 0.3  |            | 12.6                     | 81.3 | 6    | 0.1  |            |            |
| Total %     | 0.4                 | 0.3  | 0.1  | 0    | 0.8        | 0.7                      | 19.5 | 32   | 0    | 52.2       | 22.9                  | 1.1  | 2.9  | 0.1  | 27         | 2.5                      | 16.2 | 1.2  | 0    | 20         |            |
| Lights      | 18                  | 16   | 5    | 0    | 39         | 41                       | 1079 | 1763 | 0    | 2883       | 1269                  | 61   | 162  | 4    | 1496       | 136                      | 903  | 67   | 1    | 1107       | 5525       |
| % Lights    | 90                  | 84.2 | 83.3 | 0    | 86.7       | 100                      | 97.4 | 97.1 | 0    | 97.3       | 97.7                  | 96.8 | 97   | 100  | 97.6       | 95.1                     | 98   | 98.5 | 100  | 97.7       | 97.4       |
| Buses       | 0                   | 0    | 0    | 0    | 0          | 0                        | 9    | 7    | 0    | 16         | 8                     | 0    | 4    | 0    | 12         | 4                        | 6    | 0    | 0    | 10         | 38         |
| % Buses     | 0                   | 0    | 0    | 0    | 0          | 0                        | 0.8  | 0.4  | 0    | 0.5        | 0.6                   | 0    | 2.4  | 0    | 0.8        | 2.8                      | 0.7  | 0    | 0    | 0.9        | 0.7        |
| Trucks      | 2                   | 3    | 1    | 0    | 6          | 0                        | 20   | 45   | 0    | 65         | 22                    | 2    | 1    | 0    | 25         | 3                        | 12   | 1    | 0    | 16         | 112        |
| % Trucks    | 10                  | 15.8 | 16.7 | 0    | 13.3       | 0                        | 1.8  | 2.5  | 0    | 2.2        | 1.7                   | 3.2  | 0.6  | 0    | 1.6        | 2.1                      | 1.3  | 1.5  | 0    | 1.4        | 2          |

| Start Time   | IMJIN RD Southbound |      |      |            | RESERVATION RD Westbound |      |      |            | IMJIN PKWY Northbound |      |      |            | RESERVATION RD Eastbound |      |      |            | Int. Total |
|--|---------------------|------|------|------------|--------------------------|------|------|------------|-----------------------|------|------|------------|--------------------------|------|------|------------|------------|
|  | Right               | Thru | Left | App. Total | Right                    | Thru | Left | App. Total | Right                 | Thru | Left | App. Total | Right                    | Thru | Left | App. Total |            |
| Peak Hour Analysis From 07:00 AM to 08:45 AM - Peak 1 of 1 |                     |      |      |            |                          |      |      |            |                       |      |      |            |                          |      |      |            |            |
| Peak Hour for Entire Intersection Begins at 07:15 AM       |                     |      |      |            |                          |      |      |            |                       |      |      |            |                          |      |      |            |            |
| 07:15 AM   | 5                   | 1    | 1    | 7          | 4                        | 185  | 260  | 449        | 171                   | 13   | 20   | 204        | 11                       | 107  | 5    | 123        | 783        |
| 07:30 AM   | 2                   | 1    | 1    | 4          | 3                        | 166  | 233  | 402        | 190                   | 3    | 33   | 226        | 20                       | 176  | 9    | 205        | 837        |
| 07:45 AM   | 4                   | 1    | 0    | 5          | 7                        | 150  | 198  | 355        | 198                   | 8    | 48   | 254        | 22                       | 139  | 11   | 172        | 786        |
| 08:00 AM   | 4                   | 4    | 1    | 9          | 5                        | 122  | 206  | 333        | 170                   | 4    | 14   | 188        | 31                       | 120  | 11   | 162        | 692        |
| Total Volume   | 15                  | 7    | 3    | 25         | 19                       | 623  | 897  | 1539       | 729                   | 28   | 115  | 872        | 84                       | 542  | 36   | 662        | 3098       |
| % App. Total   | 60                  | 28   | 12   |            | 1.2                      | 40.5 | 58.3 |            | 83.6                  | 3.2  | 13.2 |            | 12.7                     | 81.9 | 5.4  |            |            |
| PHF  | .750                | .438 | .750 | .694       | .679                     | .842 | .863 | .857       | .920                  | .538 | .599 | .858       | .677                     | .770 | .818 | .807       | .925       |

# Traffic Data Service

San Jose, CA  
 (408) 622-4787  
 tdsbay@cs.com

File Name : 9AM FINAL  
 Site Code : 00000009  
 Start Date : 4/27/2017  
 Page No : 2

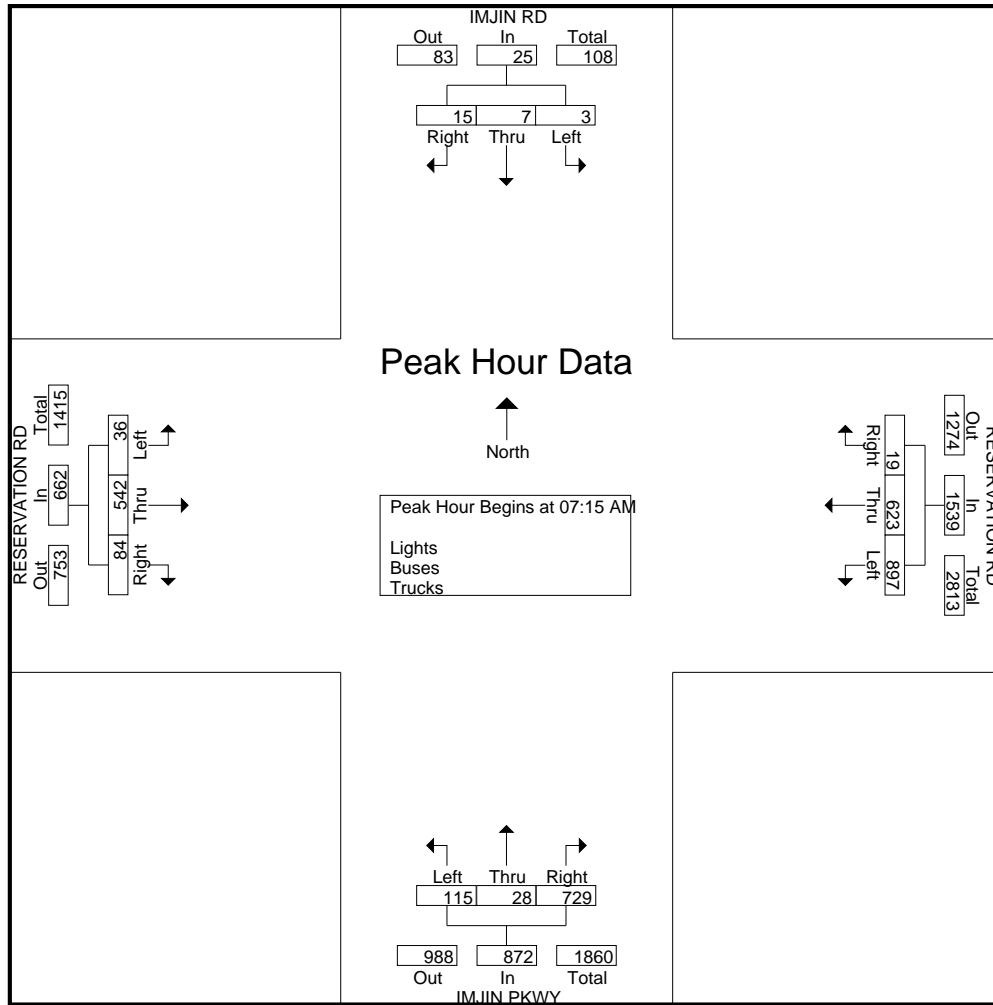

# Traffic Data Service

San Jose, CA  
 (408) 622-4787  
 tdsbay@cs.com

File Name : 9AM FINAL  
 Site Code : 00000009  
 Start Date : 4/27/2017  
 Page No : 1

Groups Printed- Bikes

| Start Time  | IMJIN RD Southbound |      |      |      |            | RESERVATION RD Westbound |      |      |      |            | IMJIN PKWY Northbound |      |      |      |            | RESERVATION RD Eastbound |      |      |      |            | Int. Total |
|-------------|---------------------|------|------|------|------------|--------------------------|------|------|------|------------|-----------------------|------|------|------|------------|--------------------------|------|------|------|------------|------------|
|             | Right               | Thru | Left | Peds | App. Total | Right                    | Thru | Left | Peds | App. Total | Right                 | Thru | Left | Peds | App. Total | Right                    | Thru | Left | Peds | App. Total |            |
| 07:00 AM    | 0                   | 0    | 0    | 0    | 0          | 0                        | 0    | 0    | 0    | 0          | 0                     | 0    | 0    | 0    | 0          | 0                        | 0    | 0    | 0    | 0          | 0          |
| 07:15 AM    | 0                   | 0    | 0    | 0    | 0          | 0                        | 0    | 0    | 0    | 0          | 0                     | 0    | 0    | 0    | 0          | 0                        | 0    | 0    | 0    | 0          | 0          |
| 07:30 AM    | 0                   | 0    | 0    | 0    | 0          | 0                        | 0    | 0    | 0    | 0          | 0                     | 0    | 0    | 0    | 0          | 0                        | 0    | 0    | 0    | 0          | 0          |
| 07:45 AM    | 0                   | 0    | 0    | 0    | 0          | 0                        | 0    | 0    | 0    | 0          | 0                     | 0    | 0    | 0    | 0          | 0                        | 0    | 0    | 0    | 0          | 0          |
| Total       | 0                   | 0    | 0    | 0    | 0          | 0                        | 0    | 0    | 0    | 0          | 0                     | 0    | 0    | 0    | 0          | 0                        | 0    | 0    | 0    | 0          | 0          |
| 08:00 AM    | 0                   | 0    | 0    | 0    | 0          | 0                        | 0    | 0    | 0    | 0          | 0                     | 0    | 0    | 0    | 0          | 0                        | 1    | 0    | 0    | 1          | 1          |
| 08:15 AM    | 0                   | 0    | 0    | 0    | 0          | 0                        | 0    | 0    | 0    | 0          | 0                     | 0    | 0    | 0    | 0          | 0                        | 0    | 0    | 0    | 0          | 0          |
| 08:30 AM    | 0                   | 0    | 0    | 0    | 0          | 0                        | 0    | 0    | 0    | 0          | 0                     | 0    | 0    | 0    | 0          | 0                        | 0    | 0    | 0    | 0          | 0          |
| 08:45 AM    | 0                   | 0    | 0    | 0    | 0          | 0                        | 0    | 0    | 0    | 0          | 0                     | 0    | 0    | 0    | 0          | 0                        | 1    | 0    | 0    | 1          | 1          |
| Total       | 0                   | 0    | 0    | 0    | 0          | 0                        | 0    | 0    | 0    | 0          | 0                     | 0    | 0    | 0    | 0          | 0                        | 2    | 0    | 0    | 2          | 2          |
| Grand Total | 0                   | 0    | 0    | 0    | 0          | 0                        | 0    | 0    | 0    | 0          | 0                     | 0    | 0    | 0    | 0          | 0                        | 2    | 0    | 0    | 2          | 2          |
| Apprch %    | 0                   | 0    | 0    | 0    | 0          | 0                        | 0    | 0    | 0    | 0          | 0                     | 0    | 0    | 0    | 0          | 0                        | 100  | 0    | 0    | 0          |            |
| Total %     | 0                   | 0    | 0    | 0    | 0          | 0                        | 0    | 0    | 0    | 0          | 0                     | 0    | 0    | 0    | 0          | 0                        | 100  | 0    | 0    | 100        |            |

| Start Time   | IMJIN RD Southbound |      |      |            | RESERVATION RD Westbound |      |      |            | IMJIN PKWY Northbound |      |      |            | RESERVATION RD Eastbound |      |      |            | Int. Total |
|--|---------------------|------|------|------------|--------------------------|------|------|------------|-----------------------|------|------|------------|--------------------------|------|------|------------|------------|
|  | Right               | Thru | Left | App. Total | Right                    | Thru | Left | App. Total | Right                 | Thru | Left | App. Total | Right                    | Thru | Left | App. Total |            |
| Peak Hour Analysis From 07:00 AM to 08:45 AM - Peak 1 of 1 |                     |      |      |            |                          |      |      |            |                       |      |      |            |                          |      |      |            |            |
| Peak Hour for Entire Intersection Begins at 08:00 AM       |                     |      |      |            |                          |      |      |            |                       |      |      |            |                          |      |      |            |            |
| 08:00 AM   | 0                   | 0    | 0    | 0          | 0                        | 0    | 0    | 0          | 0                     | 0    | 0    | 0          | 0                        | 1    | 0    | 1          | 1          |
| 08:15 AM   | 0                   | 0    | 0    | 0          | 0                        | 0    | 0    | 0          | 0                     | 0    | 0    | 0          | 0                        | 0    | 0    | 0          | 0          |
| 08:30 AM   | 0                   | 0    | 0    | 0          | 0                        | 0    | 0    | 0          | 0                     | 0    | 0    | 0          | 0                        | 0    | 0    | 0          | 0          |
| 08:45 AM   | 0                   | 0    | 0    | 0          | 0                        | 0    | 0    | 0          | 0                     | 0    | 0    | 0          | 0                        | 1    | 0    | 1          | 1          |
| Total Volume   | 0                   | 0    | 0    | 0          | 0                        | 0    | 0    | 0          | 0                     | 0    | 0    | 0          | 0                        | 2    | 0    | 2          | 2          |
| % App. Total   | 0                   | 0    | 0    | 0          | 0                        | 0    | 0    | 0          | 0                     | 0    | 0    | 0          | 0                        | 100  | 0    | 0          |            |
| PHF  | .000                | .000 | .000 | .000       | .000                     | .000 | .000 | .000       | .000                  | .000 | .000 | .000       | .000                     | .500 | .000 | .500       | .500       |

# Traffic Data Service

San Jose, CA  
(408) 622-4787  
tdsbay@cs.com

File Name : 9AM FINAL  
Site Code : 00000009  
Start Date : 4/27/2017  
Page No : 2

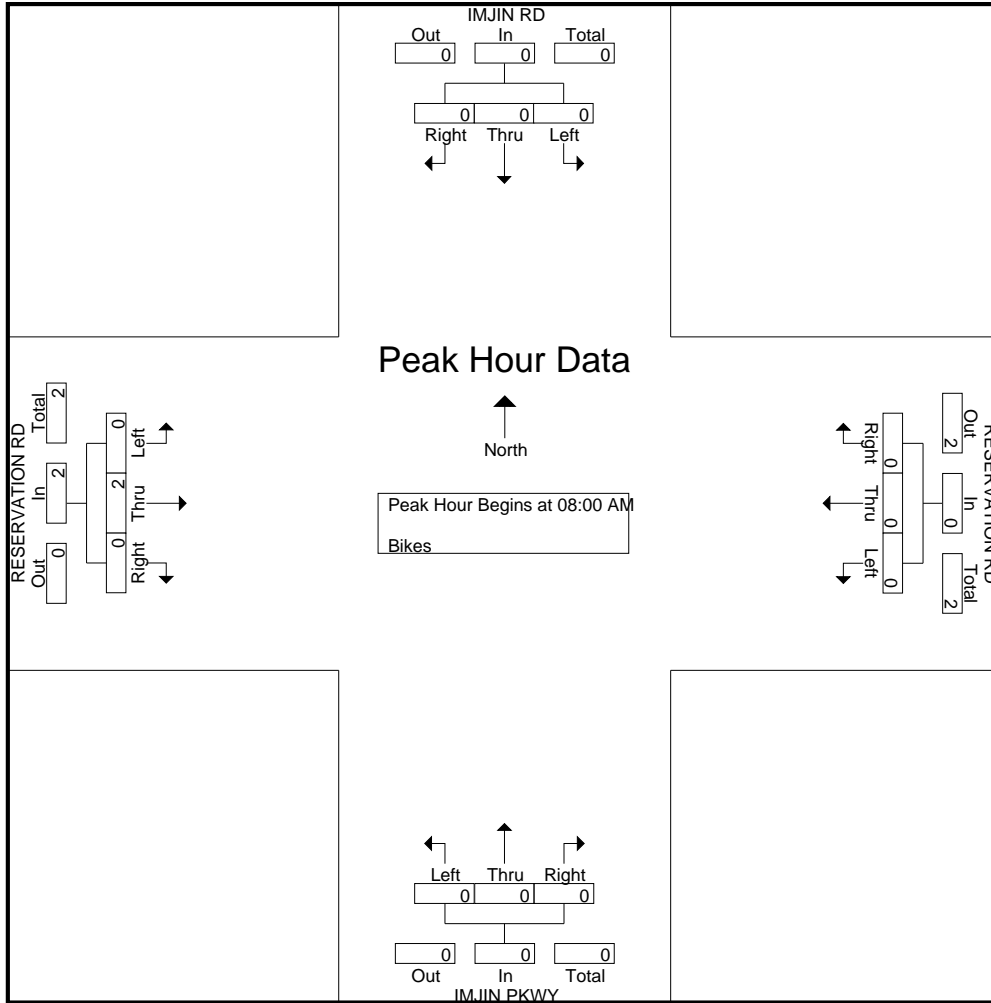

# Traffic Data Service

San Jose, CA  
 (408) 622-4787  
 tdsbay@cs.com

File Name : 9PM FINAL  
 Site Code : 00000009  
 Start Date : 4/27/2017  
 Page No : 1

## Groups Printed- Lights - Buses - Trucks

| Start Time   | IMJIN RD Southbound |           |           |          |            | RESERVATION RD Westbound |            |            |          |             | IMJIN PKWY Northbound |           |            |          |             | RESERVATION RD Eastbound |            |          |          |            | Int. Total  |
|--------------|---------------------|-----------|-----------|----------|------------|--------------------------|------------|------------|----------|-------------|-----------------------|-----------|------------|----------|-------------|--------------------------|------------|----------|----------|------------|-------------|
|              | Right               | Thru      | Left      | Peds     | App. Total | Right                    | Thru       | Left       | Peds     | App. Total  | Right                 | Thru      | Left       | Peds     | App. Total  | Right                    | Thru       | Left     | Peds     | App. Total |             |
| 04:00 PM     | 9                   | 16        | 2         | 0        | 27         | 1                        | 133        | 171        | 0        | 305         | 252                   | 3         | 17         | 0        | 272         | 39                       | 142        | 0        | 0        | 181        | 785         |
| 04:15 PM     | 5                   | 6         | 4         | 0        | 15         | 1                        | 126        | 171        | 0        | 298         | 251                   | 3         | 12         | 0        | 266         | 34                       | 185        | 1        | 0        | 220        | 799         |
| 04:30 PM     | 10                  | 8         | 7         | 0        | 25         | 0                        | 126        | 177        | 0        | 303         | 236                   | 3         | 35         | 1        | 275         | 51                       | 152        | 5        | 0        | 208        | 811         |
| 04:45 PM     | 9                   | 3         | 5         | 0        | 17         | 2                        | 122        | 175        | 0        | 299         | 248                   | 2         | 18         | 0        | 268         | 39                       | 145        | 3        | 1        | 188        | 772         |
| <b>Total</b> | <b>33</b>           | <b>33</b> | <b>18</b> | <b>0</b> | <b>84</b>  | <b>4</b>                 | <b>507</b> | <b>694</b> | <b>0</b> | <b>1205</b> | <b>987</b>            | <b>11</b> | <b>82</b>  | <b>1</b> | <b>1081</b> | <b>163</b>               | <b>624</b> | <b>9</b> | <b>1</b> | <b>797</b> | <b>3167</b> |
| 05:00 PM     | 8                   | 9         | 0         | 0        | 17         | 1                        | 117        | 210        | 0        | 328         | 241                   | 2         | 23         | 0        | 266         | 43                       | 164        | 2        | 0        | 209        | 820         |
| 05:15 PM     | 4                   | 3         | 1         | 0        | 8          | 1                        | 174        | 257        | 0        | 432         | 249                   | 1         | 30         | 0        | 280         | 43                       | 178        | 1        | 0        | 222        | 942         |
| 05:30 PM     | 1                   | 6         | 1         | 0        | 8          | 0                        | 129        | 207        | 0        | 336         | 244                   | 1         | 29         | 0        | 274         | 50                       | 157        | 1        | 1        | 209        | 827         |
| 05:45 PM     | 1                   | 3         | 2         | 0        | 6          | 0                        | 107        | 163        | 0        | 270         | 244                   | 3         | 26         | 0        | 273         | 57                       | 152        | 2        | 0        | 211        | 760         |
| <b>Total</b> | <b>14</b>           | <b>21</b> | <b>4</b>  | <b>0</b> | <b>39</b>  | <b>2</b>                 | <b>527</b> | <b>837</b> | <b>0</b> | <b>1366</b> | <b>978</b>            | <b>7</b>  | <b>108</b> | <b>0</b> | <b>1093</b> | <b>193</b>               | <b>651</b> | <b>6</b> | <b>1</b> | <b>851</b> | <b>3349</b> |
| Grand Total  | 47                  | 54        | 22        | 0        | 123        | 6                        | 1034       | 1531       | 0        | 2571        | 1965                  | 18        | 190        | 1        | 2174        | 356                      | 1275       | 15       | 2        | 1648       | 6516        |
| Apprch %     | 38.2                | 43.9      | 17.9      | 0        |            | 0.2                      | 40.2       | 59.5       | 0        |             | 90.4                  | 0.8       | 8.7        | 0        |             | 21.6                     | 77.4       | 0.9      | 0.1      |            |             |
| Total %      | 0.7                 | 0.8       | 0.3       | 0        | 1.9        | 0.1                      | 15.9       | 23.5       | 0        | 39.5        | 30.2                  | 0.3       | 2.9        | 0        | 33.4        | 5.5                      | 19.6       | 0.2      | 0        | 25.3       |             |
| Lights       | 44                  | 54        | 19        | 0        | 117        | 5                        | 1013       | 1510       | 0        | 2528        | 1939                  | 16        | 185        | 1        | 2141        | 348                      | 1261       | 11       | 2        | 1622       | 6408        |
| % Lights     | 93.6                | 100       | 86.4      | 0        | 95.1       | 83.3                     | 98         | 98.6       | 0        | 98.3        | 98.7                  | 88.9      | 97.4       | 100      | 98.5        | 97.8                     | 98.9       | 73.3     | 100      | 98.4       | 98.3        |
| Buses        | 1                   | 0         | 0         | 0        | 1          | 0                        | 9          | 6          | 0        | 15          | 6                     | 0         | 3          | 0        | 9           | 7                        | 10         | 3        | 0        | 20         | 45          |
| % Buses      | 2.1                 | 0         | 0         | 0        | 0.8        | 0                        | 0.9        | 0.4        | 0        | 0.6         | 0.3                   | 0         | 1.6        | 0        | 0.4         | 2                        | 0.8        | 20       | 0        | 1.2        | 0.7         |
| Trucks       | 2                   | 0         | 3         | 0        | 5          | 1                        | 12         | 15         | 0        | 28          | 20                    | 2         | 2          | 0        | 24          | 1                        | 4          | 1        | 0        | 6          | 63          |
| % Trucks     | 4.3                 | 0         | 13.6      | 0        | 4.1        | 16.7                     | 1.2        | 1          | 0        | 1.1         | 1                     | 11.1      | 1.1        | 0        | 1.1         | 0.3                      | 0.3        | 6.7      | 0        | 0.4        | 1           |

| Start Time   | IMJIN RD Southbound |      |      |            | RESERVATION RD Westbound |      |      |            | IMJIN PKWY Northbound |      |      |            | RESERVATION RD Eastbound |      |      |            | Int. Total |
|--|---------------------|------|------|------------|--------------------------|------|------|------------|-----------------------|------|------|------------|--------------------------|------|------|------------|------------|
|  | Right               | Thru | Left | App. Total | Right                    | Thru | Left | App. Total | Right                 | Thru | Left | App. Total | Right                    | Thru | Left | App. Total |            |
| Peak Hour Analysis From 04:00 PM to 05:45 PM - Peak 1 of 1 |                     |      |      |            |                          |      |      |            |                       |      |      |            |                          |      |      |            |            |
| Peak Hour for Entire Intersection Begins at 04:45 PM       |                     |      |      |            |                          |      |      |            |                       |      |      |            |                          |      |      |            |            |
| 04:45 PM   | 9                   | 3    | 5    | 17         | 2                        | 122  | 175  | 299        | 248                   | 2    | 18   | 268        | 39                       | 145  | 3    | 187        | 771        |
| 05:00 PM   | 8                   | 9    | 0    | 17         | 1                        | 117  | 210  | 328        | 241                   | 2    | 23   | 266        | 43                       | 164  | 2    | 209        | 820        |
| 05:15 PM   | 4                   | 3    | 1    | 8          | 1                        | 174  | 257  | 432        | 249                   | 1    | 30   | 280        | 43                       | 178  | 1    | 222        | 942        |
| 05:30 PM   | 1                   | 6    | 1    | 8          | 0                        | 129  | 207  | 336        | 244                   | 1    | 29   | 274        | 50                       | 157  | 1    | 208        | 826        |
| Total Volume   | 22                  | 21   | 7    | 50         | 4                        | 542  | 849  | 1395       | 982                   | 6    | 100  | 1088       | 175                      | 644  | 7    | 826        | 3359       |
| % App. Total   | 44                  | 42   | 14   |            | 0.3                      | 38.9 | 60.9 |            | 90.3                  | 0.6  | 9.2  |            | 21.2                     | 78   | 0.8  |            |            |
| PHF  | .611                | .583 | .350 | .735       | .500                     | .779 | .826 | .807       | .986                  | .750 | .833 | .971       | .875                     | .904 | .583 | .930       | .891       |

# Traffic Data Service

San Jose, CA  
 (408) 622-4787  
 tdsbay@cs.com

File Name : 9PM FINAL  
 Site Code : 00000009  
 Start Date : 4/27/2017  
 Page No : 2

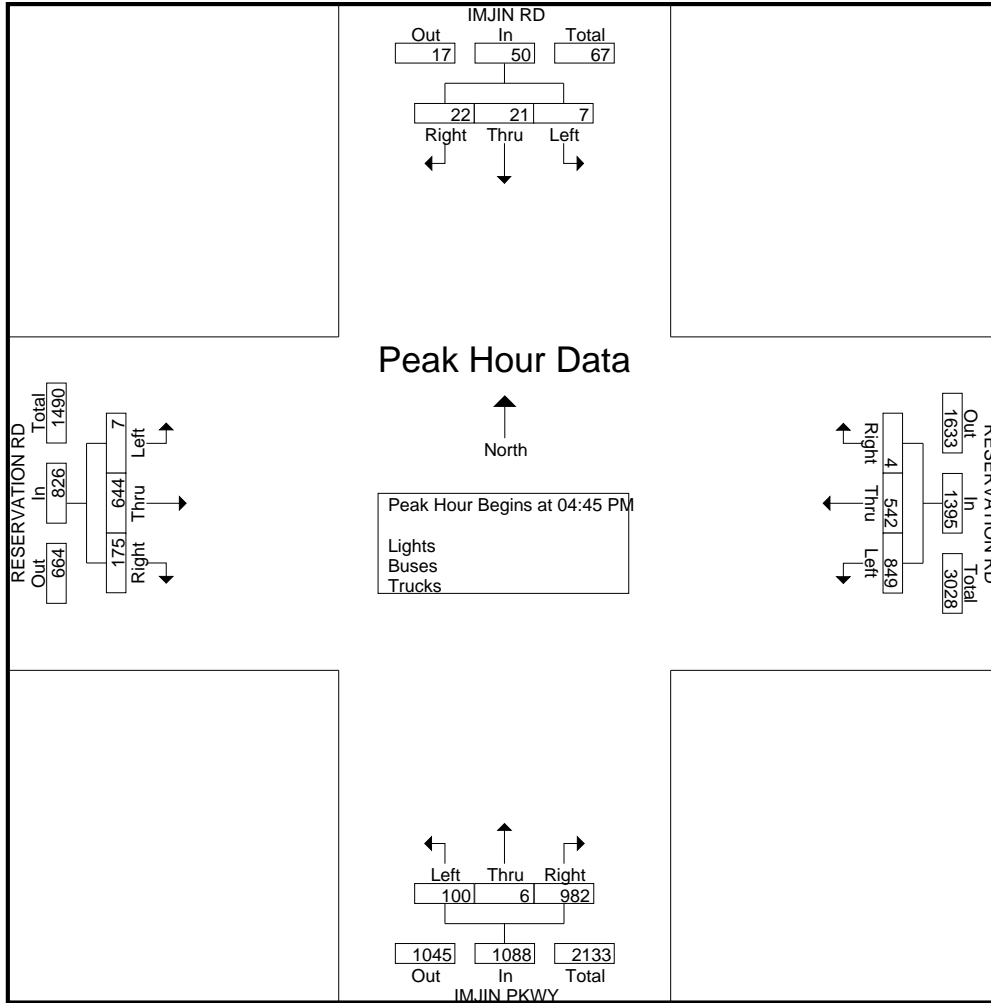

# Traffic Data Service

San Jose, CA  
 (408) 622-4787  
 tdsbay@cs.com

File Name : 9PM FINAL  
 Site Code : 00000009  
 Start Date : 4/27/2017  
 Page No : 1

Groups Printed- Bikes

| Start Time  | IMJIN RD Southbound |      |      |      |            | RESERVATION RD Westbound |      |      |      |            | IMJIN PKWY Northbound |      |      |      |            | RESERVATION RD Eastbound |      |      |      |            | Int. Total |
|-------------|---------------------|------|------|------|------------|--------------------------|------|------|------|------------|-----------------------|------|------|------|------------|--------------------------|------|------|------|------------|------------|
|             | Right               | Thru | Left | Peds | App. Total | Right                    | Thru | Left | Peds | App. Total | Right                 | Thru | Left | Peds | App. Total | Right                    | Thru | Left | Peds | App. Total |            |
| 04:00 PM    | 0                   | 0    | 0    | 0    | 0          | 0                        | 0    | 0    | 0    | 0          | 0                     | 0    | 0    | 0    | 0          | 0                        | 0    | 0    | 0    | 0          | 0          |
| 04:15 PM    | 0                   | 0    | 0    | 0    | 0          | 0                        | 0    | 0    | 0    | 0          | 0                     | 0    | 0    | 0    | 0          | 0                        | 0    | 0    | 0    | 0          | 0          |
| 04:30 PM    | 0                   | 0    | 0    | 0    | 0          | 0                        | 0    | 0    | 0    | 0          | 0                     | 0    | 0    | 0    | 0          | 0                        | 0    | 0    | 0    | 0          | 0          |
| 04:45 PM    | 0                   | 0    | 0    | 0    | 0          | 0                        | 0    | 0    | 0    | 0          | 0                     | 0    | 0    | 0    | 0          | 0                        | 0    | 0    | 0    | 0          | 0          |
| Total       | 0                   | 0    | 0    | 0    | 0          | 0                        | 0    | 0    | 0    | 0          | 0                     | 0    | 0    | 0    | 0          | 0                        | 0    | 0    | 0    | 0          | 0          |
| 05:00 PM    | 0                   | 0    | 0    | 0    | 0          | 0                        | 0    | 0    | 0    | 0          | 0                     | 0    | 0    | 0    | 0          | 0                        | 0    | 0    | 0    | 0          | 0          |
| 05:15 PM    | 0                   | 0    | 0    | 0    | 0          | 0                        | 0    | 0    | 0    | 0          | 0                     | 0    | 0    | 0    | 0          | 0                        | 0    | 0    | 0    | 0          | 0          |
| 05:30 PM    | 0                   | 0    | 0    | 0    | 0          | 0                        | 0    | 0    | 0    | 0          | 0                     | 0    | 0    | 0    | 0          | 0                        | 0    | 0    | 0    | 0          | 0          |
| 05:45 PM    | 0                   | 0    | 0    | 0    | 0          | 0                        | 0    | 0    | 0    | 0          | 0                     | 0    | 0    | 0    | 0          | 0                        | 0    | 0    | 0    | 0          | 0          |
| Total       | 0                   | 0    | 0    | 0    | 0          | 0                        | 0    | 0    | 0    | 0          | 0                     | 0    | 0    | 0    | 0          | 0                        | 0    | 0    | 0    | 0          | 0          |
| Grand Total | 0                   | 0    | 0    | 0    | 0          | 0                        | 0    | 0    | 0    | 0          | 0                     | 0    | 0    | 0    | 0          | 0                        | 0    | 0    | 0    | 0          | 0          |
| Apprch %    | 0                   | 0    | 0    | 0    |            | 0                        | 0    | 0    | 0    |            | 0                     | 0    | 0    | 0    |            | 0                        | 0    | 0    | 0    |            |            |
| Total %     |                     |      |      |      |            |                          |      |      |      |            |                       |      |      |      |            |                          |      |      |      |            |            |

| Start Time   | IMJIN RD Southbound |      |      |      |            | RESERVATION RD Westbound |      |      |      |            | IMJIN PKWY Northbound |      |      |      |            | RESERVATION RD Eastbound |      |      |      |            | Int. Total |
|--|---------------------|------|------|------|------------|--------------------------|------|------|------|------------|-----------------------|------|------|------|------------|--------------------------|------|------|------|------------|------------|
|  | Right               | Thru | Left | Peds | App. Total | Right                    | Thru | Left | Peds | App. Total | Right                 | Thru | Left | Peds | App. Total | Right                    | Thru | Left | Peds | App. Total |            |
| Peak Hour Analysis From 04:00 PM to 05:45 PM - Peak 1 of 1 |                     |      |      |      |            |                          |      |      |      |            |                       |      |      |      |            |                          |      |      |      |            |            |
| Peak Hour for Entire Intersection Begins at 04:00 PM       |                     |      |      |      |            |                          |      |      |      |            |                       |      |      |      |            |                          |      |      |      |            |            |
| 04:00 PM   | 0                   | 0    | 0    | 0    | 0          | 0                        | 0    | 0    | 0    | 0          | 0                     | 0    | 0    | 0    | 0          | 0                        | 0    | 0    | 0    | 0          | 0          |
| 04:15 PM   | 0                   | 0    | 0    | 0    | 0          | 0                        | 0    | 0    | 0    | 0          | 0                     | 0    | 0    | 0    | 0          | 0                        | 0    | 0    | 0    | 0          | 0          |
| 04:30 PM   | 0                   | 0    | 0    | 0    | 0          | 0                        | 0    | 0    | 0    | 0          | 0                     | 0    | 0    | 0    | 0          | 0                        | 0    | 0    | 0    | 0          | 0          |
| 04:45 PM   | 0                   | 0    | 0    | 0    | 0          | 0                        | 0    | 0    | 0    | 0          | 0                     | 0    | 0    | 0    | 0          | 0                        | 0    | 0    | 0    | 0          | 0          |
| Total Volume   | 0                   | 0    | 0    | 0    | 0          | 0                        | 0    | 0    | 0    | 0          | 0                     | 0    | 0    | 0    | 0          | 0                        | 0    | 0    | 0    | 0          | 0          |
| % App. Total   | 0                   | 0    | 0    | 0    |            | 0                        | 0    | 0    | 0    |            | 0                     | 0    | 0    | 0    |            | 0                        | 0    | 0    | 0    |            |            |
| PHF  | .000                | .000 | .000 | .000 | .000       | .000                     | .000 | .000 | .000 | .000       | .000                  | .000 | .000 | .000 | .000       | .000                     | .000 | .000 | .000 | .000       | .000       |

# Traffic Data Service

San Jose, CA  
(408) 622-4787  
tdsbay@cs.com

File Name : 9PM FINAL  
Site Code : 00000009  
Start Date : 4/27/2017  
Page No : 2

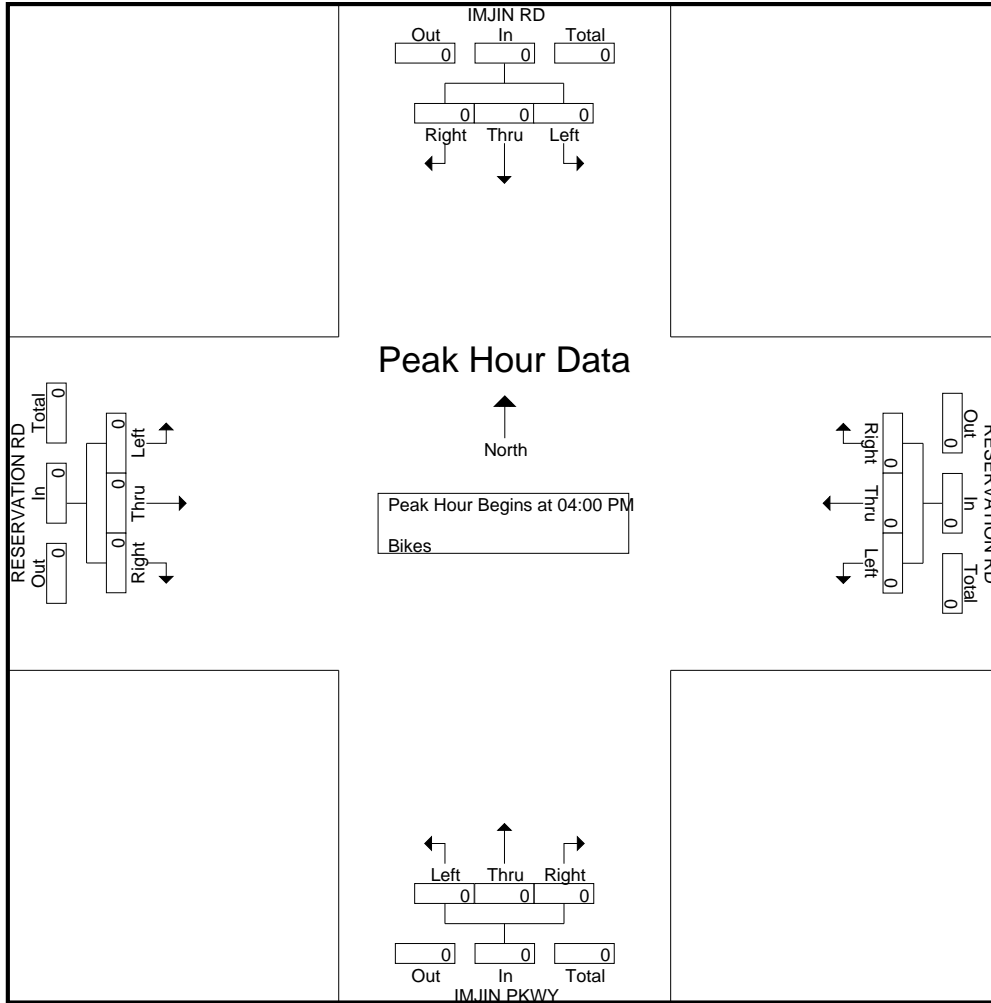



# Traffic Data Service

San Jose, CA  
 (408) 622-4787  
 tdsbay@cs.com

File Name : 10AM FINAL  
 Site Code : 00000010  
 Start Date : 4/27/2017  
 Page No : 1

## Groups Printed- Lights - Buses - Trucks

| Start Time   | 2ND AVE Southbound |            |          |          |            | 9TH ST Westbound |          |            |          |            | 2ND AVE Northbound |            |           |          |            | 9TH ST Eastbound |          |           |          |            | Int. Total |
|--------------|--------------------|------------|----------|----------|------------|------------------|----------|------------|----------|------------|--------------------|------------|-----------|----------|------------|------------------|----------|-----------|----------|------------|------------|
|              | Right              | Thru       | Left     | Peds     | App. Total | Right            | Thru     | Left       | Peds     | App. Total | Right              | Thru       | Left      | Peds     | App. Total | Right            | Thru     | Left      | Peds     | App. Total |            |
| 07:00 AM     | 2                  | 48         | 3        | 0        | 53         | 0                | 1        | 18         | 0        | 19         | 0                  | 9          | 3         | 1        | 13         | 3                | 0        | 5         | 0        | 8          | 93         |
| 07:15 AM     | 7                  | 116        | 0        | 3        | 126        | 0                | 1        | 61         | 0        | 62         | 1                  | 17         | 0         | 0        | 18         | 11               | 1        | 5         | 1        | 18         | 224        |
| 07:30 AM     | 1                  | 92         | 0        | 2        | 95         | 2                | 3        | 84         | 0        | 89         | 0                  | 27         | 1         | 0        | 28         | 12               | 0        | 10        | 3        | 25         | 237        |
| 07:45 AM     | 3                  | 110        | 1        | 0        | 114        | 1                | 4        | 77         | 0        | 82         | 0                  | 31         | 3         | 0        | 34         | 10               | 0        | 12        | 0        | 22         | 252        |
| <b>Total</b> | <b>13</b>          | <b>366</b> | <b>4</b> | <b>5</b> | <b>388</b> | <b>3</b>         | <b>9</b> | <b>240</b> | <b>0</b> | <b>252</b> | <b>1</b>           | <b>84</b>  | <b>7</b>  | <b>1</b> | <b>93</b>  | <b>36</b>        | <b>1</b> | <b>32</b> | <b>4</b> | <b>73</b>  | <b>806</b> |
| 08:00 AM     | 11                 | 141        | 1        | 0        | 153        | 0                | 2        | 20         | 0        | 22         | 3                  | 45         | 2         | 0        | 50         | 10               | 0        | 9         | 2        | 21         | 246        |
| 08:15 AM     | 5                  | 111        | 0        | 1        | 117        | 1                | 1        | 14         | 1        | 17         | 1                  | 20         | 3         | 1        | 25         | 0                | 0        | 9         | 0        | 9          | 168        |
| 08:30 AM     | 11                 | 55         | 0        | 1        | 67         | 0                | 0        | 6          | 0        | 6          | 0                  | 22         | 6         | 1        | 29         | 3                | 0        | 3         | 0        | 6          | 108        |
| 08:45 AM     | 6                  | 62         | 1        | 1        | 70         | 0                | 0        | 6          | 0        | 6          | 1                  | 23         | 1         | 0        | 25         | 5                | 0        | 5         | 0        | 10         | 111        |
| <b>Total</b> | <b>33</b>          | <b>369</b> | <b>2</b> | <b>3</b> | <b>407</b> | <b>1</b>         | <b>3</b> | <b>46</b>  | <b>1</b> | <b>51</b>  | <b>5</b>           | <b>110</b> | <b>12</b> | <b>2</b> | <b>129</b> | <b>18</b>        | <b>0</b> | <b>26</b> | <b>2</b> | <b>46</b>  | <b>633</b> |
| Grand Total  | 46                 | 735        | 6        | 8        | 795        | 4                | 12       | 286        | 1        | 303        | 6                  | 194        | 19        | 3        | 222        | 54               | 1        | 58        | 6        | 119        | 1439       |
| Apprch %     | 5.8                | 92.5       | 0.8      | 1        |            | 1.3              | 4        | 94.4       | 0.3      |            | 2.7                | 87.4       | 8.6       | 1.4      |            | 45.4             | 0.8      | 48.7      | 5        |            |            |
| Total %      | 3.2                | 51.1       | 0.4      | 0.6      | 55.2       | 0.3              | 0.8      | 19.9       | 0.1      | 21.1       | 0.4                | 13.5       | 1.3       | 0.2      | 15.4       | 3.8              | 0.1      | 4         | 0.4      | 8.3        |            |
| Lights       | 43                 | 722        | 6        | 8        | 779        | 3                | 11       | 286        | 1        | 301        | 6                  | 188        | 17        | 3        | 214        | 54               | 1        | 54        | 6        | 115        | 1409       |
| % Lights     | 93.5               | 98.2       | 100      | 100      | 98         | 75               | 91.7     | 100        | 100      | 99.3       | 100                | 96.9       | 89.5      | 100      | 96.4       | 100              | 100      | 93.1      | 100      | 96.6       | 97.9       |
| Buses        | 1                  | 9          | 0        | 0        | 10         | 0                | 1        | 0          | 0        | 1          | 0                  | 2          | 1         | 0        | 3          | 0                | 0        | 2         | 0        | 2          | 16         |
| % Buses      | 2.2                | 1.2        | 0        | 0        | 1.3        | 0                | 8.3      | 0          | 0        | 0.3        | 0                  | 1          | 5.3       | 0        | 1.4        | 0                | 0        | 3.4       | 0        | 1.7        | 1.1        |
| Trucks       | 2                  | 4          | 0        | 0        | 6          | 1                | 0        | 0          | 0        | 1          | 0                  | 4          | 1         | 0        | 5          | 0                | 0        | 2         | 0        | 2          | 14         |
| % Trucks     | 4.3                | 0.5        | 0        | 0        | 0.8        | 25               | 0        | 0          | 0        | 0.3        | 0                  | 2.1        | 5.3       | 0        | 2.3        | 0                | 0        | 3.4       | 0        | 1.7        | 1          |

| Start Time   | 2ND AVE Southbound |      |      |            | 9TH ST Westbound |      |      |            | 2ND AVE Northbound |      |      |            | 9TH ST Eastbound |      |      |            | Int. Total |
|--|--------------------|------|------|------------|------------------|------|------|------------|--------------------|------|------|------------|------------------|------|------|------------|------------|
|  | Right              | Thru | Left | App. Total | Right            | Thru | Left | App. Total | Right              | Thru | Left | App. Total | Right            | Thru | Left | App. Total |            |
| Peak Hour Analysis From 07:00 AM to 08:45 AM - Peak 1 of 1 |                    |      |      |            |                  |      |      |            |                    |      |      |            |                  |      |      |            |            |
| Peak Hour for Entire Intersection Begins at 07:15 AM       |                    |      |      |            |                  |      |      |            |                    |      |      |            |                  |      |      |            |            |
| 07:15 AM   | 7                  | 116  | 0    | 123        | 0                | 1    | 61   | 62         | 1                  | 17   | 0    | 18         | 11               | 1    | 5    | 17         | 220        |
| 07:30 AM   | 1                  | 92   | 0    | 93         | 2                | 3    | 84   | 89         | 0                  | 27   | 1    | 28         | 12               | 0    | 10   | 22         | 232        |
| 07:45 AM   | 3                  | 110  | 1    | 114        | 1                | 4    | 77   | 82         | 0                  | 31   | 3    | 34         | 10               | 0    | 12   | 22         | 252        |
| 08:00 AM   | 11                 | 141  | 1    | 153        | 0                | 2    | 20   | 22         | 3                  | 45   | 2    | 50         | 10               | 0    | 9    | 19         | 244        |
| Total Volume   | 22                 | 459  | 2    | 483        | 3                | 10   | 242  | 255        | 4                  | 120  | 6    | 130        | 43               | 1    | 36   | 80         | 948        |
| % App. Total   | 4.6                | 95   | 0.4  |            | 1.2              | 3.9  | 94.9 |            | 3.1                | 92.3 | 4.6  |            | 53.8             | 1.2  | 45   |            |            |
| PHF  | .500               | .814 | .500 | .789       | .375             | .625 | .720 | .716       | .333               | .667 | .500 | .650       | .896             | .250 | .750 | .909       | .940       |

# Traffic Data Service

San Jose, CA  
 (408) 622-4787  
 tdsbay@cs.com

File Name : 10AM FINAL  
 Site Code : 00000010  
 Start Date : 4/27/2017  
 Page No : 2

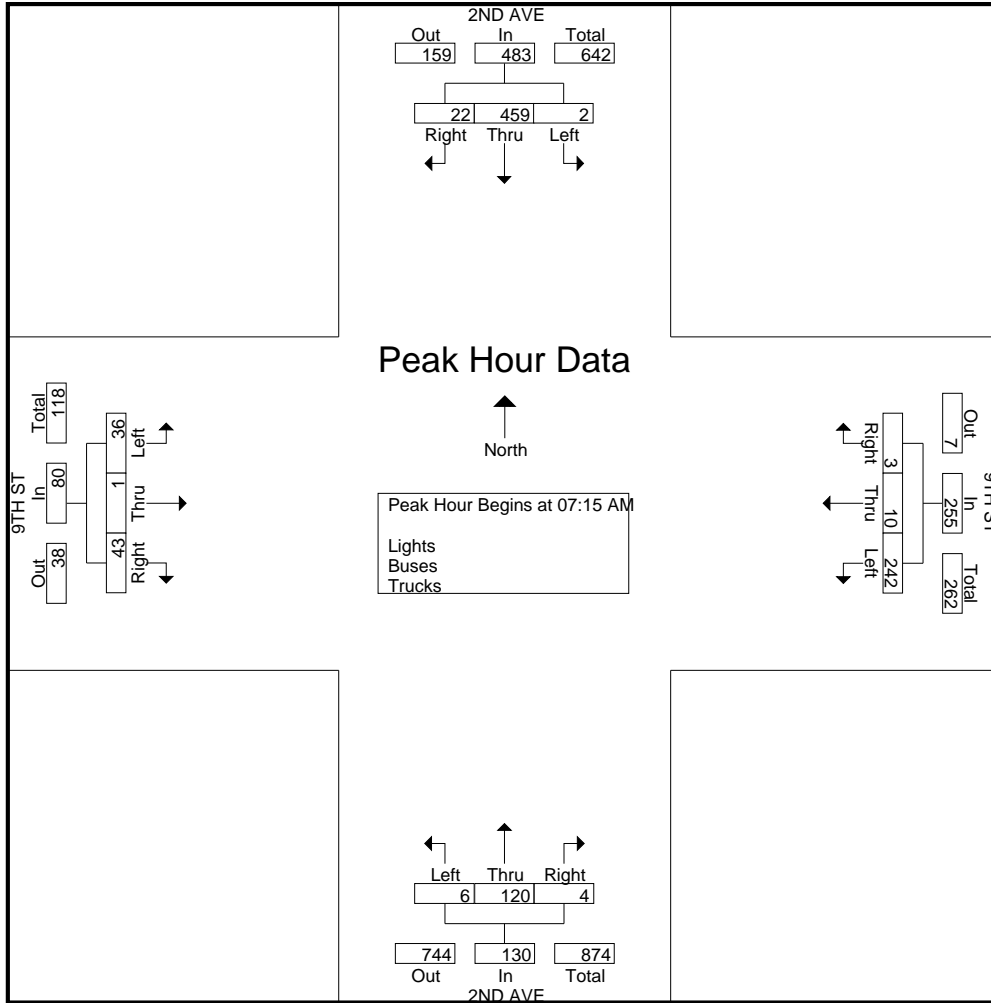

# Traffic Data Service

San Jose, CA  
 (408) 622-4787  
 tdsbay@cs.com

File Name : 10AM FINAL  
 Site Code : 00000010  
 Start Date : 4/27/2017  
 Page No : 1

Groups Printed- Bikes

| Start Time  | 2ND AVE Southbound |      |      |      |            | 9TH ST Westbound |      |      |      |            | 2ND AVE Northbound |      |      |      |            | 9TH ST Eastbound |      |      |      |            | Int. Total |
|-------------|--------------------|------|------|------|------------|------------------|------|------|------|------------|--------------------|------|------|------|------------|------------------|------|------|------|------------|------------|
|             | Right              | Thru | Left | Peds | App. Total | Right            | Thru | Left | Peds | App. Total | Right              | Thru | Left | Peds | App. Total | Right            | Thru | Left | Peds | App. Total |            |
| 07:00 AM    | 0                  | 0    | 0    | 0    | 0          | 0                | 0    | 0    | 0    | 0          | 0                  | 0    | 0    | 0    | 0          | 0                | 0    | 0    | 0    | 0          | 0          |
| 07:15 AM    | 0                  | 0    | 0    | 0    | 0          | 0                | 0    | 0    | 0    | 0          | 0                  | 0    | 0    | 0    | 0          | 0                | 0    | 0    | 0    | 0          | 0          |
| 07:30 AM    | 0                  | 0    | 0    | 0    | 0          | 0                | 1    | 0    | 0    | 1          | 0                  | 0    | 0    | 0    | 0          | 0                | 0    | 0    | 0    | 0          | 1          |
| 07:45 AM    | 0                  | 0    | 0    | 0    | 0          | 0                | 0    | 0    | 0    | 0          | 0                  | 0    | 0    | 0    | 0          | 0                | 0    | 0    | 0    | 0          | 0          |
| Total       | 0                  | 0    | 0    | 0    | 0          | 0                | 1    | 0    | 0    | 1          | 0                  | 0    | 0    | 0    | 0          | 0                | 0    | 0    | 0    | 0          | 1          |
| 08:00 AM    | 0                  | 0    | 0    | 0    | 0          | 0                | 0    | 0    | 0    | 0          | 0                  | 0    | 0    | 0    | 0          | 0                | 0    | 0    | 0    | 0          | 0          |
| 08:15 AM    | 0                  | 1    | 0    | 0    | 1          | 0                | 0    | 0    | 0    | 0          | 0                  | 0    | 0    | 0    | 0          | 0                | 0    | 0    | 0    | 0          | 1          |
| 08:30 AM    | 0                  | 0    | 0    | 0    | 0          | 0                | 0    | 0    | 0    | 0          | 0                  | 0    | 0    | 0    | 0          | 0                | 0    | 0    | 0    | 0          | 0          |
| 08:45 AM    | 0                  | 0    | 0    | 0    | 0          | 0                | 0    | 0    | 0    | 0          | 0                  | 0    | 0    | 0    | 0          | 0                | 0    | 0    | 0    | 0          | 0          |
| Total       | 0                  | 1    | 0    | 0    | 1          | 0                | 0    | 0    | 0    | 0          | 0                  | 0    | 0    | 0    | 0          | 0                | 0    | 0    | 0    | 0          | 1          |
| Grand Total | 0                  | 1    | 0    | 0    | 1          | 0                | 1    | 0    | 0    | 1          | 0                  | 0    | 0    | 0    | 0          | 0                | 0    | 0    | 0    | 0          | 2          |
| Apprch %    | 0                  | 100  | 0    | 0    |            | 0                | 100  | 0    | 0    |            | 0                  | 0    | 0    | 0    |            | 0                | 0    | 0    | 0    |            |            |
| Total %     | 0                  | 50   | 0    | 0    | 50         | 0                | 50   | 0    | 0    | 50         | 0                  | 0    | 0    | 0    | 0          | 0                | 0    | 0    | 0    | 0          |            |

| Start Time   | 2ND AVE Southbound |      |      |      |            | 9TH ST Westbound |      |      |      |            | 2ND AVE Northbound |      |      |      |            | 9TH ST Eastbound |      |      |      |            | Int. Total |
|--------------|--------------------|------|------|------|------------|------------------|------|------|------|------------|--------------------|------|------|------|------------|------------------|------|------|------|------------|------------|
|              | Right              | Thru | Left | Peds | App. Total | Right            | Thru | Left | Peds | App. Total | Right              | Thru | Left | Peds | App. Total | Right            | Thru | Left | Peds | App. Total |            |
| 07:30 AM     | 0                  | 0    | 0    | 0    | 0          | 0                | 1    | 0    | 0    | 1          | 0                  | 0    | 0    | 0    | 0          | 0                | 0    | 0    | 0    | 0          | 1          |
| 07:45 AM     | 0                  | 0    | 0    | 0    | 0          | 0                | 0    | 0    | 0    | 0          | 0                  | 0    | 0    | 0    | 0          | 0                | 0    | 0    | 0    | 0          | 0          |
| 08:00 AM     | 0                  | 0    | 0    | 0    | 0          | 0                | 0    | 0    | 0    | 0          | 0                  | 0    | 0    | 0    | 0          | 0                | 0    | 0    | 0    | 0          | 0          |
| 08:15 AM     | 0                  | 1    | 0    | 0    | 1          | 0                | 0    | 0    | 0    | 0          | 0                  | 0    | 0    | 0    | 0          | 0                | 0    | 0    | 0    | 0          | 1          |
| Total Volume | 0                  | 1    | 0    | 0    | 1          | 0                | 1    | 0    | 0    | 1          | 0                  | 0    | 0    | 0    | 0          | 0                | 0    | 0    | 0    | 0          | 2          |
| % App. Total | 0                  | 100  | 0    | 0    |            | 0                | 100  | 0    | 0    |            | 0                  | 0    | 0    | 0    |            | 0                | 0    | 0    | 0    |            |            |
| PHF          | .000               | .250 | .000 | .000 | .250       | .000             | .250 | .000 | .000 | .250       | .000               | .000 | .000 | .000 | .000       | .000             | .000 | .000 | .000 | .000       | .500       |

Peak Hour Analysis From 07:00 AM to 08:45 AM - Peak 1 of 1  
 Peak Hour for Entire Intersection Begins at 07:30 AM

# Traffic Data Service

San Jose, CA  
(408) 622-4787  
tdsbay@cs.com

File Name : 10AM FINAL  
Site Code : 00000010  
Start Date : 4/27/2017  
Page No : 2

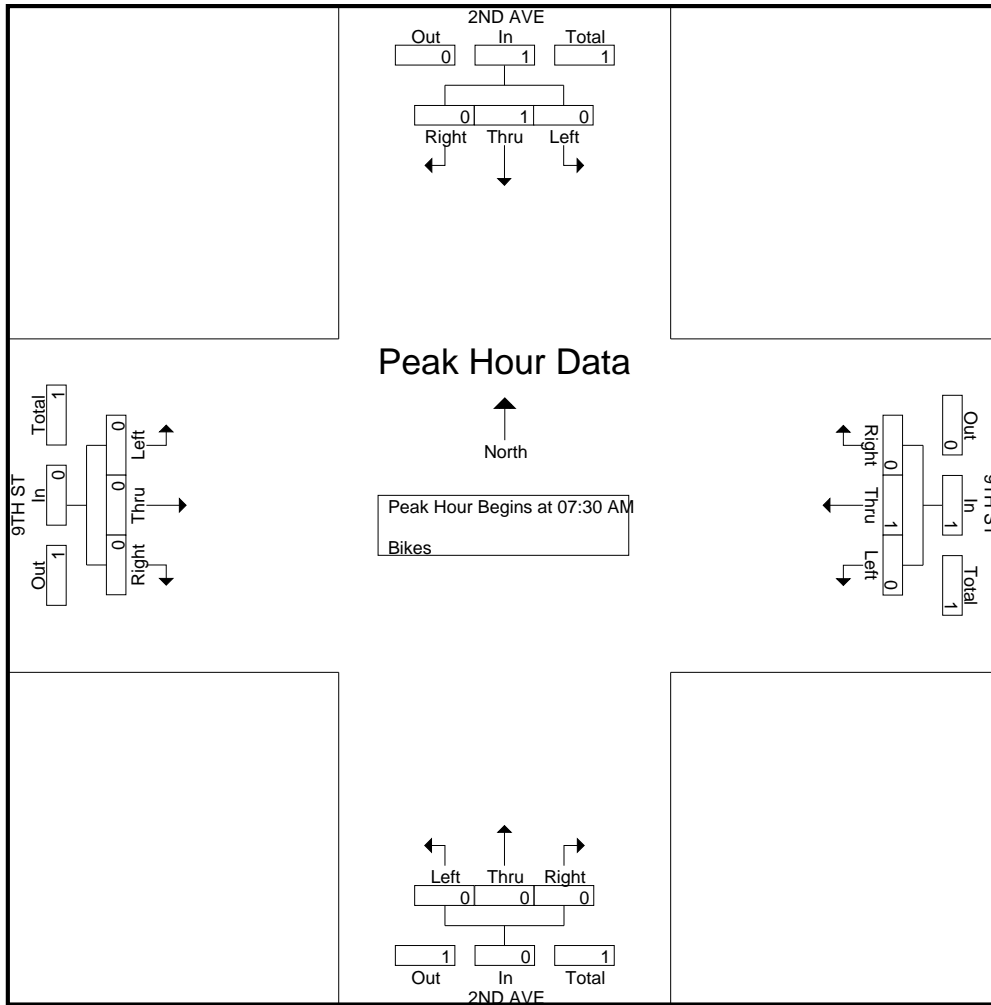

# Traffic Data Service

San Jose, CA  
 (408) 622-4787  
 tdsbay@cs.com

File Name : 10PM FINAL  
 Site Code : 00000010  
 Start Date : 4/27/2017  
 Page No : 1

Groups Printed- Lights - Buses - Trucks

| Start Time  | 2ND AVE Southbound |      |      |      |            | 9TH ST Westbound |      |      |      |            | 2ND AVE Northbound |      |      |      |            | 9TH ST Eastbound |      |      |      |            | Int. Total |
|-------------|--------------------|------|------|------|------------|------------------|------|------|------|------------|--------------------|------|------|------|------------|------------------|------|------|------|------------|------------|
|             | Right              | Thru | Left | Peds | App. Total | Right            | Thru | Left | Peds | App. Total | Right              | Thru | Left | Peds | App. Total | Right            | Thru | Left | Peds | App. Total |            |
| 04:00 PM    | 4                  | 46   | 2    | 0    | 52         | 0                | 1    | 5    | 0    | 6          | 5                  | 55   | 2    | 0    | 62         | 2                | 0    | 7    | 3    | 12         | 132        |
| 04:15 PM    | 3                  | 53   | 2    | 0    | 58         | 1                | 0    | 2    | 1    | 4          | 6                  | 51   | 6    | 0    | 63         | 4                | 2    | 8    | 0    | 14         | 139        |
| 04:30 PM    | 5                  | 63   | 1    | 0    | 69         | 2                | 0    | 0    | 2    | 4          | 7                  | 62   | 9    | 0    | 78         | 4                | 0    | 5    | 1    | 10         | 161        |
| 04:45 PM    | 12                 | 56   | 1    | 0    | 69         | 0                | 0    | 4    | 1    | 5          | 4                  | 76   | 4    | 0    | 84         | 1                | 0    | 11   | 2    | 14         | 172        |
| Total       | 24                 | 218  | 6    | 0    | 248        | 3                | 1    | 11   | 4    | 19         | 22                 | 244  | 21   | 0    | 287        | 11               | 2    | 31   | 6    | 50         | 604        |
| 05:00 PM    | 2                  | 37   | 0    | 1    | 40         | 1                | 1    | 4    | 1    | 7          | 7                  | 92   | 3    | 0    | 102        | 2                | 0    | 5    | 1    | 8          | 157        |
| 05:15 PM    | 11                 | 53   | 1    | 1    | 66         | 0                | 1    | 2    | 4    | 7          | 7                  | 97   | 3    | 0    | 107        | 3                | 0    | 5    | 1    | 9          | 189        |
| 05:30 PM    | 4                  | 46   | 0    | 0    | 50         | 1                | 0    | 5    | 0    | 6          | 5                  | 67   | 5    | 1    | 78         | 4                | 0    | 6    | 2    | 12         | 146        |
| 05:45 PM    | 9                  | 53   | 1    | 0    | 63         | 3                | 0    | 4    | 2    | 9          | 7                  | 75   | 2    | 0    | 84         | 3                | 1    | 8    | 3    | 15         | 171        |
| Total       | 26                 | 189  | 2    | 2    | 219        | 5                | 2    | 15   | 7    | 29         | 26                 | 331  | 13   | 1    | 371        | 12               | 1    | 24   | 7    | 44         | 663        |
| Grand Total | 50                 | 407  | 8    | 2    | 467        | 8                | 3    | 26   | 11   | 48         | 48                 | 575  | 34   | 1    | 658        | 23               | 3    | 55   | 13   | 94         | 1267       |
| Apprch %    | 10.7               | 87.2 | 1.7  | 0.4  |            | 16.7             | 6.2  | 54.2 | 22.9 |            | 7.3                | 87.4 | 5.2  | 0.2  |            | 24.5             | 3.2  | 58.5 | 13.8 |            |            |
| Total %     | 3.9                | 32.1 | 0.6  | 0.2  | 36.9       | 0.6              | 0.2  | 2.1  | 0.9  | 3.8        | 3.8                | 45.4 | 2.7  | 0.1  | 51.9       | 1.8              | 0.2  | 4.3  | 1    | 7.4        |            |
| Lights      | 50                 | 396  | 8    | 2    | 456        | 8                | 2    | 26   | 11   | 47         | 48                 | 572  | 33   | 1    | 654        | 23               | 3    | 54   | 13   | 93         | 1250       |
| % Lights    | 100                | 97.3 | 100  | 100  | 97.6       | 100              | 66.7 | 100  | 100  | 97.9       | 100                | 99.5 | 97.1 | 100  | 99.4       | 100              | 100  | 98.2 | 100  | 98.9       | 98.7       |
| Buses       | 0                  | 9    | 0    | 0    | 9          | 0                | 0    | 0    | 0    | 0          | 0                  | 2    | 0    | 0    | 2          | 0                | 0    | 0    | 0    | 0          | 11         |
| % Buses     | 0                  | 2.2  | 0    | 0    | 1.9        | 0                | 0    | 0    | 0    | 0          | 0                  | 0.3  | 0    | 0    | 0.3        | 0                | 0    | 0    | 0    | 0          | 0.9        |
| Trucks      | 0                  | 2    | 0    | 0    | 2          | 0                | 1    | 0    | 0    | 1          | 0                  | 1    | 1    | 0    | 2          | 0                | 0    | 1    | 0    | 1          | 6          |
| % Trucks    | 0                  | 0.5  | 0    | 0    | 0.4        | 0                | 33.3 | 0    | 0    | 2.1        | 0                  | 0.2  | 2.9  | 0    | 0.3        | 0                | 0    | 1.8  | 0    | 1.1        | 0.5        |

| Start Time   | 2ND AVE Southbound |      |      |            | 9TH ST Westbound |      |      |            | 2ND AVE Northbound |      |      |            | 9TH ST Eastbound |      |      |            | Int. Total |
|--|--------------------|------|------|------------|------------------|------|------|------------|--------------------|------|------|------------|------------------|------|------|------------|------------|
|  | Right              | Thru | Left | App. Total | Right            | Thru | Left | App. Total | Right              | Thru | Left | App. Total | Right            | Thru | Left | App. Total |            |
| Peak Hour Analysis From 04:00 PM to 05:45 PM - Peak 1 of 1 |                    |      |      |            |                  |      |      |            |                    |      |      |            |                  |      |      |            |            |
| Peak Hour for Entire Intersection Begins at 04:30 PM       |                    |      |      |            |                  |      |      |            |                    |      |      |            |                  |      |      |            |            |
| 04:30 PM   | 5                  | 63   | 1    | 69         | 2                | 0    | 0    | 2          | 7                  | 62   | 9    | 78         | 4                | 0    | 5    | 9          | 158        |
| 04:45 PM   | 12                 | 56   | 1    | 69         | 0                | 0    | 4    | 4          | 4                  | 76   | 4    | 84         | 1                | 0    | 11   | 12         | 169        |
| 05:00 PM   | 2                  | 37   | 0    | 39         | 1                | 1    | 4    | 6          | 7                  | 92   | 3    | 102        | 2                | 0    | 5    | 7          | 154        |
| 05:15 PM   | 11                 | 53   | 1    | 65         | 0                | 1    | 2    | 3          | 7                  | 97   | 3    | 107        | 3                | 0    | 5    | 8          | 183        |
| Total Volume   | 30                 | 209  | 3    | 242        | 3                | 2    | 10   | 15         | 25                 | 327  | 19   | 371        | 10               | 0    | 26   | 36         | 664        |
| % App. Total   | 12.4               | 86.4 | 1.2  |            | 20               | 13.3 | 66.7 |            | 6.7                | 88.1 | 5.1  |            | 27.8             | 0    | 72.2 |            |            |
| PHF  | .625               | .829 | .750 | .877       | .375             | .500 | .625 | .625       | .893               | .843 | .528 | .867       | .625             | .000 | .591 | .750       | .907       |

# Traffic Data Service

San Jose, CA  
 (408) 622-4787  
 tdsbay@cs.com

File Name : 10PM FINAL  
 Site Code : 00000010  
 Start Date : 4/27/2017  
 Page No : 2

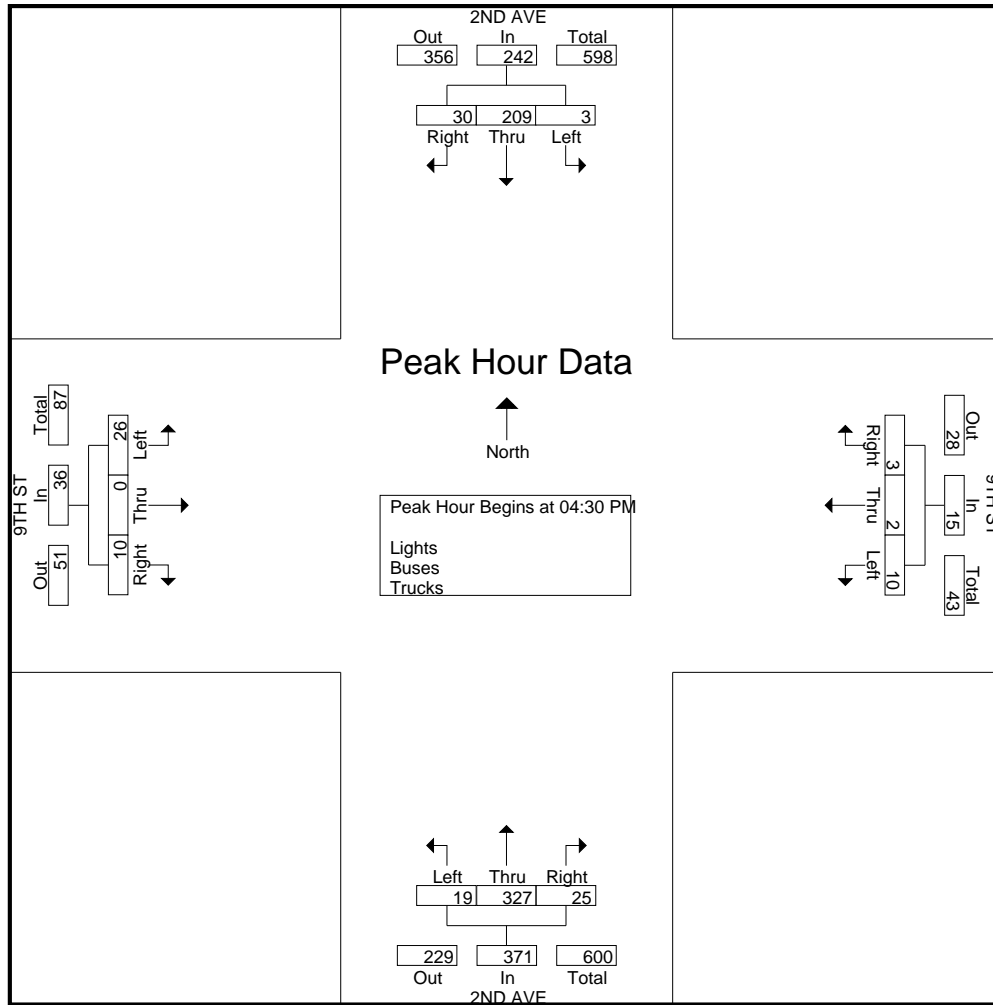

# Traffic Data Service

San Jose, CA  
 (408) 622-4787  
 tdsbay@cs.com

File Name : 10PM FINAL  
 Site Code : 00000010  
 Start Date : 4/27/2017  
 Page No : 1

Groups Printed- Bikes

| Start Time   | 2ND AVE Southbound |          |          |          |            | 9TH ST Westbound |          |          |          |            | 2ND AVE Northbound |          |          |          |            | 9TH ST Eastbound |          |          |          |            | Int. Total |
|--------------|--------------------|----------|----------|----------|------------|------------------|----------|----------|----------|------------|--------------------|----------|----------|----------|------------|------------------|----------|----------|----------|------------|------------|
|              | Right              | Thru     | Left     | Peds     | App. Total | Right            | Thru     | Left     | Peds     | App. Total | Right              | Thru     | Left     | Peds     | App. Total | Right            | Thru     | Left     | Peds     | App. Total |            |
| 04:00 PM     | 0                  | 0        | 0        | 0        | 0          | 0                | 0        | 0        | 0        | 0          | 0                  | 0        | 0        | 0        | 0          | 0                | 0        | 0        | 0        | 0          | 0          |
| 04:15 PM     | 0                  | 0        | 0        | 0        | 0          | 0                | 0        | 0        | 0        | 0          | 0                  | 0        | 0        | 0        | 0          | 0                | 0        | 0        | 0        | 0          | 0          |
| 04:30 PM     | 1                  | 0        | 0        | 0        | 1          | 0                | 0        | 0        | 0        | 0          | 0                  | 2        | 0        | 0        | 2          | 0                | 0        | 0        | 0        | 0          | 3          |
| 04:45 PM     | 0                  | 1        | 0        | 0        | 1          | 0                | 0        | 0        | 0        | 0          | 0                  | 0        | 0        | 0        | 0          | 0                | 1        | 0        | 0        | 1          | 2          |
| <b>Total</b> | <b>1</b>           | <b>1</b> | <b>0</b> | <b>0</b> | <b>2</b>   | <b>0</b>         | <b>0</b> | <b>0</b> | <b>0</b> | <b>0</b>   | <b>0</b>           | <b>2</b> | <b>0</b> | <b>0</b> | <b>2</b>   | <b>0</b>         | <b>1</b> | <b>0</b> | <b>0</b> | <b>1</b>   | <b>5</b>   |
| 05:00 PM     | 0                  | 0        | 0        | 0        | 0          | 0                | 0        | 0        | 0        | 0          | 0                  | 0        | 0        | 0        | 0          | 0                | 0        | 0        | 0        | 0          | 0          |
| 05:15 PM     | 0                  | 1        | 0        | 0        | 1          | 0                | 0        | 0        | 0        | 0          | 0                  | 0        | 0        | 0        | 0          | 0                | 0        | 0        | 0        | 0          | 1          |
| 05:30 PM     | 0                  | 0        | 0        | 0        | 0          | 0                | 0        | 0        | 0        | 0          | 0                  | 0        | 0        | 0        | 0          | 0                | 0        | 1        | 0        | 1          | 1          |
| 05:45 PM     | 0                  | 0        | 0        | 0        | 0          | 0                | 0        | 0        | 0        | 0          | 0                  | 0        | 0        | 0        | 0          | 0                | 0        | 0        | 0        | 0          | 0          |
| <b>Total</b> | <b>0</b>           | <b>1</b> | <b>0</b> | <b>0</b> | <b>1</b>   | <b>0</b>         | <b>0</b> | <b>0</b> | <b>0</b> | <b>0</b>   | <b>0</b>           | <b>0</b> | <b>0</b> | <b>0</b> | <b>0</b>   | <b>0</b>         | <b>0</b> | <b>1</b> | <b>0</b> | <b>1</b>   | <b>2</b>   |
| Grand Total  | 1                  | 2        | 0        | 0        | 3          | 0                | 0        | 0        | 0        | 0          | 0                  | 2        | 0        | 0        | 2          | 0                | 1        | 1        | 0        | 2          | 7          |
| Apprch %     | 33.3               | 66.7     | 0        | 0        |            | 0                | 0        | 0        | 0        |            | 0                  | 100      | 0        | 0        |            | 0                | 50       | 50       | 0        |            |            |
| Total %      | 14.3               | 28.6     | 0        | 0        | 42.9       | 0                | 0        | 0        | 0        | 0          | 0                  | 28.6     | 0        | 0        | 28.6       | 0                | 14.3     | 14.3     | 0        | 28.6       |            |

| Start Time   | 2ND AVE Southbound |      |      |      |            | 9TH ST Westbound |      |      |      |            | 2ND AVE Northbound |      |      |      |            | 9TH ST Eastbound |      |      |      |            | Int. Total |
|--|--------------------|------|------|------|------------|------------------|------|------|------|------------|--------------------|------|------|------|------------|------------------|------|------|------|------------|------------|
|  | Right              | Thru | Left | Peds | App. Total | Right            | Thru | Left | Peds | App. Total | Right              | Thru | Left | Peds | App. Total | Right            | Thru | Left | Peds | App. Total |            |
| Peak Hour Analysis From 04:00 PM to 05:45 PM - Peak 1 of 1 |                    |      |      |      |            |                  |      |      |      |            |                    |      |      |      |            |                  |      |      |      |            |            |
| Peak Hour for Entire Intersection Begins at 04:30 PM       |                    |      |      |      |            |                  |      |      |      |            |                    |      |      |      |            |                  |      |      |      |            |            |
| 04:30 PM   | 1                  | 0    | 0    | 0    | 1          | 0                | 0    | 0    | 0    | 0          | 0                  | 2    | 0    | 0    | 2          | 0                | 0    | 0    | 0    | 0          | 3          |
| 04:45 PM   | 0                  | 1    | 0    | 0    | 1          | 0                | 0    | 0    | 0    | 0          | 0                  | 0    | 0    | 0    | 0          | 0                | 1    | 0    | 0    | 1          | 2          |
| 05:00 PM   | 0                  | 0    | 0    | 0    | 0          | 0                | 0    | 0    | 0    | 0          | 0                  | 0    | 0    | 0    | 0          | 0                | 0    | 0    | 0    | 0          | 0          |
| 05:15 PM   | 0                  | 1    | 0    | 0    | 1          | 0                | 0    | 0    | 0    | 0          | 0                  | 0    | 0    | 0    | 0          | 0                | 0    | 0    | 0    | 0          | 1          |
| Total Volume   | 1                  | 2    | 0    | 0    | 3          | 0                | 0    | 0    | 0    | 0          | 0                  | 2    | 0    | 0    | 2          | 0                | 1    | 0    | 0    | 1          | 6          |
| % App. Total   | 33.3               | 66.7 | 0    | 0    |            | 0                | 0    | 0    | 0    |            | 0                  | 100  | 0    | 0    |            | 0                | 100  | 0    | 0    |            |            |
| PHF  | .250               | .500 | .000 | .000 | .750       | .000             | .000 | .000 | .000 | .000       | .000               | .250 | .000 | .250 | .250       | .000             | .250 | .000 | .250 | .250       | .500       |

# Traffic Data Service

San Jose, CA  
 (408) 622-4787  
 tdsbay@cs.com

File Name : 10PM FINAL  
 Site Code : 00000010  
 Start Date : 4/27/2017  
 Page No : 2

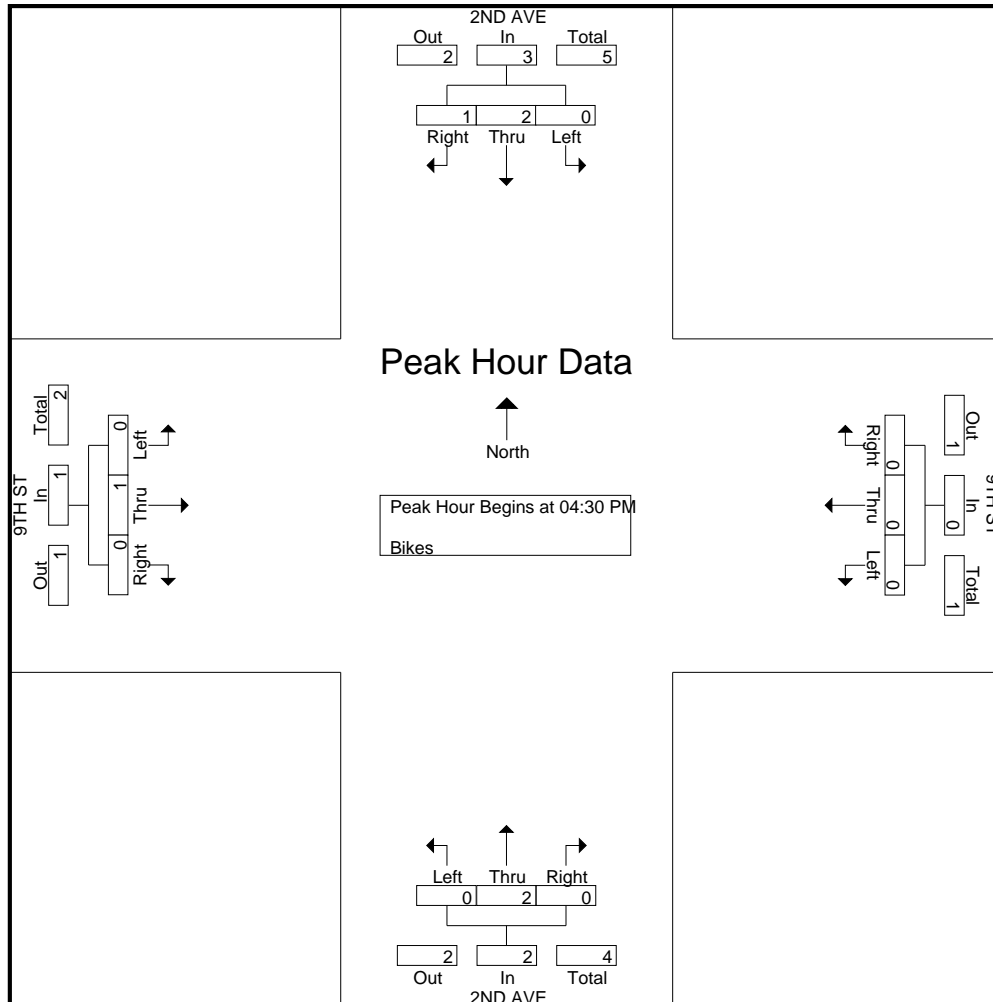



# Traffic Data Service

San Jose, CA  
**(408) 622-4787**  
*tdsbay@cs.com*

File Name : 11AM FINAL  
 Site Code : 00000011  
 Start Date : 4/27/2017  
 Page No : 1

Groups Printed- Lights - Buses - Trucks

| Start Time   | 2ND AVE Southbound |            |           |          |            | 8TH ST Westbound |          |          |          |            | 2ND AVE Northbound |            |          |          |            | 8TH ST Eastbound |          |          |          |            | Int. Total |
|--------------|--------------------|------------|-----------|----------|------------|------------------|----------|----------|----------|------------|--------------------|------------|----------|----------|------------|------------------|----------|----------|----------|------------|------------|
|              | Right              | Thru       | Left      | Peds     | App. Total | Right            | Thru     | Left     | Peds     | App. Total | Right              | Thru       | Left     | Peds     | App. Total | Right            | Thru     | Left     | Peds     | App. Total |            |
| 07:00 AM     | 0                  | 65         | 0         | 0        | 65         | 0                | 0        | 2        | 0        | 2          | 0                  | 12         | 0        | 0        | 12         | 0                | 0        | 0        | 0        | 0          | 79         |
| 07:15 AM     | 0                  | 182        | 4         | 0        | 186        | 1                | 0        | 0        | 1        | 2          | 0                  | 14         | 0        | 0        | 14         | 1                | 0        | 0        | 0        | 0          | 203        |
| 07:30 AM     | 0                  | 187        | 2         | 0        | 189        | 0                | 0        | 0        | 0        | 0          | 1                  | 30         | 0        | 0        | 31         | 0                | 0        | 0        | 0        | 0          | 220        |
| 07:45 AM     | 0                  | 188        | 8         | 0        | 196        | 0                | 0        | 0        | 0        | 0          | 0                  | 32         | 1        | 0        | 33         | 0                | 0        | 0        | 0        | 0          | 229        |
| <b>Total</b> | <b>0</b>           | <b>622</b> | <b>14</b> | <b>0</b> | <b>636</b> | <b>1</b>         | <b>0</b> | <b>2</b> | <b>1</b> | <b>4</b>   | <b>1</b>           | <b>88</b>  | <b>1</b> | <b>0</b> | <b>90</b>  | <b>1</b>         | <b>0</b> | <b>0</b> | <b>0</b> | <b>1</b>   | <b>731</b> |
| 08:00 AM     | 0                  | 177        | 1         | 0        | 178        | 1                | 0        | 3        | 0        | 4          | 1                  | 51         | 0        | 0        | 52         | 0                | 0        | 0        | 0        | 0          | 234        |
| 08:15 AM     | 1                  | 123        | 0         | 0        | 124        | 1                | 0        | 1        | 2        | 4          | 1                  | 24         | 0        | 0        | 25         | 0                | 0        | 0        | 0        | 0          | 153        |
| 08:30 AM     | 2                  | 63         | 1         | 0        | 66         | 0                | 0        | 4        | 4        | 8          | 0                  | 29         | 0        | 0        | 29         | 3                | 0        | 0        | 0        | 3          | 106        |
| 08:45 AM     | 0                  | 73         | 0         | 0        | 73         | 1                | 0        | 0        | 0        | 1          | 0                  | 21         | 1        | 1        | 23         | 0                | 0        | 1        | 0        | 1          | 98         |
| <b>Total</b> | <b>3</b>           | <b>436</b> | <b>2</b>  | <b>0</b> | <b>441</b> | <b>3</b>         | <b>0</b> | <b>8</b> | <b>6</b> | <b>17</b>  | <b>2</b>           | <b>125</b> | <b>1</b> | <b>1</b> | <b>129</b> | <b>3</b>         | <b>0</b> | <b>1</b> | <b>0</b> | <b>4</b>   | <b>591</b> |
| Grand Total  | 3                  | 1058       | 16        | 0        | 1077       | 4                | 0        | 10       | 7        | 21         | 3                  | 213        | 2        | 1        | 219        | 4                | 0        | 1        | 0        | 5          | 1322       |
| Apprch %     | 0.3                | 98.2       | 1.5       | 0        |            | 19               | 0        | 47.6     | 33.3     |            | 1.4                | 97.3       | 0.9      | 0.5      |            | 80               | 0        | 20       | 0        |            |            |
| Total %      | 0.2                | 80         | 1.2       | 0        | 81.5       | 0.3              | 0        | 0.8      | 0.5      | 1.6        | 0.2                | 16.1       | 0.2      | 0.1      | 16.6       | 0.3              | 0        | 0.1      | 0        | 0.4        |            |
| Lights       | 2                  | 1047       | 16        | 0        | 1065       | 3                | 0        | 7        | 7        | 17         | 3                  | 206        | 1        | 1        | 211        | 3                | 0        | 0        | 0        | 3          | 1296       |
| % Lights     | 66.7               | 99         | 100       | 0        | 98.9       | 75               | 0        | 70       | 100      | 81         | 100                | 96.7       | 50       | 100      | 96.3       | 75               | 0        | 0        | 0        | 60         | 98         |
| Buses        | 0                  | 9          | 0         | 0        | 9          | 0                | 0        | 0        | 0        | 0          | 0                  | 4          | 0        | 0        | 4          | 0                | 0        | 0        | 0        | 0          | 13         |
| % Buses      | 0                  | 0.9        | 0         | 0        | 0.8        | 0                | 0        | 0        | 0        | 0          | 0                  | 1.9        | 0        | 0        | 1.8        | 0                | 0        | 0        | 0        | 0          | 1          |
| Trucks       | 1                  | 2          | 0         | 0        | 3          | 1                | 0        | 3        | 0        | 4          | 0                  | 3          | 1        | 0        | 4          | 1                | 0        | 1        | 0        | 2          | 13         |
| % Trucks     | 33.3               | 0.2        | 0         | 0        | 0.3        | 25               | 0        | 30       | 0        | 19         | 0                  | 1.4        | 50       | 0        | 1.8        | 25               | 0        | 100      | 0        | 40         | 1          |

| Start Time   | 2ND AVE Southbound |            |          |            | 8TH ST Westbound |      |          |            | 2ND AVE Northbound |           |      |            | 8TH ST Eastbound |      |      |            | Int. Total |
|--|--------------------|------------|----------|------------|------------------|------|----------|------------|--------------------|-----------|------|------------|------------------|------|------|------------|------------|
|  | Right              | Thru       | Left     | App. Total | Right            | Thru | Left     | App. Total | Right              | Thru      | Left | App. Total | Right            | Thru | Left | App. Total |            |
| Peak Hour Analysis From 07:00 AM to 08:45 AM - Peak 1 of 1 |                    |            |          |            |                  |      |          |            |                    |           |      |            |                  |      |      |            |            |
| Peak Hour for Entire Intersection Begins at 07:15 AM       |                    |            |          |            |                  |      |          |            |                    |           |      |            |                  |      |      |            |            |
| 07:15 AM   | 0                  | 182        | 4        | 186        | 1                | 0    | 0        | 1          | 0                  | 14        | 0    | 14         | 1                | 0    | 0    | 1          | 202        |
| 07:30 AM   | 0                  | 187        | 2        | 189        | 0                | 0    | 0        | 0          | 1                  | 30        | 0    | 31         | 0                | 0    | 0    | 0          | 220        |
| 07:45 AM   | 0                  | <b>188</b> | <b>8</b> | <b>196</b> | 0                | 0    | 0        | 0          | 0                  | 32        | 1    | 33         | 0                | 0    | 0    | 0          | 229        |
| 08:00 AM   | 0                  | 177        | 1        | 178        | 1                | 0    | <b>3</b> | <b>4</b>   | 1                  | <b>51</b> | 0    | <b>52</b>  | 0                | 0    | 0    | 0          | <b>234</b> |
| Total Volume   | 0                  | 734        | 15       | 749        | 2                | 0    | 3        | 5          | 2                  | 127       | 1    | 130        | 1                | 0    | 0    | 1          | 885        |
| % App. Total   | 0                  | 98         | 2        |            | 40               | 0    | 60       |            | 1.5                | 97.7      | 0.8  |            | 100              | 0    | 0    |            |            |
| PHF  | .000               | .976       | .469     | .955       | .500             | .000 | .250     | .313       | .500               | .623      | .250 | .625       | .250             | .000 | .000 | .250       | .946       |

# Traffic Data Service

San Jose, CA  
 (408) 622-4787  
 tdsbay@cs.com

File Name : 11AM FINAL  
 Site Code : 00000011  
 Start Date : 4/27/2017  
 Page No : 2

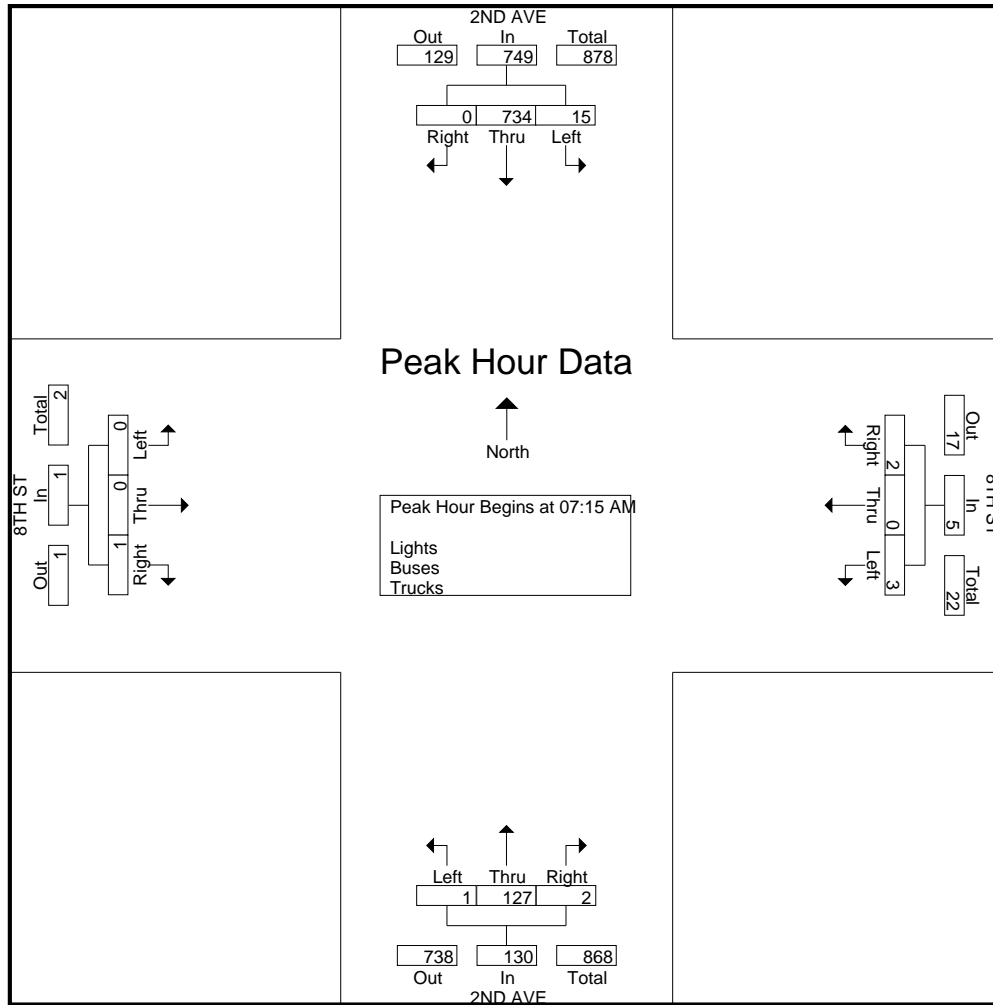

# Traffic Data Service

San Jose, CA  
 (408) 622-4787  
 tdsbay@cs.com

File Name : 11AM FINAL  
 Site Code : 00000011  
 Start Date : 4/27/2017  
 Page No : 1

Groups Printed- Bikes

| Start Time   | 2ND AVE Southbound |      |      |      |            | 8TH ST Westbound |      |      |      |            | 2ND AVE Northbound |      |      |      |            | 8TH ST Eastbound |      |      |      |            | Int. Total |
|--------------|--------------------|------|------|------|------------|------------------|------|------|------|------------|--------------------|------|------|------|------------|------------------|------|------|------|------------|------------|
|              | Right              | Thru | Left | Peds | App. Total | Right            | Thru | Left | Peds | App. Total | Right              | Thru | Left | Peds | App. Total | Right            | Thru | Left | Peds | App. Total |            |
| 07:00 AM     | 0                  | 0    | 0    | 0    | 0          | 0                | 0    | 0    | 0    | 0          | 0                  | 0    | 0    | 0    | 0          | 0                | 0    | 0    | 0    | 0          | 0          |
| 07:15 AM     | 0                  | 0    | 0    | 0    | 0          | 0                | 0    | 0    | 0    | 0          | 0                  | 0    | 0    | 0    | 0          | 0                | 0    | 0    | 0    | 0          | 0          |
| 07:30 AM     | 0                  | 0    | 0    | 0    | 0          | 0                | 0    | 1    | 0    | 1          | 0                  | 0    | 0    | 0    | 0          | 0                | 0    | 0    | 0    | 0          | 1          |
| 07:45 AM     | 0                  | 0    | 0    | 0    | 0          | 0                | 0    | 0    | 0    | 0          | 0                  | 0    | 0    | 0    | 0          | 0                | 0    | 0    | 0    | 0          | 0          |
| <b>Total</b> | 0                  | 0    | 0    | 0    | 0          | 0                | 0    | 1    | 0    | 1          | 0                  | 0    | 0    | 0    | 0          | 0                | 0    | 0    | 0    | 0          | 1          |
| 08:00 AM     | 0                  | 0    | 0    | 0    | 0          | 0                | 0    | 0    | 0    | 0          | 0                  | 0    | 0    | 0    | 0          | 0                | 0    | 0    | 0    | 0          | 0          |
| 08:15 AM     | 0                  | 0    | 0    | 0    | 0          | 0                | 0    | 0    | 0    | 0          | 0                  | 0    | 0    | 0    | 0          | 0                | 0    | 0    | 0    | 0          | 0          |
| 08:30 AM     | 0                  | 0    | 0    | 0    | 0          | 0                | 0    | 0    | 0    | 0          | 0                  | 0    | 0    | 0    | 0          | 0                | 0    | 0    | 0    | 0          | 0          |
| 08:45 AM     | 0                  | 0    | 0    | 0    | 0          | 0                | 0    | 0    | 0    | 0          | 0                  | 0    | 0    | 0    | 0          | 0                | 0    | 0    | 0    | 0          | 0          |
| <b>Total</b> | 0                  | 0    | 0    | 0    | 0          | 0                | 0    | 0    | 0    | 0          | 0                  | 0    | 0    | 0    | 0          | 0                | 0    | 0    | 0    | 0          | 0          |
| Grand Total  | 0                  | 0    | 0    | 0    | 0          | 0                | 0    | 1    | 0    | 1          | 0                  | 0    | 0    | 0    | 0          | 0                | 0    | 0    | 0    | 0          | 1          |
| Apprch %     | 0                  | 0    | 0    | 0    |            | 0                | 0    | 100  | 0    |            | 0                  | 0    | 0    | 0    |            | 0                | 0    | 0    | 0    |            |            |
| Total %      | 0                  | 0    | 0    | 0    |            | 0                | 0    | 100  | 0    | 100        | 0                  | 0    | 0    | 0    |            | 0                | 0    | 0    | 0    |            |            |

| Start Time   | 2ND AVE Southbound |      |      |      |            | 8TH ST Westbound |      |      |      |            | 2ND AVE Northbound |      |      |      |            | 8TH ST Eastbound |      |      |      |            | Int. Total |
|--|--------------------|------|------|------|------------|------------------|------|------|------|------------|--------------------|------|------|------|------------|------------------|------|------|------|------------|------------|
|  | Right              | Thru | Left | Peds | App. Total | Right            | Thru | Left | Peds | App. Total | Right              | Thru | Left | Peds | App. Total | Right            | Thru | Left | Peds | App. Total |            |
| Peak Hour Analysis From 07:00 AM to 08:45 AM - Peak 1 of 1 |                    |      |      |      |            |                  |      |      |      |            |                    |      |      |      |            |                  |      |      |      |            |            |
| Peak Hour for Entire Intersection Begins at 07:00 AM       |                    |      |      |      |            |                  |      |      |      |            |                    |      |      |      |            |                  |      |      |      |            |            |
| 07:00 AM   | 0                  | 0    | 0    | 0    | 0          | 0                | 0    | 0    | 0    | 0          | 0                  | 0    | 0    | 0    | 0          | 0                | 0    | 0    | 0    | 0          | 0          |
| 07:15 AM   | 0                  | 0    | 0    | 0    | 0          | 0                | 0    | 0    | 0    | 0          | 0                  | 0    | 0    | 0    | 0          | 0                | 0    | 0    | 0    | 0          | 0          |
| 07:30 AM   | 0                  | 0    | 0    | 0    | 0          | 0                | 0    | 1    | 0    | 1          | 0                  | 0    | 0    | 0    | 0          | 0                | 0    | 0    | 0    | 0          | 1          |
| 07:45 AM   | 0                  | 0    | 0    | 0    | 0          | 0                | 0    | 0    | 0    | 0          | 0                  | 0    | 0    | 0    | 0          | 0                | 0    | 0    | 0    | 0          | 0          |
| <b>Total Volume</b>  | 0                  | 0    | 0    | 0    | 0          | 0                | 0    | 1    | 0    | 1          | 0                  | 0    | 0    | 0    | 0          | 0                | 0    | 0    | 0    | 0          | 1          |
| <b>% App. Total</b>  | 0                  | 0    | 0    | 0    |            | 0                | 0    | 100  | 0    |            | 0                  | 0    | 0    | 0    |            | 0                | 0    | 0    | 0    |            |            |
| <b>PHF</b>   | .000               | .000 | .000 | .000 |            | .000             | .000 | .250 | .250 |            | .000               | .000 | .000 | .000 |            | .000             | .000 | .000 | .000 |            | .250       |

# Traffic Data Service

San Jose, CA  
(408) 622-4787  
tdsbay@cs.com

File Name : 11AM FINAL  
Site Code : 00000011  
Start Date : 4/27/2017  
Page No : 2

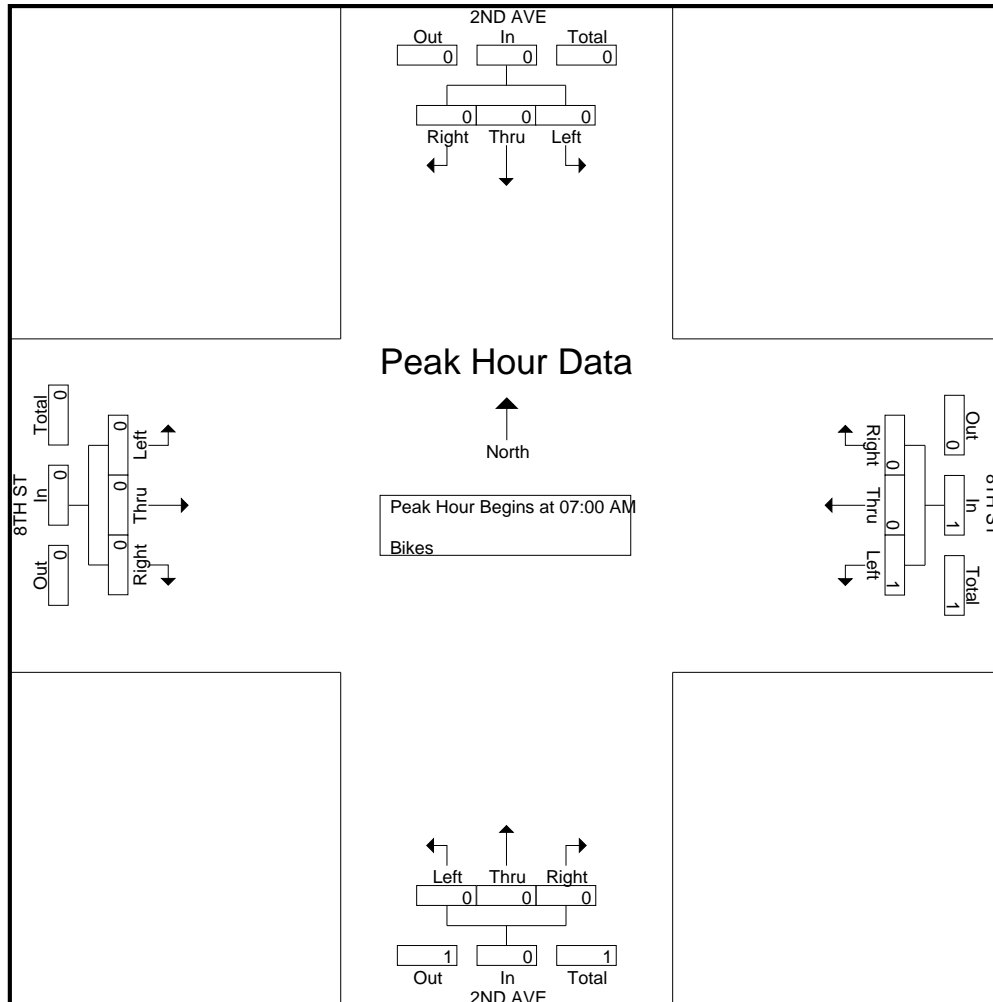

# Traffic Data Service

San Jose, CA  
 (408) 622-4787  
 tdsbay@cs.com

File Name : 11PM FINAL  
 Site Code : 00000011  
 Start Date : 4/27/2017  
 Page No : 1

## Groups Printed- Lights - Buses - Trucks

| Start Time   | 2ND AVE Southbound |            |          |          |            | 8TH ST Westbound |          |          |           |            | 2ND AVE Northbound |            |          |          |            | 8TH ST Eastbound |          |          |          |            | Int. Total |
|--------------|--------------------|------------|----------|----------|------------|------------------|----------|----------|-----------|------------|--------------------|------------|----------|----------|------------|------------------|----------|----------|----------|------------|------------|
|              | Right              | Thru       | Left     | Peds     | App. Total | Right            | Thru     | Left     | Peds      | App. Total | Right              | Thru       | Left     | Peds     | App. Total | Right            | Thru     | Left     | Peds     | App. Total |            |
| 04:00 PM     | 1                  | 53         | 0        | 0        | 54         | 6                | 0        | 1        | 0         | 7          | 1                  | 55         | 1        | 0        | 57         | 0                | 0        | 0        | 0        | 0          | 118        |
| 04:15 PM     | 1                  | 54         | 1        | 0        | 56         | 2                | 0        | 1        | 2         | 5          | 1                  | 61         | 0        | 2        | 64         | 2                | 0        | 1        | 2        | 5          | 130        |
| 04:30 PM     | 1                  | 67         | 0        | 2        | 70         | 0                | 0        | 0        | 1         | 1          | 2                  | 77         | 2        | 0        | 81         | 1                | 0        | 1        | 2        | 4          | 156        |
| 04:45 PM     | 0                  | 62         | 1        | 0        | 63         | 2                | 0        | 0        | 2         | 4          | 1                  | 82         | 0        | 2        | 85         | 0                | 0        | 1        | 2        | 3          | 155        |
| <b>Total</b> | <b>3</b>           | <b>236</b> | <b>2</b> | <b>2</b> | <b>243</b> | <b>10</b>        | <b>0</b> | <b>2</b> | <b>5</b>  | <b>17</b>  | <b>5</b>           | <b>275</b> | <b>3</b> | <b>4</b> | <b>287</b> | <b>3</b>         | <b>0</b> | <b>3</b> | <b>6</b> | <b>12</b>  | <b>559</b> |
| 05:00 PM     | 0                  | 47         | 1        | 0        | 48         | 1                | 0        | 5        | 3         | 9          | 1                  | 100        | 0        | 0        | 101        | 0                | 0        | 0        | 0        | 0          | 158        |
| 05:15 PM     | 1                  | 55         | 0        | 0        | 56         | 0                | 0        | 0        | 4         | 4          | 1                  | 106        | 1        | 0        | 108        | 0                | 0        | 0        | 0        | 0          | 168        |
| 05:30 PM     | 0                  | 57         | 0        | 0        | 57         | 0                | 0        | 0        | 1         | 1          | 0                  | 76         | 0        | 0        | 76         | 0                | 0        | 0        | 0        | 0          | 134        |
| 05:45 PM     | 0                  | 59         | 0        | 0        | 59         | 0                | 0        | 0        | 2         | 2          | 0                  | 86         | 4        | 0        | 90         | 2                | 0        | 0        | 0        | 2          | 153        |
| <b>Total</b> | <b>1</b>           | <b>218</b> | <b>1</b> | <b>0</b> | <b>220</b> | <b>1</b>         | <b>0</b> | <b>5</b> | <b>10</b> | <b>16</b>  | <b>2</b>           | <b>368</b> | <b>5</b> | <b>0</b> | <b>375</b> | <b>2</b>         | <b>0</b> | <b>0</b> | <b>0</b> | <b>2</b>   | <b>613</b> |
| Grand Total  | 4                  | 454        | 3        | 2        | 463        | 11               | 0        | 7        | 15        | 33         | 7                  | 643        | 8        | 4        | 662        | 5                | 0        | 3        | 6        | 14         | 1172       |
| Apprch %     | 0.9                | 98.1       | 0.6      | 0.4      |            | 33.3             | 0        | 21.2     | 45.5      |            | 1.1                | 97.1       | 1.2      | 0.6      |            | 35.7             | 0        | 21.4     | 42.9     |            |            |
| Total %      | 0.3                | 38.7       | 0.3      | 0.2      | 39.5       | 0.9              | 0        | 0.6      | 1.3       | 2.8        | 0.6                | 54.9       | 0.7      | 0.3      | 56.5       | 0.4              | 0        | 0.3      | 0.5      | 1.2        |            |
| Lights       | 4                  | 443        | 3        | 2        | 452        | 11               | 0        | 7        | 15        | 33         | 6                  | 640        | 8        | 4        | 658        | 5                | 0        | 3        | 6        | 14         | 1157       |
| % Lights     | 100                | 97.6       | 100      | 100      | 97.6       | 100              | 0        | 100      | 100       | 100        | 85.7               | 99.5       | 100      | 100      | 99.4       | 100              | 0        | 100      | 100      | 100        | 98.7       |
| Buses        | 0                  | 9          | 0        | 0        | 9          | 0                | 0        | 0        | 0         | 0          | 0                  | 2          | 0        | 0        | 2          | 0                | 0        | 0        | 0        | 0          | 11         |
| % Buses      | 0                  | 2          | 0        | 0        | 1.9        | 0                | 0        | 0        | 0         | 0          | 0                  | 0.3        | 0        | 0        | 0.3        | 0                | 0        | 0        | 0        | 0          | 0.9        |
| Trucks       | 0                  | 2          | 0        | 0        | 2          | 0                | 0        | 0        | 0         | 0          | 1                  | 1          | 0        | 0        | 2          | 0                | 0        | 0        | 0        | 0          | 4          |
| % Trucks     | 0                  | 0.4        | 0        | 0        | 0.4        | 0                | 0        | 0        | 0         | 0          | 14.3               | 0.2        | 0        | 0        | 0.3        | 0                | 0        | 0        | 0        | 0          | 0.3        |

| Start Time   | 2ND AVE Southbound |      |      |            | 8TH ST Westbound |      |      |            | 2ND AVE Northbound |      |      |            | 8TH ST Eastbound |      |      |            | Int. Total |
|--|--------------------|------|------|------------|------------------|------|------|------------|--------------------|------|------|------------|------------------|------|------|------------|------------|
|  | Right              | Thru | Left | App. Total | Right            | Thru | Left | App. Total | Right              | Thru | Left | App. Total | Right            | Thru | Left | App. Total |            |
| Peak Hour Analysis From 04:00 PM to 05:45 PM - Peak 1 of 1 |                    |      |      |            |                  |      |      |            |                    |      |      |            |                  |      |      |            |            |
| Peak Hour for Entire Intersection Begins at 04:30 PM       |                    |      |      |            |                  |      |      |            |                    |      |      |            |                  |      |      |            |            |
| 04:30 PM   | 1                  | 67   | 0    | 68         | 0                | 0    | 0    | 0          | 2                  | 77   | 2    | 81         | 1                | 0    | 1    | 2          | 151        |
| 04:45 PM   | 0                  | 62   | 1    | 63         | 2                | 0    | 0    | 2          | 1                  | 82   | 0    | 83         | 0                | 0    | 1    | 1          | 149        |
| 05:00 PM   | 0                  | 47   | 1    | 48         | 1                | 0    | 5    | 6          | 1                  | 100  | 0    | 101        | 0                | 0    | 0    | 0          | 155        |
| 05:15 PM   | 1                  | 55   | 0    | 56         | 0                | 0    | 0    | 0          | 1                  | 106  | 1    | 108        | 0                | 0    | 0    | 0          | 164        |
| Total Volume   | 2                  | 231  | 2    | 235        | 3                | 0    | 5    | 8          | 5                  | 365  | 3    | 373        | 1                | 0    | 2    | 3          | 619        |
| % App. Total   | 0.9                | 98.3 | 0.9  |            | 37.5             | 0    | 62.5 |            | 1.3                | 97.9 | 0.8  |            | 33.3             | 0    | 66.7 |            |            |
| PHF  | .500               | .862 | .500 | .864       | .375             | .000 | .250 | .333       | .625               | .861 | .375 | .863       | .250             | .000 | .500 | .375       | .944       |

# Traffic Data Service

San Jose, CA  
 (408) 622-4787  
 tdsbay@cs.com

File Name : 11PM FINAL  
 Site Code : 00000011  
 Start Date : 4/27/2017  
 Page No : 2

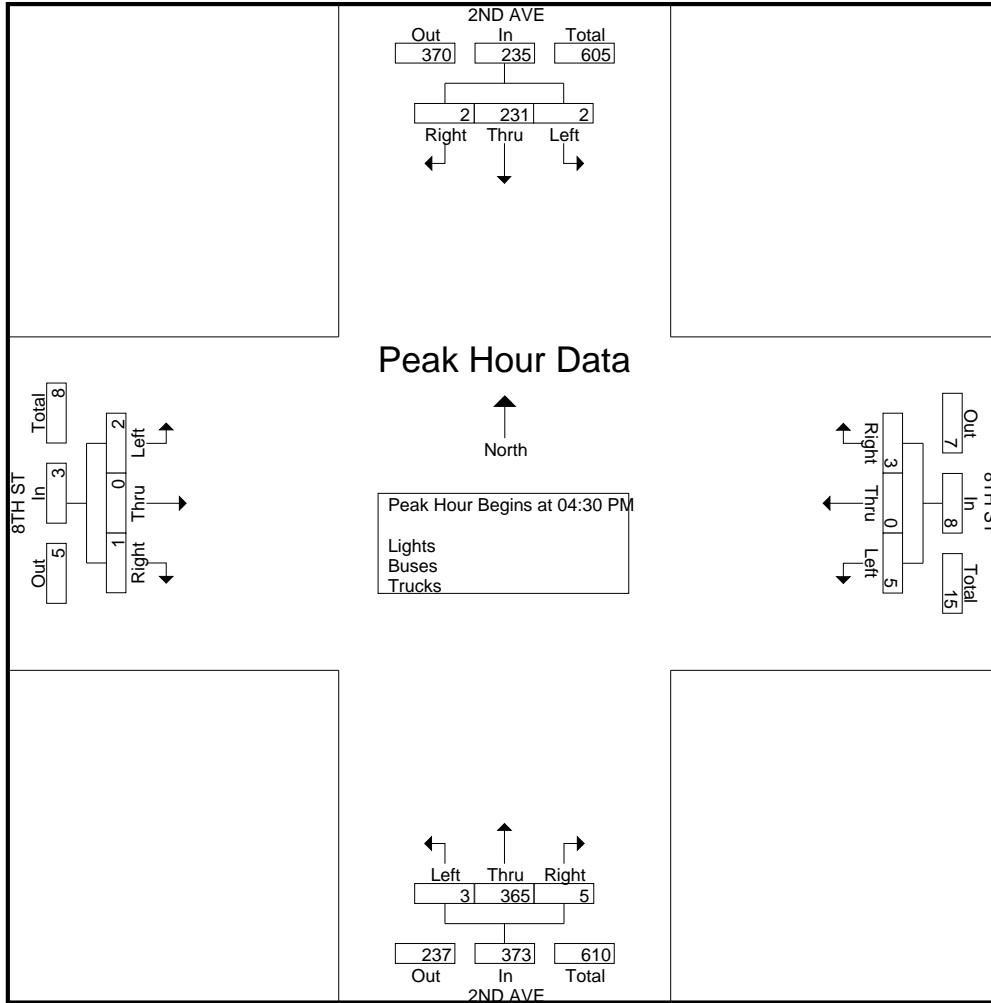

# Traffic Data Service

San Jose, CA  
 (408) 622-4787  
 tdsbay@cs.com

File Name : 11PM FINAL  
 Site Code : 00000011  
 Start Date : 4/27/2017  
 Page No : 1

Groups Printed- Bikes

| Start Time  | 2ND AVE Southbound |      |      |      |            | 8TH ST Westbound |      |      |      |            | 2ND AVE Northbound |      |      |      |            | 8TH ST Eastbound |      |      |      |            | Int. Total |   |
|-------------|--------------------|------|------|------|------------|------------------|------|------|------|------------|--------------------|------|------|------|------------|------------------|------|------|------|------------|------------|---|
|             | Right              | Thru | Left | Peds | App. Total | Right            | Thru | Left | Peds | App. Total | Right              | Thru | Left | Peds | App. Total | Right            | Thru | Left | Peds | App. Total |            |   |
| 04:00 PM    | 0                  | 0    | 0    | 0    | 0          | 0                | 0    | 0    | 0    | 0          | 0                  | 0    | 0    | 0    | 0          | 0                | 0    | 0    | 0    | 0          | 0          | 0 |
| 04:15 PM    | 0                  | 0    | 0    | 0    | 0          | 0                | 0    | 0    | 0    | 0          | 0                  | 0    | 0    | 0    | 0          | 0                | 0    | 0    | 0    | 0          | 0          | 0 |
| 04:30 PM    | 0                  | 0    | 0    | 0    | 0          | 0                | 0    | 0    | 0    | 0          | 0                  | 1    | 0    | 0    | 1          | 0                | 0    | 0    | 0    | 0          | 0          | 1 |
| 04:45 PM    | 0                  | 0    | 0    | 0    | 0          | 0                | 0    | 0    | 0    | 0          | 0                  | 0    | 0    | 0    | 0          | 0                | 0    | 0    | 0    | 0          | 0          | 0 |
| Total       | 0                  | 0    | 0    | 0    | 0          | 0                | 0    | 0    | 0    | 0          | 0                  | 1    | 0    | 0    | 1          | 0                | 0    | 0    | 0    | 0          | 0          | 1 |
| 05:00 PM    | 0                  | 0    | 0    | 0    | 0          | 0                | 0    | 1    | 0    | 1          | 0                  | 0    | 0    | 0    | 0          | 0                | 0    | 0    | 0    | 0          | 0          | 1 |
| 05:15 PM    | 0                  | 1    | 0    | 0    | 1          | 0                | 0    | 0    | 0    | 0          | 0                  | 0    | 0    | 0    | 0          | 0                | 0    | 0    | 0    | 0          | 0          | 1 |
| 05:30 PM    | 0                  | 0    | 0    | 0    | 0          | 0                | 0    | 0    | 0    | 0          | 0                  | 0    | 0    | 0    | 0          | 0                | 0    | 0    | 0    | 0          | 0          | 0 |
| 05:45 PM    | 0                  | 0    | 0    | 0    | 0          | 0                | 0    | 0    | 0    | 0          | 0                  | 0    | 0    | 0    | 0          | 0                | 0    | 0    | 0    | 0          | 0          | 0 |
| Total       | 0                  | 1    | 0    | 0    | 1          | 0                | 0    | 1    | 0    | 1          | 0                  | 0    | 0    | 0    | 0          | 0                | 0    | 0    | 0    | 0          | 0          | 2 |
| Grand Total | 0                  | 1    | 0    | 0    | 1          | 0                | 0    | 1    | 0    | 1          | 0                  | 1    | 0    | 0    | 1          | 0                | 0    | 0    | 0    | 0          | 0          | 3 |
| Apprch %    | 0                  | 100  | 0    | 0    |            | 0                | 0    | 100  | 0    |            | 0                  | 100  | 0    | 0    |            | 0                | 0    | 0    | 0    |            |            |   |
| Total %     | 0                  | 33.3 | 0    | 0    | 33.3       | 0                | 0    | 33.3 | 0    | 33.3       | 0                  | 33.3 | 0    | 0    | 33.3       | 0                | 0    | 0    | 0    | 0          |            |   |

| Start Time   | 2ND AVE Southbound |      |      |      |            | 8TH ST Westbound |      |      |      |            | 2ND AVE Northbound |      |      |      |            | 8TH ST Eastbound |      |      |      |            | Int. Total |      |
|--------------|--------------------|------|------|------|------------|------------------|------|------|------|------------|--------------------|------|------|------|------------|------------------|------|------|------|------------|------------|------|
|              | Right              | Thru | Left | Peds | App. Total | Right            | Thru | Left | Peds | App. Total | Right              | Thru | Left | Peds | App. Total | Right            | Thru | Left | Peds | App. Total |            |      |
| 04:30 PM     | 0                  | 0    | 0    | 0    | 0          | 0                | 0    | 0    | 0    | 0          | 0                  | 1    | 0    | 0    | 1          | 0                | 0    | 0    | 0    | 0          | 0          | 1    |
| 04:45 PM     | 0                  | 0    | 0    | 0    | 0          | 0                | 0    | 0    | 0    | 0          | 0                  | 0    | 0    | 0    | 0          | 0                | 0    | 0    | 0    | 0          | 0          | 0    |
| 05:00 PM     | 0                  | 0    | 0    | 0    | 0          | 0                | 0    | 1    | 0    | 1          | 0                  | 0    | 0    | 0    | 0          | 0                | 0    | 0    | 0    | 0          | 0          | 1    |
| 05:15 PM     | 0                  | 1    | 0    | 0    | 1          | 0                | 0    | 0    | 0    | 0          | 0                  | 0    | 0    | 0    | 0          | 0                | 0    | 0    | 0    | 0          | 0          | 1    |
| Total Volume | 0                  | 1    | 0    | 0    | 1          | 0                | 0    | 1    | 0    | 1          | 0                  | 1    | 0    | 0    | 1          | 0                | 0    | 0    | 0    | 0          | 0          | 3    |
| % App. Total | 0                  | 100  | 0    | 0    |            | 0                | 0    | 100  | 0    |            | 0                  | 100  | 0    | 0    |            | 0                | 0    | 0    | 0    |            |            |      |
| PHF          | .000               | .250 | .000 | .000 | .250       | .000             | .000 | .250 | .000 | .250       | .000               | .250 | .000 | .000 | .250       | .000             | .000 | .000 | .000 | .000       |            | .750 |

Peak Hour Analysis From 04:00 PM to 05:45 PM - Peak 1 of 1  
 Peak Hour for Entire Intersection Begins at 04:30 PM

# Traffic Data Service

San Jose, CA  
 (408) 622-4787  
 tdsbay@cs.com

File Name : 11PM FINAL  
 Site Code : 00000011  
 Start Date : 4/27/2017  
 Page No : 2

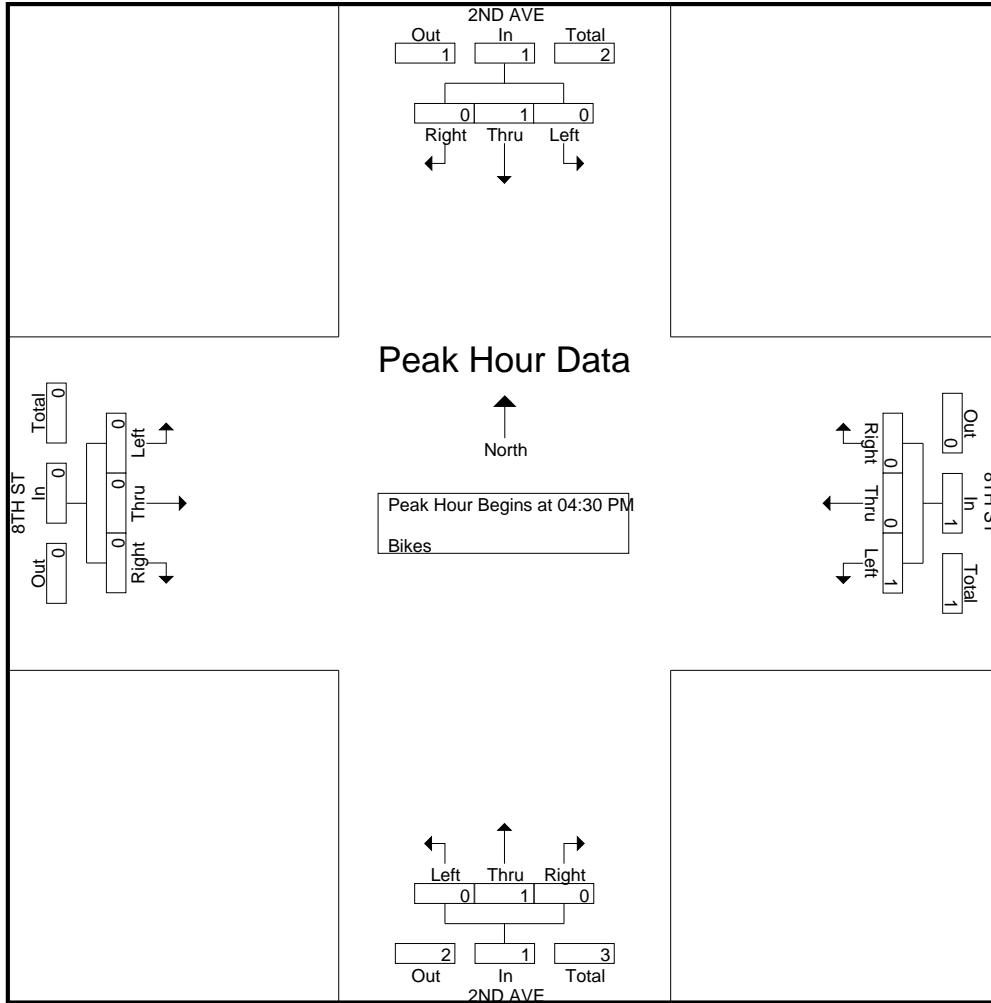



# Traffic Data Service

San Jose, CA  
 (408) 622-4787  
 tdsbay@cs.com

File Name : 12AM FINAL  
 Site Code : 00000012  
 Start Date : 4/27/2017  
 Page No : 1

Groups Printed- Lights - Buses - Trucks

| Start Time  | IMJIN RD Southbound |      |      |      |            | 8TH ST Westbound |      |      |      |            | DRIVEWAY Northbound |      |      |      |            | 8TH ST Eastbound |      |      |      |            | Int. Total |
|-------------|---------------------|------|------|------|------------|------------------|------|------|------|------------|---------------------|------|------|------|------------|------------------|------|------|------|------------|------------|
|             | Right               | Thru | Left | Peds | App. Total | Right            | Thru | Left | Peds | App. Total | Right               | Thru | Left | Peds | App. Total | Right            | Thru | Left | Peds | App. Total |            |
| 07:00 AM    | 3                   | 0    | 20   | 0    | 23         | 5                | 2    | 0    | 0    | 7          | 3                   | 1    | 0    | 0    | 4          | 0                | 15   | 0    | 0    | 15         | 49         |
| 07:15 AM    | 0                   | 2    | 58   | 0    | 60         | 5                | 1    | 0    | 0    | 6          | 1                   | 1    | 0    | 0    | 2          | 0                | 30   | 1    | 0    | 31         | 99         |
| 07:30 AM    | 1                   | 2    | 95   | 0    | 98         | 13               | 1    | 1    | 0    | 15         | 6                   | 2    | 0    | 0    | 8          | 0                | 50   | 0    | 0    | 50         | 171        |
| 07:45 AM    | 2                   | 1    | 109  | 0    | 112        | 9                | 4    | 1    | 0    | 14         | 9                   | 2    | 0    | 0    | 11         | 1                | 51   | 1    | 0    | 53         | 190        |
| Total       | 6                   | 5    | 282  | 0    | 293        | 32               | 8    | 2    | 0    | 42         | 19                  | 6    | 0    | 0    | 25         | 1                | 146  | 2    | 0    | 149        | 509        |
| 08:00 AM    | 1                   | 3    | 67   | 0    | 71         | 13               | 2    | 3    | 0    | 18         | 8                   | 2    | 0    | 0    | 10         | 0                | 41   | 1    | 0    | 42         | 141        |
| 08:15 AM    | 1                   | 0    | 66   | 0    | 67         | 13               | 2    | 1    | 0    | 16         | 6                   | 1    | 0    | 0    | 7          | 1                | 20   | 5    | 0    | 26         | 116        |
| 08:30 AM    | 0                   | 1    | 47   | 0    | 48         | 9                | 3    | 0    | 0    | 12         | 3                   | 2    | 0    | 0    | 5          | 0                | 12   | 0    | 0    | 12         | 77         |
| 08:45 AM    | 0                   | 1    | 41   | 0    | 42         | 13               | 3    | 2    | 0    | 18         | 3                   | 5    | 0    | 0    | 8          | 0                | 9    | 1    | 0    | 10         | 78         |
| Total       | 2                   | 5    | 221  | 0    | 228        | 48               | 10   | 6    | 0    | 64         | 20                  | 10   | 0    | 0    | 30         | 1                | 82   | 7    | 0    | 90         | 412        |
| Grand Total | 8                   | 10   | 503  | 0    | 521        | 80               | 18   | 8    | 0    | 106        | 39                  | 16   | 0    | 0    | 55         | 2                | 228  | 9    | 0    | 239        | 921        |
| Apprch %    | 1.5                 | 1.9  | 96.5 | 0    |            | 75.5             | 17   | 7.5  | 0    |            | 70.9                | 29.1 | 0    | 0    |            | 0.8              | 95.4 | 3.8  | 0    |            |            |
| Total %     | 0.9                 | 1.1  | 54.6 | 0    | 56.6       | 8.7              | 2    | 0.9  | 0    | 11.5       | 4.2                 | 1.7  | 0    | 0    | 6          | 0.2              | 24.8 | 1    | 0    | 26         |            |
| Lights      | 8                   | 10   | 496  | 0    | 514        | 71               | 15   | 8    | 0    | 94         | 39                  | 16   | 0    | 0    | 55         | 2                | 220  | 9    | 0    | 231        | 894        |
| % Lights    | 100                 | 100  | 98.6 | 0    | 98.7       | 88.8             | 83.3 | 100  | 0    | 88.7       | 100                 | 100  | 0    | 0    | 100        | 100              | 96.5 | 100  | 0    | 96.7       | 97.1       |
| Buses       | 0                   | 0    | 2    | 0    | 2          | 5                | 0    | 0    | 0    | 5          | 0                   | 0    | 0    | 0    | 0          | 0                | 2    | 0    | 0    | 2          | 9          |
| % Buses     | 0                   | 0    | 0.4  | 0    | 0.4        | 6.2              | 0    | 0    | 0    | 4.7        | 0                   | 0    | 0    | 0    | 0          | 0                | 0.9  | 0    | 0    | 0.8        | 1          |
| Trucks      | 0                   | 0    | 5    | 0    | 5          | 4                | 3    | 0    | 0    | 7          | 0                   | 0    | 0    | 0    | 0          | 0                | 6    | 0    | 0    | 6          | 18         |
| % Trucks    | 0                   | 0    | 1    | 0    | 1          | 5                | 16.7 | 0    | 0    | 6.6        | 0                   | 0    | 0    | 0    | 0          | 0                | 2.6  | 0    | 0    | 2.5        | 2          |

| Start Time   | IMJIN RD Southbound |      |      |            | 8TH ST Westbound |      |      |            | DRIVEWAY Northbound |      |      |            | 8TH ST Eastbound |      |      |            | Int. Total |
|--|---------------------|------|------|------------|------------------|------|------|------------|---------------------|------|------|------------|------------------|------|------|------------|------------|
|  | Right               | Thru | Left | App. Total | Right            | Thru | Left | App. Total | Right               | Thru | Left | App. Total | Right            | Thru | Left | App. Total |            |
| Peak Hour Analysis From 07:00 AM to 08:45 AM - Peak 1 of 1 |                     |      |      |            |                  |      |      |            |                     |      |      |            |                  |      |      |            |            |
| Peak Hour for Entire Intersection Begins at 07:30 AM       |                     |      |      |            |                  |      |      |            |                     |      |      |            |                  |      |      |            |            |
| 07:30 AM   | 1                   | 2    | 95   | 98         | 13               | 1    | 1    | 15         | 6                   | 2    | 0    | 8          | 0                | 50   | 0    | 50         | 171        |
| 07:45 AM   | 2                   | 1    | 109  | 112        | 9                | 4    | 1    | 14         | 9                   | 2    | 0    | 11         | 1                | 51   | 1    | 53         | 190        |
| 08:00 AM   | 1                   | 3    | 67   | 71         | 13               | 2    | 3    | 18         | 8                   | 2    | 0    | 10         | 0                | 41   | 1    | 42         | 141        |
| 08:15 AM   | 1                   | 0    | 66   | 67         | 13               | 2    | 1    | 16         | 6                   | 1    | 0    | 7          | 1                | 20   | 5    | 26         | 116        |
| Total Volume   | 5                   | 6    | 337  | 348        | 48               | 9    | 6    | 63         | 29                  | 7    | 0    | 36         | 2                | 162  | 7    | 171        | 618        |
| % App. Total   | 1.4                 | 1.7  | 96.8 |            | 76.2             | 14.3 | 9.5  |            | 80.6                | 19.4 | 0    |            | 1.2              | 94.7 | 4.1  |            |            |
| PHF  | .625                | .500 | .773 | .777       | .923             | .563 | .500 | .875       | .806                | .875 | .000 | .818       | .500             | .794 | .350 | .807       | .813       |

# Traffic Data Service

San Jose, CA  
 (408) 622-4787  
 tdsbay@cs.com

File Name : 12AM FINAL  
 Site Code : 00000012  
 Start Date : 4/27/2017  
 Page No : 2

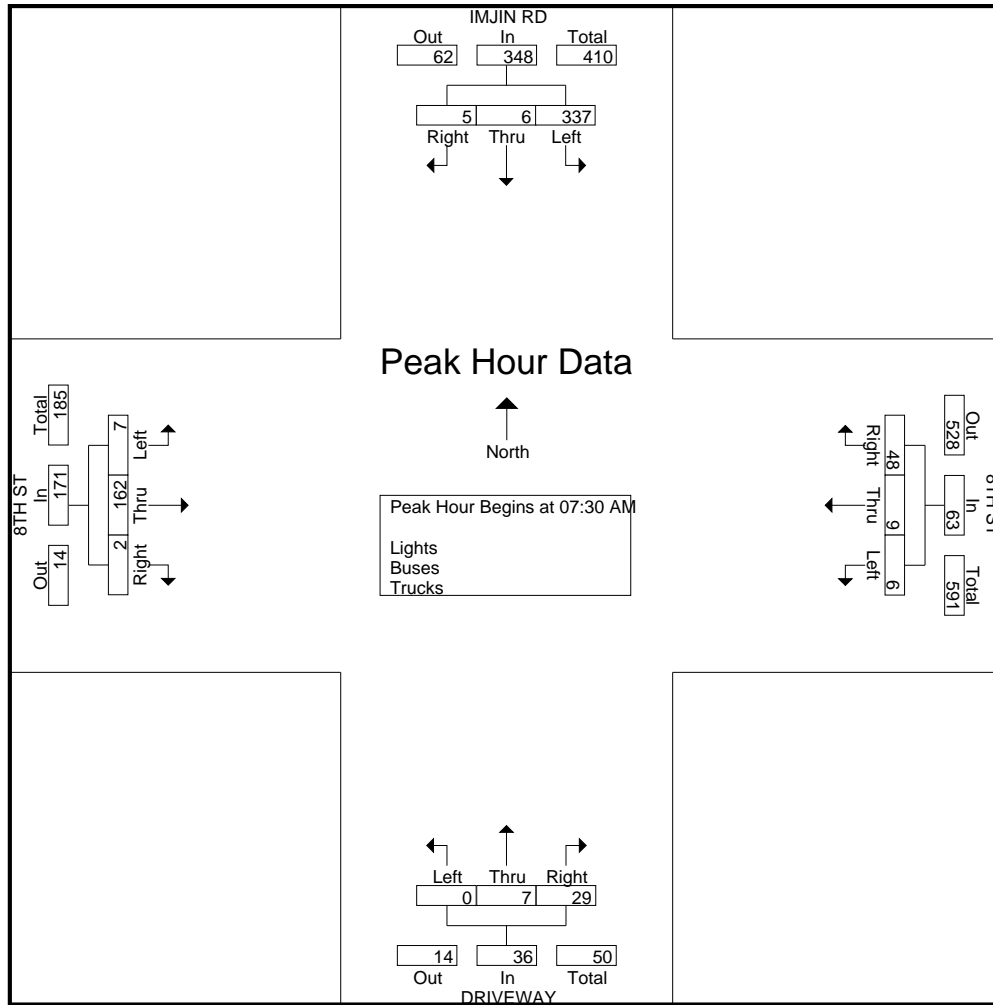

# Traffic Data Service

San Jose, CA  
 (408) 622-4787  
 tdsbay@cs.com

File Name : 12AM FINAL  
 Site Code : 00000012  
 Start Date : 4/27/2017  
 Page No : 1

Groups Printed- Bikes

| Start Time   | IMJIN RD Southbound |      |      |      |            | 8TH ST Westbound |      |      |      |            | DRIVEWAY Northbound |      |      |      |            | 8TH ST Eastbound |      |      |      |            | Int. Total |
|--------------|---------------------|------|------|------|------------|------------------|------|------|------|------------|---------------------|------|------|------|------------|------------------|------|------|------|------------|------------|
|              | Right               | Thru | Left | Peds | App. Total | Right            | Thru | Left | Peds | App. Total | Right               | Thru | Left | Peds | App. Total | Right            | Thru | Left | Peds | App. Total |            |
| 07:00 AM     | 0                   | 0    | 0    | 0    | 0          | 0                | 0    | 0    | 0    | 0          | 0                   | 0    | 0    | 0    | 0          | 0                | 0    | 0    | 0    | 0          | 0          |
| 07:15 AM     | 0                   | 0    | 0    | 0    | 0          | 0                | 0    | 0    | 0    | 0          | 0                   | 0    | 0    | 0    | 0          | 0                | 0    | 0    | 0    | 0          | 0          |
| 07:30 AM     | 0                   | 0    | 0    | 0    | 0          | 0                | 0    | 0    | 0    | 0          | 0                   | 0    | 0    | 0    | 0          | 1                | 0    | 0    | 0    | 1          | 1          |
| 07:45 AM     | 0                   | 0    | 0    | 0    | 0          | 0                | 0    | 0    | 0    | 0          | 0                   | 0    | 0    | 0    | 0          | 0                | 0    | 0    | 0    | 0          | 0          |
| <b>Total</b> | 0                   | 0    | 0    | 0    | 0          | 0                | 0    | 0    | 0    | 0          | 0                   | 0    | 0    | 0    | 0          | 1                | 0    | 0    | 0    | 1          | 1          |
| 08:00 AM     | 0                   | 0    | 0    | 0    | 0          | 0                | 0    | 0    | 0    | 0          | 0                   | 0    | 0    | 0    | 0          | 0                | 0    | 0    | 0    | 0          | 0          |
| 08:15 AM     | 0                   | 0    | 0    | 0    | 0          | 0                | 0    | 0    | 0    | 0          | 0                   | 0    | 0    | 0    | 0          | 0                | 0    | 0    | 0    | 0          | 0          |
| 08:30 AM     | 0                   | 0    | 0    | 0    | 0          | 0                | 0    | 0    | 0    | 0          | 0                   | 0    | 0    | 0    | 0          | 0                | 0    | 0    | 0    | 0          | 0          |
| 08:45 AM     | 0                   | 0    | 0    | 0    | 0          | 0                | 0    | 0    | 0    | 0          | 0                   | 0    | 0    | 0    | 0          | 0                | 0    | 0    | 0    | 0          | 0          |
| <b>Total</b> | 0                   | 0    | 0    | 0    | 0          | 0                | 0    | 0    | 0    | 0          | 0                   | 0    | 0    | 0    | 0          | 0                | 0    | 0    | 0    | 0          | 0          |
| Grand Total  | 0                   | 0    | 0    | 0    | 0          | 0                | 0    | 0    | 0    | 0          | 0                   | 0    | 0    | 0    | 0          | 1                | 0    | 0    | 0    | 1          | 1          |
| Apprch %     | 0                   | 0    | 0    | 0    | 0          | 0                | 0    | 0    | 0    | 0          | 0                   | 0    | 0    | 0    | 0          | 100              | 0    | 0    | 0    | 0          |            |
| Total %      | 0                   | 0    | 0    | 0    | 0          | 0                | 0    | 0    | 0    | 0          | 0                   | 0    | 0    | 0    | 0          | 100              | 0    | 0    | 0    | 100        |            |

| Start Time   | IMJIN RD Southbound |      |      |      |            | 8TH ST Westbound |      |      |      |            | DRIVEWAY Northbound |      |      |      |            | 8TH ST Eastbound |      |      |      |            | Int. Total |
|--|---------------------|------|------|------|------------|------------------|------|------|------|------------|---------------------|------|------|------|------------|------------------|------|------|------|------------|------------|
|  | Right               | Thru | Left | Peds | App. Total | Right            | Thru | Left | Peds | App. Total | Right               | Thru | Left | Peds | App. Total | Right            | Thru | Left | Peds | App. Total |            |
| Peak Hour Analysis From 07:00 AM to 08:45 AM - Peak 1 of 1 |                     |      |      |      |            |                  |      |      |      |            |                     |      |      |      |            |                  |      |      |      |            |            |
| Peak Hour for Entire Intersection Begins at 07:00 AM       |                     |      |      |      |            |                  |      |      |      |            |                     |      |      |      |            |                  |      |      |      |            |            |
| 07:00 AM   | 0                   | 0    | 0    | 0    | 0          | 0                | 0    | 0    | 0    | 0          | 0                   | 0    | 0    | 0    | 0          | 0                | 0    | 0    | 0    | 0          | 0          |
| 07:15 AM   | 0                   | 0    | 0    | 0    | 0          | 0                | 0    | 0    | 0    | 0          | 0                   | 0    | 0    | 0    | 0          | 0                | 0    | 0    | 0    | 0          | 0          |
| 07:30 AM   | 0                   | 0    | 0    | 0    | 0          | 0                | 0    | 0    | 0    | 0          | 0                   | 0    | 0    | 0    | 0          | 1                | 0    | 0    | 0    | 1          | 1          |
| 07:45 AM   | 0                   | 0    | 0    | 0    | 0          | 0                | 0    | 0    | 0    | 0          | 0                   | 0    | 0    | 0    | 0          | 0                | 0    | 0    | 0    | 0          | 0          |
| Total Volume   | 0                   | 0    | 0    | 0    | 0          | 0                | 0    | 0    | 0    | 0          | 0                   | 0    | 0    | 0    | 0          | 1                | 0    | 0    | 0    | 1          | 1          |
| % App. Total   | 0                   | 0    | 0    | 0    | 0          | 0                | 0    | 0    | 0    | 0          | 0                   | 0    | 0    | 0    | 0          | 100              | 0    | 0    | 0    | 0          |            |
| PHF  | .000                | .000 | .000 | .000 | .000       | .000             | .000 | .000 | .000 | .000       | .000                | .000 | .000 | .000 | .000       | .250             | .000 | .000 | .250 | .250       |            |

# Traffic Data Service

San Jose, CA  
(408) 622-4787  
tdsbay@cs.com

File Name : 12AM FINAL  
Site Code : 00000012  
Start Date : 4/27/2017  
Page No : 2

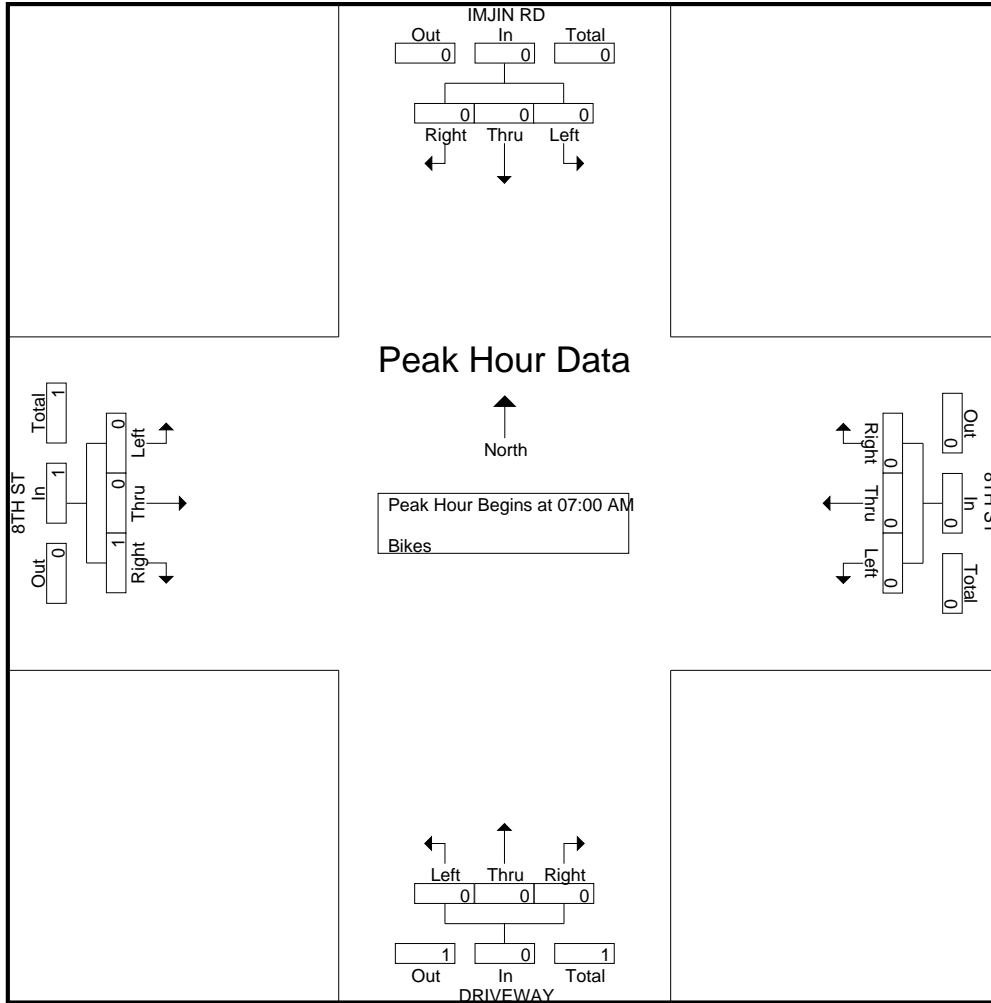

# Traffic Data Service

San Jose, CA  
(408) 622-4787  
tdsbay@cs.com

File Name : 12PM FINAL  
Site Code : 00000012  
Start Date : 4/27/2017  
Page No : 1

Groups Printed- Lights - Buses - Trucks

| Start Time   | IMJIN RD Southbound |           |            |          |            | 8TH ST Westbound |           |           |          |            | DRIVEWAY Northbound |           |          |          |            | 8TH ST Eastbound |           |          |          |            | Int. Total |
|--------------|---------------------|-----------|------------|----------|------------|------------------|-----------|-----------|----------|------------|---------------------|-----------|----------|----------|------------|------------------|-----------|----------|----------|------------|------------|
|              | Right               | Thru      | Left       | Peds     | App. Total | Right            | Thru      | Left      | Peds     | App. Total | Right               | Thru      | Left     | Peds     | App. Total | Right            | Thru      | Left     | Peds     | App. Total |            |
| 04:00 PM     | 1                   | 4         | 30         | 0        | 35         | 46               | 7         | 10        | 0        | 63         | 4                   | 9         | 0        | 0        | 13         | 2                | 8         | 1        | 0        | 11         | 122        |
| 04:15 PM     | 0                   | 0         | 16         | 0        | 16         | 26               | 7         | 3         | 0        | 36         | 6                   | 5         | 1        | 0        | 12         | 0                | 7         | 1        | 0        | 8          | 72         |
| 04:30 PM     | 1                   | 8         | 19         | 0        | 28         | 31               | 7         | 4         | 0        | 42         | 4                   | 4         | 0        | 0        | 8          | 0                | 8         | 2        | 0        | 10         | 88         |
| 04:45 PM     | 2                   | 6         | 19         | 0        | 27         | 46               | 9         | 6         | 0        | 61         | 4                   | 10        | 0        | 0        | 14         | 0                | 5         | 0        | 0        | 5          | 107        |
| <b>Total</b> | <b>4</b>            | <b>18</b> | <b>84</b>  | <b>0</b> | <b>106</b> | <b>149</b>       | <b>30</b> | <b>23</b> | <b>0</b> | <b>202</b> | <b>18</b>           | <b>28</b> | <b>1</b> | <b>0</b> | <b>47</b>  | <b>2</b>         | <b>28</b> | <b>4</b> | <b>0</b> | <b>34</b>  | <b>389</b> |
| 05:00 PM     | 0                   | 5         | 20         | 0        | 25         | 48               | 12        | 10        | 0        | 70         | 2                   | 5         | 0        | 0        | 7          | 2                | 8         | 1        | 0        | 11         | 113        |
| 05:15 PM     | 0                   | 3         | 27         | 0        | 30         | 53               | 9         | 13        | 0        | 75         | 7                   | 9         | 0        | 0        | 16         | 1                | 4         | 1        | 0        | 6          | 127        |
| 05:30 PM     | 2                   | 2         | 29         | 0        | 33         | 58               | 10        | 5         | 0        | 73         | 14                  | 6         | 2        | 0        | 22         | 1                | 4         | 0        | 0        | 5          | 133        |
| 05:45 PM     | 1                   | 6         | 30         | 0        | 37         | 44               | 11        | 15        | 0        | 70         | 18                  | 7         | 0        | 0        | 25         | 2                | 8         | 0        | 0        | 10         | 142        |
| <b>Total</b> | <b>3</b>            | <b>16</b> | <b>106</b> | <b>0</b> | <b>125</b> | <b>203</b>       | <b>42</b> | <b>43</b> | <b>0</b> | <b>288</b> | <b>41</b>           | <b>27</b> | <b>2</b> | <b>0</b> | <b>70</b>  | <b>6</b>         | <b>24</b> | <b>2</b> | <b>0</b> | <b>32</b>  | <b>515</b> |
| Grand Total  | 7                   | 34        | 190        | 0        | 231        | 352              | 72        | 66        | 0        | 490        | 59                  | 55        | 3        | 0        | 117        | 8                | 52        | 6        | 0        | 66         | 904        |
| Apprch %     | 3                   | 14.7      | 82.3       | 0        |            | 71.8             | 14.7      | 13.5      | 0        |            | 50.4                | 47        | 2.6      | 0        |            | 12.1             | 78.8      | 9.1      | 0        |            |            |
| Total %      | 0.8                 | 3.8       | 21         | 0        | 25.6       | 38.9             | 8         | 7.3       | 0        | 54.2       | 6.5                 | 6.1       | 0.3      | 0        | 12.9       | 0.9              | 5.8       | 0.7      | 0        | 7.3        |            |
| Lights       | 7                   | 34        | 188        | 0        | 229        | 347              | 72        | 65        | 0        | 484        | 58                  | 54        | 3        | 0        | 115        | 8                | 50        | 6        | 0        | 64         | 892        |
| % Lights     | 100                 | 100       | 98.9       | 0        | 99.1       | 98.6             | 100       | 98.5      | 0        | 98.8       | 98.3                | 98.2      | 100      | 0        | 98.3       | 100              | 96.2      | 100      | 0        | 97         | 98.7       |
| Buses        | 0                   | 0         | 0          | 0        | 0          | 5                | 0         | 0         | 0        | 5          | 0                   | 0         | 0        | 0        | 0          | 0                | 1         | 0        | 0        | 1          | 6          |
| % Buses      | 0                   | 0         | 0          | 0        | 0          | 1.4              | 0         | 0         | 0        | 1          | 0                   | 0         | 0        | 0        | 0          | 0                | 1.9       | 0        | 0        | 1.5        | 0.7        |
| Trucks       | 0                   | 0         | 2          | 0        | 2          | 0                | 0         | 1         | 0        | 1          | 1                   | 1         | 0        | 0        | 2          | 0                | 1         | 0        | 0        | 1          | 6          |
| % Trucks     | 0                   | 0         | 1.1        | 0        | 0.9        | 0                | 0         | 1.5       | 0        | 0.2        | 1.7                 | 1.8       | 0        | 0        | 1.7        | 0                | 1.9       | 0        | 0        | 1.5        | 0.7        |

| Start Time   | IMJIN RD Southbound |      |      |            | 8TH ST Westbound |      |      |            | DRIVEWAY Northbound |      |      |            | 8TH ST Eastbound |      |      |            | Int. Total |
|--|---------------------|------|------|------------|------------------|------|------|------------|---------------------|------|------|------------|------------------|------|------|------------|------------|
|  | Right               | Thru | Left | App. Total | Right            | Thru | Left | App. Total | Right               | Thru | Left | App. Total | Right            | Thru | Left | App. Total |            |
| Peak Hour Analysis From 04:00 PM to 05:45 PM - Peak 1 of 1 |                     |      |      |            |                  |      |      |            |                     |      |      |            |                  |      |      |            |            |
| Peak Hour for Entire Intersection Begins at 05:00 PM       |                     |      |      |            |                  |      |      |            |                     |      |      |            |                  |      |      |            |            |
| 05:00 PM   | 0                   | 5    | 20   | 25         | 48               | 12   | 10   | 70         | 2                   | 5    | 0    | 7          | 2                | 8    | 1    | 11         | 113        |
| 05:15 PM   | 0                   | 3    | 27   | 30         | 53               | 9    | 13   | 75         | 7                   | 9    | 0    | 16         | 1                | 4    | 1    | 6          | 127        |
| 05:30 PM   | 2                   | 2    | 29   | 33         | 58               | 10   | 5    | 73         | 14                  | 6    | 2    | 22         | 1                | 4    | 0    | 5          | 133        |
| 05:45 PM   | 1                   | 6    | 30   | 37         | 44               | 11   | 15   | 70         | 18                  | 7    | 0    | 25         | 2                | 8    | 0    | 10         | 142        |
| Total Volume   | 3                   | 16   | 106  | 125        | 203              | 42   | 43   | 288        | 41                  | 27   | 2    | 70         | 6                | 24   | 2    | 32         | 515        |
| % App. Total   | 2.4                 | 12.8 | 84.8 |            | 70.5             | 14.6 | 14.9 |            | 58.6                | 38.6 | 2.9  |            | 18.8             | 75   | 6.2  |            |            |
| PHF  | .375                | .667 | .883 | .845       | .875             | .875 | .717 | .960       | .569                | .750 | .250 | .700       | .750             | .750 | .500 | .727       | .907       |

# Traffic Data Service

San Jose, CA  
 (408) 622-4787  
 tdsbay@cs.com

File Name : 12PM FINAL  
 Site Code : 00000012  
 Start Date : 4/27/2017  
 Page No : 2

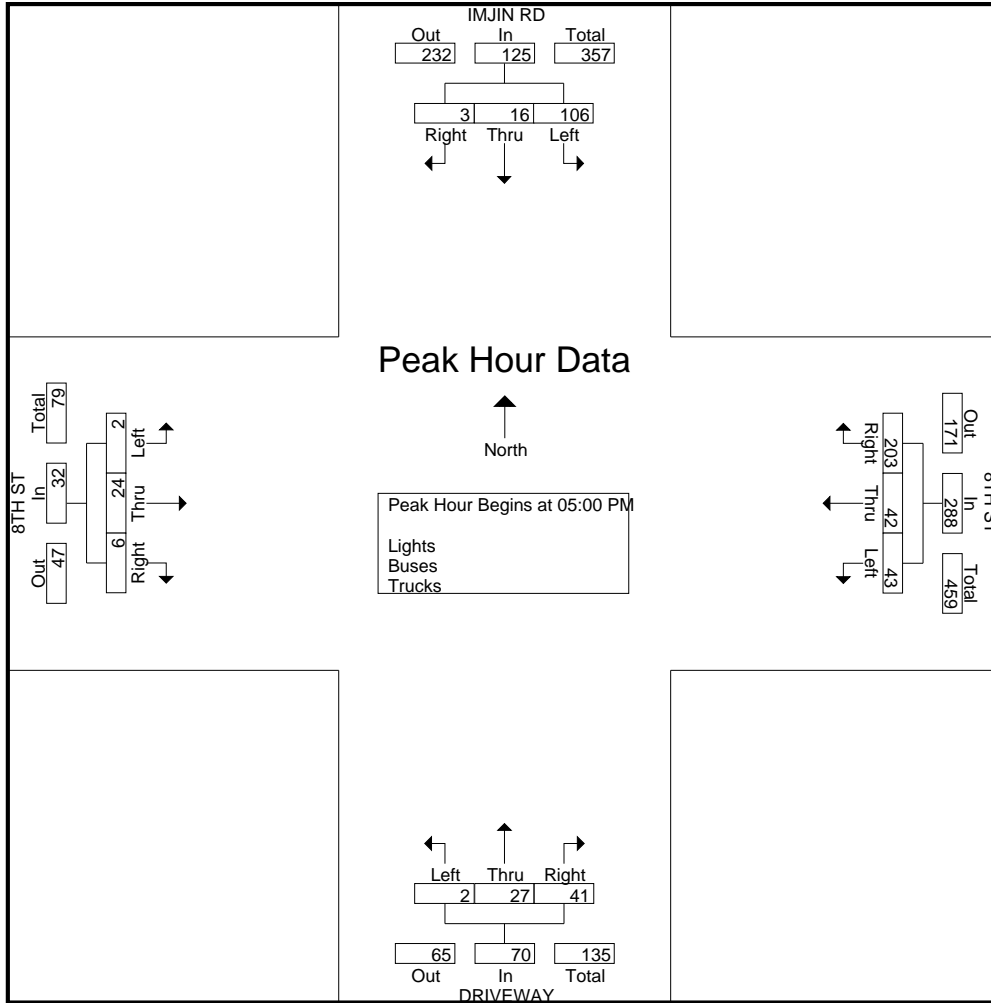

# Traffic Data Service

San Jose, CA  
 (408) 622-4787  
 tdsbay@cs.com

File Name : 12PM FINAL  
 Site Code : 00000012  
 Start Date : 4/27/2017  
 Page No : 1

Groups Printed- Bikes

| Start Time  | IMJIN RD Southbound |      |      |      |            | 8TH ST Westbound |      |      |      |            | DRIVEWAY Northbound |      |      |      |            | 8TH ST Eastbound |      |      |      |            | Int. Total |
|-------------|---------------------|------|------|------|------------|------------------|------|------|------|------------|---------------------|------|------|------|------------|------------------|------|------|------|------------|------------|
|             | Right               | Thru | Left | Peds | App. Total | Right            | Thru | Left | Peds | App. Total | Right               | Thru | Left | Peds | App. Total | Right            | Thru | Left | Peds | App. Total |            |
| 04:00 PM    | 0                   | 0    | 0    | 0    | 0          | 0                | 0    | 0    | 0    | 0          | 0                   | 0    | 0    | 0    | 0          | 0                | 0    | 0    | 0    | 0          | 0          |
| 04:15 PM    | 0                   | 0    | 0    | 0    | 0          | 0                | 0    | 0    | 0    | 0          | 0                   | 0    | 0    | 0    | 0          | 0                | 0    | 1    | 0    | 1          | 1          |
| 04:30 PM    | 0                   | 0    | 0    | 0    | 0          | 0                | 0    | 0    | 0    | 0          | 0                   | 0    | 0    | 0    | 0          | 0                | 0    | 0    | 0    | 0          | 0          |
| 04:45 PM    | 0                   | 0    | 0    | 0    | 0          | 0                | 0    | 0    | 0    | 0          | 0                   | 0    | 0    | 0    | 0          | 0                | 0    | 0    | 0    | 0          | 0          |
| Total       | 0                   | 0    | 0    | 0    | 0          | 0                | 0    | 0    | 0    | 0          | 0                   | 0    | 0    | 0    | 0          | 0                | 0    | 1    | 0    | 1          | 1          |
| 05:00 PM    | 0                   | 0    | 0    | 0    | 0          | 0                | 0    | 0    | 0    | 0          | 0                   | 0    | 0    | 0    | 0          | 0                | 0    | 0    | 0    | 0          | 0          |
| 05:15 PM    | 0                   | 0    | 0    | 0    | 0          | 0                | 0    | 0    | 0    | 0          | 0                   | 0    | 0    | 0    | 0          | 0                | 0    | 0    | 0    | 0          | 0          |
| 05:30 PM    | 0                   | 0    | 0    | 0    | 0          | 0                | 0    | 0    | 0    | 0          | 0                   | 0    | 0    | 0    | 0          | 0                | 0    | 0    | 0    | 0          | 0          |
| 05:45 PM    | 0                   | 0    | 0    | 0    | 0          | 0                | 0    | 0    | 0    | 0          | 0                   | 0    | 0    | 0    | 0          | 0                | 0    | 0    | 0    | 0          | 0          |
| Total       | 0                   | 0    | 0    | 0    | 0          | 0                | 0    | 0    | 0    | 0          | 0                   | 0    | 0    | 0    | 0          | 0                | 0    | 0    | 0    | 0          | 0          |
| Grand Total | 0                   | 0    | 0    | 0    | 0          | 0                | 0    | 0    | 0    | 0          | 0                   | 0    | 0    | 0    | 0          | 0                | 0    | 1    | 0    | 1          | 1          |
| Apprch %    | 0                   | 0    | 0    | 0    | 0          | 0                | 0    | 0    | 0    | 0          | 0                   | 0    | 0    | 0    | 0          | 0                | 0    | 100  | 0    | 0          | 0          |
| Total %     | 0                   | 0    | 0    | 0    | 0          | 0                | 0    | 0    | 0    | 0          | 0                   | 0    | 0    | 0    | 0          | 0                | 0    | 100  | 0    | 100        | 0          |

| Start Time   | IMJIN RD Southbound |      |      |      |            | 8TH ST Westbound |      |      |      |            | DRIVEWAY Northbound |      |      |      |            | 8TH ST Eastbound |      |      |      |            | Int. Total |
|--------------|---------------------|------|------|------|------------|------------------|------|------|------|------------|---------------------|------|------|------|------------|------------------|------|------|------|------------|------------|
|              | Right               | Thru | Left | Peds | App. Total | Right            | Thru | Left | Peds | App. Total | Right               | Thru | Left | Peds | App. Total | Right            | Thru | Left | Peds | App. Total |            |
| 04:00 PM     | 0                   | 0    | 0    | 0    | 0          | 0                | 0    | 0    | 0    | 0          | 0                   | 0    | 0    | 0    | 0          | 0                | 0    | 0    | 0    | 0          | 0          |
| 04:15 PM     | 0                   | 0    | 0    | 0    | 0          | 0                | 0    | 0    | 0    | 0          | 0                   | 0    | 0    | 0    | 0          | 0                | 0    | 1    | 0    | 1          | 1          |
| 04:30 PM     | 0                   | 0    | 0    | 0    | 0          | 0                | 0    | 0    | 0    | 0          | 0                   | 0    | 0    | 0    | 0          | 0                | 0    | 0    | 0    | 0          | 0          |
| 04:45 PM     | 0                   | 0    | 0    | 0    | 0          | 0                | 0    | 0    | 0    | 0          | 0                   | 0    | 0    | 0    | 0          | 0                | 0    | 0    | 0    | 0          | 0          |
| Total Volume | 0                   | 0    | 0    | 0    | 0          | 0                | 0    | 0    | 0    | 0          | 0                   | 0    | 0    | 0    | 0          | 0                | 0    | 1    | 0    | 1          | 1          |
| % App. Total | 0                   | 0    | 0    | 0    | 0          | 0                | 0    | 0    | 0    | 0          | 0                   | 0    | 0    | 0    | 0          | 0                | 0    | 100  | 0    | 0          | 0          |
| PHF          | .000                | .000 | .000 | .000 | .000       | .000             | .000 | .000 | .000 | .000       | .000                | .000 | .000 | .000 | .000       | .000             | .000 | .250 | .250 | .250       | .250       |

Peak Hour Analysis From 04:00 PM to 05:45 PM - Peak 1 of 1  
 Peak Hour for Entire Intersection Begins at 04:00 PM

# Traffic Data Service

San Jose, CA  
(408) 622-4787  
tdsbay@cs.com

File Name : 12PM FINAL  
Site Code : 00000012  
Start Date : 4/27/2017  
Page No : 2

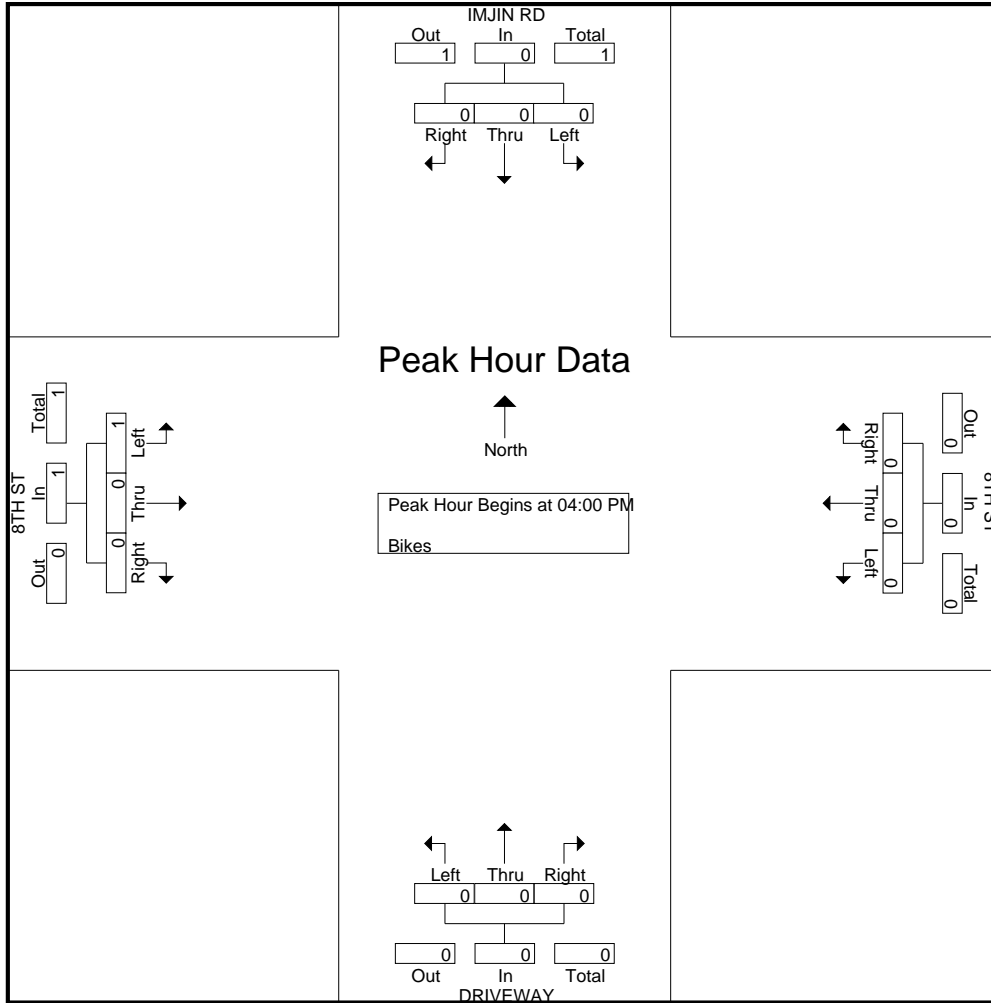



# Traffic Data Service

San Jose, CA  
 (408) 622-4787  
 tdsbay@cs.com

File Name : 13AM FINAL  
 Site Code : 00000013  
 Start Date : 4/27/2017  
 Page No : 1

Groups Printed- Lights - Buses - Trucks

| Start Time  | 2ND AVE Southbound |      |      |      |            | INTER-GARRISON RD Westbound |      |      |      |            | 2ND AVE Northbound |      |      |      |            | Eastbound |      |      |      |            | Int. Total |
|-------------|--------------------|------|------|------|------------|-----------------------------|------|------|------|------------|--------------------|------|------|------|------------|-----------|------|------|------|------------|------------|
|             | Right              | Thru | Left | Peds | App. Total | Right                       | Thru | Left | Peds | App. Total | Right              | Thru | Left | Peds | App. Total | Right     | Thru | Left | Peds | App. Total |            |
| 07:00 AM    | 0                  | 61   | 3    | 0    | 64         | 1                           | 0    | 4    | 0    | 5          | 4                  | 10   | 0    | 0    | 14         | 0         | 0    | 0    | 0    | 0          | 83         |
| 07:15 AM    | 0                  | 154  | 19   | 1    | 174        | 6                           | 0    | 1    | 1    | 8          | 1                  | 8    | 1    | 0    | 10         | 0         | 0    | 0    | 0    | 0          | 192        |
| 07:30 AM    | 0                  | 178  | 9    | 0    | 187        | 3                           | 0    | 2    | 0    | 5          | 13                 | 21   | 0    | 0    | 34         | 0         | 0    | 0    | 0    | 0          | 226        |
| 07:45 AM    | 0                  | 165  | 22   | 0    | 187        | 5                           | 0    | 5    | 0    | 10         | 5                  | 27   | 0    | 0    | 32         | 0         | 0    | 0    | 0    | 0          | 229        |
| Total       | 0                  | 558  | 53   | 1    | 612        | 15                          | 0    | 12   | 1    | 28         | 23                 | 66   | 1    | 0    | 90         | 0         | 0    | 0    | 0    | 0          | 730        |
| 08:00 AM    | 0                  | 147  | 33   | 0    | 180        | 5                           | 0    | 1    | 0    | 6          | 10                 | 40   | 0    | 0    | 50         | 0         | 0    | 0    | 0    | 0          | 236        |
| 08:15 AM    | 0                  | 103  | 24   | 0    | 127        | 2                           | 0    | 2    | 0    | 4          | 8                  | 20   | 0    | 0    | 28         | 0         | 0    | 0    | 0    | 0          | 159        |
| 08:30 AM    | 0                  | 54   | 21   | 0    | 75         | 8                           | 0    | 4    | 0    | 12         | 6                  | 16   | 0    | 0    | 22         | 0         | 0    | 0    | 0    | 0          | 109        |
| 08:45 AM    | 0                  | 52   | 18   | 0    | 70         | 10                          | 0    | 1    | 4    | 15         | 15                 | 10   | 0    | 0    | 25         | 0         | 0    | 0    | 0    | 0          | 110        |
| Total       | 0                  | 356  | 96   | 0    | 452        | 25                          | 0    | 8    | 4    | 37         | 39                 | 86   | 0    | 0    | 125        | 0         | 0    | 0    | 0    | 0          | 614        |
| Grand Total | 0                  | 914  | 149  | 1    | 1064       | 40                          | 0    | 20   | 5    | 65         | 62                 | 152  | 1    | 0    | 215        | 0         | 0    | 0    | 0    | 0          | 1344       |
| Apprch %    | 0                  | 85.9 | 14   | 0.1  |            | 61.5                        | 0    | 30.8 | 7.7  |            | 28.8               | 70.7 | 0.5  | 0    |            | 0         | 0    | 0    | 0    |            |            |
| Total %     | 0                  | 68   | 11.1 | 0.1  | 79.2       | 3                           | 0    | 1.5  | 0.4  | 4.8        | 4.6                | 11.3 | 0.1  | 0    | 16         | 0         | 0    | 0    | 0    | 0          |            |
| Lights      | 0                  | 903  | 144  | 1    | 1048       | 39                          | 0    | 19   | 5    | 63         | 62                 | 146  | 1    | 0    | 209        | 0         | 0    | 0    | 0    | 0          | 1320       |
| % Lights    | 0                  | 98.8 | 96.6 | 100  | 98.5       | 97.5                        | 0    | 95   | 100  | 96.9       | 100                | 96.1 | 100  | 0    | 97.2       | 0         | 0    | 0    | 0    | 0          | 98.2       |
| Buses       | 0                  | 5    | 4    | 0    | 9          | 0                           | 0    | 0    | 0    | 0          | 0                  | 4    | 0    | 0    | 4          | 0         | 0    | 0    | 0    | 0          | 13         |
| % Buses     | 0                  | 0.5  | 2.7  | 0    | 0.8        | 0                           | 0    | 0    | 0    | 0          | 0                  | 2.6  | 0    | 0    | 1.9        | 0         | 0    | 0    | 0    | 0          | 1          |
| Trucks      | 0                  | 6    | 1    | 0    | 7          | 1                           | 0    | 1    | 0    | 2          | 0                  | 2    | 0    | 0    | 2          | 0         | 0    | 0    | 0    | 0          | 11         |
| % Trucks    | 0                  | 0.7  | 0.7  | 0    | 0.7        | 2.5                         | 0    | 5    | 0    | 3.1        | 0                  | 1.3  | 0    | 0    | 0.9        | 0         | 0    | 0    | 0    | 0          | 0.8        |

| Start Time   | 2ND AVE Southbound |      |      |            | INTER-GARRISON RD Westbound |      |      |            | 2ND AVE Northbound |      |      |            | Eastbound |      |      |            | Int. Total |
|--|--------------------|------|------|------------|-----------------------------|------|------|------------|--------------------|------|------|------------|-----------|------|------|------------|------------|
|  | Right              | Thru | Left | App. Total | Right                       | Thru | Left | App. Total | Right              | Thru | Left | App. Total | Right     | Thru | Left | App. Total |            |
| Peak Hour Analysis From 07:00 AM to 08:45 AM - Peak 1 of 1 |                    |      |      |            |                             |      |      |            |                    |      |      |            |           |      |      |            |            |
| Peak Hour for Entire Intersection Begins at 07:15 AM       |                    |      |      |            |                             |      |      |            |                    |      |      |            |           |      |      |            |            |
| 07:15 AM   | 0                  | 154  | 19   | 173        | 6                           | 0    | 1    | 7          | 1                  | 8    | 1    | 10         | 0         | 0    | 0    | 0          | 190        |
| 07:30 AM   | 0                  | 178  | 9    | 187        | 3                           | 0    | 2    | 5          | 13                 | 21   | 0    | 34         | 0         | 0    | 0    | 0          | 226        |
| 07:45 AM   | 0                  | 165  | 22   | 187        | 5                           | 0    | 5    | 10         | 5                  | 27   | 0    | 32         | 0         | 0    | 0    | 0          | 229        |
| 08:00 AM   | 0                  | 147  | 33   | 180        | 5                           | 0    | 1    | 6          | 10                 | 40   | 0    | 50         | 0         | 0    | 0    | 0          | 236        |
| Total Volume   | 0                  | 644  | 83   | 727        | 19                          | 0    | 9    | 28         | 29                 | 96   | 1    | 126        | 0         | 0    | 0    | 0          | 881        |
| % App. Total   | 0                  | 88.6 | 11.4 |            | 67.9                        | 0    | 32.1 |            | 23                 | 76.2 | 0.8  |            | 0         | 0    | 0    |            |            |
| PHF  | .000               | .904 | .629 | .972       | .792                        | .000 | .450 | .700       | .558               | .600 | .250 | .630       | .000      | .000 | .000 | .000       | .933       |

# Traffic Data Service

San Jose, CA  
 (408) 622-4787  
 tdsbay@cs.com

File Name : 13AM FINAL  
 Site Code : 00000013  
 Start Date : 4/27/2017  
 Page No : 2

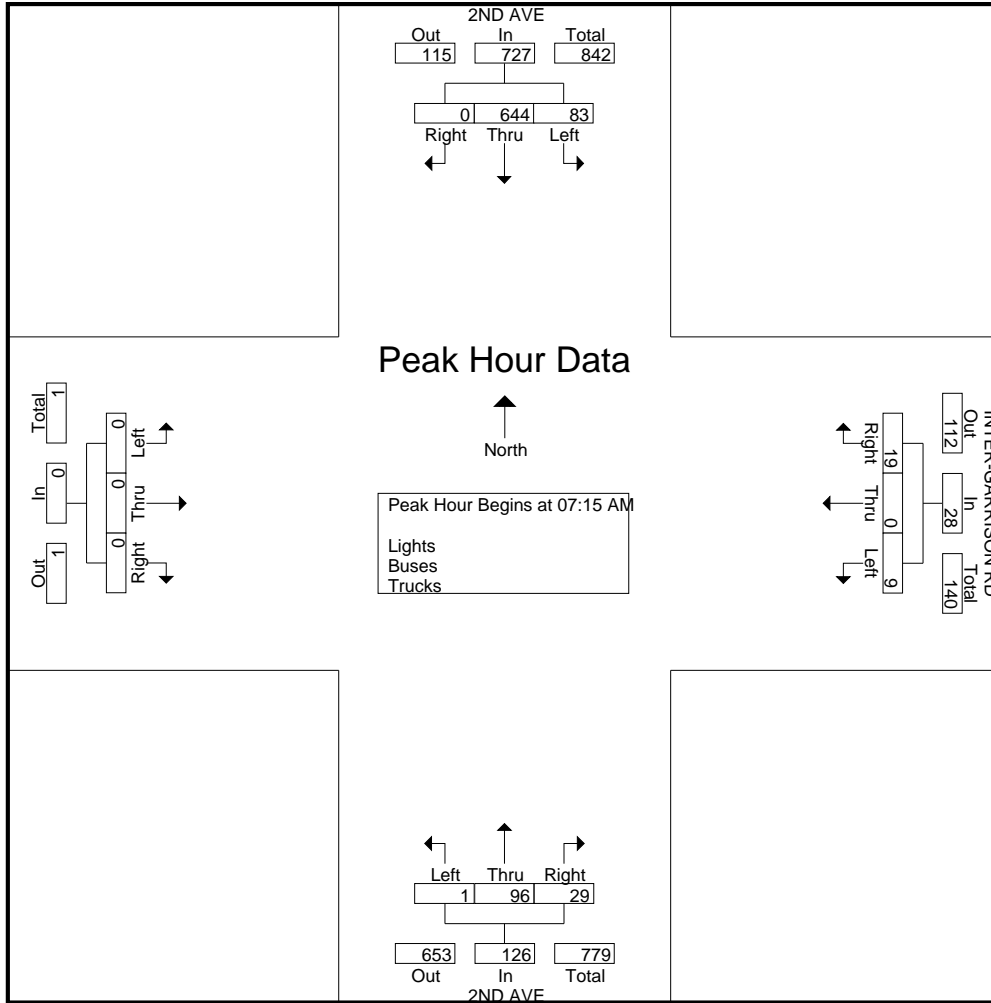

# Traffic Data Service

San Jose, CA  
 (408) 622-4787  
 tdsbay@cs.com

File Name : 13AM FINAL  
 Site Code : 00000013  
 Start Date : 4/27/2017  
 Page No : 1

Groups Printed- Bikes

| Start Time   | 2ND AVE Southbound |      |      |      |            | INTER-GARRISON RD Westbound |      |      |      |            | 2ND AVE Northbound |      |      |      |            | Eastbound |      |      |      |            | Int. Total |
|--------------|--------------------|------|------|------|------------|-----------------------------|------|------|------|------------|--------------------|------|------|------|------------|-----------|------|------|------|------------|------------|
|              | Right              | Thru | Left | Peds | App. Total | Right                       | Thru | Left | Peds | App. Total | Right              | Thru | Left | Peds | App. Total | Right     | Thru | Left | Peds | App. Total |            |
| 07:00 AM     | 0                  | 0    | 0    | 0    | 0          | 0                           | 0    | 0    | 0    | 0          | 0                  | 0    | 0    | 0    | 0          | 0         | 0    | 0    | 0    | 0          | 0          |
| 07:15 AM     | 0                  | 0    | 0    | 0    | 0          | 0                           | 0    | 0    | 0    | 0          | 0                  | 0    | 0    | 0    | 0          | 0         | 0    | 0    | 0    | 0          | 0          |
| 07:30 AM     | 0                  | 1    | 0    | 0    | 1          | 0                           | 0    | 0    | 0    | 0          | 0                  | 0    | 0    | 0    | 0          | 0         | 0    | 0    | 0    | 0          | 1          |
| 07:45 AM     | 0                  | 0    | 0    | 0    | 0          | 0                           | 0    | 0    | 0    | 0          | 0                  | 0    | 0    | 0    | 0          | 0         | 0    | 0    | 0    | 0          | 0          |
| <b>Total</b> | 0                  | 1    | 0    | 0    | 1          | 0                           | 0    | 0    | 0    | 0          | 0                  | 0    | 0    | 0    | 0          | 0         | 0    | 0    | 0    | 0          | 1          |
| 08:00 AM     | 0                  | 0    | 0    | 0    | 0          | 0                           | 0    | 0    | 0    | 0          | 0                  | 0    | 0    | 0    | 0          | 0         | 0    | 0    | 0    | 0          | 0          |
| 08:15 AM     | 0                  | 0    | 0    | 0    | 0          | 0                           | 0    | 0    | 0    | 0          | 0                  | 0    | 0    | 0    | 0          | 0         | 0    | 0    | 0    | 0          | 0          |
| 08:30 AM     | 0                  | 0    | 0    | 0    | 0          | 0                           | 0    | 0    | 0    | 0          | 0                  | 0    | 0    | 0    | 0          | 0         | 0    | 0    | 0    | 0          | 0          |
| 08:45 AM     | 0                  | 0    | 0    | 0    | 0          | 0                           | 0    | 0    | 0    | 0          | 0                  | 0    | 0    | 0    | 0          | 0         | 0    | 0    | 0    | 0          | 0          |
| <b>Total</b> | 0                  | 0    | 0    | 0    | 0          | 0                           | 0    | 0    | 0    | 0          | 0                  | 0    | 0    | 0    | 0          | 0         | 0    | 0    | 0    | 0          | 0          |
| Grand Total  | 0                  | 1    | 0    | 0    | 1          | 0                           | 0    | 0    | 0    | 0          | 0                  | 0    | 0    | 0    | 0          | 0         | 0    | 0    | 0    | 0          | 1          |
| Apprch %     | 0                  | 100  | 0    | 0    |            | 0                           | 0    | 0    | 0    |            | 0                  | 0    | 0    | 0    |            | 0         | 0    | 0    | 0    |            |            |
| Total %      | 0                  | 100  | 0    | 0    | 100        | 0                           | 0    | 0    | 0    | 0          | 0                  | 0    | 0    | 0    | 0          | 0         | 0    | 0    | 0    | 0          |            |

| Start Time   | 2ND AVE Southbound |      |      |            | INTER-GARRISON RD Westbound |      |      |            | 2ND AVE Northbound |      |      |            | Eastbound |      |      |            | Int. Total |
|--|--------------------|------|------|------------|-----------------------------|------|------|------------|--------------------|------|------|------------|-----------|------|------|------------|------------|
|  | Right              | Thru | Left | App. Total | Right                       | Thru | Left | App. Total | Right              | Thru | Left | App. Total | Right     | Thru | Left | App. Total |            |
| Peak Hour Analysis From 07:00 AM to 08:45 AM - Peak 1 of 1 |                    |      |      |            |                             |      |      |            |                    |      |      |            |           |      |      |            |            |
| Peak Hour for Entire Intersection Begins at 07:00 AM       |                    |      |      |            |                             |      |      |            |                    |      |      |            |           |      |      |            |            |
| 07:00 AM   | 0                  | 0    | 0    | 0          | 0                           | 0    | 0    | 0          | 0                  | 0    | 0    | 0          | 0         | 0    | 0    | 0          | 0          |
| 07:15 AM   | 0                  | 0    | 0    | 0          | 0                           | 0    | 0    | 0          | 0                  | 0    | 0    | 0          | 0         | 0    | 0    | 0          | 0          |
| 07:30 AM   | 0                  | 1    | 0    | 1          | 0                           | 0    | 0    | 0          | 0                  | 0    | 0    | 0          | 0         | 0    | 0    | 0          | 1          |
| 07:45 AM   | 0                  | 0    | 0    | 0          | 0                           | 0    | 0    | 0          | 0                  | 0    | 0    | 0          | 0         | 0    | 0    | 0          | 0          |
| Total Volume   | 0                  | 1    | 0    | 1          | 0                           | 0    | 0    | 0          | 0                  | 0    | 0    | 0          | 0         | 0    | 0    | 0          | 1          |
| % App. Total   | 0                  | 100  | 0    |            | 0                           | 0    | 0    |            | 0                  | 0    | 0    |            | 0         | 0    | 0    |            |            |
| PHF  | .000               | .250 | .000 | .250       | .000                        | .000 | .000 | .000       | .000               | .000 | .000 | .000       | .000      | .000 | .000 | .000       | .250       |

# Traffic Data Service

San Jose, CA  
(408) 622-4787  
tdsbay@cs.com

File Name : 13AM FINAL  
Site Code : 00000013  
Start Date : 4/27/2017  
Page No : 2

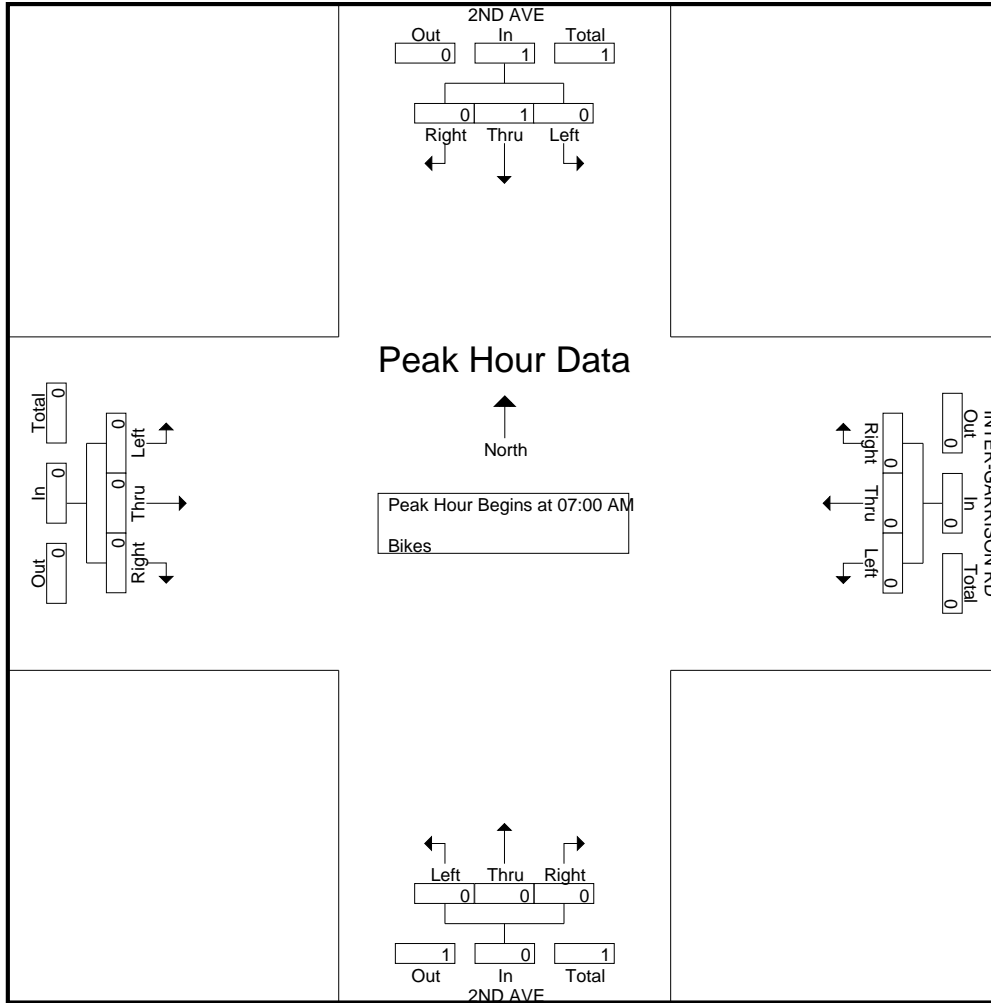

# Traffic Data Service

San Jose, CA  
 (408) 622-4787  
 tdsbay@cs.com

File Name : 13PM FINAL  
 Site Code : 00000013  
 Start Date : 4/27/2017  
 Page No : 1

Groups Printed- Lights - Buses - Trucks

| Start Time  | 2ND AVE Southbound |      |      |      |            | INTER-GARRISON RD Westbound |      |      |      |            | 2ND AVE Northbound |      |      |      |            | Eastbound |      |      |      |            | Int. Total |
|-------------|--------------------|------|------|------|------------|-----------------------------|------|------|------|------------|--------------------|------|------|------|------------|-----------|------|------|------|------------|------------|
|             | Right              | Thru | Left | Peds | App. Total | Right                       | Thru | Left | Peds | App. Total | Right              | Thru | Left | Peds | App. Total | Right     | Thru | Left | Peds | App. Total |            |
| 04:00 PM    | 0                  | 33   | 15   | 0    | 48         | 17                          | 0    | 15   | 0    | 32         | 6                  | 30   | 0    | 0    | 36         | 0         | 0    | 0    | 0    | 0          | 116        |
| 04:15 PM    | 0                  | 44   | 10   | 1    | 55         | 11                          | 0    | 4    | 2    | 17         | 4                  | 41   | 0    | 1    | 46         | 0         | 0    | 0    | 0    | 0          | 118        |
| 04:30 PM    | 0                  | 50   | 13   | 1    | 64         | 18                          | 0    | 7    | 0    | 25         | 6                  | 45   | 0    | 0    | 51         | 0         | 0    | 0    | 0    | 0          | 140        |
| 04:45 PM    | 0                  | 47   | 12   | 2    | 61         | 24                          | 0    | 8    | 2    | 34         | 5                  | 51   | 0    | 0    | 56         | 0         | 0    | 0    | 0    | 0          | 151        |
| Total       | 0                  | 174  | 50   | 4    | 228        | 70                          | 0    | 34   | 4    | 108        | 21                 | 167  | 0    | 1    | 189        | 0         | 0    | 0    | 0    | 0          | 525        |
| 05:00 PM    | 0                  | 28   | 27   | 0    | 55         | 22                          | 0    | 16   | 2    | 40         | 6                  | 73   | 0    | 0    | 79         | 0         | 0    | 0    | 0    | 0          | 174        |
| 05:15 PM    | 0                  | 37   | 15   | 0    | 52         | 35                          | 0    | 12   | 0    | 47         | 10                 | 57   | 0    | 0    | 67         | 0         | 0    | 0    | 0    | 0          | 166        |
| 05:30 PM    | 0                  | 37   | 23   | 1    | 61         | 19                          | 0    | 22   | 1    | 42         | 7                  | 56   | 1    | 0    | 64         | 0         | 0    | 0    | 0    | 0          | 167        |
| 05:45 PM    | 0                  | 41   | 20   | 0    | 61         | 21                          | 0    | 16   | 1    | 38         | 8                  | 57   | 0    | 0    | 65         | 0         | 0    | 0    | 0    | 0          | 164        |
| Total       | 0                  | 143  | 85   | 1    | 229        | 97                          | 0    | 66   | 4    | 167        | 31                 | 243  | 1    | 0    | 275        | 0         | 0    | 0    | 0    | 0          | 671        |
| Grand Total | 0                  | 317  | 135  | 5    | 457        | 167                         | 0    | 100  | 8    | 275        | 52                 | 410  | 1    | 1    | 464        | 0         | 0    | 0    | 0    | 0          | 1196       |
| Apprch %    | 0                  | 69.4 | 29.5 | 1.1  |            | 60.7                        | 0    | 36.4 | 2.9  |            | 11.2               | 88.4 | 0.2  | 0.2  |            | 0         | 0    | 0    | 0    | 0          |            |
| Total %     | 0                  | 26.5 | 11.3 | 0.4  | 38.2       | 14                          | 0    | 8.4  | 0.7  | 23         | 4.3                | 34.3 | 0.1  | 0.1  | 38.8       | 0         | 0    | 0    | 0    | 0          |            |
| Lights      | 0                  | 312  | 130  | 5    | 447        | 167                         | 0    | 100  | 8    | 275        | 52                 | 405  | 1    | 1    | 459        | 0         | 0    | 0    | 0    | 0          | 1181       |
| % Lights    | 0                  | 98.4 | 96.3 | 100  | 97.8       | 100                         | 0    | 100  | 100  | 100        | 100                | 98.8 | 100  | 100  | 98.9       | 0         | 0    | 0    | 0    | 0          | 98.7       |
| Buses       | 0                  | 4    | 4    | 0    | 8          | 0                           | 0    | 0    | 0    | 0          | 0                  | 2    | 0    | 0    | 2          | 0         | 0    | 0    | 0    | 0          | 10         |
| % Buses     | 0                  | 1.3  | 3    | 0    | 1.8        | 0                           | 0    | 0    | 0    | 0          | 0                  | 0.5  | 0    | 0    | 0.4        | 0         | 0    | 0    | 0    | 0          | 0.8        |
| Trucks      | 0                  | 1    | 1    | 0    | 2          | 0                           | 0    | 0    | 0    | 0          | 0                  | 3    | 0    | 0    | 3          | 0         | 0    | 0    | 0    | 0          | 5          |
| % Trucks    | 0                  | 0.3  | 0.7  | 0    | 0.4        | 0                           | 0    | 0    | 0    | 0          | 0                  | 0.7  | 0    | 0    | 0.6        | 0         | 0    | 0    | 0    | 0          | 0.4        |

| Start Time   | 2ND AVE Southbound |           |           |            | INTER-GARRISON RD Westbound |      |           |            | 2ND AVE Northbound |           |          |            | Eastbound |      |      |            | Int. Total |
|--|--------------------|-----------|-----------|------------|-----------------------------|------|-----------|------------|--------------------|-----------|----------|------------|-----------|------|------|------------|------------|
|  | Right              | Thru      | Left      | App. Total | Right                       | Thru | Left      | App. Total | Right              | Thru      | Left     | App. Total | Right     | Thru | Left | App. Total |            |
| Peak Hour Analysis From 04:00 PM to 05:45 PM - Peak 1 of 1 |                    |           |           |            |                             |      |           |            |                    |           |          |            |           |      |      |            |            |
| Peak Hour for Entire Intersection Begins at 05:00 PM       |                    |           |           |            |                             |      |           |            |                    |           |          |            |           |      |      |            |            |
| 05:00 PM   | 0                  | 28        | <b>27</b> | 55         | 22                          | 0    | 16        | 38         | 6                  | <b>73</b> | 0        | <b>79</b>  | 0         | 0    | 0    | 0          | <b>172</b> |
| 05:15 PM   | 0                  | 37        | 15        | 52         | <b>35</b>                   | 0    | 12        | <b>47</b>  | <b>10</b>          | 57        | 0        | 67         | 0         | 0    | 0    | 0          | 166        |
| 05:30 PM   | 0                  | 37        | 23        | 60         | 19                          | 0    | <b>22</b> | 41         | 7                  | 56        | <b>1</b> | 64         | 0         | 0    | 0    | 0          | 165        |
| 05:45 PM   | 0                  | <b>41</b> | 20        | <b>61</b>  | 21                          | 0    | 16        | 37         | 8                  | 57        | 0        | 65         | 0         | 0    | 0    | 0          | 163        |
| Total Volume   | 0                  | 143       | 85        | 228        | 97                          | 0    | 66        | 163        | 31                 | 243       | 1        | 275        | 0         | 0    | 0    | 0          | 666        |
| % App. Total   | 0                  | 62.7      | 37.3      |            | 59.5                        | 0    | 40.5      |            | 11.3               | 88.4      | 0.4      |            | 0         | 0    | 0    |            |            |
| PHF  | .000               | .872      | .787      | .934       | .693                        | .000 | .750      | .867       | .775               | .832      | .250     | .870       | .000      | .000 | .000 | .000       | .968       |

# Traffic Data Service

San Jose, CA  
 (408) 622-4787  
 tdsbay@cs.com

File Name : 13PM FINAL  
 Site Code : 00000013  
 Start Date : 4/27/2017  
 Page No : 2

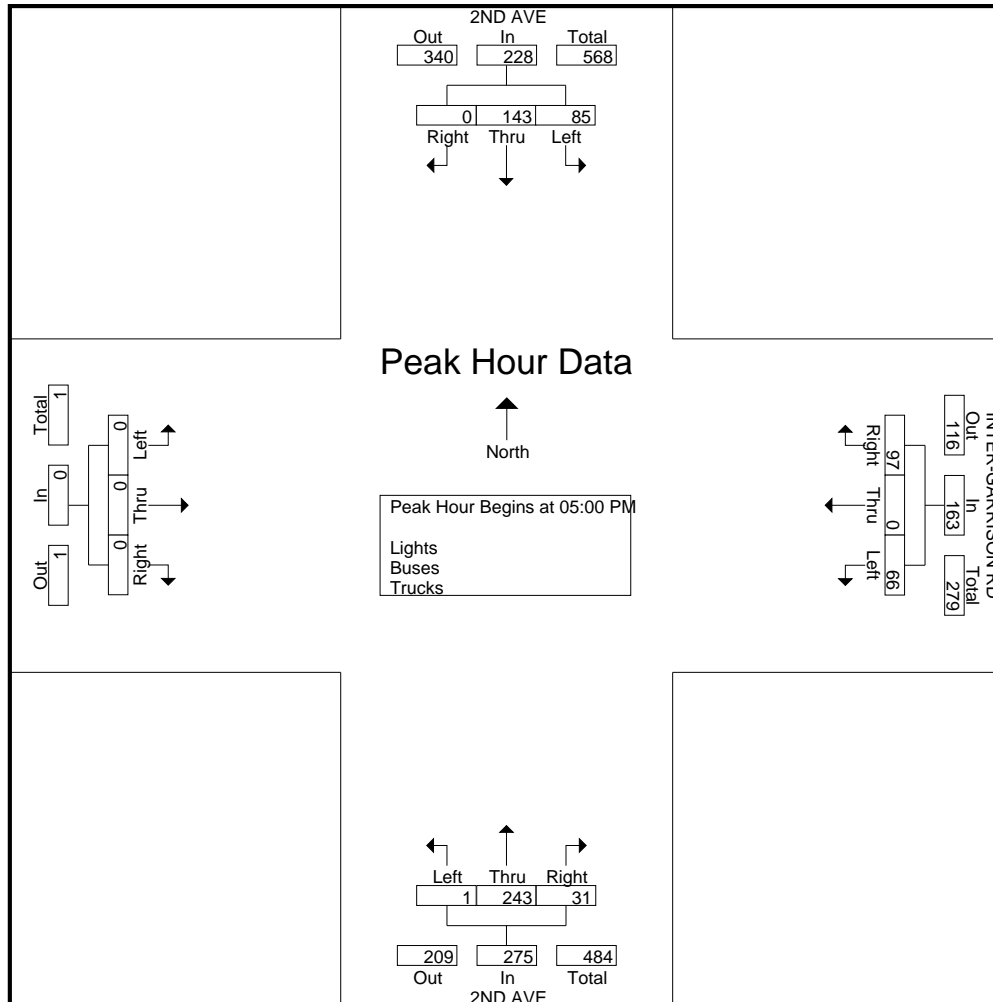

# Traffic Data Service

San Jose, CA  
 (408) 622-4787  
 tdsbay@cs.com

File Name : 13PM FINAL  
 Site Code : 00000013  
 Start Date : 4/27/2017  
 Page No : 1

Groups Printed- Bikes

| Start Time  | 2ND AVE Southbound |      |      |      |            | INTER-GARRISON RD Westbound |      |      |      |            | 2ND AVE Northbound |      |      |      |            | Eastbound |      |      |      |            | Int. Total |
|-------------|--------------------|------|------|------|------------|-----------------------------|------|------|------|------------|--------------------|------|------|------|------------|-----------|------|------|------|------------|------------|
|             | Right              | Thru | Left | Peds | App. Total | Right                       | Thru | Left | Peds | App. Total | Right              | Thru | Left | Peds | App. Total | Right     | Thru | Left | Peds | App. Total |            |
| 04:00 PM    | 0                  | 0    | 0    | 0    | 0          | 0                           | 0    | 0    | 0    | 0          | 0                  | 0    | 0    | 0    | 0          | 0         | 0    | 0    | 0    | 0          | 0          |
| 04:15 PM    | 0                  | 0    | 0    | 0    | 0          | 0                           | 0    | 1    | 0    | 1          | 0                  | 0    | 0    | 0    | 0          | 0         | 0    | 0    | 0    | 0          | 0          |
| 04:30 PM    | 0                  | 0    | 0    | 0    | 0          | 0                           | 0    | 0    | 0    | 0          | 0                  | 0    | 0    | 0    | 0          | 0         | 0    | 0    | 0    | 0          | 0          |
| 04:45 PM    | 0                  | 0    | 0    | 0    | 0          | 0                           | 0    | 0    | 0    | 0          | 0                  | 0    | 0    | 0    | 0          | 0         | 0    | 0    | 0    | 0          | 0          |
| Total       | 0                  | 0    | 0    | 0    | 0          | 0                           | 0    | 1    | 0    | 1          | 0                  | 0    | 0    | 0    | 0          | 0         | 0    | 0    | 0    | 0          | 1          |
| 05:00 PM    | 0                  | 1    | 0    | 0    | 1          | 0                           | 0    | 0    | 0    | 0          | 0                  | 0    | 0    | 0    | 0          | 0         | 0    | 0    | 0    | 0          | 1          |
| 05:15 PM    | 0                  | 0    | 1    | 0    | 1          | 0                           | 0    | 0    | 0    | 0          | 0                  | 0    | 0    | 0    | 0          | 0         | 0    | 0    | 0    | 0          | 1          |
| 05:30 PM    | 0                  | 0    | 0    | 0    | 0          | 0                           | 0    | 0    | 0    | 0          | 1                  | 0    | 0    | 0    | 1          | 0         | 0    | 0    | 0    | 0          | 1          |
| 05:45 PM    | 0                  | 0    | 0    | 0    | 0          | 0                           | 0    | 1    | 0    | 1          | 0                  | 0    | 0    | 0    | 0          | 0         | 0    | 0    | 0    | 0          | 1          |
| Total       | 0                  | 1    | 1    | 0    | 2          | 0                           | 0    | 1    | 0    | 1          | 1                  | 0    | 0    | 0    | 1          | 0         | 0    | 0    | 0    | 0          | 4          |
| Grand Total | 0                  | 1    | 1    | 0    | 2          | 0                           | 0    | 2    | 0    | 2          | 1                  | 0    | 0    | 0    | 1          | 0         | 0    | 0    | 0    | 0          | 5          |
| Apprch %    | 0                  | 50   | 50   | 0    |            | 0                           | 0    | 100  | 0    |            | 100                | 0    | 0    | 0    |            | 0         | 0    | 0    | 0    |            |            |
| Total %     | 0                  | 20   | 20   | 0    | 40         | 0                           | 0    | 40   | 0    | 40         | 20                 | 0    | 0    | 0    | 20         | 0         | 0    | 0    | 0    | 0          |            |

| Start Time   | 2ND AVE Southbound |      |      |            | INTER-GARRISON RD Westbound |      |      |            | 2ND AVE Northbound |      |      |            | Eastbound |      |      |            | Int. Total |
|--------------|--------------------|------|------|------------|-----------------------------|------|------|------------|--------------------|------|------|------------|-----------|------|------|------------|------------|
|              | Right              | Thru | Left | App. Total | Right                       | Thru | Left | App. Total | Right              | Thru | Left | App. Total | Right     | Thru | Left | App. Total |            |
| 05:00 PM     | 0                  | 1    | 0    | 1          | 0                           | 0    | 0    | 0          | 0                  | 0    | 0    | 0          | 0         | 0    | 0    | 0          | 1          |
| 05:15 PM     | 0                  | 0    | 1    | 1          | 0                           | 0    | 0    | 0          | 0                  | 0    | 0    | 0          | 0         | 0    | 0    | 0          | 1          |
| 05:30 PM     | 0                  | 0    | 0    | 0          | 0                           | 0    | 0    | 0          | 1                  | 0    | 0    | 1          | 0         | 0    | 0    | 0          | 1          |
| 05:45 PM     | 0                  | 0    | 0    | 0          | 0                           | 0    | 1    | 1          | 0                  | 0    | 0    | 0          | 0         | 0    | 0    | 0          | 1          |
| Total Volume | 0                  | 1    | 1    | 2          | 0                           | 0    | 1    | 1          | 1                  | 0    | 0    | 1          | 0         | 0    | 0    | 0          | 4          |
| % App. Total | 0                  | 50   | 50   |            | 0                           | 0    | 100  |            | 100                | 0    | 0    |            | 0         | 0    | 0    |            |            |
| PHF          | .000               | .250 | .250 | .500       | .000                        | .000 | .250 | .250       | .250               | .000 | .000 | .250       | .000      | .000 | .000 | .000       | 1.00       |

Peak Hour Analysis From 04:00 PM to 05:45 PM - Peak 1 of 1  
 Peak Hour for Entire Intersection Begins at 05:00 PM

# Traffic Data Service

San Jose, CA  
 (408) 622-4787  
 tdsbay@cs.com

File Name : 13PM FINAL  
 Site Code : 00000013  
 Start Date : 4/27/2017  
 Page No : 2

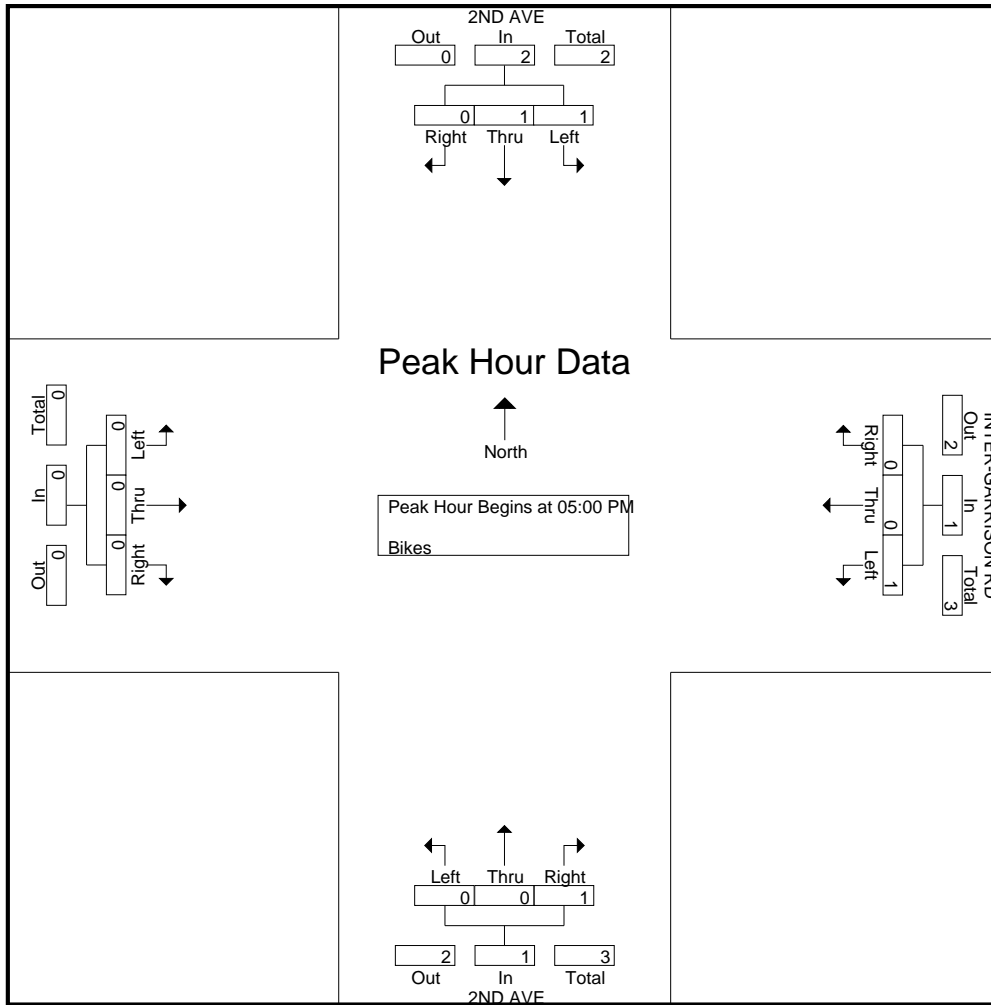



# Traffic Data Service

San Jose, CA  
(408) 622-4787  
tdsbay@cs.com

File Name : 16AM FINAL  
Site Code : 00000016  
Start Date : 4/27/2017  
Page No : 1

Groups Printed- Lights - Buses - Trucks

| Start Time   | ABRAMS DR Southbound |      |      |      |            | INTER-GARRISON RD Westbound |      |      |      |            | Northbound |      |      |      |            | INTER-GARRISON RD Eastbound |      |      |      |            | Int. Total |
|--------------|----------------------|------|------|------|------------|-----------------------------|------|------|------|------------|------------|------|------|------|------------|-----------------------------|------|------|------|------------|------------|
|              | Right                | Thru | Left | Peds | App. Total | Right                       | Thru | Left | Peds | App. Total | Right      | Thru | Left | Peds | App. Total | Right                       | Thru | Left | Peds | App. Total |            |
| 07:00 AM     | 42                   | 0    | 2    | 0    | 44         | 3                           | 131  | 0    | 0    | 134        | 0          | 0    | 0    | 0    | 0          | 0                           | 7    | 13   | 0    | 20         | 198        |
| 07:15 AM     | 82                   | 0    | 4    | 0    | 86         | 2                           | 175  | 0    | 0    | 177        | 0          | 0    | 0    | 0    | 0          | 0                           | 13   | 9    | 0    | 22         | 285        |
| 07:30 AM     | 81                   | 0    | 1    | 1    | 83         | 3                           | 165  | 0    | 0    | 168        | 0          | 0    | 0    | 0    | 0          | 0                           | 24   | 19   | 0    | 43         | 294        |
| 07:45 AM     | 74                   | 0    | 3    | 0    | 77         | 4                           | 109  | 0    | 0    | 113        | 0          | 0    | 0    | 0    | 0          | 0                           | 20   | 13   | 0    | 33         | 223        |
| <b>Total</b> | 279                  | 0    | 10   | 1    | 290        | 12                          | 580  | 0    | 0    | 592        | 0          | 0    | 0    | 0    | 0          | 0                           | 64   | 54   | 0    | 118        | 1000       |
|              |                      |      |      |      |            |                             |      |      |      |            |            |      |      |      |            |                             |      |      |      |            |            |
| 08:00 AM     | 54                   | 0    | 0    | 0    | 54         | 2                           | 85   | 0    | 0    | 87         | 0          | 0    | 0    | 0    | 0          | 0                           | 17   | 18   | 0    | 35         | 176        |
| 08:15 AM     | 40                   | 0    | 3    | 0    | 43         | 0                           | 88   | 0    | 0    | 88         | 0          | 0    | 0    | 0    | 0          | 0                           | 8    | 12   | 0    | 20         | 151        |
| 08:30 AM     | 27                   | 0    | 2    | 0    | 29         | 3                           | 65   | 0    | 0    | 68         | 0          | 0    | 0    | 0    | 0          | 0                           | 17   | 12   | 0    | 29         | 126        |
| 08:45 AM     | 45                   | 0    | 2    | 0    | 47         | 4                           | 58   | 0    | 0    | 62         | 0          | 0    | 0    | 0    | 0          | 0                           | 7    | 11   | 0    | 18         | 127        |
| <b>Total</b> | 166                  | 0    | 7    | 0    | 173        | 9                           | 296  | 0    | 0    | 305        | 0          | 0    | 0    | 0    | 0          | 0                           | 49   | 53   | 0    | 102        | 580        |
|              |                      |      |      |      |            |                             |      |      |      |            |            |      |      |      |            |                             |      |      |      |            |            |
| Grand Total  | 445                  | 0    | 17   | 1    | 463        | 21                          | 876  | 0    | 0    | 897        | 0          | 0    | 0    | 0    | 0          | 0                           | 113  | 107  | 0    | 220        | 1580       |
| Apprch %     | 96.1                 | 0    | 3.7  | 0.2  |            | 2.3                         | 97.7 | 0    | 0    |            | 0          | 0    | 0    | 0    |            | 0                           | 51.4 | 48.6 | 0    |            |            |
| Total %      | 28.2                 | 0    | 1.1  | 0.1  | 29.3       | 1.3                         | 55.4 | 0    | 0    | 56.8       | 0          | 0    | 0    | 0    | 0          | 0                           | 7.2  | 6.8  | 0    | 13.9       |            |
| Lights       | 439                  | 0    | 17   | 1    | 457        | 16                          | 867  | 0    | 0    | 883        | 0          | 0    | 0    | 0    | 0          | 0                           | 109  | 95   | 0    | 204        | 1544       |
| % Lights     | 98.7                 | 0    | 100  | 100  | 98.7       | 76.2                        | 99   | 0    | 0    | 98.4       | 0          | 0    | 0    | 0    | 0          | 0                           | 96.5 | 88.8 | 0    | 92.7       | 97.7       |
| Buses        | 4                    | 0    | 0    | 0    | 4          | 5                           | 6    | 0    | 0    | 11         | 0          | 0    | 0    | 0    | 0          | 0                           | 1    | 11   | 0    | 12         | 27         |
| % Buses      | 0.9                  | 0    | 0    | 0    | 0.9        | 23.8                        | 0.7  | 0    | 0    | 1.2        | 0          | 0    | 0    | 0    | 0          | 0                           | 0.9  | 10.3 | 0    | 5.5        | 1.7        |
| Trucks       | 2                    | 0    | 0    | 0    | 2          | 0                           | 3    | 0    | 0    | 3          | 0          | 0    | 0    | 0    | 0          | 0                           | 3    | 1    | 0    | 4          | 9          |
| % Trucks     | 0.4                  | 0    | 0    | 0    | 0.4        | 0                           | 0.3  | 0    | 0    | 0.3        | 0          | 0    | 0    | 0    | 0          | 0                           | 2.7  | 0.9  | 0    | 1.8        | 0.6        |

| Start Time   | ABRAMS DR Southbound |      |          |            | INTER-GARRISON RD Westbound |            |      |            | Northbound |      |      |            | INTER-GARRISON RD Eastbound |           |           |            | Int. Total |
|--|----------------------|------|----------|------------|-----------------------------|------------|------|------------|------------|------|------|------------|-----------------------------|-----------|-----------|------------|------------|
|  | Right                | Thru | Left     | App. Total | Right                       | Thru       | Left | App. Total | Right      | Thru | Left | App. Total | Right                       | Thru      | Left      | App. Total |            |
| Peak Hour Analysis From 07:00 AM to 08:45 AM - Peak 1 of 1 |                      |      |          |            |                             |            |      |            |            |      |      |            |                             |           |           |            |            |
| Peak Hour for Entire Intersection Begins at 07:00 AM       |                      |      |          |            |                             |            |      |            |            |      |      |            |                             |           |           |            |            |
| 07:00 AM   | 42                   | 0    | 2        | 44         | 3                           | 131        | 0    | 134        | 0          | 0    | 0    | 0          | 0                           | 7         | 13        | 20         | 198        |
| 07:15 AM   | <b>82</b>            | 0    | <b>4</b> | <b>86</b>  | 2                           | <b>175</b> | 0    | <b>177</b> | 0          | 0    | 0    | 0          | 0                           | 13        | 9         | 22         | 285        |
| 07:30 AM   | 81                   | 0    | 1        | 82         | 3                           | 165        | 0    | 168        | 0          | 0    | 0    | 0          | 0                           | <b>24</b> | <b>19</b> | <b>43</b>  | <b>293</b> |
| 07:45 AM   | 74                   | 0    | 3        | 77         | 4                           | 109        | 0    | 113        | 0          | 0    | 0    | 0          | 0                           | 20        | 13        | 33         | 223        |
| Total Volume   | 279                  | 0    | 10       | 289        | 12                          | 580        | 0    | 592        | 0          | 0    | 0    | 0          | 0                           | 64        | 54        | 118        | 999        |
| % App. Total   | 96.5                 | 0    | 3.5      |            | 2                           | 98         | 0    |            | 0          | 0    | 0    |            | 0                           | 54.2      | 45.8      |            |            |
| PHF  | .851                 | .000 | .625     | .840       | .750                        | .829       | .000 | .836       | .000       | .000 | .000 | .000       | .000                        | .667      | .711      | .686       | .852       |

# Traffic Data Service

San Jose, CA  
 (408) 622-4787  
 tdsbay@cs.com

File Name : 16AM FINAL  
 Site Code : 00000016  
 Start Date : 4/27/2017  
 Page No : 2

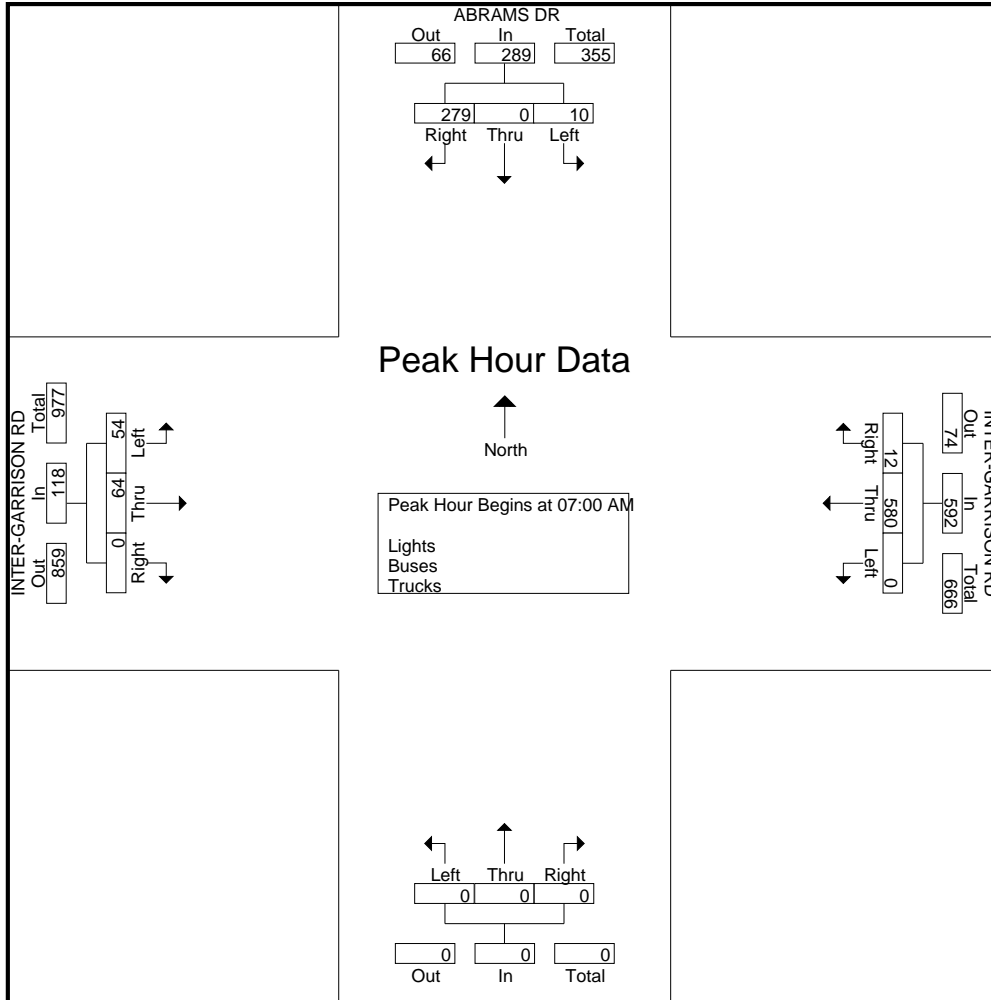

# Traffic Data Service

San Jose, CA  
 (408) 622-4787  
 tdsbay@cs.com

File Name : 16AM FINAL  
 Site Code : 00000016  
 Start Date : 4/27/2017  
 Page No : 1

Groups Printed- Bikes

| Start Time   | ABRAMS DR Southbound |          |          |          |            | INTER-GARRISON RD Westbound |          |          |          |            | Northbound |          |          |          |            | INTER-GARRISON RD Eastbound |          |          |          |            | Int. Total |
|--------------|----------------------|----------|----------|----------|------------|-----------------------------|----------|----------|----------|------------|------------|----------|----------|----------|------------|-----------------------------|----------|----------|----------|------------|------------|
|              | Right                | Thru     | Left     | Peds     | App. Total | Right                       | Thru     | Left     | Peds     | App. Total | Right      | Thru     | Left     | Peds     | App. Total | Right                       | Thru     | Left     | Peds     | App. Total |            |
| 07:00 AM     | 0                    | 0        | 0        | 0        | 0          | 0                           | 0        | 0        | 0        | 0          | 0          | 0        | 0        | 0        | 0          | 0                           | 0        | 0        | 0        | 0          | 0          |
| 07:15 AM     | 0                    | 0        | 0        | 0        | 0          | 0                           | 0        | 0        | 0        | 0          | 0          | 0        | 0        | 0        | 0          | 0                           | 0        | 0        | 0        | 0          | 0          |
| 07:30 AM     | 0                    | 0        | 0        | 0        | 0          | 0                           | 0        | 0        | 0        | 0          | 0          | 0        | 0        | 0        | 0          | 0                           | 0        | 0        | 0        | 0          | 0          |
| 07:45 AM     | 1                    | 0        | 0        | 0        | 1          | 0                           | 0        | 0        | 0        | 0          | 0          | 0        | 0        | 0        | 0          | 0                           | 0        | 0        | 0        | 0          | 1          |
| <b>Total</b> | <b>1</b>             | <b>0</b> | <b>0</b> | <b>0</b> | <b>1</b>   | <b>0</b>                    | <b>0</b> | <b>0</b> | <b>0</b> | <b>0</b>   | <b>0</b>   | <b>0</b> | <b>0</b> | <b>0</b> | <b>0</b>   | <b>0</b>                    | <b>0</b> | <b>0</b> | <b>0</b> | <b>0</b>   | <b>1</b>   |
| 08:00 AM     | 1                    | 0        | 0        | 0        | 1          | 0                           | 0        | 0        | 0        | 0          | 0          | 0        | 0        | 0        | 0          | 0                           | 1        | 0        | 0        | 1          | 2          |
| 08:15 AM     | 0                    | 0        | 0        | 0        | 0          | 0                           | 1        | 0        | 0        | 1          | 0          | 0        | 0        | 0        | 0          | 0                           | 0        | 0        | 0        | 0          | 1          |
| 08:30 AM     | 1                    | 0        | 0        | 0        | 1          | 0                           | 2        | 0        | 0        | 2          | 0          | 0        | 0        | 0        | 0          | 0                           | 0        | 0        | 0        | 0          | 3          |
| 08:45 AM     | 1                    | 0        | 0        | 0        | 1          | 0                           | 0        | 0        | 0        | 0          | 0          | 0        | 0        | 0        | 0          | 0                           | 0        | 0        | 0        | 0          | 1          |
| <b>Total</b> | <b>3</b>             | <b>0</b> | <b>0</b> | <b>0</b> | <b>3</b>   | <b>0</b>                    | <b>3</b> | <b>0</b> | <b>0</b> | <b>3</b>   | <b>0</b>   | <b>0</b> | <b>0</b> | <b>0</b> | <b>0</b>   | <b>0</b>                    | <b>1</b> | <b>0</b> | <b>0</b> | <b>1</b>   | <b>7</b>   |
| Grand Total  | 4                    | 0        | 0        | 0        | 4          | 0                           | 3        | 0        | 0        | 3          | 0          | 0        | 0        | 0        | 0          | 0                           | 1        | 0        | 0        | 1          | 8          |
| Apprch %     | 100                  | 0        | 0        | 0        |            | 0                           | 100      | 0        | 0        |            | 0          | 0        | 0        | 0        |            | 0                           | 100      | 0        | 0        |            |            |
| Total %      | 50                   | 0        | 0        | 0        | 50         | 0                           | 37.5     | 0        | 0        | 37.5       | 0          | 0        | 0        | 0        | 0          | 0                           | 12.5     | 0        | 0        | 12.5       |            |

| Start Time   | ABRAMS DR Southbound |      |      |      |            | INTER-GARRISON RD Westbound |      |      |      |            | Northbound |      |      |      |            | INTER-GARRISON RD Eastbound |      |      |      |            | Int. Total |
|--|----------------------|------|------|------|------------|-----------------------------|------|------|------|------------|------------|------|------|------|------------|-----------------------------|------|------|------|------------|------------|
|  | Right                | Thru | Left | Peds | App. Total | Right                       | Thru | Left | Peds | App. Total | Right      | Thru | Left | Peds | App. Total | Right                       | Thru | Left | Peds | App. Total |            |
| Peak Hour Analysis From 07:00 AM to 08:45 AM - Peak 1 of 1 |                      |      |      |      |            |                             |      |      |      |            |            |      |      |      |            |                             |      |      |      |            |            |
| Peak Hour for Entire Intersection Begins at 07:45 AM       |                      |      |      |      |            |                             |      |      |      |            |            |      |      |      |            |                             |      |      |      |            |            |
| 07:45 AM   | 1                    | 0    | 0    | 0    | 1          | 0                           | 0    | 0    | 0    | 0          | 0          | 0    | 0    | 0    | 0          | 0                           | 0    | 0    | 0    | 0          | 1          |
| 08:00 AM   | 1                    | 0    | 0    | 0    | 1          | 0                           | 0    | 0    | 0    | 0          | 0          | 0    | 0    | 0    | 0          | 0                           | 1    | 0    | 0    | 1          | 2          |
| 08:15 AM   | 0                    | 0    | 0    | 0    | 0          | 0                           | 1    | 0    | 0    | 1          | 0          | 0    | 0    | 0    | 0          | 0                           | 0    | 0    | 0    | 0          | 1          |
| 08:30 AM   | 1                    | 0    | 0    | 0    | 1          | 0                           | 2    | 0    | 0    | 2          | 0          | 0    | 0    | 0    | 0          | 0                           | 0    | 0    | 0    | 0          | 3          |
| Total Volume   | 3                    | 0    | 0    | 0    | 3          | 0                           | 3    | 0    | 0    | 3          | 0          | 0    | 0    | 0    | 0          | 0                           | 1    | 0    | 0    | 1          | 7          |
| % App. Total   | 100                  | 0    | 0    | 0    |            | 0                           | 100  | 0    | 0    |            | 0          | 0    | 0    | 0    |            | 0                           | 100  | 0    | 0    |            |            |
| PHF  | .750                 | .000 | .000 | .000 | .750       | .000                        | .375 | .000 | .000 | .375       | .000       | .000 | .000 | .000 | .000       | .000                        | .250 | .000 | .000 | .250       | .583       |

# Traffic Data Service

San Jose, CA  
 (408) 622-4787  
 tdsbay@cs.com

File Name : 16AM FINAL  
 Site Code : 00000016  
 Start Date : 4/27/2017  
 Page No : 2

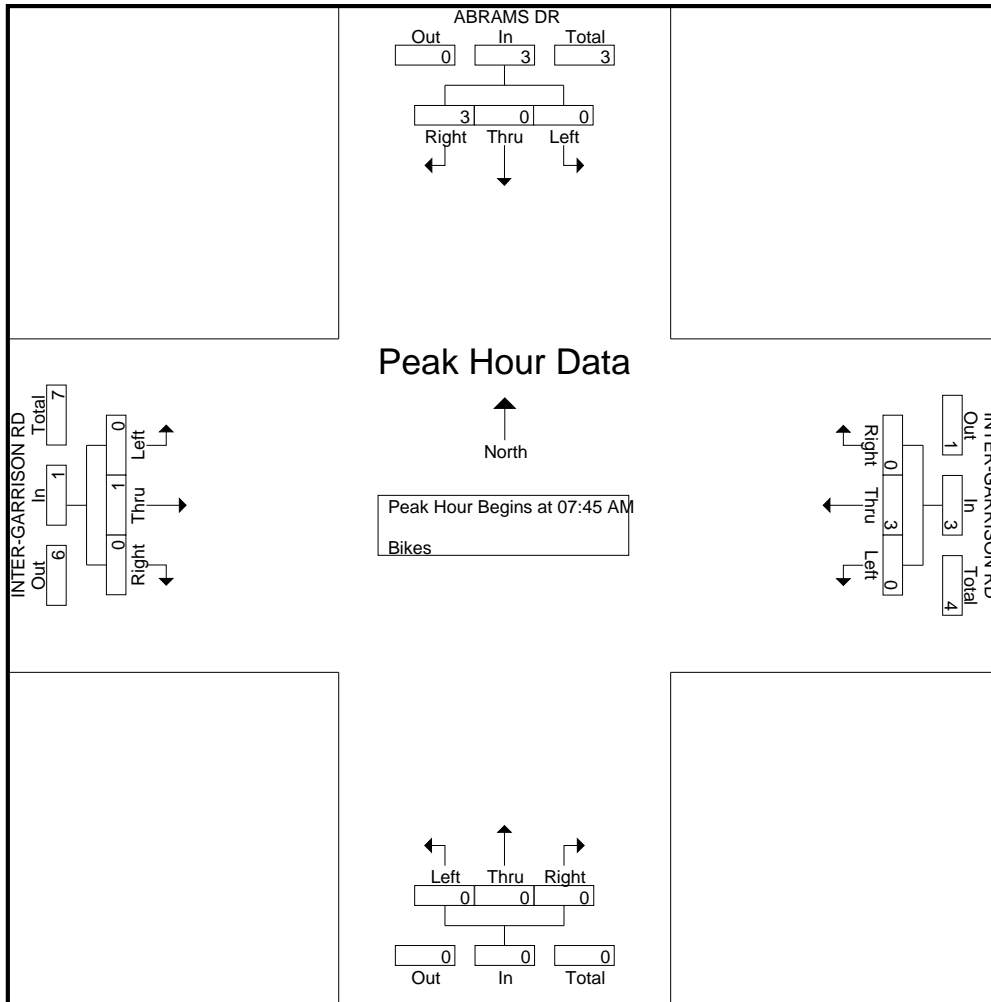

# Traffic Data Service

San Jose, CA  
 (408) 622-4787  
 tdsbay@cs.com

File Name : 16PM FINAL  
 Site Code : 00000016  
 Start Date : 4/27/2017  
 Page No : 1

Groups Printed- Lights - Buses - Trucks

| Start Time  | ABRAMS DR Southbound |      |      |      |            | INTER-GARRISON RD Westbound |      |      |      |            | Northbound |      |      |      |            | INTER-GARRISON RD Eastbound |      |      |      |            | Int. Total |
|-------------|----------------------|------|------|------|------------|-----------------------------|------|------|------|------------|------------|------|------|------|------------|-----------------------------|------|------|------|------------|------------|
|             | Right                | Thru | Left | Peds | App. Total | Right                       | Thru | Left | Peds | App. Total | Right      | Thru | Left | Peds | App. Total | Right                       | Thru | Left | Peds | App. Total |            |
| 04:00 PM    | 21                   | 0    | 1    | 0    | 22         | 0                           | 10   | 0    | 0    | 10         | 0          | 0    | 0    | 0    | 0          | 0                           | 74   | 48   | 0    | 122        | 154        |
| 04:15 PM    | 29                   | 0    | 0    | 0    | 29         | 4                           | 24   | 0    | 0    | 28         | 0          | 0    | 0    | 0    | 0          | 0                           | 65   | 43   | 0    | 108        | 165        |
| 04:30 PM    | 24                   | 0    | 2    | 0    | 26         | 6                           | 27   | 0    | 0    | 33         | 0          | 0    | 0    | 0    | 0          | 0                           | 84   | 44   | 0    | 128        | 187        |
| 04:45 PM    | 20                   | 0    | 3    | 0    | 23         | 4                           | 28   | 0    | 0    | 32         | 0          | 0    | 0    | 0    | 0          | 0                           | 91   | 58   | 0    | 149        | 204        |
| Total       | 94                   | 0    | 6    | 0    | 100        | 14                          | 89   | 0    | 0    | 103        | 0          | 0    | 0    | 0    | 0          | 0                           | 314  | 193  | 0    | 507        | 710        |
| 05:00 PM    | 23                   | 0    | 0    | 0    | 23         | 5                           | 28   | 0    | 0    | 33         | 0          | 0    | 0    | 0    | 0          | 0                           | 112  | 67   | 0    | 179        | 235        |
| 05:15 PM    | 13                   | 0    | 6    | 0    | 19         | 1                           | 24   | 0    | 0    | 25         | 0          | 0    | 0    | 0    | 0          | 0                           | 133  | 51   | 0    | 184        | 228        |
| 05:30 PM    | 34                   | 0    | 5    | 0    | 39         | 5                           | 17   | 0    | 0    | 22         | 0          | 0    | 0    | 0    | 0          | 0                           | 94   | 69   | 0    | 163        | 224        |
| 05:45 PM    | 38                   | 0    | 4    | 0    | 42         | 6                           | 22   | 0    | 0    | 28         | 0          | 0    | 0    | 0    | 0          | 0                           | 73   | 64   | 0    | 137        | 207        |
| Total       | 108                  | 0    | 15   | 0    | 123        | 17                          | 91   | 0    | 0    | 108        | 0          | 0    | 0    | 0    | 0          | 0                           | 412  | 251  | 0    | 663        | 894        |
| Grand Total | 202                  | 0    | 21   | 0    | 223        | 31                          | 180  | 0    | 0    | 211        | 0          | 0    | 0    | 0    | 0          | 0                           | 726  | 444  | 0    | 1170       | 1604       |
| Apprch %    | 90.6                 | 0    | 9.4  | 0    |            | 14.7                        | 85.3 | 0    | 0    |            | 0          | 0    | 0    | 0    | 0          | 0                           | 62.1 | 37.9 | 0    |            |            |
| Total %     | 12.6                 | 0    | 1.3  | 0    | 13.9       | 1.9                         | 11.2 | 0    | 0    | 13.2       | 0          | 0    | 0    | 0    | 0          | 0                           | 45.3 | 27.7 | 0    | 72.9       |            |
| Lights      | 195                  | 0    | 18   | 0    | 213        | 25                          | 169  | 0    | 0    | 194        | 0          | 0    | 0    | 0    | 0          | 0                           | 721  | 430  | 0    | 1151       | 1558       |
| % Lights    | 96.5                 | 0    | 85.7 | 0    | 95.5       | 80.6                        | 93.9 | 0    | 0    | 91.9       | 0          | 0    | 0    | 0    | 0          | 0                           | 99.3 | 96.8 | 0    | 98.4       | 97.1       |
| Buses       | 5                    | 0    | 1    | 0    | 6          | 6                           | 6    | 0    | 0    | 12         | 0          | 0    | 0    | 0    | 0          | 0                           | 1    | 11   | 0    | 12         | 30         |
| % Buses     | 2.5                  | 0    | 4.8  | 0    | 2.7        | 19.4                        | 3.3  | 0    | 0    | 5.7        | 0          | 0    | 0    | 0    | 0          | 0                           | 0.1  | 2.5  | 0    | 1          | 1.9        |
| Trucks      | 2                    | 0    | 2    | 0    | 4          | 0                           | 5    | 0    | 0    | 5          | 0          | 0    | 0    | 0    | 0          | 0                           | 4    | 3    | 0    | 7          | 16         |
| % Trucks    | 1                    | 0    | 9.5  | 0    | 1.8        | 0                           | 2.8  | 0    | 0    | 2.4        | 0          | 0    | 0    | 0    | 0          | 0                           | 0.6  | 0.7  | 0    | 0.6        | 1          |

| Start Time   | ABRAMS DR Southbound |      |          |            | INTER-GARRISON RD Westbound |           |      |            | Northbound |      |      |            | INTER-GARRISON RD Eastbound |      |            |            | Int. Total |            |
|--|----------------------|------|----------|------------|-----------------------------|-----------|------|------------|------------|------|------|------------|-----------------------------|------|------------|------------|------------|------------|
|  | Right                | Thru | Left     | App. Total | Right                       | Thru      | Left | App. Total | Right      | Thru | Left | App. Total | Right                       | Thru | Left       | App. Total |            |            |
| Peak Hour Analysis From 04:00 PM to 05:45 PM - Peak 1 of 1 |                      |      |          |            |                             |           |      |            |            |      |      |            |                             |      |            |            |            |            |
| Peak Hour for Entire Intersection Begins at 05:00 PM       |                      |      |          |            |                             |           |      |            |            |      |      |            |                             |      |            |            |            |            |
| 05:00 PM   | 23                   | 0    | 0        | 23         | 5                           | <b>28</b> | 0    | <b>33</b>  | 0          | 0    | 0    | 0          | 0                           | 0    | 112        | 67         | 179        | <b>235</b> |
| 05:15 PM   | 13                   | 0    | <b>6</b> | 19         | 1                           | 24        | 0    | 25         | 0          | 0    | 0    | 0          | 0                           | 0    | <b>133</b> | 51         | <b>184</b> | 228        |
| 05:30 PM   | 34                   | 0    | 5        | 39         | 5                           | 17        | 0    | 22         | 0          | 0    | 0    | 0          | 0                           | 0    | 94         | <b>69</b>  | 163        | 224        |
| 05:45 PM   | <b>38</b>            | 0    | 4        | <b>42</b>  | <b>6</b>                    | 22        | 0    | 28         | 0          | 0    | 0    | 0          | 0                           | 0    | 73         | 64         | 137        | 207        |
| Total Volume   | 108                  | 0    | 15       | 123        | 17                          | 91        | 0    | 108        | 0          | 0    | 0    | 0          | 0                           | 0    | 412        | 251        | 663        | 894        |
| % App. Total   | 87.8                 | 0    | 12.2     |            | 15.7                        | 84.3      | 0    |            | 0          | 0    | 0    |            | 0                           | 0    | 62.1       | 37.9       |            |            |
| PHF  | .711                 | .000 | .625     | .732       | .708                        | .813      | .000 | .818       | .000       | .000 | .000 | .000       | .000                        | .000 | .774       | .909       | .901       | .951       |

# Traffic Data Service

San Jose, CA  
 (408) 622-4787  
 tdsbay@cs.com

File Name : 16PM FINAL  
 Site Code : 00000016  
 Start Date : 4/27/2017  
 Page No : 2

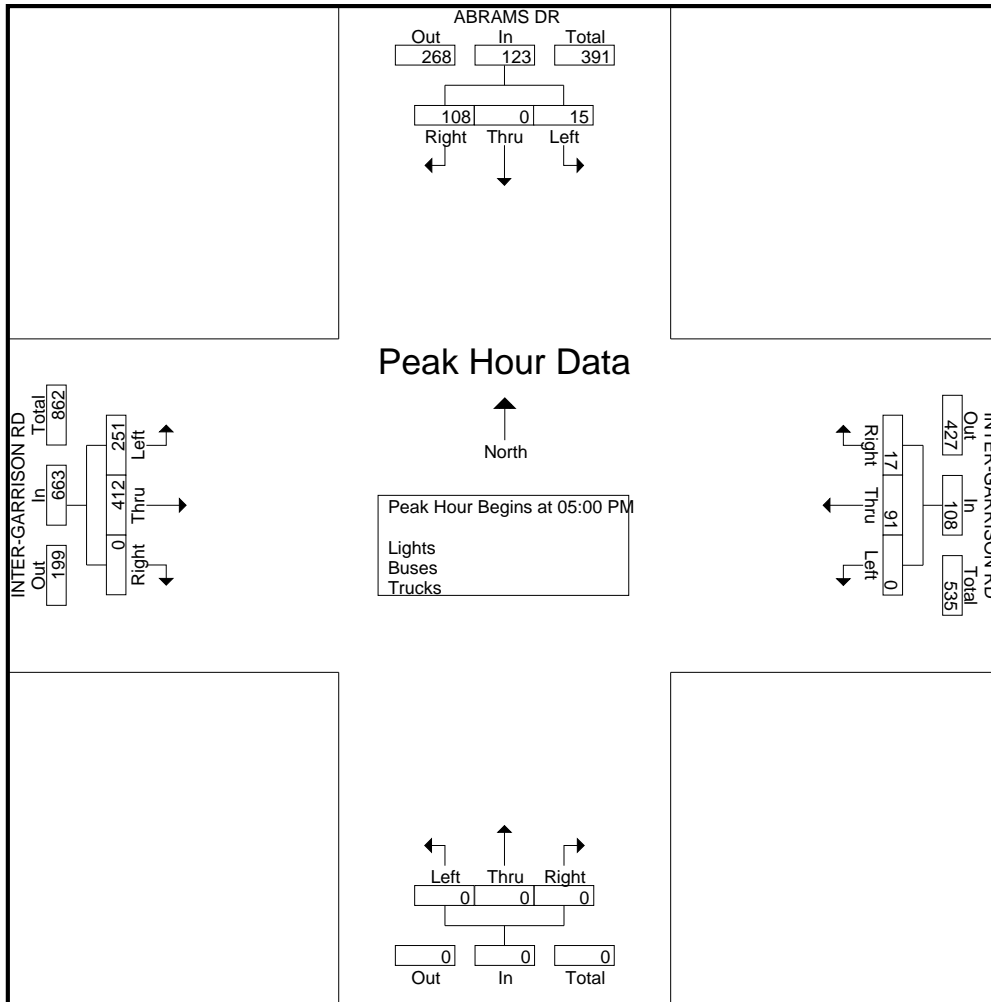

# Traffic Data Service

San Jose, CA  
 (408) 622-4787  
 tdsbay@cs.com

File Name : 16PM FINAL  
 Site Code : 00000016  
 Start Date : 4/27/2017  
 Page No : 1

Groups Printed- Bikes

| Start Time   | ABRAMS DR Southbound |      |      |      |            | INTER-GARRISON RD Westbound |      |      |      |            | Northbound |      |      |      |            | INTER-GARRISON RD Eastbound |      |      |      |            | Int. Total |
|--------------|----------------------|------|------|------|------------|-----------------------------|------|------|------|------------|------------|------|------|------|------------|-----------------------------|------|------|------|------------|------------|
|              | Right                | Thru | Left | Peds | App. Total | Right                       | Thru | Left | Peds | App. Total | Right      | Thru | Left | Peds | App. Total | Right                       | Thru | Left | Peds | App. Total |            |
| 04:00 PM     | 0                    | 0    | 0    | 0    | 0          | 0                           | 0    | 0    | 0    | 0          | 0          | 0    | 0    | 0    | 0          | 0                           | 0    | 0    | 0    | 0          | 0          |
| 04:15 PM     | 0                    | 0    | 0    | 0    | 0          | 0                           | 0    | 0    | 0    | 0          | 0          | 0    | 0    | 0    | 0          | 0                           | 0    | 0    | 0    | 0          | 0          |
| 04:30 PM     | 0                    | 0    | 0    | 0    | 0          | 0                           | 0    | 0    | 0    | 0          | 0          | 0    | 0    | 0    | 0          | 0                           | 1    | 0    | 0    | 1          | 1          |
| 04:45 PM     | 0                    | 0    | 0    | 0    | 0          | 0                           | 0    | 0    | 0    | 0          | 0          | 0    | 0    | 0    | 0          | 0                           | 1    | 0    | 0    | 1          | 1          |
| <b>Total</b> | 0                    | 0    | 0    | 0    | 0          | 0                           | 0    | 0    | 0    | 0          | 0          | 0    | 0    | 0    | 0          | 0                           | 2    | 0    | 0    | 2          | 2          |
| 05:00 PM     | 0                    | 0    | 0    | 0    | 0          | 0                           | 0    | 0    | 0    | 0          | 0          | 0    | 0    | 0    | 0          | 0                           | 0    | 1    | 0    | 1          | 1          |
| 05:15 PM     | 1                    | 0    | 0    | 0    | 1          | 0                           | 0    | 0    | 0    | 0          | 0          | 0    | 0    | 0    | 0          | 0                           | 0    | 2    | 0    | 2          | 3          |
| 05:30 PM     | 0                    | 0    | 0    | 0    | 0          | 0                           | 0    | 0    | 0    | 0          | 0          | 0    | 0    | 0    | 0          | 0                           | 0    | 1    | 0    | 1          | 1          |
| 05:45 PM     | 0                    | 0    | 0    | 0    | 0          | 0                           | 1    | 0    | 0    | 1          | 0          | 0    | 0    | 0    | 0          | 0                           | 0    | 0    | 0    | 0          | 1          |
| <b>Total</b> | 1                    | 0    | 0    | 0    | 1          | 0                           | 1    | 0    | 0    | 1          | 0          | 0    | 0    | 0    | 0          | 0                           | 0    | 4    | 0    | 4          | 6          |
| Grand Total  | 1                    | 0    | 0    | 0    | 1          | 0                           | 1    | 0    | 0    | 1          | 0          | 0    | 0    | 0    | 0          | 0                           | 2    | 4    | 0    | 6          | 8          |
| Apprch %     | 100                  | 0    | 0    | 0    |            | 0                           | 100  | 0    | 0    |            | 0          | 0    | 0    | 0    |            | 0                           | 33.3 | 66.7 | 0    |            |            |
| Total %      | 12.5                 | 0    | 0    | 0    | 12.5       | 0                           | 12.5 | 0    | 0    | 12.5       | 0          | 0    | 0    | 0    | 0          | 0                           | 25   | 50   | 0    | 75         |            |

| Start Time   | ABRAMS DR Southbound |      |      |      |            | INTER-GARRISON RD Westbound |      |      |      |            | Northbound |      |      |      |            | INTER-GARRISON RD Eastbound |      |      |      |            | Int. Total |
|--|----------------------|------|------|------|------------|-----------------------------|------|------|------|------------|------------|------|------|------|------------|-----------------------------|------|------|------|------------|------------|
|  | Right                | Thru | Left | Peds | App. Total | Right                       | Thru | Left | Peds | App. Total | Right      | Thru | Left | Peds | App. Total | Right                       | Thru | Left | Peds | App. Total |            |
| Peak Hour Analysis From 04:00 PM to 05:45 PM - Peak 1 of 1 |                      |      |      |      |            |                             |      |      |      |            |            |      |      |      |            |                             |      |      |      |            |            |
| Peak Hour for Entire Intersection Begins at 04:30 PM       |                      |      |      |      |            |                             |      |      |      |            |            |      |      |      |            |                             |      |      |      |            |            |
| 04:30 PM   | 0                    | 0    | 0    | 0    | 0          | 0                           | 0    | 0    | 0    | 0          | 0          | 0    | 0    | 0    | 0          | 0                           | 1    | 0    | 0    | 1          | 1          |
| 04:45 PM   | 0                    | 0    | 0    | 0    | 0          | 0                           | 0    | 0    | 0    | 0          | 0          | 0    | 0    | 0    | 0          | 0                           | 1    | 0    | 0    | 1          | 1          |
| 05:00 PM   | 0                    | 0    | 0    | 0    | 0          | 0                           | 0    | 0    | 0    | 0          | 0          | 0    | 0    | 0    | 0          | 0                           | 0    | 1    | 0    | 1          | 1          |
| 05:15 PM   | 1                    | 0    | 0    | 0    | 1          | 0                           | 0    | 0    | 0    | 0          | 0          | 0    | 0    | 0    | 0          | 0                           | 0    | 2    | 0    | 2          | 3          |
| Total Volume   | 1                    | 0    | 0    | 0    | 1          | 0                           | 0    | 0    | 0    | 0          | 0          | 0    | 0    | 0    | 0          | 0                           | 2    | 3    | 0    | 5          | 6          |
| % App. Total   | 100                  | 0    | 0    | 0    |            | 0                           | 0    | 0    | 0    |            | 0          | 0    | 0    | 0    |            | 0                           | 40   | 60   | 0    |            |            |
| PHF  | .250                 | .000 | .000 | .000 | .250       | .000                        | .000 | .000 | .000 | .000       | .000       | .000 | .000 | .000 | .000       | .000                        | .500 | .375 | .625 | .500       |            |

# Traffic Data Service

San Jose, CA  
(408) 622-4787  
tdsbay@cs.com

File Name : 16PM FINAL  
Site Code : 00000016  
Start Date : 4/27/2017  
Page No : 2

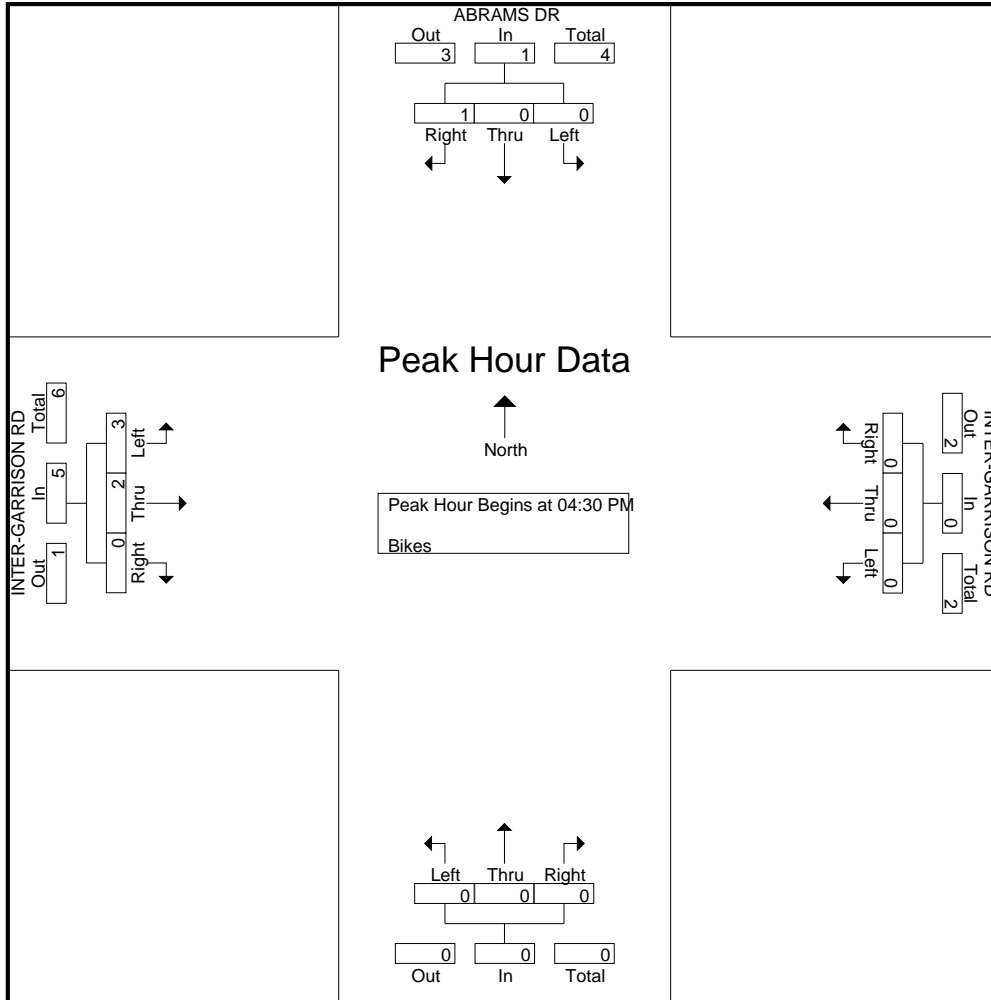



# Traffic Data Service

San Jose, CA  
 (408) 622-4787  
 tdsbay@cs.com

File Name : 17AM FINAL  
 Site Code : 00000017  
 Start Date : 4/27/2017  
 Page No : 1

Groups Printed- Lights - Buses - Trucks

| Start Time  | SCHOONOVER RD Southbound |      |      |      |            | INTER-GARRISON RD Westbound |      |      |      |            | Northbound |      |      |      |            | INTER-GARRISON RD Eastbound |      |      |      |            | Int. Total |
|-------------|--------------------------|------|------|------|------------|-----------------------------|------|------|------|------------|------------|------|------|------|------------|-----------------------------|------|------|------|------------|------------|
|             | Right                    | Thru | Left | Peds | App. Total | Right                       | Thru | Left | Peds | App. Total | Right      | Thru | Left | Peds | App. Total | Right                       | Thru | Left | Peds | App. Total |            |
| 07:00 AM    | 28                       | 0    | 8    | 0    | 36         | 0                           | 108  | 0    | 1    | 109        | 0          | 0    | 0    | 0    | 0          | 0                           | 8    | 1    | 0    | 9          | 154        |
| 07:15 AM    | 44                       | 0    | 8    | 0    | 52         | 5                           | 150  | 0    | 0    | 155        | 0          | 0    | 0    | 0    | 0          | 0                           | 14   | 3    | 0    | 17         | 224        |
| 07:30 AM    | 37                       | 0    | 12   | 0    | 49         | 4                           | 112  | 0    | 0    | 116        | 0          | 0    | 0    | 0    | 0          | 0                           | 21   | 3    | 0    | 24         | 189        |
| 07:45 AM    | 37                       | 0    | 7    | 0    | 44         | 6                           | 72   | 0    | 0    | 78         | 0          | 0    | 0    | 0    | 0          | 0                           | 18   | 5    | 0    | 23         | 145        |
| Total       | 146                      | 0    | 35   | 0    | 181        | 15                          | 442  | 0    | 1    | 458        | 0          | 0    | 0    | 0    | 0          | 0                           | 61   | 12   | 0    | 73         | 712        |
| 08:00 AM    | 17                       | 0    | 5    | 0    | 22         | 4                           | 74   | 0    | 0    | 78         | 0          | 0    | 0    | 0    | 0          | 0                           | 13   | 4    | 0    | 17         | 117        |
| 08:15 AM    | 27                       | 0    | 3    | 0    | 30         | 1                           | 59   | 0    | 0    | 60         | 0          | 0    | 0    | 0    | 0          | 0                           | 9    | 2    | 0    | 11         | 101        |
| 08:30 AM    | 14                       | 0    | 2    | 0    | 16         | 0                           | 52   | 0    | 0    | 52         | 0          | 0    | 0    | 0    | 0          | 0                           | 13   | 6    | 0    | 19         | 87         |
| 08:45 AM    | 18                       | 0    | 1    | 0    | 19         | 2                           | 42   | 0    | 0    | 44         | 0          | 0    | 0    | 0    | 0          | 0                           | 8    | 2    | 0    | 10         | 73         |
| Total       | 76                       | 0    | 11   | 0    | 87         | 7                           | 227  | 0    | 0    | 234        | 0          | 0    | 0    | 0    | 0          | 0                           | 43   | 14   | 0    | 57         | 378        |
| Grand Total | 222                      | 0    | 46   | 0    | 268        | 22                          | 669  | 0    | 1    | 692        | 0          | 0    | 0    | 0    | 0          | 0                           | 104  | 26   | 0    | 130        | 1090       |
| Apprch %    | 82.8                     | 0    | 17.2 | 0    |            | 3.2                         | 96.7 | 0    | 0.1  |            | 0          | 0    | 0    | 0    | 0          | 0                           | 80   | 20   | 0    |            |            |
| Total %     | 20.4                     | 0    | 4.2  | 0    | 24.6       | 2                           | 61.4 | 0    | 0.1  | 63.5       | 0          | 0    | 0    | 0    | 0          | 0                           | 9.5  | 2.4  | 0    | 11.9       |            |
| Lights      | 212                      | 0    | 45   | 0    | 257        | 19                          | 664  | 0    | 1    | 684        | 0          | 0    | 0    | 0    | 0          | 0                           | 100  | 26   | 0    | 126        | 1067       |
| % Lights    | 95.5                     | 0    | 97.8 | 0    | 95.9       | 86.4                        | 99.3 | 0    | 100  | 98.8       | 0          | 0    | 0    | 0    | 0          | 0                           | 96.2 | 100  | 0    | 96.9       | 97.9       |
| Buses       | 10                       | 0    | 1    | 0    | 11         | 1                           | 3    | 0    | 0    | 4          | 0          | 0    | 0    | 0    | 0          | 0                           | 1    | 0    | 0    | 1          | 16         |
| % Buses     | 4.5                      | 0    | 2.2  | 0    | 4.1        | 4.5                         | 0.4  | 0    | 0    | 0.6        | 0          | 0    | 0    | 0    | 0          | 0                           | 1    | 0    | 0    | 0.8        | 1.5        |
| Trucks      | 0                        | 0    | 0    | 0    | 0          | 2                           | 2    | 0    | 0    | 4          | 0          | 0    | 0    | 0    | 0          | 0                           | 3    | 0    | 0    | 3          | 7          |
| % Trucks    | 0                        | 0    | 0    | 0    | 0          | 9.1                         | 0.3  | 0    | 0    | 0.6        | 0          | 0    | 0    | 0    | 0          | 0                           | 2.9  | 0    | 0    | 2.3        | 0.6        |

| Start Time   | SCHOONOVER RD Southbound |      |      |            | INTER-GARRISON RD Westbound |      |      |            | Northbound |      |      |            | INTER-GARRISON RD Eastbound |      |      |            | Int. Total |      |
|--|--------------------------|------|------|------------|-----------------------------|------|------|------------|------------|------|------|------------|-----------------------------|------|------|------------|------------|------|
|  | Right                    | Thru | Left | App. Total | Right                       | Thru | Left | App. Total | Right      | Thru | Left | App. Total | Right                       | Thru | Left | App. Total |            |      |
| Peak Hour Analysis From 07:00 AM to 08:45 AM - Peak 1 of 1 |                          |      |      |            |                             |      |      |            |            |      |      |            |                             |      |      |            |            |      |
| Peak Hour for Entire Intersection Begins at 07:00 AM       |                          |      |      |            |                             |      |      |            |            |      |      |            |                             |      |      |            |            |      |
| 07:00 AM   | 28                       | 0    | 8    | 36         | 0                           | 108  | 0    | 108        | 0          | 0    | 0    | 0          | 0                           | 0    | 8    | 1          | 9          | 153  |
| 07:15 AM   | 44                       | 0    | 8    | 52         | 5                           | 150  | 0    | 155        | 0          | 0    | 0    | 0          | 0                           | 0    | 14   | 3          | 17         | 224  |
| 07:30 AM   | 37                       | 0    | 12   | 49         | 4                           | 112  | 0    | 116        | 0          | 0    | 0    | 0          | 0                           | 0    | 21   | 3          | 24         | 189  |
| 07:45 AM   | 37                       | 0    | 7    | 44         | 6                           | 72   | 0    | 78         | 0          | 0    | 0    | 0          | 0                           | 0    | 18   | 5          | 23         | 145  |
| Total Volume   | 146                      | 0    | 35   | 181        | 15                          | 442  | 0    | 457        | 0          | 0    | 0    | 0          | 0                           | 0    | 61   | 12         | 73         | 711  |
| % App. Total   | 80.7                     | 0    | 19.3 |            | 3.3                         | 96.7 | 0    |            | 0          | 0    | 0    | 0          | 0                           | 0    | 83.6 | 16.4       |            |      |
| PHF  | .830                     | .000 | .729 | .870       | .625                        | .737 | .000 | .737       | .000       | .000 | .000 | .000       | .000                        | .000 | .726 | .600       | .760       | .794 |

# Traffic Data Service

San Jose, CA  
 (408) 622-4787  
 tdsbay@cs.com

File Name : 17AM FINAL  
 Site Code : 00000017  
 Start Date : 4/27/2017  
 Page No : 2

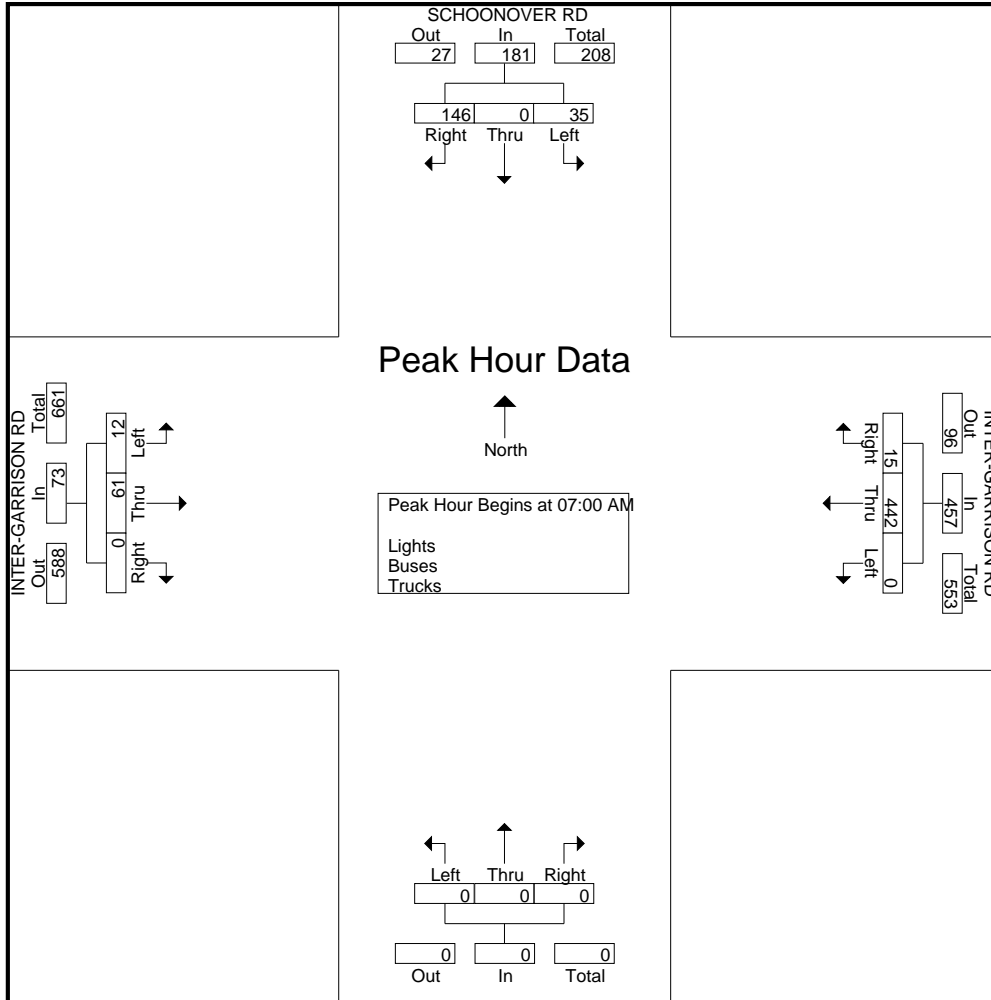

# Traffic Data Service

San Jose, CA  
(408) 622-4787  
tdsbay@cs.com

File Name : 17AM FINAL  
Site Code : 00000017  
Start Date : 4/27/2017  
Page No : 1

Groups Printed- Bikes

| Start Time   | SCHOONOVER RD Southbound |      |      |      |            | INTER-GARRISON RD Westbound |      |      |      |            | Northbound |      |      |      |            | INTER-GARRISON RD Eastbound |      |      |      |            | Int. Total |
|--------------|--------------------------|------|------|------|------------|-----------------------------|------|------|------|------------|------------|------|------|------|------------|-----------------------------|------|------|------|------------|------------|
|              | Right                    | Thru | Left | Peds | App. Total | Right                       | Thru | Left | Peds | App. Total | Right      | Thru | Left | Peds | App. Total | Right                       | Thru | Left | Peds | App. Total |            |
| 07:00 AM     | 0                        | 0    | 0    | 0    | 0          | 0                           | 1    | 0    | 0    | 1          | 0          | 0    | 0    | 0    | 0          | 0                           | 0    | 0    | 0    | 0          | 0          |
| 07:15 AM     | 0                        | 0    | 1    | 0    | 1          | 0                           | 0    | 0    | 0    | 0          | 0          | 0    | 0    | 0    | 0          | 0                           | 0    | 0    | 0    | 0          | 0          |
| 07:30 AM     | 0                        | 0    | 0    | 0    | 0          | 0                           | 0    | 0    | 0    | 0          | 0          | 0    | 0    | 0    | 0          | 0                           | 0    | 0    | 0    | 0          | 0          |
| 07:45 AM     | 0                        | 0    | 0    | 0    | 0          | 0                           | 0    | 0    | 0    | 0          | 0          | 0    | 0    | 0    | 0          | 0                           | 0    | 0    | 0    | 0          | 0          |
| <b>Total</b> | 0                        | 0    | 1    | 0    | 1          | 0                           | 1    | 0    | 0    | 1          | 0          | 0    | 0    | 0    | 0          | 0                           | 0    | 0    | 0    | 0          | 2          |
| 08:00 AM     | 0                        | 0    | 0    | 0    | 0          | 0                           | 0    | 0    | 0    | 0          | 0          | 0    | 0    | 0    | 0          | 0                           | 1    | 0    | 0    | 1          | 1          |
| 08:15 AM     | 1                        | 0    | 0    | 0    | 1          | 0                           | 0    | 0    | 0    | 0          | 0          | 0    | 0    | 0    | 0          | 0                           | 0    | 0    | 0    | 0          | 1          |
| 08:30 AM     | 0                        | 0    | 0    | 0    | 0          | 0                           | 0    | 0    | 0    | 0          | 0          | 0    | 0    | 0    | 0          | 0                           | 0    | 0    | 0    | 0          | 0          |
| 08:45 AM     | 0                        | 0    | 0    | 0    | 0          | 0                           | 0    | 0    | 0    | 0          | 0          | 0    | 0    | 0    | 0          | 0                           | 0    | 0    | 0    | 0          | 0          |
| <b>Total</b> | 1                        | 0    | 0    | 0    | 1          | 0                           | 0    | 0    | 0    | 0          | 0          | 0    | 0    | 0    | 0          | 0                           | 1    | 0    | 0    | 1          | 2          |
| Grand Total  | 1                        | 0    | 1    | 0    | 2          | 0                           | 1    | 0    | 0    | 1          | 0          | 0    | 0    | 0    | 0          | 0                           | 1    | 0    | 0    | 1          | 4          |
| Apprch %     | 50                       | 0    | 50   | 0    |            | 0                           | 100  | 0    | 0    |            | 0          | 0    | 0    | 0    |            | 0                           | 100  | 0    | 0    |            |            |
| Total %      | 25                       | 0    | 25   | 0    | 50         | 0                           | 25   | 0    | 0    | 25         | 0          | 0    | 0    | 0    | 0          | 0                           | 25   | 0    | 0    | 25         |            |

| Start Time   | SCHOONOVER RD Southbound |      |      |            | INTER-GARRISON RD Westbound |      |      |            | Northbound |      |      |            | INTER-GARRISON RD Eastbound |      |      |            | Int. Total |
|--|--------------------------|------|------|------------|-----------------------------|------|------|------------|------------|------|------|------------|-----------------------------|------|------|------------|------------|
|  | Right                    | Thru | Left | App. Total | Right                       | Thru | Left | App. Total | Right      | Thru | Left | App. Total | Right                       | Thru | Left | App. Total |            |
| Peak Hour Analysis From 07:00 AM to 08:45 AM - Peak 1 of 1 |                          |      |      |            |                             |      |      |            |            |      |      |            |                             |      |      |            |            |
| Peak Hour for Entire Intersection Begins at 07:00 AM       |                          |      |      |            |                             |      |      |            |            |      |      |            |                             |      |      |            |            |
| 07:00 AM   | 0                        | 0    | 0    | 0          | 0                           | 1    | 0    | 1          | 0          | 0    | 0    | 0          | 0                           | 0    | 0    | 0          | 0          |
| 07:15 AM   | 0                        | 0    | 1    | 1          | 0                           | 0    | 0    | 0          | 0          | 0    | 0    | 0          | 0                           | 0    | 0    | 0          | 0          |
| 07:30 AM   | 0                        | 0    | 0    | 0          | 0                           | 0    | 0    | 0          | 0          | 0    | 0    | 0          | 0                           | 0    | 0    | 0          | 0          |
| 07:45 AM   | 0                        | 0    | 0    | 0          | 0                           | 0    | 0    | 0          | 0          | 0    | 0    | 0          | 0                           | 0    | 0    | 0          | 0          |
| Total Volume   | 0                        | 0    | 1    | 1          | 0                           | 1    | 0    | 1          | 0          | 0    | 0    | 0          | 0                           | 0    | 0    | 0          | 2          |
| % App. Total   | 0                        | 0    | 100  |            | 0                           | 100  | 0    |            | 0          | 0    | 0    |            | 0                           | 0    | 0    |            |            |
| PHF  | .000                     | .000 | .250 | .250       | .000                        | .250 | .000 | .250       | .000       | .000 | .000 | .000       | .000                        | .000 | .000 | .000       | .500       |

# Traffic Data Service

San Jose, CA  
(408) 622-4787  
tdsbay@cs.com

File Name : 17AM FINAL  
Site Code : 00000017  
Start Date : 4/27/2017  
Page No : 2

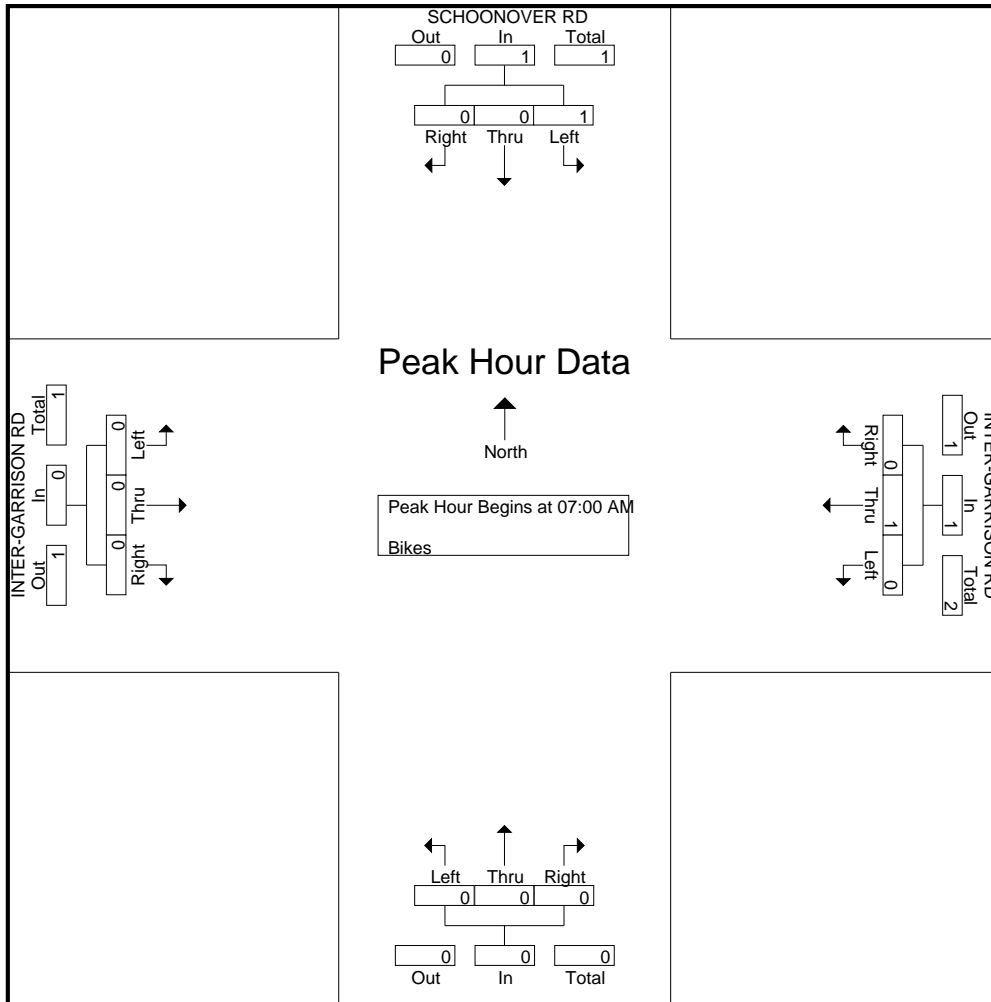

# Traffic Data Service

San Jose, CA  
 (408) 622-4787  
 tdsbay@cs.com

File Name : 17PM FINAL  
 Site Code : 00000017  
 Start Date : 4/27/2017  
 Page No : 1

Groups Printed- Lights - Buses - Trucks

| Start Time   | SCHOONOVER RD<br>Southbound |          |           |          |            | INTER-GARRISON RD<br>Westbound |           |          |          |            | Northbound |          |          |          |            | INTER-GARRISON RD<br>Eastbound |            |           |          |            | Int. Total |
|--------------|-----------------------------|----------|-----------|----------|------------|--------------------------------|-----------|----------|----------|------------|------------|----------|----------|----------|------------|--------------------------------|------------|-----------|----------|------------|------------|
|              | Right                       | Thru     | Left      | Peds     | App. Total | Right                          | Thru      | Left     | Peds     | App. Total | Right      | Thru     | Left     | Peds     | App. Total | Right                          | Thru       | Left      | Peds     | App. Total |            |
| 04:00 PM     | 4                           | 0        | 5         | 0        | 9          | 2                              | 6         | 0        | 0        | 8          | 0          | 0        | 0        | 0        | 0          | 0                              | 61         | 12        | 0        | 73         | 90         |
| 04:15 PM     | 9                           | 0        | 2         | 0        | 11         | 5                              | 20        | 0        | 0        | 25         | 0          | 0        | 0        | 0        | 0          | 0                              | 56         | 13        | 0        | 69         | 105        |
| 04:30 PM     | 10                          | 0        | 4         | 0        | 14         | 5                              | 22        | 0        | 0        | 27         | 0          | 0        | 0        | 0        | 0          | 0                              | 67         | 15        | 0        | 82         | 123        |
| 04:45 PM     | 7                           | 0        | 3         | 3        | 13         | 3                              | 24        | 0        | 0        | 27         | 0          | 0        | 0        | 0        | 0          | 0                              | 76         | 19        | 0        | 95         | 135        |
| <b>Total</b> | <b>30</b>                   | <b>0</b> | <b>14</b> | <b>3</b> | <b>47</b>  | <b>15</b>                      | <b>72</b> | <b>0</b> | <b>0</b> | <b>87</b>  | <b>0</b>   | <b>0</b> | <b>0</b> | <b>0</b> | <b>0</b>   | <b>0</b>                       | <b>260</b> | <b>59</b> | <b>0</b> | <b>319</b> | <b>453</b> |
| 05:00 PM     | 3                           | 0        | 3         | 1        | 7          | 4                              | 31        | 0        | 0        | 35         | 0          | 0        | 0        | 0        | 0          | 0                              | 86         | 28        | 0        | 114        | 156        |
| 05:15 PM     | 8                           | 0        | 3         | 0        | 11         | 4                              | 16        | 0        | 0        | 20         | 0          | 0        | 0        | 0        | 0          | 0                              | 115        | 23        | 0        | 138        | 169        |
| 05:30 PM     | 6                           | 0        | 2         | 2        | 10         | 2                              | 18        | 0        | 0        | 20         | 0          | 0        | 0        | 0        | 0          | 0                              | 76         | 24        | 0        | 100        | 130        |
| 05:45 PM     | 13                          | 0        | 2         | 0        | 15         | 7                              | 16        | 0        | 0        | 23         | 0          | 0        | 0        | 0        | 0          | 0                              | 64         | 17        | 0        | 81         | 119        |
| <b>Total</b> | <b>30</b>                   | <b>0</b> | <b>10</b> | <b>3</b> | <b>43</b>  | <b>17</b>                      | <b>81</b> | <b>0</b> | <b>0</b> | <b>98</b>  | <b>0</b>   | <b>0</b> | <b>0</b> | <b>0</b> | <b>0</b>   | <b>0</b>                       | <b>341</b> | <b>92</b> | <b>0</b> | <b>433</b> | <b>574</b> |
| Grand Total  | 60                          | 0        | 24        | 6        | 90         | 32                             | 153       | 0        | 0        | 185        | 0          | 0        | 0        | 0        | 0          | 0                              | 601        | 151       | 0        | 752        | 1027       |
| Apprch %     | 66.7                        | 0        | 26.7      | 6.7      |            | 17.3                           | 82.7      | 0        | 0        |            | 0          | 0        | 0        | 0        |            | 0                              | 79.9       | 20.1      | 0        |            |            |
| Total %      | 5.8                         | 0        | 2.3       | 0.6      | 8.8        | 3.1                            | 14.9      | 0        | 0        | 18         | 0          | 0        | 0        | 0        | 0          | 0                              | 58.5       | 14.7      | 0        | 73.2       |            |
| Lights       | 47                          | 0        | 23        | 6        | 76         | 31                             | 147       | 0        | 0        | 178        | 0          | 0        | 0        | 0        | 0          | 0                              | 596        | 151       | 0        | 747        | 1001       |
| % Lights     | 78.3                        | 0        | 95.8      | 100      | 84.4       | 96.9                           | 96.1      | 0        | 0        | 96.2       | 0          | 0        | 0        | 0        | 0          | 0                              | 99.2       | 100       | 0        | 99.3       | 97.5       |
| Buses        | 13                          | 0        | 1         | 0        | 14         | 1                              | 0         | 0        | 0        | 1          | 0          | 0        | 0        | 0        | 0          | 0                              | 2          | 0         | 0        | 2          | 17         |
| % Buses      | 21.7                        | 0        | 4.2       | 0        | 15.6       | 3.1                            | 0         | 0        | 0        | 0.5        | 0          | 0        | 0        | 0        | 0          | 0                              | 0.3        | 0         | 0        | 0.3        | 1.7        |
| Trucks       | 0                           | 0        | 0         | 0        | 0          | 0                              | 6         | 0        | 0        | 6          | 0          | 0        | 0        | 0        | 0          | 0                              | 3          | 0         | 0        | 3          | 9          |
| % Trucks     | 0                           | 0        | 0         | 0        | 0          | 0                              | 3.9       | 0        | 0        | 3.2        | 0          | 0        | 0        | 0        | 0          | 0                              | 0.5        | 0         | 0        | 0.4        | 0.9        |

| Start Time   | SCHOONOVER RD<br>Southbound |      |          |            | INTER-GARRISON RD<br>Westbound |           |      |            | Northbound |      |      |            | INTER-GARRISON RD<br>Eastbound |            |           |            | Int. Total |
|--|-----------------------------|------|----------|------------|--------------------------------|-----------|------|------------|------------|------|------|------------|--------------------------------|------------|-----------|------------|------------|
|  | Right                       | Thru | Left     | App. Total | Right                          | Thru      | Left | App. Total | Right      | Thru | Left | App. Total | Right                          | Thru       | Left      | App. Total |            |
| Peak Hour Analysis From 04:00 PM to 05:45 PM - Peak 1 of 1 |                             |      |          |            |                                |           |      |            |            |      |      |            |                                |            |           |            |            |
| Peak Hour for Entire Intersection Begins at 04:45 PM       |                             |      |          |            |                                |           |      |            |            |      |      |            |                                |            |           |            |            |
| 04:45 PM   | 7                           | 0    | <b>3</b> | 10         | 3                              | 24        | 0    | 27         | 0          | 0    | 0    | 0          | 0                              | 76         | 19        | 95         | 132        |
| 05:00 PM   | 3                           | 0    | 3        | 6          | <b>4</b>                       | <b>31</b> | 0    | <b>35</b>  | 0          | 0    | 0    | 0          | 0                              | 86         | <b>28</b> | 114        | 155        |
| 05:15 PM   | <b>8</b>                    | 0    | 3        | <b>11</b>  | 4                              | 16        | 0    | 20         | 0          | 0    | 0    | 0          | 0                              | <b>115</b> | 23        | <b>138</b> | <b>169</b> |
| 05:30 PM   | 6                           | 0    | 2        | 8          | 2                              | 18        | 0    | 20         | 0          | 0    | 0    | 0          | 0                              | 76         | 24        | 100        | 128        |
| Total Volume   | 24                          | 0    | 11       | 35         | 13                             | 89        | 0    | 102        | 0          | 0    | 0    | 0          | 0                              | 353        | 94        | 447        | 584        |
| % App. Total   | 68.6                        | 0    | 31.4     |            | 12.7                           | 87.3      | 0    |            | 0          | 0    | 0    |            | 0                              | 79         | 21        |            |            |
| PHF  | .750                        | .000 | .917     | .795       | .813                           | .718      | .000 | .729       | .000       | .000 | .000 | .000       | .000                           | .767       | .839      | .810       | .864       |

# Traffic Data Service

San Jose, CA  
 (408) 622-4787  
 tdsbay@cs.com

File Name : 17PM FINAL  
 Site Code : 00000017  
 Start Date : 4/27/2017  
 Page No : 2

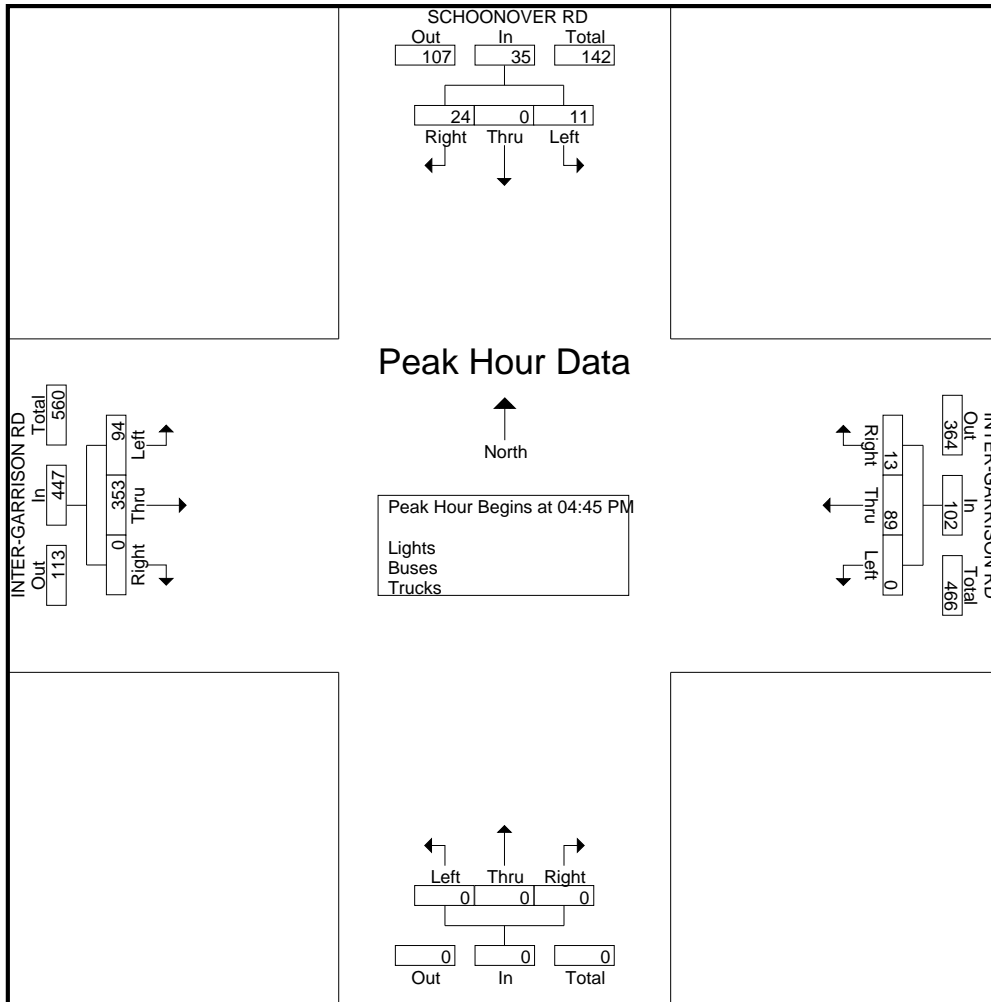

# Traffic Data Service

San Jose, CA  
 (408) 622-4787  
 tdsbay@cs.com

File Name : 17PM FINAL  
 Site Code : 00000017  
 Start Date : 4/27/2017  
 Page No : 1

Groups Printed- Bikes

| Start Time   | SCHOONOVER RD Southbound |      |      |      |            | INTER-GARRISON RD Westbound |      |      |      |            | Northbound |      |      |      |            | INTER-GARRISON RD Eastbound |      |      |      |            | Int. Total |
|--------------|--------------------------|------|------|------|------------|-----------------------------|------|------|------|------------|------------|------|------|------|------------|-----------------------------|------|------|------|------------|------------|
|              | Right                    | Thru | Left | Peds | App. Total | Right                       | Thru | Left | Peds | App. Total | Right      | Thru | Left | Peds | App. Total | Right                       | Thru | Left | Peds | App. Total |            |
| 04:00 PM     | 0                        | 0    | 0    | 0    | 0          | 0                           | 0    | 0    | 0    | 0          | 0          | 0    | 0    | 0    | 0          | 0                           | 0    | 0    | 0    | 0          | 0          |
| 04:15 PM     | 0                        | 0    | 0    | 0    | 0          | 0                           | 0    | 0    | 0    | 0          | 0          | 0    | 0    | 0    | 0          | 0                           | 0    | 0    | 0    | 0          | 0          |
| 04:30 PM     | 0                        | 0    | 0    | 0    | 0          | 0                           | 0    | 0    | 0    | 0          | 0          | 0    | 0    | 0    | 0          | 0                           | 0    | 1    | 0    | 1          | 1          |
| 04:45 PM     | 0                        | 0    | 0    | 0    | 0          | 0                           | 0    | 0    | 0    | 0          | 0          | 0    | 0    | 0    | 0          | 0                           | 0    | 0    | 0    | 0          | 0          |
| <b>Total</b> | 0                        | 0    | 0    | 0    | 0          | 0                           | 0    | 0    | 0    | 0          | 0          | 0    | 0    | 0    | 0          | 0                           | 0    | 1    | 0    | 1          | 1          |
| 05:00 PM     | 0                        | 0    | 0    | 0    | 0          | 0                           | 0    | 0    | 0    | 0          | 0          | 0    | 0    | 0    | 0          | 0                           | 0    | 1    | 0    | 1          | 1          |
| 05:15 PM     | 0                        | 0    | 0    | 0    | 0          | 0                           | 0    | 0    | 0    | 0          | 0          | 0    | 0    | 0    | 0          | 0                           | 0    | 0    | 0    | 0          | 0          |
| 05:30 PM     | 0                        | 0    | 0    | 0    | 0          | 0                           | 0    | 0    | 0    | 0          | 0          | 0    | 0    | 0    | 0          | 0                           | 0    | 0    | 0    | 0          | 0          |
| 05:45 PM     | 0                        | 0    | 0    | 0    | 0          | 0                           | 0    | 0    | 0    | 0          | 0          | 0    | 0    | 0    | 0          | 0                           | 0    | 0    | 0    | 0          | 0          |
| <b>Total</b> | 0                        | 0    | 0    | 0    | 0          | 0                           | 0    | 0    | 0    | 0          | 0          | 0    | 0    | 0    | 0          | 0                           | 0    | 1    | 0    | 1          | 1          |
| Grand Total  | 0                        | 0    | 0    | 0    | 0          | 0                           | 0    | 0    | 0    | 0          | 0          | 0    | 0    | 0    | 0          | 0                           | 0    | 2    | 0    | 2          | 2          |
| Apprch %     | 0                        | 0    | 0    | 0    | 0          | 0                           | 0    | 0    | 0    | 0          | 0          | 0    | 0    | 0    | 0          | 0                           | 0    | 100  | 0    | 0          | 0          |
| Total %      | 0                        | 0    | 0    | 0    | 0          | 0                           | 0    | 0    | 0    | 0          | 0          | 0    | 0    | 0    | 0          | 0                           | 0    | 100  | 0    | 100        | 0          |

| Start Time   | SCHOONOVER RD Southbound |      |      |      |            | INTER-GARRISON RD Westbound |      |      |      |            | Northbound |      |      |      |            | INTER-GARRISON RD Eastbound |      |      |      |            | Int. Total |
|--|--------------------------|------|------|------|------------|-----------------------------|------|------|------|------------|------------|------|------|------|------------|-----------------------------|------|------|------|------------|------------|
|  | Right                    | Thru | Left | Peds | App. Total | Right                       | Thru | Left | Peds | App. Total | Right      | Thru | Left | Peds | App. Total | Right                       | Thru | Left | Peds | App. Total |            |
| Peak Hour Analysis From 04:00 PM to 05:45 PM - Peak 1 of 1 |                          |      |      |      |            |                             |      |      |      |            |            |      |      |      |            |                             |      |      |      |            |            |
| Peak Hour for Entire Intersection Begins at 04:15 PM       |                          |      |      |      |            |                             |      |      |      |            |            |      |      |      |            |                             |      |      |      |            |            |
| 04:15 PM   | 0                        | 0    | 0    | 0    | 0          | 0                           | 0    | 0    | 0    | 0          | 0          | 0    | 0    | 0    | 0          | 0                           | 0    | 0    | 0    | 0          | 0          |
| 04:30 PM   | 0                        | 0    | 0    | 0    | 0          | 0                           | 0    | 0    | 0    | 0          | 0          | 0    | 0    | 0    | 0          | 0                           | 0    | 1    | 0    | 1          | 1          |
| 04:45 PM   | 0                        | 0    | 0    | 0    | 0          | 0                           | 0    | 0    | 0    | 0          | 0          | 0    | 0    | 0    | 0          | 0                           | 0    | 0    | 0    | 0          | 0          |
| 05:00 PM   | 0                        | 0    | 0    | 0    | 0          | 0                           | 0    | 0    | 0    | 0          | 0          | 0    | 0    | 0    | 0          | 0                           | 0    | 1    | 0    | 1          | 1          |
| Total Volume   | 0                        | 0    | 0    | 0    | 0          | 0                           | 0    | 0    | 0    | 0          | 0          | 0    | 0    | 0    | 0          | 0                           | 0    | 2    | 0    | 2          | 2          |
| % App. Total   | 0                        | 0    | 0    | 0    | 0          | 0                           | 0    | 0    | 0    | 0          | 0          | 0    | 0    | 0    | 0          | 0                           | 0    | 100  | 0    | 0          | 0          |
| PHF  | .000                     | .000 | .000 | .000 | .000       | .000                        | .000 | .000 | .000 | .000       | .000       | .000 | .000 | .000 | .000       | .000                        | .000 | .500 | .500 | .500       | .500       |

# Traffic Data Service

San Jose, CA  
(408) 622-4787  
tdsbay@cs.com

File Name : 17PM FINAL  
Site Code : 00000017  
Start Date : 4/27/2017  
Page No : 2

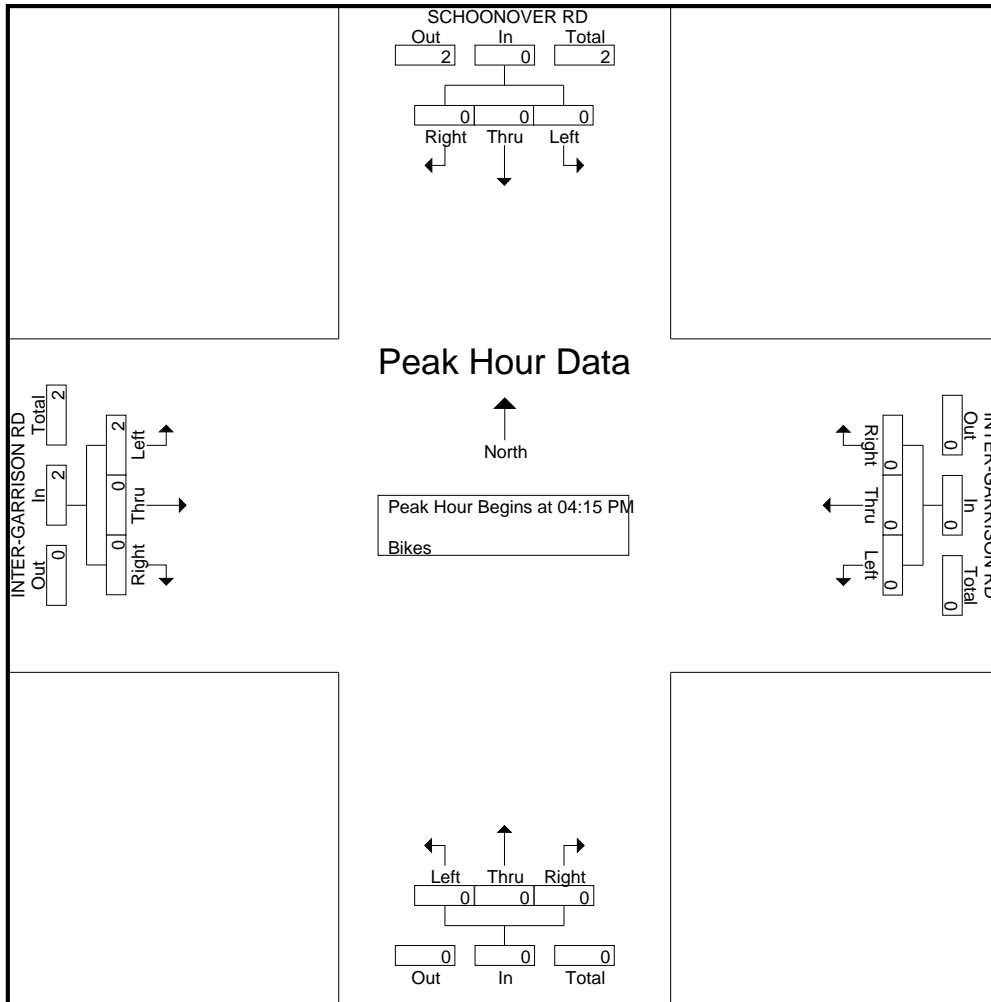



# Traffic Data Service

San Jose, CA  
 (408) 622-4787  
 tdsbay@cs.com

File Name : 18AM FINAL  
 Site Code : 00000018  
 Start Date : 4/27/2017  
 Page No : 1

Groups Printed- Lights - Buses - Trucks

| Start Time  | INTER-GARRISON RD Southbound |      |      |      |            | SHERMAN BLVD Westbound |      |      |      |            | Northbound |      |      |      |            | INTER-GARRISON RD Eastbound |      |      |      |            | Int. Total |
|-------------|------------------------------|------|------|------|------------|------------------------|------|------|------|------------|------------|------|------|------|------------|-----------------------------|------|------|------|------------|------------|
|             | Right                        | Thru | Left | Peds | App. Total | Right                  | Thru | Left | Peds | App. Total | Right      | Thru | Left | Peds | App. Total | Right                       | Thru | Left | Peds | App. Total |            |
| 07:00 AM    | 103                          | 0    | 7    | 0    | 110        | 6                      | 20   | 0    | 0    | 26         | 0          | 0    | 0    | 0    | 0          | 0                           | 1    | 14   | 0    | 15         | 151        |
| 07:15 AM    | 125                          | 0    | 3    | 0    | 128        | 2                      | 29   | 0    | 0    | 31         | 0          | 0    | 0    | 0    | 0          | 0                           | 4    | 18   | 0    | 22         | 181        |
| 07:30 AM    | 97                           | 0    | 1    | 0    | 98         | 6                      | 18   | 0    | 0    | 24         | 0          | 0    | 0    | 0    | 0          | 0                           | 2    | 25   | 0    | 27         | 149        |
| 07:45 AM    | 65                           | 0    | 2    | 0    | 67         | 4                      | 10   | 0    | 0    | 14         | 0          | 0    | 0    | 0    | 0          | 0                           | 3    | 27   | 0    | 30         | 111        |
| Total       | 390                          | 0    | 13   | 0    | 403        | 18                     | 77   | 0    | 0    | 95         | 0          | 0    | 0    | 0    | 0          | 0                           | 10   | 84   | 0    | 94         | 592        |
| 08:00 AM    | 62                           | 0    | 4    | 0    | 66         | 4                      | 11   | 0    | 0    | 15         | 0          | 0    | 0    | 0    | 0          | 0                           | 3    | 14   | 0    | 17         | 98         |
| 08:15 AM    | 53                           | 0    | 3    | 0    | 56         | 3                      | 7    | 0    | 0    | 10         | 0          | 0    | 0    | 0    | 0          | 0                           | 2    | 9    | 0    | 11         | 77         |
| 08:30 AM    | 44                           | 0    | 2    | 0    | 46         | 5                      | 7    | 0    | 0    | 12         | 0          | 0    | 0    | 0    | 0          | 0                           | 6    | 9    | 0    | 15         | 73         |
| 08:45 AM    | 34                           | 0    | 3    | 0    | 37         | 4                      | 10   | 0    | 0    | 14         | 0          | 0    | 0    | 0    | 0          | 0                           | 4    | 6    | 0    | 10         | 61         |
| Total       | 193                          | 0    | 12   | 0    | 205        | 16                     | 35   | 0    | 0    | 51         | 0          | 0    | 0    | 0    | 0          | 0                           | 15   | 38   | 0    | 53         | 309        |
| Grand Total | 583                          | 0    | 25   | 0    | 608        | 34                     | 112  | 0    | 0    | 146        | 0          | 0    | 0    | 0    | 0          | 0                           | 25   | 122  | 0    | 147        | 901        |
| Apprch %    | 95.9                         | 0    | 4.1  | 0    |            | 23.3                   | 76.7 | 0    | 0    |            | 0          | 0    | 0    | 0    | 0          | 0                           | 17   | 83   | 0    |            |            |
| Total %     | 64.7                         | 0    | 2.8  | 0    | 67.5       | 3.8                    | 12.4 | 0    | 0    | 16.2       | 0          | 0    | 0    | 0    | 0          | 0                           | 2.8  | 13.5 | 0    | 16.3       |            |
| Lights      | 583                          | 0    | 23   | 0    | 606        | 34                     | 107  | 0    | 0    | 141        | 0          | 0    | 0    | 0    | 0          | 0                           | 23   | 119  | 0    | 142        | 889        |
| % Lights    | 100                          | 0    | 92   | 0    | 99.7       | 100                    | 95.5 | 0    | 0    | 96.6       | 0          | 0    | 0    | 0    | 0          | 0                           | 92   | 97.5 | 0    | 96.6       | 98.7       |
| Buses       | 0                            | 0    | 1    | 0    | 1          | 0                      | 2    | 0    | 0    | 2          | 0          | 0    | 0    | 0    | 0          | 0                           | 1    | 1    | 0    | 2          | 5          |
| % Buses     | 0                            | 0    | 4    | 0    | 0.2        | 0                      | 1.8  | 0    | 0    | 1.4        | 0          | 0    | 0    | 0    | 0          | 0                           | 4    | 0.8  | 0    | 1.4        | 0.6        |
| Trucks      | 0                            | 0    | 1    | 0    | 1          | 0                      | 3    | 0    | 0    | 3          | 0          | 0    | 0    | 0    | 0          | 0                           | 1    | 2    | 0    | 3          | 7          |
| % Trucks    | 0                            | 0    | 4    | 0    | 0.2        | 0                      | 2.7  | 0    | 0    | 2.1        | 0          | 0    | 0    | 0    | 0          | 0                           | 4    | 1.6  | 0    | 2          | 0.8        |

| Start Time   | INTER-GARRISON RD Southbound |      |      |            | SHERMAN BLVD Westbound |      |      |            | Northbound |      |      |            | INTER-GARRISON RD Eastbound |      |      |            | Int. Total |     |
|--|------------------------------|------|------|------------|------------------------|------|------|------------|------------|------|------|------------|-----------------------------|------|------|------------|------------|-----|
|  | Right                        | Thru | Left | App. Total | Right                  | Thru | Left | App. Total | Right      | Thru | Left | App. Total | Right                       | Thru | Left | App. Total |            |     |
| Peak Hour Analysis From 07:00 AM to 08:45 AM - Peak 1 of 1 |                              |      |      |            |                        |      |      |            |            |      |      |            |                             |      |      |            |            |     |
| Peak Hour for Entire Intersection Begins at 07:00 AM       |                              |      |      |            |                        |      |      |            |            |      |      |            |                             |      |      |            |            |     |
| 07:00 AM   | 103                          | 0    | 7    | 110        | 6                      | 20   | 0    | 26         | 0          | 0    | 0    | 0          | 0                           | 0    | 1    | 14         | 15         | 151 |
| 07:15 AM   | 125                          | 0    | 3    | 128        | 2                      | 29   | 0    | 31         | 0          | 0    | 0    | 0          | 0                           | 0    | 4    | 18         | 22         | 181 |
| 07:30 AM   | 97                           | 0    | 1    | 98         | 6                      | 18   | 0    | 24         | 0          | 0    | 0    | 0          | 0                           | 2    | 25   | 27         | 149        |     |
| 07:45 AM   | 65                           | 0    | 2    | 67         | 4                      | 10   | 0    | 14         | 0          | 0    | 0    | 0          | 0                           | 3    | 27   | 30         | 111        |     |
| Total Volume   | 390                          | 0    | 13   | 403        | 18                     | 77   | 0    | 95         | 0          | 0    | 0    | 0          | 0                           | 10   | 84   | 94         | 592        |     |
| % App. Total   | 96.8                         | 0    | 3.2  |            | 18.9                   | 81.1 | 0    |            | 0          | 0    | 0    | 0          | 0                           | 10.6 | 89.4 |            |            |     |
| PHF  | .780                         | .000 | .464 | .787       | .750                   | .664 | .000 | .766       | .000       | .000 | .000 | .000       | .000                        | .625 | .778 | .783       | .818       |     |

# Traffic Data Service

San Jose, CA  
 (408) 622-4787  
 tdsbay@cs.com

File Name : 18AM FINAL  
 Site Code : 00000018  
 Start Date : 4/27/2017  
 Page No : 2

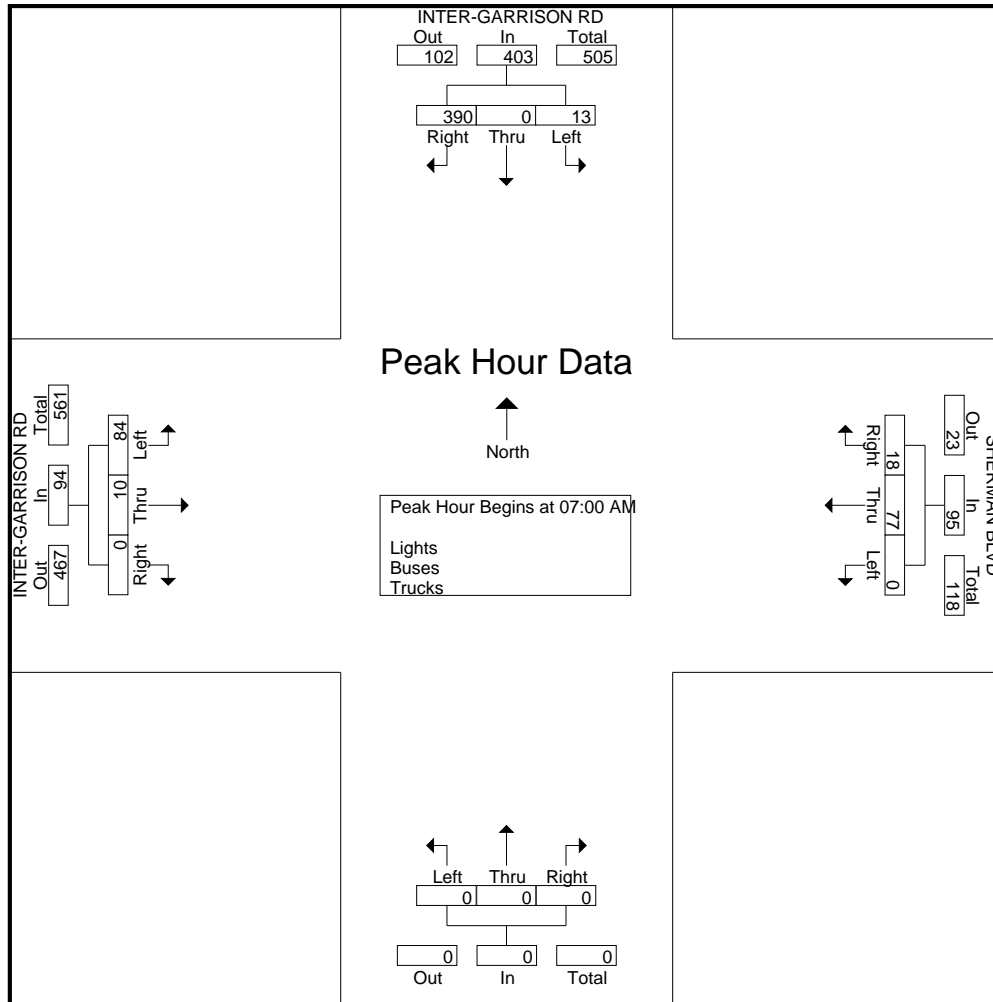

# Traffic Data Service

San Jose, CA  
 (408) 622-4787  
 tdsbay@cs.com

File Name : 18AM FINAL  
 Site Code : 00000018  
 Start Date : 4/27/2017  
 Page No : 1

Groups Printed- Bikes

| Start Time  | INTER-GARRISON RD Southbound |      |      |      |            | SHERMAN BLVD Westbound |      |      |      |            | Northbound |      |      |      |            | INTER-GARRISON RD Eastbound |      |      |      |            | Int. Total |
|-------------|------------------------------|------|------|------|------------|------------------------|------|------|------|------------|------------|------|------|------|------------|-----------------------------|------|------|------|------------|------------|
|             | Right                        | Thru | Left | Peds | App. Total | Right                  | Thru | Left | Peds | App. Total | Right      | Thru | Left | Peds | App. Total | Right                       | Thru | Left | Peds | App. Total |            |
| 07:00 AM    | 0                            | 0    | 0    | 0    | 0          | 0                      | 0    | 0    | 0    | 0          | 0          | 0    | 0    | 0    | 0          | 0                           | 0    | 0    | 0    | 0          | 0          |
| 07:15 AM    | 0                            | 0    | 0    | 0    | 0          | 0                      | 0    | 0    | 0    | 0          | 0          | 0    | 0    | 0    | 0          | 0                           | 1    | 0    | 0    | 0          | 1          |
| 07:30 AM    | 0                            | 0    | 0    | 0    | 0          | 0                      | 0    | 0    | 0    | 0          | 0          | 0    | 0    | 0    | 0          | 0                           | 0    | 0    | 0    | 0          | 0          |
| 07:45 AM    | 0                            | 0    | 0    | 0    | 0          | 0                      | 0    | 0    | 0    | 0          | 0          | 0    | 0    | 0    | 0          | 0                           | 0    | 0    | 0    | 0          | 0          |
| Total       | 0                            | 0    | 0    | 0    | 0          | 0                      | 0    | 0    | 0    | 0          | 0          | 0    | 0    | 0    | 0          | 0                           | 1    | 0    | 0    | 0          | 1          |
| 08:00 AM    | 0                            | 0    | 0    | 0    | 0          | 0                      | 0    | 0    | 0    | 0          | 0          | 0    | 0    | 0    | 0          | 0                           | 1    | 0    | 0    | 0          | 1          |
| 08:15 AM    | 0                            | 0    | 0    | 0    | 0          | 0                      | 0    | 0    | 0    | 0          | 0          | 0    | 0    | 0    | 0          | 0                           | 0    | 0    | 0    | 0          | 0          |
| 08:30 AM    | 0                            | 0    | 0    | 0    | 0          | 0                      | 0    | 0    | 0    | 0          | 0          | 0    | 0    | 0    | 0          | 0                           | 0    | 0    | 0    | 0          | 0          |
| 08:45 AM    | 0                            | 0    | 0    | 0    | 0          | 0                      | 0    | 0    | 0    | 0          | 0          | 0    | 0    | 0    | 0          | 0                           | 0    | 0    | 0    | 0          | 0          |
| Total       | 0                            | 0    | 0    | 0    | 0          | 0                      | 0    | 0    | 0    | 0          | 0          | 0    | 0    | 0    | 0          | 0                           | 1    | 0    | 0    | 0          | 1          |
| Grand Total | 0                            | 0    | 0    | 0    | 0          | 0                      | 0    | 0    | 0    | 0          | 0          | 0    | 0    | 0    | 0          | 0                           | 2    | 0    | 0    | 0          | 2          |
| Apprch %    | 0                            | 0    | 0    | 0    | 0          | 0                      | 0    | 0    | 0    | 0          | 0          | 0    | 0    | 0    | 0          | 0                           | 100  | 0    | 0    | 0          |            |
| Total %     | 0                            | 0    | 0    | 0    | 0          | 0                      | 0    | 0    | 0    | 0          | 0          | 0    | 0    | 0    | 0          | 0                           | 100  | 0    | 0    | 100        |            |

| Start Time   | INTER-GARRISON RD Southbound |      |      |      |            | SHERMAN BLVD Westbound |      |      |      |            | Northbound |      |      |      |            | INTER-GARRISON RD Eastbound |      |      |      |            | Int. Total |
|--|------------------------------|------|------|------|------------|------------------------|------|------|------|------------|------------|------|------|------|------------|-----------------------------|------|------|------|------------|------------|
|  | Right                        | Thru | Left | Peds | App. Total | Right                  | Thru | Left | Peds | App. Total | Right      | Thru | Left | Peds | App. Total | Right                       | Thru | Left | Peds | App. Total |            |
| Peak Hour Analysis From 07:00 AM to 08:45 AM - Peak 1 of 1 |                              |      |      |      |            |                        |      |      |      |            |            |      |      |      |            |                             |      |      |      |            |            |
| Peak Hour for Entire Intersection Begins at 07:15 AM       |                              |      |      |      |            |                        |      |      |      |            |            |      |      |      |            |                             |      |      |      |            |            |
| 07:15 AM   | 0                            | 0    | 0    | 0    | 0          | 0                      | 0    | 0    | 0    | 0          | 0          | 0    | 0    | 0    | 0          | 0                           | 1    | 0    | 0    | 0          | 1          |
| 07:30 AM   | 0                            | 0    | 0    | 0    | 0          | 0                      | 0    | 0    | 0    | 0          | 0          | 0    | 0    | 0    | 0          | 0                           | 0    | 0    | 0    | 0          | 0          |
| 07:45 AM   | 0                            | 0    | 0    | 0    | 0          | 0                      | 0    | 0    | 0    | 0          | 0          | 0    | 0    | 0    | 0          | 0                           | 0    | 0    | 0    | 0          | 0          |
| 08:00 AM   | 0                            | 0    | 0    | 0    | 0          | 0                      | 0    | 0    | 0    | 0          | 0          | 0    | 0    | 0    | 0          | 0                           | 1    | 0    | 0    | 0          | 1          |
| Total Volume   | 0                            | 0    | 0    | 0    | 0          | 0                      | 0    | 0    | 0    | 0          | 0          | 0    | 0    | 0    | 0          | 0                           | 2    | 0    | 0    | 0          | 2          |
| % App. Total   | 0                            | 0    | 0    | 0    | 0          | 0                      | 0    | 0    | 0    | 0          | 0          | 0    | 0    | 0    | 0          | 0                           | 100  | 0    | 0    | 0          |            |
| PHF  | .000                         | .000 | .000 | .000 | .000       | .000                   | .000 | .000 | .000 | .000       | .000       | .000 | .000 | .000 | .000       | .000                        | .500 | .000 | .500 | .000       | .500       |

# Traffic Data Service

San Jose, CA  
(408) 622-4787  
tdsbay@cs.com

File Name : 18AM FINAL  
Site Code : 00000018  
Start Date : 4/27/2017  
Page No : 2

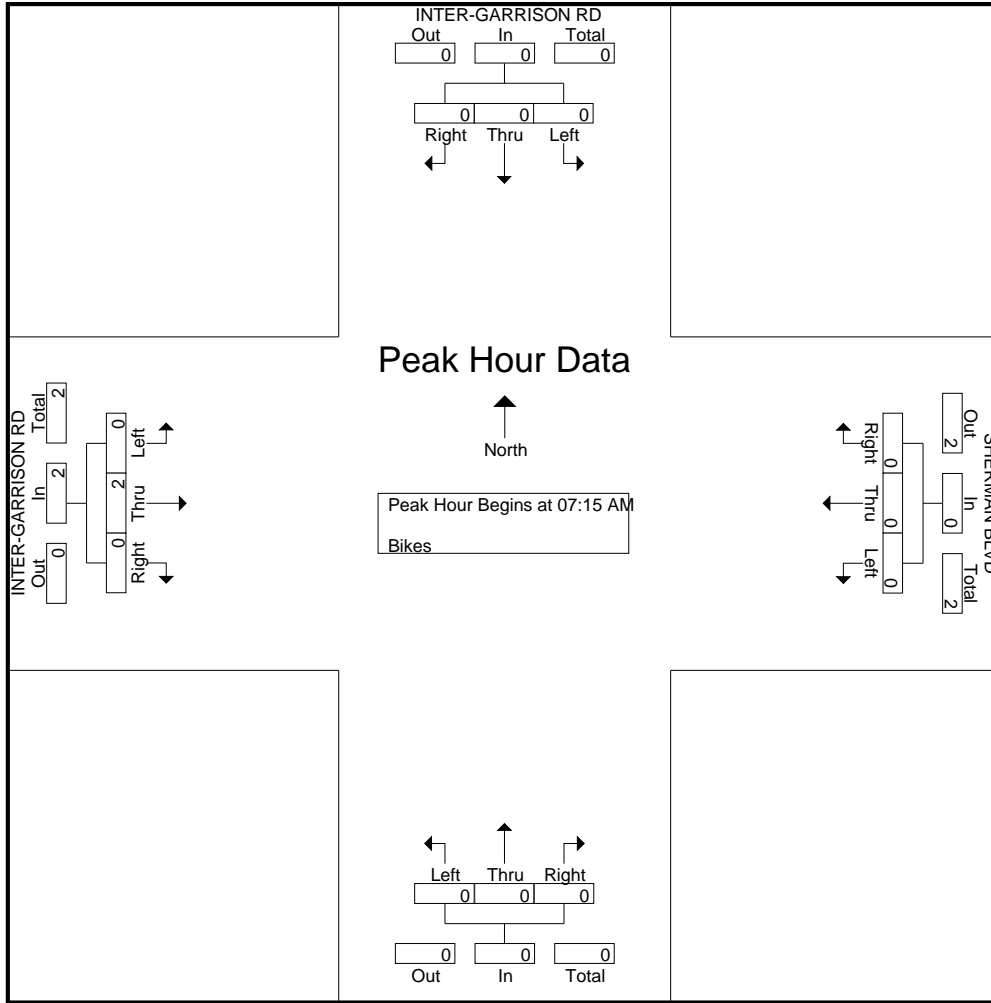

# Traffic Data Service

San Jose, CA  
 (408) 622-4787  
 tdsbay@cs.com

File Name : 18PM FINAL  
 Site Code : 00000018  
 Start Date : 4/27/2017  
 Page No : 1

Groups Printed- Lights - Buses - Trucks

| Start Time   | INTER-GARRISON RD Southbound |          |           |          |            | SHERMAN BLVD Westbound |           |          |          |            | Northbound |          |          |          |            | INTER-GARRISON RD Eastbound |           |            |          |            | Int. Total |
|--------------|------------------------------|----------|-----------|----------|------------|------------------------|-----------|----------|----------|------------|------------|----------|----------|----------|------------|-----------------------------|-----------|------------|----------|------------|------------|
|              | Right                        | Thru     | Left      | Peds     | App. Total | Right                  | Thru      | Left     | Peds     | App. Total | Right      | Thru     | Left     | Peds     | App. Total | Right                       | Thru      | Left       | Peds     | App. Total |            |
| 04:00 PM     | 9                            | 0        | 7         | 0        | 16         | 2                      | 4         | 0        | 0        | 6          | 0          | 0        | 0        | 0        | 0          | 0                           | 11        | 53         | 0        | 64         | 86         |
| 04:15 PM     | 16                           | 0        | 3         | 0        | 19         | 1                      | 6         | 0        | 0        | 7          | 0          | 0        | 0        | 0        | 0          | 0                           | 8         | 54         | 0        | 62         | 88         |
| 04:30 PM     | 21                           | 0        | 3         | 0        | 24         | 3                      | 5         | 0        | 0        | 8          | 0          | 0        | 0        | 0        | 0          | 0                           | 6         | 60         | 0        | 66         | 98         |
| 04:45 PM     | 22                           | 0        | 4         | 0        | 26         | 4                      | 5         | 0        | 0        | 9          | 0          | 0        | 0        | 0        | 0          | 0                           | 10        | 76         | 0        | 86         | 121        |
| <b>Total</b> | <b>68</b>                    | <b>0</b> | <b>17</b> | <b>0</b> | <b>85</b>  | <b>10</b>              | <b>20</b> | <b>0</b> | <b>0</b> | <b>30</b>  | <b>0</b>   | <b>0</b> | <b>0</b> | <b>0</b> | <b>0</b>   | <b>0</b>                    | <b>35</b> | <b>243</b> | <b>0</b> | <b>278</b> | <b>393</b> |
| 05:00 PM     | 21                           | 0        | 5         | 0        | 26         | 5                      | 9         | 0        | 0        | 14         | 0          | 0        | 0        | 0        | 0          | 0                           | 8         | 80         | 1        | 89         | 129        |
| 05:15 PM     | 16                           | 0        | 2         | 0        | 18         | 2                      | 5         | 0        | 0        | 7          | 0          | 0        | 0        | 0        | 0          | 0                           | 12        | 105        | 0        | 117        | 142        |
| 05:30 PM     | 16                           | 0        | 1         | 0        | 17         | 4                      | 2         | 0        | 0        | 6          | 0          | 0        | 0        | 0        | 0          | 0                           | 13        | 67         | 0        | 80         | 103        |
| 05:45 PM     | 16                           | 0        | 2         | 0        | 18         | 5                      | 4         | 0        | 0        | 9          | 0          | 0        | 0        | 0        | 0          | 0                           | 13        | 54         | 0        | 67         | 94         |
| <b>Total</b> | <b>69</b>                    | <b>0</b> | <b>10</b> | <b>0</b> | <b>79</b>  | <b>16</b>              | <b>20</b> | <b>0</b> | <b>0</b> | <b>36</b>  | <b>0</b>   | <b>0</b> | <b>0</b> | <b>0</b> | <b>0</b>   | <b>0</b>                    | <b>46</b> | <b>306</b> | <b>1</b> | <b>353</b> | <b>468</b> |
| Grand Total  | 137                          | 0        | 27        | 0        | 164        | 26                     | 40        | 0        | 0        | 66         | 0          | 0        | 0        | 0        | 0          | 0                           | 81        | 549        | 1        | 631        | 861        |
| Apprch %     | 83.5                         | 0        | 16.5      | 0        |            | 39.4                   | 60.6      | 0        | 0        |            | 0          | 0        | 0        | 0        |            | 0                           | 12.8      | 87         | 0.2      |            |            |
| Total %      | 15.9                         | 0        | 3.1       | 0        | 19         | 3                      | 4.6       | 0        | 0        | 7.7        | 0          | 0        | 0        | 0        | 0          | 0                           | 9.4       | 63.8       | 0.1      | 73.3       |            |
| Lights       | 132                          | 0        | 26        | 0        | 158        | 25                     | 38        | 0        | 0        | 63         | 0          | 0        | 0        | 0        | 0          | 0                           | 78        | 544        | 1        | 623        | 844        |
| % Lights     | 96.4                         | 0        | 96.3      | 0        | 96.3       | 96.2                   | 95        | 0        | 0        | 95.5       | 0          | 0        | 0        | 0        | 0          | 0                           | 96.3      | 99.1       | 100      | 98.7       | 98         |
| Buses        | 1                            | 0        | 0         | 0        | 1          | 1                      | 0         | 0        | 0        | 1          | 0          | 0        | 0        | 0        | 0          | 0                           | 2         | 1          | 0        | 3          | 5          |
| % Buses      | 0.7                          | 0        | 0         | 0        | 0.6        | 3.8                    | 0         | 0        | 0        | 1.5        | 0          | 0        | 0        | 0        | 0          | 0                           | 2.5       | 0.2        | 0        | 0.5        | 0.6        |
| Trucks       | 4                            | 0        | 1         | 0        | 5          | 0                      | 2         | 0        | 0        | 2          | 0          | 0        | 0        | 0        | 0          | 0                           | 1         | 4          | 0        | 5          | 12         |
| % Trucks     | 2.9                          | 0        | 3.7       | 0        | 3          | 0                      | 5         | 0        | 0        | 3          | 0          | 0        | 0        | 0        | 0          | 0                           | 1.2       | 0.7        | 0        | 0.8        | 1.4        |

| Start Time   | INTER-GARRISON RD Southbound |      |      |            | SHERMAN BLVD Westbound |          |      |            | Northbound |      |      |            | INTER-GARRISON RD Eastbound |           |            |            | Int. Total |
|--|------------------------------|------|------|------------|------------------------|----------|------|------------|------------|------|------|------------|-----------------------------|-----------|------------|------------|------------|
|  | Right                        | Thru | Left | App. Total | Right                  | Thru     | Left | App. Total | Right      | Thru | Left | App. Total | Right                       | Thru      | Left       | App. Total |            |
| Peak Hour Analysis From 04:00 PM to 05:45 PM - Peak 1 of 1 |                              |      |      |            |                        |          |      |            |            |      |      |            |                             |           |            |            |            |
| Peak Hour for Entire Intersection Begins at 04:45 PM       |                              |      |      |            |                        |          |      |            |            |      |      |            |                             |           |            |            |            |
| 04:45 PM   | <b>22</b>                    | 0    | 4    | <b>26</b>  | 4                      | 5        | 0    | 9          | 0          | 0    | 0    | 0          | 0                           | 10        | 76         | 86         | 121        |
| 05:00 PM   | 21                           | 0    | 5    | 26         | <b>5</b>               | <b>9</b> | 0    | <b>14</b>  | 0          | 0    | 0    | 0          | 0                           | 8         | 80         | 88         | 128        |
| 05:15 PM   | 16                           | 0    | 2    | 18         | 2                      | 5        | 0    | 7          | 0          | 0    | 0    | 0          | 0                           | 12        | <b>105</b> | <b>117</b> | <b>142</b> |
| 05:30 PM   | 16                           | 0    | 1    | 17         | 4                      | 2        | 0    | 6          | 0          | 0    | 0    | 0          | 0                           | <b>13</b> | 67         | 80         | 103        |
| Total Volume   | 75                           | 0    | 12   | 87         | 15                     | 21       | 0    | 36         | 0          | 0    | 0    | 0          | 0                           | 43        | 328        | 371        | 494        |
| % App. Total   | 86.2                         | 0    | 13.8 |            | 41.7                   | 58.3     | 0    |            | 0          | 0    | 0    |            | 0                           | 11.6      | 88.4       |            |            |
| PHF  | .852                         | .000 | .600 | .837       | .750                   | .583     | .000 | .643       | .000       | .000 | .000 | .000       | .000                        | .827      | .781       | .793       | .870       |

# Traffic Data Service

San Jose, CA  
 (408) 622-4787  
 tdsbay@cs.com

File Name : 18PM FINAL  
 Site Code : 00000018  
 Start Date : 4/27/2017  
 Page No : 2

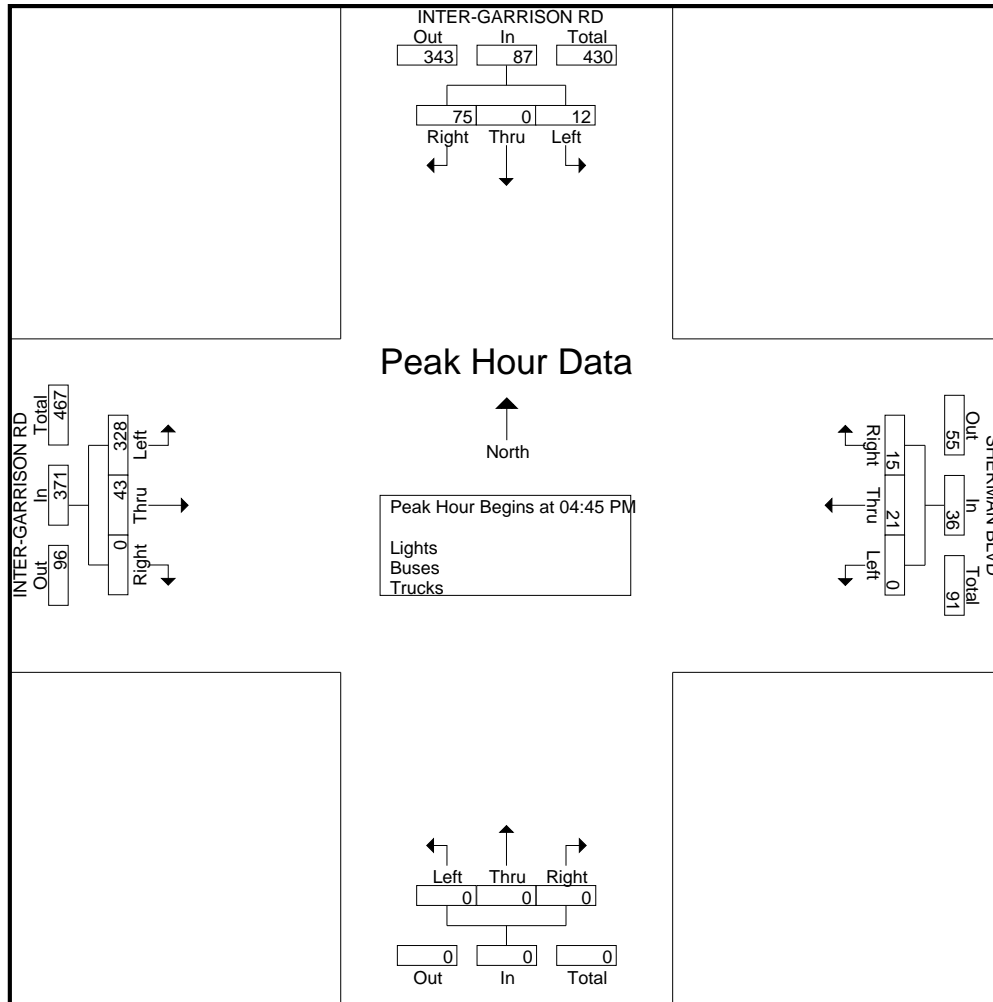

# Traffic Data Service

San Jose, CA  
 (408) 622-4787  
 tdsbay@cs.com

File Name : 18PM FINAL  
 Site Code : 00000018  
 Start Date : 4/27/2017  
 Page No : 1

Groups Printed- Bikes

| Start Time   | INTER-GARRISON RD Southbound |      |      |      |            | SHERMAN BLVD Westbound |      |      |      |            | Northbound |      |      |      |            | INTER-GARRISON RD Eastbound |      |      |      |            | Int. Total |
|--------------|------------------------------|------|------|------|------------|------------------------|------|------|------|------------|------------|------|------|------|------------|-----------------------------|------|------|------|------------|------------|
|              | Right                        | Thru | Left | Peds | App. Total | Right                  | Thru | Left | Peds | App. Total | Right      | Thru | Left | Peds | App. Total | Right                       | Thru | Left | Peds | App. Total |            |
| 04:00 PM     | 0                            | 0    | 0    | 0    | 0          | 0                      | 0    | 0    | 0    | 0          | 0          | 0    | 0    | 0    | 0          | 0                           | 0    | 0    | 0    | 0          | 0          |
| 04:15 PM     | 0                            | 0    | 0    | 1    | 1          | 0                      | 0    | 0    | 0    | 0          | 0          | 0    | 0    | 0    | 0          | 0                           | 0    | 1    | 0    | 1          | 2          |
| 04:30 PM     | 0                            | 0    | 0    | 0    | 0          | 0                      | 0    | 0    | 0    | 0          | 0          | 0    | 0    | 0    | 0          | 0                           | 0    | 0    | 0    | 0          | 0          |
| 04:45 PM     | 0                            | 0    | 0    | 0    | 0          | 0                      | 0    | 0    | 0    | 0          | 0          | 0    | 0    | 0    | 0          | 0                           | 0    | 0    | 0    | 0          | 0          |
| <b>Total</b> | 0                            | 0    | 0    | 1    | 1          | 0                      | 0    | 0    | 0    | 0          | 0          | 0    | 0    | 0    | 0          | 0                           | 0    | 1    | 0    | 1          | 2          |
| 05:00 PM     | 0                            | 0    | 0    | 0    | 0          | 0                      | 0    | 0    | 0    | 0          | 0          | 0    | 0    | 0    | 0          | 0                           | 0    | 0    | 0    | 0          | 0          |
| 05:15 PM     | 0                            | 0    | 0    | 0    | 0          | 0                      | 0    | 0    | 0    | 0          | 0          | 0    | 0    | 0    | 0          | 0                           | 0    | 0    | 0    | 0          | 0          |
| 05:30 PM     | 0                            | 0    | 0    | 0    | 0          | 0                      | 0    | 0    | 0    | 0          | 0          | 0    | 0    | 0    | 0          | 0                           | 0    | 0    | 0    | 0          | 0          |
| 05:45 PM     | 0                            | 0    | 0    | 0    | 0          | 0                      | 0    | 0    | 0    | 0          | 0          | 0    | 0    | 0    | 0          | 0                           | 0    | 0    | 0    | 0          | 0          |
| <b>Total</b> | 0                            | 0    | 0    | 0    | 0          | 0                      | 0    | 0    | 0    | 0          | 0          | 0    | 0    | 0    | 0          | 0                           | 0    | 0    | 0    | 0          | 0          |
| Grand Total  | 0                            | 0    | 0    | 1    | 1          | 0                      | 0    | 0    | 0    | 0          | 0          | 0    | 0    | 0    | 0          | 0                           | 0    | 1    | 0    | 1          | 2          |
| Apprch %     | 0                            | 0    | 0    | 100  |            | 0                      | 0    | 0    | 0    |            | 0          | 0    | 0    | 0    |            | 0                           | 0    | 100  | 0    |            |            |
| Total %      | 0                            | 0    | 0    | 50   | 50         | 0                      | 0    | 0    | 0    | 0          | 0          | 0    | 0    | 0    | 0          | 0                           | 0    | 50   | 0    | 50         |            |

| Start Time   | INTER-GARRISON RD Southbound |      |      |      |            | SHERMAN BLVD Westbound |      |      |      |            | Northbound |      |      |      |            | INTER-GARRISON RD Eastbound |      |      |      |            | Int. Total |
|--|------------------------------|------|------|------|------------|------------------------|------|------|------|------------|------------|------|------|------|------------|-----------------------------|------|------|------|------------|------------|
|  | Right                        | Thru | Left | Peds | App. Total | Right                  | Thru | Left | Peds | App. Total | Right      | Thru | Left | Peds | App. Total | Right                       | Thru | Left | Peds | App. Total |            |
| Peak Hour Analysis From 04:00 PM to 05:45 PM - Peak 1 of 1 |                              |      |      |      |            |                        |      |      |      |            |            |      |      |      |            |                             |      |      |      |            |            |
| Peak Hour for Entire Intersection Begins at 04:00 PM       |                              |      |      |      |            |                        |      |      |      |            |            |      |      |      |            |                             |      |      |      |            |            |
| 04:00 PM   | 0                            | 0    | 0    | 0    | 0          | 0                      | 0    | 0    | 0    | 0          | 0          | 0    | 0    | 0    | 0          | 0                           | 0    | 0    | 0    | 0          | 0          |
| 04:15 PM   | 0                            | 0    | 0    | 0    | 0          | 0                      | 0    | 0    | 0    | 0          | 0          | 0    | 0    | 0    | 0          | 0                           | 0    | 1    | 0    | 1          | 1          |
| 04:30 PM   | 0                            | 0    | 0    | 0    | 0          | 0                      | 0    | 0    | 0    | 0          | 0          | 0    | 0    | 0    | 0          | 0                           | 0    | 0    | 0    | 0          | 0          |
| 04:45 PM   | 0                            | 0    | 0    | 0    | 0          | 0                      | 0    | 0    | 0    | 0          | 0          | 0    | 0    | 0    | 0          | 0                           | 0    | 0    | 0    | 0          | 0          |
| Total Volume   | 0                            | 0    | 0    | 0    | 0          | 0                      | 0    | 0    | 0    | 0          | 0          | 0    | 0    | 0    | 0          | 0                           | 0    | 1    | 0    | 1          | 1          |
| % App. Total   | 0                            | 0    | 0    | 0    |            | 0                      | 0    | 0    | 0    |            | 0          | 0    | 0    | 0    |            | 0                           | 0    | 100  | 0    |            |            |
| PHF  | .000                         | .000 | .000 | .000 | .000       | .000                   | .000 | .000 | .000 | .000       | .000       | .000 | .000 | .000 | .000       | .000                        | .000 | .250 | .250 | .250       | .250       |

# Traffic Data Service

San Jose, CA  
(408) 622-4787  
tdsbay@cs.com

File Name : 18PM FINAL  
Site Code : 00000018  
Start Date : 4/27/2017  
Page No : 2

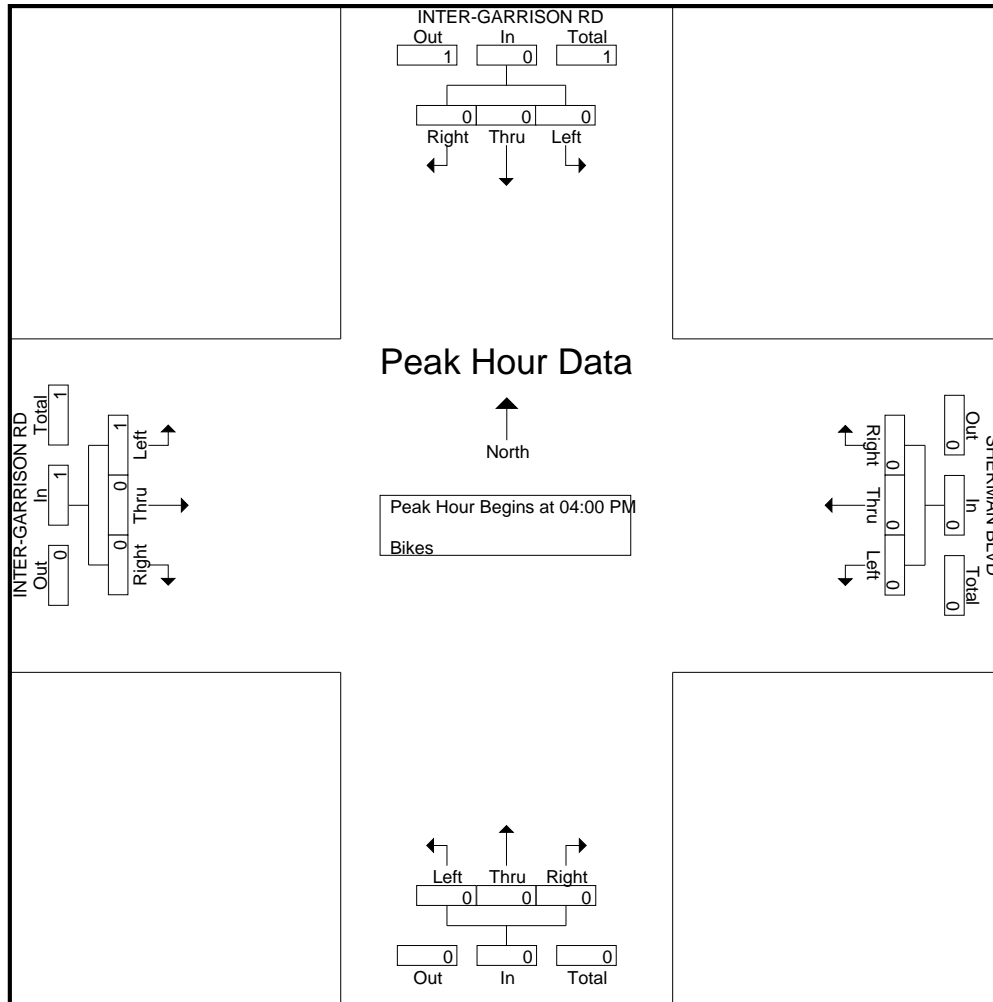



# Traffic Data Service

San Jose, CA  
 (408) 622-4787  
 tdsbay@cs.com

File Name : 19AM FINAL  
 Site Code : 00000019  
 Start Date : 4/27/2017  
 Page No : 1

Groups Printed- Lights - Buses - Trucks

| Start Time   | Southbound |      |      |      |            | RESERVATION RD<br>Westbound |      |      |      |            | INTER-GARRISON RD<br>Northbound |      |      |      |            | RESERVATION RD<br>Eastbound |      |      |      |            | Int. Total |
|--------------|------------|------|------|------|------------|-----------------------------|------|------|------|------------|---------------------------------|------|------|------|------------|-----------------------------|------|------|------|------------|------------|
|              | Right      | Thru | Left | Peds | App. Total | Right                       | Thru | Left | Peds | App. Total | Right                           | Thru | Left | Peds | App. Total | Right                       | Thru | Left | Peds | App. Total |            |
| 07:00 AM     | 0          | 0    | 0    | 0    | 0          | 0                           | 112  | 102  | 0    | 214        | 18                              | 0    | 17   | 0    | 35         | 10                          | 37   | 0    | 0    | 47         | 296        |
| 07:15 AM     | 0          | 0    | 0    | 0    | 0          | 0                           | 105  | 116  | 0    | 221        | 20                              | 0    | 8    | 0    | 28         | 12                          | 46   | 0    | 0    | 58         | 307        |
| 07:30 AM     | 0          | 0    | 0    | 0    | 0          | 0                           | 75   | 89   | 0    | 164        | 24                              | 0    | 17   | 0    | 41         | 8                           | 69   | 0    | 0    | 77         | 282        |
| 07:45 AM     | 0          | 0    | 0    | 0    | 0          | 0                           | 79   | 66   | 0    | 145        | 28                              | 0    | 11   | 0    | 39         | 10                          | 80   | 0    | 0    | 90         | 274        |
| <b>Total</b> | 0          | 0    | 0    | 0    | 0          | 0                           | 371  | 373  | 0    | 744        | 90                              | 0    | 53   | 0    | 143        | 40                          | 232  | 0    | 0    | 272        | 1159       |
| 08:00 AM     | 0          | 0    | 0    | 0    | 0          | 0                           | 81   | 57   | 0    | 138        | 13                              | 0    | 11   | 0    | 24         | 15                          | 51   | 0    | 0    | 66         | 228        |
| 08:15 AM     | 0          | 0    | 0    | 0    | 0          | 0                           | 86   | 50   | 0    | 136        | 9                               | 0    | 10   | 0    | 19         | 7                           | 67   | 0    | 0    | 74         | 229        |
| 08:30 AM     | 0          | 0    | 0    | 0    | 0          | 0                           | 66   | 42   | 0    | 108        | 9                               | 0    | 5    | 0    | 14         | 4                           | 44   | 0    | 0    | 48         | 170        |
| 08:45 AM     | 0          | 0    | 0    | 0    | 0          | 0                           | 58   | 33   | 0    | 91         | 7                               | 0    | 10   | 0    | 17         | 7                           | 47   | 1    | 0    | 55         | 163        |
| <b>Total</b> | 0          | 0    | 0    | 0    | 0          | 0                           | 291  | 182  | 0    | 473        | 38                              | 0    | 36   | 0    | 74         | 33                          | 209  | 1    | 0    | 243        | 790        |
| Grand Total  | 0          | 0    | 0    | 0    | 0          | 0                           | 662  | 555  | 0    | 1217       | 128                             | 0    | 89   | 0    | 217        | 73                          | 441  | 1    | 0    | 515        | 1949       |
| Apprch %     | 0          | 0    | 0    | 0    | 0          | 0                           | 54.4 | 45.6 | 0    |            | 59                              | 0    | 41   | 0    |            | 14.2                        | 85.6 | 0.2  | 0    |            |            |
| Total %      | 0          | 0    | 0    | 0    | 0          | 0                           | 34   | 28.5 | 0    | 62.4       | 6.6                             | 0    | 4.6  | 0    | 11.1       | 3.7                         | 22.6 | 0.1  | 0    | 26.4       |            |
| Lights       | 0          | 0    | 0    | 0    | 0          | 0                           | 634  | 554  | 0    | 1188       | 125                             | 0    | 88   | 0    | 213        | 71                          | 417  | 1    | 0    | 489        | 1890       |
| % Lights     | 0          | 0    | 0    | 0    | 0          | 0                           | 95.8 | 99.8 | 0    | 97.6       | 97.7                            | 0    | 98.9 | 0    | 98.2       | 97.3                        | 94.6 | 100  | 0    | 95         | 97         |
| Buses        | 0          | 0    | 0    | 0    | 0          | 0                           | 3    | 1    | 0    | 4          | 1                               | 0    | 0    | 0    | 1          | 1                           | 4    | 0    | 0    | 5          | 10         |
| % Buses      | 0          | 0    | 0    | 0    | 0          | 0                           | 0.5  | 0.2  | 0    | 0.3        | 0.8                             | 0    | 0    | 0    | 0.5        | 1.4                         | 0.9  | 0    | 0    | 1          | 0.5        |
| Trucks       | 0          | 0    | 0    | 0    | 0          | 0                           | 25   | 0    | 0    | 25         | 2                               | 0    | 1    | 0    | 3          | 1                           | 20   | 0    | 0    | 21         | 49         |
| % Trucks     | 0          | 0    | 0    | 0    | 0          | 0                           | 3.8  | 0    | 0    | 2.1        | 1.6                             | 0    | 1.1  | 0    | 1.4        | 1.4                         | 4.5  | 0    | 0    | 4.1        | 2.5        |

| Start Time   | Southbound |      |      |            | RESERVATION RD<br>Westbound |      |      |            | INTER-GARRISON RD<br>Northbound |      |      |            | RESERVATION RD<br>Eastbound |      |      |            | Int. Total |
|--|------------|------|------|------------|-----------------------------|------|------|------------|---------------------------------|------|------|------------|-----------------------------|------|------|------------|------------|
|  | Right      | Thru | Left | App. Total | Right                       | Thru | Left | App. Total | Right                           | Thru | Left | App. Total | Right                       | Thru | Left | App. Total |            |
| Peak Hour Analysis From 07:00 AM to 08:45 AM - Peak 1 of 1 |            |      |      |            |                             |      |      |            |                                 |      |      |            |                             |      |      |            |            |
| Peak Hour for Entire Intersection Begins at 07:00 AM       |            |      |      |            |                             |      |      |            |                                 |      |      |            |                             |      |      |            |            |
| 07:00 AM   | 0          | 0    | 0    | 0          | 0                           | 112  | 102  | 214        | 18                              | 0    | 17   | 35         | 10                          | 37   | 0    | 47         | 296        |
| 07:15 AM   | 0          | 0    | 0    | 0          | 0                           | 105  | 116  | 221        | 20                              | 0    | 8    | 28         | 12                          | 46   | 0    | 58         | 307        |
| 07:30 AM   | 0          | 0    | 0    | 0          | 0                           | 75   | 89   | 164        | 24                              | 0    | 17   | 41         | 8                           | 69   | 0    | 77         | 282        |
| 07:45 AM   | 0          | 0    | 0    | 0          | 0                           | 79   | 66   | 145        | 28                              | 0    | 11   | 39         | 10                          | 80   | 0    | 90         | 274        |
| Total Volume   | 0          | 0    | 0    | 0          | 0                           | 371  | 373  | 744        | 90                              | 0    | 53   | 143        | 40                          | 232  | 0    | 272        | 1159       |
| % App. Total   | 0          | 0    | 0    | 0          | 0                           | 49.9 | 50.1 |            | 62.9                            | 0    | 37.1 |            | 14.7                        | 85.3 | 0    |            |            |
| PHF  | .000       | .000 | .000 | .000       | .000                        | .828 | .804 | .842       | .804                            | .000 | .779 | .872       | .833                        | .725 | .000 | .756       | .944       |

# Traffic Data Service

San Jose, CA  
 (408) 622-4787  
 tdsbay@cs.com

File Name : 19AM FINAL  
 Site Code : 00000019  
 Start Date : 4/27/2017  
 Page No : 2

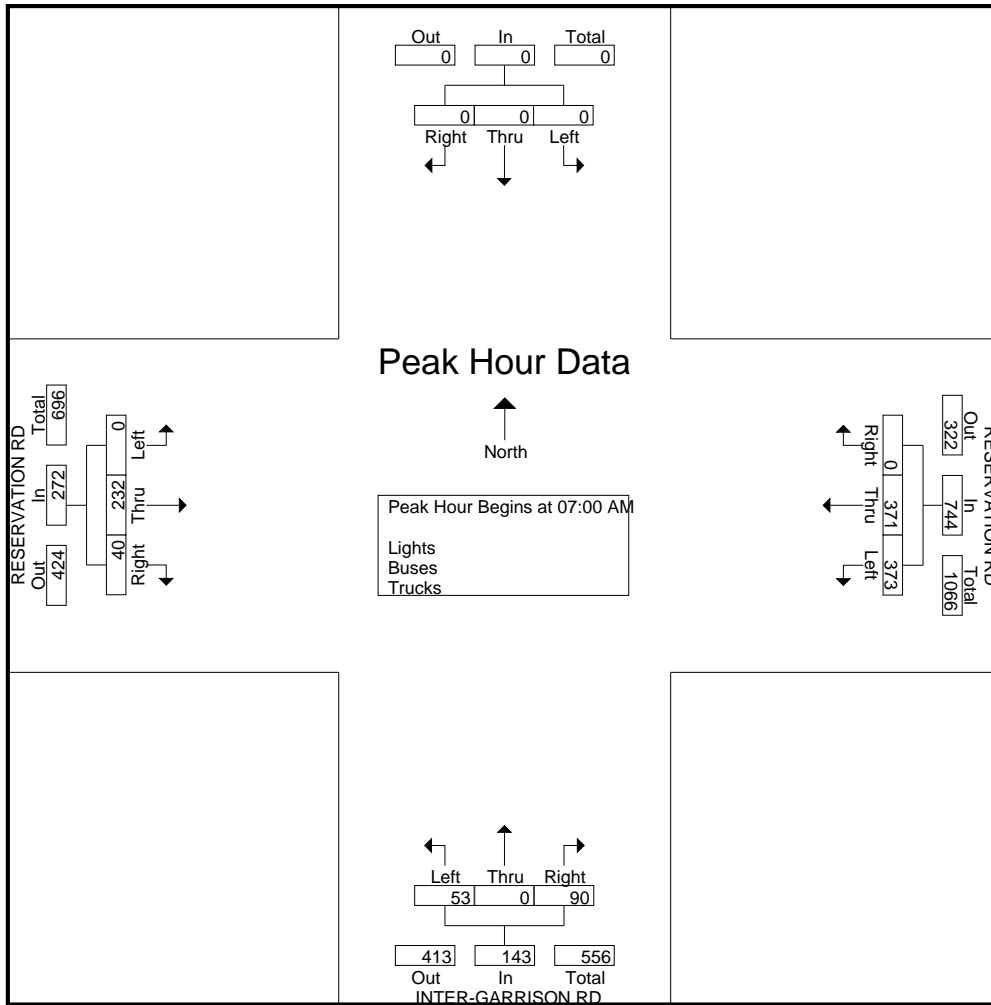

# Traffic Data Service

San Jose, CA  
(408) 622-4787  
tdsbay@cs.com

File Name : 19AM FINAL  
Site Code : 00000019  
Start Date : 4/27/2017  
Page No : 1

Groups Printed- Bikes

| Start Time   | Southbound |      |      |      |            | RESERVATION RD Westbound |      |      |      |            | INTER-GARRISON RD Northbound |      |      |      |            | RESERVATION RD Eastbound |      |      |      |            | Int. Total |
|--------------|------------|------|------|------|------------|--------------------------|------|------|------|------------|------------------------------|------|------|------|------------|--------------------------|------|------|------|------------|------------|
|              | Right      | Thru | Left | Peds | App. Total | Right                    | Thru | Left | Peds | App. Total | Right                        | Thru | Left | Peds | App. Total | Right                    | Thru | Left | Peds | App. Total |            |
| 07:00 AM     | 0          | 0    | 0    | 0    | 0          | 0                        | 0    | 1    | 0    | 1          | 0                            | 0    | 0    | 0    | 0          | 0                        | 0    | 0    | 0    | 0          | 0          |
| 07:15 AM     | 0          | 0    | 0    | 0    | 0          | 0                        | 0    | 0    | 0    | 0          | 0                            | 0    | 0    | 0    | 0          | 0                        | 0    | 0    | 0    | 0          | 0          |
| 07:30 AM     | 0          | 0    | 0    | 0    | 0          | 0                        | 0    | 0    | 0    | 0          | 0                            | 0    | 0    | 0    | 0          | 0                        | 0    | 0    | 0    | 0          | 0          |
| 07:45 AM     | 0          | 0    | 0    | 0    | 0          | 0                        | 0    | 0    | 0    | 0          | 0                            | 0    | 0    | 0    | 0          | 0                        | 0    | 0    | 0    | 0          | 0          |
| <b>Total</b> | 0          | 0    | 0    | 0    | 0          | 0                        | 0    | 1    | 0    | 1          | 0                            | 0    | 0    | 0    | 0          | 0                        | 0    | 0    | 0    | 0          | 1          |
| 08:00 AM     | 0          | 0    | 0    | 0    | 0          | 0                        | 0    | 0    | 0    | 0          | 0                            | 0    | 0    | 0    | 0          | 0                        | 0    | 0    | 0    | 0          | 0          |
| 08:15 AM     | 0          | 0    | 0    | 0    | 0          | 0                        | 0    | 0    | 0    | 0          | 0                            | 0    | 0    | 0    | 0          | 0                        | 0    | 0    | 0    | 0          | 0          |
| 08:30 AM     | 0          | 0    | 0    | 0    | 0          | 0                        | 0    | 0    | 0    | 0          | 0                            | 0    | 0    | 0    | 0          | 0                        | 0    | 0    | 0    | 0          | 0          |
| 08:45 AM     | 0          | 0    | 0    | 0    | 0          | 0                        | 0    | 0    | 0    | 0          | 0                            | 0    | 0    | 0    | 0          | 0                        | 0    | 0    | 0    | 0          | 0          |
| <b>Total</b> | 0          | 0    | 0    | 0    | 0          | 0                        | 0    | 0    | 0    | 0          | 0                            | 0    | 0    | 0    | 0          | 0                        | 0    | 0    | 0    | 0          | 0          |
| Grand Total  | 0          | 0    | 0    | 0    | 0          | 0                        | 0    | 1    | 0    | 1          | 0                            | 0    | 0    | 0    | 0          | 0                        | 0    | 0    | 0    | 0          | 1          |
| Apprch %     | 0          | 0    | 0    | 0    |            | 0                        | 0    | 100  | 0    |            | 0                            | 0    | 0    | 0    |            | 0                        | 0    | 0    | 0    |            |            |
| Total %      | 0          | 0    | 0    | 0    |            | 0                        | 0    | 100  | 0    | 100        | 0                            | 0    | 0    | 0    |            | 0                        | 0    | 0    | 0    |            |            |

| Start Time   | Southbound |      |      |      |            | RESERVATION RD Westbound |      |      |      |            | INTER-GARRISON RD Northbound |      |      |      |            | RESERVATION RD Eastbound |      |      |      |            | Int. Total |
|--|------------|------|------|------|------------|--------------------------|------|------|------|------------|------------------------------|------|------|------|------------|--------------------------|------|------|------|------------|------------|
|  | Right      | Thru | Left | Peds | App. Total | Right                    | Thru | Left | Peds | App. Total | Right                        | Thru | Left | Peds | App. Total | Right                    | Thru | Left | Peds | App. Total |            |
| Peak Hour Analysis From 07:00 AM to 08:45 AM - Peak 1 of 1 |            |      |      |      |            |                          |      |      |      |            |                              |      |      |      |            |                          |      |      |      |            |            |
| Peak Hour for Entire Intersection Begins at 07:00 AM       |            |      |      |      |            |                          |      |      |      |            |                              |      |      |      |            |                          |      |      |      |            |            |
| 07:00 AM   | 0          | 0    | 0    | 0    | 0          | 0                        | 0    | 1    | 0    | 1          | 0                            | 0    | 0    | 0    | 0          | 0                        | 0    | 0    | 0    | 0          | 1          |
| 07:15 AM   | 0          | 0    | 0    | 0    | 0          | 0                        | 0    | 0    | 0    | 0          | 0                            | 0    | 0    | 0    | 0          | 0                        | 0    | 0    | 0    | 0          | 0          |
| 07:30 AM   | 0          | 0    | 0    | 0    | 0          | 0                        | 0    | 0    | 0    | 0          | 0                            | 0    | 0    | 0    | 0          | 0                        | 0    | 0    | 0    | 0          | 0          |
| 07:45 AM   | 0          | 0    | 0    | 0    | 0          | 0                        | 0    | 0    | 0    | 0          | 0                            | 0    | 0    | 0    | 0          | 0                        | 0    | 0    | 0    | 0          | 0          |
| Total Volume   | 0          | 0    | 0    | 0    | 0          | 0                        | 0    | 1    | 0    | 1          | 0                            | 0    | 0    | 0    | 0          | 0                        | 0    | 0    | 0    | 0          | 1          |
| % App. Total   | 0          | 0    | 0    | 0    |            | 0                        | 0    | 100  | 0    |            | 0                            | 0    | 0    | 0    |            | 0                        | 0    | 0    | 0    |            |            |
| PHF  | .000       | .000 | .000 | .000 | .000       | .000                     | .000 | .250 | .250 | .250       | .000                         | .000 | .000 | .000 | .000       | .000                     | .000 | .000 | .000 | .000       | .250       |

# Traffic Data Service

San Jose, CA  
(408) 622-4787  
tdsbay@cs.com

File Name : 19AM FINAL  
Site Code : 00000019  
Start Date : 4/27/2017  
Page No : 2

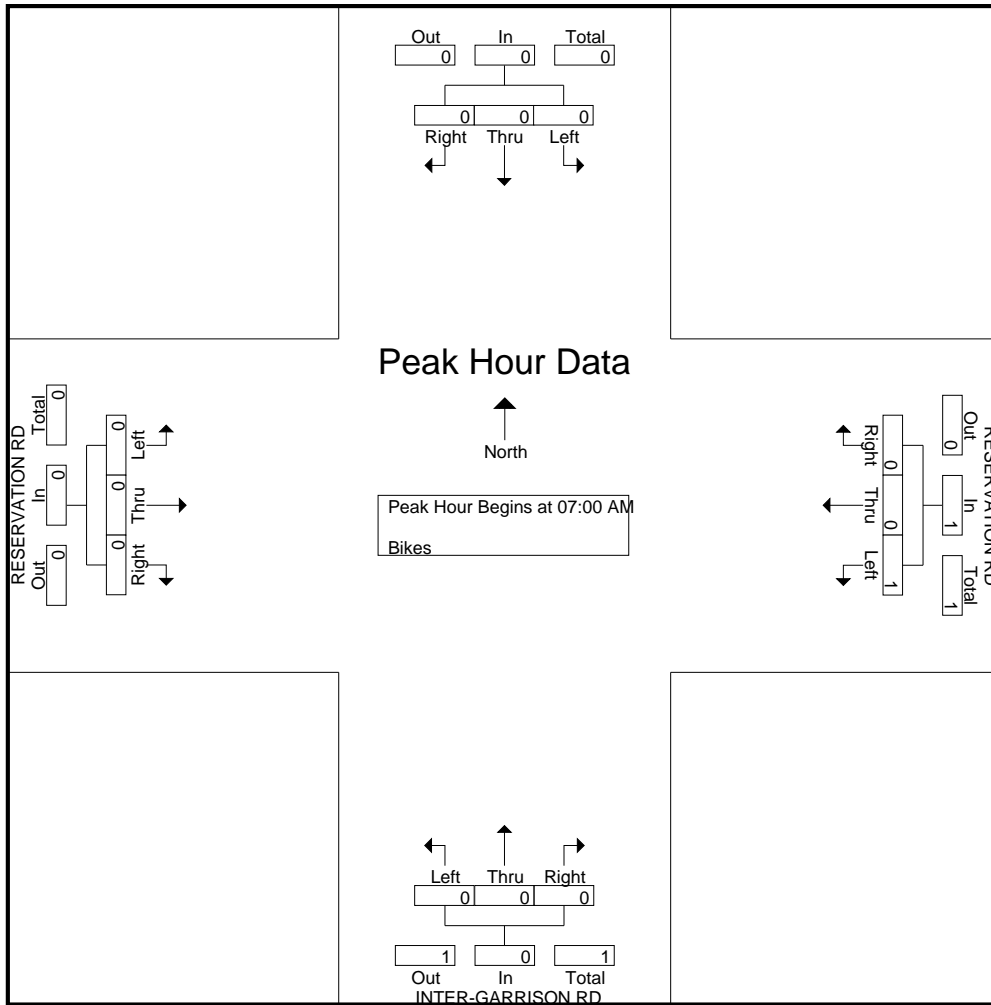

# Traffic Data Service

San Jose, CA  
 (408) 622-4787  
 tdsbay@cs.com

File Name : 19PM FINAL  
 Site Code : 00000019  
 Start Date : 4/27/2017  
 Page No : 1

Groups Printed- Lights - Buses - Trucks

| Start Time  | Southbound |      |      |      |            | RESERVATION RD<br>Westbound |      |      |      |            | INTER-GARRISON RD<br>Northbound |      |      |      |            | RESERVATION RD<br>Eastbound |      |      |      |            | Int. Total |
|-------------|------------|------|------|------|------------|-----------------------------|------|------|------|------------|---------------------------------|------|------|------|------------|-----------------------------|------|------|------|------------|------------|
|             | Right      | Thru | Left | Peds | App. Total | Right                       | Thru | Left | Peds | App. Total | Right                           | Thru | Left | Peds | App. Total | Right                       | Thru | Left | Peds | App. Total |            |
| 04:00 PM    | 0          | 0    | 0    | 0    | 0          | 0                           | 47   | 10   | 0    | 57         | 52                              | 0    | 5    | 0    | 57         | 14                          | 87   | 0    | 0    | 101        | 215        |
| 04:15 PM    | 0          | 0    | 0    | 0    | 0          | 0                           | 63   | 16   | 0    | 79         | 53                              | 0    | 8    | 0    | 61         | 13                          | 117  | 0    | 0    | 130        | 270        |
| 04:30 PM    | 0          | 0    | 0    | 0    | 0          | 0                           | 85   | 18   | 0    | 103        | 58                              | 0    | 10   | 0    | 68         | 10                          | 105  | 0    | 0    | 115        | 286        |
| 04:45 PM    | 0          | 0    | 0    | 0    | 0          | 0                           | 69   | 23   | 0    | 92         | 75                              | 0    | 6    | 0    | 81         | 10                          | 90   | 0    | 0    | 100        | 273        |
| Total       | 0          | 0    | 0    | 0    | 0          | 0                           | 264  | 67   | 0    | 331        | 238                             | 0    | 29   | 0    | 267        | 47                          | 399  | 0    | 0    | 446        | 1044       |
| 05:00 PM    | 0          | 0    | 0    | 0    | 0          | 0                           | 75   | 20   | 0    | 95         | 70                              | 0    | 16   | 0    | 86         | 12                          | 104  | 0    | 0    | 116        | 297        |
| 05:15 PM    | 0          | 0    | 0    | 0    | 0          | 0                           | 98   | 17   | 0    | 115        | 98                              | 0    | 13   | 0    | 111        | 13                          | 134  | 0    | 0    | 147        | 373        |
| 05:30 PM    | 0          | 0    | 0    | 0    | 0          | 0                           | 62   | 15   | 0    | 77         | 73                              | 0    | 12   | 0    | 85         | 13                          | 94   | 0    | 0    | 107        | 269        |
| 05:45 PM    | 0          | 0    | 0    | 0    | 0          | 0                           | 42   | 14   | 0    | 56         | 55                              | 0    | 9    | 0    | 64         | 11                          | 114  | 0    | 0    | 125        | 245        |
| Total       | 0          | 0    | 0    | 0    | 0          | 0                           | 277  | 66   | 0    | 343        | 296                             | 0    | 50   | 0    | 346        | 49                          | 446  | 0    | 0    | 495        | 1184       |
| Grand Total | 0          | 0    | 0    | 0    | 0          | 0                           | 541  | 133  | 0    | 674        | 534                             | 0    | 79   | 0    | 613        | 96                          | 845  | 0    | 0    | 941        | 2228       |
| Apprch %    | 0          | 0    | 0    | 0    | 0          | 0                           | 80.3 | 19.7 | 0    |            | 87.1                            | 0    | 12.9 | 0    |            | 10.2                        | 89.8 | 0    | 0    |            |            |
| Total %     | 0          | 0    | 0    | 0    | 0          | 0                           | 24.3 | 6    | 0    | 30.3       | 24                              | 0    | 3.5  | 0    | 27.5       | 4.3                         | 37.9 | 0    | 0    | 42.2       |            |
| Lights      | 0          | 0    | 0    | 0    | 0          | 0                           | 527  | 128  | 0    | 655        | 529                             | 0    | 78   | 0    | 607        | 95                          | 830  | 0    | 0    | 925        | 2187       |
| % Lights    | 0          | 0    | 0    | 0    | 0          | 0                           | 97.4 | 96.2 | 0    | 97.2       | 99.1                            | 0    | 98.7 | 0    | 99         | 99                          | 98.2 | 0    | 0    | 98.3       | 98.2       |
| Buses       | 0          | 0    | 0    | 0    | 0          | 0                           | 1    | 1    | 0    | 2          | 1                               | 0    | 1    | 0    | 2          | 0                           | 3    | 0    | 0    | 3          | 7          |
| % Buses     | 0          | 0    | 0    | 0    | 0          | 0                           | 0.2  | 0.8  | 0    | 0.3        | 0.2                             | 0    | 1.3  | 0    | 0.3        | 0                           | 0.4  | 0    | 0    | 0.3        | 0.3        |
| Trucks      | 0          | 0    | 0    | 0    | 0          | 0                           | 13   | 4    | 0    | 17         | 4                               | 0    | 0    | 0    | 4          | 1                           | 12   | 0    | 0    | 13         | 34         |
| % Trucks    | 0          | 0    | 0    | 0    | 0          | 0                           | 2.4  | 3    | 0    | 2.5        | 0.7                             | 0    | 0    | 0    | 0.7        | 1                           | 1.4  | 0    | 0    | 1.4        | 1.5        |

| Start Time   | Southbound |      |      |            | RESERVATION RD<br>Westbound |      |      |            | INTER-GARRISON RD<br>Northbound |      |      |            | RESERVATION RD<br>Eastbound |      |      |            | Int. Total |
|--|------------|------|------|------------|-----------------------------|------|------|------------|---------------------------------|------|------|------------|-----------------------------|------|------|------------|------------|
|  | Right      | Thru | Left | App. Total | Right                       | Thru | Left | App. Total | Right                           | Thru | Left | App. Total | Right                       | Thru | Left | App. Total |            |
| Peak Hour Analysis From 04:00 PM to 05:45 PM - Peak 1 of 1 |            |      |      |            |                             |      |      |            |                                 |      |      |            |                             |      |      |            |            |
| Peak Hour for Entire Intersection Begins at 04:30 PM       |            |      |      |            |                             |      |      |            |                                 |      |      |            |                             |      |      |            |            |
| 04:30 PM   | 0          | 0    | 0    | 0          | 0                           | 85   | 18   | 103        | 58                              | 0    | 10   | 68         | 10                          | 105  | 0    | 115        | 286        |
| 04:45 PM   | 0          | 0    | 0    | 0          | 0                           | 69   | 23   | 92         | 75                              | 0    | 6    | 81         | 10                          | 90   | 0    | 100        | 273        |
| 05:00 PM   | 0          | 0    | 0    | 0          | 0                           | 75   | 20   | 95         | 70                              | 0    | 16   | 86         | 12                          | 104  | 0    | 116        | 297        |
| 05:15 PM   | 0          | 0    | 0    | 0          | 0                           | 98   | 17   | 115        | 98                              | 0    | 13   | 111        | 13                          | 134  | 0    | 147        | 373        |
| Total Volume   | 0          | 0    | 0    | 0          | 0                           | 327  | 78   | 405        | 301                             | 0    | 45   | 346        | 45                          | 433  | 0    | 478        | 1229       |
| % App. Total   | 0          | 0    | 0    | 0          | 0                           | 80.7 | 19.3 |            | 87                              | 0    | 13   |            | 9.4                         | 90.6 | 0    |            |            |
| PHF  | .000       | .000 | .000 | .000       | .000                        | .834 | .848 | .880       | .768                            | .000 | .703 | .779       | .865                        | .808 | .000 | .813       | .824       |

# Traffic Data Service

San Jose, CA  
 (408) 622-4787  
 tdsbay@cs.com

File Name : 19PM FINAL  
 Site Code : 00000019  
 Start Date : 4/27/2017  
 Page No : 2

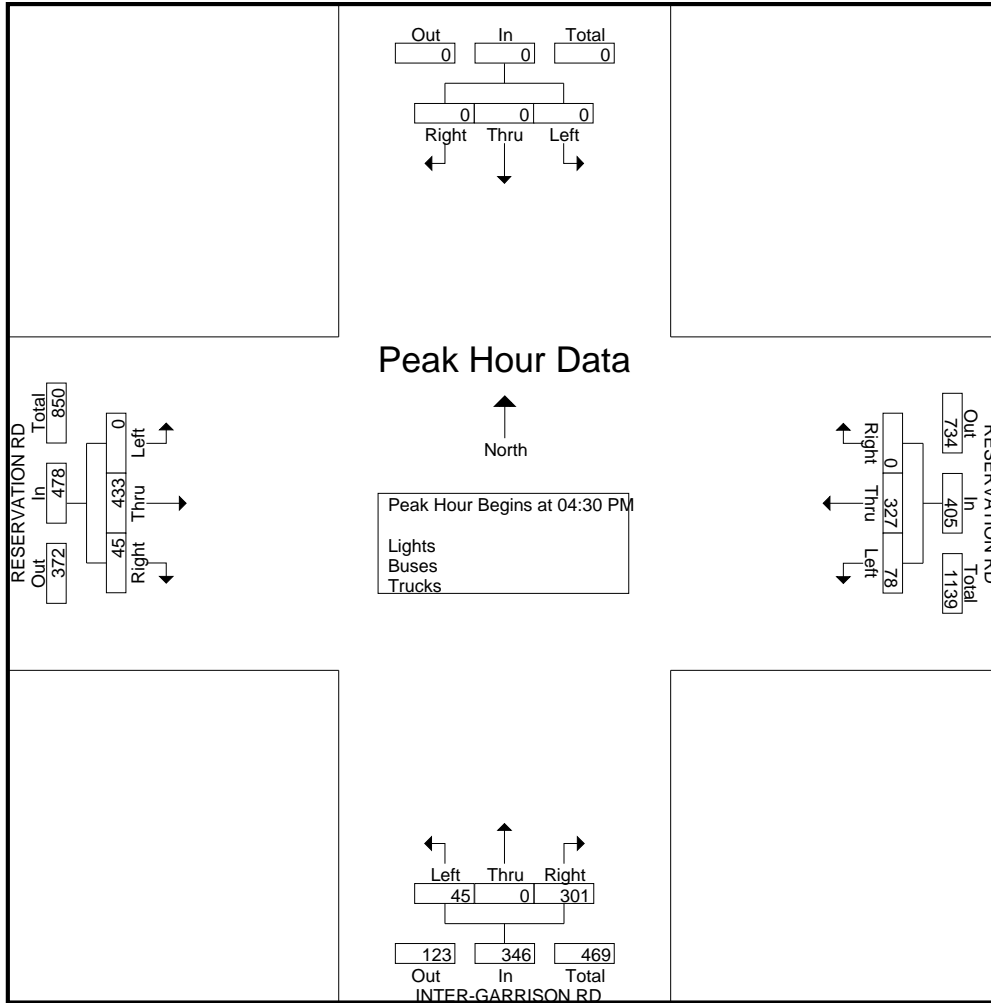

# Traffic Data Service

San Jose, CA  
 (408) 622-4787  
 tdsbay@cs.com

File Name : 19PM FINAL  
 Site Code : 00000019  
 Start Date : 4/27/2017  
 Page No : 1

Groups Printed- Bikes

| Start Time  | Southbound |      |      |      |            | RESERVATION RD Westbound |      |      |      |            | INTER-GARRISON RD Northbound |      |      |      |            | RESERVATION RD Eastbound |      |      |      |            | Int. Total |
|-------------|------------|------|------|------|------------|--------------------------|------|------|------|------------|------------------------------|------|------|------|------------|--------------------------|------|------|------|------------|------------|
|             | Right      | Thru | Left | Peds | App. Total | Right                    | Thru | Left | Peds | App. Total | Right                        | Thru | Left | Peds | App. Total | Right                    | Thru | Left | Peds | App. Total |            |
| 04:00 PM    | 0          | 0    | 0    | 0    | 0          | 0                        | 0    | 0    | 0    | 0          | 0                            | 0    | 0    | 0    | 0          | 0                        | 0    | 0    | 0    | 0          | 0          |
| 04:15 PM    | 0          | 0    | 0    | 0    | 0          | 0                        | 0    | 1    | 0    | 1          | 0                            | 0    | 0    | 0    | 0          | 0                        | 0    | 0    | 0    | 0          | 1          |
| 04:30 PM    | 0          | 0    | 0    | 0    | 0          | 0                        | 0    | 0    | 0    | 0          | 0                            | 0    | 0    | 0    | 0          | 0                        | 0    | 0    | 0    | 0          | 0          |
| 04:45 PM    | 0          | 0    | 0    | 0    | 0          | 0                        | 0    | 0    | 0    | 0          | 0                            | 0    | 0    | 0    | 0          | 0                        | 0    | 0    | 0    | 0          | 0          |
| Total       | 0          | 0    | 0    | 0    | 0          | 0                        | 0    | 1    | 0    | 1          | 0                            | 0    | 0    | 0    | 0          | 0                        | 0    | 0    | 0    | 0          | 1          |
| 05:00 PM    | 0          | 0    | 0    | 0    | 0          | 0                        | 0    | 0    | 0    | 0          | 0                            | 0    | 0    | 0    | 0          | 0                        | 0    | 0    | 0    | 0          | 0          |
| 05:15 PM    | 0          | 0    | 0    | 0    | 0          | 0                        | 0    | 0    | 0    | 0          | 0                            | 0    | 0    | 0    | 0          | 0                        | 0    | 0    | 0    | 0          | 0          |
| 05:30 PM    | 0          | 0    | 0    | 0    | 0          | 0                        | 0    | 0    | 0    | 0          | 0                            | 0    | 0    | 0    | 0          | 0                        | 0    | 0    | 0    | 0          | 0          |
| 05:45 PM    | 0          | 0    | 0    | 0    | 0          | 0                        | 0    | 0    | 0    | 0          | 0                            | 0    | 0    | 0    | 0          | 0                        | 0    | 0    | 0    | 0          | 0          |
| Total       | 0          | 0    | 0    | 0    | 0          | 0                        | 0    | 0    | 0    | 0          | 0                            | 0    | 0    | 0    | 0          | 0                        | 0    | 0    | 0    | 0          | 0          |
| Grand Total | 0          | 0    | 0    | 0    | 0          | 0                        | 0    | 1    | 0    | 1          | 0                            | 0    | 0    | 0    | 0          | 0                        | 0    | 0    | 0    | 0          | 1          |
| Apprch %    | 0          | 0    | 0    | 0    |            | 0                        | 0    | 100  | 0    |            | 0                            | 0    | 0    | 0    |            | 0                        | 0    | 0    | 0    |            |            |
| Total %     | 0          | 0    | 0    | 0    |            | 0                        | 0    | 100  | 0    | 100        | 0                            | 0    | 0    | 0    |            | 0                        | 0    | 0    | 0    |            |            |

| Start Time   | Southbound |      |      |            | RESERVATION RD Westbound |      |      |            | INTER-GARRISON RD Northbound |      |      |            | RESERVATION RD Eastbound |      |      |            | Int. Total |
|--|------------|------|------|------------|--------------------------|------|------|------------|------------------------------|------|------|------------|--------------------------|------|------|------------|------------|
|  | Right      | Thru | Left | App. Total | Right                    | Thru | Left | App. Total | Right                        | Thru | Left | App. Total | Right                    | Thru | Left | App. Total |            |
| Peak Hour Analysis From 04:00 PM to 05:45 PM - Peak 1 of 1 |            |      |      |            |                          |      |      |            |                              |      |      |            |                          |      |      |            |            |
| Peak Hour for Entire Intersection Begins at 04:00 PM       |            |      |      |            |                          |      |      |            |                              |      |      |            |                          |      |      |            |            |
| 04:00 PM   | 0          | 0    | 0    | 0          | 0                        | 0    | 0    | 0          | 0                            | 0    | 0    | 0          | 0                        | 0    | 0    | 0          | 0          |
| 04:15 PM   | 0          | 0    | 0    | 0          | 0                        | 0    | 1    | 1          | 0                            | 0    | 0    | 0          | 0                        | 0    | 0    | 0          | 1          |
| 04:30 PM   | 0          | 0    | 0    | 0          | 0                        | 0    | 0    | 0          | 0                            | 0    | 0    | 0          | 0                        | 0    | 0    | 0          | 0          |
| 04:45 PM   | 0          | 0    | 0    | 0          | 0                        | 0    | 0    | 0          | 0                            | 0    | 0    | 0          | 0                        | 0    | 0    | 0          | 0          |
| Total Volume   | 0          | 0    | 0    | 0          | 0                        | 0    | 1    | 1          | 0                            | 0    | 0    | 0          | 0                        | 0    | 0    | 0          | 1          |
| % App. Total   | 0          | 0    | 0    |            | 0                        | 0    | 100  |            | 0                            | 0    | 0    |            | 0                        | 0    | 0    |            |            |
| PHF  | .000       | .000 | .000 | .000       | .000                     | .000 | .250 | .250       | .000                         | .000 | .000 | .000       | .000                     | .000 | .000 | .000       | .250       |

# Traffic Data Service

San Jose, CA  
 (408) 622-4787  
 tdsbay@cs.com

File Name : 19PM FINAL  
 Site Code : 00000019  
 Start Date : 4/27/2017  
 Page No : 2

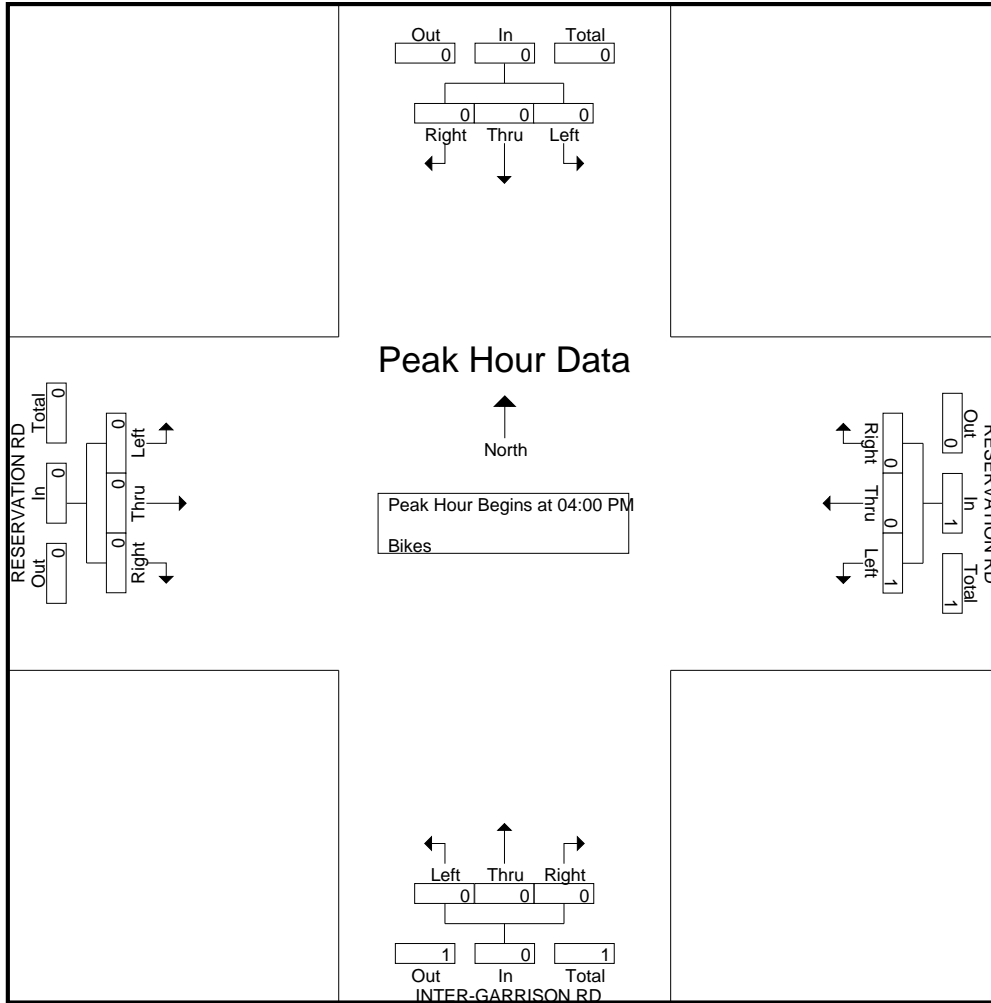



# Traffic Data Service

San Jose, CA  
 (408) 622-4787  
 tdsbay@cs.com

File Name : 20AM FINAL  
 Site Code : 00000020  
 Start Date : 4/27/2017  
 Page No : 1

Groups Printed- Lights - Buses - Trucks

| Start Time  | 2ND AVE Southbound |      |      |      |            | DIVARTY ST Westbound |      |      |      |            | 2ND AVE Northbound |      |      |      |            | DIVARTY ST Eastbound |      |      |      |            | Int. Total |
|-------------|--------------------|------|------|------|------------|----------------------|------|------|------|------------|--------------------|------|------|------|------------|----------------------|------|------|------|------------|------------|
|             | Right              | Thru | Left | Peds | App. Total | Right                | Thru | Left | Peds | App. Total | Right              | Thru | Left | Peds | App. Total | Right                | Thru | Left | Peds | App. Total |            |
| 07:00 AM    | 0                  | 60   | 1    | 0    | 61         | 0                    | 0    | 0    | 0    | 0          | 0                  | 13   | 2    | 0    | 15         | 0                    | 0    | 0    | 0    | 0          | 76         |
| 07:15 AM    | 1                  | 149  | 3    | 1    | 154        | 0                    | 1    | 2    | 0    | 3          | 0                  | 10   | 2    | 0    | 12         | 1                    | 0    | 0    | 1    | 2          | 171        |
| 07:30 AM    | 1                  | 176  | 5    | 0    | 182        | 1                    | 0    | 2    | 0    | 3          | 5                  | 32   | 1    | 0    | 38         | 0                    | 3    | 1    | 1    | 5          | 228        |
| 07:45 AM    | 6                  | 159  | 6    | 0    | 171        | 1                    | 0    | 3    | 0    | 4          | 6                  | 33   | 10   | 0    | 49         | 0                    | 1    | 0    | 0    | 1          | 225        |
| Total       | 8                  | 544  | 15   | 1    | 568        | 2                    | 1    | 7    | 0    | 10         | 11                 | 88   | 15   | 0    | 114        | 1                    | 4    | 1    | 2    | 8          | 700        |
| 08:00 AM    | 5                  | 125  | 18   | 0    | 148        | 0                    | 0    | 0    | 0    | 0          | 2                  | 47   | 5    | 0    | 54         | 0                    | 1    | 0    | 0    | 1          | 203        |
| 08:15 AM    | 5                  | 95   | 7    | 3    | 110        | 1                    | 0    | 2    | 0    | 3          | 4                  | 24   | 0    | 0    | 28         | 2                    | 0    | 3    | 0    | 5          | 146        |
| 08:30 AM    | 2                  | 53   | 4    | 1    | 60         | 2                    | 3    | 5    | 0    | 10         | 0                  | 19   | 2    | 0    | 21         | 0                    | 0    | 3    | 0    | 3          | 94         |
| 08:45 AM    | 1                  | 45   | 8    | 0    | 54         | 2                    | 1    | 2    | 5    | 10         | 3                  | 20   | 7    | 0    | 30         | 0                    | 2    | 2    | 0    | 4          | 98         |
| Total       | 13                 | 318  | 37   | 4    | 372        | 5                    | 4    | 9    | 5    | 23         | 9                  | 110  | 14   | 0    | 133        | 2                    | 3    | 8    | 0    | 13         | 541        |
| Grand Total | 21                 | 862  | 52   | 5    | 940        | 7                    | 5    | 16   | 5    | 33         | 20                 | 198  | 29   | 0    | 247        | 3                    | 7    | 9    | 2    | 21         | 1241       |
| Apprch %    | 2.2                | 91.7 | 5.5  | 0.5  |            | 21.2                 | 15.2 | 48.5 | 15.2 |            | 8.1                | 80.2 | 11.7 | 0    |            | 14.3                 | 33.3 | 42.9 | 9.5  |            |            |
| Total %     | 1.7                | 69.5 | 4.2  | 0.4  | 75.7       | 0.6                  | 0.4  | 1.3  | 0.4  | 2.7        | 1.6                | 16   | 2.3  | 0    | 19.9       | 0.2                  | 0.6  | 0.7  | 0.2  | 1.7        |            |
| Lights      | 21                 | 850  | 51   | 5    | 927        | 6                    | 4    | 16   | 5    | 31         | 20                 | 194  | 25   | 0    | 239        | 1                    | 6    | 9    | 2    | 18         | 1215       |
| % Lights    | 100                | 98.6 | 98.1 | 100  | 98.6       | 85.7                 | 80   | 100  | 100  | 93.9       | 100                | 98   | 86.2 | 0    | 96.8       | 33.3                 | 85.7 | 100  | 100  | 85.7       | 97.9       |
| Buses       | 0                  | 4    | 1    | 0    | 5          | 0                    | 0    | 0    | 0    | 0          | 0                  | 3    | 0    | 0    | 3          | 1                    | 0    | 0    | 0    | 1          | 9          |
| % Buses     | 0                  | 0.5  | 1.9  | 0    | 0.5        | 0                    | 0    | 0    | 0    | 0          | 0                  | 1.5  | 0    | 0    | 1.2        | 33.3                 | 0    | 0    | 0    | 4.8        | 0.7        |
| Trucks      | 0                  | 8    | 0    | 0    | 8          | 1                    | 1    | 0    | 0    | 2          | 0                  | 1    | 4    | 0    | 5          | 1                    | 1    | 0    | 0    | 2          | 17         |
| % Trucks    | 0                  | 0.9  | 0    | 0    | 0.9        | 14.3                 | 20   | 0    | 0    | 6.1        | 0                  | 0.5  | 13.8 | 0    | 2          | 33.3                 | 14.3 | 0    | 0    | 9.5        | 1.4        |

| Start Time   | 2ND AVE Southbound |      |      |            | DIVARTY ST Westbound |      |      |            | 2ND AVE Northbound |      |      |            | DIVARTY ST Eastbound |      |      |            | Int. Total |
|--|--------------------|------|------|------------|----------------------|------|------|------------|--------------------|------|------|------------|----------------------|------|------|------------|------------|
|  | Right              | Thru | Left | App. Total | Right                | Thru | Left | App. Total | Right              | Thru | Left | App. Total | Right                | Thru | Left | App. Total |            |
| Peak Hour Analysis From 07:00 AM to 08:45 AM - Peak 1 of 1 |                    |      |      |            |                      |      |      |            |                    |      |      |            |                      |      |      |            |            |
| Peak Hour for Entire Intersection Begins at 07:15 AM       |                    |      |      |            |                      |      |      |            |                    |      |      |            |                      |      |      |            |            |
| 07:15 AM   | 1                  | 149  | 3    | 153        | 0                    | 1    | 2    | 3          | 0                  | 10   | 2    | 12         | 1                    | 0    | 0    | 1          | 169        |
| 07:30 AM   | 1                  | 176  | 5    | 182        | 1                    | 0    | 2    | 3          | 5                  | 32   | 1    | 38         | 0                    | 3    | 1    | 4          | 227        |
| 07:45 AM   | 6                  | 159  | 6    | 171        | 1                    | 0    | 3    | 4          | 6                  | 33   | 10   | 49         | 0                    | 1    | 0    | 1          | 225        |
| 08:00 AM   | 5                  | 125  | 18   | 148        | 0                    | 0    | 0    | 0          | 2                  | 47   | 5    | 54         | 0                    | 1    | 0    | 1          | 203        |
| Total Volume   | 13                 | 609  | 32   | 654        | 2                    | 1    | 7    | 10         | 13                 | 122  | 18   | 153        | 1                    | 5    | 1    | 7          | 824        |
| % App. Total   | 2                  | 93.1 | 4.9  |            | 20                   | 10   | 70   |            | 8.5                | 79.7 | 11.8 |            | 14.3                 | 71.4 | 14.3 |            |            |
| PHF  | .542               | .865 | .444 | .898       | .500                 | .250 | .583 | .625       | .542               | .649 | .450 | .708       | .250                 | .417 | .250 | .438       | .907       |

# Traffic Data Service

San Jose, CA  
 (408) 622-4787  
 tdsbay@cs.com

File Name : 20AM FINAL  
 Site Code : 00000020  
 Start Date : 4/27/2017  
 Page No : 2

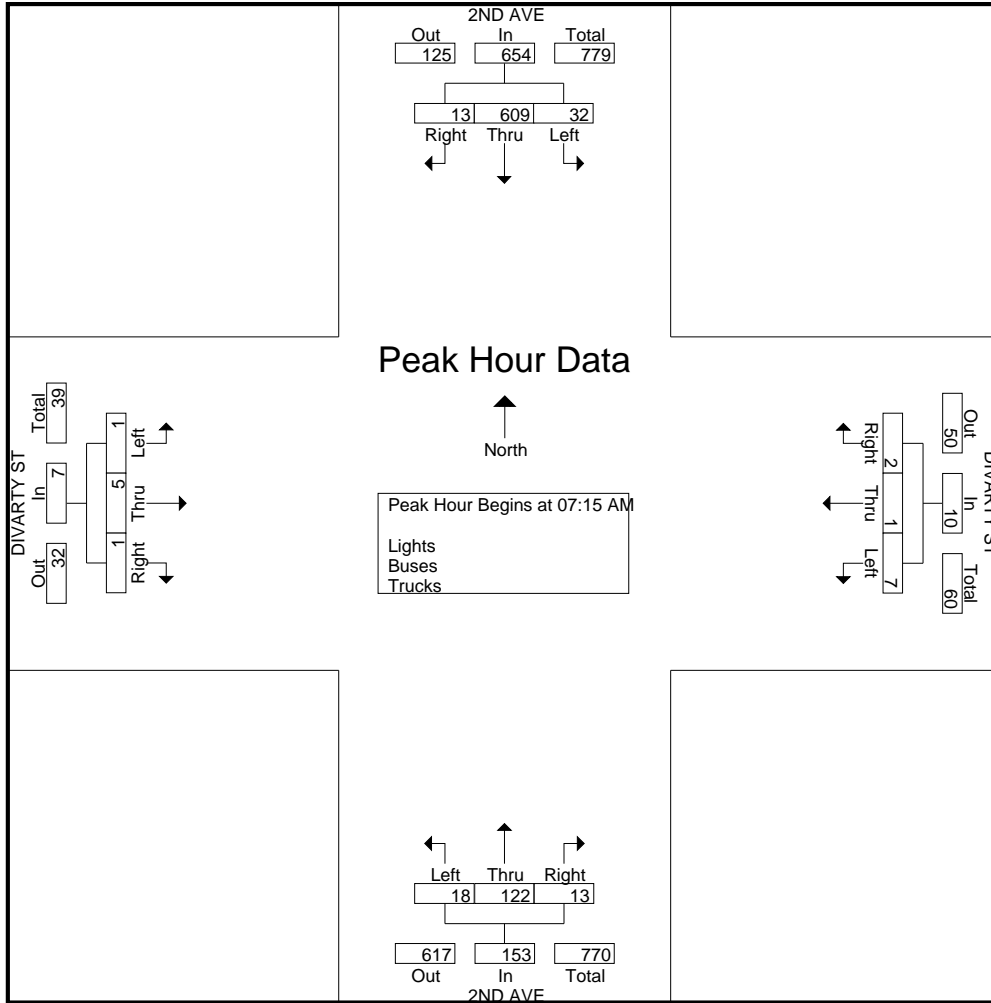

# Traffic Data Service

San Jose, CA  
 (408) 622-4787  
 tdsbay@cs.com

File Name : 20AM FINAL  
 Site Code : 00000020  
 Start Date : 4/27/2017  
 Page No : 1

## Groups Printed- Bikes

| Start Time  | 2ND AVE Southbound |      |      |      |            | DIVARTY ST Westbound |      |      |      |            | 2ND AVE Northbound |      |      |      |            | DIVARTY ST Eastbound |      |      |      |            | Int. Total |   |
|-------------|--------------------|------|------|------|------------|----------------------|------|------|------|------------|--------------------|------|------|------|------------|----------------------|------|------|------|------------|------------|---|
|             | Right              | Thru | Left | Peds | App. Total | Right                | Thru | Left | Peds | App. Total | Right              | Thru | Left | Peds | App. Total | Right                | Thru | Left | Peds | App. Total |            |   |
| 07:00 AM    | 0                  | 0    | 0    | 0    | 0          | 0                    | 0    | 0    | 0    | 0          | 0                  | 0    | 0    | 0    | 0          | 0                    | 0    | 0    | 0    | 0          | 0          | 0 |
| 07:15 AM    | 0                  | 0    | 0    | 0    | 0          | 0                    | 0    | 0    | 0    | 0          | 0                  | 0    | 0    | 0    | 0          | 0                    | 0    | 0    | 0    | 0          | 0          | 0 |
| 07:30 AM    | 0                  | 0    | 0    | 0    | 0          | 0                    | 0    | 0    | 0    | 0          | 0                  | 0    | 0    | 0    | 0          | 0                    | 0    | 0    | 0    | 0          | 0          | 0 |
| 07:45 AM    | 0                  | 0    | 0    | 0    | 0          | 0                    | 0    | 0    | 0    | 0          | 0                  | 0    | 0    | 0    | 0          | 0                    | 1    | 0    | 0    | 0          | 1          | 1 |
| Total       | 0                  | 0    | 0    | 0    | 0          | 0                    | 0    | 0    | 0    | 0          | 0                  | 0    | 0    | 0    | 0          | 0                    | 1    | 0    | 0    | 0          | 1          | 1 |
| 08:00 AM    | 0                  | 0    | 0    | 0    | 0          | 0                    | 0    | 0    | 0    | 0          | 0                  | 0    | 0    | 0    | 0          | 0                    | 1    | 0    | 0    | 0          | 1          | 1 |
| 08:15 AM    | 0                  | 0    | 0    | 0    | 0          | 0                    | 0    | 0    | 0    | 0          | 0                  | 0    | 0    | 0    | 0          | 0                    | 1    | 0    | 0    | 0          | 1          | 1 |
| 08:30 AM    | 0                  | 0    | 0    | 0    | 0          | 0                    | 0    | 0    | 0    | 0          | 0                  | 0    | 0    | 0    | 0          | 0                    | 0    | 0    | 0    | 0          | 0          | 0 |
| 08:45 AM    | 0                  | 0    | 0    | 0    | 0          | 0                    | 0    | 0    | 0    | 0          | 0                  | 0    | 0    | 0    | 0          | 0                    | 0    | 0    | 0    | 0          | 0          | 0 |
| Total       | 0                  | 0    | 0    | 0    | 0          | 0                    | 0    | 0    | 0    | 0          | 0                  | 0    | 0    | 0    | 0          | 0                    | 2    | 0    | 0    | 0          | 2          | 2 |
| Grand Total | 0                  | 0    | 0    | 0    | 0          | 0                    | 0    | 0    | 0    | 0          | 0                  | 0    | 0    | 0    | 0          | 0                    | 3    | 0    | 0    | 0          | 3          | 3 |
| Apprch %    | 0                  | 0    | 0    | 0    | 0          | 0                    | 0    | 0    | 0    | 0          | 0                  | 0    | 0    | 0    | 0          | 0                    | 100  | 0    | 0    | 0          |            |   |
| Total %     | 0                  | 0    | 0    | 0    | 0          | 0                    | 0    | 0    | 0    | 0          | 0                  | 0    | 0    | 0    | 0          | 0                    | 100  | 0    | 0    | 0          | 100        |   |

| Start Time   | 2ND AVE Southbound |      |      |      |            | DIVARTY ST Westbound |      |      |      |            | 2ND AVE Northbound |      |      |      |            | DIVARTY ST Eastbound |      |      |      |            | Int. Total |   |
|--------------|--------------------|------|------|------|------------|----------------------|------|------|------|------------|--------------------|------|------|------|------------|----------------------|------|------|------|------------|------------|---|
|              | Right              | Thru | Left | Peds | App. Total | Right                | Thru | Left | Peds | App. Total | Right              | Thru | Left | Peds | App. Total | Right                | Thru | Left | Peds | App. Total |            |   |
| 07:30 AM     | 0                  | 0    | 0    | 0    | 0          | 0                    | 0    | 0    | 0    | 0          | 0                  | 0    | 0    | 0    | 0          | 0                    | 0    | 0    | 0    | 0          | 0          | 0 |
| 07:45 AM     | 0                  | 0    | 0    | 0    | 0          | 0                    | 0    | 0    | 0    | 0          | 0                  | 0    | 0    | 0    | 0          | 0                    | 1    | 0    | 0    | 0          | 1          | 1 |
| 08:00 AM     | 0                  | 0    | 0    | 0    | 0          | 0                    | 0    | 0    | 0    | 0          | 0                  | 0    | 0    | 0    | 0          | 0                    | 1    | 0    | 0    | 0          | 1          | 1 |
| 08:15 AM     | 0                  | 0    | 0    | 0    | 0          | 0                    | 0    | 0    | 0    | 0          | 0                  | 0    | 0    | 0    | 0          | 0                    | 1    | 0    | 0    | 0          | 1          | 1 |
| Total Volume | 0                  | 0    | 0    | 0    | 0          | 0                    | 0    | 0    | 0    | 0          | 0                  | 0    | 0    | 0    | 0          | 0                    | 3    | 0    | 0    | 0          | 3          | 3 |
| % App. Total | 0                  | 0    | 0    | 0    | 0          | 0                    | 0    | 0    | 0    | 0          | 0                  | 0    | 0    | 0    | 0          | 0                    | 100  | 0    | 0    | 0          |            |   |
| PHF          | .000               | .000 | .000 | .000 | .000       | .000                 | .000 | .000 | .000 | .000       | .000               | .000 | .000 | .000 | .000       | .000                 | .750 | .000 | .750 | .750       |            |   |

Peak Hour Analysis From 07:00 AM to 08:45 AM - Peak 1 of 1  
 Peak Hour for Entire Intersection Begins at 07:30 AM

# Traffic Data Service

San Jose, CA  
(408) 622-4787  
tdsbay@cs.com

File Name : 20AM FINAL  
Site Code : 00000020  
Start Date : 4/27/2017  
Page No : 2

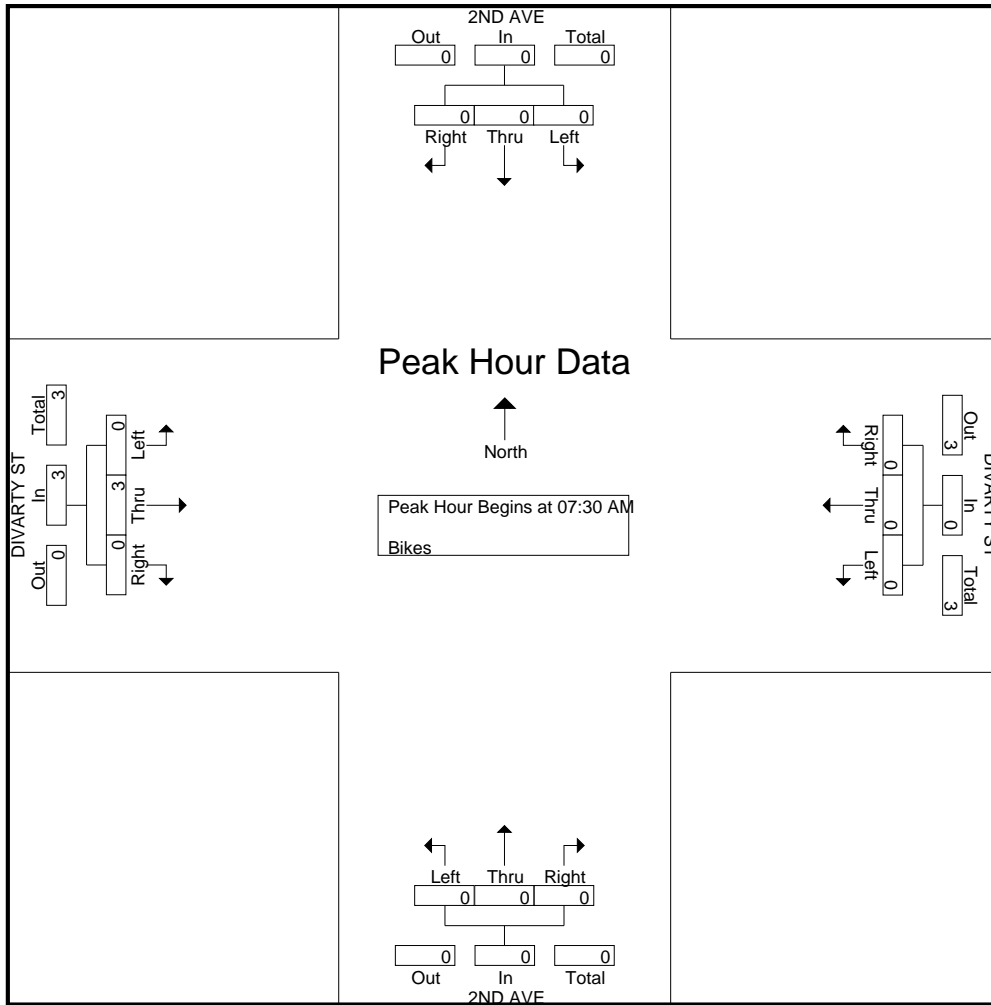

# Traffic Data Service

San Jose, CA  
 (408) 622-4787  
 tdsbay@cs.com

File Name : 20PM FINAL  
 Site Code : 00000020  
 Start Date : 4/27/2017  
 Page No : 1

Groups Printed- Lights - Buses - Trucks

| Start Time  | 2ND AVE Southbound |      |      |      |            | DIVARTY ST Westbound |      |      |      |            | 2ND AVE Northbound |      |      |      |            | DIVARTY ST Eastbound |      |      |      |            | Int. Total |
|-------------|--------------------|------|------|------|------------|----------------------|------|------|------|------------|--------------------|------|------|------|------------|----------------------|------|------|------|------------|------------|
|             | Right              | Thru | Left | Peds | App. Total | Right                | Thru | Left | Peds | App. Total | Right              | Thru | Left | Peds | App. Total | Right                | Thru | Left | Peds | App. Total |            |
| 04:00 PM    | 2                  | 41   | 7    | 0    | 50         | 7                    | 4    | 4    | 0    | 15         | 0                  | 28   | 2    | 0    | 30         | 0                    | 0    | 1    | 0    | 1          | 96         |
| 04:15 PM    | 5                  | 39   | 2    | 0    | 46         | 8                    | 1    | 3    | 1    | 13         | 2                  | 33   | 4    | 0    | 39         | 0                    | 1    | 3    | 2    | 6          | 104        |
| 04:30 PM    | 5                  | 52   | 5    | 0    | 62         | 6                    | 5    | 5    | 0    | 16         | 1                  | 44   | 6    | 0    | 51         | 0                    | 2    | 2    | 0    | 4          | 133        |
| 04:45 PM    | 1                  | 52   | 2    | 2    | 57         | 8                    | 2    | 2    | 1    | 13         | 1                  | 44   | 2    | 1    | 48         | 4                    | 0    | 3    | 1    | 8          | 126        |
| Total       | 13                 | 184  | 16   | 2    | 215        | 29                   | 12   | 14   | 2    | 57         | 4                  | 149  | 14   | 1    | 168        | 4                    | 3    | 9    | 3    | 19         | 459        |
| 05:00 PM    | 2                  | 38   | 4    | 1    | 45         | 18                   | 1    | 7    | 2    | 28         | 2                  | 62   | 1    | 1    | 66         | 0                    | 0    | 2    | 0    | 2          | 141        |
| 05:15 PM    | 1                  | 45   | 0    | 2    | 48         | 1                    | 0    | 2    | 0    | 3          | 0                  | 60   | 5    | 1    | 66         | 0                    | 0    | 1    | 3    | 4          | 121        |
| 05:30 PM    | 2                  | 54   | 4    | 1    | 61         | 8                    | 1    | 8    | 0    | 17         | 0                  | 55   | 0    | 0    | 55         | 0                    | 0    | 1    | 1    | 2          | 135        |
| 05:45 PM    | 3                  | 54   | 2    | 1    | 60         | 12                   | 2    | 10   | 0    | 24         | 2                  | 49   | 2    | 0    | 53         | 2                    | 0    | 1    | 0    | 3          | 140        |
| Total       | 8                  | 191  | 10   | 5    | 214        | 39                   | 4    | 27   | 2    | 72         | 4                  | 226  | 8    | 2    | 240        | 2                    | 0    | 5    | 4    | 11         | 537        |
| Grand Total | 21                 | 375  | 26   | 7    | 429        | 68                   | 16   | 41   | 4    | 129        | 8                  | 375  | 22   | 3    | 408        | 6                    | 3    | 14   | 7    | 30         | 996        |
| Apprch %    | 4.9                | 87.4 | 6.1  | 1.6  |            | 52.7                 | 12.4 | 31.8 | 3.1  |            | 2                  | 91.9 | 5.4  | 0.7  |            | 20                   | 10   | 46.7 | 23.3 |            |            |
| Total %     | 2.1                | 37.7 | 2.6  | 0.7  | 43.1       | 6.8                  | 1.6  | 4.1  | 0.4  | 13         | 0.8                | 37.7 | 2.2  | 0.3  | 41         | 0.6                  | 0.3  | 1.4  | 0.7  | 3          |            |
| Lights      | 21                 | 369  | 26   | 7    | 423        | 67                   | 16   | 41   | 4    | 128        | 8                  | 372  | 21   | 3    | 404        | 6                    | 3    | 14   | 7    | 30         | 985        |
| % Lights    | 100                | 98.4 | 100  | 100  | 98.6       | 98.5                 | 100  | 100  | 100  | 99.2       | 100                | 99.2 | 95.5 | 100  | 99         | 100                  | 100  | 100  | 100  | 100        | 98.9       |
| Buses       | 0                  | 4    | 0    | 0    | 4          | 1                    | 0    | 0    | 0    | 1          | 0                  | 1    | 0    | 0    | 1          | 0                    | 0    | 0    | 0    | 0          | 6          |
| % Buses     | 0                  | 1.1  | 0    | 0    | 0.9        | 1.5                  | 0    | 0    | 0    | 0.8        | 0                  | 0.3  | 0    | 0    | 0.2        | 0                    | 0    | 0    | 0    | 0          | 0.6        |
| Trucks      | 0                  | 2    | 0    | 0    | 2          | 0                    | 0    | 0    | 0    | 0          | 0                  | 2    | 1    | 0    | 3          | 0                    | 0    | 0    | 0    | 0          | 5          |
| % Trucks    | 0                  | 0.5  | 0    | 0    | 0.5        | 0                    | 0    | 0    | 0    | 0          | 0                  | 0.5  | 4.5  | 0    | 0.7        | 0                    | 0    | 0    | 0    | 0          | 0.5        |

| Start Time   | 2ND AVE Southbound |      |      |            | DIVARTY ST Westbound |      |      |            | 2ND AVE Northbound |      |      |            | DIVARTY ST Eastbound |      |      |            | Int. Total |
|--|--------------------|------|------|------------|----------------------|------|------|------------|--------------------|------|------|------------|----------------------|------|------|------------|------------|
|  | Right              | Thru | Left | App. Total | Right                | Thru | Left | App. Total | Right              | Thru | Left | App. Total | Right                | Thru | Left | App. Total |            |
| Peak Hour Analysis From 04:00 PM to 05:45 PM - Peak 1 of 1 |                    |      |      |            |                      |      |      |            |                    |      |      |            |                      |      |      |            |            |
| Peak Hour for Entire Intersection Begins at 05:00 PM       |                    |      |      |            |                      |      |      |            |                    |      |      |            |                      |      |      |            |            |
| 05:00 PM   | 2                  | 38   | 4    | 44         | 18                   | 1    | 7    | 26         | 2                  | 62   | 1    | 65         | 0                    | 0    | 2    | 2          | 137        |
| 05:15 PM   | 1                  | 45   | 0    | 46         | 1                    | 0    | 2    | 3          | 0                  | 60   | 5    | 65         | 0                    | 0    | 1    | 1          | 115        |
| 05:30 PM   | 2                  | 54   | 4    | 60         | 8                    | 1    | 8    | 17         | 0                  | 55   | 0    | 55         | 0                    | 0    | 1    | 1          | 133        |
| 05:45 PM   | 3                  | 54   | 2    | 59         | 12                   | 2    | 10   | 24         | 2                  | 49   | 2    | 53         | 2                    | 0    | 1    | 3          | 139        |
| Total Volume   | 8                  | 191  | 10   | 209        | 39                   | 4    | 27   | 70         | 4                  | 226  | 8    | 238        | 2                    | 0    | 5    | 7          | 524        |
| % App. Total   | 3.8                | 91.4 | 4.8  |            | 55.7                 | 5.7  | 38.6 |            | 1.7                | 95   | 3.4  |            | 28.6                 | 0    | 71.4 |            |            |
| PHF  | .667               | .884 | .625 | .871       | .542                 | .500 | .675 | .673       | .500               | .911 | .400 | .915       | .250                 | .000 | .625 | .583       | .942       |

# Traffic Data Service

San Jose, CA  
 (408) 622-4787  
 tdsbay@cs.com

File Name : 20PM FINAL  
 Site Code : 00000020  
 Start Date : 4/27/2017  
 Page No : 2

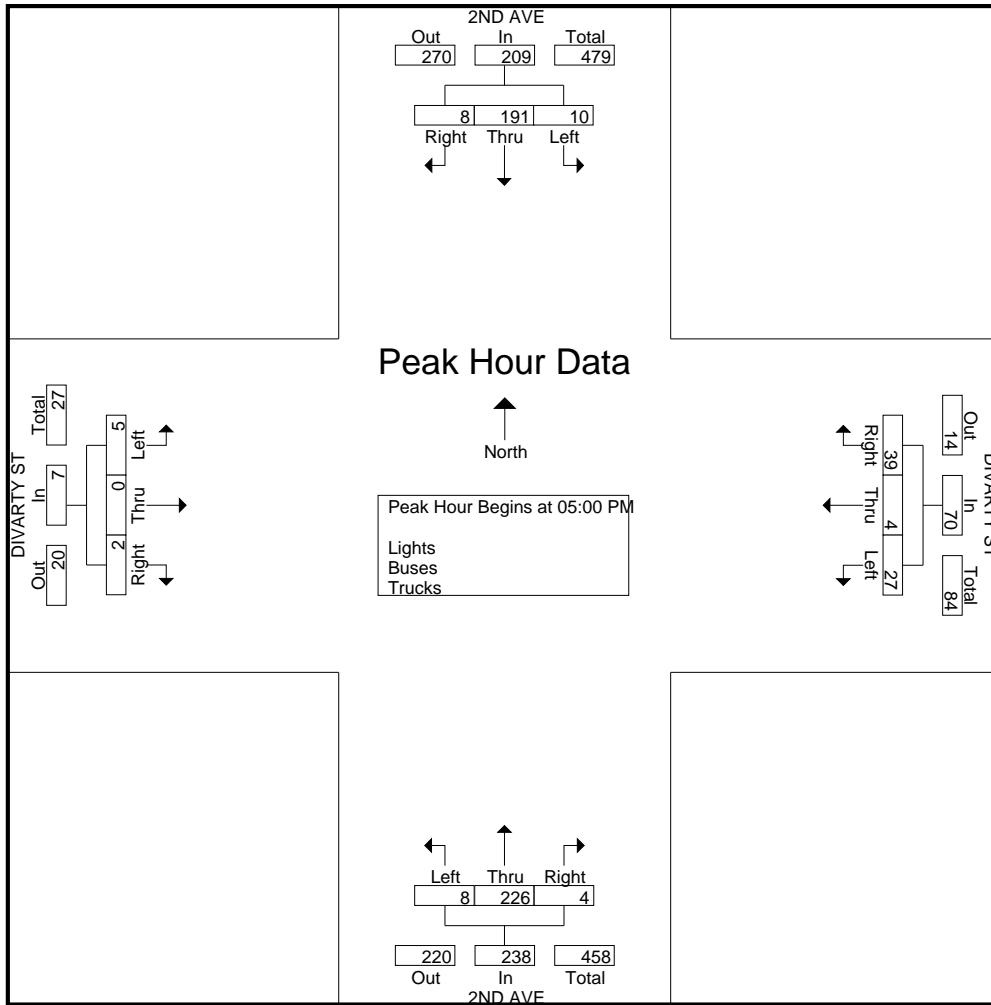

# Traffic Data Service

San Jose, CA  
 (408) 622-4787  
 tdsbay@cs.com

File Name : 20PM FINAL  
 Site Code : 00000020  
 Start Date : 4/27/2017  
 Page No : 1

Groups Printed- Bikes

| Start Time   | 2ND AVE Southbound |      |      |      |            | DIVARTY ST Westbound |      |      |      |            | 2ND AVE Northbound |      |      |      |            | DIVARTY ST Eastbound |      |      |      |            | Int. Total |   |
|--------------|--------------------|------|------|------|------------|----------------------|------|------|------|------------|--------------------|------|------|------|------------|----------------------|------|------|------|------------|------------|---|
|              | Right              | Thru | Left | Peds | App. Total | Right                | Thru | Left | Peds | App. Total | Right              | Thru | Left | Peds | App. Total | Right                | Thru | Left | Peds | App. Total |            |   |
| 04:00 PM     | 0                  | 0    | 0    | 0    | 0          | 0                    | 0    | 0    | 0    | 0          | 0                  | 0    | 0    | 0    | 0          | 0                    | 0    | 0    | 0    | 0          | 0          | 0 |
| 04:15 PM     | 0                  | 0    | 0    | 0    | 0          | 0                    | 0    | 0    | 0    | 0          | 0                  | 0    | 0    | 0    | 0          | 0                    | 0    | 0    | 0    | 0          | 0          | 0 |
| 04:30 PM     | 0                  | 0    | 0    | 0    | 0          | 0                    | 0    | 0    | 0    | 0          | 0                  | 0    | 0    | 0    | 0          | 0                    | 0    | 0    | 0    | 0          | 0          | 0 |
| 04:45 PM     | 0                  | 0    | 0    | 0    | 0          | 0                    | 0    | 0    | 0    | 0          | 0                  | 0    | 0    | 0    | 0          | 0                    | 0    | 0    | 0    | 0          | 0          | 0 |
| <b>Total</b> | 0                  | 0    | 0    | 0    | 0          | 0                    | 0    | 0    | 0    | 0          | 0                  | 0    | 0    | 0    | 0          | 0                    | 0    | 0    | 0    | 0          | 0          | 0 |
| 05:00 PM     | 0                  | 1    | 0    | 0    | 1          | 0                    | 0    | 0    | 0    | 0          | 0                  | 0    | 0    | 0    | 0          | 0                    | 1    | 0    | 0    | 1          |            | 2 |
| 05:15 PM     | 0                  | 0    | 0    | 0    | 0          | 0                    | 0    | 0    | 0    | 0          | 0                  | 0    | 0    | 0    | 0          | 0                    | 0    | 0    | 0    | 0          |            | 0 |
| 05:30 PM     | 0                  | 0    | 0    | 0    | 0          | 0                    | 0    | 0    | 0    | 0          | 0                  | 0    | 0    | 0    | 0          | 0                    | 0    | 0    | 0    | 0          |            | 0 |
| 05:45 PM     | 0                  | 0    | 0    | 0    | 0          | 0                    | 2    | 0    | 0    | 2          | 0                  | 0    | 0    | 0    | 0          | 0                    | 0    | 0    | 0    | 0          |            | 2 |
| <b>Total</b> | 0                  | 1    | 0    | 0    | 1          | 0                    | 2    | 0    | 0    | 2          | 0                  | 0    | 0    | 0    | 0          | 0                    | 1    | 0    | 0    | 1          |            | 4 |
| Grand Total  | 0                  | 1    | 0    | 0    | 1          | 0                    | 2    | 0    | 0    | 2          | 0                  | 0    | 0    | 0    | 0          | 0                    | 1    | 0    | 0    | 1          |            | 4 |
| Apprch %     | 0                  | 100  | 0    | 0    |            | 0                    | 100  | 0    | 0    |            | 0                  | 0    | 0    | 0    |            | 0                    | 100  | 0    | 0    |            |            |   |
| Total %      | 0                  | 25   | 0    | 0    | 25         | 0                    | 50   | 0    | 0    | 50         | 0                  | 0    | 0    | 0    | 0          | 0                    | 25   | 0    | 0    | 25         |            |   |

| Start Time   | 2ND AVE Southbound |      |      |      |            | DIVARTY ST Westbound |      |      |      |            | 2ND AVE Northbound |      |      |      |            | DIVARTY ST Eastbound |      |      |      |            | Int. Total |      |
|--|--------------------|------|------|------|------------|----------------------|------|------|------|------------|--------------------|------|------|------|------------|----------------------|------|------|------|------------|------------|------|
|  | Right              | Thru | Left | Peds | App. Total | Right                | Thru | Left | Peds | App. Total | Right              | Thru | Left | Peds | App. Total | Right                | Thru | Left | Peds | App. Total |            |      |
| Peak Hour Analysis From 04:00 PM to 05:45 PM - Peak 1 of 1 |                    |      |      |      |            |                      |      |      |      |            |                    |      |      |      |            |                      |      |      |      |            |            |      |
| Peak Hour for Entire Intersection Begins at 05:00 PM       |                    |      |      |      |            |                      |      |      |      |            |                    |      |      |      |            |                      |      |      |      |            |            |      |
| 05:00 PM   | 0                  | 1    | 0    | 0    | 1          | 0                    | 0    | 0    | 0    | 0          | 0                  | 0    | 0    | 0    | 0          | 0                    | 1    | 0    | 0    | 1          |            | 2    |
| 05:15 PM   | 0                  | 0    | 0    | 0    | 0          | 0                    | 0    | 0    | 0    | 0          | 0                  | 0    | 0    | 0    | 0          | 0                    | 0    | 0    | 0    | 0          |            | 0    |
| 05:30 PM   | 0                  | 0    | 0    | 0    | 0          | 0                    | 0    | 0    | 0    | 0          | 0                  | 0    | 0    | 0    | 0          | 0                    | 0    | 0    | 0    | 0          |            | 0    |
| 05:45 PM   | 0                  | 0    | 0    | 0    | 0          | 0                    | 2    | 0    | 0    | 2          | 0                  | 0    | 0    | 0    | 0          | 0                    | 0    | 0    | 0    | 0          |            | 2    |
| <b>Total Volume</b>  | 0                  | 1    | 0    | 0    | 1          | 0                    | 2    | 0    | 0    | 2          | 0                  | 0    | 0    | 0    | 0          | 0                    | 1    | 0    | 0    | 1          |            | 4    |
| % App. Total   | 0                  | 100  | 0    | 0    |            | 0                    | 100  | 0    | 0    |            | 0                  | 0    | 0    | 0    |            | 0                    | 100  | 0    | 0    |            |            |      |
| PHF  | .000               | .250 | .000 | .000 | .250       | .000                 | .250 | .000 | .000 | .250       | .000               | .000 | .000 | .000 | .000       | .000                 | .250 | .000 | .000 | .250       |            | .500 |

# Traffic Data Service

San Jose, CA  
 (408) 622-4787  
 tdsbay@cs.com

File Name : 20PM FINAL  
 Site Code : 00000020  
 Start Date : 4/27/2017  
 Page No : 2

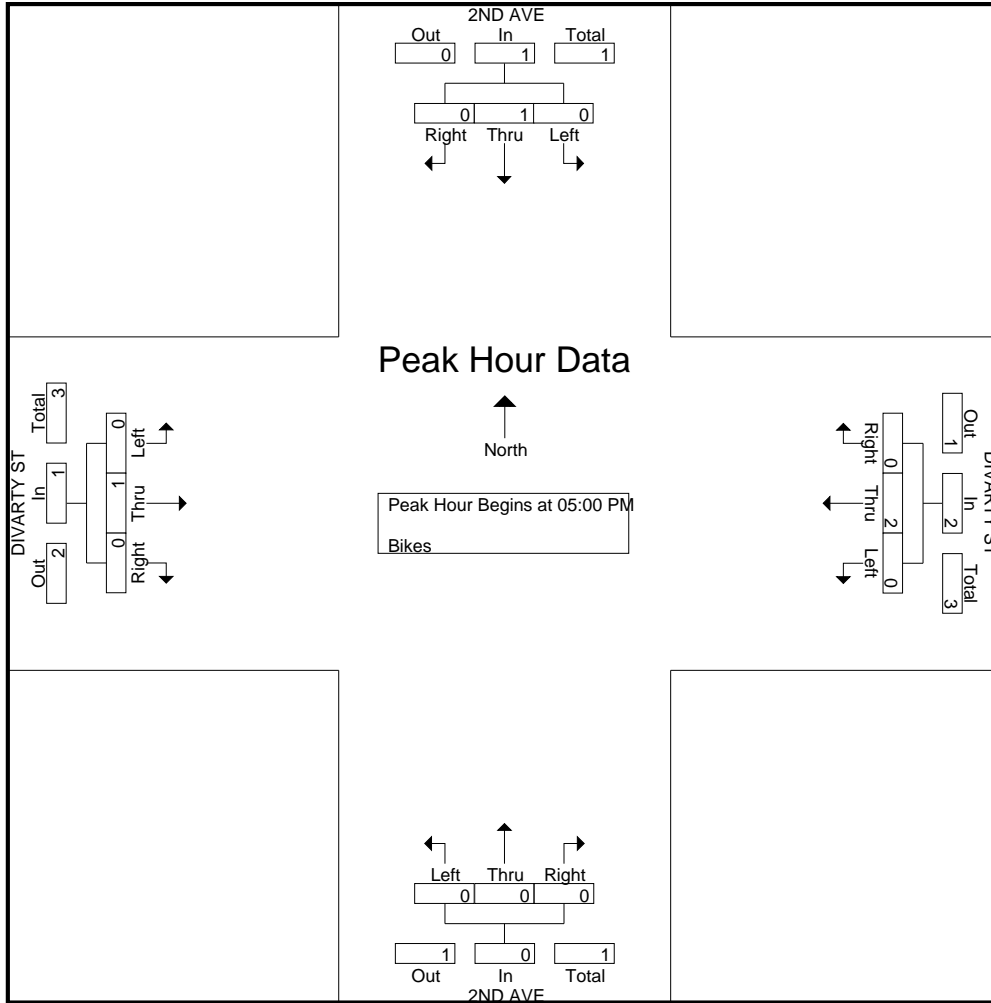



# Traffic Data Service

San Jose, CA  
 (408) 622-4787  
 tdsbay@cs.com

File Name : 21AM FINAL  
 Site Code : 00000021  
 Start Date : 4/27/2017  
 Page No : 1

Groups Printed- Lights - Buses - Trucks

| Start Time   | GENERAL JIM MOORE BLVD Southbound |            |           |          |            | DIVARTY ST Westbound |           |           |          |            | GENERAL JIM MOORE BLVD Northbound |            |           |          |            | DIVARTY ST Eastbound |           |          |          |            | Int. Total |
|--------------|-----------------------------------|------------|-----------|----------|------------|----------------------|-----------|-----------|----------|------------|-----------------------------------|------------|-----------|----------|------------|----------------------|-----------|----------|----------|------------|------------|
|              | Right                             | Thru       | Left      | Peds     | App. Total | Right                | Thru      | Left      | Peds     | App. Total | Right                             | Thru       | Left      | Peds     | App. Total | Right                | Thru      | Left     | Peds     | App. Total |            |
| 07:00 AM     | 0                                 | 10         | 1         | 0        | 11         | 0                    | 0         | 9         | 0        | 9          | 3                                 | 4          | 2         | 0        | 9          | 1                    | 0         | 0        | 0        | 1          | 30         |
| 07:15 AM     | 0                                 | 33         | 0         | 1        | 34         | 1                    | 1         | 24        | 0        | 26         | 6                                 | 11         | 1         | 1        | 19         | 4                    | 4         | 0        | 0        | 8          | 87         |
| 07:30 AM     | 1                                 | 51         | 0         | 0        | 52         | 2                    | 0         | 34        | 0        | 36         | 7                                 | 25         | 1         | 1        | 34         | 1                    | 8         | 3        | 0        | 12         | 134        |
| 07:45 AM     | 1                                 | 37         | 2         | 3        | 43         | 5                    | 4         | 12        | 0        | 21         | 27                                | 29         | 4         | 1        | 61         | 1                    | 9         | 2        | 0        | 12         | 137        |
| <b>Total</b> | <b>2</b>                          | <b>131</b> | <b>3</b>  | <b>4</b> | <b>140</b> | <b>8</b>             | <b>5</b>  | <b>79</b> | <b>0</b> | <b>92</b>  | <b>43</b>                         | <b>69</b>  | <b>8</b>  | <b>3</b> | <b>123</b> | <b>7</b>             | <b>21</b> | <b>5</b> | <b>0</b> | <b>33</b>  | <b>388</b> |
| 08:00 AM     | 0                                 | 25         | 7         | 0        | 32         | 7                    | 3         | 9         | 0        | 19         | 20                                | 31         | 1         | 0        | 52         | 2                    | 21        | 1        | 0        | 24         | 127        |
| 08:15 AM     | 0                                 | 23         | 3         | 3        | 29         | 4                    | 1         | 2         | 0        | 7          | 8                                 | 37         | 3         | 0        | 48         | 1                    | 6         | 1        | 0        | 8          | 92         |
| 08:30 AM     | 1                                 | 20         | 1         | 0        | 22         | 6                    | 2         | 3         | 3        | 14         | 11                                | 32         | 5         | 1        | 49         | 0                    | 4         | 0        | 0        | 4          | 89         |
| 08:45 AM     | 0                                 | 13         | 2         | 0        | 15         | 11                   | 4         | 7         | 0        | 22         | 16                                | 30         | 5         | 0        | 51         | 1                    | 9         | 1        | 1        | 12         | 100        |
| <b>Total</b> | <b>1</b>                          | <b>81</b>  | <b>13</b> | <b>3</b> | <b>98</b>  | <b>28</b>            | <b>10</b> | <b>21</b> | <b>3</b> | <b>62</b>  | <b>55</b>                         | <b>130</b> | <b>14</b> | <b>1</b> | <b>200</b> | <b>4</b>             | <b>40</b> | <b>3</b> | <b>1</b> | <b>48</b>  | <b>408</b> |
| Grand Total  | 3                                 | 212        | 16        | 7        | 238        | 36                   | 15        | 100       | 3        | 154        | 98                                | 199        | 22        | 4        | 323        | 11                   | 61        | 8        | 1        | 81         | 796        |
| Apprch %     | 1.3                               | 89.1       | 6.7       | 2.9      |            | 23.4                 | 9.7       | 64.9      | 1.9      |            | 30.3                              | 61.6       | 6.8       | 1.2      |            | 13.6                 | 75.3      | 9.9      | 1.2      |            |            |
| Total %      | 0.4                               | 26.6       | 2         | 0.9      | 29.9       | 4.5                  | 1.9       | 12.6      | 0.4      | 19.3       | 12.3                              | 25         | 2.8       | 0.5      | 40.6       | 1.4                  | 7.7       | 1        | 0.1      | 10.2       |            |
| Lights       | 3                                 | 209        | 16        | 7        | 235        | 32                   | 14        | 99        | 3        | 148        | 97                                | 195        | 20        | 4        | 316        | 10                   | 60        | 8        | 1        | 79         | 778        |
| % Lights     | 100                               | 98.6       | 100       | 100      | 98.7       | 88.9                 | 93.3      | 99        | 100      | 96.1       | 99                                | 98         | 90.9      | 100      | 97.8       | 90.9                 | 98.4      | 100      | 100      | 97.5       | 97.7       |
| Buses        | 0                                 | 1          | 0         | 0        | 1          | 4                    | 0         | 1         | 0        | 5          | 0                                 | 2          | 0         | 0        | 2          | 0                    | 1         | 0        | 0        | 1          | 9          |
| % Buses      | 0                                 | 0.5        | 0         | 0        | 0.4        | 11.1                 | 0         | 1         | 0        | 3.2        | 0                                 | 1          | 0         | 0        | 0.6        | 0                    | 1.6       | 0        | 0        | 1.2        | 1.1        |
| Trucks       | 0                                 | 2          | 0         | 0        | 2          | 0                    | 1         | 0         | 0        | 1          | 1                                 | 2          | 2         | 0        | 5          | 1                    | 0         | 0        | 0        | 1          | 9          |
| % Trucks     | 0                                 | 0.9        | 0         | 0        | 0.8        | 0                    | 6.7       | 0         | 0        | 0.6        | 1                                 | 1          | 9.1       | 0        | 1.5        | 9.1                  | 0         | 0        | 0        | 1.2        | 1.1        |

| Start Time   | GENERAL JIM MOORE BLVD Southbound |      |      |      |            | DIVARTY ST Westbound |      |      |      |            | GENERAL JIM MOORE BLVD Northbound |      |      |      |            | DIVARTY ST Eastbound |      |      |      |            | Int. Total |
|--|-----------------------------------|------|------|------|------------|----------------------|------|------|------|------------|-----------------------------------|------|------|------|------------|----------------------|------|------|------|------------|------------|
|  | Right                             | Thru | Left | Peds | App. Total | Right                | Thru | Left | Peds | App. Total | Right                             | Thru | Left | Peds | App. Total | Right                | Thru | Left | Peds | App. Total |            |
| Peak Hour Analysis From 07:00 AM to 08:45 AM - Peak 1 of 1 |                                   |      |      |      |            |                      |      |      |      |            |                                   |      |      |      |            |                      |      |      |      |            |            |
| Peak Hour for Entire Intersection Begins at 07:30 AM       |                                   |      |      |      |            |                      |      |      |      |            |                                   |      |      |      |            |                      |      |      |      |            |            |
| 07:30 AM   | 1                                 | 51   | 0    | 0    | 52         | 2                    | 0    | 34   | 0    | 36         | 7                                 | 25   | 1    | 0    | 33         | 1                    | 8    | 3    | 0    | 12         | 133        |
| 07:45 AM   | 1                                 | 37   | 2    | 0    | 40         | 5                    | 4    | 12   | 0    | 21         | 27                                | 29   | 4    | 0    | 60         | 1                    | 9    | 2    | 0    | 12         | 133        |
| 08:00 AM   | 0                                 | 25   | 7    | 0    | 32         | 7                    | 3    | 9    | 0    | 19         | 20                                | 31   | 1    | 0    | 52         | 2                    | 21   | 1    | 0    | 24         | 127        |
| 08:15 AM   | 0                                 | 23   | 3    | 3    | 26         | 4                    | 1    | 2    | 0    | 7          | 8                                 | 37   | 3    | 0    | 48         | 1                    | 6    | 1    | 0    | 8          | 89         |
| Total Volume   | 2                                 | 136  | 12   | 0    | 150        | 18                   | 8    | 57   | 0    | 83         | 62                                | 122  | 9    | 0    | 193        | 5                    | 44   | 7    | 0    | 56         | 482        |
| % App. Total   | 1.3                               | 90.7 | 8    | 0    |            | 21.7                 | 9.6  | 68.7 | 0    |            | 32.1                              | 63.2 | 4.7  | 0    |            | 8.9                  | 78.6 | 12.5 | 0    |            |            |
| PHF  | .500                              | .667 | .429 |      | .721       | .643                 | .500 | .419 |      | .576       | .574                              | .824 | .563 |      | .804       | .625                 | .524 | .583 |      | .583       | .906       |

# Traffic Data Service

San Jose, CA  
 (408) 622-4787  
 tdsbay@cs.com

File Name : 21AM FINAL  
 Site Code : 00000021  
 Start Date : 4/27/2017  
 Page No : 2

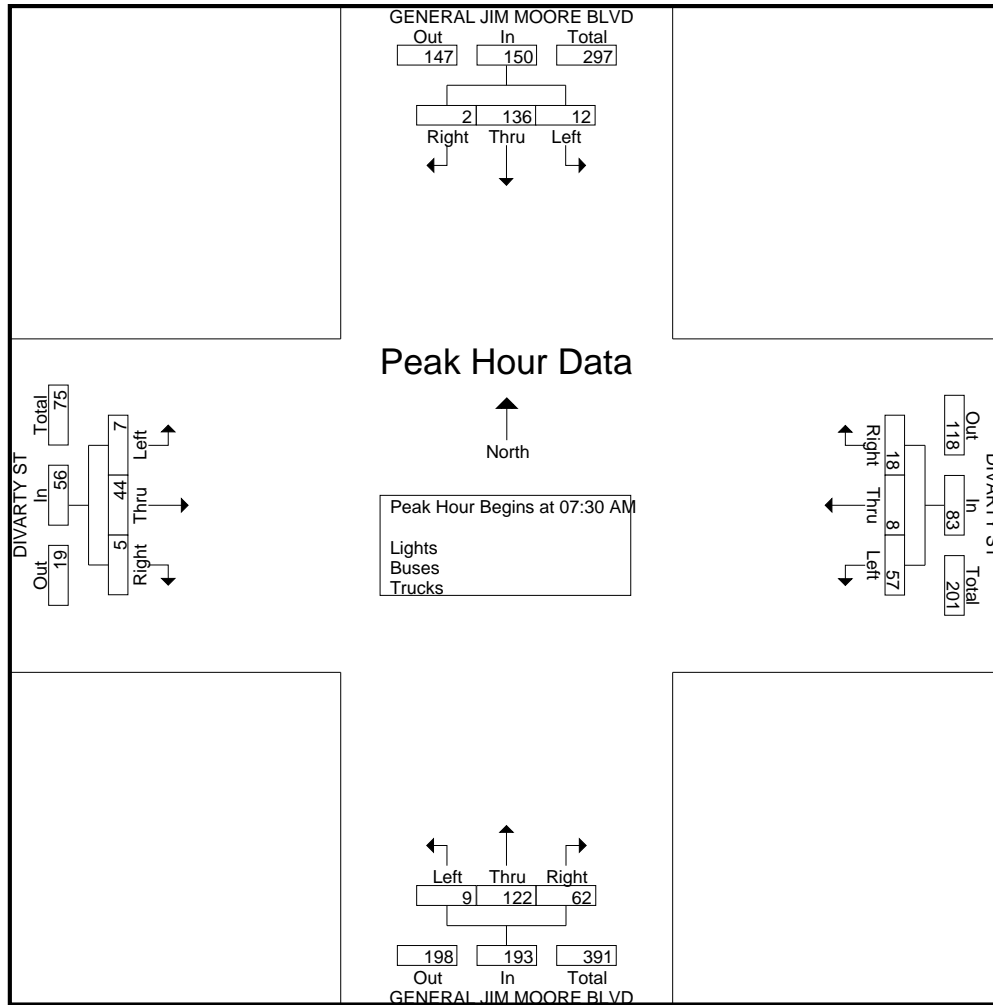

# Traffic Data Service

San Jose, CA  
 (408) 622-4787  
 tdsbay@cs.com

File Name : 21AM FINAL  
 Site Code : 00000021  
 Start Date : 4/27/2017  
 Page No : 1

Groups Printed- Bikes

| Start Time  | GENERAL JIM MOORE BLVD Southbound |      |      |      |            | DIVARTY ST Westbound |      |      |      |            | GENERAL JIM MOORE BLVD Northbound |      |      |      |            | DIVARTY ST Eastbound |      |      |      |            | Int. Total |      |   |   |      |   |
|-------------|-----------------------------------|------|------|------|------------|----------------------|------|------|------|------------|-----------------------------------|------|------|------|------------|----------------------|------|------|------|------------|------------|------|---|---|------|---|
|             | Right                             | Thru | Left | Peds | App. Total | Right                | Thru | Left | Peds | App. Total | Right                             | Thru | Left | Peds | App. Total | Right                | Thru | Left | Peds | App. Total |            |      |   |   |      |   |
| 07:00 AM    | 0                                 | 0    | 0    | 0    | 0          | 0                    | 0    | 0    | 0    | 0          | 0                                 | 0    | 0    | 0    | 0          | 0                    | 0    | 0    | 0    | 0          | 0          | 0    | 0 | 0 | 0    | 0 |
| 07:15 AM    | 0                                 | 0    | 0    | 0    | 0          | 0                    | 0    | 0    | 0    | 0          | 0                                 | 0    | 0    | 0    | 0          | 0                    | 0    | 0    | 0    | 0          | 0          | 0    | 0 | 0 | 0    | 0 |
| 07:30 AM    | 0                                 | 1    | 0    | 0    | 1          | 0                    | 0    | 0    | 0    | 0          | 0                                 | 0    | 0    | 0    | 0          | 0                    | 0    | 0    | 0    | 0          | 0          | 0    | 0 | 0 | 0    | 1 |
| 07:45 AM    | 0                                 | 0    | 0    | 0    | 0          | 0                    | 0    | 0    | 0    | 0          | 0                                 | 0    | 0    | 0    | 0          | 0                    | 0    | 3    | 0    | 0          | 0          | 3    | 0 | 0 | 3    | 3 |
| Total       | 0                                 | 1    | 0    | 0    | 1          | 0                    | 0    | 0    | 0    | 0          | 0                                 | 0    | 0    | 0    | 0          | 0                    | 0    | 3    | 0    | 0          | 0          | 3    | 0 | 0 | 3    | 4 |
| 08:00 AM    | 0                                 | 0    | 0    | 0    | 0          | 0                    | 0    | 0    | 0    | 0          | 1                                 | 1    | 0    | 0    | 2          | 0                    | 1    | 0    | 0    | 1          | 0          | 1    | 0 | 0 | 1    | 3 |
| 08:15 AM    | 0                                 | 0    | 0    | 0    | 0          | 0                    | 0    | 0    | 0    | 0          | 0                                 | 0    | 0    | 0    | 0          | 0                    | 1    | 0    | 0    | 1          | 0          | 1    | 0 | 0 | 1    | 1 |
| 08:30 AM    | 0                                 | 0    | 0    | 0    | 0          | 0                    | 0    | 0    | 0    | 0          | 0                                 | 0    | 0    | 0    | 0          | 0                    | 0    | 0    | 0    | 0          | 0          | 0    | 0 | 0 | 0    | 0 |
| 08:45 AM    | 0                                 | 0    | 0    | 0    | 0          | 0                    | 0    | 0    | 0    | 0          | 0                                 | 0    | 0    | 0    | 0          | 0                    | 0    | 0    | 0    | 0          | 0          | 0    | 0 | 0 | 0    | 0 |
| Total       | 0                                 | 0    | 0    | 0    | 0          | 0                    | 0    | 0    | 0    | 0          | 1                                 | 1    | 0    | 0    | 2          | 0                    | 2    | 0    | 0    | 2          | 0          | 2    | 0 | 0 | 2    | 4 |
| Grand Total | 0                                 | 1    | 0    | 0    | 1          | 0                    | 0    | 0    | 0    | 0          | 1                                 | 1    | 0    | 0    | 2          | 0                    | 5    | 0    | 0    | 5          | 0          | 5    | 0 | 0 | 5    | 8 |
| Apprch %    | 0                                 | 100  | 0    | 0    |            | 0                    | 0    | 0    | 0    |            | 50                                | 50   | 0    | 0    |            | 0                    | 100  | 0    | 0    |            | 0          | 100  | 0 | 0 |      |   |
| Total %     | 0                                 | 12.5 | 0    | 0    | 12.5       | 0                    | 0    | 0    | 0    | 0          | 12.5                              | 12.5 | 0    | 0    | 25         | 0                    | 62.5 | 0    | 0    | 62.5       | 0          | 62.5 | 0 | 0 | 62.5 |   |

| Start Time   | GENERAL JIM MOORE BLVD Southbound |      |      |      |            | DIVARTY ST Westbound |      |      |      |            | GENERAL JIM MOORE BLVD Northbound |      |      |      |            | DIVARTY ST Eastbound |      |      |      |            | Int. Total |      |      |      |      |   |
|--|-----------------------------------|------|------|------|------------|----------------------|------|------|------|------------|-----------------------------------|------|------|------|------------|----------------------|------|------|------|------------|------------|------|------|------|------|---|
|  | Right                             | Thru | Left | Peds | App. Total | Right                | Thru | Left | Peds | App. Total | Right                             | Thru | Left | Peds | App. Total | Right                | Thru | Left | Peds | App. Total |            |      |      |      |      |   |
| Peak Hour Analysis From 07:00 AM to 08:45 AM - Peak 1 of 1 |                                   |      |      |      |            |                      |      |      |      |            |                                   |      |      |      |            |                      |      |      |      |            |            |      |      |      |      |   |
| Peak Hour for Entire Intersection Begins at 07:30 AM       |                                   |      |      |      |            |                      |      |      |      |            |                                   |      |      |      |            |                      |      |      |      |            |            |      |      |      |      |   |
| 07:30 AM   | 0                                 | 1    | 0    | 0    | 1          | 0                    | 0    | 0    | 0    | 0          | 0                                 | 0    | 0    | 0    | 0          | 0                    | 0    | 0    | 0    | 0          | 0          | 1    | 0    | 0    | 1    | 1 |
| 07:45 AM   | 0                                 | 0    | 0    | 0    | 0          | 0                    | 0    | 0    | 0    | 0          | 0                                 | 0    | 0    | 0    | 0          | 0                    | 3    | 0    | 0    | 3          | 0          | 3    | 0    | 0    | 3    | 3 |
| 08:00 AM   | 0                                 | 0    | 0    | 0    | 0          | 0                    | 0    | 0    | 0    | 0          | 1                                 | 1    | 0    | 0    | 2          | 0                    | 1    | 0    | 0    | 1          | 0          | 1    | 0    | 0    | 1    | 3 |
| 08:15 AM   | 0                                 | 0    | 0    | 0    | 0          | 0                    | 0    | 0    | 0    | 0          | 0                                 | 0    | 0    | 0    | 0          | 0                    | 1    | 0    | 0    | 1          | 0          | 1    | 0    | 0    | 1    | 1 |
| Total Volume   | 0                                 | 1    | 0    | 0    | 1          | 0                    | 0    | 0    | 0    | 0          | 1                                 | 1    | 0    | 0    | 2          | 0                    | 5    | 0    | 0    | 5          | 0          | 5    | 0    | 0    | 5    | 8 |
| % App. Total   | 0                                 | 100  | 0    | 0    |            | 0                    | 0    | 0    | 0    |            | 50                                | 50   | 0    | 0    |            | 0                    | 100  | 0    | 0    |            | 0          | 100  | 0    | 0    |      |   |
| PHF  | .000                              | .250 | .000 | .000 | .250       | .000                 | .000 | .000 | .000 | .000       | .250                              | .250 | .000 | .250 | .250       | .000                 | .417 | .000 | .000 | .417       | .000       | .417 | .000 | .417 | .667 |   |

# Traffic Data Service

San Jose, CA  
 (408) 622-4787  
 tdsbay@cs.com

File Name : 21AM FINAL  
 Site Code : 00000021  
 Start Date : 4/27/2017  
 Page No : 2

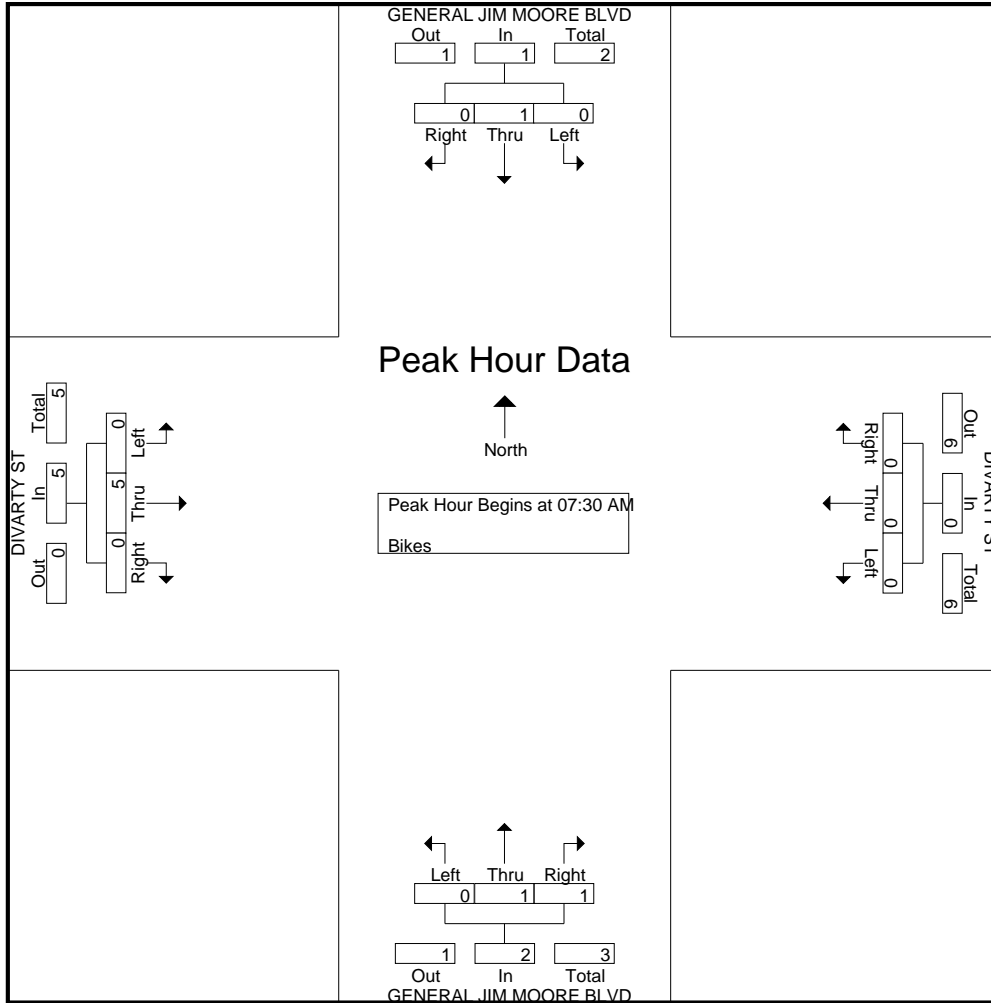

# Traffic Data Service

San Jose, CA  
 (408) 622-4787  
 tdsbay@cs.com

File Name : 21PM FINAL  
 Site Code : 00000021  
 Start Date : 4/27/2017  
 Page No : 1

Groups Printed- Lights - Buses - Trucks

| Start Time   | GENERAL JIM MOORE BLVD Southbound |            |           |           |            | DIVARTY ST Westbound |           |           |          |            | GENERAL JIM MOORE BLVD Northbound |            |           |          |            | DIVARTY ST Eastbound |           |          |          |            | Int. Total |
|--------------|-----------------------------------|------------|-----------|-----------|------------|----------------------|-----------|-----------|----------|------------|-----------------------------------|------------|-----------|----------|------------|----------------------|-----------|----------|----------|------------|------------|
|              | Right                             | Thru       | Left      | Peds      | App. Total | Right                | Thru      | Left      | Peds     | App. Total | Right                             | Thru       | Left      | Peds     | App. Total | Right                | Thru      | Left     | Peds     | App. Total |            |
| 04:00 PM     | 1                                 | 25         | 3         | 3         | 32         | 25                   | 10        | 16        | 0        | 51         | 5                                 | 37         | 7         | 0        | 49         | 7                    | 7         | 4        | 1        | 19         | 151        |
| 04:15 PM     | 1                                 | 18         | 1         | 4         | 24         | 14                   | 3         | 11        | 0        | 28         | 6                                 | 23         | 8         | 0        | 37         | 1                    | 4         | 1        | 0        | 6          | 95         |
| 04:30 PM     | 3                                 | 23         | 1         | 2         | 29         | 17                   | 7         | 11        | 1        | 36         | 3                                 | 27         | 9         | 1        | 40         | 2                    | 5         | 0        | 1        | 8          | 113        |
| 04:45 PM     | 1                                 | 27         | 4         | 2         | 34         | 15                   | 10        | 8         | 1        | 34         | 5                                 | 36         | 1         | 1        | 43         | 3                    | 1         | 0        | 0        | 4          | 115        |
| <b>Total</b> | <b>6</b>                          | <b>93</b>  | <b>9</b>  | <b>11</b> | <b>119</b> | <b>71</b>            | <b>30</b> | <b>46</b> | <b>2</b> | <b>149</b> | <b>19</b>                         | <b>123</b> | <b>25</b> | <b>2</b> | <b>169</b> | <b>13</b>            | <b>17</b> | <b>5</b> | <b>2</b> | <b>37</b>  | <b>474</b> |
| 05:00 PM     | 3                                 | 30         | 1         | 7         | 41         | 32                   | 16        | 14        | 2        | 64         | 6                                 | 37         | 7         | 0        | 50         | 7                    | 3         | 1        | 2        | 13         | 168        |
| 05:15 PM     | 0                                 | 32         | 2         | 0         | 34         | 24                   | 2         | 12        | 0        | 38         | 8                                 | 44         | 1         | 1        | 54         | 0                    | 2         | 1        | 0        | 3          | 129        |
| 05:30 PM     | 0                                 | 27         | 2         | 0         | 29         | 19                   | 11        | 14        | 2        | 46         | 5                                 | 42         | 4         | 1        | 52         | 0                    | 6         | 1        | 0        | 7          | 134        |
| 05:45 PM     | 1                                 | 29         | 6         | 4         | 40         | 43                   | 18        | 23        | 2        | 86         | 6                                 | 37         | 5         | 2        | 50         | 1                    | 2         | 1        | 1        | 5          | 181        |
| <b>Total</b> | <b>4</b>                          | <b>118</b> | <b>11</b> | <b>11</b> | <b>144</b> | <b>118</b>           | <b>47</b> | <b>63</b> | <b>6</b> | <b>234</b> | <b>25</b>                         | <b>160</b> | <b>17</b> | <b>4</b> | <b>206</b> | <b>8</b>             | <b>13</b> | <b>4</b> | <b>3</b> | <b>28</b>  | <b>612</b> |
| Grand Total  | 10                                | 211        | 20        | 22        | 263        | 189                  | 77        | 109       | 8        | 383        | 44                                | 283        | 42        | 6        | 375        | 21                   | 30        | 9        | 5        | 65         | 1086       |
| Apprch %     | 3.8                               | 80.2       | 7.6       | 8.4       |            | 49.3                 | 20.1      | 28.5      | 2.1      |            | 11.7                              | 75.5       | 11.2      | 1.6      |            | 32.3                 | 46.2      | 13.8     | 7.7      |            |            |
| Total %      | 0.9                               | 19.4       | 1.8       | 2         | 24.2       | 17.4                 | 7.1       | 10        | 0.7      | 35.3       | 4.1                               | 26.1       | 3.9       | 0.6      | 34.5       | 1.9                  | 2.8       | 0.8      | 0.5      | 6          |            |
| Lights       | 10                                | 210        | 20        | 22        | 262        | 185                  | 77        | 106       | 8        | 376        | 44                                | 281        | 41        | 6        | 372        | 21                   | 30        | 9        | 5        | 65         | 1075       |
| % Lights     | 100                               | 99.5       | 100       | 100       | 99.6       | 97.9                 | 100       | 97.2      | 100      | 98.2       | 100                               | 99.3       | 97.6      | 100      | 99.2       | 100                  | 100       | 100      | 100      | 100        | 99         |
| Buses        | 0                                 | 0          | 0         | 0         | 0          | 4                    | 0         | 3         | 0        | 7          | 0                                 | 2          | 1         | 0        | 3          | 0                    | 0         | 0        | 0        | 0          | 10         |
| % Buses      | 0                                 | 0          | 0         | 0         | 0          | 2.1                  | 0         | 2.8       | 0        | 1.8        | 0                                 | 0.7        | 2.4       | 0        | 0.8        | 0                    | 0         | 0        | 0        | 0          | 0.9        |
| Trucks       | 0                                 | 1          | 0         | 0         | 1          | 0                    | 0         | 0         | 0        | 0          | 0                                 | 0          | 0         | 0        | 0          | 0                    | 0         | 0        | 0        | 0          | 1          |
| % Trucks     | 0                                 | 0.5        | 0         | 0         | 0.4        | 0                    | 0         | 0         | 0        | 0          | 0                                 | 0          | 0         | 0        | 0          | 0                    | 0         | 0        | 0        | 0          | 0.1        |

| Start Time   | GENERAL JIM MOORE BLVD Southbound |      |      |      |            | DIVARTY ST Westbound |      |      |      |            | GENERAL JIM MOORE BLVD Northbound |      |      |      |            | DIVARTY ST Eastbound |      |      |      |            | Int. Total |
|--|-----------------------------------|------|------|------|------------|----------------------|------|------|------|------------|-----------------------------------|------|------|------|------------|----------------------|------|------|------|------------|------------|
|  | Right                             | Thru | Left | Peds | App. Total | Right                | Thru | Left | Peds | App. Total | Right                             | Thru | Left | Peds | App. Total | Right                | Thru | Left | Peds | App. Total |            |
| Peak Hour Analysis From 04:00 PM to 05:45 PM - Peak 1 of 1 |                                   |      |      |      |            |                      |      |      |      |            |                                   |      |      |      |            |                      |      |      |      |            |            |
| Peak Hour for Entire Intersection Begins at 05:00 PM       |                                   |      |      |      |            |                      |      |      |      |            |                                   |      |      |      |            |                      |      |      |      |            |            |
| 05:00 PM   | 3                                 | 30   | 1    |      | 34         | 32                   | 16   | 14   |      | 62         | 6                                 | 37   | 7    |      | 50         | 7                    | 3    | 1    |      | 11         | 157        |
| 05:15 PM   | 0                                 | 32   | 2    |      | 34         | 24                   | 2    | 12   |      | 38         | 8                                 | 44   | 1    |      | 53         | 0                    | 2    | 1    |      | 3          | 128        |
| 05:30 PM   | 0                                 | 27   | 2    |      | 29         | 19                   | 11   | 14   |      | 44         | 5                                 | 42   | 4    |      | 51         | 0                    | 6    | 1    |      | 7          | 131        |
| 05:45 PM   | 1                                 | 29   | 6    |      | 36         | 43                   | 18   | 23   |      | 84         | 6                                 | 37   | 5    |      | 48         | 1                    | 2    | 1    |      | 4          | 172        |
| Total Volume   | 4                                 | 118  | 11   |      | 133        | 118                  | 47   | 63   |      | 228        | 25                                | 160  | 17   |      | 202        | 8                    | 13   | 4    |      | 25         | 588        |
| % App. Total   | 3                                 | 88.7 | 8.3  |      |            | 51.8                 | 20.6 | 27.6 |      |            | 12.4                              | 79.2 | 8.4  |      |            | 32                   | 52   | 16   |      |            |            |
| PHF  | .333                              | .922 | .458 |      | .924       | .686                 | .653 | .685 |      | .679       | .781                              | .909 | .607 |      | .953       | .286                 | .542 | 1.00 |      | .568       | .855       |

# Traffic Data Service

San Jose, CA  
 (408) 622-4787  
 tdsbay@cs.com

File Name : 21PM FINAL  
 Site Code : 00000021  
 Start Date : 4/27/2017  
 Page No : 2

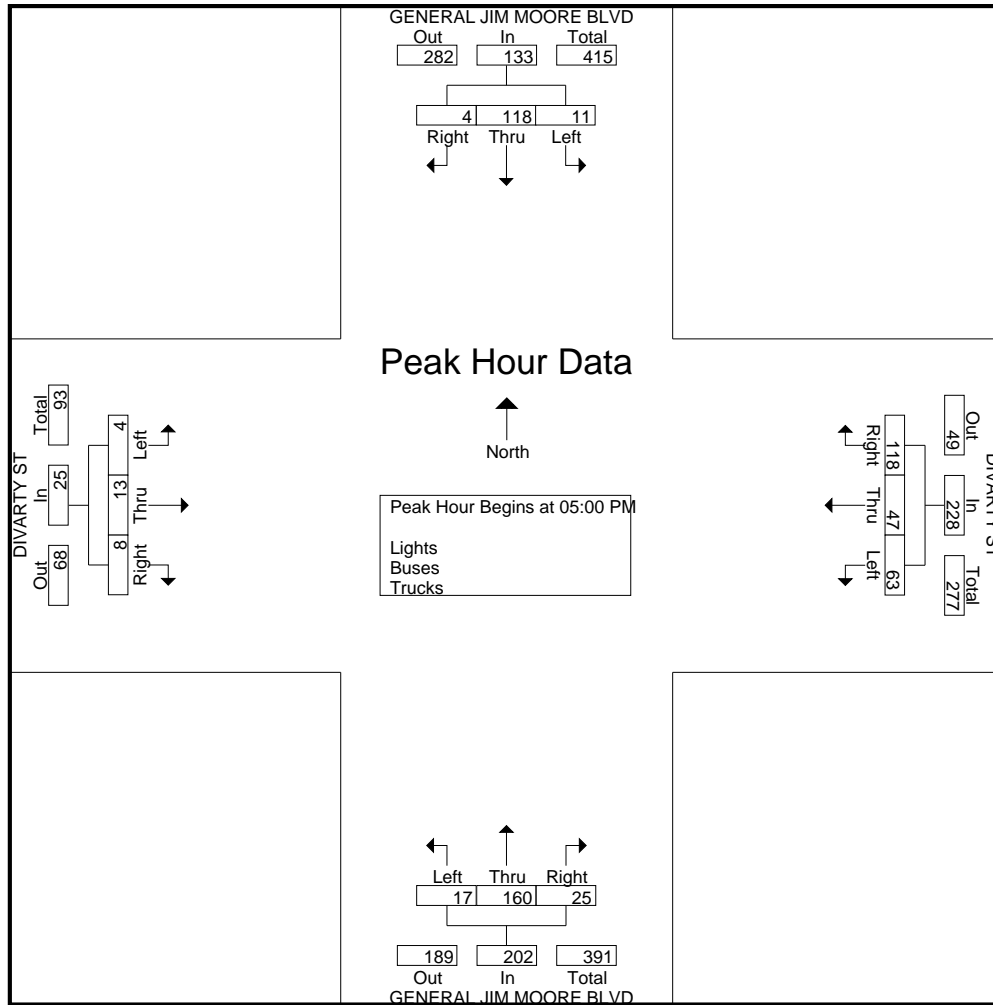

# Traffic Data Service

San Jose, CA  
 (408) 622-4787  
 tdsbay@cs.com

File Name : 21PM FINAL  
 Site Code : 00000021  
 Start Date : 4/27/2017  
 Page No : 1

Groups Printed- Bikes

| Start Time  | GENERAL JIM MOORE BLVD Southbound |      |      |      |            | DIVARTY ST Westbound |      |      |      |            | GENERAL JIM MOORE BLVD Northbound |      |      |      |            | DIVARTY ST Eastbound |      |      |      |            | Int. Total |   |   |   |   |   |
|-------------|-----------------------------------|------|------|------|------------|----------------------|------|------|------|------------|-----------------------------------|------|------|------|------------|----------------------|------|------|------|------------|------------|---|---|---|---|---|
|             | Right                             | Thru | Left | Peds | App. Total | Right                | Thru | Left | Peds | App. Total | Right                             | Thru | Left | Peds | App. Total | Right                | Thru | Left | Peds | App. Total |            |   |   |   |   |   |
| 04:00 PM    | 0                                 | 1    | 0    | 0    | 1          | 0                    | 0    | 0    | 0    | 0          | 0                                 | 0    | 0    | 0    | 0          | 0                    | 0    | 0    | 0    | 0          | 0          | 0 | 0 | 0 | 0 | 1 |
| 04:15 PM    | 0                                 | 0    | 0    | 0    | 0          | 0                    | 0    | 0    | 0    | 0          | 0                                 | 1    | 0    | 0    | 1          | 0                    | 0    | 0    | 0    | 0          | 0          | 0 | 0 | 0 | 0 | 1 |
| 04:30 PM    | 0                                 | 0    | 0    | 0    | 0          | 0                    | 0    | 0    | 0    | 0          | 0                                 | 0    | 0    | 0    | 0          | 0                    | 0    | 0    | 0    | 0          | 0          | 0 | 0 | 0 | 0 | 0 |
| 04:45 PM    | 0                                 | 0    | 0    | 0    | 0          | 0                    | 0    | 0    | 0    | 0          | 0                                 | 0    | 0    | 0    | 0          | 0                    | 0    | 0    | 0    | 0          | 0          | 0 | 0 | 0 | 0 | 0 |
| Total       | 0                                 | 1    | 0    | 0    | 1          | 0                    | 0    | 0    | 0    | 0          | 0                                 | 1    | 0    | 0    | 1          | 0                    | 0    | 0    | 0    | 0          | 0          | 0 | 0 | 0 | 0 | 2 |
| 05:00 PM    | 0                                 | 0    | 0    | 0    | 0          | 0                    | 0    | 0    | 0    | 0          | 0                                 | 0    | 0    | 0    | 0          | 0                    | 0    | 1    | 0    | 1          | 0          | 0 | 0 | 0 | 1 | 1 |
| 05:15 PM    | 0                                 | 0    | 0    | 0    | 0          | 0                    | 0    | 0    | 0    | 0          | 0                                 | 0    | 0    | 0    | 0          | 0                    | 0    | 0    | 0    | 0          | 0          | 0 | 0 | 0 | 0 | 0 |
| 05:30 PM    | 1                                 | 0    | 0    | 0    | 1          | 0                    | 0    | 0    | 0    | 0          | 0                                 | 0    | 0    | 0    | 0          | 0                    | 0    | 0    | 0    | 0          | 0          | 0 | 0 | 0 | 0 | 1 |
| 05:45 PM    | 0                                 | 0    | 0    | 0    | 0          | 0                    | 2    | 0    | 0    | 2          | 0                                 | 1    | 0    | 0    | 1          | 0                    | 0    | 0    | 0    | 0          | 0          | 0 | 0 | 0 | 0 | 3 |
| Total       | 1                                 | 0    | 0    | 0    | 1          | 0                    | 2    | 0    | 0    | 2          | 0                                 | 1    | 0    | 0    | 1          | 0                    | 0    | 1    | 0    | 1          | 0          | 0 | 0 | 0 | 1 | 5 |
| Grand Total | 1                                 | 1    | 0    | 0    | 2          | 0                    | 2    | 0    | 0    | 2          | 0                                 | 2    | 0    | 0    | 2          | 0                    | 0    | 1    | 0    | 1          | 0          | 0 | 0 | 0 | 7 |   |
| Apprch %    | 50                                | 50   | 0    | 0    |            | 0                    | 100  | 0    | 0    |            | 0                                 | 100  | 0    | 0    |            | 0                    | 0    | 100  | 0    |            |            |   |   |   |   |   |
| Total %     | 14.3                              | 14.3 | 0    | 0    | 28.6       | 0                    | 28.6 | 0    | 0    | 28.6       | 0                                 | 28.6 | 0    | 0    | 28.6       | 0                    | 0    | 14.3 | 0    | 14.3       |            |   |   |   |   |   |

| Start Time   | GENERAL JIM MOORE BLVD Southbound |      |      |      |            | DIVARTY ST Westbound |      |      |      |            | GENERAL JIM MOORE BLVD Northbound |      |      |      |            | DIVARTY ST Eastbound |      |      |      |            | Int. Total |   |   |   |      |
|--------------|-----------------------------------|------|------|------|------------|----------------------|------|------|------|------------|-----------------------------------|------|------|------|------------|----------------------|------|------|------|------------|------------|---|---|---|------|
|              | Right                             | Thru | Left | Peds | App. Total | Right                | Thru | Left | Peds | App. Total | Right                             | Thru | Left | Peds | App. Total | Right                | Thru | Left | Peds | App. Total |            |   |   |   |      |
| 05:00 PM     | 0                                 | 0    | 0    | 0    | 0          | 0                    | 0    | 0    | 0    | 0          | 0                                 | 0    | 0    | 0    | 0          | 0                    | 0    | 1    | 0    | 1          | 0          | 0 | 0 | 0 | 1    |
| 05:15 PM     | 0                                 | 0    | 0    | 0    | 0          | 0                    | 0    | 0    | 0    | 0          | 0                                 | 0    | 0    | 0    | 0          | 0                    | 0    | 0    | 0    | 0          | 0          | 0 | 0 | 0 | 0    |
| 05:30 PM     | 1                                 | 0    | 0    | 0    | 1          | 0                    | 0    | 0    | 0    | 0          | 0                                 | 0    | 0    | 0    | 0          | 0                    | 0    | 0    | 0    | 0          | 0          | 0 | 0 | 0 | 1    |
| 05:45 PM     | 0                                 | 0    | 0    | 0    | 0          | 0                    | 2    | 0    | 0    | 2          | 0                                 | 1    | 0    | 0    | 1          | 0                    | 0    | 0    | 0    | 0          | 0          | 0 | 0 | 0 | 3    |
| Total Volume | 1                                 | 0    | 0    | 0    | 1          | 0                    | 2    | 0    | 0    | 2          | 0                                 | 1    | 0    | 0    | 1          | 0                    | 0    | 1    | 0    | 1          | 0          | 0 | 0 | 0 | 5    |
| % App. Total | 100                               | 0    | 0    | 0    |            | 0                    | 100  | 0    | 0    |            | 0                                 | 100  | 0    | 0    |            | 0                    | 0    | 100  | 0    |            |            |   |   |   |      |
| PHF          | .250                              | .000 | .000 | .000 | .250       | .000                 | .250 | .000 | .000 | .250       | .000                              | .250 | .000 | .000 | .250       | .000                 | .000 | .250 | .000 | .250       |            |   |   |   | .417 |

Peak Hour Analysis From 04:00 PM to 05:45 PM - Peak 1 of 1  
 Peak Hour for Entire Intersection Begins at 05:00 PM

# Traffic Data Service

San Jose, CA  
 (408) 622-4787  
 tdsbay@cs.com

File Name : 21PM FINAL  
 Site Code : 00000021  
 Start Date : 4/27/2017  
 Page No : 2

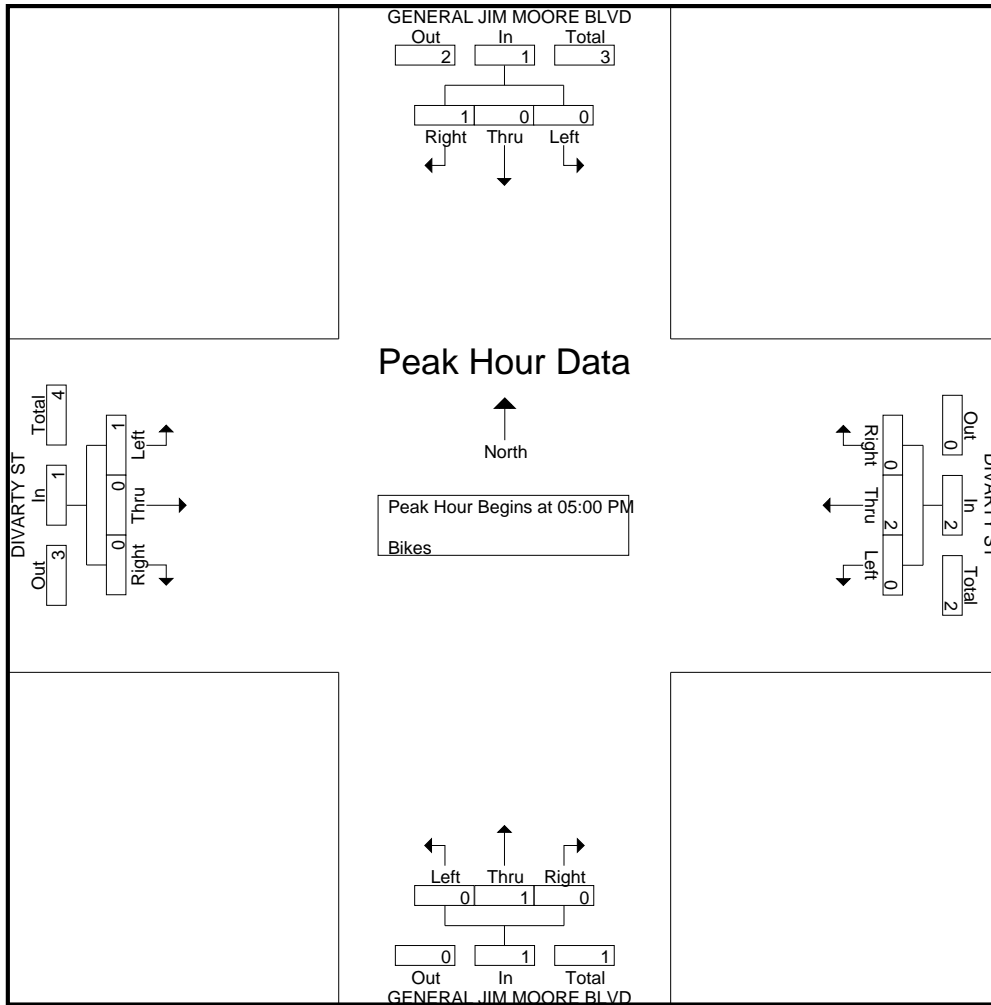



# Traffic Data Service

San Jose, CA  
 (408) 622-4787  
 tdsbay@cs.com

File Name : 22AM FINAL  
 Site Code : 00000022  
 Start Date : 4/27/2017  
 Page No : 1

## Groups Printed- Lights - Buses - Trucks

| Start Time  | 1ST AVE Southbound |      |      |      |            | LIGHTFIGHTER DR Westbound |      |      |      |            | 1ST AVE Northbound |      |      |      |            | LIGHTFIGHTER DR Eastbound |      |      |      |            | Int. Total |
|-------------|--------------------|------|------|------|------------|---------------------------|------|------|------|------------|--------------------|------|------|------|------------|---------------------------|------|------|------|------------|------------|
|             | Right              | Thru | Left | Peds | App. Total | Right                     | Thru | Left | Peds | App. Total | Right              | Thru | Left | Peds | App. Total | Right                     | Thru | Left | Peds | App. Total |            |
| 07:00 AM    | 2                  | 0    | 0    | 0    | 2          | 0                         | 126  | 1    | 0    | 127        | 0                  | 0    | 53   | 0    | 53         | 12                        | 107  | 0    | 0    | 119        | 301        |
| 07:15 AM    | 4                  | 1    | 0    | 0    | 5          | 0                         | 160  | 7    | 0    | 167        | 0                  | 0    | 44   | 0    | 44         | 22                        | 160  | 0    | 0    | 182        | 398        |
| 07:30 AM    | 5                  | 0    | 1    | 0    | 6          | 0                         | 270  | 3    | 0    | 273        | 1                  | 0    | 43   | 0    | 44         | 31                        | 199  | 0    | 0    | 230        | 553        |
| 07:45 AM    | 5                  | 2    | 3    | 0    | 10         | 0                         | 182  | 1    | 0    | 183        | 10                 | 0    | 35   | 0    | 45         | 44                        | 233  | 0    | 0    | 277        | 515        |
| Total       | 16                 | 3    | 4    | 0    | 23         | 0                         | 738  | 12   | 0    | 750        | 11                 | 0    | 175  | 0    | 186        | 109                       | 699  | 0    | 0    | 808        | 1767       |
| 08:00 AM    | 4                  | 1    | 10   | 0    | 15         | 0                         | 142  | 9    | 0    | 151        | 5                  | 0    | 36   | 0    | 41         | 29                        | 156  | 0    | 0    | 185        | 392        |
| 08:15 AM    | 4                  | 0    | 0    | 0    | 4          | 0                         | 99   | 8    | 0    | 107        | 7                  | 0    | 28   | 0    | 35         | 40                        | 146  | 0    | 0    | 186        | 332        |
| 08:30 AM    | 0                  | 0    | 0    | 0    | 0          | 0                         | 70   | 2    | 0    | 72         | 0                  | 0    | 21   | 0    | 21         | 54                        | 137  | 1    | 0    | 192        | 285        |
| 08:45 AM    | 3                  | 0    | 0    | 0    | 3          | 0                         | 72   | 3    | 0    | 75         | 1                  | 0    | 20   | 0    | 21         | 37                        | 149  | 1    | 0    | 187        | 286        |
| Total       | 11                 | 1    | 10   | 0    | 22         | 0                         | 383  | 22   | 0    | 405        | 13                 | 0    | 105  | 0    | 118        | 160                       | 588  | 2    | 0    | 750        | 1295       |
| Grand Total | 27                 | 4    | 14   | 0    | 45         | 0                         | 1121 | 34   | 0    | 1155       | 24                 | 0    | 280  | 0    | 304        | 269                       | 1287 | 2    | 0    | 1558       | 3062       |
| Apprch %    | 60                 | 8.9  | 31.1 | 0    |            | 0                         | 97.1 | 2.9  | 0    |            | 7.9                | 0    | 92.1 | 0    |            | 17.3                      | 82.6 | 0.1  | 0    |            |            |
| Total %     | 0.9                | 0.1  | 0.5  | 0    | 1.5        | 0                         | 36.6 | 1.1  | 0    | 37.7       | 0.8                | 0    | 9.1  | 0    | 9.9        | 8.8                       | 42   | 0.1  | 0    | 50.9       |            |
| Lights      | 26                 | 3    | 14   | 0    | 43         | 0                         | 1093 | 34   | 0    | 1127       | 23                 | 0    | 276  | 0    | 299        | 257                       | 1256 | 2    | 0    | 1515       | 2984       |
| % Lights    | 96.3               | 75   | 100  | 0    | 95.6       | 0                         | 97.5 | 100  | 0    | 97.6       | 95.8               | 0    | 98.6 | 0    | 98.4       | 95.5                      | 97.6 | 100  | 0    | 97.2       | 97.5       |
| Buses       | 0                  | 1    | 0    | 0    | 1          | 0                         | 10   | 0    | 0    | 10         | 0                  | 0    | 2    | 0    | 2          | 8                         | 12   | 0    | 0    | 20         | 33         |
| % Buses     | 0                  | 25   | 0    | 0    | 2.2        | 0                         | 0.9  | 0    | 0    | 0.9        | 0                  | 0    | 0.7  | 0    | 0.7        | 3                         | 0.9  | 0    | 0    | 1.3        | 1.1        |
| Trucks      | 1                  | 0    | 0    | 0    | 1          | 0                         | 18   | 0    | 0    | 18         | 1                  | 0    | 2    | 0    | 3          | 4                         | 19   | 0    | 0    | 23         | 45         |
| % Trucks    | 3.7                | 0    | 0    | 0    | 2.2        | 0                         | 1.6  | 0    | 0    | 1.6        | 4.2                | 0    | 0.7  | 0    | 1          | 1.5                       | 1.5  | 0    | 0    | 1.5        | 1.5        |

| Start Time   | 1ST AVE Southbound |      |      |            | LIGHTFIGHTER DR Westbound |      |      |            | 1ST AVE Northbound |      |      |            | LIGHTFIGHTER DR Eastbound |      |      |            | Int. Total |
|--|--------------------|------|------|------------|---------------------------|------|------|------------|--------------------|------|------|------------|---------------------------|------|------|------------|------------|
|  | Right              | Thru | Left | App. Total | Right                     | Thru | Left | App. Total | Right              | Thru | Left | App. Total | Right                     | Thru | Left | App. Total |            |
| Peak Hour Analysis From 07:00 AM to 08:45 AM - Peak 1 of 1 |                    |      |      |            |                           |      |      |            |                    |      |      |            |                           |      |      |            |            |
| Peak Hour for Entire Intersection Begins at 07:15 AM       |                    |      |      |            |                           |      |      |            |                    |      |      |            |                           |      |      |            |            |
| 07:15 AM   | 4                  | 1    | 0    | 5          | 0                         | 160  | 7    | 167        | 0                  | 0    | 44   | 44         | 22                        | 160  | 0    | 182        | 398        |
| 07:30 AM   | 5                  | 0    | 1    | 6          | 0                         | 270  | 3    | 273        | 1                  | 0    | 43   | 44         | 31                        | 199  | 0    | 230        | 553        |
| 07:45 AM   | 5                  | 2    | 3    | 10         | 0                         | 182  | 1    | 183        | 10                 | 0    | 35   | 45         | 44                        | 233  | 0    | 277        | 515        |
| 08:00 AM   | 4                  | 1    | 10   | 15         | 0                         | 142  | 9    | 151        | 5                  | 0    | 36   | 41         | 29                        | 156  | 0    | 185        | 392        |
| Total Volume   | 18                 | 4    | 14   | 36         | 0                         | 754  | 20   | 774        | 16                 | 0    | 158  | 174        | 126                       | 748  | 0    | 874        | 1858       |
| % App. Total   | 50                 | 11.1 | 38.9 |            | 0                         | 97.4 | 2.6  |            | 9.2                | 0    | 90.8 |            | 14.4                      | 85.6 | 0    |            |            |
| PHF  | .900               | .500 | .350 | .600       | .000                      | .698 | .556 | .709       | .400               | .000 | .898 | .967       | .716                      | .803 | .000 | .789       | .840       |

# Traffic Data Service

San Jose, CA  
 (408) 622-4787  
 tdsbay@cs.com

File Name : 22AM FINAL  
 Site Code : 00000022  
 Start Date : 4/27/2017  
 Page No : 2

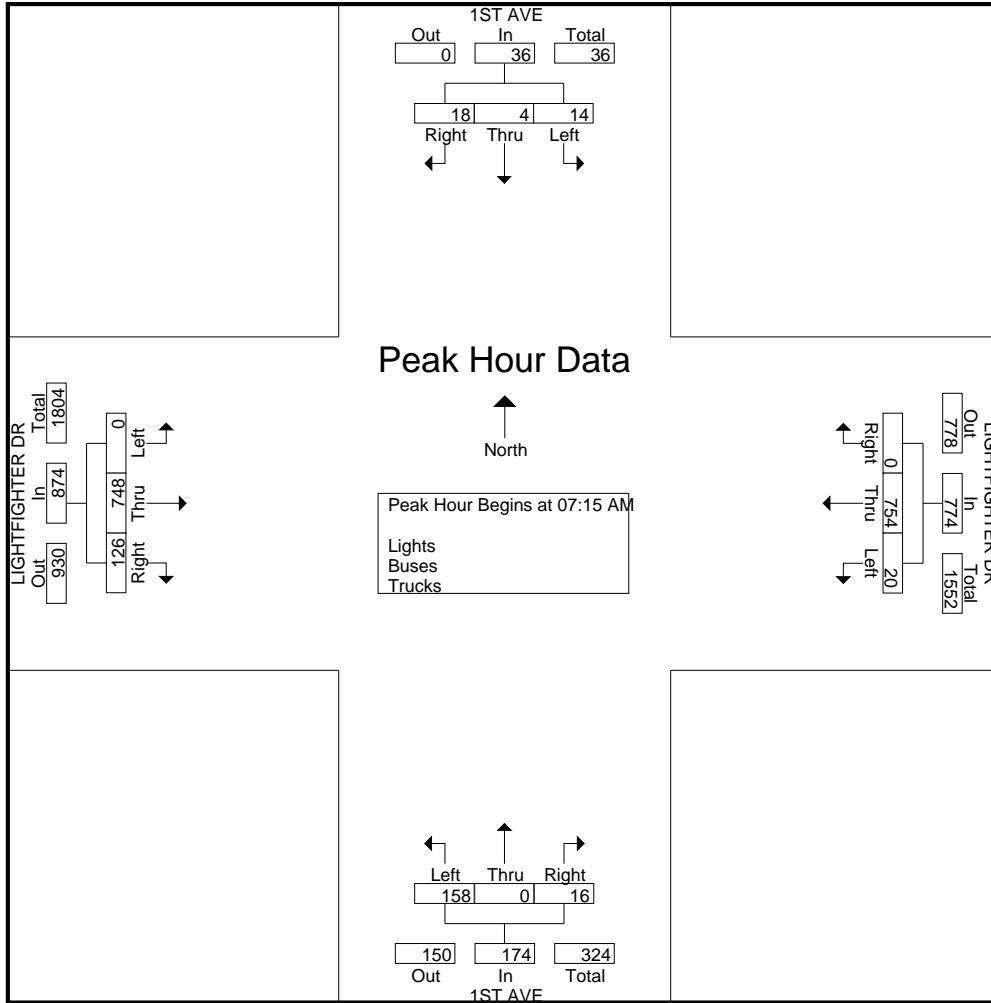

# Traffic Data Service

San Jose, CA  
 (408) 622-4787  
 tdsbay@cs.com

File Name : 22AM FINAL  
 Site Code : 00000022  
 Start Date : 4/27/2017  
 Page No : 1

Groups Printed- Bikes

| Start Time   | 1ST AVE Southbound |      |      |      |            | LIGHTFIGHTER DR Westbound |      |      |      |            | 1ST AVE Northbound |      |      |      |            | LIGHTFIGHTER DR Eastbound |      |      |      |            | Int. Total |
|--------------|--------------------|------|------|------|------------|---------------------------|------|------|------|------------|--------------------|------|------|------|------------|---------------------------|------|------|------|------------|------------|
|              | Right              | Thru | Left | Peds | App. Total | Right                     | Thru | Left | Peds | App. Total | Right              | Thru | Left | Peds | App. Total | Right                     | Thru | Left | Peds | App. Total |            |
| 07:00 AM     | 0                  | 0    | 0    | 0    | 0          | 0                         | 0    | 0    | 0    | 0          | 0                  | 0    | 0    | 0    | 0          | 0                         | 0    | 0    | 0    | 0          | 0          |
| 07:15 AM     | 0                  | 0    | 0    | 0    | 0          | 0                         | 0    | 0    | 0    | 0          | 0                  | 0    | 0    | 0    | 0          | 0                         | 0    | 0    | 0    | 0          | 0          |
| 07:30 AM     | 0                  | 0    | 0    | 0    | 0          | 0                         | 1    | 0    | 0    | 1          | 0                  | 0    | 0    | 0    | 0          | 0                         | 0    | 0    | 0    | 0          | 1          |
| 07:45 AM     | 0                  | 0    | 0    | 0    | 0          | 0                         | 0    | 0    | 0    | 0          | 0                  | 0    | 0    | 0    | 0          | 0                         | 0    | 0    | 0    | 0          | 0          |
| <b>Total</b> | 0                  | 0    | 0    | 0    | 0          | 0                         | 1    | 0    | 0    | 1          | 0                  | 0    | 0    | 0    | 0          | 0                         | 0    | 0    | 0    | 0          | 1          |
| 08:00 AM     | 0                  | 0    | 0    | 0    | 0          | 0                         | 0    | 0    | 0    | 0          | 0                  | 0    | 0    | 0    | 0          | 0                         | 0    | 0    | 0    | 0          | 0          |
| 08:15 AM     | 0                  | 0    | 0    | 0    | 0          | 0                         | 0    | 0    | 0    | 0          | 0                  | 0    | 0    | 0    | 0          | 0                         | 0    | 0    | 0    | 0          | 0          |
| 08:30 AM     | 0                  | 0    | 0    | 0    | 0          | 0                         | 0    | 0    | 0    | 0          | 0                  | 0    | 0    | 0    | 0          | 0                         | 0    | 0    | 0    | 0          | 0          |
| 08:45 AM     | 0                  | 0    | 0    | 0    | 0          | 0                         | 0    | 0    | 0    | 0          | 0                  | 0    | 0    | 0    | 0          | 0                         | 0    | 0    | 0    | 0          | 0          |
| <b>Total</b> | 0                  | 0    | 0    | 0    | 0          | 0                         | 0    | 0    | 0    | 0          | 0                  | 0    | 0    | 0    | 0          | 0                         | 0    | 0    | 0    | 0          | 0          |
| Grand Total  | 0                  | 0    | 0    | 0    | 0          | 0                         | 1    | 0    | 0    | 1          | 0                  | 0    | 0    | 0    | 0          | 0                         | 0    | 0    | 0    | 0          | 1          |
| Apprch %     | 0                  | 0    | 0    | 0    |            | 0                         | 100  | 0    | 0    |            | 0                  | 0    | 0    | 0    |            | 0                         | 0    | 0    | 0    |            |            |
| Total %      | 0                  | 0    | 0    | 0    |            | 0                         | 100  | 0    | 0    | 100        | 0                  | 0    | 0    | 0    |            | 0                         | 0    | 0    | 0    |            |            |

| Start Time   | 1ST AVE Southbound |      |      |      |            | LIGHTFIGHTER DR Westbound |      |      |      |            | 1ST AVE Northbound |      |      |      |            | LIGHTFIGHTER DR Eastbound |      |      |      |            | Int. Total |
|--|--------------------|------|------|------|------------|---------------------------|------|------|------|------------|--------------------|------|------|------|------------|---------------------------|------|------|------|------------|------------|
|  | Right              | Thru | Left | Peds | App. Total | Right                     | Thru | Left | Peds | App. Total | Right              | Thru | Left | Peds | App. Total | Right                     | Thru | Left | Peds | App. Total |            |
| Peak Hour Analysis From 07:00 AM to 08:45 AM - Peak 1 of 1 |                    |      |      |      |            |                           |      |      |      |            |                    |      |      |      |            |                           |      |      |      |            |            |
| Peak Hour for Entire Intersection Begins at 07:00 AM       |                    |      |      |      |            |                           |      |      |      |            |                    |      |      |      |            |                           |      |      |      |            |            |
| 07:00 AM   | 0                  | 0    | 0    | 0    | 0          | 0                         | 0    | 0    | 0    | 0          | 0                  | 0    | 0    | 0    | 0          | 0                         | 0    | 0    | 0    | 0          | 0          |
| 07:15 AM   | 0                  | 0    | 0    | 0    | 0          | 0                         | 0    | 0    | 0    | 0          | 0                  | 0    | 0    | 0    | 0          | 0                         | 0    | 0    | 0    | 0          | 0          |
| 07:30 AM   | 0                  | 0    | 0    | 0    | 0          | 0                         | 1    | 0    | 0    | 1          | 0                  | 0    | 0    | 0    | 0          | 0                         | 0    | 0    | 0    | 0          | 1          |
| 07:45 AM   | 0                  | 0    | 0    | 0    | 0          | 0                         | 0    | 0    | 0    | 0          | 0                  | 0    | 0    | 0    | 0          | 0                         | 0    | 0    | 0    | 0          | 0          |
| Total Volume   | 0                  | 0    | 0    | 0    | 0          | 0                         | 1    | 0    | 0    | 1          | 0                  | 0    | 0    | 0    | 0          | 0                         | 0    | 0    | 0    | 0          | 1          |
| % App. Total   | 0                  | 0    | 0    | 0    |            | 0                         | 100  | 0    | 0    |            | 0                  | 0    | 0    | 0    |            | 0                         | 0    | 0    | 0    |            |            |
| PHF  | .000               | .000 | .000 | .000 | .000       | .000                      | .250 | .000 | .250 | .000       | .000               | .000 | .000 | .000 | .000       | .000                      | .000 | .000 | .000 | .000       | .250       |

# Traffic Data Service

San Jose, CA  
 (408) 622-4787  
 tdsbay@cs.com

File Name : 22AM FINAL  
 Site Code : 00000022  
 Start Date : 4/27/2017  
 Page No : 2

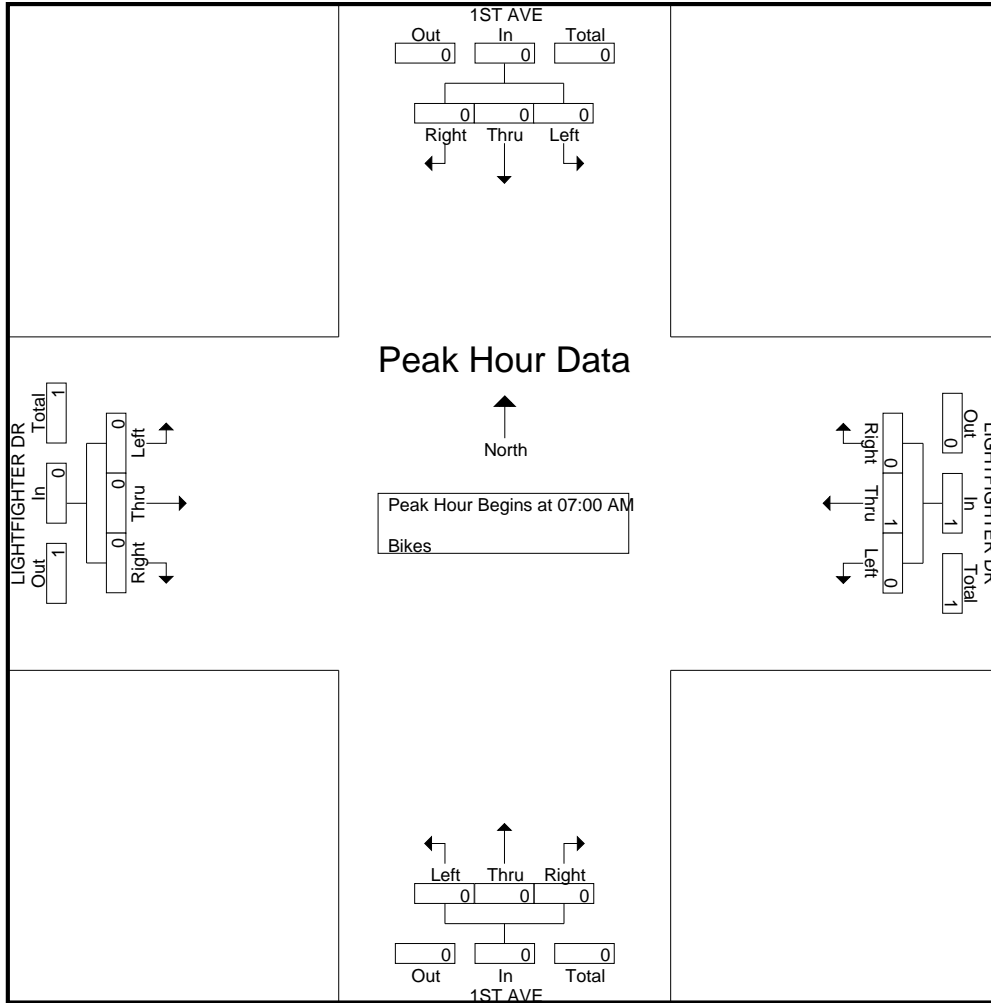

# Traffic Data Service

San Jose, CA  
(408) 622-4787  
tdsbay@cs.com

File Name : 22PM FINAL  
Site Code : 00000022  
Start Date : 4/27/2017  
Page No : 1

Groups Printed- Lights - Buses - Trucks

| Start Time   | 1ST AVE Southbound |          |          |          |            | LIGHTFIGHTER DR Westbound |            |           |          |            | 1ST AVE Northbound |          |            |          |            | LIGHTFIGHTER DR Eastbound |            |          |          |            | Int. Total  |
|--------------|--------------------|----------|----------|----------|------------|---------------------------|------------|-----------|----------|------------|--------------------|----------|------------|----------|------------|---------------------------|------------|----------|----------|------------|-------------|
|              | Right              | Thru     | Left     | Peds     | App. Total | Right                     | Thru       | Left      | Peds     | App. Total | Right              | Thru     | Left       | Peds     | App. Total | Right                     | Thru       | Left     | Peds     | App. Total |             |
| 04:00 PM     | 6                  | 0        | 0        | 0        | 6          | 0                         | 204        | 5         | 0        | 209        | 6                  | 0        | 55         | 0        | 61         | 33                        | 86         | 0        | 0        | 119        | 395         |
| 04:15 PM     | 4                  | 0        | 0        | 0        | 4          | 0                         | 159        | 4         | 0        | 163        | 6                  | 0        | 44         | 0        | 50         | 27                        | 107        | 0        | 0        | 134        | 351         |
| 04:30 PM     | 4                  | 0        | 0        | 0        | 4          | 0                         | 222        | 1         | 0        | 223        | 4                  | 0        | 53         | 0        | 57         | 32                        | 103        | 0        | 0        | 135        | 419         |
| 04:45 PM     | 4                  | 0        | 1        | 0        | 5          | 0                         | 261        | 8         | 0        | 269        | 4                  | 0        | 52         | 0        | 56         | 33                        | 107        | 0        | 0        | 140        | 470         |
| <b>Total</b> | <b>18</b>          | <b>0</b> | <b>1</b> | <b>0</b> | <b>19</b>  | <b>0</b>                  | <b>846</b> | <b>18</b> | <b>0</b> | <b>864</b> | <b>20</b>          | <b>0</b> | <b>204</b> | <b>0</b> | <b>224</b> | <b>125</b>                | <b>403</b> | <b>0</b> | <b>0</b> | <b>528</b> | <b>1635</b> |
| 05:00 PM     | 12                 | 0        | 0        | 0        | 12         | 0                         | 241        | 3         | 0        | 244        | 4                  | 0        | 55         | 0        | 59         | 16                        | 132        | 0        | 0        | 148        | 463         |
| 05:15 PM     | 0                  | 0        | 0        | 0        | 0          | 0                         | 247        | 2         | 0        | 249        | 10                 | 0        | 35         | 0        | 45         | 22                        | 111        | 0        | 0        | 133        | 427         |
| 05:30 PM     | 8                  | 0        | 0        | 0        | 8          | 0                         | 208        | 4         | 0        | 212        | 4                  | 0        | 41         | 0        | 45         | 21                        | 122        | 0        | 0        | 143        | 408         |
| 05:45 PM     | 4                  | 0        | 0        | 0        | 4          | 1                         | 189        | 2         | 0        | 192        | 5                  | 0        | 29         | 0        | 34         | 25                        | 128        | 0        | 0        | 153        | 383         |
| <b>Total</b> | <b>24</b>          | <b>0</b> | <b>0</b> | <b>0</b> | <b>24</b>  | <b>1</b>                  | <b>885</b> | <b>11</b> | <b>0</b> | <b>897</b> | <b>23</b>          | <b>0</b> | <b>160</b> | <b>0</b> | <b>183</b> | <b>84</b>                 | <b>493</b> | <b>0</b> | <b>0</b> | <b>577</b> | <b>1681</b> |
| Grand Total  | 42                 | 0        | 1        | 0        | 43         | 1                         | 1731       | 29        | 0        | 1761       | 43                 | 0        | 364        | 0        | 407        | 209                       | 896        | 0        | 0        | 1105       | 3316        |
| Apprch %     | 97.7               | 0        | 2.3      | 0        |            | 0.1                       | 98.3       | 1.6       | 0        |            | 10.6               | 0        | 89.4       | 0        |            | 18.9                      | 81.1       | 0        | 0        |            |             |
| Total %      | 1.3                | 0        | 0        | 0        | 1.3        | 0                         | 52.2       | 0.9       | 0        | 53.1       | 1.3                | 0        | 11         | 0        | 12.3       | 6.3                       | 27         | 0        | 0        | 33.3       |             |
| Lights       | 41                 | 0        | 1        | 0        | 42         | 0                         | 1718       | 27        | 0        | 1745       | 43                 | 0        | 358        | 0        | 401        | 205                       | 881        | 0        | 0        | 1086       | 3274        |
| % Lights     | 97.6               | 0        | 100      | 0        | 97.7       | 0                         | 99.2       | 93.1      | 0        | 99.1       | 100                | 0        | 98.4       | 0        | 98.5       | 98.1                      | 98.3       | 0        | 0        | 98.3       | 98.7        |
| Buses        | 0                  | 0        | 0        | 0        | 0          | 0                         | 5          | 2         | 0        | 7          | 0                  | 0        | 4          | 0        | 4          | 4                         | 10         | 0        | 0        | 14         | 25          |
| % Buses      | 0                  | 0        | 0        | 0        | 0          | 0                         | 0.3        | 6.9       | 0        | 0.4        | 0                  | 0        | 1.1        | 0        | 1          | 1.9                       | 1.1        | 0        | 0        | 1.3        | 0.8         |
| Trucks       | 1                  | 0        | 0        | 0        | 1          | 1                         | 8          | 0         | 0        | 9          | 0                  | 0        | 2          | 0        | 2          | 0                         | 5          | 0        | 0        | 5          | 17          |
| % Trucks     | 2.4                | 0        | 0        | 0        | 2.3        | 100                       | 0.5        | 0         | 0        | 0.5        | 0                  | 0        | 0.5        | 0        | 0.5        | 0                         | 0.6        | 0        | 0        | 0.5        | 0.5         |

| Start Time   | 1ST AVE Southbound |      |      |            | LIGHTFIGHTER DR Westbound |            |          |            | 1ST AVE Northbound |      |           |            | LIGHTFIGHTER DR Eastbound |            |      |            | Int. Total |
|--|--------------------|------|------|------------|---------------------------|------------|----------|------------|--------------------|------|-----------|------------|---------------------------|------------|------|------------|------------|
|  | Right              | Thru | Left | App. Total | Right                     | Thru       | Left     | App. Total | Right              | Thru | Left      | App. Total | Right                     | Thru       | Left | App. Total |            |
| Peak Hour Analysis From 04:00 PM to 05:45 PM - Peak 1 of 1 |                    |      |      |            |                           |            |          |            |                    |      |           |            |                           |            |      |            |            |
| Peak Hour for Entire Intersection Begins at 04:30 PM       |                    |      |      |            |                           |            |          |            |                    |      |           |            |                           |            |      |            |            |
| 04:30 PM   | 4                  | 0    | 0    | 4          | 0                         | 222        | 1        | 223        | 4                  | 0    | 53        | 57         | 32                        | 103        | 0    | 135        | 419        |
| 04:45 PM   | 4                  | 0    | 1    | 5          | 0                         | <b>261</b> | <b>8</b> | <b>269</b> | 4                  | 0    | 52        | 56         | <b>33</b>                 | 107        | 0    | 140        | <b>470</b> |
| 05:00 PM   | <b>12</b>          | 0    | 0    | <b>12</b>  | 0                         | 241        | 3        | 244        | 4                  | 0    | <b>55</b> | <b>59</b>  | 16                        | <b>132</b> | 0    | <b>148</b> | 463        |
| 05:15 PM   | 0                  | 0    | 0    | 0          | 0                         | 247        | 2        | 249        | <b>10</b>          | 0    | 35        | 45         | 22                        | 111        | 0    | 133        | 427        |
| Total Volume   | 20                 | 0    | 1    | 21         | 0                         | 971        | 14       | 985        | 22                 | 0    | 195       | 217        | 103                       | 453        | 0    | 556        | 1779       |
| % App. Total   | 95.2               | 0    | 4.8  |            | 0                         | 98.6       | 1.4      |            | 10.1               | 0    | 89.9      |            | 18.5                      | 81.5       | 0    |            |            |
| PHF  | .417               | .000 | .250 | .438       | .000                      | .930       | .438     | .915       | .550               | .000 | .886      | .919       | .780                      | .858       | .000 | .939       | .946       |

# Traffic Data Service

San Jose, CA  
 (408) 622-4787  
 tdsbay@cs.com

File Name : 22PM FINAL  
 Site Code : 00000022  
 Start Date : 4/27/2017  
 Page No : 2

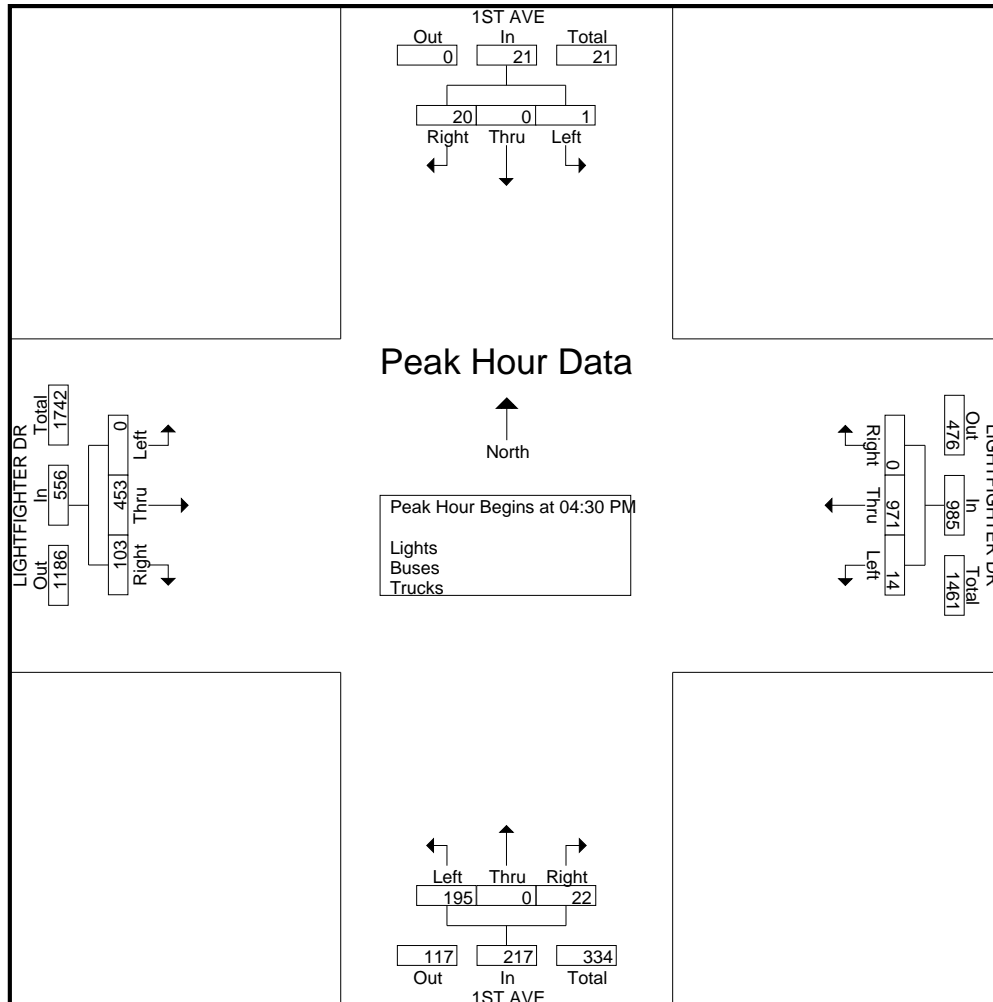

# Traffic Data Service

San Jose, CA  
 (408) 622-4787  
 tdsbay@cs.com

File Name : 22PM FINAL  
 Site Code : 00000022  
 Start Date : 4/27/2017  
 Page No : 1

Groups Printed- Bikes

| Start Time  | 1ST AVE Southbound |      |      |      |            | LIGHTFIGHTER DR Westbound |      |      |      |            | 1ST AVE Northbound |      |      |      |            | LIGHTFIGHTER DR Eastbound |      |      |      |            | Int. Total |
|-------------|--------------------|------|------|------|------------|---------------------------|------|------|------|------------|--------------------|------|------|------|------------|---------------------------|------|------|------|------------|------------|
|             | Right              | Thru | Left | Peds | App. Total | Right                     | Thru | Left | Peds | App. Total | Right              | Thru | Left | Peds | App. Total | Right                     | Thru | Left | Peds | App. Total |            |
| 04:00 PM    | 0                  | 0    | 0    | 0    | 0          | 0                         | 0    | 0    | 0    | 0          | 0                  | 0    | 0    | 0    | 0          | 0                         | 0    | 0    | 0    | 0          | 0          |
| 04:15 PM    | 0                  | 0    | 0    | 0    | 0          | 0                         | 0    | 0    | 0    | 0          | 0                  | 0    | 0    | 0    | 0          | 0                         | 0    | 0    | 0    | 0          | 0          |
| 04:30 PM    | 0                  | 0    | 0    | 0    | 0          | 0                         | 0    | 0    | 0    | 0          | 0                  | 0    | 0    | 0    | 0          | 0                         | 0    | 0    | 0    | 0          | 0          |
| 04:45 PM    | 0                  | 0    | 0    | 0    | 0          | 0                         | 0    | 0    | 0    | 0          | 0                  | 0    | 0    | 0    | 0          | 0                         | 0    | 0    | 0    | 0          | 0          |
| Total       | 0                  | 0    | 0    | 0    | 0          | 0                         | 0    | 0    | 0    | 0          | 0                  | 0    | 0    | 0    | 0          | 0                         | 0    | 0    | 0    | 0          | 0          |
| 05:00 PM    | 0                  | 0    | 0    | 0    | 0          | 0                         | 0    | 0    | 0    | 0          | 0                  | 0    | 0    | 0    | 0          | 0                         | 0    | 0    | 0    | 0          | 0          |
| 05:15 PM    | 0                  | 0    | 0    | 0    | 0          | 0                         | 0    | 0    | 0    | 0          | 0                  | 0    | 0    | 0    | 0          | 0                         | 0    | 0    | 0    | 0          | 0          |
| 05:30 PM    | 0                  | 0    | 0    | 0    | 0          | 0                         | 0    | 0    | 0    | 0          | 0                  | 0    | 0    | 0    | 0          | 0                         | 0    | 0    | 0    | 0          | 0          |
| 05:45 PM    | 0                  | 0    | 0    | 0    | 0          | 0                         | 0    | 0    | 0    | 0          | 0                  | 0    | 0    | 0    | 0          | 0                         | 0    | 0    | 0    | 0          | 0          |
| Total       | 0                  | 0    | 0    | 0    | 0          | 0                         | 0    | 0    | 0    | 0          | 0                  | 0    | 0    | 0    | 0          | 0                         | 0    | 0    | 0    | 0          | 0          |
| Grand Total | 0                  | 0    | 0    | 0    | 0          | 0                         | 0    | 0    | 0    | 0          | 0                  | 0    | 0    | 0    | 0          | 0                         | 0    | 0    | 0    | 0          | 0          |
| Apprch %    | 0                  | 0    | 0    | 0    |            | 0                         | 0    | 0    | 0    |            | 0                  | 0    | 0    | 0    |            | 0                         | 0    | 0    | 0    |            |            |
| Total %     |                    |      |      |      |            |                           |      |      |      |            |                    |      |      |      |            |                           |      |      |      |            |            |

| Start Time   | 1ST AVE Southbound |      |      |      |            | LIGHTFIGHTER DR Westbound |      |      |      |            | 1ST AVE Northbound |      |      |      |            | LIGHTFIGHTER DR Eastbound |      |      |      |            | Int. Total |
|--|--------------------|------|------|------|------------|---------------------------|------|------|------|------------|--------------------|------|------|------|------------|---------------------------|------|------|------|------------|------------|
|  | Right              | Thru | Left | Peds | App. Total | Right                     | Thru | Left | Peds | App. Total | Right              | Thru | Left | Peds | App. Total | Right                     | Thru | Left | Peds | App. Total |            |
| Peak Hour Analysis From 04:00 PM to 05:45 PM - Peak 1 of 1 |                    |      |      |      |            |                           |      |      |      |            |                    |      |      |      |            |                           |      |      |      |            |            |
| Peak Hour for Entire Intersection Begins at 04:00 PM       |                    |      |      |      |            |                           |      |      |      |            |                    |      |      |      |            |                           |      |      |      |            |            |
| 04:00 PM   | 0                  | 0    | 0    | 0    | 0          | 0                         | 0    | 0    | 0    | 0          | 0                  | 0    | 0    | 0    | 0          | 0                         | 0    | 0    | 0    | 0          | 0          |
| 04:15 PM   | 0                  | 0    | 0    | 0    | 0          | 0                         | 0    | 0    | 0    | 0          | 0                  | 0    | 0    | 0    | 0          | 0                         | 0    | 0    | 0    | 0          | 0          |
| 04:30 PM   | 0                  | 0    | 0    | 0    | 0          | 0                         | 0    | 0    | 0    | 0          | 0                  | 0    | 0    | 0    | 0          | 0                         | 0    | 0    | 0    | 0          | 0          |
| 04:45 PM   | 0                  | 0    | 0    | 0    | 0          | 0                         | 0    | 0    | 0    | 0          | 0                  | 0    | 0    | 0    | 0          | 0                         | 0    | 0    | 0    | 0          | 0          |
| Total Volume   | 0                  | 0    | 0    | 0    | 0          | 0                         | 0    | 0    | 0    | 0          | 0                  | 0    | 0    | 0    | 0          | 0                         | 0    | 0    | 0    | 0          | 0          |
| % App. Total   | 0                  | 0    | 0    | 0    |            | 0                         | 0    | 0    | 0    |            | 0                  | 0    | 0    | 0    |            | 0                         | 0    | 0    | 0    |            |            |
| PHF  | .000               | .000 | .000 | .000 | .000       | .000                      | .000 | .000 | .000 | .000       | .000               | .000 | .000 | .000 | .000       | .000                      | .000 | .000 | .000 | .000       | .000       |

# Traffic Data Service

San Jose, CA  
(408) 622-4787  
tdsbay@cs.com

File Name : 22PM FINAL  
Site Code : 00000022  
Start Date : 4/27/2017  
Page No : 2

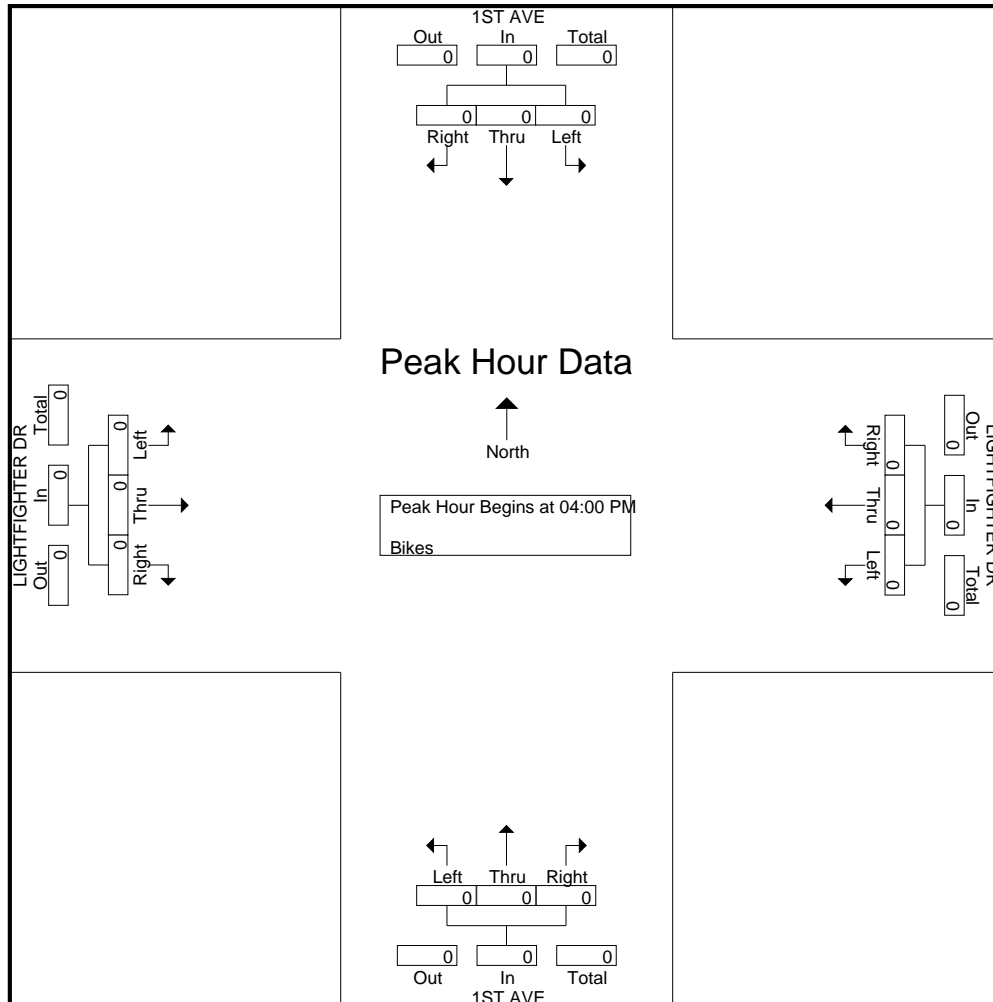



# Traffic Data Service

San Jose, CA  
 (408) 622-4787  
 tdsbay@cs.com

File Name : 23AM FINAL  
 Site Code : 00000023  
 Start Date : 4/27/2017  
 Page No : 1

Groups Printed- Lights - Buses - Trucks

| Start Time   | 2ND AVE Southbound |      |      |      |            | LIGHTFIGHTER DR Westbound |      |      |      |            | 2ND AVE Northbound |      |      |      |            | LIGHTFIGHTER DR Eastbound |      |      |      |            | Int. Total |
|--------------|--------------------|------|------|------|------------|---------------------------|------|------|------|------------|--------------------|------|------|------|------------|---------------------------|------|------|------|------------|------------|
|              | Right              | Thru | Left | Peds | App. Total | Right                     | Thru | Left | Peds | App. Total | Right              | Thru | Left | Peds | App. Total | Right                     | Thru | Left | Peds | App. Total |            |
| 07:00 AM     | 32                 | 1    | 19   | 0    | 52         | 5                         | 103  | 0    | 0    | 108        | 0                  | 1    | 0    | 0    | 1          | 0                         | 96   | 6    | 0    | 102        | 263        |
| 07:15 AM     | 79                 | 1    | 70   | 0    | 150        | 7                         | 102  | 0    | 0    | 109        | 1                  | 0    | 0    | 0    | 1          | 0                         | 155  | 8    | 0    | 163        | 423        |
| 07:30 AM     | 121                | 1    | 64   | 0    | 186        | 14                        | 135  | 3    | 0    | 152        | 0                  | 0    | 0    | 0    | 0          | 1                         | 174  | 14   | 0    | 189        | 527        |
| 07:45 AM     | 87                 | 0    | 70   | 0    | 157        | 28                        | 94   | 1    | 0    | 123        | 0                  | 0    | 0    | 0    | 0          | 1                         | 215  | 27   | 0    | 243        | 523        |
| <b>Total</b> | 319                | 3    | 223  | 0    | 545        | 54                        | 434  | 4    | 0    | 492        | 1                  | 1    | 0    | 0    | 2          | 2                         | 640  | 55   | 0    | 697        | 1736       |
| 08:00 AM     | 56                 | 2    | 68   | 0    | 126        | 19                        | 93   | 1    | 0    | 113        | 0                  | 1    | 2    | 0    | 3          | 0                         | 152  | 29   | 0    | 181        | 423        |
| 08:15 AM     | 38                 | 1    | 59   | 3    | 101        | 7                         | 61   | 0    | 3    | 71         | 0                  | 1    | 0    | 10   | 11         | 0                         | 129  | 23   | 8    | 160        | 343        |
| 08:30 AM     | 21                 | 0    | 32   | 0    | 53         | 8                         | 50   | 0    | 1    | 59         | 2                  | 0    | 1    | 0    | 3          | 0                         | 121  | 13   | 0    | 134        | 249        |
| 08:45 AM     | 21                 | 2    | 29   | 0    | 52         | 5                         | 51   | 2    | 1    | 59         | 2                  | 0    | 0    | 0    | 2          | 0                         | 126  | 23   | 0    | 149        | 262        |
| <b>Total</b> | 136                | 5    | 188  | 3    | 332        | 39                        | 255  | 3    | 5    | 302        | 4                  | 2    | 3    | 10   | 19         | 0                         | 528  | 88   | 8    | 624        | 1277       |
| Grand Total  | 455                | 8    | 411  | 3    | 877        | 93                        | 689  | 7    | 5    | 794        | 5                  | 3    | 3    | 10   | 21         | 2                         | 1168 | 143  | 8    | 1321       | 3013       |
| Apprch %     | 51.9               | 0.9  | 46.9 | 0.3  |            | 11.7                      | 86.8 | 0.9  | 0.6  |            | 23.8               | 14.3 | 14.3 | 47.6 |            | 0.2                       | 88.4 | 10.8 | 0.6  |            |            |
| Total %      | 15.1               | 0.3  | 13.6 | 0.1  | 29.1       | 3.1                       | 22.9 | 0.2  | 0.2  | 26.4       | 0.2                | 0.1  | 0.1  | 0.3  | 0.7        | 0.1                       | 38.8 | 4.7  | 0.3  | 43.8       |            |
| Lights       | 450                | 8    | 403  | 3    | 864        | 88                        | 665  | 7    | 3    | 763        | 4                  | 3    | 3    | 10   | 20         | 2                         | 1142 | 139  | 8    | 1291       | 2938       |
| % Lights     | 98.9               | 100  | 98.1 | 100  | 98.5       | 94.6                      | 96.5 | 100  | 60   | 96.1       | 80                 | 100  | 100  | 100  | 95.2       | 100                       | 97.8 | 97.2 | 100  | 97.7       | 97.5       |
| Buses        | 2                  | 0    | 4    | 0    | 6          | 2                         | 8    | 0    | 0    | 10         | 0                  | 0    | 0    | 0    | 0          | 0                         | 11   | 1    | 0    | 12         | 28         |
| % Buses      | 0.4                | 0    | 1    | 0    | 0.7        | 2.2                       | 1.2  | 0    | 0    | 1.3        | 0                  | 0    | 0    | 0    | 0          | 0                         | 0.9  | 0.7  | 0    | 0.9        | 0.9        |
| Trucks       | 3                  | 0    | 4    | 0    | 7          | 3                         | 16   | 0    | 2    | 21         | 1                  | 0    | 0    | 0    | 1          | 0                         | 15   | 3    | 0    | 18         | 47         |
| % Trucks     | 0.7                | 0    | 1    | 0    | 0.8        | 3.2                       | 2.3  | 0    | 40   | 2.6        | 20                 | 0    | 0    | 0    | 4.8        | 0                         | 1.3  | 2.1  | 0    | 1.4        | 1.6        |

| Start Time   | 2ND AVE Southbound |      |      |            | LIGHTFIGHTER DR Westbound |      |      |            | 2ND AVE Northbound |      |      |            | LIGHTFIGHTER DR Eastbound |      |      |            | Int. Total |
|--|--------------------|------|------|------------|---------------------------|------|------|------------|--------------------|------|------|------------|---------------------------|------|------|------------|------------|
|  | Right              | Thru | Left | App. Total | Right                     | Thru | Left | App. Total | Right              | Thru | Left | App. Total | Right                     | Thru | Left | App. Total |            |
| Peak Hour Analysis From 07:00 AM to 08:45 AM - Peak 1 of 1 |                    |      |      |            |                           |      |      |            |                    |      |      |            |                           |      |      |            |            |
| Peak Hour for Entire Intersection Begins at 07:15 AM       |                    |      |      |            |                           |      |      |            |                    |      |      |            |                           |      |      |            |            |
| 07:15 AM   | 79                 | 1    | 70   | 150        | 7                         | 102  | 0    | 109        | 1                  | 0    | 0    | 1          | 0                         | 155  | 8    | 163        | 423        |
| 07:30 AM   | 121                | 1    | 64   | 186        | 14                        | 135  | 3    | 152        | 0                  | 0    | 0    | 0          | 1                         | 174  | 14   | 189        | 527        |
| 07:45 AM   | 87                 | 0    | 70   | 157        | 28                        | 94   | 1    | 123        | 0                  | 0    | 0    | 0          | 1                         | 215  | 27   | 243        | 523        |
| 08:00 AM   | 56                 | 2    | 68   | 126        | 19                        | 93   | 1    | 113        | 0                  | 1    | 2    | 3          | 0                         | 152  | 29   | 181        | 423        |
| Total Volume   | 343                | 4    | 272  | 619        | 68                        | 424  | 5    | 497        | 1                  | 1    | 2    | 4          | 2                         | 696  | 78   | 776        | 1896       |
| % App. Total   | 55.4               | 0.6  | 43.9 |            | 13.7                      | 85.3 | 1    |            | 25                 | 25   | 50   |            | 0.3                       | 89.7 | 10.1 |            |            |
| PHF  | .709               | .500 | .971 | .832       | .607                      | .785 | .417 | .817       | .250               | .250 | .250 | .333       | .500                      | .809 | .672 | .798       | .899       |

# Traffic Data Service

San Jose, CA  
 (408) 622-4787  
 tdsbay@cs.com

File Name : 23AM FINAL  
 Site Code : 00000023  
 Start Date : 4/27/2017  
 Page No : 2

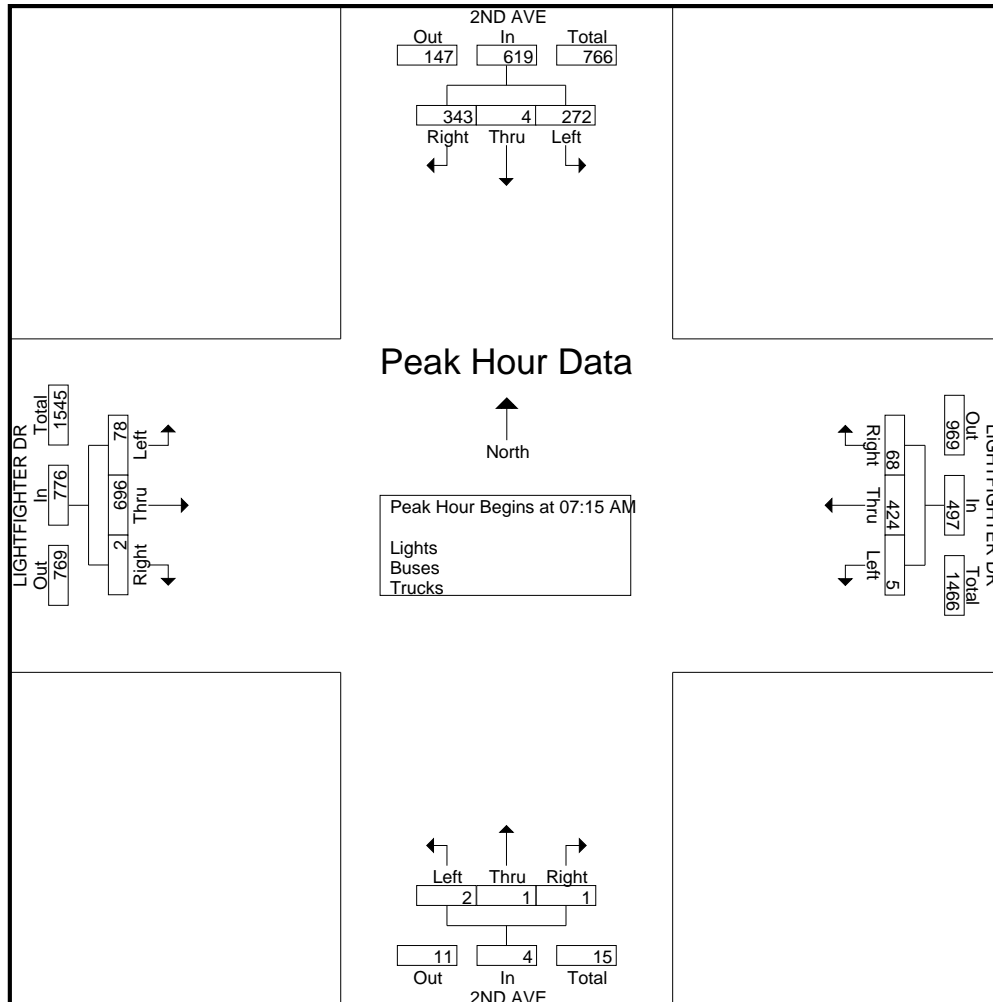

# Traffic Data Service

San Jose, CA  
 (408) 622-4787  
 tdsbay@cs.com

File Name : 23AM FINAL  
 Site Code : 00000023  
 Start Date : 4/27/2017  
 Page No : 1

Groups Printed- Bikes

| Start Time  | 2ND AVE Southbound |      |      |      |            | LIGHTFIGHTER DR Westbound |      |      |      |            | 2ND AVE Northbound |      |      |      |            | LIGHTFIGHTER DR Eastbound |      |      |      |            | Int. Total |
|-------------|--------------------|------|------|------|------------|---------------------------|------|------|------|------------|--------------------|------|------|------|------------|---------------------------|------|------|------|------------|------------|
|             | Right              | Thru | Left | Peds | App. Total | Right                     | Thru | Left | Peds | App. Total | Right              | Thru | Left | Peds | App. Total | Right                     | Thru | Left | Peds | App. Total |            |
| 07:00 AM    | 0                  | 0    | 0    | 0    | 0          | 0                         | 0    | 0    | 0    | 0          | 0                  | 0    | 0    | 0    | 0          | 0                         | 0    | 0    | 0    | 0          | 0          |
| 07:15 AM    | 0                  | 0    | 0    | 0    | 0          | 0                         | 0    | 0    | 0    | 0          | 0                  | 0    | 0    | 0    | 0          | 0                         | 0    | 0    | 0    | 0          | 0          |
| 07:30 AM    | 0                  | 0    | 0    | 0    | 0          | 0                         | 0    | 0    | 0    | 0          | 0                  | 0    | 0    | 0    | 0          | 0                         | 0    | 0    | 0    | 0          | 0          |
| 07:45 AM    | 0                  | 0    | 0    | 0    | 0          | 0                         | 0    | 0    | 0    | 0          | 0                  | 0    | 0    | 0    | 0          | 0                         | 0    | 0    | 0    | 0          | 0          |
| Total       | 0                  | 0    | 0    | 0    | 0          | 0                         | 0    | 0    | 0    | 0          | 0                  | 0    | 0    | 0    | 0          | 0                         | 0    | 0    | 0    | 0          | 0          |
| 08:00 AM    | 0                  | 0    | 0    | 0    | 0          | 0                         | 0    | 0    | 0    | 0          | 0                  | 0    | 0    | 0    | 0          | 0                         | 0    | 0    | 0    | 0          | 0          |
| 08:15 AM    | 0                  | 0    | 0    | 0    | 0          | 0                         | 0    | 0    | 0    | 0          | 0                  | 0    | 0    | 0    | 0          | 0                         | 0    | 0    | 0    | 0          | 0          |
| 08:30 AM    | 0                  | 0    | 0    | 0    | 0          | 0                         | 0    | 0    | 0    | 0          | 0                  | 0    | 0    | 0    | 0          | 0                         | 0    | 0    | 0    | 0          | 0          |
| 08:45 AM    | 0                  | 0    | 0    | 0    | 0          | 0                         | 0    | 0    | 0    | 0          | 0                  | 0    | 0    | 0    | 0          | 0                         | 0    | 0    | 0    | 0          | 0          |
| Total       | 0                  | 0    | 0    | 0    | 0          | 0                         | 0    | 0    | 0    | 0          | 0                  | 0    | 0    | 0    | 0          | 0                         | 0    | 0    | 0    | 0          | 0          |
| Grand Total | 0                  | 0    | 0    | 0    | 0          | 0                         | 0    | 0    | 0    | 0          | 0                  | 0    | 0    | 0    | 0          | 0                         | 0    | 0    | 0    | 0          | 0          |
| Apprch %    | 0                  | 0    | 0    | 0    |            | 0                         | 0    | 0    | 0    |            | 0                  | 0    | 0    | 0    |            | 0                         | 0    | 0    | 0    |            |            |
| Total %     |                    |      |      |      |            |                           |      |      |      |            |                    |      |      |      |            |                           |      |      |      |            |            |

| Start Time   | 2ND AVE Southbound |      |      |      |            | LIGHTFIGHTER DR Westbound |      |      |      |            | 2ND AVE Northbound |      |      |      |            | LIGHTFIGHTER DR Eastbound |      |      |      |            | Int. Total |
|--|--------------------|------|------|------|------------|---------------------------|------|------|------|------------|--------------------|------|------|------|------------|---------------------------|------|------|------|------------|------------|
|  | Right              | Thru | Left | Peds | App. Total | Right                     | Thru | Left | Peds | App. Total | Right              | Thru | Left | Peds | App. Total | Right                     | Thru | Left | Peds | App. Total |            |
| Peak Hour Analysis From 07:00 AM to 08:45 AM - Peak 1 of 1 |                    |      |      |      |            |                           |      |      |      |            |                    |      |      |      |            |                           |      |      |      |            |            |
| Peak Hour for Entire Intersection Begins at 07:00 AM       |                    |      |      |      |            |                           |      |      |      |            |                    |      |      |      |            |                           |      |      |      |            |            |
| 07:00 AM   | 0                  | 0    | 0    | 0    | 0          | 0                         | 0    | 0    | 0    | 0          | 0                  | 0    | 0    | 0    | 0          | 0                         | 0    | 0    | 0    | 0          | 0          |
| 07:15 AM   | 0                  | 0    | 0    | 0    | 0          | 0                         | 0    | 0    | 0    | 0          | 0                  | 0    | 0    | 0    | 0          | 0                         | 0    | 0    | 0    | 0          | 0          |
| 07:30 AM   | 0                  | 0    | 0    | 0    | 0          | 0                         | 0    | 0    | 0    | 0          | 0                  | 0    | 0    | 0    | 0          | 0                         | 0    | 0    | 0    | 0          | 0          |
| 07:45 AM   | 0                  | 0    | 0    | 0    | 0          | 0                         | 0    | 0    | 0    | 0          | 0                  | 0    | 0    | 0    | 0          | 0                         | 0    | 0    | 0    | 0          | 0          |
| Total Volume   | 0                  | 0    | 0    | 0    | 0          | 0                         | 0    | 0    | 0    | 0          | 0                  | 0    | 0    | 0    | 0          | 0                         | 0    | 0    | 0    | 0          | 0          |
| % App. Total   | 0                  | 0    | 0    | 0    |            | 0                         | 0    | 0    | 0    |            | 0                  | 0    | 0    | 0    |            | 0                         | 0    | 0    | 0    |            |            |
| PHF  | .000               | .000 | .000 | .000 | .000       | .000                      | .000 | .000 | .000 | .000       | .000               | .000 | .000 | .000 | .000       | .000                      | .000 | .000 | .000 | .000       | .000       |

# Traffic Data Service

San Jose, CA  
(408) 622-4787  
tdsbay@cs.com

File Name : 23AM FINAL  
Site Code : 00000023  
Start Date : 4/27/2017  
Page No : 2

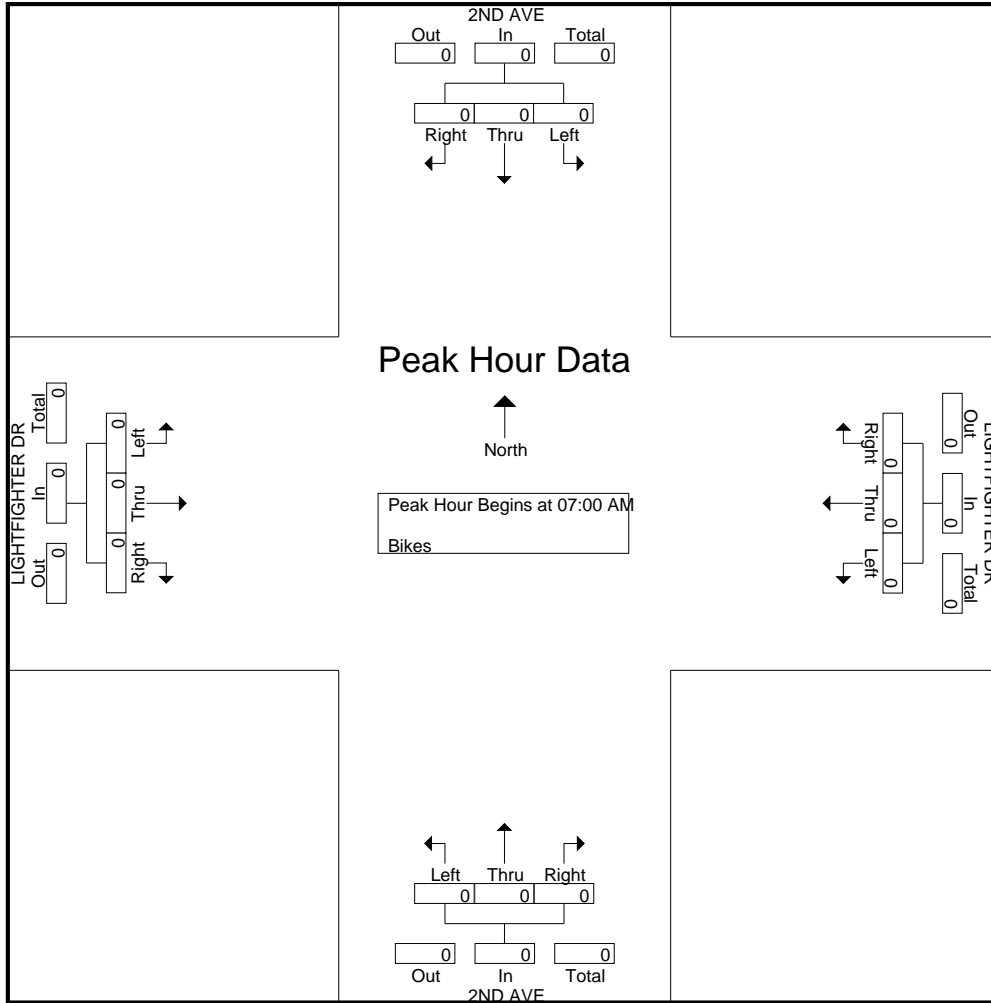

# Traffic Data Service

San Jose, CA  
 (408) 622-4787  
 tdsbay@cs.com

File Name : 23PM FINAL  
 Site Code : 00000023  
 Start Date : 4/27/2017  
 Page No : 1

Groups Printed- Lights - Buses - Trucks

| Start Time   | 2ND AVE Southbound |      |      |      |            | LIGHTFIGHTER DR Westbound |      |      |      |            | 2ND AVE Northbound |      |      |      |            | LIGHTFIGHTER DR Eastbound |      |      |      |            | Int. Total |
|--------------|--------------------|------|------|------|------------|---------------------------|------|------|------|------------|--------------------|------|------|------|------------|---------------------------|------|------|------|------------|------------|
|              | Right              | Thru | Left | Peds | App. Total | Right                     | Thru | Left | Peds | App. Total | Right              | Thru | Left | Peds | App. Total | Right                     | Thru | Left | Peds | App. Total |            |
| 04:00 PM     | 21                 | 0    | 16   | 0    | 37         | 16                        | 188  | 1    | 0    | 205        | 2                  | 1    | 0    | 4    | 7          | 0                         | 80   | 16   | 2    | 98         | 347        |
| 04:15 PM     | 16                 | 0    | 25   | 0    | 41         | 17                        | 147  | 0    | 0    | 164        | 2                  | 0    | 4    | 0    | 6          | 1                         | 79   | 33   | 0    | 113        | 324        |
| 04:30 PM     | 21                 | 1    | 20   | 0    | 42         | 24                        | 212  | 0    | 0    | 236        | 3                  | 1    | 2    | 0    | 6          | 0                         | 67   | 40   | 0    | 107        | 391        |
| 04:45 PM     | 21                 | 3    | 27   | 0    | 51         | 30                        | 238  | 1    | 0    | 269        | 3                  | 0    | 1    | 1    | 5          | 1                         | 79   | 30   | 2    | 112        | 437        |
| <b>Total</b> | 79                 | 4    | 88   | 0    | 171        | 87                        | 785  | 2    | 0    | 874        | 10                 | 2    | 7    | 5    | 24         | 2                         | 305  | 119  | 4    | 430        | 1499       |
| 05:00 PM     | 43                 | 0    | 11   | 0    | 54         | 33                        | 192  | 0    | 0    | 225        | 1                  | 0    | 0    | 0    | 1          | 0                         | 86   | 42   | 0    | 128        | 408        |
| 05:15 PM     | 28                 | 1    | 20   | 0    | 49         | 39                        | 226  | 1    | 0    | 266        | 1                  | 0    | 2    | 1    | 4          | 0                         | 90   | 33   | 2    | 125        | 444        |
| 05:30 PM     | 46                 | 0    | 21   | 0    | 67         | 32                        | 157  | 0    | 0    | 189        | 0                  | 1    | 1    | 0    | 2          | 0                         | 101  | 32   | 0    | 133        | 391        |
| 05:45 PM     | 38                 | 0    | 27   | 0    | 65         | 31                        | 148  | 0    | 1    | 180        | 0                  | 1    | 3    | 0    | 4          | 0                         | 96   | 34   | 1    | 131        | 380        |
| <b>Total</b> | 155                | 1    | 79   | 0    | 235        | 135                       | 723  | 1    | 1    | 860        | 2                  | 2    | 6    | 1    | 11         | 0                         | 373  | 141  | 3    | 517        | 1623       |
| Grand Total  | 234                | 5    | 167  | 0    | 406        | 222                       | 1508 | 3    | 1    | 1734       | 12                 | 4    | 13   | 6    | 35         | 2                         | 678  | 260  | 7    | 947        | 3122       |
| Apprch %     | 57.6               | 1.2  | 41.1 | 0    |            | 12.8                      | 87   | 0.2  | 0.1  |            | 34.3               | 11.4 | 37.1 | 17.1 |            | 0.2                       | 71.6 | 27.5 | 0.7  |            |            |
| Total %      | 7.5                | 0.2  | 5.3  | 0    | 13         | 7.1                       | 48.3 | 0.1  | 0    | 55.5       | 0.4                | 0.1  | 0.4  | 0.2  | 1.1        | 0.1                       | 21.7 | 8.3  | 0.2  | 30.3       |            |
| Lights       | 231                | 5    | 165  | 0    | 401        | 220                       | 1496 | 3    | 0    | 1719       | 12                 | 4    | 13   | 6    | 35         | 2                         | 665  | 256  | 7    | 930        | 3085       |
| % Lights     | 98.7               | 100  | 98.8 | 0    | 98.8       | 99.1                      | 99.2 | 100  | 0    | 99.1       | 100                | 100  | 100  | 100  | 100        | 100                       | 98.1 | 98.5 | 100  | 98.2       | 98.8       |
| Buses        | 2                  | 0    | 2    | 0    | 4          | 1                         | 4    | 0    | 0    | 5          | 0                  | 0    | 0    | 0    | 0          | 0                         | 9    | 1    | 0    | 10         | 19         |
| % Buses      | 0.9                | 0    | 1.2  | 0    | 1          | 0.5                       | 0.3  | 0    | 0    | 0.3        | 0                  | 0    | 0    | 0    | 0          | 0                         | 1.3  | 0.4  | 0    | 1.1        | 0.6        |
| Trucks       | 1                  | 0    | 0    | 0    | 1          | 1                         | 8    | 0    | 1    | 10         | 0                  | 0    | 0    | 0    | 0          | 0                         | 4    | 3    | 0    | 7          | 18         |
| % Trucks     | 0.4                | 0    | 0    | 0    | 0.2        | 0.5                       | 0.5  | 0    | 100  | 0.6        | 0                  | 0    | 0    | 0    | 0          | 0                         | 0.6  | 1.2  | 0    | 0.7        | 0.6        |

| Start Time   | 2ND AVE Southbound |          |           |            | LIGHTFIGHTER DR Westbound |            |          |            | 2ND AVE Northbound |          |          |            | LIGHTFIGHTER DR Eastbound |           |           |            | Int. Total |
|--|--------------------|----------|-----------|------------|---------------------------|------------|----------|------------|--------------------|----------|----------|------------|---------------------------|-----------|-----------|------------|------------|
|  | Right              | Thru     | Left      | App. Total | Right                     | Thru       | Left     | App. Total | Right              | Thru     | Left     | App. Total | Right                     | Thru      | Left      | App. Total |            |
| Peak Hour Analysis From 04:00 PM to 05:45 PM - Peak 1 of 1 |                    |          |           |            |                           |            |          |            |                    |          |          |            |                           |           |           |            |            |
| Peak Hour for Entire Intersection Begins at 04:30 PM       |                    |          |           |            |                           |            |          |            |                    |          |          |            |                           |           |           |            |            |
| 04:30 PM   | 21                 | 1        | 20        | 42         | 24                        | 212        | 0        | 236        | <b>3</b>           | <b>1</b> | <b>2</b> | <b>6</b>   | 0                         | 67        | 40        | 107        | 391        |
| 04:45 PM   | 21                 | <b>3</b> | <b>27</b> | 51         | 30                        | <b>238</b> | <b>1</b> | <b>269</b> | 3                  | 0        | 1        | 4          | 1                         | 79        | 30        | 110        | 434        |
| 05:00 PM   | <b>43</b>          | 0        | 11        | <b>54</b>  | 33                        | 192        | 0        | 225        | 1                  | 0        | 0        | 1          | 0                         | 86        | <b>42</b> | <b>128</b> | 408        |
| 05:15 PM   | 28                 | 1        | 20        | 49         | <b>39</b>                 | 226        | 1        | 266        | 1                  | 0        | 2        | 3          | 0                         | <b>90</b> | 33        | 123        | <b>441</b> |
| Total Volume   | 113                | 5        | 78        | 196        | 126                       | 868        | 2        | 996        | 8                  | 1        | 5        | 14         | 1                         | 322       | 145       | 468        | 1674       |
| % App. Total   | 57.7               | 2.6      | 39.8      |            | 12.7                      | 87.1       | 0.2      |            | 57.1               | 7.1      | 35.7     |            | 0.2                       | 68.8      | 31        |            |            |
| PHF  | .657               | .417     | .722      | .907       | .808                      | .912       | .500     | .926       | .667               | .250     | .625     | .583       | .250                      | .894      | .863      | .914       | .949       |

# Traffic Data Service

San Jose, CA  
 (408) 622-4787  
 tdsbay@cs.com

File Name : 23PM FINAL  
 Site Code : 00000023  
 Start Date : 4/27/2017  
 Page No : 2

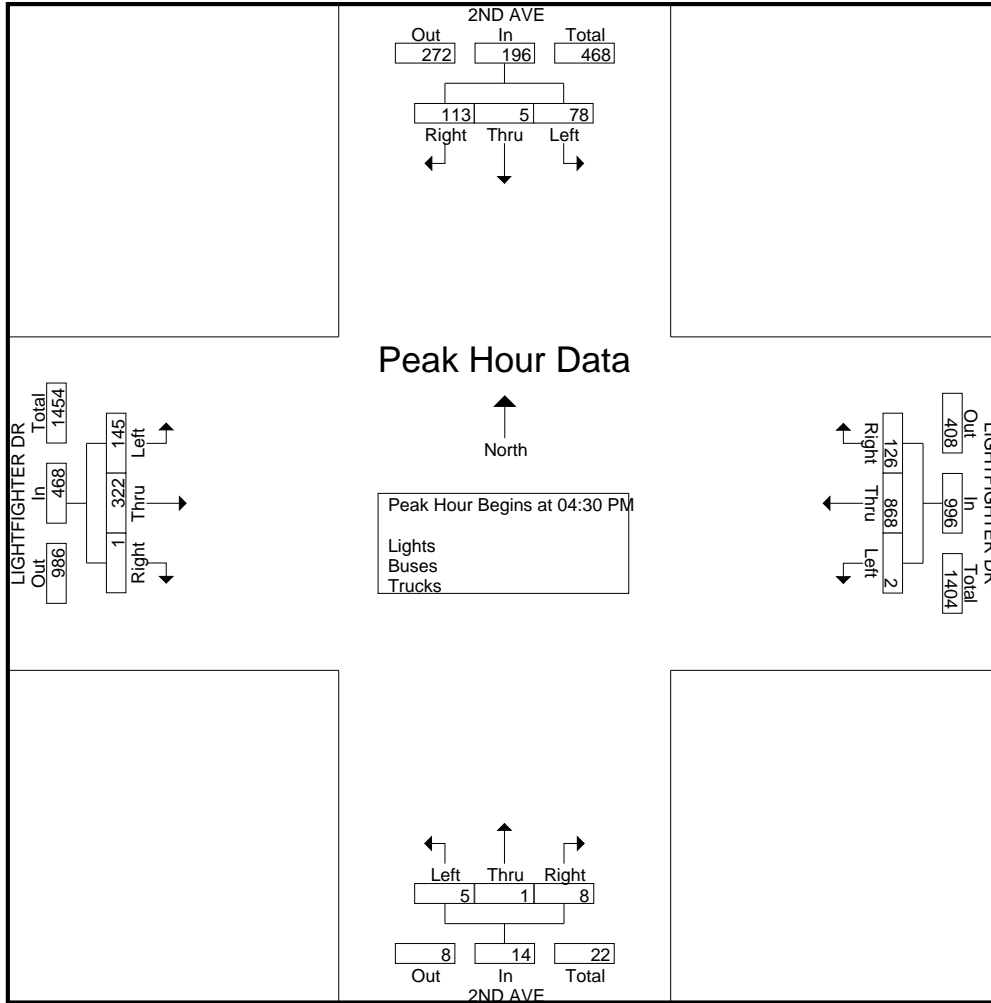

# Traffic Data Service

San Jose, CA  
 (408) 622-4787  
 tdsbay@cs.com

File Name : 23PM FINAL  
 Site Code : 00000023  
 Start Date : 4/27/2017  
 Page No : 1

Groups Printed- Bikes

| Start Time   | 2ND AVE Southbound |      |      |      |            | LIGHTFIGHTER DR Westbound |      |      |      |            | 2ND AVE Northbound |      |      |      |            | LIGHTFIGHTER DR Eastbound |      |      |      |            | Int. Total |
|--------------|--------------------|------|------|------|------------|---------------------------|------|------|------|------------|--------------------|------|------|------|------------|---------------------------|------|------|------|------------|------------|
|              | Right              | Thru | Left | Peds | App. Total | Right                     | Thru | Left | Peds | App. Total | Right              | Thru | Left | Peds | App. Total | Right                     | Thru | Left | Peds | App. Total |            |
| 04:00 PM     | 0                  | 0    | 0    | 0    | 0          | 0                         | 0    | 0    | 0    | 0          | 0                  | 0    | 0    | 0    | 0          | 0                         | 0    | 0    | 0    | 0          | 0          |
| 04:15 PM     | 0                  | 0    | 0    | 0    | 0          | 0                         | 0    | 0    | 0    | 0          | 0                  | 0    | 0    | 0    | 0          | 0                         | 0    | 0    | 0    | 0          | 0          |
| 04:30 PM     | 0                  | 0    | 0    | 0    | 0          | 0                         | 0    | 0    | 0    | 0          | 0                  | 0    | 0    | 0    | 0          | 0                         | 0    | 0    | 0    | 0          | 0          |
| 04:45 PM     | 0                  | 0    | 0    | 0    | 0          | 0                         | 0    | 0    | 0    | 0          | 0                  | 0    | 0    | 0    | 0          | 0                         | 0    | 0    | 0    | 0          | 0          |
| <b>Total</b> | 0                  | 0    | 0    | 0    | 0          | 0                         | 0    | 0    | 0    | 0          | 0                  | 0    | 0    | 0    | 0          | 0                         | 0    | 0    | 0    | 0          | 0          |
| 05:00 PM     | 0                  | 1    | 0    | 0    | 1          | 0                         | 0    | 0    | 0    | 0          | 0                  | 0    | 0    | 0    | 0          | 0                         | 0    | 0    | 0    | 0          | 1          |
| 05:15 PM     | 0                  | 0    | 0    | 0    | 0          | 0                         | 0    | 0    | 0    | 0          | 0                  | 0    | 0    | 0    | 0          | 0                         | 0    | 0    | 0    | 0          | 0          |
| 05:30 PM     | 0                  | 0    | 0    | 0    | 0          | 0                         | 0    | 0    | 0    | 0          | 0                  | 0    | 0    | 0    | 0          | 0                         | 0    | 0    | 0    | 0          | 0          |
| 05:45 PM     | 0                  | 0    | 0    | 0    | 0          | 0                         | 0    | 0    | 0    | 0          | 0                  | 0    | 0    | 0    | 0          | 0                         | 0    | 0    | 0    | 0          | 0          |
| <b>Total</b> | 0                  | 1    | 0    | 0    | 1          | 0                         | 0    | 0    | 0    | 0          | 0                  | 0    | 0    | 0    | 0          | 0                         | 0    | 0    | 0    | 0          | 1          |
| Grand Total  | 0                  | 1    | 0    | 0    | 1          | 0                         | 0    | 0    | 0    | 0          | 0                  | 0    | 0    | 0    | 0          | 0                         | 0    | 0    | 0    | 0          | 1          |
| Apprch %     | 0                  | 100  | 0    | 0    |            | 0                         | 0    | 0    | 0    |            | 0                  | 0    | 0    | 0    |            | 0                         | 0    | 0    | 0    |            |            |
| Total %      | 0                  | 100  | 0    | 0    | 100        | 0                         | 0    | 0    | 0    | 0          | 0                  | 0    | 0    | 0    | 0          | 0                         | 0    | 0    | 0    | 0          |            |

| Start Time   | 2ND AVE Southbound |      |      |      |            | LIGHTFIGHTER DR Westbound |      |      |      |            | 2ND AVE Northbound |      |      |      |            | LIGHTFIGHTER DR Eastbound |      |      |      |            | Int. Total |
|--|--------------------|------|------|------|------------|---------------------------|------|------|------|------------|--------------------|------|------|------|------------|---------------------------|------|------|------|------------|------------|
|  | Right              | Thru | Left | Peds | App. Total | Right                     | Thru | Left | Peds | App. Total | Right              | Thru | Left | Peds | App. Total | Right                     | Thru | Left | Peds | App. Total |            |
| Peak Hour Analysis From 04:00 PM to 05:45 PM - Peak 1 of 1 |                    |      |      |      |            |                           |      |      |      |            |                    |      |      |      |            |                           |      |      |      |            |            |
| Peak Hour for Entire Intersection Begins at 04:15 PM       |                    |      |      |      |            |                           |      |      |      |            |                    |      |      |      |            |                           |      |      |      |            |            |
| 04:15 PM   | 0                  | 0    | 0    | 0    | 0          | 0                         | 0    | 0    | 0    | 0          | 0                  | 0    | 0    | 0    | 0          | 0                         | 0    | 0    | 0    | 0          | 0          |
| 04:30 PM   | 0                  | 0    | 0    | 0    | 0          | 0                         | 0    | 0    | 0    | 0          | 0                  | 0    | 0    | 0    | 0          | 0                         | 0    | 0    | 0    | 0          | 0          |
| 04:45 PM   | 0                  | 0    | 0    | 0    | 0          | 0                         | 0    | 0    | 0    | 0          | 0                  | 0    | 0    | 0    | 0          | 0                         | 0    | 0    | 0    | 0          | 0          |
| 05:00 PM   | 0                  | 1    | 0    | 0    | 1          | 0                         | 0    | 0    | 0    | 0          | 0                  | 0    | 0    | 0    | 0          | 0                         | 0    | 0    | 0    | 0          | 1          |
| Total Volume   | 0                  | 1    | 0    | 0    | 1          | 0                         | 0    | 0    | 0    | 0          | 0                  | 0    | 0    | 0    | 0          | 0                         | 0    | 0    | 0    | 0          | 1          |
| % App. Total   | 0                  | 100  | 0    | 0    |            | 0                         | 0    | 0    | 0    |            | 0                  | 0    | 0    | 0    |            | 0                         | 0    | 0    | 0    |            |            |
| PHF  | .000               | .250 | .000 | .000 | .250       | .000                      | .000 | .000 | .000 | .000       | .000               | .000 | .000 | .000 | .000       | .000                      | .000 | .000 | .000 | .000       | .250       |

# Traffic Data Service

San Jose, CA  
(408) 622-4787  
tdsbay@cs.com

File Name : 23PM FINAL  
Site Code : 00000023  
Start Date : 4/27/2017  
Page No : 2

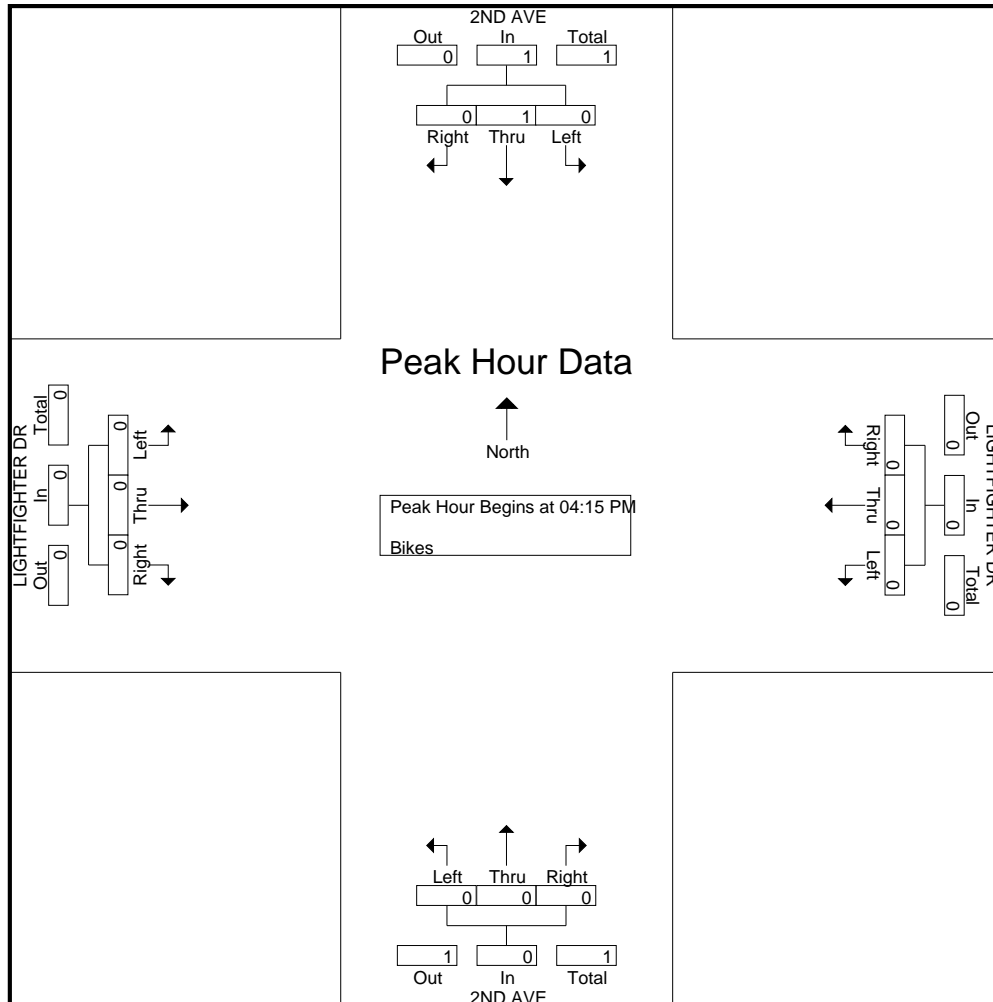



# Traffic Data Service

San Jose, CA  
(408) 622-4787  
tdsbay@cs.com

File Name : 24AM FINAL  
Site Code : 00000024  
Start Date : 4/27/2017  
Page No : 1

Groups Printed- Lights - Buses - Trucks

| Start Time   | GENERAL JIM MOORE BLVD Southbound |            |           |          |            | LIGHTFIGHTER DR Westbound |            |           |          |            | GENERAL JIM MOORE BLVD Northbound |            |            |          |            | LIGHTFIGHTER DR Eastbound |            |            |          |            | Int. Total  |
|--------------|-----------------------------------|------------|-----------|----------|------------|---------------------------|------------|-----------|----------|------------|-----------------------------------|------------|------------|----------|------------|---------------------------|------------|------------|----------|------------|-------------|
|              | Right                             | Thru       | Left      | Peds     | App. Total | Right                     | Thru       | Left      | Peds     | App. Total | Right                             | Thru       | Left       | Peds     | App. Total | Right                     | Thru       | Left       | Peds     | App. Total |             |
| 07:00 AM     | 6                                 | 11         | 0         | 0        | 17         | 0                         | 71         | 9         | 0        | 80         | 0                                 | 3          | 32         | 0        | 35         | 92                        | 19         | 10         | 0        | 121        | 253         |
| 07:15 AM     | 15                                | 43         | 2         | 0        | 60         | 1                         | 59         | 5         | 0        | 65         | 0                                 | 14         | 42         | 0        | 56         | 189                       | 27         | 9          | 0        | 225        | 406         |
| 07:30 AM     | 23                                | 74         | 0         | 0        | 97         | 2                         | 62         | 12        | 0        | 76         | 0                                 | 21         | 64         | 0        | 85         | 180                       | 32         | 24         | 0        | 236        | 494         |
| 07:45 AM     | 11                                | 33         | 0         | 2        | 46         | 1                         | 39         | 4         | 2        | 46         | 2                                 | 27         | 67         | 0        | 96         | 188                       | 36         | 52         | 1        | 277        | 465         |
| <b>Total</b> | <b>55</b>                         | <b>161</b> | <b>2</b>  | <b>2</b> | <b>220</b> | <b>4</b>                  | <b>231</b> | <b>30</b> | <b>2</b> | <b>267</b> | <b>2</b>                          | <b>65</b>  | <b>205</b> | <b>0</b> | <b>272</b> | <b>649</b>                | <b>114</b> | <b>95</b>  | <b>1</b> | <b>859</b> | <b>1618</b> |
|              |                                   |            |           |          |            |                           |            |           |          |            |                                   |            |            |          |            |                           |            |            |          |            |             |
| 08:00 AM     | 10                                | 29         | 8         | 0        | 47         | 6                         | 27         | 0         | 0        | 33         | 0                                 | 28         | 77         | 0        | 105        | 153                       | 32         | 38         | 0        | 223        | 408         |
| 08:15 AM     | 5                                 | 26         | 1         | 0        | 32         | 2                         | 21         | 2         | 0        | 25         | 1                                 | 28         | 42         | 0        | 71         | 128                       | 29         | 32         | 0        | 189        | 317         |
| 08:30 AM     | 3                                 | 19         | 1         | 2        | 25         | 3                         | 24         | 1         | 2        | 30         | 0                                 | 28         | 34         | 0        | 62         | 91                        | 18         | 31         | 0        | 140        | 257         |
| 08:45 AM     | 16                                | 15         | 2         | 3        | 36         | 5                         | 14         | 5         | 1        | 25         | 1                                 | 26         | 28         | 0        | 55         | 92                        | 27         | 39         | 0        | 158        | 274         |
| <b>Total</b> | <b>34</b>                         | <b>89</b>  | <b>12</b> | <b>5</b> | <b>140</b> | <b>16</b>                 | <b>86</b>  | <b>8</b>  | <b>3</b> | <b>113</b> | <b>2</b>                          | <b>110</b> | <b>181</b> | <b>0</b> | <b>293</b> | <b>464</b>                | <b>106</b> | <b>140</b> | <b>0</b> | <b>710</b> | <b>1256</b> |
|              |                                   |            |           |          |            |                           |            |           |          |            |                                   |            |            |          |            |                           |            |            |          |            |             |
| Grand Total  | 89                                | 250        | 14        | 7        | 360        | 20                        | 317        | 38        | 5        | 380        | 4                                 | 175        | 386        | 0        | 565        | 1113                      | 220        | 235        | 1        | 1569       | 2874        |
| Apprch %     | 24.7                              | 69.4       | 3.9       | 1.9      |            | 5.3                       | 83.4       | 10        | 1.3      |            | 0.7                               | 31         | 68.3       | 0        |            | 70.9                      | 14         | 15         | 0.1      |            |             |
| Total %      | 3.1                               | 8.7        | 0.5       | 0.2      | 12.5       | 0.7                       | 11         | 1.3       | 0.2      | 13.2       | 0.1                               | 6.1        | 13.4       | 0        | 19.7       | 38.7                      | 7.7        | 8.2        | 0        | 54.6       |             |
| Lights       | 87                                | 244        | 14        | 7        | 352        | 19                        | 300        | 37        | 5        | 361        | 4                                 | 171        | 377        | 0        | 552        | 1086                      | 213        | 233        | 1        | 1533       | 2798        |
| % Lights     | 97.8                              | 97.6       | 100       | 100      | 97.8       | 95                        | 94.6       | 97.4      | 100      | 95         | 100                               | 97.7       | 97.7       | 0        | 97.7       | 97.6                      | 96.8       | 99.1       | 100      | 97.7       | 97.4        |
| Buses        | 1                                 | 4          | 0         | 0        | 5          | 0                         | 1          | 0         | 0        | 1          | 0                                 | 2          | 7          | 0        | 9          | 12                        | 3          | 0          | 0        | 15         | 30          |
| % Buses      | 1.1                               | 1.6        | 0         | 0        | 1.4        | 0                         | 0.3        | 0         | 0        | 0.3        | 0                                 | 1.1        | 1.8        | 0        | 1.6        | 1.1                       | 1.4        | 0          | 0        | 1          | 1           |
| Trucks       | 1                                 | 2          | 0         | 0        | 3          | 1                         | 16         | 1         | 0        | 18         | 0                                 | 2          | 2          | 0        | 4          | 15                        | 4          | 2          | 0        | 21         | 46          |
| % Trucks     | 1.1                               | 0.8        | 0         | 0        | 0.8        | 5                         | 5          | 2.6       | 0        | 4.7        | 0                                 | 1.1        | 0.5        | 0        | 0.7        | 1.3                       | 1.8        | 0.9        | 0        | 1.3        | 1.6         |

| Start Time   | GENERAL JIM MOORE BLVD Southbound |           |          |            | LIGHTFIGHTER DR Westbound |           |           |            | GENERAL JIM MOORE BLVD Northbound |           |           |            | LIGHTFIGHTER DR Eastbound |           |           |            | Int. Total |
|--|-----------------------------------|-----------|----------|------------|---------------------------|-----------|-----------|------------|-----------------------------------|-----------|-----------|------------|---------------------------|-----------|-----------|------------|------------|
|  | Right                             | Thru      | Left     | App. Total | Right                     | Thru      | Left      | App. Total | Right                             | Thru      | Left      | App. Total | Right                     | Thru      | Left      | App. Total |            |
| Peak Hour Analysis From 07:00 AM to 08:45 AM - Peak 1 of 1 |                                   |           |          |            |                           |           |           |            |                                   |           |           |            |                           |           |           |            |            |
| Peak Hour for Entire Intersection Begins at 07:15 AM       |                                   |           |          |            |                           |           |           |            |                                   |           |           |            |                           |           |           |            |            |
| 07:15 AM   | 15                                | 43        | 2        | 60         | 1                         | 59        | 5         | 65         | 0                                 | 14        | 42        | 56         | <b>189</b>                | 27        | 9         | 225        | 406        |
| 07:30 AM   | <b>23</b>                         | <b>74</b> | 0        | <b>97</b>  | 2                         | <b>62</b> | <b>12</b> | <b>76</b>  | 0                                 | 21        | 64        | 85         | 180                       | 32        | 24        | 236        | <b>494</b> |
| 07:45 AM   | 11                                | 33        | 0        | 44         | 1                         | 39        | 4         | 44         | 2                                 | 27        | 67        | 96         | 188                       | <b>36</b> | <b>52</b> | <b>276</b> | 460        |
| 08:00 AM   | 10                                | 29        | <b>8</b> | 47         | <b>6</b>                  | 27        | 0         | 33         | 0                                 | <b>28</b> | <b>77</b> | <b>105</b> | 153                       | 32        | 38        | 223        | 408        |
| Total Volume   | 59                                | 179       | 10       | 248        | 10                        | 187       | 21        | 218        | 2                                 | 90        | 250       | 342        | 710                       | 127       | 123       | 960        | 1768       |
| % App. Total   | 23.8                              | 72.2      | 4        |            | 4.6                       | 85.8      | 9.6       |            | 0.6                               | 26.3      | 73.1      |            | 74                        | 13.2      | 12.8      |            |            |
| PHF  | .641                              | .605      | .313     | .639       | .417                      | .754      | .438      | .717       | .250                              | .804      | .812      | .814       | .939                      | .882      | .591      | .870       | .895       |

# Traffic Data Service

San Jose, CA  
 (408) 622-4787  
 tdsbay@cs.com

File Name : 24AM FINAL  
 Site Code : 00000024  
 Start Date : 4/27/2017  
 Page No : 2

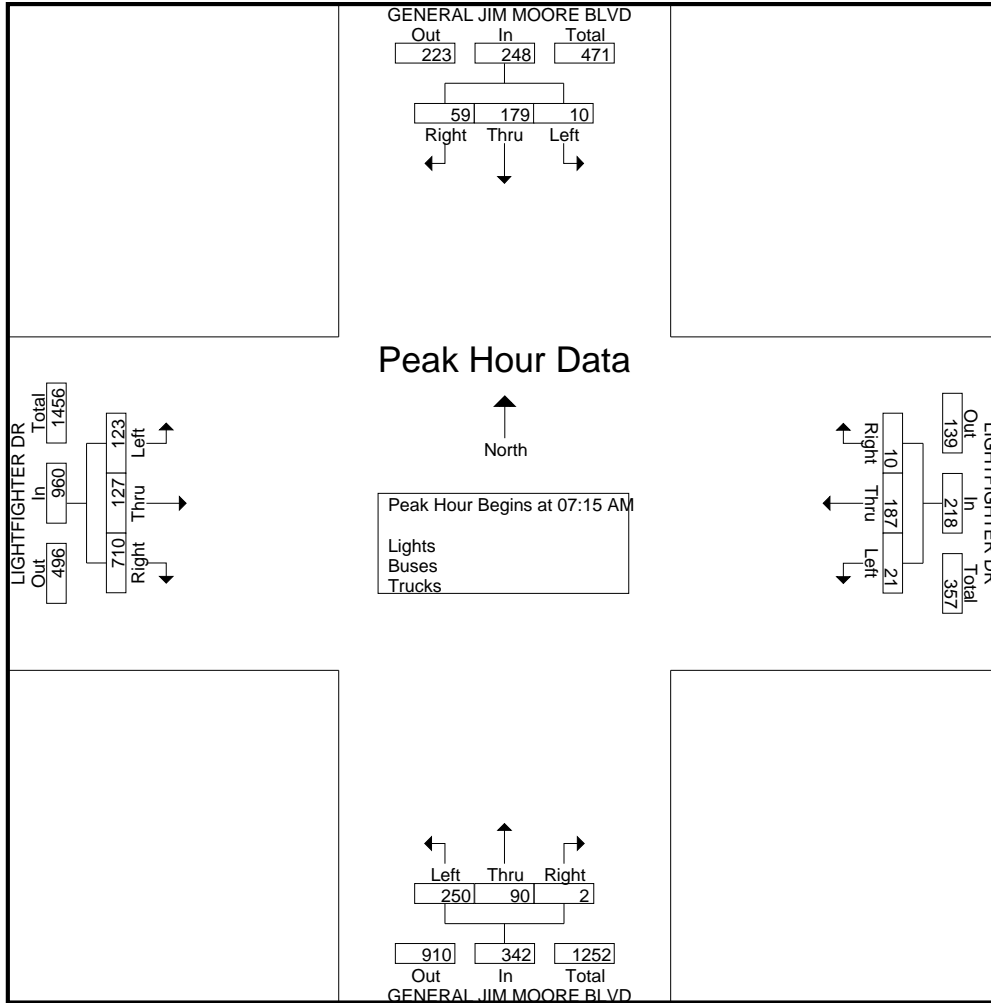

# Traffic Data Service

San Jose, CA  
 (408) 622-4787  
 tdsbay@cs.com

File Name : 24AM FINAL  
 Site Code : 00000024  
 Start Date : 4/27/2017  
 Page No : 1

Groups Printed- Bikes

| Start Time  | GENERAL JIM MOORE BLVD Southbound |      |      |      |            | LIGHTFIGHTER DR Westbound |      |      |      |            | GENERAL JIM MOORE BLVD Northbound |      |      |      |            | LIGHTFIGHTER DR Eastbound |      |      |      |            | Int. Total |   |   |   |   |   |
|-------------|-----------------------------------|------|------|------|------------|---------------------------|------|------|------|------------|-----------------------------------|------|------|------|------------|---------------------------|------|------|------|------------|------------|---|---|---|---|---|
|             | Right                             | Thru | Left | Peds | App. Total | Right                     | Thru | Left | Peds | App. Total | Right                             | Thru | Left | Peds | App. Total | Right                     | Thru | Left | Peds | App. Total |            |   |   |   |   |   |
| 07:00 AM    | 0                                 | 0    | 0    | 0    | 0          | 0                         | 0    | 0    | 0    | 0          | 0                                 | 0    | 0    | 0    | 0          | 0                         | 0    | 0    | 0    | 0          | 0          | 0 | 0 | 0 | 0 | 0 |
| 07:15 AM    | 0                                 | 0    | 0    | 0    | 0          | 0                         | 0    | 0    | 0    | 0          | 0                                 | 0    | 0    | 0    | 0          | 0                         | 0    | 0    | 0    | 0          | 0          | 0 | 0 | 0 | 0 | 0 |
| 07:30 AM    | 0                                 | 0    | 0    | 0    | 0          | 0                         | 0    | 0    | 0    | 0          | 0                                 | 0    | 0    | 0    | 0          | 0                         | 0    | 0    | 0    | 0          | 0          | 0 | 0 | 0 | 0 | 0 |
| 07:45 AM    | 0                                 | 0    | 0    | 0    | 0          | 0                         | 0    | 0    | 0    | 0          | 0                                 | 0    | 0    | 0    | 0          | 0                         | 0    | 0    | 0    | 0          | 0          | 0 | 0 | 0 | 0 | 0 |
| Total       | 0                                 | 0    | 0    | 0    | 0          | 0                         | 0    | 0    | 0    | 0          | 0                                 | 0    | 0    | 0    | 0          | 0                         | 0    | 0    | 0    | 0          | 0          | 0 | 0 | 0 | 0 | 0 |
| 08:00 AM    | 0                                 | 0    | 0    | 0    | 0          | 0                         | 0    | 0    | 0    | 0          | 0                                 | 2    | 0    | 0    | 2          | 0                         | 0    | 0    | 0    | 0          | 0          | 0 | 0 | 0 | 2 | 2 |
| 08:15 AM    | 0                                 | 0    | 0    | 0    | 0          | 0                         | 0    | 0    | 0    | 0          | 0                                 | 0    | 0    | 0    | 0          | 0                         | 0    | 0    | 0    | 0          | 0          | 0 | 0 | 0 | 0 | 0 |
| 08:30 AM    | 0                                 | 0    | 0    | 0    | 0          | 0                         | 0    | 0    | 0    | 0          | 0                                 | 0    | 0    | 0    | 0          | 0                         | 0    | 0    | 0    | 0          | 0          | 0 | 0 | 0 | 0 | 0 |
| 08:45 AM    | 0                                 | 0    | 0    | 0    | 0          | 0                         | 0    | 0    | 0    | 0          | 0                                 | 0    | 0    | 0    | 0          | 0                         | 0    | 0    | 0    | 0          | 0          | 0 | 0 | 0 | 0 | 0 |
| Total       | 0                                 | 0    | 0    | 0    | 0          | 0                         | 0    | 0    | 0    | 0          | 0                                 | 2    | 0    | 0    | 2          | 0                         | 0    | 0    | 0    | 0          | 0          | 0 | 0 | 0 | 2 | 2 |
| Grand Total | 0                                 | 0    | 0    | 0    | 0          | 0                         | 0    | 0    | 0    | 0          | 0                                 | 2    | 0    | 0    | 2          | 0                         | 0    | 0    | 0    | 0          | 0          | 0 | 0 | 0 | 2 | 2 |
| Apprch %    | 0                                 | 0    | 0    | 0    |            | 0                         | 0    | 0    | 0    |            | 0                                 | 100  | 0    | 0    |            | 0                         | 0    | 0    | 0    |            | 0          | 0 | 0 | 0 |   |   |
| Total %     | 0                                 | 0    | 0    | 0    |            | 0                         | 0    | 0    | 0    |            | 0                                 | 100  | 0    | 0    | 100        | 0                         | 0    | 0    | 0    |            | 0          | 0 | 0 | 0 |   |   |

| Start Time   | GENERAL JIM MOORE BLVD Southbound |      |      |      |            | LIGHTFIGHTER DR Westbound |      |      |      |            | GENERAL JIM MOORE BLVD Northbound |      |      |      |            | LIGHTFIGHTER DR Eastbound |      |      |      |            | Int. Total |      |      |      |      |   |
|--|-----------------------------------|------|------|------|------------|---------------------------|------|------|------|------------|-----------------------------------|------|------|------|------------|---------------------------|------|------|------|------------|------------|------|------|------|------|---|
|  | Right                             | Thru | Left | Peds | App. Total | Right                     | Thru | Left | Peds | App. Total | Right                             | Thru | Left | Peds | App. Total | Right                     | Thru | Left | Peds | App. Total |            |      |      |      |      |   |
| Peak Hour Analysis From 07:00 AM to 08:45 AM - Peak 1 of 1 |                                   |      |      |      |            |                           |      |      |      |            |                                   |      |      |      |            |                           |      |      |      |            |            |      |      |      |      |   |
| Peak Hour for Entire Intersection Begins at 07:15 AM       |                                   |      |      |      |            |                           |      |      |      |            |                                   |      |      |      |            |                           |      |      |      |            |            |      |      |      |      |   |
| 07:15 AM   | 0                                 | 0    | 0    | 0    | 0          | 0                         | 0    | 0    | 0    | 0          | 0                                 | 0    | 0    | 0    | 0          | 0                         | 0    | 0    | 0    | 0          | 0          | 0    | 0    | 0    | 0    | 0 |
| 07:30 AM   | 0                                 | 0    | 0    | 0    | 0          | 0                         | 0    | 0    | 0    | 0          | 0                                 | 0    | 0    | 0    | 0          | 0                         | 0    | 0    | 0    | 0          | 0          | 0    | 0    | 0    | 0    | 0 |
| 07:45 AM   | 0                                 | 0    | 0    | 0    | 0          | 0                         | 0    | 0    | 0    | 0          | 0                                 | 0    | 0    | 0    | 0          | 0                         | 0    | 0    | 0    | 0          | 0          | 0    | 0    | 0    | 0    | 0 |
| 08:00 AM   | 0                                 | 0    | 0    | 0    | 0          | 0                         | 0    | 0    | 0    | 0          | 0                                 | 2    | 0    | 0    | 2          | 0                         | 0    | 0    | 0    | 0          | 0          | 0    | 0    | 0    | 2    | 2 |
| Total Volume   | 0                                 | 0    | 0    | 0    | 0          | 0                         | 0    | 0    | 0    | 0          | 0                                 | 2    | 0    | 0    | 2          | 0                         | 0    | 0    | 0    | 0          | 0          | 0    | 0    | 0    | 2    | 2 |
| % App. Total   | 0                                 | 0    | 0    | 0    |            | 0                         | 0    | 0    | 0    |            | 0                                 | 100  | 0    | 0    |            | 0                         | 0    | 0    | 0    |            | 0          | 0    | 0    | 0    |      |   |
| PHF  | .000                              | .000 | .000 | .000 |            | .000                      | .000 | .000 | .000 |            | .000                              | .250 | .000 | .250 |            | .000                      | .000 | .000 | .000 |            | .000       | .000 | .000 | .000 | .250 |   |

# Traffic Data Service

San Jose, CA  
 (408) 622-4787  
 tdsbay@cs.com

File Name : 24AM FINAL  
 Site Code : 00000024  
 Start Date : 4/27/2017  
 Page No : 2

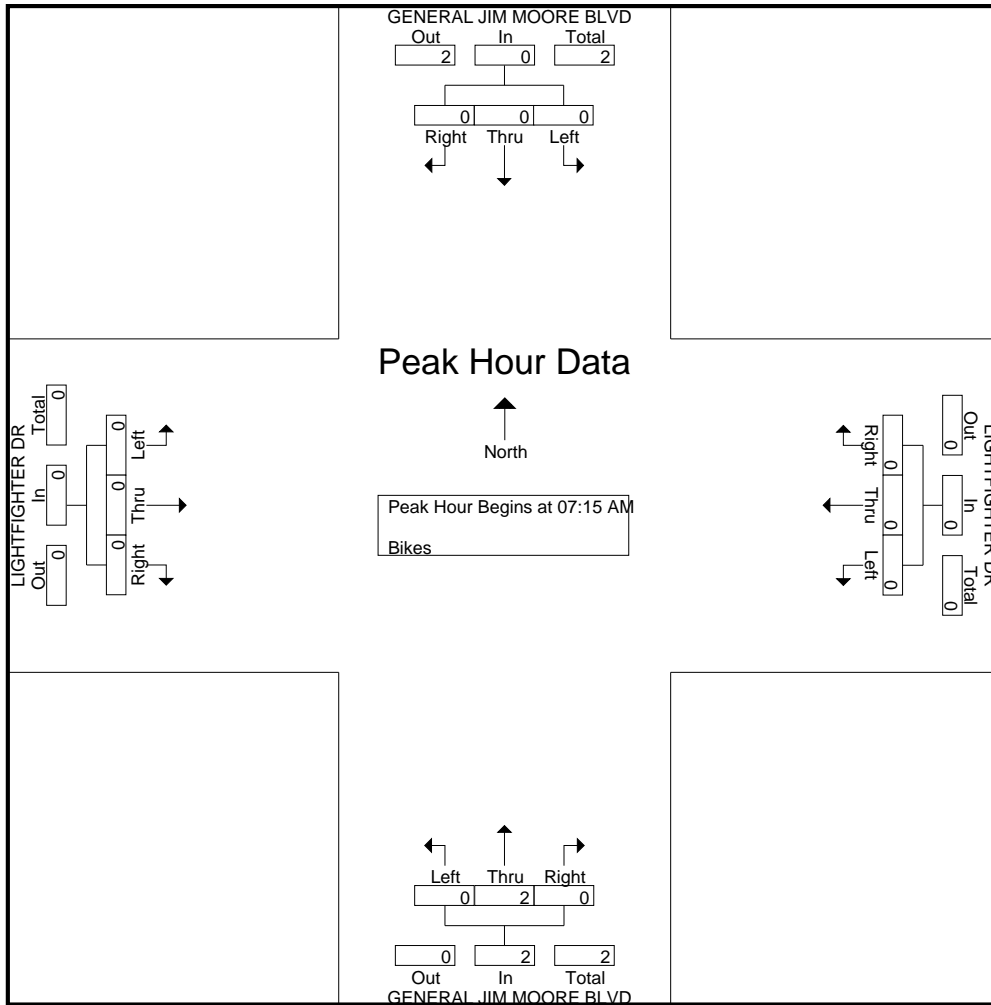

# Traffic Data Service

San Jose, CA  
 (408) 622-4787  
 tdsbay@cs.com

File Name : 24PM FINAL  
 Site Code : 00000024  
 Start Date : 4/27/2017  
 Page No : 1

Groups Printed- Lights - Buses - Trucks

| Start Time  | GENERAL JIM MOORE BLVD Southbound |      |      |      |            | LIGHTFIGHTER DR Westbound |      |      |      |            | GENERAL JIM MOORE BLVD Northbound |      |      |      |            | LIGHTFIGHTER DR Eastbound |      |      |      |            | Int. Total |
|-------------|-----------------------------------|------|------|------|------------|---------------------------|------|------|------|------------|-----------------------------------|------|------|------|------------|---------------------------|------|------|------|------------|------------|
|             | Right                             | Thru | Left | Peds | App. Total | Right                     | Thru | Left | Peds | App. Total | Right                             | Thru | Left | Peds | App. Total | Right                     | Thru | Left | Peds | App. Total |            |
| 04:00 PM    | 44                                | 24   | 8    | 0    | 76         | 5                         | 36   | 0    | 0    | 41         | 3                                 | 33   | 106  | 1    | 143        | 60                        | 22   | 15   | 0    | 97         | 357        |
| 04:15 PM    | 23                                | 16   | 4    | 0    | 43         | 0                         | 28   | 0    | 0    | 28         | 2                                 | 29   | 113  | 0    | 144        | 66                        | 33   | 11   | 0    | 110        | 325        |
| 04:30 PM    | 33                                | 26   | 2    | 0    | 61         | 3                         | 50   | 4    | 0    | 57         | 2                                 | 21   | 163  | 0    | 186        | 53                        | 28   | 13   | 0    | 94         | 398        |
| 04:45 PM    | 30                                | 17   | 2    | 0    | 49         | 0                         | 61   | 3    | 0    | 64         | 2                                 | 27   | 175  | 0    | 204        | 55                        | 26   | 14   | 0    | 95         | 412        |
| Total       | 130                               | 83   | 16   | 0    | 229        | 8                         | 175  | 7    | 0    | 190        | 9                                 | 110  | 557  | 1    | 677        | 234                       | 109  | 53   | 0    | 396        | 1492       |
| 05:00 PM    | 37                                | 23   | 1    | 0    | 61         | 4                         | 37   | 0    | 0    | 41         | 1                                 | 36   | 151  | 0    | 188        | 45                        | 42   | 17   | 0    | 104        | 394        |
| 05:15 PM    | 37                                | 20   | 2    | 0    | 59         | 0                         | 65   | 1    | 0    | 66         | 2                                 | 24   | 160  | 0    | 186        | 47                        | 42   | 22   | 0    | 111        | 422        |
| 05:30 PM    | 37                                | 13   | 2    | 0    | 52         | 3                         | 19   | 0    | 0    | 22         | 1                                 | 29   | 127  | 0    | 157        | 51                        | 45   | 26   | 1    | 123        | 354        |
| 05:45 PM    | 40                                | 22   | 3    | 0    | 65         | 3                         | 30   | 2    | 0    | 35         | 1                                 | 27   | 108  | 0    | 136        | 64                        | 29   | 23   | 2    | 118        | 354        |
| Total       | 151                               | 78   | 8    | 0    | 237        | 10                        | 151  | 3    | 0    | 164        | 5                                 | 116  | 546  | 0    | 667        | 207                       | 158  | 88   | 3    | 456        | 1524       |
| Grand Total | 281                               | 161  | 24   | 0    | 466        | 18                        | 326  | 10   | 0    | 354        | 14                                | 226  | 1103 | 1    | 1344       | 441                       | 267  | 141  | 3    | 852        | 3016       |
| Apprch %    | 60.3                              | 34.5 | 5.2  | 0    |            | 5.1                       | 92.1 | 2.8  | 0    |            | 1                                 | 16.8 | 82.1 | 0.1  |            | 51.8                      | 31.3 | 16.5 | 0.4  |            |            |
| Total %     | 9.3                               | 5.3  | 0.8  | 0    | 15.5       | 0.6                       | 10.8 | 0.3  | 0    | 11.7       | 0.5                               | 7.5  | 36.6 | 0    | 44.6       | 14.6                      | 8.9  | 4.7  | 0.1  | 28.2       |            |
| Lights      | 279                               | 159  | 23   | 0    | 461        | 18                        | 325  | 10   | 0    | 353        | 14                                | 223  | 1097 | 1    | 1335       | 429                       | 265  | 140  | 0    | 834        | 2983       |
| % Lights    | 99.3                              | 98.8 | 95.8 | 0    | 98.9       | 100                       | 99.7 | 100  | 0    | 99.7       | 100                               | 98.7 | 99.5 | 100  | 99.3       | 97.3                      | 99.3 | 99.3 | 0    | 97.9       | 98.9       |
| Buses       | 1                                 | 2    | 0    | 0    | 3          | 0                         | 0    | 0    | 0    | 0          | 0                                 | 3    | 3    | 0    | 6          | 8                         | 2    | 1    | 0    | 11         | 20         |
| % Buses     | 0.4                               | 1.2  | 0    | 0    | 0.6        | 0                         | 0    | 0    | 0    | 0          | 0                                 | 1.3  | 0.3  | 0    | 0.4        | 1.8                       | 0.7  | 0.7  | 0    | 1.3        | 0.7        |
| Trucks      | 1                                 | 0    | 1    | 0    | 2          | 0                         | 1    | 0    | 0    | 1          | 0                                 | 0    | 3    | 0    | 3          | 4                         | 0    | 0    | 3    | 7          | 13         |
| % Trucks    | 0.4                               | 0    | 4.2  | 0    | 0.4        | 0                         | 0.3  | 0    | 0    | 0.3        | 0                                 | 0    | 0.3  | 0    | 0.2        | 0.9                       | 0    | 0    | 100  | 0.8        | 0.4        |

| Start Time   | GENERAL JIM MOORE BLVD Southbound |           |          |           |            | LIGHTFIGHTER DR Westbound |           |          |           |            | GENERAL JIM MOORE BLVD Northbound |           |            |            |            | LIGHTFIGHTER DR Eastbound |           |           |            |            | Int. Total |
|--|-----------------------------------|-----------|----------|-----------|------------|---------------------------|-----------|----------|-----------|------------|-----------------------------------|-----------|------------|------------|------------|---------------------------|-----------|-----------|------------|------------|------------|
|  | Right                             | Thru      | Left     | Peds      | App. Total | Right                     | Thru      | Left     | Peds      | App. Total | Right                             | Thru      | Left       | Peds       | App. Total | Right                     | Thru      | Left      | Peds       | App. Total |            |
| Peak Hour Analysis From 04:00 PM to 05:45 PM - Peak 1 of 1 |                                   |           |          |           |            |                           |           |          |           |            |                                   |           |            |            |            |                           |           |           |            |            |            |
| Peak Hour for Entire Intersection Begins at 04:30 PM       |                                   |           |          |           |            |                           |           |          |           |            |                                   |           |            |            |            |                           |           |           |            |            |            |
| 04:30 PM   | 33                                | <b>26</b> | <b>2</b> | <b>61</b> |            | 3                         | 50        | <b>4</b> | 57        |            | 2                                 | 21        | 163        | 186        |            | 53                        | 28        | 13        | 94         | 398        |            |
| 04:45 PM   | 30                                | 17        | 2        | 49        |            | 0                         | 61        | 3        | 64        |            | 2                                 | 27        | <b>175</b> | <b>204</b> |            | <b>55</b>                 | 26        | 14        | 95         | 412        |            |
| 05:00 PM   | <b>37</b>                         | 23        | 1        | 61        |            | <b>4</b>                  | 37        | 0        | 41        |            | 1                                 | <b>36</b> | 151        | 188        |            | 45                        | <b>42</b> | 17        | 104        | 394        |            |
| 05:15 PM   | 37                                | 20        | 2        | 59        |            | 0                         | <b>65</b> | 1        | <b>66</b> |            | 2                                 | 24        | 160        | 186        |            | 47                        | 42        | <b>22</b> | <b>111</b> | <b>422</b> |            |
| Total Volume   | 137                               | 86        | 7        | 230       |            | 7                         | 213       | 8        | 228       |            | 7                                 | 108       | 649        | 764        |            | 200                       | 138       | 66        | 404        | 1626       |            |
| % App. Total   | 59.6                              | 37.4      | 3        |           |            | 3.1                       | 93.4      | 3.5      |           |            | 0.9                               | 14.1      | 84.9       |            |            | 49.5                      | 34.2      | 16.3      |            |            |            |
| PHF  | .926                              | .827      | .875     | .943      |            | .438                      | .819      | .500     | .864      |            | .875                              | .750      | .927       | .936       |            | .909                      | .821      | .750      | .910       | .963       |            |

# Traffic Data Service

San Jose, CA  
 (408) 622-4787  
 tdsbay@cs.com

File Name : 24PM FINAL  
 Site Code : 00000024  
 Start Date : 4/27/2017  
 Page No : 2

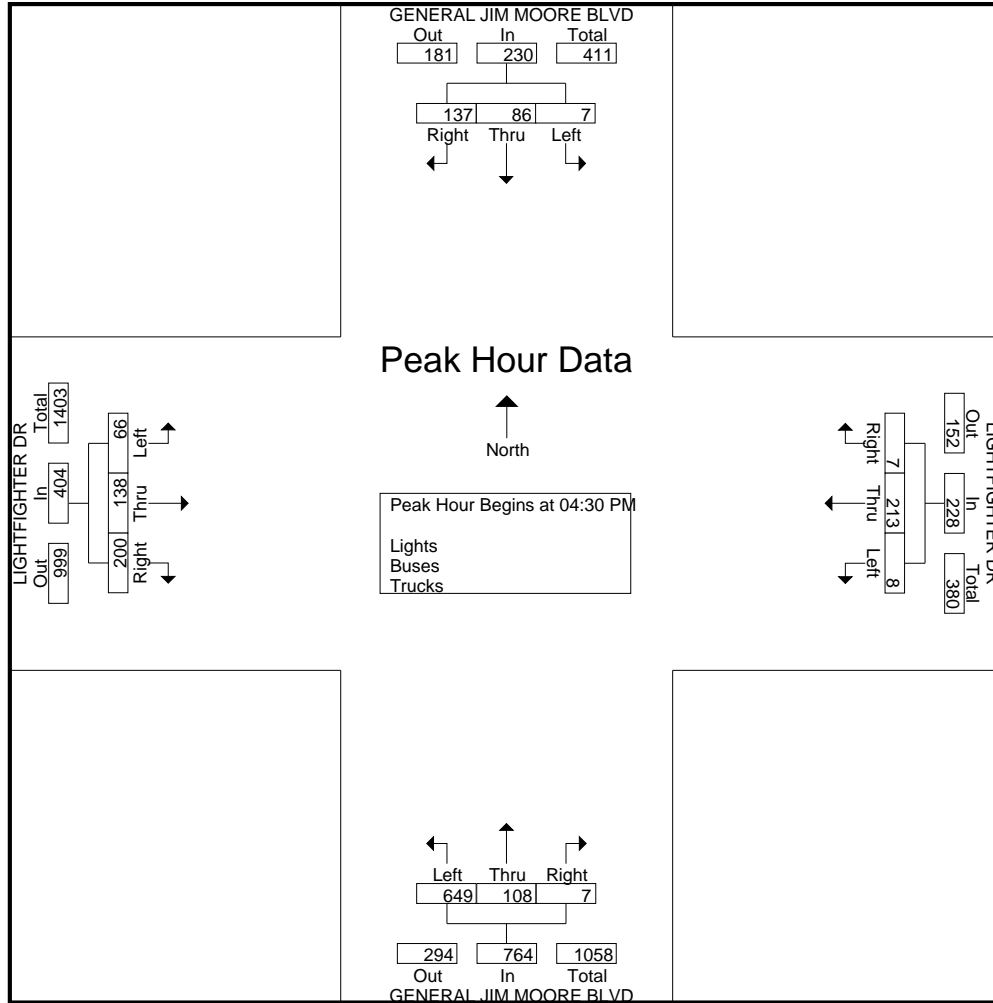

# Traffic Data Service

San Jose, CA  
 (408) 622-4787  
 tdsbay@cs.com

File Name : 24PM FINAL  
 Site Code : 00000024  
 Start Date : 4/27/2017  
 Page No : 1

Groups Printed- Bikes

| Start Time  | GENERAL JIM MOORE BLVD Southbound |      |      |      |            | LIGHTFIGHTER DR Westbound |      |      |      |            | GENERAL JIM MOORE BLVD Northbound |      |      |      |            | LIGHTFIGHTER DR Eastbound |      |      |      |            | Int. Total |   |
|-------------|-----------------------------------|------|------|------|------------|---------------------------|------|------|------|------------|-----------------------------------|------|------|------|------------|---------------------------|------|------|------|------------|------------|---|
|             | Right                             | Thru | Left | Peds | App. Total | Right                     | Thru | Left | Peds | App. Total | Right                             | Thru | Left | Peds | App. Total | Right                     | Thru | Left | Peds | App. Total |            |   |
| 04:00 PM    | 0                                 | 1    | 0    | 0    | 1          | 0                         | 0    | 0    | 0    | 0          | 0                                 | 0    | 1    | 0    | 1          | 0                         | 0    | 0    | 0    | 0          | 0          | 2 |
| 04:15 PM    | 0                                 | 0    | 0    | 0    | 0          | 0                         | 0    | 0    | 0    | 0          | 0                                 | 1    | 0    | 0    | 1          | 0                         | 0    | 0    | 0    | 0          | 0          | 1 |
| 04:30 PM    | 0                                 | 0    | 0    | 0    | 0          | 0                         | 0    | 0    | 0    | 0          | 0                                 | 0    | 0    | 0    | 0          | 0                         | 0    | 0    | 0    | 0          | 0          | 0 |
| 04:45 PM    | 0                                 | 0    | 0    | 0    | 0          | 0                         | 0    | 0    | 0    | 0          | 0                                 | 0    | 0    | 0    | 0          | 1                         | 0    | 0    | 0    | 0          | 1          | 1 |
| Total       | 0                                 | 1    | 0    | 0    | 1          | 0                         | 0    | 0    | 0    | 0          | 0                                 | 1    | 1    | 0    | 2          | 1                         | 0    | 0    | 0    | 0          | 1          | 4 |
| 05:00 PM    | 0                                 | 0    | 0    | 0    | 0          | 0                         | 0    | 0    | 0    | 0          | 0                                 | 0    | 0    | 0    | 0          | 0                         | 0    | 0    | 0    | 0          | 0          | 0 |
| 05:15 PM    | 0                                 | 0    | 0    | 0    | 0          | 0                         | 0    | 0    | 0    | 0          | 0                                 | 0    | 0    | 0    | 0          | 0                         | 0    | 0    | 0    | 0          | 0          | 0 |
| 05:30 PM    | 0                                 | 0    | 0    | 0    | 0          | 0                         | 0    | 0    | 0    | 0          | 0                                 | 1    | 0    | 0    | 1          | 0                         | 0    | 0    | 0    | 0          | 0          | 1 |
| 05:45 PM    | 0                                 | 0    | 0    | 0    | 0          | 1                         | 0    | 0    | 0    | 1          | 0                                 | 0    | 0    | 0    | 0          | 0                         | 0    | 0    | 0    | 0          | 0          | 1 |
| Total       | 0                                 | 0    | 0    | 0    | 0          | 1                         | 0    | 0    | 0    | 1          | 0                                 | 1    | 0    | 0    | 1          | 0                         | 0    | 0    | 0    | 0          | 0          | 2 |
| Grand Total | 0                                 | 1    | 0    | 0    | 1          | 1                         | 0    | 0    | 0    | 1          | 0                                 | 2    | 1    | 0    | 3          | 1                         | 0    | 0    | 0    | 0          | 1          | 6 |
| Apprch %    | 0                                 | 100  | 0    | 0    |            | 100                       | 0    | 0    | 0    |            | 0                                 | 66.7 | 33.3 | 0    |            | 100                       | 0    | 0    | 0    |            |            |   |
| Total %     | 0                                 | 16.7 | 0    | 0    | 16.7       | 16.7                      | 0    | 0    | 0    | 16.7       | 0                                 | 33.3 | 16.7 | 0    | 50         | 16.7                      | 0    | 0    | 0    | 16.7       |            |   |

| Start Time   | GENERAL JIM MOORE BLVD Southbound |      |      |      |            | LIGHTFIGHTER DR Westbound |      |      |      |            | GENERAL JIM MOORE BLVD Northbound |      |      |      |            | LIGHTFIGHTER DR Eastbound |      |      |      |            | Int. Total |
|--|-----------------------------------|------|------|------|------------|---------------------------|------|------|------|------------|-----------------------------------|------|------|------|------------|---------------------------|------|------|------|------------|------------|
|  | Right                             | Thru | Left | Peds | App. Total | Right                     | Thru | Left | Peds | App. Total | Right                             | Thru | Left | Peds | App. Total | Right                     | Thru | Left | Peds | App. Total |            |
| Peak Hour Analysis From 04:00 PM to 05:45 PM - Peak 1 of 1 |                                   |      |      |      |            |                           |      |      |      |            |                                   |      |      |      |            |                           |      |      |      |            |            |
| Peak Hour for Entire Intersection Begins at 04:00 PM       |                                   |      |      |      |            |                           |      |      |      |            |                                   |      |      |      |            |                           |      |      |      |            |            |
| 04:00 PM   | 0                                 | 1    | 0    | 0    | 1          | 0                         | 0    | 0    | 0    | 0          | 0                                 | 0    | 1    | 1    | 0          | 0                         | 0    | 0    | 0    | 0          | 2          |
| 04:15 PM   | 0                                 | 0    | 0    | 0    | 0          | 0                         | 0    | 0    | 0    | 0          | 0                                 | 1    | 0    | 1    | 0          | 0                         | 0    | 0    | 0    | 0          | 1          |
| 04:30 PM   | 0                                 | 0    | 0    | 0    | 0          | 0                         | 0    | 0    | 0    | 0          | 0                                 | 0    | 0    | 0    | 0          | 0                         | 0    | 0    | 0    | 0          | 0          |
| 04:45 PM   | 0                                 | 0    | 0    | 0    | 0          | 0                         | 0    | 0    | 0    | 0          | 0                                 | 0    | 0    | 0    | 1          | 0                         | 0    | 0    | 0    | 1          | 1          |
| Total Volume   | 0                                 | 1    | 0    | 0    | 1          | 0                         | 0    | 0    | 0    | 0          | 0                                 | 1    | 1    | 2    | 1          | 0                         | 0    | 0    | 0    | 1          | 4          |
| % App. Total   | 0                                 | 100  | 0    | 0    |            | 0                         | 0    | 0    | 0    |            | 0                                 | 50   | 50   |      | 100        | 0                         | 0    | 0    |      |            |            |
| PHF  | .000                              | .250 | .000 | .000 | .250       | .000                      | .000 | .000 | .000 | .000       | .000                              | .250 | .250 | .500 | .250       | .000                      | .000 | .000 | .250 | .250       | .500       |

# Traffic Data Service

San Jose, CA  
 (408) 622-4787  
 tdsbay@cs.com

File Name : 24PM FINAL  
 Site Code : 00000024  
 Start Date : 4/27/2017  
 Page No : 2

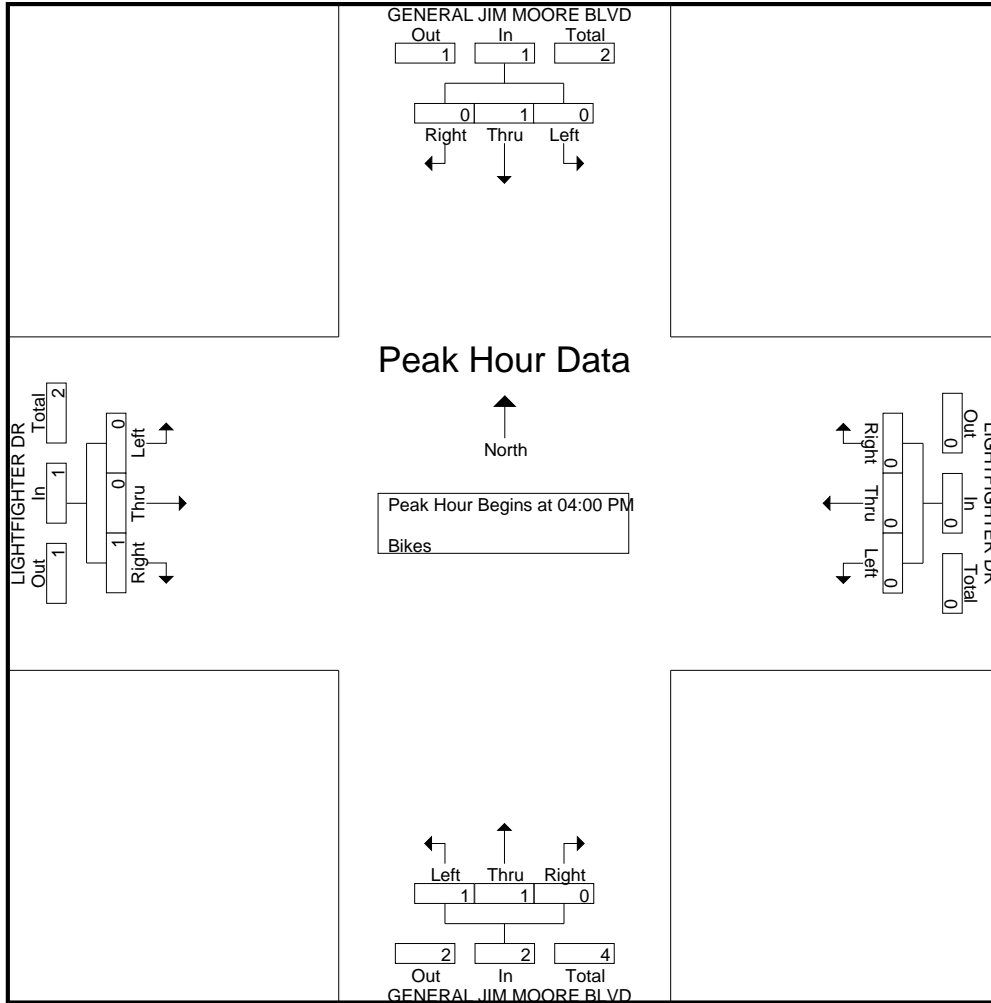



# Traffic Data Service

San Jose, CA  
 (408) 622-4787  
 tdsbay@cs.com

File Name : 25AM FINAL  
 Site Code : 00000025  
 Start Date : 4/27/2017  
 Page No : 1

Groups Printed- Lights - Buses - Trucks

| Start Time  | GENERAL JIM MOORE BLVD Southbound |      |      |      |            | GIGLING RD Westbound |      |      |      |            | GENERAL JIM MOORE BLVD Northbound |      |      |      |            | GIGLING RD Eastbound |      |      |      |            | Int. Total |
|-------------|-----------------------------------|------|------|------|------------|----------------------|------|------|------|------------|-----------------------------------|------|------|------|------------|----------------------|------|------|------|------------|------------|
|             | Right                             | Thru | Left | Peds | App. Total | Right                | Thru | Left | Peds | App. Total | Right                             | Thru | Left | Peds | App. Total | Right                | Thru | Left | Peds | App. Total |            |
| 07:00 AM    | 4                                 | 65   | 28   | 0    | 97         | 8                    | 1    | 57   | 0    | 66         | 14                                | 21   | 1    | 1    | 37         | 2                    | 4    | 5    | 0    | 11         | 211        |
| 07:15 AM    | 7                                 | 180  | 39   | 0    | 226        | 7                    | 5    | 107  | 0    | 119        | 23                                | 58   | 3    | 0    | 84         | 10                   | 9    | 3    | 0    | 22         | 451        |
| 07:30 AM    | 12                                | 217  | 41   | 0    | 270        | 9                    | 9    | 107  | 0    | 125        | 45                                | 92   | 10   | 0    | 147        | 29                   | 29   | 2    | 0    | 60         | 602        |
| 07:45 AM    | 16                                | 176  | 42   | 0    | 234        | 16                   | 14   | 92   | 0    | 122        | 65                                | 78   | 22   | 0    | 165        | 31                   | 41   | 9    | 0    | 81         | 602        |
| Total       | 39                                | 638  | 150  | 0    | 827        | 40                   | 29   | 363  | 0    | 432        | 147                               | 249  | 36   | 1    | 433        | 72                   | 83   | 19   | 0    | 174        | 1866       |
| 08:00 AM    | 11                                | 144  | 40   | 0    | 195        | 14                   | 3    | 55   | 0    | 72         | 45                                | 89   | 12   | 1    | 147        | 5                    | 15   | 8    | 0    | 28         | 442        |
| 08:15 AM    | 12                                | 134  | 26   | 0    | 172        | 9                    | 2    | 44   | 0    | 55         | 24                                | 65   | 5    | 1    | 95         | 13                   | 14   | 4    | 0    | 31         | 353        |
| 08:30 AM    | 6                                 | 96   | 28   | 0    | 130        | 17                   | 4    | 46   | 0    | 67         | 12                                | 46   | 8    | 0    | 66         | 23                   | 22   | 4    | 0    | 49         | 312        |
| 08:45 AM    | 9                                 | 69   | 29   | 0    | 107        | 5                    | 2    | 37   | 0    | 44         | 27                                | 56   | 8    | 1    | 92         | 8                    | 21   | 3    | 0    | 32         | 275        |
| Total       | 38                                | 443  | 123  | 0    | 604        | 45                   | 11   | 182  | 0    | 238        | 108                               | 256  | 33   | 3    | 400        | 49                   | 72   | 19   | 0    | 140        | 1382       |
| Grand Total | 77                                | 1081 | 273  | 0    | 1431       | 85                   | 40   | 545  | 0    | 670        | 255                               | 505  | 69   | 4    | 833        | 121                  | 155  | 38   | 0    | 314        | 3248       |
| Apprch %    | 5.4                               | 75.5 | 19.1 | 0    |            | 12.7                 | 6    | 81.3 | 0    |            | 30.6                              | 60.6 | 8.3  | 0.5  |            | 38.5                 | 49.4 | 12.1 | 0    |            |            |
| Total %     | 2.4                               | 33.3 | 8.4  | 0    | 44.1       | 2.6                  | 1.2  | 16.8 | 0    | 20.6       | 7.9                               | 15.5 | 2.1  | 0.1  | 25.6       | 3.7                  | 4.8  | 1.2  | 0    | 9.7        |            |
| Lights      | 73                                | 1060 | 265  | 0    | 1398       | 79                   | 39   | 539  | 0    | 657        | 250                               | 504  | 67   | 4    | 825        | 117                  | 147  | 34   | 0    | 298        | 3178       |
| % Lights    | 94.8                              | 98.1 | 97.1 | 0    | 97.7       | 92.9                 | 97.5 | 98.9 | 0    | 98.1       | 98                                | 99.8 | 97.1 | 100  | 99         | 96.7                 | 94.8 | 89.5 | 0    | 94.9       | 97.8       |
| Buses       | 2                                 | 6    | 8    | 0    | 16         | 2                    | 1    | 3    | 0    | 6          | 2                                 | 0    | 0    | 0    | 2          | 3                    | 7    | 4    | 0    | 14         | 38         |
| % Buses     | 2.6                               | 0.6  | 2.9  | 0    | 1.1        | 2.4                  | 2.5  | 0.6  | 0    | 0.9        | 0.8                               | 0    | 0    | 0    | 0.2        | 2.5                  | 4.5  | 10.5 | 0    | 4.5        | 1.2        |
| Trucks      | 2                                 | 15   | 0    | 0    | 17         | 4                    | 0    | 3    | 0    | 7          | 3                                 | 1    | 2    | 0    | 6          | 1                    | 1    | 0    | 0    | 2          | 32         |
| % Trucks    | 2.6                               | 1.4  | 0    | 0    | 1.2        | 4.7                  | 0    | 0.6  | 0    | 1          | 1.2                               | 0.2  | 2.9  | 0    | 0.7        | 0.8                  | 0.6  | 0    | 0    | 0.6        | 1          |

| Start Time   | GENERAL JIM MOORE BLVD Southbound |      |      |      |            | GIGLING RD Westbound |      |      |      |            | GENERAL JIM MOORE BLVD Northbound |      |      |      |            | GIGLING RD Eastbound |      |      |      |            | Int. Total |
|--|-----------------------------------|------|------|------|------------|----------------------|------|------|------|------------|-----------------------------------|------|------|------|------------|----------------------|------|------|------|------------|------------|
|  | Right                             | Thru | Left | Peds | App. Total | Right                | Thru | Left | Peds | App. Total | Right                             | Thru | Left | Peds | App. Total | Right                | Thru | Left | Peds | App. Total |            |
| Peak Hour Analysis From 07:00 AM to 08:45 AM - Peak 1 of 1 |                                   |      |      |      |            |                      |      |      |      |            |                                   |      |      |      |            |                      |      |      |      |            |            |
| Peak Hour for Entire Intersection Begins at 07:15 AM       |                                   |      |      |      |            |                      |      |      |      |            |                                   |      |      |      |            |                      |      |      |      |            |            |
| 07:15 AM   | 7                                 | 180  | 39   | 0    | 226        | 7                    | 5    | 107  | 0    | 119        | 23                                | 58   | 3    | 0    | 84         | 10                   | 9    | 3    | 0    | 22         | 451        |
| 07:30 AM   | 12                                | 217  | 41   | 0    | 270        | 9                    | 9    | 107  | 0    | 125        | 45                                | 92   | 10   | 0    | 147        | 29                   | 29   | 2    | 0    | 60         | 602        |
| 07:45 AM   | 16                                | 176  | 42   | 0    | 234        | 16                   | 14   | 92   | 0    | 122        | 65                                | 78   | 22   | 0    | 165        | 31                   | 41   | 9    | 0    | 81         | 602        |
| 08:00 AM   | 11                                | 144  | 40   | 0    | 195        | 14                   | 3    | 55   | 0    | 72         | 45                                | 89   | 12   | 1    | 146        | 5                    | 15   | 8    | 0    | 28         | 441        |
| Total Volume   | 46                                | 717  | 162  | 0    | 925        | 46                   | 31   | 361  | 0    | 438        | 178                               | 317  | 47   | 1    | 542        | 75                   | 94   | 22   | 0    | 191        | 2096       |
| % App. Total   | 5                                 | 77.5 | 17.5 | 0    |            | 10.5                 | 7.1  | 82.4 | 0    |            | 32.8                              | 58.5 | 8.7  | 0    |            | 39.3                 | 49.2 | 11.5 | 0    |            |            |
| PHF  | .719                              | .826 | .964 | 0    | .856       | .719                 | .554 | .843 | 0    | .876       | .685                              | .861 | .534 | 0    | .821       | .605                 | .573 | .611 | 0    | .590       | .870       |

# Traffic Data Service

San Jose, CA  
 (408) 622-4787  
 tdsbay@cs.com

File Name : 25AM FINAL  
 Site Code : 00000025  
 Start Date : 4/27/2017  
 Page No : 2

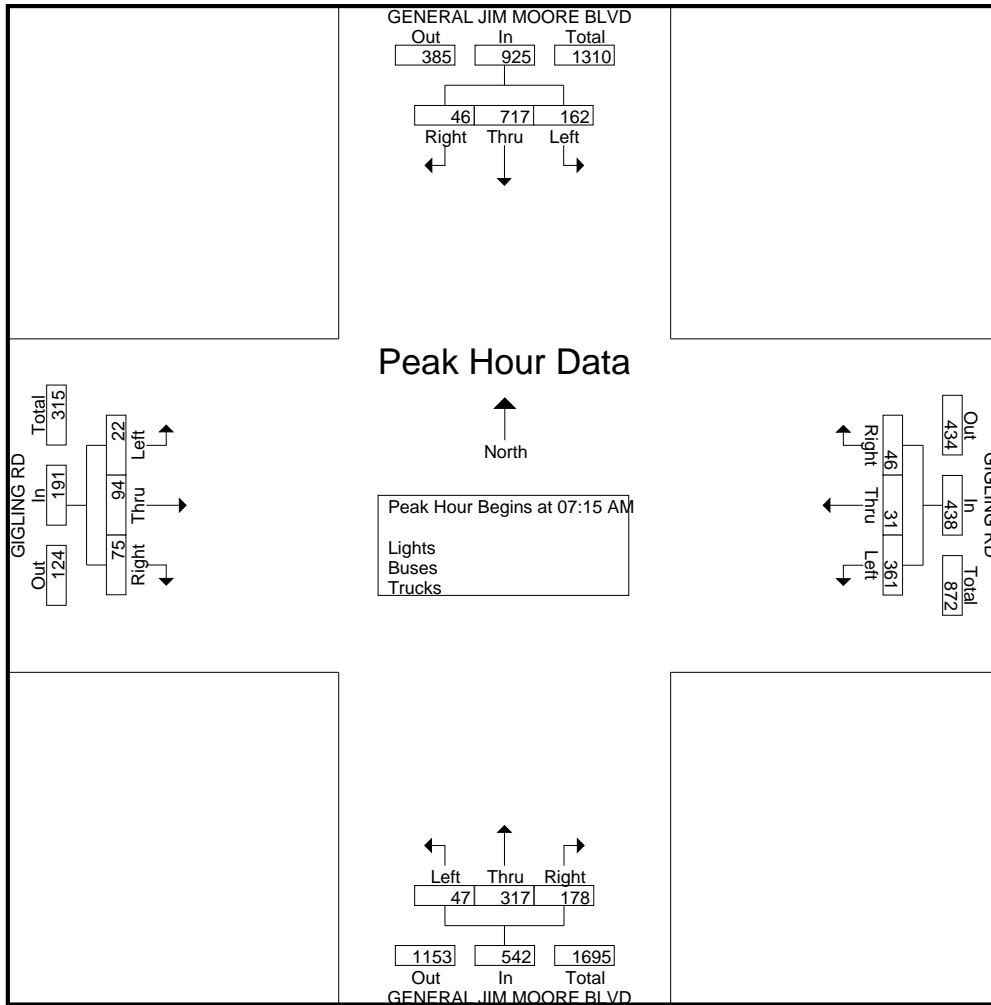

# Traffic Data Service

San Jose, CA  
 (408) 622-4787  
 tdsbay@cs.com

File Name : 25AM FINAL  
 Site Code : 00000025  
 Start Date : 4/27/2017  
 Page No : 1

Groups Printed- Bikes

| Start Time  | GENERAL JIM MOORE BLVD Southbound |      |      |      |            | GIGLING RD Westbound |      |      |      |            | GENERAL JIM MOORE BLVD Northbound |      |      |      |            | GIGLING RD Eastbound |      |      |      |            | Int. Total |      |   |   |      |   |
|-------------|-----------------------------------|------|------|------|------------|----------------------|------|------|------|------------|-----------------------------------|------|------|------|------------|----------------------|------|------|------|------------|------------|------|---|---|------|---|
|             | Right                             | Thru | Left | Peds | App. Total | Right                | Thru | Left | Peds | App. Total | Right                             | Thru | Left | Peds | App. Total | Right                | Thru | Left | Peds | App. Total |            |      |   |   |      |   |
| 07:00 AM    | 0                                 | 0    | 0    | 0    | 0          | 0                    | 0    | 0    | 0    | 0          | 0                                 | 0    | 0    | 0    | 0          | 0                    | 0    | 0    | 0    | 0          | 0          | 0    | 0 | 0 | 0    | 0 |
| 07:15 AM    | 0                                 | 0    | 0    | 0    | 0          | 0                    | 0    | 0    | 0    | 0          | 0                                 | 0    | 0    | 0    | 0          | 0                    | 0    | 0    | 0    | 0          | 0          | 0    | 0 | 0 | 0    | 0 |
| 07:30 AM    | 0                                 | 0    | 0    | 0    | 0          | 0                    | 0    | 0    | 0    | 0          | 0                                 | 0    | 0    | 0    | 0          | 0                    | 0    | 0    | 0    | 0          | 0          | 0    | 0 | 0 | 0    | 0 |
| 07:45 AM    | 0                                 | 0    | 0    | 0    | 0          | 0                    | 0    | 0    | 0    | 0          | 0                                 | 1    | 0    | 0    | 1          | 0                    | 0    | 0    | 0    | 0          | 0          | 0    | 0 | 0 | 0    | 1 |
| Total       | 0                                 | 0    | 0    | 0    | 0          | 0                    | 0    | 0    | 0    | 0          | 0                                 | 1    | 0    | 0    | 1          | 0                    | 0    | 0    | 0    | 0          | 0          | 0    | 0 | 0 | 0    | 1 |
| 08:00 AM    | 0                                 | 0    | 0    | 0    | 0          | 0                    | 0    | 0    | 0    | 0          | 0                                 | 1    | 0    | 0    | 1          | 0                    | 0    | 0    | 0    | 0          | 0          | 0    | 0 | 0 | 0    | 1 |
| 08:15 AM    | 0                                 | 0    | 0    | 0    | 0          | 0                    | 0    | 0    | 0    | 0          | 0                                 | 0    | 0    | 0    | 0          | 0                    | 0    | 0    | 0    | 0          | 0          | 0    | 0 | 0 | 0    | 0 |
| 08:30 AM    | 0                                 | 0    | 0    | 0    | 0          | 0                    | 0    | 0    | 0    | 0          | 0                                 | 0    | 0    | 0    | 0          | 0                    | 0    | 0    | 0    | 0          | 0          | 0    | 0 | 0 | 0    | 0 |
| 08:45 AM    | 0                                 | 0    | 0    | 0    | 0          | 0                    | 0    | 0    | 0    | 0          | 0                                 | 0    | 0    | 0    | 0          | 0                    | 1    | 0    | 0    | 1          | 0          | 1    | 0 | 0 | 1    | 1 |
| Total       | 0                                 | 0    | 0    | 0    | 0          | 0                    | 0    | 0    | 0    | 0          | 0                                 | 1    | 0    | 0    | 1          | 0                    | 1    | 0    | 0    | 1          | 0          | 1    | 0 | 0 | 1    | 2 |
| Grand Total | 0                                 | 0    | 0    | 0    | 0          | 0                    | 0    | 0    | 0    | 0          | 0                                 | 2    | 0    | 0    | 2          | 0                    | 1    | 0    | 0    | 1          | 0          | 1    | 0 | 0 | 1    | 3 |
| Apprch %    | 0                                 | 0    | 0    | 0    |            | 0                    | 0    | 0    | 0    |            | 0                                 | 100  | 0    | 0    |            | 0                    | 100  | 0    | 0    |            | 0          | 100  | 0 | 0 |      |   |
| Total %     | 0                                 | 0    | 0    | 0    |            | 0                    | 0    | 0    | 0    |            | 0                                 | 66.7 | 0    | 0    | 66.7       | 0                    | 33.3 | 0    | 0    | 33.3       | 0          | 33.3 | 0 | 0 | 33.3 |   |

| Start Time   | GENERAL JIM MOORE BLVD Southbound |      |      |      |            | GIGLING RD Westbound |      |      |      |            | GENERAL JIM MOORE BLVD Northbound |      |      |      |            | GIGLING RD Eastbound |      |      |      |            | Int. Total |      |      |      |   |      |
|--|-----------------------------------|------|------|------|------------|----------------------|------|------|------|------------|-----------------------------------|------|------|------|------------|----------------------|------|------|------|------------|------------|------|------|------|---|------|
|  | Right                             | Thru | Left | Peds | App. Total | Right                | Thru | Left | Peds | App. Total | Right                             | Thru | Left | Peds | App. Total | Right                | Thru | Left | Peds | App. Total |            |      |      |      |   |      |
| Peak Hour Analysis From 07:00 AM to 08:45 AM - Peak 1 of 1 |                                   |      |      |      |            |                      |      |      |      |            |                                   |      |      |      |            |                      |      |      |      |            |            |      |      |      |   |      |
| Peak Hour for Entire Intersection Begins at 07:15 AM       |                                   |      |      |      |            |                      |      |      |      |            |                                   |      |      |      |            |                      |      |      |      |            |            |      |      |      |   |      |
| 07:15 AM   | 0                                 | 0    | 0    | 0    | 0          | 0                    | 0    | 0    | 0    | 0          | 0                                 | 0    | 0    | 0    | 0          | 0                    | 0    | 0    | 0    | 0          | 0          | 0    | 0    | 0    | 0 | 0    |
| 07:30 AM   | 0                                 | 0    | 0    | 0    | 0          | 0                    | 0    | 0    | 0    | 0          | 0                                 | 0    | 0    | 0    | 0          | 0                    | 0    | 0    | 0    | 0          | 0          | 0    | 0    | 0    | 0 | 0    |
| 07:45 AM   | 0                                 | 0    | 0    | 0    | 0          | 0                    | 0    | 0    | 0    | 0          | 0                                 | 1    | 0    | 0    | 1          | 0                    | 0    | 0    | 0    | 0          | 0          | 0    | 0    | 0    | 0 | 1    |
| 08:00 AM   | 0                                 | 0    | 0    | 0    | 0          | 0                    | 0    | 0    | 0    | 0          | 0                                 | 1    | 0    | 0    | 1          | 0                    | 0    | 0    | 0    | 0          | 0          | 0    | 0    | 0    | 0 | 1    |
| Total Volume   | 0                                 | 0    | 0    | 0    | 0          | 0                    | 0    | 0    | 0    | 0          | 0                                 | 2    | 0    | 0    | 2          | 0                    | 0    | 0    | 0    | 0          | 0          | 0    | 0    | 0    | 0 | 2    |
| % App. Total   | 0                                 | 0    | 0    | 0    |            | 0                    | 0    | 0    | 0    |            | 0                                 | 100  | 0    | 0    |            | 0                    | 0    | 0    | 0    |            | 0          | 0    | 0    | 0    |   |      |
| PHF  | .000                              | .000 | .000 | .000 |            | .000                 | .000 | .000 | .000 |            | .000                              | .500 | .000 | .500 |            | .000                 | .000 | .000 | .000 |            | .000       | .000 | .000 | .000 |   | .500 |

# Traffic Data Service

San Jose, CA  
 (408) 622-4787  
 tdsbay@cs.com

File Name : 25AM FINAL  
 Site Code : 00000025  
 Start Date : 4/27/2017  
 Page No : 2

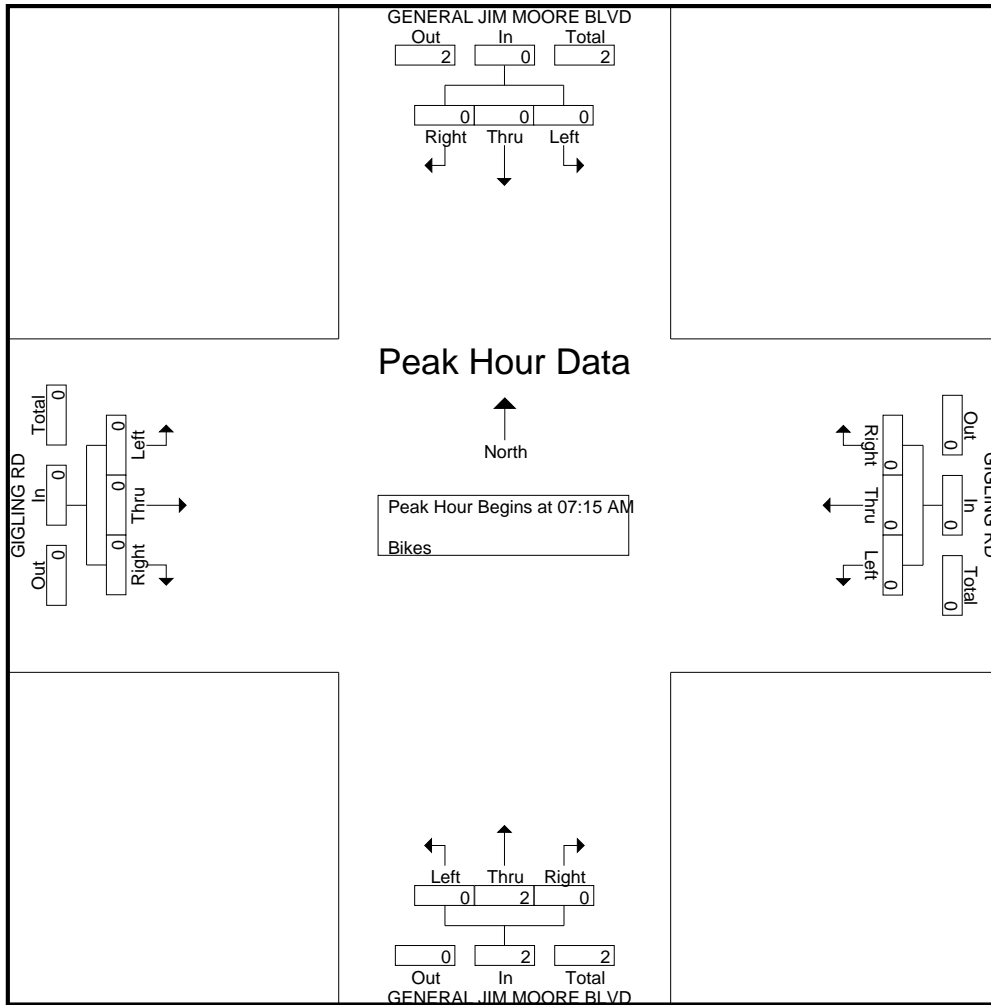

# Traffic Data Service

San Jose, CA  
 (408) 622-4787  
 tdsbay@cs.com

File Name : 25PM FINAL  
 Site Code : 00000025  
 Start Date : 4/27/2017  
 Page No : 1

Groups Printed- Lights - Buses - Trucks

| Start Time  | GENERAL JIM MOORE BLVD Southbound |      |      |      |            | GIGLING RD Westbound |      |      |      |            | GENERAL JIM MOORE BLVD Northbound |      |      |      |            | GIGLING RD Eastbound |      |      |      |            | Int. Total |
|-------------|-----------------------------------|------|------|------|------------|----------------------|------|------|------|------------|-----------------------------------|------|------|------|------------|----------------------|------|------|------|------------|------------|
|             | Right                             | Thru | Left | Peds | App. Total | Right                | Thru | Left | Peds | App. Total | Right                             | Thru | Left | Peds | App. Total | Right                | Thru | Left | Peds | App. Total |            |
| 04:00 PM    | 10                                | 53   | 18   | 0    | 81         | 43                   | 18   | 26   | 0    | 87         | 44                                | 88   | 16   | 0    | 148        | 10                   | 8    | 5    | 0    | 23         | 339        |
| 04:15 PM    | 16                                | 61   | 19   | 2    | 98         | 38                   | 14   | 39   | 0    | 91         | 64                                | 97   | 12   | 0    | 173        | 10                   | 5    | 7    | 1    | 23         | 385        |
| 04:30 PM    | 13                                | 61   | 13   | 0    | 87         | 68                   | 8    | 41   | 1    | 118        | 56                                | 138  | 10   | 0    | 204        | 3                    | 3    | 3    | 0    | 9          | 418        |
| 04:45 PM    | 17                                | 62   | 21   | 0    | 100        | 67                   | 16   | 55   | 0    | 138        | 79                                | 133  | 18   | 0    | 230        | 11                   | 7    | 6    | 1    | 25         | 493        |
| Total       | 56                                | 237  | 71   | 2    | 366        | 216                  | 56   | 161  | 1    | 434        | 243                               | 456  | 56   | 0    | 755        | 34                   | 23   | 21   | 2    | 80         | 1635       |
| 05:00 PM    | 9                                 | 53   | 15   | 0    | 77         | 48                   | 6    | 37   | 0    | 91         | 84                                | 143  | 13   | 2    | 242        | 7                    | 2    | 2    | 1    | 12         | 422        |
| 05:15 PM    | 7                                 | 58   | 18   | 0    | 83         | 35                   | 12   | 34   | 0    | 81         | 89                                | 140  | 16   | 0    | 245        | 6                    | 0    | 7    | 0    | 13         | 422        |
| 05:30 PM    | 10                                | 52   | 23   | 0    | 85         | 31                   | 3    | 17   | 0    | 51         | 75                                | 120  | 7    | 0    | 202        | 7                    | 3    | 5    | 0    | 15         | 353        |
| 05:45 PM    | 13                                | 58   | 17   | 0    | 88         | 28                   | 1    | 19   | 0    | 48         | 57                                | 109  | 10   | 0    | 176        | 5                    | 1    | 6    | 0    | 12         | 324        |
| Total       | 39                                | 221  | 73   | 0    | 333        | 142                  | 22   | 107  | 0    | 271        | 305                               | 512  | 46   | 2    | 865        | 25                   | 6    | 20   | 1    | 52         | 1521       |
| Grand Total | 95                                | 458  | 144  | 2    | 699        | 358                  | 78   | 268  | 1    | 705        | 548                               | 968  | 102  | 2    | 1620       | 59                   | 29   | 41   | 3    | 132        | 3156       |
| Apprch %    | 13.6                              | 65.5 | 20.6 | 0.3  |            | 50.8                 | 11.1 | 38   | 0.1  |            | 33.8                              | 59.8 | 6.3  | 0.1  |            | 44.7                 | 22   | 31.1 | 2.3  |            |            |
| Total %     | 3                                 | 14.5 | 4.6  | 0.1  | 22.1       | 11.3                 | 2.5  | 8.5  | 0    | 22.3       | 17.4                              | 30.7 | 3.2  | 0.1  | 51.3       | 1.9                  | 0.9  | 1.3  | 0.1  | 4.2        |            |
| Lights      | 93                                | 453  | 137  | 2    | 685        | 353                  | 76   | 267  | 1    | 697        | 532                               | 966  | 102  | 2    | 1602       | 58                   | 27   | 38   | 3    | 126        | 3110       |
| % Lights    | 97.9                              | 98.9 | 95.1 | 100  | 98         | 98.6                 | 97.4 | 99.6 | 100  | 98.9       | 97.1                              | 99.8 | 100  | 100  | 98.9       | 98.3                 | 93.1 | 92.7 | 100  | 95.5       | 98.5       |
| Buses       | 2                                 | 3    | 5    | 0    | 10         | 4                    | 2    | 1    | 0    | 7          | 6                                 | 0    | 0    | 0    | 6          | 1                    | 2    | 2    | 0    | 5          | 28         |
| % Buses     | 2.1                               | 0.7  | 3.5  | 0    | 1.4        | 1.1                  | 2.6  | 0.4  | 0    | 1          | 1.1                               | 0    | 0    | 0    | 0.4        | 1.7                  | 6.9  | 4.9  | 0    | 3.8        | 0.9        |
| Trucks      | 0                                 | 2    | 2    | 0    | 4          | 1                    | 0    | 0    | 0    | 1          | 10                                | 2    | 0    | 0    | 12         | 0                    | 0    | 1    | 0    | 1          | 18         |
| % Trucks    | 0                                 | 0.4  | 1.4  | 0    | 0.6        | 0.3                  | 0    | 0    | 0    | 0.1        | 1.8                               | 0.2  | 0    | 0    | 0.7        | 0                    | 0    | 2.4  | 0    | 0.8        | 0.6        |

| Start Time   | GENERAL JIM MOORE BLVD Southbound |      |      |      |            | GIGLING RD Westbound |      |      |      |            | GENERAL JIM MOORE BLVD Northbound |      |      |      |            | GIGLING RD Eastbound |      |      |      |            | Int. Total |
|--|-----------------------------------|------|------|------|------------|----------------------|------|------|------|------------|-----------------------------------|------|------|------|------------|----------------------|------|------|------|------------|------------|
|  | Right                             | Thru | Left | Peds | App. Total | Right                | Thru | Left | Peds | App. Total | Right                             | Thru | Left | Peds | App. Total | Right                | Thru | Left | Peds | App. Total |            |
| Peak Hour Analysis From 04:00 PM to 05:45 PM - Peak 1 of 1 |                                   |      |      |      |            |                      |      |      |      |            |                                   |      |      |      |            |                      |      |      |      |            |            |
| Peak Hour for Entire Intersection Begins at 04:30 PM       |                                   |      |      |      |            |                      |      |      |      |            |                                   |      |      |      |            |                      |      |      |      |            |            |
| 04:30 PM   | 13                                | 61   | 13   |      | 87         | 68                   | 8    | 41   |      | 117        | 56                                | 138  | 10   |      | 204        | 3                    | 3    | 3    |      | 9          | 417        |
| 04:45 PM   | 17                                | 62   | 21   |      | 100        | 67                   | 16   | 55   |      | 138        | 79                                | 133  | 18   |      | 230        | 11                   | 7    | 6    |      | 24         | 492        |
| 05:00 PM   | 9                                 | 53   | 15   |      | 77         | 48                   | 6    | 37   |      | 91         | 84                                | 143  | 13   |      | 240        | 7                    | 2    | 2    |      | 11         | 419        |
| 05:15 PM   | 7                                 | 58   | 18   |      | 83         | 35                   | 12   | 34   |      | 81         | 89                                | 140  | 16   |      | 245        | 6                    | 0    | 7    |      | 13         | 422        |
| Total Volume   | 46                                | 234  | 67   |      | 347        | 218                  | 42   | 167  |      | 427        | 308                               | 554  | 57   |      | 919        | 27                   | 12   | 18   |      | 57         | 1750       |
| % App. Total   | 13.3                              | 67.4 | 19.3 |      |            | 51.1                 | 9.8  | 39.1 |      |            | 33.5                              | 60.3 | 6.2  |      |            | 47.4                 | 21.1 | 31.6 |      |            |            |
| PHF  | .676                              | .944 | .798 |      | .868       | .801                 | .656 | .759 |      | .774       | .865                              | .969 | .792 |      | .938       | .614                 | .429 | .643 |      | .594       | .889       |

# Traffic Data Service

San Jose, CA  
 (408) 622-4787  
 tdsbay@cs.com

File Name : 25PM FINAL  
 Site Code : 00000025  
 Start Date : 4/27/2017  
 Page No : 2

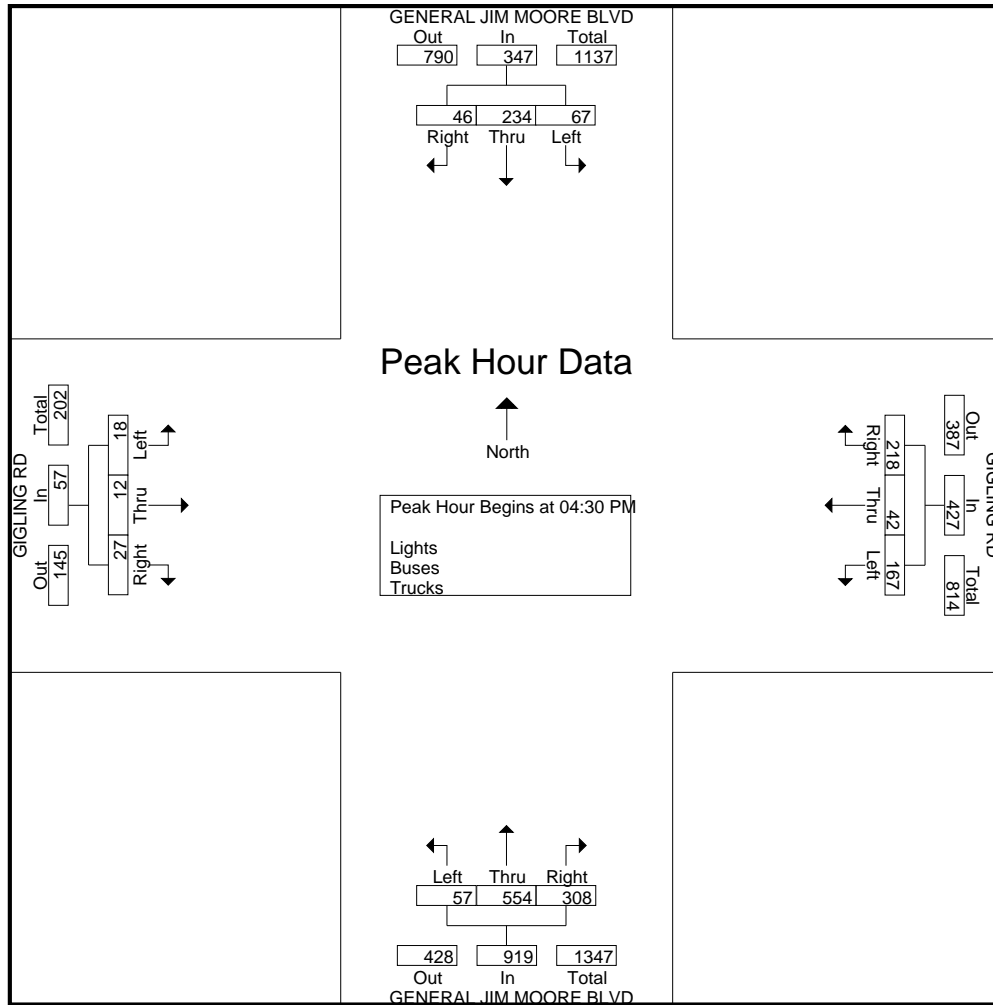

# Traffic Data Service

San Jose, CA  
 (408) 622-4787  
 tdsbay@cs.com

File Name : 25PM FINAL  
 Site Code : 00000025  
 Start Date : 4/27/2017  
 Page No : 1

Groups Printed- Bikes

| Start Time  | GENERAL JIM MOORE BLVD Southbound |      |      |      |            | GIGLING RD Westbound |      |      |      |            | GENERAL JIM MOORE BLVD Northbound |      |      |      |            | GIGLING RD Eastbound |      |      |      |            | Int. Total |   |   |   |   |   |
|-------------|-----------------------------------|------|------|------|------------|----------------------|------|------|------|------------|-----------------------------------|------|------|------|------------|----------------------|------|------|------|------------|------------|---|---|---|---|---|
|             | Right                             | Thru | Left | Peds | App. Total | Right                | Thru | Left | Peds | App. Total | Right                             | Thru | Left | Peds | App. Total | Right                | Thru | Left | Peds | App. Total |            |   |   |   |   |   |
| 04:00 PM    | 0                                 | 0    | 0    | 0    | 0          | 1                    | 0    | 0    | 0    | 1          | 0                                 | 0    | 0    | 0    | 0          | 0                    | 0    | 0    | 0    | 0          | 0          | 0 | 0 | 0 | 0 | 1 |
| 04:15 PM    | 0                                 | 0    | 0    | 0    | 0          | 0                    | 0    | 1    | 0    | 1          | 0                                 | 0    | 0    | 0    | 0          | 0                    | 0    | 1    | 0    | 1          | 0          | 0 | 0 | 0 | 0 | 2 |
| 04:30 PM    | 0                                 | 0    | 0    | 0    | 0          | 0                    | 0    | 0    | 0    | 0          | 0                                 | 0    | 0    | 0    | 0          | 0                    | 0    | 0    | 0    | 0          | 0          | 0 | 0 | 0 | 0 | 0 |
| 04:45 PM    | 0                                 | 0    | 0    | 0    | 0          | 0                    | 0    | 0    | 0    | 0          | 0                                 | 0    | 0    | 0    | 0          | 0                    | 0    | 0    | 0    | 0          | 0          | 0 | 0 | 0 | 0 | 0 |
| Total       | 0                                 | 0    | 0    | 0    | 0          | 1                    | 0    | 1    | 0    | 2          | 0                                 | 0    | 0    | 0    | 0          | 0                    | 0    | 1    | 0    | 1          | 0          | 0 | 0 | 0 | 0 | 3 |
| 05:00 PM    | 0                                 | 0    | 0    | 0    | 0          | 0                    | 0    | 0    | 0    | 0          | 0                                 | 0    | 0    | 0    | 0          | 0                    | 0    | 0    | 0    | 0          | 0          | 0 | 0 | 0 | 0 | 0 |
| 05:15 PM    | 0                                 | 0    | 0    | 0    | 0          | 0                    | 0    | 0    | 0    | 0          | 0                                 | 0    | 0    | 0    | 0          | 0                    | 0    | 0    | 0    | 0          | 0          | 0 | 0 | 0 | 0 | 0 |
| 05:30 PM    | 0                                 | 0    | 0    | 0    | 0          | 0                    | 0    | 0    | 0    | 0          | 0                                 | 0    | 0    | 0    | 0          | 0                    | 1    | 0    | 0    | 1          | 0          | 0 | 0 | 0 | 1 | 1 |
| 05:45 PM    | 0                                 | 0    | 0    | 0    | 0          | 0                    | 0    | 0    | 0    | 0          | 0                                 | 0    | 0    | 0    | 0          | 0                    | 0    | 0    | 0    | 0          | 0          | 0 | 0 | 0 | 0 | 0 |
| Total       | 0                                 | 0    | 0    | 0    | 0          | 0                    | 0    | 0    | 0    | 0          | 0                                 | 0    | 0    | 0    | 0          | 0                    | 1    | 0    | 0    | 1          | 0          | 0 | 0 | 0 | 1 | 1 |
| Grand Total | 0                                 | 0    | 0    | 0    | 0          | 1                    | 0    | 1    | 0    | 2          | 0                                 | 0    | 0    | 0    | 0          | 0                    | 1    | 1    | 0    | 2          | 0          | 0 | 0 | 0 | 4 |   |
| Apprch %    | 0                                 | 0    | 0    | 0    |            | 50                   | 0    | 50   | 0    |            | 0                                 | 0    | 0    | 0    |            | 0                    | 50   | 50   | 0    |            |            |   |   |   |   |   |
| Total %     | 0                                 | 0    | 0    | 0    | 0          | 25                   | 0    | 25   | 0    | 50         | 0                                 | 0    | 0    | 0    | 0          | 0                    | 25   | 25   | 0    | 50         |            |   |   |   |   |   |

| Start Time   | GENERAL JIM MOORE BLVD Southbound |      |      |      |            | GIGLING RD Westbound |      |      |      |            | GENERAL JIM MOORE BLVD Northbound |      |      |      |            | GIGLING RD Eastbound |      |      |      |            | Int. Total |      |      |      |      |   |
|--|-----------------------------------|------|------|------|------------|----------------------|------|------|------|------------|-----------------------------------|------|------|------|------------|----------------------|------|------|------|------------|------------|------|------|------|------|---|
|  | Right                             | Thru | Left | Peds | App. Total | Right                | Thru | Left | Peds | App. Total | Right                             | Thru | Left | Peds | App. Total | Right                | Thru | Left | Peds | App. Total |            |      |      |      |      |   |
| Peak Hour Analysis From 04:00 PM to 05:45 PM - Peak 1 of 1 |                                   |      |      |      |            |                      |      |      |      |            |                                   |      |      |      |            |                      |      |      |      |            |            |      |      |      |      |   |
| Peak Hour for Entire Intersection Begins at 04:00 PM       |                                   |      |      |      |            |                      |      |      |      |            |                                   |      |      |      |            |                      |      |      |      |            |            |      |      |      |      |   |
| 04:00 PM   | 0                                 | 0    | 0    | 0    | 0          | 1                    | 0    | 0    | 0    | 1          | 0                                 | 0    | 0    | 0    | 0          | 0                    | 0    | 0    | 0    | 0          | 0          | 0    | 0    | 0    | 0    | 1 |
| 04:15 PM   | 0                                 | 0    | 0    | 0    | 0          | 0                    | 0    | 1    | 0    | 1          | 0                                 | 0    | 0    | 0    | 0          | 0                    | 0    | 1    | 0    | 1          | 0          | 0    | 0    | 0    | 0    | 2 |
| 04:30 PM   | 0                                 | 0    | 0    | 0    | 0          | 0                    | 0    | 0    | 0    | 0          | 0                                 | 0    | 0    | 0    | 0          | 0                    | 0    | 0    | 0    | 0          | 0          | 0    | 0    | 0    | 0    | 0 |
| 04:45 PM   | 0                                 | 0    | 0    | 0    | 0          | 0                    | 0    | 0    | 0    | 0          | 0                                 | 0    | 0    | 0    | 0          | 0                    | 0    | 0    | 0    | 0          | 0          | 0    | 0    | 0    | 0    | 0 |
| Total Volume   | 0                                 | 0    | 0    | 0    | 0          | 1                    | 0    | 1    | 0    | 2          | 0                                 | 0    | 0    | 0    | 0          | 0                    | 0    | 1    | 0    | 1          | 0          | 0    | 0    | 0    | 1    | 3 |
| % App. Total   | 0                                 | 0    | 0    | 0    |            | 50                   | 0    | 50   | 0    |            | 0                                 | 0    | 0    | 0    |            | 0                    | 0    | 100  | 0    |            |            |      |      |      |      |   |
| PHF  | .000                              | .000 | .000 | .000 | .000       | .250                 | .000 | .250 | .500 | .000       | .000                              | .000 | .000 | .000 | .000       | .000                 | .000 | .250 | .250 | .000       | .000       | .000 | .375 | .000 | .375 |   |

# Traffic Data Service

San Jose, CA  
 (408) 622-4787  
 tdsbay@cs.com

File Name : 25PM FINAL  
 Site Code : 00000025  
 Start Date : 4/27/2017  
 Page No : 2

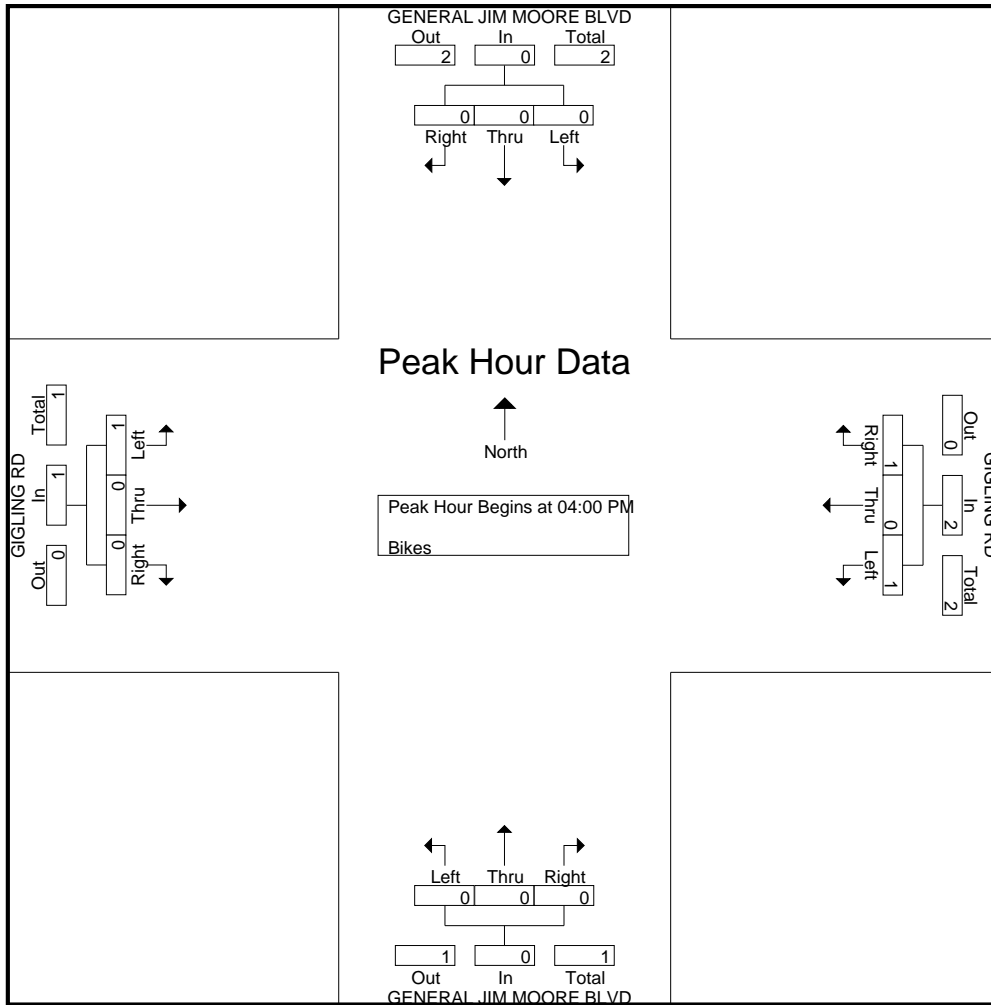



# Traffic Data Service

San Jose, CA  
(408) 622-4787  
tdsbay@cs.com

File Name : 26AM FINAL  
Site Code : 00000026  
Start Date : 4/27/2017  
Page No : 1

Groups Printed- Lights - Buses - Trucks

| Start Time   | CA-1 NB ON-RAMP<br>Southbound |      |      |      |            | LIGHTFIGHTER DR<br>Westbound |      |      |      |            | CA-1 NB OFF-RAMP<br>Northbound |      |      |      |            | CA-1 SB RAMPS<br>Eastbound |      |      |      |            | Int. Total |
|--------------|-------------------------------|------|------|------|------------|------------------------------|------|------|------|------------|--------------------------------|------|------|------|------------|----------------------------|------|------|------|------------|------------|
|              | Right                         | Thru | Left | Peds | App. Total | Right                        | Thru | Left | Peds | App. Total | Right                          | Thru | Left | Peds | App. Total | Right                      | Thru | Left | Peds | App. Total |            |
| 07:00 AM     | 0                             | 0    | 0    | 0    | 0          | 17                           | 166  | 0    | 0    | 183        | 40                             | 0    | 0    | 0    | 40         | 0                          | 83   | 0    | 0    | 83         | 306        |
| 07:15 AM     | 0                             | 0    | 0    | 0    | 0          | 32                           | 180  | 0    | 0    | 212        | 85                             | 0    | 0    | 0    | 85         | 0                          | 104  | 0    | 0    | 104        | 401        |
| 07:30 AM     | 0                             | 0    | 0    | 0    | 0          | 59                           | 261  | 0    | 0    | 320        | 124                            | 0    | 0    | 0    | 124        | 0                          | 107  | 0    | 0    | 107        | 551        |
| 07:45 AM     | 0                             | 0    | 0    | 0    | 0          | 40                           | 181  | 0    | 0    | 221        | 150                            | 0    | 0    | 0    | 150        | 0                          | 119  | 0    | 0    | 119        | 490        |
| <b>Total</b> | 0                             | 0    | 0    | 0    | 0          | 148                          | 788  | 0    | 0    | 936        | 399                            | 0    | 0    | 0    | 399        | 0                          | 413  | 0    | 0    | 413        | 1748       |
| 08:00 AM     | 0                             | 0    | 0    | 0    | 0          | 66                           | 117  | 0    | 0    | 183        | 101                            | 0    | 0    | 0    | 101        | 0                          | 101  | 0    | 0    | 101        | 385        |
| 08:15 AM     | 0                             | 0    | 0    | 0    | 0          | 49                           | 82   | 0    | 0    | 131        | 109                            | 0    | 0    | 0    | 109        | 0                          | 70   | 0    | 0    | 70         | 310        |
| 08:30 AM     | 0                             | 0    | 0    | 0    | 0          | 24                           | 68   | 0    | 0    | 92         | 86                             | 0    | 0    | 0    | 86         | 0                          | 112  | 0    | 0    | 112        | 290        |
| 08:45 AM     | 0                             | 0    | 0    | 0    | 0          | 32                           | 62   | 0    | 0    | 94         | 101                            | 0    | 0    | 0    | 101        | 0                          | 83   | 0    | 0    | 83         | 278        |
| <b>Total</b> | 0                             | 0    | 0    | 0    | 0          | 171                          | 329  | 0    | 0    | 500        | 397                            | 0    | 0    | 0    | 397        | 0                          | 366  | 0    | 0    | 366        | 1263       |
| Grand Total  | 0                             | 0    | 0    | 0    | 0          | 319                          | 1117 | 0    | 0    | 1436       | 796                            | 0    | 0    | 0    | 796        | 0                          | 779  | 0    | 0    | 779        | 3011       |
| Apprch %     | 0                             | 0    | 0    | 0    | 0          | 22.2                         | 77.8 | 0    | 0    |            | 100                            | 0    | 0    | 0    |            | 0                          | 100  | 0    | 0    |            |            |
| Total %      | 0                             | 0    | 0    | 0    | 0          | 10.6                         | 37.1 | 0    | 0    | 47.7       | 26.4                           | 0    | 0    | 0    | 26.4       | 0                          | 25.9 | 0    | 0    | 25.9       |            |
| Lights       | 0                             | 0    | 0    | 0    | 0          | 309                          | 1092 | 0    | 0    | 1401       | 772                            | 0    | 0    | 0    | 772        | 0                          | 757  | 0    | 0    | 757        | 2930       |
| % Lights     | 0                             | 0    | 0    | 0    | 0          | 96.9                         | 97.8 | 0    | 0    | 97.6       | 97                             | 0    | 0    | 0    | 97         | 0                          | 97.2 | 0    | 0    | 97.2       | 97.3       |
| Buses        | 0                             | 0    | 0    | 0    | 0          | 4                            | 7    | 0    | 0    | 11         | 15                             | 0    | 0    | 0    | 15         | 0                          | 6    | 0    | 0    | 6          | 32         |
| % Buses      | 0                             | 0    | 0    | 0    | 0          | 1.3                          | 0.6  | 0    | 0    | 0.8        | 1.9                            | 0    | 0    | 0    | 1.9        | 0                          | 0.8  | 0    | 0    | 0.8        | 1.1        |
| Trucks       | 0                             | 0    | 0    | 0    | 0          | 6                            | 18   | 0    | 0    | 24         | 9                              | 0    | 0    | 0    | 9          | 0                          | 16   | 0    | 0    | 16         | 49         |
| % Trucks     | 0                             | 0    | 0    | 0    | 0          | 1.9                          | 1.6  | 0    | 0    | 1.7        | 1.1                            | 0    | 0    | 0    | 1.1        | 0                          | 2.1  | 0    | 0    | 2.1        | 1.6        |

| Start Time   | CA-1 NB ON-RAMP<br>Southbound |      |      |            | LIGHTFIGHTER DR<br>Westbound |            |      |            | CA-1 NB OFF-RAMP<br>Northbound |      |      |            | CA-1 SB RAMPS<br>Eastbound |            |      |            | Int. Total |
|--|-------------------------------|------|------|------------|------------------------------|------------|------|------------|--------------------------------|------|------|------------|----------------------------|------------|------|------------|------------|
|  | Right                         | Thru | Left | App. Total | Right                        | Thru       | Left | App. Total | Right                          | Thru | Left | App. Total | Right                      | Thru       | Left | App. Total |            |
| Peak Hour Analysis From 07:00 AM to 08:45 AM - Peak 1 of 1 |                               |      |      |            |                              |            |      |            |                                |      |      |            |                            |            |      |            |            |
| Peak Hour for Entire Intersection Begins at 07:15 AM       |                               |      |      |            |                              |            |      |            |                                |      |      |            |                            |            |      |            |            |
| 07:15 AM   | 0                             | 0    | 0    | 0          | 32                           | 180        | 0    | 212        | 85                             | 0    | 0    | 85         | 0                          | 104        | 0    | 104        | 401        |
| 07:30 AM   | 0                             | 0    | 0    | 0          | 59                           | <b>261</b> | 0    | <b>320</b> | 124                            | 0    | 0    | 124        | 0                          | 107        | 0    | 107        | <b>551</b> |
| 07:45 AM   | 0                             | 0    | 0    | 0          | 40                           | 181        | 0    | 221        | <b>150</b>                     | 0    | 0    | <b>150</b> | 0                          | <b>119</b> | 0    | <b>119</b> | 490        |
| 08:00 AM   | 0                             | 0    | 0    | 0          | <b>66</b>                    | 117        | 0    | 183        | 101                            | 0    | 0    | 101        | 0                          | 101        | 0    | 101        | 385        |
| Total Volume   | 0                             | 0    | 0    | 0          | 197                          | 739        | 0    | 936        | 460                            | 0    | 0    | 460        | 0                          | 431        | 0    | 431        | 1827       |
| % App. Total   | 0                             | 0    | 0    | 0          | 21                           | 79         | 0    |            | 100                            | 0    | 0    |            | 0                          | 100        | 0    |            |            |
| PHF  | .000                          | .000 | .000 | .000       | .746                         | .708       | .000 | .731       | .767                           | .000 | .000 | .767       | .000                       | .905       | .000 | .905       | .829       |

# Traffic Data Service

San Jose, CA  
 (408) 622-4787  
 tdsbay@cs.com

File Name : 26AM FINAL  
 Site Code : 00000026  
 Start Date : 4/27/2017  
 Page No : 2

sb off-ramp

nb on-ramp

sb-on ramp

nb-off ramp

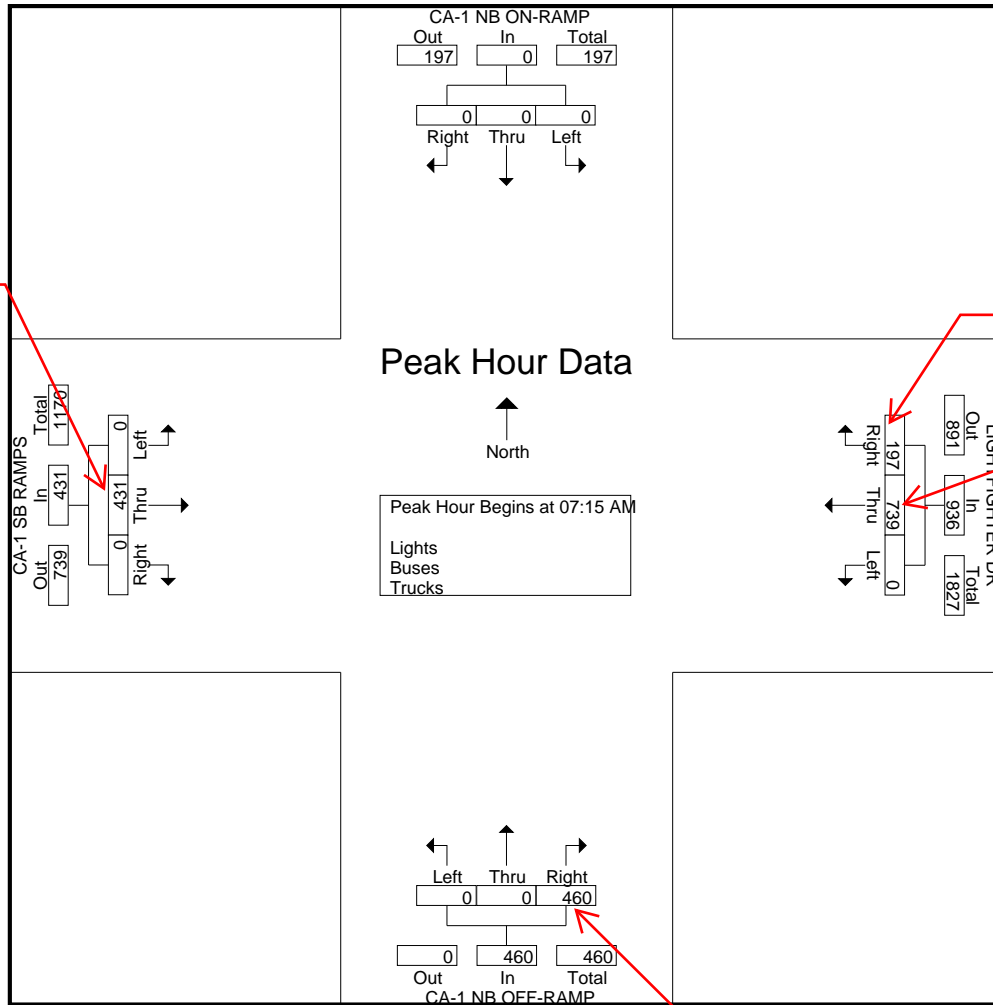

# Traffic Data Service

San Jose, CA  
(408) 622-4787  
tdsbay@cs.com

File Name : 26AM FINAL  
Site Code : 00000026  
Start Date : 4/27/2017  
Page No : 1

Groups Printed- Bikes

| Start Time   | CA-1 NB ON-RAMP<br>Southbound |      |      |      |            | LIGHTFIGHTER DR<br>Westbound |      |      |      |            | CA-1 NB OFF-RAMP<br>Northbound |      |      |      |            | CA-1 SB RAMPS<br>Eastbound |      |      |      |            | Int. Total |
|--------------|-------------------------------|------|------|------|------------|------------------------------|------|------|------|------------|--------------------------------|------|------|------|------------|----------------------------|------|------|------|------------|------------|
|              | Right                         | Thru | Left | Peds | App. Total | Right                        | Thru | Left | Peds | App. Total | Right                          | Thru | Left | Peds | App. Total | Right                      | Thru | Left | Peds | App. Total |            |
| 07:00 AM     | 0                             | 0    | 0    | 0    | 0          | 0                            | 0    | 0    | 0    | 0          | 0                              | 0    | 0    | 0    | 0          | 0                          | 0    | 0    | 0    | 0          | 0          |
| 07:15 AM     | 0                             | 0    | 0    | 0    | 0          | 0                            | 0    | 0    | 0    | 0          | 0                              | 0    | 0    | 0    | 0          | 0                          | 0    | 0    | 0    | 0          | 0          |
| 07:30 AM     | 0                             | 0    | 0    | 0    | 0          | 0                            | 1    | 0    | 0    | 1          | 0                              | 0    | 0    | 0    | 0          | 0                          | 0    | 0    | 0    | 0          | 1          |
| 07:45 AM     | 0                             | 0    | 0    | 0    | 0          | 0                            | 0    | 0    | 0    | 0          | 0                              | 0    | 0    | 0    | 0          | 0                          | 0    | 0    | 0    | 0          | 0          |
| <b>Total</b> | 0                             | 0    | 0    | 0    | 0          | 0                            | 1    | 0    | 0    | 1          | 0                              | 0    | 0    | 0    | 0          | 0                          | 0    | 0    | 0    | 0          | 1          |
| 08:00 AM     | 0                             | 0    | 0    | 0    | 0          | 0                            | 0    | 0    | 0    | 0          | 0                              | 0    | 0    | 0    | 0          | 0                          | 0    | 0    | 0    | 0          | 0          |
| 08:15 AM     | 0                             | 0    | 0    | 0    | 0          | 0                            | 0    | 0    | 0    | 0          | 0                              | 0    | 0    | 0    | 0          | 0                          | 0    | 0    | 0    | 0          | 0          |
| 08:30 AM     | 0                             | 0    | 0    | 0    | 0          | 0                            | 0    | 0    | 0    | 0          | 0                              | 0    | 0    | 0    | 0          | 0                          | 1    | 0    | 0    | 1          | 1          |
| 08:45 AM     | 0                             | 0    | 0    | 0    | 0          | 0                            | 0    | 0    | 0    | 0          | 0                              | 0    | 0    | 0    | 0          | 0                          | 0    | 0    | 0    | 0          | 0          |
| <b>Total</b> | 0                             | 0    | 0    | 0    | 0          | 0                            | 0    | 0    | 0    | 0          | 0                              | 0    | 0    | 0    | 0          | 0                          | 1    | 0    | 0    | 1          | 1          |
| Grand Total  | 0                             | 0    | 0    | 0    | 0          | 0                            | 1    | 0    | 0    | 1          | 0                              | 0    | 0    | 0    | 0          | 0                          | 1    | 0    | 0    | 1          | 2          |
| Apprch %     | 0                             | 0    | 0    | 0    |            | 0                            | 100  | 0    | 0    |            | 0                              | 0    | 0    | 0    |            | 0                          | 100  | 0    | 0    |            |            |
| Total %      | 0                             | 0    | 0    | 0    |            | 0                            | 50   | 0    | 0    | 50         | 0                              | 0    | 0    | 0    |            | 0                          | 50   | 0    | 0    | 50         |            |

| Start Time   | CA-1 NB ON-RAMP<br>Southbound |      |      |            | LIGHTFIGHTER DR<br>Westbound |      |      |            | CA-1 NB OFF-RAMP<br>Northbound |      |      |            | CA-1 SB RAMPS<br>Eastbound |      |      |            | Int. Total |
|--|-------------------------------|------|------|------------|------------------------------|------|------|------------|--------------------------------|------|------|------------|----------------------------|------|------|------------|------------|
|  | Right                         | Thru | Left | App. Total | Right                        | Thru | Left | App. Total | Right                          | Thru | Left | App. Total | Right                      | Thru | Left | App. Total |            |
| Peak Hour Analysis From 07:00 AM to 08:45 AM - Peak 1 of 1 |                               |      |      |            |                              |      |      |            |                                |      |      |            |                            |      |      |            |            |
| Peak Hour for Entire Intersection Begins at 07:00 AM       |                               |      |      |            |                              |      |      |            |                                |      |      |            |                            |      |      |            |            |
| 07:00 AM   | 0                             | 0    | 0    | 0          | 0                            | 0    | 0    | 0          | 0                              | 0    | 0    | 0          | 0                          | 0    | 0    | 0          | 0          |
| 07:15 AM   | 0                             | 0    | 0    | 0          | 0                            | 0    | 0    | 0          | 0                              | 0    | 0    | 0          | 0                          | 0    | 0    | 0          | 0          |
| 07:30 AM   | 0                             | 0    | 0    | 0          | 0                            | 1    | 0    | 1          | 0                              | 0    | 0    | 0          | 0                          | 0    | 0    | 0          | 1          |
| 07:45 AM   | 0                             | 0    | 0    | 0          | 0                            | 0    | 0    | 0          | 0                              | 0    | 0    | 0          | 0                          | 0    | 0    | 0          | 0          |
| Total Volume   | 0                             | 0    | 0    | 0          | 0                            | 1    | 0    | 1          | 0                              | 0    | 0    | 0          | 0                          | 0    | 0    | 0          | 1          |
| % App. Total   | 0                             | 0    | 0    |            | 0                            | 100  | 0    |            | 0                              | 0    | 0    |            | 0                          | 0    | 0    |            |            |
| PHF  | .000                          | .000 | .000 | .000       | .000                         | .250 | .000 | .250       | .000                           | .000 | .000 | .000       | .000                       | .000 | .000 | .000       | .250       |

# Traffic Data Service

San Jose, CA  
(408) 622-4787  
tdsbay@cs.com

File Name : 26AM FINAL  
Site Code : 00000026  
Start Date : 4/27/2017  
Page No : 2

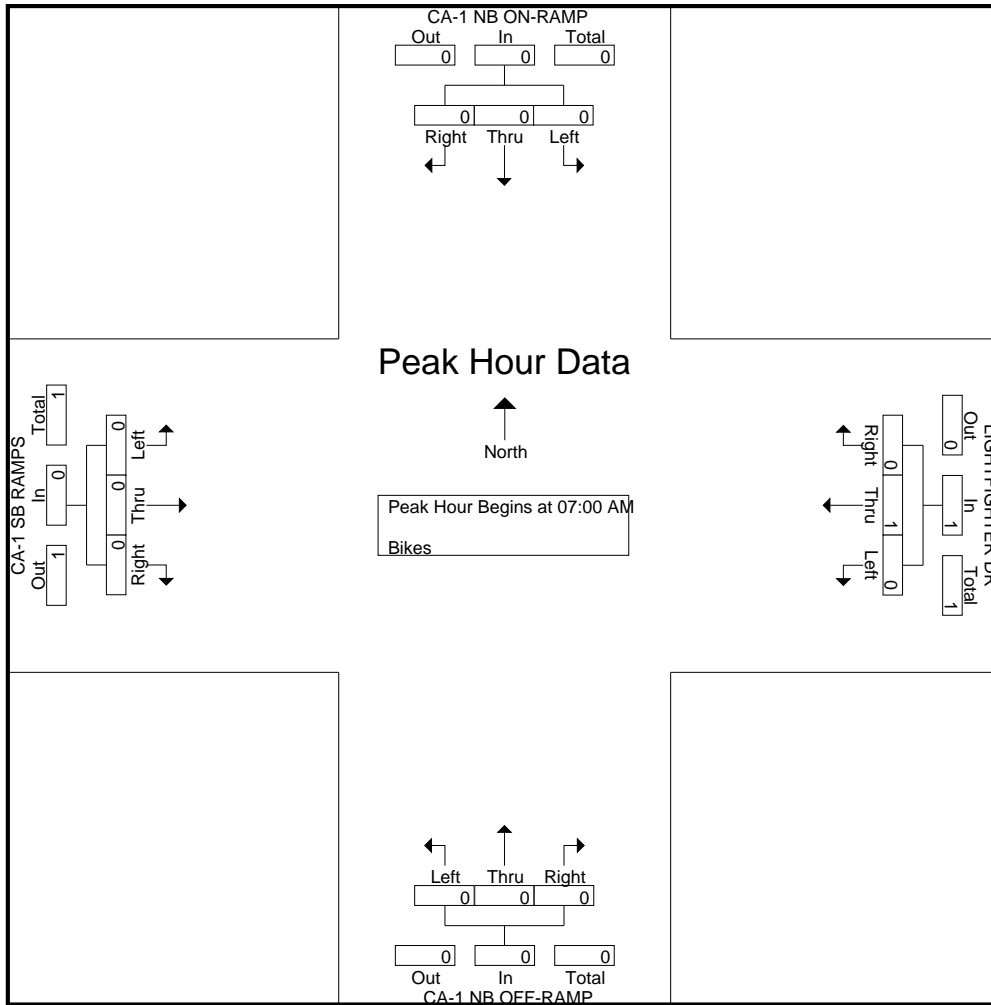

# Traffic Data Service

San Jose, CA  
**(408) 622-4787**  
*tdsbay@cs.com*

File Name : 26PM FINAL  
 Site Code : 00000026  
 Start Date : 4/27/2017  
 Page No : 1

Groups Printed- Lights - Buses - Trucks

| Start Time   | CA-1 NB ON-RAMP<br>Southbound |      |      |      |            | LIGHTFIGHTER DR<br>Westbound |      |      |      |            | CA-1 NB OFF-RAMP<br>Northbound |      |      |      |            | CA-1 SB RAMPS<br>Eastbound |      |      |      |            | Int. Total |
|--------------|-------------------------------|------|------|------|------------|------------------------------|------|------|------|------------|--------------------------------|------|------|------|------------|----------------------------|------|------|------|------------|------------|
|              | Right                         | Thru | Left | Peds | App. Total | Right                        | Thru | Left | Peds | App. Total | Right                          | Thru | Left | Peds | App. Total | Right                      | Thru | Left | Peds | App. Total |            |
| 04:00 PM     | 0                             | 0    | 0    | 0    | 0          | 137                          | 126  | 0    | 0    | 263        | 86                             | 0    | 0    | 0    | 86         | 0                          | 33   | 0    | 0    | 33         | 382        |
| 04:15 PM     | 0                             | 0    | 0    | 0    | 0          | 107                          | 99   | 0    | 0    | 206        | 97                             | 0    | 0    | 0    | 97         | 0                          | 41   | 0    | 0    | 41         | 344        |
| 04:30 PM     | 0                             | 0    | 0    | 0    | 0          | 155                          | 135  | 0    | 0    | 290        | 87                             | 0    | 0    | 0    | 87         | 0                          | 48   | 0    | 0    | 48         | 425        |
| 04:45 PM     | 0                             | 0    | 0    | 0    | 0          | 166                          | 155  | 0    | 0    | 321        | 101                            | 0    | 0    | 0    | 101        | 0                          | 44   | 0    | 0    | 44         | 466        |
| <b>Total</b> | 0                             | 0    | 0    | 0    | 0          | 565                          | 515  | 0    | 0    | 1080       | 371                            | 0    | 0    | 0    | 371        | 0                          | 166  | 0    | 0    | 166        | 1617       |
| 05:00 PM     | 0                             | 0    | 0    | 0    | 0          | 172                          | 131  | 0    | 0    | 303        | 98                             | 0    | 0    | 0    | 98         | 0                          | 41   | 0    | 0    | 41         | 442        |
| 05:15 PM     | 0                             | 0    | 0    | 0    | 0          | 168                          | 117  | 0    | 0    | 285        | 98                             | 0    | 0    | 0    | 98         | 0                          | 34   | 0    | 0    | 34         | 417        |
| 05:30 PM     | 0                             | 0    | 0    | 0    | 0          | 121                          | 133  | 0    | 0    | 254        | 113                            | 0    | 0    | 0    | 113        | 0                          | 36   | 0    | 0    | 36         | 403        |
| 05:45 PM     | 0                             | 0    | 0    | 0    | 0          | 112                          | 111  | 0    | 0    | 223        | 103                            | 0    | 0    | 0    | 103        | 0                          | 53   | 0    | 0    | 53         | 379        |
| <b>Total</b> | 0                             | 0    | 0    | 0    | 0          | 573                          | 492  | 0    | 0    | 1065       | 412                            | 0    | 0    | 0    | 412        | 0                          | 164  | 0    | 0    | 164        | 1641       |
| Grand Total  | 0                             | 0    | 0    | 0    | 0          | 1138                         | 1007 | 0    | 0    | 2145       | 783                            | 0    | 0    | 0    | 783        | 0                          | 330  | 0    | 0    | 330        | 3258       |
| Apprch %     | 0                             | 0    | 0    | 0    | 0          | 53.1                         | 46.9 | 0    | 0    |            | 100                            | 0    | 0    | 0    |            | 0                          | 100  | 0    | 0    |            |            |
| Total %      | 0                             | 0    | 0    | 0    | 0          | 34.9                         | 30.9 | 0    | 0    | 65.8       | 24                             | 0    | 0    | 0    | 24         | 0                          | 10.1 | 0    | 0    | 10.1       |            |
| Lights       | 0                             | 0    | 0    | 0    | 0          | 1126                         | 1001 | 0    | 0    | 2127       | 771                            | 0    | 0    | 0    | 771        | 0                          | 323  | 0    | 0    | 323        | 3221       |
| % Lights     | 0                             | 0    | 0    | 0    | 0          | 98.9                         | 99.4 | 0    | 0    | 99.2       | 98.5                           | 0    | 0    | 0    | 98.5       | 0                          | 97.9 | 0    | 0    | 97.9       | 98.9       |
| Buses        | 0                             | 0    | 0    | 0    | 0          | 2                            | 4    | 0    | 0    | 6          | 9                              | 0    | 0    | 0    | 9          | 0                          | 4    | 0    | 0    | 4          | 19         |
| % Buses      | 0                             | 0    | 0    | 0    | 0          | 0.2                          | 0.4  | 0    | 0    | 0.3        | 1.1                            | 0    | 0    | 0    | 1.1        | 0                          | 1.2  | 0    | 0    | 1.2        | 0.6        |
| Trucks       | 0                             | 0    | 0    | 0    | 0          | 10                           | 2    | 0    | 0    | 12         | 3                              | 0    | 0    | 0    | 3          | 0                          | 3    | 0    | 0    | 3          | 18         |
| % Trucks     | 0                             | 0    | 0    | 0    | 0          | 0.9                          | 0.2  | 0    | 0    | 0.6        | 0.4                            | 0    | 0    | 0    | 0.4        | 0                          | 0.9  | 0    | 0    | 0.9        | 0.6        |

| Start Time   | CA-1 NB ON-RAMP<br>Southbound |      |      |            | LIGHTFIGHTER DR<br>Westbound |            |      |            | CA-1 NB OFF-RAMP<br>Northbound |      |      |            | CA-1 SB RAMPS<br>Eastbound |           |      |            | Int. Total |
|--|-------------------------------|------|------|------------|------------------------------|------------|------|------------|--------------------------------|------|------|------------|----------------------------|-----------|------|------------|------------|
|  | Right                         | Thru | Left | App. Total | Right                        | Thru       | Left | App. Total | Right                          | Thru | Left | App. Total | Right                      | Thru      | Left | App. Total |            |
| Peak Hour Analysis From 04:00 PM to 05:45 PM - Peak 1 of 1 |                               |      |      |            |                              |            |      |            |                                |      |      |            |                            |           |      |            |            |
| Peak Hour for Entire Intersection Begins at 04:30 PM       |                               |      |      |            |                              |            |      |            |                                |      |      |            |                            |           |      |            |            |
| 04:30 PM   | 0                             | 0    | 0    | 0          | 155                          | 135        | 0    | 290        | 87                             | 0    | 0    | 87         | 0                          | <b>48</b> | 0    | <b>48</b>  | 425        |
| 04:45 PM   | 0                             | 0    | 0    | 0          | 166                          | <b>155</b> | 0    | <b>321</b> | <b>101</b>                     | 0    | 0    | <b>101</b> | 0                          | 44        | 0    | 44         | <b>466</b> |
| 05:00 PM   | 0                             | 0    | 0    | 0          | <b>172</b>                   | 131        | 0    | 303        | 98                             | 0    | 0    | 98         | 0                          | 41        | 0    | 41         | 442        |
| 05:15 PM   | 0                             | 0    | 0    | 0          | 168                          | 117        | 0    | 285        | 98                             | 0    | 0    | 98         | 0                          | 34        | 0    | 34         | 417        |
| Total Volume   | 0                             | 0    | 0    | 0          | 661                          | 538        | 0    | 1199       | 384                            | 0    | 0    | 384        | 0                          | 167       | 0    | 167        | 1750       |
| % App. Total   | 0                             | 0    | 0    | 0          | 55.1                         | 44.9       | 0    |            | 100                            | 0    | 0    |            | 0                          | 100       | 0    |            |            |
| PHF  | .000                          | .000 | .000 | .000       | .961                         | .868       | .000 | .934       | .950                           | .000 | .000 | .950       | .000                       | .870      | .000 | .870       | .939       |

# Traffic Data Service

San Jose, CA  
 (408) 622-4787  
 tdsbay@cs.com

File Name : 26PM FINAL  
 Site Code : 00000026  
 Start Date : 4/27/2017  
 Page No : 2

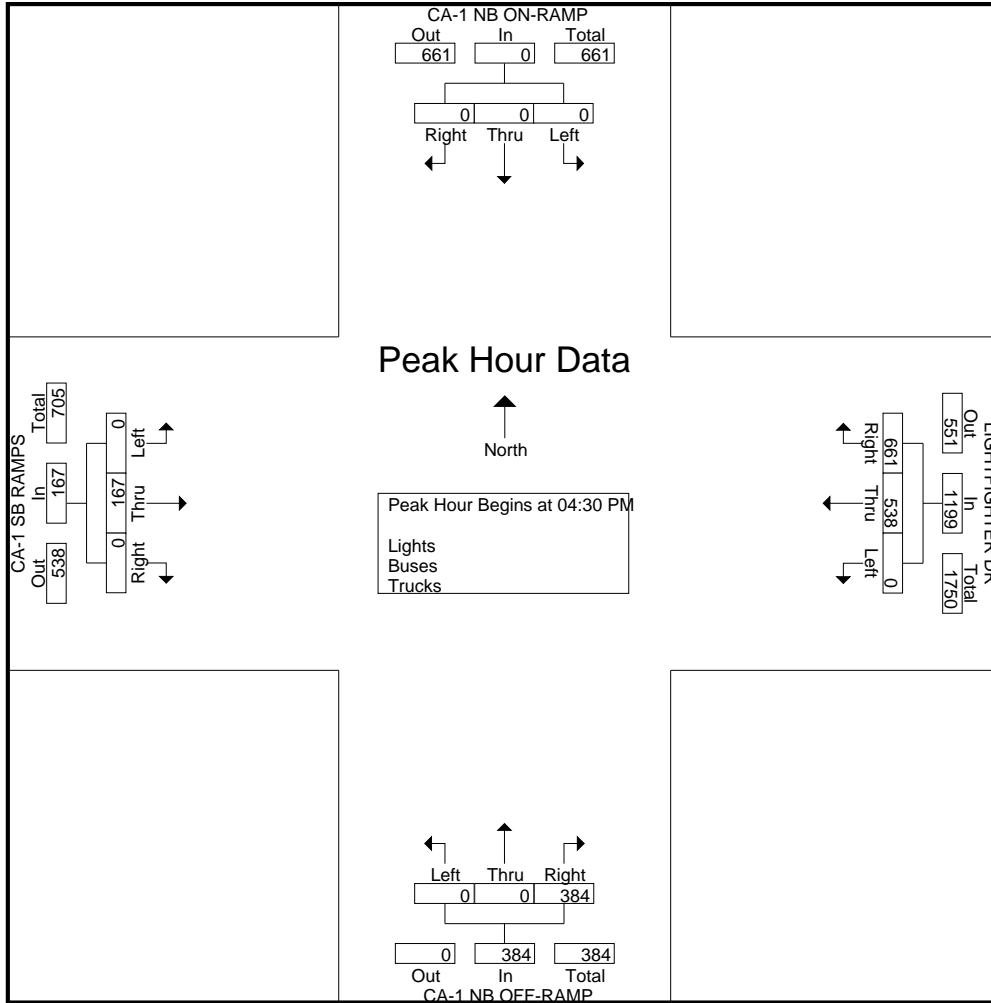

# Traffic Data Service

San Jose, CA  
 (408) 622-4787  
 tdsbay@cs.com

File Name : 26PM FINAL  
 Site Code : 00000026  
 Start Date : 4/27/2017  
 Page No : 1

Groups Printed- Bikes

| Start Time   | CA-1 NB ON-RAMP<br>Southbound |      |      |      |            | LIGHTFIGHTER DR<br>Westbound |      |      |      |            | CA-1 NB OFF-RAMP<br>Northbound |      |      |      |            | CA-1 SB RAMPS<br>Eastbound |      |      |      |            | Int. Total |
|--------------|-------------------------------|------|------|------|------------|------------------------------|------|------|------|------------|--------------------------------|------|------|------|------------|----------------------------|------|------|------|------------|------------|
|              | Right                         | Thru | Left | Peds | App. Total | Right                        | Thru | Left | Peds | App. Total | Right                          | Thru | Left | Peds | App. Total | Right                      | Thru | Left | Peds | App. Total |            |
| 04:00 PM     | 0                             | 0    | 0    | 0    | 0          | 0                            | 0    | 0    | 0    | 0          | 0                              | 0    | 0    | 0    | 0          | 0                          | 0    | 0    | 0    | 0          | 0          |
| 04:15 PM     | 0                             | 0    | 0    | 0    | 0          | 0                            | 0    | 0    | 0    | 0          | 0                              | 0    | 0    | 0    | 0          | 0                          | 0    | 0    | 0    | 0          | 0          |
| 04:30 PM     | 0                             | 0    | 0    | 0    | 0          | 0                            | 0    | 0    | 0    | 0          | 0                              | 0    | 0    | 0    | 0          | 0                          | 0    | 0    | 0    | 0          | 0          |
| 04:45 PM     | 0                             | 0    | 0    | 0    | 0          | 0                            | 0    | 0    | 0    | 0          | 0                              | 0    | 0    | 0    | 0          | 0                          | 0    | 0    | 0    | 0          | 0          |
| <b>Total</b> | 0                             | 0    | 0    | 0    | 0          | 0                            | 0    | 0    | 0    | 0          | 0                              | 0    | 0    | 0    | 0          | 0                          | 0    | 0    | 0    | 0          | 0          |
| 05:00 PM     | 0                             | 0    | 0    | 0    | 0          | 0                            | 0    | 0    | 0    | 0          | 0                              | 0    | 0    | 0    | 0          | 0                          | 0    | 0    | 0    | 0          | 0          |
| 05:15 PM     | 0                             | 0    | 0    | 0    | 0          | 0                            | 0    | 0    | 0    | 0          | 0                              | 0    | 0    | 0    | 0          | 0                          | 0    | 0    | 0    | 0          | 0          |
| 05:30 PM     | 0                             | 0    | 0    | 0    | 0          | 0                            | 0    | 0    | 0    | 0          | 0                              | 0    | 0    | 0    | 0          | 0                          | 0    | 0    | 0    | 0          | 0          |
| 05:45 PM     | 0                             | 0    | 0    | 0    | 0          | 0                            | 0    | 0    | 0    | 0          | 0                              | 0    | 0    | 0    | 0          | 0                          | 0    | 0    | 0    | 0          | 0          |
| <b>Total</b> | 0                             | 0    | 0    | 0    | 0          | 0                            | 0    | 0    | 0    | 0          | 0                              | 0    | 0    | 0    | 0          | 0                          | 0    | 0    | 0    | 0          | 0          |
| Grand Total  | 0                             | 0    | 0    | 0    | 0          | 0                            | 0    | 0    | 0    | 0          | 0                              | 0    | 0    | 0    | 0          | 0                          | 0    | 0    | 0    | 0          | 0          |
| Apprch %     | 0                             | 0    | 0    | 0    |            | 0                            | 0    | 0    | 0    |            | 0                              | 0    | 0    | 0    |            | 0                          | 0    | 0    | 0    |            |            |
| Total %      |                               |      |      |      |            |                              |      |      |      |            |                                |      |      |      |            |                            |      |      |      |            |            |

| Start Time   | CA-1 NB ON-RAMP<br>Southbound |      |      |            | LIGHTFIGHTER DR<br>Westbound |      |      |            | CA-1 NB OFF-RAMP<br>Northbound |      |      |            | CA-1 SB RAMPS<br>Eastbound |      |      |            | Int. Total |
|--|-------------------------------|------|------|------------|------------------------------|------|------|------------|--------------------------------|------|------|------------|----------------------------|------|------|------------|------------|
|  | Right                         | Thru | Left | App. Total | Right                        | Thru | Left | App. Total | Right                          | Thru | Left | App. Total | Right                      | Thru | Left | App. Total |            |
| Peak Hour Analysis From 04:00 PM to 05:45 PM - Peak 1 of 1 |                               |      |      |            |                              |      |      |            |                                |      |      |            |                            |      |      |            |            |
| Peak Hour for Entire Intersection Begins at 04:00 PM       |                               |      |      |            |                              |      |      |            |                                |      |      |            |                            |      |      |            |            |
| 04:00 PM   | 0                             | 0    | 0    | 0          | 0                            | 0    | 0    | 0          | 0                              | 0    | 0    | 0          | 0                          | 0    | 0    | 0          | 0          |
| 04:15 PM   | 0                             | 0    | 0    | 0          | 0                            | 0    | 0    | 0          | 0                              | 0    | 0    | 0          | 0                          | 0    | 0    | 0          | 0          |
| 04:30 PM   | 0                             | 0    | 0    | 0          | 0                            | 0    | 0    | 0          | 0                              | 0    | 0    | 0          | 0                          | 0    | 0    | 0          | 0          |
| 04:45 PM   | 0                             | 0    | 0    | 0          | 0                            | 0    | 0    | 0          | 0                              | 0    | 0    | 0          | 0                          | 0    | 0    | 0          | 0          |
| Total Volume   | 0                             | 0    | 0    | 0          | 0                            | 0    | 0    | 0          | 0                              | 0    | 0    | 0          | 0                          | 0    | 0    | 0          | 0          |
| % App. Total   | 0                             | 0    | 0    |            | 0                            | 0    | 0    |            | 0                              | 0    | 0    |            | 0                          | 0    | 0    |            |            |
| PHF  | .000                          | .000 | .000 | .000       | .000                         | .000 | .000 | .000       | .000                           | .000 | .000 | .000       | .000                       | .000 | .000 | .000       | .000       |

# Traffic Data Service

San Jose, CA  
(408) 622-4787  
tdsbay@cs.com

File Name : 26PM FINAL  
Site Code : 00000026  
Start Date : 4/27/2017  
Page No : 2

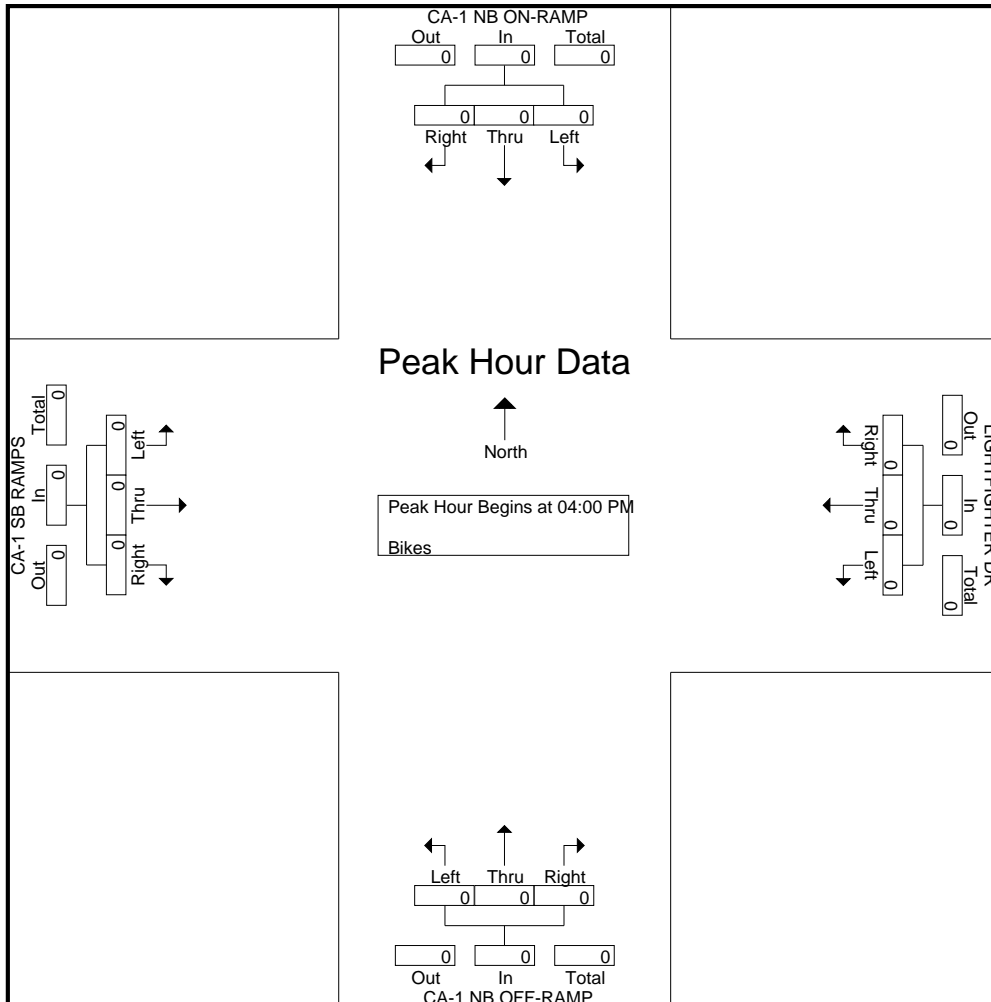



# Traffic Data Service

San Jose, CA  
 (408) 622-4787  
 tdsbay@cs.com

File Name : 1AM FINAL  
 Site Code : 00000001  
 Start Date : 4/25/2018  
 Page No : 1

## Groups Printed- Lights - Buses - Trucks

| Start Time  | DEL MONTE BLVD<br>Southbound |      |      |      |            | REINDOLLAR AVE<br>Westbound |      |      |      |            | DEL MONTE BLVD<br>Northbound |      |      |      |            | Eastbound |      |      |      |            | Int. Total |
|-------------|------------------------------|------|------|------|------------|-----------------------------|------|------|------|------------|------------------------------|------|------|------|------------|-----------|------|------|------|------------|------------|
|             | Right                        | Thru | Left | Peds | App. Total | Right                       | Thru | Left | Peds | App. Total | Right                        | Thru | Left | Peds | App. Total | Right     | Thru | Left | Peds | App. Total |            |
| 07:00 AM    | 0                            | 260  | 11   | 0    | 271        | 6                           | 0    | 135  | 0    | 141        | 12                           | 51   | 3    | 0    | 66         | 0         | 0    | 0    | 0    | 0          | 478        |
| 07:15 AM    | 0                            | 293  | 16   | 4    | 313        | 9                           | 0    | 135  | 2    | 146        | 24                           | 55   | 1    | 0    | 80         | 0         | 0    | 0    | 0    | 0          | 539        |
| 07:30 AM    | 0                            | 229  | 21   | 1    | 251        | 17                          | 0    | 91   | 0    | 108        | 32                           | 72   | 1    | 0    | 105        | 0         | 0    | 0    | 0    | 0          | 464        |
| 07:45 AM    | 0                            | 157  | 15   | 3    | 175        | 26                          | 0    | 69   | 0    | 95         | 37                           | 111  | 0    | 0    | 148        | 0         | 0    | 0    | 0    | 0          | 418        |
| Total       | 0                            | 939  | 63   | 8    | 1010       | 58                          | 0    | 430  | 2    | 490        | 105                          | 289  | 5    | 0    | 399        | 0         | 0    | 0    | 0    | 0          | 1899       |
| 08:00 AM    | 0                            | 161  | 15   | 2    | 178        | 14                          | 0    | 76   | 1    | 91         | 50                           | 105  | 2    | 0    | 157        | 0         | 0    | 0    | 0    | 0          | 426        |
| 08:15 AM    | 0                            | 150  | 10   | 2    | 162        | 14                          | 0    | 55   | 1    | 70         | 36                           | 93   | 3    | 0    | 132        | 0         | 0    | 0    | 0    | 0          | 364        |
| 08:30 AM    | 0                            | 194  | 16   | 1    | 211        | 18                          | 0    | 73   | 0    | 91         | 27                           | 84   | 2    | 0    | 113        | 0         | 0    | 0    | 0    | 0          | 415        |
| 08:45 AM    | 0                            | 166  | 11   | 0    | 177        | 12                          | 0    | 57   | 0    | 69         | 23                           | 83   | 1    | 0    | 107        | 0         | 0    | 0    | 0    | 0          | 353        |
| Total       | 0                            | 671  | 52   | 5    | 728        | 58                          | 0    | 261  | 2    | 321        | 136                          | 365  | 8    | 0    | 509        | 0         | 0    | 0    | 0    | 0          | 1558       |
| Grand Total | 0                            | 1610 | 115  | 13   | 1738       | 116                         | 0    | 691  | 4    | 811        | 241                          | 654  | 13   | 0    | 908        | 0         | 0    | 0    | 0    | 0          | 3457       |
| Apprch %    | 0                            | 92.6 | 6.6  | 0.7  |            | 14.3                        | 0    | 85.2 | 0.5  |            | 26.5                         | 72   | 1.4  | 0    |            | 0         | 0    | 0    | 0    | 0          |            |
| Total %     | 0                            | 46.6 | 3.3  | 0.4  | 50.3       | 3.4                         | 0    | 20   | 0.1  | 23.5       | 7                            | 18.9 | 0.4  | 0    | 26.3       | 0         | 0    | 0    | 0    | 0          | 0          |
| Lights      | 0                            | 1557 | 112  | 10   | 1679       | 112                         | 0    | 683  | 4    | 799        | 234                          | 633  | 13   | 0    | 880        | 0         | 0    | 0    | 0    | 0          | 3358       |
| % Lights    | 0                            | 96.7 | 97.4 | 76.9 | 96.6       | 96.6                        | 0    | 98.8 | 100  | 98.5       | 97.1                         | 96.8 | 100  | 0    | 96.9       | 0         | 0    | 0    | 0    | 0          | 97.1       |
| Buses       | 0                            | 18   | 1    | 0    | 19         | 1                           | 0    | 3    | 0    | 4          | 5                            | 10   | 0    | 0    | 15         | 0         | 0    | 0    | 0    | 0          | 38         |
| % Buses     | 0                            | 1.1  | 0.9  | 0    | 1.1        | 0.9                         | 0    | 0.4  | 0    | 0.5        | 2.1                          | 1.5  | 0    | 0    | 1.7        | 0         | 0    | 0    | 0    | 0          | 1.1        |
| Trucks      | 0                            | 35   | 2    | 3    | 40         | 3                           | 0    | 5    | 0    | 8          | 2                            | 11   | 0    | 0    | 13         | 0         | 0    | 0    | 0    | 0          | 61         |
| % Trucks    | 0                            | 2.2  | 1.7  | 23.1 | 2.3        | 2.6                         | 0    | 0.7  | 0    | 1          | 0.8                          | 1.7  | 0    | 0    | 1.4        | 0         | 0    | 0    | 0    | 0          | 1.8        |

| Start Time   | DEL MONTE BLVD<br>Southbound |            |           |            | REINDOLLAR AVE<br>Westbound |      |            |            | DEL MONTE BLVD<br>Northbound |            |          |            | Eastbound |      |      |            | Int. Total |
|--|------------------------------|------------|-----------|------------|-----------------------------|------|------------|------------|------------------------------|------------|----------|------------|-----------|------|------|------------|------------|
|  | Right                        | Thru       | Left      | App. Total | Right                       | Thru | Left       | App. Total | Right                        | Thru       | Left     | App. Total | Right     | Thru | Left | App. Total |            |
| Peak Hour Analysis From 07:00 AM to 08:45 AM - Peak 1 of 1 |                              |            |           |            |                             |      |            |            |                              |            |          |            |           |      |      |            |            |
| Peak Hour for Entire Intersection Begins at 07:00 AM       |                              |            |           |            |                             |      |            |            |                              |            |          |            |           |      |      |            |            |
| 07:00 AM   | 0                            | 260        | 11        | 271        | 6                           | 0    | <b>135</b> | 141        | 12                           | 51         | <b>3</b> | 66         | 0         | 0    | 0    | 0          | 478        |
| 07:15 AM   | 0                            | <b>293</b> | 16        | <b>309</b> | 9                           | 0    | 135        | <b>144</b> | 24                           | 55         | 1        | 80         | 0         | 0    | 0    | 0          | <b>533</b> |
| 07:30 AM   | 0                            | 229        | <b>21</b> | 250        | 17                          | 0    | 91         | 108        | 32                           | 72         | 1        | 105        | 0         | 0    | 0    | 0          | 463        |
| 07:45 AM   | 0                            | 157        | 15        | 172        | <b>26</b>                   | 0    | 69         | 95         | <b>37</b>                    | <b>111</b> | 0        | <b>148</b> | 0         | 0    | 0    | 0          | 415        |
| Total Volume   | 0                            | 939        | 63        | 1002       | 58                          | 0    | 430        | 488        | 105                          | 289        | 5        | 399        | 0         | 0    | 0    | 0          | 1889       |
| % App. Total   | 0                            | 93.7       | 6.3       |            | 11.9                        | 0    | 88.1       |            | 26.3                         | 72.4       | 1.3      |            | 0         | 0    | 0    |            |            |
| PHF  | .000                         | .801       | .750      | .811       | .558                        | .000 | .796       | .847       | .709                         | .651       | .417     | .674       | .000      | .000 | .000 | .000       | .886       |

# Traffic Data Service

San Jose, CA  
 (408) 622-4787  
 tdsbay@cs.com

File Name : 1AM FINAL  
 Site Code : 00000001  
 Start Date : 4/25/2018  
 Page No : 2

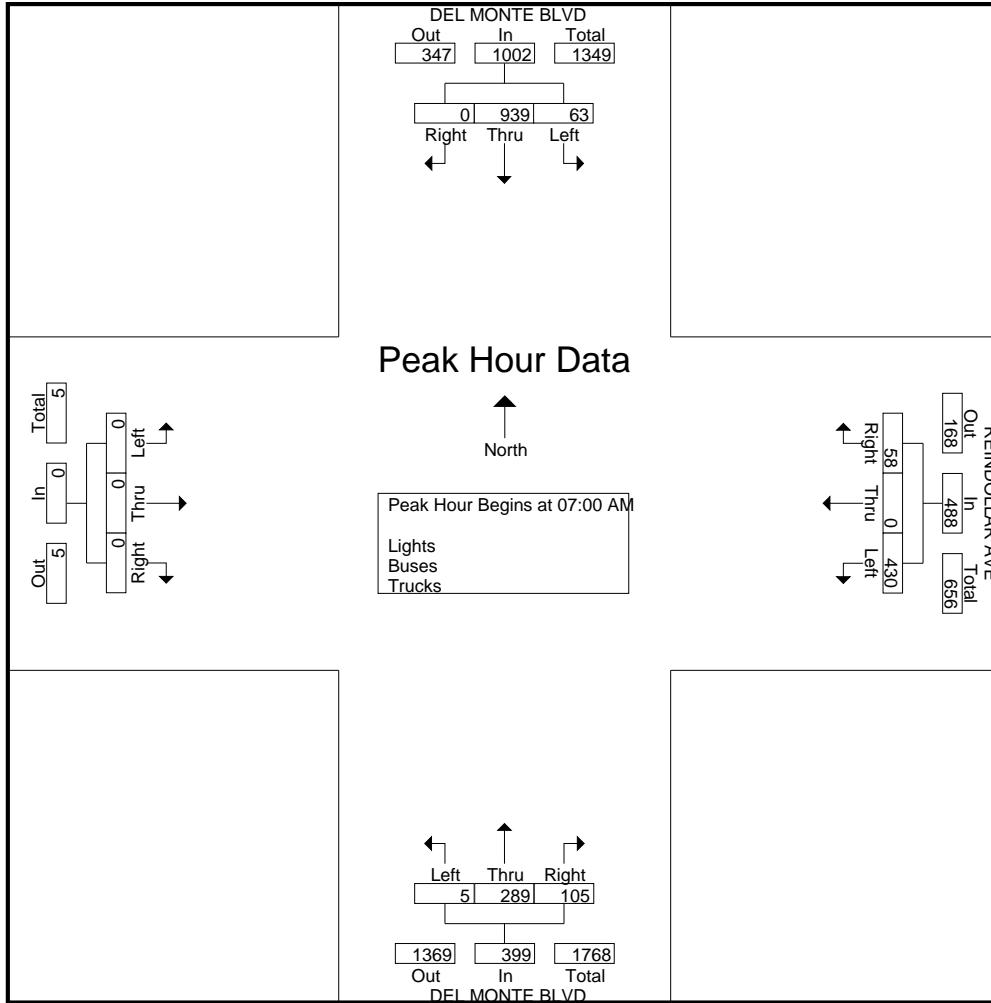

# Traffic Data Service

San Jose, CA  
**(408) 622-4787**  
*tdsbay@cs.com*

File Name : 1AM FINAL  
 Site Code : 00000001  
 Start Date : 4/25/2018  
 Page No : 1

Groups Printed- Bikes

| Start Time   | DEL MONTE BLVD Southbound |      |      |      |            | REINDOLLAR AVE Westbound |      |      |      |            | DEL MONTE BLVD Northbound |      |      |      |            | Eastbound |      |      |      |            | Int. Total |
|--------------|---------------------------|------|------|------|------------|--------------------------|------|------|------|------------|---------------------------|------|------|------|------------|-----------|------|------|------|------------|------------|
|              | Right                     | Thru | Left | Peds | App. Total | Right                    | Thru | Left | Peds | App. Total | Right                     | Thru | Left | Peds | App. Total | Right     | Thru | Left | Peds | App. Total |            |
| 07:00 AM     | 0                         | 0    | 0    | 0    | 0          | 0                        | 0    | 0    | 0    | 0          | 0                         | 0    | 0    | 0    | 0          | 0         | 0    | 0    | 0    | 0          | 0          |
| 07:15 AM     | 0                         | 0    | 0    | 0    | 0          | 1                        | 0    | 1    | 0    | 2          | 0                         | 0    | 0    | 0    | 0          | 0         | 0    | 0    | 0    | 0          | 0          |
| 07:30 AM     | 0                         | 0    | 0    | 0    | 0          | 0                        | 0    | 0    | 0    | 0          | 0                         | 0    | 0    | 0    | 0          | 0         | 0    | 0    | 0    | 0          | 0          |
| 07:45 AM     | 0                         | 0    | 0    | 0    | 0          | 0                        | 0    | 0    | 0    | 0          | 0                         | 0    | 0    | 0    | 0          | 0         | 0    | 0    | 0    | 0          | 0          |
| <b>Total</b> | 0                         | 0    | 0    | 0    | 0          | 1                        | 0    | 1    | 0    | 2          | 0                         | 0    | 0    | 0    | 0          | 0         | 0    | 0    | 0    | 0          | 2          |
| 08:00 AM     | 0                         | 0    | 0    | 0    | 0          | 0                        | 0    | 0    | 0    | 0          | 0                         | 0    | 0    | 0    | 0          | 0         | 0    | 0    | 0    | 0          | 0          |
| 08:15 AM     | 0                         | 0    | 0    | 0    | 0          | 0                        | 0    | 0    | 0    | 0          | 0                         | 0    | 0    | 0    | 0          | 0         | 0    | 0    | 0    | 0          | 0          |
| 08:30 AM     | 0                         | 0    | 0    | 0    | 0          | 0                        | 0    | 0    | 0    | 0          | 0                         | 0    | 0    | 0    | 0          | 0         | 0    | 0    | 0    | 0          | 0          |
| 08:45 AM     | 0                         | 0    | 0    | 0    | 0          | 0                        | 0    | 0    | 0    | 0          | 0                         | 0    | 0    | 0    | 0          | 0         | 0    | 0    | 0    | 0          | 0          |
| <b>Total</b> | 0                         | 0    | 0    | 0    | 0          | 0                        | 0    | 0    | 0    | 0          | 0                         | 0    | 0    | 0    | 0          | 0         | 0    | 0    | 0    | 0          | 0          |
| Grand Total  | 0                         | 0    | 0    | 0    | 0          | 1                        | 0    | 1    | 0    | 2          | 0                         | 0    | 0    | 0    | 0          | 0         | 0    | 0    | 0    | 0          | 2          |
| Apprch %     | 0                         | 0    | 0    | 0    | 0          | 50                       | 0    | 50   | 0    | 100        | 0                         | 0    | 0    | 0    | 0          | 0         | 0    | 0    | 0    | 0          |            |
| Total %      | 0                         | 0    | 0    | 0    | 0          | 50                       | 0    | 50   | 0    | 100        | 0                         | 0    | 0    | 0    | 0          | 0         | 0    | 0    | 0    | 0          |            |

| Start Time   | DEL MONTE BLVD Southbound |      |      |            | REINDOLLAR AVE Westbound |      |      |            | DEL MONTE BLVD Northbound |      |      |            | Eastbound |      |      |            | Int. Total |
|--|---------------------------|------|------|------------|--------------------------|------|------|------------|---------------------------|------|------|------------|-----------|------|------|------------|------------|
|  | Right                     | Thru | Left | App. Total | Right                    | Thru | Left | App. Total | Right                     | Thru | Left | App. Total | Right     | Thru | Left | App. Total |            |
| Peak Hour Analysis From 07:00 AM to 08:45 AM - Peak 1 of 1 |                           |      |      |            |                          |      |      |            |                           |      |      |            |           |      |      |            |            |
| Peak Hour for Entire Intersection Begins at 07:00 AM       |                           |      |      |            |                          |      |      |            |                           |      |      |            |           |      |      |            |            |
| 07:00 AM   | 0                         | 0    | 0    | 0          | 0                        | 0    | 0    | 0          | 0                         | 0    | 0    | 0          | 0         | 0    | 0    | 0          | 0          |
| 07:15 AM   | 0                         | 0    | 0    | 0          | 1                        | 0    | 1    | 2          | 0                         | 0    | 0    | 0          | 0         | 0    | 0    | 0          | 2          |
| 07:30 AM   | 0                         | 0    | 0    | 0          | 0                        | 0    | 0    | 0          | 0                         | 0    | 0    | 0          | 0         | 0    | 0    | 0          | 0          |
| 07:45 AM   | 0                         | 0    | 0    | 0          | 0                        | 0    | 0    | 0          | 0                         | 0    | 0    | 0          | 0         | 0    | 0    | 0          | 0          |
| Total Volume   | 0                         | 0    | 0    | 0          | 1                        | 0    | 1    | 2          | 0                         | 0    | 0    | 0          | 0         | 0    | 0    | 0          | 2          |
| % App. Total   | 0                         | 0    | 0    | 0          | 50                       | 0    | 50   | 100        | 0                         | 0    | 0    | 0          | 0         | 0    | 0    | 0          |            |
| PHF  | .000                      | .000 | .000 | .000       | .250                     | .000 | .250 | .250       | .000                      | .000 | .000 | .000       | .000      | .000 | .000 | .000       | .250       |

# Traffic Data Service

San Jose, CA  
 (408) 622-4787  
 tdsbay@cs.com

File Name : 1AM FINAL  
 Site Code : 00000001  
 Start Date : 4/25/2018  
 Page No : 2

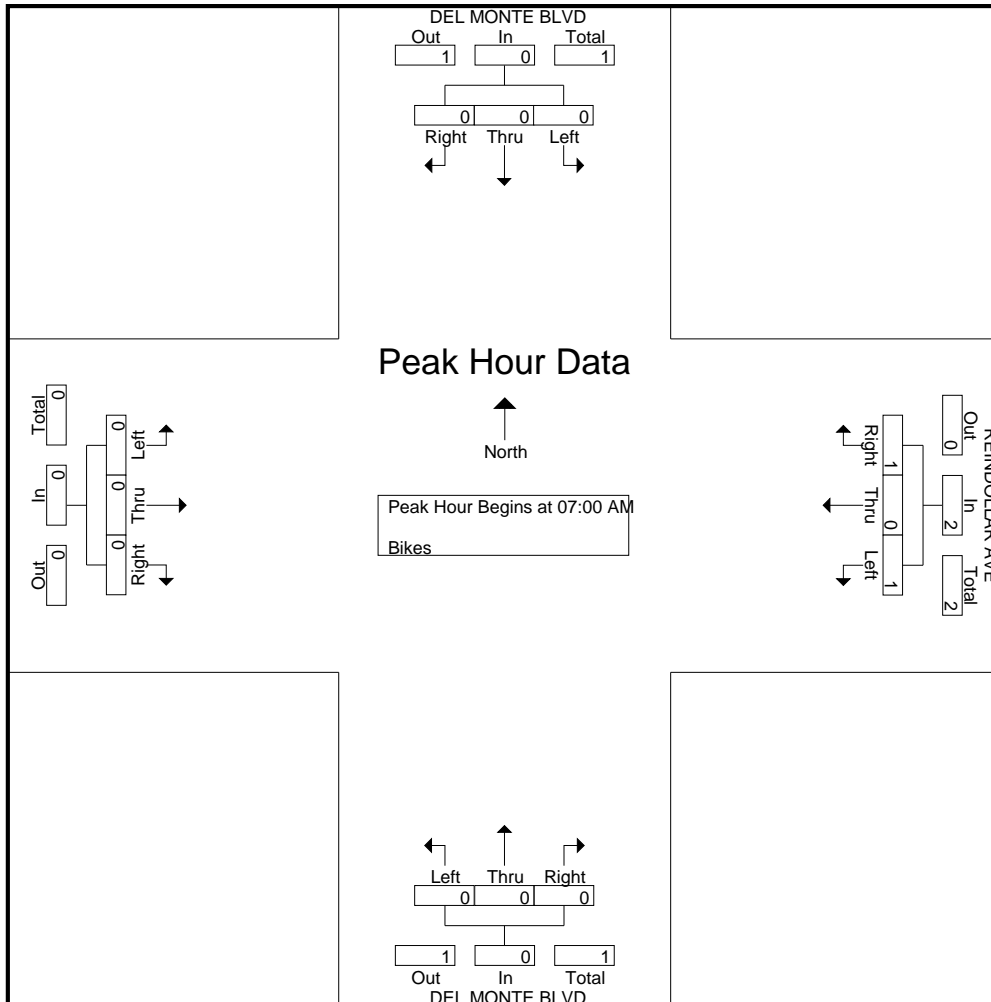

# Traffic Data Service

San Jose, CA  
 (408) 622-4787  
 tdsbay@cs.com

File Name : 1PM FINAL  
 Site Code : 00000001  
 Start Date : 4/25/2018  
 Page No : 1

Groups Printed- Lights - Buses - Trucks

| Start Time   | DEL MONTE BLVD Southbound |      |      |      |            | REINDOLLAR AVE Westbound |      |      |      |            | DEL MONTE BLVD Northbound |      |      |      |            | Eastbound |      |      |      |            | Int. Total |
|--------------|---------------------------|------|------|------|------------|--------------------------|------|------|------|------------|---------------------------|------|------|------|------------|-----------|------|------|------|------------|------------|
|              | Right                     | Thru | Left | Peds | App. Total | Right                    | Thru | Left | Peds | App. Total | Right                     | Thru | Left | Peds | App. Total | Right     | Thru | Left | Peds | App. Total |            |
| 04:00 PM     | 0                         | 123  | 4    | 3    | 130        | 28                       | 0    | 41   | 1    | 70         | 74                        | 212  | 0    | 0    | 286        | 0         | 0    | 0    | 0    | 0          | 486        |
| 04:15 PM     | 0                         | 127  | 12   | 0    | 139        | 18                       | 0    | 34   | 0    | 52         | 79                        | 236  | 1    | 0    | 316        | 0         | 0    | 0    | 0    | 0          | 507        |
| 04:30 PM     | 0                         | 103  | 10   | 2    | 115        | 13                       | 0    | 37   | 1    | 51         | 57                        | 229  | 1    | 0    | 287        | 0         | 0    | 0    | 0    | 0          | 453        |
| 04:45 PM     | 0                         | 121  | 12   | 5    | 138        | 23                       | 0    | 46   | 3    | 72         | 78                        | 229  | 2    | 0    | 309        | 0         | 0    | 0    | 0    | 0          | 519        |
| <b>Total</b> | 0                         | 474  | 38   | 10   | 522        | 82                       | 0    | 158  | 5    | 245        | 288                       | 906  | 4    | 0    | 1198       | 0         | 0    | 0    | 0    | 0          | 1965       |
| 05:00 PM     | 0                         | 131  | 21   | 1    | 153        | 20                       | 0    | 35   | 0    | 55         | 94                        | 232  | 1    | 0    | 327        | 0         | 0    | 0    | 0    | 0          | 535        |
| 05:15 PM     | 0                         | 96   | 11   | 4    | 111        | 25                       | 0    | 40   | 0    | 65         | 78                        | 240  | 2    | 0    | 320        | 0         | 0    | 0    | 0    | 0          | 496        |
| 05:30 PM     | 0                         | 106  | 16   | 0    | 122        | 20                       | 0    | 54   | 0    | 74         | 72                        | 285  | 0    | 0    | 357        | 0         | 0    | 0    | 0    | 0          | 553        |
| 05:45 PM     | 0                         | 142  | 25   | 3    | 170        | 20                       | 0    | 42   | 0    | 62         | 74                        | 253  | 1    | 0    | 328        | 0         | 0    | 0    | 0    | 0          | 560        |
| <b>Total</b> | 0                         | 475  | 73   | 8    | 556        | 85                       | 0    | 171  | 0    | 256        | 318                       | 1010 | 4    | 0    | 1332       | 0         | 0    | 0    | 0    | 0          | 2144       |
| Grand Total  | 0                         | 949  | 111  | 18   | 1078       | 167                      | 0    | 329  | 5    | 501        | 606                       | 1916 | 8    | 0    | 2530       | 0         | 0    | 0    | 0    | 0          | 4109       |
| Apprch %     | 0                         | 88   | 10.3 | 1.7  |            | 33.3                     | 0    | 65.7 | 1    |            | 24                        | 75.7 | 0.3  | 0    |            | 0         | 0    | 0    | 0    |            |            |
| Total %      | 0                         | 23.1 | 2.7  | 0.4  | 26.2       | 4.1                      | 0    | 8    | 0.1  | 12.2       | 14.7                      | 46.6 | 0.2  | 0    | 61.6       | 0         | 0    | 0    | 0    | 0          |            |
| Lights       | 0                         | 938  | 110  | 18   | 1066       | 167                      | 0    | 322  | 5    | 494        | 603                       | 1896 | 8    | 0    | 2507       | 0         | 0    | 0    | 0    | 0          | 4067       |
| % Lights     | 0                         | 98.8 | 99.1 | 100  | 98.9       | 100                      | 0    | 97.9 | 100  | 98.6       | 99.5                      | 99   | 100  | 0    | 99.1       | 0         | 0    | 0    | 0    | 0          | 99         |
| Buses        | 0                         | 5    | 1    | 0    | 6          | 0                        | 0    | 1    | 0    | 1          | 2                         | 7    | 0    | 0    | 9          | 0         | 0    | 0    | 0    | 0          | 16         |
| % Buses      | 0                         | 0.5  | 0.9  | 0    | 0.6        | 0                        | 0    | 0.3  | 0    | 0.2        | 0.3                       | 0.4  | 0    | 0    | 0.4        | 0         | 0    | 0    | 0    | 0          | 0.4        |
| Trucks       | 0                         | 6    | 0    | 0    | 6          | 0                        | 0    | 6    | 0    | 6          | 1                         | 13   | 0    | 0    | 14         | 0         | 0    | 0    | 0    | 0          | 26         |
| % Trucks     | 0                         | 0.6  | 0    | 0    | 0.6        | 0                        | 0    | 1.8  | 0    | 1.2        | 0.2                       | 0.7  | 0    | 0    | 0.6        | 0         | 0    | 0    | 0    | 0          | 0.6        |

| Start Time   | DEL MONTE BLVD Southbound |      |      |            | REINDOLLAR AVE Westbound |      |      |            | DEL MONTE BLVD Northbound |      |      |            | Eastbound |      |      |            | Int. Total |
|--|---------------------------|------|------|------------|--------------------------|------|------|------------|---------------------------|------|------|------------|-----------|------|------|------------|------------|
|  | Right                     | Thru | Left | App. Total | Right                    | Thru | Left | App. Total | Right                     | Thru | Left | App. Total | Right     | Thru | Left | App. Total |            |
| Peak Hour Analysis From 04:00 PM to 05:45 PM - Peak 1 of 1 |                           |      |      |            |                          |      |      |            |                           |      |      |            |           |      |      |            |            |
| Peak Hour for Entire Intersection Begins at 05:00 PM       |                           |      |      |            |                          |      |      |            |                           |      |      |            |           |      |      |            |            |
| 05:00 PM   | 0                         | 131  | 21   | 152        | 20                       | 0    | 35   | 55         | 94                        | 232  | 1    | 327        | 0         | 0    | 0    | 0          | 534        |
| 05:15 PM   | 0                         | 96   | 11   | 107        | 25                       | 0    | 40   | 65         | 78                        | 240  | 2    | 320        | 0         | 0    | 0    | 0          | 492        |
| 05:30 PM   | 0                         | 106  | 16   | 122        | 20                       | 0    | 54   | 74         | 72                        | 285  | 0    | 357        | 0         | 0    | 0    | 0          | 553        |
| 05:45 PM   | 0                         | 142  | 25   | 167        | 20                       | 0    | 42   | 62         | 74                        | 253  | 1    | 328        | 0         | 0    | 0    | 0          | 557        |
| Total Volume   | 0                         | 475  | 73   | 548        | 85                       | 0    | 171  | 256        | 318                       | 1010 | 4    | 1332       | 0         | 0    | 0    | 0          | 2136       |
| % App. Total   | 0                         | 86.7 | 13.3 |            | 33.2                     | 0    | 66.8 |            | 23.9                      | 75.8 | 0.3  |            | 0         | 0    | 0    |            |            |
| PHF  | .000                      | .836 | .730 | .820       | .850                     | .000 | .792 | .865       | .846                      | .886 | .500 | .933       | .000      | .000 | .000 | .000       | .959       |

# Traffic Data Service

San Jose, CA  
 (408) 622-4787  
 tdsbay@cs.com

File Name : 1PM FINAL  
 Site Code : 00000001  
 Start Date : 4/25/2018  
 Page No : 2

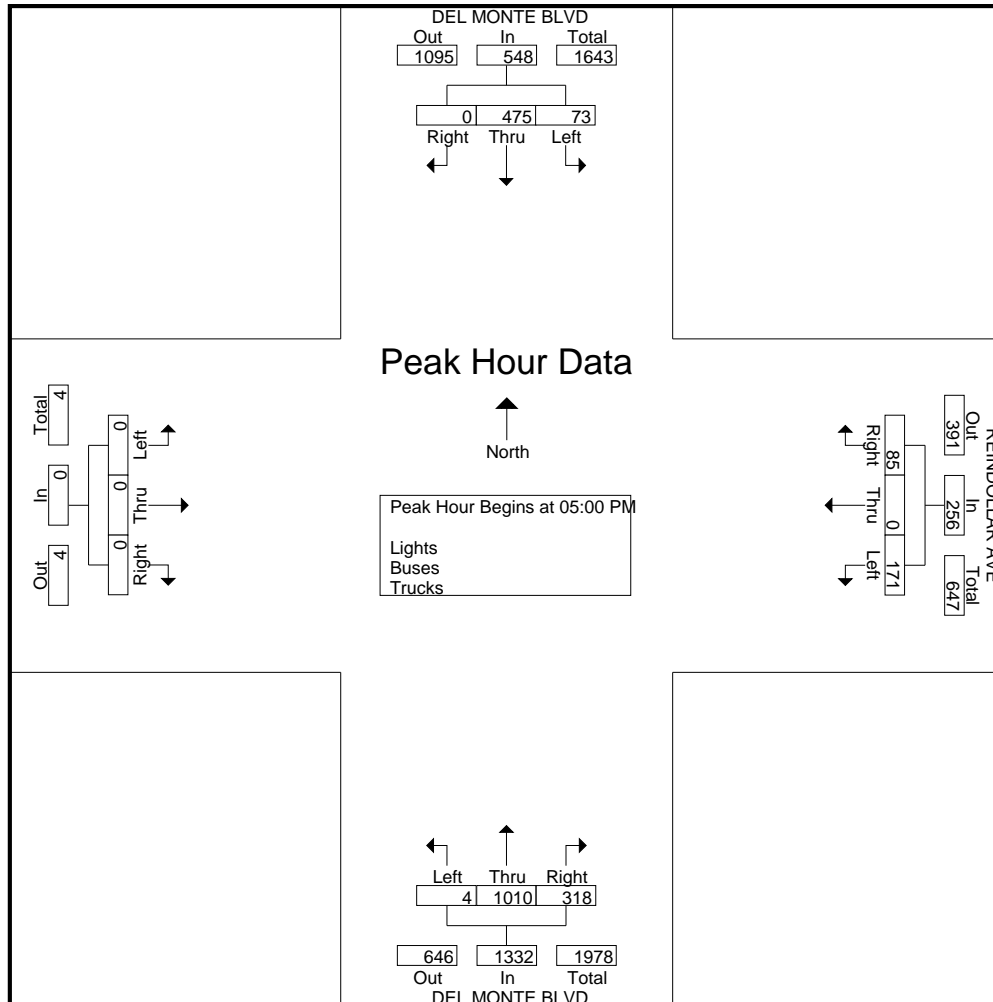

# Traffic Data Service

San Jose, CA  
 (408) 622-4787  
 tdsbay@cs.com

File Name : 1PM FINAL  
 Site Code : 00000001  
 Start Date : 4/25/2018  
 Page No : 1

Groups Printed- Bikes

| Start Time  | DEL MONTE BLVD Southbound |      |      |      |            | REINDOLLAR AVE Westbound |      |      |      |            | DEL MONTE BLVD Northbound |      |      |      |            | Eastbound |      |      |      |            | Int. Total |
|-------------|---------------------------|------|------|------|------------|--------------------------|------|------|------|------------|---------------------------|------|------|------|------------|-----------|------|------|------|------------|------------|
|             | Right                     | Thru | Left | Peds | App. Total | Right                    | Thru | Left | Peds | App. Total | Right                     | Thru | Left | Peds | App. Total | Right     | Thru | Left | Peds | App. Total |            |
| 04:00 PM    | 0                         | 0    | 0    | 0    | 0          | 0                        | 0    | 0    | 0    | 0          | 0                         | 0    | 0    | 0    | 0          | 0         | 0    | 0    | 0    | 0          | 0          |
| 04:15 PM    | 0                         | 0    | 0    | 0    | 0          | 0                        | 0    | 0    | 0    | 0          | 0                         | 0    | 0    | 0    | 0          | 0         | 0    | 0    | 0    | 0          | 0          |
| 04:30 PM    | 0                         | 0    | 0    | 0    | 0          | 0                        | 0    | 0    | 0    | 0          | 0                         | 0    | 0    | 0    | 0          | 0         | 0    | 0    | 0    | 0          | 0          |
| 04:45 PM    | 0                         | 0    | 0    | 0    | 0          | 0                        | 0    | 0    | 0    | 0          | 0                         | 0    | 0    | 0    | 0          | 0         | 0    | 0    | 0    | 0          | 0          |
| Total       | 0                         | 0    | 0    | 0    | 0          | 0                        | 0    | 0    | 0    | 0          | 0                         | 0    | 0    | 0    | 0          | 0         | 0    | 0    | 0    | 0          | 0          |
| 05:00 PM    | 0                         | 0    | 0    | 0    | 0          | 0                        | 0    | 0    | 0    | 0          | 0                         | 0    | 0    | 0    | 0          | 0         | 0    | 0    | 0    | 0          | 0          |
| 05:15 PM    | 0                         | 0    | 0    | 0    | 0          | 0                        | 0    | 0    | 0    | 0          | 0                         | 0    | 0    | 0    | 0          | 0         | 0    | 0    | 0    | 0          | 0          |
| 05:30 PM    | 0                         | 0    | 0    | 0    | 0          | 0                        | 0    | 0    | 0    | 0          | 0                         | 0    | 0    | 0    | 0          | 0         | 0    | 0    | 0    | 0          | 0          |
| 05:45 PM    | 0                         | 0    | 0    | 0    | 0          | 0                        | 0    | 0    | 0    | 0          | 0                         | 0    | 0    | 0    | 0          | 0         | 0    | 0    | 0    | 0          | 0          |
| Total       | 0                         | 0    | 0    | 0    | 0          | 0                        | 0    | 0    | 0    | 0          | 0                         | 0    | 0    | 0    | 0          | 0         | 0    | 0    | 0    | 0          | 0          |
| Grand Total | 0                         | 0    | 0    | 0    | 0          | 0                        | 0    | 0    | 0    | 0          | 0                         | 0    | 0    | 0    | 0          | 0         | 0    | 0    | 0    | 0          | 0          |
| Apprch %    | 0                         | 0    | 0    | 0    |            | 0                        | 0    | 0    | 0    |            | 0                         | 0    | 0    | 0    |            | 0         | 0    | 0    | 0    |            |            |
| Total %     |                           |      |      |      |            |                          |      |      |      |            |                           |      |      |      |            |           |      |      |      |            |            |

| Start Time   | DEL MONTE BLVD Southbound |      |      |            | REINDOLLAR AVE Westbound |      |      |            | DEL MONTE BLVD Northbound |      |      |            | Eastbound |      |      |            | Int. Total |
|--|---------------------------|------|------|------------|--------------------------|------|------|------------|---------------------------|------|------|------------|-----------|------|------|------------|------------|
|  | Right                     | Thru | Left | App. Total | Right                    | Thru | Left | App. Total | Right                     | Thru | Left | App. Total | Right     | Thru | Left | App. Total |            |
| Peak Hour Analysis From 04:00 PM to 05:45 PM - Peak 1 of 1 |                           |      |      |            |                          |      |      |            |                           |      |      |            |           |      |      |            |            |
| Peak Hour for Entire Intersection Begins at 04:00 PM       |                           |      |      |            |                          |      |      |            |                           |      |      |            |           |      |      |            |            |
| 04:00 PM   | 0                         | 0    | 0    | 0          | 0                        | 0    | 0    | 0          | 0                         | 0    | 0    | 0          | 0         | 0    | 0    | 0          | 0          |
| 04:15 PM   | 0                         | 0    | 0    | 0          | 0                        | 0    | 0    | 0          | 0                         | 0    | 0    | 0          | 0         | 0    | 0    | 0          | 0          |
| 04:30 PM   | 0                         | 0    | 0    | 0          | 0                        | 0    | 0    | 0          | 0                         | 0    | 0    | 0          | 0         | 0    | 0    | 0          | 0          |
| 04:45 PM   | 0                         | 0    | 0    | 0          | 0                        | 0    | 0    | 0          | 0                         | 0    | 0    | 0          | 0         | 0    | 0    | 0          | 0          |
| Total Volume   | 0                         | 0    | 0    | 0          | 0                        | 0    | 0    | 0          | 0                         | 0    | 0    | 0          | 0         | 0    | 0    | 0          | 0          |
| % App. Total   | 0                         | 0    | 0    |            | 0                        | 0    | 0    |            | 0                         | 0    | 0    |            | 0         | 0    | 0    |            |            |
| PHF  | .000                      | .000 | .000 | .000       | .000                     | .000 | .000 | .000       | .000                      | .000 | .000 | .000       | .000      | .000 | .000 | .000       | .000       |

# Traffic Data Service

San Jose, CA  
(408) 622-4787  
tdsbay@cs.com

File Name : 1PM FINAL  
Site Code : 00000001  
Start Date : 4/25/2018  
Page No : 2

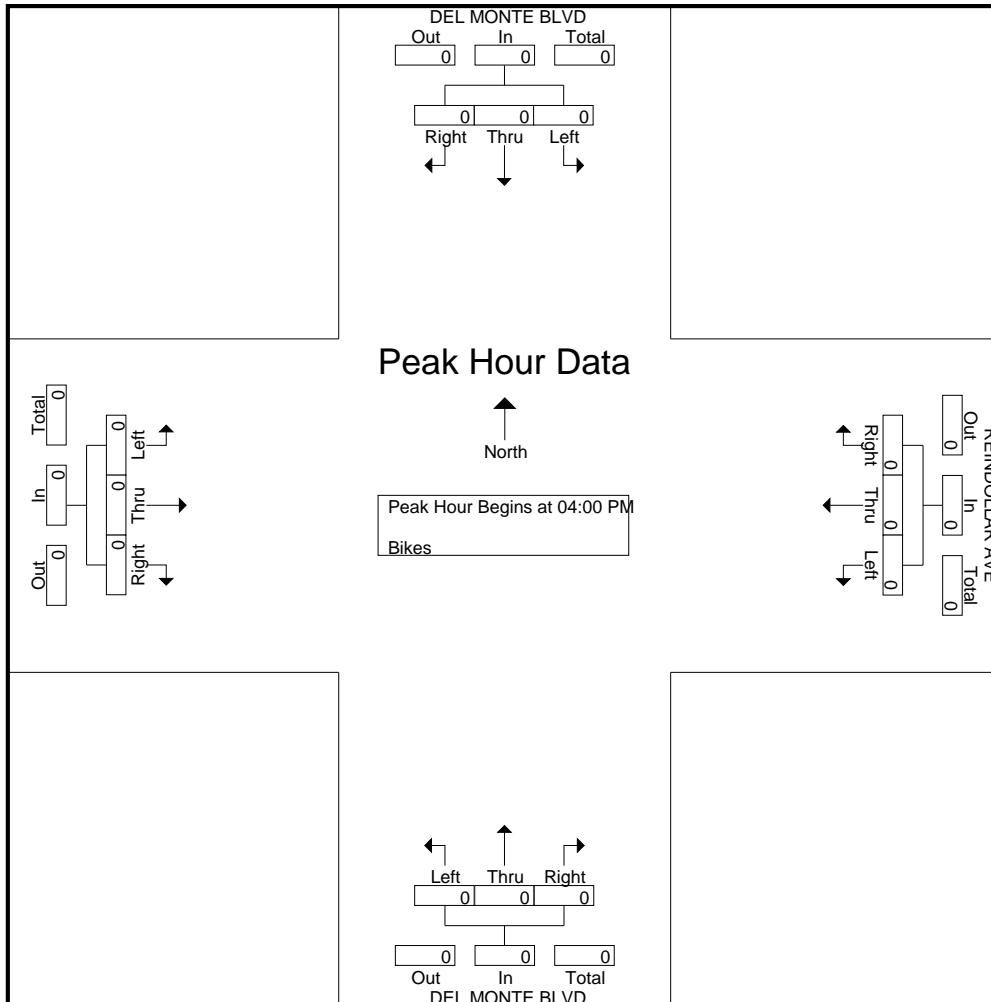



# Traffic Data Service

San Jose, CA  
 (408) 622-4787  
 tdsbay@cs.com

File Name : 2AM FINAL  
 Site Code : 00000002  
 Start Date : 4/25/2018  
 Page No : 1

Groups Printed- Lights - Buses - Trucks

| Start Time  | CALIFORNIA AVE Southbound |      |      |      |            | Westbound |      |      |      |            | CALIFORNIA AVE Northbound |      |      |      |            | PATTON PKWY Eastbound |      |      |      |            | Int. Total |
|-------------|---------------------------|------|------|------|------------|-----------|------|------|------|------------|---------------------------|------|------|------|------------|-----------------------|------|------|------|------------|------------|
|             | Right                     | Thru | Left | Peds | App. Total | Right     | Thru | Left | Peds | App. Total | Right                     | Thru | Left | Peds | App. Total | Right                 | Thru | Left | Peds | App. Total |            |
| 07:00 AM    | 2                         | 107  | 0    | 0    | 109        | 0         | 0    | 0    | 0    | 0          | 0                         | 11   | 2    | 0    | 13         | 0                     | 0    | 1    | 1    | 2          | 124        |
| 07:15 AM    | 9                         | 173  | 0    | 0    | 182        | 0         | 0    | 0    | 0    | 0          | 0                         | 25   | 5    | 0    | 30         | 4                     | 0    | 1    | 0    | 5          | 217        |
| 07:30 AM    | 48                        | 153  | 0    | 0    | 201        | 0         | 0    | 0    | 0    | 0          | 0                         | 47   | 12   | 0    | 59         | 10                    | 0    | 8    | 2    | 20         | 280        |
| 07:45 AM    | 15                        | 115  | 0    | 0    | 130        | 0         | 0    | 0    | 0    | 0          | 0                         | 75   | 9    | 0    | 84         | 12                    | 0    | 17   | 0    | 29         | 243        |
| Total       | 74                        | 548  | 0    | 0    | 622        | 0         | 0    | 0    | 0    | 0          | 0                         | 158  | 28   | 0    | 186        | 26                    | 0    | 27   | 3    | 56         | 864        |
| 08:00 AM    | 2                         | 133  | 0    | 0    | 135        | 0         | 0    | 0    | 0    | 0          | 0                         | 41   | 1    | 0    | 42         | 2                     | 0    | 3    | 1    | 6          | 183        |
| 08:15 AM    | 0                         | 78   | 0    | 0    | 78         | 0         | 0    | 0    | 0    | 0          | 0                         | 45   | 1    | 0    | 46         | 2                     | 0    | 0    | 3    | 5          | 129        |
| 08:30 AM    | 0                         | 90   | 0    | 0    | 90         | 0         | 0    | 0    | 0    | 0          | 0                         | 29   | 3    | 0    | 32         | 3                     | 0    | 0    | 3    | 6          | 128        |
| 08:45 AM    | 1                         | 68   | 0    | 0    | 69         | 0         | 0    | 0    | 0    | 0          | 0                         | 24   | 0    | 0    | 24         | 6                     | 0    | 0    | 1    | 7          | 100        |
| Total       | 3                         | 369  | 0    | 0    | 372        | 0         | 0    | 0    | 0    | 0          | 0                         | 139  | 5    | 0    | 144        | 13                    | 0    | 3    | 8    | 24         | 540        |
| Grand Total | 77                        | 917  | 0    | 0    | 994        | 0         | 0    | 0    | 0    | 0          | 0                         | 297  | 33   | 0    | 330        | 39                    | 0    | 30   | 11   | 80         | 1404       |
| Apprch %    | 7.7                       | 92.3 | 0    | 0    |            | 0         | 0    | 0    | 0    |            | 0                         | 90   | 10   | 0    |            | 48.8                  | 0    | 37.5 | 13.8 |            |            |
| Total %     | 5.5                       | 65.3 | 0    | 0    | 70.8       | 0         | 0    | 0    | 0    | 0          | 0                         | 21.2 | 2.4  | 0    | 23.5       | 2.8                   | 0    | 2.1  | 0.8  | 5.7        |            |
| Lights      | 76                        | 897  | 0    | 0    | 973        | 0         | 0    | 0    | 0    | 0          | 0                         | 275  | 32   | 0    | 307        | 37                    | 0    | 30   | 11   | 78         | 1358       |
| % Lights    | 98.7                      | 97.8 | 0    | 0    | 97.9       | 0         | 0    | 0    | 0    | 0          | 0                         | 92.6 | 97   | 0    | 93         | 94.9                  | 0    | 100  | 100  | 97.5       | 96.7       |
| Buses       | 1                         | 3    | 0    | 0    | 4          | 0         | 0    | 0    | 0    | 0          | 0                         | 6    | 1    | 0    | 7          | 1                     | 0    | 0    | 0    | 1          | 12         |
| % Buses     | 1.3                       | 0.3  | 0    | 0    | 0.4        | 0         | 0    | 0    | 0    | 0          | 0                         | 2    | 3    | 0    | 2.1        | 2.6                   | 0    | 0    | 0    | 1.2        | 0.9        |
| Trucks      | 0                         | 17   | 0    | 0    | 17         | 0         | 0    | 0    | 0    | 0          | 0                         | 16   | 0    | 0    | 16         | 1                     | 0    | 0    | 0    | 1          | 34         |
| % Trucks    | 0                         | 1.9  | 0    | 0    | 1.7        | 0         | 0    | 0    | 0    | 0          | 0                         | 5.4  | 0    | 0    | 4.8        | 2.6                   | 0    | 0    | 0    | 1.2        | 2.4        |

| Start Time   | CALIFORNIA AVE Southbound |      |      |            | Westbound |      |      |            | CALIFORNIA AVE Northbound |      |      |            | PATTON PKWY Eastbound |      |      |            | Int. Total |      |
|--|---------------------------|------|------|------------|-----------|------|------|------------|---------------------------|------|------|------------|-----------------------|------|------|------------|------------|------|
|  | Right                     | Thru | Left | App. Total | Right     | Thru | Left | App. Total | Right                     | Thru | Left | App. Total | Right                 | Thru | Left | App. Total |            |      |
| Peak Hour Analysis From 07:00 AM to 08:45 AM - Peak 1 of 1 |                           |      |      |            |           |      |      |            |                           |      |      |            |                       |      |      |            |            |      |
| Peak Hour for Entire Intersection Begins at 07:15 AM       |                           |      |      |            |           |      |      |            |                           |      |      |            |                       |      |      |            |            |      |
| 07:15 AM   | 9                         | 173  | 0    | 182        | 0         | 0    | 0    | 0          | 0                         | 0    | 25   | 5          | 30                    | 4    | 0    | 1          | 5          | 217  |
| 07:30 AM   | 48                        | 153  | 0    | 201        | 0         | 0    | 0    | 0          | 0                         | 0    | 47   | 12         | 59                    | 10   | 0    | 8          | 18         | 278  |
| 07:45 AM   | 15                        | 115  | 0    | 130        | 0         | 0    | 0    | 0          | 0                         | 0    | 75   | 9          | 84                    | 12   | 0    | 17         | 29         | 243  |
| 08:00 AM   | 2                         | 133  | 0    | 135        | 0         | 0    | 0    | 0          | 0                         | 0    | 41   | 1          | 42                    | 2    | 0    | 3          | 5          | 182  |
| Total Volume   | 74                        | 574  | 0    | 648        | 0         | 0    | 0    | 0          | 0                         | 0    | 188  | 27         | 215                   | 28   | 0    | 29         | 57         | 920  |
| % App. Total   | 11.4                      | 88.6 | 0    |            | 0         | 0    | 0    |            | 0                         | 0    | 87.4 | 12.6       |                       | 49.1 | 0    | 50.9       |            |      |
| PHF  | .385                      | .829 | .000 | .806       | .000      | .000 | .000 | .000       | .000                      | .000 | .627 | .563       | .640                  | .583 | .000 | .426       | .491       | .827 |

# Traffic Data Service

San Jose, CA  
 (408) 622-4787  
 tdsbay@cs.com

File Name : 2AM FINAL  
 Site Code : 00000002  
 Start Date : 4/25/2018  
 Page No : 2

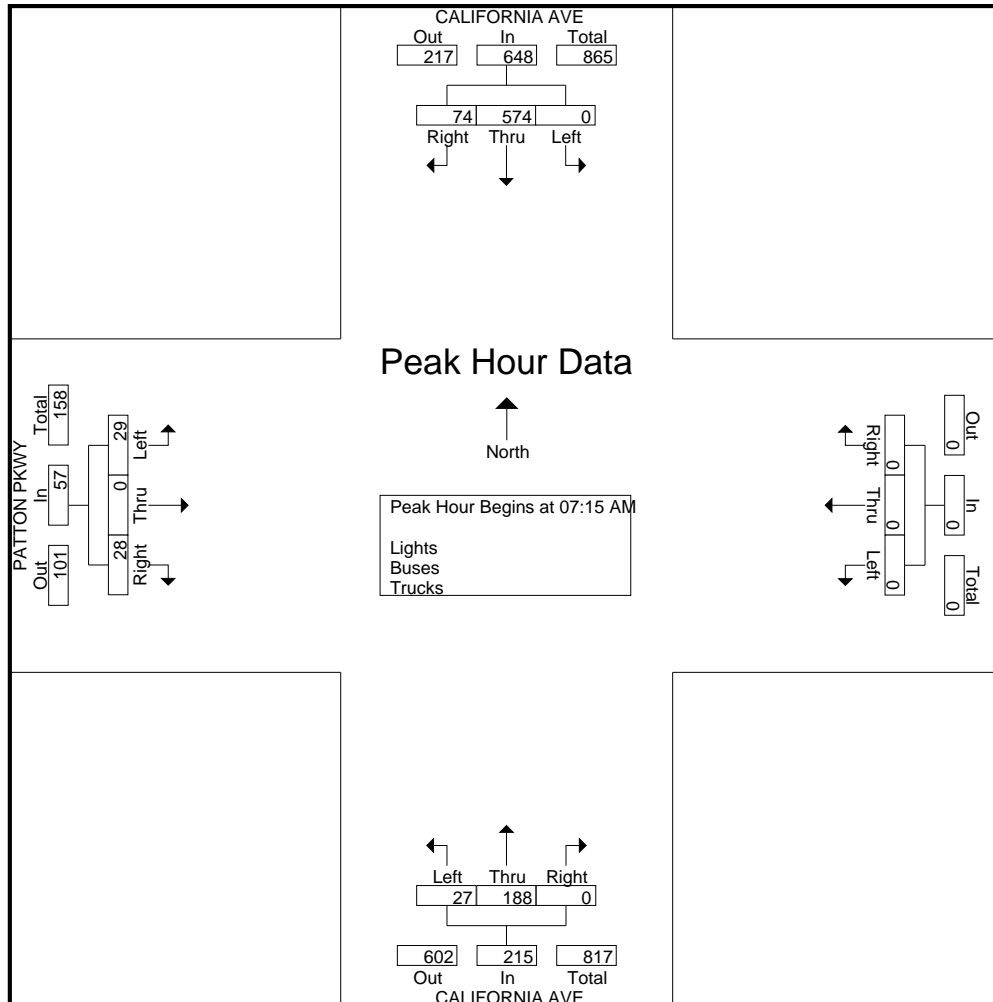

# Traffic Data Service

San Jose, CA  
 (408) 622-4787  
 tdsbay@cs.com

File Name : 2AM FINAL  
 Site Code : 00000002  
 Start Date : 4/25/2018  
 Page No : 1

Groups Printed- Bikes

| Start Time  | CALIFORNIA AVE Southbound |      |      |      |            | Westbound |      |      |      |            | CALIFORNIA AVE Northbound |      |      |      |            | PATTON PKWY Eastbound |      |      |      |            | Int. Total |
|-------------|---------------------------|------|------|------|------------|-----------|------|------|------|------------|---------------------------|------|------|------|------------|-----------------------|------|------|------|------------|------------|
|             | Right                     | Thru | Left | Peds | App. Total | Right     | Thru | Left | Peds | App. Total | Right                     | Thru | Left | Peds | App. Total | Right                 | Thru | Left | Peds | App. Total |            |
| 07:00 AM    | 0                         | 0    | 0    | 0    | 0          | 0         | 0    | 0    | 0    | 0          | 0                         | 0    | 0    | 0    | 0          | 1                     | 0    | 0    | 0    | 0          | 1          |
| 07:15 AM    | 0                         | 0    | 0    | 0    | 0          | 0         | 0    | 0    | 0    | 0          | 0                         | 0    | 0    | 0    | 0          | 0                     | 0    | 0    | 0    | 0          | 0          |
| 07:30 AM    | 0                         | 0    | 0    | 0    | 0          | 0         | 0    | 0    | 0    | 0          | 0                         | 0    | 0    | 0    | 0          | 0                     | 0    | 0    | 0    | 0          | 0          |
| 07:45 AM    | 0                         | 0    | 0    | 0    | 0          | 0         | 0    | 0    | 0    | 0          | 0                         | 0    | 0    | 0    | 0          | 0                     | 0    | 0    | 0    | 0          | 0          |
| Total       | 0                         | 0    | 0    | 0    | 0          | 0         | 0    | 0    | 0    | 0          | 0                         | 0    | 0    | 0    | 0          | 1                     | 0    | 0    | 0    | 0          | 1          |
| 08:00 AM    | 0                         | 0    | 0    | 0    | 0          | 0         | 0    | 0    | 0    | 0          | 0                         | 0    | 0    | 0    | 0          | 0                     | 0    | 0    | 0    | 0          | 0          |
| 08:15 AM    | 0                         | 0    | 0    | 0    | 0          | 0         | 0    | 0    | 0    | 0          | 0                         | 0    | 0    | 0    | 0          | 0                     | 0    | 0    | 0    | 0          | 0          |
| 08:30 AM    | 0                         | 0    | 0    | 0    | 0          | 0         | 0    | 0    | 0    | 0          | 0                         | 0    | 0    | 0    | 0          | 0                     | 0    | 0    | 0    | 0          | 0          |
| 08:45 AM    | 0                         | 0    | 0    | 0    | 0          | 0         | 0    | 0    | 0    | 0          | 0                         | 0    | 0    | 0    | 0          | 0                     | 0    | 0    | 0    | 0          | 0          |
| Total       | 0                         | 0    | 0    | 0    | 0          | 0         | 0    | 0    | 0    | 0          | 0                         | 0    | 0    | 0    | 0          | 0                     | 0    | 0    | 0    | 0          | 0          |
| Grand Total | 0                         | 0    | 0    | 0    | 0          | 0         | 0    | 0    | 0    | 0          | 0                         | 0    | 0    | 0    | 0          | 1                     | 0    | 0    | 0    | 0          | 1          |
| Apprch %    | 0                         | 0    | 0    | 0    | 0          | 0         | 0    | 0    | 0    | 0          | 0                         | 0    | 0    | 0    | 0          | 100                   | 0    | 0    | 0    | 0          |            |
| Total %     | 0                         | 0    | 0    | 0    | 0          | 0         | 0    | 0    | 0    | 0          | 0                         | 0    | 0    | 0    | 0          | 100                   | 0    | 0    | 0    | 100        |            |

| Start Time   | CALIFORNIA AVE Southbound |      |      |      |            | Westbound |      |      |      |            | CALIFORNIA AVE Northbound |      |      |      |            | PATTON PKWY Eastbound |      |      |      |            | Int. Total |
|--------------|---------------------------|------|------|------|------------|-----------|------|------|------|------------|---------------------------|------|------|------|------------|-----------------------|------|------|------|------------|------------|
|              | Right                     | Thru | Left | Peds | App. Total | Right     | Thru | Left | Peds | App. Total | Right                     | Thru | Left | Peds | App. Total | Right                 | Thru | Left | Peds | App. Total |            |
| 07:00 AM     | 0                         | 0    | 0    | 0    | 0          | 0         | 0    | 0    | 0    | 0          | 0                         | 0    | 0    | 0    | 0          | 1                     | 0    | 0    | 0    | 0          | 1          |
| 07:15 AM     | 0                         | 0    | 0    | 0    | 0          | 0         | 0    | 0    | 0    | 0          | 0                         | 0    | 0    | 0    | 0          | 0                     | 0    | 0    | 0    | 0          | 0          |
| 07:30 AM     | 0                         | 0    | 0    | 0    | 0          | 0         | 0    | 0    | 0    | 0          | 0                         | 0    | 0    | 0    | 0          | 0                     | 0    | 0    | 0    | 0          | 0          |
| 07:45 AM     | 0                         | 0    | 0    | 0    | 0          | 0         | 0    | 0    | 0    | 0          | 0                         | 0    | 0    | 0    | 0          | 0                     | 0    | 0    | 0    | 0          | 0          |
| Total Volume | 0                         | 0    | 0    | 0    | 0          | 0         | 0    | 0    | 0    | 0          | 0                         | 0    | 0    | 0    | 0          | 1                     | 0    | 0    | 0    | 0          | 1          |
| % App. Total | 0                         | 0    | 0    | 0    | 0          | 0         | 0    | 0    | 0    | 0          | 0                         | 0    | 0    | 0    | 0          | 100                   | 0    | 0    | 0    | 0          |            |
| PHF          | .000                      | .000 | .000 | .000 | .000       | .000      | .000 | .000 | .000 | .000       | .000                      | .000 | .000 | .000 | .000       | .250                  | .000 | .000 | .250 | .250       |            |

Peak Hour Analysis From 07:00 AM to 08:45 AM - Peak 1 of 1  
 Peak Hour for Entire Intersection Begins at 07:00 AM

# Traffic Data Service

San Jose, CA  
 (408) 622-4787  
 tdsbay@cs.com

File Name : 2AM FINAL  
 Site Code : 00000002  
 Start Date : 4/25/2018  
 Page No : 2

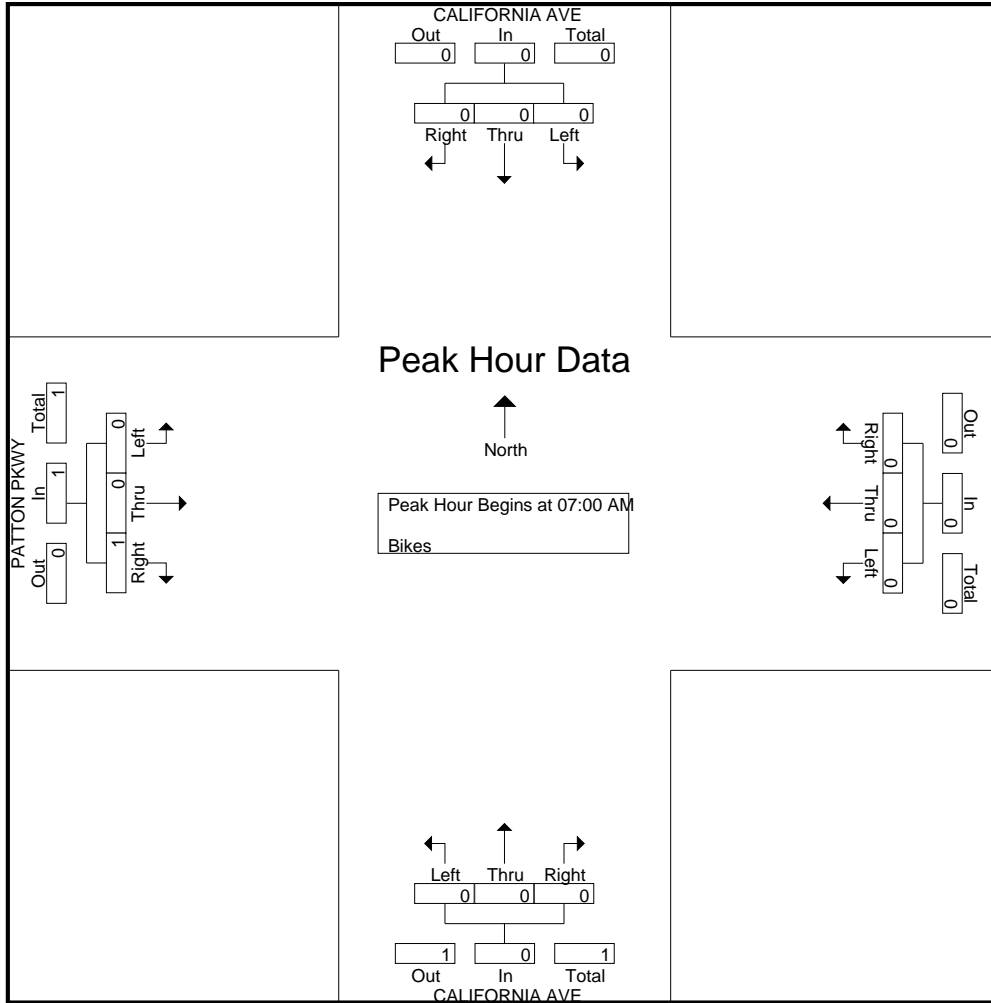

# Traffic Data Service

San Jose, CA  
 (408) 622-4787  
 tdsbay@cs.com

File Name : 2PM FINAL  
 Site Code : 00000002  
 Start Date : 4/25/2018  
 Page No : 1

Groups Printed- Lights - Buses - Trucks

| Start Time  | CALIFORNIA AVE Southbound |      |      |      |            | Westbound |      |      |      |            | CALIFORNIA AVE Northbound |      |      |      |            | PATTON PKWY Eastbound |      |      |      |            | Int. Total |
|-------------|---------------------------|------|------|------|------------|-----------|------|------|------|------------|---------------------------|------|------|------|------------|-----------------------|------|------|------|------------|------------|
|             | Right                     | Thru | Left | Peds | App. Total | Right     | Thru | Left | Peds | App. Total | Right                     | Thru | Left | Peds | App. Total | Right                 | Thru | Left | Peds | App. Total |            |
| 04:00 PM    | 5                         | 35   | 0    | 0    | 40         | 0         | 0    | 0    | 0    | 0          | 0                         | 81   | 3    | 0    | 84         | 6                     | 0    | 3    | 0    | 9          | 133        |
| 04:15 PM    | 0                         | 49   | 0    | 0    | 49         | 0         | 0    | 0    | 0    | 0          | 0                         | 90   | 3    | 0    | 93         | 3                     | 0    | 0    | 2    | 5          | 147        |
| 04:30 PM    | 0                         | 50   | 0    | 0    | 50         | 0         | 0    | 0    | 0    | 0          | 0                         | 92   | 2    | 0    | 94         | 1                     | 0    | 0    | 0    | 1          | 145        |
| 04:45 PM    | 1                         | 47   | 0    | 0    | 48         | 0         | 0    | 0    | 0    | 0          | 0                         | 112  | 4    | 0    | 116        | 1                     | 0    | 1    | 1    | 3          | 167        |
| Total       | 6                         | 181  | 0    | 0    | 187        | 0         | 0    | 0    | 0    | 0          | 0                         | 375  | 12   | 0    | 387        | 11                    | 0    | 4    | 3    | 18         | 592        |
| 05:00 PM    | 1                         | 62   | 0    | 0    | 63         | 0         | 0    | 0    | 0    | 0          | 0                         | 84   | 4    | 0    | 88         | 3                     | 0    | 0    | 2    | 5          | 156        |
| 05:15 PM    | 0                         | 52   | 0    | 0    | 52         | 0         | 0    | 0    | 0    | 0          | 0                         | 90   | 5    | 0    | 95         | 3                     | 0    | 1    | 0    | 4          | 151        |
| 05:30 PM    | 0                         | 64   | 0    | 0    | 64         | 0         | 0    | 0    | 0    | 0          | 0                         | 63   | 3    | 0    | 66         | 3                     | 0    | 0    | 1    | 4          | 134        |
| 05:45 PM    | 0                         | 67   | 0    | 0    | 67         | 0         | 0    | 0    | 0    | 0          | 0                         | 79   | 2    | 0    | 81         | 1                     | 0    | 0    | 2    | 3          | 151        |
| Total       | 1                         | 245  | 0    | 0    | 246        | 0         | 0    | 0    | 0    | 0          | 0                         | 316  | 14   | 0    | 330        | 10                    | 0    | 1    | 5    | 16         | 592        |
| Grand Total | 7                         | 426  | 0    | 0    | 433        | 0         | 0    | 0    | 0    | 0          | 0                         | 691  | 26   | 0    | 717        | 21                    | 0    | 5    | 8    | 34         | 1184       |
| Apprch %    | 1.6                       | 98.4 | 0    | 0    |            | 0         | 0    | 0    | 0    |            | 0                         | 96.4 | 3.6  | 0    |            | 61.8                  | 0    | 14.7 | 23.5 |            |            |
| Total %     | 0.6                       | 36   | 0    | 0    | 36.6       | 0         | 0    | 0    | 0    | 0          | 0                         | 58.4 | 2.2  | 0    | 60.6       | 1.8                   | 0    | 0.4  | 0.7  | 2.9        |            |
| Lights      | 7                         | 419  | 0    | 0    | 426        | 0         | 0    | 0    | 0    | 0          | 0                         | 685  | 26   | 0    | 711        | 21                    | 0    | 5    | 8    | 34         | 1171       |
| % Lights    | 100                       | 98.4 | 0    | 0    | 98.4       | 0         | 0    | 0    | 0    | 0          | 0                         | 99.1 | 100  | 0    | 99.2       | 100                   | 0    | 100  | 100  | 100        | 98.9       |
| Buses       | 0                         | 1    | 0    | 0    | 1          | 0         | 0    | 0    | 0    | 0          | 0                         | 1    | 0    | 0    | 1          | 0                     | 0    | 0    | 0    | 0          | 2          |
| % Buses     | 0                         | 0.2  | 0    | 0    | 0.2        | 0         | 0    | 0    | 0    | 0          | 0                         | 0.1  | 0    | 0    | 0.1        | 0                     | 0    | 0    | 0    | 0          | 0.2        |
| Trucks      | 0                         | 6    | 0    | 0    | 6          | 0         | 0    | 0    | 0    | 0          | 0                         | 5    | 0    | 0    | 5          | 0                     | 0    | 0    | 0    | 0          | 11         |
| % Trucks    | 0                         | 1.4  | 0    | 0    | 1.4        | 0         | 0    | 0    | 0    | 0          | 0                         | 0.7  | 0    | 0    | 0.7        | 0                     | 0    | 0    | 0    | 0          | 0.9        |

| Start Time   | CALIFORNIA AVE Southbound |      |      |            | Westbound |      |      |            | CALIFORNIA AVE Northbound |      |      |            | PATTON PKWY Eastbound |      |      |            | Int. Total |      |
|--|---------------------------|------|------|------------|-----------|------|------|------------|---------------------------|------|------|------------|-----------------------|------|------|------------|------------|------|
|  | Right                     | Thru | Left | App. Total | Right     | Thru | Left | App. Total | Right                     | Thru | Left | App. Total | Right                 | Thru | Left | App. Total |            |      |
| Peak Hour Analysis From 04:00 PM to 05:45 PM - Peak 1 of 1 |                           |      |      |            |           |      |      |            |                           |      |      |            |                       |      |      |            |            |      |
| Peak Hour for Entire Intersection Begins at 04:30 PM       |                           |      |      |            |           |      |      |            |                           |      |      |            |                       |      |      |            |            |      |
| 04:30 PM   | 0                         | 50   | 0    | 50         | 0         | 0    | 0    | 0          | 0                         | 0    | 92   | 2          | 94                    | 1    | 0    | 0          | 1          | 145  |
| 04:45 PM   | 1                         | 47   | 0    | 48         | 0         | 0    | 0    | 0          | 0                         | 0    | 112  | 4          | 116                   | 1    | 0    | 1          | 2          | 166  |
| 05:00 PM   | 1                         | 62   | 0    | 63         | 0         | 0    | 0    | 0          | 0                         | 0    | 84   | 4          | 88                    | 3    | 0    | 0          | 3          | 154  |
| 05:15 PM   | 0                         | 52   | 0    | 52         | 0         | 0    | 0    | 0          | 0                         | 0    | 90   | 5          | 95                    | 3    | 0    | 1          | 4          | 151  |
| Total Volume   | 2                         | 211  | 0    | 213        | 0         | 0    | 0    | 0          | 0                         | 0    | 378  | 15         | 393                   | 8    | 0    | 2          | 10         | 616  |
| % App. Total   | 0.9                       | 99.1 | 0    |            | 0         | 0    | 0    |            | 0                         | 0    | 96.2 | 3.8        |                       | 80   | 0    | 20         |            |      |
| PHF  | .500                      | .851 | .000 | .845       | .000      | .000 | .000 | .000       | .000                      | .000 | .844 | .750       | .847                  | .667 | .000 | .500       | .625       | .928 |

# Traffic Data Service

San Jose, CA  
 (408) 622-4787  
 tdsbay@cs.com

File Name : 2PM FINAL  
 Site Code : 00000002  
 Start Date : 4/25/2018  
 Page No : 2

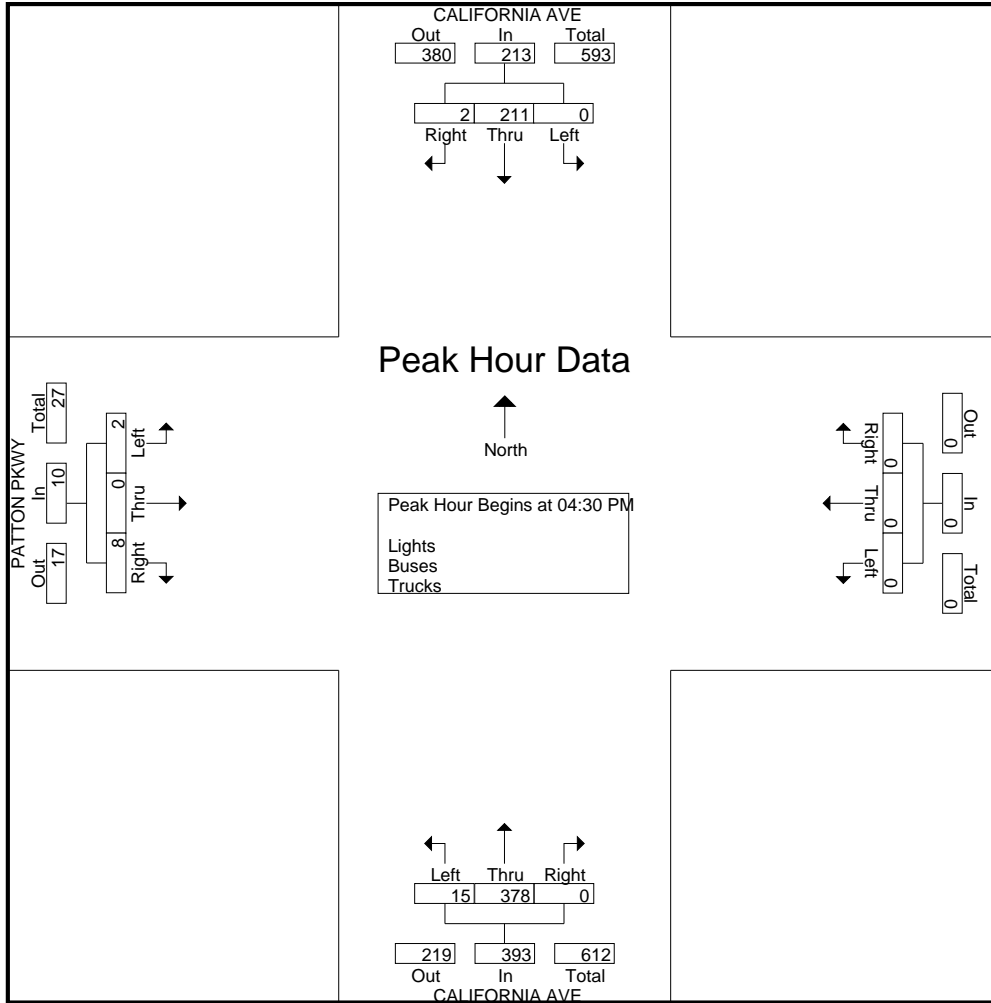

# Traffic Data Service

San Jose, CA  
 (408) 622-4787  
 tdsbay@cs.com

File Name : 2PM FINAL  
 Site Code : 00000002  
 Start Date : 4/25/2018  
 Page No : 1

Groups Printed- Bikes

| Start Time   | CALIFORNIA AVE Southbound |      |      |      |            | Westbound |      |      |      |            | CALIFORNIA AVE Northbound |      |      |      |            | PATTON PKWY Eastbound |      |      |      |            | Int. Total |
|--------------|---------------------------|------|------|------|------------|-----------|------|------|------|------------|---------------------------|------|------|------|------------|-----------------------|------|------|------|------------|------------|
|              | Right                     | Thru | Left | Peds | App. Total | Right     | Thru | Left | Peds | App. Total | Right                     | Thru | Left | Peds | App. Total | Right                 | Thru | Left | Peds | App. Total |            |
| 04:00 PM     | 0                         | 0    | 0    | 0    | 0          | 0         | 0    | 0    | 0    | 0          | 0                         | 0    | 0    | 0    | 0          | 1                     | 0    | 1    | 0    | 2          | 2          |
| 04:15 PM     | 0                         | 0    | 0    | 0    | 0          | 0         | 0    | 0    | 0    | 0          | 0                         | 0    | 0    | 0    | 0          | 0                     | 0    | 0    | 0    | 0          | 0          |
| 04:30 PM     | 0                         | 1    | 0    | 0    | 1          | 0         | 0    | 0    | 0    | 0          | 0                         | 0    | 0    | 0    | 0          | 0                     | 0    | 0    | 0    | 0          | 1          |
| 04:45 PM     | 0                         | 0    | 0    | 0    | 0          | 0         | 0    | 0    | 0    | 0          | 0                         | 0    | 0    | 0    | 0          | 0                     | 0    | 0    | 0    | 0          | 0          |
| <b>Total</b> | 0                         | 1    | 0    | 0    | 1          | 0         | 0    | 0    | 0    | 0          | 0                         | 0    | 0    | 0    | 0          | 1                     | 0    | 1    | 0    | 2          | 3          |
| 05:00 PM     | 0                         | 0    | 0    | 0    | 0          | 0         | 0    | 0    | 0    | 0          | 0                         | 0    | 0    | 0    | 0          | 0                     | 0    | 0    | 0    | 0          | 0          |
| 05:15 PM     | 0                         | 0    | 0    | 0    | 0          | 0         | 0    | 0    | 0    | 0          | 0                         | 0    | 0    | 0    | 0          | 0                     | 0    | 0    | 0    | 0          | 0          |
| 05:30 PM     | 0                         | 0    | 0    | 0    | 0          | 0         | 0    | 0    | 0    | 0          | 0                         | 0    | 0    | 0    | 0          | 0                     | 0    | 0    | 0    | 0          | 0          |
| 05:45 PM     | 0                         | 1    | 0    | 0    | 1          | 0         | 0    | 0    | 0    | 0          | 0                         | 0    | 0    | 0    | 0          | 0                     | 0    | 0    | 0    | 0          | 1          |
| <b>Total</b> | 0                         | 1    | 0    | 0    | 1          | 0         | 0    | 0    | 0    | 0          | 0                         | 0    | 0    | 0    | 0          | 0                     | 0    | 0    | 0    | 0          | 1          |
| Grand Total  | 0                         | 2    | 0    | 0    | 2          | 0         | 0    | 0    | 0    | 0          | 0                         | 0    | 0    | 0    | 0          | 1                     | 0    | 1    | 0    | 2          | 4          |
| Apprch %     | 0                         | 100  | 0    | 0    |            | 0         | 0    | 0    | 0    |            | 0                         | 0    | 0    | 0    |            | 50                    | 0    | 50   | 0    |            |            |
| Total %      | 0                         | 50   | 0    | 0    | 50         | 0         | 0    | 0    | 0    | 0          | 0                         | 0    | 0    | 0    | 0          | 25                    | 0    | 25   | 0    | 50         |            |

| Start Time   | CALIFORNIA AVE Southbound |      |      |            | Westbound |      |      |            | CALIFORNIA AVE Northbound |      |      |            | PATTON PKWY Eastbound |      |      |            | Int. Total |
|--|---------------------------|------|------|------------|-----------|------|------|------------|---------------------------|------|------|------------|-----------------------|------|------|------------|------------|
|  | Right                     | Thru | Left | App. Total | Right     | Thru | Left | App. Total | Right                     | Thru | Left | App. Total | Right                 | Thru | Left | App. Total |            |
| Peak Hour Analysis From 04:00 PM to 05:45 PM - Peak 1 of 1 |                           |      |      |            |           |      |      |            |                           |      |      |            |                       |      |      |            |            |
| Peak Hour for Entire Intersection Begins at 04:00 PM       |                           |      |      |            |           |      |      |            |                           |      |      |            |                       |      |      |            |            |
| 04:00 PM   | 0                         | 0    | 0    | 0          | 0         | 0    | 0    | 0          | 0                         | 0    | 0    | 0          | 1                     | 0    | 1    | 2          | 2          |
| 04:15 PM   | 0                         | 0    | 0    | 0          | 0         | 0    | 0    | 0          | 0                         | 0    | 0    | 0          | 0                     | 0    | 0    | 0          | 0          |
| 04:30 PM   | 0                         | 1    | 0    | 1          | 0         | 0    | 0    | 0          | 0                         | 0    | 0    | 0          | 0                     | 0    | 0    | 0          | 1          |
| 04:45 PM   | 0                         | 0    | 0    | 0          | 0         | 0    | 0    | 0          | 0                         | 0    | 0    | 0          | 0                     | 0    | 0    | 0          | 0          |
| Total Volume   | 0                         | 1    | 0    | 1          | 0         | 0    | 0    | 0          | 0                         | 0    | 0    | 0          | 1                     | 0    | 1    | 2          | 3          |
| % App. Total   | 0                         | 100  | 0    |            | 0         | 0    | 0    |            | 0                         | 0    | 0    |            | 50                    | 0    | 50   |            |            |
| PHF  | .000                      | .250 | .000 | .250       | .000      | .000 | .000 | .000       | .000                      | .000 | .000 | .000       | .250                  | .000 | .250 | .250       | .375       |

# Traffic Data Service

San Jose, CA  
(408) 622-4787  
tdsbay@cs.com

File Name : 2PM FINAL  
Site Code : 00000002  
Start Date : 4/25/2018  
Page No : 2

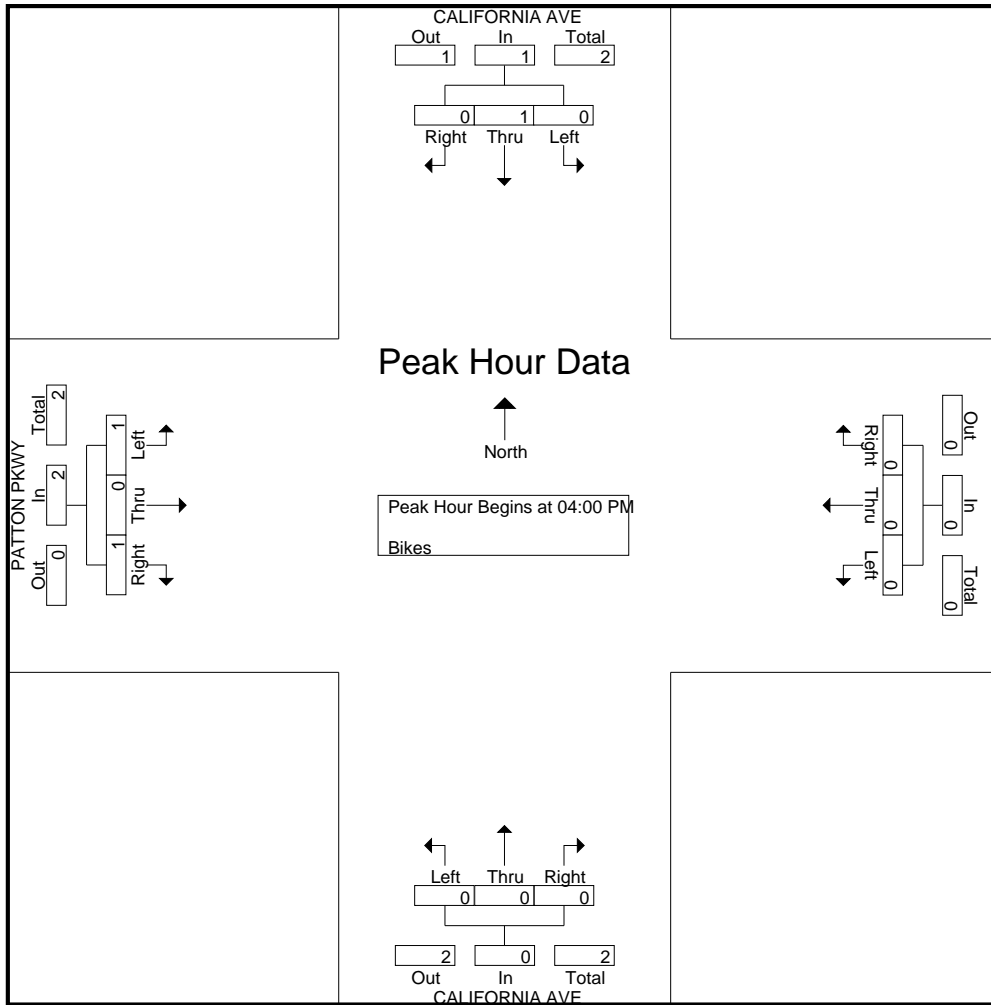



# Traffic Data Service

San Jose, CA  
 (408) 622-4787  
 tdsbay@cs.com

File Name : 3AM FINAL  
 Site Code : 00000003  
 Start Date : 4/25/2018  
 Page No : 1

Groups Printed- Lights - Buses - Trucks

| Start Time  | BLANCO RD Southbound |      |      |      |            | RESERVATION RD Westbound |      |      |      |            | Northbound |      |      |      |            | RESERVATION RD Eastbound |      |      |      |            | Int. Total |
|-------------|----------------------|------|------|------|------------|--------------------------|------|------|------|------------|------------|------|------|------|------------|--------------------------|------|------|------|------------|------------|
|             | Right                | Thru | Left | Peds | App. Total | Right                    | Thru | Left | Peds | App. Total | Right      | Thru | Left | Peds | App. Total | Right                    | Thru | Left | Peds | App. Total |            |
| 07:00 AM    | 312                  | 0    | 6    | 0    | 318        | 11                       | 89   | 0    | 0    | 100        | 0          | 0    | 0    | 0    | 0          | 0                        | 52   | 139  | 0    | 191        | 609        |
| 07:15 AM    | 322                  | 0    | 8    | 0    | 330        | 9                        | 92   | 0    | 0    | 101        | 0          | 0    | 0    | 0    | 0          | 0                        | 49   | 243  | 0    | 292        | 723        |
| 07:30 AM    | 294                  | 0    | 6    | 0    | 300        | 8                        | 111  | 0    | 0    | 119        | 0          | 0    | 0    | 0    | 0          | 0                        | 68   | 293  | 0    | 361        | 780        |
| 07:45 AM    | 282                  | 0    | 5    | 0    | 287        | 8                        | 80   | 0    | 0    | 88         | 0          | 0    | 0    | 0    | 0          | 0                        | 91   | 288  | 0    | 379        | 754        |
| Total       | 1210                 | 0    | 25   | 0    | 1235       | 36                       | 372  | 0    | 0    | 408        | 0          | 0    | 0    | 0    | 0          | 0                        | 260  | 963  | 0    | 1223       | 2866       |
| 08:00 AM    | 267                  | 0    | 9    | 0    | 276        | 1                        | 89   | 0    | 0    | 90         | 0          | 0    | 0    | 0    | 0          | 0                        | 52   | 224  | 0    | 276        | 642        |
| 08:15 AM    | 274                  | 0    | 7    | 0    | 281        | 11                       | 90   | 0    | 0    | 101        | 0          | 0    | 0    | 0    | 0          | 0                        | 58   | 172  | 0    | 230        | 612        |
| 08:30 AM    | 284                  | 0    | 6    | 0    | 290        | 8                        | 70   | 0    | 0    | 78         | 0          | 0    | 0    | 0    | 0          | 0                        | 34   | 180  | 0    | 214        | 582        |
| 08:45 AM    | 230                  | 0    | 3    | 0    | 233        | 5                        | 65   | 0    | 0    | 70         | 0          | 0    | 0    | 0    | 0          | 0                        | 54   | 154  | 0    | 208        | 511        |
| Total       | 1055                 | 0    | 25   | 0    | 1080       | 25                       | 314  | 0    | 0    | 339        | 0          | 0    | 0    | 0    | 0          | 0                        | 198  | 730  | 0    | 928        | 2347       |
| Grand Total | 2265                 | 0    | 50   | 0    | 2315       | 61                       | 686  | 0    | 0    | 747        | 0          | 0    | 0    | 0    | 0          | 0                        | 458  | 1693 | 0    | 2151       | 5213       |
| Apprch %    | 97.8                 | 0    | 2.2  | 0    |            | 8.2                      | 91.8 | 0    | 0    |            | 0          | 0    | 0    | 0    | 0          | 0                        | 21.3 | 78.7 | 0    |            |            |
| Total %     | 43.4                 | 0    | 1    | 0    | 44.4       | 1.2                      | 13.2 | 0    | 0    | 14.3       | 0          | 0    | 0    | 0    | 0          | 0                        | 8.8  | 32.5 | 0    | 41.3       |            |
| Lights      | 2202                 | 0    | 43   | 0    | 2245       | 58                       | 670  | 0    | 0    | 728        | 0          | 0    | 0    | 0    | 0          | 0                        | 439  | 1658 | 0    | 2097       | 5070       |
| % Lights    | 97.2                 | 0    | 86   | 0    | 97         | 95.1                     | 97.7 | 0    | 0    | 97.5       | 0          | 0    | 0    | 0    | 0          | 0                        | 95.9 | 97.9 | 0    | 97.5       | 97.3       |
| Buses       | 14                   | 0    | 1    | 0    | 15         | 0                        | 3    | 0    | 0    | 3          | 0          | 0    | 0    | 0    | 0          | 0                        | 5    | 14   | 0    | 19         | 37         |
| % Buses     | 0.6                  | 0    | 2    | 0    | 0.6        | 0                        | 0.4  | 0    | 0    | 0.4        | 0          | 0    | 0    | 0    | 0          | 0                        | 1.1  | 0.8  | 0    | 0.9        | 0.7        |
| Trucks      | 49                   | 0    | 6    | 0    | 55         | 3                        | 13   | 0    | 0    | 16         | 0          | 0    | 0    | 0    | 0          | 0                        | 14   | 21   | 0    | 35         | 106        |
| % Trucks    | 2.2                  | 0    | 12   | 0    | 2.4        | 4.9                      | 1.9  | 0    | 0    | 2.1        | 0          | 0    | 0    | 0    | 0          | 0                        | 3.1  | 1.2  | 0    | 1.6        | 2          |

| Start Time   | BLANCO RD Southbound |      |          |            | RESERVATION RD Westbound |            |      |            | Northbound |      |      |            | RESERVATION RD Eastbound |           |            |            | Int. Total |     |
|--|----------------------|------|----------|------------|--------------------------|------------|------|------------|------------|------|------|------------|--------------------------|-----------|------------|------------|------------|-----|
|  | Right                | Thru | Left     | App. Total | Right                    | Thru       | Left | App. Total | Right      | Thru | Left | App. Total | Right                    | Thru      | Left       | App. Total |            |     |
| Peak Hour Analysis From 07:00 AM to 08:45 AM - Peak 1 of 1 |                      |      |          |            |                          |            |      |            |            |      |      |            |                          |           |            |            |            |     |
| Peak Hour for Entire Intersection Begins at 07:15 AM       |                      |      |          |            |                          |            |      |            |            |      |      |            |                          |           |            |            |            |     |
| 07:15 AM   | <b>322</b>           | 0    | 8        | <b>330</b> | <b>9</b>                 | 92         | 0    | 101        | 0          | 0    | 0    | 0          | 0                        | 0         | 49         | 243        | 292        | 723 |
| 07:30 AM   | 294                  | 0    | 6        | 300        | 8                        | <b>111</b> | 0    | <b>119</b> | 0          | 0    | 0    | 0          | 0                        | 68        | <b>293</b> | 361        | <b>780</b> |     |
| 07:45 AM   | 282                  | 0    | 5        | 287        | 8                        | 80         | 0    | 88         | 0          | 0    | 0    | 0          | 0                        | <b>91</b> | 288        | <b>379</b> | 754        |     |
| 08:00 AM   | 267                  | 0    | <b>9</b> | 276        | 1                        | 89         | 0    | 90         | 0          | 0    | 0    | 0          | 0                        | 52        | 224        | 276        | 642        |     |
| Total Volume   | 1165                 | 0    | 28       | 1193       | 26                       | 372        | 0    | 398        | 0          | 0    | 0    | 0          | 0                        | 260       | 1048       | 1308       | 2899       |     |
| % App. Total   | 97.7                 | 0    | 2.3      |            | 6.5                      | 93.5       | 0    |            | 0          | 0    | 0    |            | 0                        | 19.9      | 80.1       |            |            |     |
| PHF  | .905                 | .000 | .778     | .904       | .722                     | .838       | .000 | .836       | .000       | .000 | .000 | .000       | .000                     | .714      | .894       | .863       | .929       |     |

# Traffic Data Service

San Jose, CA  
 (408) 622-4787  
 tdsbay@cs.com

File Name : 3AM FINAL  
 Site Code : 00000003  
 Start Date : 4/25/2018  
 Page No : 2

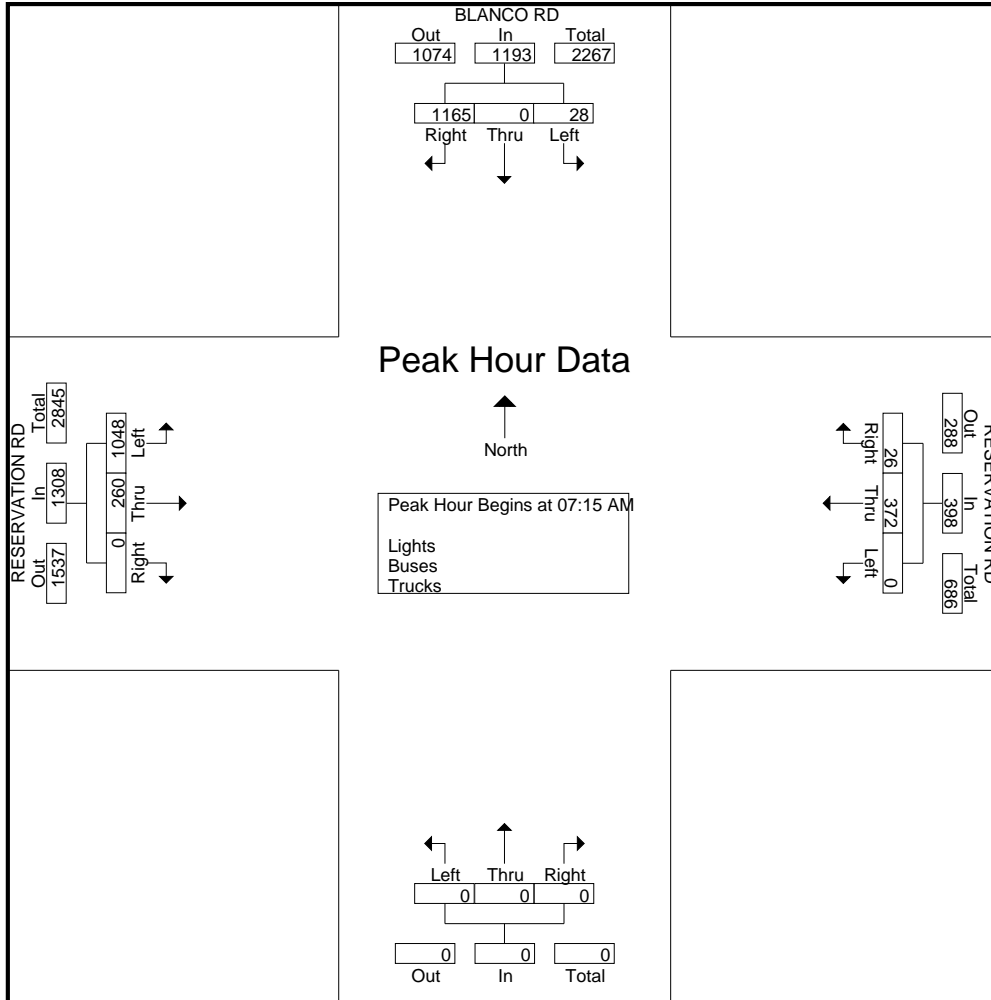

# Traffic Data Service

San Jose, CA  
 (408) 622-4787  
 tdsbay@cs.com

File Name : 3AM FINAL  
 Site Code : 00000003  
 Start Date : 4/25/2018  
 Page No : 1

Groups Printed- Bikes

| Start Time   | BLANCO RD Southbound |      |      |      |            | RESERVATION RD Westbound |      |      |      |            | Northbound |      |      |      |            | RESERVATION RD Eastbound |      |      |      |            | Int. Total |
|--------------|----------------------|------|------|------|------------|--------------------------|------|------|------|------------|------------|------|------|------|------------|--------------------------|------|------|------|------------|------------|
|              | Right                | Thru | Left | Peds | App. Total | Right                    | Thru | Left | Peds | App. Total | Right      | Thru | Left | Peds | App. Total | Right                    | Thru | Left | Peds | App. Total |            |
| 07:00 AM     | 0                    | 0    | 0    | 0    | 0          | 0                        | 0    | 0    | 0    | 0          | 0          | 0    | 0    | 0    | 0          | 0                        | 0    | 0    | 0    | 0          | 0          |
| 07:15 AM     | 0                    | 0    | 0    | 0    | 0          | 0                        | 0    | 0    | 0    | 0          | 0          | 0    | 0    | 0    | 0          | 0                        | 0    | 0    | 0    | 0          | 0          |
| 07:30 AM     | 0                    | 0    | 0    | 0    | 0          | 0                        | 0    | 0    | 0    | 0          | 0          | 0    | 0    | 0    | 0          | 0                        | 0    | 1    | 0    | 1          | 1          |
| 07:45 AM     | 0                    | 0    | 0    | 0    | 0          | 0                        | 0    | 0    | 0    | 0          | 0          | 0    | 0    | 0    | 0          | 0                        | 0    | 0    | 0    | 0          | 0          |
| <b>Total</b> | 0                    | 0    | 0    | 0    | 0          | 0                        | 0    | 0    | 0    | 0          | 0          | 0    | 0    | 0    | 0          | 0                        | 0    | 1    | 0    | 1          | 1          |
| 08:00 AM     | 0                    | 0    | 0    | 0    | 0          | 0                        | 0    | 0    | 0    | 0          | 0          | 0    | 0    | 0    | 0          | 0                        | 0    | 0    | 0    | 0          | 0          |
| 08:15 AM     | 0                    | 0    | 0    | 0    | 0          | 0                        | 0    | 0    | 0    | 0          | 0          | 0    | 0    | 0    | 0          | 0                        | 0    | 1    | 0    | 1          | 1          |
| 08:30 AM     | 0                    | 0    | 0    | 0    | 0          | 0                        | 0    | 0    | 0    | 0          | 0          | 0    | 0    | 0    | 0          | 0                        | 0    | 0    | 0    | 0          | 0          |
| 08:45 AM     | 0                    | 0    | 0    | 0    | 0          | 0                        | 0    | 0    | 0    | 0          | 0          | 0    | 0    | 0    | 0          | 0                        | 0    | 0    | 0    | 0          | 0          |
| <b>Total</b> | 0                    | 0    | 0    | 0    | 0          | 0                        | 0    | 0    | 0    | 0          | 0          | 0    | 0    | 0    | 0          | 0                        | 0    | 1    | 0    | 1          | 1          |
| Grand Total  | 0                    | 0    | 0    | 0    | 0          | 0                        | 0    | 0    | 0    | 0          | 0          | 0    | 0    | 0    | 0          | 0                        | 0    | 2    | 0    | 2          | 2          |
| Apprch %     | 0                    | 0    | 0    | 0    | 0          | 0                        | 0    | 0    | 0    | 0          | 0          | 0    | 0    | 0    | 0          | 0                        | 0    | 100  | 0    | 0          | 0          |
| Total %      | 0                    | 0    | 0    | 0    | 0          | 0                        | 0    | 0    | 0    | 0          | 0          | 0    | 0    | 0    | 0          | 0                        | 0    | 100  | 0    | 100        | 0          |

| Start Time   | BLANCO RD Southbound |      |      |      |            | RESERVATION RD Westbound |      |      |      |            | Northbound |      |      |      |            | RESERVATION RD Eastbound |      |      |      |            | Int. Total |
|--|----------------------|------|------|------|------------|--------------------------|------|------|------|------------|------------|------|------|------|------------|--------------------------|------|------|------|------------|------------|
|  | Right                | Thru | Left | Peds | App. Total | Right                    | Thru | Left | Peds | App. Total | Right      | Thru | Left | Peds | App. Total | Right                    | Thru | Left | Peds | App. Total |            |
| Peak Hour Analysis From 07:00 AM to 08:45 AM - Peak 1 of 1 |                      |      |      |      |            |                          |      |      |      |            |            |      |      |      |            |                          |      |      |      |            |            |
| Peak Hour for Entire Intersection Begins at 07:30 AM       |                      |      |      |      |            |                          |      |      |      |            |            |      |      |      |            |                          |      |      |      |            |            |
| 07:30 AM   | 0                    | 0    | 0    | 0    | 0          | 0                        | 0    | 0    | 0    | 0          | 0          | 0    | 0    | 0    | 0          | 0                        | 0    | 1    | 0    | 1          | 1          |
| 07:45 AM   | 0                    | 0    | 0    | 0    | 0          | 0                        | 0    | 0    | 0    | 0          | 0          | 0    | 0    | 0    | 0          | 0                        | 0    | 0    | 0    | 0          | 0          |
| 08:00 AM   | 0                    | 0    | 0    | 0    | 0          | 0                        | 0    | 0    | 0    | 0          | 0          | 0    | 0    | 0    | 0          | 0                        | 0    | 0    | 0    | 0          | 0          |
| 08:15 AM   | 0                    | 0    | 0    | 0    | 0          | 0                        | 0    | 0    | 0    | 0          | 0          | 0    | 0    | 0    | 0          | 0                        | 0    | 1    | 0    | 1          | 1          |
| Total Volume   | 0                    | 0    | 0    | 0    | 0          | 0                        | 0    | 0    | 0    | 0          | 0          | 0    | 0    | 0    | 0          | 0                        | 0    | 2    | 0    | 2          | 2          |
| % App. Total   | 0                    | 0    | 0    | 0    | 0          | 0                        | 0    | 0    | 0    | 0          | 0          | 0    | 0    | 0    | 0          | 0                        | 0    | 100  | 0    | 0          | 0          |
| PHF  | .000                 | .000 | .000 | .000 | .000       | .000                     | .000 | .000 | .000 | .000       | .000       | .000 | .000 | .000 | .000       | .000                     | .000 | .500 | .500 | .500       | .500       |

# Traffic Data Service

San Jose, CA  
 (408) 622-4787  
 tdsbay@cs.com

File Name : 3AM FINAL  
 Site Code : 00000003  
 Start Date : 4/25/2018  
 Page No : 2

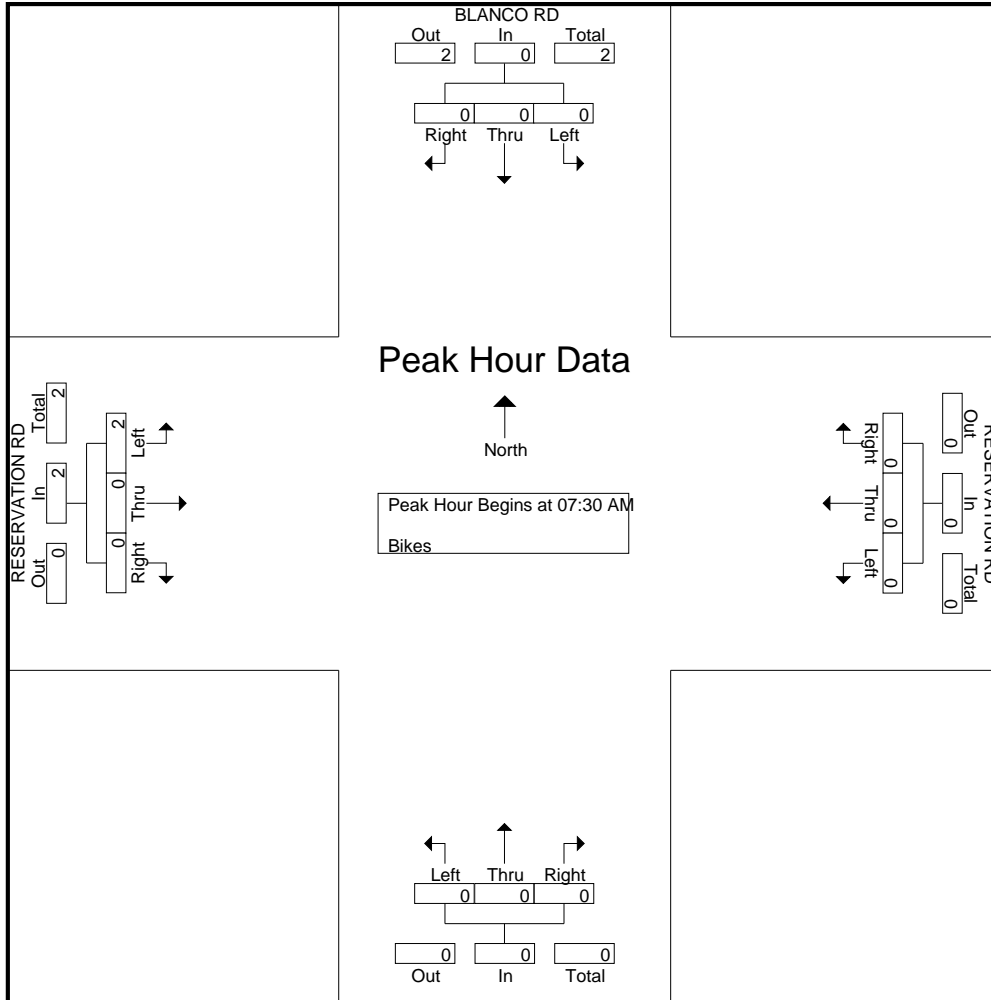

# Traffic Data Service

San Jose, CA  
 (408) 622-4787  
 tdsbay@cs.com

File Name : 3PM FINAL  
 Site Code : 00000003  
 Start Date : 4/25/2018  
 Page No : 1

Groups Printed- Lights - Buses - Trucks

| Start Time  | BLANCO RD Southbound |      |      |      |            | RESERVATION RD Westbound |      |      |      |            | Northbound |      |      |      |            | RESERVATION RD Eastbound |      |      |      |            | Int. Total |
|-------------|----------------------|------|------|------|------------|--------------------------|------|------|------|------------|------------|------|------|------|------------|--------------------------|------|------|------|------------|------------|
|             | Right                | Thru | Left | Peds | App. Total | Right                    | Thru | Left | Peds | App. Total | Right      | Thru | Left | Peds | App. Total | Right                    | Thru | Left | Peds | App. Total |            |
| 04:00 PM    | 224                  | 0    | 9    | 0    | 233        | 8                        | 57   | 0    | 0    | 65         | 0          | 0    | 0    | 0    | 0          | 0                        | 106  | 308  | 0    | 414        | 712        |
| 04:15 PM    | 214                  | 0    | 12   | 0    | 226        | 10                       | 70   | 0    | 0    | 80         | 0          | 0    | 0    | 0    | 0          | 0                        | 107  | 271  | 0    | 378        | 684        |
| 04:30 PM    | 236                  | 0    | 3    | 0    | 239        | 7                        | 82   | 0    | 0    | 89         | 0          | 0    | 0    | 0    | 0          | 0                        | 117  | 282  | 0    | 399        | 727        |
| 04:45 PM    | 231                  | 0    | 10   | 0    | 241        | 6                        | 72   | 0    | 0    | 78         | 0          | 0    | 0    | 0    | 0          | 0                        | 124  | 288  | 0    | 412        | 731        |
| Total       | 905                  | 0    | 34   | 0    | 939        | 31                       | 281  | 0    | 0    | 312        | 0          | 0    | 0    | 0    | 0          | 0                        | 454  | 1149 | 0    | 1603       | 2854       |
| 05:00 PM    | 249                  | 0    | 6    | 0    | 255        | 10                       | 73   | 0    | 0    | 83         | 0          | 0    | 0    | 0    | 0          | 0                        | 124  | 251  | 0    | 375        | 713        |
| 05:15 PM    | 325                  | 0    | 0    | 0    | 325        | 11                       | 80   | 0    | 0    | 91         | 0          | 0    | 0    | 0    | 0          | 0                        | 100  | 287  | 0    | 387        | 803        |
| 05:30 PM    | 280                  | 0    | 5    | 0    | 285        | 6                        | 100  | 0    | 0    | 106        | 0          | 0    | 0    | 0    | 0          | 0                        | 113  | 268  | 0    | 381        | 772        |
| 05:45 PM    | 248                  | 0    | 6    | 0    | 254        | 6                        | 78   | 0    | 0    | 84         | 0          | 0    | 0    | 0    | 0          | 0                        | 121  | 243  | 0    | 364        | 702        |
| Total       | 1102                 | 0    | 17   | 0    | 1119       | 33                       | 331  | 0    | 0    | 364        | 0          | 0    | 0    | 0    | 0          | 0                        | 458  | 1049 | 0    | 1507       | 2990       |
| Grand Total | 2007                 | 0    | 51   | 0    | 2058       | 64                       | 612  | 0    | 0    | 676        | 0          | 0    | 0    | 0    | 0          | 0                        | 912  | 2198 | 0    | 3110       | 5844       |
| Apprch %    | 97.5                 | 0    | 2.5  | 0    |            | 9.5                      | 90.5 | 0    | 0    |            | 0          | 0    | 0    | 0    | 0          | 0                        | 29.3 | 70.7 | 0    |            |            |
| Total %     | 34.3                 | 0    | 0.9  | 0    | 35.2       | 1.1                      | 10.5 | 0    | 0    | 11.6       | 0          | 0    | 0    | 0    | 0          | 0                        | 15.6 | 37.6 | 0    | 53.2       |            |
| Lights      | 1972                 | 0    | 47   | 0    | 2019       | 63                       | 598  | 0    | 0    | 661        | 0          | 0    | 0    | 0    | 0          | 0                        | 897  | 2160 | 0    | 3057       | 5737       |
| % Lights    | 98.3                 | 0    | 92.2 | 0    | 98.1       | 98.4                     | 97.7 | 0    | 0    | 97.8       | 0          | 0    | 0    | 0    | 0          | 0                        | 98.4 | 98.3 | 0    | 98.3       | 98.2       |
| Buses       | 13                   | 0    | 0    | 0    | 13         | 0                        | 0    | 0    | 0    | 0          | 0          | 0    | 0    | 0    | 0          | 0                        | 4    | 17   | 0    | 21         | 34         |
| % Buses     | 0.6                  | 0    | 0    | 0    | 0.6        | 0                        | 0    | 0    | 0    | 0          | 0          | 0    | 0    | 0    | 0          | 0                        | 0.4  | 0.8  | 0    | 0.7        | 0.6        |
| Trucks      | 22                   | 0    | 4    | 0    | 26         | 1                        | 14   | 0    | 0    | 15         | 0          | 0    | 0    | 0    | 0          | 0                        | 11   | 21   | 0    | 32         | 73         |
| % Trucks    | 1.1                  | 0    | 7.8  | 0    | 1.3        | 1.6                      | 2.3  | 0    | 0    | 2.2        | 0          | 0    | 0    | 0    | 0          | 0                        | 1.2  | 1    | 0    | 1          | 1.2        |

| Start Time   | BLANCO RD Southbound |      |           |            | RESERVATION RD Westbound |            |      |            | Northbound |      |      |            | RESERVATION RD Eastbound |      |            |            | Int. Total |            |
|--|----------------------|------|-----------|------------|--------------------------|------------|------|------------|------------|------|------|------------|--------------------------|------|------------|------------|------------|------------|
|  | Right                | Thru | Left      | App. Total | Right                    | Thru       | Left | App. Total | Right      | Thru | Left | App. Total | Right                    | Thru | Left       | App. Total |            |            |
| Peak Hour Analysis From 04:00 PM to 05:45 PM - Peak 1 of 1 |                      |      |           |            |                          |            |      |            |            |      |      |            |                          |      |            |            |            |            |
| Peak Hour for Entire Intersection Begins at 04:45 PM       |                      |      |           |            |                          |            |      |            |            |      |      |            |                          |      |            |            |            |            |
| 04:45 PM   | 231                  | 0    | <b>10</b> | 241        | 6                        | 72         | 0    | 78         | 0          | 0    | 0    | 0          | 0                        | 0    | <b>124</b> | <b>288</b> | <b>412</b> | 731        |
| 05:00 PM   | 249                  | 0    | 6         | 255        | 10                       | 73         | 0    | 83         | 0          | 0    | 0    | 0          | 0                        | 0    | 100        | 287        | 387        | 713        |
| 05:15 PM   | <b>325</b>           | 0    | 0         | <b>325</b> | <b>11</b>                | 80         | 0    | 91         | 0          | 0    | 0    | 0          | 0                        | 0    | 113        | 268        | 381        | <b>803</b> |
| 05:30 PM   | 280                  | 0    | 5         | 285        | 6                        | <b>100</b> | 0    | <b>106</b> | 0          | 0    | 0    | 0          | 0                        | 0    | 113        | 268        | 381        | 772        |
| Total Volume   | 1085                 | 0    | 21        | 1106       | 33                       | 325        | 0    | 358        | 0          | 0    | 0    | 0          | 0                        | 0    | 461        | 1094       | 1555       | 3019       |
| % App. Total   | 98.1                 | 0    | 1.9       |            | 9.2                      | 90.8       | 0    |            | 0          | 0    | 0    | 0          | 0                        | 0    | 29.6       | 70.4       |            |            |
| PHF  | .835                 | .000 | .525      | .851       | .750                     | .813       | .000 | .844       | .000       | .000 | .000 | .000       | .000                     | .000 | .929       | .950       | .944       | .940       |

# Traffic Data Service

San Jose, CA  
 (408) 622-4787  
 tdsbay@cs.com

File Name : 3PM FINAL  
 Site Code : 00000003  
 Start Date : 4/25/2018  
 Page No : 2

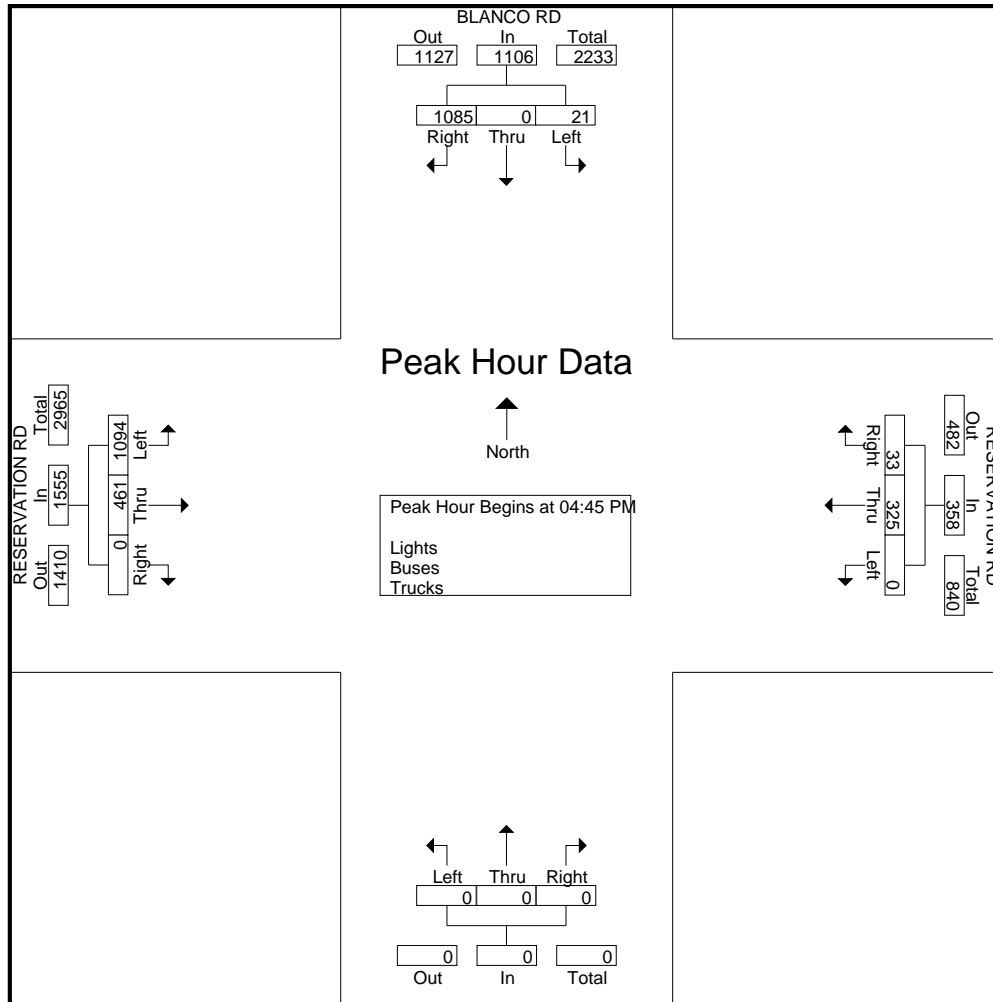

# Traffic Data Service

San Jose, CA  
 (408) 622-4787  
 tdsbay@cs.com

File Name : 3PM FINAL  
 Site Code : 00000003  
 Start Date : 4/25/2018  
 Page No : 1

Groups Printed- Bikes

| Start Time  | BLANCO RD Southbound |      |      |      |            | RESERVATION RD Westbound |      |      |      |            | Northbound |      |      |      |            | RESERVATION RD Eastbound |      |      |      |            | Int. Total |
|-------------|----------------------|------|------|------|------------|--------------------------|------|------|------|------------|------------|------|------|------|------------|--------------------------|------|------|------|------------|------------|
|             | Right                | Thru | Left | Peds | App. Total | Right                    | Thru | Left | Peds | App. Total | Right      | Thru | Left | Peds | App. Total | Right                    | Thru | Left | Peds | App. Total |            |
| 04:00 PM    | 0                    | 0    | 0    | 0    | 0          | 0                        | 0    | 0    | 0    | 0          | 0          | 0    | 0    | 0    | 0          | 0                        | 0    | 0    | 0    | 0          | 0          |
| 04:15 PM    | 0                    | 0    | 0    | 0    | 0          | 0                        | 0    | 0    | 0    | 0          | 0          | 0    | 0    | 0    | 0          | 0                        | 0    | 0    | 0    | 0          | 0          |
| 04:30 PM    | 0                    | 0    | 0    | 0    | 0          | 0                        | 0    | 0    | 0    | 0          | 0          | 0    | 0    | 0    | 0          | 0                        | 0    | 0    | 0    | 0          | 0          |
| 04:45 PM    | 0                    | 0    | 0    | 0    | 0          | 0                        | 0    | 0    | 0    | 0          | 0          | 0    | 0    | 0    | 0          | 0                        | 0    | 0    | 0    | 0          | 0          |
| Total       | 0                    | 0    | 0    | 0    | 0          | 0                        | 0    | 0    | 0    | 0          | 0          | 0    | 0    | 0    | 0          | 0                        | 0    | 0    | 0    | 0          | 0          |
| 05:00 PM    | 0                    | 0    | 0    | 0    | 0          | 0                        | 0    | 0    | 0    | 0          | 0          | 0    | 0    | 0    | 0          | 0                        | 0    | 0    | 0    | 0          | 0          |
| 05:15 PM    | 0                    | 0    | 0    | 0    | 0          | 0                        | 0    | 0    | 0    | 0          | 0          | 0    | 0    | 0    | 0          | 0                        | 0    | 0    | 0    | 0          | 0          |
| 05:30 PM    | 0                    | 0    | 0    | 0    | 0          | 0                        | 0    | 0    | 0    | 0          | 0          | 0    | 0    | 0    | 0          | 0                        | 0    | 1    | 0    | 1          | 1          |
| 05:45 PM    | 0                    | 0    | 0    | 0    | 0          | 0                        | 0    | 0    | 0    | 0          | 0          | 0    | 0    | 0    | 0          | 0                        | 0    | 0    | 0    | 0          | 0          |
| Total       | 0                    | 0    | 0    | 0    | 0          | 0                        | 0    | 0    | 0    | 0          | 0          | 0    | 0    | 0    | 0          | 0                        | 0    | 1    | 0    | 1          | 1          |
| Grand Total | 0                    | 0    | 0    | 0    | 0          | 0                        | 0    | 0    | 0    | 0          | 0          | 0    | 0    | 0    | 0          | 0                        | 0    | 1    | 0    | 1          | 1          |
| Apprch %    | 0                    | 0    | 0    | 0    |            | 0                        | 0    | 0    | 0    |            | 0          | 0    | 0    | 0    |            | 0                        | 0    | 100  | 0    |            |            |
| Total %     | 0                    | 0    | 0    | 0    |            | 0                        | 0    | 0    | 0    |            | 0          | 0    | 0    | 0    |            | 0                        | 0    | 100  | 0    | 100        |            |

| Start Time   | BLANCO RD Southbound |      |      |      |            | RESERVATION RD Westbound |      |      |      |            | Northbound |      |      |      |            | RESERVATION RD Eastbound |      |      |      |            | Int. Total |
|--------------|----------------------|------|------|------|------------|--------------------------|------|------|------|------------|------------|------|------|------|------------|--------------------------|------|------|------|------------|------------|
|              | Right                | Thru | Left | Peds | App. Total | Right                    | Thru | Left | Peds | App. Total | Right      | Thru | Left | Peds | App. Total | Right                    | Thru | Left | Peds | App. Total |            |
| 04:45 PM     | 0                    | 0    | 0    | 0    | 0          | 0                        | 0    | 0    | 0    | 0          | 0          | 0    | 0    | 0    | 0          | 0                        | 0    | 0    | 0    | 0          | 0          |
| 05:00 PM     | 0                    | 0    | 0    | 0    | 0          | 0                        | 0    | 0    | 0    | 0          | 0          | 0    | 0    | 0    | 0          | 0                        | 0    | 0    | 0    | 0          | 0          |
| 05:15 PM     | 0                    | 0    | 0    | 0    | 0          | 0                        | 0    | 0    | 0    | 0          | 0          | 0    | 0    | 0    | 0          | 0                        | 0    | 0    | 0    | 0          | 0          |
| 05:30 PM     | 0                    | 0    | 0    | 0    | 0          | 0                        | 0    | 0    | 0    | 0          | 0          | 0    | 0    | 0    | 0          | 0                        | 0    | 1    | 0    | 1          | 1          |
| Total Volume | 0                    | 0    | 0    | 0    | 0          | 0                        | 0    | 0    | 0    | 0          | 0          | 0    | 0    | 0    | 0          | 0                        | 0    | 1    | 0    | 1          | 1          |
| % App. Total | 0                    | 0    | 0    | 0    |            | 0                        | 0    | 0    | 0    |            | 0          | 0    | 0    | 0    |            | 0                        | 0    | 100  | 0    |            |            |
| PHF          | .000                 | .000 | .000 | .000 |            | .000                     | .000 | .000 | .000 |            | .000       | .000 | .000 | .000 |            | .000                     | .000 | .250 | .250 |            | .250       |

Peak Hour Analysis From 04:00 PM to 05:45 PM - Peak 1 of 1  
 Peak Hour for Entire Intersection Begins at 04:45 PM

# Traffic Data Service

San Jose, CA  
(408) 622-4787  
tdsbay@cs.com

File Name : 3PM FINAL  
Site Code : 00000003  
Start Date : 4/25/2018  
Page No : 2

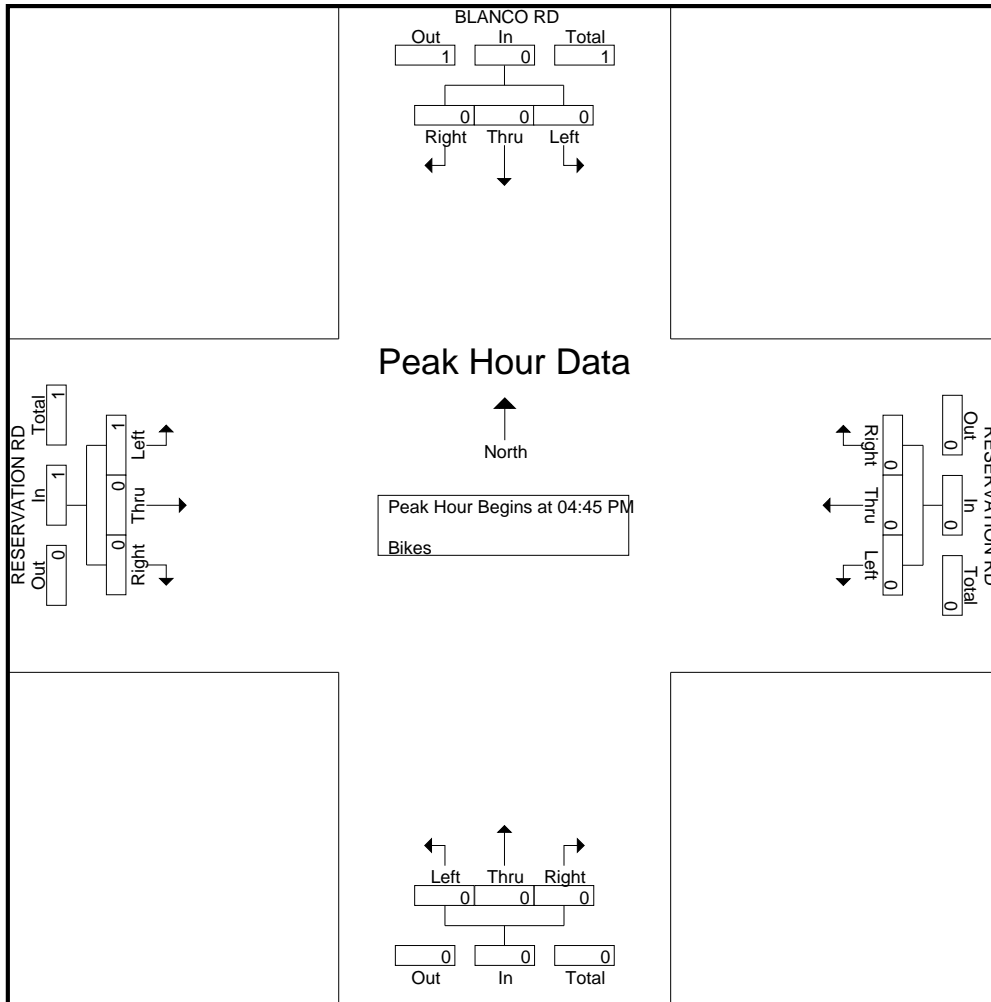



# Traffic Data Service

San Jose, CA  
 (408) 622-4787  
 tdsbay@cs.com

File Name : 4AM FINAL  
 Site Code : 00000004  
 Start Date : 4/25/2018  
 Page No : 1

Groups Printed- Lights - Buses - Trucks

| Start Time  | Southbound |      |      |      |            | RESERVATION RD<br>Westbound |      |      |      |            | E GARRISON RD<br>Northbound |      |      |      |            | RESERVATION RD<br>Eastbound |      |      |      |            | Int. Total |
|-------------|------------|------|------|------|------------|-----------------------------|------|------|------|------------|-----------------------------|------|------|------|------------|-----------------------------|------|------|------|------------|------------|
|             | Right      | Thru | Left | Peds | App. Total | Right                       | Thru | Left | Peds | App. Total | Right                       | Thru | Left | Peds | App. Total | Right                       | Thru | Left | Peds | App. Total |            |
| 07:00 AM    | 0          | 0    | 0    | 0    | 0          | 0                           | 187  | 11   | 0    | 198        | 15                          | 0    | 4    | 0    | 19         | 3                           | 59   | 0    | 0    | 62         | 279        |
| 07:15 AM    | 0          | 0    | 0    | 0    | 0          | 0                           | 198  | 14   | 0    | 212        | 10                          | 0    | 10   | 0    | 20         | 1                           | 78   | 0    | 0    | 79         | 311        |
| 07:30 AM    | 0          | 0    | 0    | 0    | 0          | 0                           | 209  | 6    | 0    | 215        | 24                          | 0    | 14   | 0    | 38         | 1                           | 92   | 0    | 0    | 93         | 346        |
| 07:45 AM    | 0          | 0    | 0    | 0    | 0          | 0                           | 159  | 7    | 0    | 166        | 23                          | 0    | 5    | 0    | 28         | 3                           | 93   | 0    | 0    | 96         | 290        |
| Total       | 0          | 0    | 0    | 0    | 0          | 0                           | 753  | 38   | 0    | 791        | 72                          | 0    | 33   | 0    | 105        | 8                           | 322  | 0    | 0    | 330        | 1226       |
| 08:00 AM    | 0          | 0    | 0    | 0    | 0          | 0                           | 146  | 4    | 0    | 150        | 17                          | 0    | 4    | 2    | 23         | 4                           | 66   | 0    | 2    | 72         | 245        |
| 08:15 AM    | 0          | 0    | 0    | 0    | 0          | 0                           | 135  | 7    | 0    | 142        | 6                           | 0    | 4    | 0    | 10         | 4                           | 77   | 0    | 0    | 81         | 233        |
| 08:30 AM    | 0          | 0    | 0    | 0    | 0          | 0                           | 116  | 5    | 0    | 121        | 9                           | 0    | 3    | 0    | 12         | 2                           | 39   | 0    | 0    | 41         | 174        |
| 08:45 AM    | 0          | 0    | 0    | 0    | 0          | 0                           | 77   | 5    | 0    | 82         | 9                           | 0    | 2    | 0    | 11         | 6                           | 47   | 0    | 0    | 53         | 146        |
| Total       | 0          | 0    | 0    | 0    | 0          | 0                           | 474  | 21   | 0    | 495        | 41                          | 0    | 13   | 2    | 56         | 16                          | 229  | 0    | 2    | 247        | 798        |
| Grand Total | 0          | 0    | 0    | 0    | 0          | 0                           | 1227 | 59   | 0    | 1286       | 113                         | 0    | 46   | 2    | 161        | 24                          | 551  | 0    | 2    | 577        | 2024       |
| Apprch %    | 0          | 0    | 0    | 0    | 0          | 0                           | 95.4 | 4.6  | 0    |            | 70.2                        | 0    | 28.6 | 1.2  |            | 4.2                         | 95.5 | 0    | 0.3  |            |            |
| Total %     | 0          | 0    | 0    | 0    | 0          | 0                           | 60.6 | 2.9  | 0    | 63.5       | 5.6                         | 0    | 2.3  | 0.1  | 8          | 1.2                         | 27.2 | 0    | 0.1  | 28.5       |            |
| Lights      | 0          | 0    | 0    | 0    | 0          | 0                           | 1206 | 51   | 0    | 1257       | 111                         | 0    | 44   | 2    | 157        | 18                          | 534  | 0    | 2    | 554        | 1968       |
| % Lights    | 0          | 0    | 0    | 0    | 0          | 0                           | 98.3 | 86.4 | 0    | 97.7       | 98.2                        | 0    | 95.7 | 100  | 97.5       | 75                          | 96.9 | 0    | 100  | 96         | 97.2       |
| Buses       | 0          | 0    | 0    | 0    | 0          | 0                           | 5    | 0    | 0    | 5          | 0                           | 0    | 0    | 0    | 0          | 3                           | 3    | 0    | 0    | 6          | 11         |
| % Buses     | 0          | 0    | 0    | 0    | 0          | 0                           | 0.4  | 0    | 0    | 0.4        | 0                           | 0    | 0    | 0    | 0          | 12.5                        | 0.5  | 0    | 0    | 1          | 0.5        |
| Trucks      | 0          | 0    | 0    | 0    | 0          | 0                           | 16   | 8    | 0    | 24         | 2                           | 0    | 2    | 0    | 4          | 3                           | 14   | 0    | 0    | 17         | 45         |
| % Trucks    | 0          | 0    | 0    | 0    | 0          | 0                           | 1.3  | 13.6 | 0    | 1.9        | 1.8                         | 0    | 4.3  | 0    | 2.5        | 12.5                        | 2.5  | 0    | 0    | 2.9        | 2.2        |

| Start Time   | Southbound |      |      |            | RESERVATION RD<br>Westbound |            |      |            | E GARRISON RD<br>Northbound |      |           |            | RESERVATION RD<br>Eastbound |           |      |            | Int. Total |
|--|------------|------|------|------------|-----------------------------|------------|------|------------|-----------------------------|------|-----------|------------|-----------------------------|-----------|------|------------|------------|
|  | Right      | Thru | Left | App. Total | Right                       | Thru       | Left | App. Total | Right                       | Thru | Left      | App. Total | Right                       | Thru      | Left | App. Total |            |
| Peak Hour Analysis From 07:00 AM to 08:45 AM - Peak 1 of 1 |            |      |      |            |                             |            |      |            |                             |      |           |            |                             |           |      |            |            |
| Peak Hour for Entire Intersection Begins at 07:00 AM       |            |      |      |            |                             |            |      |            |                             |      |           |            |                             |           |      |            |            |
| 07:00 AM   | 0          | 0    | 0    | 0          | 0                           | 187        | 11   | 198        | 15                          | 0    | 4         | 19         | 3                           | 59        | 0    | 62         | 279        |
| 07:15 AM   | 0          | 0    | 0    | 0          | 0                           | 198        | 14   | 212        | 10                          | 0    | 10        | 20         | 1                           | 78        | 0    | 79         | 311        |
| 07:30 AM   | 0          | 0    | 0    | 0          | 0                           | <b>209</b> | 6    | <b>215</b> | <b>24</b>                   | 0    | <b>14</b> | <b>38</b>  | 1                           | 92        | 0    | 93         | <b>346</b> |
| 07:45 AM   | 0          | 0    | 0    | 0          | 0                           | 159        | 7    | 166        | 23                          | 0    | 5         | 28         | 3                           | <b>93</b> | 0    | <b>96</b>  | 290        |
| Total Volume   | 0          | 0    | 0    | 0          | 0                           | 753        | 38   | 791        | 72                          | 0    | 33        | 105        | 8                           | 322       | 0    | 330        | 1226       |
| % App. Total   | 0          | 0    | 0    | 0          | 0                           | 95.2       | 4.8  |            | 68.6                        | 0    | 31.4      |            | 2.4                         | 97.6      | 0    |            |            |
| PHF  | .000       | .000 | .000 | .000       | .000                        | .901       | .679 | .920       | .750                        | .000 | .589      | .691       | .667                        | .866      | .000 | .859       | .886       |

# Traffic Data Service

San Jose, CA  
 (408) 622-4787  
 tdsbay@cs.com

File Name : 4AM FINAL  
 Site Code : 00000004  
 Start Date : 4/25/2018  
 Page No : 2

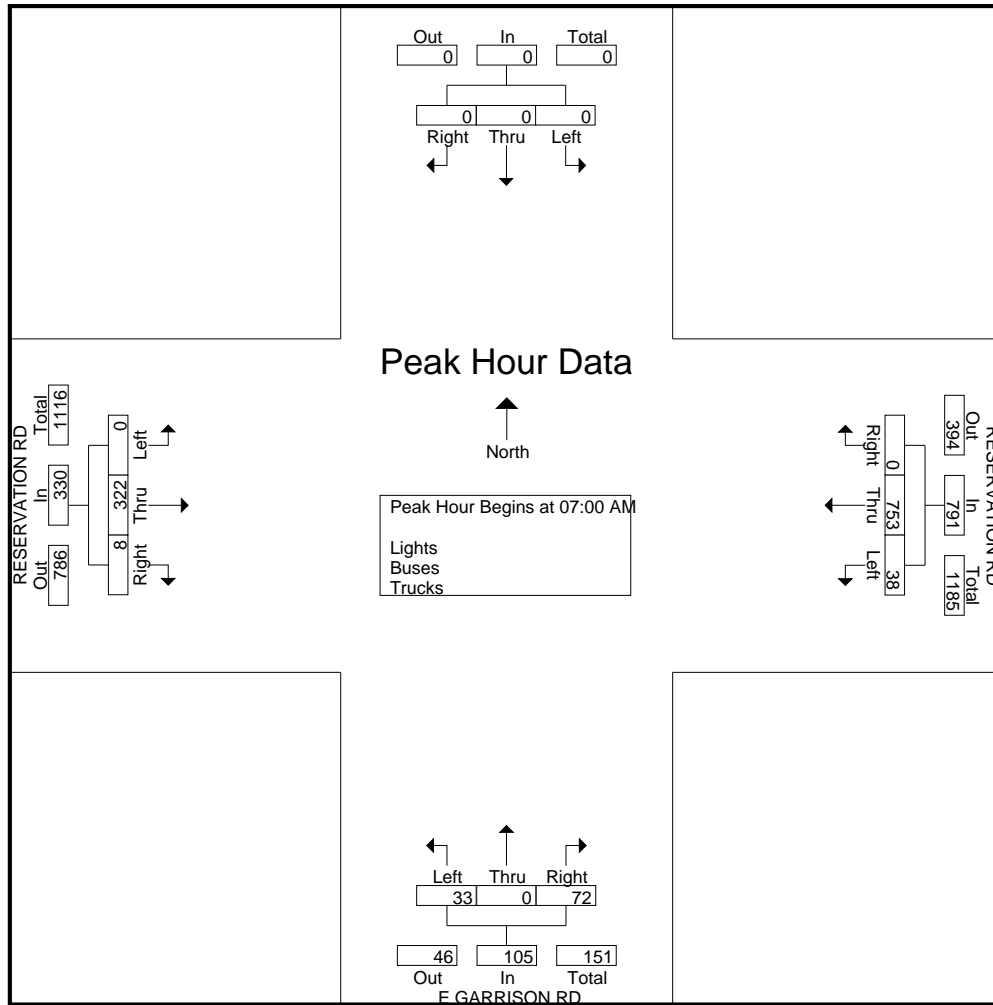

# Traffic Data Service

San Jose, CA  
 (408) 622-4787  
 tdsbay@cs.com

File Name : 4AM FINAL  
 Site Code : 00000004  
 Start Date : 4/25/2018  
 Page No : 1

Groups Printed- Bikes

| Start Time  | Southbound |      |      |      |            | RESERVATION RD<br>Westbound |      |      |      |            | E GARRISON RD<br>Northbound |      |      |      |            | RESERVATION RD<br>Eastbound |      |      |      |            | Int. Total |
|-------------|------------|------|------|------|------------|-----------------------------|------|------|------|------------|-----------------------------|------|------|------|------------|-----------------------------|------|------|------|------------|------------|
|             | Right      | Thru | Left | Peds | App. Total | Right                       | Thru | Left | Peds | App. Total | Right                       | Thru | Left | Peds | App. Total | Right                       | Thru | Left | Peds | App. Total |            |
| 07:00 AM    | 0          | 0    | 0    | 0    | 0          | 0                           | 0    | 0    | 0    | 0          | 0                           | 0    | 0    | 0    | 0          | 0                           | 0    | 0    | 0    | 0          | 0          |
| 07:15 AM    | 0          | 0    | 0    | 0    | 0          | 0                           | 0    | 0    | 0    | 0          | 0                           | 0    | 0    | 0    | 0          | 0                           | 0    | 0    | 0    | 0          | 0          |
| 07:30 AM    | 0          | 0    | 0    | 0    | 0          | 0                           | 0    | 0    | 0    | 0          | 0                           | 0    | 0    | 0    | 0          | 0                           | 0    | 0    | 0    | 0          | 0          |
| 07:45 AM    | 0          | 0    | 0    | 0    | 0          | 0                           | 0    | 0    | 0    | 0          | 0                           | 0    | 0    | 0    | 0          | 0                           | 0    | 0    | 0    | 0          | 0          |
| Total       | 0          | 0    | 0    | 0    | 0          | 0                           | 0    | 0    | 0    | 0          | 0                           | 0    | 0    | 0    | 0          | 0                           | 0    | 0    | 0    | 0          | 0          |
| 08:00 AM    | 0          | 0    | 0    | 0    | 0          | 0                           | 0    | 0    | 0    | 0          | 0                           | 0    | 0    | 0    | 0          | 0                           | 0    | 0    | 0    | 0          | 0          |
| 08:15 AM    | 0          | 0    | 0    | 0    | 0          | 0                           | 0    | 0    | 0    | 0          | 0                           | 0    | 0    | 0    | 0          | 0                           | 0    | 0    | 0    | 0          | 0          |
| 08:30 AM    | 0          | 0    | 0    | 0    | 0          | 0                           | 0    | 0    | 0    | 0          | 0                           | 0    | 0    | 0    | 0          | 0                           | 0    | 0    | 0    | 0          | 0          |
| 08:45 AM    | 0          | 0    | 0    | 0    | 0          | 0                           | 0    | 0    | 0    | 0          | 0                           | 0    | 0    | 0    | 0          | 0                           | 0    | 0    | 0    | 0          | 0          |
| Total       | 0          | 0    | 0    | 0    | 0          | 0                           | 0    | 0    | 0    | 0          | 0                           | 0    | 0    | 0    | 0          | 0                           | 0    | 0    | 0    | 0          | 0          |
| Grand Total | 0          | 0    | 0    | 0    | 0          | 0                           | 0    | 0    | 0    | 0          | 0                           | 0    | 0    | 0    | 0          | 0                           | 0    | 0    | 0    | 0          | 0          |
| Apprch %    | 0          | 0    | 0    | 0    |            | 0                           | 0    | 0    | 0    |            | 0                           | 0    | 0    | 0    |            | 0                           | 0    | 0    | 0    |            |            |
| Total %     |            |      |      |      |            |                             |      |      |      |            |                             |      |      |      |            |                             |      |      |      |            |            |

| Start Time   | Southbound |      |      |      |            | RESERVATION RD<br>Westbound |      |      |      |            | E GARRISON RD<br>Northbound |      |      |      |            | RESERVATION RD<br>Eastbound |      |      |      |            | Int. Total |
|--|------------|------|------|------|------------|-----------------------------|------|------|------|------------|-----------------------------|------|------|------|------------|-----------------------------|------|------|------|------------|------------|
|  | Right      | Thru | Left | Peds | App. Total | Right                       | Thru | Left | Peds | App. Total | Right                       | Thru | Left | Peds | App. Total | Right                       | Thru | Left | Peds | App. Total |            |
| Peak Hour Analysis From 07:00 AM to 08:45 AM - Peak 1 of 1 |            |      |      |      |            |                             |      |      |      |            |                             |      |      |      |            |                             |      |      |      |            |            |
| Peak Hour for Entire Intersection Begins at 07:00 AM       |            |      |      |      |            |                             |      |      |      |            |                             |      |      |      |            |                             |      |      |      |            |            |
| 07:00 AM   | 0          | 0    | 0    | 0    | 0          | 0                           | 0    | 0    | 0    | 0          | 0                           | 0    | 0    | 0    | 0          | 0                           | 0    | 0    | 0    | 0          | 0          |
| 07:15 AM   | 0          | 0    | 0    | 0    | 0          | 0                           | 0    | 0    | 0    | 0          | 0                           | 0    | 0    | 0    | 0          | 0                           | 0    | 0    | 0    | 0          | 0          |
| 07:30 AM   | 0          | 0    | 0    | 0    | 0          | 0                           | 0    | 0    | 0    | 0          | 0                           | 0    | 0    | 0    | 0          | 0                           | 0    | 0    | 0    | 0          | 0          |
| 07:45 AM   | 0          | 0    | 0    | 0    | 0          | 0                           | 0    | 0    | 0    | 0          | 0                           | 0    | 0    | 0    | 0          | 0                           | 0    | 0    | 0    | 0          | 0          |
| Total Volume   | 0          | 0    | 0    | 0    | 0          | 0                           | 0    | 0    | 0    | 0          | 0                           | 0    | 0    | 0    | 0          | 0                           | 0    | 0    | 0    | 0          | 0          |
| % App. Total   | 0          | 0    | 0    | 0    |            | 0                           | 0    | 0    | 0    |            | 0                           | 0    | 0    | 0    |            | 0                           | 0    | 0    | 0    |            |            |
| PHF  | .000       | .000 | .000 | .000 | .000       | .000                        | .000 | .000 | .000 | .000       | .000                        | .000 | .000 | .000 | .000       | .000                        | .000 | .000 | .000 | .000       | .000       |

# Traffic Data Service

San Jose, CA  
(408) 622-4787  
tdsbay@cs.com

File Name : 4AM FINAL  
Site Code : 00000004  
Start Date : 4/25/2018  
Page No : 2

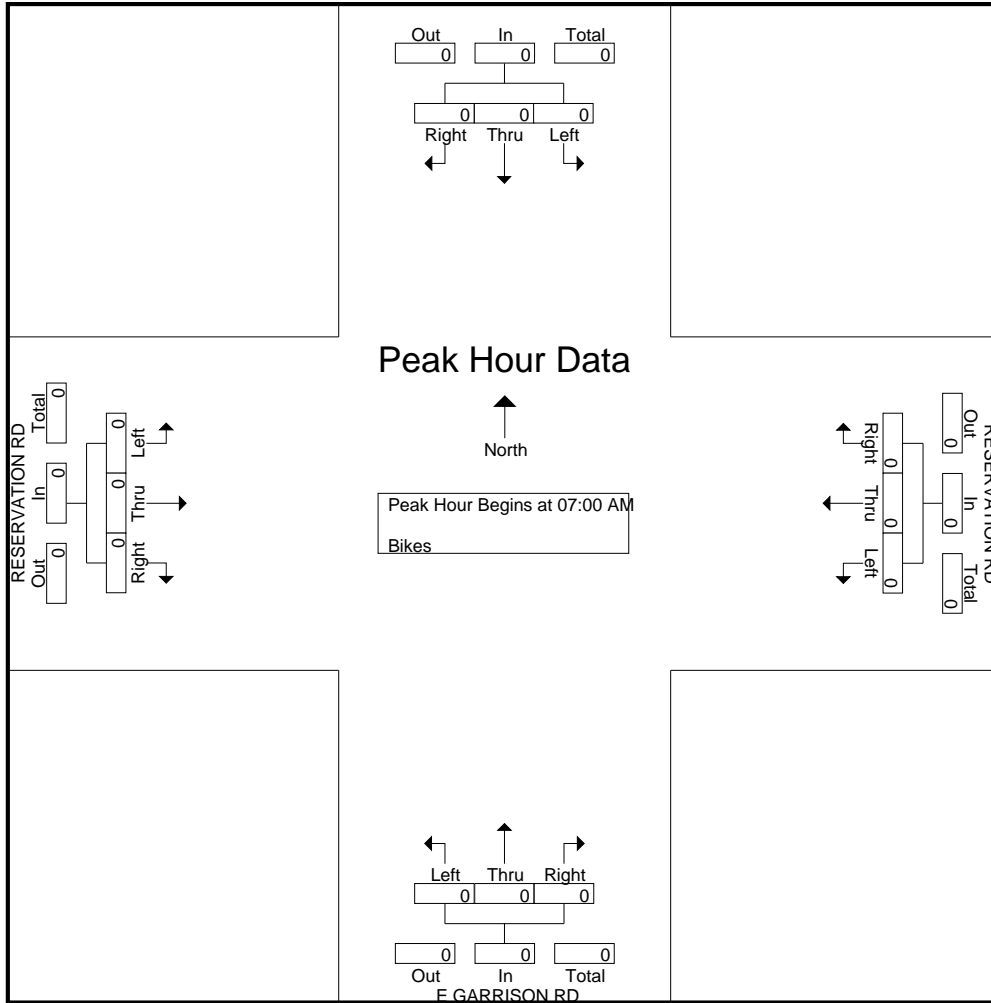

# Traffic Data Service

San Jose, CA  
 (408) 622-4787  
 tdsbay@cs.com

File Name : 4PM FINAL  
 Site Code : 00000004  
 Start Date : 4/25/2018  
 Page No : 1

## Groups Printed- Lights - Buses - Trucks

| Start Time  | Southbound |      |      |      |            | RESERVATION RD<br>Westbound |      |      |      |            | E GARRISON RD<br>Northbound |      |      |      |            | RESERVATION RD<br>Eastbound |      |      |      |            | Int. Total |
|-------------|------------|------|------|------|------------|-----------------------------|------|------|------|------------|-----------------------------|------|------|------|------------|-----------------------------|------|------|------|------------|------------|
|             | Right      | Thru | Left | Peds | App. Total | Right                       | Thru | Left | Peds | App. Total | Right                       | Thru | Left | Peds | App. Total | Right                       | Thru | Left | Peds | App. Total |            |
| 04:00 PM    | 0          | 0    | 0    | 0    | 0          | 0                           | 78   | 14   | 0    | 92         | 14                          | 0    | 6    | 0    | 20         | 1                           | 160  | 0    | 0    | 161        | 273        |
| 04:15 PM    | 0          | 0    | 0    | 0    | 0          | 0                           | 80   | 10   | 0    | 90         | 15                          | 0    | 1    | 0    | 16         | 9                           | 148  | 1    | 0    | 158        | 264        |
| 04:30 PM    | 0          | 0    | 0    | 0    | 0          | 0                           | 90   | 12   | 0    | 102        | 9                           | 0    | 2    | 0    | 11         | 7                           | 140  | 1    | 0    | 148        | 261        |
| 04:45 PM    | 0          | 0    | 0    | 0    | 0          | 0                           | 78   | 10   | 0    | 88         | 6                           | 0    | 3    | 0    | 9          | 7                           | 181  | 0    | 0    | 188        | 285        |
| Total       | 0          | 0    | 0    | 0    | 0          | 0                           | 326  | 46   | 0    | 372        | 44                          | 0    | 12   | 0    | 56         | 24                          | 629  | 2    | 0    | 655        | 1083       |
| 05:00 PM    | 0          | 0    | 0    | 0    | 0          | 0                           | 99   | 10   | 0    | 109        | 11                          | 0    | 3    | 0    | 14         | 6                           | 172  | 1    | 0    | 179        | 302        |
| 05:15 PM    | 0          | 0    | 0    | 0    | 0          | 0                           | 125  | 16   | 0    | 141        | 9                           | 0    | 1    | 0    | 10         | 5                           | 159  | 0    | 0    | 164        | 315        |
| 05:30 PM    | 0          | 0    | 0    | 0    | 0          | 0                           | 110  | 14   | 0    | 124        | 3                           | 0    | 2    | 0    | 5          | 6                           | 177  | 0    | 0    | 183        | 312        |
| 05:45 PM    | 0          | 0    | 0    | 0    | 0          | 0                           | 96   | 11   | 0    | 107        | 7                           | 0    | 3    | 0    | 10         | 7                           | 173  | 0    | 0    | 180        | 297        |
| Total       | 0          | 0    | 0    | 0    | 0          | 0                           | 430  | 51   | 0    | 481        | 30                          | 0    | 9    | 0    | 39         | 24                          | 681  | 1    | 0    | 706        | 1226       |
| Grand Total | 0          | 0    | 0    | 0    | 0          | 0                           | 756  | 97   | 0    | 853        | 74                          | 0    | 21   | 0    | 95         | 48                          | 1310 | 3    | 0    | 1361       | 2309       |
| Apprch %    | 0          | 0    | 0    | 0    | 0          | 0                           | 88.6 | 11.4 | 0    |            | 77.9                        | 0    | 22.1 | 0    |            | 3.5                         | 96.3 | 0.2  | 0    |            |            |
| Total %     | 0          | 0    | 0    | 0    | 0          | 0                           | 32.7 | 4.2  | 0    | 36.9       | 3.2                         | 0    | 0.9  | 0    | 4.1        | 2.1                         | 56.7 | 0.1  | 0    | 58.9       |            |
| Lights      | 0          | 0    | 0    | 0    | 0          | 0                           | 741  | 96   | 0    | 837        | 72                          | 0    | 21   | 0    | 93         | 46                          | 1281 | 3    | 0    | 1330       | 2260       |
| % Lights    | 0          | 0    | 0    | 0    | 0          | 0                           | 98   | 99   | 0    | 98.1       | 97.3                        | 0    | 100  | 0    | 97.9       | 95.8                        | 97.8 | 100  | 0    | 97.7       | 97.9       |
| Buses       | 0          | 0    | 0    | 0    | 0          | 0                           | 1    | 0    | 0    | 1          | 0                           | 0    | 0    | 0    | 0          | 0                           | 7    | 0    | 0    | 7          | 8          |
| % Buses     | 0          | 0    | 0    | 0    | 0          | 0                           | 0.1  | 0    | 0    | 0.1        | 0                           | 0    | 0    | 0    | 0          | 0                           | 0.5  | 0    | 0    | 0.5        | 0.3        |
| Trucks      | 0          | 0    | 0    | 0    | 0          | 0                           | 14   | 1    | 0    | 15         | 2                           | 0    | 0    | 0    | 2          | 2                           | 22   | 0    | 0    | 24         | 41         |
| % Trucks    | 0          | 0    | 0    | 0    | 0          | 0                           | 1.9  | 1    | 0    | 1.8        | 2.7                         | 0    | 0    | 0    | 2.1        | 4.2                         | 1.7  | 0    | 0    | 1.8        | 1.8        |

| Start Time   | Southbound |      |      |            | RESERVATION RD<br>Westbound |      |      |            | E GARRISON RD<br>Northbound |      |      |            | RESERVATION RD<br>Eastbound |      |      |            | Int. Total |
|--|------------|------|------|------------|-----------------------------|------|------|------------|-----------------------------|------|------|------------|-----------------------------|------|------|------------|------------|
|  | Right      | Thru | Left | App. Total | Right                       | Thru | Left | App. Total | Right                       | Thru | Left | App. Total | Right                       | Thru | Left | App. Total |            |
| Peak Hour Analysis From 04:00 PM to 05:45 PM - Peak 1 of 1 |            |      |      |            |                             |      |      |            |                             |      |      |            |                             |      |      |            |            |
| Peak Hour for Entire Intersection Begins at 05:00 PM       |            |      |      |            |                             |      |      |            |                             |      |      |            |                             |      |      |            |            |
| 05:00 PM   | 0          | 0    | 0    | 0          | 0                           | 99   | 10   | 109        | 11                          | 0    | 3    | 14         | 6                           | 172  | 1    | 179        | 302        |
| 05:15 PM   | 0          | 0    | 0    | 0          | 0                           | 125  | 16   | 141        | 9                           | 0    | 1    | 10         | 5                           | 159  | 0    | 164        | 315        |
| 05:30 PM   | 0          | 0    | 0    | 0          | 0                           | 110  | 14   | 124        | 3                           | 0    | 2    | 5          | 6                           | 177  | 0    | 183        | 312        |
| 05:45 PM   | 0          | 0    | 0    | 0          | 0                           | 96   | 11   | 107        | 7                           | 0    | 3    | 10         | 7                           | 173  | 0    | 180        | 297        |
| Total Volume   | 0          | 0    | 0    | 0          | 0                           | 430  | 51   | 481        | 30                          | 0    | 9    | 39         | 24                          | 681  | 1    | 706        | 1226       |
| % App. Total   | 0          | 0    | 0    | 0          | 0                           | 89.4 | 10.6 |            | 76.9                        | 0    | 23.1 |            | 3.4                         | 96.5 | 0.1  |            |            |
| PHF  | .000       | .000 | .000 | .000       | .000                        | .860 | .797 | .853       | .682                        | .000 | .750 | .696       | .857                        | .962 | .250 | .964       | .973       |

# Traffic Data Service

San Jose, CA  
 (408) 622-4787  
 tdsbay@cs.com

File Name : 4PM FINAL  
 Site Code : 00000004  
 Start Date : 4/25/2018  
 Page No : 2

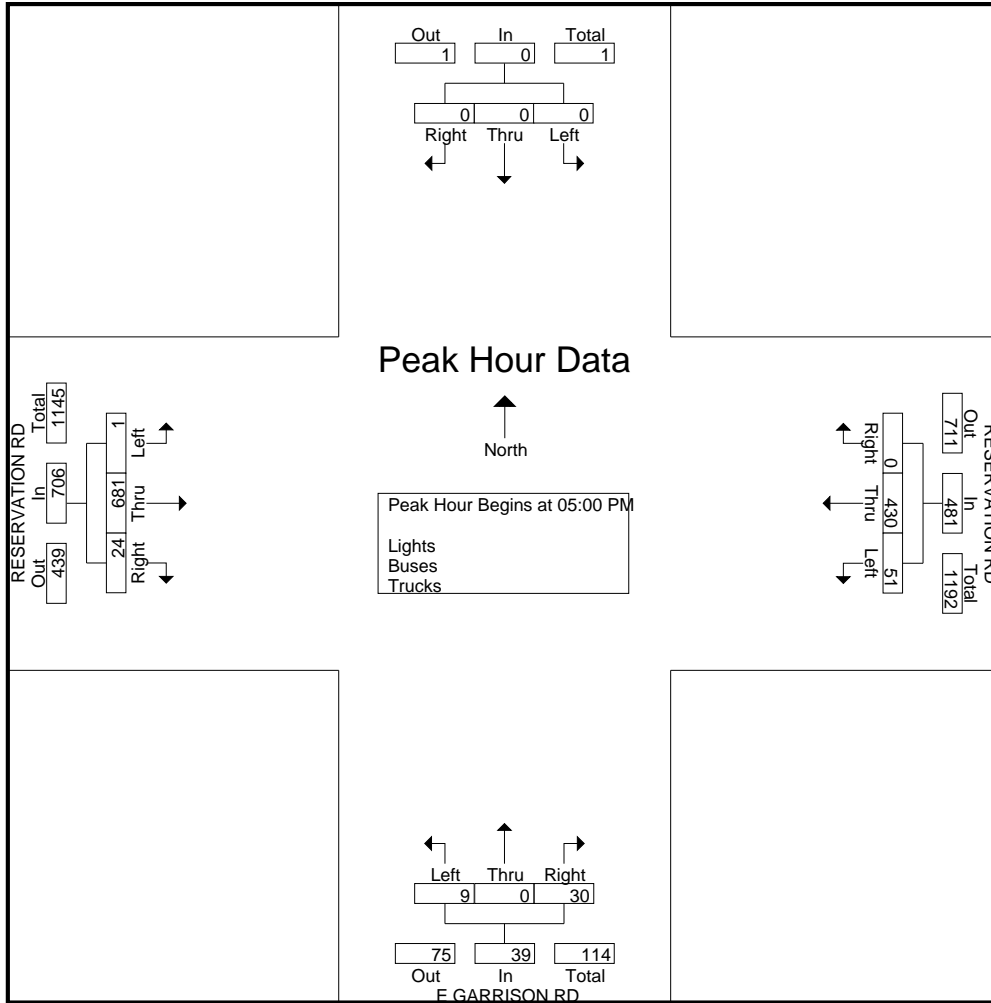

# Traffic Data Service

San Jose, CA  
 (408) 622-4787  
 tdsbay@cs.com

File Name : 4PM FINAL  
 Site Code : 00000004  
 Start Date : 4/25/2018  
 Page No : 1

Groups Printed- Bikes

| Start Time  | Southbound |      |      |      |            | RESERVATION RD Westbound |      |      |      |            | E GARRISON RD Northbound |      |      |      |            | RESERVATION RD Eastbound |      |      |      |            | Int. Total |
|-------------|------------|------|------|------|------------|--------------------------|------|------|------|------------|--------------------------|------|------|------|------------|--------------------------|------|------|------|------------|------------|
|             | Right      | Thru | Left | Peds | App. Total | Right                    | Thru | Left | Peds | App. Total | Right                    | Thru | Left | Peds | App. Total | Right                    | Thru | Left | Peds | App. Total |            |
| 04:00 PM    | 0          | 0    | 0    | 0    | 0          | 0                        | 0    | 0    | 0    | 0          | 0                        | 0    | 0    | 0    | 0          | 0                        | 0    | 0    | 0    | 0          | 0          |
| 04:15 PM    | 0          | 0    | 0    | 0    | 0          | 0                        | 0    | 0    | 0    | 0          | 0                        | 0    | 0    | 0    | 0          | 0                        | 0    | 0    | 0    | 0          | 0          |
| 04:30 PM    | 0          | 0    | 0    | 0    | 0          | 0                        | 0    | 0    | 0    | 0          | 0                        | 0    | 0    | 0    | 0          | 0                        | 0    | 0    | 0    | 0          | 0          |
| 04:45 PM    | 0          | 0    | 0    | 0    | 0          | 0                        | 0    | 0    | 0    | 0          | 0                        | 0    | 0    | 0    | 0          | 0                        | 0    | 0    | 0    | 0          | 0          |
| Total       | 0          | 0    | 0    | 0    | 0          | 0                        | 0    | 0    | 0    | 0          | 0                        | 0    | 0    | 0    | 0          | 0                        | 0    | 0    | 0    | 0          | 0          |
| 05:00 PM    | 0          | 0    | 0    | 0    | 0          | 0                        | 0    | 0    | 0    | 0          | 0                        | 0    | 0    | 0    | 0          | 0                        | 0    | 0    | 0    | 0          | 0          |
| 05:15 PM    | 0          | 0    | 0    | 0    | 0          | 0                        | 0    | 0    | 0    | 0          | 0                        | 0    | 0    | 0    | 0          | 0                        | 0    | 0    | 0    | 0          | 0          |
| 05:30 PM    | 0          | 0    | 0    | 0    | 0          | 0                        | 0    | 0    | 0    | 0          | 0                        | 0    | 0    | 0    | 0          | 0                        | 0    | 0    | 0    | 0          | 0          |
| 05:45 PM    | 0          | 0    | 0    | 0    | 0          | 0                        | 0    | 0    | 0    | 0          | 0                        | 0    | 0    | 0    | 0          | 0                        | 0    | 0    | 0    | 0          | 0          |
| Total       | 0          | 0    | 0    | 0    | 0          | 0                        | 0    | 0    | 0    | 0          | 0                        | 0    | 0    | 0    | 0          | 0                        | 0    | 0    | 0    | 0          | 0          |
| Grand Total | 0          | 0    | 0    | 0    | 0          | 0                        | 0    | 0    | 0    | 0          | 0                        | 0    | 0    | 0    | 0          | 0                        | 0    | 0    | 0    | 0          | 0          |
| Apprch %    | 0          | 0    | 0    | 0    |            | 0                        | 0    | 0    | 0    |            | 0                        | 0    | 0    | 0    |            | 0                        | 0    | 0    | 0    |            |            |
| Total %     |            |      |      |      |            |                          |      |      |      |            |                          |      |      |      |            |                          |      |      |      |            |            |

| Start Time   | Southbound |      |      |      |            | RESERVATION RD Westbound |      |      |      |            | E GARRISON RD Northbound |      |      |      |            | RESERVATION RD Eastbound |      |      |      |            | Int. Total |
|--|------------|------|------|------|------------|--------------------------|------|------|------|------------|--------------------------|------|------|------|------------|--------------------------|------|------|------|------------|------------|
|  | Right      | Thru | Left | Peds | App. Total | Right                    | Thru | Left | Peds | App. Total | Right                    | Thru | Left | Peds | App. Total | Right                    | Thru | Left | Peds | App. Total |            |
| Peak Hour Analysis From 04:00 PM to 05:45 PM - Peak 1 of 1 |            |      |      |      |            |                          |      |      |      |            |                          |      |      |      |            |                          |      |      |      |            |            |
| Peak Hour for Entire Intersection Begins at 04:00 PM       |            |      |      |      |            |                          |      |      |      |            |                          |      |      |      |            |                          |      |      |      |            |            |
| 04:00 PM   | 0          | 0    | 0    | 0    | 0          | 0                        | 0    | 0    | 0    | 0          | 0                        | 0    | 0    | 0    | 0          | 0                        | 0    | 0    | 0    | 0          | 0          |
| 04:15 PM   | 0          | 0    | 0    | 0    | 0          | 0                        | 0    | 0    | 0    | 0          | 0                        | 0    | 0    | 0    | 0          | 0                        | 0    | 0    | 0    | 0          | 0          |
| 04:30 PM   | 0          | 0    | 0    | 0    | 0          | 0                        | 0    | 0    | 0    | 0          | 0                        | 0    | 0    | 0    | 0          | 0                        | 0    | 0    | 0    | 0          | 0          |
| 04:45 PM   | 0          | 0    | 0    | 0    | 0          | 0                        | 0    | 0    | 0    | 0          | 0                        | 0    | 0    | 0    | 0          | 0                        | 0    | 0    | 0    | 0          | 0          |
| Total Volume   | 0          | 0    | 0    | 0    | 0          | 0                        | 0    | 0    | 0    | 0          | 0                        | 0    | 0    | 0    | 0          | 0                        | 0    | 0    | 0    | 0          | 0          |
| % App. Total   | 0          | 0    | 0    | 0    |            | 0                        | 0    | 0    | 0    |            | 0                        | 0    | 0    | 0    |            | 0                        | 0    | 0    | 0    |            |            |
| PHF  | .000       | .000 | .000 | .000 | .000       | .000                     | .000 | .000 | .000 | .000       | .000                     | .000 | .000 | .000 | .000       | .000                     | .000 | .000 | .000 | .000       | .000       |

# Traffic Data Service

San Jose, CA  
(408) 622-4787  
tdsbay@cs.com

File Name : 4PM FINAL  
Site Code : 00000004  
Start Date : 4/25/2018  
Page No : 2

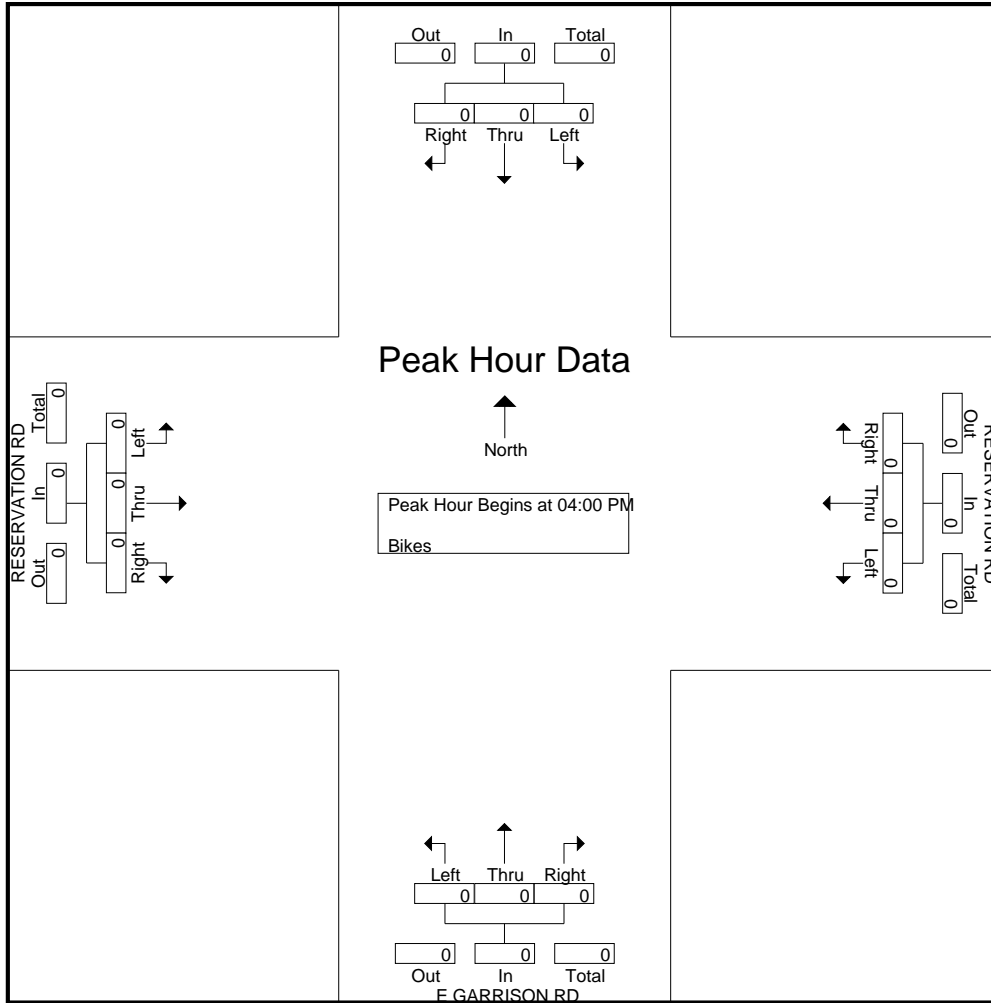



# Traffic Data Service

San Jose, CA  
 (408) 622-4787  
 tdsbay@cs.com

File Name : 5AM FINAL  
 Site Code : 00000005  
 Start Date : 4/25/2018  
 Page No : 1

Groups Printed- Lights - Buses - Trucks

| Start Time  | 4TH AVE Southbound |      |      |      |            | INTER-GARRISON RD Westbound |      |      |      |            | 4TH AVE Northbound |      |      |      |            | INTER-GARRISON RD Eastbound |      |      |      |            | Int. Total |
|-------------|--------------------|------|------|------|------------|-----------------------------|------|------|------|------------|--------------------|------|------|------|------------|-----------------------------|------|------|------|------------|------------|
|             | Right              | Thru | Left | Peds | App. Total | Right                       | Thru | Left | Peds | App. Total | Right              | Thru | Left | Peds | App. Total | Right                       | Thru | Left | Peds | App. Total |            |
| 07:00 AM    | 0                  | 1    | 0    | 1    | 2          | 0                           | 8    | 6    | 0    | 14         | 5                  | 0    | 1    | 1    | 7          | 1                           | 10   | 0    | 0    | 11         | 34         |
| 07:15 AM    | 0                  | 2    | 1    | 0    | 3          | 1                           | 13   | 18   | 0    | 32         | 10                 | 1    | 0    | 1    | 12         | 0                           | 9    | 0    | 0    | 9          | 56         |
| 07:30 AM    | 1                  | 1    | 0    | 3    | 5          | 5                           | 11   | 29   | 1    | 46         | 16                 | 1    | 1    | 6    | 24         | 8                           | 8    | 0    | 0    | 16         | 91         |
| 07:45 AM    | 1                  | 2    | 1    | 10   | 14         | 10                          | 25   | 23   | 6    | 64         | 26                 | 3    | 3    | 3    | 35         | 3                           | 18   | 0    | 2    | 23         | 136        |
| Total       | 2                  | 6    | 2    | 14   | 24         | 16                          | 57   | 76   | 7    | 156        | 57                 | 5    | 5    | 11   | 78         | 12                          | 45   | 0    | 2    | 59         | 317        |
| 08:00 AM    | 1                  | 1    | 0    | 5    | 7          | 7                           | 29   | 18   | 2    | 56         | 15                 | 1    | 2    | 3    | 21         | 3                           | 22   | 0    | 2    | 27         | 111        |
| 08:15 AM    | 3                  | 2    | 1    | 11   | 17         | 6                           | 28   | 15   | 8    | 57         | 7                  | 0    | 1    | 6    | 14         | 2                           | 30   | 0    | 4    | 36         | 124        |
| 08:30 AM    | 0                  | 1    | 0    | 2    | 3          | 4                           | 19   | 8    | 3    | 34         | 5                  | 0    | 1    | 5    | 11         | 2                           | 17   | 1    | 1    | 21         | 69         |
| 08:45 AM    | 2                  | 1    | 1    | 2    | 6          | 7                           | 17   | 11   | 1    | 36         | 3                  | 0    | 3    | 3    | 9          | 2                           | 20   | 0    | 1    | 23         | 74         |
| Total       | 6                  | 5    | 2    | 20   | 33         | 24                          | 93   | 52   | 14   | 183        | 30                 | 1    | 7    | 17   | 55         | 9                           | 89   | 1    | 8    | 107        | 378        |
| Grand Total | 8                  | 11   | 4    | 34   | 57         | 40                          | 150  | 128  | 21   | 339        | 87                 | 6    | 12   | 28   | 133        | 21                          | 134  | 1    | 10   | 166        | 695        |
| Apprch %    | 14                 | 19.3 | 7    | 59.6 |            | 11.8                        | 44.2 | 37.8 | 6.2  |            | 65.4               | 4.5  | 9    | 21.1 |            | 12.7                        | 80.7 | 0.6  | 6    |            |            |
| Total %     | 1.2                | 1.6  | 0.6  | 4.9  | 8.2        | 5.8                         | 21.6 | 18.4 | 3    | 48.8       | 12.5               | 0.9  | 1.7  | 4    | 19.1       | 3                           | 19.3 | 0.1  | 1.4  | 23.9       |            |
| Lights      | 8                  | 11   | 4    | 34   | 57         | 40                          | 144  | 125  | 21   | 330        | 79                 | 6    | 12   | 28   | 125        | 20                          | 125  | 1    | 10   | 156        | 668        |
| % Lights    | 100                | 100  | 100  | 100  | 100        | 100                         | 96   | 97.7 | 100  | 97.3       | 90.8               | 100  | 100  | 100  | 94         | 95.2                        | 93.3 | 100  | 100  | 94         | 96.1       |
| Buses       | 0                  | 0    | 0    | 0    | 0          | 0                           | 1    | 0    | 0    | 1          | 5                  | 0    | 0    | 0    | 5          | 0                           | 5    | 0    | 0    | 5          | 11         |
| % Buses     | 0                  | 0    | 0    | 0    | 0          | 0                           | 0.7  | 0    | 0    | 0.3        | 5.7                | 0    | 0    | 0    | 3.8        | 0                           | 3.7  | 0    | 0    | 3          | 1.6        |
| Trucks      | 0                  | 0    | 0    | 0    | 0          | 0                           | 5    | 3    | 0    | 8          | 3                  | 0    | 0    | 0    | 3          | 1                           | 4    | 0    | 0    | 5          | 16         |
| % Trucks    | 0                  | 0    | 0    | 0    | 0          | 0                           | 3.3  | 2.3  | 0    | 2.4        | 3.4                | 0    | 0    | 0    | 2.3        | 4.8                         | 3    | 0    | 0    | 3          | 2.3        |

| Start Time   | 4TH AVE Southbound |      |      |            | INTER-GARRISON RD Westbound |      |      |            | 4TH AVE Northbound |      |      |            | INTER-GARRISON RD Eastbound |      |      |            | Int. Total |
|--|--------------------|------|------|------------|-----------------------------|------|------|------------|--------------------|------|------|------------|-----------------------------|------|------|------------|------------|
|  | Right              | Thru | Left | App. Total | Right                       | Thru | Left | App. Total | Right              | Thru | Left | App. Total | Right                       | Thru | Left | App. Total |            |
| Peak Hour Analysis From 07:00 AM to 08:45 AM - Peak 1 of 1 |                    |      |      |            |                             |      |      |            |                    |      |      |            |                             |      |      |            |            |
| Peak Hour for Entire Intersection Begins at 07:30 AM       |                    |      |      |            |                             |      |      |            |                    |      |      |            |                             |      |      |            |            |
| 07:30 AM   | 1                  | 1    | 0    | 2          | 5                           | 11   | 29   | 45         | 16                 | 1    | 1    | 18         | 8                           | 8    | 0    | 16         | 81         |
| 07:45 AM   | 1                  | 2    | 1    | 4          | 10                          | 25   | 23   | 58         | 26                 | 3    | 3    | 32         | 3                           | 18   | 0    | 21         | 115        |
| 08:00 AM   | 1                  | 1    | 0    | 2          | 7                           | 29   | 18   | 54         | 15                 | 1    | 2    | 18         | 3                           | 22   | 0    | 25         | 99         |
| 08:15 AM   | 3                  | 2    | 1    | 6          | 6                           | 28   | 15   | 49         | 7                  | 0    | 1    | 8          | 2                           | 30   | 0    | 32         | 95         |
| Total Volume   | 6                  | 6    | 2    | 14         | 28                          | 93   | 85   | 206        | 64                 | 5    | 7    | 76         | 16                          | 78   | 0    | 94         | 390        |
| % App. Total   | 42.9               | 42.9 | 14.3 |            | 13.6                        | 45.1 | 41.3 |            | 84.2               | 6.6  | 9.2  |            | 17                          | 83   | 0    |            |            |
| PHF  | .500               | .750 | .500 | .583       | .700                        | .802 | .733 | .888       | .615               | .417 | .583 | .594       | .500                        | .650 | .000 | .734       | .848       |

# Traffic Data Service

San Jose, CA  
 (408) 622-4787  
 tdsbay@cs.com

File Name : 5AM FINAL  
 Site Code : 00000005  
 Start Date : 4/25/2018  
 Page No : 2

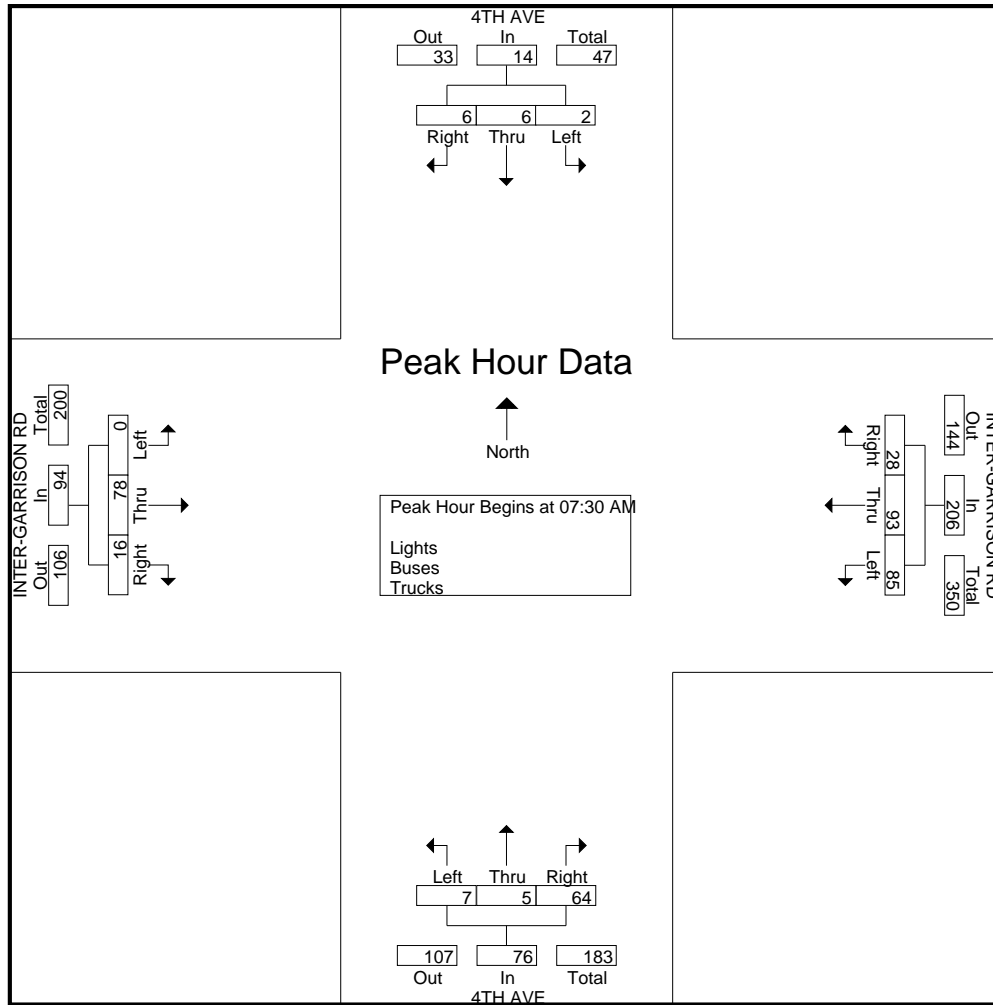

# Traffic Data Service

San Jose, CA  
 (408) 622-4787  
 tdsbay@cs.com

File Name : 5AM FINAL  
 Site Code : 00000005  
 Start Date : 4/25/2018  
 Page No : 1

Groups Printed- Bikes

| Start Time  | 4TH AVE Southbound |      |      |      |            | INTER-GARRISON RD Westbound |      |      |      |            | 4TH AVE Northbound |      |      |      |            | INTER-GARRISON RD Eastbound |      |      |      |            | Int. Total |   |   |   |   |   |
|-------------|--------------------|------|------|------|------------|-----------------------------|------|------|------|------------|--------------------|------|------|------|------------|-----------------------------|------|------|------|------------|------------|---|---|---|---|---|
|             | Right              | Thru | Left | Peds | App. Total | Right                       | Thru | Left | Peds | App. Total | Right              | Thru | Left | Peds | App. Total | Right                       | Thru | Left | Peds | App. Total |            |   |   |   |   |   |
| 07:00 AM    | 1                  | 0    | 0    | 0    | 1          | 0                           | 1    | 0    | 0    | 1          | 0                  | 0    | 0    | 0    | 0          | 0                           | 0    | 0    | 0    | 0          | 0          | 0 | 0 | 0 | 0 | 2 |
| 07:15 AM    | 0                  | 0    | 0    | 0    | 0          | 0                           | 0    | 0    | 0    | 0          | 0                  | 0    | 0    | 0    | 0          | 0                           | 0    | 0    | 0    | 0          | 0          | 0 | 0 | 0 | 0 | 0 |
| 07:30 AM    | 0                  | 0    | 0    | 0    | 0          | 0                           | 0    | 0    | 0    | 0          | 0                  | 0    | 0    | 0    | 0          | 0                           | 0    | 0    | 0    | 0          | 0          | 0 | 0 | 0 | 0 | 0 |
| 07:45 AM    | 0                  | 0    | 1    | 0    | 1          | 0                           | 0    | 0    | 0    | 0          | 0                  | 0    | 2    | 0    | 2          | 0                           | 0    | 0    | 0    | 0          | 0          | 0 | 0 | 0 | 0 | 3 |
| Total       | 1                  | 0    | 1    | 0    | 2          | 0                           | 1    | 0    | 0    | 1          | 0                  | 0    | 2    | 0    | 2          | 0                           | 0    | 0    | 0    | 0          | 0          | 0 | 0 | 0 | 0 | 5 |
| 08:00 AM    | 0                  | 0    | 0    | 0    | 0          | 0                           | 0    | 0    | 0    | 0          | 0                  | 0    | 0    | 0    | 0          | 0                           | 0    | 0    | 0    | 0          | 0          | 0 | 0 | 0 | 0 | 0 |
| 08:15 AM    | 0                  | 0    | 0    | 0    | 0          | 0                           | 0    | 1    | 0    | 1          | 0                  | 0    | 0    | 0    | 0          | 0                           | 0    | 0    | 0    | 0          | 0          | 0 | 0 | 0 | 1 |   |
| 08:30 AM    | 0                  | 0    | 0    | 0    | 0          | 0                           | 0    | 0    | 1    | 1          | 0                  | 0    | 0    | 0    | 0          | 0                           | 0    | 0    | 0    | 0          | 0          | 0 | 0 | 0 | 1 |   |
| 08:45 AM    | 0                  | 0    | 0    | 0    | 0          | 0                           | 1    | 0    | 0    | 1          | 0                  | 0    | 0    | 0    | 0          | 0                           | 0    | 0    | 0    | 0          | 0          | 0 | 0 | 0 | 1 |   |
| Total       | 0                  | 0    | 0    | 0    | 0          | 0                           | 1    | 1    | 1    | 3          | 0                  | 0    | 0    | 0    | 0          | 0                           | 0    | 0    | 0    | 0          | 0          | 0 | 0 | 0 | 3 |   |
| Grand Total | 1                  | 0    | 1    | 0    | 2          | 0                           | 2    | 1    | 1    | 4          | 0                  | 0    | 2    | 0    | 2          | 0                           | 0    | 0    | 0    | 0          | 0          | 0 | 0 | 0 | 8 |   |
| Apprch %    | 50                 | 0    | 50   | 0    |            | 0                           | 50   | 25   | 25   |            | 0                  | 0    | 100  | 0    |            | 0                           | 0    | 0    | 0    |            |            |   |   |   |   |   |
| Total %     | 12.5               | 0    | 12.5 | 0    | 25         | 0                           | 25   | 12.5 | 12.5 | 50         | 0                  | 0    | 25   | 0    | 25         | 0                           | 0    | 0    | 0    | 0          |            |   |   |   |   |   |

| Start Time   | 4TH AVE Southbound |      |      |            | INTER-GARRISON RD Westbound |      |      |            | 4TH AVE Northbound |      |      |            | INTER-GARRISON RD Eastbound |      |      |            | Int. Total |
|--|--------------------|------|------|------------|-----------------------------|------|------|------------|--------------------|------|------|------------|-----------------------------|------|------|------------|------------|
|  | Right              | Thru | Left | App. Total | Right                       | Thru | Left | App. Total | Right              | Thru | Left | App. Total | Right                       | Thru | Left | App. Total |            |
| Peak Hour Analysis From 07:00 AM to 08:45 AM - Peak 1 of 1 |                    |      |      |            |                             |      |      |            |                    |      |      |            |                             |      |      |            |            |
| Peak Hour for Entire Intersection Begins at 07:00 AM       |                    |      |      |            |                             |      |      |            |                    |      |      |            |                             |      |      |            |            |
| 07:00 AM   | 1                  | 0    | 0    | 1          | 0                           | 1    | 0    | 1          | 0                  | 0    | 0    | 0          | 0                           | 0    | 0    | 0          | 2          |
| 07:15 AM   | 0                  | 0    | 0    | 0          | 0                           | 0    | 0    | 0          | 0                  | 0    | 0    | 0          | 0                           | 0    | 0    | 0          | 0          |
| 07:30 AM   | 0                  | 0    | 0    | 0          | 0                           | 0    | 0    | 0          | 0                  | 0    | 0    | 0          | 0                           | 0    | 0    | 0          | 0          |
| 07:45 AM   | 0                  | 0    | 1    | 1          | 0                           | 0    | 0    | 0          | 0                  | 0    | 2    | 2          | 0                           | 0    | 0    | 0          | 3          |
| Total Volume   | 1                  | 0    | 1    | 2          | 0                           | 1    | 0    | 1          | 0                  | 0    | 2    | 2          | 0                           | 0    | 0    | 0          | 5          |
| % App. Total   | 50                 | 0    | 50   |            | 0                           | 100  | 0    |            | 0                  | 0    | 100  |            | 0                           | 0    | 0    |            |            |
| PHF  | .250               | .000 | .250 | .500       | .000                        | .250 | .000 | .250       | .000               | .000 | .250 | .250       | .000                        | .000 | .000 | .000       | .417       |

# Traffic Data Service

San Jose, CA  
 (408) 622-4787  
 tdsbay@cs.com

File Name : 5AM FINAL  
 Site Code : 00000005  
 Start Date : 4/25/2018  
 Page No : 2

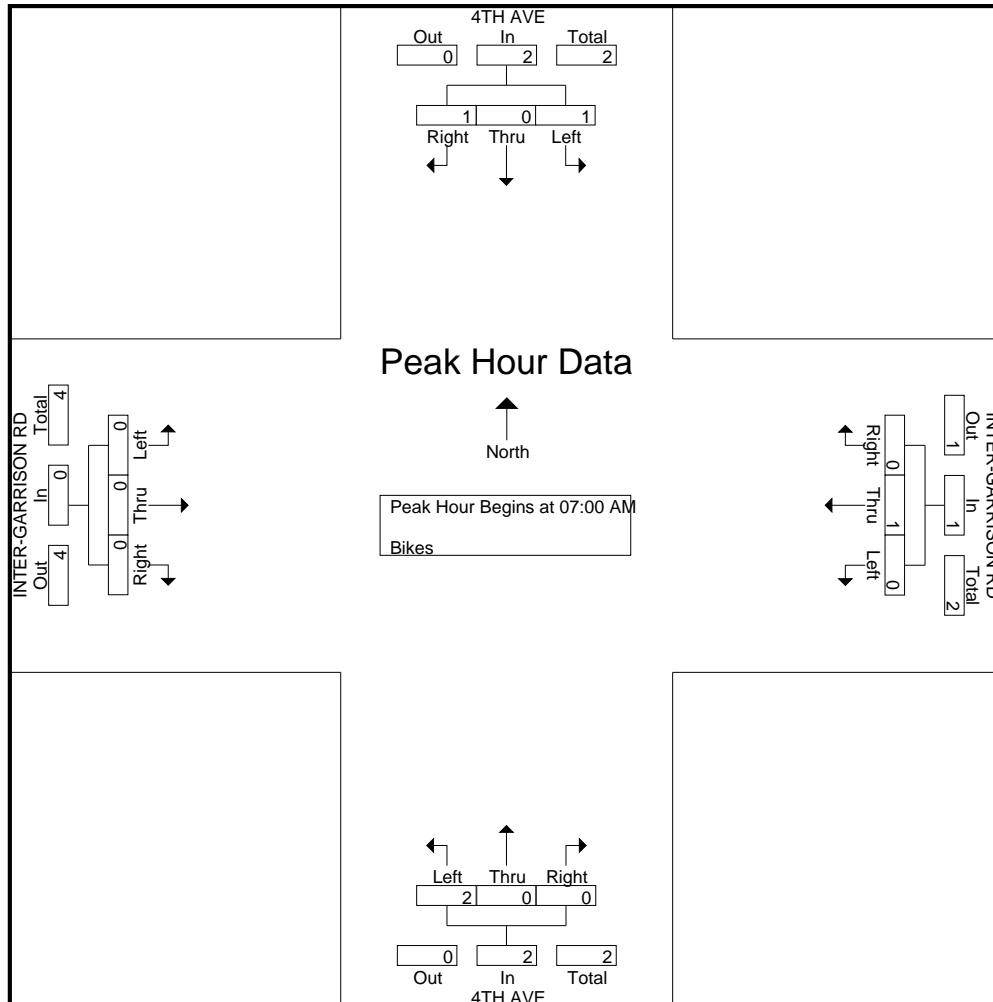

# Traffic Data Service

San Jose, CA  
(408) 622-4787  
tdsbay@cs.com

File Name : 5PM FINAL  
Site Code : 00000005  
Start Date : 4/25/2018  
Page No : 1

Groups Printed- Lights - Buses - Trucks

| Start Time   | 4TH AVE Southbound |           |           |           |            | INTER-GARRISON RD Westbound |           |           |           |            | 4TH AVE Northbound |           |           |           |            | INTER-GARRISON RD Eastbound |            |          |           |            | Int. Total |
|--------------|--------------------|-----------|-----------|-----------|------------|-----------------------------|-----------|-----------|-----------|------------|--------------------|-----------|-----------|-----------|------------|-----------------------------|------------|----------|-----------|------------|------------|
|              | Right              | Thru      | Left      | Peds      | App. Total | Right                       | Thru      | Left      | Peds      | App. Total | Right              | Thru      | Left      | Peds      | App. Total | Right                       | Thru       | Left     | Peds      | App. Total |            |
| 04:00 PM     | 1                  | 2         | 3         | 8         | 14         | 7                           | 23        | 18        | 2         | 50         | 30                 | 6         | 3         | 10        | 49         | 4                           | 28         | 2        | 5         | 39         | 152        |
| 04:15 PM     | 0                  | 2         | 3         | 2         | 7          | 2                           | 19        | 9         | 0         | 30         | 26                 | 4         | 4         | 6         | 40         | 0                           | 12         | 1        | 3         | 16         | 93         |
| 04:30 PM     | 1                  | 4         | 6         | 5         | 16         | 7                           | 17        | 10        | 4         | 38         | 23                 | 7         | 2         | 5         | 37         | 0                           | 23         | 0        | 1         | 24         | 115        |
| 04:45 PM     | 1                  | 3         | 7         | 6         | 17         | 4                           | 16        | 11        | 1         | 32         | 33                 | 9         | 8         | 8         | 58         | 4                           | 28         | 2        | 3         | 37         | 144        |
| <b>Total</b> | <b>3</b>           | <b>11</b> | <b>19</b> | <b>21</b> | <b>54</b>  | <b>20</b>                   | <b>75</b> | <b>48</b> | <b>7</b>  | <b>150</b> | <b>112</b>         | <b>26</b> | <b>17</b> | <b>29</b> | <b>184</b> | <b>8</b>                    | <b>91</b>  | <b>5</b> | <b>12</b> | <b>116</b> | <b>504</b> |
| 05:00 PM     | 2                  | 6         | 4         | 7         | 19         | 4                           | 10        | 18        | 5         | 37         | 34                 | 3         | 7         | 4         | 48         | 1                           | 29         | 1        | 1         | 32         | 136        |
| 05:15 PM     | 1                  | 4         | 6         | 12        | 23         | 7                           | 21        | 26        | 6         | 60         | 34                 | 7         | 3         | 9         | 53         | 1                           | 36         | 0        | 3         | 40         | 176        |
| 05:30 PM     | 1                  | 3         | 6         | 11        | 21         | 5                           | 17        | 21        | 5         | 48         | 44                 | 6         | 10        | 11        | 71         | 2                           | 30         | 3        | 5         | 40         | 180        |
| 05:45 PM     | 1                  | 4         | 5         | 8         | 18         | 3                           | 37        | 28        | 4         | 72         | 43                 | 7         | 17        | 10        | 77         | 4                           | 30         | 2        | 7         | 43         | 210        |
| <b>Total</b> | <b>5</b>           | <b>17</b> | <b>21</b> | <b>38</b> | <b>81</b>  | <b>19</b>                   | <b>85</b> | <b>93</b> | <b>20</b> | <b>217</b> | <b>155</b>         | <b>23</b> | <b>37</b> | <b>34</b> | <b>249</b> | <b>8</b>                    | <b>125</b> | <b>6</b> | <b>16</b> | <b>155</b> | <b>702</b> |
| Grand Total  | 8                  | 28        | 40        | 59        | 135        | 39                          | 160       | 141       | 27        | 367        | 267                | 49        | 54        | 63        | 433        | 16                          | 216        | 11       | 28        | 271        | 1206       |
| Apprch %     | 5.9                | 20.7      | 29.6      | 43.7      |            | 10.6                        | 43.6      | 38.4      | 7.4       |            | 61.7               | 11.3      | 12.5      | 14.5      |            | 5.9                         | 79.7       | 4.1      | 10.3      |            |            |
| Total %      | 0.7                | 2.3       | 3.3       | 4.9       | 11.2       | 3.2                         | 13.3      | 11.7      | 2.2       | 30.4       | 22.1               | 4.1       | 4.5       | 5.2       | 35.9       | 1.3                         | 17.9       | 0.9      | 2.3       | 22.5       |            |
| Lights       | 8                  | 28        | 40        | 59        | 135        | 39                          | 158       | 140       | 27        | 364        | 256                | 49        | 54        | 63        | 422        | 16                          | 211        | 11       | 28        | 266        | 1187       |
| % Lights     | 100                | 100       | 100       | 100       | 100        | 100                         | 98.8      | 99.3      | 100       | 99.2       | 95.9               | 100       | 100       | 100       | 97.5       | 100                         | 97.7       | 100      | 100       | 98.2       | 98.4       |
| Buses        | 0                  | 0         | 0         | 0         | 0          | 0                           | 0         | 0         | 0         | 0          | 7                  | 0         | 0         | 0         | 7          | 0                           | 4          | 0        | 0         | 4          | 11         |
| % Buses      | 0                  | 0         | 0         | 0         | 0          | 0                           | 0         | 0         | 0         | 0          | 2.6                | 0         | 0         | 0         | 1.6        | 0                           | 1.9        | 0        | 0         | 1.5        | 0.9        |
| Trucks       | 0                  | 0         | 0         | 0         | 0          | 0                           | 2         | 1         | 0         | 3          | 4                  | 0         | 0         | 0         | 4          | 0                           | 1          | 0        | 0         | 1          | 8          |
| % Trucks     | 0                  | 0         | 0         | 0         | 0          | 0                           | 1.2       | 0.7       | 0         | 0.8        | 1.5                | 0         | 0         | 0         | 0.9        | 0                           | 0.5        | 0        | 0         | 0.4        | 0.7        |

| Start Time   | 4TH AVE Southbound |      |      |            | INTER-GARRISON RD Westbound |      |      |            | 4TH AVE Northbound |      |      |            | INTER-GARRISON RD Eastbound |      |      |            | Int. Total |
|--|--------------------|------|------|------------|-----------------------------|------|------|------------|--------------------|------|------|------------|-----------------------------|------|------|------------|------------|
|  | Right              | Thru | Left | App. Total | Right                       | Thru | Left | App. Total | Right              | Thru | Left | App. Total | Right                       | Thru | Left | App. Total |            |
| Peak Hour Analysis From 04:00 PM to 05:45 PM - Peak 1 of 1 |                    |      |      |            |                             |      |      |            |                    |      |      |            |                             |      |      |            |            |
| Peak Hour for Entire Intersection Begins at 05:00 PM       |                    |      |      |            |                             |      |      |            |                    |      |      |            |                             |      |      |            |            |
| 05:00 PM   | 2                  | 6    | 4    | 12         | 4                           | 10   | 18   | 32         | 34                 | 3    | 7    | 44         | 1                           | 29   | 1    | 31         | 119        |
| 05:15 PM   | 1                  | 4    | 6    | 11         | 7                           | 21   | 26   | 54         | 34                 | 7    | 3    | 44         | 1                           | 36   | 0    | 37         | 146        |
| 05:30 PM   | 1                  | 3    | 6    | 10         | 5                           | 17   | 21   | 43         | 44                 | 6    | 10   | 60         | 2                           | 30   | 3    | 35         | 148        |
| 05:45 PM   | 1                  | 4    | 5    | 10         | 3                           | 37   | 28   | 68         | 43                 | 7    | 17   | 67         | 4                           | 30   | 2    | 36         | 181        |
| Total Volume   | 5                  | 17   | 21   | 43         | 19                          | 85   | 93   | 197        | 155                | 23   | 37   | 215        | 8                           | 125  | 6    | 139        | 594        |
| % App. Total   | 11.6               | 39.5 | 48.8 |            | 9.6                         | 43.1 | 47.2 |            | 72.1               | 10.7 | 17.2 |            | 5.8                         | 89.9 | 4.3  |            |            |
| PHF  | .625               | .708 | .875 | .896       | .679                        | .574 | .830 | .724       | .881               | .821 | .544 | .802       | .500                        | .868 | .500 | .939       | .820       |

# Traffic Data Service

San Jose, CA  
 (408) 622-4787  
 tdsbay@cs.com

File Name : 5PM FINAL  
 Site Code : 00000005  
 Start Date : 4/25/2018  
 Page No : 2

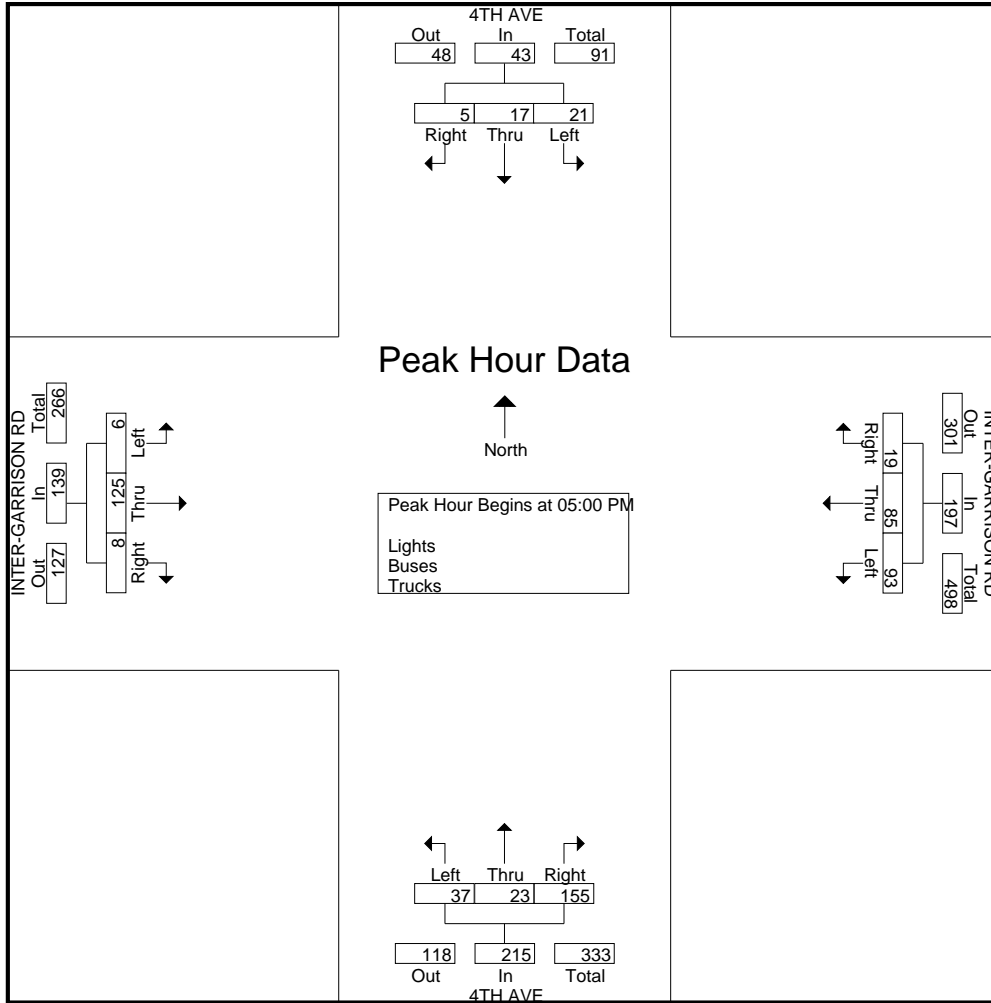

# Traffic Data Service

San Jose, CA  
 (408) 622-4787  
 tdsbay@cs.com

File Name : 5PM FINAL  
 Site Code : 00000005  
 Start Date : 4/25/2018  
 Page No : 1

Groups Printed- Bikes

| Start Time  | 4TH AVE Southbound |      |      |      |            | INTER-GARRISON RD Westbound |      |      |      |            | 4TH AVE Northbound |      |      |      |            | INTER-GARRISON RD Eastbound |      |      |      |            | Int. Total |    |
|-------------|--------------------|------|------|------|------------|-----------------------------|------|------|------|------------|--------------------|------|------|------|------------|-----------------------------|------|------|------|------------|------------|----|
|             | Right              | Thru | Left | Peds | App. Total | Right                       | Thru | Left | Peds | App. Total | Right              | Thru | Left | Peds | App. Total | Right                       | Thru | Left | Peds | App. Total |            |    |
| 04:00 PM    | 0                  | 0    | 2    | 0    | 2          | 0                           | 1    | 0    | 0    | 1          | 0                  | 0    | 0    | 0    | 0          | 0                           | 1    | 0    | 0    | 0          | 1          | 4  |
| 04:15 PM    | 0                  | 0    | 0    | 0    | 0          | 0                           | 0    | 0    | 0    | 0          | 0                  | 0    | 0    | 0    | 0          | 0                           | 1    | 0    | 0    | 0          | 1          | 1  |
| 04:30 PM    | 0                  | 0    | 1    | 0    | 1          | 0                           | 0    | 0    | 0    | 0          | 0                  | 0    | 0    | 0    | 0          | 0                           | 0    | 0    | 0    | 0          | 0          | 1  |
| 04:45 PM    | 0                  | 0    | 0    | 0    | 0          | 0                           | 0    | 0    | 0    | 0          | 0                  | 0    | 0    | 0    | 0          | 0                           | 0    | 0    | 0    | 0          | 0          | 0  |
| Total       | 0                  | 0    | 3    | 0    | 3          | 0                           | 1    | 0    | 0    | 1          | 0                  | 0    | 0    | 0    | 0          | 0                           | 2    | 0    | 0    | 0          | 2          | 6  |
| 05:00 PM    | 0                  | 0    | 0    | 0    | 0          | 0                           | 0    | 0    | 0    | 0          | 0                  | 1    | 0    | 0    | 1          | 0                           | 2    | 0    | 0    | 0          | 2          | 3  |
| 05:15 PM    | 0                  | 0    | 0    | 0    | 0          | 0                           | 0    | 0    | 0    | 0          | 0                  | 0    | 0    | 0    | 0          | 1                           | 0    | 0    | 0    | 0          | 1          | 1  |
| 05:30 PM    | 0                  | 0    | 0    | 0    | 0          | 0                           | 0    | 0    | 0    | 0          | 0                  | 0    | 0    | 0    | 0          | 0                           | 0    | 0    | 0    | 0          | 0          | 0  |
| 05:45 PM    | 0                  | 0    | 0    | 0    | 0          | 0                           | 0    | 1    | 0    | 1          | 0                  | 0    | 0    | 0    | 0          | 0                           | 0    | 0    | 0    | 0          | 0          | 1  |
| Total       | 0                  | 0    | 0    | 0    | 0          | 0                           | 0    | 1    | 0    | 1          | 0                  | 1    | 0    | 0    | 1          | 1                           | 2    | 0    | 0    | 0          | 3          | 5  |
| Grand Total | 0                  | 0    | 3    | 0    | 3          | 0                           | 1    | 1    | 0    | 2          | 0                  | 1    | 0    | 0    | 1          | 1                           | 4    | 0    | 0    | 0          | 5          | 11 |
| Apprch %    | 0                  | 0    | 100  | 0    |            | 0                           | 50   | 50   | 0    |            | 0                  | 100  | 0    | 0    |            | 20                          | 80   | 0    | 0    |            |            |    |
| Total %     | 0                  | 0    | 27.3 | 0    | 27.3       | 0                           | 9.1  | 9.1  | 0    | 18.2       | 0                  | 9.1  | 0    | 0    | 9.1        | 9.1                         | 36.4 | 0    | 0    | 45.5       |            |    |

| Start Time   | 4TH AVE Southbound |      |      |            | INTER-GARRISON RD Westbound |      |      |            | 4TH AVE Northbound |      |      |            | INTER-GARRISON RD Eastbound |      |      |            | Int. Total |
|--------------|--------------------|------|------|------------|-----------------------------|------|------|------------|--------------------|------|------|------------|-----------------------------|------|------|------------|------------|
|              | Right              | Thru | Left | App. Total | Right                       | Thru | Left | App. Total | Right              | Thru | Left | App. Total | Right                       | Thru | Left | App. Total |            |
| 04:00 PM     | 0                  | 0    | 2    | 2          | 0                           | 1    | 0    | 1          | 0                  | 0    | 0    | 0          | 0                           | 1    | 0    | 1          | 4          |
| 04:15 PM     | 0                  | 0    | 0    | 0          | 0                           | 0    | 0    | 0          | 0                  | 0    | 0    | 0          | 0                           | 1    | 0    | 1          | 1          |
| 04:30 PM     | 0                  | 0    | 1    | 1          | 0                           | 0    | 0    | 0          | 0                  | 0    | 0    | 0          | 0                           | 0    | 0    | 0          | 1          |
| 04:45 PM     | 0                  | 0    | 0    | 0          | 0                           | 0    | 0    | 0          | 0                  | 0    | 0    | 0          | 0                           | 0    | 0    | 0          | 0          |
| Total Volume | 0                  | 0    | 3    | 3          | 0                           | 1    | 0    | 1          | 0                  | 0    | 0    | 0          | 0                           | 2    | 0    | 2          | 6          |
| % App. Total | 0                  | 0    | 100  |            | 0                           | 100  | 0    |            | 0                  | 0    | 0    |            | 0                           | 100  | 0    |            |            |
| PHF          | .000               | .000 | .375 | .375       | .000                        | .250 | .000 | .250       | .000               | .000 | .000 | .000       | .000                        | .500 | .000 | .500       | .375       |

Peak Hour Analysis From 04:00 PM to 05:45 PM - Peak 1 of 1  
 Peak Hour for Entire Intersection Begins at 04:00 PM

# Traffic Data Service

San Jose, CA  
 (408) 622-4787  
 tdsbay@cs.com

File Name : 5PM FINAL  
 Site Code : 00000005  
 Start Date : 4/25/2018  
 Page No : 2

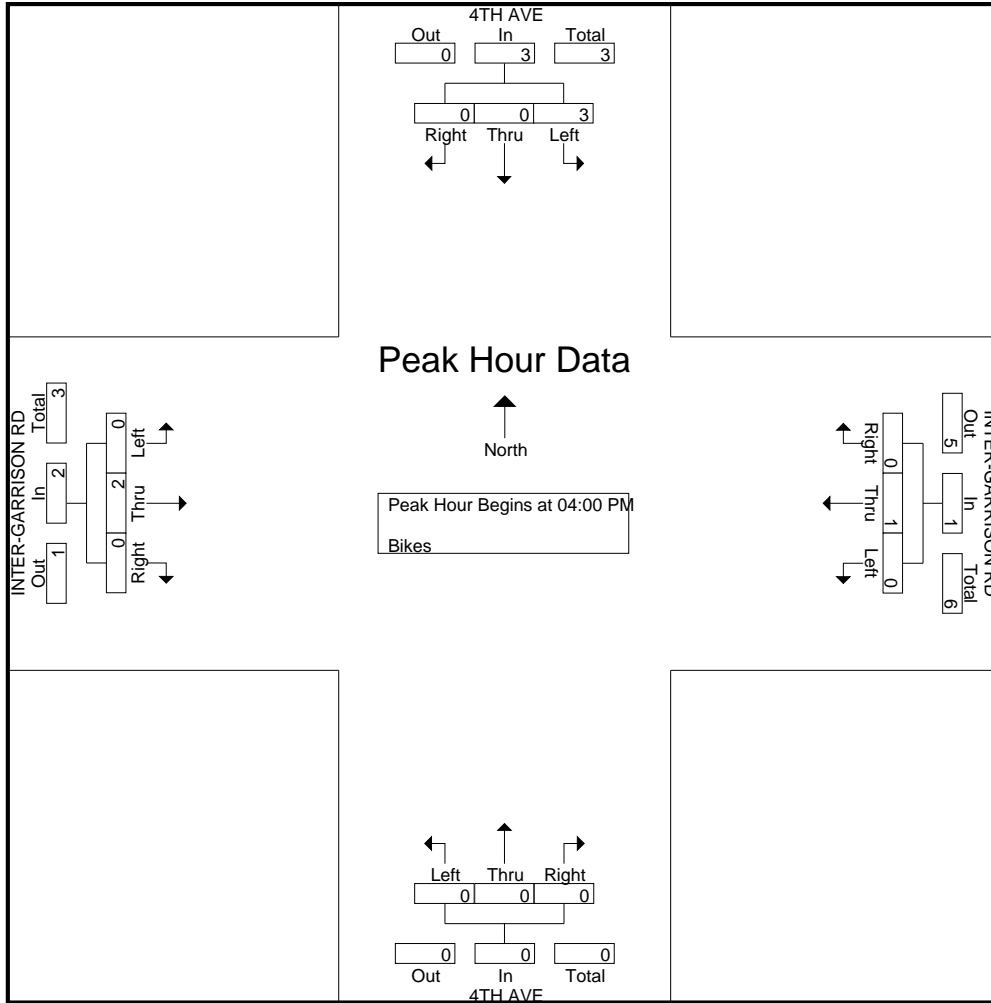



# Traffic Data Service

San Jose, CA  
 (408) 622-4787  
 tdsbay@cs.com

File Name : 6AM FINAL  
 Site Code : 00000006  
 Start Date : 4/25/2018  
 Page No : 1

Groups Printed- Lights - Buses - Trucks

| Start Time  | RESERVATION RD Southbound |      |      |      |            | Westbound |      |      |      |            | RESERVATION RD Northbound |      |      |      |            | WATKINS GATE RD Eastbound |      |      |      |            | Int. Total |
|-------------|---------------------------|------|------|------|------------|-----------|------|------|------|------------|---------------------------|------|------|------|------------|---------------------------|------|------|------|------------|------------|
|             | Right                     | Thru | Left | Peds | App. Total | Right     | Thru | Left | Peds | App. Total | Right                     | Thru | Left | Peds | App. Total | Right                     | Thru | Left | Peds | App. Total |            |
| 07:00 AM    | 0                         | 77   | 0    | 0    | 77         | 0         | 0    | 0    | 0    | 0          | 0                         | 190  | 0    | 0    | 190        | 0                         | 0    | 0    | 0    | 0          | 267        |
| 07:15 AM    | 0                         | 91   | 0    | 0    | 91         | 0         | 0    | 0    | 0    | 0          | 0                         | 202  | 0    | 0    | 202        | 0                         | 0    | 0    | 0    | 0          | 293        |
| 07:30 AM    | 0                         | 116  | 0    | 0    | 116        | 0         | 0    | 0    | 0    | 0          | 0                         | 218  | 0    | 0    | 218        | 0                         | 0    | 0    | 0    | 0          | 334        |
| 07:45 AM    | 0                         | 114  | 0    | 0    | 114        | 0         | 0    | 0    | 0    | 0          | 0                         | 161  | 0    | 0    | 161        | 0                         | 0    | 0    | 0    | 0          | 275        |
| Total       | 0                         | 398  | 0    | 0    | 398        | 0         | 0    | 0    | 0    | 0          | 0                         | 771  | 0    | 0    | 771        | 0                         | 0    | 0    | 0    | 0          | 1169       |
| 08:00 AM    | 0                         | 91   | 0    | 0    | 91         | 0         | 0    | 0    | 0    | 0          | 0                         | 149  | 0    | 0    | 149        | 0                         | 0    | 0    | 0    | 0          | 240        |
| 08:15 AM    | 0                         | 77   | 0    | 0    | 77         | 0         | 0    | 0    | 0    | 0          | 0                         | 153  | 0    | 0    | 153        | 0                         | 0    | 0    | 0    | 0          | 230        |
| 08:30 AM    | 0                         | 51   | 0    | 0    | 51         | 0         | 0    | 0    | 0    | 0          | 0                         | 111  | 0    | 0    | 111        | 0                         | 0    | 0    | 0    | 0          | 162        |
| 08:45 AM    | 0                         | 60   | 0    | 0    | 60         | 0         | 0    | 0    | 0    | 0          | 0                         | 88   | 0    | 0    | 88         | 0                         | 0    | 0    | 0    | 0          | 148        |
| Total       | 0                         | 279  | 0    | 0    | 279        | 0         | 0    | 0    | 0    | 0          | 0                         | 501  | 0    | 0    | 501        | 0                         | 0    | 0    | 0    | 0          | 780        |
| Grand Total | 0                         | 677  | 0    | 0    | 677        | 0         | 0    | 0    | 0    | 0          | 0                         | 1272 | 0    | 0    | 1272       | 0                         | 0    | 0    | 0    | 0          | 1949       |
| Apprch %    | 0                         | 100  | 0    | 0    |            | 0         | 0    | 0    | 0    |            | 0                         | 100  | 0    | 0    |            | 0                         | 0    | 0    | 0    |            |            |
| Total %     | 0                         | 34.7 | 0    | 0    | 34.7       | 0         | 0    | 0    | 0    | 0          | 0                         | 65.3 | 0    | 0    | 65.3       | 0                         | 0    | 0    | 0    | 0          |            |
| Lights      | 0                         | 655  | 0    | 0    | 655        | 0         | 0    | 0    | 0    | 0          | 0                         | 1243 | 0    | 0    | 1243       | 0                         | 0    | 0    | 0    | 0          | 1898       |
| % Lights    | 0                         | 96.8 | 0    | 0    | 96.8       | 0         | 0    | 0    | 0    | 0          | 0                         | 97.7 | 0    | 0    | 97.7       | 0                         | 0    | 0    | 0    | 0          | 97.4       |
| Buses       | 0                         | 4    | 0    | 0    | 4          | 0         | 0    | 0    | 0    | 0          | 0                         | 6    | 0    | 0    | 6          | 0                         | 0    | 0    | 0    | 0          | 10         |
| % Buses     | 0                         | 0.6  | 0    | 0    | 0.6        | 0         | 0    | 0    | 0    | 0          | 0                         | 0.5  | 0    | 0    | 0.5        | 0                         | 0    | 0    | 0    | 0          | 0.5        |
| Trucks      | 0                         | 18   | 0    | 0    | 18         | 0         | 0    | 0    | 0    | 0          | 0                         | 23   | 0    | 0    | 23         | 0                         | 0    | 0    | 0    | 0          | 41         |
| % Trucks    | 0                         | 2.7  | 0    | 0    | 2.7        | 0         | 0    | 0    | 0    | 0          | 0                         | 1.8  | 0    | 0    | 1.8        | 0                         | 0    | 0    | 0    | 0          | 2.1        |

| Start Time   | RESERVATION RD Southbound |            |      |            | Westbound |      |      |            | RESERVATION RD Northbound |      |            |            | WATKINS GATE RD Eastbound |      |      |            | Int. Total |            |
|--|---------------------------|------------|------|------------|-----------|------|------|------------|---------------------------|------|------------|------------|---------------------------|------|------|------------|------------|------------|
|  | Right                     | Thru       | Left | App. Total | Right     | Thru | Left | App. Total | Right                     | Thru | Left       | App. Total | Right                     | Thru | Left | App. Total |            |            |
| Peak Hour Analysis From 07:00 AM to 08:45 AM - Peak 1 of 1 |                           |            |      |            |           |      |      |            |                           |      |            |            |                           |      |      |            |            |            |
| Peak Hour for Entire Intersection Begins at 07:00 AM       |                           |            |      |            |           |      |      |            |                           |      |            |            |                           |      |      |            |            |            |
| 07:00 AM   | 0                         | 77         | 0    | 77         | 0         | 0    | 0    | 0          | 0                         | 0    | 190        | 0          | 190                       | 0    | 0    | 0          | 0          | 267        |
| 07:15 AM   | 0                         | 91         | 0    | 91         | 0         | 0    | 0    | 0          | 0                         | 0    | 202        | 0          | 202                       | 0    | 0    | 0          | 0          | 293        |
| 07:30 AM   | 0                         | <b>116</b> | 0    | <b>116</b> | 0         | 0    | 0    | 0          | 0                         | 0    | <b>218</b> | 0          | <b>218</b>                | 0    | 0    | 0          | 0          | <b>334</b> |
| 07:45 AM   | 0                         | 114        | 0    | 114        | 0         | 0    | 0    | 0          | 0                         | 0    | 161        | 0          | 161                       | 0    | 0    | 0          | 0          | 275        |
| Total Volume   | 0                         | 398        | 0    | 398        | 0         | 0    | 0    | 0          | 0                         | 0    | 771        | 0          | 771                       | 0    | 0    | 0          | 0          | 1169       |
| % App. Total   | 0                         | 100        | 0    |            | 0         | 0    | 0    |            | 0                         | 0    | 100        | 0          |                           | 0    | 0    | 0          |            |            |
| PHF  | .000                      | .858       | .000 | .858       | .000      | .000 | .000 | .000       | .000                      | .000 | .884       | .000       | .884                      | .000 | .000 | .000       | .000       | .875       |

# Traffic Data Service

San Jose, CA  
 (408) 622-4787  
 tdsbay@cs.com

File Name : 6AM FINAL  
 Site Code : 00000006  
 Start Date : 4/25/2018  
 Page No : 2

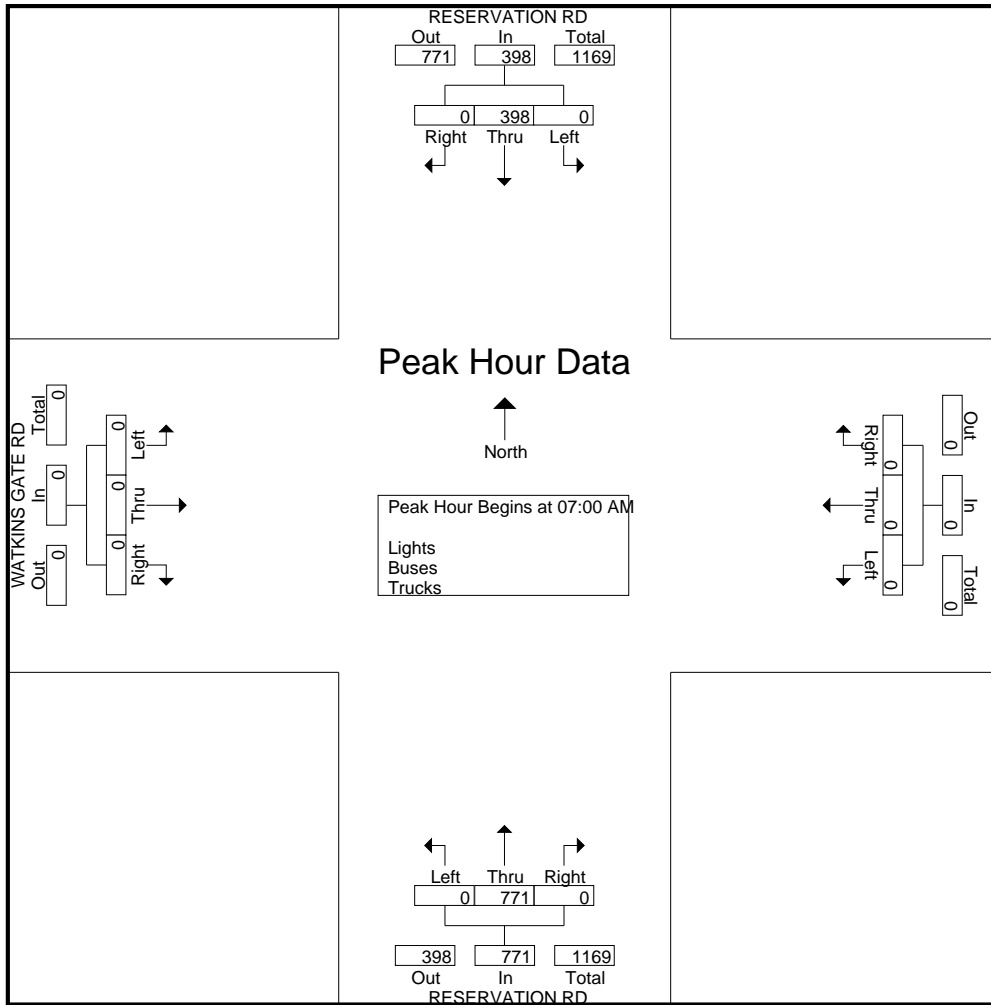

# Traffic Data Service

San Jose, CA  
 (408) 622-4787  
 tdsbay@cs.com

File Name : 6AM FINAL  
 Site Code : 00000006  
 Start Date : 4/25/2018  
 Page No : 1

Groups Printed- Bikes

| Start Time  | RESERVATION RD Southbound |      |      |      |            | Westbound |      |      |      |            | RESERVATION RD Northbound |      |      |      |            | WATKINS GATE RD Eastbound |      |      |      |            | Int. Total |
|-------------|---------------------------|------|------|------|------------|-----------|------|------|------|------------|---------------------------|------|------|------|------------|---------------------------|------|------|------|------------|------------|
|             | Right                     | Thru | Left | Peds | App. Total | Right     | Thru | Left | Peds | App. Total | Right                     | Thru | Left | Peds | App. Total | Right                     | Thru | Left | Peds | App. Total |            |
| 07:00 AM    | 0                         | 0    | 0    | 0    | 0          | 0         | 0    | 0    | 0    | 0          | 0                         | 0    | 0    | 0    | 0          | 0                         | 0    | 0    | 0    | 0          | 0          |
| 07:15 AM    | 0                         | 0    | 0    | 0    | 0          | 0         | 0    | 0    | 0    | 0          | 0                         | 0    | 0    | 0    | 0          | 0                         | 0    | 0    | 0    | 0          | 0          |
| 07:30 AM    | 0                         | 0    | 0    | 0    | 0          | 0         | 0    | 0    | 0    | 0          | 0                         | 0    | 0    | 0    | 0          | 0                         | 0    | 0    | 0    | 0          | 0          |
| 07:45 AM    | 0                         | 0    | 0    | 0    | 0          | 0         | 0    | 0    | 0    | 0          | 0                         | 0    | 0    | 0    | 0          | 0                         | 0    | 0    | 0    | 0          | 0          |
| Total       | 0                         | 0    | 0    | 0    | 0          | 0         | 0    | 0    | 0    | 0          | 0                         | 0    | 0    | 0    | 0          | 0                         | 0    | 0    | 0    | 0          | 0          |
| 08:00 AM    | 0                         | 0    | 0    | 0    | 0          | 0         | 0    | 0    | 0    | 0          | 0                         | 0    | 0    | 0    | 0          | 0                         | 0    | 0    | 0    | 0          | 0          |
| 08:15 AM    | 0                         | 0    | 0    | 0    | 0          | 0         | 0    | 0    | 0    | 0          | 0                         | 0    | 0    | 0    | 0          | 0                         | 0    | 0    | 0    | 0          | 0          |
| 08:30 AM    | 0                         | 0    | 0    | 0    | 0          | 0         | 0    | 0    | 0    | 0          | 0                         | 0    | 0    | 0    | 0          | 0                         | 0    | 0    | 0    | 0          | 0          |
| 08:45 AM    | 0                         | 0    | 0    | 0    | 0          | 0         | 0    | 0    | 0    | 0          | 0                         | 0    | 0    | 0    | 0          | 0                         | 0    | 0    | 0    | 0          | 0          |
| Total       | 0                         | 0    | 0    | 0    | 0          | 0         | 0    | 0    | 0    | 0          | 0                         | 0    | 0    | 0    | 0          | 0                         | 0    | 0    | 0    | 0          | 0          |
| Grand Total | 0                         | 0    | 0    | 0    | 0          | 0         | 0    | 0    | 0    | 0          | 0                         | 0    | 0    | 0    | 0          | 0                         | 0    | 0    | 0    | 0          | 0          |
| Apprch %    | 0                         | 0    | 0    | 0    |            | 0         | 0    | 0    | 0    |            | 0                         | 0    | 0    | 0    |            | 0                         | 0    | 0    | 0    |            |            |
| Total %     |                           |      |      |      |            |           |      |      |      |            |                           |      |      |      |            |                           |      |      |      |            |            |

| Start Time   | RESERVATION RD Southbound |      |      |      |            | Westbound |      |      |      |            | RESERVATION RD Northbound |      |      |      |            | WATKINS GATE RD Eastbound |      |      |      |            | Int. Total |
|--|---------------------------|------|------|------|------------|-----------|------|------|------|------------|---------------------------|------|------|------|------------|---------------------------|------|------|------|------------|------------|
|  | Right                     | Thru | Left | Peds | App. Total | Right     | Thru | Left | Peds | App. Total | Right                     | Thru | Left | Peds | App. Total | Right                     | Thru | Left | Peds | App. Total |            |
| Peak Hour Analysis From 07:00 AM to 08:45 AM - Peak 1 of 1 |                           |      |      |      |            |           |      |      |      |            |                           |      |      |      |            |                           |      |      |      |            |            |
| Peak Hour for Entire Intersection Begins at 07:00 AM       |                           |      |      |      |            |           |      |      |      |            |                           |      |      |      |            |                           |      |      |      |            |            |
| 07:00 AM   | 0                         | 0    | 0    | 0    | 0          | 0         | 0    | 0    | 0    | 0          | 0                         | 0    | 0    | 0    | 0          | 0                         | 0    | 0    | 0    | 0          | 0          |
| 07:15 AM   | 0                         | 0    | 0    | 0    | 0          | 0         | 0    | 0    | 0    | 0          | 0                         | 0    | 0    | 0    | 0          | 0                         | 0    | 0    | 0    | 0          | 0          |
| 07:30 AM   | 0                         | 0    | 0    | 0    | 0          | 0         | 0    | 0    | 0    | 0          | 0                         | 0    | 0    | 0    | 0          | 0                         | 0    | 0    | 0    | 0          | 0          |
| 07:45 AM   | 0                         | 0    | 0    | 0    | 0          | 0         | 0    | 0    | 0    | 0          | 0                         | 0    | 0    | 0    | 0          | 0                         | 0    | 0    | 0    | 0          | 0          |
| Total Volume   | 0                         | 0    | 0    | 0    | 0          | 0         | 0    | 0    | 0    | 0          | 0                         | 0    | 0    | 0    | 0          | 0                         | 0    | 0    | 0    | 0          | 0          |
| % App. Total   | 0                         | 0    | 0    | 0    |            | 0         | 0    | 0    | 0    |            | 0                         | 0    | 0    | 0    |            | 0                         | 0    | 0    | 0    |            |            |
| PHF  | .000                      | .000 | .000 | .000 | .000       | .000      | .000 | .000 | .000 | .000       | .000                      | .000 | .000 | .000 | .000       | .000                      | .000 | .000 | .000 | .000       | .000       |

# Traffic Data Service

San Jose, CA  
(408) 622-4787  
tdsbay@cs.com

File Name : 6AM FINAL  
Site Code : 00000006  
Start Date : 4/25/2018  
Page No : 2

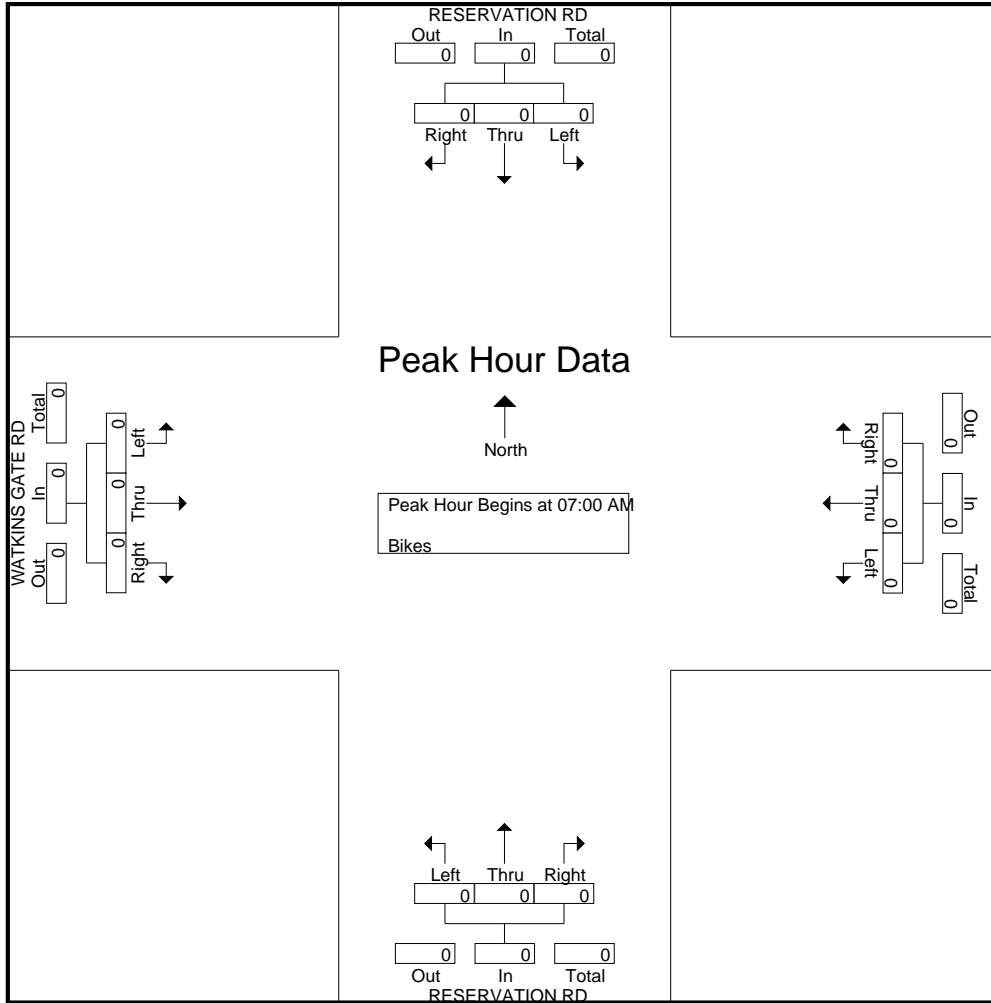

# Traffic Data Service

San Jose, CA  
 (408) 622-4787  
 tdsbay@cs.com

File Name : 6PM FINAL  
 Site Code : 00000006  
 Start Date : 4/25/2018  
 Page No : 1

Groups Printed- Lights - Buses - Trucks

| Start Time   | RESERVATION RD Southbound |      |      |      |            | Westbound |      |      |      |            | RESERVATION RD Northbound |      |      |      |            | WATKINS GATE RD Eastbound |      |      |      |            | Int. Total |      |
|--------------|---------------------------|------|------|------|------------|-----------|------|------|------|------------|---------------------------|------|------|------|------------|---------------------------|------|------|------|------------|------------|------|
|              | Right                     | Thru | Left | Peds | App. Total | Right     | Thru | Left | Peds | App. Total | Right                     | Thru | Left | Peds | App. Total | Right                     | Thru | Left | Peds | App. Total |            |      |
| 04:00 PM     | 0                         | 174  | 0    | 0    | 174        | 0         | 0    | 0    | 0    | 0          | 0                         | 101  | 0    | 0    | 101        | 0                         | 0    | 0    | 0    | 0          | 0          | 275  |
| 04:15 PM     | 0                         | 167  | 0    | 0    | 167        | 0         | 0    | 0    | 0    | 0          | 0                         | 95   | 0    | 0    | 95         | 0                         | 0    | 0    | 0    | 0          | 0          | 262  |
| 04:30 PM     | 0                         | 144  | 1    | 0    | 145        | 0         | 0    | 0    | 0    | 0          | 0                         | 91   | 0    | 0    | 91         | 0                         | 0    | 0    | 0    | 0          | 0          | 236  |
| 04:45 PM     | 0                         | 186  | 0    | 0    | 186        | 0         | 0    | 0    | 0    | 0          | 0                         | 96   | 0    | 0    | 96         | 0                         | 0    | 0    | 0    | 0          | 0          | 282  |
| <b>Total</b> | 0                         | 671  | 1    | 0    | 672        | 0         | 0    | 0    | 0    | 0          | 0                         | 383  | 0    | 0    | 383        | 0                         | 0    | 0    | 0    | 0          | 0          | 1055 |
| 05:00 PM     | 0                         | 192  | 0    | 0    | 192        | 0         | 0    | 0    | 0    | 0          | 0                         | 109  | 0    | 0    | 109        | 0                         | 0    | 0    | 0    | 0          | 0          | 301  |
| 05:15 PM     | 0                         | 166  | 0    | 0    | 166        | 0         | 0    | 0    | 0    | 0          | 0                         | 145  | 0    | 0    | 145        | 0                         | 0    | 0    | 0    | 0          | 0          | 311  |
| 05:30 PM     | 0                         | 171  | 0    | 0    | 171        | 0         | 0    | 0    | 0    | 0          | 0                         | 123  | 0    | 0    | 123        | 0                         | 0    | 0    | 0    | 0          | 0          | 294  |
| 05:45 PM     | 0                         | 187  | 0    | 0    | 187        | 0         | 0    | 0    | 0    | 0          | 0                         | 105  | 0    | 0    | 105        | 0                         | 0    | 0    | 0    | 0          | 0          | 292  |
| <b>Total</b> | 0                         | 716  | 0    | 0    | 716        | 0         | 0    | 0    | 0    | 0          | 0                         | 482  | 0    | 0    | 482        | 0                         | 0    | 0    | 0    | 0          | 0          | 1198 |
| Grand Total  | 0                         | 1387 | 1    | 0    | 1388       | 0         | 0    | 0    | 0    | 0          | 0                         | 865  | 0    | 0    | 865        | 0                         | 0    | 0    | 0    | 0          | 0          | 2253 |
| Apprch %     | 0                         | 99.9 | 0.1  | 0    |            | 0         | 0    | 0    | 0    |            | 0                         | 100  | 0    | 0    |            | 0                         | 0    | 0    | 0    |            |            |      |
| Total %      | 0                         | 61.6 | 0    | 0    | 61.6       | 0         | 0    | 0    | 0    | 0          | 0                         | 38.4 | 0    | 0    | 38.4       | 0                         | 0    | 0    | 0    | 0          | 0          |      |
| Lights       | 0                         | 1356 | 1    | 0    | 1357       | 0         | 0    | 0    | 0    | 0          | 0                         | 851  | 0    | 0    | 851        | 0                         | 0    | 0    | 0    | 0          | 0          | 2208 |
| % Lights     | 0                         | 97.8 | 100  | 0    | 97.8       | 0         | 0    | 0    | 0    | 0          | 0                         | 98.4 | 0    | 0    | 98.4       | 0                         | 0    | 0    | 0    | 0          | 0          | 98   |
| Buses        | 0                         | 6    | 0    | 0    | 6          | 0         | 0    | 0    | 0    | 0          | 0                         | 0    | 0    | 0    | 0          | 0                         | 0    | 0    | 0    | 0          | 0          | 6    |
| % Buses      | 0                         | 0.4  | 0    | 0    | 0.4        | 0         | 0    | 0    | 0    | 0          | 0                         | 0    | 0    | 0    | 0          | 0                         | 0    | 0    | 0    | 0          | 0          | 0.3  |
| Trucks       | 0                         | 25   | 0    | 0    | 25         | 0         | 0    | 0    | 0    | 0          | 0                         | 14   | 0    | 0    | 14         | 0                         | 0    | 0    | 0    | 0          | 0          | 39   |
| % Trucks     | 0                         | 1.8  | 0    | 0    | 1.8        | 0         | 0    | 0    | 0    | 0          | 0                         | 1.6  | 0    | 0    | 1.6        | 0                         | 0    | 0    | 0    | 0          | 0          | 1.7  |

| Start Time   | RESERVATION RD Southbound |      |      |            | Westbound |      |      |            | RESERVATION RD Northbound |      |      |            | WATKINS GATE RD Eastbound |      |      |            | Int. Total |      |
|--|---------------------------|------|------|------------|-----------|------|------|------------|---------------------------|------|------|------------|---------------------------|------|------|------------|------------|------|
|  | Right                     | Thru | Left | App. Total | Right     | Thru | Left | App. Total | Right                     | Thru | Left | App. Total | Right                     | Thru | Left | App. Total |            |      |
| Peak Hour Analysis From 04:00 PM to 05:45 PM - Peak 1 of 1 |                           |      |      |            |           |      |      |            |                           |      |      |            |                           |      |      |            |            |      |
| Peak Hour for Entire Intersection Begins at 05:00 PM       |                           |      |      |            |           |      |      |            |                           |      |      |            |                           |      |      |            |            |      |
| 05:00 PM   | 0                         | 192  | 0    | 192        | 0         | 0    | 0    | 0          | 0                         | 109  | 0    | 109        | 0                         | 0    | 0    | 0          | 0          | 301  |
| 05:15 PM   | 0                         | 166  | 0    | 166        | 0         | 0    | 0    | 0          | 0                         | 145  | 0    | 145        | 0                         | 0    | 0    | 0          | 0          | 311  |
| 05:30 PM   | 0                         | 171  | 0    | 171        | 0         | 0    | 0    | 0          | 0                         | 123  | 0    | 123        | 0                         | 0    | 0    | 0          | 0          | 294  |
| 05:45 PM   | 0                         | 187  | 0    | 187        | 0         | 0    | 0    | 0          | 0                         | 105  | 0    | 105        | 0                         | 0    | 0    | 0          | 0          | 292  |
| Total Volume   | 0                         | 716  | 0    | 716        | 0         | 0    | 0    | 0          | 0                         | 482  | 0    | 482        | 0                         | 0    | 0    | 0          | 0          | 1198 |
| % App. Total   | 0                         | 100  | 0    |            | 0         | 0    | 0    |            | 0                         | 100  | 0    |            | 0                         | 0    | 0    |            |            |      |
| PHF  | .000                      | .932 | .000 | .932       | .000      | .000 | .000 | .000       | .000                      | .831 | .000 | .831       | .000                      | .000 | .000 | .000       | .000       | .963 |

# Traffic Data Service

San Jose, CA  
 (408) 622-4787  
 tdsbay@cs.com

File Name : 6PM FINAL  
 Site Code : 00000006  
 Start Date : 4/25/2018  
 Page No : 2

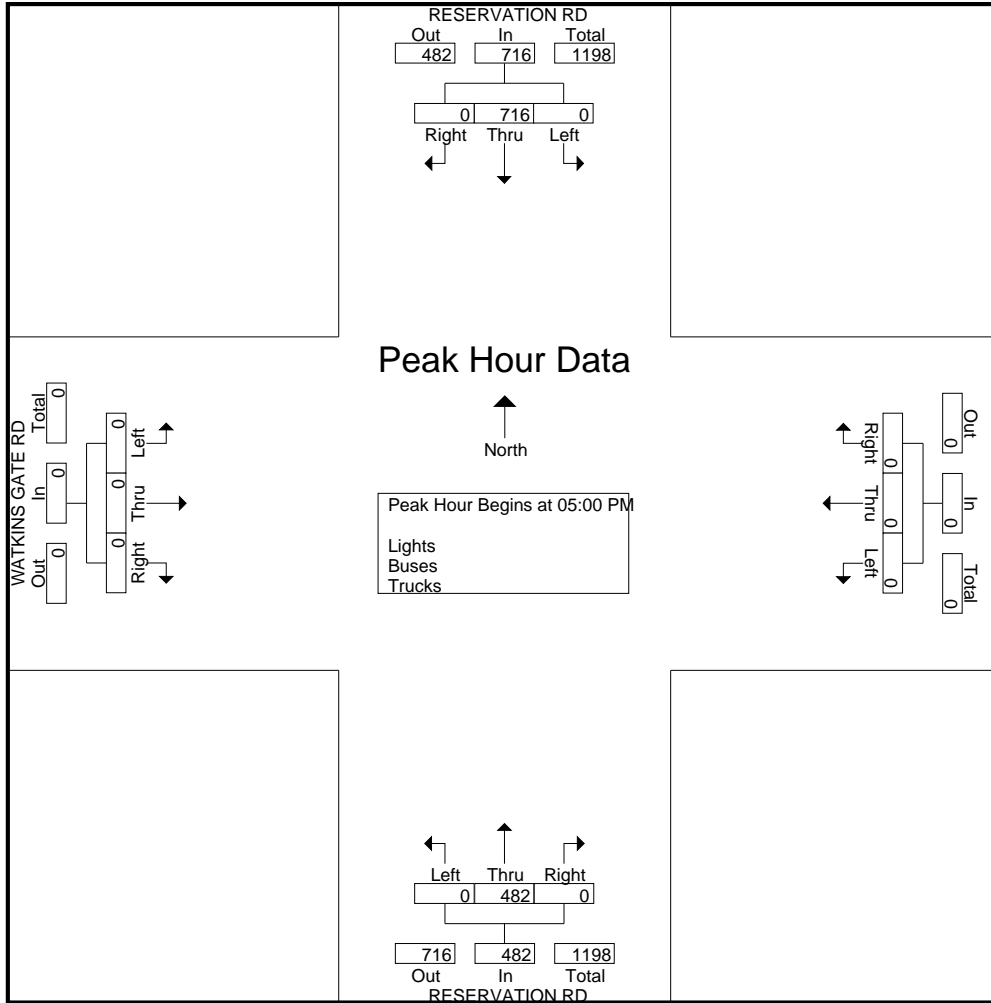

# Traffic Data Service

San Jose, CA  
 (408) 622-4787  
 tdsbay@cs.com

File Name : 6PM FINAL  
 Site Code : 00000006  
 Start Date : 4/25/2018  
 Page No : 1

Groups Printed- Bikes

| Start Time  | RESERVATION RD Southbound |      |      |      |            | Westbound |      |      |      |            | RESERVATION RD Northbound |      |      |      |            | WATKINS GATE RD Eastbound |      |      |      |            | Int. Total |
|-------------|---------------------------|------|------|------|------------|-----------|------|------|------|------------|---------------------------|------|------|------|------------|---------------------------|------|------|------|------------|------------|
|             | Right                     | Thru | Left | Peds | App. Total | Right     | Thru | Left | Peds | App. Total | Right                     | Thru | Left | Peds | App. Total | Right                     | Thru | Left | Peds | App. Total |            |
| 04:00 PM    | 0                         | 0    | 0    | 0    | 0          | 0         | 0    | 0    | 0    | 0          | 0                         | 0    | 0    | 0    | 0          | 0                         | 0    | 0    | 0    | 0          | 0          |
| 04:15 PM    | 0                         | 0    | 0    | 0    | 0          | 0         | 0    | 0    | 0    | 0          | 0                         | 0    | 0    | 0    | 0          | 0                         | 0    | 0    | 0    | 0          | 0          |
| 04:30 PM    | 0                         | 0    | 0    | 0    | 0          | 0         | 0    | 0    | 0    | 0          | 0                         | 0    | 0    | 0    | 0          | 0                         | 0    | 0    | 0    | 0          | 0          |
| 04:45 PM    | 0                         | 0    | 0    | 0    | 0          | 0         | 0    | 0    | 0    | 0          | 0                         | 0    | 0    | 0    | 0          | 0                         | 0    | 0    | 0    | 0          | 0          |
| Total       | 0                         | 0    | 0    | 0    | 0          | 0         | 0    | 0    | 0    | 0          | 0                         | 0    | 0    | 0    | 0          | 0                         | 0    | 0    | 0    | 0          | 0          |
| 05:00 PM    | 0                         | 0    | 0    | 0    | 0          | 0         | 0    | 0    | 0    | 0          | 0                         | 0    | 0    | 0    | 0          | 0                         | 0    | 0    | 0    | 0          | 0          |
| 05:15 PM    | 0                         | 0    | 0    | 0    | 0          | 0         | 0    | 0    | 0    | 0          | 0                         | 0    | 0    | 0    | 0          | 0                         | 0    | 0    | 0    | 0          | 0          |
| 05:30 PM    | 0                         | 0    | 0    | 0    | 0          | 0         | 0    | 0    | 0    | 0          | 0                         | 1    | 0    | 0    | 1          | 0                         | 0    | 0    | 0    | 0          | 1          |
| 05:45 PM    | 0                         | 0    | 0    | 0    | 0          | 0         | 0    | 0    | 0    | 0          | 0                         | 1    | 0    | 0    | 1          | 0                         | 0    | 0    | 0    | 0          | 1          |
| Total       | 0                         | 0    | 0    | 0    | 0          | 0         | 0    | 0    | 0    | 0          | 0                         | 2    | 0    | 0    | 2          | 0                         | 0    | 0    | 0    | 0          | 2          |
| Grand Total | 0                         | 0    | 0    | 0    | 0          | 0         | 0    | 0    | 0    | 0          | 0                         | 2    | 0    | 0    | 2          | 0                         | 0    | 0    | 0    | 0          | 2          |
| Apprch %    | 0                         | 0    | 0    | 0    | 0          | 0         | 0    | 0    | 0    | 0          | 0                         | 100  | 0    | 0    | 0          | 0                         | 0    | 0    | 0    | 0          |            |
| Total %     | 0                         | 0    | 0    | 0    | 0          | 0         | 0    | 0    | 0    | 0          | 0                         | 100  | 0    | 0    | 100        | 0                         | 0    | 0    | 0    | 0          |            |

| Start Time   | RESERVATION RD Southbound |      |      |      |            | Westbound |      |      |      |            | RESERVATION RD Northbound |      |      |      |            | WATKINS GATE RD Eastbound |      |      |      |            | Int. Total |
|--------------|---------------------------|------|------|------|------------|-----------|------|------|------|------------|---------------------------|------|------|------|------------|---------------------------|------|------|------|------------|------------|
|              | Right                     | Thru | Left | Peds | App. Total | Right     | Thru | Left | Peds | App. Total | Right                     | Thru | Left | Peds | App. Total | Right                     | Thru | Left | Peds | App. Total |            |
| 05:00 PM     | 0                         | 0    | 0    | 0    | 0          | 0         | 0    | 0    | 0    | 0          | 0                         | 0    | 0    | 0    | 0          | 0                         | 0    | 0    | 0    | 0          | 0          |
| 05:15 PM     | 0                         | 0    | 0    | 0    | 0          | 0         | 0    | 0    | 0    | 0          | 0                         | 0    | 0    | 0    | 0          | 0                         | 0    | 0    | 0    | 0          | 0          |
| 05:30 PM     | 0                         | 0    | 0    | 0    | 0          | 0         | 0    | 0    | 0    | 0          | 0                         | 1    | 0    | 0    | 1          | 0                         | 0    | 0    | 0    | 0          | 1          |
| 05:45 PM     | 0                         | 0    | 0    | 0    | 0          | 0         | 0    | 0    | 0    | 0          | 0                         | 1    | 0    | 0    | 1          | 0                         | 0    | 0    | 0    | 0          | 1          |
| Total Volume | 0                         | 0    | 0    | 0    | 0          | 0         | 0    | 0    | 0    | 0          | 0                         | 2    | 0    | 0    | 2          | 0                         | 0    | 0    | 0    | 0          | 2          |
| % App. Total | 0                         | 0    | 0    | 0    | 0          | 0         | 0    | 0    | 0    | 0          | 0                         | 100  | 0    | 0    | 0          | 0                         | 0    | 0    | 0    | 0          |            |
| PHF          | .000                      | .000 | .000 | .000 | .000       | .000      | .000 | .000 | .000 | .000       | .000                      | .500 | .000 | .500 | .000       | .000                      | .000 | .000 | .000 | .000       | .500       |

Peak Hour Analysis From 04:00 PM to 05:45 PM - Peak 1 of 1  
 Peak Hour for Entire Intersection Begins at 05:00 PM

# Traffic Data Service

San Jose, CA  
(408) 622-4787  
tdsbay@cs.com

File Name : 6PM FINAL  
Site Code : 00000006  
Start Date : 4/25/2018  
Page No : 2

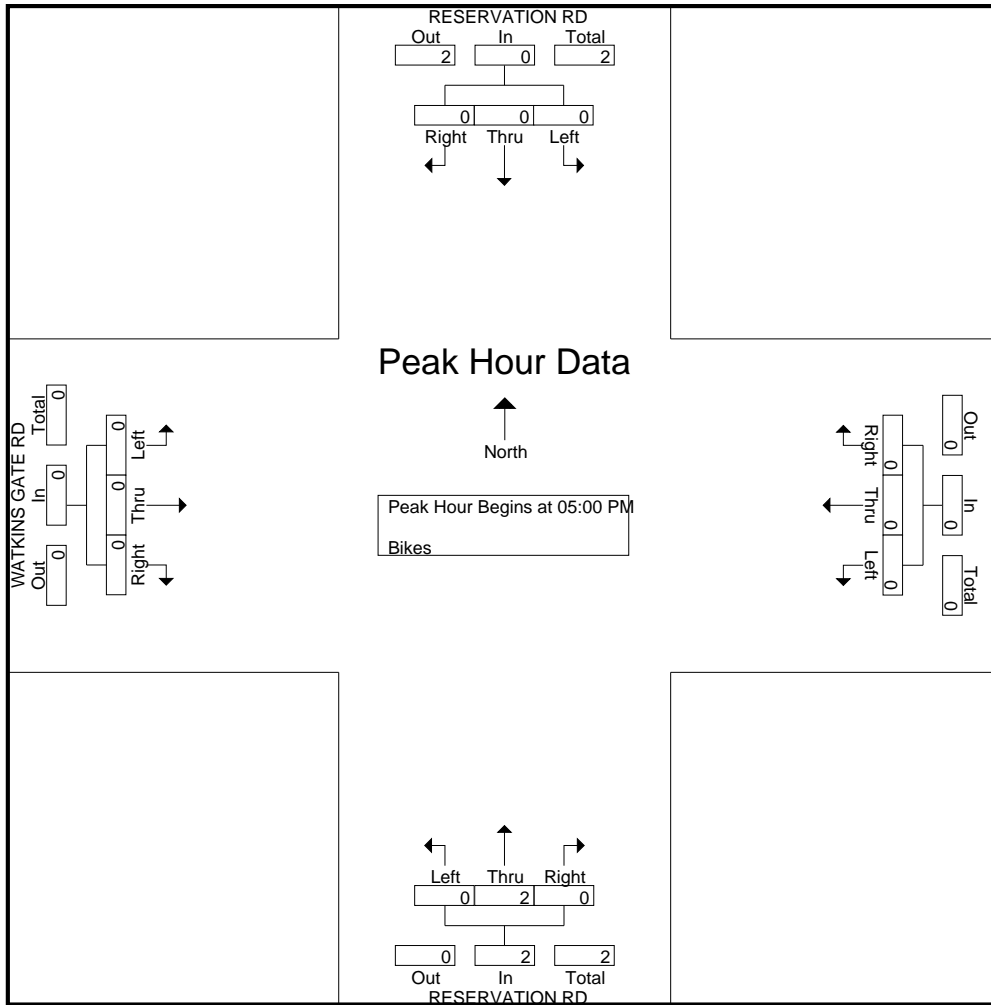



# Traffic Data Service

San Jose, CA  
(408) 622-4787  
tdsbay@cs.com

File Name : 7AM FINAL  
Site Code : 00000007  
Start Date : 4/25/2018  
Page No : 1

Groups Printed- Lights - Buses - Trucks

| Start Time   | S DAVIS RD Southbound |          |            |          |            | RESERVATION RD Westbound |            |          |          |            | DRIVEWAY Northbound |          |          |          |            | RESERVATION RD Eastbound |            |            |          |            | Int. Total  |
|--------------|-----------------------|----------|------------|----------|------------|--------------------------|------------|----------|----------|------------|---------------------|----------|----------|----------|------------|--------------------------|------------|------------|----------|------------|-------------|
|              | Right                 | Thru     | Left       | Peds     | App. Total | Right                    | Thru       | Left     | Peds     | App. Total | Right               | Thru     | Left     | Peds     | App. Total | Right                    | Thru       | Left       | Peds     | App. Total |             |
| 07:00 AM     | 96                    | 0        | 32         | 0        | 128        | 14                       | 102        | 1        | 0        | 117        | 0                   | 3        | 0        | 0        | 3          | 0                        | 52         | 19         | 0        | 71         | 319         |
| 07:15 AM     | 83                    | 1        | 32         | 0        | 116        | 24                       | 128        | 0        | 0        | 152        | 1                   | 0        | 1        | 0        | 2          | 0                        | 49         | 30         | 0        | 79         | 349         |
| 07:30 AM     | 74                    | 2        | 38         | 0        | 114        | 38                       | 138        | 0        | 0        | 176        | 3                   | 1        | 2        | 0        | 6          | 1                        | 78         | 48         | 0        | 127        | 423         |
| 07:45 AM     | 48                    | 0        | 43         | 0        | 91         | 28                       | 121        | 0        | 0        | 149        | 0                   | 2        | 0        | 0        | 2          | 0                        | 82         | 35         | 0        | 117        | 359         |
| <b>Total</b> | <b>301</b>            | <b>3</b> | <b>145</b> | <b>0</b> | <b>449</b> | <b>104</b>               | <b>489</b> | <b>1</b> | <b>0</b> | <b>594</b> | <b>4</b>            | <b>6</b> | <b>3</b> | <b>0</b> | <b>13</b>  | <b>1</b>                 | <b>261</b> | <b>132</b> | <b>0</b> | <b>394</b> | <b>1450</b> |
| 08:00 AM     | 45                    | 1        | 39         | 0        | 85         | 33                       | 92         | 0        | 0        | 125        | 0                   | 1        | 0        | 0        | 1          | 1                        | 59         | 40         | 0        | 100        | 311         |
| 08:15 AM     | 43                    | 2        | 36         | 0        | 81         | 19                       | 106        | 0        | 0        | 125        | 1                   | 0        | 0        | 0        | 1          | 0                        | 52         | 23         | 0        | 75         | 282         |
| 08:30 AM     | 27                    | 2        | 27         | 0        | 56         | 27                       | 81         | 1        | 0        | 109        | 1                   | 1        | 3        | 0        | 5          | 0                        | 42         | 14         | 0        | 56         | 226         |
| 08:45 AM     | 20                    | 0        | 37         | 0        | 57         | 33                       | 61         | 1        | 0        | 95         | 0                   | 0        | 0        | 0        | 0          | 0                        | 34         | 23         | 0        | 57         | 209         |
| <b>Total</b> | <b>135</b>            | <b>5</b> | <b>139</b> | <b>0</b> | <b>279</b> | <b>112</b>               | <b>340</b> | <b>2</b> | <b>0</b> | <b>454</b> | <b>2</b>            | <b>2</b> | <b>3</b> | <b>0</b> | <b>7</b>   | <b>1</b>                 | <b>187</b> | <b>100</b> | <b>0</b> | <b>288</b> | <b>1028</b> |
| Grand Total  | 436                   | 8        | 284        | 0        | 728        | 216                      | 829        | 3        | 0        | 1048       | 6                   | 8        | 6        | 0        | 20         | 2                        | 448        | 232        | 0        | 682        | 2478        |
| Apprch %     | 59.9                  | 1.1      | 39         | 0        |            | 20.6                     | 79.1       | 0.3      | 0        |            | 30                  | 40       | 30       | 0        |            | 0.3                      | 65.7       | 34         | 0        |            |             |
| Total %      | 17.6                  | 0.3      | 11.5       | 0        | 29.4       | 8.7                      | 33.5       | 0.1      | 0        | 42.3       | 0.2                 | 0.3      | 0.2      | 0        | 0.8        | 0.1                      | 18.1       | 9.4        | 0        | 27.5       |             |
| Lights       | 426                   | 8        | 265        | 0        | 699        | 213                      | 809        | 3        | 0        | 1025       | 6                   | 8        | 6        | 0        | 20         | 2                        | 434        | 223        | 0        | 659        | 2403        |
| % Lights     | 97.7                  | 100      | 93.3       | 0        | 96         | 98.6                     | 97.6       | 100      | 0        | 97.8       | 100                 | 100      | 100      | 0        | 100        | 100                      | 96.9       | 96.1       | 0        | 96.6       | 97          |
| Buses        | 3                     | 0        | 3          | 0        | 6          | 0                        | 4          | 0        | 0        | 4          | 0                   | 0        | 0        | 0        | 0          | 0                        | 2          | 2          | 0        | 4          | 14          |
| % Buses      | 0.7                   | 0        | 1.1        | 0        | 0.8        | 0                        | 0.5        | 0        | 0        | 0.4        | 0                   | 0        | 0        | 0        | 0          | 0                        | 0.4        | 0.9        | 0        | 0.6        | 0.6         |
| Trucks       | 7                     | 0        | 16         | 0        | 23         | 3                        | 16         | 0        | 0        | 19         | 0                   | 0        | 0        | 0        | 0          | 0                        | 12         | 7          | 0        | 19         | 61          |
| % Trucks     | 1.6                   | 0        | 5.6        | 0        | 3.2        | 1.4                      | 1.9        | 0        | 0        | 1.8        | 0                   | 0        | 0        | 0        | 0          | 0                        | 2.7        | 3          | 0        | 2.8        | 2.5         |

| Start Time   | S DAVIS RD Southbound |          |           |            | RESERVATION RD Westbound |            |      |            | DRIVEWAY Northbound |          |          |            | RESERVATION RD Eastbound |           |           |            | Int. Total |
|--|-----------------------|----------|-----------|------------|--------------------------|------------|------|------------|---------------------|----------|----------|------------|--------------------------|-----------|-----------|------------|------------|
|  | Right                 | Thru     | Left      | App. Total | Right                    | Thru       | Left | App. Total | Right               | Thru     | Left     | App. Total | Right                    | Thru      | Left      | App. Total |            |
| Peak Hour Analysis From 07:00 AM to 08:45 AM - Peak 1 of 1 |                       |          |           |            |                          |            |      |            |                     |          |          |            |                          |           |           |            |            |
| Peak Hour for Entire Intersection Begins at 07:00 AM       |                       |          |           |            |                          |            |      |            |                     |          |          |            |                          |           |           |            |            |
| 07:00 AM   | <b>96</b>             | 0        | 32        | <b>128</b> | 14                       | 102        | 1    | 117        | 0                   | <b>3</b> | 0        | 3          | 0                        | 52        | 19        | 71         | 319        |
| 07:15 AM   | 83                    | 1        | 32        | 116        | 24                       | 128        | 0    | 152        | 1                   | 0        | 1        | 2          | 0                        | 49        | 30        | 79         | 349        |
| 07:30 AM   | 74                    | <b>2</b> | 38        | 114        | <b>38</b>                | <b>138</b> | 0    | <b>176</b> | <b>3</b>            | 1        | <b>2</b> | <b>6</b>   | <b>1</b>                 | 78        | <b>48</b> | <b>127</b> | <b>423</b> |
| 07:45 AM   | 48                    | 0        | <b>43</b> | 91         | 28                       | 121        | 0    | 149        | 0                   | 2        | 0        | 2          | 0                        | <b>82</b> | 35        | 117        | 359        |
| Total Volume   | 301                   | 3        | 145       | 449        | 104                      | 489        | 1    | 594        | 4                   | 6        | 3        | 13         | 1                        | 261       | 132       | 394        | 1450       |
| % App. Total   | 67                    | 0.7      | 32.3      |            | 17.5                     | 82.3       | 0.2  |            | 30.8                | 46.2     | 23.1     |            | 0.3                      | 66.2      | 33.5      |            |            |
| PHF  | .784                  | .375     | .843      | .877       | .684                     | .886       | .250 | .844       | .333                | .500     | .375     | .542       | .250                     | .796      | .688      | .776       | .857       |

# Traffic Data Service

San Jose, CA  
 (408) 622-4787  
 tdsbay@cs.com

File Name : 7AM FINAL  
 Site Code : 00000007  
 Start Date : 4/25/2018  
 Page No : 2

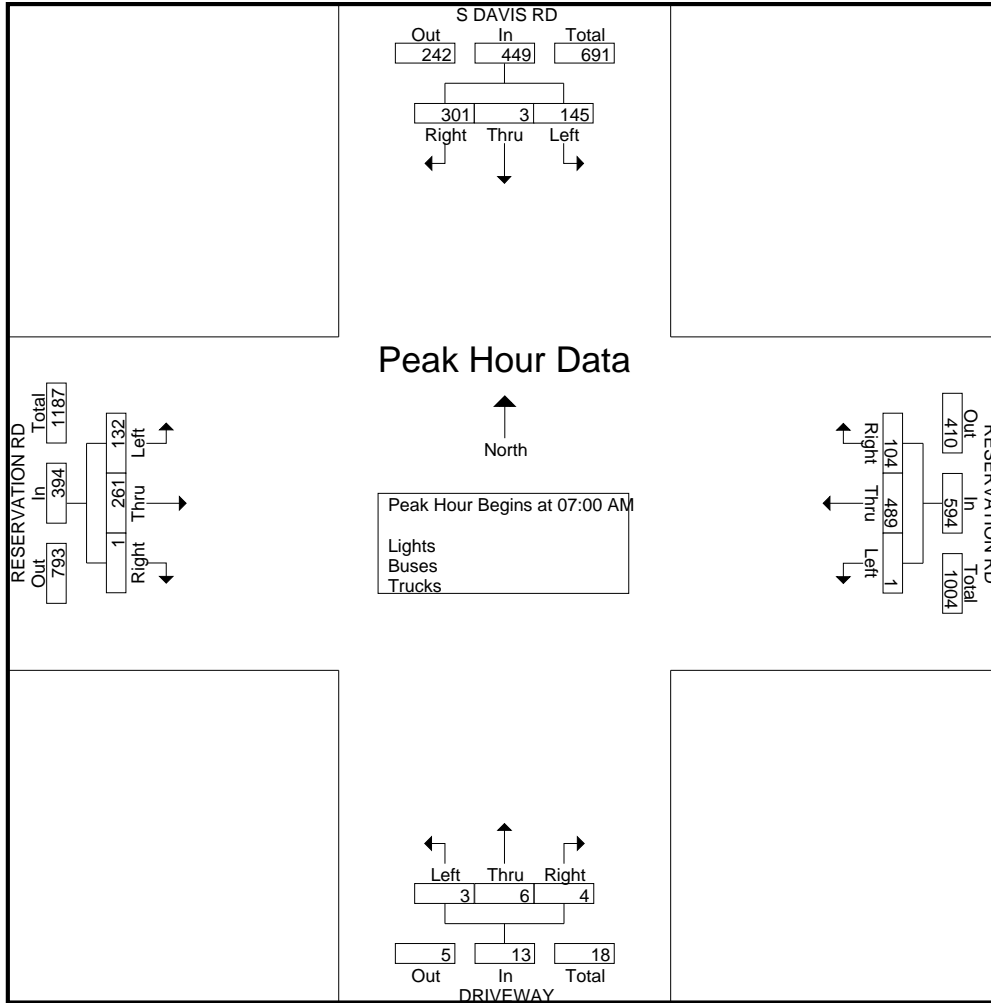

# Traffic Data Service

San Jose, CA  
 (408) 622-4787  
 tdsbay@cs.com

File Name : 7AM FINAL  
 Site Code : 00000007  
 Start Date : 4/25/2018  
 Page No : 1

Groups Printed- Bikes

| Start Time  | S DAVIS RD Southbound |      |      |      |            | RESERVATION RD Westbound |      |      |      |            | DRIVEWAY Northbound |      |      |      |            | RESERVATION RD Eastbound |      |      |      |            | Int. Total |
|-------------|-----------------------|------|------|------|------------|--------------------------|------|------|------|------------|---------------------|------|------|------|------------|--------------------------|------|------|------|------------|------------|
|             | Right                 | Thru | Left | Peds | App. Total | Right                    | Thru | Left | Peds | App. Total | Right               | Thru | Left | Peds | App. Total | Right                    | Thru | Left | Peds | App. Total |            |
| 07:00 AM    | 0                     | 0    | 0    | 0    | 0          | 0                        | 0    | 0    | 0    | 0          | 1                   | 0    | 0    | 0    | 1          | 1                        | 0    | 0    | 0    | 1          | 2          |
| 07:15 AM    | 0                     | 0    | 0    | 0    | 0          | 0                        | 0    | 0    | 0    | 0          | 0                   | 0    | 0    | 0    | 0          | 0                        | 0    | 0    | 0    | 0          | 0          |
| 07:30 AM    | 0                     | 0    | 0    | 0    | 0          | 0                        | 0    | 0    | 0    | 0          | 0                   | 0    | 0    | 0    | 0          | 0                        | 0    | 0    | 0    | 0          | 0          |
| 07:45 AM    | 0                     | 0    | 0    | 0    | 0          | 0                        | 0    | 0    | 0    | 0          | 0                   | 0    | 0    | 0    | 0          | 0                        | 0    | 0    | 0    | 0          | 0          |
| Total       | 0                     | 0    | 0    | 0    | 0          | 0                        | 0    | 0    | 0    | 0          | 1                   | 0    | 0    | 0    | 1          | 1                        | 0    | 0    | 0    | 1          | 2          |
| 08:00 AM    | 0                     | 0    | 0    | 0    | 0          | 0                        | 0    | 0    | 0    | 0          | 0                   | 0    | 0    | 0    | 0          | 0                        | 0    | 0    | 0    | 0          | 0          |
| 08:15 AM    | 0                     | 0    | 0    | 0    | 0          | 0                        | 0    | 0    | 0    | 0          | 0                   | 0    | 0    | 0    | 0          | 0                        | 0    | 0    | 0    | 0          | 0          |
| 08:30 AM    | 0                     | 0    | 0    | 0    | 0          | 0                        | 0    | 0    | 0    | 0          | 0                   | 0    | 0    | 0    | 0          | 0                        | 0    | 0    | 0    | 0          | 0          |
| 08:45 AM    | 0                     | 0    | 0    | 0    | 0          | 1                        | 0    | 0    | 0    | 1          | 0                   | 0    | 0    | 0    | 0          | 0                        | 0    | 0    | 0    | 0          | 1          |
| Total       | 0                     | 0    | 0    | 0    | 0          | 1                        | 0    | 0    | 0    | 1          | 0                   | 0    | 0    | 0    | 0          | 0                        | 0    | 0    | 0    | 0          | 1          |
| Grand Total | 0                     | 0    | 0    | 0    | 0          | 1                        | 0    | 0    | 0    | 1          | 1                   | 0    | 0    | 0    | 1          | 1                        | 0    | 0    | 0    | 1          | 3          |
| Apprch %    | 0                     | 0    | 0    | 0    | 0          | 100                      | 0    | 0    | 0    | 100        | 100                 | 0    | 0    | 0    | 100        | 100                      | 0    | 0    | 0    | 100        |            |
| Total %     | 0                     | 0    | 0    | 0    | 0          | 33.3                     | 0    | 0    | 0    | 33.3       | 33.3                | 0    | 0    | 0    | 33.3       | 33.3                     | 0    | 0    | 0    | 33.3       |            |

| Start Time   | S DAVIS RD Southbound |      |      |      |            | RESERVATION RD Westbound |      |      |      |            | DRIVEWAY Northbound |      |      |      |            | RESERVATION RD Eastbound |      |      |      |            | Int. Total |
|--------------|-----------------------|------|------|------|------------|--------------------------|------|------|------|------------|---------------------|------|------|------|------------|--------------------------|------|------|------|------------|------------|
|              | Right                 | Thru | Left | Peds | App. Total | Right                    | Thru | Left | Peds | App. Total | Right               | Thru | Left | Peds | App. Total | Right                    | Thru | Left | Peds | App. Total |            |
| 07:00 AM     | 0                     | 0    | 0    | 0    | 0          | 0                        | 0    | 0    | 0    | 0          | 1                   | 0    | 0    | 0    | 1          | 1                        | 0    | 0    | 0    | 1          | 2          |
| 07:15 AM     | 0                     | 0    | 0    | 0    | 0          | 0                        | 0    | 0    | 0    | 0          | 0                   | 0    | 0    | 0    | 0          | 0                        | 0    | 0    | 0    | 0          | 0          |
| 07:30 AM     | 0                     | 0    | 0    | 0    | 0          | 0                        | 0    | 0    | 0    | 0          | 0                   | 0    | 0    | 0    | 0          | 0                        | 0    | 0    | 0    | 0          | 0          |
| 07:45 AM     | 0                     | 0    | 0    | 0    | 0          | 0                        | 0    | 0    | 0    | 0          | 0                   | 0    | 0    | 0    | 0          | 0                        | 0    | 0    | 0    | 0          | 0          |
| Total Volume | 0                     | 0    | 0    | 0    | 0          | 0                        | 0    | 0    | 0    | 0          | 1                   | 0    | 0    | 0    | 1          | 1                        | 0    | 0    | 0    | 1          | 2          |
| % App. Total | 0                     | 0    | 0    | 0    | 0          | 0                        | 0    | 0    | 0    | 0          | 100                 | 0    | 0    | 0    | 100        | 100                      | 0    | 0    | 0    | 100        |            |
| PHF          | .000                  | .000 | .000 | .000 | .000       | .000                     | .000 | .000 | .000 | .000       | .250                | .000 | .000 | .250 | .250       | .000                     | .000 | .250 | .250 | .250       |            |

Peak Hour Analysis From 07:00 AM to 08:45 AM - Peak 1 of 1  
 Peak Hour for Entire Intersection Begins at 07:00 AM

# Traffic Data Service

San Jose, CA  
 (408) 622-4787  
 tdsbay@cs.com

File Name : 7AM FINAL  
 Site Code : 00000007  
 Start Date : 4/25/2018  
 Page No : 2

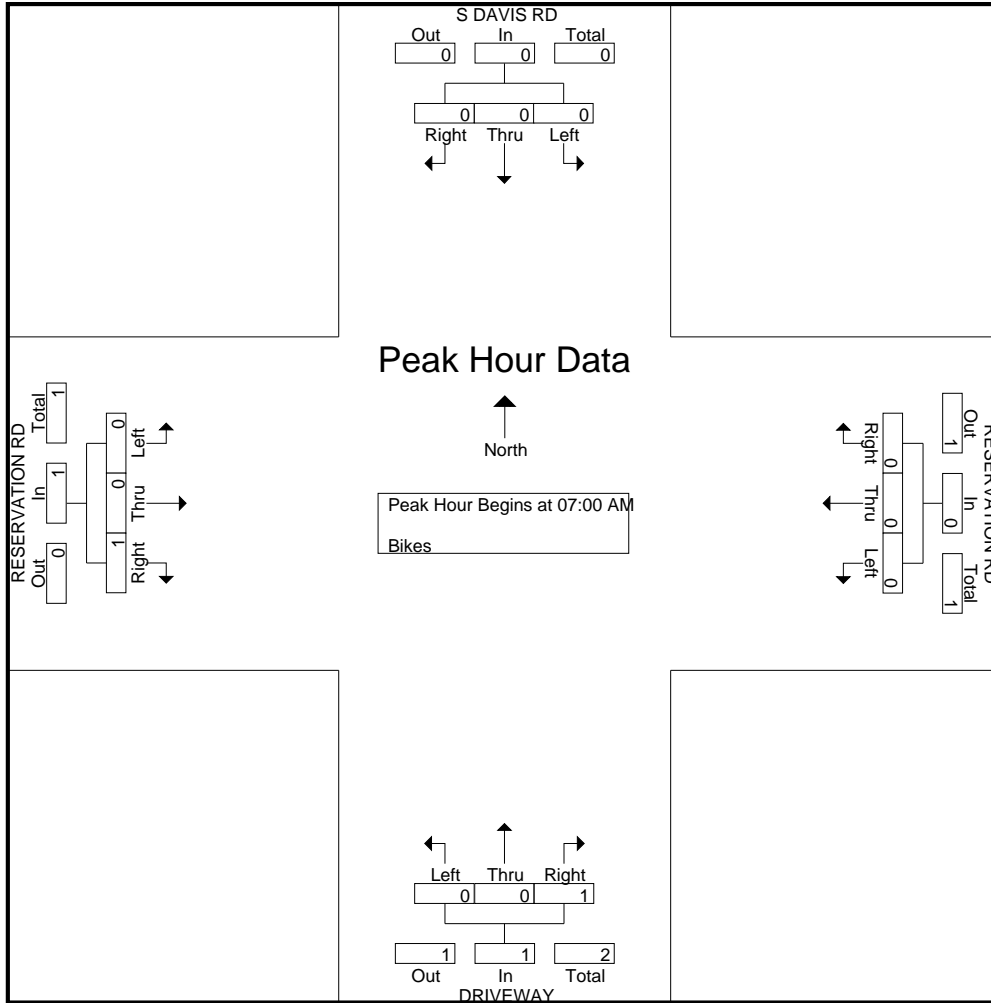

# Traffic Data Service

San Jose, CA  
 (408) 622-4787  
 tdsbay@cs.com

File Name : 7PM FINAL  
 Site Code : 00000007  
 Start Date : 4/25/2018  
 Page No : 1

## Groups Printed- Lights - Buses - Trucks

| Start Time  | S DAVIS RD Southbound |      |      |      |            | RESERVATION RD Westbound |      |      |      |            | DRIVEWAY Northbound |      |      |      |            | RESERVATION RD Eastbound |      |      |      |            | Int. Total |
|-------------|-----------------------|------|------|------|------------|--------------------------|------|------|------|------------|---------------------|------|------|------|------------|--------------------------|------|------|------|------------|------------|
|             | Right                 | Thru | Left | Peds | App. Total | Right                    | Thru | Left | Peds | App. Total | Right               | Thru | Left | Peds | App. Total | Right                    | Thru | Left | Peds | App. Total |            |
| 04:00 PM    | 33                    | 1    | 23   | 0    | 57         | 27                       | 65   | 1    | 0    | 93         | 1                   | 0    | 0    | 0    | 1          | 1                        | 96   | 59   | 0    | 156        | 307        |
| 04:15 PM    | 27                    | 0    | 37   | 0    | 64         | 24                       | 78   | 0    | 0    | 102        | 0                   | 0    | 0    | 0    | 0          | 0                        | 101  | 79   | 0    | 180        | 346        |
| 04:30 PM    | 32                    | 2    | 33   | 0    | 67         | 27                       | 59   | 1    | 0    | 87         | 1                   | 0    | 0    | 0    | 1          | 0                        | 86   | 52   | 0    | 138        | 293        |
| 04:45 PM    | 19                    | 1    | 31   | 0    | 51         | 17                       | 75   | 0    | 0    | 92         | 1                   | 0    | 1    | 0    | 2          | 0                        | 106  | 74   | 0    | 180        | 325        |
| Total       | 111                   | 4    | 124  | 0    | 239        | 95                       | 277  | 2    | 0    | 374        | 3                   | 0    | 1    | 0    | 4          | 1                        | 389  | 264  | 0    | 654        | 1271       |
| 05:00 PM    | 39                    | 1    | 23   | 0    | 63         | 47                       | 71   | 0    | 0    | 118        | 0                   | 1    | 0    | 0    | 1          | 0                        | 119  | 71   | 0    | 190        | 372        |
| 05:15 PM    | 67                    | 0    | 34   | 0    | 101        | 26                       | 80   | 0    | 0    | 106        | 1                   | 0    | 2    | 0    | 3          | 1                        | 98   | 77   | 0    | 176        | 386        |
| 05:30 PM    | 36                    | 2    | 26   | 0    | 64         | 20                       | 82   | 2    | 0    | 104        | 0                   | 0    | 0    | 0    | 0          | 0                        | 111  | 75   | 0    | 186        | 354        |
| 05:45 PM    | 40                    | 0    | 30   | 0    | 70         | 16                       | 65   | 3    | 0    | 84         | 2                   | 0    | 0    | 0    | 2          | 1                        | 103  | 78   | 0    | 182        | 338        |
| Total       | 182                   | 3    | 113  | 0    | 298        | 109                      | 298  | 5    | 0    | 412        | 3                   | 1    | 2    | 0    | 6          | 2                        | 431  | 301  | 0    | 734        | 1450       |
| Grand Total | 293                   | 7    | 237  | 0    | 537        | 204                      | 575  | 7    | 0    | 786        | 6                   | 1    | 3    | 0    | 10         | 3                        | 820  | 565  | 0    | 1388       | 2721       |
| Apprch %    | 54.6                  | 1.3  | 44.1 | 0    |            | 26                       | 73.2 | 0.9  | 0    |            | 60                  | 10   | 30   | 0    |            | 0.2                      | 59.1 | 40.7 | 0    |            |            |
| Total %     | 10.8                  | 0.3  | 8.7  | 0    | 19.7       | 7.5                      | 21.1 | 0.3  | 0    | 28.9       | 0.2                 | 0    | 0.1  | 0    | 0.4        | 0.1                      | 30.1 | 20.8 | 0    | 51         |            |
| Lights      | 290                   | 7    | 228  | 0    | 525        | 193                      | 556  | 7    | 0    | 756        | 6                   | 1    | 3    | 0    | 10         | 3                        | 798  | 559  | 0    | 1360       | 2651       |
| % Lights    | 99                    | 100  | 96.2 | 0    | 97.8       | 94.6                     | 96.7 | 100  | 0    | 96.2       | 100                 | 100  | 100  | 0    | 100        | 100                      | 97.3 | 98.9 | 0    | 98         | 97.4       |
| Buses       | 0                     | 0    | 0    | 0    | 0          | 0                        | 0    | 0    | 0    | 0          | 0                   | 0    | 0    | 0    | 0          | 0                        | 5    | 0    | 0    | 5          | 5          |
| % Buses     | 0                     | 0    | 0    | 0    | 0          | 0                        | 0    | 0    | 0    | 0          | 0                   | 0    | 0    | 0    | 0          | 0                        | 0.6  | 0    | 0    | 0.4        | 0.2        |
| Trucks      | 3                     | 0    | 9    | 0    | 12         | 11                       | 19   | 0    | 0    | 30         | 0                   | 0    | 0    | 0    | 0          | 0                        | 17   | 6    | 0    | 23         | 65         |
| % Trucks    | 1                     | 0    | 3.8  | 0    | 2.2        | 5.4                      | 3.3  | 0    | 0    | 3.8        | 0                   | 0    | 0    | 0    | 0          | 0                        | 2.1  | 1.1  | 0    | 1.7        | 2.4        |

| Start Time   | S DAVIS RD Southbound |      |      |      |            | RESERVATION RD Westbound |      |      |      |            | DRIVEWAY Northbound |      |      |      |            | RESERVATION RD Eastbound |      |      |      |            | Int. Total |
|--|-----------------------|------|------|------|------------|--------------------------|------|------|------|------------|---------------------|------|------|------|------------|--------------------------|------|------|------|------------|------------|
|  | Right                 | Thru | Left | Peds | App. Total | Right                    | Thru | Left | Peds | App. Total | Right               | Thru | Left | Peds | App. Total | Right                    | Thru | Left | Peds | App. Total |            |
| Peak Hour Analysis From 04:00 PM to 05:45 PM - Peak 1 of 1 |                       |      |      |      |            |                          |      |      |      |            |                     |      |      |      |            |                          |      |      |      |            |            |
| Peak Hour for Entire Intersection Begins at 05:00 PM       |                       |      |      |      |            |                          |      |      |      |            |                     |      |      |      |            |                          |      |      |      |            |            |
| 05:00 PM   | 39                    | 1    | 23   | 0    | 63         | 47                       | 71   | 0    | 0    | 118        | 0                   | 1    | 0    | 0    | 1          | 0                        | 119  | 71   | 0    | 190        | 372        |
| 05:15 PM   | 67                    | 0    | 34   | 0    | 101        | 26                       | 80   | 0    | 0    | 106        | 1                   | 0    | 2    | 0    | 3          | 1                        | 98   | 77   | 0    | 176        | 386        |
| 05:30 PM   | 36                    | 2    | 26   | 0    | 64         | 20                       | 82   | 2    | 0    | 104        | 0                   | 0    | 0    | 0    | 0          | 0                        | 111  | 75   | 0    | 186        | 354        |
| 05:45 PM   | 40                    | 0    | 30   | 0    | 70         | 16                       | 65   | 3    | 0    | 84         | 2                   | 0    | 0    | 0    | 2          | 1                        | 103  | 78   | 0    | 182        | 338        |
| Total Volume   | 182                   | 3    | 113  | 0    | 298        | 109                      | 298  | 5    | 0    | 412        | 3                   | 1    | 2    | 0    | 6          | 2                        | 431  | 301  | 0    | 734        | 1450       |
| % App. Total   | 61.1                  | 1    | 37.9 | 0    |            | 26.5                     | 72.3 | 1.2  | 0    |            | 50                  | 16.7 | 33.3 | 0    |            | 0.3                      | 58.7 | 41   | 0    |            |            |
| PHF  | .679                  | .375 | .831 | 0    | .738       | .580                     | .909 | .417 | 0    | .873       | .375                | .250 | .250 | 0    | .500       | .500                     | .905 | .965 | 0    | .966       | .939       |

# Traffic Data Service

San Jose, CA  
 (408) 622-4787  
 tdsbay@cs.com

File Name : 7PM FINAL  
 Site Code : 00000007  
 Start Date : 4/25/2018  
 Page No : 2

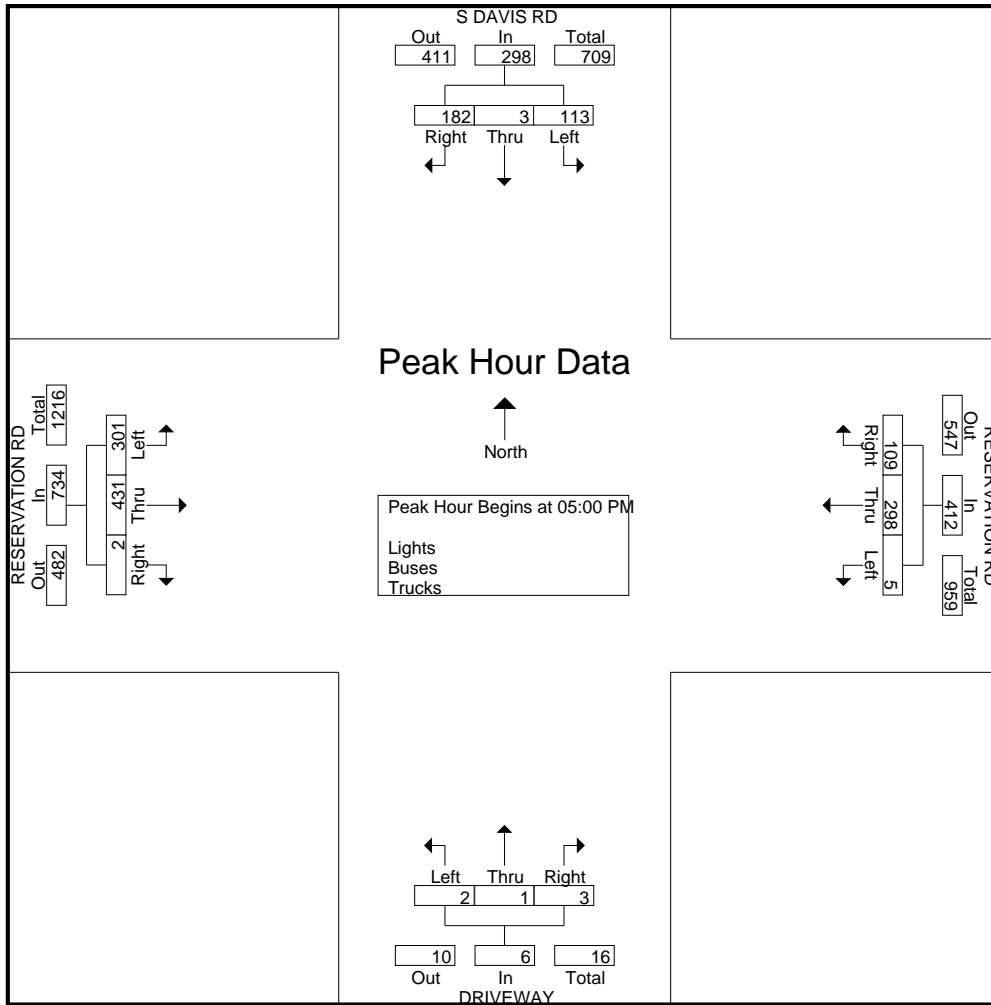

# Traffic Data Service

San Jose, CA  
 (408) 622-4787  
 tdsbay@cs.com

File Name : 7PM FINAL  
 Site Code : 00000007  
 Start Date : 4/25/2018  
 Page No : 1

Groups Printed- Bikes

| Start Time  | S DAVIS RD Southbound |      |      |      |            | RESERVATION RD Westbound |      |      |      |            | DRIVEWAY Northbound |      |      |      |            | RESERVATION RD Eastbound |      |      |      |            | Int. Total |
|-------------|-----------------------|------|------|------|------------|--------------------------|------|------|------|------------|---------------------|------|------|------|------------|--------------------------|------|------|------|------------|------------|
|             | Right                 | Thru | Left | Peds | App. Total | Right                    | Thru | Left | Peds | App. Total | Right               | Thru | Left | Peds | App. Total | Right                    | Thru | Left | Peds | App. Total |            |
| 04:00 PM    | 0                     | 0    | 0    | 0    | 0          | 0                        | 0    | 0    | 0    | 0          | 0                   | 0    | 0    | 0    | 0          | 0                        | 0    | 0    | 0    | 0          | 0          |
| 04:15 PM    | 0                     | 0    | 1    | 0    | 1          | 0                        | 0    | 0    | 0    | 0          | 0                   | 0    | 0    | 0    | 0          | 0                        | 0    | 0    | 0    | 0          | 0          |
| 04:30 PM    | 0                     | 0    | 0    | 0    | 0          | 0                        | 0    | 0    | 0    | 0          | 0                   | 0    | 0    | 0    | 0          | 0                        | 0    | 0    | 0    | 0          | 0          |
| 04:45 PM    | 0                     | 0    | 0    | 0    | 0          | 0                        | 0    | 0    | 0    | 0          | 0                   | 0    | 0    | 0    | 0          | 0                        | 0    | 0    | 0    | 0          | 0          |
| Total       | 0                     | 0    | 1    | 0    | 1          | 0                        | 0    | 0    | 0    | 0          | 0                   | 0    | 0    | 0    | 0          | 0                        | 0    | 0    | 0    | 0          | 1          |
| 05:00 PM    | 0                     | 0    | 0    | 0    | 0          | 0                        | 0    | 0    | 0    | 0          | 0                   | 0    | 0    | 0    | 0          | 0                        | 0    | 0    | 0    | 0          | 0          |
| 05:15 PM    | 0                     | 0    | 0    | 0    | 0          | 0                        | 0    | 0    | 0    | 0          | 0                   | 0    | 0    | 0    | 0          | 0                        | 0    | 0    | 0    | 0          | 0          |
| 05:30 PM    | 0                     | 0    | 0    | 0    | 0          | 0                        | 0    | 0    | 0    | 0          | 0                   | 0    | 0    | 0    | 0          | 0                        | 0    | 0    | 0    | 0          | 0          |
| 05:45 PM    | 1                     | 0    | 0    | 0    | 1          | 0                        | 0    | 0    | 0    | 0          | 0                   | 0    | 0    | 0    | 0          | 0                        | 0    | 0    | 0    | 0          | 1          |
| Total       | 1                     | 0    | 0    | 0    | 1          | 0                        | 0    | 0    | 0    | 0          | 0                   | 0    | 0    | 0    | 0          | 0                        | 0    | 0    | 0    | 0          | 1          |
| Grand Total | 1                     | 0    | 1    | 0    | 2          | 0                        | 0    | 0    | 0    | 0          | 0                   | 0    | 0    | 0    | 0          | 0                        | 0    | 0    | 0    | 0          | 2          |
| Apprch %    | 50                    | 0    | 50   | 0    |            | 0                        | 0    | 0    | 0    |            | 0                   | 0    | 0    | 0    |            | 0                        | 0    | 0    | 0    |            |            |
| Total %     | 50                    | 0    | 50   | 0    | 100        | 0                        | 0    | 0    | 0    |            | 0                   | 0    | 0    | 0    |            | 0                        | 0    | 0    | 0    |            |            |

| Start Time   | S DAVIS RD Southbound |      |      |            | RESERVATION RD Westbound |      |      |            | DRIVEWAY Northbound |      |      |            | RESERVATION RD Eastbound |      |      |            | Int. Total |
|--|-----------------------|------|------|------------|--------------------------|------|------|------------|---------------------|------|------|------------|--------------------------|------|------|------------|------------|
|  | Right                 | Thru | Left | App. Total | Right                    | Thru | Left | App. Total | Right               | Thru | Left | App. Total | Right                    | Thru | Left | App. Total |            |
| Peak Hour Analysis From 04:00 PM to 05:45 PM - Peak 1 of 1 |                       |      |      |            |                          |      |      |            |                     |      |      |            |                          |      |      |            |            |
| Peak Hour for Entire Intersection Begins at 04:00 PM       |                       |      |      |            |                          |      |      |            |                     |      |      |            |                          |      |      |            |            |
| 04:00 PM   | 0                     | 0    | 0    | 0          | 0                        | 0    | 0    | 0          | 0                   | 0    | 0    | 0          | 0                        | 0    | 0    | 0          |            |
| 04:15 PM   | 0                     | 0    | 1    | 1          | 0                        | 0    | 0    | 0          | 0                   | 0    | 0    | 0          | 0                        | 0    | 0    | 0          |            |
| 04:30 PM   | 0                     | 0    | 0    | 0          | 0                        | 0    | 0    | 0          | 0                   | 0    | 0    | 0          | 0                        | 0    | 0    | 0          |            |
| 04:45 PM   | 0                     | 0    | 0    | 0          | 0                        | 0    | 0    | 0          | 0                   | 0    | 0    | 0          | 0                        | 0    | 0    | 0          |            |
| Total Volume   | 0                     | 0    | 1    | 1          | 0                        | 0    | 0    | 0          | 0                   | 0    | 0    | 0          | 0                        | 0    | 0    | 0          |            |
| % App. Total   | 0                     | 0    | 100  |            | 0                        | 0    | 0    |            | 0                   | 0    | 0    |            | 0                        | 0    | 0    |            |            |
| PHF  | .000                  | .000 | .250 | .250       | .000                     | .000 | .000 | .000       | .000                | .000 | .000 | .000       | .000                     | .000 | .000 | .000       |            |

# Traffic Data Service

San Jose, CA  
(408) 622-4787  
tdsbay@cs.com

File Name : 7PM FINAL  
Site Code : 00000007  
Start Date : 4/25/2018  
Page No : 2

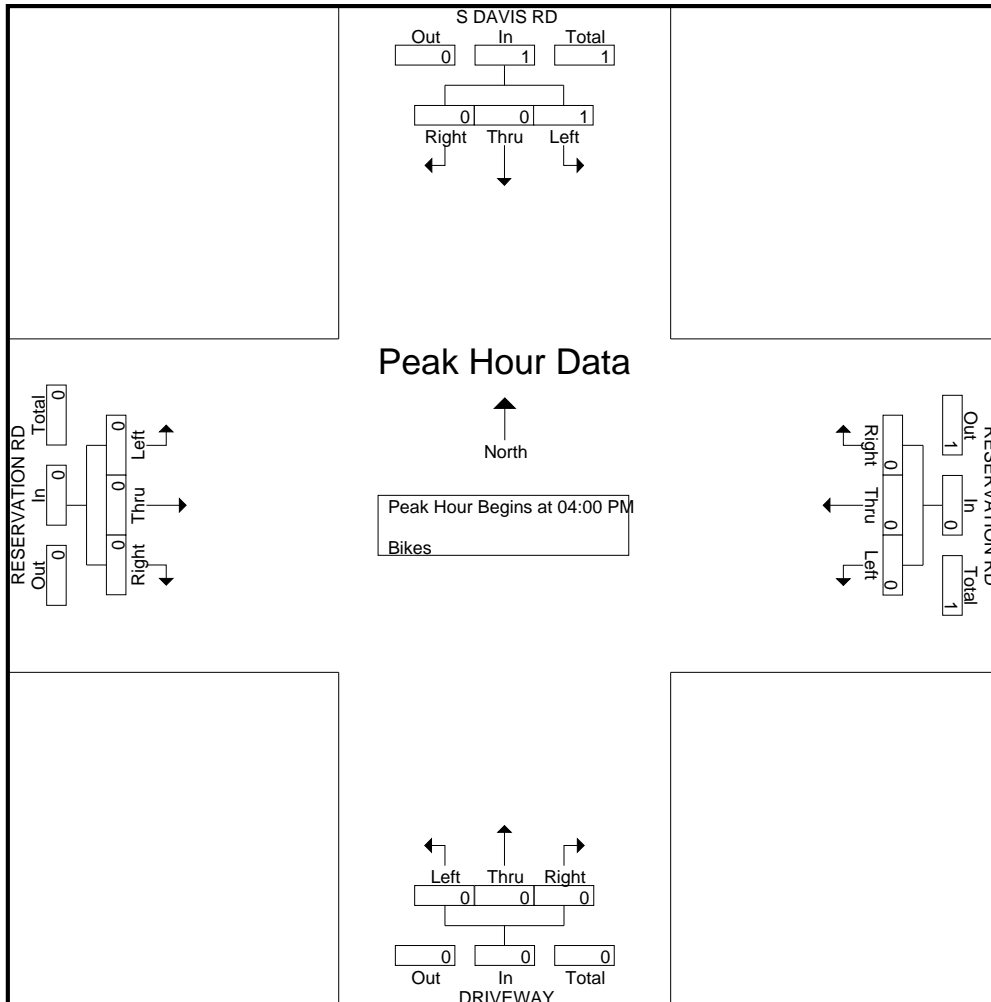



# Traffic Data Service

San Jose, CA  
 (408) 622-4787  
 tdsbay@cs.com

File Name : 8AM FINAL  
 Site Code : 00000008  
 Start Date : 4/25/2018  
 Page No : 1

Groups Printed- Lights - Buses - Trucks

| Start Time   | LIGHTFIGHTER DR<br>Southbound |      |      |      |            | COLONEL DURHAM ST<br>Westbound |      |      |      |            | MALMEDY RD<br>Northbound |      |      |      |            | DRIVEWAY<br>Eastbound |      |      |      |            | Int. Total |
|--------------|-------------------------------|------|------|------|------------|--------------------------------|------|------|------|------------|--------------------------|------|------|------|------------|-----------------------|------|------|------|------------|------------|
|              | Right                         | Thru | Left | Peds | App. Total | Right                          | Thru | Left | Peds | App. Total | Right                    | Thru | Left | Peds | App. Total | Right                 | Thru | Left | Peds | App. Total |            |
| 07:00 AM     | 0                             | 3    | 20   | 0    | 23         | 64                             | 0    | 1    | 0    | 65         | 0                        | 9    | 0    | 0    | 9          | 0                     | 0    | 0    | 0    | 0          | 97         |
| 07:15 AM     | 0                             | 5    | 28   | 0    | 33         | 74                             | 0    | 2    | 0    | 76         | 0                        | 19   | 0    | 0    | 19         | 0                     | 0    | 0    | 0    | 0          | 128        |
| 07:30 AM     | 0                             | 7    | 44   | 0    | 51         | 89                             | 0    | 6    | 0    | 95         | 3                        | 14   | 0    | 0    | 17         | 0                     | 0    | 0    | 0    | 0          | 163        |
| 07:45 AM     | 0                             | 14   | 46   | 0    | 60         | 33                             | 0    | 3    | 0    | 36         | 0                        | 16   | 0    | 0    | 16         | 0                     | 0    | 0    | 0    | 0          | 112        |
| <b>Total</b> | 0                             | 29   | 138  | 0    | 167        | 260                            | 0    | 12   | 0    | 272        | 3                        | 58   | 0    | 0    | 61         | 0                     | 0    | 0    | 0    | 0          | 500        |
| 08:00 AM     | 1                             | 15   | 29   | 0    | 45         | 34                             | 0    | 4    | 0    | 38         | 1                        | 12   | 0    | 0    | 13         | 1                     | 0    | 0    | 0    | 1          | 97         |
| 08:15 AM     | 1                             | 9    | 42   | 0    | 52         | 27                             | 0    | 1    | 0    | 28         | 1                        | 12   | 0    | 0    | 13         | 0                     | 0    | 0    | 0    | 0          | 93         |
| 08:30 AM     | 1                             | 12   | 34   | 0    | 47         | 29                             | 0    | 0    | 0    | 29         | 0                        | 2    | 0    | 0    | 2          | 0                     | 0    | 1    | 0    | 1          | 79         |
| 08:45 AM     | 0                             | 12   | 36   | 0    | 48         | 22                             | 0    | 0    | 0    | 22         | 1                        | 9    | 0    | 0    | 10         | 0                     | 0    | 0    | 0    | 0          | 80         |
| <b>Total</b> | 3                             | 48   | 141  | 0    | 192        | 112                            | 0    | 5    | 0    | 117        | 3                        | 35   | 0    | 0    | 38         | 1                     | 0    | 1    | 0    | 2          | 349        |
| Grand Total  | 3                             | 77   | 279  | 0    | 359        | 372                            | 0    | 17   | 0    | 389        | 6                        | 93   | 0    | 0    | 99         | 1                     | 0    | 1    | 0    | 2          | 849        |
| Apprch %     | 0.8                           | 21.4 | 77.7 | 0    |            | 95.6                           | 0    | 4.4  | 0    |            | 6.1                      | 93.9 | 0    | 0    |            | 50                    | 0    | 50   | 0    |            |            |
| Total %      | 0.4                           | 9.1  | 32.9 | 0    | 42.3       | 43.8                           | 0    | 2    | 0    | 45.8       | 0.7                      | 11   | 0    | 0    | 11.7       | 0.1                   | 0    | 0.1  | 0    | 0.2        |            |
| Lights       | 1                             | 76   | 270  | 0    | 347        | 362                            | 0    | 15   | 0    | 377        | 5                        | 89   | 0    | 0    | 94         | 1                     | 0    | 0    | 0    | 1          | 819        |
| % Lights     | 33.3                          | 98.7 | 96.8 | 0    | 96.7       | 97.3                           | 0    | 88.2 | 0    | 96.9       | 83.3                     | 95.7 | 0    | 0    | 94.9       | 100                   | 0    | 0    | 0    | 50         | 96.5       |
| Buses        | 0                             | 0    | 7    | 0    | 7          | 0                              | 0    | 0    | 0    | 0          | 0                        | 0    | 0    | 0    | 0          | 0                     | 0    | 0    | 0    | 0          | 7          |
| % Buses      | 0                             | 0    | 2.5  | 0    | 1.9        | 0                              | 0    | 0    | 0    | 0          | 0                        | 0    | 0    | 0    | 0          | 0                     | 0    | 0    | 0    | 0          | 0.8        |
| Trucks       | 2                             | 1    | 2    | 0    | 5          | 10                             | 0    | 2    | 0    | 12         | 1                        | 4    | 0    | 0    | 5          | 0                     | 0    | 1    | 0    | 1          | 23         |
| % Trucks     | 66.7                          | 1.3  | 0.7  | 0    | 1.4        | 2.7                            | 0    | 11.8 | 0    | 3.1        | 16.7                     | 4.3  | 0    | 0    | 5.1        | 0                     | 0    | 100  | 0    | 50         | 2.7        |

| Start Time   | LIGHTFIGHTER DR<br>Southbound |      |      |            | COLONEL DURHAM ST<br>Westbound |      |      |            | MALMEDY RD<br>Northbound |      |      |            | DRIVEWAY<br>Eastbound |      |      |            | Int. Total |
|--|-------------------------------|------|------|------------|--------------------------------|------|------|------------|--------------------------|------|------|------------|-----------------------|------|------|------------|------------|
|  | Right                         | Thru | Left | App. Total | Right                          | Thru | Left | App. Total | Right                    | Thru | Left | App. Total | Right                 | Thru | Left | App. Total |            |
| Peak Hour Analysis From 07:00 AM to 08:45 AM - Peak 1 of 1 |                               |      |      |            |                                |      |      |            |                          |      |      |            |                       |      |      |            |            |
| Peak Hour for Entire Intersection Begins at 07:00 AM       |                               |      |      |            |                                |      |      |            |                          |      |      |            |                       |      |      |            |            |
| 07:00 AM   | 0                             | 3    | 20   | 23         | 64                             | 0    | 1    | 65         | 0                        | 9    | 0    | 9          | 0                     | 0    | 0    | 0          | 97         |
| 07:15 AM   | 0                             | 5    | 28   | 33         | 74                             | 0    | 2    | 76         | 0                        | 19   | 0    | 19         | 0                     | 0    | 0    | 0          | 128        |
| 07:30 AM   | 0                             | 7    | 44   | 51         | 89                             | 0    | 6    | 95         | 3                        | 14   | 0    | 17         | 0                     | 0    | 0    | 0          | 163        |
| 07:45 AM   | 0                             | 14   | 46   | 60         | 33                             | 0    | 3    | 36         | 0                        | 16   | 0    | 16         | 0                     | 0    | 0    | 0          | 112        |
| Total Volume   | 0                             | 29   | 138  | 167        | 260                            | 0    | 12   | 272        | 3                        | 58   | 0    | 61         | 0                     | 0    | 0    | 0          | 500        |
| % App. Total   | 0                             | 17.4 | 82.6 |            | 95.6                           | 0    | 4.4  |            | 4.9                      | 95.1 | 0    |            | 0                     | 0    | 0    |            |            |
| PHF  | .000                          | .518 | .750 | .696       | .730                           | .000 | .500 | .716       | .250                     | .763 | .000 | .803       | .000                  | .000 | .000 | .000       | .767       |

# Traffic Data Service

San Jose, CA  
 (408) 622-4787  
 tdsbay@cs.com

File Name : 8AM FINAL  
 Site Code : 00000008  
 Start Date : 4/25/2018  
 Page No : 2

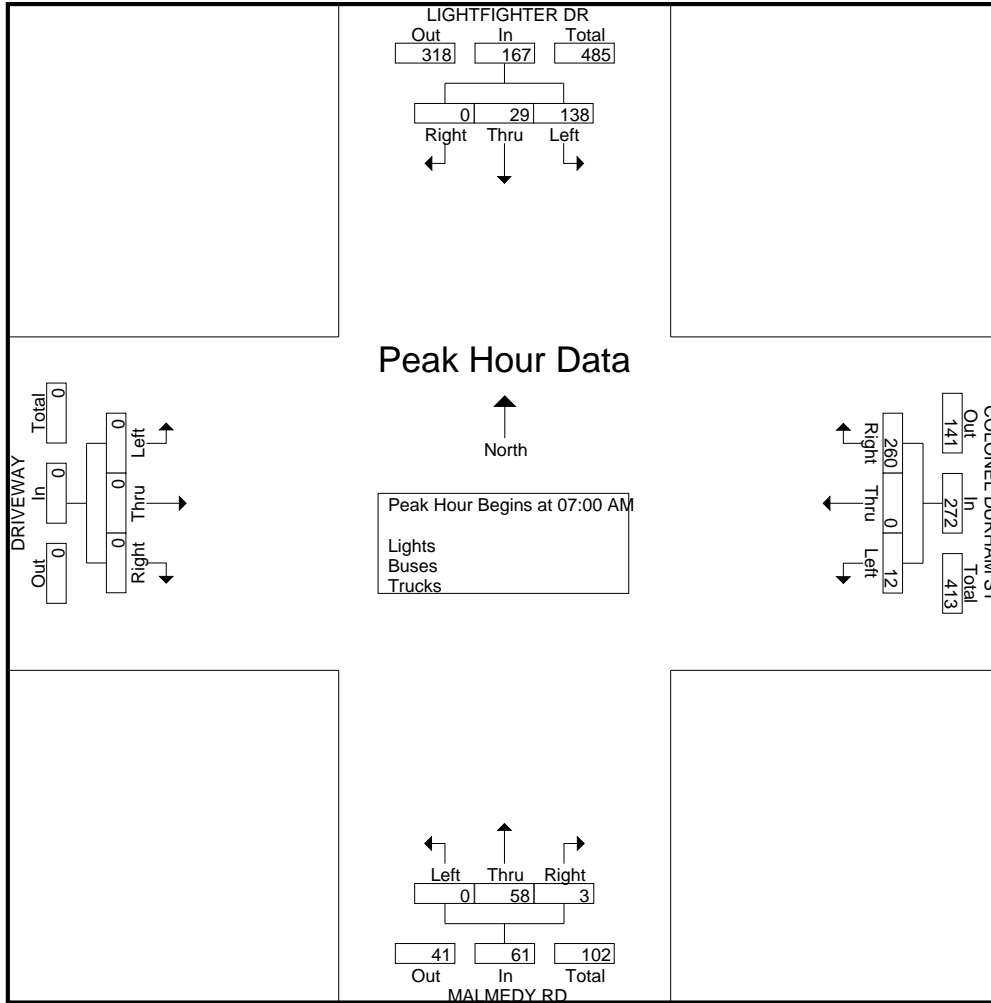

# Traffic Data Service

San Jose, CA  
 (408) 622-4787  
 tdsbay@cs.com

File Name : 8AM FINAL  
 Site Code : 00000008  
 Start Date : 4/25/2018  
 Page No : 1

Groups Printed- Bikes

| Start Time  | LIGHTFIGHTER DR Southbound |      |      |      |            | COLONEL DURHAM ST Westbound |      |      |      |            | MALMEDY RD Northbound |      |      |      |            | DRIVEWAY Eastbound |      |      |      |            | Int. Total |
|-------------|----------------------------|------|------|------|------------|-----------------------------|------|------|------|------------|-----------------------|------|------|------|------------|--------------------|------|------|------|------------|------------|
|             | Right                      | Thru | Left | Peds | App. Total | Right                       | Thru | Left | Peds | App. Total | Right                 | Thru | Left | Peds | App. Total | Right              | Thru | Left | Peds | App. Total |            |
| 07:00 AM    | 0                          | 0    | 0    | 0    | 0          | 0                           | 0    | 0    | 0    | 0          | 1                     | 0    | 0    | 0    | 1          | 0                  | 0    | 0    | 0    | 0          | 0          |
| 07:15 AM    | 0                          | 0    | 1    | 0    | 1          | 0                           | 0    | 0    | 0    | 0          | 0                     | 0    | 0    | 0    | 0          | 0                  | 0    | 0    | 0    | 0          | 0          |
| 07:30 AM    | 0                          | 0    | 0    | 0    | 0          | 0                           | 0    | 0    | 0    | 0          | 0                     | 0    | 0    | 0    | 0          | 0                  | 0    | 0    | 0    | 0          | 0          |
| 07:45 AM    | 0                          | 0    | 0    | 0    | 0          | 0                           | 0    | 0    | 0    | 0          | 0                     | 0    | 0    | 0    | 0          | 0                  | 0    | 0    | 0    | 0          | 0          |
| Total       | 0                          | 0    | 1    | 0    | 1          | 0                           | 0    | 0    | 0    | 0          | 1                     | 0    | 0    | 0    | 1          | 0                  | 0    | 0    | 0    | 0          | 2          |
| 08:00 AM    | 0                          | 0    | 0    | 0    | 0          | 0                           | 0    | 0    | 0    | 0          | 0                     | 0    | 0    | 0    | 0          | 0                  | 0    | 0    | 0    | 0          | 0          |
| 08:15 AM    | 0                          | 0    | 0    | 0    | 0          | 0                           | 0    | 0    | 0    | 0          | 0                     | 0    | 0    | 0    | 0          | 0                  | 0    | 0    | 0    | 0          | 0          |
| 08:30 AM    | 0                          | 0    | 1    | 0    | 1          | 0                           | 0    | 0    | 0    | 0          | 0                     | 0    | 0    | 0    | 0          | 0                  | 0    | 0    | 0    | 0          | 1          |
| 08:45 AM    | 0                          | 0    | 0    | 0    | 0          | 0                           | 0    | 0    | 0    | 0          | 0                     | 0    | 0    | 0    | 0          | 0                  | 0    | 0    | 0    | 0          | 0          |
| Total       | 0                          | 0    | 1    | 0    | 1          | 0                           | 0    | 0    | 0    | 0          | 0                     | 0    | 0    | 0    | 0          | 0                  | 0    | 0    | 0    | 0          | 1          |
| Grand Total | 0                          | 0    | 2    | 0    | 2          | 0                           | 0    | 0    | 0    | 0          | 1                     | 0    | 0    | 0    | 1          | 0                  | 0    | 0    | 0    | 0          | 3          |
| Apprch %    | 0                          | 0    | 100  | 0    |            | 0                           | 0    | 0    | 0    |            | 100                   | 0    | 0    | 0    |            | 0                  | 0    | 0    | 0    |            |            |
| Total %     | 0                          | 0    | 66.7 | 0    | 66.7       | 0                           | 0    | 0    | 0    | 0          | 33.3                  | 0    | 0    | 0    | 33.3       | 0                  | 0    | 0    | 0    | 0          |            |

| Start Time   | LIGHTFIGHTER DR Southbound |      |      |            | COLONEL DURHAM ST Westbound |      |      |            | MALMEDY RD Northbound |      |      |            | DRIVEWAY Eastbound |      |      |            | Int. Total |
|--|----------------------------|------|------|------------|-----------------------------|------|------|------------|-----------------------|------|------|------------|--------------------|------|------|------------|------------|
|  | Right                      | Thru | Left | App. Total | Right                       | Thru | Left | App. Total | Right                 | Thru | Left | App. Total | Right              | Thru | Left | App. Total |            |
| Peak Hour Analysis From 07:00 AM to 08:45 AM - Peak 1 of 1 |                            |      |      |            |                             |      |      |            |                       |      |      |            |                    |      |      |            |            |
| Peak Hour for Entire Intersection Begins at 07:00 AM       |                            |      |      |            |                             |      |      |            |                       |      |      |            |                    |      |      |            |            |
| 07:00 AM   | 0                          | 0    | 0    | 0          | 0                           | 0    | 0    | 0          | 1                     | 0    | 0    | 1          | 0                  | 0    | 0    | 0          | 1          |
| 07:15 AM   | 0                          | 0    | 1    | 1          | 0                           | 0    | 0    | 0          | 0                     | 0    | 0    | 0          | 0                  | 0    | 0    | 0          | 1          |
| 07:30 AM   | 0                          | 0    | 0    | 0          | 0                           | 0    | 0    | 0          | 0                     | 0    | 0    | 0          | 0                  | 0    | 0    | 0          | 0          |
| 07:45 AM   | 0                          | 0    | 0    | 0          | 0                           | 0    | 0    | 0          | 0                     | 0    | 0    | 0          | 0                  | 0    | 0    | 0          | 0          |
| Total Volume   | 0                          | 0    | 1    | 1          | 0                           | 0    | 0    | 0          | 1                     | 0    | 0    | 1          | 0                  | 0    | 0    | 0          | 2          |
| % App. Total   | 0                          | 0    | 100  |            | 0                           | 0    | 0    |            | 100                   | 0    | 0    |            | 0                  | 0    | 0    |            |            |
| PHF  | .000                       | .000 | .250 | .250       | .000                        | .000 | .000 | .000       | .250                  | .000 | .000 | .250       | .000               | .000 | .000 | .000       | .500       |

# Traffic Data Service

San Jose, CA  
(408) 622-4787  
tdsbay@cs.com

File Name : 8AM FINAL  
Site Code : 00000008  
Start Date : 4/25/2018  
Page No : 2

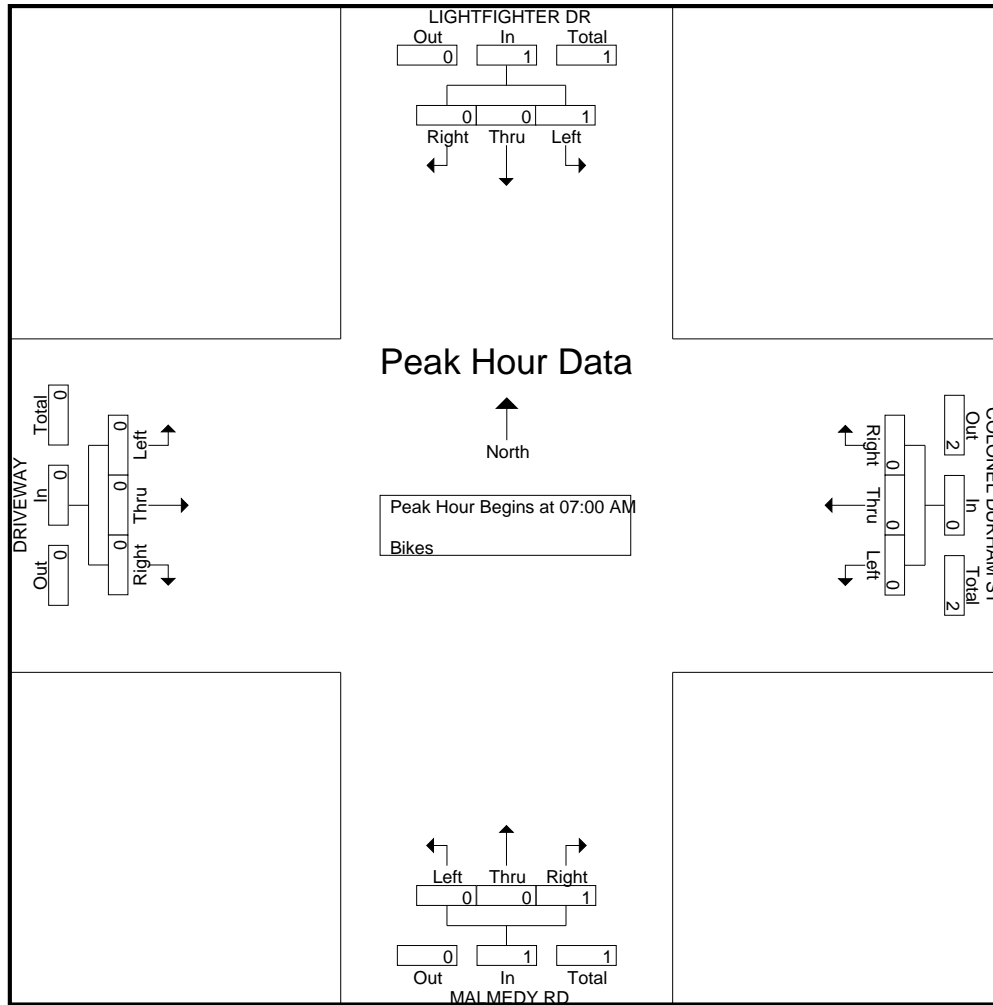

# Traffic Data Service

San Jose, CA  
 (408) 622-4787  
 tdsbay@cs.com

File Name : 8PM FINAL  
 Site Code : 00000008  
 Start Date : 4/25/2018  
 Page No : 1

Groups Printed- Lights - Buses - Trucks

| Start Time  | LIGHTFIGHTER DR Southbound |      |      |      |            | COLONEL DURHAM ST Westbound |      |      |      |            | MALMEDY RD Northbound |      |      |      |            | DRIVEWAY Eastbound |      |      |      |            | Int. Total |      |
|-------------|----------------------------|------|------|------|------------|-----------------------------|------|------|------|------------|-----------------------|------|------|------|------------|--------------------|------|------|------|------------|------------|------|
|             | Right                      | Thru | Left | Peds | App. Total | Right                       | Thru | Left | Peds | App. Total | Right                 | Thru | Left | Peds | App. Total | Right              | Thru | Left | Peds | App. Total |            |      |
| 04:00 PM    | 0                          | 12   | 32   | 0    | 44         | 46                          | 0    | 0    | 0    | 46         | 0                     | 10   | 0    | 0    | 10         | 0                  | 0    | 0    | 0    | 0          | 0          | 100  |
| 04:15 PM    | 0                          | 9    | 17   | 0    | 26         | 29                          | 0    | 1    | 0    | 30         | 2                     | 13   | 0    | 0    | 15         | 0                  | 0    | 0    | 0    | 0          | 0          | 71   |
| 04:30 PM    | 0                          | 8    | 29   | 0    | 37         | 35                          | 0    | 0    | 0    | 35         | 1                     | 13   | 0    | 0    | 14         | 0                  | 0    | 0    | 0    | 0          | 0          | 86   |
| 04:45 PM    | 0                          | 12   | 32   | 0    | 44         | 41                          | 0    | 3    | 0    | 44         | 3                     | 10   | 0    | 0    | 13         | 0                  | 0    | 0    | 0    | 0          | 0          | 101  |
| Total       | 0                          | 41   | 110  | 0    | 151        | 151                         | 0    | 4    | 0    | 155        | 6                     | 46   | 0    | 0    | 52         | 0                  | 0    | 0    | 0    | 0          | 0          | 358  |
| 05:00 PM    | 0                          | 10   | 34   | 0    | 44         | 49                          | 0    | 2    | 0    | 51         | 1                     | 10   | 0    | 0    | 11         | 0                  | 0    | 0    | 0    | 0          | 0          | 106  |
| 05:15 PM    | 0                          | 7    | 20   | 0    | 27         | 42                          | 0    | 1    | 0    | 43         | 0                     | 12   | 0    | 0    | 12         | 0                  | 0    | 0    | 0    | 0          | 0          | 82   |
| 05:30 PM    | 0                          | 9    | 34   | 0    | 43         | 25                          | 1    | 3    | 0    | 29         | 2                     | 9    | 0    | 0    | 11         | 0                  | 1    | 0    | 0    | 1          | 1          | 84   |
| 05:45 PM    | 0                          | 5    | 32   | 0    | 37         | 26                          | 0    | 2    | 0    | 28         | 0                     | 9    | 0    | 0    | 9          | 0                  | 0    | 0    | 0    | 0          | 0          | 74   |
| Total       | 0                          | 31   | 120  | 0    | 151        | 142                         | 1    | 8    | 0    | 151        | 3                     | 40   | 0    | 0    | 43         | 0                  | 1    | 0    | 0    | 1          | 1          | 346  |
| Grand Total | 0                          | 72   | 230  | 0    | 302        | 293                         | 1    | 12   | 0    | 306        | 9                     | 86   | 0    | 0    | 95         | 0                  | 1    | 0    | 0    | 1          | 1          | 704  |
| Apprch %    | 0                          | 23.8 | 76.2 | 0    |            | 95.8                        | 0.3  | 3.9  | 0    |            | 9.5                   | 90.5 | 0    | 0    |            | 0                  | 100  | 0    | 0    |            |            |      |
| Total %     | 0                          | 10.2 | 32.7 | 0    | 42.9       | 41.6                        | 0.1  | 1.7  | 0    | 43.5       | 1.3                   | 12.2 | 0    | 0    | 13.5       | 0                  | 0.1  | 0    | 0    | 0.1        |            |      |
| Lights      | 0                          | 70   | 224  | 0    | 294        | 290                         | 1    | 12   | 0    | 303        | 9                     | 85   | 0    | 0    | 94         | 0                  | 1    | 0    | 0    | 1          | 1          | 692  |
| % Lights    | 0                          | 97.2 | 97.4 | 0    | 97.4       | 99                          | 100  | 100  | 0    | 99         | 100                   | 98.8 | 0    | 0    | 98.9       | 0                  | 100  | 0    | 0    | 100        | 100        | 98.3 |
| Buses       | 0                          | 1    | 1    | 0    | 2          | 2                           | 0    | 0    | 0    | 2          | 0                     | 0    | 0    | 0    | 0          | 0                  | 0    | 0    | 0    | 0          | 0          | 4    |
| % Buses     | 0                          | 1.4  | 0.4  | 0    | 0.7        | 0.7                         | 0    | 0    | 0    | 0.7        | 0                     | 0    | 0    | 0    | 0          | 0                  | 0    | 0    | 0    | 0          | 0          | 0.6  |
| Trucks      | 0                          | 1    | 5    | 0    | 6          | 1                           | 0    | 0    | 0    | 1          | 0                     | 1    | 0    | 0    | 1          | 0                  | 0    | 0    | 0    | 0          | 0          | 8    |
| % Trucks    | 0                          | 1.4  | 2.2  | 0    | 2          | 0.3                         | 0    | 0    | 0    | 0.3        | 0                     | 1.2  | 0    | 0    | 1.1        | 0                  | 0    | 0    | 0    | 0          | 0          | 1.1  |

| Start Time   | LIGHTFIGHTER DR Southbound |      |      |            | COLONEL DURHAM ST Westbound |      |      |            | MALMEDY RD Northbound |      |      |            | DRIVEWAY Eastbound |      |      |            | Int. Total |    |
|--|----------------------------|------|------|------------|-----------------------------|------|------|------------|-----------------------|------|------|------------|--------------------|------|------|------------|------------|----|
|  | Right                      | Thru | Left | App. Total | Right                       | Thru | Left | App. Total | Right                 | Thru | Left | App. Total | Right              | Thru | Left | App. Total |            |    |
| Peak Hour Analysis From 04:00 PM to 05:45 PM - Peak 1 of 1 |                            |      |      |            |                             |      |      |            |                       |      |      |            |                    |      |      |            |            |    |
| Peak Hour for Entire Intersection Begins at 04:30 PM       |                            |      |      |            |                             |      |      |            |                       |      |      |            |                    |      |      |            |            |    |
| 04:30 PM   | 0                          | 8    | 29   | 37         | 35                          | 0    | 0    | 35         | 1                     | 13   | 0    | 14         | 0                  | 0    | 0    | 0          | 0          | 86 |
| 04:45 PM   | 0                          | 12   | 32   | 44         | 41                          | 0    | 3    | 44         | 3                     | 10   | 0    | 13         | 0                  | 0    | 0    | 0          | 101        |    |
| 05:00 PM   | 0                          | 10   | 34   | 44         | 49                          | 0    | 2    | 51         | 1                     | 10   | 0    | 11         | 0                  | 0    | 0    | 0          | 106        |    |
| 05:15 PM   | 0                          | 7    | 20   | 27         | 42                          | 0    | 1    | 43         | 0                     | 12   | 0    | 12         | 0                  | 0    | 0    | 0          | 82         |    |
| Total Volume   | 0                          | 37   | 115  | 152        | 167                         | 0    | 6    | 173        | 5                     | 45   | 0    | 50         | 0                  | 0    | 0    | 0          | 375        |    |
| % App. Total   | 0                          | 24.3 | 75.7 |            | 96.5                        | 0    | 3.5  |            | 10                    | 90   | 0    |            | 0                  | 0    | 0    |            |            |    |
| PHF  | .000                       | .771 | .846 | .864       | .852                        | .000 | .500 | .848       | .417                  | .865 | .000 | .893       | .000               | .000 | .000 | .000       | .884       |    |

# Traffic Data Service

San Jose, CA  
 (408) 622-4787  
 tdsbay@cs.com

File Name : 8PM FINAL  
 Site Code : 00000008  
 Start Date : 4/25/2018  
 Page No : 2

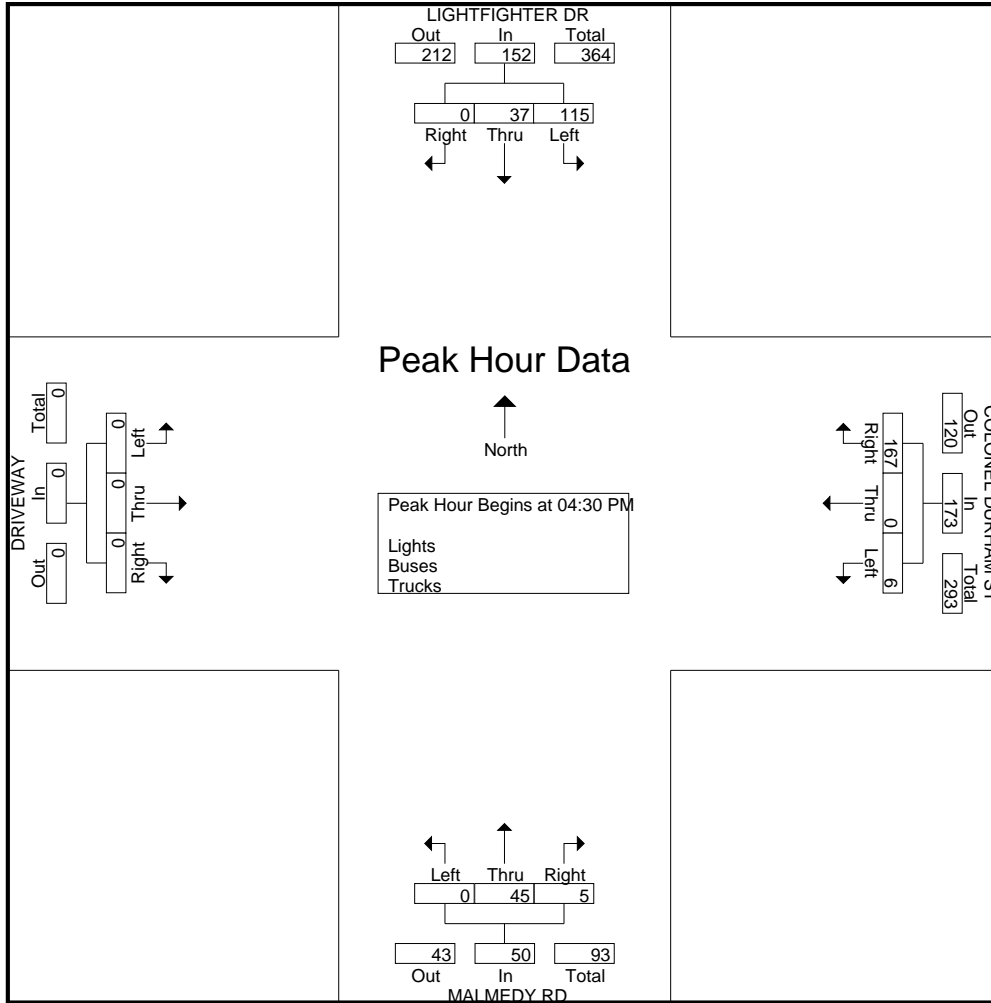

# Traffic Data Service

San Jose, CA  
 (408) 622-4787  
 tdsbay@cs.com

File Name : 8PM FINAL  
 Site Code : 00000008  
 Start Date : 4/25/2018  
 Page No : 1

Groups Printed- Bikes

| Start Time  | LIGHTFIGHTER DR Southbound |      |      |      |            | COLONEL DURHAM ST Westbound |      |      |      |            | MALMEDY RD Northbound |      |      |      |            | DRIVEWAY Eastbound |      |      |      |            | Int. Total |
|-------------|----------------------------|------|------|------|------------|-----------------------------|------|------|------|------------|-----------------------|------|------|------|------------|--------------------|------|------|------|------------|------------|
|             | Right                      | Thru | Left | Peds | App. Total | Right                       | Thru | Left | Peds | App. Total | Right                 | Thru | Left | Peds | App. Total | Right              | Thru | Left | Peds | App. Total |            |
| 04:00 PM    | 0                          | 0    | 0    | 0    | 0          | 0                           | 0    | 0    | 0    | 0          | 0                     | 0    | 0    | 0    | 0          | 0                  | 0    | 0    | 0    | 0          | 0          |
| 04:15 PM    | 0                          | 0    | 0    | 0    | 0          | 0                           | 0    | 0    | 0    | 0          | 0                     | 1    | 0    | 0    | 1          | 0                  | 0    | 0    | 0    | 0          | 0          |
| 04:30 PM    | 0                          | 0    | 0    | 0    | 0          | 0                           | 0    | 0    | 0    | 0          | 0                     | 0    | 0    | 0    | 0          | 0                  | 0    | 0    | 0    | 0          | 0          |
| 04:45 PM    | 0                          | 0    | 0    | 0    | 0          | 0                           | 0    | 0    | 0    | 0          | 1                     | 0    | 0    | 0    | 1          | 0                  | 0    | 0    | 0    | 0          | 0          |
| Total       | 0                          | 0    | 0    | 0    | 0          | 0                           | 0    | 0    | 0    | 0          | 1                     | 1    | 0    | 0    | 2          | 0                  | 0    | 0    | 0    | 0          | 0          |
| 05:00 PM    | 0                          | 0    | 0    | 0    | 0          | 0                           | 0    | 0    | 0    | 0          | 0                     | 0    | 0    | 0    | 0          | 0                  | 0    | 0    | 0    | 0          | 0          |
| 05:15 PM    | 0                          | 1    | 0    | 0    | 1          | 0                           | 0    | 0    | 0    | 0          | 0                     | 0    | 0    | 0    | 0          | 0                  | 0    | 0    | 0    | 0          | 0          |
| 05:30 PM    | 0                          | 0    | 0    | 0    | 0          | 0                           | 0    | 0    | 0    | 0          | 0                     | 0    | 0    | 0    | 0          | 0                  | 0    | 0    | 0    | 0          | 0          |
| 05:45 PM    | 0                          | 0    | 0    | 0    | 0          | 0                           | 0    | 0    | 0    | 0          | 0                     | 0    | 0    | 0    | 0          | 0                  | 0    | 0    | 0    | 0          | 0          |
| Total       | 0                          | 1    | 0    | 0    | 1          | 0                           | 0    | 0    | 0    | 0          | 0                     | 0    | 0    | 0    | 0          | 0                  | 0    | 0    | 0    | 0          | 0          |
| Grand Total | 0                          | 1    | 0    | 0    | 1          | 0                           | 0    | 0    | 0    | 0          | 1                     | 1    | 0    | 0    | 2          | 0                  | 0    | 0    | 0    | 0          | 3          |
| Apprch %    | 0                          | 100  | 0    | 0    |            | 0                           | 0    | 0    | 0    |            | 50                    | 50   | 0    | 0    |            | 0                  | 0    | 0    | 0    |            |            |
| Total %     | 0                          | 33.3 | 0    | 0    | 33.3       | 0                           | 0    | 0    | 0    | 0          | 33.3                  | 33.3 | 0    | 0    | 66.7       | 0                  | 0    | 0    | 0    | 0          |            |

| Start Time   | LIGHTFIGHTER DR Southbound |      |      |      |            | COLONEL DURHAM ST Westbound |      |      |      |            | MALMEDY RD Northbound |      |      |      |            | DRIVEWAY Eastbound |      |      |      |            | Int. Total |
|--------------|----------------------------|------|------|------|------------|-----------------------------|------|------|------|------------|-----------------------|------|------|------|------------|--------------------|------|------|------|------------|------------|
|              | Right                      | Thru | Left | Peds | App. Total | Right                       | Thru | Left | Peds | App. Total | Right                 | Thru | Left | Peds | App. Total | Right              | Thru | Left | Peds | App. Total |            |
| 04:00 PM     | 0                          | 0    | 0    | 0    | 0          | 0                           | 0    | 0    | 0    | 0          | 0                     | 0    | 0    | 0    | 0          | 0                  | 0    | 0    | 0    | 0          | 0          |
| 04:15 PM     | 0                          | 0    | 0    | 0    | 0          | 0                           | 0    | 0    | 0    | 0          | 0                     | 1    | 0    | 0    | 1          | 0                  | 0    | 0    | 0    | 0          | 0          |
| 04:30 PM     | 0                          | 0    | 0    | 0    | 0          | 0                           | 0    | 0    | 0    | 0          | 0                     | 0    | 0    | 0    | 0          | 0                  | 0    | 0    | 0    | 0          | 0          |
| 04:45 PM     | 0                          | 0    | 0    | 0    | 0          | 0                           | 0    | 0    | 0    | 0          | 1                     | 0    | 0    | 0    | 1          | 0                  | 0    | 0    | 0    | 0          | 0          |
| Total Volume | 0                          | 0    | 0    | 0    | 0          | 0                           | 0    | 0    | 0    | 0          | 1                     | 1    | 0    | 0    | 2          | 0                  | 0    | 0    | 0    | 0          | 2          |
| % App. Total | 0                          | 0    | 0    | 0    |            | 0                           | 0    | 0    | 0    |            | 50                    | 50   | 0    | 0    |            | 0                  | 0    | 0    | 0    |            |            |
| PHF          | .000                       | .000 | .000 | .000 | .000       | .000                        | .000 | .000 | .000 | .000       | .250                  | .250 | .000 | .500 | .500       | .000               | .000 | .000 | .000 | .000       | .500       |

Peak Hour Analysis From 04:00 PM to 05:45 PM - Peak 1 of 1  
 Peak Hour for Entire Intersection Begins at 04:00 PM

# Traffic Data Service

San Jose, CA  
 (408) 622-4787  
 tdsbay@cs.com

File Name : 8PM FINAL  
 Site Code : 00000008  
 Start Date : 4/25/2018  
 Page No : 2

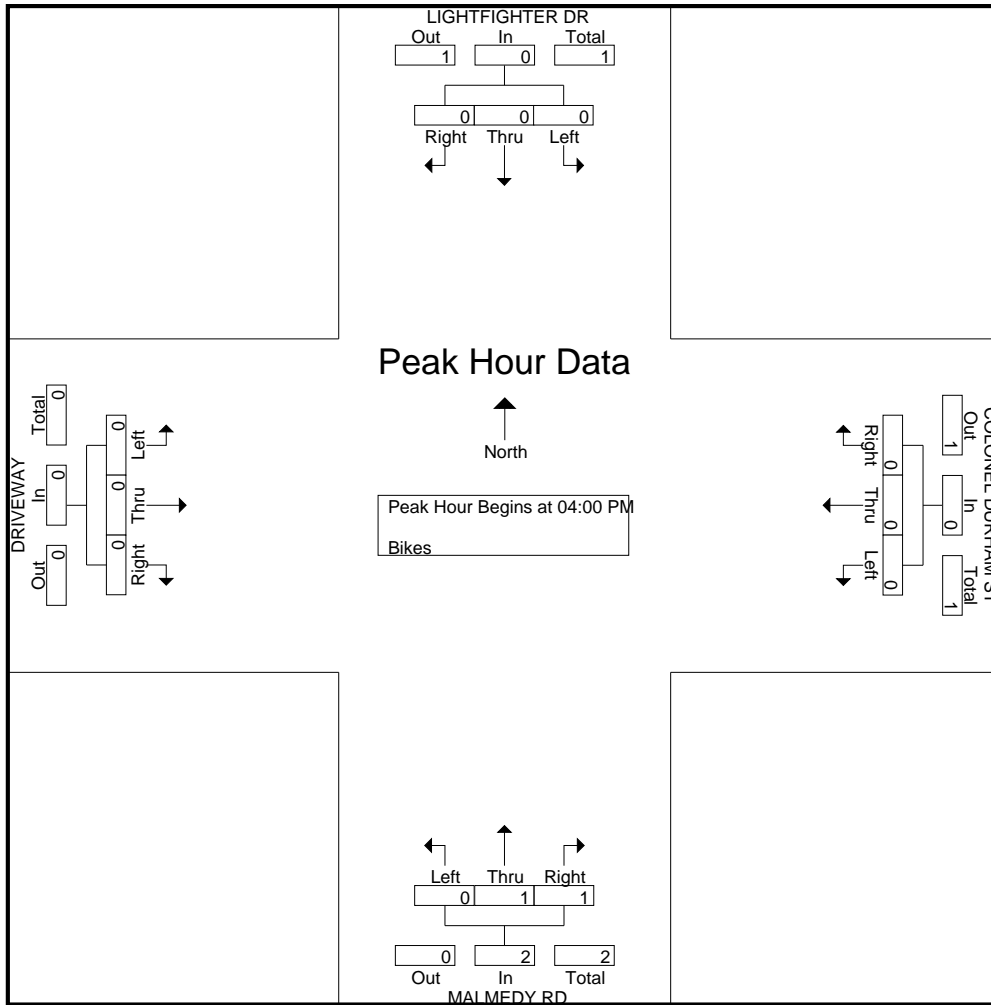



# Traffic Data Service

San Jose, CA  
(408) 622-4787  
tdsbay@cs.com

File Name : 9AM FINAL  
Site Code : 00000009  
Start Date : 4/25/2018  
Page No : 1

## Groups Printed- Lights - Buses - Trucks

| Start Time  | Southbound |      |      |      |            | COLONEL DURHAM ST Westbound |      |      |      |            | PARKER FLATS CUT OFF RD Northbound |      |      |      |            | COLONEL DURHAM ST Eastbound |      |      |      |            | Int. Total |
|-------------|------------|------|------|------|------------|-----------------------------|------|------|------|------------|------------------------------------|------|------|------|------------|-----------------------------|------|------|------|------------|------------|
|             | Right      | Thru | Left | Peds | App. Total | Right                       | Thru | Left | Peds | App. Total | Right                              | Thru | Left | Peds | App. Total | Right                       | Thru | Left | Peds | App. Total |            |
| 07:00 AM    | 0          | 0    | 0    | 0    | 0          | 0                           | 61   | 1    | 0    | 62         | 1                                  | 0    | 1    | 0    | 2          | 1                           | 9    | 0    | 0    | 10         | 74         |
| 07:15 AM    | 0          | 0    | 0    | 0    | 0          | 0                           | 82   | 3    | 0    | 85         | 1                                  | 0    | 2    | 0    | 3          | 4                           | 10   | 0    | 0    | 14         | 102        |
| 07:30 AM    | 0          | 0    | 0    | 0    | 0          | 0                           | 92   | 1    | 0    | 93         | 0                                  | 0    | 2    | 0    | 2          | 6                           | 23   | 0    | 0    | 29         | 124        |
| 07:45 AM    | 0          | 0    | 0    | 0    | 0          | 0                           | 42   | 3    | 0    | 45         | 1                                  | 0    | 2    | 0    | 3          | 6                           | 34   | 0    | 0    | 40         | 88         |
| Total       | 0          | 0    | 0    | 0    | 0          | 0                           | 277  | 8    | 0    | 285        | 3                                  | 0    | 7    | 0    | 10         | 17                          | 76   | 0    | 0    | 93         | 388        |
| 08:00 AM    | 0          | 0    | 0    | 0    | 0          | 0                           | 37   | 1    | 0    | 38         | 2                                  | 0    | 1    | 0    | 3          | 6                           | 27   | 0    | 0    | 33         | 74         |
| 08:15 AM    | 0          | 0    | 0    | 0    | 0          | 0                           | 24   | 2    | 0    | 26         | 1                                  | 0    | 2    | 0    | 3          | 4                           | 36   | 0    | 0    | 40         | 69         |
| 08:30 AM    | 0          | 0    | 0    | 0    | 0          | 0                           | 28   | 0    | 0    | 28         | 1                                  | 0    | 0    | 0    | 1          | 4                           | 28   | 0    | 0    | 32         | 61         |
| 08:45 AM    | 0          | 0    | 0    | 0    | 0          | 0                           | 21   | 1    | 0    | 22         | 0                                  | 0    | 3    | 0    | 3          | 8                           | 27   | 0    | 0    | 35         | 60         |
| Total       | 0          | 0    | 0    | 0    | 0          | 0                           | 110  | 4    | 0    | 114        | 4                                  | 0    | 6    | 0    | 10         | 22                          | 118  | 0    | 0    | 140        | 264        |
| Grand Total | 0          | 0    | 0    | 0    | 0          | 0                           | 387  | 12   | 0    | 399        | 7                                  | 0    | 13   | 0    | 20         | 39                          | 194  | 0    | 0    | 233        | 652        |
| Apprch %    | 0          | 0    | 0    | 0    | 0          | 0                           | 97   | 3    | 0    | 97.2       | 35                                 | 0    | 65   | 0    | 100        | 16.7                        | 83.3 | 0    | 0    | 96.1       |            |
| Total %     | 0          | 0    | 0    | 0    | 0          | 0                           | 59.4 | 1.8  | 0    | 61.2       | 1.1                                | 0    | 2    | 0    | 3.1        | 6                           | 29.8 | 0    | 0    | 35.7       |            |
| Lights      | 0          | 0    | 0    | 0    | 0          | 0                           | 376  | 12   | 0    | 388        | 7                                  | 0    | 13   | 0    | 20         | 39                          | 185  | 0    | 0    | 224        | 632        |
| % Lights    | 0          | 0    | 0    | 0    | 0          | 0                           | 97.2 | 100  | 0    | 97.2       | 100                                | 0    | 100  | 0    | 100        | 100                         | 95.4 | 0    | 0    | 96.1       | 96.9       |
| Buses       | 0          | 0    | 0    | 0    | 0          | 0                           | 0    | 0    | 0    | 0          | 0                                  | 0    | 0    | 0    | 0          | 0                           | 7    | 0    | 0    | 7          | 7          |
| % Buses     | 0          | 0    | 0    | 0    | 0          | 0                           | 0    | 0    | 0    | 0          | 0                                  | 0    | 0    | 0    | 0          | 0                           | 3.6  | 0    | 0    | 3          | 1.1        |
| Trucks      | 0          | 0    | 0    | 0    | 0          | 0                           | 11   | 0    | 0    | 11         | 0                                  | 0    | 0    | 0    | 0          | 0                           | 2    | 0    | 0    | 2          | 13         |
| % Trucks    | 0          | 0    | 0    | 0    | 0          | 0                           | 2.8  | 0    | 0    | 2.8        | 0                                  | 0    | 0    | 0    | 0          | 0                           | 1    | 0    | 0    | 0.9        | 2          |

| Start Time   | Southbound |      |      |      |            | COLONEL DURHAM ST Westbound |      |      |      |            | PARKER FLATS CUT OFF RD Northbound |      |      |      |            | COLONEL DURHAM ST Eastbound |      |      |      |            | Int. Total |
|--------------|------------|------|------|------|------------|-----------------------------|------|------|------|------------|------------------------------------|------|------|------|------------|-----------------------------|------|------|------|------------|------------|
|              | Right      | Thru | Left | Peds | App. Total | Right                       | Thru | Left | Peds | App. Total | Right                              | Thru | Left | Peds | App. Total | Right                       | Thru | Left | Peds | App. Total |            |
| 07:00 AM     | 0          | 0    | 0    | 0    | 0          | 0                           | 61   | 1    | 0    | 62         | 1                                  | 0    | 1    | 0    | 2          | 1                           | 9    | 0    | 0    | 10         | 74         |
| 07:15 AM     | 0          | 0    | 0    | 0    | 0          | 0                           | 82   | 3    | 0    | 85         | 1                                  | 0    | 2    | 0    | 3          | 4                           | 10   | 0    | 0    | 14         | 102        |
| 07:30 AM     | 0          | 0    | 0    | 0    | 0          | 0                           | 92   | 1    | 0    | 93         | 0                                  | 0    | 2    | 0    | 2          | 6                           | 23   | 0    | 0    | 29         | 124        |
| 07:45 AM     | 0          | 0    | 0    | 0    | 0          | 0                           | 42   | 3    | 0    | 45         | 1                                  | 0    | 2    | 0    | 3          | 6                           | 34   | 0    | 0    | 40         | 88         |
| Total Volume | 0          | 0    | 0    | 0    | 0          | 0                           | 277  | 8    | 0    | 285        | 3                                  | 0    | 7    | 0    | 10         | 17                          | 76   | 0    | 0    | 93         | 388        |
| % App. Total | 0          | 0    | 0    | 0    | 0          | 0                           | 97.2 | 2.8  | 0    | 97.2       | 30                                 | 0    | 70   | 0    | 100        | 18.3                        | 81.7 | 0    | 0    | 96.1       |            |
| PHF          | .000       | .000 | .000 | .000 | .000       | .000                        | .753 | .667 | .766 | .766       | .750                               | .000 | .875 | .833 | .833       | .708                        | .559 | .000 | .581 | .581       | .782       |

Peak Hour Analysis From 07:00 AM to 08:45 AM - Peak 1 of 1

Peak Hour for Entire Intersection Begins at 07:00 AM

# Traffic Data Service

San Jose, CA  
 (408) 622-4787  
 tdsbay@cs.com

File Name : 9AM FINAL  
 Site Code : 00000009  
 Start Date : 4/25/2018  
 Page No : 2

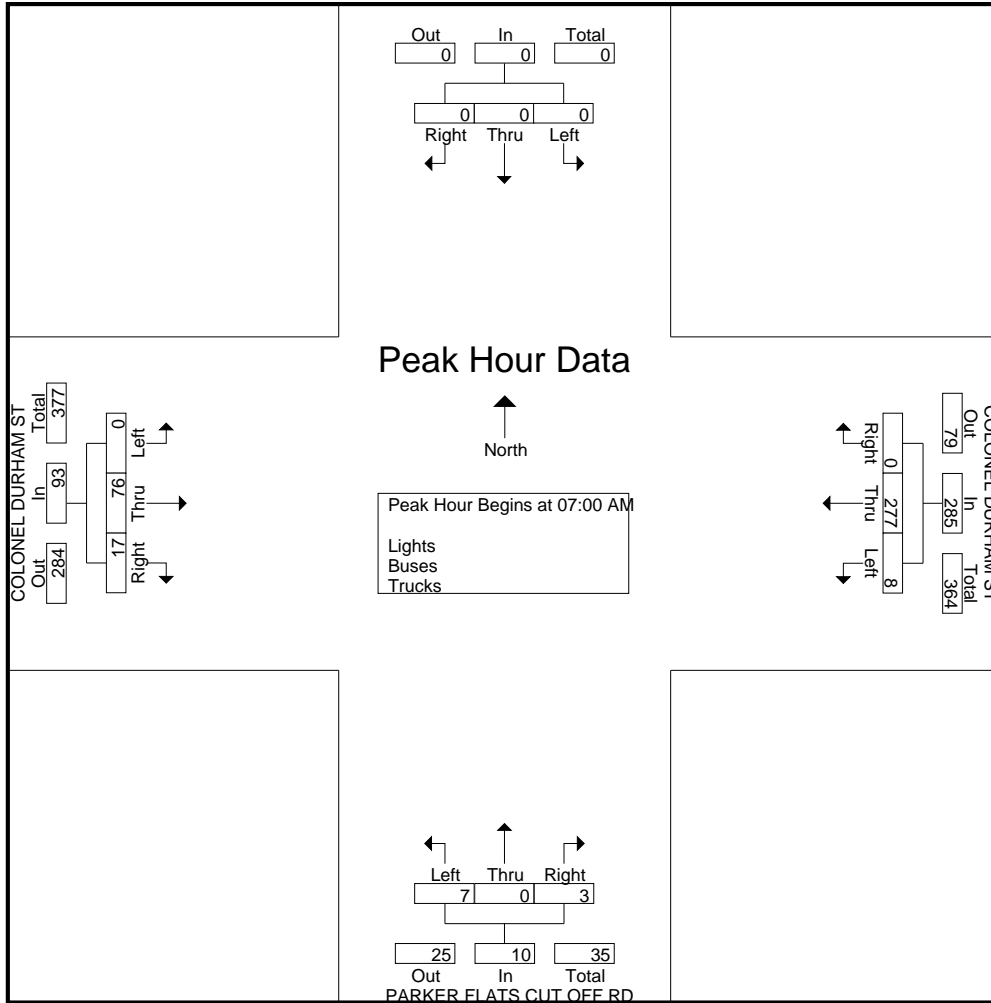

# Traffic Data Service

San Jose, CA  
 (408) 622-4787  
 tdsbay@cs.com

File Name : 9AM FINAL  
 Site Code : 00000009  
 Start Date : 4/25/2018  
 Page No : 1

Groups Printed- Bikes

| Start Time  | Southbound |      |      |      |            | COLONEL DURHAM ST Westbound |      |      |      |            | PARKER FLATS CUT OFF RD Northbound |      |      |      |            | COLONEL DURHAM ST Eastbound |      |      |      |            | Int. Total |
|-------------|------------|------|------|------|------------|-----------------------------|------|------|------|------------|------------------------------------|------|------|------|------------|-----------------------------|------|------|------|------------|------------|
|             | Right      | Thru | Left | Peds | App. Total | Right                       | Thru | Left | Peds | App. Total | Right                              | Thru | Left | Peds | App. Total | Right                       | Thru | Left | Peds | App. Total |            |
| 07:00 AM    | 0          | 0    | 0    | 0    | 0          | 0                           | 0    | 0    | 0    | 0          | 0                                  | 0    | 0    | 0    | 0          | 0                           | 1    | 0    | 0    | 0          | 1          |
| 07:15 AM    | 0          | 0    | 0    | 0    | 0          | 0                           | 0    | 0    | 0    | 0          | 0                                  | 0    | 0    | 0    | 0          | 1                           | 0    | 0    | 0    | 0          | 1          |
| 07:30 AM    | 0          | 0    | 0    | 0    | 0          | 0                           | 0    | 1    | 0    | 1          | 0                                  | 0    | 0    | 0    | 0          | 0                           | 0    | 0    | 0    | 0          | 0          |
| 07:45 AM    | 0          | 0    | 0    | 0    | 0          | 0                           | 0    | 1    | 0    | 1          | 1                                  | 0    | 0    | 0    | 1          | 0                           | 0    | 0    | 0    | 0          | 0          |
| Total       | 0          | 0    | 0    | 0    | 0          | 0                           | 0    | 2    | 0    | 2          | 1                                  | 0    | 0    | 0    | 1          | 1                           | 1    | 0    | 0    | 0          | 2          |
| 08:00 AM    | 0          | 0    | 0    | 0    | 0          | 0                           | 0    | 0    | 0    | 0          | 0                                  | 0    | 0    | 0    | 0          | 0                           | 0    | 0    | 0    | 0          | 0          |
| 08:15 AM    | 0          | 0    | 0    | 0    | 0          | 0                           | 0    | 0    | 0    | 0          | 0                                  | 0    | 0    | 0    | 0          | 0                           | 0    | 0    | 0    | 0          | 0          |
| 08:30 AM    | 0          | 0    | 0    | 0    | 0          | 0                           | 0    | 0    | 0    | 0          | 0                                  | 0    | 0    | 0    | 0          | 0                           | 1    | 0    | 0    | 0          | 1          |
| 08:45 AM    | 0          | 0    | 0    | 0    | 0          | 0                           | 0    | 0    | 0    | 0          | 0                                  | 0    | 0    | 0    | 0          | 0                           | 0    | 0    | 0    | 0          | 0          |
| Total       | 0          | 0    | 0    | 0    | 0          | 0                           | 0    | 0    | 0    | 0          | 0                                  | 0    | 0    | 0    | 0          | 0                           | 1    | 0    | 0    | 0          | 1          |
| Grand Total | 0          | 0    | 0    | 0    | 0          | 0                           | 0    | 2    | 0    | 2          | 1                                  | 0    | 0    | 0    | 1          | 1                           | 2    | 0    | 0    | 0          | 3          |
| Apprch %    | 0          | 0    | 0    | 0    | 0          | 0                           | 0    | 100  | 0    | 0          | 100                                | 0    | 0    | 0    | 0          | 33.3                        | 66.7 | 0    | 0    | 0          | 0          |
| Total %     | 0          | 0    | 0    | 0    | 0          | 0                           | 0    | 33.3 | 0    | 33.3       | 16.7                               | 0    | 0    | 0    | 16.7       | 16.7                        | 33.3 | 0    | 0    | 0          | 50         |

| Start Time   | Southbound |      |      |      |            | COLONEL DURHAM ST Westbound |      |      |      |            | PARKER FLATS CUT OFF RD Northbound |      |      |      |            | COLONEL DURHAM ST Eastbound |      |      |      |            | Int. Total |
|--------------|------------|------|------|------|------------|-----------------------------|------|------|------|------------|------------------------------------|------|------|------|------------|-----------------------------|------|------|------|------------|------------|
|              | Right      | Thru | Left | Peds | App. Total | Right                       | Thru | Left | Peds | App. Total | Right                              | Thru | Left | Peds | App. Total | Right                       | Thru | Left | Peds | App. Total |            |
| 07:00 AM     | 0          | 0    | 0    | 0    | 0          | 0                           | 0    | 0    | 0    | 0          | 0                                  | 0    | 0    | 0    | 0          | 0                           | 1    | 0    | 0    | 0          | 1          |
| 07:15 AM     | 0          | 0    | 0    | 0    | 0          | 0                           | 0    | 0    | 0    | 0          | 0                                  | 0    | 0    | 0    | 0          | 1                           | 0    | 0    | 0    | 0          | 1          |
| 07:30 AM     | 0          | 0    | 0    | 0    | 0          | 0                           | 0    | 1    | 0    | 1          | 0                                  | 0    | 0    | 0    | 0          | 0                           | 0    | 0    | 0    | 0          | 0          |
| 07:45 AM     | 0          | 0    | 0    | 0    | 0          | 0                           | 0    | 1    | 0    | 1          | 1                                  | 0    | 0    | 0    | 1          | 0                           | 0    | 0    | 0    | 0          | 0          |
| Total Volume | 0          | 0    | 0    | 0    | 0          | 0                           | 0    | 2    | 0    | 2          | 1                                  | 0    | 0    | 0    | 1          | 1                           | 1    | 0    | 0    | 0          | 2          |
| % App. Total | 0          | 0    | 0    | 0    | 0          | 0                           | 0    | 100  | 0    | 0          | 100                                | 0    | 0    | 0    | 0          | 50                          | 50   | 0    | 0    | 0          | 0          |
| PHF          | .000       | .000 | .000 | .000 | .000       | .000                        | .000 | .500 | .000 | .500       | .250                               | .000 | .000 | .250 | .250       | .250                        | .250 | .000 | .000 | .500       | .625       |

Peak Hour Analysis From 07:00 AM to 08:45 AM - Peak 1 of 1  
 Peak Hour for Entire Intersection Begins at 07:00 AM

# Traffic Data Service

San Jose, CA  
 (408) 622-4787  
 tdsbay@cs.com

File Name : 9AM FINAL  
 Site Code : 00000009  
 Start Date : 4/25/2018  
 Page No : 2

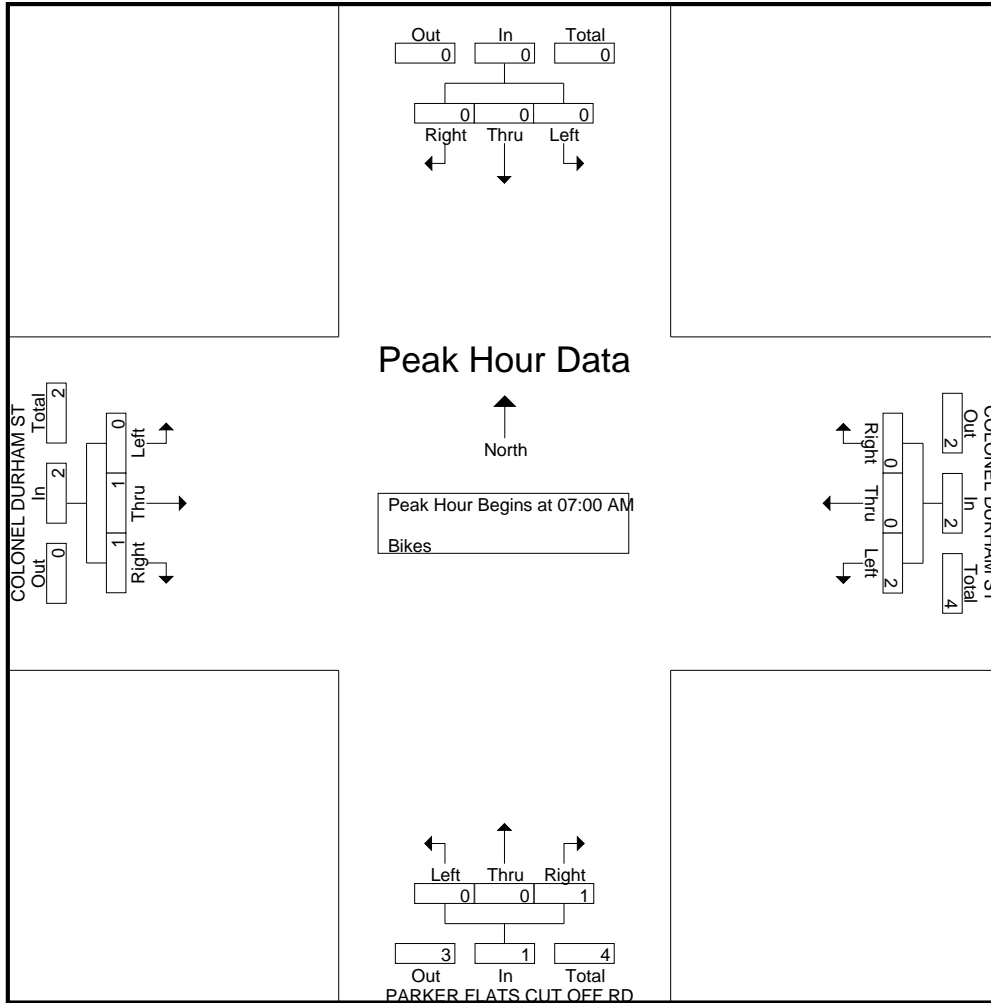

# Traffic Data Service

San Jose, CA  
(408) 622-4787  
tdsbay@cs.com

File Name : 9PM FINAL  
Site Code : 00000009  
Start Date : 4/25/2018  
Page No : 1

Groups Printed- Lights - Buses - Trucks

| Start Time  | Southbound |      |      |      |            | COLONEL DURHAM ST Westbound |      |      |      |            | PARKER FLATS CUT OFF RD Northbound |      |      |      |            | COLONEL DURHAM ST Eastbound |      |      |      |            | Int. Total |
|-------------|------------|------|------|------|------------|-----------------------------|------|------|------|------------|------------------------------------|------|------|------|------------|-----------------------------|------|------|------|------------|------------|
|             | Right      | Thru | Left | Peds | App. Total | Right                       | Thru | Left | Peds | App. Total | Right                              | Thru | Left | Peds | App. Total | Right                       | Thru | Left | Peds | App. Total |            |
| 04:00 PM    | 0          | 0    | 0    | 0    | 0          | 0                           | 32   | 3    | 0    | 35         | 2                                  | 0    | 8    | 0    | 10         | 1                           | 33   | 0    | 0    | 34         | 79         |
| 04:15 PM    | 0          | 0    | 0    | 0    | 0          | 0                           | 17   | 0    | 0    | 17         | 3                                  | 0    | 7    | 0    | 10         | 1                           | 16   | 0    | 0    | 17         | 44         |
| 04:30 PM    | 0          | 0    | 0    | 0    | 0          | 0                           | 26   | 2    | 0    | 28         | 0                                  | 0    | 6    | 0    | 6          | 0                           | 23   | 0    | 0    | 23         | 57         |
| 04:45 PM    | 0          | 0    | 0    | 0    | 0          | 0                           | 38   | 0    | 0    | 38         | 3                                  | 0    | 5    | 0    | 8          | 0                           | 31   | 0    | 0    | 31         | 77         |
| Total       | 0          | 0    | 0    | 0    | 0          | 0                           | 113  | 5    | 0    | 118        | 8                                  | 0    | 26   | 0    | 34         | 2                           | 103  | 0    | 0    | 105        | 257        |
| 05:00 PM    | 0          | 0    | 0    | 0    | 0          | 0                           | 37   | 0    | 0    | 37         | 0                                  | 0    | 9    | 0    | 9          | 2                           | 32   | 0    | 0    | 34         | 80         |
| 05:15 PM    | 0          | 0    | 0    | 0    | 0          | 0                           | 35   | 0    | 0    | 35         | 1                                  | 0    | 4    | 2    | 7          | 2                           | 15   | 0    | 0    | 17         | 59         |
| 05:30 PM    | 0          | 0    | 0    | 0    | 0          | 0                           | 19   | 1    | 0    | 20         | 1                                  | 0    | 8    | 0    | 9          | 1                           | 24   | 0    | 0    | 25         | 54         |
| 05:45 PM    | 0          | 0    | 0    | 0    | 0          | 0                           | 21   | 0    | 0    | 21         | 0                                  | 0    | 4    | 2    | 6          | 0                           | 21   | 0    | 0    | 21         | 48         |
| Total       | 0          | 0    | 0    | 0    | 0          | 0                           | 112  | 1    | 0    | 113        | 2                                  | 0    | 25   | 4    | 31         | 5                           | 92   | 0    | 0    | 97         | 241        |
| Grand Total | 0          | 0    | 0    | 0    | 0          | 0                           | 225  | 6    | 0    | 231        | 10                                 | 0    | 51   | 4    | 65         | 7                           | 195  | 0    | 0    | 202        | 498        |
| Apprch %    | 0          | 0    | 0    | 0    | 0          | 0                           | 97.4 | 2.6  | 0    | 231        | 15.4                               | 0    | 78.5 | 6.2  | 65         | 3.5                         | 96.5 | 0    | 0    | 202        |            |
| Total %     | 0          | 0    | 0    | 0    | 0          | 0                           | 45.2 | 1.2  | 0    | 46.4       | 2                                  | 0    | 10.2 | 0.8  | 13.1       | 1.4                         | 39.2 | 0    | 0    | 40.6       |            |
| Lights      | 0          | 0    | 0    | 0    | 0          | 0                           | 223  | 6    | 0    | 229        | 10                                 | 0    | 51   | 4    | 65         | 7                           | 188  | 0    | 0    | 195        | 489        |
| % Lights    | 0          | 0    | 0    | 0    | 0          | 0                           | 99.1 | 100  | 0    | 99.1       | 100                                | 0    | 100  | 100  | 100        | 100                         | 96.4 | 0    | 0    | 96.5       | 98.2       |
| Buses       | 0          | 0    | 0    | 0    | 0          | 0                           | 2    | 0    | 0    | 2          | 0                                  | 0    | 0    | 0    | 0          | 0                           | 1    | 0    | 0    | 1          | 3          |
| % Buses     | 0          | 0    | 0    | 0    | 0          | 0                           | 0.9  | 0    | 0    | 0.9        | 0                                  | 0    | 0    | 0    | 0          | 0                           | 0.5  | 0    | 0    | 0.5        | 0.6        |
| Trucks      | 0          | 0    | 0    | 0    | 0          | 0                           | 0    | 0    | 0    | 0          | 0                                  | 0    | 0    | 0    | 0          | 0                           | 6    | 0    | 0    | 6          | 6          |
| % Trucks    | 0          | 0    | 0    | 0    | 0          | 0                           | 0    | 0    | 0    | 0          | 0                                  | 0    | 0    | 0    | 0          | 0                           | 3.1  | 0    | 0    | 3          | 1.2        |

| Start Time   | Southbound |      |      |            | COLONEL DURHAM ST Westbound |      |      |            | PARKER FLATS CUT OFF RD Northbound |      |      |            | COLONEL DURHAM ST Eastbound |      |      |            | Int. Total |
|--|------------|------|------|------------|-----------------------------|------|------|------------|------------------------------------|------|------|------------|-----------------------------|------|------|------------|------------|
|  | Right      | Thru | Left | App. Total | Right                       | Thru | Left | App. Total | Right                              | Thru | Left | App. Total | Right                       | Thru | Left | App. Total |            |
| Peak Hour Analysis From 04:00 PM to 05:45 PM - Peak 1 of 1 |            |      |      |            |                             |      |      |            |                                    |      |      |            |                             |      |      |            |            |
| Peak Hour for Entire Intersection Begins at 04:30 PM       |            |      |      |            |                             |      |      |            |                                    |      |      |            |                             |      |      |            |            |
| 04:30 PM   | 0          | 0    | 0    | 0          | 0                           | 26   | 2    | 28         | 0                                  | 0    | 6    | 6          | 0                           | 23   | 0    | 23         | 57         |
| 04:45 PM   | 0          | 0    | 0    | 0          | 0                           | 38   | 0    | 38         | 3                                  | 0    | 5    | 8          | 0                           | 31   | 0    | 31         | 77         |
| 05:00 PM   | 0          | 0    | 0    | 0          | 0                           | 37   | 0    | 37         | 0                                  | 0    | 9    | 9          | 2                           | 32   | 0    | 34         | 80         |
| 05:15 PM   | 0          | 0    | 0    | 0          | 0                           | 35   | 0    | 35         | 1                                  | 0    | 4    | 5          | 2                           | 15   | 0    | 17         | 57         |
| Total Volume   | 0          | 0    | 0    | 0          | 0                           | 136  | 2    | 138        | 4                                  | 0    | 24   | 28         | 4                           | 101  | 0    | 105        | 271        |
| % App. Total   | 0          | 0    | 0    | 0          | 0                           | 98.6 | 1.4  | 138        | 14.3                               | 0    | 85.7 | 28         | 3.8                         | 96.2 | 0    | 105        |            |
| PHF  | .000       | .000 | .000 | .000       | .000                        | .895 | .250 | .908       | .333                               | .000 | .667 | .778       | .500                        | .789 | .000 | .772       | .847       |

# Traffic Data Service

San Jose, CA  
 (408) 622-4787  
 tdsbay@cs.com

File Name : 9PM FINAL  
 Site Code : 00000009  
 Start Date : 4/25/2018  
 Page No : 2

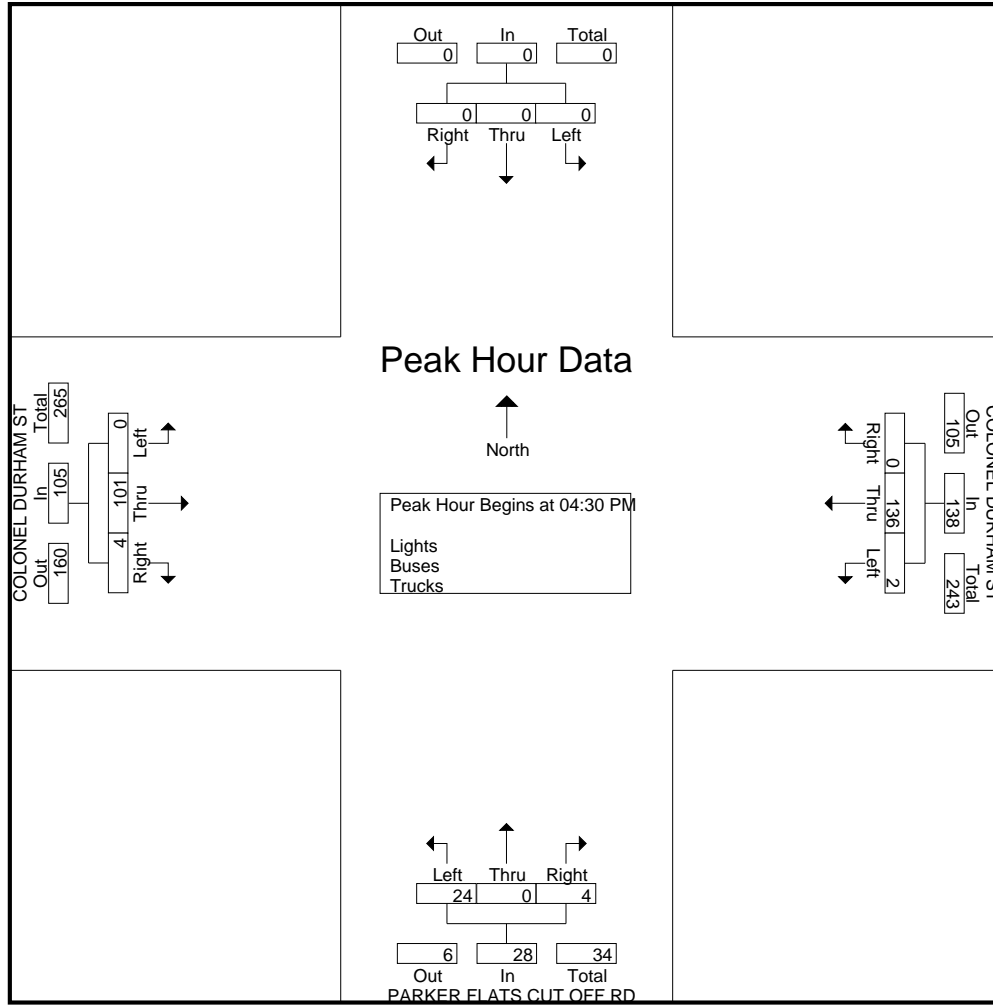

# Traffic Data Service

San Jose, CA  
 (408) 622-4787  
 tdsbay@cs.com

File Name : 9PM FINAL  
 Site Code : 00000009  
 Start Date : 4/25/2018  
 Page No : 1

Groups Printed- Bikes

| Start Time  | Southbound |      |      |      |            | COLONEL DURHAM ST Westbound |      |      |      |            | PARKER FLATS CUT OFF RD Northbound |      |      |      |            | COLONEL DURHAM ST Eastbound |      |      |      |            | Int. Total |
|-------------|------------|------|------|------|------------|-----------------------------|------|------|------|------------|------------------------------------|------|------|------|------------|-----------------------------|------|------|------|------------|------------|
|             | Right      | Thru | Left | Peds | App. Total | Right                       | Thru | Left | Peds | App. Total | Right                              | Thru | Left | Peds | App. Total | Right                       | Thru | Left | Peds | App. Total |            |
| 04:00 PM    | 0          | 0    | 0    | 0    | 0          | 0                           | 0    | 0    | 0    | 0          | 0                                  | 0    | 0    | 0    | 0          | 0                           | 0    | 0    | 0    | 0          | 0          |
| 04:15 PM    | 0          | 0    | 0    | 0    | 0          | 0                           | 0    | 0    | 0    | 0          | 0                                  | 0    | 0    | 0    | 0          | 0                           | 0    | 0    | 0    | 0          | 0          |
| 04:30 PM    | 0          | 0    | 0    | 0    | 0          | 0                           | 0    | 1    | 0    | 1          | 0                                  | 0    | 0    | 0    | 0          | 0                           | 0    | 0    | 0    | 0          | 1          |
| 04:45 PM    | 0          | 0    | 0    | 0    | 0          | 0                           | 0    | 0    | 0    | 0          | 0                                  | 0    | 0    | 0    | 0          | 0                           | 0    | 0    | 0    | 0          | 0          |
| Total       | 0          | 0    | 0    | 0    | 0          | 0                           | 0    | 1    | 0    | 1          | 0                                  | 0    | 0    | 0    | 0          | 0                           | 0    | 0    | 0    | 0          | 1          |
| 05:00 PM    | 0          | 0    | 0    | 0    | 0          | 0                           | 0    | 0    | 0    | 0          | 0                                  | 0    | 0    | 0    | 0          | 0                           | 1    | 0    | 0    | 1          | 1          |
| 05:15 PM    | 0          | 0    | 0    | 0    | 0          | 0                           | 0    | 0    | 0    | 0          | 0                                  | 0    | 0    | 0    | 0          | 0                           | 0    | 0    | 0    | 0          | 0          |
| 05:30 PM    | 0          | 0    | 0    | 0    | 0          | 0                           | 0    | 0    | 0    | 0          | 0                                  | 0    | 0    | 0    | 0          | 0                           | 0    | 0    | 0    | 0          | 0          |
| 05:45 PM    | 0          | 0    | 0    | 0    | 0          | 0                           | 0    | 0    | 0    | 0          | 0                                  | 0    | 0    | 0    | 0          | 0                           | 0    | 0    | 0    | 0          | 0          |
| Total       | 0          | 0    | 0    | 0    | 0          | 0                           | 0    | 0    | 0    | 0          | 0                                  | 0    | 0    | 0    | 0          | 0                           | 1    | 0    | 0    | 1          | 1          |
| Grand Total | 0          | 0    | 0    | 0    | 0          | 0                           | 0    | 1    | 0    | 1          | 0                                  | 0    | 0    | 0    | 0          | 0                           | 1    | 0    | 0    | 1          | 2          |
| Apprch %    | 0          | 0    | 0    | 0    |            | 0                           | 0    | 100  | 0    |            | 0                                  | 0    | 0    | 0    |            | 0                           | 100  | 0    | 0    |            |            |
| Total %     | 0          | 0    | 0    | 0    | 0          | 0                           | 0    | 50   | 0    | 50         | 0                                  | 0    | 0    | 0    | 0          | 0                           | 50   | 0    | 0    | 50         |            |

| Start Time   | Southbound |      |      |      |            | COLONEL DURHAM ST Westbound |      |      |      |            | PARKER FLATS CUT OFF RD Northbound |      |      |      |            | COLONEL DURHAM ST Eastbound |      |      |      |            | Int. Total |
|--------------|------------|------|------|------|------------|-----------------------------|------|------|------|------------|------------------------------------|------|------|------|------------|-----------------------------|------|------|------|------------|------------|
|              | Right      | Thru | Left | Peds | App. Total | Right                       | Thru | Left | Peds | App. Total | Right                              | Thru | Left | Peds | App. Total | Right                       | Thru | Left | Peds | App. Total |            |
| 04:15 PM     | 0          | 0    | 0    | 0    | 0          | 0                           | 0    | 0    | 0    | 0          | 0                                  | 0    | 0    | 0    | 0          | 0                           | 0    | 0    | 0    | 0          | 0          |
| 04:30 PM     | 0          | 0    | 0    | 0    | 0          | 0                           | 0    | 1    | 0    | 1          | 0                                  | 0    | 0    | 0    | 0          | 0                           | 0    | 0    | 0    | 0          | 1          |
| 04:45 PM     | 0          | 0    | 0    | 0    | 0          | 0                           | 0    | 0    | 0    | 0          | 0                                  | 0    | 0    | 0    | 0          | 0                           | 0    | 0    | 0    | 0          | 0          |
| 05:00 PM     | 0          | 0    | 0    | 0    | 0          | 0                           | 0    | 0    | 0    | 0          | 0                                  | 0    | 0    | 0    | 0          | 0                           | 1    | 0    | 0    | 1          | 1          |
| Total Volume | 0          | 0    | 0    | 0    | 0          | 0                           | 0    | 1    | 0    | 1          | 0                                  | 0    | 0    | 0    | 0          | 0                           | 1    | 0    | 0    | 1          | 2          |
| % App. Total | 0          | 0    | 0    | 0    |            | 0                           | 0    | 100  | 0    |            | 0                                  | 0    | 0    | 0    |            | 0                           | 100  | 0    | 0    |            |            |
| PHF          | .000       | .000 | .000 | .000 | .000       | .000                        | .000 | .250 | .250 | .000       | .000                               | .000 | .000 | .000 | .000       | .000                        | .250 | .000 | .250 | .500       |            |

Peak Hour Analysis From 04:00 PM to 05:45 PM - Peak 1 of 1  
 Peak Hour for Entire Intersection Begins at 04:15 PM

# Traffic Data Service

San Jose, CA  
 (408) 622-4787  
 tdsbay@cs.com

File Name : 9PM FINAL  
 Site Code : 00000009  
 Start Date : 4/25/2018  
 Page No : 2

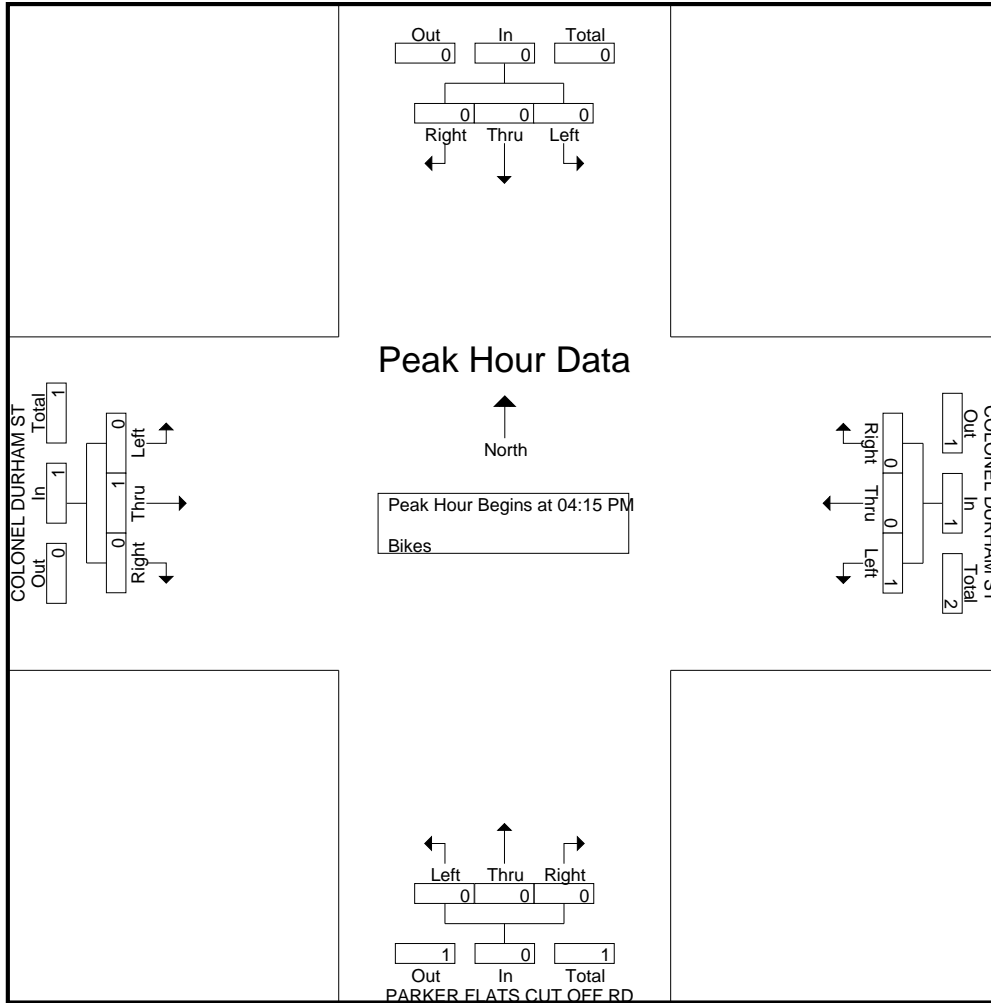



# Traffic Data Service

San Jose, CA  
 (408) 622-4787  
 tdsbay@cs.com

File Name : 10AM FINAL  
 Site Code : 00000010  
 Start Date : 4/25/2018  
 Page No : 1

Groups Printed- Lights - Buses - Trucks

| Start Time  | 6TH AVE Southbound |      |      |      |            | COLONEL DURHAM ST Westbound |      |      |      |            | 6TH AVE Northbound |      |      |      |            | COLONEL DURHAM ST Eastbound |      |      |      |            | Int. Total |
|-------------|--------------------|------|------|------|------------|-----------------------------|------|------|------|------------|--------------------|------|------|------|------------|-----------------------------|------|------|------|------------|------------|
|             | Right              | Thru | Left | Peds | App. Total | Right                       | Thru | Left | Peds | App. Total | Right              | Thru | Left | Peds | App. Total | Right                       | Thru | Left | Peds | App. Total |            |
| 07:00 AM    | 11                 | 0    | 0    | 0    | 11         | 0                           | 55   | 0    | 0    | 55         | 0                  | 0    | 0    | 0    | 0          | 1                           | 7    | 1    | 0    | 9          | 75         |
| 07:15 AM    | 21                 | 1    | 0    | 0    | 22         | 0                           | 58   | 2    | 0    | 60         | 0                  | 1    | 0    | 0    | 1          | 5                           | 6    | 2    | 0    | 13         | 96         |
| 07:30 AM    | 13                 | 3    | 0    | 0    | 16         | 0                           | 78   | 4    | 0    | 82         | 1                  | 2    | 1    | 0    | 4          | 7                           | 9    | 5    | 0    | 21         | 123        |
| 07:45 AM    | 8                  | 1    | 0    | 0    | 9          | 0                           | 39   | 4    | 0    | 43         | 1                  | 4    | 0    | 0    | 5          | 10                          | 23   | 6    | 0    | 39         | 96         |
| Total       | 53                 | 5    | 0    | 0    | 58         | 0                           | 230  | 10   | 0    | 240        | 2                  | 7    | 1    | 0    | 10         | 23                          | 45   | 14   | 0    | 82         | 390        |
| 08:00 AM    | 7                  | 5    | 0    | 0    | 12         | 0                           | 31   | 2    | 0    | 33         | 0                  | 1    | 0    | 0    | 1          | 5                           | 17   | 4    | 1    | 27         | 73         |
| 08:15 AM    | 6                  | 1    | 1    | 0    | 8          | 0                           | 20   | 1    | 0    | 21         | 0                  | 2    | 0    | 0    | 2          | 3                           | 16   | 14   | 0    | 33         | 64         |
| 08:30 AM    | 3                  | 0    | 0    | 0    | 3          | 0                           | 22   | 1    | 0    | 23         | 0                  | 3    | 3    | 0    | 6          | 4                           | 14   | 14   | 0    | 32         | 64         |
| 08:45 AM    | 4                  | 0    | 0    | 0    | 4          | 0                           | 17   | 1    | 0    | 18         | 0                  | 3    | 0    | 0    | 3          | 2                           | 9    | 15   | 0    | 26         | 51         |
| Total       | 20                 | 6    | 1    | 0    | 27         | 0                           | 90   | 5    | 0    | 95         | 0                  | 9    | 3    | 0    | 12         | 14                          | 56   | 47   | 1    | 118        | 252        |
| Grand Total | 73                 | 11   | 1    | 0    | 85         | 0                           | 320  | 15   | 0    | 335        | 2                  | 16   | 4    | 0    | 22         | 37                          | 101  | 61   | 1    | 200        | 642        |
| Apprch %    | 85.9               | 12.9 | 1.2  | 0    |            | 0                           | 95.5 | 4.5  | 0    |            | 9.1                | 72.7 | 18.2 | 0    |            | 18.5                        | 50.5 | 30.5 | 0.5  |            |            |
| Total %     | 11.4               | 1.7  | 0.2  | 0    | 13.2       | 0                           | 49.8 | 2.3  | 0    | 52.2       | 0.3                | 2.5  | 0.6  | 0    | 3.4        | 5.8                         | 15.7 | 9.5  | 0.2  | 31.2       |            |
| Lights      | 72                 | 10   | 1    | 0    | 83         | 0                           | 310  | 15   | 0    | 325        | 1                  | 15   | 4    | 0    | 20         | 37                          | 93   | 60   | 1    | 191        | 619        |
| % Lights    | 98.6               | 90.9 | 100  | 0    | 97.6       | 0                           | 96.9 | 100  | 0    | 97         | 50                 | 93.8 | 100  | 0    | 90.9       | 100                         | 92.1 | 98.4 | 100  | 95.5       | 96.4       |
| Buses       | 0                  | 1    | 0    | 0    | 1          | 0                           | 0    | 0    | 0    | 0          | 1                  | 1    | 0    | 0    | 2          | 0                           | 6    | 1    | 0    | 7          | 10         |
| % Buses     | 0                  | 9.1  | 0    | 0    | 1.2        | 0                           | 0    | 0    | 0    | 0          | 50                 | 6.2  | 0    | 0    | 9.1        | 0                           | 5.9  | 1.6  | 0    | 3.5        | 1.6        |
| Trucks      | 1                  | 0    | 0    | 0    | 1          | 0                           | 10   | 0    | 0    | 10         | 0                  | 0    | 0    | 0    | 0          | 0                           | 2    | 0    | 0    | 2          | 13         |
| % Trucks    | 1.4                | 0    | 0    | 0    | 1.2        | 0                           | 3.1  | 0    | 0    | 3          | 0                  | 0    | 0    | 0    | 0          | 0                           | 2    | 0    | 0    | 1          | 2          |

| Start Time   | 6TH AVE Southbound |      |      |      | App. Total | COLONEL DURHAM ST Westbound |      |      |      | App. Total | 6TH AVE Northbound |      |      |      | App. Total | COLONEL DURHAM ST Eastbound |      |      |      | Int. Total |     |
|--|--------------------|------|------|------|------------|-----------------------------|------|------|------|------------|--------------------|------|------|------|------------|-----------------------------|------|------|------|------------|-----|
|  | Right              | Thru | Left | Peds |            | Right                       | Thru | Left | Peds |            | Right              | Thru | Left | Peds |            | Right                       | Thru | Left | Peds |            |     |
| Peak Hour Analysis From 07:00 AM to 08:45 AM - Peak 1 of 1 |                    |      |      |      |            |                             |      |      |      |            |                    |      |      |      |            |                             |      |      |      |            |     |
| Peak Hour for Entire Intersection Begins at 07:00 AM       |                    |      |      |      |            |                             |      |      |      |            |                    |      |      |      |            |                             |      |      |      |            |     |
| 07:00 AM   | 11                 | 0    | 0    | 0    | 11         | 0                           | 55   | 0    | 0    | 55         | 0                  | 0    | 0    | 0    | 0          | 1                           | 7    | 1    | 0    | 9          | 75  |
| 07:15 AM   | 21                 | 1    | 0    | 0    | 22         | 0                           | 58   | 2    | 0    | 60         | 0                  | 1    | 0    | 0    | 1          | 5                           | 6    | 2    | 0    | 13         | 96  |
| 07:30 AM   | 13                 | 3    | 0    | 0    | 16         | 0                           | 78   | 4    | 0    | 82         | 1                  | 2    | 1    | 0    | 4          | 7                           | 9    | 5    | 0    | 21         | 123 |
| 07:45 AM   | 8                  | 1    | 0    | 0    | 9          | 0                           | 39   | 4    | 0    | 43         | 1                  | 4    | 0    | 0    | 5          | 10                          | 23   | 6    | 0    | 39         | 96  |
| Total Volume   | 53                 | 5    | 0    | 0    | 58         | 0                           | 230  | 10   | 0    | 240        | 2                  | 7    | 1    | 0    | 10         | 23                          | 45   | 14   | 0    | 82         | 390 |
| % App. Total   | 91.4               | 8.6  | 0    | 0    |            | 0                           | 95.8 | 4.2  | 0    |            | 20                 | 70   | 10   | 0    |            | 28                          | 54.9 | 17.1 | 0    |            |     |
| PHF  | .631               | .417 | .000 | .000 | .659       | .000                        | .737 | .625 | .732 | .500       | .438               | .250 | .500 | .575 | .489       | .583                        | .526 | .793 |      |            |     |

# Traffic Data Service

San Jose, CA  
 (408) 622-4787  
 tdsbay@cs.com

File Name : 10AM FINAL  
 Site Code : 00000010  
 Start Date : 4/25/2018  
 Page No : 2

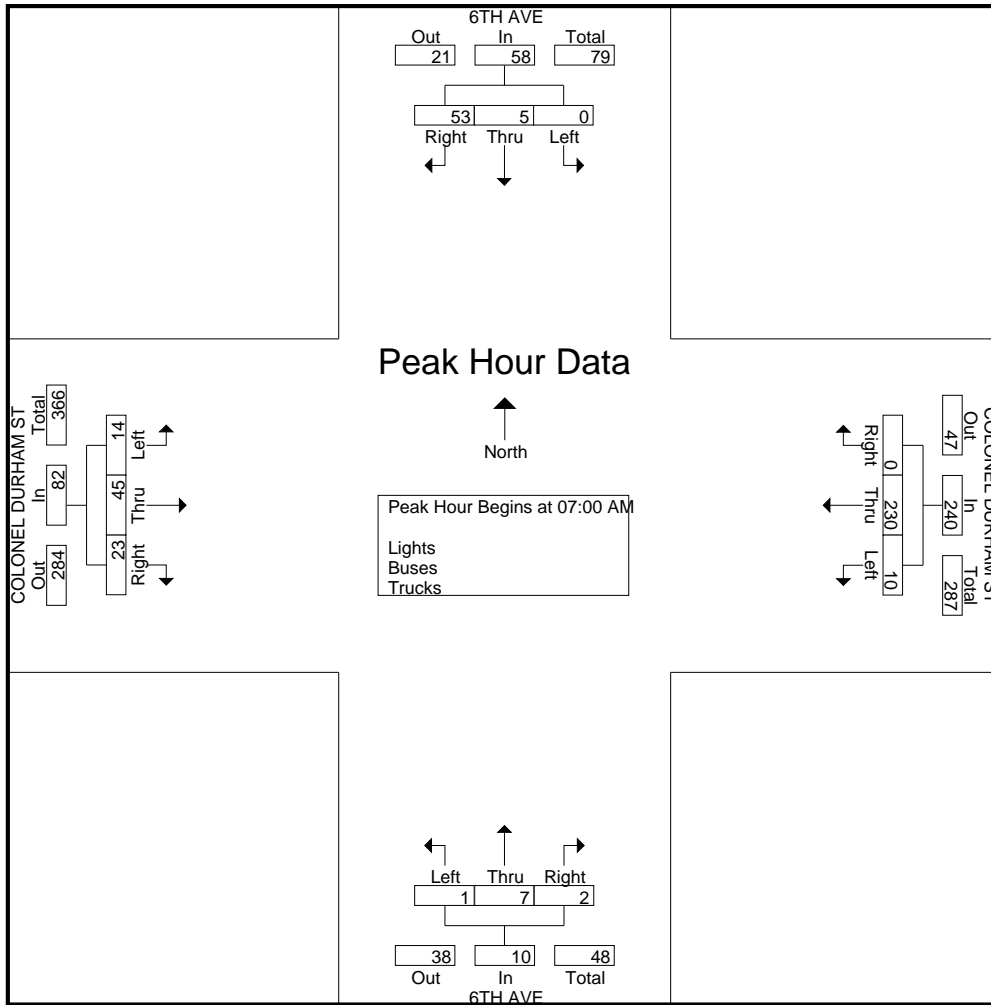

# Traffic Data Service

San Jose, CA  
 (408) 622-4787  
 tdsbay@cs.com

File Name : 10AM FINAL  
 Site Code : 00000010  
 Start Date : 4/25/2018  
 Page No : 1

Groups Printed- Bikes

| Start Time  | 6TH AVE Southbound |      |      |      |            | COLONEL DURHAM ST Westbound |      |      |      |            | 6TH AVE Northbound |      |      |      |            | COLONEL DURHAM ST Eastbound |      |      |      |            | Int. Total |   |
|-------------|--------------------|------|------|------|------------|-----------------------------|------|------|------|------------|--------------------|------|------|------|------------|-----------------------------|------|------|------|------------|------------|---|
|             | Right              | Thru | Left | Peds | App. Total | Right                       | Thru | Left | Peds | App. Total | Right              | Thru | Left | Peds | App. Total | Right                       | Thru | Left | Peds | App. Total |            |   |
| 07:00 AM    | 0                  | 0    | 0    | 0    | 0          | 0                           | 0    | 0    | 0    | 0          | 0                  | 0    | 0    | 0    | 0          | 0                           | 0    | 0    | 0    | 0          | 0          | 0 |
| 07:15 AM    | 0                  | 0    | 0    | 0    | 0          | 0                           | 0    | 0    | 0    | 0          | 0                  | 0    | 0    | 0    | 0          | 0                           | 0    | 0    | 0    | 0          | 0          | 0 |
| 07:30 AM    | 1                  | 0    | 0    | 0    | 1          | 0                           | 0    | 0    | 0    | 0          | 0                  | 0    | 0    | 0    | 0          | 0                           | 0    | 0    | 0    | 0          | 0          | 1 |
| 07:45 AM    | 1                  | 0    | 0    | 0    | 1          | 0                           | 0    | 0    | 0    | 0          | 0                  | 0    | 0    | 0    | 0          | 0                           | 0    | 0    | 0    | 0          | 0          | 1 |
| Total       | 2                  | 0    | 0    | 0    | 2          | 0                           | 0    | 0    | 0    | 0          | 0                  | 0    | 0    | 0    | 0          | 0                           | 0    | 0    | 0    | 0          | 0          | 2 |
| 08:00 AM    | 0                  | 1    | 0    | 0    | 1          | 0                           | 0    | 0    | 0    | 0          | 0                  | 0    | 0    | 0    | 0          | 0                           | 0    | 0    | 0    | 0          | 0          | 1 |
| 08:15 AM    | 0                  | 0    | 0    | 0    | 0          | 0                           | 0    | 0    | 0    | 0          | 0                  | 0    | 0    | 0    | 0          | 0                           | 0    | 0    | 0    | 0          | 0          | 0 |
| 08:30 AM    | 0                  | 1    | 0    | 0    | 1          | 0                           | 0    | 0    | 0    | 0          | 0                  | 0    | 0    | 0    | 0          | 0                           | 0    | 1    | 0    | 1          | 0          | 2 |
| 08:45 AM    | 0                  | 1    | 0    | 0    | 1          | 0                           | 0    | 0    | 0    | 0          | 0                  | 0    | 0    | 0    | 0          | 0                           | 0    | 0    | 0    | 0          | 0          | 1 |
| Total       | 0                  | 3    | 0    | 0    | 3          | 0                           | 0    | 0    | 0    | 0          | 0                  | 0    | 0    | 0    | 0          | 0                           | 0    | 1    | 0    | 1          | 0          | 4 |
| Grand Total | 2                  | 3    | 0    | 0    | 5          | 0                           | 0    | 0    | 0    | 0          | 0                  | 0    | 0    | 0    | 0          | 0                           | 0    | 1    | 0    | 1          | 0          | 6 |
| Apprch %    | 40                 | 60   | 0    | 0    |            | 0                           | 0    | 0    | 0    |            | 0                  | 0    | 0    | 0    |            | 0                           | 0    | 100  | 0    |            |            |   |
| Total %     | 33.3               | 50   | 0    | 0    | 83.3       | 0                           | 0    | 0    | 0    | 0          | 0                  | 0    | 0    | 0    | 0          | 0                           | 0    | 16.7 | 0    | 16.7       |            |   |

| Start Time   | 6TH AVE Southbound |      |      |      |            | COLONEL DURHAM ST Westbound |      |      |      |            | 6TH AVE Northbound |      |      |      |            | COLONEL DURHAM ST Eastbound |      |      |      |            | Int. Total |   |
|--------------|--------------------|------|------|------|------------|-----------------------------|------|------|------|------------|--------------------|------|------|------|------------|-----------------------------|------|------|------|------------|------------|---|
|              | Right              | Thru | Left | Peds | App. Total | Right                       | Thru | Left | Peds | App. Total | Right              | Thru | Left | Peds | App. Total | Right                       | Thru | Left | Peds | App. Total |            |   |
| 07:45 AM     | 1                  | 0    | 0    | 0    | 1          | 0                           | 0    | 0    | 0    | 0          | 0                  | 0    | 0    | 0    | 0          | 0                           | 0    | 0    | 0    | 0          | 0          | 1 |
| 08:00 AM     | 0                  | 1    | 0    | 0    | 1          | 0                           | 0    | 0    | 0    | 0          | 0                  | 0    | 0    | 0    | 0          | 0                           | 0    | 0    | 0    | 0          | 0          | 1 |
| 08:15 AM     | 0                  | 0    | 0    | 0    | 0          | 0                           | 0    | 0    | 0    | 0          | 0                  | 0    | 0    | 0    | 0          | 0                           | 0    | 0    | 0    | 0          | 0          | 0 |
| 08:30 AM     | 0                  | 1    | 0    | 0    | 1          | 0                           | 0    | 0    | 0    | 0          | 0                  | 0    | 0    | 0    | 0          | 0                           | 0    | 1    | 0    | 1          | 0          | 2 |
| Total Volume | 1                  | 2    | 0    | 0    | 3          | 0                           | 0    | 0    | 0    | 0          | 0                  | 0    | 0    | 0    | 0          | 0                           | 0    | 1    | 0    | 1          | 0          | 4 |
| % App. Total | 33.3               | 66.7 | 0    | 0    |            | 0                           | 0    | 0    | 0    |            | 0                  | 0    | 0    | 0    |            | 0                           | 0    | 100  | 0    |            |            |   |
| PHF          | .250               | .500 | .000 | .000 | .750       | .000                        | .000 | .000 | .000 | .000       | .000               | .000 | .000 | .000 | .000       | .000                        | .000 | .250 | .250 | .500       |            |   |

Peak Hour Analysis From 07:00 AM to 08:45 AM - Peak 1 of 1  
 Peak Hour for Entire Intersection Begins at 07:45 AM

# Traffic Data Service

San Jose, CA  
 (408) 622-4787  
 tdsbay@cs.com

File Name : 10AM FINAL  
 Site Code : 00000010  
 Start Date : 4/25/2018  
 Page No : 2

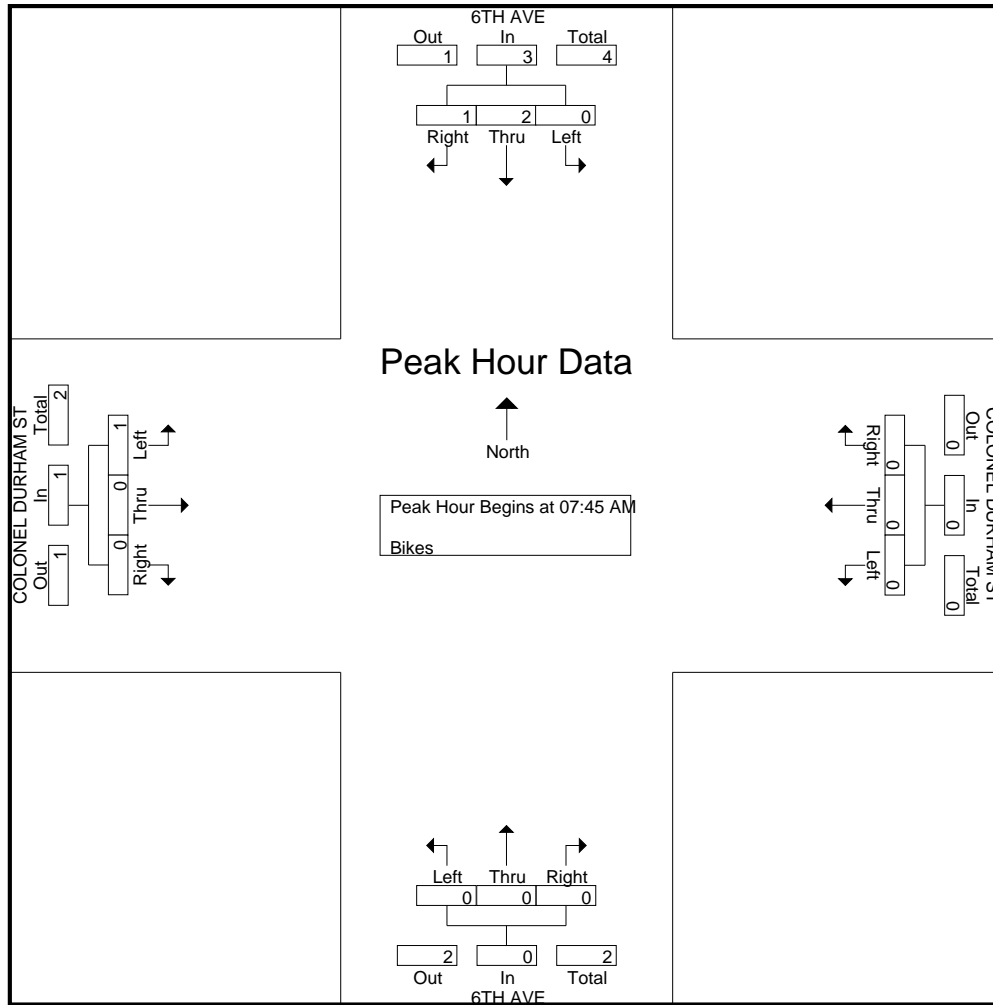

# Traffic Data Service

San Jose, CA  
 (408) 622-4787  
 tdsbay@cs.com

File Name : 10PM FINAL  
 Site Code : 00000010  
 Start Date : 4/25/2018  
 Page No : 1

Groups Printed- Lights - Buses - Trucks

| Start Time  | 6TH AVE Southbound |      |      |      |            | COLONEL DURHAM ST Westbound |      |      |      |            | 6TH AVE Northbound |      |      |      |            | COLONEL DURHAM ST Eastbound |      |      |      |            | Int. Total |
|-------------|--------------------|------|------|------|------------|-----------------------------|------|------|------|------------|--------------------|------|------|------|------------|-----------------------------|------|------|------|------------|------------|
|             | Right              | Thru | Left | Peds | App. Total | Right                       | Thru | Left | Peds | App. Total | Right              | Thru | Left | Peds | App. Total | Right                       | Thru | Left | Peds | App. Total |            |
| 04:00 PM    | 15                 | 1    | 0    | 0    | 16         | 0                           | 11   | 0    | 0    | 11         | 1                  | 2    | 7    | 0    | 10         | 0                           | 26   | 7    | 0    | 33         | 70         |
| 04:15 PM    | 4                  | 1    | 0    | 0    | 5          | 0                           | 11   | 0    | 0    | 11         | 0                  | 4    | 2    | 0    | 6          | 0                           | 20   | 1    | 0    | 21         | 43         |
| 04:30 PM    | 6                  | 1    | 0    | 0    | 7          | 0                           | 14   | 0    | 0    | 14         | 2                  | 1    | 8    | 0    | 11         | 0                           | 22   | 1    | 1    | 24         | 56         |
| 04:45 PM    | 9                  | 2    | 0    | 0    | 11         | 0                           | 25   | 0    | 0    | 25         | 1                  | 4    | 5    | 0    | 10         | 0                           | 30   | 2    | 0    | 32         | 78         |
| Total       | 34                 | 5    | 0    | 0    | 39         | 0                           | 61   | 0    | 0    | 61         | 4                  | 11   | 22   | 0    | 37         | 0                           | 98   | 11   | 1    | 110        | 247        |
| 05:00 PM    | 12                 | 7    | 1    | 0    | 20         | 0                           | 13   | 0    | 0    | 13         | 2                  | 5    | 13   | 0    | 20         | 0                           | 24   | 8    | 2    | 34         | 87         |
| 05:15 PM    | 11                 | 4    | 0    | 0    | 15         | 0                           | 19   | 0    | 0    | 19         | 0                  | 5    | 4    | 0    | 9          | 0                           | 15   | 2    | 0    | 17         | 60         |
| 05:30 PM    | 6                  | 3    | 1    | 0    | 10         | 0                           | 11   | 1    | 0    | 12         | 0                  | 2    | 3    | 0    | 5          | 0                           | 19   | 3    | 4    | 26         | 53         |
| 05:45 PM    | 12                 | 0    | 0    | 0    | 12         | 0                           | 10   | 0    | 0    | 10         | 0                  | 2    | 1    | 0    | 3          | 0                           | 21   | 3    | 0    | 24         | 49         |
| Total       | 41                 | 14   | 2    | 0    | 57         | 0                           | 53   | 1    | 0    | 54         | 2                  | 14   | 21   | 0    | 37         | 0                           | 79   | 16   | 6    | 101        | 249        |
| Grand Total | 75                 | 19   | 2    | 0    | 96         | 0                           | 114  | 1    | 0    | 115        | 6                  | 25   | 43   | 0    | 74         | 0                           | 177  | 27   | 7    | 211        | 496        |
| Apprch %    | 78.1               | 19.8 | 2.1  | 0    |            | 0                           | 99.1 | 0.9  | 0    |            | 8.1                | 33.8 | 58.1 | 0    |            | 0                           | 83.9 | 12.8 | 3.3  |            |            |
| Total %     | 15.1               | 3.8  | 0.4  | 0    | 19.4       | 0                           | 23   | 0.2  | 0    | 23.2       | 1.2                | 5    | 8.7  | 0    | 14.9       | 0                           | 35.7 | 5.4  | 1.4  | 42.5       |            |
| Lights      | 74                 | 19   | 2    | 0    | 95         | 0                           | 113  | 1    | 0    | 114        | 5                  | 25   | 43   | 0    | 73         | 0                           | 172  | 27   | 7    | 206        | 488        |
| % Lights    | 98.7               | 100  | 100  | 0    | 99         | 0                           | 99.1 | 100  | 0    | 99.1       | 83.3               | 100  | 100  | 0    | 98.6       | 0                           | 97.2 | 100  | 100  | 97.6       | 98.4       |
| Buses       | 1                  | 0    | 0    | 0    | 1          | 0                           | 1    | 0    | 0    | 1          | 1                  | 0    | 0    | 0    | 1          | 0                           | 1    | 0    | 0    | 1          | 4          |
| % Buses     | 1.3                | 0    | 0    | 0    | 1          | 0                           | 0.9  | 0    | 0    | 0.9        | 16.7               | 0    | 0    | 0    | 1.4        | 0                           | 0.6  | 0    | 0    | 0.5        | 0.8        |
| Trucks      | 0                  | 0    | 0    | 0    | 0          | 0                           | 0    | 0    | 0    | 0          | 0                  | 0    | 0    | 0    | 0          | 0                           | 4    | 0    | 0    | 4          | 4          |
| % Trucks    | 0                  | 0    | 0    | 0    | 0          | 0                           | 0    | 0    | 0    | 0          | 0                  | 0    | 0    | 0    | 0          | 0                           | 2.3  | 0    | 0    | 1.9        | 0.8        |

| Start Time   | 6TH AVE Southbound |      |      |            | COLONEL DURHAM ST Westbound |      |      |            | 6TH AVE Northbound |      |      |            | COLONEL DURHAM ST Eastbound |      |      |            | Int. Total |
|--|--------------------|------|------|------------|-----------------------------|------|------|------------|--------------------|------|------|------------|-----------------------------|------|------|------------|------------|
|  | Right              | Thru | Left | App. Total | Right                       | Thru | Left | App. Total | Right              | Thru | Left | App. Total | Right                       | Thru | Left | App. Total |            |
| Peak Hour Analysis From 04:00 PM to 05:45 PM - Peak 1 of 1 |                    |      |      |            |                             |      |      |            |                    |      |      |            |                             |      |      |            |            |
| Peak Hour for Entire Intersection Begins at 04:30 PM       |                    |      |      |            |                             |      |      |            |                    |      |      |            |                             |      |      |            |            |
| 04:30 PM   | 6                  | 1    | 0    | 7          | 0                           | 14   | 0    | 14         | 2                  | 1    | 8    | 11         | 0                           | 22   | 1    | 23         | 55         |
| 04:45 PM   | 9                  | 2    | 0    | 11         | 0                           | 25   | 0    | 25         | 1                  | 4    | 5    | 10         | 0                           | 30   | 2    | 32         | 78         |
| 05:00 PM   | 12                 | 7    | 1    | 20         | 0                           | 13   | 0    | 13         | 2                  | 5    | 13   | 20         | 0                           | 24   | 8    | 32         | 85         |
| 05:15 PM   | 11                 | 4    | 0    | 15         | 0                           | 19   | 0    | 19         | 0                  | 5    | 4    | 9          | 0                           | 15   | 2    | 17         | 60         |
| Total Volume   | 38                 | 14   | 1    | 53         | 0                           | 71   | 0    | 71         | 5                  | 15   | 30   | 50         | 0                           | 91   | 13   | 104        | 278        |
| % App. Total   | 71.7               | 26.4 | 1.9  |            | 0                           | 100  | 0    |            | 10                 | 30   | 60   |            | 0                           | 87.5 | 12.5 |            |            |
| PHF  | .792               | .500 | .250 | .663       | .000                        | .710 | .000 | .710       | .625               | .750 | .577 | .625       | .000                        | .758 | .406 | .813       | .818       |

# Traffic Data Service

San Jose, CA  
 (408) 622-4787  
 tdsbay@cs.com

File Name : 10PM FINAL  
 Site Code : 00000010  
 Start Date : 4/25/2018  
 Page No : 2

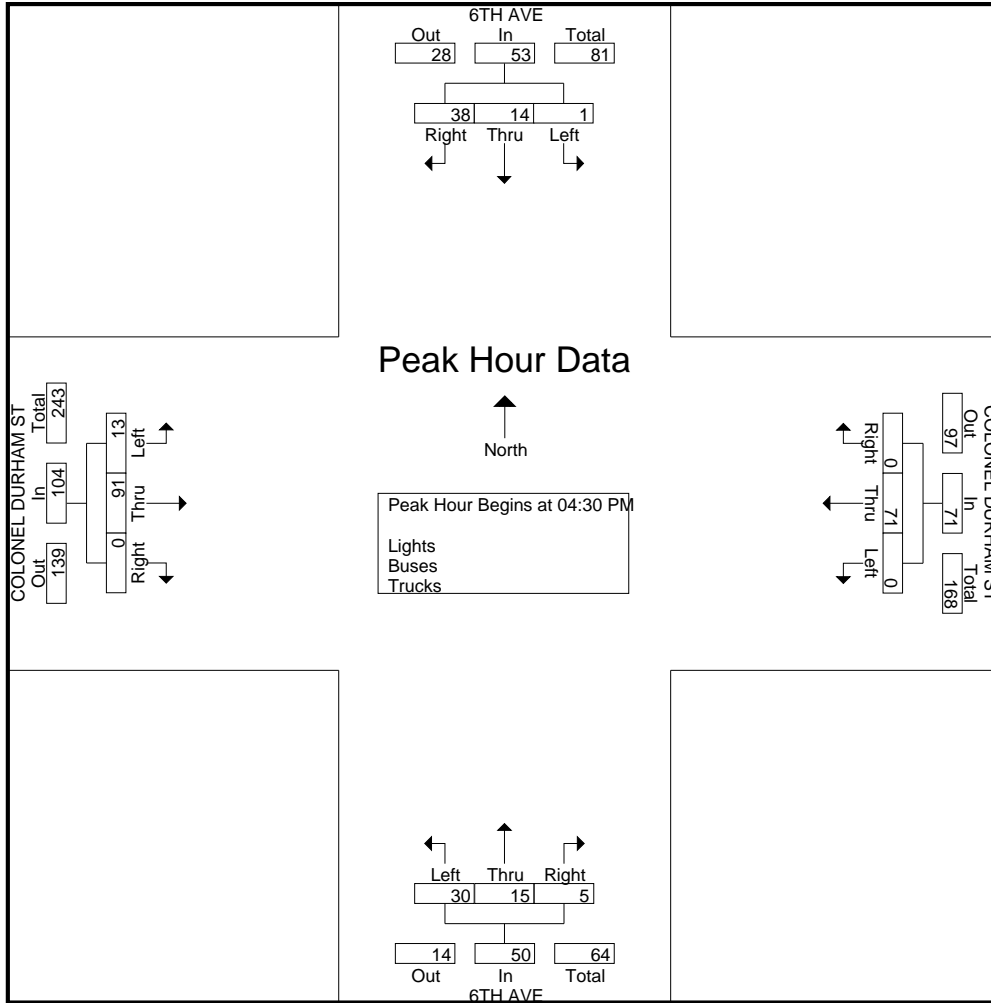

# Traffic Data Service

San Jose, CA  
 (408) 622-4787  
 tdsbay@cs.com

File Name : 10PM FINAL  
 Site Code : 00000010  
 Start Date : 4/25/2018  
 Page No : 1

Groups Printed- Bikes

| Start Time   | 6TH AVE Southbound |          |          |          |            | COLONEL DURHAM ST Westbound |          |          |          |            | 6TH AVE Northbound |          |          |          |            | COLONEL DURHAM ST Eastbound |          |          |          |            | Int. Total |
|--------------|--------------------|----------|----------|----------|------------|-----------------------------|----------|----------|----------|------------|--------------------|----------|----------|----------|------------|-----------------------------|----------|----------|----------|------------|------------|
|              | Right              | Thru     | Left     | Peds     | App. Total | Right                       | Thru     | Left     | Peds     | App. Total | Right              | Thru     | Left     | Peds     | App. Total | Right                       | Thru     | Left     | Peds     | App. Total |            |
| 04:00 PM     | 0                  | 0        | 0        | 0        | 0          | 0                           | 0        | 0        | 0        | 0          | 0                  | 0        | 0        | 0        | 0          | 0                           | 0        | 0        | 0        | 0          | 0          |
| 04:15 PM     | 0                  | 0        | 0        | 0        | 0          | 1                           | 0        | 0        | 0        | 1          | 0                  | 0        | 0        | 0        | 0          | 0                           | 0        | 0        | 0        | 0          | 0          |
| 04:30 PM     | 1                  | 0        | 1        | 0        | 2          | 0                           | 0        | 0        | 0        | 0          | 0                  | 0        | 0        | 0        | 0          | 0                           | 0        | 0        | 0        | 0          | 0          |
| 04:45 PM     | 0                  | 0        | 0        | 0        | 0          | 1                           | 0        | 0        | 0        | 1          | 0                  | 0        | 0        | 0        | 0          | 0                           | 0        | 0        | 0        | 0          | 0          |
| <b>Total</b> | <b>1</b>           | <b>0</b> | <b>1</b> | <b>0</b> | <b>2</b>   | <b>2</b>                    | <b>0</b> | <b>0</b> | <b>0</b> | <b>2</b>   | <b>0</b>           | <b>0</b> | <b>0</b> | <b>0</b> | <b>0</b>   | <b>0</b>                    | <b>0</b> | <b>0</b> | <b>0</b> | <b>0</b>   | <b>4</b>   |
| 05:00 PM     | 0                  | 0        | 0        | 0        | 0          | 0                           | 0        | 0        | 0        | 0          | 0                  | 1        | 0        | 0        | 1          | 0                           | 0        | 1        | 0        | 1          | 2          |
| 05:15 PM     | 0                  | 0        | 0        | 0        | 0          | 0                           | 0        | 0        | 0        | 0          | 0                  | 0        | 0        | 0        | 0          | 0                           | 0        | 0        | 0        | 0          | 0          |
| 05:30 PM     | 0                  | 0        | 0        | 0        | 0          | 0                           | 0        | 0        | 0        | 0          | 0                  | 0        | 0        | 0        | 0          | 0                           | 0        | 0        | 0        | 0          | 0          |
| 05:45 PM     | 0                  | 0        | 0        | 0        | 0          | 0                           | 0        | 0        | 0        | 0          | 0                  | 0        | 0        | 0        | 0          | 0                           | 0        | 0        | 0        | 0          | 0          |
| <b>Total</b> | <b>0</b>           | <b>0</b> | <b>0</b> | <b>0</b> | <b>0</b>   | <b>0</b>                    | <b>0</b> | <b>0</b> | <b>0</b> | <b>0</b>   | <b>0</b>           | <b>1</b> | <b>0</b> | <b>0</b> | <b>1</b>   | <b>0</b>                    | <b>0</b> | <b>1</b> | <b>0</b> | <b>1</b>   | <b>2</b>   |
| Grand Total  | 1                  | 0        | 1        | 0        | 2          | 2                           | 0        | 0        | 0        | 2          | 0                  | 1        | 0        | 0        | 1          | 0                           | 0        | 1        | 0        | 1          | 6          |
| Apprch %     | 50                 | 0        | 50       | 0        |            | 100                         | 0        | 0        | 0        |            | 0                  | 100      | 0        | 0        |            | 0                           | 0        | 100      | 0        |            |            |
| Total %      | 16.7               | 0        | 16.7     | 0        | 33.3       | 33.3                        | 0        | 0        | 0        | 33.3       | 0                  | 16.7     | 0        | 0        | 16.7       | 0                           | 0        | 16.7     | 0        | 16.7       |            |

| Start Time          | 6TH AVE Southbound |          |          |          |            | COLONEL DURHAM ST Westbound |          |          |          |            | 6TH AVE Northbound |          |          |          |            | COLONEL DURHAM ST Eastbound |          |          |          |            | Int. Total |
|---------------------|--------------------|----------|----------|----------|------------|-----------------------------|----------|----------|----------|------------|--------------------|----------|----------|----------|------------|-----------------------------|----------|----------|----------|------------|------------|
|                     | Right              | Thru     | Left     | Peds     | App. Total | Right                       | Thru     | Left     | Peds     | App. Total | Right              | Thru     | Left     | Peds     | App. Total | Right                       | Thru     | Left     | Peds     | App. Total |            |
| 04:15 PM            | 0                  | 0        | 0        | 0        | 0          | 1                           | 0        | 0        | 0        | 1          | 0                  | 0        | 0        | 0        | 0          | 0                           | 0        | 0        | 0        | 0          | 1          |
| 04:30 PM            | 1                  | 0        | 1        | 0        | 2          | 0                           | 0        | 0        | 0        | 0          | 0                  | 0        | 0        | 0        | 0          | 0                           | 0        | 0        | 0        | 0          | 2          |
| 04:45 PM            | 0                  | 0        | 0        | 0        | 0          | 1                           | 0        | 0        | 0        | 1          | 0                  | 0        | 0        | 0        | 0          | 0                           | 0        | 0        | 0        | 0          | 1          |
| 05:00 PM            | 0                  | 0        | 0        | 0        | 0          | 0                           | 0        | 0        | 0        | 0          | 0                  | 1        | 0        | 0        | 1          | 0                           | 0        | 1        | 0        | 1          | 2          |
| <b>Total Volume</b> | <b>1</b>           | <b>0</b> | <b>1</b> | <b>0</b> | <b>2</b>   | <b>2</b>                    | <b>0</b> | <b>0</b> | <b>0</b> | <b>2</b>   | <b>0</b>           | <b>1</b> | <b>0</b> | <b>0</b> | <b>1</b>   | <b>0</b>                    | <b>0</b> | <b>1</b> | <b>0</b> | <b>1</b>   | <b>6</b>   |
| % App. Total        | 50                 | 0        | 50       | 0        |            | 100                         | 0        | 0        | 0        |            | 0                  | 100      | 0        | 0        |            | 0                           | 0        | 100      | 0        |            |            |
| PHF                 | .250               | .000     | .250     | .250     |            | .500                        | .000     | .000     | .500     |            | .000               | .250     | .000     | .250     |            | .000                        | .000     | .250     | .250     |            | .750       |

Peak Hour Analysis From 04:00 PM to 05:45 PM - Peak 1 of 1  
 Peak Hour for Entire Intersection Begins at 04:15 PM

# Traffic Data Service

San Jose, CA  
 (408) 622-4787  
 tdsbay@cs.com

File Name : 10PM FINAL  
 Site Code : 00000010  
 Start Date : 4/25/2018  
 Page No : 2

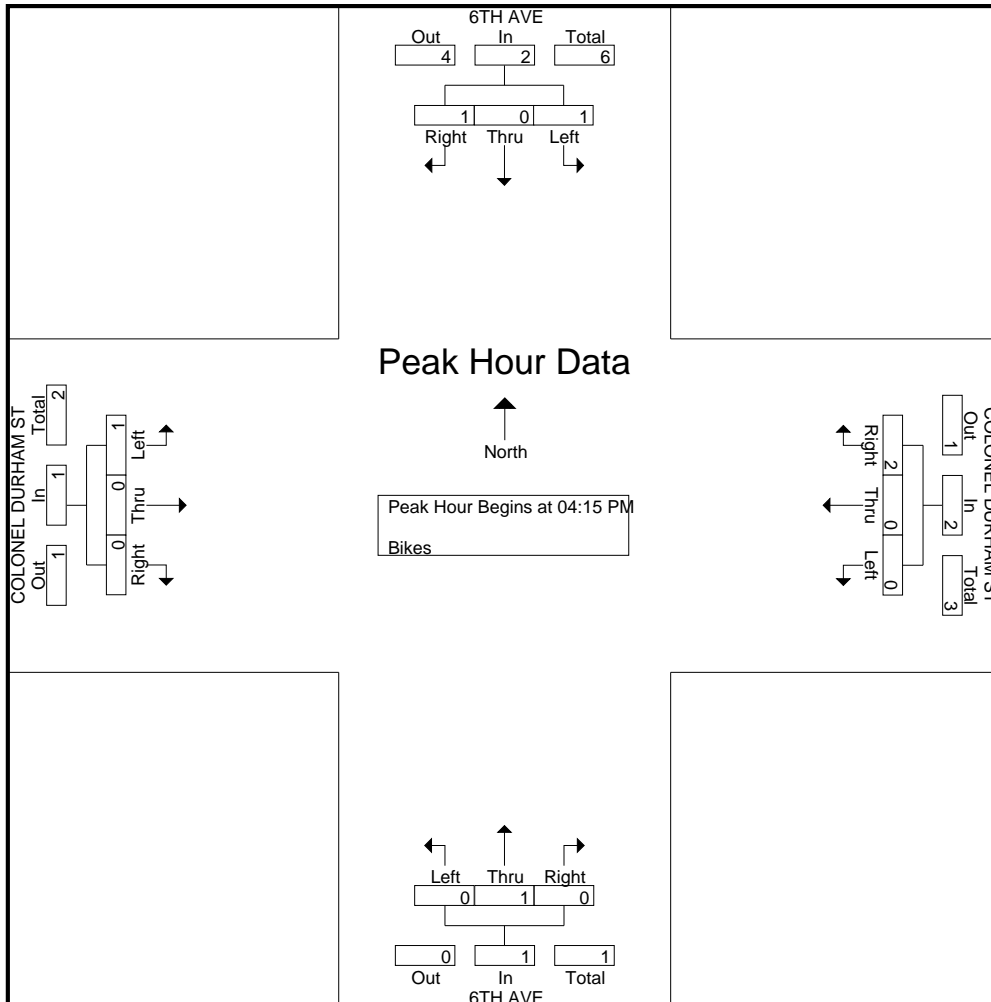



# Traffic Data Service

San Jose, CA  
 (408) 622-4787  
 tdsbay@cs.com

File Name : 11AM FINAL  
 Site Code : 00000011  
 Start Date : 4/25/2018  
 Page No : 1

Groups Printed- Lights - Buses - Trucks

| Start Time  | 7TH AVE Southbound |      |      |      |            | COLONEL DURHAM ST Westbound |      |      |      |            | 7TH AVE Northbound |      |      |      |            | COLONEL DURHAM ST Eastbound |      |      |      |            | Int. Total |
|-------------|--------------------|------|------|------|------------|-----------------------------|------|------|------|------------|--------------------|------|------|------|------------|-----------------------------|------|------|------|------------|------------|
|             | Right              | Thru | Left | Peds | App. Total | Right                       | Thru | Left | Peds | App. Total | Right              | Thru | Left | Peds | App. Total | Right                       | Thru | Left | Peds | App. Total |            |
| 07:00 AM    | 9                  | 7    | 0    | 0    | 16         | 0                           | 44   | 0    | 0    | 44         | 0                  | 2    | 0    | 0    | 2          | 0                           | 3    | 4    | 0    | 7          | 69         |
| 07:15 AM    | 20                 | 25   | 0    | 0    | 45         | 0                           | 43   | 0    | 0    | 43         | 0                  | 0    | 0    | 0    | 0          | 0                           | 4    | 2    | 0    | 6          | 94         |
| 07:30 AM    | 22                 | 24   | 0    | 0    | 46         | 0                           | 56   | 2    | 0    | 58         | 0                  | 6    | 0    | 0    | 6          | 0                           | 7    | 3    | 0    | 10         | 120        |
| 07:45 AM    | 11                 | 32   | 0    | 0    | 43         | 0                           | 31   | 0    | 0    | 31         | 0                  | 7    | 0    | 0    | 7          | 1                           | 18   | 3    | 0    | 22         | 103        |
| Total       | 62                 | 88   | 0    | 0    | 150        | 0                           | 174  | 2    | 0    | 176        | 0                  | 15   | 0    | 0    | 15         | 1                           | 32   | 12   | 0    | 45         | 386        |
| 08:00 AM    | 7                  | 16   | 0    | 0    | 23         | 0                           | 27   | 0    | 0    | 27         | 0                  | 7    | 0    | 0    | 7          | 0                           | 8    | 11   | 1    | 20         | 77         |
| 08:15 AM    | 1                  | 17   | 0    | 0    | 18         | 0                           | 19   | 0    | 0    | 19         | 0                  | 1    | 0    | 0    | 1          | 0                           | 7    | 9    | 0    | 16         | 54         |
| 08:30 AM    | 4                  | 17   | 0    | 0    | 21         | 0                           | 19   | 0    | 0    | 19         | 0                  | 3    | 0    | 0    | 3          | 2                           | 9    | 4    | 0    | 15         | 58         |
| 08:45 AM    | 3                  | 6    | 0    | 0    | 9          | 0                           | 15   | 0    | 0    | 15         | 0                  | 1    | 0    | 0    | 1          | 0                           | 5    | 4    | 0    | 9          | 34         |
| Total       | 15                 | 56   | 0    | 0    | 71         | 0                           | 80   | 0    | 0    | 80         | 0                  | 12   | 0    | 0    | 12         | 2                           | 29   | 28   | 1    | 60         | 223        |
| Grand Total | 77                 | 144  | 0    | 0    | 221        | 0                           | 254  | 2    | 0    | 256        | 0                  | 27   | 0    | 0    | 27         | 3                           | 61   | 40   | 1    | 105        | 609        |
| Apprch %    | 34.8               | 65.2 | 0    | 0    |            | 0                           | 99.2 | 0.8  | 0    |            | 0                  | 100  | 0    | 0    |            | 2.9                         | 58.1 | 38.1 | 1    |            |            |
| Total %     | 12.6               | 23.6 | 0    | 0    | 36.3       | 0                           | 41.7 | 0.3  | 0    | 42         | 0                  | 4.4  | 0    | 0    | 4.4        | 0.5                         | 10   | 6.6  | 0.2  | 17.2       |            |
| Lights      | 68                 | 135  | 0    | 0    | 203        | 0                           | 254  | 2    | 0    | 256        | 0                  | 25   | 0    | 0    | 25         | 1                           | 55   | 39   | 1    | 96         | 580        |
| % Lights    | 88.3               | 93.8 | 0    | 0    | 91.9       | 0                           | 100  | 100  | 0    | 100        | 0                  | 92.6 | 0    | 0    | 92.6       | 33.3                        | 90.2 | 97.5 | 100  | 91.4       | 95.2       |
| Buses       | 0                  | 1    | 0    | 0    | 1          | 0                           | 0    | 0    | 0    | 0          | 0                  | 1    | 0    | 0    | 1          | 2                           | 5    | 0    | 0    | 7          | 9          |
| % Buses     | 0                  | 0.7  | 0    | 0    | 0.5        | 0                           | 0    | 0    | 0    | 0          | 0                  | 3.7  | 0    | 0    | 3.7        | 66.7                        | 8.2  | 0    | 0    | 6.7        | 1.5        |
| Trucks      | 9                  | 8    | 0    | 0    | 17         | 0                           | 0    | 0    | 0    | 0          | 0                  | 1    | 0    | 0    | 1          | 0                           | 1    | 1    | 0    | 2          | 20         |
| % Trucks    | 11.7               | 5.6  | 0    | 0    | 7.7        | 0                           | 0    | 0    | 0    | 0          | 0                  | 3.7  | 0    | 0    | 3.7        | 0                           | 1.6  | 2.5  | 0    | 1.9        | 3.3        |

| Start Time   | 7TH AVE Southbound |      |      |            | COLONEL DURHAM ST Westbound |      |      |            | 7TH AVE Northbound |      |      |            | COLONEL DURHAM ST Eastbound |      |      |            | Int. Total |    |
|--|--------------------|------|------|------------|-----------------------------|------|------|------------|--------------------|------|------|------------|-----------------------------|------|------|------------|------------|----|
|  | Right              | Thru | Left | App. Total | Right                       | Thru | Left | App. Total | Right              | Thru | Left | App. Total | Right                       | Thru | Left | App. Total |            |    |
| Peak Hour Analysis From 07:00 AM to 08:45 AM - Peak 1 of 1 |                    |      |      |            |                             |      |      |            |                    |      |      |            |                             |      |      |            |            |    |
| Peak Hour for Entire Intersection Begins at 07:15 AM       |                    |      |      |            |                             |      |      |            |                    |      |      |            |                             |      |      |            |            |    |
| 07:15 AM   | 20                 | 25   | 0    | 45         | 0                           | 43   | 0    | 43         | 0                  | 0    | 0    | 0          | 0                           | 0    | 4    | 2          | 6          | 94 |
| 07:30 AM   | 22                 | 24   | 0    | 46         | 0                           | 56   | 2    | 58         | 0                  | 6    | 0    | 6          | 0                           | 7    | 3    | 10         | 120        |    |
| 07:45 AM   | 11                 | 32   | 0    | 43         | 0                           | 31   | 0    | 31         | 0                  | 7    | 0    | 7          | 1                           | 18   | 3    | 22         | 103        |    |
| 08:00 AM   | 7                  | 16   | 0    | 23         | 0                           | 27   | 0    | 27         | 0                  | 7    | 0    | 7          | 0                           | 8    | 11   | 19         | 76         |    |
| Total Volume   | 60                 | 97   | 0    | 157        | 0                           | 157  | 2    | 159        | 0                  | 20   | 0    | 20         | 1                           | 37   | 19   | 57         | 393        |    |
| % App. Total   | 38.2               | 61.8 | 0    |            | 0                           | 98.7 | 1.3  |            | 0                  | 100  | 0    |            | 1.8                         | 64.9 | 33.3 |            |            |    |
| PHF  | .682               | .758 | .000 | .853       | .000                        | .701 | .250 | .685       | .000               | .714 | .000 | .714       | .250                        | .514 | .432 | .648       | .819       |    |

# Traffic Data Service

San Jose, CA  
 (408) 622-4787  
 tdsbay@cs.com

File Name : 11AM FINAL  
 Site Code : 00000011  
 Start Date : 4/25/2018  
 Page No : 2

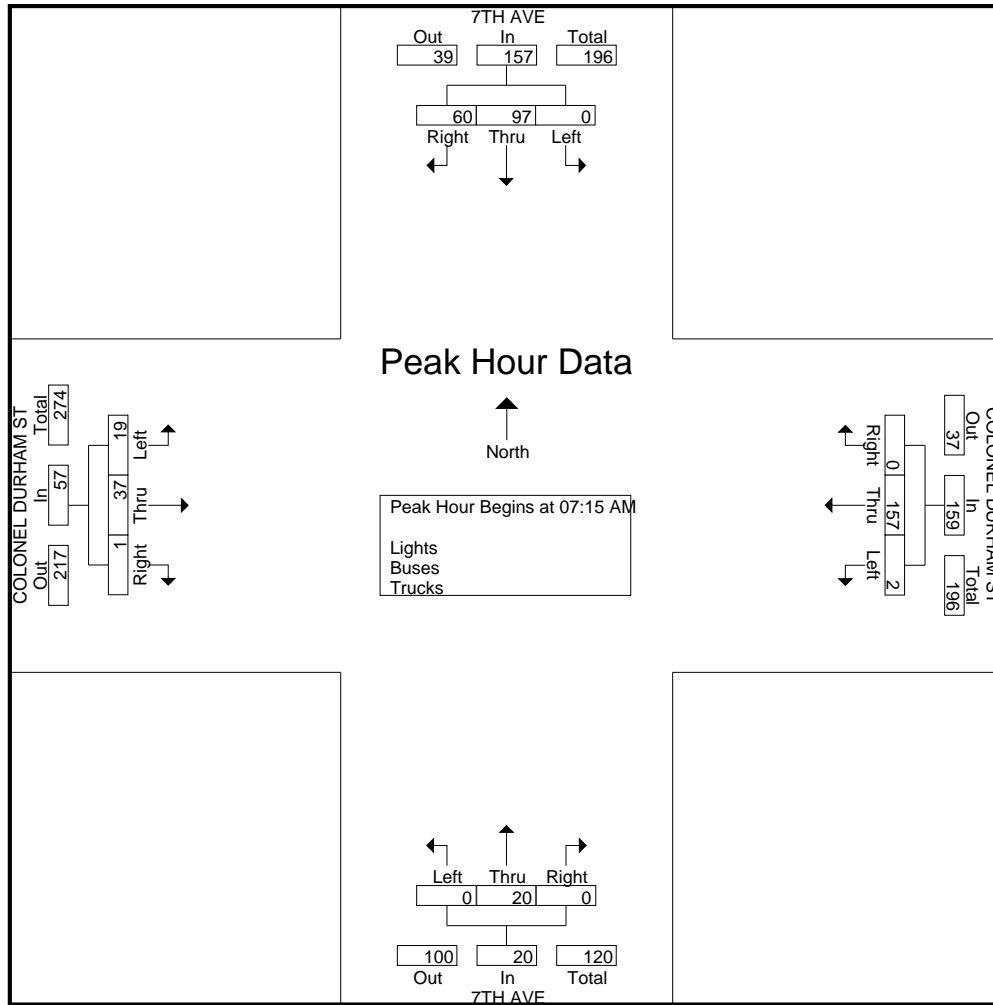

# Traffic Data Service

San Jose, CA  
 (408) 622-4787  
 tdsbay@cs.com

File Name : 11AM FINAL  
 Site Code : 00000011  
 Start Date : 4/25/2018  
 Page No : 1

Groups Printed- Bikes

| Start Time  | 7TH AVE Southbound |      |      |      |            | COLONEL DURHAM ST Westbound |      |      |      |            | 7TH AVE Northbound |      |      |      |            | COLONEL DURHAM ST Eastbound |      |      |      |            | Int. Total |
|-------------|--------------------|------|------|------|------------|-----------------------------|------|------|------|------------|--------------------|------|------|------|------------|-----------------------------|------|------|------|------------|------------|
|             | Right              | Thru | Left | Peds | App. Total | Right                       | Thru | Left | Peds | App. Total | Right              | Thru | Left | Peds | App. Total | Right                       | Thru | Left | Peds | App. Total |            |
| 07:00 AM    | 0                  | 0    | 0    | 0    | 0          | 0                           | 0    | 0    | 0    | 0          | 0                  | 0    | 0    | 0    | 0          | 0                           | 0    | 0    | 0    | 0          | 0          |
| 07:15 AM    | 0                  | 0    | 0    | 0    | 0          | 0                           | 0    | 0    | 0    | 0          | 0                  | 0    | 0    | 0    | 0          | 0                           | 0    | 0    | 0    | 0          | 0          |
| 07:30 AM    | 0                  | 0    | 0    | 0    | 0          | 0                           | 0    | 0    | 0    | 0          | 0                  | 0    | 0    | 0    | 0          | 0                           | 0    | 0    | 0    | 0          | 0          |
| 07:45 AM    | 0                  | 0    | 0    | 0    | 0          | 0                           | 0    | 0    | 0    | 0          | 0                  | 0    | 0    | 0    | 0          | 0                           | 0    | 0    | 0    | 0          | 0          |
| Total       | 0                  | 0    | 0    | 0    | 0          | 0                           | 0    | 0    | 0    | 0          | 0                  | 0    | 0    | 0    | 0          | 0                           | 0    | 0    | 0    | 0          | 0          |
| 08:00 AM    | 0                  | 0    | 0    | 0    | 0          | 0                           | 0    | 0    | 0    | 0          | 0                  | 0    | 0    | 0    | 0          | 0                           | 0    | 0    | 0    | 0          | 0          |
| 08:15 AM    | 0                  | 0    | 0    | 0    | 0          | 0                           | 0    | 0    | 0    | 0          | 0                  | 0    | 0    | 0    | 0          | 0                           | 0    | 0    | 0    | 0          | 0          |
| 08:30 AM    | 0                  | 0    | 0    | 0    | 0          | 0                           | 0    | 0    | 0    | 0          | 0                  | 0    | 0    | 0    | 0          | 0                           | 0    | 0    | 0    | 0          | 0          |
| 08:45 AM    | 0                  | 0    | 0    | 0    | 0          | 0                           | 0    | 0    | 0    | 0          | 0                  | 0    | 0    | 0    | 0          | 0                           | 0    | 0    | 0    | 0          | 0          |
| Total       | 0                  | 0    | 0    | 0    | 0          | 0                           | 0    | 0    | 0    | 0          | 0                  | 0    | 0    | 0    | 0          | 0                           | 0    | 0    | 0    | 0          | 0          |
| Grand Total | 0                  | 0    | 0    | 0    | 0          | 0                           | 0    | 0    | 0    | 0          | 0                  | 0    | 0    | 0    | 0          | 0                           | 0    | 0    | 0    | 0          | 0          |
| Apprch %    | 0                  | 0    | 0    | 0    |            | 0                           | 0    | 0    | 0    |            | 0                  | 0    | 0    | 0    |            | 0                           | 0    | 0    | 0    |            |            |
| Total %     |                    |      |      |      |            |                             |      |      |      |            |                    |      |      |      |            |                             |      |      |      |            |            |

| Start Time   | 7TH AVE Southbound |      |      |      |            | COLONEL DURHAM ST Westbound |      |      |      |            | 7TH AVE Northbound |      |      |      |            | COLONEL DURHAM ST Eastbound |      |      |      |            | Int. Total |
|--|--------------------|------|------|------|------------|-----------------------------|------|------|------|------------|--------------------|------|------|------|------------|-----------------------------|------|------|------|------------|------------|
|  | Right              | Thru | Left | Peds | App. Total | Right                       | Thru | Left | Peds | App. Total | Right              | Thru | Left | Peds | App. Total | Right                       | Thru | Left | Peds | App. Total |            |
| Peak Hour Analysis From 07:00 AM to 08:45 AM - Peak 1 of 1 |                    |      |      |      |            |                             |      |      |      |            |                    |      |      |      |            |                             |      |      |      |            |            |
| Peak Hour for Entire Intersection Begins at 07:00 AM       |                    |      |      |      |            |                             |      |      |      |            |                    |      |      |      |            |                             |      |      |      |            |            |
| 07:00 AM   | 0                  | 0    | 0    | 0    | 0          | 0                           | 0    | 0    | 0    | 0          | 0                  | 0    | 0    | 0    | 0          | 0                           | 0    | 0    | 0    | 0          | 0          |
| 07:15 AM   | 0                  | 0    | 0    | 0    | 0          | 0                           | 0    | 0    | 0    | 0          | 0                  | 0    | 0    | 0    | 0          | 0                           | 0    | 0    | 0    | 0          | 0          |
| 07:30 AM   | 0                  | 0    | 0    | 0    | 0          | 0                           | 0    | 0    | 0    | 0          | 0                  | 0    | 0    | 0    | 0          | 0                           | 0    | 0    | 0    | 0          | 0          |
| 07:45 AM   | 0                  | 0    | 0    | 0    | 0          | 0                           | 0    | 0    | 0    | 0          | 0                  | 0    | 0    | 0    | 0          | 0                           | 0    | 0    | 0    | 0          | 0          |
| Total Volume   | 0                  | 0    | 0    | 0    | 0          | 0                           | 0    | 0    | 0    | 0          | 0                  | 0    | 0    | 0    | 0          | 0                           | 0    | 0    | 0    | 0          | 0          |
| % App. Total   | 0                  | 0    | 0    | 0    |            | 0                           | 0    | 0    | 0    |            | 0                  | 0    | 0    | 0    |            | 0                           | 0    | 0    | 0    |            |            |
| PHF  | .000               | .000 | .000 | .000 | .000       | .000                        | .000 | .000 | .000 | .000       | .000               | .000 | .000 | .000 | .000       | .000                        | .000 | .000 | .000 | .000       | .000       |

# Traffic Data Service

San Jose, CA  
(408) 622-4787  
tdsbay@cs.com

File Name : 11AM FINAL  
Site Code : 00000011  
Start Date : 4/25/2018  
Page No : 2

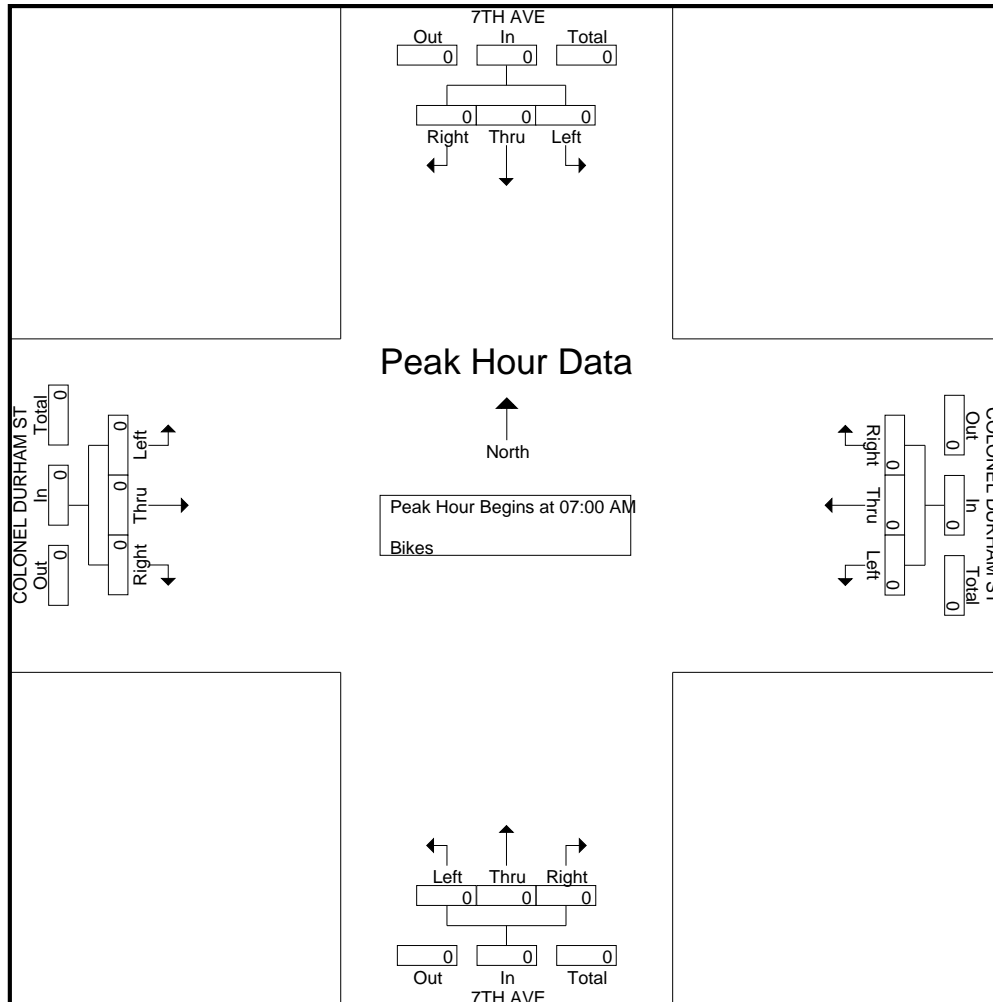

# Traffic Data Service

San Jose, CA  
 (408) 622-4787  
 tdsbay@cs.com

File Name : 11PM FINAL  
 Site Code : 00000011  
 Start Date : 4/25/2018  
 Page No : 1

Groups Printed- Lights - Buses - Trucks

| Start Time  | 7TH AVE Southbound |      |      |      |            | COLONEL DURHAM ST Westbound |      |      |      |            | 7TH AVE Northbound |      |      |      |            | COLONEL DURHAM ST Eastbound |      |      |      |            | Int. Total |
|-------------|--------------------|------|------|------|------------|-----------------------------|------|------|------|------------|--------------------|------|------|------|------------|-----------------------------|------|------|------|------------|------------|
|             | Right              | Thru | Left | Peds | App. Total | Right                       | Thru | Left | Peds | App. Total | Right              | Thru | Left | Peds | App. Total | Right                       | Thru | Left | Peds | App. Total |            |
| 04:00 PM    | 4                  | 4    | 0    | 0    | 8          | 0                           | 7    | 0    | 0    | 7          | 0                  | 6    | 0    | 0    | 6          | 0                           | 18   | 9    | 0    | 27         | 48         |
| 04:15 PM    | 2                  | 6    | 0    | 0    | 8          | 0                           | 9    | 0    | 0    | 9          | 0                  | 8    | 0    | 0    | 8          | 0                           | 15   | 6    | 0    | 21         | 46         |
| 04:30 PM    | 4                  | 4    | 0    | 0    | 8          | 0                           | 10   | 0    | 0    | 10         | 0                  | 7    | 0    | 0    | 7          | 0                           | 15   | 5    | 0    | 20         | 45         |
| 04:45 PM    | 1                  | 6    | 0    | 0    | 7          | 0                           | 25   | 0    | 0    | 25         | 0                  | 12   | 0    | 0    | 12         | 1                           | 28   | 3    | 0    | 32         | 76         |
| Total       | 11                 | 20   | 0    | 0    | 31         | 0                           | 51   | 0    | 0    | 51         | 0                  | 33   | 0    | 0    | 33         | 1                           | 76   | 23   | 0    | 100        | 215        |
| 05:00 PM    | 7                  | 7    | 0    | 0    | 14         | 0                           | 6    | 0    | 0    | 6          | 0                  | 9    | 0    | 0    | 9          | 0                           | 27   | 3    | 0    | 30         | 59         |
| 05:15 PM    | 5                  | 6    | 0    | 0    | 11         | 0                           | 12   | 0    | 0    | 12         | 0                  | 2    | 0    | 0    | 2          | 0                           | 14   | 1    | 0    | 15         | 40         |
| 05:30 PM    | 3                  | 5    | 0    | 0    | 8          | 0                           | 10   | 0    | 0    | 10         | 0                  | 8    | 0    | 0    | 8          | 0                           | 17   | 2    | 0    | 19         | 45         |
| 05:45 PM    | 6                  | 11   | 0    | 0    | 17         | 0                           | 5    | 0    | 0    | 5          | 0                  | 5    | 1    | 0    | 6          | 0                           | 19   | 2    | 0    | 21         | 49         |
| Total       | 21                 | 29   | 0    | 0    | 50         | 0                           | 33   | 0    | 0    | 33         | 0                  | 24   | 1    | 0    | 25         | 0                           | 77   | 8    | 0    | 85         | 193        |
| Grand Total | 32                 | 49   | 0    | 0    | 81         | 0                           | 84   | 0    | 0    | 84         | 0                  | 57   | 1    | 0    | 58         | 1                           | 153  | 31   | 0    | 185        | 408        |
| Apprch %    | 39.5               | 60.5 | 0    | 0    |            | 0                           | 100  | 0    | 0    |            | 0                  | 98.3 | 1.7  | 0    |            | 0.5                         | 82.7 | 16.8 | 0    |            |            |
| Total %     | 7.8                | 12   | 0    | 0    | 19.9       | 0                           | 20.6 | 0    | 0    | 20.6       | 0                  | 14   | 0.2  | 0    | 14.2       | 0.2                         | 37.5 | 7.6  | 0    | 45.3       |            |
| Lights      | 32                 | 46   | 0    | 0    | 78         | 0                           | 82   | 0    | 0    | 82         | 0                  | 53   | 1    | 0    | 54         | 0                           | 151  | 25   | 0    | 176        | 390        |
| % Lights    | 100                | 93.9 | 0    | 0    | 96.3       | 0                           | 97.6 | 0    | 0    | 97.6       | 0                  | 93   | 100  | 0    | 93.1       | 0                           | 98.7 | 80.6 | 0    | 95.1       | 95.6       |
| Buses       | 0                  | 0    | 0    | 0    | 0          | 0                           | 1    | 0    | 0    | 1          | 0                  | 1    | 0    | 0    | 1          | 1                           | 1    | 0    | 0    | 2          | 4          |
| % Buses     | 0                  | 0    | 0    | 0    | 0          | 0                           | 1.2  | 0    | 0    | 1.2        | 0                  | 1.8  | 0    | 0    | 1.7        | 100                         | 0.7  | 0    | 0    | 1.1        | 1          |
| Trucks      | 0                  | 3    | 0    | 0    | 3          | 0                           | 1    | 0    | 0    | 1          | 0                  | 3    | 0    | 0    | 3          | 0                           | 1    | 6    | 0    | 7          | 14         |
| % Trucks    | 0                  | 6.1  | 0    | 0    | 3.7        | 0                           | 1.2  | 0    | 0    | 1.2        | 0                  | 5.3  | 0    | 0    | 5.2        | 0                           | 0.7  | 19.4 | 0    | 3.8        | 3.4        |

| Start Time   | 7TH AVE Southbound |      |      |            | COLONEL DURHAM ST Westbound |      |      |            | 7TH AVE Northbound |      |      |            | COLONEL DURHAM ST Eastbound |      |      |            | Int. Total |      |    |
|--|--------------------|------|------|------------|-----------------------------|------|------|------------|--------------------|------|------|------------|-----------------------------|------|------|------------|------------|------|----|
|  | Right              | Thru | Left | App. Total | Right                       | Thru | Left | App. Total | Right              | Thru | Left | App. Total | Right                       | Thru | Left | App. Total |            |      |    |
| Peak Hour Analysis From 04:00 PM to 05:45 PM - Peak 1 of 1 |                    |      |      |            |                             |      |      |            |                    |      |      |            |                             |      |      |            |            |      |    |
| Peak Hour for Entire Intersection Begins at 04:15 PM       |                    |      |      |            |                             |      |      |            |                    |      |      |            |                             |      |      |            |            |      |    |
| 04:15 PM   | 2                  | 6    | 0    | 8          | 0                           | 9    | 0    | 9          | 0                  | 8    | 0    | 8          | 0                           | 8    | 0    | 15         | 6          | 21   | 46 |
| 04:30 PM   | 4                  | 4    | 0    | 8          | 0                           | 10   | 0    | 10         | 0                  | 7    | 0    | 7          | 0                           | 7    | 0    | 15         | 5          | 20   | 45 |
| 04:45 PM   | 1                  | 6    | 0    | 7          | 0                           | 25   | 0    | 25         | 0                  | 12   | 0    | 12         | 1                           | 28   | 3    | 32         | 76         | 76   |    |
| 05:00 PM   | 7                  | 7    | 0    | 14         | 0                           | 6    | 0    | 6          | 0                  | 9    | 0    | 9          | 0                           | 27   | 3    | 30         | 59         | 59   |    |
| Total Volume   | 14                 | 23   | 0    | 37         | 0                           | 50   | 0    | 50         | 0                  | 36   | 0    | 36         | 1                           | 85   | 17   | 103        | 226        | 226  |    |
| % App. Total   | 37.8               | 62.2 | 0    |            | 0                           | 100  | 0    |            | 0                  | 100  | 0    |            | 1                           | 82.5 | 16.5 |            |            |      |    |
| PHF  | .500               | .821 | .000 | .661       | .000                        | .500 | .000 | .500       | .000               | .750 | .000 | .750       | .250                        | .759 | .708 | .805       | .743       | .743 |    |

# Traffic Data Service

San Jose, CA  
 (408) 622-4787  
 tdsbay@cs.com

File Name : 11PM FINAL  
 Site Code : 00000011  
 Start Date : 4/25/2018  
 Page No : 2

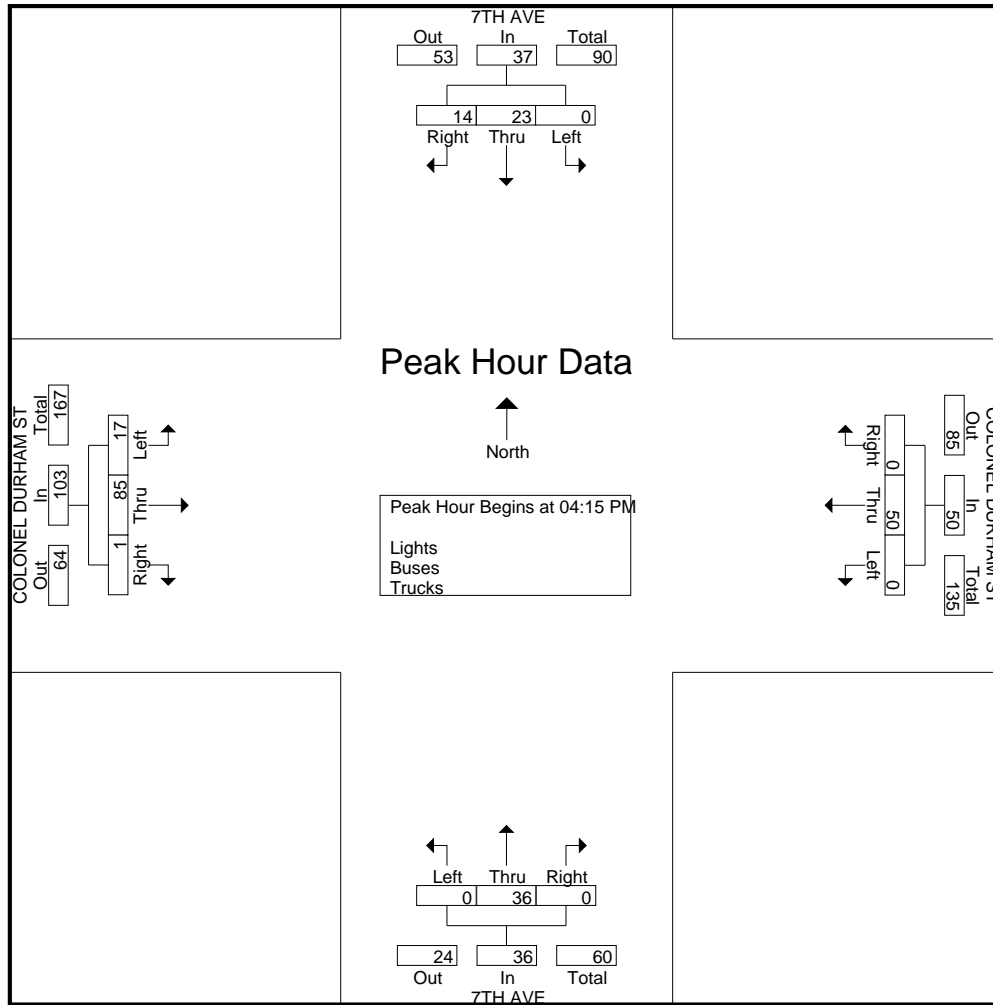

# Traffic Data Service

San Jose, CA  
 (408) 622-4787  
 tdsbay@cs.com

File Name : 11PM FINAL  
 Site Code : 00000011  
 Start Date : 4/25/2018  
 Page No : 1

Groups Printed- Bikes

| Start Time   | 7TH AVE Southbound |      |      |      |            | COLONEL DURHAM ST Westbound |      |      |      |            | 7TH AVE Northbound |      |      |      |            | COLONEL DURHAM ST Eastbound |      |      |      |            | Int. Total |   |
|--------------|--------------------|------|------|------|------------|-----------------------------|------|------|------|------------|--------------------|------|------|------|------------|-----------------------------|------|------|------|------------|------------|---|
|              | Right              | Thru | Left | Peds | App. Total | Right                       | Thru | Left | Peds | App. Total | Right              | Thru | Left | Peds | App. Total | Right                       | Thru | Left | Peds | App. Total |            |   |
| 04:00 PM     | 0                  | 0    | 0    | 0    | 0          | 0                           | 0    | 0    | 0    | 0          | 0                  | 0    | 0    | 0    | 0          | 0                           | 0    | 0    | 0    | 0          | 0          | 0 |
| 04:15 PM     | 0                  | 0    | 0    | 0    | 0          | 0                           | 0    | 0    | 0    | 0          | 0                  | 0    | 1    | 0    | 1          | 0                           | 0    | 0    | 0    | 0          | 0          | 0 |
| 04:30 PM     | 0                  | 0    | 0    | 0    | 0          | 0                           | 0    | 0    | 0    | 0          | 0                  | 0    | 0    | 0    | 0          | 1                           | 0    | 0    | 0    | 1          | 1          | 1 |
| 04:45 PM     | 0                  | 0    | 0    | 0    | 0          | 0                           | 0    | 0    | 0    | 0          | 0                  | 0    | 1    | 0    | 1          | 0                           | 0    | 0    | 0    | 0          | 0          | 1 |
| <b>Total</b> | 0                  | 0    | 0    | 0    | 0          | 0                           | 0    | 0    | 0    | 0          | 0                  | 0    | 2    | 0    | 2          | 1                           | 0    | 0    | 0    | 1          | 1          | 3 |
| 05:00 PM     | 0                  | 0    | 0    | 0    | 0          | 0                           | 0    | 0    | 0    | 0          | 0                  | 0    | 0    | 0    | 0          | 0                           | 0    | 0    | 0    | 0          | 0          | 0 |
| 05:15 PM     | 0                  | 0    | 0    | 0    | 0          | 0                           | 0    | 0    | 0    | 0          | 0                  | 1    | 0    | 0    | 1          | 0                           | 0    | 0    | 0    | 0          | 0          | 1 |
| 05:30 PM     | 0                  | 0    | 0    | 0    | 0          | 0                           | 0    | 0    | 0    | 0          | 0                  | 0    | 0    | 0    | 0          | 0                           | 0    | 0    | 0    | 0          | 0          | 0 |
| 05:45 PM     | 0                  | 0    | 0    | 0    | 0          | 0                           | 0    | 0    | 0    | 0          | 0                  | 0    | 0    | 0    | 0          | 0                           | 0    | 0    | 0    | 0          | 0          | 0 |
| <b>Total</b> | 0                  | 0    | 0    | 0    | 0          | 0                           | 0    | 0    | 0    | 0          | 0                  | 1    | 0    | 0    | 1          | 0                           | 0    | 0    | 0    | 0          | 0          | 1 |
| Grand Total  | 0                  | 0    | 0    | 0    | 0          | 0                           | 0    | 0    | 0    | 0          | 0                  | 1    | 2    | 0    | 3          | 1                           | 0    | 0    | 0    | 1          | 1          | 4 |
| Apprch %     | 0                  | 0    | 0    | 0    | 0          | 0                           | 0    | 0    | 0    | 0          | 0                  | 33.3 | 66.7 | 0    | 0          | 100                         | 0    | 0    | 0    | 0          | 0          | 0 |
| Total %      | 0                  | 0    | 0    | 0    | 0          | 0                           | 0    | 0    | 0    | 0          | 0                  | 25   | 50   | 0    | 75         | 25                          | 0    | 0    | 0    | 25         | 0          | 0 |

| Start Time   | 7TH AVE Southbound |      |      |      |            | COLONEL DURHAM ST Westbound |      |      |      |            | 7TH AVE Northbound |      |      |      |            | COLONEL DURHAM ST Eastbound |      |      |      |            | Int. Total |   |
|--|--------------------|------|------|------|------------|-----------------------------|------|------|------|------------|--------------------|------|------|------|------------|-----------------------------|------|------|------|------------|------------|---|
|  | Right              | Thru | Left | Peds | App. Total | Right                       | Thru | Left | Peds | App. Total | Right              | Thru | Left | Peds | App. Total | Right                       | Thru | Left | Peds | App. Total |            |   |
| Peak Hour Analysis From 04:00 PM to 05:45 PM - Peak 1 of 1 |                    |      |      |      |            |                             |      |      |      |            |                    |      |      |      |            |                             |      |      |      |            |            |   |
| Peak Hour for Entire Intersection Begins at 04:00 PM       |                    |      |      |      |            |                             |      |      |      |            |                    |      |      |      |            |                             |      |      |      |            |            |   |
| 04:00 PM   | 0                  | 0    | 0    | 0    | 0          | 0                           | 0    | 0    | 0    | 0          | 0                  | 0    | 0    | 0    | 0          | 0                           | 0    | 0    | 0    | 0          | 0          | 0 |
| 04:15 PM   | 0                  | 0    | 0    | 0    | 0          | 0                           | 0    | 0    | 0    | 0          | 0                  | 0    | 1    | 0    | 1          | 0                           | 0    | 0    | 0    | 0          | 0          | 1 |
| 04:30 PM   | 0                  | 0    | 0    | 0    | 0          | 0                           | 0    | 0    | 0    | 0          | 0                  | 0    | 0    | 0    | 0          | 1                           | 0    | 0    | 0    | 1          | 1          | 1 |
| 04:45 PM   | 0                  | 0    | 0    | 0    | 0          | 0                           | 0    | 0    | 0    | 0          | 0                  | 0    | 1    | 0    | 1          | 0                           | 0    | 0    | 0    | 0          | 0          | 1 |
| <b>Total Volume</b>  | 0                  | 0    | 0    | 0    | 0          | 0                           | 0    | 0    | 0    | 0          | 0                  | 0    | 2    | 0    | 2          | 1                           | 0    | 0    | 0    | 1          | 1          | 3 |
| <b>% App. Total</b>  | 0                  | 0    | 0    | 0    | 0          | 0                           | 0    | 0    | 0    | 0          | 0                  | 0    | 100  | 0    | 0          | 100                         | 0    | 0    | 0    | 0          | 0          | 0 |
| <b>PHF</b>   | .000               | .000 | .000 | .000 | .000       | .000                        | .000 | .000 | .000 | .000       | .000               | .000 | .500 | .500 | .250       | .000                        | .000 | .000 | .250 | .250       | .750       |   |

# Traffic Data Service

San Jose, CA  
 (408) 622-4787  
 tdsbay@cs.com

File Name : 11PM FINAL  
 Site Code : 00000011  
 Start Date : 4/25/2018  
 Page No : 2

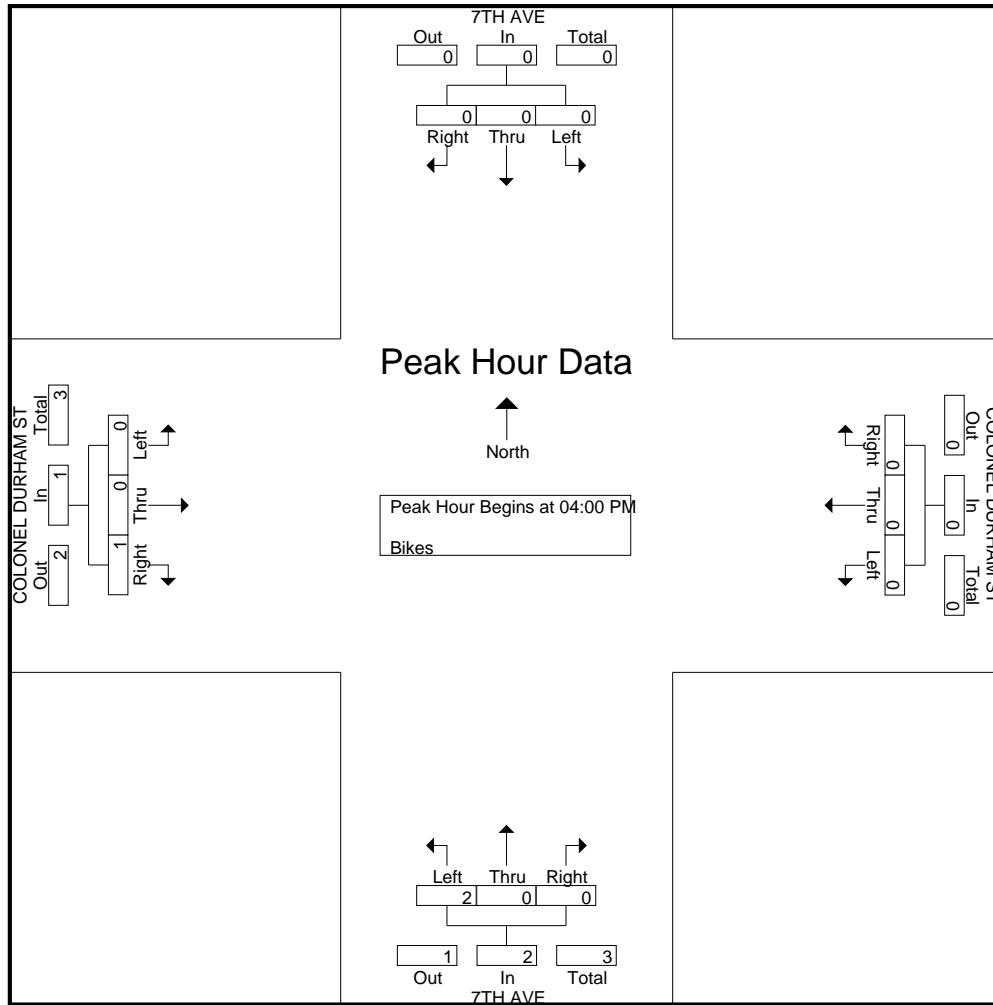



# Traffic Data Service

San Jose, CA  
 (408) 622-4787  
 tdsbay@cs.com

File Name : 12AM FINAL  
 Site Code : 00000012  
 Start Date : 4/25/2018  
 Page No : 1

Groups Printed- Lights - Buses - Trucks

| Start Time  | 8TH AVE Southbound |      |      |      |            | Westbound |      |      |      |            | 8TH AVE Northbound |      |      |      |            | COLONEL DURHAM ST Eastbound |      |      |      |            | Int. Total |
|-------------|--------------------|------|------|------|------------|-----------|------|------|------|------------|--------------------|------|------|------|------------|-----------------------------|------|------|------|------------|------------|
|             | Right              | Thru | Left | Peds | App. Total | Right     | Thru | Left | Peds | App. Total | Right              | Thru | Left | Peds | App. Total | Right                       | Thru | Left | Peds | App. Total |            |
| 07:00 AM    | 44                 | 78   | 0    | 0    | 122        | 0         | 0    | 0    | 0    | 0          | 0                  | 15   | 0    | 0    | 15         | 0                           | 0    | 3    | 0    | 3          | 140        |
| 07:15 AM    | 46                 | 126  | 0    | 0    | 172        | 0         | 0    | 0    | 0    | 0          | 0                  | 18   | 0    | 0    | 18         | 0                           | 0    | 2    | 0    | 2          | 192        |
| 07:30 AM    | 56                 | 107  | 0    | 0    | 163        | 0         | 0    | 0    | 0    | 0          | 0                  | 27   | 0    | 0    | 27         | 0                           | 0    | 7    | 0    | 7          | 197        |
| 07:45 AM    | 30                 | 98   | 0    | 0    | 128        | 0         | 0    | 0    | 0    | 0          | 0                  | 28   | 0    | 0    | 28         | 0                           | 0    | 19   | 0    | 19         | 175        |
| Total       | 176                | 409  | 0    | 0    | 585        | 0         | 0    | 0    | 0    | 0          | 0                  | 88   | 0    | 0    | 88         | 0                           | 0    | 31   | 0    | 31         | 704        |
| 08:00 AM    | 27                 | 50   | 0    | 0    | 77         | 0         | 0    | 0    | 0    | 0          | 0                  | 25   | 0    | 0    | 25         | 0                           | 0    | 9    | 0    | 9          | 111        |
| 08:15 AM    | 22                 | 55   | 0    | 0    | 77         | 0         | 0    | 0    | 0    | 0          | 0                  | 27   | 0    | 0    | 27         | 0                           | 0    | 6    | 0    | 6          | 110        |
| 08:30 AM    | 18                 | 40   | 0    | 0    | 58         | 0         | 0    | 0    | 0    | 0          | 0                  | 21   | 0    | 0    | 21         | 0                           | 0    | 9    | 0    | 9          | 88         |
| 08:45 AM    | 13                 | 31   | 0    | 0    | 44         | 0         | 0    | 0    | 0    | 0          | 0                  | 13   | 0    | 0    | 13         | 0                           | 0    | 5    | 0    | 5          | 62         |
| Total       | 80                 | 176  | 0    | 0    | 256        | 0         | 0    | 0    | 0    | 0          | 0                  | 86   | 0    | 0    | 86         | 0                           | 0    | 29   | 0    | 29         | 371        |
| Grand Total | 256                | 585  | 0    | 0    | 841        | 0         | 0    | 0    | 0    | 0          | 0                  | 174  | 0    | 0    | 174        | 0                           | 0    | 60   | 0    | 60         | 1075       |
| Apprch %    | 30.4               | 69.6 | 0    | 0    |            | 0         | 0    | 0    | 0    |            | 0                  | 100  | 0    | 0    |            | 0                           | 0    | 100  | 0    |            |            |
| Total %     | 23.8               | 54.4 | 0    | 0    | 78.2       | 0         | 0    | 0    | 0    | 0          | 0                  | 16.2 | 0    | 0    | 16.2       | 0                           | 0    | 5.6  | 0    | 5.6        |            |
| Lights      | 256                | 582  | 0    | 0    | 838        | 0         | 0    | 0    | 0    | 0          | 0                  | 166  | 0    | 0    | 166        | 0                           | 0    | 54   | 0    | 54         | 1058       |
| % Lights    | 100                | 99.5 | 0    | 0    | 99.6       | 0         | 0    | 0    | 0    | 0          | 0                  | 95.4 | 0    | 0    | 95.4       | 0                           | 0    | 90   | 0    | 90         | 98.4       |
| Buses       | 0                  | 3    | 0    | 0    | 3          | 0         | 0    | 0    | 0    | 0          | 0                  | 6    | 0    | 0    | 6          | 0                           | 0    | 5    | 0    | 5          | 14         |
| % Buses     | 0                  | 0.5  | 0    | 0    | 0.4        | 0         | 0    | 0    | 0    | 0          | 0                  | 3.4  | 0    | 0    | 3.4        | 0                           | 0    | 8.3  | 0    | 8.3        | 1.3        |
| Trucks      | 0                  | 0    | 0    | 0    | 0          | 0         | 0    | 0    | 0    | 0          | 0                  | 2    | 0    | 0    | 2          | 0                           | 0    | 1    | 0    | 1          | 3          |
| % Trucks    | 0                  | 0    | 0    | 0    | 0          | 0         | 0    | 0    | 0    | 0          | 0                  | 1.1  | 0    | 0    | 1.1        | 0                           | 0    | 1.7  | 0    | 1.7        | 0.3        |

| Start Time   | 8TH AVE Southbound |      |      |            | Westbound |      |      |            | 8TH AVE Northbound |      |      |            | COLONEL DURHAM ST Eastbound |      |      |            | Int. Total |
|--|--------------------|------|------|------------|-----------|------|------|------------|--------------------|------|------|------------|-----------------------------|------|------|------------|------------|
|  | Right              | Thru | Left | App. Total | Right     | Thru | Left | App. Total | Right              | Thru | Left | App. Total | Right                       | Thru | Left | App. Total |            |
| Peak Hour Analysis From 07:00 AM to 08:45 AM - Peak 1 of 1 |                    |      |      |            |           |      |      |            |                    |      |      |            |                             |      |      |            |            |
| Peak Hour for Entire Intersection Begins at 07:00 AM       |                    |      |      |            |           |      |      |            |                    |      |      |            |                             |      |      |            |            |
| 07:00 AM   | 44                 | 78   | 0    | 122        | 0         | 0    | 0    | 0          | 0                  | 15   | 0    | 15         | 0                           | 0    | 3    | 3          | 140        |
| 07:15 AM   | 46                 | 126  | 0    | 172        | 0         | 0    | 0    | 0          | 0                  | 18   | 0    | 18         | 0                           | 0    | 2    | 2          | 192        |
| 07:30 AM   | 56                 | 107  | 0    | 163        | 0         | 0    | 0    | 0          | 0                  | 27   | 0    | 27         | 0                           | 0    | 7    | 7          | 197        |
| 07:45 AM   | 30                 | 98   | 0    | 128        | 0         | 0    | 0    | 0          | 0                  | 28   | 0    | 28         | 0                           | 0    | 19   | 19         | 175        |
| Total Volume   | 176                | 409  | 0    | 585        | 0         | 0    | 0    | 0          | 0                  | 88   | 0    | 88         | 0                           | 0    | 31   | 31         | 704        |
| % App. Total   | 30.1               | 69.9 | 0    |            | 0         | 0    | 0    |            | 0                  | 100  | 0    |            | 0                           | 0    | 100  |            |            |
| PHF  | .786               | .812 | .000 | .850       | .000      | .000 | .000 | .000       | .000               | .786 | .000 | .786       | .000                        | .000 | .408 | .408       | .893       |

# Traffic Data Service

San Jose, CA  
 (408) 622-4787  
 tdsbay@cs.com

File Name : 12AM FINAL  
 Site Code : 00000012  
 Start Date : 4/25/2018  
 Page No : 2

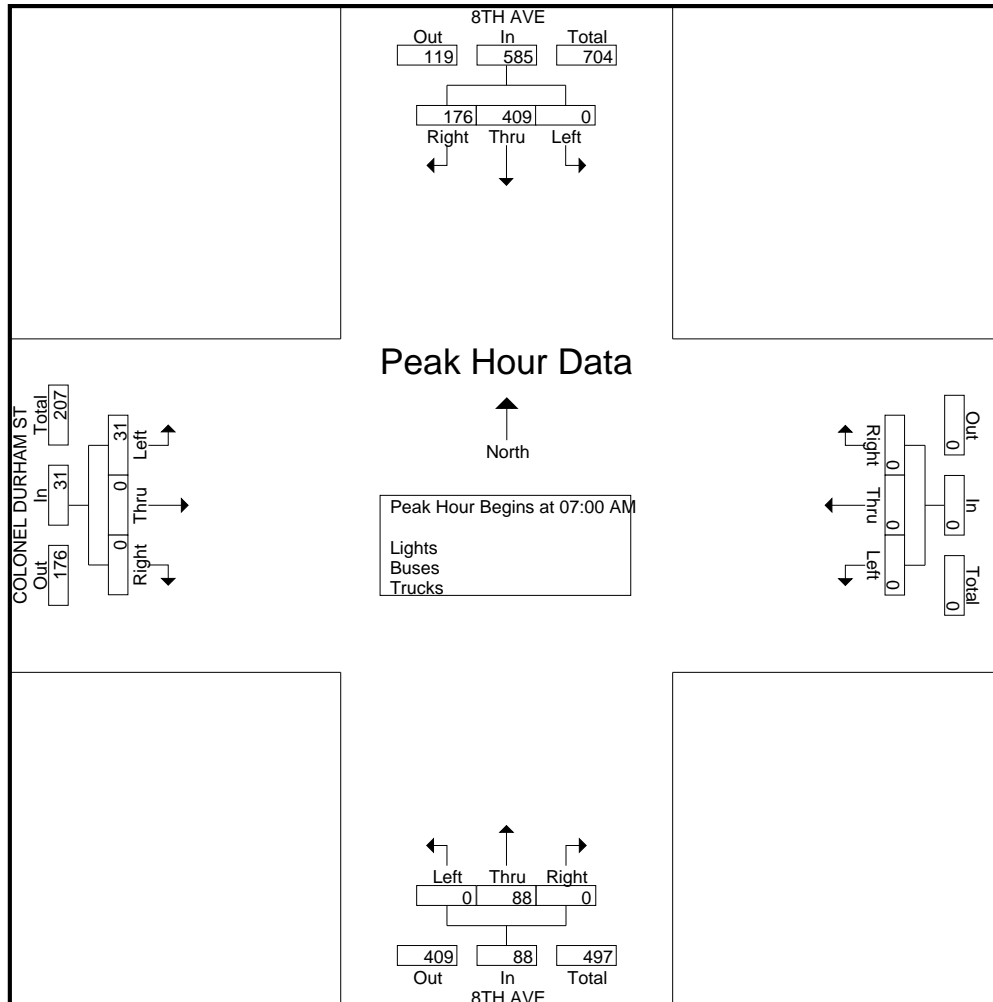

# Traffic Data Service

San Jose, CA  
 (408) 622-4787  
 tdsbay@cs.com

File Name : 12AM FINAL  
 Site Code : 00000012  
 Start Date : 4/25/2018  
 Page No : 1

Groups Printed- Bikes

| Start Time  | 8TH AVE Southbound |      |      |      |            | Westbound |      |      |      |            | 8TH AVE Northbound |      |      |      |            | COLONEL DURHAM ST Eastbound |      |      |      |            | Int. Total |
|-------------|--------------------|------|------|------|------------|-----------|------|------|------|------------|--------------------|------|------|------|------------|-----------------------------|------|------|------|------------|------------|
|             | Right              | Thru | Left | Peds | App. Total | Right     | Thru | Left | Peds | App. Total | Right              | Thru | Left | Peds | App. Total | Right                       | Thru | Left | Peds | App. Total |            |
| 07:00 AM    | 0                  | 0    | 0    | 0    | 0          | 0         | 0    | 0    | 0    | 0          | 0                  | 0    | 0    | 0    | 0          | 0                           | 0    | 0    | 0    | 0          | 0          |
| 07:15 AM    | 0                  | 0    | 0    | 0    | 0          | 0         | 0    | 0    | 0    | 0          | 0                  | 0    | 0    | 0    | 0          | 0                           | 0    | 0    | 0    | 0          | 0          |
| 07:30 AM    | 0                  | 0    | 0    | 0    | 0          | 0         | 0    | 0    | 0    | 0          | 0                  | 0    | 0    | 0    | 0          | 0                           | 0    | 0    | 0    | 0          | 0          |
| 07:45 AM    | 0                  | 0    | 0    | 0    | 0          | 0         | 0    | 0    | 0    | 0          | 0                  | 0    | 0    | 0    | 0          | 0                           | 0    | 0    | 0    | 0          | 0          |
| Total       | 0                  | 0    | 0    | 0    | 0          | 0         | 0    | 0    | 0    | 0          | 0                  | 0    | 0    | 0    | 0          | 0                           | 0    | 0    | 0    | 0          | 0          |
| 08:00 AM    | 0                  | 0    | 0    | 0    | 0          | 0         | 0    | 0    | 0    | 0          | 0                  | 0    | 0    | 0    | 0          | 0                           | 0    | 0    | 0    | 0          | 0          |
| 08:15 AM    | 0                  | 0    | 0    | 0    | 0          | 0         | 0    | 0    | 0    | 0          | 0                  | 0    | 0    | 0    | 0          | 0                           | 0    | 0    | 0    | 0          | 0          |
| 08:30 AM    | 0                  | 0    | 0    | 0    | 0          | 0         | 0    | 0    | 0    | 0          | 0                  | 0    | 0    | 0    | 0          | 0                           | 0    | 0    | 0    | 0          | 0          |
| 08:45 AM    | 0                  | 0    | 0    | 0    | 0          | 0         | 0    | 0    | 0    | 0          | 0                  | 0    | 0    | 0    | 0          | 0                           | 0    | 0    | 0    | 0          | 0          |
| Total       | 0                  | 0    | 0    | 0    | 0          | 0         | 0    | 0    | 0    | 0          | 0                  | 0    | 0    | 0    | 0          | 0                           | 0    | 0    | 0    | 0          | 0          |
| Grand Total | 0                  | 0    | 0    | 0    | 0          | 0         | 0    | 0    | 0    | 0          | 0                  | 0    | 0    | 0    | 0          | 0                           | 0    | 0    | 0    | 0          | 0          |
| Apprch %    | 0                  | 0    | 0    | 0    |            | 0         | 0    | 0    | 0    |            | 0                  | 0    | 0    | 0    |            | 0                           | 0    | 0    | 0    |            |            |
| Total %     |                    |      |      |      |            |           |      |      |      |            |                    |      |      |      |            |                             |      |      |      |            |            |

| Start Time   | 8TH AVE Southbound |      |      |      |            | Westbound |      |      |      |            | 8TH AVE Northbound |      |      |      |            | COLONEL DURHAM ST Eastbound |      |      |      |            | Int. Total |
|--|--------------------|------|------|------|------------|-----------|------|------|------|------------|--------------------|------|------|------|------------|-----------------------------|------|------|------|------------|------------|
|  | Right              | Thru | Left | Peds | App. Total | Right     | Thru | Left | Peds | App. Total | Right              | Thru | Left | Peds | App. Total | Right                       | Thru | Left | Peds | App. Total |            |
| Peak Hour Analysis From 07:00 AM to 08:45 AM - Peak 1 of 1 |                    |      |      |      |            |           |      |      |      |            |                    |      |      |      |            |                             |      |      |      |            |            |
| Peak Hour for Entire Intersection Begins at 07:00 AM       |                    |      |      |      |            |           |      |      |      |            |                    |      |      |      |            |                             |      |      |      |            |            |
| 07:00 AM   | 0                  | 0    | 0    | 0    | 0          | 0         | 0    | 0    | 0    | 0          | 0                  | 0    | 0    | 0    | 0          | 0                           | 0    | 0    | 0    | 0          | 0          |
| 07:15 AM   | 0                  | 0    | 0    | 0    | 0          | 0         | 0    | 0    | 0    | 0          | 0                  | 0    | 0    | 0    | 0          | 0                           | 0    | 0    | 0    | 0          | 0          |
| 07:30 AM   | 0                  | 0    | 0    | 0    | 0          | 0         | 0    | 0    | 0    | 0          | 0                  | 0    | 0    | 0    | 0          | 0                           | 0    | 0    | 0    | 0          | 0          |
| 07:45 AM   | 0                  | 0    | 0    | 0    | 0          | 0         | 0    | 0    | 0    | 0          | 0                  | 0    | 0    | 0    | 0          | 0                           | 0    | 0    | 0    | 0          | 0          |
| Total Volume   | 0                  | 0    | 0    | 0    | 0          | 0         | 0    | 0    | 0    | 0          | 0                  | 0    | 0    | 0    | 0          | 0                           | 0    | 0    | 0    | 0          | 0          |
| % App. Total   | 0                  | 0    | 0    | 0    |            | 0         | 0    | 0    | 0    |            | 0                  | 0    | 0    | 0    |            | 0                           | 0    | 0    | 0    |            |            |
| PHF  | .000               | .000 | .000 | .000 | .000       | .000      | .000 | .000 | .000 | .000       | .000               | .000 | .000 | .000 | .000       | .000                        | .000 | .000 | .000 | .000       | .000       |

# Traffic Data Service

San Jose, CA  
(408) 622-4787  
tdsbay@cs.com

File Name : 12AM FINAL  
Site Code : 00000012  
Start Date : 4/25/2018  
Page No : 2

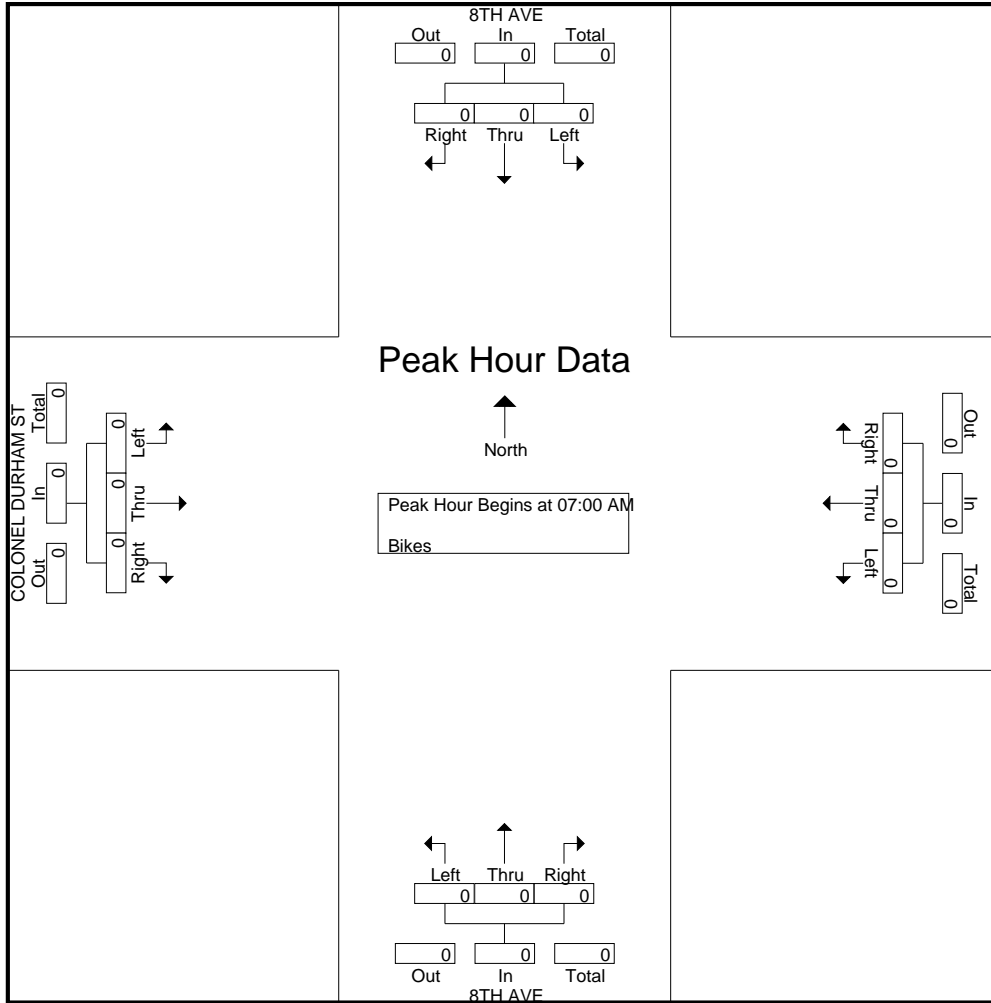

# Traffic Data Service

San Jose, CA  
(408) 622-4787  
tdsbay@cs.com

File Name : 12PM FINAL  
Site Code : 00000012  
Start Date : 4/25/2018  
Page No : 1

Groups Printed- Lights - Buses - Trucks

| Start Time   | 8TH AVE Southbound |      |      |      |            | Westbound |      |      |      |            | 8TH AVE Northbound |      |      |      |            | COLONEL DURHAM ST Eastbound |      |      |      |            | Int. Total |
|--------------|--------------------|------|------|------|------------|-----------|------|------|------|------------|--------------------|------|------|------|------------|-----------------------------|------|------|------|------------|------------|
|              | Right              | Thru | Left | Peds | App. Total | Right     | Thru | Left | Peds | App. Total | Right              | Thru | Left | Peds | App. Total | Right                       | Thru | Left | Peds | App. Total |            |
| 04:00 PM     | 9                  | 28   | 0    | 0    | 37         | 0         | 0    | 0    | 0    | 0          | 0                  | 62   | 0    | 0    | 62         | 1                           | 0    | 17   | 0    | 18         | 117        |
| 04:15 PM     | 7                  | 16   | 0    | 0    | 23         | 0         | 0    | 0    | 0    | 0          | 0                  | 76   | 0    | 0    | 76         | 0                           | 0    | 14   | 0    | 14         | 113        |
| 04:30 PM     | 10                 | 21   | 0    | 0    | 31         | 0         | 0    | 0    | 0    | 0          | 0                  | 72   | 0    | 0    | 72         | 0                           | 0    | 16   | 0    | 16         | 119        |
| 04:45 PM     | 25                 | 29   | 0    | 0    | 54         | 0         | 0    | 0    | 0    | 0          | 0                  | 88   | 0    | 0    | 88         | 1                           | 0    | 27   | 0    | 28         | 170        |
| <b>Total</b> | 51                 | 94   | 0    | 0    | 145        | 0         | 0    | 0    | 0    | 0          | 0                  | 298  | 0    | 0    | 298        | 2                           | 0    | 74   | 0    | 76         | 519        |
| 05:00 PM     | 6                  | 26   | 0    | 0    | 32         | 0         | 0    | 0    | 0    | 0          | 0                  | 77   | 0    | 0    | 77         | 0                           | 0    | 27   | 0    | 27         | 136        |
| 05:15 PM     | 13                 | 29   | 0    | 0    | 42         | 0         | 0    | 0    | 0    | 0          | 0                  | 97   | 0    | 0    | 97         | 0                           | 0    | 13   | 0    | 13         | 152        |
| 05:30 PM     | 10                 | 33   | 0    | 0    | 43         | 0         | 0    | 0    | 0    | 0          | 0                  | 78   | 0    | 0    | 78         | 0                           | 0    | 19   | 0    | 19         | 140        |
| 05:45 PM     | 5                  | 21   | 0    | 0    | 26         | 0         | 0    | 0    | 0    | 0          | 0                  | 55   | 0    | 0    | 55         | 0                           | 0    | 15   | 0    | 15         | 96         |
| <b>Total</b> | 34                 | 109  | 0    | 0    | 143        | 0         | 0    | 0    | 0    | 0          | 0                  | 307  | 0    | 0    | 307        | 0                           | 0    | 74   | 0    | 74         | 524        |
| Grand Total  | 85                 | 203  | 0    | 0    | 288        | 0         | 0    | 0    | 0    | 0          | 0                  | 605  | 0    | 0    | 605        | 2                           | 0    | 148  | 0    | 150        | 1043       |
| Apprch %     | 29.5               | 70.5 | 0    | 0    |            | 0         | 0    | 0    | 0    |            | 0                  | 100  | 0    | 0    |            | 1.3                         | 0    | 98.7 | 0    |            |            |
| Total %      | 8.1                | 19.5 | 0    | 0    | 27.6       | 0         | 0    | 0    | 0    | 0          | 0                  | 58   | 0    | 0    | 58         | 0.2                         | 0    | 14.2 | 0    | 14.4       |            |
| Lights       | 84                 | 200  | 0    | 0    | 284        | 0         | 0    | 0    | 0    | 0          | 0                  | 591  | 0    | 0    | 591        | 1                           | 0    | 147  | 0    | 148        | 1023       |
| % Lights     | 98.8               | 98.5 | 0    | 0    | 98.6       | 0         | 0    | 0    | 0    | 0          | 0                  | 97.7 | 0    | 0    | 97.7       | 50                          | 0    | 99.3 | 0    | 98.7       | 98.1       |
| Buses        | 1                  | 2    | 0    | 0    | 3          | 0         | 0    | 0    | 0    | 0          | 0                  | 7    | 0    | 0    | 7          | 0                           | 0    | 1    | 0    | 1          | 11         |
| % Buses      | 1.2                | 1    | 0    | 0    | 1          | 0         | 0    | 0    | 0    | 0          | 0                  | 1.2  | 0    | 0    | 1.2        | 0                           | 0    | 0.7  | 0    | 0.7        | 1.1        |
| Trucks       | 0                  | 1    | 0    | 0    | 1          | 0         | 0    | 0    | 0    | 0          | 0                  | 7    | 0    | 0    | 7          | 1                           | 0    | 0    | 0    | 1          | 9          |
| % Trucks     | 0                  | 0.5  | 0    | 0    | 0.3        | 0         | 0    | 0    | 0    | 0          | 0                  | 1.2  | 0    | 0    | 1.2        | 50                          | 0    | 0    | 0    | 0.7        | 0.9        |

| Start Time   | 8TH AVE Southbound |      |      |            | Westbound |      |      |            | 8TH AVE Northbound |      |      |            | COLONEL DURHAM ST Eastbound |      |      |            | Int. Total |
|--|--------------------|------|------|------------|-----------|------|------|------------|--------------------|------|------|------------|-----------------------------|------|------|------------|------------|
|  | Right              | Thru | Left | App. Total | Right     | Thru | Left | App. Total | Right              | Thru | Left | App. Total | Right                       | Thru | Left | App. Total |            |
| Peak Hour Analysis From 04:00 PM to 05:45 PM - Peak 1 of 1 |                    |      |      |            |           |      |      |            |                    |      |      |            |                             |      |      |            |            |
| Peak Hour for Entire Intersection Begins at 04:45 PM       |                    |      |      |            |           |      |      |            |                    |      |      |            |                             |      |      |            |            |
| 04:45 PM   | 25                 | 29   | 0    | 54         | 0         | 0    | 0    | 0          | 0                  | 88   | 0    | 88         | 1                           | 0    | 27   | 28         | 170        |
| 05:00 PM   | 6                  | 26   | 0    | 32         | 0         | 0    | 0    | 0          | 0                  | 77   | 0    | 77         | 0                           | 0    | 27   | 27         | 136        |
| 05:15 PM   | 13                 | 29   | 0    | 42         | 0         | 0    | 0    | 0          | 0                  | 97   | 0    | 97         | 0                           | 0    | 13   | 13         | 152        |
| 05:30 PM   | 10                 | 33   | 0    | 43         | 0         | 0    | 0    | 0          | 0                  | 78   | 0    | 78         | 0                           | 0    | 19   | 19         | 140        |
| Total Volume   | 54                 | 117  | 0    | 171        | 0         | 0    | 0    | 0          | 0                  | 340  | 0    | 340        | 1                           | 0    | 86   | 87         | 598        |
| % App. Total   | 31.6               | 68.4 | 0    |            | 0         | 0    | 0    |            | 0                  | 100  | 0    |            | 1.1                         | 0    | 98.9 |            |            |
| PHF  | .540               | .886 | .000 | .792       | .000      | .000 | .000 | .000       | .000               | .876 | .000 | .876       | .250                        | .000 | .796 | .777       | .879       |

# Traffic Data Service

San Jose, CA  
 (408) 622-4787  
 tdsbay@cs.com

File Name : 12PM FINAL  
 Site Code : 00000012  
 Start Date : 4/25/2018  
 Page No : 2

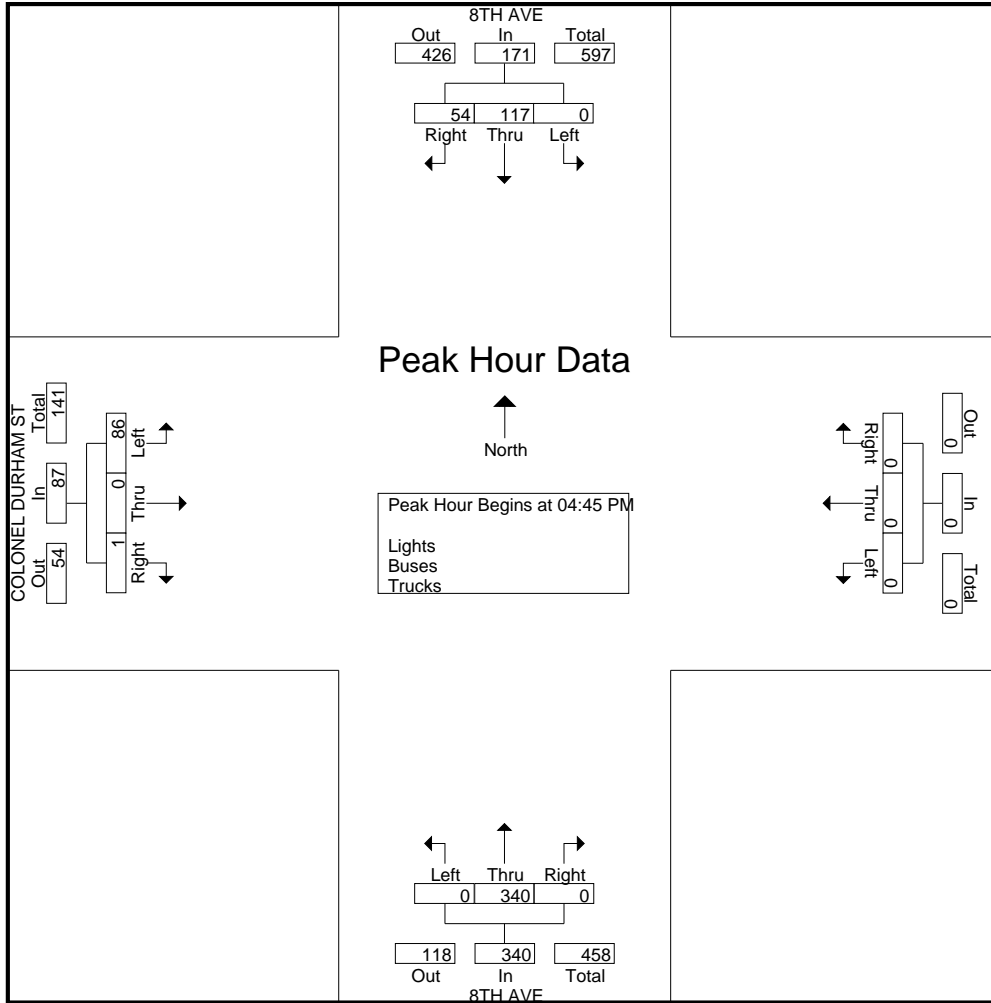

# Traffic Data Service

San Jose, CA  
 (408) 622-4787  
 tdsbay@cs.com

File Name : 12PM FINAL  
 Site Code : 00000012  
 Start Date : 4/25/2018  
 Page No : 1

Groups Printed- Bikes

| Start Time   | 8TH AVE Southbound |      |      |      |            | Westbound |      |      |      |            | 8TH AVE Northbound |      |      |      |            | COLONEL DURHAM ST Eastbound |      |      |      |            | Int. Total |
|--------------|--------------------|------|------|------|------------|-----------|------|------|------|------------|--------------------|------|------|------|------------|-----------------------------|------|------|------|------------|------------|
|              | Right              | Thru | Left | Peds | App. Total | Right     | Thru | Left | Peds | App. Total | Right              | Thru | Left | Peds | App. Total | Right                       | Thru | Left | Peds | App. Total |            |
| 04:00 PM     | 0                  | 0    | 0    | 0    | 0          | 0         | 0    | 0    | 0    | 0          | 0                  | 0    | 0    | 0    | 0          | 0                           | 0    | 0    | 0    | 0          | 0          |
| 04:15 PM     | 0                  | 0    | 0    | 0    | 0          | 0         | 0    | 0    | 0    | 0          | 0                  | 0    | 0    | 0    | 0          | 0                           | 0    | 0    | 0    | 0          | 0          |
| 04:30 PM     | 0                  | 0    | 0    | 0    | 0          | 0         | 0    | 0    | 0    | 0          | 0                  | 0    | 0    | 0    | 0          | 0                           | 0    | 0    | 0    | 0          | 0          |
| 04:45 PM     | 0                  | 0    | 0    | 0    | 0          | 0         | 0    | 0    | 0    | 0          | 0                  | 0    | 0    | 0    | 0          | 0                           | 0    | 0    | 0    | 0          | 0          |
| <b>Total</b> | 0                  | 0    | 0    | 0    | 0          | 0         | 0    | 0    | 0    | 0          | 0                  | 0    | 0    | 0    | 0          | 0                           | 0    | 0    | 0    | 0          | 0          |
| 05:00 PM     | 0                  | 0    | 0    | 0    | 0          | 0         | 0    | 0    | 0    | 0          | 0                  | 0    | 0    | 0    | 0          | 0                           | 0    | 0    | 0    | 0          | 0          |
| 05:15 PM     | 0                  | 1    | 0    | 0    | 1          | 0         | 0    | 0    | 0    | 0          | 0                  | 0    | 0    | 0    | 0          | 0                           | 0    | 0    | 0    | 0          | 1          |
| 05:30 PM     | 0                  | 0    | 0    | 0    | 0          | 0         | 0    | 0    | 0    | 0          | 0                  | 0    | 0    | 0    | 0          | 0                           | 0    | 0    | 0    | 0          | 0          |
| 05:45 PM     | 0                  | 0    | 0    | 0    | 0          | 0         | 0    | 0    | 0    | 0          | 0                  | 0    | 0    | 0    | 0          | 0                           | 0    | 0    | 0    | 0          | 0          |
| <b>Total</b> | 0                  | 1    | 0    | 0    | 1          | 0         | 0    | 0    | 0    | 0          | 0                  | 0    | 0    | 0    | 0          | 0                           | 0    | 0    | 0    | 0          | 1          |
| Grand Total  | 0                  | 1    | 0    | 0    | 1          | 0         | 0    | 0    | 0    | 0          | 0                  | 0    | 0    | 0    | 0          | 0                           | 0    | 0    | 0    | 0          | 1          |
| Apprch %     | 0                  | 100  | 0    | 0    |            | 0         | 0    | 0    | 0    |            | 0                  | 0    | 0    | 0    |            | 0                           | 0    | 0    | 0    |            |            |
| Total %      | 0                  | 100  | 0    | 0    | 100        | 0         | 0    | 0    | 0    | 0          | 0                  | 0    | 0    | 0    | 0          | 0                           | 0    | 0    | 0    | 0          |            |

| Start Time   | 8TH AVE Southbound |      |      |      |            | Westbound |      |      |      |            | 8TH AVE Northbound |      |      |      |            | COLONEL DURHAM ST Eastbound |      |      |      |            | Int. Total |
|--|--------------------|------|------|------|------------|-----------|------|------|------|------------|--------------------|------|------|------|------------|-----------------------------|------|------|------|------------|------------|
|  | Right              | Thru | Left | Peds | App. Total | Right     | Thru | Left | Peds | App. Total | Right              | Thru | Left | Peds | App. Total | Right                       | Thru | Left | Peds | App. Total |            |
| Peak Hour Analysis From 04:00 PM to 05:45 PM - Peak 1 of 1 |                    |      |      |      |            |           |      |      |      |            |                    |      |      |      |            |                             |      |      |      |            |            |
| Peak Hour for Entire Intersection Begins at 04:30 PM       |                    |      |      |      |            |           |      |      |      |            |                    |      |      |      |            |                             |      |      |      |            |            |
| 04:30 PM   | 0                  | 0    | 0    | 0    | 0          | 0         | 0    | 0    | 0    | 0          | 0                  | 0    | 0    | 0    | 0          | 0                           | 0    | 0    | 0    | 0          | 0          |
| 04:45 PM   | 0                  | 0    | 0    | 0    | 0          | 0         | 0    | 0    | 0    | 0          | 0                  | 0    | 0    | 0    | 0          | 0                           | 0    | 0    | 0    | 0          | 0          |
| 05:00 PM   | 0                  | 0    | 0    | 0    | 0          | 0         | 0    | 0    | 0    | 0          | 0                  | 0    | 0    | 0    | 0          | 0                           | 0    | 0    | 0    | 0          | 0          |
| 05:15 PM   | 0                  | 1    | 0    | 0    | 1          | 0         | 0    | 0    | 0    | 0          | 0                  | 0    | 0    | 0    | 0          | 0                           | 0    | 0    | 0    | 0          | 1          |
| Total Volume   | 0                  | 1    | 0    | 0    | 1          | 0         | 0    | 0    | 0    | 0          | 0                  | 0    | 0    | 0    | 0          | 0                           | 0    | 0    | 0    | 0          | 1          |
| % App. Total   | 0                  | 100  | 0    | 0    |            | 0         | 0    | 0    | 0    |            | 0                  | 0    | 0    | 0    |            | 0                           | 0    | 0    | 0    |            |            |
| PHF  | .000               | .250 | .000 | .000 | .250       | .000      | .000 | .000 | .000 | .000       | .000               | .000 | .000 | .000 | .000       | .000                        | .000 | .000 | .000 | .000       | .250       |

# Traffic Data Service

San Jose, CA  
 (408) 622-4787  
 tdsbay@cs.com

File Name : 12PM FINAL  
 Site Code : 00000012  
 Start Date : 4/25/2018  
 Page No : 2

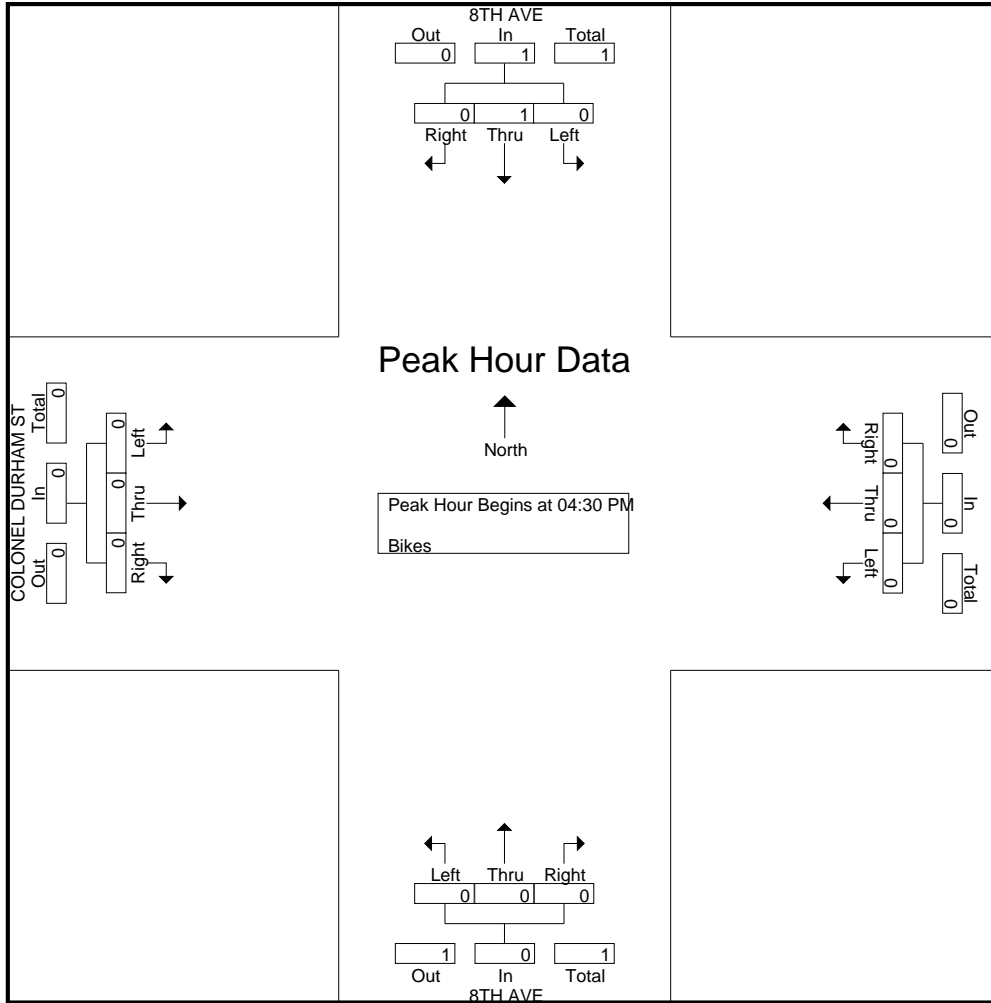



# Traffic Data Service

San Jose, CA  
(408) 622-4787  
tdsbay@cs.com

File Name : 13AM FINAL  
Site Code : 00000013  
Start Date : 4/25/2018  
Page No : 1

Groups Printed- Lights - Buses - Trucks

| Start Time   | MALMEDY RD Southbound |      |      |      |            | GIGLING RD Westbound |      |      |      |            | MALMEDY RD Northbound |      |      |      |            | GIGLING RD Eastbound |      |      |      |            | Int. Total |
|--------------|-----------------------|------|------|------|------------|----------------------|------|------|------|------------|-----------------------|------|------|------|------------|----------------------|------|------|------|------------|------------|
|              | Right                 | Thru | Left | Peds | App. Total | Right                | Thru | Left | Peds | App. Total | Right                 | Thru | Left | Peds | App. Total | Right                | Thru | Left | Peds | App. Total |            |
| 07:00 AM     | 1                     | 1    | 1    | 0    | 3          | 0                    | 69   | 0    | 0    | 69         | 2                     | 10   | 1    | 0    | 13         | 1                    | 43   | 0    | 0    | 44         | 129        |
| 07:15 AM     | 3                     | 1    | 2    | 0    | 6          | 4                    | 111  | 1    | 0    | 116        | 0                     | 15   | 6    | 0    | 21         | 2                    | 54   | 0    | 0    | 56         | 199        |
| 07:30 AM     | 3                     | 0    | 5    | 0    | 8          | 6                    | 125  | 1    | 0    | 132        | 2                     | 11   | 5    | 0    | 18         | 6                    | 92   | 2    | 0    | 100        | 258        |
| 07:45 AM     | 3                     | 2    | 13   | 1    | 19         | 4                    | 87   | 10   | 0    | 101        | 3                     | 10   | 8    | 0    | 21         | 5                    | 114  | 0    | 0    | 119        | 260        |
| <b>Total</b> | 10                    | 4    | 21   | 1    | 36         | 14                   | 392  | 12   | 0    | 418        | 7                     | 46   | 20   | 0    | 73         | 14                   | 303  | 2    | 0    | 319        | 846        |
| 08:00 AM     | 4                     | 6    | 10   | 0    | 20         | 1                    | 59   | 1    | 0    | 61         | 2                     | 9    | 11   | 0    | 22         | 3                    | 93   | 1    | 0    | 97         | 200        |
| 08:15 AM     | 2                     | 5    | 7    | 0    | 14         | 4                    | 78   | 4    | 0    | 86         | 1                     | 9    | 2    | 0    | 12         | 1                    | 73   | 1    | 0    | 75         | 187        |
| 08:30 AM     | 2                     | 3    | 9    | 0    | 14         | 0                    | 61   | 1    | 0    | 62         | 1                     | 1    | 1    | 0    | 3          | 2                    | 59   | 0    | 0    | 61         | 140        |
| 08:45 AM     | 2                     | 3    | 6    | 0    | 11         | 2                    | 30   | 0    | 0    | 32         | 3                     | 4    | 4    | 0    | 11         | 2                    | 45   | 2    | 0    | 49         | 103        |
| <b>Total</b> | 10                    | 17   | 32   | 0    | 59         | 7                    | 228  | 6    | 0    | 241        | 7                     | 23   | 18   | 0    | 48         | 8                    | 270  | 4    | 0    | 282        | 630        |
| Grand Total  | 20                    | 21   | 53   | 1    | 95         | 21                   | 620  | 18   | 0    | 659        | 14                    | 69   | 38   | 0    | 121        | 22                   | 573  | 6    | 0    | 601        | 1476       |
| Apprch %     | 21.1                  | 22.1 | 55.8 | 1.1  |            | 3.2                  | 94.1 | 2.7  | 0    |            | 11.6                  | 57   | 31.4 | 0    |            | 3.7                  | 95.3 | 1    | 0    |            |            |
| Total %      | 1.4                   | 1.4  | 3.6  | 0.1  | 6.4        | 1.4                  | 42   | 1.2  | 0    | 44.6       | 0.9                   | 4.7  | 2.6  | 0    | 8.2        | 1.5                  | 38.8 | 0.4  | 0    | 40.7       |            |
| Lights       | 20                    | 21   | 50   | 1    | 92         | 18                   | 600  | 18   | 0    | 636        | 13                    | 69   | 37   | 0    | 119        | 20                   | 555  | 5    | 0    | 580        | 1427       |
| % Lights     | 100                   | 100  | 94.3 | 100  | 96.8       | 85.7                 | 96.8 | 100  | 0    | 96.5       | 92.9                  | 100  | 97.4 | 0    | 98.3       | 90.9                 | 96.9 | 83.3 | 0    | 96.5       | 96.7       |
| Buses        | 0                     | 0    | 0    | 0    | 0          | 0                    | 10   | 0    | 0    | 10         | 0                     | 0    | 1    | 0    | 1          | 2                    | 11   | 0    | 0    | 13         | 24         |
| % Buses      | 0                     | 0    | 0    | 0    | 0          | 0                    | 1.6  | 0    | 0    | 1.5        | 0                     | 0    | 2.6  | 0    | 0.8        | 9.1                  | 1.9  | 0    | 0    | 2.2        | 1.6        |
| Trucks       | 0                     | 0    | 3    | 0    | 3          | 3                    | 10   | 0    | 0    | 13         | 1                     | 0    | 0    | 0    | 1          | 0                    | 7    | 1    | 0    | 8          | 25         |
| % Trucks     | 0                     | 0    | 5.7  | 0    | 3.2        | 14.3                 | 1.6  | 0    | 0    | 2          | 7.1                   | 0    | 0    | 0    | 0.8        | 0                    | 1.2  | 16.7 | 0    | 1.3        | 1.7        |

| Start Time   | MALMEDY RD Southbound |      |      |            | GIGLING RD Westbound |      |      |            | MALMEDY RD Northbound |      |      |            | GIGLING RD Eastbound |      |      |            | Int. Total |
|--|-----------------------|------|------|------------|----------------------|------|------|------------|-----------------------|------|------|------------|----------------------|------|------|------------|------------|
|  | Right                 | Thru | Left | App. Total | Right                | Thru | Left | App. Total | Right                 | Thru | Left | App. Total | Right                | Thru | Left | App. Total |            |
| Peak Hour Analysis From 07:00 AM to 08:45 AM - Peak 1 of 1 |                       |      |      |            |                      |      |      |            |                       |      |      |            |                      |      |      |            |            |
| Peak Hour for Entire Intersection Begins at 07:15 AM       |                       |      |      |            |                      |      |      |            |                       |      |      |            |                      |      |      |            |            |
| 07:15 AM   | 3                     | 1    | 2    | 6          | 4                    | 111  | 1    | 116        | 0                     | 15   | 6    | 21         | 2                    | 54   | 0    | 56         | 199        |
| 07:30 AM   | 3                     | 0    | 5    | 8          | 6                    | 125  | 1    | 132        | 2                     | 11   | 5    | 18         | 6                    | 92   | 2    | 100        | 258        |
| 07:45 AM   | 3                     | 2    | 13   | 18         | 4                    | 87   | 10   | 101        | 3                     | 10   | 8    | 21         | 5                    | 114  | 0    | 119        | 259        |
| 08:00 AM   | 4                     | 6    | 10   | 20         | 1                    | 59   | 1    | 61         | 2                     | 9    | 11   | 22         | 3                    | 93   | 1    | 97         | 200        |
| Total Volume   | 13                    | 9    | 30   | 52         | 15                   | 382  | 13   | 410        | 7                     | 45   | 30   | 82         | 16                   | 353  | 3    | 372        | 916        |
| % App. Total   | 25                    | 17.3 | 57.7 |            | 3.7                  | 93.2 | 3.2  |            | 8.5                   | 54.9 | 36.6 |            | 4.3                  | 94.9 | 0.8  |            |            |
| PHF  | .813                  | .375 | .577 | .650       | .625                 | .764 | .325 | .777       | .583                  | .750 | .682 | .932       | .667                 | .774 | .375 | .782       | .884       |

# Traffic Data Service

San Jose, CA  
 (408) 622-4787  
 tdsbay@cs.com

File Name : 13AM FINAL  
 Site Code : 00000013  
 Start Date : 4/25/2018  
 Page No : 2

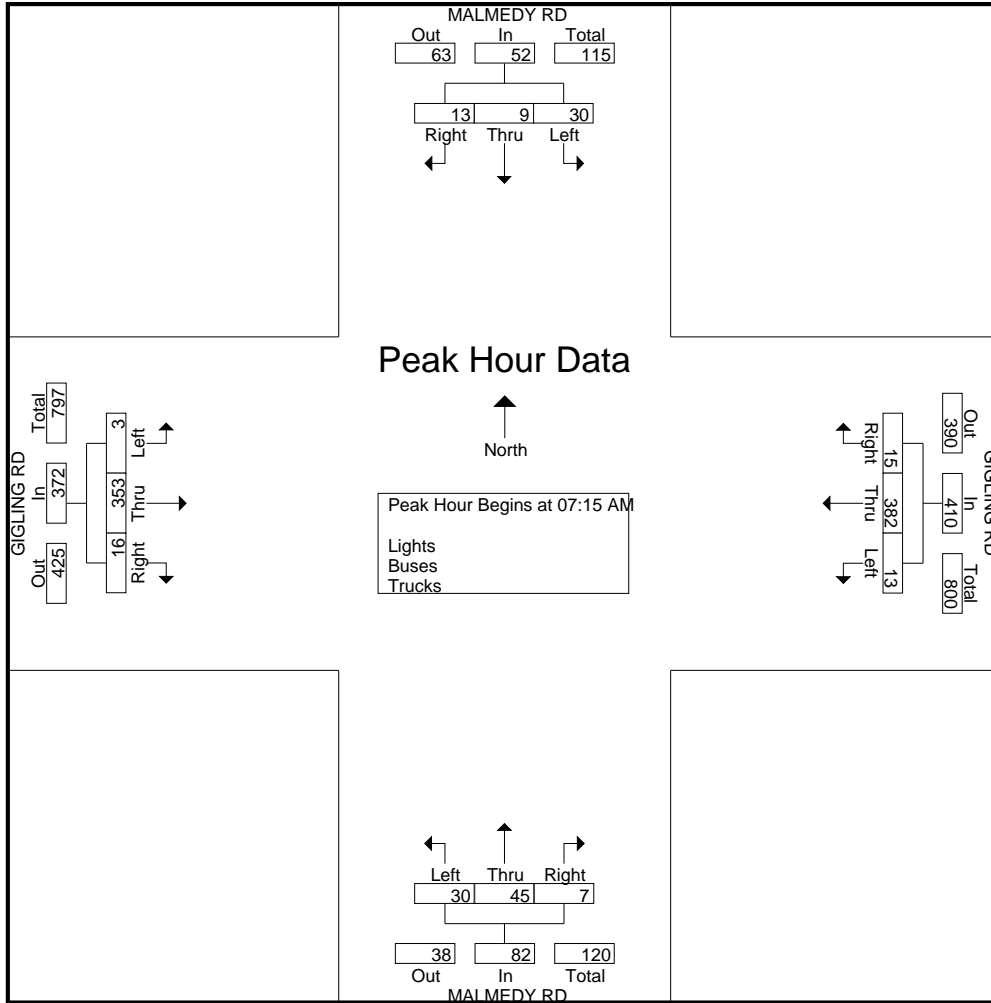

# Traffic Data Service

San Jose, CA  
 (408) 622-4787  
 tdsbay@cs.com

File Name : 13AM FINAL  
 Site Code : 00000013  
 Start Date : 4/25/2018  
 Page No : 1

Groups Printed- Bikes

| Start Time  | MALMEDY RD Southbound |      |      |      |            | GIGLING RD Westbound |      |      |      |            | MALMEDY RD Northbound |      |      |      |            | GIGLING RD Eastbound |      |      |      |            | Int. Total |
|-------------|-----------------------|------|------|------|------------|----------------------|------|------|------|------------|-----------------------|------|------|------|------------|----------------------|------|------|------|------------|------------|
|             | Right                 | Thru | Left | Peds | App. Total | Right                | Thru | Left | Peds | App. Total | Right                 | Thru | Left | Peds | App. Total | Right                | Thru | Left | Peds | App. Total |            |
| 07:00 AM    | 0                     | 0    | 0    | 0    | 0          | 0                    | 0    | 0    | 0    | 0          | 0                     | 0    | 0    | 0    | 0          | 0                    | 0    | 1    | 0    | 0          | 1          |
| 07:15 AM    | 0                     | 0    | 0    | 0    | 0          | 0                    | 0    | 0    | 0    | 0          | 0                     | 0    | 0    | 0    | 0          | 0                    | 0    | 0    | 0    | 0          | 0          |
| 07:30 AM    | 0                     | 0    | 0    | 0    | 0          | 0                    | 0    | 0    | 0    | 0          | 0                     | 0    | 0    | 0    | 0          | 0                    | 0    | 0    | 0    | 0          | 0          |
| 07:45 AM    | 0                     | 0    | 0    | 0    | 0          | 0                    | 0    | 0    | 0    | 0          | 0                     | 0    | 0    | 0    | 0          | 0                    | 0    | 0    | 0    | 0          | 0          |
| Total       | 0                     | 0    | 0    | 0    | 0          | 0                    | 0    | 0    | 0    | 0          | 0                     | 0    | 0    | 0    | 0          | 0                    | 0    | 1    | 0    | 1          | 1          |
| 08:00 AM    | 0                     | 0    | 0    | 0    | 0          | 0                    | 0    | 0    | 0    | 0          | 0                     | 0    | 0    | 0    | 0          | 0                    | 0    | 0    | 0    | 0          | 0          |
| 08:15 AM    | 0                     | 0    | 0    | 0    | 0          | 0                    | 0    | 0    | 0    | 0          | 0                     | 0    | 0    | 0    | 0          | 0                    | 0    | 0    | 0    | 0          | 0          |
| 08:30 AM    | 0                     | 0    | 0    | 0    | 0          | 0                    | 0    | 0    | 0    | 0          | 0                     | 0    | 0    | 0    | 0          | 0                    | 0    | 0    | 0    | 0          | 0          |
| 08:45 AM    | 0                     | 0    | 0    | 0    | 0          | 0                    | 0    | 0    | 0    | 0          | 0                     | 0    | 0    | 0    | 0          | 0                    | 0    | 0    | 0    | 0          | 0          |
| Total       | 0                     | 0    | 0    | 0    | 0          | 0                    | 0    | 0    | 0    | 0          | 0                     | 0    | 0    | 0    | 0          | 0                    | 0    | 0    | 0    | 0          | 0          |
| Grand Total | 0                     | 0    | 0    | 0    | 0          | 0                    | 0    | 0    | 0    | 0          | 0                     | 0    | 0    | 0    | 0          | 0                    | 0    | 1    | 0    | 1          | 1          |
| Apprch %    | 0                     | 0    | 0    | 0    |            | 0                    | 0    | 0    | 0    |            | 0                     | 0    | 0    | 0    |            | 0                    | 0    | 100  | 0    |            |            |
| Total %     | 0                     | 0    | 0    | 0    |            | 0                    | 0    | 0    | 0    |            | 0                     | 0    | 0    | 0    |            | 0                    | 0    | 100  | 0    | 100        |            |

| Start Time   | MALMEDY RD Southbound |      |      |      |            | GIGLING RD Westbound |      |      |      |            | MALMEDY RD Northbound |      |      |      |            | GIGLING RD Eastbound |      |      |      |            | Int. Total |
|--|-----------------------|------|------|------|------------|----------------------|------|------|------|------------|-----------------------|------|------|------|------------|----------------------|------|------|------|------------|------------|
|  | Right                 | Thru | Left | Peds | App. Total | Right                | Thru | Left | Peds | App. Total | Right                 | Thru | Left | Peds | App. Total | Right                | Thru | Left | Peds | App. Total |            |
| Peak Hour Analysis From 07:00 AM to 08:45 AM - Peak 1 of 1 |                       |      |      |      |            |                      |      |      |      |            |                       |      |      |      |            |                      |      |      |      |            |            |
| Peak Hour for Entire Intersection Begins at 07:00 AM       |                       |      |      |      |            |                      |      |      |      |            |                       |      |      |      |            |                      |      |      |      |            |            |
| 07:00 AM   | 0                     | 0    | 0    | 0    | 0          | 0                    | 0    | 0    | 0    | 0          | 0                     | 0    | 0    | 0    | 0          | 0                    | 0    | 1    | 0    | 1          | 1          |
| 07:15 AM   | 0                     | 0    | 0    | 0    | 0          | 0                    | 0    | 0    | 0    | 0          | 0                     | 0    | 0    | 0    | 0          | 0                    | 0    | 0    | 0    | 0          | 0          |
| 07:30 AM   | 0                     | 0    | 0    | 0    | 0          | 0                    | 0    | 0    | 0    | 0          | 0                     | 0    | 0    | 0    | 0          | 0                    | 0    | 0    | 0    | 0          | 0          |
| 07:45 AM   | 0                     | 0    | 0    | 0    | 0          | 0                    | 0    | 0    | 0    | 0          | 0                     | 0    | 0    | 0    | 0          | 0                    | 0    | 0    | 0    | 0          | 0          |
| Total Volume   | 0                     | 0    | 0    | 0    | 0          | 0                    | 0    | 0    | 0    | 0          | 0                     | 0    | 0    | 0    | 0          | 0                    | 0    | 1    | 0    | 1          | 1          |
| % App. Total   | 0                     | 0    | 0    | 0    |            | 0                    | 0    | 0    | 0    |            | 0                     | 0    | 0    | 0    |            | 0                    | 0    | 100  | 0    |            |            |
| PHF  | .000                  | .000 | .000 | .000 | .000       | .000                 | .000 | .000 | .000 | .000       | .000                  | .000 | .000 | .000 | .000       | .000                 | .000 | .250 | .250 | .250       | .250       |

# Traffic Data Service

San Jose, CA  
(408) 622-4787  
tdsbay@cs.com

File Name : 13AM FINAL  
Site Code : 00000013  
Start Date : 4/25/2018  
Page No : 2

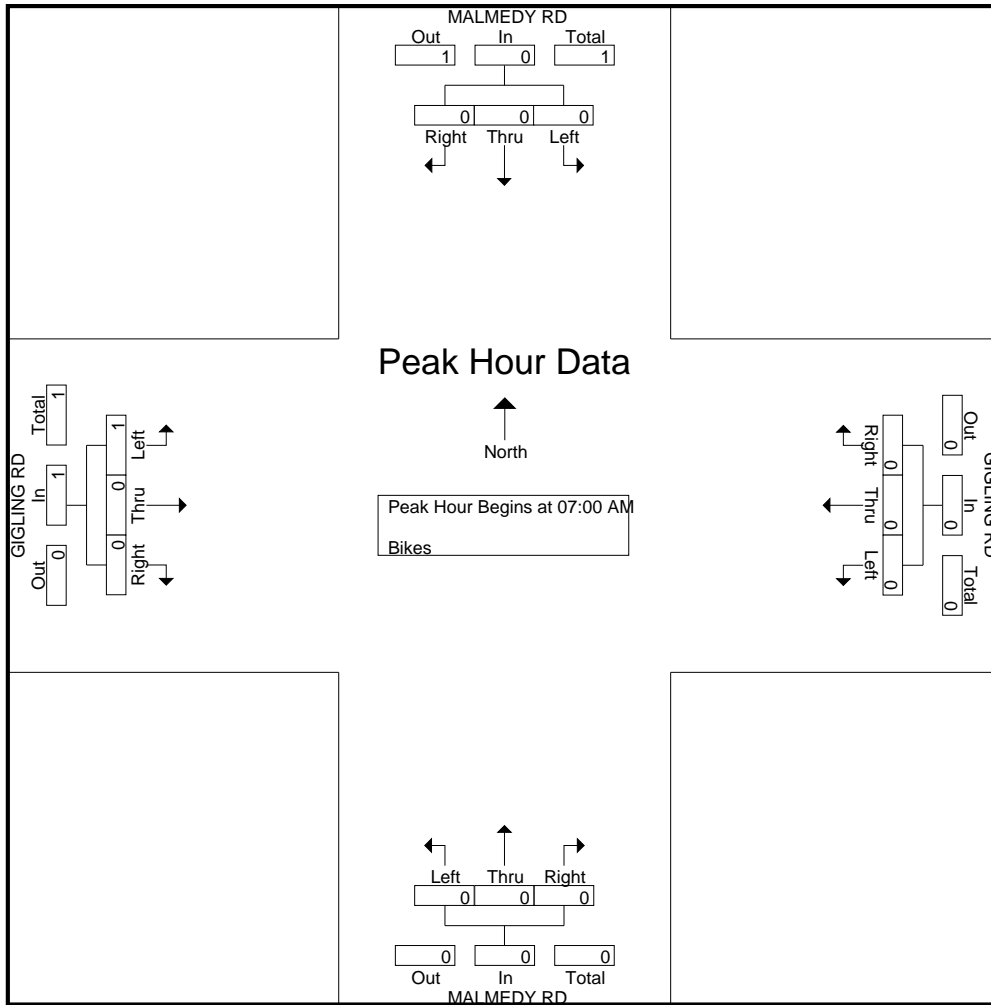

# Traffic Data Service

San Jose, CA  
 (408) 622-4787  
 tdsbay@cs.com

File Name : 13PM FINAL  
 Site Code : 00000013  
 Start Date : 4/25/2018  
 Page No : 1

Groups Printed- Lights - Buses - Trucks

| Start Time  | MALMEDY RD Southbound |      |      |      |            | GIGLING RD Westbound |      |      |      |            | MALMEDY RD Northbound |      |      |      |            | GIGLING RD Eastbound |      |      |      |            | Int. Total |
|-------------|-----------------------|------|------|------|------------|----------------------|------|------|------|------------|-----------------------|------|------|------|------------|----------------------|------|------|------|------------|------------|
|             | Right                 | Thru | Left | Peds | App. Total | Right                | Thru | Left | Peds | App. Total | Right                 | Thru | Left | Peds | App. Total | Right                | Thru | Left | Peds | App. Total |            |
| 04:00 PM    | 1                     | 6    | 5    | 0    | 12         | 4                    | 89   | 2    | 0    | 95         | 0                     | 5    | 2    | 0    | 7          | 6                    | 52   | 0    | 0    | 58         | 172        |
| 04:15 PM    | 1                     | 5    | 4    | 0    | 10         | 5                    | 70   | 1    | 0    | 76         | 0                     | 9    | 1    | 0    | 10         | 4                    | 59   | 1    | 0    | 64         | 160        |
| 04:30 PM    | 0                     | 4    | 3    | 0    | 7          | 6                    | 81   | 0    | 0    | 87         | 3                     | 8    | 3    | 1    | 15         | 3                    | 57   | 0    | 0    | 60         | 169        |
| 04:45 PM    | 1                     | 11   | 3    | 0    | 15         | 4                    | 99   | 1    | 0    | 104        | 2                     | 5    | 4    | 0    | 11         | 11                   | 79   | 0    | 0    | 90         | 220        |
| Total       | 3                     | 26   | 15   | 0    | 44         | 19                   | 339  | 4    | 0    | 362        | 5                     | 27   | 10   | 1    | 43         | 24                   | 247  | 1    | 0    | 272        | 721        |
| 05:00 PM    | 0                     | 5    | 3    | 0    | 8          | 3                    | 83   | 5    | 0    | 91         | 1                     | 5    | 6    | 0    | 12         | 11                   | 83   | 1    | 0    | 95         | 206        |
| 05:15 PM    | 2                     | 7    | 1    | 1    | 11         | 3                    | 74   | 4    | 0    | 81         | 0                     | 9    | 0    | 0    | 9          | 6                    | 99   | 0    | 0    | 105        | 206        |
| 05:30 PM    | 2                     | 4    | 2    | 1    | 9          | 3                    | 56   | 2    | 0    | 61         | 3                     | 6    | 2    | 1    | 12         | 11                   | 79   | 2    | 0    | 92         | 174        |
| 05:45 PM    | 0                     | 4    | 2    | 0    | 6          | 2                    | 49   | 2    | 0    | 53         | 1                     | 7    | 1    | 0    | 9          | 8                    | 62   | 0    | 0    | 70         | 138        |
| Total       | 4                     | 20   | 8    | 2    | 34         | 11                   | 262  | 13   | 0    | 286        | 5                     | 27   | 9    | 1    | 42         | 36                   | 323  | 3    | 0    | 362        | 724        |
| Grand Total | 7                     | 46   | 23   | 2    | 78         | 30                   | 601  | 17   | 0    | 648        | 10                    | 54   | 19   | 2    | 85         | 60                   | 570  | 4    | 0    | 634        | 1445       |
| Apprch %    | 9                     | 59   | 29.5 | 2.6  |            | 4.6                  | 92.7 | 2.6  | 0    |            | 11.8                  | 63.5 | 22.4 | 2.4  |            | 9.5                  | 89.9 | 0.6  | 0    |            |            |
| Total %     | 0.5                   | 3.2  | 1.6  | 0.1  | 5.4        | 2.1                  | 41.6 | 1.2  | 0    | 44.8       | 0.7                   | 3.7  | 1.3  | 0.1  | 5.9        | 4.2                  | 39.4 | 0.3  | 0    | 43.9       |            |
| Lights      | 7                     | 45   | 22   | 2    | 76         | 30                   | 591  | 17   | 0    | 638        | 10                    | 53   | 19   | 2    | 84         | 59                   | 552  | 4    | 0    | 615        | 1413       |
| % Lights    | 100                   | 97.8 | 95.7 | 100  | 97.4       | 100                  | 98.3 | 100  | 0    | 98.5       | 100                   | 98.1 | 100  | 100  | 98.8       | 98.3                 | 96.8 | 100  | 0    | 97         | 97.8       |
| Buses       | 0                     | 0    | 1    | 0    | 1          | 0                    | 6    | 0    | 0    | 6          | 0                     | 0    | 0    | 0    | 0          | 1                    | 11   | 0    | 0    | 12         | 19         |
| % Buses     | 0                     | 0    | 4.3  | 0    | 1.3        | 0                    | 1    | 0    | 0    | 0.9        | 0                     | 0    | 0    | 0    | 0          | 1.7                  | 1.9  | 0    | 0    | 1.9        | 1.3        |
| Trucks      | 0                     | 1    | 0    | 0    | 1          | 0                    | 4    | 0    | 0    | 4          | 0                     | 1    | 0    | 0    | 1          | 0                    | 7    | 0    | 0    | 7          | 13         |
| % Trucks    | 0                     | 2.2  | 0    | 0    | 1.3        | 0                    | 0.7  | 0    | 0    | 0.6        | 0                     | 1.9  | 0    | 0    | 1.2        | 0                    | 1.2  | 0    | 0    | 1.1        | 0.9        |

| Start Time   | MALMEDY RD Southbound |      |      |            | GIGLING RD Westbound |      |      |            | MALMEDY RD Northbound |      |      |            | GIGLING RD Eastbound |      |      |            | Int. Total |
|--|-----------------------|------|------|------------|----------------------|------|------|------------|-----------------------|------|------|------------|----------------------|------|------|------------|------------|
|  | Right                 | Thru | Left | App. Total | Right                | Thru | Left | App. Total | Right                 | Thru | Left | App. Total | Right                | Thru | Left | App. Total |            |
| Peak Hour Analysis From 04:00 PM to 05:45 PM - Peak 1 of 1 |                       |      |      |            |                      |      |      |            |                       |      |      |            |                      |      |      |            |            |
| Peak Hour for Entire Intersection Begins at 04:45 PM       |                       |      |      |            |                      |      |      |            |                       |      |      |            |                      |      |      |            |            |
| 04:45 PM   | 1                     | 11   | 3    | 15         | 4                    | 99   | 1    | 104        | 2                     | 5    | 4    | 11         | 11                   | 79   | 0    | 90         | 220        |
| 05:00 PM   | 0                     | 5    | 3    | 8          | 3                    | 83   | 5    | 91         | 1                     | 5    | 6    | 12         | 11                   | 83   | 1    | 95         | 206        |
| 05:15 PM   | 2                     | 7    | 1    | 10         | 3                    | 74   | 4    | 81         | 0                     | 9    | 0    | 9          | 6                    | 99   | 0    | 105        | 205        |
| 05:30 PM   | 2                     | 4    | 2    | 8          | 3                    | 56   | 2    | 61         | 3                     | 6    | 2    | 11         | 11                   | 79   | 2    | 92         | 172        |
| Total Volume   | 5                     | 27   | 9    | 41         | 13                   | 312  | 12   | 337        | 6                     | 25   | 12   | 43         | 39                   | 340  | 3    | 382        | 803        |
| % App. Total   | 12.2                  | 65.9 | 22   |            | 3.9                  | 92.6 | 3.6  |            | 14                    | 58.1 | 27.9 |            | 10.2                 | 89   | 0.8  |            |            |
| PHF  | .625                  | .614 | .750 | .683       | .813                 | .788 | .600 | .810       | .500                  | .694 | .500 | .896       | .886                 | .859 | .375 | .910       | .913       |

# Traffic Data Service

San Jose, CA  
 (408) 622-4787  
 tdsbay@cs.com

File Name : 13PM FINAL  
 Site Code : 00000013  
 Start Date : 4/25/2018  
 Page No : 2

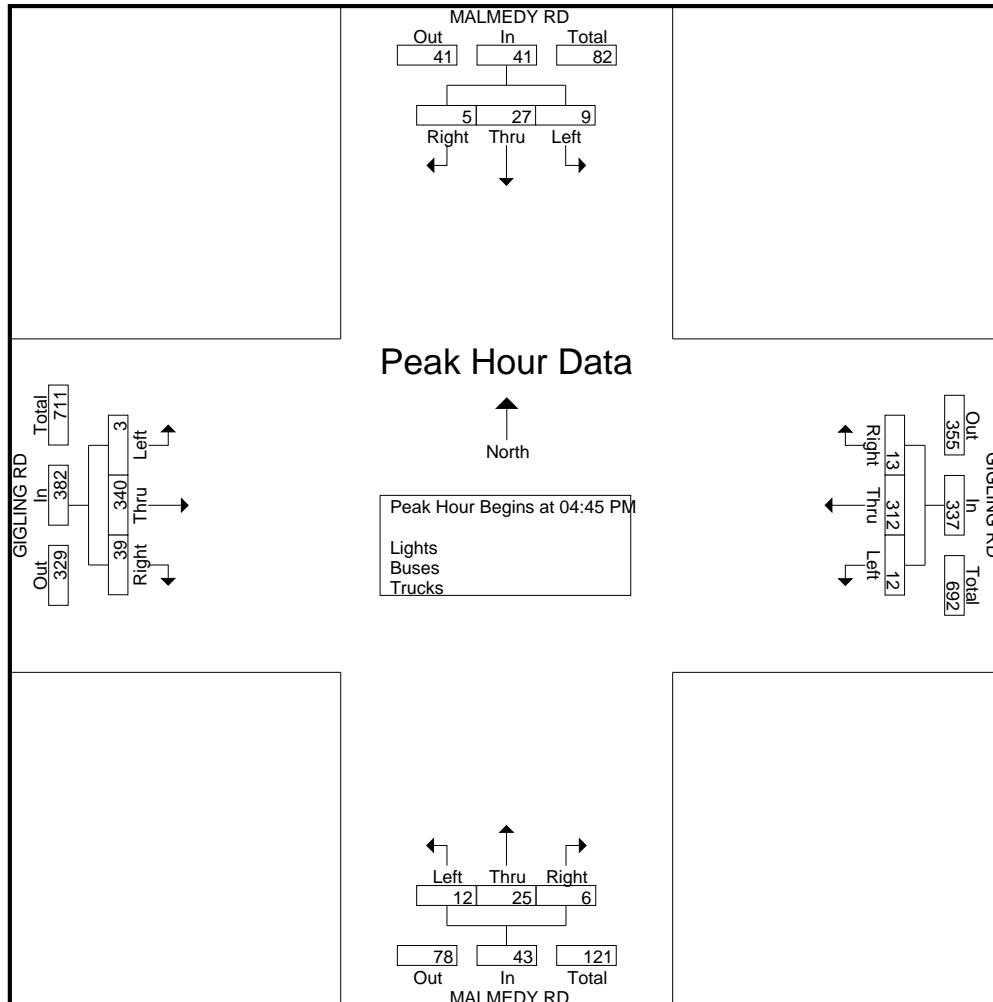

# Traffic Data Service

San Jose, CA  
 (408) 622-4787  
 tdsbay@cs.com

File Name : 13PM FINAL  
 Site Code : 00000013  
 Start Date : 4/25/2018  
 Page No : 1

Groups Printed- Bikes

| Start Time   | MALMEDY RD Southbound |      |      |      |            | GIGLING RD Westbound |      |      |      |            | MALMEDY RD Northbound |      |      |      |            | GIGLING RD Eastbound |      |      |      |            | Int. Total |   |
|--------------|-----------------------|------|------|------|------------|----------------------|------|------|------|------------|-----------------------|------|------|------|------------|----------------------|------|------|------|------------|------------|---|
|              | Right                 | Thru | Left | Peds | App. Total | Right                | Thru | Left | Peds | App. Total | Right                 | Thru | Left | Peds | App. Total | Right                | Thru | Left | Peds | App. Total |            |   |
| 04:00 PM     | 0                     | 0    | 0    | 0    | 0          | 0                    | 0    | 0    | 0    | 0          | 0                     | 0    | 0    | 0    | 0          | 0                    | 0    | 0    | 0    | 0          | 0          | 0 |
| 04:15 PM     | 0                     | 0    | 0    | 0    | 0          | 0                    | 0    | 0    | 0    | 0          | 0                     | 1    | 0    | 0    | 1          | 0                    | 0    | 0    | 0    | 0          | 0          | 0 |
| 04:30 PM     | 0                     | 0    | 0    | 0    | 0          | 0                    | 0    | 0    | 0    | 0          | 0                     | 0    | 0    | 0    | 0          | 0                    | 0    | 0    | 0    | 0          | 0          | 0 |
| 04:45 PM     | 0                     | 0    | 0    | 0    | 0          | 0                    | 0    | 0    | 0    | 0          | 0                     | 0    | 0    | 0    | 0          | 0                    | 0    | 0    | 0    | 0          | 0          | 0 |
| <b>Total</b> | 0                     | 0    | 0    | 0    | 0          | 0                    | 0    | 0    | 0    | 0          | 0                     | 1    | 0    | 0    | 1          | 0                    | 0    | 0    | 0    | 0          | 0          | 0 |
| 05:00 PM     | 0                     | 0    | 0    | 0    | 0          | 0                    | 0    | 0    | 0    | 0          | 0                     | 0    | 0    | 0    | 0          | 0                    | 0    | 0    | 0    | 0          | 0          | 0 |
| 05:15 PM     | 0                     | 1    | 0    | 0    | 1          | 0                    | 0    | 0    | 0    | 0          | 0                     | 0    | 0    | 0    | 0          | 0                    | 0    | 0    | 0    | 0          | 0          | 1 |
| 05:30 PM     | 0                     | 0    | 0    | 0    | 0          | 0                    | 0    | 0    | 0    | 0          | 0                     | 0    | 0    | 0    | 0          | 0                    | 0    | 0    | 0    | 0          | 0          | 0 |
| 05:45 PM     | 0                     | 0    | 0    | 0    | 0          | 0                    | 0    | 0    | 0    | 0          | 0                     | 0    | 0    | 0    | 0          | 0                    | 0    | 0    | 0    | 0          | 0          | 0 |
| <b>Total</b> | 0                     | 1    | 0    | 0    | 1          | 0                    | 0    | 0    | 0    | 0          | 0                     | 0    | 0    | 0    | 0          | 0                    | 0    | 0    | 0    | 0          | 0          | 1 |
| Grand Total  | 0                     | 1    | 0    | 0    | 1          | 0                    | 0    | 0    | 0    | 0          | 0                     | 1    | 0    | 0    | 1          | 0                    | 0    | 0    | 0    | 0          | 0          | 2 |
| Apprch %     | 0                     | 100  | 0    | 0    |            | 0                    | 0    | 0    | 0    |            | 0                     | 100  | 0    | 0    |            | 0                    | 0    | 0    | 0    |            |            |   |
| Total %      | 0                     | 50   | 0    | 0    | 50         | 0                    | 0    | 0    | 0    | 0          | 0                     | 50   | 0    | 0    | 50         | 0                    | 0    | 0    | 0    | 0          |            |   |

| Start Time   | MALMEDY RD Southbound |      |      |      |            | GIGLING RD Westbound |      |      |      |            | MALMEDY RD Northbound |      |      |      |            | GIGLING RD Eastbound |      |      |      |            | Int. Total |      |
|--|-----------------------|------|------|------|------------|----------------------|------|------|------|------------|-----------------------|------|------|------|------------|----------------------|------|------|------|------------|------------|------|
|  | Right                 | Thru | Left | Peds | App. Total | Right                | Thru | Left | Peds | App. Total | Right                 | Thru | Left | Peds | App. Total | Right                | Thru | Left | Peds | App. Total |            |      |
| Peak Hour Analysis From 04:00 PM to 05:45 PM - Peak 1 of 1 |                       |      |      |      |            |                      |      |      |      |            |                       |      |      |      |            |                      |      |      |      |            |            |      |
| Peak Hour for Entire Intersection Begins at 04:00 PM       |                       |      |      |      |            |                      |      |      |      |            |                       |      |      |      |            |                      |      |      |      |            |            |      |
| 04:00 PM   | 0                     | 0    | 0    | 0    | 0          | 0                    | 0    | 0    | 0    | 0          | 0                     | 0    | 0    | 0    | 0          | 0                    | 0    | 0    | 0    | 0          | 0          | 0    |
| 04:15 PM   | 0                     | 0    | 0    | 0    | 0          | 0                    | 0    | 0    | 0    | 0          | 0                     | 1    | 0    | 0    | 1          | 0                    | 0    | 0    | 0    | 0          | 0          | 1    |
| 04:30 PM   | 0                     | 0    | 0    | 0    | 0          | 0                    | 0    | 0    | 0    | 0          | 0                     | 0    | 0    | 0    | 0          | 0                    | 0    | 0    | 0    | 0          | 0          | 0    |
| 04:45 PM   | 0                     | 0    | 0    | 0    | 0          | 0                    | 0    | 0    | 0    | 0          | 0                     | 0    | 0    | 0    | 0          | 0                    | 0    | 0    | 0    | 0          | 0          | 0    |
| Total Volume   | 0                     | 0    | 0    | 0    | 0          | 0                    | 0    | 0    | 0    | 0          | 0                     | 1    | 0    | 0    | 1          | 0                    | 0    | 0    | 0    | 0          | 0          | 1    |
| % App. Total   | 0                     | 0    | 0    | 0    |            | 0                    | 0    | 0    | 0    |            | 0                     | 100  | 0    | 0    |            | 0                    | 0    | 0    | 0    |            |            |      |
| PHF  | .000                  | .000 | .000 | .000 | .000       | .000                 | .000 | .000 | .000 | .000       | .000                  | .250 | .000 | .250 | .000       | .000                 | .000 | .000 | .000 | .000       | .000       | .250 |

# Traffic Data Service

San Jose, CA  
(408) 622-4787  
tdsbay@cs.com

File Name : 13PM FINAL  
Site Code : 00000013  
Start Date : 4/25/2018  
Page No : 2

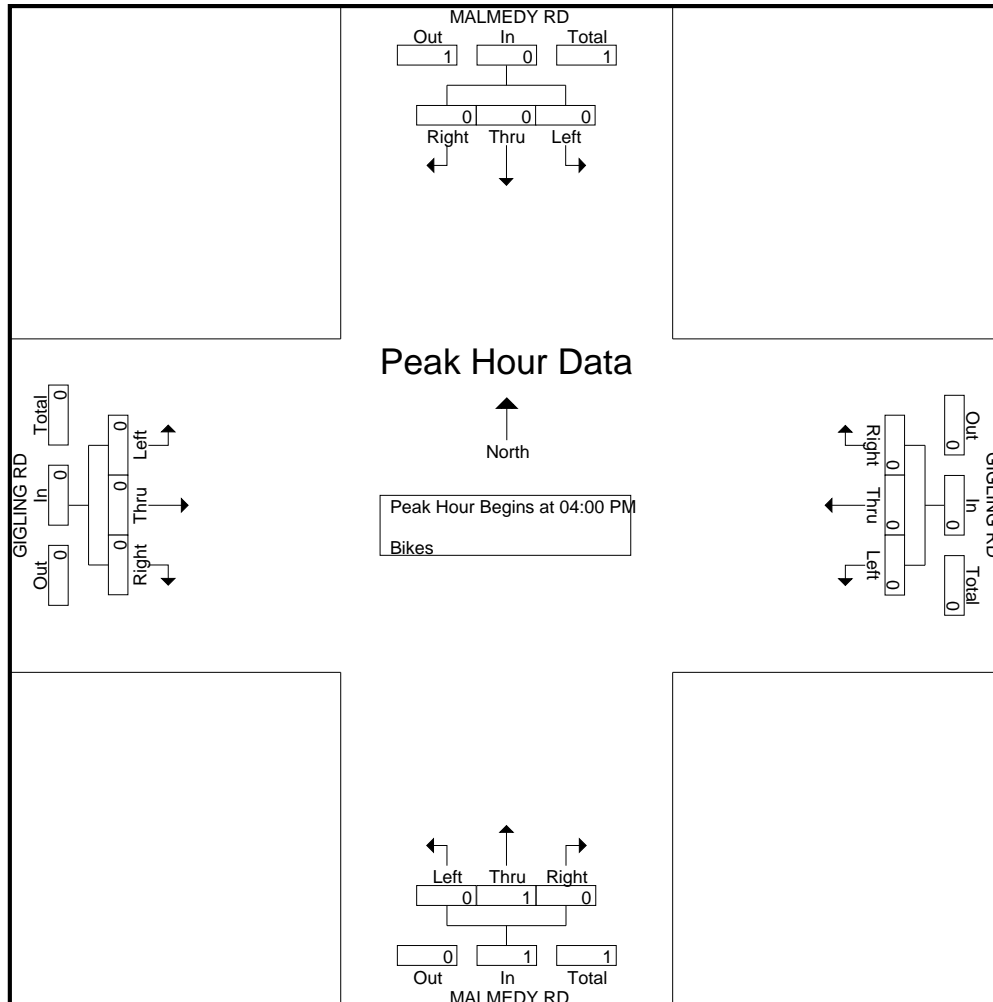



# Traffic Data Service

San Jose, CA  
 (408) 622-4787  
 tdsbay@cs.com

File Name : 14AM FINAL  
 Site Code : 00000014  
 Start Date : 4/25/2018  
 Page No : 1

Groups Printed- Lights - Buses - Trucks

| Start Time  | PARKER FLATS CUT OFF RD Southbound |      |      |      |            | GIGLING RD Westbound |      |      |      |            | PARKER FLATS CUT OFF RD Northbound |      |      |      |            | GIGLING RD Eastbound |      |      |      |            | Int. Total |
|-------------|------------------------------------|------|------|------|------------|----------------------|------|------|------|------------|------------------------------------|------|------|------|------------|----------------------|------|------|------|------------|------------|
|             | Right                              | Thru | Left | Peds | App. Total | Right                | Thru | Left | Peds | App. Total | Right                              | Thru | Left | Peds | App. Total | Right                | Thru | Left | Peds | App. Total |            |
| 07:00 AM    | 0                                  | 1    | 0    | 0    | 1          | 0                    | 62   | 3    | 0    | 65         | 2                                  | 1    | 2    | 0    | 5          | 8                    | 41   | 0    | 0    | 49         | 120        |
| 07:15 AM    | 0                                  | 2    | 1    | 0    | 3          | 0                    | 112  | 9    | 0    | 121        | 6                                  | 2    | 4    | 0    | 12         | 10                   | 45   | 0    | 0    | 55         | 191        |
| 07:30 AM    | 0                                  | 2    | 4    | 0    | 6          | 0                    | 124  | 10   | 0    | 134        | 9                                  | 3    | 1    | 0    | 13         | 17                   | 80   | 2    | 0    | 99         | 252        |
| 07:45 AM    | 0                                  | 5    | 1    | 0    | 6          | 0                    | 84   | 17   | 0    | 101        | 9                                  | 3    | 6    | 0    | 18         | 40                   | 97   | 0    | 0    | 137        | 262        |
| Total       | 0                                  | 10   | 6    | 0    | 16         | 0                    | 382  | 39   | 0    | 421        | 26                                 | 9    | 13   | 0    | 48         | 75                   | 263  | 2    | 0    | 340        | 825        |
| 08:00 AM    | 0                                  | 2    | 1    | 0    | 3          | 0                    | 61   | 5    | 0    | 66         | 7                                  | 1    | 6    | 0    | 14         | 24                   | 63   | 3    | 0    | 90         | 173        |
| 08:15 AM    | 0                                  | 4    | 0    | 0    | 4          | 1                    | 55   | 4    | 0    | 60         | 3                                  | 3    | 12   | 0    | 18         | 25                   | 56   | 0    | 0    | 81         | 163        |
| 08:30 AM    | 0                                  | 4    | 0    | 0    | 4          | 0                    | 45   | 4    | 0    | 49         | 2                                  | 0    | 6    | 1    | 9          | 17                   | 47   | 1    | 0    | 65         | 127        |
| 08:45 AM    | 0                                  | 8    | 1    | 0    | 9          | 0                    | 25   | 4    | 0    | 29         | 3                                  | 2    | 4    | 0    | 9          | 9                    | 43   | 1    | 0    | 53         | 100        |
| Total       | 0                                  | 18   | 2    | 0    | 20         | 1                    | 186  | 17   | 0    | 204        | 15                                 | 6    | 28   | 1    | 50         | 75                   | 209  | 5    | 0    | 289        | 563        |
| Grand Total | 0                                  | 28   | 8    | 0    | 36         | 1                    | 568  | 56   | 0    | 625        | 41                                 | 15   | 41   | 1    | 98         | 150                  | 472  | 7    | 0    | 629        | 1388       |
| Apprch %    | 0                                  | 77.8 | 22.2 | 0    |            | 0.2                  | 90.9 | 9    | 0    |            | 41.8                               | 15.3 | 41.8 | 1    |            | 23.8                 | 75   | 1.1  | 0    |            |            |
| Total %     | 0                                  | 2    | 0.6  | 0    | 2.6        | 0.1                  | 40.9 | 4    | 0    | 45         | 3                                  | 1.1  | 3    | 0.1  | 7.1        | 10.8                 | 34   | 0.5  | 0    | 45.3       |            |
| Lights      | 0                                  | 28   | 8    | 0    | 36         | 1                    | 554  | 56   | 0    | 611        | 41                                 | 15   | 34   | 1    | 91         | 142                  | 460  | 7    | 0    | 609        | 1347       |
| % Lights    | 0                                  | 100  | 100  | 0    | 100        | 100                  | 97.5 | 100  | 0    | 97.8       | 100                                | 100  | 82.9 | 100  | 92.9       | 94.7                 | 97.5 | 100  | 0    | 96.8       | 97         |
| Buses       | 0                                  | 0    | 0    | 0    | 0          | 0                    | 6    | 0    | 0    | 6          | 0                                  | 0    | 7    | 0    | 7          | 2                    | 8    | 0    | 0    | 10         | 23         |
| % Buses     | 0                                  | 0    | 0    | 0    | 0          | 0                    | 1.1  | 0    | 0    | 1          | 0                                  | 0    | 17.1 | 0    | 7.1        | 1.3                  | 1.7  | 0    | 0    | 1.6        | 1.7        |
| Trucks      | 0                                  | 0    | 0    | 0    | 0          | 0                    | 8    | 0    | 0    | 8          | 0                                  | 0    | 0    | 0    | 0          | 6                    | 4    | 0    | 0    | 10         | 18         |
| % Trucks    | 0                                  | 0    | 0    | 0    | 0          | 0                    | 1.4  | 0    | 0    | 1.3        | 0                                  | 0    | 0    | 0    | 0          | 4                    | 0.8  | 0    | 0    | 1.6        | 1.3        |

| Start Time   | PARKER FLATS CUT OFF RD Southbound |      |      |      |            | GIGLING RD Westbound |      |      |      |            | PARKER FLATS CUT OFF RD Northbound |      |      |      |            | GIGLING RD Eastbound |      |      |      |            | Int. Total |
|--|------------------------------------|------|------|------|------------|----------------------|------|------|------|------------|------------------------------------|------|------|------|------------|----------------------|------|------|------|------------|------------|
|  | Right                              | Thru | Left | Peds | App. Total | Right                | Thru | Left | Peds | App. Total | Right                              | Thru | Left | Peds | App. Total | Right                | Thru | Left | Peds | App. Total |            |
| Peak Hour Analysis From 07:00 AM to 08:45 AM - Peak 1 of 1 |                                    |      |      |      |            |                      |      |      |      |            |                                    |      |      |      |            |                      |      |      |      |            |            |
| Peak Hour for Entire Intersection Begins at 07:15 AM       |                                    |      |      |      |            |                      |      |      |      |            |                                    |      |      |      |            |                      |      |      |      |            |            |
| 07:15 AM   | 0                                  | 2    | 1    | 0    | 3          | 0                    | 112  | 9    | 0    | 121        | 6                                  | 2    | 4    | 0    | 12         | 10                   | 45   | 0    | 0    | 55         | 191        |
| 07:30 AM   | 0                                  | 2    | 4    | 0    | 6          | 0                    | 124  | 10   | 0    | 134        | 9                                  | 3    | 1    | 0    | 13         | 17                   | 80   | 2    | 0    | 99         | 252        |
| 07:45 AM   | 0                                  | 5    | 1    | 0    | 6          | 0                    | 84   | 17   | 0    | 101        | 9                                  | 3    | 6    | 0    | 18         | 40                   | 97   | 0    | 0    | 137        | 262        |
| 08:00 AM   | 0                                  | 2    | 1    | 0    | 3          | 0                    | 61   | 5    | 0    | 66         | 7                                  | 1    | 6    | 0    | 14         | 24                   | 63   | 3    | 0    | 90         | 173        |
| Total Volume   | 0                                  | 11   | 7    | 0    | 18         | 0                    | 381  | 41   | 0    | 422        | 31                                 | 9    | 17   | 0    | 57         | 91                   | 285  | 5    | 0    | 381        | 878        |
| % App. Total   | 0                                  | 61.1 | 38.9 | 0    |            | 0                    | 90.3 | 9.7  | 0    |            | 54.4                               | 15.8 | 29.8 | 0    |            | 23.9                 | 74.8 | 1.3  | 0    |            |            |
| PHF  | .000                               | .550 | .438 | .750 |            | .000                 | .768 | .603 | .787 |            | .861                               | .750 | .708 | .792 |            | .569                 | .735 | .417 | .695 |            | .838       |

# Traffic Data Service

San Jose, CA  
 (408) 622-4787  
 tdsbay@cs.com

File Name : 14AM FINAL  
 Site Code : 00000014  
 Start Date : 4/25/2018  
 Page No : 2

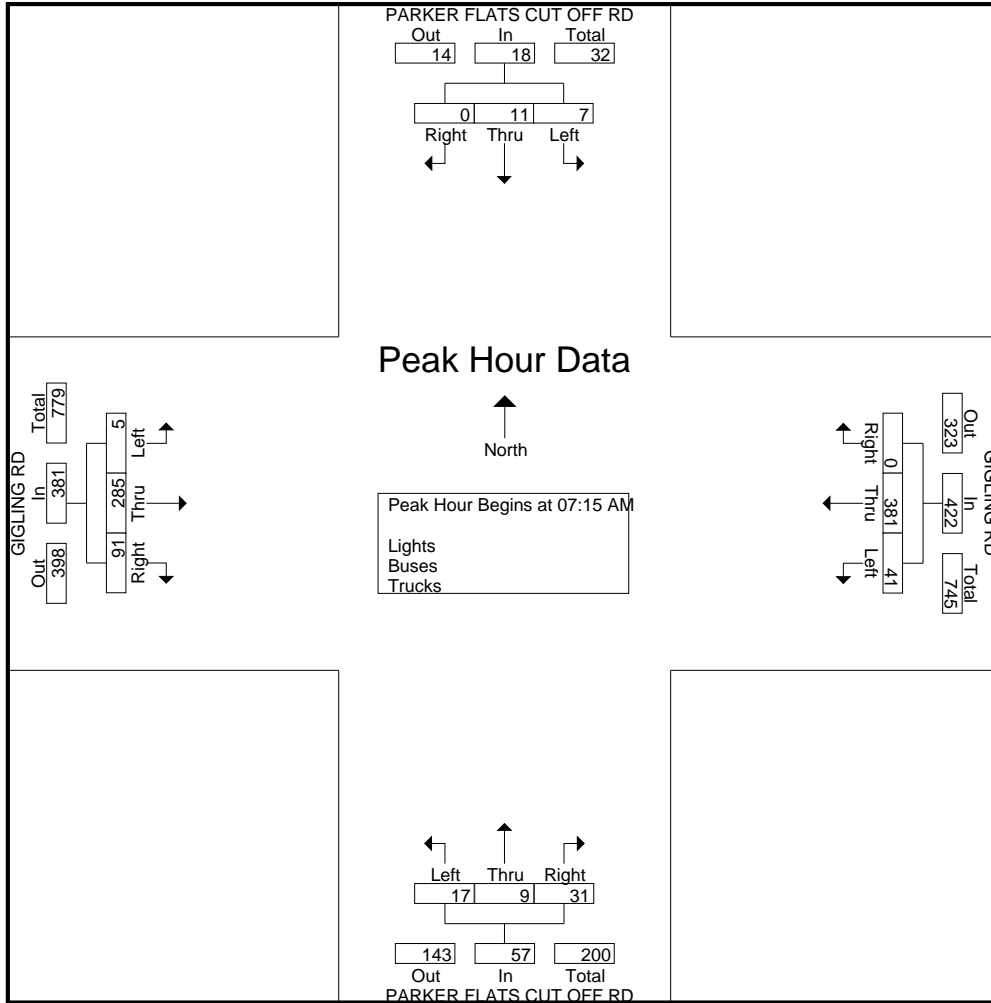

# Traffic Data Service

San Jose, CA  
 (408) 622-4787  
 tdsbay@cs.com

File Name : 14AM FINAL  
 Site Code : 00000014  
 Start Date : 4/25/2018  
 Page No : 1

Groups Printed- Bikes

| Start Time  | PARKER FLATS CUT OFF RD Southbound |      |      |      |            | GIGLING RD Westbound |      |      |      |            | PARKER FLATS CUT OFF RD Northbound |      |      |      |            | GIGLING RD Eastbound |      |      |      |            | Int. Total |   |   |   |   |   |
|-------------|------------------------------------|------|------|------|------------|----------------------|------|------|------|------------|------------------------------------|------|------|------|------------|----------------------|------|------|------|------------|------------|---|---|---|---|---|
|             | Right                              | Thru | Left | Peds | App. Total | Right                | Thru | Left | Peds | App. Total | Right                              | Thru | Left | Peds | App. Total | Right                | Thru | Left | Peds | App. Total |            |   |   |   |   |   |
| 07:00 AM    | 0                                  | 0    | 0    | 0    | 0          | 0                    | 0    | 0    | 0    | 0          | 0                                  | 0    | 0    | 0    | 0          | 0                    | 0    | 0    | 0    | 0          | 0          | 0 | 0 | 0 | 0 | 0 |
| 07:15 AM    | 0                                  | 0    | 1    | 0    | 1          | 0                    | 0    | 0    | 0    | 0          | 0                                  | 0    | 0    | 0    | 0          | 0                    | 0    | 0    | 0    | 0          | 0          | 0 | 0 | 0 | 0 | 1 |
| 07:30 AM    | 0                                  | 1    | 0    | 0    | 1          | 0                    | 0    | 0    | 0    | 0          | 0                                  | 0    | 0    | 0    | 0          | 0                    | 0    | 0    | 0    | 0          | 0          | 0 | 0 | 0 | 0 | 1 |
| 07:45 AM    | 0                                  | 1    | 0    | 0    | 1          | 0                    | 0    | 0    | 0    | 0          | 0                                  | 1    | 0    | 0    | 1          | 0                    | 0    | 0    | 0    | 0          | 0          | 0 | 0 | 0 | 0 | 2 |
| Total       | 0                                  | 2    | 1    | 0    | 3          | 0                    | 0    | 0    | 0    | 0          | 0                                  | 1    | 0    | 0    | 1          | 0                    | 0    | 0    | 0    | 0          | 0          | 0 | 0 | 0 | 0 | 4 |
| 08:00 AM    | 0                                  | 0    | 0    | 0    | 0          | 0                    | 0    | 0    | 0    | 0          | 0                                  | 0    | 0    | 0    | 0          | 0                    | 0    | 0    | 0    | 0          | 0          | 0 | 0 | 0 | 0 | 0 |
| 08:15 AM    | 0                                  | 0    | 0    | 0    | 0          | 0                    | 0    | 0    | 0    | 0          | 0                                  | 0    | 0    | 0    | 0          | 0                    | 0    | 0    | 0    | 0          | 0          | 0 | 0 | 0 | 0 | 0 |
| 08:30 AM    | 0                                  | 0    | 0    | 0    | 0          | 0                    | 0    | 0    | 0    | 0          | 0                                  | 0    | 0    | 0    | 0          | 0                    | 0    | 0    | 0    | 0          | 0          | 0 | 0 | 0 | 0 | 0 |
| 08:45 AM    | 0                                  | 0    | 0    | 0    | 0          | 0                    | 0    | 0    | 0    | 0          | 0                                  | 0    | 0    | 0    | 0          | 0                    | 0    | 0    | 0    | 0          | 0          | 0 | 0 | 0 | 0 | 0 |
| Total       | 0                                  | 0    | 0    | 0    | 0          | 0                    | 0    | 0    | 0    | 0          | 0                                  | 0    | 0    | 0    | 0          | 0                    | 0    | 0    | 0    | 0          | 0          | 0 | 0 | 0 | 0 | 0 |
| Grand Total | 0                                  | 2    | 1    | 0    | 3          | 0                    | 0    | 0    | 0    | 0          | 0                                  | 1    | 0    | 0    | 1          | 0                    | 0    | 0    | 0    | 0          | 0          | 0 | 0 | 0 | 0 | 4 |
| Apprch %    | 0                                  | 66.7 | 33.3 | 0    |            | 0                    | 0    | 0    | 0    |            | 0                                  | 100  | 0    | 0    |            | 0                    | 0    | 0    | 0    |            | 0          | 0 | 0 | 0 |   |   |
| Total %     | 0                                  | 50   | 25   | 0    | 75         | 0                    | 0    | 0    | 0    | 0          | 0                                  | 25   | 0    | 0    | 25         | 0                    | 0    | 0    | 0    | 0          | 0          | 0 | 0 | 0 | 0 |   |

| Start Time   | PARKER FLATS CUT OFF RD Southbound |      |      |      |            | GIGLING RD Westbound |      |      |      |            | PARKER FLATS CUT OFF RD Northbound |      |      |      |            | GIGLING RD Eastbound |      |      |      |            | Int. Total |      |      |   |      |   |
|--------------|------------------------------------|------|------|------|------------|----------------------|------|------|------|------------|------------------------------------|------|------|------|------------|----------------------|------|------|------|------------|------------|------|------|---|------|---|
|              | Right                              | Thru | Left | Peds | App. Total | Right                | Thru | Left | Peds | App. Total | Right                              | Thru | Left | Peds | App. Total | Right                | Thru | Left | Peds | App. Total |            |      |      |   |      |   |
| 07:00 AM     | 0                                  | 0    | 0    | 0    | 0          | 0                    | 0    | 0    | 0    | 0          | 0                                  | 0    | 0    | 0    | 0          | 0                    | 0    | 0    | 0    | 0          | 0          | 0    | 0    | 0 | 0    | 0 |
| 07:15 AM     | 0                                  | 0    | 1    | 0    | 1          | 0                    | 0    | 0    | 0    | 0          | 0                                  | 0    | 0    | 0    | 0          | 0                    | 0    | 0    | 0    | 0          | 0          | 0    | 0    | 0 | 0    | 1 |
| 07:30 AM     | 0                                  | 1    | 0    | 0    | 1          | 0                    | 0    | 0    | 0    | 0          | 0                                  | 0    | 0    | 0    | 0          | 0                    | 0    | 0    | 0    | 0          | 0          | 0    | 0    | 0 | 0    | 1 |
| 07:45 AM     | 0                                  | 1    | 0    | 0    | 1          | 0                    | 0    | 0    | 0    | 0          | 0                                  | 1    | 0    | 0    | 1          | 0                    | 0    | 0    | 0    | 0          | 0          | 0    | 0    | 0 | 0    | 2 |
| Total Volume | 0                                  | 2    | 1    | 0    | 3          | 0                    | 0    | 0    | 0    | 0          | 0                                  | 1    | 0    | 0    | 1          | 0                    | 0    | 0    | 0    | 0          | 0          | 0    | 0    | 0 | 0    | 4 |
| % App. Total | 0                                  | 66.7 | 33.3 | 0    |            | 0                    | 0    | 0    | 0    |            | 0                                  | 100  | 0    | 0    |            | 0                    | 0    | 0    | 0    |            | 0          | 0    | 0    | 0 |      |   |
| PHF          | .000                               | .500 | .250 |      | .750       | .000                 | .000 | .000 |      | .000       | .000                               | .250 | .000 |      | .250       | .000                 | .000 | .000 |      | .000       | .000       | .000 | .000 |   | .500 |   |

Peak Hour Analysis From 07:00 AM to 08:45 AM - Peak 1 of 1

Peak Hour for Entire Intersection Begins at 07:00 AM

# Traffic Data Service

San Jose, CA  
 (408) 622-4787  
 tdsbay@cs.com

File Name : 14AM FINAL  
 Site Code : 00000014  
 Start Date : 4/25/2018  
 Page No : 2

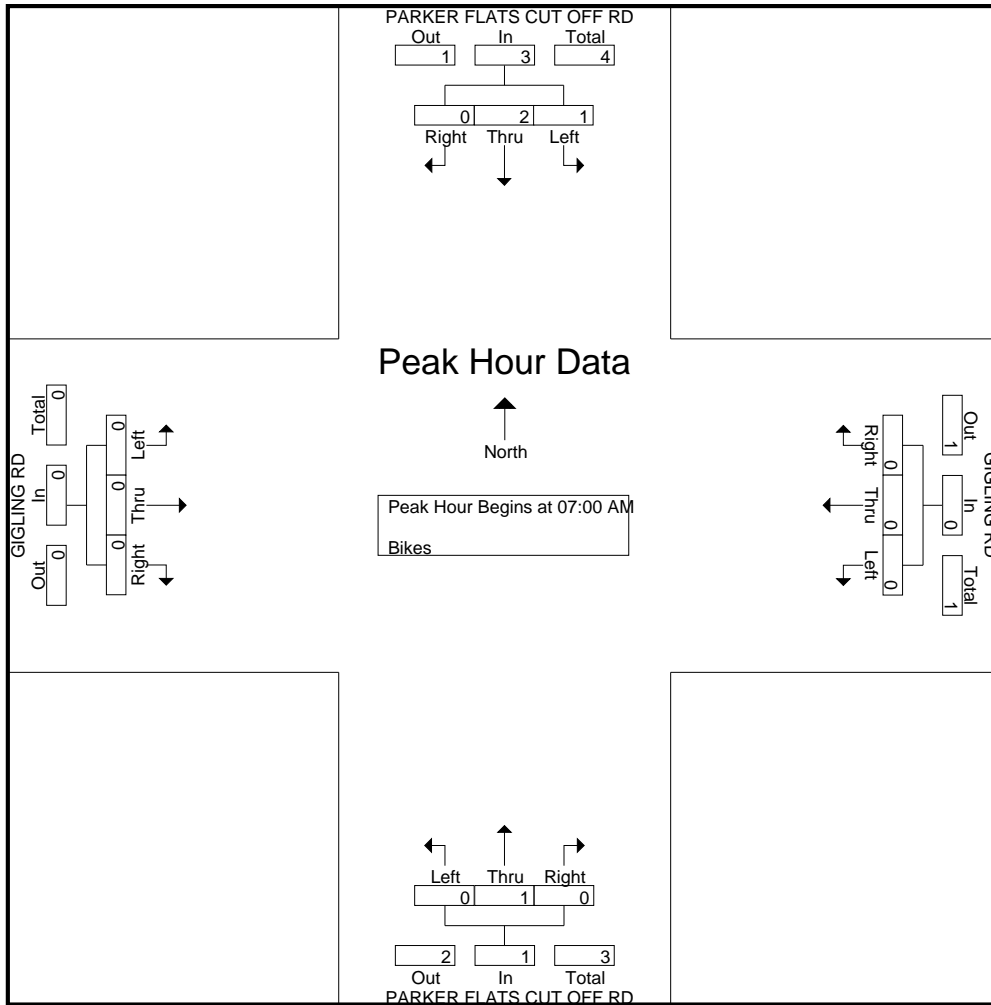

# Traffic Data Service

San Jose, CA  
 (408) 622-4787  
 tdsbay@cs.com

File Name : 14PM FINAL  
 Site Code : 00000014  
 Start Date : 4/25/2018  
 Page No : 1

Groups Printed- Lights - Buses - Trucks

| Start Time   | PARKER FLATS CUT OFF RD Southbound |          |          |          |            | GIGLING RD Westbound |            |           |          |            | PARKER FLATS CUT OFF RD Northbound |           |           |          |            | GIGLING RD Eastbound |            |          |          |            | Int. Total |
|--------------|------------------------------------|----------|----------|----------|------------|----------------------|------------|-----------|----------|------------|------------------------------------|-----------|-----------|----------|------------|----------------------|------------|----------|----------|------------|------------|
|              | Right                              | Thru     | Left     | Peds     | App. Total | Right                | Thru       | Left      | Peds     | App. Total | Right                              | Thru      | Left      | Peds     | App. Total | Right                | Thru       | Left     | Peds     | App. Total |            |
| 04:00 PM     | 2                                  | 1        | 0        | 0        | 3          | 0                    | 64         | 2         | 1        | 67         | 7                                  | 6         | 18        | 1        | 32         | 2                    | 55         | 0        | 0        | 57         | 159        |
| 04:15 PM     | 0                                  | 1        | 0        | 0        | 1          | 0                    | 48         | 3         | 0        | 51         | 6                                  | 9         | 18        | 0        | 33         | 3                    | 53         | 1        | 0        | 57         | 142        |
| 04:30 PM     | 0                                  | 1        | 0        | 0        | 1          | 0                    | 65         | 4         | 0        | 69         | 7                                  | 6         | 20        | 1        | 34         | 2                    | 62         | 0        | 0        | 64         | 168        |
| 04:45 PM     | 0                                  | 0        | 0        | 0        | 0          | 1                    | 81         | 5         | 0        | 87         | 6                                  | 5         | 25        | 0        | 36         | 2                    | 81         | 1        | 0        | 84         | 207        |
| <b>Total</b> | <b>2</b>                           | <b>3</b> | <b>0</b> | <b>0</b> | <b>5</b>   | <b>1</b>             | <b>258</b> | <b>14</b> | <b>1</b> | <b>274</b> | <b>26</b>                          | <b>26</b> | <b>81</b> | <b>2</b> | <b>135</b> | <b>9</b>             | <b>251</b> | <b>2</b> | <b>0</b> | <b>262</b> | <b>676</b> |
| 05:00 PM     | 0                                  | 0        | 0        | 0        | 0          | 1                    | 80         | 2         | 2        | 85         | 5                                  | 7         | 6         | 0        | 18         | 2                    | 77         | 0        | 0        | 79         | 182        |
| 05:15 PM     | 0                                  | 2        | 0        | 0        | 2          | 0                    | 58         | 1         | 0        | 59         | 3                                  | 3         | 14        | 2        | 22         | 2                    | 96         | 1        | 0        | 99         | 182        |
| 05:30 PM     | 1                                  | 2        | 0        | 0        | 3          | 0                    | 50         | 3         | 0        | 53         | 3                                  | 7         | 7         | 0        | 17         | 2                    | 82         | 1        | 0        | 85         | 158        |
| 05:45 PM     | 1                                  | 0        | 0        | 0        | 1          | 0                    | 45         | 1         | 0        | 46         | 3                                  | 2         | 8         | 0        | 13         | 2                    | 55         | 0        | 0        | 57         | 117        |
| <b>Total</b> | <b>2</b>                           | <b>4</b> | <b>0</b> | <b>0</b> | <b>6</b>   | <b>1</b>             | <b>233</b> | <b>7</b>  | <b>2</b> | <b>243</b> | <b>14</b>                          | <b>19</b> | <b>35</b> | <b>2</b> | <b>70</b>  | <b>8</b>             | <b>310</b> | <b>2</b> | <b>0</b> | <b>320</b> | <b>639</b> |
| Grand Total  | 4                                  | 7        | 0        | 0        | 11         | 2                    | 491        | 21        | 3        | 517        | 40                                 | 45        | 116       | 4        | 205        | 17                   | 561        | 4        | 0        | 582        | 1315       |
| Apprch %     | 36.4                               | 63.6     | 0        | 0        |            | 0.4                  | 95         | 4.1       | 0.6      |            | 19.5                               | 22        | 56.6      | 2        |            | 2.9                  | 96.4       | 0.7      | 0        |            |            |
| Total %      | 0.3                                | 0.5      | 0        | 0        | 0.8        | 0.2                  | 37.3       | 1.6       | 0.2      | 39.3       | 3                                  | 3.4       | 8.8       | 0.3      | 15.6       | 1.3                  | 42.7       | 0.3      | 0        | 44.3       |            |
| Lights       | 4                                  | 7        | 0        | 0        | 11         | 2                    | 482        | 21        | 3        | 508        | 39                                 | 45        | 114       | 4        | 202        | 17                   | 543        | 4        | 0        | 564        | 1285       |
| % Lights     | 100                                | 100      | 0        | 0        | 100        | 100                  | 98.2       | 100       | 100      | 98.3       | 97.5                               | 100       | 98.3      | 100      | 98.5       | 100                  | 96.8       | 100      | 0        | 96.9       | 97.7       |
| Buses        | 0                                  | 0        | 0        | 0        | 0          | 0                    | 6          | 0         | 0        | 6          | 0                                  | 0         | 0         | 0        | 0          | 0                    | 12         | 0        | 0        | 12         | 18         |
| % Buses      | 0                                  | 0        | 0        | 0        | 0          | 0                    | 1.2        | 0         | 0        | 1.2        | 0                                  | 0         | 0         | 0        | 0          | 0                    | 2.1        | 0        | 0        | 2.1        | 1.4        |
| Trucks       | 0                                  | 0        | 0        | 0        | 0          | 0                    | 3          | 0         | 0        | 3          | 1                                  | 0         | 2         | 0        | 3          | 0                    | 6          | 0        | 0        | 6          | 12         |
| % Trucks     | 0                                  | 0        | 0        | 0        | 0          | 0                    | 0.6        | 0         | 0        | 0.6        | 2.5                                | 0         | 1.7       | 0        | 1.5        | 0                    | 1.1        | 0        | 0        | 1          | 0.9        |

| Start Time   | PARKER FLATS CUT OFF RD Southbound |      |      |      |            | GIGLING RD Westbound |      |      |      |            | PARKER FLATS CUT OFF RD Northbound |      |      |      |            | GIGLING RD Eastbound |      |      |      |            | Int. Total |
|--|------------------------------------|------|------|------|------------|----------------------|------|------|------|------------|------------------------------------|------|------|------|------------|----------------------|------|------|------|------------|------------|
|  | Right                              | Thru | Left | Peds | App. Total | Right                | Thru | Left | Peds | App. Total | Right                              | Thru | Left | Peds | App. Total | Right                | Thru | Left | Peds | App. Total |            |
| Peak Hour Analysis From 04:00 PM to 05:45 PM - Peak 1 of 1 |                                    |      |      |      |            |                      |      |      |      |            |                                    |      |      |      |            |                      |      |      |      |            |            |
| Peak Hour for Entire Intersection Begins at 04:30 PM       |                                    |      |      |      |            |                      |      |      |      |            |                                    |      |      |      |            |                      |      |      |      |            |            |
| 04:30 PM   | 0                                  | 1    | 0    | 0    | 1          | 0                    | 65   | 4    | 0    | 69         | 7                                  | 6    | 20   | 33   | 2          | 62                   | 0    | 0    | 64   | 167        |            |
| 04:45 PM   | 0                                  | 0    | 0    | 0    | 0          | 1                    | 81   | 5    | 0    | 87         | 6                                  | 5    | 25   | 36   | 2          | 81                   | 1    | 0    | 84   | 207        |            |
| 05:00 PM   | 0                                  | 0    | 0    | 0    | 0          | 1                    | 80   | 2    | 0    | 83         | 5                                  | 7    | 6    | 18   | 2          | 77                   | 0    | 0    | 79   | 180        |            |
| 05:15 PM   | 0                                  | 2    | 0    | 0    | 2          | 0                    | 58   | 1    | 0    | 59         | 3                                  | 3    | 14   | 20   | 2          | 96                   | 1    | 0    | 99   | 180        |            |
| Total Volume   | 0                                  | 3    | 0    | 0    | 3          | 2                    | 284  | 12   | 0    | 298        | 21                                 | 21   | 65   | 107  | 8          | 316                  | 2    | 0    | 326  | 734        |            |
| % App. Total   | 0                                  | 100  | 0    | 0    |            | 0.7                  | 95.3 | 4    | 0    |            | 19.6                               | 19.6 | 60.7 |      | 2.5        | 96.9                 | 0.6  | 0    |      |            |            |
| PHF  | .000                               | .375 | .000 | .000 | .375       | .500                 | .877 | .600 | .000 | .856       | .750                               | .750 | .650 | .743 | 1.00       | .823                 | .500 | .000 | .823 | .886       |            |

# Traffic Data Service

San Jose, CA  
 (408) 622-4787  
 tdsbay@cs.com

File Name : 14PM FINAL  
 Site Code : 00000014  
 Start Date : 4/25/2018  
 Page No : 2

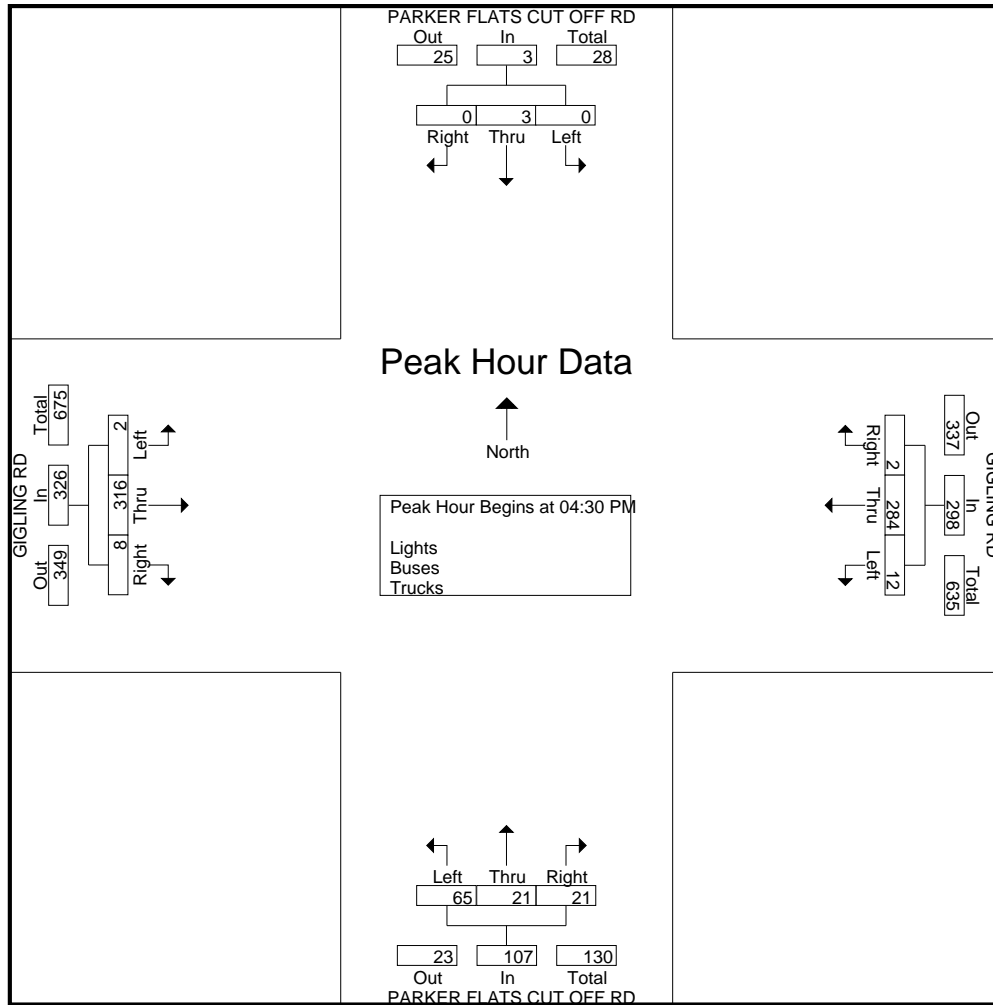

# Traffic Data Service

San Jose, CA  
(408) 622-4787  
tdsbay@cs.com

File Name : 14PM FINAL  
Site Code : 00000014  
Start Date : 4/25/2018  
Page No : 1

Groups Printed- Bikes

| Start Time   | PARKER FLATS CUT OFF RD<br>Southbound |          |          |          |            | GIGLING RD<br>Westbound |          |          |          |            | PARKER FLATS CUT OFF RD<br>Northbound |          |          |          |            | GIGLING RD<br>Eastbound |          |          |          |            | Int. Total |          |          |          |          |          |
|--------------|---------------------------------------|----------|----------|----------|------------|-------------------------|----------|----------|----------|------------|---------------------------------------|----------|----------|----------|------------|-------------------------|----------|----------|----------|------------|------------|----------|----------|----------|----------|----------|
|              | Right                                 | Thru     | Left     | Peds     | App. Total | Right                   | Thru     | Left     | Peds     | App. Total | Right                                 | Thru     | Left     | Peds     | App. Total | Right                   | Thru     | Left     | Peds     | App. Total |            |          |          |          |          |          |
| 04:00 PM     | 0                                     | 0        | 0        | 0        | 0          | 0                       | 0        | 0        | 0        | 0          | 0                                     | 0        | 0        | 0        | 0          | 0                       | 0        | 0        | 0        | 0          | 0          | 0        | 0        | 0        | 0        | 0        |
| 04:15 PM     | 0                                     | 0        | 0        | 0        | 0          | 0                       | 0        | 0        | 0        | 0          | 0                                     | 0        | 0        | 0        | 0          | 0                       | 0        | 0        | 0        | 0          | 0          | 0        | 0        | 0        | 0        | 0        |
| 04:30 PM     | 0                                     | 0        | 0        | 0        | 0          | 0                       | 0        | 0        | 0        | 0          | 0                                     | 0        | 0        | 0        | 0          | 0                       | 0        | 0        | 0        | 0          | 0          | 0        | 0        | 0        | 0        | 0        |
| 04:45 PM     | 0                                     | 1        | 0        | 0        | 1          | 0                       | 0        | 0        | 0        | 0          | 0                                     | 0        | 0        | 0        | 0          | 0                       | 0        | 0        | 0        | 0          | 0          | 0        | 0        | 0        | 0        | 1        |
| <b>Total</b> | <b>0</b>                              | <b>1</b> | <b>0</b> | <b>0</b> | <b>1</b>   | <b>0</b>                | <b>0</b> | <b>0</b> | <b>0</b> | <b>0</b>   | <b>0</b>                              | <b>0</b> | <b>0</b> | <b>0</b> | <b>0</b>   | <b>0</b>                | <b>0</b> | <b>0</b> | <b>0</b> | <b>0</b>   | <b>0</b>   | <b>0</b> | <b>0</b> | <b>0</b> | <b>0</b> | <b>1</b> |
| 05:00 PM     | 0                                     | 0        | 0        | 0        | 0          | 0                       | 0        | 0        | 0        | 0          | 0                                     | 0        | 0        | 0        | 0          | 0                       | 0        | 0        | 0        | 0          | 0          | 0        | 0        | 0        | 0        | 0        |
| 05:15 PM     | 0                                     | 0        | 0        | 0        | 0          | 0                       | 0        | 0        | 0        | 0          | 0                                     | 0        | 0        | 0        | 0          | 0                       | 0        | 0        | 0        | 0          | 0          | 0        | 0        | 0        | 0        | 0        |
| 05:30 PM     | 0                                     | 0        | 0        | 0        | 0          | 0                       | 0        | 0        | 0        | 0          | 0                                     | 0        | 0        | 0        | 0          | 0                       | 0        | 0        | 0        | 0          | 0          | 0        | 0        | 0        | 0        | 0        |
| 05:45 PM     | 0                                     | 0        | 0        | 0        | 0          | 0                       | 0        | 0        | 0        | 0          | 0                                     | 0        | 0        | 0        | 0          | 0                       | 0        | 0        | 0        | 0          | 0          | 0        | 0        | 0        | 0        | 0        |
| <b>Total</b> | <b>0</b>                              | <b>0</b> | <b>0</b> | <b>0</b> | <b>0</b>   | <b>0</b>                | <b>0</b> | <b>0</b> | <b>0</b> | <b>0</b>   | <b>0</b>                              | <b>0</b> | <b>0</b> | <b>0</b> | <b>0</b>   | <b>0</b>                | <b>0</b> | <b>0</b> | <b>0</b> | <b>0</b>   | <b>0</b>   | <b>0</b> | <b>0</b> | <b>0</b> | <b>0</b> | <b>0</b> |
| Grand Total  | 0                                     | 1        | 0        | 0        | 1          | 0                       | 0        | 0        | 0        | 0          | 0                                     | 0        | 0        | 0        | 0          | 0                       | 0        | 0        | 0        | 0          | 0          | 0        | 0        | 0        | 0        | 1        |
| Apprch %     | 0                                     | 100      | 0        | 0        |            | 0                       | 0        | 0        | 0        |            | 0                                     | 0        | 0        | 0        |            | 0                       | 0        | 0        | 0        |            | 0          | 0        | 0        | 0        |          |          |
| Total %      | 0                                     | 100      | 0        | 0        | 100        | 0                       | 0        | 0        | 0        | 0          | 0                                     | 0        | 0        | 0        | 0          | 0                       | 0        | 0        | 0        | 0          | 0          | 0        | 0        | 0        | 0        |          |

| Start Time   | PARKER FLATS CUT OFF RD<br>Southbound |          |          |          |            | GIGLING RD<br>Westbound |          |          |          |            | PARKER FLATS CUT OFF RD<br>Northbound |          |          |          |            | GIGLING RD<br>Eastbound |          |          |          |            | Int. Total |          |          |          |          |   |
|--|---------------------------------------|----------|----------|----------|------------|-------------------------|----------|----------|----------|------------|---------------------------------------|----------|----------|----------|------------|-------------------------|----------|----------|----------|------------|------------|----------|----------|----------|----------|---|
|  | Right                                 | Thru     | Left     | Peds     | App. Total | Right                   | Thru     | Left     | Peds     | App. Total | Right                                 | Thru     | Left     | Peds     | App. Total | Right                   | Thru     | Left     | Peds     | App. Total |            |          |          |          |          |   |
| Peak Hour Analysis From 04:00 PM to 05:45 PM - Peak 1 of 1 |                                       |          |          |          |            |                         |          |          |          |            |                                       |          |          |          |            |                         |          |          |          |            |            |          |          |          |          |   |
| Peak Hour for Entire Intersection Begins at 04:00 PM       |                                       |          |          |          |            |                         |          |          |          |            |                                       |          |          |          |            |                         |          |          |          |            |            |          |          |          |          |   |
| 04:00 PM   | 0                                     | 0        | 0        | 0        | 0          | 0                       | 0        | 0        | 0        | 0          | 0                                     | 0        | 0        | 0        | 0          | 0                       | 0        | 0        | 0        | 0          | 0          | 0        | 0        | 0        | 0        | 0 |
| 04:15 PM   | 0                                     | 0        | 0        | 0        | 0          | 0                       | 0        | 0        | 0        | 0          | 0                                     | 0        | 0        | 0        | 0          | 0                       | 0        | 0        | 0        | 0          | 0          | 0        | 0        | 0        | 0        | 0 |
| 04:30 PM   | 0                                     | 0        | 0        | 0        | 0          | 0                       | 0        | 0        | 0        | 0          | 0                                     | 0        | 0        | 0        | 0          | 0                       | 0        | 0        | 0        | 0          | 0          | 0        | 0        | 0        | 0        | 0 |
| 04:45 PM   | 0                                     | 1        | 0        | 0        | 1          | 0                       | 0        | 0        | 0        | 0          | 0                                     | 0        | 0        | 0        | 0          | 0                       | 0        | 0        | 0        | 0          | 0          | 0        | 0        | 0        | 0        | 1 |
| <b>Total Volume</b>  | <b>0</b>                              | <b>1</b> | <b>0</b> | <b>0</b> | <b>1</b>   | <b>0</b>                | <b>0</b> | <b>0</b> | <b>0</b> | <b>0</b>   | <b>0</b>                              | <b>0</b> | <b>0</b> | <b>0</b> | <b>0</b>   | <b>0</b>                | <b>0</b> | <b>0</b> | <b>0</b> | <b>0</b>   | <b>0</b>   | <b>0</b> | <b>0</b> | <b>0</b> | <b>1</b> |   |
| % App. Total   | 0                                     | 100      | 0        | 0        |            | 0                       | 0        | 0        | 0        |            | 0                                     | 0        | 0        | 0        |            | 0                       | 0        | 0        | 0        |            | 0          | 0        | 0        | 0        |          |   |
| PHF  | .000                                  | .250     | .000     | .000     | .250       | .000                    | .000     | .000     | .000     | .000       | .000                                  | .000     | .000     | .000     | .000       | .000                    | .000     | .000     | .000     | .000       | .000       | .000     | .000     | .000     | .250     |   |

# Traffic Data Service

San Jose, CA  
(408) 622-4787  
tdsbay@cs.com

File Name : 14PM FINAL  
Site Code : 00000014  
Start Date : 4/25/2018  
Page No : 2

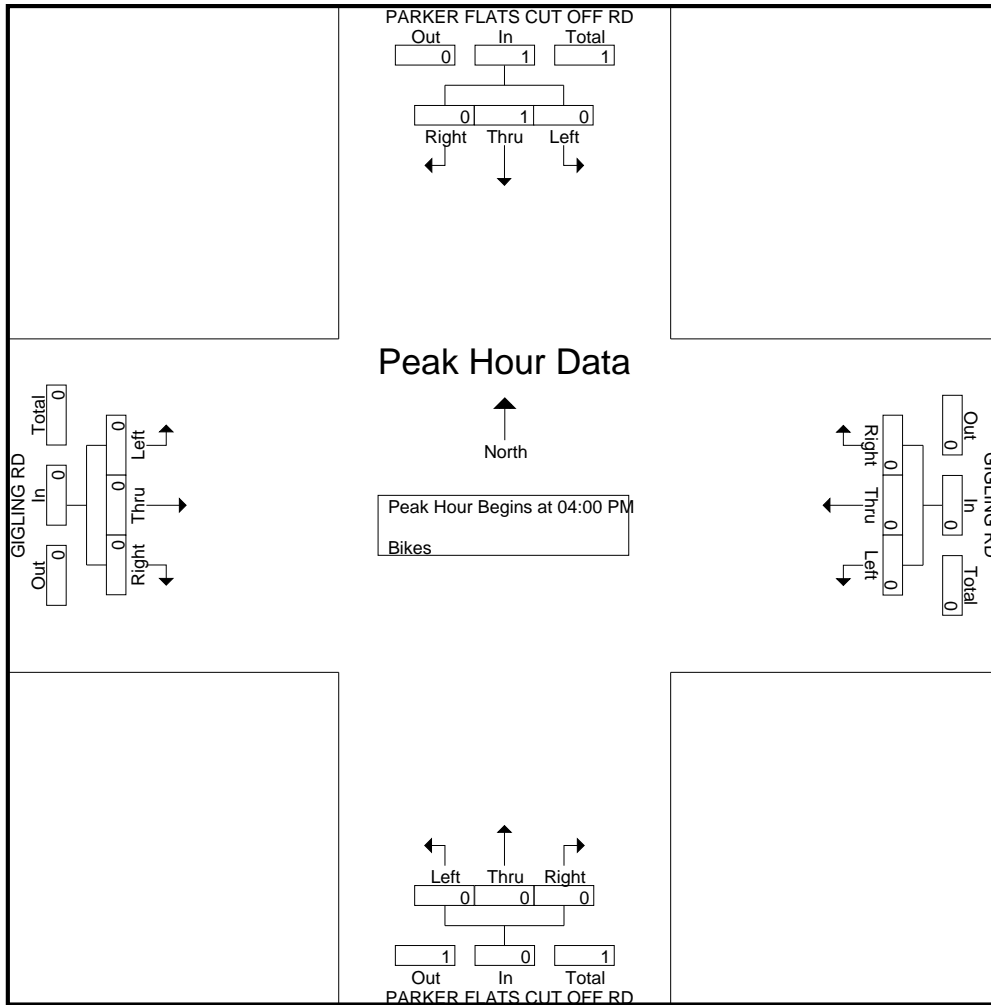



# Traffic Data Service

San Jose, CA  
 (408) 622-4787  
 tdsbay@cs.com

File Name : 15AM FINAL  
 Site Code : 00000015  
 Start Date : 4/25/2018  
 Page No : 1

Groups Printed- Lights - Buses - Trucks

| Start Time   | 6TH AVE Southbound |           |          |          |            | GIGLING RD Westbound |            |           |          |            | 6TH AVE Northbound |          |          |          |            | GIGLING RD Eastbound |            |          |          |            | Int. Total |
|--------------|--------------------|-----------|----------|----------|------------|----------------------|------------|-----------|----------|------------|--------------------|----------|----------|----------|------------|----------------------|------------|----------|----------|------------|------------|
|              | Right              | Thru      | Left     | Peds     | App. Total | Right                | Thru       | Left      | Peds     | App. Total | Right              | Thru     | Left     | Peds     | App. Total | Right                | Thru       | Left     | Peds     | App. Total |            |
| 07:00 AM     | 0                  | 1         | 0        | 0        | 1          | 0                    | 71         | 13        | 0        | 84         | 0                  | 0        | 0        | 0        | 0          | 1                    | 23         | 0        | 0        | 24         | 109        |
| 07:15 AM     | 2                  | 6         | 0        | 0        | 8          | 1                    | 126        | 17        | 0        | 144        | 1                  | 1        | 0        | 0        | 2          | 4                    | 28         | 1        | 0        | 33         | 187        |
| 07:30 AM     | 6                  | 8         | 0        | 0        | 14         | 1                    | 121        | 17        | 0        | 139        | 0                  | 0        | 0        | 0        | 0          | 13                   | 33         | 3        | 1        | 50         | 203        |
| 07:45 AM     | 2                  | 13        | 0        | 0        | 15         | 0                    | 100        | 26        | 0        | 126        | 0                  | 0        | 0        | 0        | 0          | 14                   | 37         | 5        | 0        | 56         | 197        |
| <b>Total</b> | <b>10</b>          | <b>28</b> | <b>0</b> | <b>0</b> | <b>38</b>  | <b>2</b>             | <b>418</b> | <b>73</b> | <b>0</b> | <b>493</b> | <b>1</b>           | <b>1</b> | <b>0</b> | <b>0</b> | <b>2</b>   | <b>32</b>            | <b>121</b> | <b>9</b> | <b>1</b> | <b>163</b> | <b>696</b> |
| 08:00 AM     | 3                  | 9         | 0        | 0        | 12         | 0                    | 61         | 15        | 0        | 76         | 1                  | 0        | 0        | 0        | 1          | 10                   | 35         | 0        | 1        | 46         | 135        |
| 08:15 AM     | 0                  | 5         | 0        | 0        | 5          | 0                    | 61         | 8         | 0        | 69         | 1                  | 0        | 1        | 0        | 2          | 6                    | 26         | 2        | 0        | 34         | 110        |
| 08:30 AM     | 0                  | 5         | 0        | 0        | 5          | 0                    | 50         | 10        | 0        | 60         | 0                  | 3        | 0        | 0        | 3          | 8                    | 20         | 3        | 0        | 31         | 99         |
| 08:45 AM     | 0                  | 3         | 0        | 0        | 3          | 0                    | 26         | 10        | 0        | 36         | 0                  | 0        | 0        | 0        | 0          | 6                    | 15         | 3        | 0        | 24         | 63         |
| <b>Total</b> | <b>3</b>           | <b>22</b> | <b>0</b> | <b>0</b> | <b>25</b>  | <b>0</b>             | <b>198</b> | <b>43</b> | <b>0</b> | <b>241</b> | <b>2</b>           | <b>3</b> | <b>1</b> | <b>0</b> | <b>6</b>   | <b>30</b>            | <b>96</b>  | <b>8</b> | <b>1</b> | <b>135</b> | <b>407</b> |
| Grand Total  | 13                 | 50        | 0        | 0        | 63         | 2                    | 616        | 116       | 0        | 734        | 3                  | 4        | 1        | 0        | 8          | 62                   | 217        | 17       | 2        | 298        | 1103       |
| Apprch %     | 20.6               | 79.4      | 0        | 0        |            | 0.3                  | 83.9       | 15.8      | 0        |            | 37.5               | 50       | 12.5     | 0        |            | 20.8                 | 72.8       | 5.7      | 0.7      |            |            |
| Total %      | 1.2                | 4.5       | 0        | 0        | 5.7        | 0.2                  | 55.8       | 10.5      | 0        | 66.5       | 0.3                | 0.4      | 0.1      | 0        | 0.7        | 5.6                  | 19.7       | 1.5      | 0.2      | 27         |            |
| Lights       | 13                 | 49        | 0        | 0        | 62         | 2                    | 605        | 115       | 0        | 722        | 2                  | 4        | 1        | 0        | 7          | 62                   | 210        | 15       | 2        | 289        | 1080       |
| % Lights     | 100                | 98        | 0        | 0        | 98.4       | 100                  | 98.2       | 99.1      | 0        | 98.4       | 66.7               | 100      | 100      | 0        | 87.5       | 100                  | 96.8       | 88.2     | 100      | 97         | 97.9       |
| Buses        | 0                  | 1         | 0        | 0        | 1          | 0                    | 4          | 1         | 0        | 5          | 1                  | 0        | 0        | 0        | 1          | 0                    | 5          | 2        | 0        | 7          | 14         |
| % Buses      | 0                  | 2         | 0        | 0        | 1.6        | 0                    | 0.6        | 0.9       | 0        | 0.7        | 33.3               | 0        | 0        | 0        | 12.5       | 0                    | 2.3        | 11.8     | 0        | 2.3        | 1.3        |
| Trucks       | 0                  | 0         | 0        | 0        | 0          | 0                    | 7          | 0         | 0        | 7          | 0                  | 0        | 0        | 0        | 0          | 0                    | 2          | 0        | 0        | 2          | 9          |
| % Trucks     | 0                  | 0         | 0        | 0        | 0          | 0                    | 1.1        | 0         | 0        | 1          | 0                  | 0        | 0        | 0        | 0          | 0                    | 0.9        | 0        | 0        | 0.7        | 0.8        |

| Start Time   | 6TH AVE Southbound |      |      |            | GIGLING RD Westbound |      |      |            | 6TH AVE Northbound |      |      |            | GIGLING RD Eastbound |      |      |            | Int. Total |
|--|--------------------|------|------|------------|----------------------|------|------|------------|--------------------|------|------|------------|----------------------|------|------|------------|------------|
|  | Right              | Thru | Left | App. Total | Right                | Thru | Left | App. Total | Right              | Thru | Left | App. Total | Right                | Thru | Left | App. Total |            |
| Peak Hour Analysis From 07:00 AM to 08:45 AM - Peak 1 of 1 |                    |      |      |            |                      |      |      |            |                    |      |      |            |                      |      |      |            |            |
| Peak Hour for Entire Intersection Begins at 07:15 AM       |                    |      |      |            |                      |      |      |            |                    |      |      |            |                      |      |      |            |            |
| 07:15 AM   | 2                  | 6    | 0    | 8          | 1                    | 126  | 17   | 144        | 1                  | 1    | 0    | 2          | 4                    | 28   | 1    | 33         | 187        |
| 07:30 AM   | 6                  | 8    | 0    | 14         | 1                    | 121  | 17   | 139        | 0                  | 0    | 0    | 0          | 13                   | 33   | 3    | 49         | 202        |
| 07:45 AM   | 2                  | 13   | 0    | 15         | 0                    | 100  | 26   | 126        | 0                  | 0    | 0    | 0          | 14                   | 37   | 5    | 56         | 197        |
| 08:00 AM   | 3                  | 9    | 0    | 12         | 0                    | 61   | 15   | 76         | 1                  | 0    | 0    | 1          | 10                   | 35   | 0    | 45         | 134        |
| Total Volume   | 13                 | 36   | 0    | 49         | 2                    | 408  | 75   | 485        | 2                  | 1    | 0    | 3          | 41                   | 133  | 9    | 183        | 720        |
| % App. Total   | 26.5               | 73.5 | 0    |            | 0.4                  | 84.1 | 15.5 |            | 66.7               | 33.3 | 0    |            | 22.4                 | 72.7 | 4.9  |            |            |
| PHF  | .542               | .692 | .000 | .817       | .500                 | .810 | .721 | .842       | .500               | .250 | .000 | .375       | .732                 | .899 | .450 | .817       | .891       |

# Traffic Data Service

San Jose, CA  
 (408) 622-4787  
 tdsbay@cs.com

File Name : 15AM FINAL  
 Site Code : 00000015  
 Start Date : 4/25/2018  
 Page No : 2

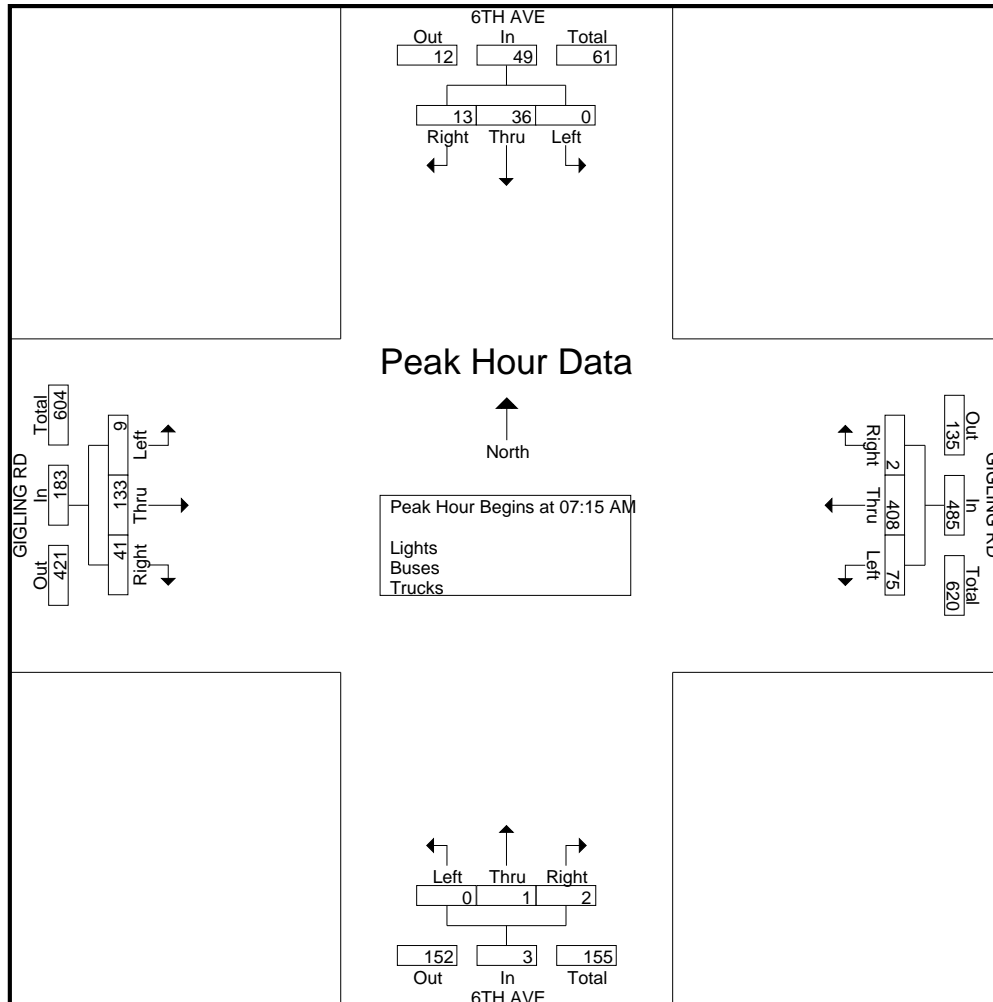

# Traffic Data Service

San Jose, CA  
 (408) 622-4787  
 tdsbay@cs.com

File Name : 15AM FINAL  
 Site Code : 00000015  
 Start Date : 4/25/2018  
 Page No : 1

Groups Printed- Bikes

| Start Time  | 6TH AVE Southbound |      |      |      |            | GIGLING RD Westbound |      |      |      |            | 6TH AVE Northbound |      |      |      |            | GIGLING RD Eastbound |      |      |      |            | Int. Total |
|-------------|--------------------|------|------|------|------------|----------------------|------|------|------|------------|--------------------|------|------|------|------------|----------------------|------|------|------|------------|------------|
|             | Right              | Thru | Left | Peds | App. Total | Right                | Thru | Left | Peds | App. Total | Right              | Thru | Left | Peds | App. Total | Right                | Thru | Left | Peds | App. Total |            |
| 07:00 AM    | 0                  | 0    | 0    | 0    | 0          | 0                    | 0    | 0    | 0    | 0          | 0                  | 0    | 0    | 0    | 0          | 0                    | 0    | 0    | 0    | 0          | 0          |
| 07:15 AM    | 0                  | 0    | 0    | 0    | 0          | 0                    | 0    | 0    | 0    | 0          | 0                  | 0    | 0    | 0    | 0          | 0                    | 0    | 0    | 0    | 0          | 0          |
| 07:30 AM    | 0                  | 0    | 0    | 0    | 0          | 0                    | 0    | 0    | 0    | 0          | 0                  | 0    | 0    | 0    | 0          | 0                    | 0    | 0    | 0    | 0          | 0          |
| 07:45 AM    | 0                  | 0    | 0    | 0    | 0          | 0                    | 0    | 0    | 0    | 0          | 0                  | 0    | 0    | 0    | 0          | 0                    | 0    | 0    | 0    | 0          | 0          |
| Total       | 0                  | 0    | 0    | 0    | 0          | 0                    | 0    | 0    | 0    | 0          | 0                  | 0    | 0    | 0    | 0          | 0                    | 0    | 0    | 0    | 0          | 0          |
| 08:00 AM    | 0                  | 0    | 0    | 0    | 0          | 0                    | 0    | 0    | 0    | 0          | 0                  | 0    | 0    | 0    | 0          | 0                    | 0    | 0    | 0    | 0          | 0          |
| 08:15 AM    | 0                  | 0    | 0    | 0    | 0          | 0                    | 0    | 0    | 0    | 0          | 0                  | 0    | 0    | 0    | 0          | 0                    | 0    | 0    | 0    | 0          | 0          |
| 08:30 AM    | 1                  | 0    | 0    | 0    | 1          | 0                    | 0    | 0    | 0    | 0          | 0                  | 0    | 0    | 0    | 0          | 0                    | 0    | 0    | 0    | 0          | 1          |
| 08:45 AM    | 0                  | 0    | 0    | 0    | 0          | 0                    | 0    | 0    | 0    | 0          | 0                  | 0    | 0    | 0    | 0          | 0                    | 0    | 0    | 0    | 0          | 0          |
| Total       | 1                  | 0    | 0    | 0    | 1          | 0                    | 0    | 0    | 0    | 0          | 0                  | 0    | 0    | 0    | 0          | 0                    | 0    | 0    | 0    | 0          | 1          |
| Grand Total | 1                  | 0    | 0    | 0    | 1          | 0                    | 0    | 0    | 0    | 0          | 0                  | 0    | 0    | 0    | 0          | 0                    | 0    | 0    | 0    | 0          | 1          |
| Apprch %    | 100                | 0    | 0    | 0    |            | 0                    | 0    | 0    | 0    |            | 0                  | 0    | 0    | 0    |            | 0                    | 0    | 0    | 0    |            |            |
| Total %     | 100                | 0    | 0    | 0    | 100        | 0                    | 0    | 0    | 0    | 0          | 0                  | 0    | 0    | 0    | 0          | 0                    | 0    | 0    | 0    | 0          |            |

| Start Time   | 6TH AVE Southbound |      |      |            | GIGLING RD Westbound |      |      |            | 6TH AVE Northbound |      |      |            | GIGLING RD Eastbound |      |      |            | Int. Total |
|--|--------------------|------|------|------------|----------------------|------|------|------------|--------------------|------|------|------------|----------------------|------|------|------------|------------|
|  | Right              | Thru | Left | App. Total | Right                | Thru | Left | App. Total | Right              | Thru | Left | App. Total | Right                | Thru | Left | App. Total |            |
| Peak Hour Analysis From 07:00 AM to 08:45 AM - Peak 1 of 1 |                    |      |      |            |                      |      |      |            |                    |      |      |            |                      |      |      |            |            |
| Peak Hour for Entire Intersection Begins at 07:45 AM       |                    |      |      |            |                      |      |      |            |                    |      |      |            |                      |      |      |            |            |
| 07:45 AM   | 0                  | 0    | 0    | 0          | 0                    | 0    | 0    | 0          | 0                  | 0    | 0    | 0          | 0                    | 0    | 0    | 0          | 0          |
| 08:00 AM   | 0                  | 0    | 0    | 0          | 0                    | 0    | 0    | 0          | 0                  | 0    | 0    | 0          | 0                    | 0    | 0    | 0          | 0          |
| 08:15 AM   | 0                  | 0    | 0    | 0          | 0                    | 0    | 0    | 0          | 0                  | 0    | 0    | 0          | 0                    | 0    | 0    | 0          | 0          |
| 08:30 AM   | 1                  | 0    | 0    | 1          | 0                    | 0    | 0    | 0          | 0                  | 0    | 0    | 0          | 0                    | 0    | 0    | 0          | 1          |
| Total Volume   | 1                  | 0    | 0    | 1          | 0                    | 0    | 0    | 0          | 0                  | 0    | 0    | 0          | 0                    | 0    | 0    | 0          | 1          |
| % App. Total   | 100                | 0    | 0    |            | 0                    | 0    | 0    |            | 0                  | 0    | 0    |            | 0                    | 0    | 0    |            |            |
| PHF  | .250               | .000 | .000 | .250       | .000                 | .000 | .000 | .000       | .000               | .000 | .000 | .000       | .000                 | .000 | .000 | .000       | .250       |

# Traffic Data Service

San Jose, CA  
(408) 622-4787  
tdsbay@cs.com

File Name : 15AM FINAL  
Site Code : 00000015  
Start Date : 4/25/2018  
Page No : 2

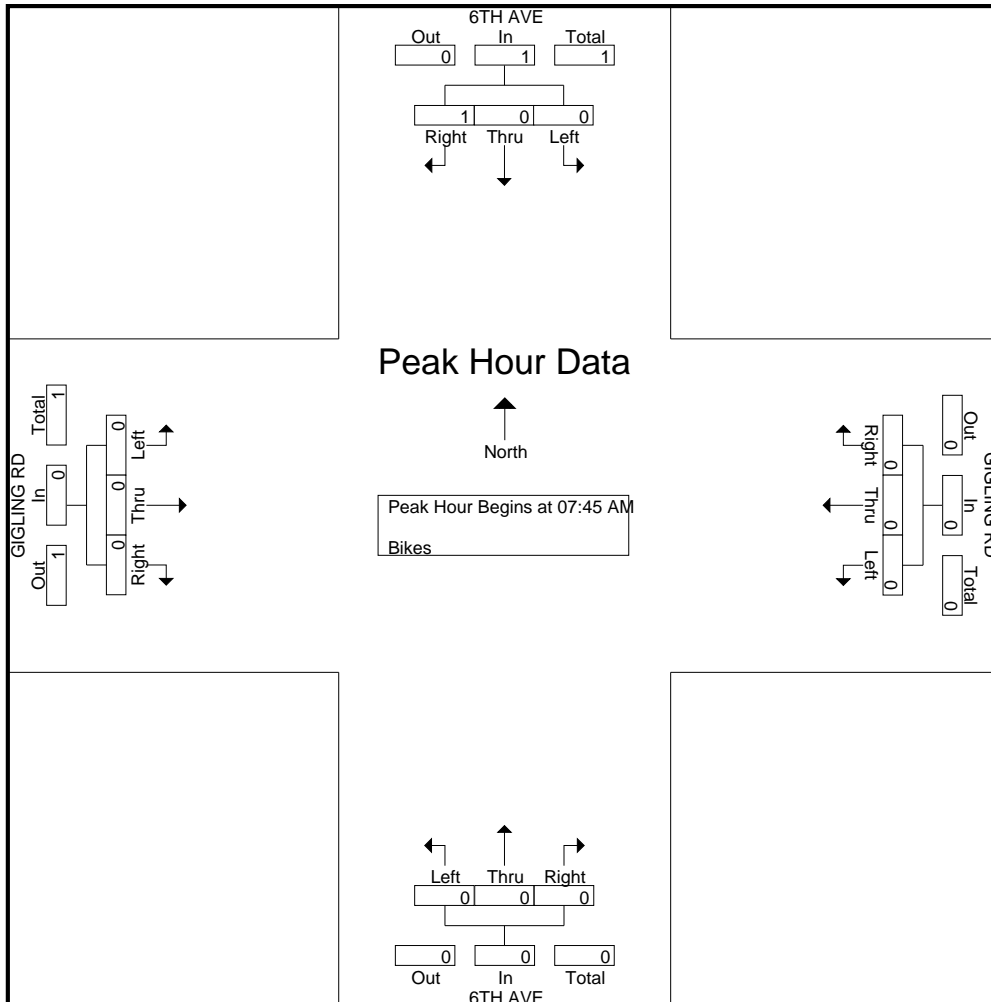

# Traffic Data Service

San Jose, CA  
 (408) 622-4787  
 tdsbay@cs.com

File Name : 15PM FINAL  
 Site Code : 00000015  
 Start Date : 4/25/2018  
 Page No : 1

Groups Printed- Lights - Buses - Trucks

| Start Time   | 6TH AVE Southbound |          |          |          |            | GIGLING RD Westbound |            |          |          |            | 6TH AVE Northbound |           |           |          |            | GIGLING RD Eastbound |            |           |          |            | Int. Total |
|--------------|--------------------|----------|----------|----------|------------|----------------------|------------|----------|----------|------------|--------------------|-----------|-----------|----------|------------|----------------------|------------|-----------|----------|------------|------------|
|              | Right              | Thru     | Left     | Peds     | App. Total | Right                | Thru       | Left     | Peds     | App. Total | Right              | Thru      | Left      | Peds     | App. Total | Right                | Thru       | Left      | Peds     | App. Total |            |
| 04:00 PM     | 1                  | 0        | 0        | 0        | 1          | 0                    | 30         | 0        | 0        | 30         | 11                 | 8         | 9         | 0        | 28         | 1                    | 61         | 3         | 1        | 66         | 125        |
| 04:15 PM     | 1                  | 0        | 0        | 0        | 1          | 0                    | 22         | 0        | 0        | 22         | 8                  | 2         | 13        | 0        | 23         | 0                    | 57         | 3         | 0        | 60         | 106        |
| 04:30 PM     | 1                  | 0        | 0        | 0        | 1          | 0                    | 28         | 1        | 0        | 29         | 20                 | 10        | 12        | 0        | 42         | 0                    | 66         | 1         | 0        | 67         | 139        |
| 04:45 PM     | 3                  | 0        | 0        | 0        | 3          | 1                    | 36         | 0        | 0        | 37         | 12                 | 5         | 14        | 0        | 31         | 0                    | 85         | 5         | 1        | 91         | 162        |
| <b>Total</b> | <b>6</b>           | <b>0</b> | <b>0</b> | <b>0</b> | <b>6</b>   | <b>1</b>             | <b>116</b> | <b>1</b> | <b>0</b> | <b>118</b> | <b>51</b>          | <b>25</b> | <b>48</b> | <b>0</b> | <b>124</b> | <b>1</b>             | <b>269</b> | <b>12</b> | <b>2</b> | <b>284</b> | <b>532</b> |
| 05:00 PM     | 7                  | 0        | 0        | 0        | 7          | 0                    | 35         | 0        | 0        | 35         | 15                 | 13        | 12        | 0        | 40         | 0                    | 78         | 5         | 0        | 83         | 165        |
| 05:15 PM     | 4                  | 0        | 0        | 0        | 4          | 1                    | 33         | 0        | 0        | 34         | 5                  | 6         | 11        | 0        | 22         | 0                    | 98         | 2         | 0        | 100        | 160        |
| 05:30 PM     | 3                  | 0        | 0        | 0        | 3          | 1                    | 33         | 0        | 0        | 34         | 5                  | 2         | 10        | 0        | 17         | 0                    | 82         | 1         | 0        | 83         | 137        |
| 05:45 PM     | 0                  | 0        | 0        | 0        | 0          | 0                    | 31         | 0        | 0        | 31         | 2                  | 1         | 4         | 0        | 7          | 0                    | 57         | 2         | 0        | 59         | 97         |
| <b>Total</b> | <b>14</b>          | <b>0</b> | <b>0</b> | <b>0</b> | <b>14</b>  | <b>2</b>             | <b>132</b> | <b>0</b> | <b>0</b> | <b>134</b> | <b>27</b>          | <b>22</b> | <b>37</b> | <b>0</b> | <b>86</b>  | <b>0</b>             | <b>315</b> | <b>10</b> | <b>0</b> | <b>325</b> | <b>559</b> |
| Grand Total  | 20                 | 0        | 0        | 0        | 20         | 3                    | 248        | 1        | 0        | 252        | 78                 | 47        | 85        | 0        | 210        | 1                    | 584        | 22        | 2        | 609        | 1091       |
| Apprch %     | 100                | 0        | 0        | 0        |            | 1.2                  | 98.4       | 0.4      | 0        |            | 37.1               | 22.4      | 40.5      | 0        |            | 0.2                  | 95.9       | 3.6       | 0.3      |            |            |
| Total %      | 1.8                | 0        | 0        | 0        | 1.8        | 0.3                  | 22.7       | 0.1      | 0        | 23.1       | 7.1                | 4.3       | 7.8       | 0        | 19.2       | 0.1                  | 53.5       | 2         | 0.2      | 55.8       |            |
| Lights       | 20                 | 0        | 0        | 0        | 20         | 3                    | 241        | 1        | 0        | 245        | 78                 | 47        | 85        | 0        | 210        | 1                    | 568        | 21        | 2        | 592        | 1067       |
| % Lights     | 100                | 0        | 0        | 0        | 100        | 100                  | 97.2       | 100      | 0        | 97.2       | 100                | 100       | 100       | 0        | 100        | 100                  | 97.3       | 95.5      | 100      | 97.2       | 97.8       |
| Buses        | 0                  | 0        | 0        | 0        | 0          | 0                    | 4          | 0        | 0        | 4          | 0                  | 0         | 0         | 0        | 0          | 0                    | 10         | 1         | 0        | 11         | 15         |
| % Buses      | 0                  | 0        | 0        | 0        | 0          | 0                    | 1.6        | 0        | 0        | 1.6        | 0                  | 0         | 0         | 0        | 0          | 0                    | 1.7        | 4.5       | 0        | 1.8        | 1.4        |
| Trucks       | 0                  | 0        | 0        | 0        | 0          | 0                    | 3          | 0        | 0        | 3          | 0                  | 0         | 0         | 0        | 0          | 0                    | 6          | 0         | 0        | 6          | 9          |
| % Trucks     | 0                  | 0        | 0        | 0        | 0          | 0                    | 1.2        | 0        | 0        | 1.2        | 0                  | 0         | 0         | 0        | 0          | 0                    | 1          | 0         | 0        | 1          | 0.8        |

| Start Time   | 6TH AVE Southbound |      |      |            | GIGLING RD Westbound |           |      |            | 6TH AVE Northbound |           |           |            | GIGLING RD Eastbound |           |          |            | Int. Total |
|--|--------------------|------|------|------------|----------------------|-----------|------|------------|--------------------|-----------|-----------|------------|----------------------|-----------|----------|------------|------------|
|  | Right              | Thru | Left | App. Total | Right                | Thru      | Left | App. Total | Right              | Thru      | Left      | App. Total | Right                | Thru      | Left     | App. Total |            |
| Peak Hour Analysis From 04:00 PM to 05:45 PM - Peak 1 of 1 |                    |      |      |            |                      |           |      |            |                    |           |           |            |                      |           |          |            |            |
| Peak Hour for Entire Intersection Begins at 04:30 PM       |                    |      |      |            |                      |           |      |            |                    |           |           |            |                      |           |          |            |            |
| 04:30 PM   | 1                  | 0    | 0    | 1          | 0                    | 28        | 1    | 29         | <b>20</b>          | 10        | 12        | <b>42</b>  | 0                    | 66        | 1        | 67         | 139        |
| 04:45 PM   | 3                  | 0    | 0    | 3          | 1                    | <b>36</b> | 0    | <b>37</b>  | 12                 | 5         | <b>14</b> | 31         | 0                    | 85        | <b>5</b> | 90         | 161        |
| 05:00 PM   | <b>7</b>           | 0    | 0    | <b>7</b>   | 0                    | 35        | 0    | 35         | 15                 | <b>13</b> | 12        | 40         | 0                    | 78        | 5        | 83         | <b>165</b> |
| 05:15 PM   | 4                  | 0    | 0    | 4          | 1                    | 33        | 0    | 34         | 5                  | 6         | 11        | 22         | 0                    | <b>98</b> | 2        | <b>100</b> | 160        |
| Total Volume   | 15                 | 0    | 0    | 15         | 2                    | 132       | 1    | 135        | 52                 | 34        | 49        | 135        | 0                    | 327       | 13       | 340        | 625        |
| % App. Total   | 100                | 0    | 0    |            | 1.5                  | 97.8      | 0.7  |            | 38.5               | 25.2      | 36.3      |            | 0                    | 96.2      | 3.8      |            |            |
| PHF  | .536               | .000 | .000 | .536       | .500                 | .917      | .250 | .912       | .650               | .654      | .875      | .804       | .000                 | .834      | .650     | .850       | .947       |

# Traffic Data Service

San Jose, CA  
 (408) 622-4787  
 tdsbay@cs.com

File Name : 15PM FINAL  
 Site Code : 00000015  
 Start Date : 4/25/2018  
 Page No : 2

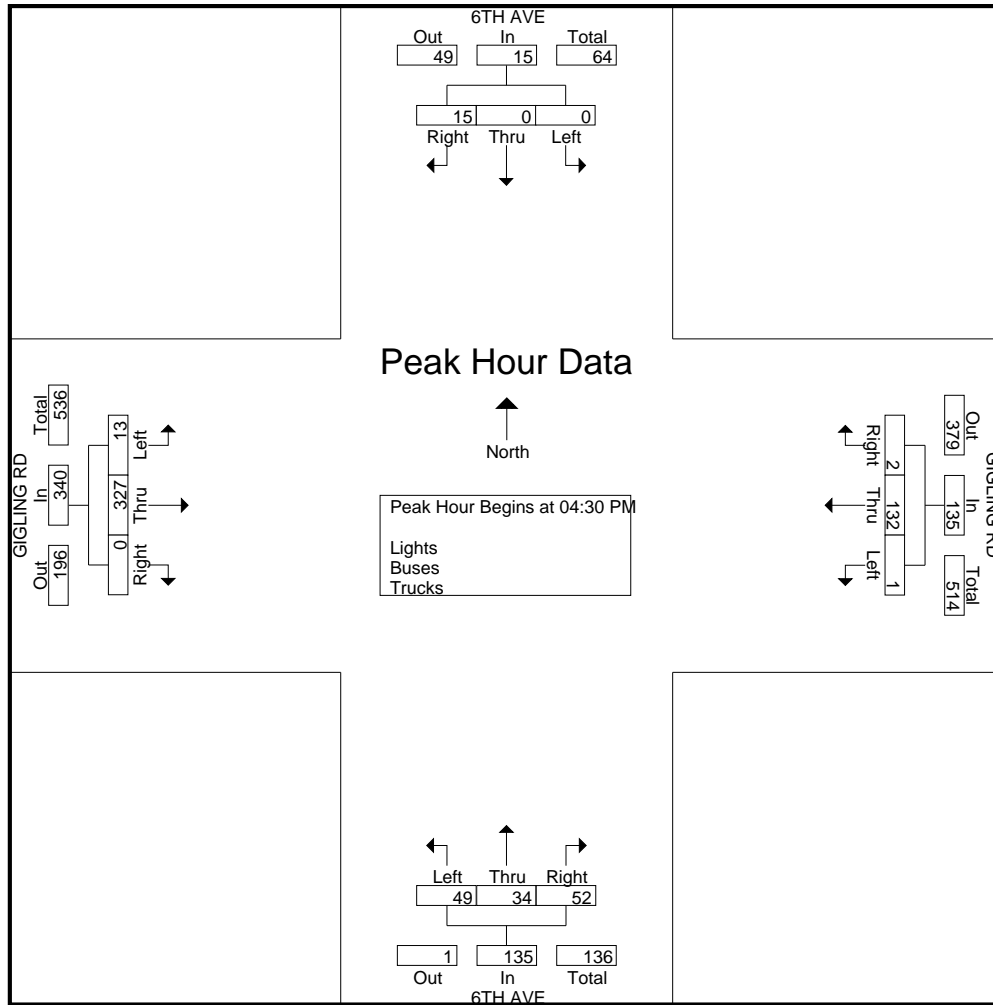

# Traffic Data Service

San Jose, CA  
 (408) 622-4787  
 tdsbay@cs.com

File Name : 15PM FINAL  
 Site Code : 00000015  
 Start Date : 4/25/2018  
 Page No : 1

Groups Printed- Bikes

| Start Time   | 6TH AVE Southbound |      |      |      |            | GIGLING RD Westbound |      |      |      |            | 6TH AVE Northbound |      |      |      |            | GIGLING RD Eastbound |      |      |      |            | Int. Total |   |
|--------------|--------------------|------|------|------|------------|----------------------|------|------|------|------------|--------------------|------|------|------|------------|----------------------|------|------|------|------------|------------|---|
|              | Right              | Thru | Left | Peds | App. Total | Right                | Thru | Left | Peds | App. Total | Right              | Thru | Left | Peds | App. Total | Right                | Thru | Left | Peds | App. Total |            |   |
| 04:00 PM     | 0                  | 0    | 0    | 0    | 0          | 0                    | 0    | 0    | 0    | 0          | 0                  | 0    | 0    | 0    | 0          | 0                    | 0    | 0    | 0    | 0          | 0          | 0 |
| 04:15 PM     | 0                  | 0    | 0    | 0    | 0          | 0                    | 0    | 0    | 0    | 0          | 0                  | 0    | 0    | 0    | 0          | 0                    | 0    | 0    | 0    | 0          | 0          | 0 |
| 04:30 PM     | 0                  | 0    | 0    | 0    | 0          | 0                    | 0    | 0    | 0    | 0          | 0                  | 0    | 0    | 0    | 0          | 0                    | 0    | 0    | 0    | 0          | 0          | 0 |
| 04:45 PM     | 0                  | 0    | 0    | 0    | 0          | 0                    | 0    | 0    | 0    | 0          | 0                  | 0    | 0    | 0    | 0          | 0                    | 0    | 0    | 0    | 0          | 0          | 0 |
| <b>Total</b> | 0                  | 0    | 0    | 0    | 0          | 0                    | 0    | 0    | 0    | 0          | 0                  | 0    | 0    | 0    | 0          | 0                    | 0    | 0    | 0    | 0          | 0          | 0 |
| 05:00 PM     | 0                  | 0    | 0    | 0    | 0          | 0                    | 0    | 0    | 0    | 0          | 0                  | 2    | 0    | 0    | 2          | 0                    | 0    | 0    | 0    | 0          | 0          | 2 |
| 05:15 PM     | 0                  | 0    | 0    | 0    | 0          | 0                    | 0    | 0    | 0    | 0          | 0                  | 0    | 0    | 0    | 0          | 0                    | 1    | 0    | 0    | 0          | 0          | 1 |
| 05:30 PM     | 0                  | 0    | 0    | 0    | 0          | 0                    | 0    | 0    | 0    | 0          | 0                  | 0    | 0    | 0    | 0          | 0                    | 0    | 0    | 0    | 0          | 0          | 0 |
| 05:45 PM     | 0                  | 0    | 0    | 0    | 0          | 0                    | 0    | 0    | 0    | 0          | 0                  | 0    | 0    | 0    | 0          | 0                    | 0    | 0    | 0    | 0          | 0          | 0 |
| <b>Total</b> | 0                  | 0    | 0    | 0    | 0          | 0                    | 0    | 0    | 0    | 0          | 0                  | 2    | 0    | 0    | 2          | 0                    | 1    | 0    | 0    | 0          | 0          | 3 |
| Grand Total  | 0                  | 0    | 0    | 0    | 0          | 0                    | 0    | 0    | 0    | 0          | 0                  | 2    | 0    | 0    | 2          | 0                    | 1    | 0    | 0    | 0          | 0          | 3 |
| Apprch %     | 0                  | 0    | 0    | 0    | 0          | 0                    | 0    | 0    | 0    | 0          | 0                  | 100  | 0    | 0    | 0          | 0                    | 100  | 0    | 0    | 0          | 0          | 0 |
| Total %      | 0                  | 0    | 0    | 0    | 0          | 0                    | 0    | 0    | 0    | 0          | 0                  | 66.7 | 0    | 0    | 66.7       | 0                    | 33.3 | 0    | 0    | 33.3       | 0          | 0 |

| Start Time   | 6TH AVE Southbound |      |      |      |            | GIGLING RD Westbound |      |      |      |            | 6TH AVE Northbound |      |      |      |            | GIGLING RD Eastbound |      |      |      |            | Int. Total |      |
|--|--------------------|------|------|------|------------|----------------------|------|------|------|------------|--------------------|------|------|------|------------|----------------------|------|------|------|------------|------------|------|
|  | Right              | Thru | Left | Peds | App. Total | Right                | Thru | Left | Peds | App. Total | Right              | Thru | Left | Peds | App. Total | Right                | Thru | Left | Peds | App. Total |            |      |
| Peak Hour Analysis From 04:00 PM to 05:45 PM - Peak 1 of 1 |                    |      |      |      |            |                      |      |      |      |            |                    |      |      |      |            |                      |      |      |      |            |            |      |
| Peak Hour for Entire Intersection Begins at 04:30 PM       |                    |      |      |      |            |                      |      |      |      |            |                    |      |      |      |            |                      |      |      |      |            |            |      |
| 04:30 PM   | 0                  | 0    | 0    | 0    | 0          | 0                    | 0    | 0    | 0    | 0          | 0                  | 0    | 0    | 0    | 0          | 0                    | 0    | 0    | 0    | 0          | 0          | 0    |
| 04:45 PM   | 0                  | 0    | 0    | 0    | 0          | 0                    | 0    | 0    | 0    | 0          | 0                  | 0    | 0    | 0    | 0          | 0                    | 0    | 0    | 0    | 0          | 0          | 0    |
| 05:00 PM   | 0                  | 0    | 0    | 0    | 0          | 0                    | 0    | 0    | 0    | 0          | 0                  | 2    | 0    | 0    | 2          | 0                    | 0    | 0    | 0    | 0          | 0          | 2    |
| 05:15 PM   | 0                  | 0    | 0    | 0    | 0          | 0                    | 0    | 0    | 0    | 0          | 0                  | 0    | 0    | 0    | 0          | 0                    | 1    | 0    | 0    | 0          | 0          | 1    |
| Total Volume   | 0                  | 0    | 0    | 0    | 0          | 0                    | 0    | 0    | 0    | 0          | 0                  | 2    | 0    | 0    | 2          | 0                    | 1    | 0    | 0    | 0          | 0          | 3    |
| % App. Total   | 0                  | 0    | 0    | 0    | 0          | 0                    | 0    | 0    | 0    | 0          | 0                  | 100  | 0    | 0    | 0          | 0                    | 100  | 0    | 0    | 0          | 0          | 0    |
| PHF  | .000               | .000 | .000 | .000 | .000       | .000                 | .000 | .000 | .000 | .000       | .000               | .250 | .000 | .250 | .000       | .000                 | .250 | .000 | .250 | .000       | .000       | .375 |

# Traffic Data Service

San Jose, CA  
 (408) 622-4787  
 tdsbay@cs.com

File Name : 15PM FINAL  
 Site Code : 00000015  
 Start Date : 4/25/2018  
 Page No : 2

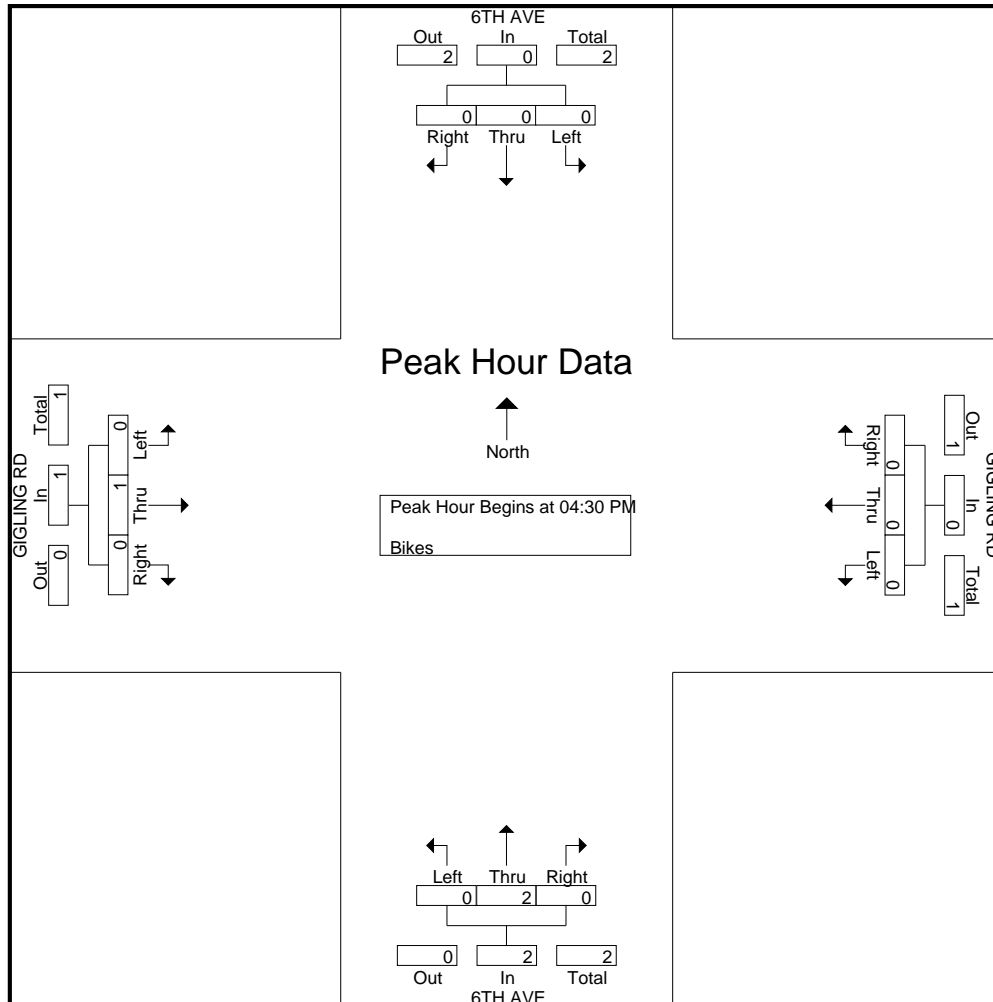



# Traffic Data Service

San Jose, CA  
 (408) 622-4787  
 tdsbay@cs.com

File Name : 16AM FINAL  
 Site Code : 00000016  
 Start Date : 4/25/2018  
 Page No : 1

Groups Printed- Lights - Buses - Trucks

| Start Time  | 7TH AVE Southbound |      |      |      |            | GIGLING RD Westbound |      |      |      |            | DRIVEWAY Northbound |      |      |      |            | GIGLING RD Eastbound |      |      |      |            | Int. Total |
|-------------|--------------------|------|------|------|------------|----------------------|------|------|------|------------|---------------------|------|------|------|------------|----------------------|------|------|------|------------|------------|
|             | Right              | Thru | Left | Peds | App. Total | Right                | Thru | Left | Peds | App. Total | Right               | Thru | Left | Peds | App. Total | Right                | Thru | Left | Peds | App. Total |            |
| 07:00 AM    | 6                  | 0    | 0    | 0    | 6          | 0                    | 76   | 0    | 0    | 76         | 0                   | 0    | 0    | 0    | 0          | 0                    | 21   | 2    | 0    | 23         | 105        |
| 07:15 AM    | 26                 | 0    | 0    | 0    | 26         | 0                    | 125  | 0    | 0    | 125        | 0                   | 0    | 0    | 0    | 0          | 0                    | 27   | 1    | 0    | 28         | 179        |
| 07:30 AM    | 27                 | 0    | 0    | 0    | 27         | 0                    | 108  | 0    | 0    | 108        | 0                   | 0    | 0    | 0    | 0          | 0                    | 27   | 5    | 0    | 32         | 167        |
| 07:45 AM    | 31                 | 0    | 1    | 0    | 32         | 0                    | 100  | 0    | 0    | 100        | 0                   | 0    | 0    | 0    | 0          | 0                    | 28   | 8    | 0    | 36         | 168        |
| Total       | 90                 | 0    | 1    | 0    | 91         | 0                    | 409  | 0    | 0    | 409        | 0                   | 0    | 0    | 0    | 0          | 0                    | 103  | 16   | 0    | 119        | 619        |
| 08:00 AM    | 16                 | 0    | 0    | 1    | 17         | 0                    | 52   | 0    | 0    | 52         | 0                   | 0    | 0    | 0    | 0          | 0                    | 29   | 8    | 0    | 37         | 106        |
| 08:15 AM    | 16                 | 0    | 1    | 0    | 17         | 0                    | 54   | 0    | 0    | 54         | 0                   | 0    | 0    | 0    | 0          | 0                    | 27   | 1    | 0    | 28         | 99         |
| 08:30 AM    | 16                 | 0    | 3    | 0    | 19         | 0                    | 42   | 0    | 0    | 42         | 0                   | 0    | 0    | 0    | 0          | 0                    | 18   | 2    | 0    | 20         | 81         |
| 08:45 AM    | 6                  | 0    | 0    | 0    | 6          | 0                    | 30   | 0    | 0    | 30         | 0                   | 0    | 0    | 0    | 0          | 0                    | 14   | 1    | 0    | 15         | 51         |
| Total       | 54                 | 0    | 4    | 1    | 59         | 0                    | 178  | 0    | 0    | 178        | 0                   | 0    | 0    | 0    | 0          | 0                    | 88   | 12   | 0    | 100        | 337        |
| Grand Total | 144                | 0    | 5    | 1    | 150        | 0                    | 587  | 0    | 0    | 587        | 0                   | 0    | 0    | 0    | 0          | 0                    | 191  | 28   | 0    | 219        | 956        |
| Apprch %    | 96                 | 0    | 3.3  | 0.7  |            | 0                    | 100  | 0    | 0    |            | 0                   | 0    | 0    | 0    |            | 0                    | 87.2 | 12.8 | 0    |            |            |
| Total %     | 15.1               | 0    | 0.5  | 0.1  | 15.7       | 0                    | 61.4 | 0    | 0    | 61.4       | 0                   | 0    | 0    | 0    | 0          | 0                    | 20   | 2.9  | 0    | 22.9       |            |
| Lights      | 136                | 0    | 2    | 1    | 139        | 0                    | 584  | 0    | 0    | 584        | 0                   | 0    | 0    | 0    | 0          | 0                    | 185  | 26   | 0    | 211        | 934        |
| % Lights    | 94.4               | 0    | 40   | 100  | 92.7       | 0                    | 99.5 | 0    | 0    | 99.5       | 0                   | 0    | 0    | 0    | 0          | 0                    | 96.9 | 92.9 | 0    | 96.3       | 97.7       |
| Buses       | 2                  | 0    | 1    | 0    | 3          | 0                    | 2    | 0    | 0    | 2          | 0                   | 0    | 0    | 0    | 0          | 0                    | 5    | 1    | 0    | 6          | 11         |
| % Buses     | 1.4                | 0    | 20   | 0    | 2          | 0                    | 0.3  | 0    | 0    | 0.3        | 0                   | 0    | 0    | 0    | 0          | 0                    | 2.6  | 3.6  | 0    | 2.7        | 1.2        |
| Trucks      | 6                  | 0    | 2    | 0    | 8          | 0                    | 1    | 0    | 0    | 1          | 0                   | 0    | 0    | 0    | 0          | 0                    | 1    | 1    | 0    | 2          | 11         |
| % Trucks    | 4.2                | 0    | 40   | 0    | 5.3        | 0                    | 0.2  | 0    | 0    | 0.2        | 0                   | 0    | 0    | 0    | 0          | 0                    | 0.5  | 3.6  | 0    | 0.9        | 1.2        |

| Start Time   | 7TH AVE Southbound |      |      |            | GIGLING RD Westbound |      |      |            | DRIVEWAY Northbound |      |      |            | GIGLING RD Eastbound |      |      |            | Int. Total |      |
|--|--------------------|------|------|------------|----------------------|------|------|------------|---------------------|------|------|------------|----------------------|------|------|------------|------------|------|
|  | Right              | Thru | Left | App. Total | Right                | Thru | Left | App. Total | Right               | Thru | Left | App. Total | Right                | Thru | Left | App. Total |            |      |
| Peak Hour Analysis From 07:00 AM to 08:45 AM - Peak 1 of 1 |                    |      |      |            |                      |      |      |            |                     |      |      |            |                      |      |      |            |            |      |
| Peak Hour for Entire Intersection Begins at 07:00 AM       |                    |      |      |            |                      |      |      |            |                     |      |      |            |                      |      |      |            |            |      |
| 07:00 AM   | 6                  | 0    | 0    | 6          | 0                    | 76   | 0    | 76         | 0                   | 0    | 0    | 0          | 0                    | 0    | 21   | 2          | 23         | 105  |
| 07:15 AM   | 26                 | 0    | 0    | 26         | 0                    | 125  | 0    | 125        | 0                   | 0    | 0    | 0          | 0                    | 0    | 27   | 1          | 28         | 179  |
| 07:30 AM   | 27                 | 0    | 0    | 27         | 0                    | 108  | 0    | 108        | 0                   | 0    | 0    | 0          | 0                    | 0    | 27   | 5          | 32         | 167  |
| 07:45 AM   | 31                 | 0    | 1    | 32         | 0                    | 100  | 0    | 100        | 0                   | 0    | 0    | 0          | 0                    | 0    | 28   | 8          | 36         | 168  |
| Total Volume   | 90                 | 0    | 1    | 91         | 0                    | 409  | 0    | 409        | 0                   | 0    | 0    | 0          | 0                    | 0    | 103  | 16         | 119        | 619  |
| % App. Total   | 98.9               | 0    | 1.1  |            | 0                    | 100  | 0    |            | 0                   | 0    | 0    |            | 0                    | 86.6 | 13.4 |            |            |      |
| PHF  | .726               | .000 | .250 | .711       | .000                 | .818 | .000 | .818       | .000                | .000 | .000 | .000       | .000                 | .000 | .920 | .500       | .826       | .865 |

# Traffic Data Service

San Jose, CA  
 (408) 622-4787  
 tdsbay@cs.com

File Name : 16AM FINAL  
 Site Code : 00000016  
 Start Date : 4/25/2018  
 Page No : 2

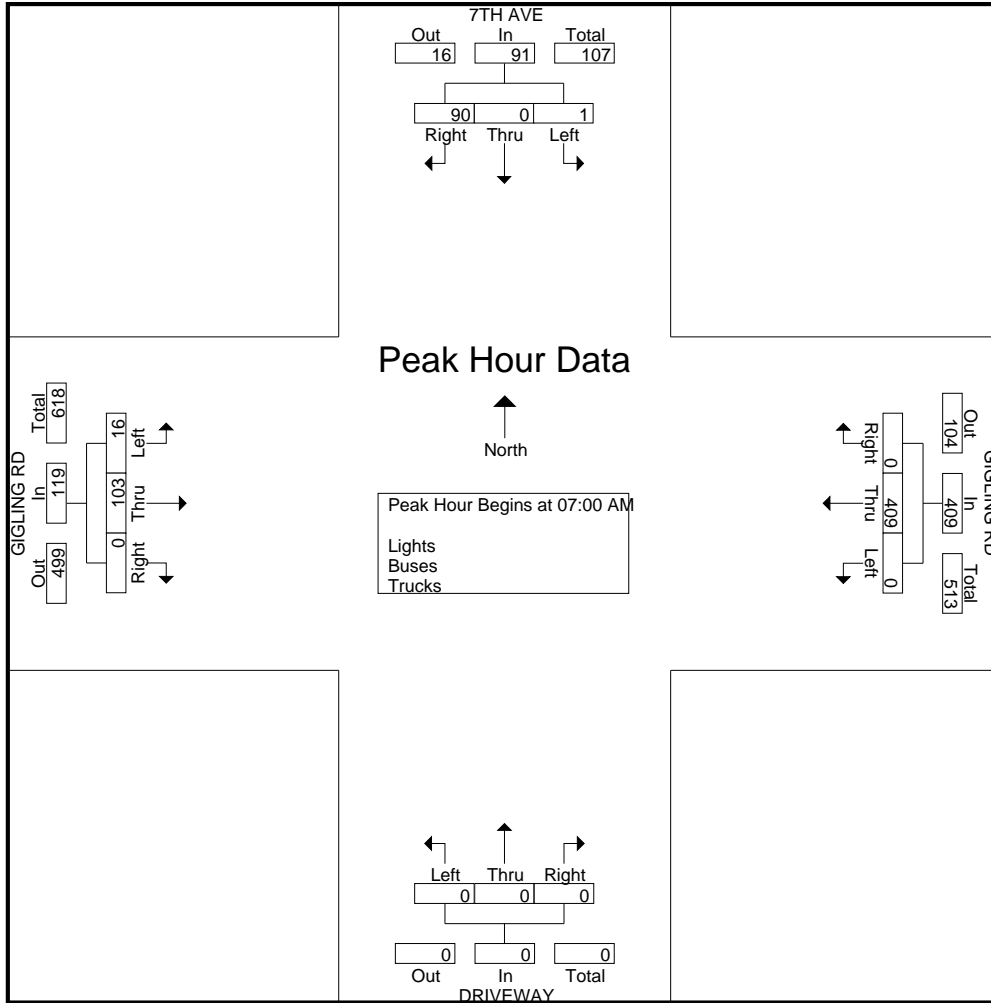

# Traffic Data Service

San Jose, CA  
 (408) 622-4787  
 tdsbay@cs.com

File Name : 16AM FINAL  
 Site Code : 00000016  
 Start Date : 4/25/2018  
 Page No : 1

Groups Printed- Bikes

| Start Time   | 7TH AVE Southbound |      |      |      |            | GIGLING RD Westbound |      |      |      |            | DRIVEWAY Northbound |      |      |      |            | GIGLING RD Eastbound |      |      |      |            | Int. Total |
|--------------|--------------------|------|------|------|------------|----------------------|------|------|------|------------|---------------------|------|------|------|------------|----------------------|------|------|------|------------|------------|
|              | Right              | Thru | Left | Peds | App. Total | Right                | Thru | Left | Peds | App. Total | Right               | Thru | Left | Peds | App. Total | Right                | Thru | Left | Peds | App. Total |            |
| 07:00 AM     | 0                  | 0    | 0    | 0    | 0          | 0                    | 0    | 0    | 0    | 0          | 0                   | 0    | 0    | 0    | 0          | 0                    | 0    | 0    | 0    | 0          | 0          |
| 07:15 AM     | 0                  | 0    | 0    | 0    | 0          | 0                    | 0    | 0    | 0    | 0          | 0                   | 0    | 0    | 0    | 0          | 0                    | 0    | 0    | 0    | 0          | 0          |
| 07:30 AM     | 0                  | 0    | 0    | 0    | 0          | 0                    | 0    | 0    | 0    | 0          | 0                   | 0    | 0    | 0    | 0          | 0                    | 0    | 0    | 0    | 0          | 0          |
| 07:45 AM     | 0                  | 0    | 0    | 0    | 0          | 0                    | 0    | 0    | 0    | 0          | 0                   | 0    | 0    | 0    | 0          | 0                    | 0    | 0    | 0    | 0          | 0          |
| <b>Total</b> | 0                  | 0    | 0    | 0    | 0          | 0                    | 0    | 0    | 0    | 0          | 0                   | 0    | 0    | 0    | 0          | 0                    | 0    | 0    | 0    | 0          | 0          |
| 08:00 AM     | 0                  | 0    | 0    | 0    | 0          | 0                    | 0    | 0    | 0    | 0          | 0                   | 0    | 0    | 0    | 0          | 0                    | 0    | 0    | 0    | 0          | 0          |
| 08:15 AM     | 0                  | 0    | 0    | 0    | 0          | 0                    | 0    | 0    | 0    | 0          | 0                   | 0    | 0    | 0    | 0          | 0                    | 0    | 0    | 0    | 0          | 0          |
| 08:30 AM     | 0                  | 0    | 0    | 0    | 0          | 0                    | 0    | 0    | 0    | 0          | 0                   | 0    | 0    | 0    | 0          | 0                    | 0    | 0    | 0    | 0          | 0          |
| 08:45 AM     | 0                  | 0    | 0    | 0    | 0          | 0                    | 0    | 0    | 0    | 0          | 0                   | 0    | 0    | 0    | 0          | 0                    | 0    | 0    | 0    | 0          | 0          |
| <b>Total</b> | 0                  | 0    | 0    | 0    | 0          | 0                    | 0    | 0    | 0    | 0          | 0                   | 0    | 0    | 0    | 0          | 0                    | 0    | 0    | 0    | 0          | 0          |
| Grand Total  | 0                  | 0    | 0    | 0    | 0          | 0                    | 0    | 0    | 0    | 0          | 0                   | 0    | 0    | 0    | 0          | 0                    | 0    | 0    | 0    | 0          | 0          |
| Apprch %     | 0                  | 0    | 0    | 0    |            | 0                    | 0    | 0    | 0    |            | 0                   | 0    | 0    | 0    |            | 0                    | 0    | 0    | 0    |            |            |
| Total %      |                    |      |      |      |            |                      |      |      |      |            |                     |      |      |      |            |                      |      |      |      |            |            |

| Start Time   | 7TH AVE Southbound |      |      |      |            | GIGLING RD Westbound |      |      |      |            | DRIVEWAY Northbound |      |      |      |            | GIGLING RD Eastbound |      |      |      |            | Int. Total |
|--|--------------------|------|------|------|------------|----------------------|------|------|------|------------|---------------------|------|------|------|------------|----------------------|------|------|------|------------|------------|
|  | Right              | Thru | Left | Peds | App. Total | Right                | Thru | Left | Peds | App. Total | Right               | Thru | Left | Peds | App. Total | Right                | Thru | Left | Peds | App. Total |            |
| Peak Hour Analysis From 07:00 AM to 08:45 AM - Peak 1 of 1 |                    |      |      |      |            |                      |      |      |      |            |                     |      |      |      |            |                      |      |      |      |            |            |
| Peak Hour for Entire Intersection Begins at 07:00 AM       |                    |      |      |      |            |                      |      |      |      |            |                     |      |      |      |            |                      |      |      |      |            |            |
| 07:00 AM   | 0                  | 0    | 0    | 0    | 0          | 0                    | 0    | 0    | 0    | 0          | 0                   | 0    | 0    | 0    | 0          | 0                    | 0    | 0    | 0    | 0          | 0          |
| 07:15 AM   | 0                  | 0    | 0    | 0    | 0          | 0                    | 0    | 0    | 0    | 0          | 0                   | 0    | 0    | 0    | 0          | 0                    | 0    | 0    | 0    | 0          | 0          |
| 07:30 AM   | 0                  | 0    | 0    | 0    | 0          | 0                    | 0    | 0    | 0    | 0          | 0                   | 0    | 0    | 0    | 0          | 0                    | 0    | 0    | 0    | 0          | 0          |
| 07:45 AM   | 0                  | 0    | 0    | 0    | 0          | 0                    | 0    | 0    | 0    | 0          | 0                   | 0    | 0    | 0    | 0          | 0                    | 0    | 0    | 0    | 0          | 0          |
| Total Volume   | 0                  | 0    | 0    | 0    | 0          | 0                    | 0    | 0    | 0    | 0          | 0                   | 0    | 0    | 0    | 0          | 0                    | 0    | 0    | 0    | 0          | 0          |
| % App. Total   | 0                  | 0    | 0    | 0    |            | 0                    | 0    | 0    | 0    |            | 0                   | 0    | 0    | 0    |            | 0                    | 0    | 0    | 0    |            |            |
| PHF  | .000               | .000 | .000 | .000 | .000       | .000                 | .000 | .000 | .000 | .000       | .000                | .000 | .000 | .000 | .000       | .000                 | .000 | .000 | .000 | .000       | .000       |

# Traffic Data Service

San Jose, CA  
(408) 622-4787  
tdsbay@cs.com

File Name : 16AM FINAL  
Site Code : 00000016  
Start Date : 4/25/2018  
Page No : 2

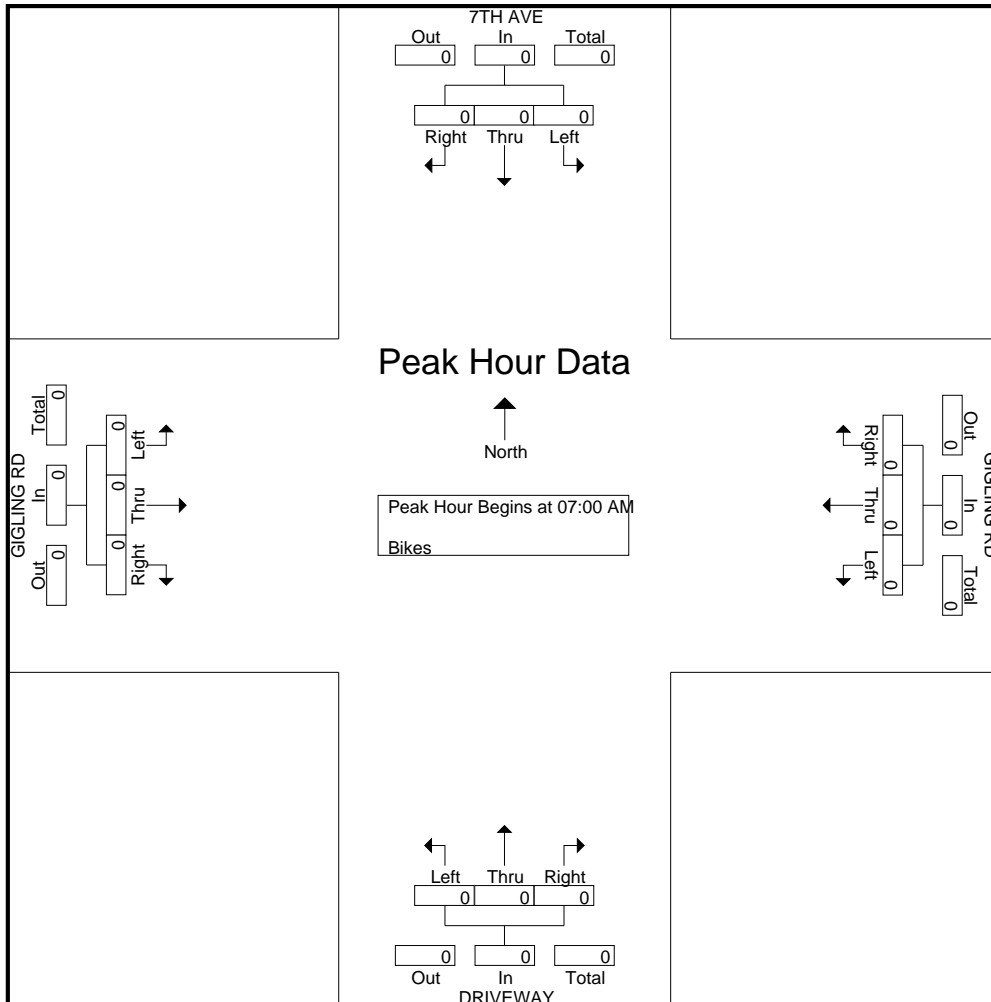

# Traffic Data Service

San Jose, CA  
 (408) 622-4787  
 tdsbay@cs.com

File Name : 16PM FINAL  
 Site Code : 00000016  
 Start Date : 4/25/2018  
 Page No : 1

## Groups Printed- Lights - Buses - Trucks

| Start Time   | 7TH AVE Southbound |          |          |          |            | GIGLING RD Westbound |            |          |          |            | DRIVEWAY Northbound |          |          |          |            | GIGLING RD Eastbound |            |           |          |            | Int. Total |
|--------------|--------------------|----------|----------|----------|------------|----------------------|------------|----------|----------|------------|---------------------|----------|----------|----------|------------|----------------------|------------|-----------|----------|------------|------------|
|              | Right              | Thru     | Left     | Peds     | App. Total | Right                | Thru       | Left     | Peds     | App. Total | Right               | Thru     | Left     | Peds     | App. Total | Right                | Thru       | Left      | Peds     | App. Total |            |
| 04:00 PM     | 3                  | 0        | 1        | 0        | 4          | 1                    | 28         | 0        | 0        | 29         | 0                   | 0        | 0        | 0        | 0          | 0                    | 59         | 9         | 0        | 68         | 101        |
| 04:15 PM     | 6                  | 0        | 0        | 0        | 6          | 0                    | 15         | 0        | 0        | 15         | 0                   | 0        | 0        | 0        | 0          | 0                    | 61         | 7         | 0        | 68         | 89         |
| 04:30 PM     | 4                  | 0        | 0        | 0        | 4          | 0                    | 25         | 1        | 0        | 26         | 0                   | 0        | 0        | 0        | 0          | 0                    | 75         | 8         | 0        | 83         | 113        |
| 04:45 PM     | 7                  | 0        | 0        | 0        | 7          | 1                    | 30         | 0        | 0        | 31         | 0                   | 0        | 0        | 0        | 0          | 0                    | 86         | 11        | 0        | 97         | 135        |
| <b>Total</b> | <b>20</b>          | <b>0</b> | <b>1</b> | <b>0</b> | <b>21</b>  | <b>2</b>             | <b>98</b>  | <b>1</b> | <b>0</b> | <b>101</b> | <b>0</b>            | <b>0</b> | <b>0</b> | <b>0</b> | <b>0</b>   | <b>0</b>             | <b>281</b> | <b>35</b> | <b>0</b> | <b>316</b> | <b>438</b> |
| 05:00 PM     | 7                  | 0        | 0        | 0        | 7          | 0                    | 27         | 0        | 0        | 27         | 0                   | 0        | 0        | 0        | 0          | 0                    | 86         | 8         | 0        | 94         | 128        |
| 05:15 PM     | 6                  | 0        | 0        | 0        | 6          | 0                    | 29         | 0        | 1        | 30         | 0                   | 0        | 0        | 0        | 0          | 0                    | 100        | 2         | 0        | 102        | 138        |
| 05:30 PM     | 4                  | 0        | 0        | 0        | 4          | 0                    | 30         | 0        | 0        | 30         | 0                   | 0        | 0        | 0        | 0          | 0                    | 81         | 9         | 0        | 90         | 124        |
| 05:45 PM     | 7                  | 0        | 3        | 0        | 10         | 0                    | 23         | 0        | 0        | 23         | 0                   | 0        | 0        | 0        | 0          | 0                    | 53         | 4         | 0        | 57         | 90         |
| <b>Total</b> | <b>24</b>          | <b>0</b> | <b>3</b> | <b>0</b> | <b>27</b>  | <b>0</b>             | <b>109</b> | <b>0</b> | <b>1</b> | <b>110</b> | <b>0</b>            | <b>0</b> | <b>0</b> | <b>0</b> | <b>0</b>   | <b>0</b>             | <b>320</b> | <b>23</b> | <b>0</b> | <b>343</b> | <b>480</b> |
| Grand Total  | 44                 | 0        | 4        | 0        | 48         | 2                    | 207        | 1        | 1        | 211        | 0                   | 0        | 0        | 0        | 0          | 0                    | 601        | 58        | 0        | 659        | 918        |
| Apprch %     | 91.7               | 0        | 8.3      | 0        |            | 0.9                  | 98.1       | 0.5      | 0.5      |            | 0                   | 0        | 0        | 0        | 0          | 0                    | 91.2       | 8.8       | 0        |            |            |
| Total %      | 4.8                | 0        | 0.4      | 0        | 5.2        | 0.2                  | 22.5       | 0.1      | 0.1      | 23         | 0                   | 0        | 0        | 0        | 0          | 0                    | 65.5       | 6.3       | 0        | 71.8       |            |
| Lights       | 41                 | 0        | 4        | 0        | 45         | 1                    | 204        | 1        | 1        | 207        | 0                   | 0        | 0        | 0        | 0          | 0                    | 589        | 53        | 0        | 642        | 894        |
| % Lights     | 93.2               | 0        | 100      | 0        | 93.8       | 50                   | 98.6       | 100      | 100      | 98.1       | 0                   | 0        | 0        | 0        | 0          | 0                    | 98         | 91.4      | 0        | 97.4       | 97.4       |
| Buses        | 2                  | 0        | 0        | 0        | 2          | 0                    | 2          | 0        | 0        | 2          | 0                   | 0        | 0        | 0        | 0          | 0                    | 7          | 2         | 0        | 9          | 13         |
| % Buses      | 4.5                | 0        | 0        | 0        | 4.2        | 0                    | 1          | 0        | 0        | 0.9        | 0                   | 0        | 0        | 0        | 0          | 0                    | 1.2        | 3.4       | 0        | 1.4        | 1.4        |
| Trucks       | 1                  | 0        | 0        | 0        | 1          | 1                    | 1          | 0        | 0        | 2          | 0                   | 0        | 0        | 0        | 0          | 0                    | 5          | 3         | 0        | 8          | 11         |
| % Trucks     | 2.3                | 0        | 0        | 0        | 2.1        | 50                   | 0.5        | 0        | 0        | 0.9        | 0                   | 0        | 0        | 0        | 0          | 0                    | 0.8        | 5.2       | 0        | 1.2        | 1.2        |

| Start Time   | 7TH AVE Southbound |      |      |            | GIGLING RD Westbound |      |      |            | DRIVEWAY Northbound |      |      |            | GIGLING RD Eastbound |      |      |            | Int. Total |      |
|--|--------------------|------|------|------------|----------------------|------|------|------------|---------------------|------|------|------------|----------------------|------|------|------------|------------|------|
|  | Right              | Thru | Left | App. Total | Right                | Thru | Left | App. Total | Right               | Thru | Left | App. Total | Right                | Thru | Left | App. Total |            |      |
| Peak Hour Analysis From 04:00 PM to 05:45 PM - Peak 1 of 1 |                    |      |      |            |                      |      |      |            |                     |      |      |            |                      |      |      |            |            |      |
| Peak Hour for Entire Intersection Begins at 04:45 PM       |                    |      |      |            |                      |      |      |            |                     |      |      |            |                      |      |      |            |            |      |
| 04:45 PM   | 7                  | 0    | 0    | 7          | 1                    | 30   | 0    | 31         | 0                   | 0    | 0    | 0          | 0                    | 0    | 86   | 11         | 97         | 135  |
| 05:00 PM   | 7                  | 0    | 0    | 7          | 0                    | 27   | 0    | 27         | 0                   | 0    | 0    | 0          | 0                    | 0    | 86   | 8          | 94         | 128  |
| 05:15 PM   | 6                  | 0    | 0    | 6          | 0                    | 29   | 0    | 29         | 0                   | 0    | 0    | 0          | 0                    | 0    | 100  | 2          | 102        | 137  |
| 05:30 PM   | 4                  | 0    | 0    | 4          | 0                    | 30   | 0    | 30         | 0                   | 0    | 0    | 0          | 0                    | 0    | 81   | 9          | 90         | 124  |
| Total Volume   | 24                 | 0    | 0    | 24         | 1                    | 116  | 0    | 117        | 0                   | 0    | 0    | 0          | 0                    | 0    | 353  | 30         | 383        | 524  |
| % App. Total   | 100                | 0    | 0    |            | 0.9                  | 99.1 | 0    |            | 0                   | 0    | 0    | 0          | 0                    | 0    | 92.2 | 7.8        |            |      |
| PHF  | .857               | .000 | .000 | .857       | .250                 | .967 | .000 | .944       | .000                | .000 | .000 | .000       | .000                 | .000 | .883 | .682       | .939       | .956 |

# Traffic Data Service

San Jose, CA  
 (408) 622-4787  
 tdsbay@cs.com

File Name : 16PM FINAL  
 Site Code : 00000016  
 Start Date : 4/25/2018  
 Page No : 2

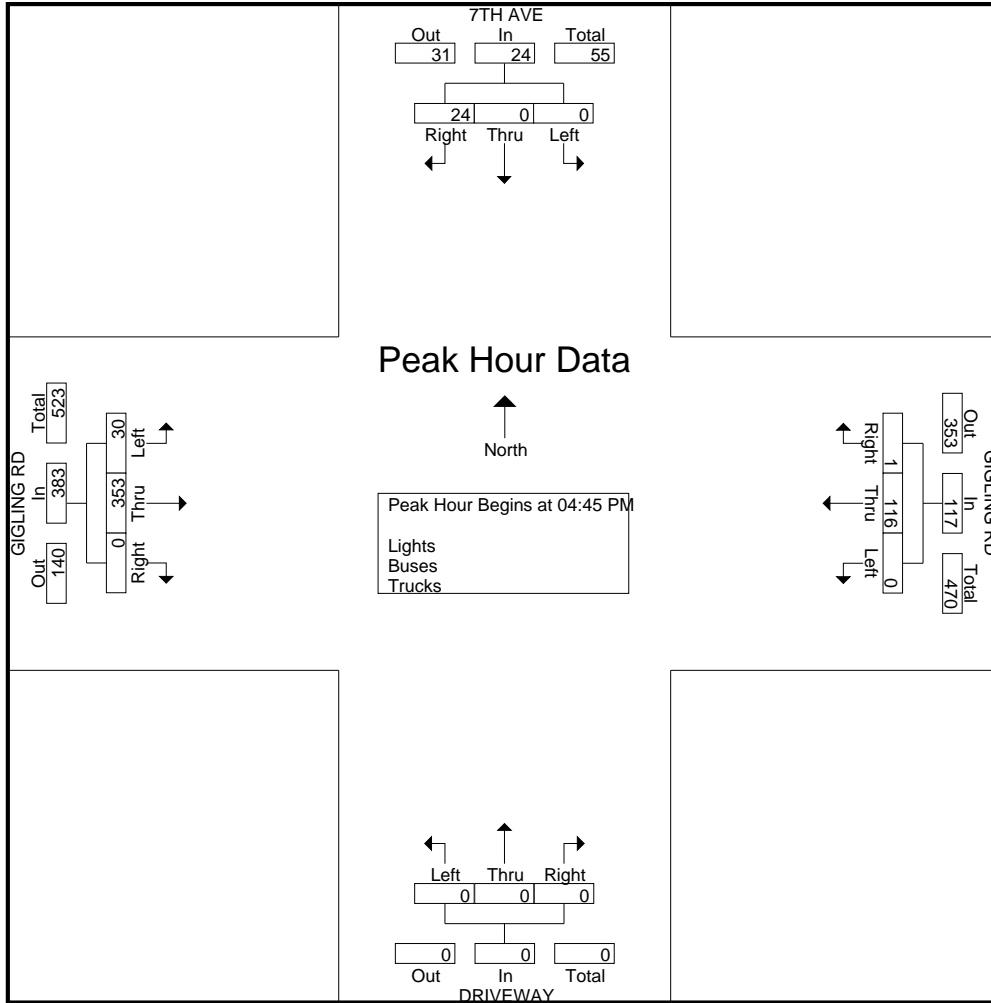

# Traffic Data Service

San Jose, CA  
 (408) 622-4787  
 tdsbay@cs.com

File Name : 16PM FINAL  
 Site Code : 00000016  
 Start Date : 4/25/2018  
 Page No : 1

Groups Printed- Bikes

| Start Time  | 7TH AVE Southbound |      |      |      |            | GIGLING RD Westbound |      |      |      |            | DRIVEWAY Northbound |      |      |      |            | GIGLING RD Eastbound |      |      |      |            | Int. Total |
|-------------|--------------------|------|------|------|------------|----------------------|------|------|------|------------|---------------------|------|------|------|------------|----------------------|------|------|------|------------|------------|
|             | Right              | Thru | Left | Peds | App. Total | Right                | Thru | Left | Peds | App. Total | Right               | Thru | Left | Peds | App. Total | Right                | Thru | Left | Peds | App. Total |            |
| 04:00 PM    | 0                  | 0    | 0    | 0    | 0          | 0                    | 0    | 0    | 0    | 0          | 0                   | 0    | 0    | 0    | 0          | 0                    | 0    | 0    | 0    | 0          | 0          |
| 04:15 PM    | 0                  | 0    | 0    | 0    | 0          | 1                    | 0    | 0    | 0    | 1          | 0                   | 0    | 0    | 0    | 0          | 0                    | 0    | 0    | 0    | 0          | 0          |
| 04:30 PM    | 0                  | 0    | 1    | 0    | 1          | 0                    | 0    | 0    | 0    | 0          | 0                   | 0    | 0    | 0    | 0          | 0                    | 0    | 0    | 0    | 0          | 0          |
| 04:45 PM    | 0                  | 0    | 0    | 0    | 0          | 1                    | 0    | 0    | 0    | 1          | 0                   | 0    | 0    | 0    | 0          | 0                    | 0    | 0    | 0    | 0          | 0          |
| Total       | 0                  | 0    | 1    | 0    | 1          | 2                    | 0    | 0    | 0    | 2          | 0                   | 0    | 0    | 0    | 0          | 0                    | 0    | 0    | 0    | 0          | 3          |
| 05:00 PM    | 0                  | 0    | 0    | 0    | 0          | 0                    | 0    | 0    | 0    | 0          | 0                   | 0    | 0    | 0    | 0          | 0                    | 0    | 0    | 0    | 0          | 0          |
| 05:15 PM    | 0                  | 0    | 0    | 0    | 0          | 0                    | 0    | 0    | 0    | 0          | 0                   | 0    | 0    | 0    | 0          | 0                    | 0    | 1    | 0    | 1          | 1          |
| 05:30 PM    | 0                  | 0    | 0    | 0    | 0          | 0                    | 0    | 0    | 0    | 0          | 0                   | 0    | 0    | 0    | 0          | 0                    | 0    | 0    | 0    | 0          | 0          |
| 05:45 PM    | 0                  | 0    | 0    | 0    | 0          | 0                    | 0    | 0    | 0    | 0          | 0                   | 0    | 0    | 0    | 0          | 0                    | 0    | 0    | 0    | 0          | 0          |
| Total       | 0                  | 0    | 0    | 0    | 0          | 0                    | 0    | 0    | 0    | 0          | 0                   | 0    | 0    | 0    | 0          | 0                    | 0    | 1    | 0    | 1          | 1          |
| Grand Total | 0                  | 0    | 1    | 0    | 1          | 2                    | 0    | 0    | 0    | 2          | 0                   | 0    | 0    | 0    | 0          | 0                    | 0    | 1    | 0    | 1          | 4          |
| Apprch %    | 0                  | 0    | 100  | 0    |            | 100                  | 0    | 0    | 0    |            | 0                   | 0    | 0    | 0    |            | 0                    | 0    | 100  | 0    |            |            |
| Total %     | 0                  | 0    | 25   | 0    | 25         | 50                   | 0    | 0    | 0    | 50         | 0                   | 0    | 0    | 0    | 0          | 0                    | 0    | 25   | 0    | 25         |            |

| Start Time   | 7TH AVE Southbound |      |      |      |            | GIGLING RD Westbound |      |      |      |            | DRIVEWAY Northbound |      |      |      |            | GIGLING RD Eastbound |      |      |      |            | Int. Total |
|--------------|--------------------|------|------|------|------------|----------------------|------|------|------|------------|---------------------|------|------|------|------------|----------------------|------|------|------|------------|------------|
|              | Right              | Thru | Left | Peds | App. Total | Right                | Thru | Left | Peds | App. Total | Right               | Thru | Left | Peds | App. Total | Right                | Thru | Left | Peds | App. Total |            |
| 04:00 PM     | 0                  | 0    | 0    | 0    | 0          | 0                    | 0    | 0    | 0    | 0          | 0                   | 0    | 0    | 0    | 0          | 0                    | 0    | 0    | 0    | 0          | 0          |
| 04:15 PM     | 0                  | 0    | 0    | 0    | 0          | 1                    | 0    | 0    | 0    | 1          | 0                   | 0    | 0    | 0    | 0          | 0                    | 0    | 0    | 0    | 0          | 1          |
| 04:30 PM     | 0                  | 0    | 1    | 0    | 1          | 0                    | 0    | 0    | 0    | 0          | 0                   | 0    | 0    | 0    | 0          | 0                    | 0    | 0    | 0    | 0          | 1          |
| 04:45 PM     | 0                  | 0    | 0    | 0    | 0          | 1                    | 0    | 0    | 0    | 1          | 0                   | 0    | 0    | 0    | 0          | 0                    | 0    | 0    | 0    | 0          | 1          |
| Total Volume | 0                  | 0    | 1    | 0    | 1          | 2                    | 0    | 0    | 0    | 2          | 0                   | 0    | 0    | 0    | 0          | 0                    | 0    | 0    | 0    | 0          | 3          |
| % App. Total | 0                  | 0    | 100  | 0    |            | 100                  | 0    | 0    | 0    |            | 0                   | 0    | 0    | 0    |            | 0                    | 0    | 0    | 0    |            |            |
| PHF          | .000               | .000 | .250 | 0    | .250       | .500                 | .000 | .000 | 0    | .500       | .000                | .000 | .000 | 0    | .000       | .000                 | .000 | .000 | 0    | .000       | .750       |

Peak Hour Analysis From 04:00 PM to 05:45 PM - Peak 1 of 1  
 Peak Hour for Entire Intersection Begins at 04:00 PM

# Traffic Data Service

San Jose, CA  
(408) 622-4787  
tdsbay@cs.com

File Name : 16PM FINAL  
Site Code : 00000016  
Start Date : 4/25/2018  
Page No : 2

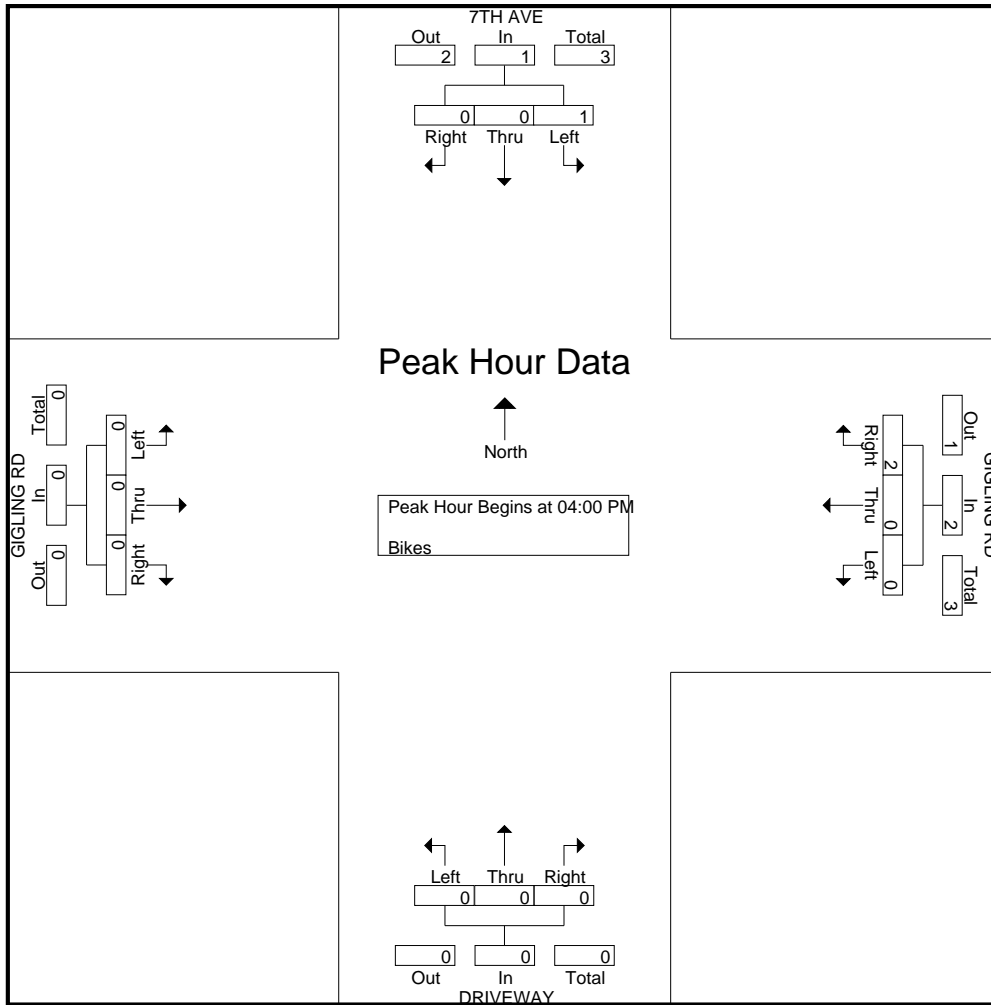



# Traffic Data Service

San Jose, CA  
 (408) 622-4787  
 tdsbay@cs.com

File Name : 17AM FINAL  
 Site Code : 00000017  
 Start Date : 4/25/2018  
 Page No : 1

Groups Printed- Lights - Buses - Trucks

| Start Time   | 8TH AVE Southbound |          |          |          |            | GIGLING RD Westbound |          |          |          |            | 8TH AVE Northbound |          |          |          |            | GIGLING RD Eastbound |           |          |            |            | Int. Total |
|--------------|--------------------|----------|----------|----------|------------|----------------------|----------|----------|----------|------------|--------------------|----------|----------|----------|------------|----------------------|-----------|----------|------------|------------|------------|
|              | Right              | Thru     | Left     | Peds     | App. Total | Right                | Thru     | Left     | Peds     | App. Total | Right              | Thru     | Left     | Peds     | App. Total | Right                | Thru      | Left     | Peds       | App. Total |            |
| 07:00 AM     | 78                 | 0        | 1        | 0        | 79         | 0                    | 0        | 0        | 0        | 0          | 0                  | 0        | 0        | 0        | 0          | 4                    | 1         | 15       | 0          | 20         | 99         |
| 07:15 AM     | 125                | 0        | 0        | 0        | 125        | 0                    | 0        | 0        | 0        | 0          | 0                  | 0        | 0        | 0        | 0          | 6                    | 1         | 19       | 0          | 26         | 151        |
| 07:30 AM     | 107                | 1        | 0        | 0        | 108        | 0                    | 0        | 0        | 0        | 0          | 0                  | 0        | 1        | 1        | 2          | 0                    | 26        | 0        | 28         | 137        |            |
| 07:45 AM     | 98                 | 2        | 0        | 0        | 100        | 0                    | 0        | 0        | 0        | 0          | 0                  | 0        | 0        | 0        | 1          | 0                    | 28        | 0        | 29         | 129        |            |
| <b>Total</b> | <b>408</b>         | <b>3</b> | <b>1</b> | <b>0</b> | <b>412</b> | <b>0</b>             | <b>0</b> | <b>0</b> | <b>0</b> | <b>0</b>   | <b>0</b>           | <b>0</b> | <b>1</b> | <b>1</b> | <b>13</b>  | <b>2</b>             | <b>88</b> | <b>0</b> | <b>103</b> | <b>516</b> |            |
| 08:00 AM     | 51                 | 0        | 0        | 1        | 52         | 0                    | 0        | 0        | 0        | 0          | 0                  | 0        | 0        | 0        | 0          | 0                    | 0         | 27       | 0          | 27         | 79         |
| 08:15 AM     | 55                 | 0        | 0        | 0        | 55         | 0                    | 0        | 0        | 0        | 0          | 0                  | 0        | 0        | 0        | 0          | 0                    | 1         | 26       | 0          | 27         | 82         |
| 08:30 AM     | 42                 | 1        | 1        | 0        | 44         | 0                    | 0        | 0        | 0        | 0          | 0                  | 0        | 0        | 0        | 1          | 0                    | 19        | 0        | 20         | 64         |            |
| 08:45 AM     | 28                 | 1        | 0        | 0        | 29         | 0                    | 0        | 0        | 0        | 0          | 0                  | 0        | 1        | 1        | 0          | 0                    | 13        | 0        | 13         | 43         |            |
| <b>Total</b> | <b>176</b>         | <b>2</b> | <b>1</b> | <b>1</b> | <b>180</b> | <b>0</b>             | <b>0</b> | <b>0</b> | <b>0</b> | <b>0</b>   | <b>0</b>           | <b>0</b> | <b>1</b> | <b>1</b> | <b>1</b>   | <b>1</b>             | <b>85</b> | <b>0</b> | <b>87</b>  | <b>268</b> |            |
| Grand Total  | 584                | 5        | 2        | 1        | 592        | 0                    | 0        | 0        | 0        | 0          | 0                  | 0        | 2        | 2        | 14         | 3                    | 173       | 0        | 190        | 784        |            |
| Apprch %     | 98.6               | 0.8      | 0.3      | 0.2      |            | 0                    | 0        | 0        | 0        | 0          | 0                  | 100      | 0        |          | 7.4        | 1.6                  | 91.1      | 0        |            |            |            |
| Total %      | 74.5               | 0.6      | 0.3      | 0.1      | 75.5       | 0                    | 0        | 0        | 0        | 0          | 0                  | 0.3      | 0        | 0.3      | 1.8        | 0.4                  | 22.1      | 0        | 24.2       |            |            |
| Lights       | 581                | 5        | 2        | 1        | 589        | 0                    | 0        | 0        | 0        | 0          | 0                  | 2        | 0        | 2        | 14         | 2                    | 165       | 0        | 181        | 772        |            |
| % Lights     | 99.5               | 100      | 100      | 100      | 99.5       | 0                    | 0        | 0        | 0        | 0          | 0                  | 100      | 0        | 100      | 100        | 66.7                 | 95.4      | 0        | 95.3       | 98.5       |            |
| Buses        | 2                  | 0        | 0        | 0        | 2          | 0                    | 0        | 0        | 0        | 0          | 0                  | 0        | 0        | 0        | 0          | 0                    | 6         | 0        | 6          | 8          |            |
| % Buses      | 0.3                | 0        | 0        | 0        | 0.3        | 0                    | 0        | 0        | 0        | 0          | 0                  | 0        | 0        | 0        | 0          | 0                    | 3.5       | 0        | 3.2        | 1          |            |
| Trucks       | 1                  | 0        | 0        | 0        | 1          | 0                    | 0        | 0        | 0        | 0          | 0                  | 0        | 0        | 0        | 0          | 1                    | 2         | 0        | 3          | 4          |            |
| % Trucks     | 0.2                | 0        | 0        | 0        | 0.2        | 0                    | 0        | 0        | 0        | 0          | 0                  | 0        | 0        | 0        | 0          | 33.3                 | 1.2       | 0        | 1.6        | 0.5        |            |

| Start Time   | 8TH AVE Southbound |      |      |            | GIGLING RD Westbound |      |      |            | 8TH AVE Northbound |      |      |            | GIGLING RD Eastbound |      |      |            | Int. Total |     |
|--|--------------------|------|------|------------|----------------------|------|------|------------|--------------------|------|------|------------|----------------------|------|------|------------|------------|-----|
|  | Right              | Thru | Left | App. Total | Right                | Thru | Left | App. Total | Right              | Thru | Left | App. Total | Right                | Thru | Left | App. Total |            |     |
| Peak Hour Analysis From 07:00 AM to 08:45 AM - Peak 1 of 1 |                    |      |      |            |                      |      |      |            |                    |      |      |            |                      |      |      |            |            |     |
| Peak Hour for Entire Intersection Begins at 07:00 AM       |                    |      |      |            |                      |      |      |            |                    |      |      |            |                      |      |      |            |            |     |
| 07:00 AM   | 78                 | 0    | 1    | 79         | 0                    | 0    | 0    | 0          | 0                  | 0    | 0    | 0          | 0                    | 4    | 1    | 15         | 20         | 99  |
| 07:15 AM   | 125                | 0    | 0    | 125        | 0                    | 0    | 0    | 0          | 0                  | 0    | 0    | 0          | 0                    | 6    | 1    | 19         | 26         | 151 |
| 07:30 AM   | 107                | 1    | 0    | 108        | 0                    | 0    | 0    | 0          | 0                  | 0    | 1    | 1          | 2                    | 0    | 26   | 28         | 137        |     |
| 07:45 AM   | 98                 | 2    | 0    | 100        | 0                    | 0    | 0    | 0          | 0                  | 0    | 0    | 0          | 1                    | 0    | 28   | 29         | 129        |     |
| Total Volume   | 408                | 3    | 1    | 412        | 0                    | 0    | 0    | 0          | 0                  | 0    | 1    | 1          | 13                   | 2    | 88   | 103        | 516        |     |
| % App. Total   | 99                 | 0.7  | 0.2  |            | 0                    | 0    | 0    |            | 0                  | 0    | 100  |            | 12.6                 | 1.9  | 85.4 |            |            |     |
| PHF  | .816               | .375 | .250 | .824       | .000                 | .000 | .000 | .000       | .000               | .000 | .250 | .250       | .542                 | .500 | .786 | .888       | .854       |     |

# Traffic Data Service

San Jose, CA  
 (408) 622-4787  
 tdsbay@cs.com

File Name : 17AM FINAL  
 Site Code : 00000017  
 Start Date : 4/25/2018  
 Page No : 2

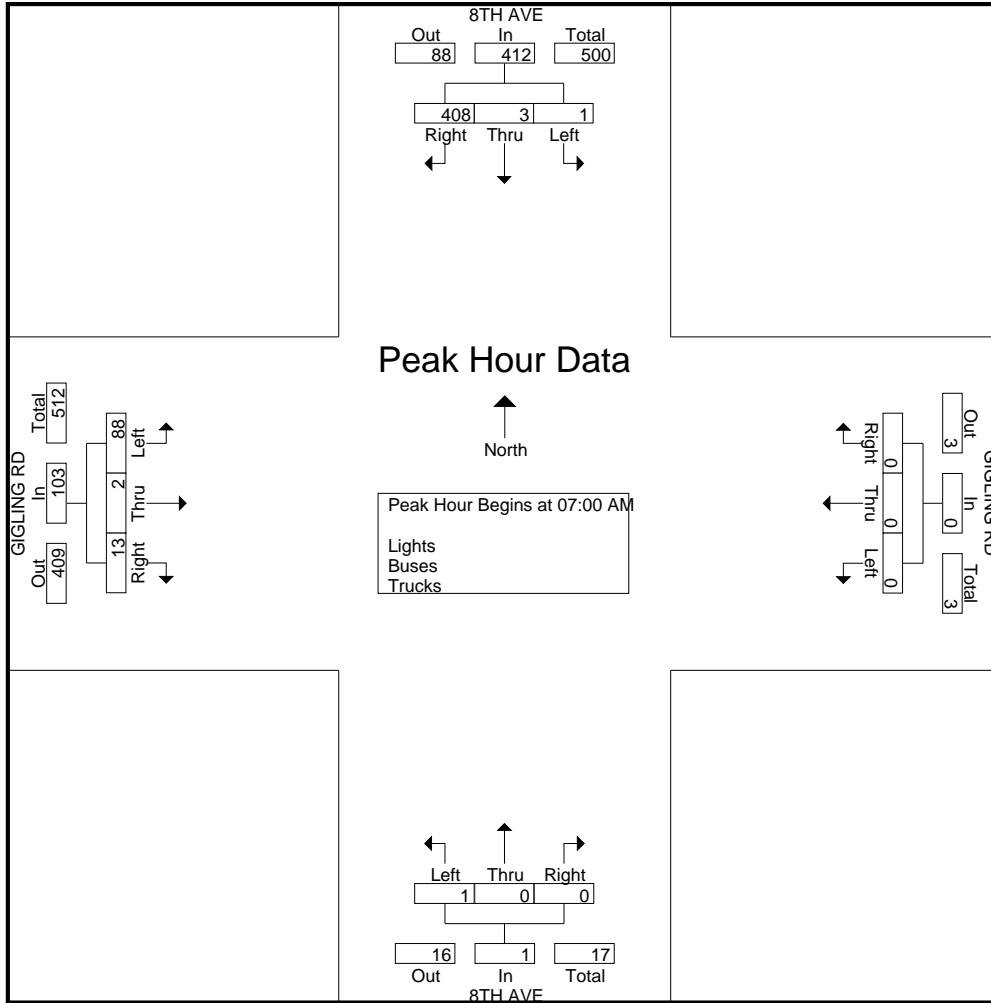

# Traffic Data Service

San Jose, CA  
 (408) 622-4787  
 tdsbay@cs.com

File Name : 17AM FINAL  
 Site Code : 00000017  
 Start Date : 4/25/2018  
 Page No : 1

Groups Printed- Bikes

| Start Time   | 8TH AVE Southbound |          |          |          |            | GIGLING RD Westbound |          |          |          |            | 8TH AVE Northbound |          |          |          |            | GIGLING RD Eastbound |          |          |          |            | Int. Total |
|--------------|--------------------|----------|----------|----------|------------|----------------------|----------|----------|----------|------------|--------------------|----------|----------|----------|------------|----------------------|----------|----------|----------|------------|------------|
|              | Right              | Thru     | Left     | Peds     | App. Total | Right                | Thru     | Left     | Peds     | App. Total | Right              | Thru     | Left     | Peds     | App. Total | Right                | Thru     | Left     | Peds     | App. Total |            |
| 07:00 AM     | 0                  | 0        | 0        | 0        | 0          | 0                    | 0        | 0        | 0        | 0          | 0                  | 0        | 0        | 0        | 0          | 0                    | 2        | 0        | 0        | 0          | 2          |
| 07:15 AM     | 0                  | 0        | 0        | 0        | 0          | 0                    | 0        | 0        | 0        | 0          | 0                  | 0        | 0        | 0        | 0          | 0                    | 0        | 0        | 0        | 0          | 0          |
| 07:30 AM     | 1                  | 0        | 0        | 0        | 1          | 0                    | 0        | 0        | 0        | 0          | 0                  | 0        | 0        | 0        | 0          | 0                    | 0        | 0        | 0        | 0          | 0          |
| 07:45 AM     | 0                  | 0        | 0        | 0        | 0          | 0                    | 0        | 0        | 0        | 0          | 0                  | 0        | 0        | 0        | 0          | 0                    | 0        | 0        | 0        | 0          | 0          |
| <b>Total</b> | <b>1</b>           | <b>0</b> | <b>0</b> | <b>0</b> | <b>1</b>   | <b>0</b>             | <b>0</b> | <b>0</b> | <b>0</b> | <b>0</b>   | <b>0</b>           | <b>0</b> | <b>0</b> | <b>0</b> | <b>0</b>   | <b>0</b>             | <b>2</b> | <b>0</b> | <b>0</b> | <b>2</b>   | <b>3</b>   |
| 08:00 AM     | 0                  | 0        | 0        | 0        | 0          | 0                    | 0        | 0        | 0        | 0          | 0                  | 0        | 1        | 0        | 1          | 0                    | 0        | 0        | 0        | 0          | 0          |
| 08:15 AM     | 0                  | 0        | 0        | 0        | 0          | 0                    | 0        | 0        | 0        | 0          | 0                  | 0        | 0        | 0        | 0          | 2                    | 0        | 0        | 0        | 0          | 2          |
| 08:30 AM     | 0                  | 0        | 0        | 0        | 0          | 0                    | 0        | 0        | 0        | 0          | 0                  | 0        | 0        | 0        | 0          | 0                    | 0        | 0        | 0        | 0          | 0          |
| 08:45 AM     | 0                  | 0        | 0        | 0        | 0          | 0                    | 0        | 0        | 0        | 0          | 0                  | 0        | 0        | 0        | 0          | 0                    | 0        | 0        | 0        | 0          | 0          |
| <b>Total</b> | <b>0</b>           | <b>0</b> | <b>0</b> | <b>0</b> | <b>0</b>   | <b>0</b>             | <b>0</b> | <b>0</b> | <b>0</b> | <b>0</b>   | <b>0</b>           | <b>0</b> | <b>1</b> | <b>0</b> | <b>1</b>   | <b>2</b>             | <b>0</b> | <b>0</b> | <b>0</b> | <b>2</b>   | <b>3</b>   |
| Grand Total  | 1                  | 0        | 0        | 0        | 1          | 0                    | 0        | 0        | 0        | 0          | 0                  | 0        | 1        | 0        | 1          | 2                    | 2        | 0        | 0        | 4          | 6          |
| Apprch %     | 100                | 0        | 0        | 0        |            | 0                    | 0        | 0        | 0        |            | 0                  | 0        | 100      | 0        |            | 50                   | 50       | 0        | 0        |            |            |
| Total %      | 16.7               | 0        | 0        | 0        | 16.7       | 0                    | 0        | 0        | 0        | 0          | 0                  | 0        | 16.7     | 0        | 16.7       | 33.3                 | 33.3     | 0        | 0        | 66.7       |            |

| Start Time   | 8TH AVE Southbound |      |      |      |            | GIGLING RD Westbound |      |      |      |            | 8TH AVE Northbound |      |      |      |            | GIGLING RD Eastbound |      |      |      |            | Int. Total |
|--------------|--------------------|------|------|------|------------|----------------------|------|------|------|------------|--------------------|------|------|------|------------|----------------------|------|------|------|------------|------------|
|              | Right              | Thru | Left | Peds | App. Total | Right                | Thru | Left | Peds | App. Total | Right              | Thru | Left | Peds | App. Total | Right                | Thru | Left | Peds | App. Total |            |
| 07:30 AM     | 1                  | 0    | 0    | 0    | 1          | 0                    | 0    | 0    | 0    | 0          | 0                  | 0    | 0    | 0    | 0          | 0                    | 0    | 0    | 0    | 0          | 0          |
| 07:45 AM     | 0                  | 0    | 0    | 0    | 0          | 0                    | 0    | 0    | 0    | 0          | 0                  | 0    | 0    | 0    | 0          | 0                    | 0    | 0    | 0    | 0          | 0          |
| 08:00 AM     | 0                  | 0    | 0    | 0    | 0          | 0                    | 0    | 0    | 0    | 0          | 0                  | 0    | 0    | 1    | 1          | 0                    | 0    | 0    | 0    | 0          | 0          |
| 08:15 AM     | 0                  | 0    | 0    | 0    | 0          | 0                    | 0    | 0    | 0    | 0          | 0                  | 0    | 0    | 0    | 0          | 2                    | 0    | 0    | 0    | 2          | 2          |
| Total Volume | 1                  | 0    | 0    | 0    | 1          | 0                    | 0    | 0    | 0    | 0          | 0                  | 0    | 1    | 0    | 1          | 2                    | 0    | 0    | 0    | 2          | 4          |
| % App. Total | 100                | 0    | 0    | 0    |            | 0                    | 0    | 0    | 0    |            | 0                  | 0    | 100  | 0    |            | 100                  | 0    | 0    | 0    |            |            |
| PHF          | .250               | .000 | .000 | .000 | .250       | .000                 | .000 | .000 | .000 | .000       | .000               | .000 | .250 | .250 | .250       | .000                 | .000 | .000 | .250 | .500       |            |

Peak Hour Analysis From 07:00 AM to 08:45 AM - Peak 1 of 1  
 Peak Hour for Entire Intersection Begins at 07:30 AM

# Traffic Data Service

San Jose, CA  
 (408) 622-4787  
 tdsbay@cs.com

File Name : 17AM FINAL  
 Site Code : 00000017  
 Start Date : 4/25/2018  
 Page No : 2

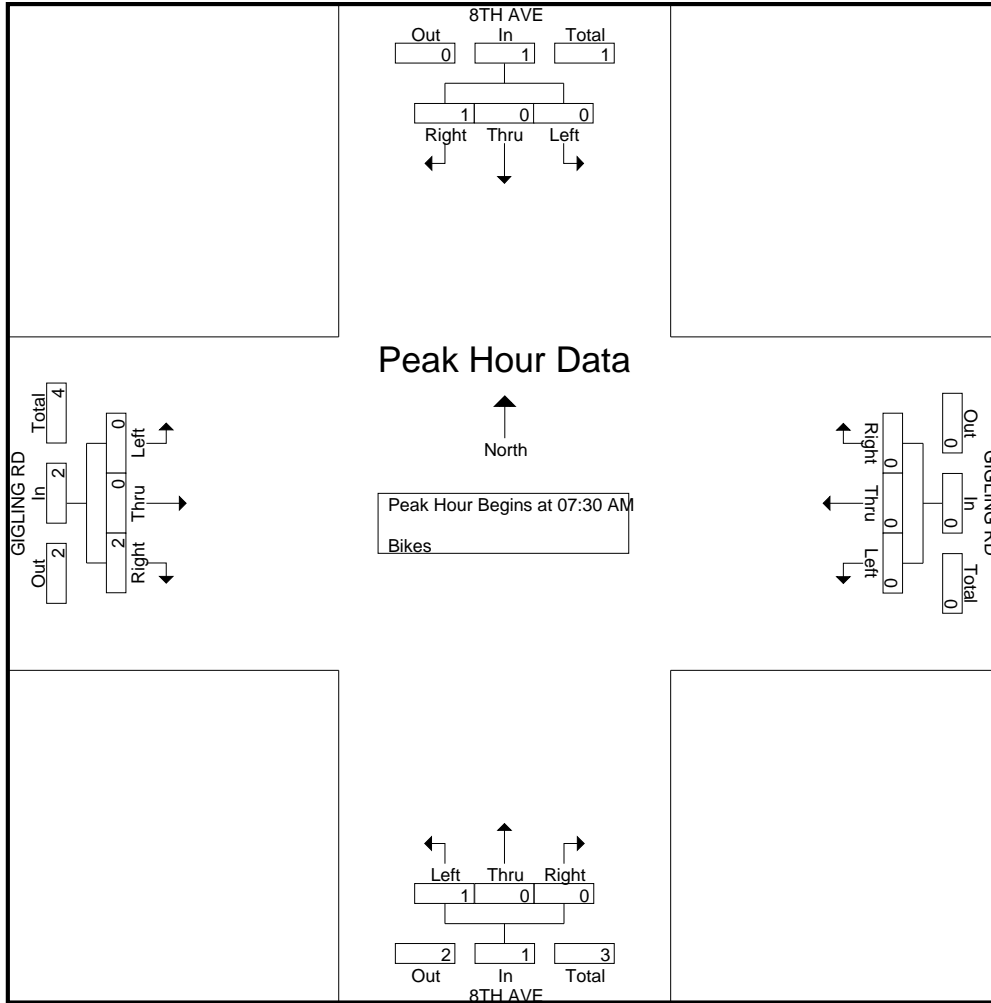

# Traffic Data Service

San Jose, CA  
 (408) 622-4787  
 tdsbay@cs.com

File Name : 17PM FINAL  
 Site Code : 00000017  
 Start Date : 4/25/2018  
 Page No : 1

Groups Printed- Lights - Buses - Trucks

| Start Time   | 8TH AVE Southbound |          |          |          |            | GIGLING RD Westbound |          |          |          |            | 8TH AVE Northbound |           |          |          |            | GIGLING RD Eastbound |          |            |          |            | Int. Total |
|--------------|--------------------|----------|----------|----------|------------|----------------------|----------|----------|----------|------------|--------------------|-----------|----------|----------|------------|----------------------|----------|------------|----------|------------|------------|
|              | Right              | Thru     | Left     | Peds     | App. Total | Right                | Thru     | Left     | Peds     | App. Total | Right              | Thru      | Left     | Peds     | App. Total | Right                | Thru     | Left       | Peds     | App. Total |            |
| 04:00 PM     | 28                 | 1        | 0        | 0        | 29         | 0                    | 0        | 0        | 0        | 0          | 1                  | 5         | 1        | 0        | 7          | 0                    | 0        | 60         | 0        | 60         | 96         |
| 04:15 PM     | 14                 | 0        | 0        | 0        | 14         | 0                    | 0        | 0        | 0        | 0          | 0                  | 17        | 1        | 0        | 18         | 0                    | 0        | 59         | 0        | 59         | 91         |
| 04:30 PM     | 24                 | 0        | 0        | 0        | 24         | 0                    | 0        | 0        | 0        | 0          | 0                  | 1         | 0        | 0        | 1          | 0                    | 0        | 74         | 0        | 74         | 99         |
| 04:45 PM     | 30                 | 0        | 0        | 0        | 30         | 0                    | 0        | 0        | 0        | 0          | 0                  | 0         | 1        | 0        | 1          | 0                    | 0        | 83         | 0        | 83         | 114        |
| <b>Total</b> | <b>96</b>          | <b>1</b> | <b>0</b> | <b>0</b> | <b>97</b>  | <b>0</b>             | <b>0</b> | <b>0</b> | <b>0</b> | <b>0</b>   | <b>1</b>           | <b>23</b> | <b>3</b> | <b>0</b> | <b>27</b>  | <b>0</b>             | <b>0</b> | <b>276</b> | <b>0</b> | <b>276</b> | <b>400</b> |
| 05:00 PM     | 26                 | 0        | 0        | 0        | 26         | 0                    | 0        | 0        | 0        | 0          | 0                  | 0         | 1        | 0        | 1          | 1                    | 0        | 81         | 0        | 82         | 109        |
| 05:15 PM     | 27                 | 0        | 0        | 0        | 27         | 0                    | 0        | 0        | 1        | 1          | 0                  | 0         | 0        | 0        | 0          | 2                    | 0        | 98         | 0        | 100        | 128        |
| 05:30 PM     | 31                 | 0        | 0        | 0        | 31         | 0                    | 0        | 0        | 0        | 0          | 0                  | 0         | 0        | 0        | 0          | 2                    | 0        | 78         | 0        | 80         | 111        |
| 05:45 PM     | 23                 | 0        | 0        | 0        | 23         | 0                    | 0        | 0        | 0        | 0          | 0                  | 0         | 2        | 0        | 2          | 1                    | 0        | 54         | 0        | 55         | 80         |
| <b>Total</b> | <b>107</b>         | <b>0</b> | <b>0</b> | <b>0</b> | <b>107</b> | <b>0</b>             | <b>0</b> | <b>0</b> | <b>1</b> | <b>1</b>   | <b>0</b>           | <b>0</b>  | <b>3</b> | <b>0</b> | <b>3</b>   | <b>6</b>             | <b>0</b> | <b>311</b> | <b>0</b> | <b>317</b> | <b>428</b> |
| Grand Total  | 203                | 1        | 0        | 0        | 204        | 0                    | 0        | 0        | 1        | 1          | 1                  | 23        | 6        | 0        | 30         | 6                    | 0        | 587        | 0        | 593        | 828        |
| Apprch %     | 99.5               | 0.5      | 0        | 0        |            | 0                    | 0        | 0        | 100      |            | 3.3                | 76.7      | 20       | 0        |            | 1                    | 0        | 99         | 0        |            |            |
| Total %      | 24.5               | 0.1      | 0        | 0        | 24.6       | 0                    | 0        | 0        | 0.1      | 0.1        | 0.1                | 2.8       | 0.7      | 0        | 3.6        | 0.7                  | 0        | 70.9       | 0        | 71.6       |            |
| Lights       | 200                | 1        | 0        | 0        | 201        | 0                    | 0        | 0        | 1        | 1          | 1                  | 23        | 6        | 0        | 30         | 6                    | 0        | 575        | 0        | 581        | 813        |
| % Lights     | 98.5               | 100      | 0        | 0        | 98.5       | 0                    | 0        | 0        | 100      | 100        | 100                | 100       | 100      | 0        | 100        | 100                  | 0        | 98         | 0        | 98         | 98.2       |
| Buses        | 2                  | 0        | 0        | 0        | 2          | 0                    | 0        | 0        | 0        | 0          | 0                  | 0         | 0        | 0        | 0          | 0                    | 0        | 7          | 0        | 7          | 9          |
| % Buses      | 1                  | 0        | 0        | 0        | 1          | 0                    | 0        | 0        | 0        | 0          | 0                  | 0         | 0        | 0        | 0          | 0                    | 0        | 1.2        | 0        | 1.2        | 1.1        |
| Trucks       | 1                  | 0        | 0        | 0        | 1          | 0                    | 0        | 0        | 0        | 0          | 0                  | 0         | 0        | 0        | 0          | 0                    | 0        | 5          | 0        | 5          | 6          |
| % Trucks     | 0.5                | 0        | 0        | 0        | 0.5        | 0                    | 0        | 0        | 0        | 0          | 0                  | 0         | 0        | 0        | 0          | 0                    | 0        | 0.9        | 0        | 0.8        | 0.7        |

| Start Time   | 8TH AVE Southbound |      |      |            | GIGLING RD Westbound |      |      |            | 8TH AVE Northbound |      |      |            | GIGLING RD Eastbound |      |      |            | Int. Total |      |
|--|--------------------|------|------|------------|----------------------|------|------|------------|--------------------|------|------|------------|----------------------|------|------|------------|------------|------|
|  | Right              | Thru | Left | App. Total | Right                | Thru | Left | App. Total | Right              | Thru | Left | App. Total | Right                | Thru | Left | App. Total |            |      |
| Peak Hour Analysis From 04:00 PM to 05:45 PM - Peak 1 of 1 |                    |      |      |            |                      |      |      |            |                    |      |      |            |                      |      |      |            |            |      |
| Peak Hour for Entire Intersection Begins at 04:45 PM       |                    |      |      |            |                      |      |      |            |                    |      |      |            |                      |      |      |            |            |      |
| 04:45 PM   | 30                 | 0    | 0    | 30         | 0                    | 0    | 0    | 0          | 0                  | 0    | 0    | 1          | 1                    | 0    | 0    | 83         | 83         | 114  |
| 05:00 PM   | 26                 | 0    | 0    | 26         | 0                    | 0    | 0    | 0          | 0                  | 0    | 0    | 1          | 1                    | 1    | 0    | 81         | 82         | 109  |
| 05:15 PM   | 27                 | 0    | 0    | 27         | 0                    | 0    | 0    | 0          | 0                  | 0    | 0    | 0          | 0                    | 2    | 0    | 98         | 100        | 127  |
| 05:30 PM   | 31                 | 0    | 0    | 31         | 0                    | 0    | 0    | 0          | 0                  | 0    | 0    | 0          | 0                    | 2    | 0    | 78         | 80         | 111  |
| Total Volume   | 114                | 0    | 0    | 114        | 0                    | 0    | 0    | 0          | 0                  | 0    | 0    | 2          | 2                    | 5    | 0    | 340        | 345        | 461  |
| % App. Total   | 100                | 0    | 0    |            | 0                    | 0    | 0    |            |                    |      | 0    | 100        |                      | 1.4  | 0    | 98.6       |            |      |
| PHF  | .919               | .000 | .000 | .919       | .000                 | .000 | .000 | .000       | .000               | .000 | .000 | .500       | .500                 | .625 | .000 | .867       | .863       | .907 |

# Traffic Data Service

San Jose, CA  
 (408) 622-4787  
 tdsbay@cs.com

File Name : 17PM FINAL  
 Site Code : 00000017  
 Start Date : 4/25/2018  
 Page No : 2

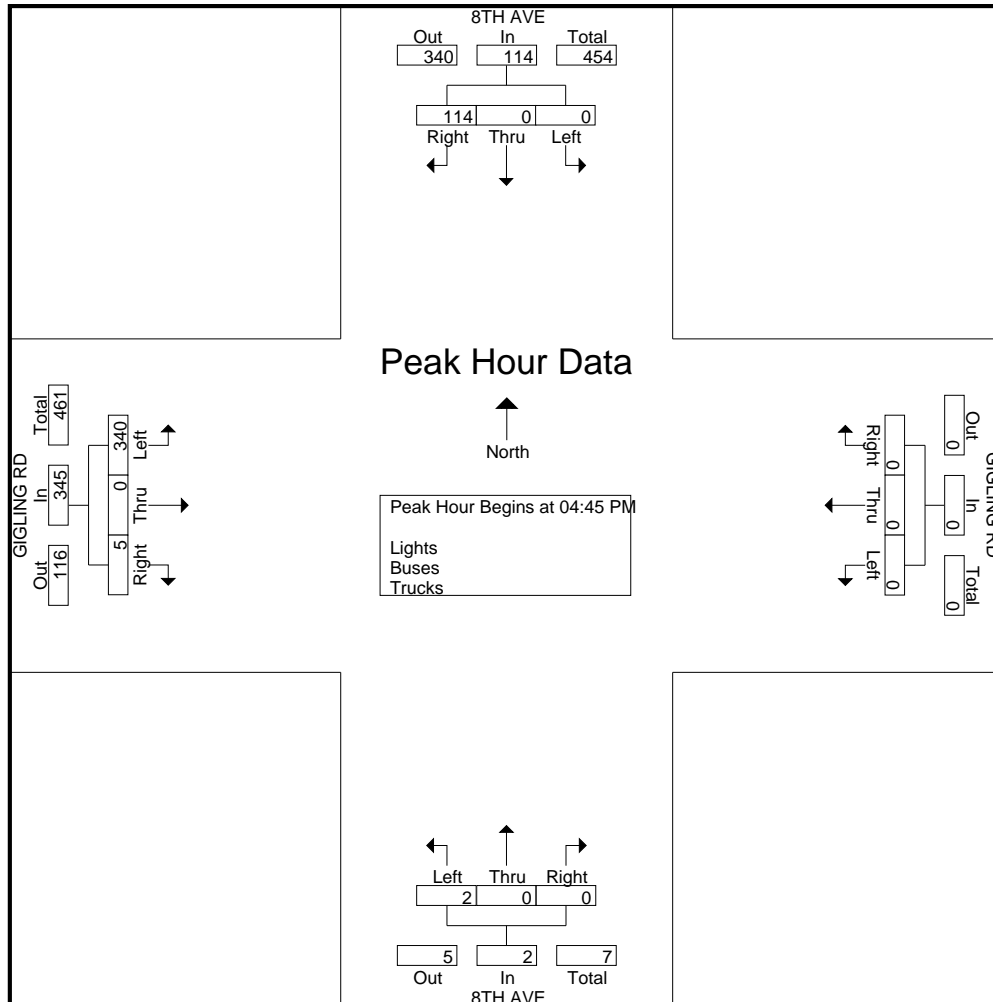

# Traffic Data Service

San Jose, CA  
 (408) 622-4787  
 tdsbay@cs.com

File Name : 17PM FINAL  
 Site Code : 00000017  
 Start Date : 4/25/2018  
 Page No : 1

Groups Printed- Bikes

| Start Time  | 8TH AVE Southbound |      |      |      |            | GIGLING RD Westbound |      |      |      |            | 8TH AVE Northbound |      |      |      |            | GIGLING RD Eastbound |      |      |      |            | Int. Total |
|-------------|--------------------|------|------|------|------------|----------------------|------|------|------|------------|--------------------|------|------|------|------------|----------------------|------|------|------|------------|------------|
|             | Right              | Thru | Left | Peds | App. Total | Right                | Thru | Left | Peds | App. Total | Right              | Thru | Left | Peds | App. Total | Right                | Thru | Left | Peds | App. Total |            |
| 04:00 PM    | 0                  | 0    | 0    | 0    | 0          | 0                    | 0    | 0    | 0    | 0          | 0                  | 0    | 0    | 0    | 0          | 0                    | 0    | 0    | 0    | 0          | 0          |
| 04:15 PM    | 0                  | 0    | 0    | 0    | 0          | 0                    | 0    | 0    | 0    | 0          | 1                  | 0    | 1    | 0    | 2          | 0                    | 0    | 0    | 0    | 0          | 0          |
| 04:30 PM    | 0                  | 0    | 0    | 0    | 0          | 0                    | 0    | 0    | 0    | 0          | 1                  | 0    | 0    | 0    | 1          | 0                    | 0    | 0    | 0    | 0          | 0          |
| 04:45 PM    | 0                  | 0    | 0    | 0    | 0          | 0                    | 0    | 0    | 0    | 0          | 1                  | 0    | 0    | 0    | 1          | 0                    | 0    | 0    | 0    | 0          | 0          |
| Total       | 0                  | 0    | 0    | 0    | 0          | 0                    | 0    | 0    | 0    | 0          | 3                  | 0    | 1    | 0    | 4          | 0                    | 0    | 0    | 0    | 0          | 0          |
| 05:00 PM    | 0                  | 0    | 0    | 0    | 0          | 0                    | 0    | 1    | 0    | 1          | 1                  | 0    | 0    | 0    | 1          | 0                    | 0    | 0    | 0    | 0          | 0          |
| 05:15 PM    | 0                  | 1    | 1    | 0    | 2          | 0                    | 0    | 0    | 0    | 0          | 0                  | 0    | 0    | 0    | 0          | 0                    | 0    | 0    | 0    | 0          | 0          |
| 05:30 PM    | 0                  | 0    | 0    | 0    | 0          | 0                    | 0    | 1    | 0    | 1          | 0                  | 0    | 0    | 1    | 1          | 0                    | 0    | 0    | 0    | 0          | 0          |
| 05:45 PM    | 0                  | 0    | 0    | 0    | 0          | 0                    | 0    | 3    | 0    | 3          | 2                  | 1    | 0    | 0    | 3          | 0                    | 0    | 0    | 0    | 0          | 0          |
| Total       | 0                  | 1    | 1    | 0    | 2          | 0                    | 0    | 5    | 0    | 5          | 3                  | 1    | 0    | 1    | 5          | 0                    | 0    | 0    | 0    | 0          | 0          |
| Grand Total | 0                  | 1    | 1    | 0    | 2          | 0                    | 0    | 5    | 0    | 5          | 6                  | 1    | 1    | 1    | 9          | 0                    | 0    | 0    | 0    | 0          | 0          |
| Apprch %    | 0                  | 50   | 50   | 0    |            | 0                    | 0    | 100  | 0    |            | 66.7               | 11.1 | 11.1 | 11.1 |            | 0                    | 0    | 0    | 0    |            |            |
| Total %     | 0                  | 6.2  | 6.2  | 0    | 12.5       | 0                    | 0    | 31.2 | 0    | 31.2       | 37.5               | 6.2  | 6.2  | 6.2  | 56.2       | 0                    | 0    | 0    | 0    | 0          |            |

| Start Time   | 8TH AVE Southbound |      |      |      |            | GIGLING RD Westbound |      |      |      |            | 8TH AVE Northbound |      |      |      |            | GIGLING RD Eastbound |      |      |      |            | Int. Total |
|--------------|--------------------|------|------|------|------------|----------------------|------|------|------|------------|--------------------|------|------|------|------------|----------------------|------|------|------|------------|------------|
|              | Right              | Thru | Left | Peds | App. Total | Right                | Thru | Left | Peds | App. Total | Right              | Thru | Left | Peds | App. Total | Right                | Thru | Left | Peds | App. Total |            |
| 05:00 PM     | 0                  | 0    | 0    | 0    | 0          | 0                    | 0    | 1    | 0    | 1          | 1                  | 0    | 0    | 0    | 1          | 0                    | 0    | 0    | 0    | 0          | 0          |
| 05:15 PM     | 0                  | 1    | 1    | 0    | 2          | 0                    | 0    | 0    | 0    | 0          | 0                  | 0    | 0    | 0    | 0          | 0                    | 0    | 0    | 0    | 0          | 0          |
| 05:30 PM     | 0                  | 0    | 0    | 0    | 0          | 0                    | 0    | 1    | 0    | 1          | 0                  | 0    | 0    | 0    | 0          | 0                    | 0    | 0    | 0    | 0          | 0          |
| 05:45 PM     | 0                  | 0    | 0    | 0    | 0          | 0                    | 0    | 3    | 0    | 3          | 2                  | 1    | 0    | 0    | 3          | 0                    | 0    | 0    | 0    | 0          | 0          |
| Total Volume | 0                  | 1    | 1    | 0    | 2          | 0                    | 0    | 5    | 0    | 5          | 3                  | 1    | 0    | 0    | 4          | 0                    | 0    | 0    | 0    | 0          | 0          |
| % App. Total | 0                  | 50   | 50   | 0    |            | 0                    | 0    | 100  | 0    |            | 75                 | 25   | 0    | 0    |            | 0                    | 0    | 0    | 0    |            |            |
| PHF          | .000               | .250 | .250 | 0    | .250       | .000                 | .000 | .417 | 0    | .417       | .375               | .250 | .000 | 0    | .333       | .000                 | .000 | .000 | 0    | .000       | .458       |

Peak Hour Analysis From 04:00 PM to 05:45 PM - Peak 1 of 1  
 Peak Hour for Entire Intersection Begins at 05:00 PM

# Traffic Data Service

San Jose, CA  
 (408) 622-4787  
 tdsbay@cs.com

File Name : 17PM FINAL  
 Site Code : 00000017  
 Start Date : 4/25/2018  
 Page No : 2

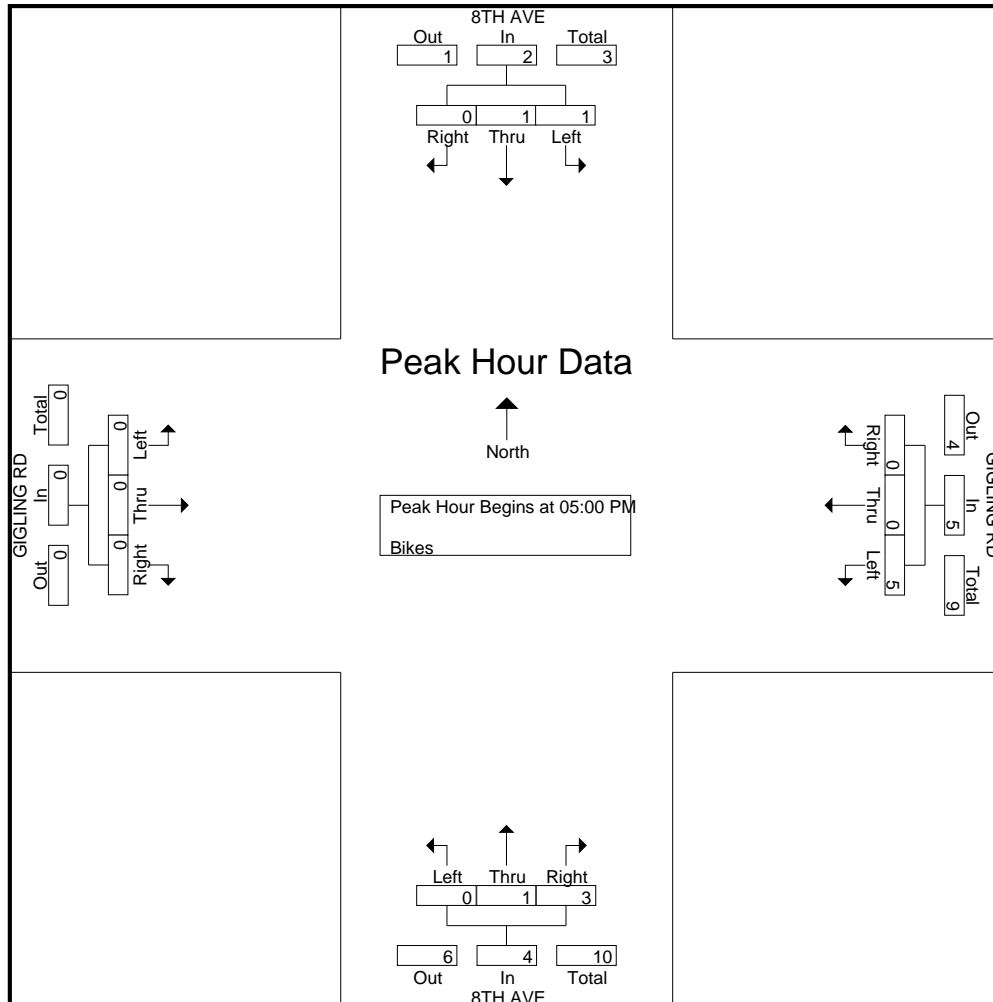



# Traffic Data Service

San Jose, CA  
 (408) 622-4787  
 tdsbay@cs.com

File Name : 18AM FINAL  
 Site Code : 00000018  
 Start Date : 4/25/2018  
 Page No : 1

Groups Printed- Lights - Buses - Trucks

| Start Time  | GENERAL JIM MOORE BLVD Southbound |      |      |      |            | NORMANDY RD Westbound |      |      |      |            | GENERAL JIM MOORE BLVD Northbound |      |      |      |            | NORMANDY RD Eastbound |      |      |      |            | Int. Total |
|-------------|-----------------------------------|------|------|------|------------|-----------------------|------|------|------|------------|-----------------------------------|------|------|------|------------|-----------------------|------|------|------|------------|------------|
|             | Right                             | Thru | Left | Peds | App. Total | Right                 | Thru | Left | Peds | App. Total | Right                             | Thru | Left | Peds | App. Total | Right                 | Thru | Left | Peds | App. Total |            |
| 07:00 AM    | 8                                 | 97   | 6    | 0    | 111        | 0                     | 4    | 7    | 0    | 11         | 3                                 | 46   | 6    | 0    | 55         | 7                     | 3    | 10   | 3    | 23         | 200        |
| 07:15 AM    | 23                                | 191  | 10   | 3    | 227        | 2                     | 7    | 20   | 1    | 30         | 17                                | 50   | 13   | 0    | 80         | 20                    | 8    | 14   | 2    | 44         | 381        |
| 07:30 AM    | 37                                | 238  | 22   | 14   | 311        | 8                     | 19   | 43   | 0    | 70         | 32                                | 85   | 36   | 0    | 153        | 29                    | 28   | 14   | 0    | 71         | 605        |
| 07:45 AM    | 66                                | 186  | 35   | 13   | 300        | 11                    | 28   | 42   | 1    | 82         | 49                                | 103  | 61   | 0    | 213        | 30                    | 35   | 13   | 5    | 83         | 678        |
| Total       | 134                               | 712  | 73   | 30   | 949        | 21                    | 58   | 112  | 2    | 193        | 101                               | 284  | 116  | 0    | 501        | 86                    | 74   | 51   | 10   | 221        | 1864       |
| 08:00 AM    | 23                                | 144  | 7    | 0    | 174        | 14                    | 16   | 36   | 0    | 66         | 7                                 | 92   | 12   | 0    | 111        | 39                    | 7    | 24   | 0    | 70         | 421        |
| 08:15 AM    | 9                                 | 172  | 8    | 1    | 190        | 2                     | 3    | 10   | 0    | 15         | 9                                 | 53   | 9    | 0    | 71         | 7                     | 4    | 6    | 2    | 19         | 295        |
| 08:30 AM    | 7                                 | 113  | 1    | 3    | 124        | 3                     | 2    | 11   | 1    | 17         | 3                                 | 52   | 3    | 0    | 58         | 7                     | 5    | 7    | 1    | 20         | 219        |
| 08:45 AM    | 11                                | 82   | 3    | 2    | 98         | 5                     | 3    | 8    | 2    | 18         | 2                                 | 51   | 7    | 2    | 62         | 6                     | 1    | 7    | 2    | 16         | 194        |
| Total       | 50                                | 511  | 19   | 6    | 586        | 24                    | 24   | 65   | 3    | 116        | 21                                | 248  | 31   | 2    | 302        | 59                    | 17   | 44   | 5    | 125        | 1129       |
| Grand Total | 184                               | 1223 | 92   | 36   | 1535       | 45                    | 82   | 177  | 5    | 309        | 122                               | 532  | 147  | 2    | 803        | 145                   | 91   | 95   | 15   | 346        | 2993       |
| Apprch %    | 12                                | 79.7 | 6    | 2.3  |            | 14.6                  | 26.5 | 57.3 | 1.6  |            | 15.2                              | 66.3 | 18.3 | 0.2  |            | 41.9                  | 26.3 | 27.5 | 4.3  |            |            |
| Total %     | 6.1                               | 40.9 | 3.1  | 1.2  | 51.3       | 1.5                   | 2.7  | 5.9  | 0.2  | 10.3       | 4.1                               | 17.8 | 4.9  | 0.1  | 26.8       | 4.8                   | 3    | 3.2  | 0.5  | 11.6       |            |
| Lights      | 183                               | 1191 | 92   | 36   | 1502       | 41                    | 80   | 176  | 5    | 302        | 120                               | 528  | 142  | 2    | 792        | 141                   | 91   | 95   | 15   | 342        | 2938       |
| % Lights    | 99.5                              | 97.4 | 100  | 100  | 97.9       | 91.1                  | 97.6 | 99.4 | 100  | 97.7       | 98.4                              | 99.2 | 96.6 | 100  | 98.6       | 97.2                  | 100  | 100  | 100  | 98.8       | 98.2       |
| Buses       | 0                                 | 16   | 0    | 0    | 16         | 2                     | 2    | 1    | 0    | 5          | 1                                 | 2    | 3    | 0    | 6          | 3                     | 0    | 0    | 0    | 3          | 30         |
| % Buses     | 0                                 | 1.3  | 0    | 0    | 1          | 4.4                   | 2.4  | 0.6  | 0    | 1.6        | 0.8                               | 0.4  | 2    | 0    | 0.7        | 2.1                   | 0    | 0    | 0    | 0.9        | 1          |
| Trucks      | 1                                 | 16   | 0    | 0    | 17         | 2                     | 0    | 0    | 0    | 2          | 1                                 | 2    | 2    | 0    | 5          | 1                     | 0    | 0    | 0    | 1          | 25         |
| % Trucks    | 0.5                               | 1.3  | 0    | 0    | 1.1        | 4.4                   | 0    | 0    | 0    | 0.6        | 0.8                               | 0.4  | 1.4  | 0    | 0.6        | 0.7                   | 0    | 0    | 0    | 0.3        | 0.8        |

| Start Time   | GENERAL JIM MOORE BLVD Southbound |            |           |      |            | NORMANDY RD Westbound |           |           |      |            | GENERAL JIM MOORE BLVD Northbound |            |           |      |            | NORMANDY RD Eastbound |           |           |      |            | Int. Total |
|--|-----------------------------------|------------|-----------|------|------------|-----------------------|-----------|-----------|------|------------|-----------------------------------|------------|-----------|------|------------|-----------------------|-----------|-----------|------|------------|------------|
|  | Right                             | Thru       | Left      | Peds | App. Total | Right                 | Thru      | Left      | Peds | App. Total | Right                             | Thru       | Left      | Peds | App. Total | Right                 | Thru      | Left      | Peds | App. Total |            |
| Peak Hour Analysis From 07:00 AM to 08:45 AM - Peak 1 of 1 |                                   |            |           |      |            |                       |           |           |      |            |                                   |            |           |      |            |                       |           |           |      |            |            |
| Peak Hour for Entire Intersection Begins at 07:15 AM       |                                   |            |           |      |            |                       |           |           |      |            |                                   |            |           |      |            |                       |           |           |      |            |            |
| 07:15 AM   | 23                                | 191        | 10        |      | 224        | 2                     | 7         | 20        |      | 29         | 17                                | 50         | 13        |      | 80         | 20                    | 8         | 14        |      | 42         | 375        |
| 07:30 AM   | 37                                | <b>238</b> | 22        |      | <b>297</b> | 8                     | 19        | <b>43</b> |      | 70         | 32                                | 85         | 36        |      | 153        | 29                    | 28        | 14        |      | 71         | 591        |
| 07:45 AM   | <b>66</b>                         | 186        | <b>35</b> |      | 287        | 11                    | <b>28</b> | 42        |      | <b>81</b>  | <b>49</b>                         | <b>103</b> | <b>61</b> |      | <b>213</b> | 30                    | <b>35</b> | 13        |      | <b>78</b>  | <b>659</b> |
| 08:00 AM   | 23                                | 144        | 7         |      | 174        | 14                    | 16        | 36        |      | 66         | 7                                 | 92         | 12        |      | 111        | <b>39</b>             | 7         | <b>24</b> |      | 70         | 421        |
| Total Volume   | 149                               | 759        | 74        |      | 982        | 35                    | 70        | 141       |      | 246        | 105                               | 330        | 122       |      | 557        | 118                   | 78        | 65        |      | 261        | 2046       |
| % App. Total   | 15.2                              | 77.3       | 7.5       |      |            | 14.2                  | 28.5      | 57.3      |      |            | 18.9                              | 59.2       | 21.9      |      |            | 45.2                  | 29.9      | 24.9      |      |            |            |
| PHF  | .564                              | .797       | .529      |      | .827       | .625                  | .625      | .820      |      | .759       | .536                              | .801       | .500      |      | .654       | .756                  | .557      | .677      |      | .837       | .776       |

# Traffic Data Service

San Jose, CA  
 (408) 622-4787  
 tdsbay@cs.com

File Name : 18AM FINAL  
 Site Code : 00000018  
 Start Date : 4/25/2018  
 Page No : 2

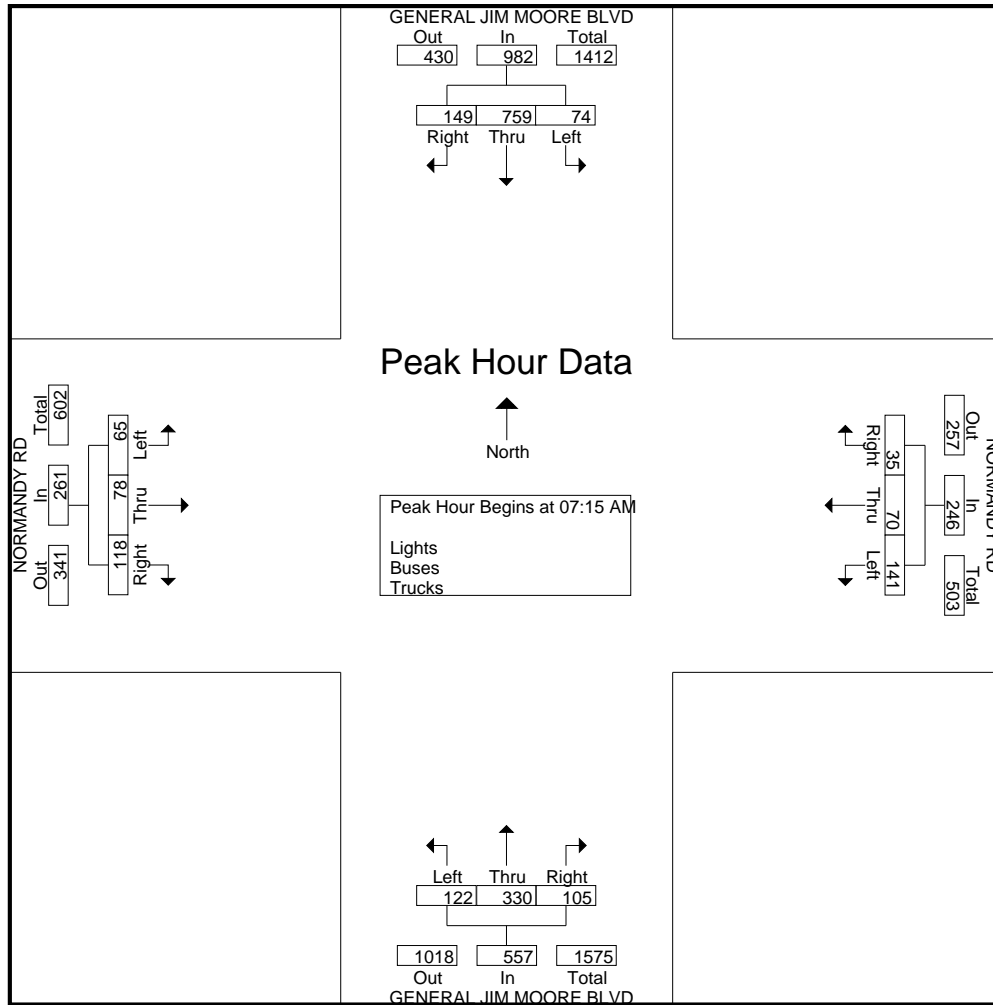

# Traffic Data Service

San Jose, CA  
 (408) 622-4787  
 tdsbay@cs.com

File Name : 18AM FINAL  
 Site Code : 00000018  
 Start Date : 4/25/2018  
 Page No : 1

Groups Printed- Bikes

| Start Time  | GENERAL JIM MOORE BLVD Southbound |      |      |      |            | NORMANDY RD Westbound |      |      |      |            | GENERAL JIM MOORE BLVD Northbound |      |      |      |            | NORMANDY RD Eastbound |      |      |      |            | Int. Total |   |   |   |   |   |
|-------------|-----------------------------------|------|------|------|------------|-----------------------|------|------|------|------------|-----------------------------------|------|------|------|------------|-----------------------|------|------|------|------------|------------|---|---|---|---|---|
|             | Right                             | Thru | Left | Peds | App. Total | Right                 | Thru | Left | Peds | App. Total | Right                             | Thru | Left | Peds | App. Total | Right                 | Thru | Left | Peds | App. Total |            |   |   |   |   |   |
| 07:00 AM    | 0                                 | 0    | 0    | 0    | 0          | 0                     | 0    | 0    | 0    | 0          | 0                                 | 1    | 0    | 0    | 1          | 0                     | 0    | 0    | 0    | 0          | 0          | 0 | 0 | 0 | 0 | 1 |
| 07:15 AM    | 0                                 | 0    | 0    | 0    | 0          | 0                     | 0    | 0    | 0    | 0          | 0                                 | 0    | 0    | 0    | 0          | 0                     | 0    | 0    | 0    | 0          | 0          | 0 | 0 | 0 | 0 | 0 |
| 07:30 AM    | 0                                 | 0    | 0    | 0    | 0          | 0                     | 0    | 0    | 0    | 0          | 0                                 | 0    | 0    | 0    | 0          | 0                     | 0    | 0    | 0    | 0          | 0          | 0 | 0 | 0 | 0 | 0 |
| 07:45 AM    | 0                                 | 0    | 0    | 0    | 0          | 0                     | 0    | 0    | 0    | 0          | 0                                 | 0    | 0    | 0    | 0          | 0                     | 0    | 0    | 0    | 0          | 0          | 0 | 0 | 0 | 0 | 0 |
| Total       | 0                                 | 0    | 0    | 0    | 0          | 0                     | 0    | 0    | 0    | 0          | 0                                 | 1    | 0    | 0    | 1          | 0                     | 0    | 0    | 0    | 0          | 0          | 0 | 0 | 0 | 0 | 1 |
| 08:00 AM    | 0                                 | 0    | 0    | 0    | 0          | 0                     | 0    | 0    | 0    | 0          | 0                                 | 0    | 0    | 0    | 0          | 0                     | 0    | 0    | 0    | 0          | 0          | 0 | 0 | 0 | 0 | 0 |
| 08:15 AM    | 0                                 | 0    | 0    | 0    | 0          | 0                     | 0    | 0    | 0    | 0          | 0                                 | 0    | 0    | 0    | 0          | 0                     | 0    | 0    | 0    | 0          | 0          | 0 | 0 | 0 | 0 | 0 |
| 08:30 AM    | 0                                 | 0    | 0    | 0    | 0          | 0                     | 0    | 0    | 0    | 0          | 1                                 | 0    | 0    | 0    | 1          | 0                     | 1    | 0    | 0    | 1          | 0          | 0 | 0 | 0 | 1 | 2 |
| 08:45 AM    | 0                                 | 0    | 0    | 0    | 0          | 0                     | 0    | 0    | 0    | 0          | 0                                 | 0    | 0    | 0    | 0          | 0                     | 0    | 0    | 0    | 0          | 0          | 0 | 0 | 0 | 0 | 0 |
| Total       | 0                                 | 0    | 0    | 0    | 0          | 0                     | 0    | 0    | 0    | 0          | 1                                 | 0    | 0    | 0    | 1          | 0                     | 1    | 0    | 0    | 1          | 0          | 0 | 0 | 0 | 1 | 2 |
| Grand Total | 0                                 | 0    | 0    | 0    | 0          | 0                     | 0    | 0    | 0    | 0          | 1                                 | 1    | 0    | 0    | 2          | 0                     | 1    | 0    | 0    | 1          | 0          | 0 | 0 | 0 | 3 | 3 |
| Apprch %    | 0                                 | 0    | 0    | 0    | 0          | 0                     | 0    | 0    | 0    | 0          | 50                                | 50   | 0    | 0    |            | 0                     | 100  | 0    | 0    |            | 0          | 0 | 0 | 0 |   |   |
| Total %     | 0                                 | 0    | 0    | 0    | 0          | 0                     | 0    | 0    | 0    | 0          | 33.3                              | 33.3 | 0    | 0    | 66.7       | 0                     | 33.3 | 0    | 0    | 33.3       |            |   |   |   |   |   |

| Start Time   | GENERAL JIM MOORE BLVD Southbound |      |      |      |            | NORMANDY RD Westbound |      |      |      |            | GENERAL JIM MOORE BLVD Northbound |      |      |      |            | NORMANDY RD Eastbound |      |      |      |            | Int. Total |      |      |      |      |   |
|--|-----------------------------------|------|------|------|------------|-----------------------|------|------|------|------------|-----------------------------------|------|------|------|------------|-----------------------|------|------|------|------------|------------|------|------|------|------|---|
|  | Right                             | Thru | Left | Peds | App. Total | Right                 | Thru | Left | Peds | App. Total | Right                             | Thru | Left | Peds | App. Total | Right                 | Thru | Left | Peds | App. Total |            |      |      |      |      |   |
| Peak Hour Analysis From 07:00 AM to 08:45 AM - Peak 1 of 1 |                                   |      |      |      |            |                       |      |      |      |            |                                   |      |      |      |            |                       |      |      |      |            |            |      |      |      |      |   |
| Peak Hour for Entire Intersection Begins at 07:45 AM       |                                   |      |      |      |            |                       |      |      |      |            |                                   |      |      |      |            |                       |      |      |      |            |            |      |      |      |      |   |
| 07:45 AM   | 0                                 | 0    | 0    | 0    | 0          | 0                     | 0    | 0    | 0    | 0          | 0                                 | 0    | 0    | 0    | 0          | 0                     | 0    | 0    | 0    | 0          | 0          | 0    | 0    | 0    | 0    | 0 |
| 08:00 AM   | 0                                 | 0    | 0    | 0    | 0          | 0                     | 0    | 0    | 0    | 0          | 0                                 | 0    | 0    | 0    | 0          | 0                     | 0    | 0    | 0    | 0          | 0          | 0    | 0    | 0    | 0    | 0 |
| 08:15 AM   | 0                                 | 0    | 0    | 0    | 0          | 0                     | 0    | 0    | 0    | 0          | 0                                 | 0    | 0    | 0    | 0          | 0                     | 0    | 0    | 0    | 0          | 0          | 0    | 0    | 0    | 0    | 0 |
| 08:30 AM   | 0                                 | 0    | 0    | 0    | 0          | 0                     | 0    | 0    | 0    | 0          | 1                                 | 0    | 0    | 0    | 1          | 0                     | 1    | 0    | 0    | 1          | 0          | 0    | 0    | 0    | 1    | 2 |
| Total Volume   | 0                                 | 0    | 0    | 0    | 0          | 0                     | 0    | 0    | 0    | 0          | 1                                 | 0    | 0    | 0    | 1          | 0                     | 1    | 0    | 0    | 1          | 0          | 0    | 0    | 0    | 1    | 2 |
| % App. Total   | 0                                 | 0    | 0    | 0    | 0          | 0                     | 0    | 0    | 0    | 0          | 100                               | 0    | 0    | 0    |            | 0                     | 100  | 0    | 0    |            | 0          | 0    | 0    | 0    |      |   |
| PHF  | .000                              | .000 | .000 | .000 | .000       | .000                  | .000 | .000 | .000 | .000       | .250                              | .000 | .000 | .250 |            | .000                  | .250 | .000 | .250 |            | .000       | .000 | .000 | .250 | .250 |   |

# Traffic Data Service

San Jose, CA  
 (408) 622-4787  
 tdsbay@cs.com

File Name : 18AM FINAL  
 Site Code : 00000018  
 Start Date : 4/25/2018  
 Page No : 2

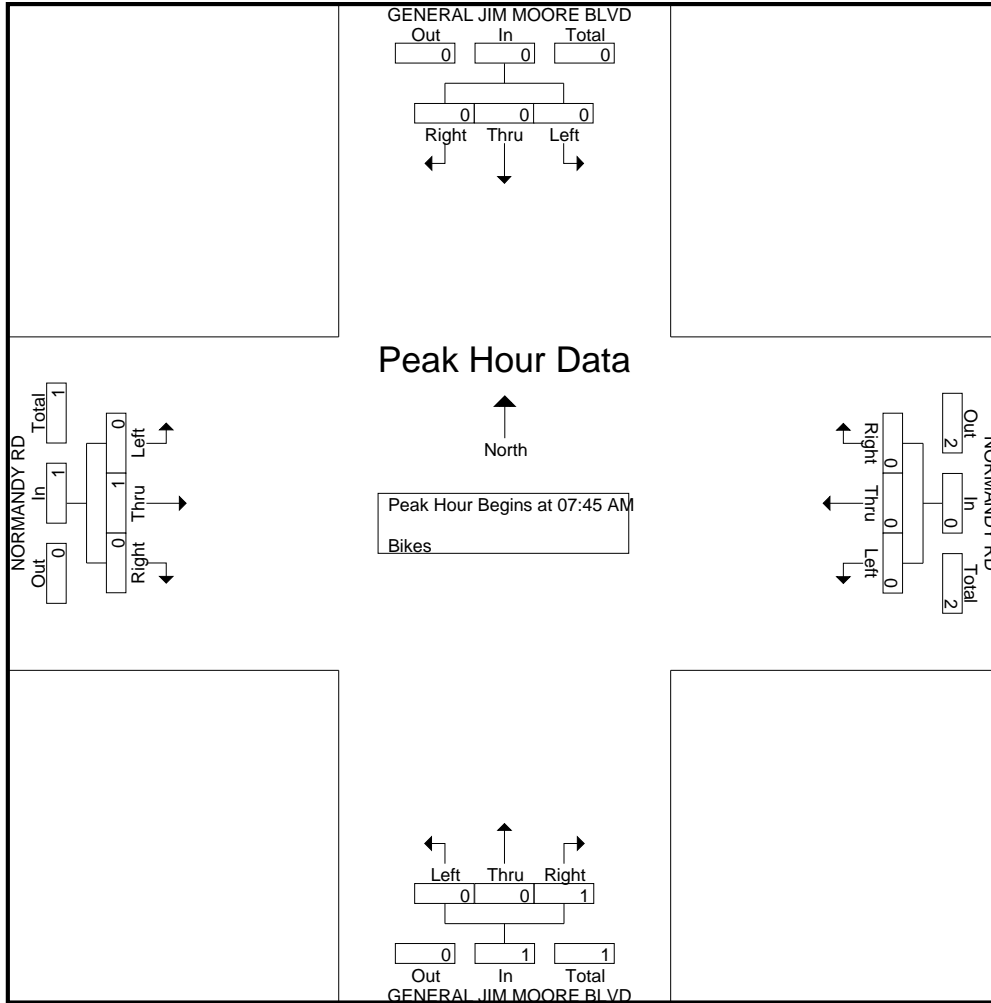

# Traffic Data Service

San Jose, CA  
 (408) 622-4787  
 tdsbay@cs.com

File Name : 18PM FINAL  
 Site Code : 00000018  
 Start Date : 4/25/2018  
 Page No : 1

Groups Printed- Lights - Buses - Trucks

| Start Time   | GENERAL JIM MOORE BLVD Southbound |            |           |          |            | NORMANDY RD Westbound |           |           |          |            | GENERAL JIM MOORE BLVD Northbound |            |           |          |            | NORMANDY RD Eastbound |           |           |          |            | Int. Total  |
|--------------|-----------------------------------|------------|-----------|----------|------------|-----------------------|-----------|-----------|----------|------------|-----------------------------------|------------|-----------|----------|------------|-----------------------|-----------|-----------|----------|------------|-------------|
|              | Right                             | Thru       | Left      | Peds     | App. Total | Right                 | Thru      | Left      | Peds     | App. Total | Right                             | Thru       | Left      | Peds     | App. Total | Right                 | Thru      | Left      | Peds     | App. Total |             |
| 04:00 PM     | 9                                 | 79         | 8         | 0        | 96         | 5                     | 4         | 8         | 0        | 17         | 6                                 | 114        | 5         | 0        | 125        | 8                     | 3         | 10        | 0        | 21         | 259         |
| 04:15 PM     | 9                                 | 63         | 5         | 2        | 79         | 3                     | 9         | 12        | 0        | 24         | 9                                 | 118        | 12        | 0        | 139        | 7                     | 9         | 7         | 0        | 23         | 265         |
| 04:30 PM     | 13                                | 83         | 4         | 0        | 100        | 2                     | 5         | 4         | 0        | 11         | 14                                | 149        | 12        | 1        | 176        | 8                     | 3         | 10        | 1        | 22         | 309         |
| 04:45 PM     | 8                                 | 102        | 9         | 0        | 119        | 2                     | 1         | 13        | 0        | 16         | 14                                | 171        | 13        | 0        | 198        | 8                     | 7         | 5         | 1        | 21         | 354         |
| <b>Total</b> | <b>39</b>                         | <b>327</b> | <b>26</b> | <b>2</b> | <b>394</b> | <b>12</b>             | <b>19</b> | <b>37</b> | <b>0</b> | <b>68</b>  | <b>43</b>                         | <b>552</b> | <b>42</b> | <b>1</b> | <b>638</b> | <b>31</b>             | <b>22</b> | <b>32</b> | <b>2</b> | <b>87</b>  | <b>1187</b> |
| 05:00 PM     | 13                                | 92         | 5         | 0        | 110        | 2                     | 11        | 8         | 0        | 21         | 18                                | 180        | 17        | 0        | 215        | 8                     | 8         | 12        | 0        | 28         | 374         |
| 05:15 PM     | 11                                | 87         | 8         | 0        | 106        | 1                     | 5         | 15        | 0        | 21         | 19                                | 206        | 11        | 0        | 236        | 11                    | 7         | 15        | 0        | 33         | 396         |
| 05:30 PM     | 13                                | 80         | 9         | 3        | 105        | 1                     | 11        | 8         | 0        | 20         | 16                                | 172        | 8         | 0        | 196        | 6                     | 5         | 13        | 0        | 24         | 345         |
| 05:45 PM     | 12                                | 65         | 11        | 4        | 92         | 1                     | 8         | 6         | 0        | 15         | 16                                | 145        | 12        | 0        | 173        | 12                    | 8         | 10        | 0        | 30         | 310         |
| <b>Total</b> | <b>49</b>                         | <b>324</b> | <b>33</b> | <b>7</b> | <b>413</b> | <b>5</b>              | <b>35</b> | <b>37</b> | <b>0</b> | <b>77</b>  | <b>69</b>                         | <b>703</b> | <b>48</b> | <b>0</b> | <b>820</b> | <b>37</b>             | <b>28</b> | <b>50</b> | <b>0</b> | <b>115</b> | <b>1425</b> |
| Grand Total  | 88                                | 651        | 59        | 9        | 807        | 17                    | 54        | 74        | 0        | 145        | 112                               | 1255       | 90        | 1        | 1458       | 68                    | 50        | 82        | 2        | 202        | 2612        |
| Apprch %     | 10.9                              | 80.7       | 7.3       | 1.1      |            | 11.7                  | 37.2      | 51        | 0        |            | 7.7                               | 86.1       | 6.2       | 0.1      |            | 33.7                  | 24.8      | 40.6      | 1        |            |             |
| Total %      | 3.4                               | 24.9       | 2.3       | 0.3      | 30.9       | 0.7                   | 2.1       | 2.8       | 0        | 5.6        | 4.3                               | 48         | 3.4       | 0        | 55.8       | 2.6                   | 1.9       | 3.1       | 0.1      | 7.7        |             |
| Lights       | 87                                | 646        | 59        | 9        | 801        | 17                    | 54        | 72        | 0        | 143        | 112                               | 1242       | 88        | 1        | 1443       | 67                    | 50        | 81        | 2        | 200        | 2587        |
| % Lights     | 98.9                              | 99.2       | 100       | 100      | 99.3       | 100                   | 100       | 97.3      | 0        | 98.6       | 100                               | 99         | 97.8      | 100      | 99         | 98.5                  | 100       | 98.8      | 100      | 99         | 99          |
| Buses        | 0                                 | 0          | 0         | 0        | 0          | 0                     | 0         | 1         | 0        | 1          | 0                                 | 4          | 2         | 0        | 6          | 0                     | 0         | 0         | 0        | 0          | 7           |
| % Buses      | 0                                 | 0          | 0         | 0        | 0          | 0                     | 0         | 1.4       | 0        | 0.7        | 0                                 | 0.3        | 2.2       | 0        | 0.4        | 0                     | 0         | 0         | 0        | 0          | 0.3         |
| Trucks       | 1                                 | 5          | 0         | 0        | 6          | 0                     | 0         | 1         | 0        | 1          | 0                                 | 9          | 0         | 0        | 9          | 1                     | 0         | 1         | 0        | 2          | 18          |
| % Trucks     | 1.1                               | 0.8        | 0         | 0        | 0.7        | 0                     | 0         | 1.4       | 0        | 0.7        | 0                                 | 0.7        | 0         | 0        | 0.6        | 1.5                   | 0         | 1.2       | 0        | 1          | 0.7         |

| Start Time   | GENERAL JIM MOORE BLVD Southbound |      |      |      |            | NORMANDY RD Westbound |      |      |      |            | GENERAL JIM MOORE BLVD Northbound |      |      |      |            | NORMANDY RD Eastbound |      |      |      |            | Int. Total |
|--|-----------------------------------|------|------|------|------------|-----------------------|------|------|------|------------|-----------------------------------|------|------|------|------------|-----------------------|------|------|------|------------|------------|
|  | Right                             | Thru | Left | Peds | App. Total | Right                 | Thru | Left | Peds | App. Total | Right                             | Thru | Left | Peds | App. Total | Right                 | Thru | Left | Peds | App. Total |            |
| Peak Hour Analysis From 04:00 PM to 05:45 PM - Peak 1 of 1 |                                   |      |      |      |            |                       |      |      |      |            |                                   |      |      |      |            |                       |      |      |      |            |            |
| Peak Hour for Entire Intersection Begins at 04:45 PM       |                                   |      |      |      |            |                       |      |      |      |            |                                   |      |      |      |            |                       |      |      |      |            |            |
| 04:45 PM   | 8                                 | 102  | 9    |      | 119        | 2                     | 1    | 13   |      | 16         | 14                                | 171  | 13   |      | 198        | 8                     | 7    | 5    |      | 20         | 353        |
| 05:00 PM   | 13                                | 92   | 5    |      | 110        | 2                     | 11   | 8    |      | 21         | 18                                | 180  | 17   |      | 215        | 8                     | 8    | 12   |      | 28         | 374        |
| 05:15 PM   | 11                                | 87   | 8    |      | 106        | 1                     | 5    | 15   |      | 21         | 19                                | 206  | 11   |      | 236        | 11                    | 7    | 15   |      | 33         | 396        |
| 05:30 PM   | 13                                | 80   | 9    |      | 102        | 1                     | 11   | 8    |      | 20         | 16                                | 172  | 8    |      | 196        | 6                     | 5    | 13   |      | 24         | 342        |
| Total Volume   | 45                                | 361  | 31   |      | 437        | 6                     | 28   | 44   |      | 78         | 67                                | 729  | 49   |      | 845        | 33                    | 27   | 45   |      | 105        | 1465       |
| % App. Total   | 10.3                              | 82.6 | 7.1  |      |            | 7.7                   | 35.9 | 56.4 |      |            | 7.9                               | 86.3 | 5.8  |      |            | 31.4                  | 25.7 | 42.9 |      |            |            |
| PHF  | .865                              | .885 | .861 |      | .918       | .750                  | .636 | .733 |      | .929       | .882                              | .885 | .721 |      | .895       | .750                  | .844 | .750 |      | .795       | .925       |

# Traffic Data Service

San Jose, CA  
 (408) 622-4787  
 tdsbay@cs.com

File Name : 18PM FINAL  
 Site Code : 00000018  
 Start Date : 4/25/2018  
 Page No : 2

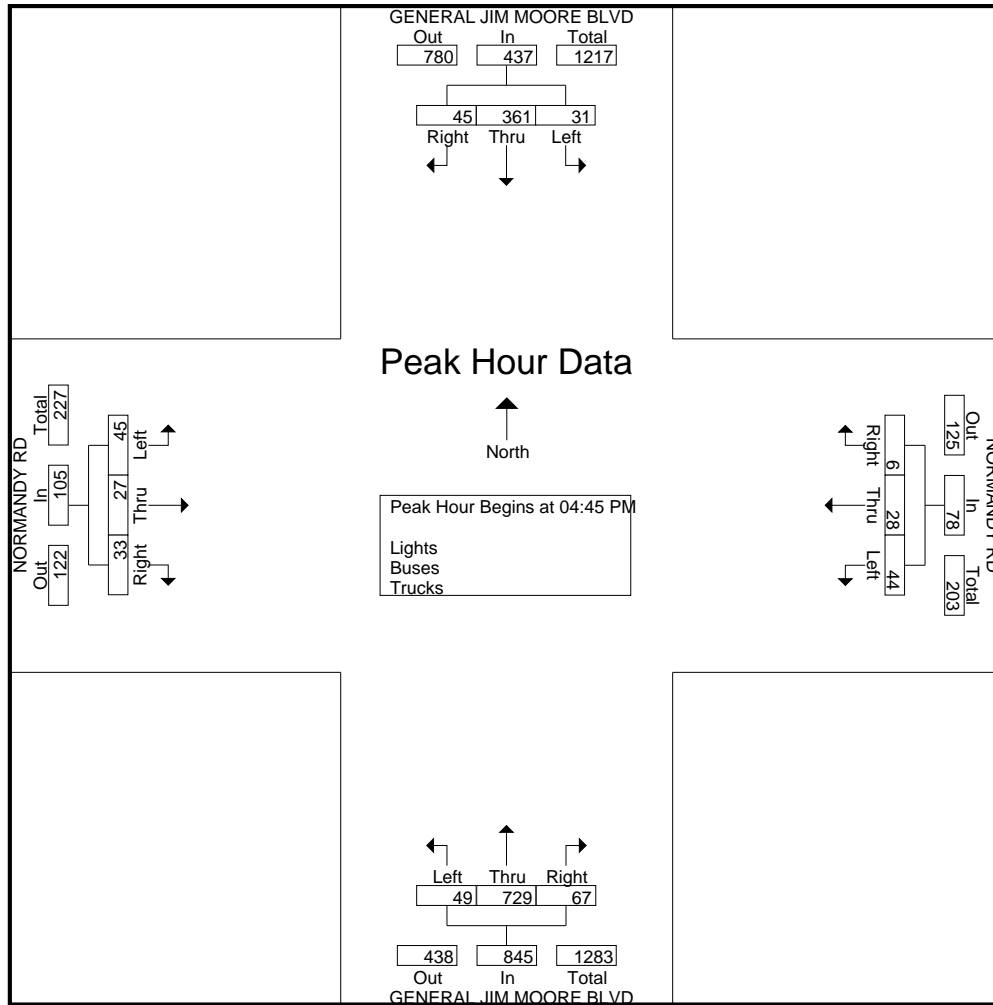

# Traffic Data Service

San Jose, CA  
 (408) 622-4787  
 tdsbay@cs.com

File Name : 18PM FINAL  
 Site Code : 00000018  
 Start Date : 4/25/2018  
 Page No : 1

Groups Printed- Bikes

| Start Time  | GENERAL JIM MOORE BLVD Southbound |      |      |      |            | NORMANDY RD Westbound |      |      |      |            | GENERAL JIM MOORE BLVD Northbound |      |      |      |            | NORMANDY RD Eastbound |      |      |      |            | Int. Total |   |   |   |   |   |
|-------------|-----------------------------------|------|------|------|------------|-----------------------|------|------|------|------------|-----------------------------------|------|------|------|------------|-----------------------|------|------|------|------------|------------|---|---|---|---|---|
|             | Right                             | Thru | Left | Peds | App. Total | Right                 | Thru | Left | Peds | App. Total | Right                             | Thru | Left | Peds | App. Total | Right                 | Thru | Left | Peds | App. Total |            |   |   |   |   |   |
| 04:00 PM    | 0                                 | 0    | 0    | 0    | 0          | 0                     | 0    | 0    | 0    | 0          | 0                                 | 0    | 0    | 0    | 0          | 0                     | 0    | 0    | 0    | 0          | 0          | 0 | 0 | 0 | 0 | 0 |
| 04:15 PM    | 0                                 | 0    | 0    | 0    | 0          | 0                     | 0    | 0    | 0    | 0          | 0                                 | 0    | 0    | 0    | 0          | 0                     | 0    | 0    | 0    | 0          | 0          | 0 | 0 | 0 | 0 | 0 |
| 04:30 PM    | 0                                 | 0    | 1    | 0    | 1          | 0                     | 0    | 0    | 0    | 0          | 0                                 | 0    | 0    | 0    | 0          | 0                     | 0    | 0    | 0    | 0          | 0          | 0 | 0 | 0 | 0 | 1 |
| 04:45 PM    | 0                                 | 0    | 0    | 0    | 0          | 1                     | 0    | 0    | 0    | 1          | 0                                 | 0    | 0    | 0    | 0          | 0                     | 0    | 0    | 0    | 0          | 0          | 0 | 0 | 0 | 0 | 1 |
| Total       | 0                                 | 0    | 1    | 0    | 1          | 1                     | 0    | 0    | 0    | 1          | 0                                 | 0    | 0    | 0    | 0          | 0                     | 0    | 0    | 0    | 0          | 0          | 0 | 0 | 0 | 0 | 2 |
| 05:00 PM    | 0                                 | 0    | 0    | 0    | 0          | 0                     | 0    | 1    | 0    | 1          | 0                                 | 0    | 0    | 0    | 0          | 0                     | 0    | 0    | 0    | 0          | 0          | 0 | 0 | 0 | 0 | 1 |
| 05:15 PM    | 0                                 | 0    | 0    | 0    | 0          | 0                     | 0    | 2    | 0    | 2          | 0                                 | 0    | 0    | 0    | 0          | 0                     | 0    | 0    | 0    | 0          | 0          | 0 | 0 | 0 | 0 | 2 |
| 05:30 PM    | 0                                 | 0    | 0    | 0    | 0          | 0                     | 0    | 0    | 0    | 0          | 0                                 | 0    | 0    | 0    | 0          | 0                     | 0    | 0    | 0    | 0          | 0          | 0 | 0 | 0 | 0 | 0 |
| 05:45 PM    | 0                                 | 0    | 0    | 0    | 0          | 0                     | 0    | 0    | 0    | 0          | 0                                 | 0    | 0    | 0    | 0          | 0                     | 0    | 0    | 0    | 0          | 0          | 0 | 0 | 0 | 0 | 0 |
| Total       | 0                                 | 0    | 0    | 0    | 0          | 0                     | 0    | 3    | 0    | 3          | 0                                 | 0    | 0    | 0    | 0          | 0                     | 0    | 0    | 0    | 0          | 0          | 0 | 0 | 0 | 0 | 3 |
| Grand Total | 0                                 | 0    | 1    | 0    | 1          | 1                     | 0    | 3    | 0    | 4          | 0                                 | 0    | 0    | 0    | 0          | 0                     | 0    | 0    | 0    | 0          | 0          | 0 | 0 | 0 | 0 | 5 |
| Apprch %    | 0                                 | 0    | 100  | 0    |            | 25                    | 0    | 75   | 0    |            | 0                                 | 0    | 0    | 0    |            | 0                     | 0    | 0    | 0    |            | 0          | 0 | 0 | 0 |   |   |
| Total %     | 0                                 | 0    | 20   | 0    | 20         | 20                    | 0    | 60   | 0    | 80         | 0                                 | 0    | 0    | 0    | 0          | 0                     | 0    | 0    | 0    | 0          | 0          | 0 | 0 | 0 | 0 |   |

| Start Time   | GENERAL JIM MOORE BLVD Southbound |      |      |      |            | NORMANDY RD Westbound |      |      |      |            | GENERAL JIM MOORE BLVD Northbound |      |      |      |            | NORMANDY RD Eastbound |      |      |      |            | Int. Total |      |      |   |      |   |
|--|-----------------------------------|------|------|------|------------|-----------------------|------|------|------|------------|-----------------------------------|------|------|------|------------|-----------------------|------|------|------|------------|------------|------|------|---|------|---|
|  | Right                             | Thru | Left | Peds | App. Total | Right                 | Thru | Left | Peds | App. Total | Right                             | Thru | Left | Peds | App. Total | Right                 | Thru | Left | Peds | App. Total |            |      |      |   |      |   |
| Peak Hour Analysis From 04:00 PM to 05:45 PM - Peak 1 of 1 |                                   |      |      |      |            |                       |      |      |      |            |                                   |      |      |      |            |                       |      |      |      |            |            |      |      |   |      |   |
| Peak Hour for Entire Intersection Begins at 04:30 PM       |                                   |      |      |      |            |                       |      |      |      |            |                                   |      |      |      |            |                       |      |      |      |            |            |      |      |   |      |   |
| 04:30 PM   | 0                                 | 0    | 1    | 0    | 1          | 0                     | 0    | 0    | 0    | 0          | 0                                 | 0    | 0    | 0    | 0          | 0                     | 0    | 0    | 0    | 0          | 0          | 0    | 0    | 0 | 0    | 1 |
| 04:45 PM   | 0                                 | 0    | 0    | 0    | 0          | 1                     | 0    | 0    | 0    | 1          | 0                                 | 0    | 0    | 0    | 0          | 0                     | 0    | 0    | 0    | 0          | 0          | 0    | 0    | 0 | 0    | 1 |
| 05:00 PM   | 0                                 | 0    | 0    | 0    | 0          | 0                     | 0    | 1    | 0    | 1          | 0                                 | 0    | 0    | 0    | 0          | 0                     | 0    | 0    | 0    | 0          | 0          | 0    | 0    | 0 | 0    | 1 |
| 05:15 PM   | 0                                 | 0    | 0    | 0    | 0          | 0                     | 0    | 2    | 0    | 2          | 0                                 | 0    | 0    | 0    | 0          | 0                     | 0    | 0    | 0    | 0          | 0          | 0    | 0    | 0 | 0    | 2 |
| Total Volume   | 0                                 | 0    | 1    | 0    | 1          | 1                     | 0    | 3    | 0    | 4          | 0                                 | 0    | 0    | 0    | 0          | 0                     | 0    | 0    | 0    | 0          | 0          | 0    | 0    | 0 | 0    | 5 |
| % App. Total   | 0                                 | 0    | 100  | 0    |            | 25                    | 0    | 75   | 0    |            | 0                                 | 0    | 0    | 0    |            | 0                     | 0    | 0    | 0    |            | 0          | 0    | 0    | 0 |      |   |
| PHF  | .000                              | .000 | .250 | 0    | .250       | .250                  | .000 | .375 | 0    | .500       | .000                              | .000 | .000 | 0    | .000       | .000                  | .000 | .000 | 0    | .000       | .000       | .000 | .000 | 0 | .625 |   |

# Traffic Data Service

San Jose, CA  
 (408) 622-4787  
 tdsbay@cs.com

File Name : 18PM FINAL  
 Site Code : 00000018  
 Start Date : 4/25/2018  
 Page No : 2

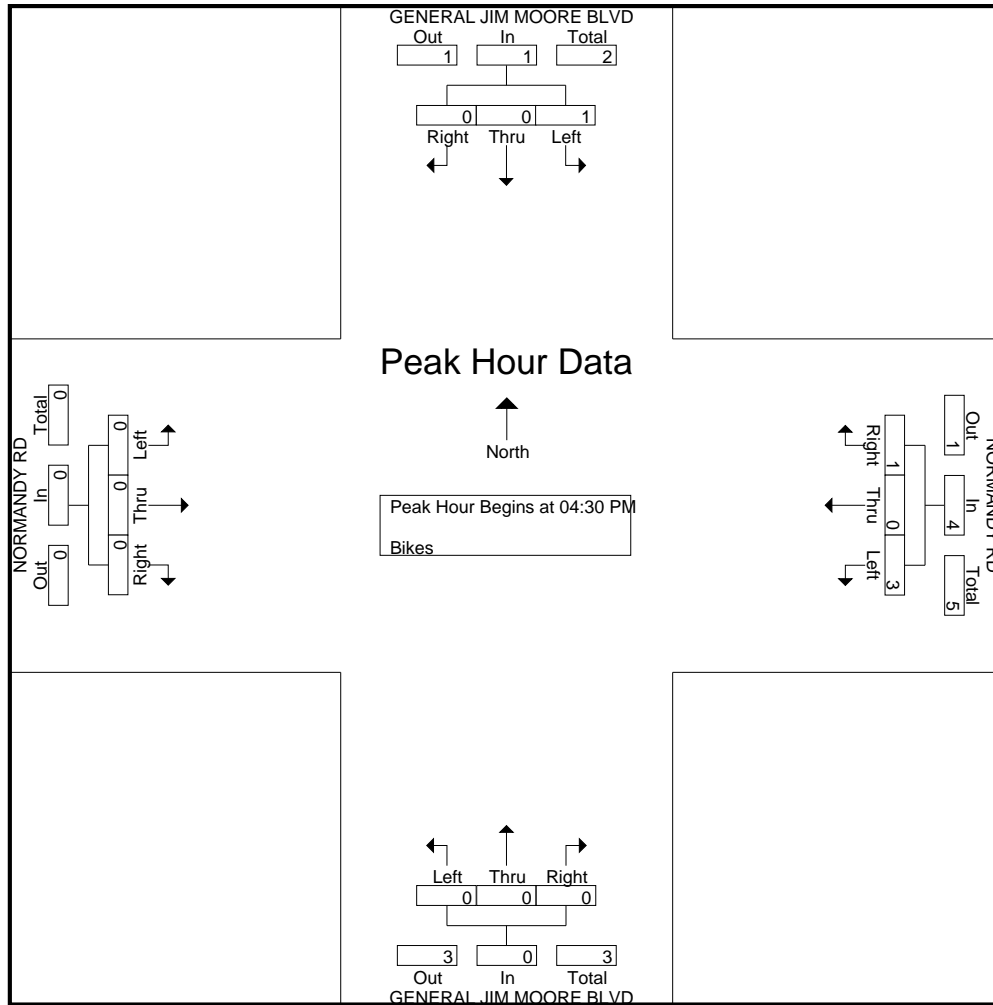



# Traffic Data Service

San Jose, CA  
 (408) 622-4787  
 tdsbay@cs.com

File Name : 19AM FINAL  
 Site Code : 00000019  
 Start Date : 4/25/2018  
 Page No : 1

Groups Printed- Lights - Buses - Trucks

| Start Time  | GENERAL JIM MOORE BLVD Southbound |      |      |      |            | EUCALYPTUS RD Westbound |      |      |      |            | GENERAL JIM MOORE BLVD Northbound |      |      |      |            | COE AVE Eastbound |      |      |      |            | Int. Total |
|-------------|-----------------------------------|------|------|------|------------|-------------------------|------|------|------|------------|-----------------------------------|------|------|------|------------|-------------------|------|------|------|------------|------------|
|             | Right                             | Thru | Left | Peds | App. Total | Right                   | Thru | Left | Peds | App. Total | Right                             | Thru | Left | Peds | App. Total | Right             | Thru | Left | Peds | App. Total |            |
| 07:00 AM    | 5                                 | 121  | 0    | 0    | 126        | 0                       | 0    | 0    | 1    | 1          | 0                                 | 29   | 15   | 0    | 44         | 21                | 0    | 7    | 0    | 28         | 199        |
| 07:15 AM    | 19                                | 239  | 0    | 0    | 258        | 0                       | 0    | 0    | 0    | 0          | 0                                 | 57   | 17   | 0    | 74         | 60                | 0    | 14   | 2    | 76         | 408        |
| 07:30 AM    | 19                                | 258  | 0    | 0    | 277        | 0                       | 0    | 0    | 0    | 0          | 0                                 | 103  | 26   | 0    | 129        | 99                | 0    | 31   | 0    | 130        | 536        |
| 07:45 AM    | 42                                | 230  | 0    | 1    | 273        | 0                       | 0    | 0    | 0    | 0          | 1                                 | 122  | 48   | 0    | 171        | 111               | 0    | 34   | 0    | 145        | 589        |
| Total       | 85                                | 848  | 0    | 1    | 934        | 0                       | 0    | 0    | 1    | 1          | 1                                 | 311  | 106  | 0    | 418        | 291               | 0    | 86   | 2    | 379        | 1732       |
| 08:00 AM    | 37                                | 198  | 0    | 0    | 235        | 0                       | 0    | 0    | 0    | 0          | 0                                 | 68   | 93   | 0    | 161        | 104               | 0    | 29   | 2    | 135        | 531        |
| 08:15 AM    | 37                                | 188  | 0    | 0    | 225        | 0                       | 0    | 0    | 0    | 0          | 0                                 | 46   | 54   | 0    | 100        | 116               | 0    | 20   | 0    | 136        | 461        |
| 08:30 AM    | 8                                 | 125  | 0    | 0    | 133        | 0                       | 0    | 0    | 0    | 0          | 0                                 | 38   | 14   | 0    | 52         | 49                | 0    | 10   | 2    | 61         | 246        |
| 08:45 AM    | 9                                 | 102  | 0    | 0    | 111        | 0                       | 0    | 0    | 0    | 0          | 0                                 | 49   | 11   | 0    | 60         | 21                | 0    | 6    | 1    | 28         | 199        |
| Total       | 91                                | 613  | 0    | 0    | 704        | 0                       | 0    | 0    | 0    | 0          | 0                                 | 201  | 172  | 0    | 373        | 290               | 0    | 65   | 5    | 360        | 1437       |
| Grand Total | 176                               | 1461 | 0    | 1    | 1638       | 0                       | 0    | 0    | 1    | 1          | 1                                 | 512  | 278  | 0    | 791        | 581               | 0    | 151  | 7    | 739        | 3169       |
| Apprch %    | 10.7                              | 89.2 | 0    | 0.1  |            | 0                       | 0    | 0    | 100  |            | 0.1                               | 64.7 | 35.1 | 0    |            | 78.6              | 0    | 20.4 | 0.9  |            |            |
| Total %     | 5.6                               | 46.1 | 0    | 0    | 51.7       | 0                       | 0    | 0    | 0    | 0          | 0                                 | 16.2 | 8.8  | 0    | 25         | 18.3              | 0    | 4.8  | 0.2  | 23.3       |            |
| Lights      | 170                               | 1431 | 0    | 1    | 1602       | 0                       | 0    | 0    | 1    | 1          | 1                                 | 506  | 272  | 0    | 779        | 568               | 0    | 149  | 7    | 724        | 3106       |
| % Lights    | 96.6                              | 97.9 | 0    | 100  | 97.8       | 0                       | 0    | 0    | 100  | 100        | 100                               | 98.8 | 97.8 | 0    | 98.5       | 97.8              | 0    | 98.7 | 100  | 98         | 98         |
| Buses       | 5                                 | 15   | 0    | 0    | 20         | 0                       | 0    | 0    | 0    | 0          | 0                                 | 4    | 5    | 0    | 9          | 9                 | 0    | 2    | 0    | 11         | 40         |
| % Buses     | 2.8                               | 1    | 0    | 0    | 1.2        | 0                       | 0    | 0    | 0    | 0          | 0                                 | 0.8  | 1.8  | 0    | 1.1        | 1.5               | 0    | 1.3  | 0    | 1.5        | 1.3        |
| Trucks      | 1                                 | 15   | 0    | 0    | 16         | 0                       | 0    | 0    | 0    | 0          | 0                                 | 2    | 1    | 0    | 3          | 4                 | 0    | 0    | 0    | 4          | 23         |
| % Trucks    | 0.6                               | 1    | 0    | 0    | 1          | 0                       | 0    | 0    | 0    | 0          | 0                                 | 0.4  | 0.4  | 0    | 0.4        | 0.7               | 0    | 0    | 0    | 0.5        | 0.7        |

| Start Time   | GENERAL JIM MOORE BLVD Southbound |            |      |      |            | EUCALYPTUS RD Westbound |      |      |      |            | GENERAL JIM MOORE BLVD Northbound |            |           |            |            | COE AVE Eastbound |           |            |      |            | Int. Total |
|--|-----------------------------------|------------|------|------|------------|-------------------------|------|------|------|------------|-----------------------------------|------------|-----------|------------|------------|-------------------|-----------|------------|------|------------|------------|
|  | Right                             | Thru       | Left | Peds | App. Total | Right                   | Thru | Left | Peds | App. Total | Right                             | Thru       | Left      | Peds       | App. Total | Right             | Thru      | Left       | Peds | App. Total |            |
| Peak Hour Analysis From 07:00 AM to 08:45 AM - Peak 1 of 1 |                                   |            |      |      |            |                         |      |      |      |            |                                   |            |           |            |            |                   |           |            |      |            |            |
| Peak Hour for Entire Intersection Begins at 07:30 AM       |                                   |            |      |      |            |                         |      |      |      |            |                                   |            |           |            |            |                   |           |            |      |            |            |
| 07:30 AM   | 19                                | <b>258</b> | 0    |      | <b>277</b> | 0                       | 0    | 0    | 0    |            | 0                                 | 103        | 26        | 129        | 99         | 0                 | 31        | 130        |      | 536        |            |
| 07:45 AM   | <b>42</b>                         | 230        | 0    |      | 272        | 0                       | 0    | 0    | 0    |            | <b>1</b>                          | <b>122</b> | 48        | <b>171</b> | 111        | 0                 | <b>34</b> | <b>145</b> |      | <b>588</b> |            |
| 08:00 AM   | 37                                | 198        | 0    |      | 235        | 0                       | 0    | 0    | 0    |            | 0                                 | 68         | <b>93</b> | 161        | 104        | 0                 | 29        | 133        |      | 529        |            |
| 08:15 AM   | 37                                | 188        | 0    |      | 225        | 0                       | 0    | 0    | 0    |            | 0                                 | 46         | 54        | 100        | <b>116</b> | 0                 | 20        | 136        |      | 461        |            |
| Total Volume   | 135                               | 874        | 0    |      | 1009       | 0                       | 0    | 0    | 0    |            | 1                                 | 339        | 221       | 561        | 430        | 0                 | 114       | 544        |      | 2114       |            |
| % App. Total   | 13.4                              | 86.6       | 0    |      |            | 0                       | 0    | 0    | 0    |            | 0.2                               | 60.4       | 39.4      |            | 79         | 0                 | 21        |            |      |            |            |
| PHF  | .804                              | .847       | .000 |      | .911       | .000                    | .000 | .000 | .000 |            | .250                              | .695       | .594      | .820       | .927       | .000              | .838      | .938       |      | .899       |            |

# Traffic Data Service

San Jose, CA  
 (408) 622-4787  
 tdsbay@cs.com

File Name : 19AM FINAL  
 Site Code : 00000019  
 Start Date : 4/25/2018  
 Page No : 2

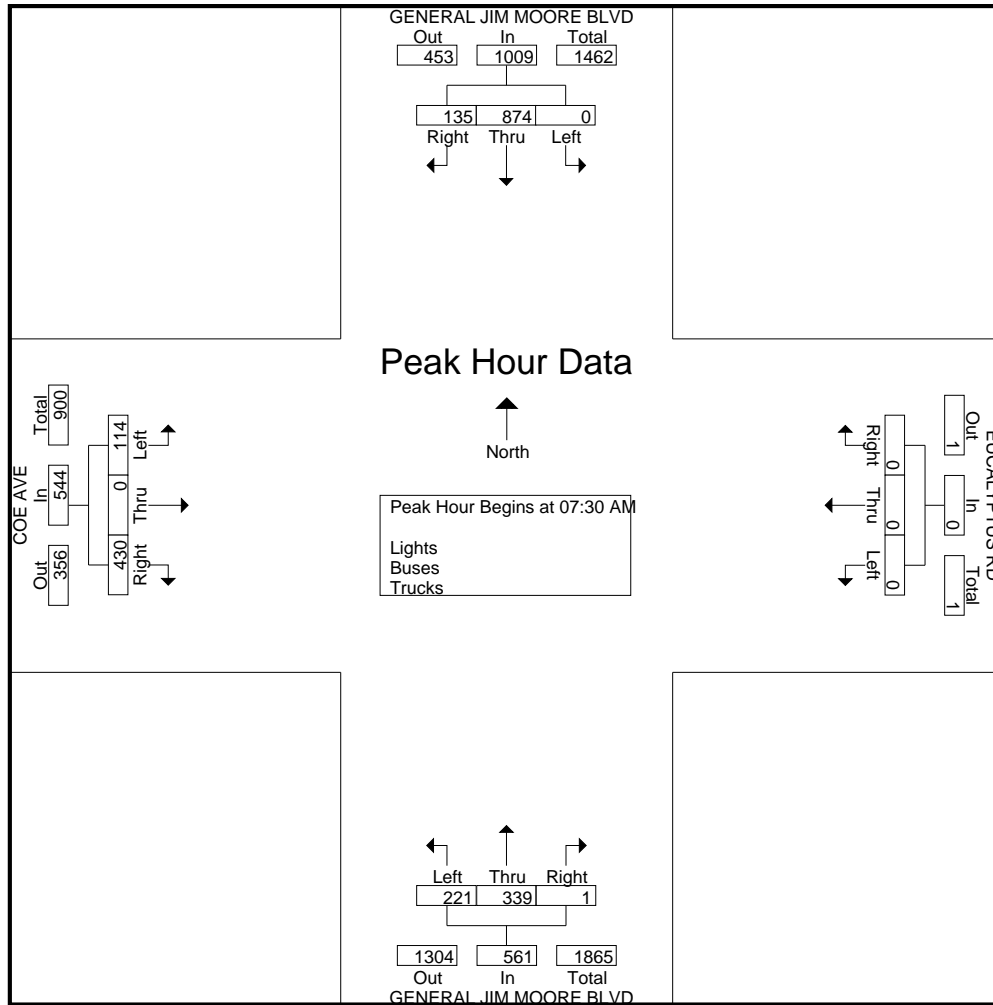

# Traffic Data Service

San Jose, CA  
 (408) 622-4787  
 tdsbay@cs.com

File Name : 19AM FINAL  
 Site Code : 00000019  
 Start Date : 4/25/2018  
 Page No : 1

Groups Printed- Bikes

| Start Time  | GENERAL JIM MOORE BLVD Southbound |      |      |      |            | EUCALYPTUS RD Westbound |      |      |      |            | GENERAL JIM MOORE BLVD Northbound |      |      |      |            | COE AVE Eastbound |      |      |      |            | Int. Total |
|-------------|-----------------------------------|------|------|------|------------|-------------------------|------|------|------|------------|-----------------------------------|------|------|------|------------|-------------------|------|------|------|------------|------------|
|             | Right                             | Thru | Left | Peds | App. Total | Right                   | Thru | Left | Peds | App. Total | Right                             | Thru | Left | Peds | App. Total | Right             | Thru | Left | Peds | App. Total |            |
| 07:00 AM    | 0                                 | 0    | 0    | 0    | 0          | 0                       | 0    | 0    | 0    | 0          | 0                                 | 1    | 0    | 0    | 1          | 0                 | 0    | 0    | 0    | 0          | 0          |
| 07:15 AM    | 0                                 | 0    | 0    | 0    | 0          | 0                       | 0    | 0    | 0    | 0          | 0                                 | 0    | 0    | 0    | 0          | 0                 | 0    | 0    | 0    | 0          | 0          |
| 07:30 AM    | 0                                 | 0    | 0    | 0    | 0          | 0                       | 0    | 0    | 0    | 0          | 0                                 | 0    | 0    | 0    | 0          | 0                 | 0    | 0    | 0    | 0          | 0          |
| 07:45 AM    | 0                                 | 0    | 0    | 0    | 0          | 0                       | 0    | 0    | 0    | 0          | 0                                 | 0    | 0    | 0    | 0          | 0                 | 0    | 0    | 0    | 0          | 0          |
| Total       | 0                                 | 0    | 0    | 0    | 0          | 0                       | 0    | 0    | 0    | 0          | 0                                 | 1    | 0    | 0    | 1          | 0                 | 0    | 0    | 0    | 0          | 0          |
| 08:00 AM    | 0                                 | 0    | 0    | 0    | 0          | 0                       | 0    | 0    | 0    | 0          | 0                                 | 0    | 0    | 0    | 0          | 0                 | 0    | 0    | 0    | 0          | 0          |
| 08:15 AM    | 0                                 | 1    | 0    | 0    | 1          | 0                       | 0    | 0    | 0    | 0          | 0                                 | 1    | 0    | 0    | 1          | 0                 | 0    | 0    | 0    | 0          | 2          |
| 08:30 AM    | 0                                 | 0    | 0    | 0    | 0          | 0                       | 0    | 0    | 0    | 0          | 0                                 | 0    | 0    | 0    | 0          | 0                 | 0    | 0    | 0    | 0          | 0          |
| 08:45 AM    | 0                                 | 0    | 0    | 0    | 0          | 0                       | 0    | 0    | 0    | 0          | 1                                 | 1    | 0    | 0    | 2          | 0                 | 0    | 0    | 0    | 0          | 2          |
| Total       | 0                                 | 1    | 0    | 0    | 1          | 0                       | 0    | 0    | 0    | 0          | 1                                 | 2    | 0    | 0    | 3          | 0                 | 0    | 0    | 0    | 0          | 4          |
| Grand Total | 0                                 | 1    | 0    | 0    | 1          | 0                       | 0    | 0    | 0    | 0          | 1                                 | 3    | 0    | 0    | 4          | 0                 | 0    | 0    | 0    | 0          | 5          |
| Apprch %    | 0                                 | 100  | 0    | 0    |            | 0                       | 0    | 0    | 0    |            | 25                                | 75   | 0    | 0    |            | 0                 | 0    | 0    | 0    |            |            |
| Total %     | 0                                 | 20   | 0    | 0    | 20         | 0                       | 0    | 0    | 0    | 0          | 20                                | 60   | 0    | 0    | 80         | 0                 | 0    | 0    | 0    | 0          |            |

| Start Time   | GENERAL JIM MOORE BLVD Southbound |      |      |      |            | EUCALYPTUS RD Westbound |      |      |      |            | GENERAL JIM MOORE BLVD Northbound |      |      |      |            | COE AVE Eastbound |      |      |      |            | Int. Total |
|--|-----------------------------------|------|------|------|------------|-------------------------|------|------|------|------------|-----------------------------------|------|------|------|------------|-------------------|------|------|------|------------|------------|
|  | Right                             | Thru | Left | Peds | App. Total | Right                   | Thru | Left | Peds | App. Total | Right                             | Thru | Left | Peds | App. Total | Right             | Thru | Left | Peds | App. Total |            |
| Peak Hour Analysis From 07:00 AM to 08:45 AM - Peak 1 of 1 |                                   |      |      |      |            |                         |      |      |      |            |                                   |      |      |      |            |                   |      |      |      |            |            |
| Peak Hour for Entire Intersection Begins at 08:00 AM       |                                   |      |      |      |            |                         |      |      |      |            |                                   |      |      |      |            |                   |      |      |      |            |            |
| 08:00 AM   | 0                                 | 0    | 0    | 0    | 0          | 0                       | 0    | 0    | 0    | 0          | 0                                 | 0    | 0    | 0    | 0          | 0                 | 0    | 0    | 0    | 0          | 0          |
| 08:15 AM   | 0                                 | 1    | 0    | 0    | 1          | 0                       | 0    | 0    | 0    | 0          | 0                                 | 1    | 0    | 0    | 1          | 0                 | 0    | 0    | 0    | 0          | 2          |
| 08:30 AM   | 0                                 | 0    | 0    | 0    | 0          | 0                       | 0    | 0    | 0    | 0          | 0                                 | 0    | 0    | 0    | 0          | 0                 | 0    | 0    | 0    | 0          | 0          |
| 08:45 AM   | 0                                 | 0    | 0    | 0    | 0          | 0                       | 0    | 0    | 0    | 0          | 1                                 | 1    | 0    | 0    | 2          | 0                 | 0    | 0    | 0    | 0          | 2          |
| Total Volume   | 0                                 | 1    | 0    | 0    | 1          | 0                       | 0    | 0    | 0    | 0          | 1                                 | 2    | 0    | 0    | 3          | 0                 | 0    | 0    | 0    | 0          | 4          |
| % App. Total   | 0                                 | 100  | 0    | 0    |            | 0                       | 0    | 0    | 0    |            | 33.3                              | 66.7 | 0    | 0    |            | 0                 | 0    | 0    | 0    |            |            |
| PHF  | .000                              | .250 | .000 | .000 | .250       | .000                    | .000 | .000 | .000 | .000       | .250                              | .500 | .000 | .375 | .375       | .000              | .000 | .000 | .000 | .000       | .500       |

# Traffic Data Service

San Jose, CA  
 (408) 622-4787  
 tdsbay@cs.com

File Name : 19AM FINAL  
 Site Code : 00000019  
 Start Date : 4/25/2018  
 Page No : 2

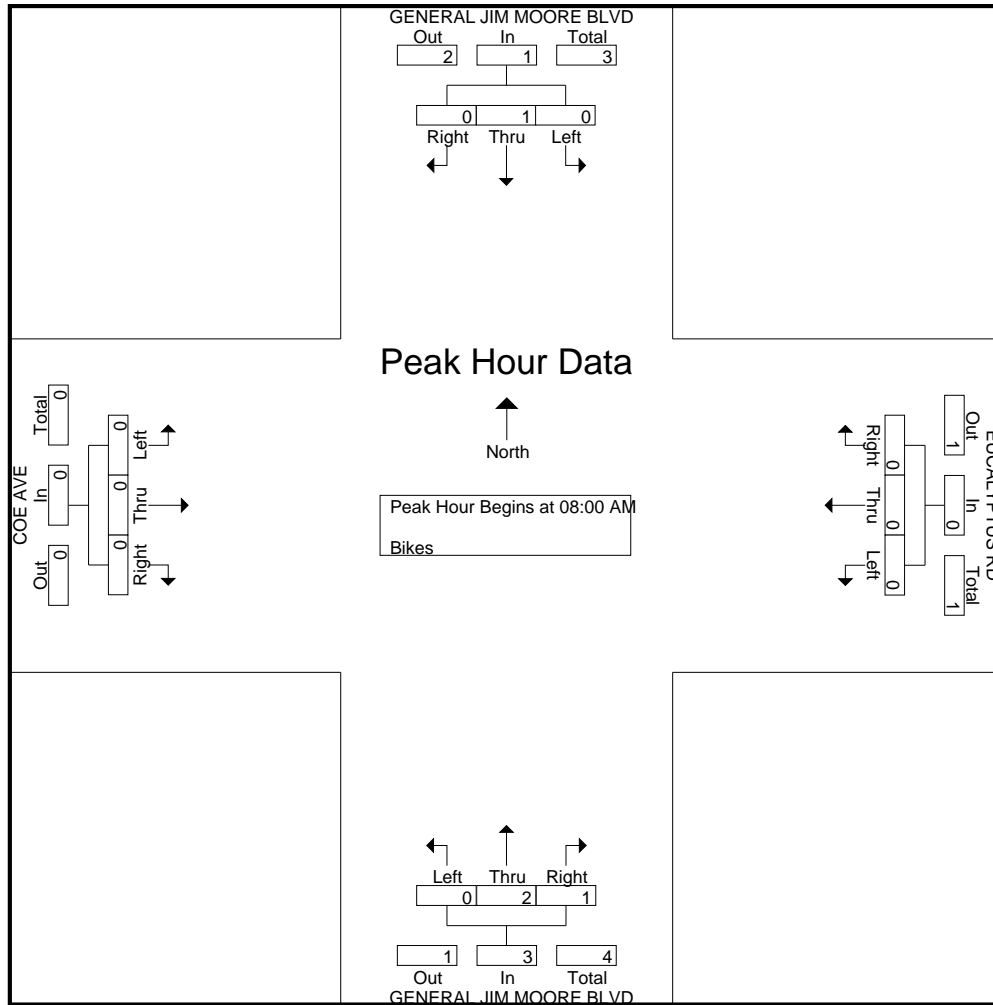

# Traffic Data Service

San Jose, CA  
(408) 622-4787  
tdsbay@cs.com

File Name : 19PM FINAL  
Site Code : 00000019  
Start Date : 4/25/2018  
Page No : 1

Groups Printed- Lights - Buses - Trucks

| Start Time   | GENERAL JIM MOORE BLVD Southbound |            |          |          |            | EUCALYPTUS RD Westbound |          |          |          |            | GENERAL JIM MOORE BLVD Northbound |            |            |          |            | COE AVE Eastbound |          |           |          |            | Int. Total  |
|--------------|-----------------------------------|------------|----------|----------|------------|-------------------------|----------|----------|----------|------------|-----------------------------------|------------|------------|----------|------------|-------------------|----------|-----------|----------|------------|-------------|
|              | Right                             | Thru       | Left     | Peds     | App. Total | Right                   | Thru     | Left     | Peds     | App. Total | Right                             | Thru       | Left       | Peds     | App. Total | Right             | Thru     | Left      | Peds     | App. Total |             |
| 04:00 PM     | 16                                | 77         | 0        | 0        | 93         | 0                       | 0        | 1        | 0        | 1          | 3                                 | 139        | 26         | 0        | 168        | 14                | 0        | 9         | 1        | 24         | 286         |
| 04:15 PM     | 12                                | 54         | 0        | 0        | 66         | 0                       | 1        | 0        | 0        | 1          | 1                                 | 130        | 40         | 3        | 174        | 13                | 0        | 2         | 0        | 15         | 256         |
| 04:30 PM     | 13                                | 60         | 0        | 0        | 73         | 1                       | 0        | 1        | 1        | 3          | 2                                 | 170        | 28         | 0        | 200        | 14                | 1        | 19        | 0        | 34         | 310         |
| 04:45 PM     | 20                                | 89         | 0        | 3        | 112        | 2                       | 1        | 0        | 2        | 5          | 0                                 | 197        | 35         | 3        | 235        | 17                | 0        | 12        | 0        | 29         | 381         |
| <b>Total</b> | <b>61</b>                         | <b>280</b> | <b>0</b> | <b>3</b> | <b>344</b> | <b>3</b>                | <b>2</b> | <b>2</b> | <b>3</b> | <b>10</b>  | <b>6</b>                          | <b>636</b> | <b>129</b> | <b>6</b> | <b>777</b> | <b>58</b>         | <b>1</b> | <b>42</b> | <b>1</b> | <b>102</b> | <b>1233</b> |
| 05:00 PM     | 20                                | 83         | 1        | 2        | 106        | 0                       | 0        | 0        | 3        | 3          | 1                                 | 203        | 42         | 1        | 247        | 22                | 0        | 10        | 0        | 32         | 388         |
| 05:15 PM     | 22                                | 80         | 1        | 1        | 104        | 0                       | 0        | 3        | 0        | 3          | 1                                 | 227        | 39         | 0        | 267        | 38                | 1        | 20        | 1        | 60         | 434         |
| 05:30 PM     | 23                                | 56         | 0        | 2        | 81         | 0                       | 0        | 0        | 0        | 0          | 1                                 | 211        | 37         | 2        | 251        | 20                | 0        | 10        | 0        | 30         | 362         |
| 05:45 PM     | 21                                | 62         | 1        | 1        | 85         | 0                       | 0        | 1        | 2        | 3          | 1                                 | 139        | 26         | 3        | 169        | 17                | 0        | 18        | 0        | 35         | 292         |
| <b>Total</b> | <b>86</b>                         | <b>281</b> | <b>3</b> | <b>6</b> | <b>376</b> | <b>0</b>                | <b>0</b> | <b>4</b> | <b>5</b> | <b>9</b>   | <b>4</b>                          | <b>780</b> | <b>144</b> | <b>6</b> | <b>934</b> | <b>97</b>         | <b>1</b> | <b>58</b> | <b>1</b> | <b>157</b> | <b>1476</b> |
| Grand Total  | 147                               | 561        | 3        | 9        | 720        | 3                       | 2        | 6        | 8        | 19         | 10                                | 1416       | 273        | 12       | 1711       | 155               | 2        | 100       | 2        | 259        | 2709        |
| Apprch %     | 20.4                              | 77.9       | 0.4      | 1.2      |            | 15.8                    | 10.5     | 31.6     | 42.1     |            | 0.6                               | 82.8       | 16         | 0.7      |            | 59.8              | 0.8      | 38.6      | 0.8      |            |             |
| Total %      | 5.4                               | 20.7       | 0.1      | 0.3      | 26.6       | 0.1                     | 0.1      | 0.2      | 0.3      | 0.7        | 0.4                               | 52.3       | 10.1       | 0.4      | 63.2       | 5.7               | 0.1      | 3.7       | 0.1      | 9.6        |             |
| Lights       | 144                               | 555        | 3        | 9        | 711        | 3                       | 2        | 6        | 8        | 19         | 10                                | 1404       | 272        | 12       | 1698       | 154               | 2        | 99        | 2        | 257        | 2685        |
| % Lights     | 98                                | 98.9       | 100      | 100      | 98.8       | 100                     | 100      | 100      | 100      | 100        | 100                               | 99.2       | 99.6       | 100      | 99.2       | 99.4              | 100      | 99        | 100      | 99.2       | 99.1        |
| Buses        | 1                                 | 0          | 0        | 0        | 1          | 0                       | 0        | 0        | 0        | 0          | 0                                 | 2          | 0          | 0        | 2          | 1                 | 0        | 1         | 0        | 2          | 5           |
| % Buses      | 0.7                               | 0          | 0        | 0        | 0.1        | 0                       | 0        | 0        | 0        | 0          | 0                                 | 0.1        | 0          | 0        | 0.1        | 0.6               | 0        | 1         | 0        | 0.8        | 0.2         |
| Trucks       | 2                                 | 6          | 0        | 0        | 8          | 0                       | 0        | 0        | 0        | 0          | 0                                 | 10         | 1          | 0        | 11         | 0                 | 0        | 0         | 0        | 0          | 19          |
| % Trucks     | 1.4                               | 1.1        | 0        | 0        | 1.1        | 0                       | 0        | 0        | 0        | 0          | 0                                 | 0.7        | 0.4        | 0        | 0.6        | 0                 | 0        | 0         | 0        | 0          | 0.7         |

| Start Time   | GENERAL JIM MOORE BLVD Southbound |           |      |            |            | EUCALYPTUS RD Westbound |          |      |          |            | GENERAL JIM MOORE BLVD Northbound |      |      |      |            | COE AVE Eastbound |      |      |      |            | Int. Total |
|--|-----------------------------------|-----------|------|------------|------------|-------------------------|----------|------|----------|------------|-----------------------------------|------|------|------|------------|-------------------|------|------|------|------------|------------|
|  | Right                             | Thru      | Left | Peds       | App. Total | Right                   | Thru     | Left | Peds     | App. Total | Right                             | Thru | Left | Peds | App. Total | Right             | Thru | Left | Peds | App. Total |            |
| Peak Hour Analysis From 04:00 PM to 05:45 PM - Peak 1 of 1 |                                   |           |      |            |            |                         |          |      |          |            |                                   |      |      |      |            |                   |      |      |      |            |            |
| Peak Hour for Entire Intersection Begins at 04:45 PM       |                                   |           |      |            |            |                         |          |      |          |            |                                   |      |      |      |            |                   |      |      |      |            |            |
| 04:45 PM   | 20                                | <b>89</b> | 0    | <b>109</b> |            | <b>2</b>                | <b>1</b> | 0    | <b>3</b> |            | 0                                 | 197  | 35   | 232  | 17         | 0                 | 12   | 29   | 373  |            |            |
| 05:00 PM   | 20                                | 83        | 1    | 104        |            | 0                       | 0        | 0    | 0        |            | 1                                 | 203  | 42   | 246  | 22         | 0                 | 10   | 32   | 382  |            |            |
| 05:15 PM   | 22                                | 80        | 1    | 103        |            | 0                       | 0        | 3    | 3        |            | 1                                 | 227  | 39   | 267  | 38         | 1                 | 20   | 59   | 432  |            |            |
| 05:30 PM   | 23                                | 56        | 0    | 79         |            | 0                       | 0        | 0    | 0        |            | 1                                 | 211  | 37   | 249  | 20         | 0                 | 10   | 30   | 358  |            |            |
| Total Volume   | 85                                | 308       | 2    | 395        |            | 2                       | 1        | 3    | 6        |            | 3                                 | 838  | 153  | 994  | 97         | 1                 | 52   | 150  | 1545 |            |            |
| % App. Total   | 21.5                              | 78        | 0.5  |            |            | 33.3                    | 16.7     | 50   |          |            | 0.3                               | 84.3 | 15.4 |      | 64.7       | 0.7               | 34.7 |      |      |            |            |
| PHF  | .924                              | .865      | .500 | .906       |            | .250                    | .250     | .250 | .500     |            | .750                              | .923 | .911 | .931 | .638       | .250              | .650 | .636 |      | .894       |            |

# Traffic Data Service

San Jose, CA  
 (408) 622-4787  
 tdsbay@cs.com

File Name : 19PM FINAL  
 Site Code : 00000019  
 Start Date : 4/25/2018  
 Page No : 2

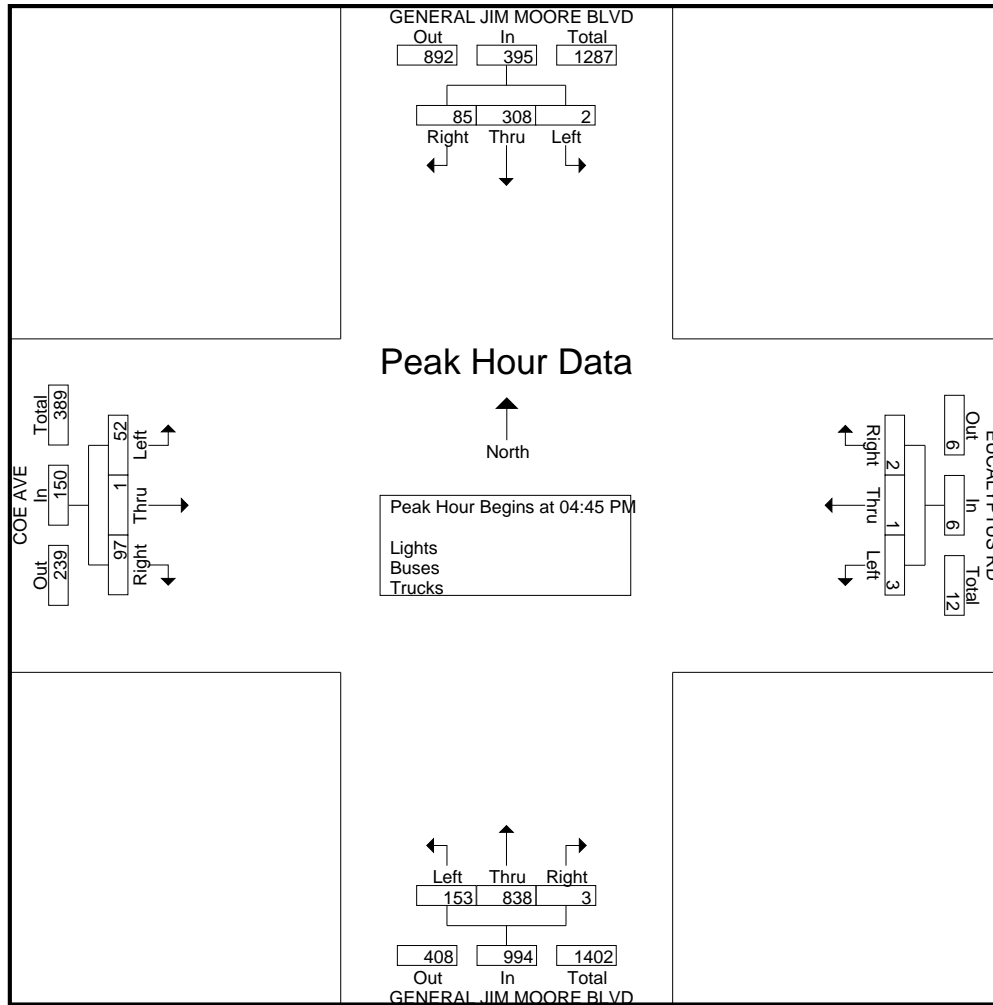

# Traffic Data Service

San Jose, CA  
 (408) 622-4787  
 tdsbay@cs.com

File Name : 19PM FINAL  
 Site Code : 00000019  
 Start Date : 4/25/2018  
 Page No : 1

Groups Printed- Bikes

| Start Time  | GENERAL JIM MOORE BLVD Southbound |      |      |      |            | EUCALYPTUS RD Westbound |      |      |      |            | GENERAL JIM MOORE BLVD Northbound |      |      |      |            | COE AVE Eastbound |      |      |      |            | Int. Total |   |   |   |   |   |
|-------------|-----------------------------------|------|------|------|------------|-------------------------|------|------|------|------------|-----------------------------------|------|------|------|------------|-------------------|------|------|------|------------|------------|---|---|---|---|---|
|             | Right                             | Thru | Left | Peds | App. Total | Right                   | Thru | Left | Peds | App. Total | Right                             | Thru | Left | Peds | App. Total | Right             | Thru | Left | Peds | App. Total |            |   |   |   |   |   |
| 04:00 PM    | 0                                 | 0    | 0    | 0    | 0          | 0                       | 0    | 0    | 0    | 0          | 0                                 | 0    | 0    | 0    | 0          | 0                 | 0    | 0    | 0    | 0          | 0          | 0 | 0 | 0 | 0 | 0 |
| 04:15 PM    | 0                                 | 1    | 0    | 0    | 1          | 0                       | 0    | 1    | 0    | 1          | 0                                 | 0    | 0    | 0    | 0          | 0                 | 0    | 0    | 0    | 0          | 0          | 0 | 0 | 0 | 0 | 2 |
| 04:30 PM    | 0                                 | 0    | 0    | 0    | 0          | 0                       | 0    | 0    | 0    | 0          | 0                                 | 0    | 0    | 0    | 0          | 0                 | 0    | 0    | 0    | 0          | 0          | 0 | 0 | 0 | 0 | 0 |
| 04:45 PM    | 0                                 | 0    | 0    | 0    | 0          | 0                       | 0    | 0    | 0    | 0          | 0                                 | 1    | 0    | 0    | 1          | 0                 | 0    | 0    | 0    | 0          | 0          | 0 | 0 | 0 | 0 | 1 |
| Total       | 0                                 | 1    | 0    | 0    | 1          | 0                       | 0    | 1    | 0    | 1          | 0                                 | 1    | 0    | 0    | 1          | 0                 | 0    | 0    | 0    | 0          | 0          | 0 | 0 | 0 | 0 | 3 |
| 05:00 PM    | 0                                 | 0    | 0    | 0    | 0          | 0                       | 0    | 0    | 0    | 0          | 0                                 | 0    | 0    | 0    | 0          | 0                 | 0    | 0    | 0    | 0          | 0          | 0 | 0 | 0 | 0 | 0 |
| 05:15 PM    | 0                                 | 1    | 0    | 0    | 1          | 0                       | 0    | 0    | 0    | 0          | 0                                 | 0    | 0    | 0    | 0          | 0                 | 0    | 0    | 0    | 0          | 0          | 0 | 0 | 0 | 0 | 1 |
| 05:30 PM    | 0                                 | 1    | 0    | 0    | 1          | 0                       | 0    | 0    | 0    | 0          | 0                                 | 0    | 1    | 0    | 1          | 0                 | 0    | 0    | 0    | 0          | 0          | 0 | 0 | 0 | 0 | 2 |
| 05:45 PM    | 0                                 | 0    | 0    | 0    | 0          | 0                       | 0    | 0    | 0    | 0          | 0                                 | 0    | 0    | 0    | 0          | 0                 | 0    | 0    | 0    | 0          | 0          | 0 | 0 | 0 | 0 | 0 |
| Total       | 0                                 | 2    | 0    | 0    | 2          | 0                       | 0    | 0    | 0    | 0          | 0                                 | 0    | 1    | 0    | 1          | 0                 | 0    | 0    | 0    | 0          | 0          | 0 | 0 | 0 | 0 | 3 |
| Grand Total | 0                                 | 3    | 0    | 0    | 3          | 0                       | 0    | 1    | 0    | 1          | 0                                 | 1    | 1    | 0    | 2          | 0                 | 0    | 0    | 0    | 0          | 0          | 0 | 0 | 0 | 0 | 6 |
| Apprch %    | 0                                 | 100  | 0    | 0    |            | 0                       | 0    | 100  | 0    |            | 0                                 | 50   | 50   | 0    |            | 0                 | 0    | 0    | 0    |            | 0          | 0 | 0 | 0 |   |   |
| Total %     | 0                                 | 50   | 0    | 0    | 50         | 0                       | 0    | 16.7 | 0    | 16.7       | 0                                 | 16.7 | 16.7 | 0    | 33.3       | 0                 | 0    | 0    | 0    | 0          | 0          | 0 | 0 | 0 | 0 |   |

| Start Time   | GENERAL JIM MOORE BLVD Southbound |      |      |      |            | EUCALYPTUS RD Westbound |      |      |      |            | GENERAL JIM MOORE BLVD Northbound |      |      |      |            | COE AVE Eastbound |      |      |      |            | Int. Total |      |      |      |      |   |
|--|-----------------------------------|------|------|------|------------|-------------------------|------|------|------|------------|-----------------------------------|------|------|------|------------|-------------------|------|------|------|------------|------------|------|------|------|------|---|
|  | Right                             | Thru | Left | Peds | App. Total | Right                   | Thru | Left | Peds | App. Total | Right                             | Thru | Left | Peds | App. Total | Right             | Thru | Left | Peds | App. Total |            |      |      |      |      |   |
| Peak Hour Analysis From 04:00 PM to 05:45 PM - Peak 1 of 1 |                                   |      |      |      |            |                         |      |      |      |            |                                   |      |      |      |            |                   |      |      |      |            |            |      |      |      |      |   |
| Peak Hour for Entire Intersection Begins at 04:45 PM       |                                   |      |      |      |            |                         |      |      |      |            |                                   |      |      |      |            |                   |      |      |      |            |            |      |      |      |      |   |
| 04:45 PM   | 0                                 | 0    | 0    | 0    | 0          | 0                       | 0    | 0    | 0    | 0          | 0                                 | 1    | 0    | 0    | 1          | 0                 | 0    | 0    | 0    | 0          | 0          | 0    | 0    | 0    | 0    | 1 |
| 05:00 PM   | 0                                 | 0    | 0    | 0    | 0          | 0                       | 0    | 0    | 0    | 0          | 0                                 | 0    | 0    | 0    | 0          | 0                 | 0    | 0    | 0    | 0          | 0          | 0    | 0    | 0    | 0    | 0 |
| 05:15 PM   | 0                                 | 1    | 0    | 0    | 1          | 0                       | 0    | 0    | 0    | 0          | 0                                 | 0    | 0    | 0    | 0          | 0                 | 0    | 0    | 0    | 0          | 0          | 0    | 0    | 0    | 0    | 1 |
| 05:30 PM   | 0                                 | 1    | 0    | 0    | 1          | 0                       | 0    | 0    | 0    | 0          | 0                                 | 0    | 1    | 0    | 1          | 0                 | 0    | 0    | 0    | 0          | 0          | 0    | 0    | 0    | 0    | 2 |
| Total Volume   | 0                                 | 2    | 0    | 0    | 2          | 0                       | 0    | 0    | 0    | 0          | 0                                 | 1    | 1    | 0    | 2          | 0                 | 0    | 0    | 0    | 0          | 0          | 0    | 0    | 0    | 0    | 4 |
| % App. Total   | 0                                 | 100  | 0    | 0    |            | 0                       | 0    | 0    | 0    |            | 0                                 | 50   | 50   | 0    |            | 0                 | 0    | 0    | 0    |            | 0          | 0    | 0    | 0    |      |   |
| PHF  | .000                              | .500 | .000 | .000 | .500       | .000                    | .000 | .000 | .000 | .000       | .000                              | .250 | .250 | .000 | .500       | .000              | .000 | .000 | .000 | .000       | .000       | .000 | .000 | .000 | .500 |   |

# Traffic Data Service

San Jose, CA  
 (408) 622-4787  
 tdsbay@cs.com

File Name : 19PM FINAL  
 Site Code : 00000019  
 Start Date : 4/25/2018  
 Page No : 2

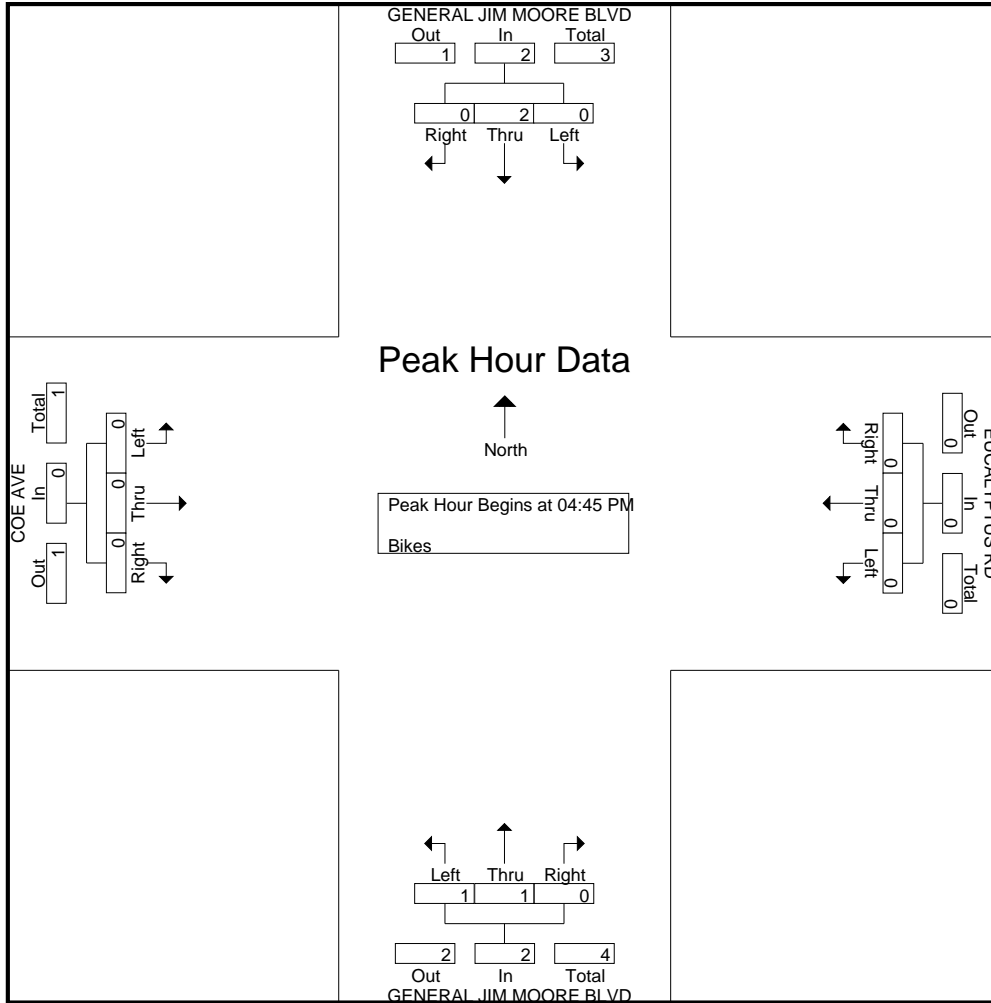



# Traffic Data Service

San Jose, CA  
 (408) 622-4787  
 tdsbay@cs.com

File Name : 20AM FINAL  
 Site Code : 00000020  
 Start Date : 4/25/2018  
 Page No : 1

Groups Printed- Lights - Buses - Trucks

| Start Time  | HWY 1 RAMPS<br>Southbound |      |      |      |            | MONTEREY RD<br>Westbound |      |      |      |            | FREMONT BLVD<br>Northbound |      |      |      |            | MONTEREY RD<br>Eastbound |      |      |      |            | Int. Total |
|-------------|---------------------------|------|------|------|------------|--------------------------|------|------|------|------------|----------------------------|------|------|------|------------|--------------------------|------|------|------|------------|------------|
|             | Right                     | Thru | Left | Peds | App. Total | Right                    | Thru | Left | Peds | App. Total | Right                      | Thru | Left | Peds | App. Total | Right                    | Thru | Left | Peds | App. Total |            |
| 07:00 AM    | 49                        | 179  | 15   | 0    | 243        | 15                       | 78   | 17   | 0    | 110        | 11                         | 94   | 29   | 3    | 137        | 7                        | 8    | 14   | 0    | 29         | 519        |
| 07:15 AM    | 51                        | 187  | 19   | 0    | 257        | 7                        | 66   | 20   | 0    | 93         | 11                         | 109  | 49   | 6    | 175        | 8                        | 25   | 16   | 1    | 50         | 575        |
| 07:30 AM    | 41                        | 174  | 30   | 0    | 245        | 4                        | 78   | 22   | 0    | 104        | 30                         | 130  | 49   | 3    | 212        | 22                       | 39   | 19   | 3    | 83         | 644        |
| 07:45 AM    | 40                        | 197  | 36   | 0    | 273        | 7                        | 70   | 29   | 0    | 106        | 59                         | 142  | 53   | 1    | 255        | 21                       | 46   | 18   | 5    | 90         | 724        |
| Total       | 181                       | 737  | 100  | 0    | 1018       | 33                       | 292  | 88   | 0    | 413        | 111                        | 475  | 180  | 13   | 779        | 58                       | 118  | 67   | 9    | 252        | 2462       |
| 08:00 AM    | 35                        | 216  | 19   | 0    | 270        | 2                        | 64   | 29   | 0    | 95         | 28                         | 127  | 39   | 5    | 199        | 18                       | 30   | 16   | 4    | 68         | 632        |
| 08:15 AM    | 37                        | 217  | 8    | 1    | 263        | 6                        | 71   | 33   | 0    | 110        | 23                         | 107  | 52   | 4    | 186        | 33                       | 21   | 16   | 1    | 71         | 630        |
| 08:30 AM    | 34                        | 191  | 6    | 1    | 232        | 7                        | 57   | 32   | 0    | 96         | 12                         | 124  | 50   | 8    | 194        | 21                       | 25   | 27   | 0    | 73         | 595        |
| 08:45 AM    | 37                        | 207  | 6    | 1    | 251        | 5                        | 59   | 35   | 0    | 99         | 18                         | 103  | 45   | 1    | 167        | 21                       | 25   | 19   | 1    | 66         | 583        |
| Total       | 143                       | 831  | 39   | 3    | 1016       | 20                       | 251  | 129  | 0    | 400        | 81                         | 461  | 186  | 18   | 746        | 93                       | 101  | 78   | 6    | 278        | 2440       |
| Grand Total | 324                       | 1568 | 139  | 3    | 2034       | 53                       | 543  | 217  | 0    | 813        | 192                        | 936  | 366  | 31   | 1525       | 151                      | 219  | 145  | 15   | 530        | 4902       |
| Apprch %    | 15.9                      | 77.1 | 6.8  | 0.1  |            | 6.5                      | 66.8 | 26.7 | 0    |            | 12.6                       | 61.4 | 24   | 2    |            | 28.5                     | 41.3 | 27.4 | 2.8  |            |            |
| Total %     | 6.6                       | 32   | 2.8  | 0.1  | 41.5       | 1.1                      | 11.1 | 4.4  | 0    | 16.6       | 3.9                        | 19.1 | 7.5  | 0.6  | 31.1       | 3.1                      | 4.5  | 3    | 0.3  | 10.8       |            |
| Lights      | 312                       | 1515 | 138  | 3    | 1968       | 52                       | 538  | 211  | 0    | 801        | 184                        | 887  | 359  | 31   | 1461       | 147                      | 216  | 136  | 15   | 514        | 4744       |
| % Lights    | 96.3                      | 96.6 | 99.3 | 100  | 96.8       | 98.1                     | 99.1 | 97.2 | 0    | 98.5       | 95.8                       | 94.8 | 98.1 | 100  | 95.8       | 97.4                     | 98.6 | 93.8 | 100  | 97         | 96.8       |
| Buses       | 6                         | 7    | 0    | 0    | 13         | 0                        | 2    | 2    | 0    | 4          | 5                          | 9    | 2    | 0    | 16         | 1                        | 1    | 4    | 0    | 6          | 39         |
| % Buses     | 1.9                       | 0.4  | 0    | 0    | 0.6        | 0                        | 0.4  | 0.9  | 0    | 0.5        | 2.6                        | 1    | 0.5  | 0    | 1          | 0.7                      | 0.5  | 2.8  | 0    | 1.1        | 0.8        |
| Trucks      | 6                         | 46   | 1    | 0    | 53         | 1                        | 3    | 4    | 0    | 8          | 3                          | 40   | 5    | 0    | 48         | 3                        | 2    | 5    | 0    | 10         | 119        |
| % Trucks    | 1.9                       | 2.9  | 0.7  | 0    | 2.6        | 1.9                      | 0.6  | 1.8  | 0    | 1          | 1.6                        | 4.3  | 1.4  | 0    | 3.1        | 2                        | 0.9  | 3.4  | 0    | 1.9        | 2.4        |

| Start Time   | HWY 1 RAMPS<br>Southbound |      |      |            | MONTEREY RD<br>Westbound |      |      |            | FREMONT BLVD<br>Northbound |      |      |            | MONTEREY RD<br>Eastbound |      |      |            | Int. Total |
|--|---------------------------|------|------|------------|--------------------------|------|------|------------|----------------------------|------|------|------------|--------------------------|------|------|------------|------------|
|  | Right                     | Thru | Left | App. Total | Right                    | Thru | Left | App. Total | Right                      | Thru | Left | App. Total | Right                    | Thru | Left | App. Total |            |
| Peak Hour Analysis From 07:00 AM to 08:45 AM - Peak 1 of 1 |                           |      |      |            |                          |      |      |            |                            |      |      |            |                          |      |      |            |            |
| Peak Hour for Entire Intersection Begins at 07:30 AM       |                           |      |      |            |                          |      |      |            |                            |      |      |            |                          |      |      |            |            |
| 07:30 AM   | 41                        | 174  | 30   | 245        | 4                        | 78   | 22   | 104        | 30                         | 130  | 49   | 209        | 22                       | 39   | 19   | 80         | 638        |
| 07:45 AM   | 40                        | 197  | 36   | 273        | 7                        | 70   | 29   | 106        | 59                         | 142  | 53   | 254        | 21                       | 46   | 18   | 85         | 718        |
| 08:00 AM   | 35                        | 216  | 19   | 270        | 2                        | 64   | 29   | 95         | 28                         | 127  | 39   | 194        | 18                       | 30   | 16   | 64         | 623        |
| 08:15 AM   | 37                        | 217  | 8    | 262        | 6                        | 71   | 33   | 110        | 23                         | 107  | 52   | 182        | 33                       | 21   | 16   | 70         | 624        |
| Total Volume   | 153                       | 804  | 93   | 1050       | 19                       | 283  | 113  | 415        | 140                        | 506  | 193  | 839        | 94                       | 136  | 69   | 299        | 2603       |
| % App. Total   | 14.6                      | 76.6 | 8.9  |            | 4.6                      | 68.2 | 27.2 |            | 16.7                       | 60.3 | 23   |            | 31.4                     | 45.5 | 23.1 |            |            |
| PHF  | .933                      | .926 | .646 | .962       | .679                     | .907 | .856 | .943       | .593                       | .891 | .910 | .826       | .712                     | .739 | .908 | .879       | .906       |

# Traffic Data Service

San Jose, CA  
 (408) 622-4787  
 tdsbay@cs.com

File Name : 20AM FINAL  
 Site Code : 00000020  
 Start Date : 4/25/2018  
 Page No : 2

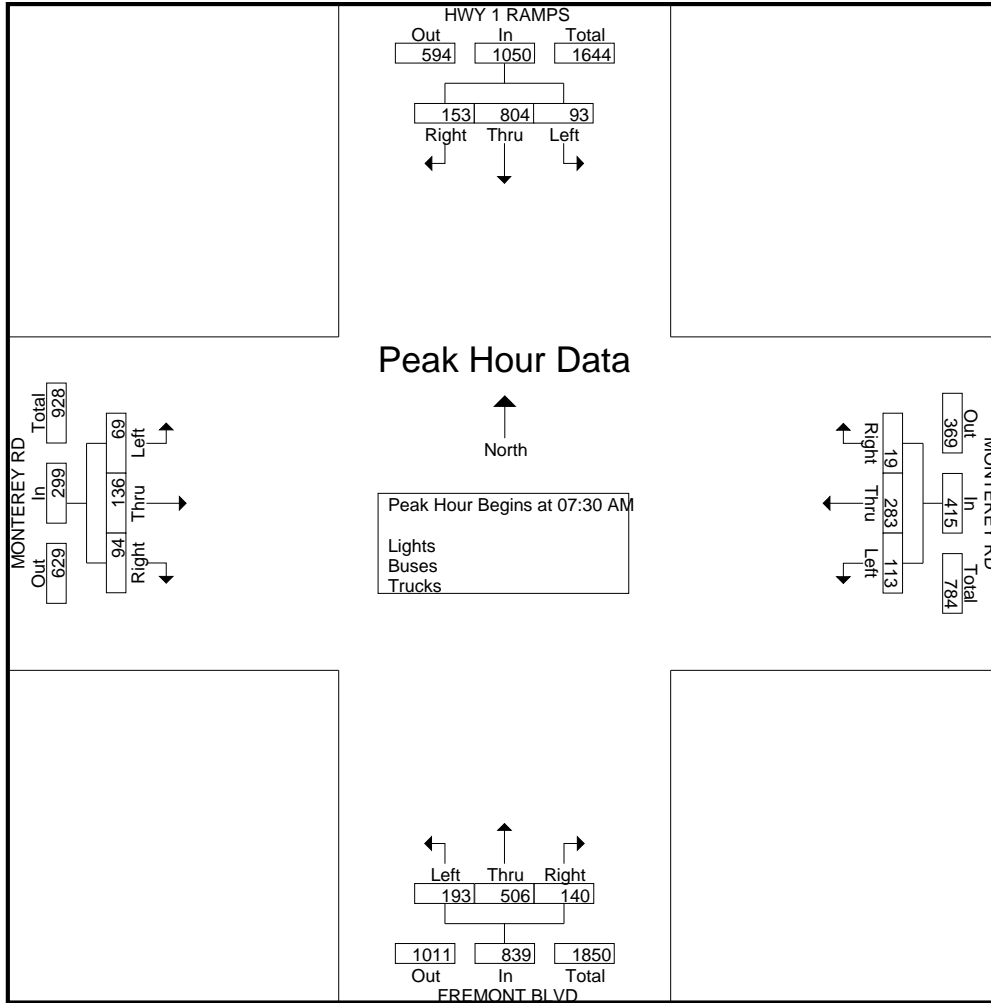

# Traffic Data Service

San Jose, CA  
 (408) 622-4787  
 tdsbay@cs.com

File Name : 20AM FINAL  
 Site Code : 00000020  
 Start Date : 4/25/2018  
 Page No : 1

Groups Printed- Bikes

| Start Time  | HWY 1 RAMPS Southbound |      |      |      |            | MONTEREY RD Westbound |      |      |      |            | FREMONT BLVD Northbound |      |      |      |            | MONTEREY RD Eastbound |      |      |      |            | Int. Total |
|-------------|------------------------|------|------|------|------------|-----------------------|------|------|------|------------|-------------------------|------|------|------|------------|-----------------------|------|------|------|------------|------------|
|             | Right                  | Thru | Left | Peds | App. Total | Right                 | Thru | Left | Peds | App. Total | Right                   | Thru | Left | Peds | App. Total | Right                 | Thru | Left | Peds | App. Total |            |
| 07:00 AM    | 0                      | 0    | 0    | 0    | 0          | 0                     | 0    | 0    | 0    | 0          | 0                       | 0    | 0    | 0    | 0          | 0                     | 0    | 0    | 0    | 0          | 0          |
| 07:15 AM    | 0                      | 0    | 0    | 0    | 0          | 0                     | 0    | 0    | 0    | 0          | 0                       | 0    | 0    | 0    | 0          | 0                     | 0    | 0    | 0    | 0          | 0          |
| 07:30 AM    | 0                      | 0    | 0    | 0    | 0          | 0                     | 1    | 0    | 0    | 1          | 0                       | 0    | 0    | 0    | 0          | 0                     | 1    | 0    | 0    | 1          | 2          |
| 07:45 AM    | 0                      | 0    | 0    | 0    | 0          | 0                     | 0    | 0    | 0    | 0          | 0                       | 0    | 0    | 0    | 0          | 0                     | 0    | 0    | 0    | 0          | 0          |
| Total       | 0                      | 0    | 0    | 0    | 0          | 0                     | 1    | 0    | 0    | 1          | 0                       | 0    | 0    | 0    | 0          | 0                     | 1    | 0    | 0    | 1          | 2          |
| 08:00 AM    | 0                      | 0    | 0    | 0    | 0          | 0                     | 1    | 0    | 0    | 1          | 0                       | 0    | 0    | 0    | 0          | 0                     | 0    | 0    | 0    | 0          | 1          |
| 08:15 AM    | 0                      | 0    | 0    | 0    | 0          | 0                     | 0    | 0    | 0    | 0          | 0                       | 0    | 0    | 0    | 0          | 0                     | 0    | 0    | 0    | 0          | 0          |
| 08:30 AM    | 0                      | 0    | 0    | 0    | 0          | 0                     | 0    | 0    | 0    | 0          | 0                       | 0    | 0    | 0    | 0          | 0                     | 0    | 0    | 0    | 0          | 0          |
| 08:45 AM    | 0                      | 0    | 0    | 0    | 0          | 0                     | 0    | 0    | 0    | 0          | 0                       | 0    | 0    | 0    | 0          | 1                     | 0    | 0    | 0    | 1          | 1          |
| Total       | 0                      | 0    | 0    | 0    | 0          | 0                     | 1    | 0    | 0    | 1          | 0                       | 0    | 0    | 0    | 0          | 1                     | 0    | 0    | 0    | 1          | 2          |
| Grand Total | 0                      | 0    | 0    | 0    | 0          | 0                     | 2    | 0    | 0    | 2          | 0                       | 0    | 0    | 0    | 0          | 1                     | 1    | 0    | 0    | 2          | 4          |
| Apprch %    | 0                      | 0    | 0    | 0    | 0          | 0                     | 100  | 0    | 0    | 100        | 0                       | 0    | 0    | 0    | 0          | 50                    | 50   | 0    | 0    | 50         |            |
| Total %     | 0                      | 0    | 0    | 0    | 0          | 0                     | 50   | 0    | 0    | 50         | 0                       | 0    | 0    | 0    | 0          | 25                    | 25   | 0    | 0    | 50         |            |

| Start Time   | HWY 1 RAMPS Southbound |      |      |            | MONTEREY RD Westbound |      |      |            | FREMONT BLVD Northbound |      |      |            | MONTEREY RD Eastbound |      |      |            | Int. Total |
|--|------------------------|------|------|------------|-----------------------|------|------|------------|-------------------------|------|------|------------|-----------------------|------|------|------------|------------|
|  | Right                  | Thru | Left | App. Total | Right                 | Thru | Left | App. Total | Right                   | Thru | Left | App. Total | Right                 | Thru | Left | App. Total |            |
| Peak Hour Analysis From 07:00 AM to 08:45 AM - Peak 1 of 1 |                        |      |      |            |                       |      |      |            |                         |      |      |            |                       |      |      |            |            |
| Peak Hour for Entire Intersection Begins at 07:15 AM       |                        |      |      |            |                       |      |      |            |                         |      |      |            |                       |      |      |            |            |
| 07:15 AM   | 0                      | 0    | 0    | 0          | 0                     | 0    | 0    | 0          | 0                       | 0    | 0    | 0          | 0                     | 0    | 0    | 0          | 0          |
| 07:30 AM   | 0                      | 0    | 0    | 0          | 0                     | 1    | 0    | 1          | 0                       | 0    | 0    | 0          | 0                     | 1    | 0    | 1          | 2          |
| 07:45 AM   | 0                      | 0    | 0    | 0          | 0                     | 0    | 0    | 0          | 0                       | 0    | 0    | 0          | 0                     | 0    | 0    | 0          | 0          |
| 08:00 AM   | 0                      | 0    | 0    | 0          | 0                     | 1    | 0    | 1          | 0                       | 0    | 0    | 0          | 0                     | 0    | 0    | 0          | 1          |
| Total Volume   | 0                      | 0    | 0    | 0          | 0                     | 2    | 0    | 2          | 0                       | 0    | 0    | 0          | 0                     | 1    | 0    | 1          | 3          |
| % App. Total   | 0                      | 0    | 0    | 0          | 0                     | 100  | 0    | 100        | 0                       | 0    | 0    | 0          | 0                     | 100  | 0    | 100        |            |
| PHF  | .000                   | .000 | .000 | .000       | .000                  | .500 | .000 | .500       | .000                    | .000 | .000 | .000       | .000                  | .250 | .000 | .250       | .375       |

# Traffic Data Service

San Jose, CA  
(408) 622-4787  
tdsbay@cs.com

File Name : 20AM FINAL  
Site Code : 00000020  
Start Date : 4/25/2018  
Page No : 2

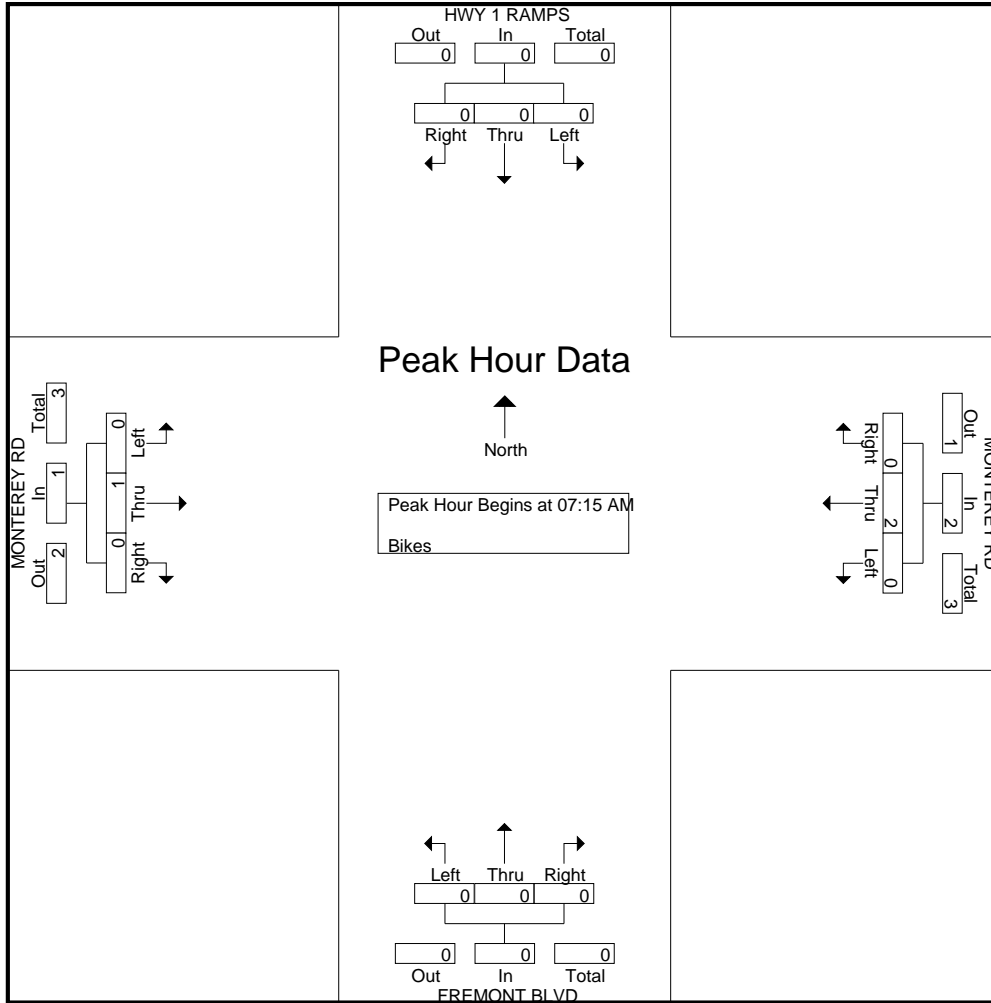

# Traffic Data Service

San Jose, CA  
 (408) 622-4787  
 tdsbay@cs.com

File Name : 20PM FINAL  
 Site Code : 00000020  
 Start Date : 4/25/2018  
 Page No : 1

Groups Printed- Lights - Buses - Trucks

| Start Time  | HWY 1 RAMPS<br>Southbound |      |      |      |            | MONTEREY RD<br>Westbound |      |      |      |            | FREMONT BLVD<br>Northbound |      |      |      |            | MONTEREY RD<br>Eastbound |      |      |      |            | Int. Total |     |
|-------------|---------------------------|------|------|------|------------|--------------------------|------|------|------|------------|----------------------------|------|------|------|------------|--------------------------|------|------|------|------------|------------|-----|
|             | Right                     | Thru | Left | Peds | App. Total | Right                    | Thru | Left | Peds | App. Total | Right                      | Thru | Left | Peds | App. Total | Right                    | Thru | Left | Peds | App. Total |            |     |
| 04:00 PM    | 63                        | 164  | 13   | 0    | 240        | 15                       | 24   | 15   | 0    | 54         | 43                         | 250  | 36   | 2    | 331        | 19                       | 41   | 52   | 0    | 112        | 737        |     |
| 04:15 PM    | 46                        | 147  | 20   | 0    | 213        | 14                       | 38   | 20   | 0    | 72         | 38                         | 211  | 34   | 0    | 283        | 20                       | 51   | 62   | 1    | 134        | 702        |     |
| 04:30 PM    | 42                        | 141  | 15   | 0    | 198        | 19                       | 39   | 18   | 0    | 76         | 38                         | 222  | 46   | 6    | 312        | 13                       | 42   | 55   | 1    | 111        | 697        |     |
| 04:45 PM    | 49                        | 148  | 14   | 0    | 211        | 14                       | 32   | 16   | 0    | 62         | 50                         | 238  | 35   | 2    | 325        | 19                       | 37   | 36   | 5    | 97         | 695        |     |
| Total       | 200                       | 600  | 62   | 0    | 862        | 62                       | 133  | 69   | 0    | 264        | 169                        | 921  | 151  | 10   | 1251       | 71                       | 171  | 205  | 7    | 454        | 2831       |     |
| 05:00 PM    | 39                        | 183  | 12   | 0    | 234        | 12                       | 45   | 17   | 0    | 74         | 46                         | 269  | 31   | 0    | 346        | 9                        | 50   | 50   | 0    | 109        | 763        |     |
| 05:15 PM    | 51                        | 128  | 26   | 0    | 205        | 12                       | 41   | 23   | 0    | 76         | 60                         | 248  | 22   | 3    | 333        | 14                       | 43   | 49   | 2    | 108        | 722        |     |
| 05:30 PM    | 52                        | 129  | 18   | 0    | 199        | 15                       | 32   | 18   | 0    | 65         | 61                         | 230  | 24   | 1    | 316        | 13                       | 71   | 66   | 1    | 151        | 731        |     |
| 05:45 PM    | 56                        | 136  | 22   | 1    | 215        | 16                       | 43   | 31   | 0    | 90         | 59                         | 225  | 34   | 0    | 318        | 21                       | 59   | 48   | 3    | 131        | 754        |     |
| Total       | 198                       | 576  | 78   | 1    | 853        | 55                       | 161  | 89   | 0    | 305        | 226                        | 972  | 111  | 4    | 1313       | 57                       | 223  | 213  | 6    | 499        | 2970       |     |
| Grand Total | 398                       | 1176 | 140  | 1    | 1715       | 117                      | 294  | 158  | 0    | 569        | 395                        | 1893 | 262  | 14   | 2564       | 128                      | 394  | 418  | 13   | 953        | 5801       |     |
| Apprch %    | 23.2                      | 68.6 | 8.2  | 0.1  |            | 20.6                     | 51.7 | 27.8 | 0    |            | 15.4                       | 73.8 | 10.2 | 0.5  |            | 13.4                     | 41.3 | 43.9 | 1.4  |            |            |     |
| Total %     | 6.9                       | 20.3 | 2.4  | 0    | 29.6       | 2                        | 5.1  | 2.7  | 0    | 9.8        | 6.8                        | 32.6 | 4.5  | 0.2  | 44.2       | 2.2                      | 6.8  | 7.2  | 0.2  | 16.4       |            |     |
| Lights      | 391                       | 1159 | 140  | 1    | 1691       | 116                      | 292  | 158  | 0    | 566        | 391                        | 1869 | 260  | 14   | 2534       | 127                      | 390  | 414  | 13   | 944        | 5735       |     |
| % Lights    | 98.2                      | 98.6 | 100  | 100  | 98.6       | 99.1                     | 99.3 | 100  | 0    | 99.5       | 99                         | 98.7 | 99.2 | 100  | 98.8       | 99.2                     | 99   | 99   | 100  | 99.1       | 98.9       |     |
| Buses       | 6                         | 4    | 0    | 0    | 10         | 0                        | 2    | 0    | 0    | 2          | 0                          | 4    | 1    | 0    | 5          | 0                        | 4    | 4    | 0    | 0          | 8          | 25  |
| % Buses     | 1.5                       | 0.3  | 0    | 0    | 0.6        | 0                        | 0.7  | 0    | 0    | 0.4        | 0                          | 0.2  | 0.4  | 0    | 0.2        | 0                        | 1    | 1    | 0    | 0          | 0.8        | 0.4 |
| Trucks      | 1                         | 13   | 0    | 0    | 14         | 1                        | 0    | 0    | 0    | 1          | 4                          | 20   | 1    | 0    | 25         | 1                        | 0    | 0    | 0    | 0          | 1          | 41  |
| % Trucks    | 0.3                       | 1.1  | 0    | 0    | 0.8        | 0.9                      | 0    | 0    | 0    | 0.2        | 1                          | 1.1  | 0.4  | 0    | 1          | 0.8                      | 0    | 0    | 0    | 0          | 0.1        | 0.7 |

| Start Time   | HWY 1 RAMPS<br>Southbound |            |           |      |            | MONTEREY RD<br>Westbound |           |           |      |            | FREMONT BLVD<br>Northbound |            |           |      |            | MONTEREY RD<br>Eastbound |           |           |      |            | Int. Total |
|--|---------------------------|------------|-----------|------|------------|--------------------------|-----------|-----------|------|------------|----------------------------|------------|-----------|------|------------|--------------------------|-----------|-----------|------|------------|------------|
|  | Right                     | Thru       | Left      | Peds | App. Total | Right                    | Thru      | Left      | Peds | App. Total | Right                      | Thru       | Left      | Peds | App. Total | Right                    | Thru      | Left      | Peds | App. Total |            |
| Peak Hour Analysis From 04:00 PM to 05:45 PM - Peak 1 of 1 |                           |            |           |      |            |                          |           |           |      |            |                            |            |           |      |            |                          |           |           |      |            |            |
| Peak Hour for Entire Intersection Begins at 05:00 PM       |                           |            |           |      |            |                          |           |           |      |            |                            |            |           |      |            |                          |           |           |      |            |            |
| 05:00 PM   | 39                        | <b>183</b> | 12        |      | <b>234</b> | 12                       | <b>45</b> | 17        |      | 74         | 46                         | <b>269</b> | 31        |      | <b>346</b> | 9                        | 50        | 50        |      | 109        | <b>763</b> |
| 05:15 PM   | 51                        | 128        | <b>26</b> |      | 205        | 12                       | 41        | 23        |      | 76         | 60                         | 248        | 22        |      | 330        | 14                       | 43        | 49        |      | 106        | 717        |
| 05:30 PM   | 52                        | 129        | 18        |      | 199        | 15                       | 32        | 18        |      | 65         | <b>61</b>                  | 230        | 24        |      | 315        | 13                       | <b>71</b> | <b>66</b> |      | <b>150</b> | 729        |
| 05:45 PM   | <b>56</b>                 | 136        | 22        |      | 214        | <b>16</b>                | 43        | <b>31</b> |      | <b>90</b>  | 59                         | 225        | <b>34</b> |      | 318        | <b>21</b>                | 59        | 48        |      | 128        | 750        |
| Total Volume   | 198                       | 576        | 78        |      | 852        | 55                       | 161       | 89        |      | 305        | 226                        | 972        | 111       |      | 1309       | 57                       | 223       | 213       |      | 493        | 2959       |
| % App. Total   | 23.2                      | 67.6       | 9.2       |      |            | 18                       | 52.8      | 29.2      |      |            | 17.3                       | 74.3       | 8.5       |      |            | 11.6                     | 45.2      | 43.2      |      |            |            |
| PHF  | .884                      | .787       | .750      |      | .910       | .859                     | .894      | .718      |      | .847       | .926                       | .903       | .816      |      | .946       | .679                     | .785      | .807      |      | .822       | .970       |

# Traffic Data Service

San Jose, CA  
 (408) 622-4787  
 tdsbay@cs.com

File Name : 20PM FINAL  
 Site Code : 00000020  
 Start Date : 4/25/2018  
 Page No : 2

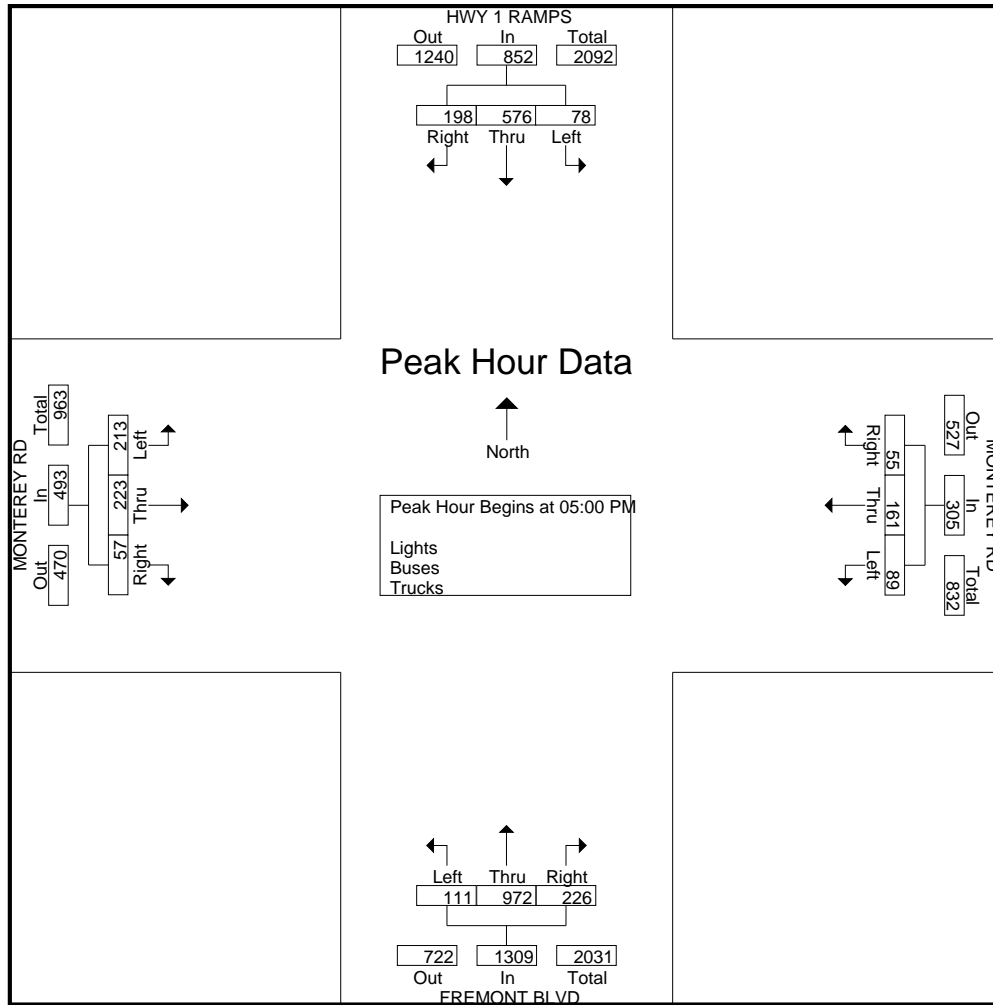

# Traffic Data Service

San Jose, CA  
 (408) 622-4787  
 tdsbay@cs.com

File Name : 20PM FINAL  
 Site Code : 00000020  
 Start Date : 4/25/2018  
 Page No : 1

Groups Printed- Bikes

| Start Time  | HWY 1 RAMPS Southbound |      |      |      |            | MONTEREY RD Westbound |      |      |      |            | FREMONT BLVD Northbound |      |      |      |            | MONTEREY RD Eastbound |      |      |      |            | Int. Total |
|-------------|------------------------|------|------|------|------------|-----------------------|------|------|------|------------|-------------------------|------|------|------|------------|-----------------------|------|------|------|------------|------------|
|             | Right                  | Thru | Left | Peds | App. Total | Right                 | Thru | Left | Peds | App. Total | Right                   | Thru | Left | Peds | App. Total | Right                 | Thru | Left | Peds | App. Total |            |
| 04:00 PM    | 1                      | 0    | 0    | 0    | 1          | 0                     | 0    | 0    | 0    | 0          | 0                       | 0    | 0    | 0    | 0          | 0                     | 0    | 0    | 0    | 0          | 0          |
| 04:15 PM    | 1                      | 0    | 0    | 0    | 1          | 0                     | 0    | 0    | 0    | 0          | 0                       | 0    | 0    | 0    | 0          | 0                     | 0    | 0    | 0    | 0          | 0          |
| 04:30 PM    | 0                      | 0    | 0    | 0    | 0          | 0                     | 0    | 0    | 0    | 0          | 0                       | 0    | 0    | 0    | 0          | 0                     | 0    | 0    | 0    | 0          | 0          |
| 04:45 PM    | 0                      | 1    | 0    | 0    | 1          | 0                     | 0    | 0    | 0    | 0          | 0                       | 0    | 0    | 0    | 0          | 0                     | 1    | 0    | 0    | 0          | 1          |
| Total       | 2                      | 1    | 0    | 0    | 3          | 0                     | 0    | 0    | 0    | 0          | 0                       | 0    | 0    | 0    | 0          | 0                     | 1    | 0    | 0    | 0          | 1          |
| 05:00 PM    | 0                      | 0    | 0    | 0    | 0          | 0                     | 0    | 0    | 0    | 0          | 0                       | 0    | 0    | 0    | 0          | 0                     | 0    | 0    | 0    | 0          | 0          |
| 05:15 PM    | 0                      | 0    | 0    | 0    | 0          | 0                     | 0    | 0    | 0    | 0          | 0                       | 0    | 0    | 0    | 0          | 0                     | 1    | 0    | 0    | 0          | 1          |
| 05:30 PM    | 0                      | 0    | 0    | 0    | 0          | 0                     | 0    | 0    | 0    | 0          | 0                       | 0    | 0    | 0    | 0          | 0                     | 0    | 0    | 0    | 0          | 0          |
| 05:45 PM    | 0                      | 0    | 0    | 0    | 0          | 0                     | 0    | 0    | 0    | 0          | 0                       | 0    | 0    | 0    | 0          | 0                     | 0    | 0    | 0    | 0          | 0          |
| Total       | 0                      | 0    | 0    | 0    | 0          | 0                     | 0    | 0    | 0    | 0          | 0                       | 0    | 0    | 0    | 0          | 0                     | 1    | 0    | 0    | 0          | 1          |
| Grand Total | 2                      | 1    | 0    | 0    | 3          | 0                     | 0    | 0    | 0    | 0          | 0                       | 0    | 0    | 0    | 0          | 0                     | 2    | 0    | 0    | 0          | 2          |
| Apprch %    | 66.7                   | 33.3 | 0    | 0    |            | 0                     | 0    | 0    | 0    |            | 0                       | 0    | 0    | 0    |            | 0                     | 100  | 0    | 0    |            |            |
| Total %     | 40                     | 20   | 0    | 0    | 60         | 0                     | 0    | 0    | 0    | 0          | 0                       | 0    | 0    | 0    | 0          | 0                     | 40   | 0    | 0    | 40         |            |

| Start Time   | HWY 1 RAMPS Southbound |      |      |      |            | MONTEREY RD Westbound |      |      |      |            | FREMONT BLVD Northbound |      |      |      |            | MONTEREY RD Eastbound |      |      |      |            | Int. Total |
|--------------|------------------------|------|------|------|------------|-----------------------|------|------|------|------------|-------------------------|------|------|------|------------|-----------------------|------|------|------|------------|------------|
|              | Right                  | Thru | Left | Peds | App. Total | Right                 | Thru | Left | Peds | App. Total | Right                   | Thru | Left | Peds | App. Total | Right                 | Thru | Left | Peds | App. Total |            |
| 04:00 PM     | 1                      | 0    | 0    | 0    | 1          | 0                     | 0    | 0    | 0    | 0          | 0                       | 0    | 0    | 0    | 0          | 0                     | 0    | 0    | 0    | 0          | 0          |
| 04:15 PM     | 1                      | 0    | 0    | 0    | 1          | 0                     | 0    | 0    | 0    | 0          | 0                       | 0    | 0    | 0    | 0          | 0                     | 0    | 0    | 0    | 0          | 0          |
| 04:30 PM     | 0                      | 0    | 0    | 0    | 0          | 0                     | 0    | 0    | 0    | 0          | 0                       | 0    | 0    | 0    | 0          | 0                     | 0    | 0    | 0    | 0          | 0          |
| 04:45 PM     | 0                      | 1    | 0    | 0    | 1          | 0                     | 0    | 0    | 0    | 0          | 0                       | 0    | 0    | 0    | 0          | 0                     | 1    | 0    | 0    | 0          | 1          |
| Total Volume | 2                      | 1    | 0    | 0    | 3          | 0                     | 0    | 0    | 0    | 0          | 0                       | 0    | 0    | 0    | 0          | 0                     | 1    | 0    | 0    | 0          | 1          |
| % App. Total | 66.7                   | 33.3 | 0    | 0    |            | 0                     | 0    | 0    | 0    |            | 0                       | 0    | 0    | 0    |            | 0                     | 100  | 0    | 0    |            |            |
| PHF          | .500                   | .250 | .000 | .000 | .750       | .000                  | .000 | .000 | .000 | .000       | .000                    | .000 | .000 | .000 | .000       | .000                  | .250 | .000 | .000 | .250       | .500       |

Peak Hour Analysis From 04:00 PM to 05:45 PM - Peak 1 of 1  
 Peak Hour for Entire Intersection Begins at 04:00 PM

# Traffic Data Service

San Jose, CA  
 (408) 622-4787  
 tdsbay@cs.com

File Name : 20PM FINAL  
 Site Code : 00000020  
 Start Date : 4/25/2018  
 Page No : 2

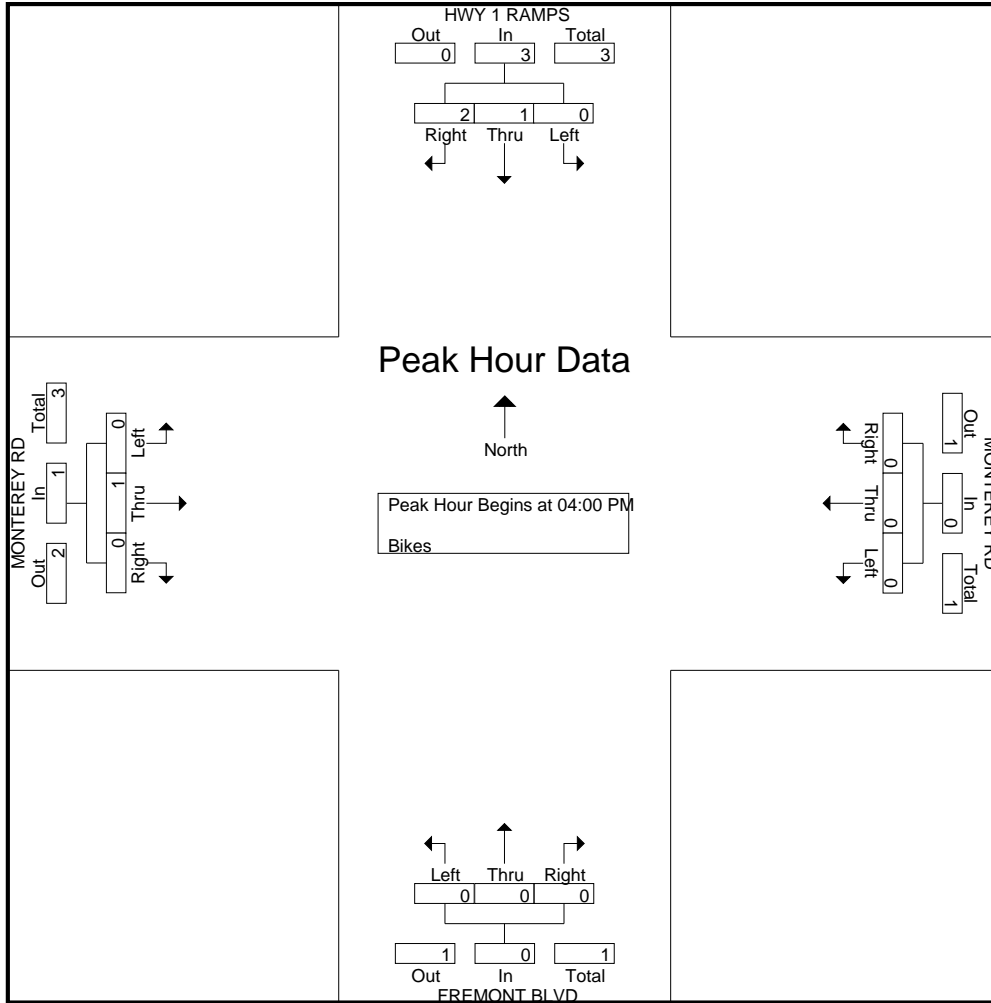



# Traffic Data Service

San Jose, CA  
 (408) 622-4787  
 tdsbay@cs.com

File Name : 21AM FINAL  
 Site Code : 00000021  
 Start Date : 4/25/2018  
 Page No : 1

Groups Printed- Lights - Buses - Trucks

| Start Time  | HWY 1 SB ON-RAMP<br>Southbound |      |      |      |            | MONTEREY RD<br>Westbound |      |      |      |            | CALIFORNIA AVE<br>Northbound |      |      |      |            | HWY 1 NB OFF-RAMP<br>Eastbound |      |      |      |            | Int. Total |
|-------------|--------------------------------|------|------|------|------------|--------------------------|------|------|------|------------|------------------------------|------|------|------|------------|--------------------------------|------|------|------|------------|------------|
|             | Right                          | Thru | Left | Peds | App. Total | Right                    | Thru | Left | Peds | App. Total | Right                        | Thru | Left | Peds | App. Total | Right                          | Thru | Left | Peds | App. Total |            |
| 07:00 AM    | 0                              | 0    | 0    | 0    | 0          | 102                      | 0    | 53   | 0    | 155        | 19                           | 17   | 0    | 0    | 36         | 16                             | 13   | 1    | 0    | 30         | 221        |
| 07:15 AM    | 0                              | 0    | 0    | 0    | 0          | 107                      | 0    | 55   | 0    | 162        | 23                           | 17   | 0    | 0    | 40         | 14                             | 27   | 0    | 0    | 41         | 243        |
| 07:30 AM    | 0                              | 0    | 0    | 0    | 0          | 118                      | 0    | 52   | 0    | 170        | 28                           | 6    | 0    | 0    | 34         | 13                             | 48   | 0    | 0    | 61         | 265        |
| 07:45 AM    | 0                              | 0    | 0    | 0    | 0          | 111                      | 0    | 54   | 0    | 165        | 33                           | 8    | 0    | 1    | 42         | 22                             | 53   | 0    | 0    | 75         | 282        |
| Total       | 0                              | 0    | 0    | 0    | 0          | 438                      | 0    | 214  | 0    | 652        | 103                          | 48   | 0    | 1    | 152        | 65                             | 141  | 1    | 0    | 207        | 1011       |
| 08:00 AM    | 0                              | 1    | 0    | 0    | 1          | 90                       | 0    | 62   | 3    | 155        | 23                           | 12   | 0    | 0    | 35         | 31                             | 50   | 0    | 0    | 81         | 272        |
| 08:15 AM    | 0                              | 0    | 0    | 0    | 0          | 97                       | 0    | 57   | 0    | 154        | 25                           | 15   | 0    | 1    | 41         | 34                             | 47   | 2    | 0    | 83         | 278        |
| 08:30 AM    | 0                              | 0    | 1    | 0    | 1          | 90                       | 0    | 57   | 0    | 147        | 36                           | 13   | 0    | 0    | 49         | 29                             | 35   | 2    | 0    | 66         | 263        |
| 08:45 AM    | 0                              | 0    | 1    | 0    | 1          | 97                       | 0    | 47   | 0    | 144        | 33                           | 18   | 0    | 1    | 52         | 23                             | 34   | 0    | 0    | 57         | 254        |
| Total       | 0                              | 1    | 2    | 0    | 3          | 374                      | 0    | 223  | 3    | 600        | 117                          | 58   | 0    | 2    | 177        | 117                            | 166  | 4    | 0    | 287        | 1067       |
| Grand Total | 0                              | 1    | 2    | 0    | 3          | 812                      | 0    | 437  | 3    | 1252       | 220                          | 106  | 0    | 3    | 329        | 182                            | 307  | 5    | 0    | 494        | 2078       |
| Apprch %    | 0                              | 33.3 | 66.7 | 0    |            | 64.9                     | 0    | 34.9 | 0.2  |            | 66.9                         | 32.2 | 0    | 0.9  |            | 36.8                           | 62.1 | 1    | 0    |            |            |
| Total %     | 0                              | 0    | 0.1  | 0    | 0.1        | 39.1                     | 0    | 21   | 0.1  | 60.3       | 10.6                         | 5.1  | 0    | 0.1  | 15.8       | 8.8                            | 14.8 | 0.2  | 0    | 23.8       |            |
| Lights      | 0                              | 1    | 2    | 0    | 3          | 801                      | 0    | 421  | 3    | 1225       | 209                          | 103  | 0    | 3    | 315        | 174                            | 300  | 5    | 0    | 479        | 2022       |
| % Lights    | 0                              | 100  | 100  | 0    | 100        | 98.6                     | 0    | 96.3 | 100  | 97.8       | 95                           | 97.2 | 0    | 100  | 95.7       | 95.6                           | 97.7 | 100  | 0    | 97         | 97.3       |
| Buses       | 0                              | 0    | 0    | 0    | 0          | 2                        | 0    | 7    | 0    | 9          | 4                            | 0    | 0    | 0    | 4          | 5                              | 1    | 0    | 0    | 6          | 19         |
| % Buses     | 0                              | 0    | 0    | 0    | 0          | 0.2                      | 0    | 1.6  | 0    | 0.7        | 1.8                          | 0    | 0    | 0    | 1.2        | 2.7                            | 0.3  | 0    | 0    | 1.2        | 0.9        |
| Trucks      | 0                              | 0    | 0    | 0    | 0          | 9                        | 0    | 9    | 0    | 18         | 7                            | 3    | 0    | 0    | 10         | 3                              | 6    | 0    | 0    | 9          | 37         |
| % Trucks    | 0                              | 0    | 0    | 0    | 0          | 1.1                      | 0    | 2.1  | 0    | 1.4        | 3.2                          | 2.8  | 0    | 0    | 3          | 1.6                            | 2    | 0    | 0    | 1.8        | 1.8        |

| Start Time   | HWY 1 SB ON-RAMP<br>Southbound |      |      |            | MONTEREY RD<br>Westbound |      |      |            | CALIFORNIA AVE<br>Northbound |      |      |            | HWY 1 NB OFF-RAMP<br>Eastbound |      |      |            | Int. Total |
|--|--------------------------------|------|------|------------|--------------------------|------|------|------------|------------------------------|------|------|------------|--------------------------------|------|------|------------|------------|
|  | Right                          | Thru | Left | App. Total | Right                    | Thru | Left | App. Total | Right                        | Thru | Left | App. Total | Right                          | Thru | Left | App. Total |            |
| Peak Hour Analysis From 07:00 AM to 08:45 AM - Peak 1 of 1 |                                |      |      |            |                          |      |      |            |                              |      |      |            |                                |      |      |            |            |
| Peak Hour for Entire Intersection Begins at 07:30 AM       |                                |      |      |            |                          |      |      |            |                              |      |      |            |                                |      |      |            |            |
| 07:30 AM   | 0                              | 0    | 0    | 0          | 118                      | 0    | 52   | 170        | 28                           | 6    | 0    | 34         | 13                             | 48   | 0    | 61         | 265        |
| 07:45 AM   | 0                              | 0    | 0    | 0          | 111                      | 0    | 54   | 165        | 33                           | 8    | 0    | 41         | 22                             | 53   | 0    | 75         | 281        |
| 08:00 AM   | 0                              | 1    | 0    | 1          | 90                       | 0    | 62   | 152        | 23                           | 12   | 0    | 35         | 31                             | 50   | 0    | 81         | 269        |
| 08:15 AM   | 0                              | 0    | 0    | 0          | 97                       | 0    | 57   | 154        | 25                           | 15   | 0    | 40         | 34                             | 47   | 2    | 83         | 277        |
| Total Volume   | 0                              | 1    | 0    | 1          | 416                      | 0    | 225  | 641        | 109                          | 41   | 0    | 150        | 100                            | 198  | 2    | 300        | 1092       |
| % App. Total   | 0                              | 100  | 0    |            | 64.9                     | 0    | 35.1 |            | 72.7                         | 27.3 | 0    |            | 33.3                           | 66   | 0.7  |            |            |
| PHF  | .000                           | .250 | .000 | .250       | .881                     | .000 | .907 | .943       | .826                         | .683 | .000 | .915       | .735                           | .934 | .250 | .904       | .972       |

# Traffic Data Service

San Jose, CA  
 (408) 622-4787  
 tdsbay@cs.com

File Name : 21AM FINAL  
 Site Code : 00000021  
 Start Date : 4/25/2018  
 Page No : 2

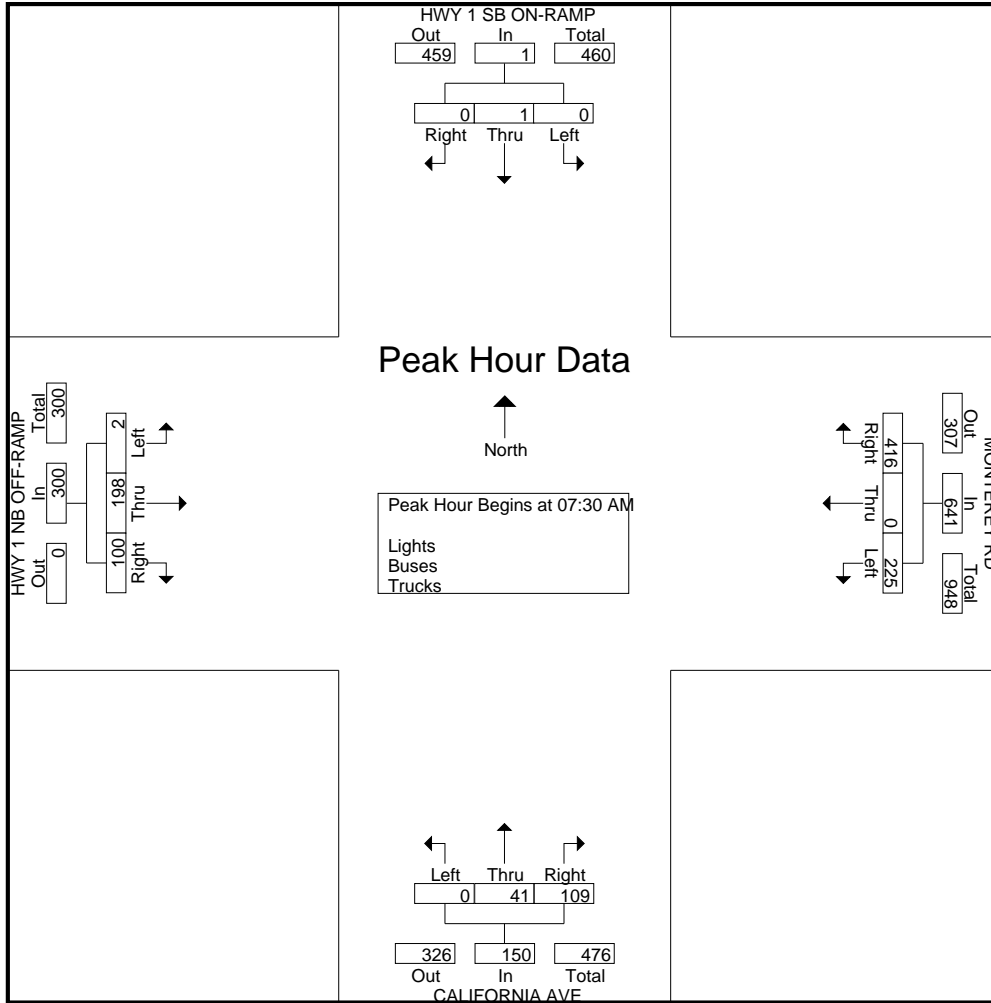

# Traffic Data Service

San Jose, CA  
 (408) 622-4787  
 tdsbay@cs.com

File Name : 21AM FINAL  
 Site Code : 00000021  
 Start Date : 4/25/2018  
 Page No : 1

Groups Printed- Bikes

| Start Time   | HWY 1 SB ON-RAMP<br>Southbound |      |      |      |            | MONTEREY RD<br>Westbound |      |      |      |            | CALIFORNIA AVE<br>Northbound |      |      |      |            | HWY 1 NB OFF-RAMP<br>Eastbound |      |      |      |            | Int. Total |
|--------------|--------------------------------|------|------|------|------------|--------------------------|------|------|------|------------|------------------------------|------|------|------|------------|--------------------------------|------|------|------|------------|------------|
|              | Right                          | Thru | Left | Peds | App. Total | Right                    | Thru | Left | Peds | App. Total | Right                        | Thru | Left | Peds | App. Total | Right                          | Thru | Left | Peds | App. Total |            |
| 07:00 AM     | 0                              | 0    | 0    | 0    | 0          | 0                        | 0    | 0    | 0    | 0          | 0                            | 0    | 0    | 0    | 0          | 0                              | 0    | 0    | 0    | 0          | 0          |
| 07:15 AM     | 0                              | 0    | 0    | 0    | 0          | 0                        | 0    | 1    | 0    | 1          | 0                            | 0    | 0    | 0    | 0          | 0                              | 0    | 0    | 0    | 0          | 1          |
| 07:30 AM     | 0                              | 0    | 0    | 0    | 0          | 0                        | 0    | 1    | 0    | 1          | 0                            | 0    | 0    | 0    | 0          | 0                              | 0    | 0    | 0    | 0          | 1          |
| 07:45 AM     | 0                              | 0    | 0    | 0    | 0          | 0                        | 0    | 0    | 0    | 0          | 1                            | 0    | 0    | 0    | 1          | 0                              | 0    | 0    | 0    | 0          | 1          |
| <b>Total</b> | 0                              | 0    | 0    | 0    | 0          | 0                        | 0    | 2    | 0    | 2          | 1                            | 0    | 0    | 0    | 1          | 0                              | 0    | 0    | 0    | 0          | 3          |
| 08:00 AM     | 0                              | 0    | 0    | 0    | 0          | 0                        | 0    | 1    | 0    | 1          | 0                            | 0    | 0    | 0    | 0          | 0                              | 0    | 0    | 0    | 0          | 1          |
| 08:15 AM     | 0                              | 0    | 0    | 0    | 0          | 0                        | 0    | 0    | 0    | 0          | 1                            | 0    | 0    | 0    | 1          | 0                              | 0    | 0    | 0    | 0          | 1          |
| 08:30 AM     | 0                              | 0    | 0    | 0    | 0          | 0                        | 0    | 0    | 0    | 0          | 0                            | 0    | 0    | 0    | 0          | 0                              | 0    | 0    | 0    | 0          | 0          |
| 08:45 AM     | 0                              | 0    | 0    | 0    | 0          | 0                        | 0    | 0    | 0    | 0          | 1                            | 0    | 0    | 0    | 1          | 0                              | 0    | 0    | 0    | 0          | 1          |
| <b>Total</b> | 0                              | 0    | 0    | 0    | 0          | 0                        | 0    | 1    | 0    | 1          | 2                            | 0    | 0    | 0    | 2          | 0                              | 0    | 0    | 0    | 0          | 3          |
| Grand Total  | 0                              | 0    | 0    | 0    | 0          | 0                        | 0    | 3    | 0    | 3          | 3                            | 0    | 0    | 0    | 3          | 0                              | 0    | 0    | 0    | 0          | 6          |
| Apprch %     | 0                              | 0    | 0    | 0    | 0          | 0                        | 0    | 100  | 0    | 100        | 100                          | 0    | 0    | 0    | 100        | 0                              | 0    | 0    | 0    | 0          |            |
| Total %      | 0                              | 0    | 0    | 0    | 0          | 0                        | 0    | 50   | 0    | 50         | 50                           | 0    | 0    | 0    | 50         | 0                              | 0    | 0    | 0    | 0          |            |

| Start Time   | HWY 1 SB ON-RAMP<br>Southbound |      |      |      |            | MONTEREY RD<br>Westbound |      |      |      |            | CALIFORNIA AVE<br>Northbound |      |      |      |            | HWY 1 NB OFF-RAMP<br>Eastbound |      |      |      |            | Int. Total |
|--|--------------------------------|------|------|------|------------|--------------------------|------|------|------|------------|------------------------------|------|------|------|------------|--------------------------------|------|------|------|------------|------------|
|  | Right                          | Thru | Left | Peds | App. Total | Right                    | Thru | Left | Peds | App. Total | Right                        | Thru | Left | Peds | App. Total | Right                          | Thru | Left | Peds | App. Total |            |
| Peak Hour Analysis From 07:00 AM to 08:45 AM - Peak 1 of 1 |                                |      |      |      |            |                          |      |      |      |            |                              |      |      |      |            |                                |      |      |      |            |            |
| Peak Hour for Entire Intersection Begins at 07:15 AM       |                                |      |      |      |            |                          |      |      |      |            |                              |      |      |      |            |                                |      |      |      |            |            |
| 07:15 AM   | 0                              | 0    | 0    | 0    | 0          | 0                        | 0    | 1    | 0    | 1          | 0                            | 0    | 0    | 0    | 0          | 0                              | 0    | 0    | 0    | 0          | 1          |
| 07:30 AM   | 0                              | 0    | 0    | 0    | 0          | 0                        | 0    | 1    | 0    | 1          | 0                            | 0    | 0    | 0    | 0          | 0                              | 0    | 0    | 0    | 0          | 1          |
| 07:45 AM   | 0                              | 0    | 0    | 0    | 0          | 0                        | 0    | 0    | 0    | 0          | 1                            | 0    | 0    | 0    | 1          | 0                              | 0    | 0    | 0    | 0          | 1          |
| 08:00 AM   | 0                              | 0    | 0    | 0    | 0          | 0                        | 0    | 1    | 0    | 1          | 0                            | 0    | 0    | 0    | 0          | 0                              | 0    | 0    | 0    | 0          | 1          |
| Total Volume   | 0                              | 0    | 0    | 0    | 0          | 0                        | 0    | 3    | 0    | 3          | 1                            | 0    | 0    | 0    | 1          | 0                              | 0    | 0    | 0    | 0          | 4          |
| % App. Total   | 0                              | 0    | 0    | 0    | 0          | 0                        | 0    | 100  | 0    | 100        | 100                          | 0    | 0    | 0    | 100        | 0                              | 0    | 0    | 0    | 0          |            |
| PHF  | .000                           | .000 | .000 | .000 | .000       | .000                     | .000 | .750 | .000 | .750       | .250                         | .000 | .000 | .250 | .250       | .000                           | .000 | .000 | .000 | .000       | 1.00       |

# Traffic Data Service

San Jose, CA  
 (408) 622-4787  
 tdsbay@cs.com

File Name : 21AM FINAL  
 Site Code : 00000021  
 Start Date : 4/25/2018  
 Page No : 2

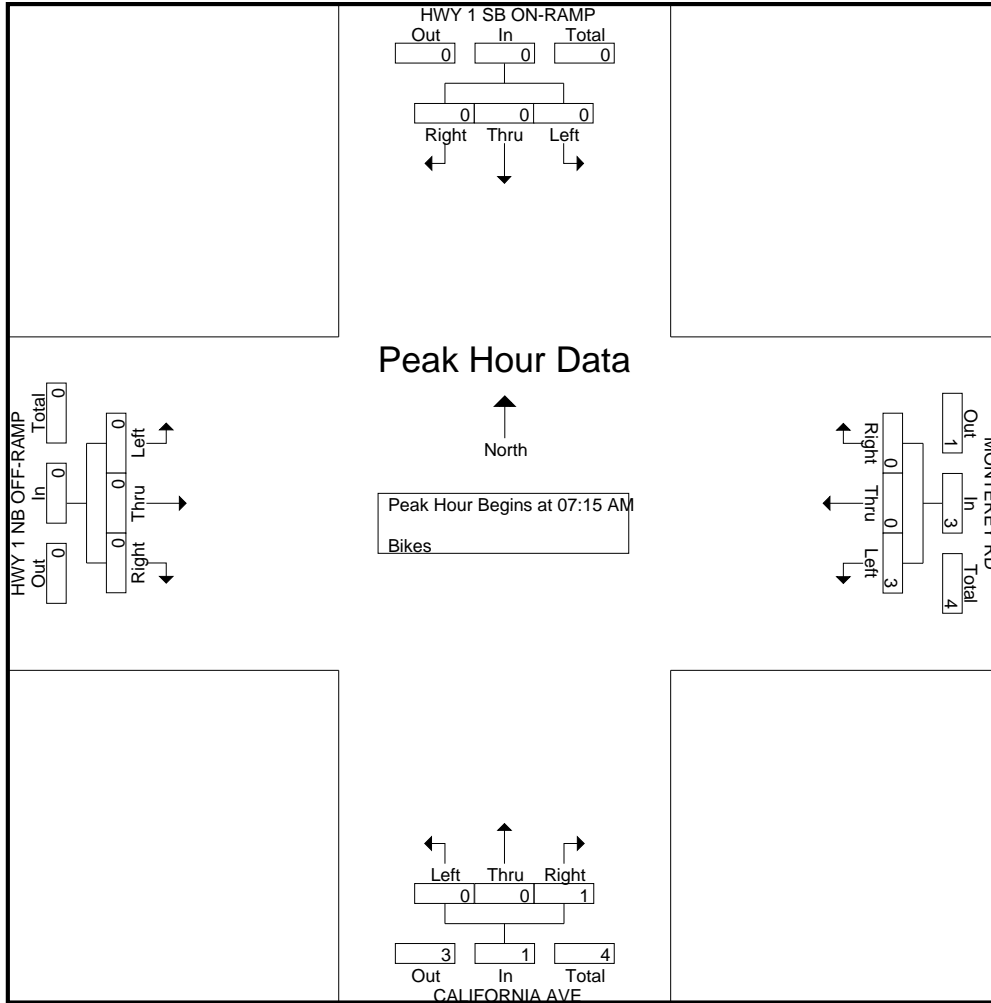

# Traffic Data Service

San Jose, CA  
 (408) 622-4787  
 tdsbay@cs.com

File Name : 21PM FINAL  
 Site Code : 00000021  
 Start Date : 4/25/2018  
 Page No : 1

Groups Printed- Lights - Buses - Trucks

| Start Time  | HWY 1 SB ON-RAMP<br>Southbound |      |      |      |            | MONTEREY RD<br>Westbound |      |      |      |            | CALIFORNIA AVE<br>Northbound |      |      |      |            | HWY 1 NB OFF-RAMP<br>Eastbound |      |      |      |            | Int. Total |
|-------------|--------------------------------|------|------|------|------------|--------------------------|------|------|------|------------|------------------------------|------|------|------|------------|--------------------------------|------|------|------|------------|------------|
|             | Right                          | Thru | Left | Peds | App. Total | Right                    | Thru | Left | Peds | App. Total | Right                        | Thru | Left | Peds | App. Total | Right                          | Thru | Left | Peds | App. Total |            |
| 04:00 PM    | 0                              | 0    | 0    | 0    | 0          | 44                       | 0    | 74   | 0    | 118        | 67                           | 23   | 0    | 1    | 91         | 31                             | 45   | 0    | 0    | 76         | 285        |
| 04:15 PM    | 0                              | 0    | 0    | 0    | 0          | 60                       | 0    | 57   | 0    | 117        | 85                           | 32   | 0    | 0    | 117        | 35                             | 51   | 0    | 0    | 86         | 320        |
| 04:30 PM    | 0                              | 0    | 0    | 0    | 0          | 65                       | 0    | 52   | 1    | 118        | 75                           | 32   | 0    | 1    | 108        | 17                             | 35   | 0    | 0    | 52         | 278        |
| 04:45 PM    | 0                              | 0    | 1    | 0    | 1          | 47                       | 0    | 69   | 0    | 116        | 55                           | 30   | 0    | 2    | 87         | 28                             | 35   | 0    | 0    | 63         | 267        |
| Total       | 0                              | 0    | 1    | 0    | 1          | 216                      | 0    | 252  | 1    | 469        | 282                          | 117  | 0    | 4    | 403        | 111                            | 166  | 0    | 0    | 277        | 1150       |
| 05:00 PM    | 0                              | 1    | 0    | 0    | 1          | 53                       | 0    | 60   | 0    | 113        | 65                           | 34   | 0    | 0    | 99         | 22                             | 49   | 0    | 0    | 71         | 284        |
| 05:15 PM    | 0                              | 0    | 0    | 0    | 0          | 45                       | 0    | 71   | 0    | 116        | 69                           | 23   | 0    | 3    | 95         | 24                             | 39   | 0    | 0    | 63         | 274        |
| 05:30 PM    | 0                              | 0    | 1    | 0    | 1          | 43                       | 0    | 61   | 0    | 104        | 80                           | 28   | 0    | 0    | 108        | 29                             | 62   | 0    | 0    | 91         | 304        |
| 05:45 PM    | 0                              | 0    | 0    | 0    | 0          | 49                       | 0    | 80   | 0    | 129        | 71                           | 27   | 0    | 0    | 98         | 45                             | 54   | 0    | 0    | 99         | 326        |
| Total       | 0                              | 1    | 1    | 0    | 2          | 190                      | 0    | 272  | 0    | 462        | 285                          | 112  | 0    | 3    | 400        | 120                            | 204  | 0    | 0    | 324        | 1188       |
| Grand Total | 0                              | 1    | 2    | 0    | 3          | 406                      | 0    | 524  | 1    | 931        | 567                          | 229  | 0    | 7    | 803        | 231                            | 370  | 0    | 0    | 601        | 2338       |
| Apprch %    | 0                              | 33.3 | 66.7 | 0    |            | 43.6                     | 0    | 56.3 | 0.1  |            | 70.6                         | 28.5 | 0    | 0.9  |            | 38.4                           | 61.6 | 0    | 0    |            |            |
| Total %     | 0                              | 0    | 0.1  | 0    | 0.1        | 17.4                     | 0    | 22.4 | 0    | 39.8       | 24.3                         | 9.8  | 0    | 0.3  | 34.3       | 9.9                            | 15.8 | 0    | 0    | 25.7       |            |
| Lights      | 0                              | 1    | 2    | 0    | 3          | 403                      | 0    | 516  | 1    | 920        | 562                          | 224  | 0    | 7    | 793        | 229                            | 366  | 0    | 0    | 595        | 2311       |
| % Lights    | 0                              | 100  | 100  | 0    | 100        | 99.3                     | 0    | 98.5 | 100  | 98.8       | 99.1                         | 97.8 | 0    | 100  | 98.8       | 99.1                           | 98.9 | 0    | 0    | 99         | 98.8       |
| Buses       | 0                              | 0    | 0    | 0    | 0          | 2                        | 0    | 7    | 0    | 9          | 5                            | 4    | 0    | 0    | 9          | 1                              | 3    | 0    | 0    | 4          | 22         |
| % Buses     | 0                              | 0    | 0    | 0    | 0          | 0.5                      | 0    | 1.3  | 0    | 1          | 0.9                          | 1.7  | 0    | 0    | 1.1        | 0.4                            | 0.8  | 0    | 0    | 0.7        | 0.9        |
| Trucks      | 0                              | 0    | 0    | 0    | 0          | 1                        | 0    | 1    | 0    | 2          | 0                            | 1    | 0    | 0    | 1          | 1                              | 1    | 0    | 0    | 2          | 5          |
| % Trucks    | 0                              | 0    | 0    | 0    | 0          | 0.2                      | 0    | 0.2  | 0    | 0.2        | 0                            | 0.4  | 0    | 0    | 0.1        | 0.4                            | 0.3  | 0    | 0    | 0.3        | 0.2        |

| Start Time   | HWY 1 SB ON-RAMP<br>Southbound |      |      |            | MONTEREY RD<br>Westbound |      |      |            | CALIFORNIA AVE<br>Northbound |      |      |            | HWY 1 NB OFF-RAMP<br>Eastbound |      |      |            | Int. Total |
|--|--------------------------------|------|------|------------|--------------------------|------|------|------------|------------------------------|------|------|------------|--------------------------------|------|------|------------|------------|
|  | Right                          | Thru | Left | App. Total | Right                    | Thru | Left | App. Total | Right                        | Thru | Left | App. Total | Right                          | Thru | Left | App. Total |            |
| Peak Hour Analysis From 04:00 PM to 05:45 PM - Peak 1 of 1 |                                |      |      |            |                          |      |      |            |                              |      |      |            |                                |      |      |            |            |
| Peak Hour for Entire Intersection Begins at 05:00 PM       |                                |      |      |            |                          |      |      |            |                              |      |      |            |                                |      |      |            |            |
| 05:00 PM   | 0                              | 1    | 0    | 1          | 53                       | 0    | 60   | 113        | 65                           | 34   | 0    | 99         | 22                             | 49   | 0    | 71         | 284        |
| 05:15 PM   | 0                              | 0    | 0    | 0          | 45                       | 0    | 71   | 116        | 69                           | 23   | 0    | 92         | 24                             | 39   | 0    | 63         | 271        |
| 05:30 PM   | 0                              | 0    | 1    | 1          | 43                       | 0    | 61   | 104        | 80                           | 28   | 0    | 108        | 29                             | 62   | 0    | 91         | 304        |
| 05:45 PM   | 0                              | 0    | 0    | 0          | 49                       | 0    | 80   | 129        | 71                           | 27   | 0    | 98         | 45                             | 54   | 0    | 99         | 326        |
| Total Volume   | 0                              | 1    | 1    | 2          | 190                      | 0    | 272  | 462        | 285                          | 112  | 0    | 397        | 120                            | 204  | 0    | 324        | 1185       |
| % App. Total   | 0                              | 50   | 50   |            | 41.1                     | 0    | 58.9 |            | 71.8                         | 28.2 | 0    |            | 37                             | 63   | 0    |            |            |
| PHF  | .000                           | .250 | .250 | .500       | .896                     | .000 | .850 | .895       | .891                         | .824 | .000 | .919       | .667                           | .823 | .000 | .818       | .909       |

# Traffic Data Service

San Jose, CA  
 (408) 622-4787  
 tdsbay@cs.com

File Name : 21PM FINAL  
 Site Code : 00000021  
 Start Date : 4/25/2018  
 Page No : 2

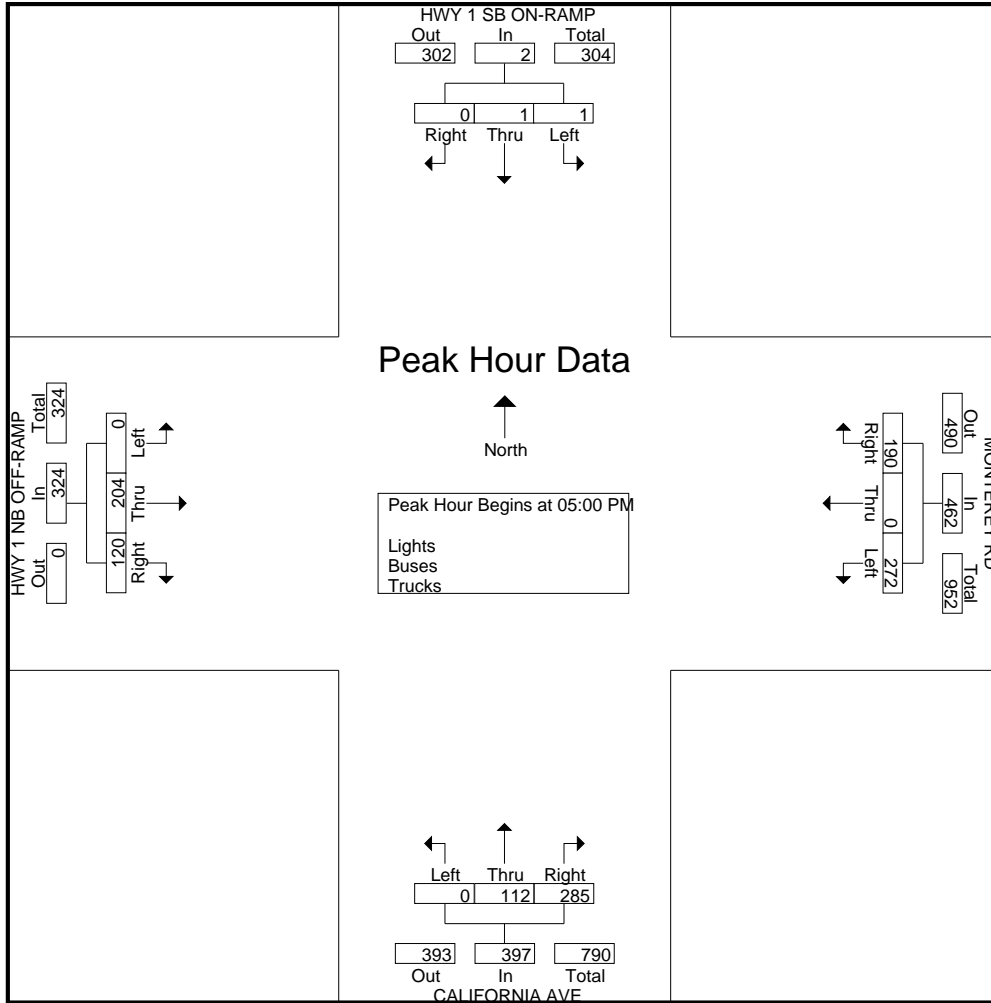

# Traffic Data Service

San Jose, CA  
 (408) 622-4787  
 tdsbay@cs.com

File Name : 21PM FINAL  
 Site Code : 00000021  
 Start Date : 4/25/2018  
 Page No : 1

Groups Printed- Bikes

| Start Time  | HWY 1 SB ON-RAMP<br>Southbound |      |      |      |            | MONTEREY RD<br>Westbound |      |      |      |            | CALIFORNIA AVE<br>Northbound |      |      |      |            | HWY 1 NB OFF-RAMP<br>Eastbound |      |      |      |            | Int. Total |
|-------------|--------------------------------|------|------|------|------------|--------------------------|------|------|------|------------|------------------------------|------|------|------|------------|--------------------------------|------|------|------|------------|------------|
|             | Right                          | Thru | Left | Peds | App. Total | Right                    | Thru | Left | Peds | App. Total | Right                        | Thru | Left | Peds | App. Total | Right                          | Thru | Left | Peds | App. Total |            |
| 04:00 PM    | 0                              | 0    | 0    | 0    | 0          | 0                        | 0    | 1    | 0    | 1          | 0                            | 0    | 0    | 0    | 0          | 0                              | 0    | 0    | 0    | 0          | 0          |
| 04:15 PM    | 0                              | 0    | 0    | 0    | 0          | 0                        | 0    | 1    | 0    | 1          | 0                            | 0    | 0    | 0    | 0          | 0                              | 0    | 0    | 0    | 0          | 0          |
| 04:30 PM    | 0                              | 0    | 0    | 0    | 0          | 0                        | 0    | 0    | 0    | 0          | 0                            | 0    | 0    | 0    | 0          | 0                              | 0    | 0    | 0    | 0          | 0          |
| 04:45 PM    | 0                              | 0    | 0    | 0    | 0          | 0                        | 0    | 1    | 0    | 1          | 0                            | 0    | 0    | 0    | 0          | 0                              | 0    | 0    | 0    | 0          | 0          |
| Total       | 0                              | 0    | 0    | 0    | 0          | 0                        | 0    | 3    | 0    | 3          | 0                            | 0    | 0    | 0    | 0          | 0                              | 0    | 0    | 0    | 0          | 3          |
| 05:00 PM    | 0                              | 0    | 0    | 0    | 0          | 0                        | 0    | 0    | 0    | 0          | 0                            | 0    | 0    | 0    | 0          | 0                              | 0    | 0    | 0    | 0          | 0          |
| 05:15 PM    | 0                              | 0    | 0    | 0    | 0          | 0                        | 0    | 0    | 0    | 0          | 0                            | 0    | 0    | 0    | 0          | 0                              | 0    | 0    | 0    | 0          | 0          |
| 05:30 PM    | 0                              | 0    | 0    | 0    | 0          | 0                        | 0    | 0    | 0    | 0          | 0                            | 0    | 0    | 0    | 0          | 0                              | 0    | 0    | 0    | 0          | 0          |
| 05:45 PM    | 0                              | 0    | 0    | 0    | 0          | 0                        | 0    | 0    | 0    | 0          | 0                            | 0    | 0    | 0    | 0          | 0                              | 0    | 0    | 0    | 0          | 0          |
| Total       | 0                              | 0    | 0    | 0    | 0          | 0                        | 0    | 0    | 0    | 0          | 0                            | 0    | 0    | 0    | 0          | 0                              | 0    | 0    | 0    | 0          | 0          |
| Grand Total | 0                              | 0    | 0    | 0    | 0          | 0                        | 0    | 3    | 0    | 3          | 0                            | 0    | 0    | 0    | 0          | 0                              | 0    | 0    | 0    | 0          | 3          |
| Apprch %    | 0                              | 0    | 0    | 0    | 0          | 0                        | 0    | 100  | 0    | 100        | 0                            | 0    | 0    | 0    | 0          | 0                              | 0    | 0    | 0    | 0          | 0          |
| Total %     | 0                              | 0    | 0    | 0    | 0          | 0                        | 0    | 100  | 0    | 100        | 0                            | 0    | 0    | 0    | 0          | 0                              | 0    | 0    | 0    | 0          | 0          |

| Start Time   | HWY 1 SB ON-RAMP<br>Southbound |      |      |      |            | MONTEREY RD<br>Westbound |      |      |      |            | CALIFORNIA AVE<br>Northbound |      |      |      |            | HWY 1 NB OFF-RAMP<br>Eastbound |      |      |      |            | Int. Total |
|--------------|--------------------------------|------|------|------|------------|--------------------------|------|------|------|------------|------------------------------|------|------|------|------------|--------------------------------|------|------|------|------------|------------|
|              | Right                          | Thru | Left | Peds | App. Total | Right                    | Thru | Left | Peds | App. Total | Right                        | Thru | Left | Peds | App. Total | Right                          | Thru | Left | Peds | App. Total |            |
| 04:00 PM     | 0                              | 0    | 0    | 0    | 0          | 0                        | 0    | 1    | 0    | 1          | 0                            | 0    | 0    | 0    | 0          | 0                              | 0    | 0    | 0    | 0          | 0          |
| 04:15 PM     | 0                              | 0    | 0    | 0    | 0          | 0                        | 0    | 1    | 0    | 1          | 0                            | 0    | 0    | 0    | 0          | 0                              | 0    | 0    | 0    | 0          | 0          |
| 04:30 PM     | 0                              | 0    | 0    | 0    | 0          | 0                        | 0    | 0    | 0    | 0          | 0                            | 0    | 0    | 0    | 0          | 0                              | 0    | 0    | 0    | 0          | 0          |
| 04:45 PM     | 0                              | 0    | 0    | 0    | 0          | 0                        | 0    | 1    | 0    | 1          | 0                            | 0    | 0    | 0    | 0          | 0                              | 0    | 0    | 0    | 0          | 0          |
| Total Volume | 0                              | 0    | 0    | 0    | 0          | 0                        | 0    | 3    | 0    | 3          | 0                            | 0    | 0    | 0    | 0          | 0                              | 0    | 0    | 0    | 0          | 3          |
| % App. Total | 0                              | 0    | 0    | 0    | 0          | 0                        | 0    | 100  | 0    | 100        | 0                            | 0    | 0    | 0    | 0          | 0                              | 0    | 0    | 0    | 0          | 0          |
| PHF          | .000                           | .000 | .000 | .000 | .000       | .000                     | .000 | .750 | .000 | .750       | .000                         | .000 | .000 | .000 | .000       | .000                           | .000 | .000 | .000 | .000       | .750       |

Peak Hour Analysis From 04:00 PM to 05:45 PM - Peak 1 of 1  
 Peak Hour for Entire Intersection Begins at 04:00 PM

# Traffic Data Service

San Jose, CA  
(408) 622-4787  
tdsbay@cs.com

File Name : 21PM FINAL  
Site Code : 00000021  
Start Date : 4/25/2018  
Page No : 2

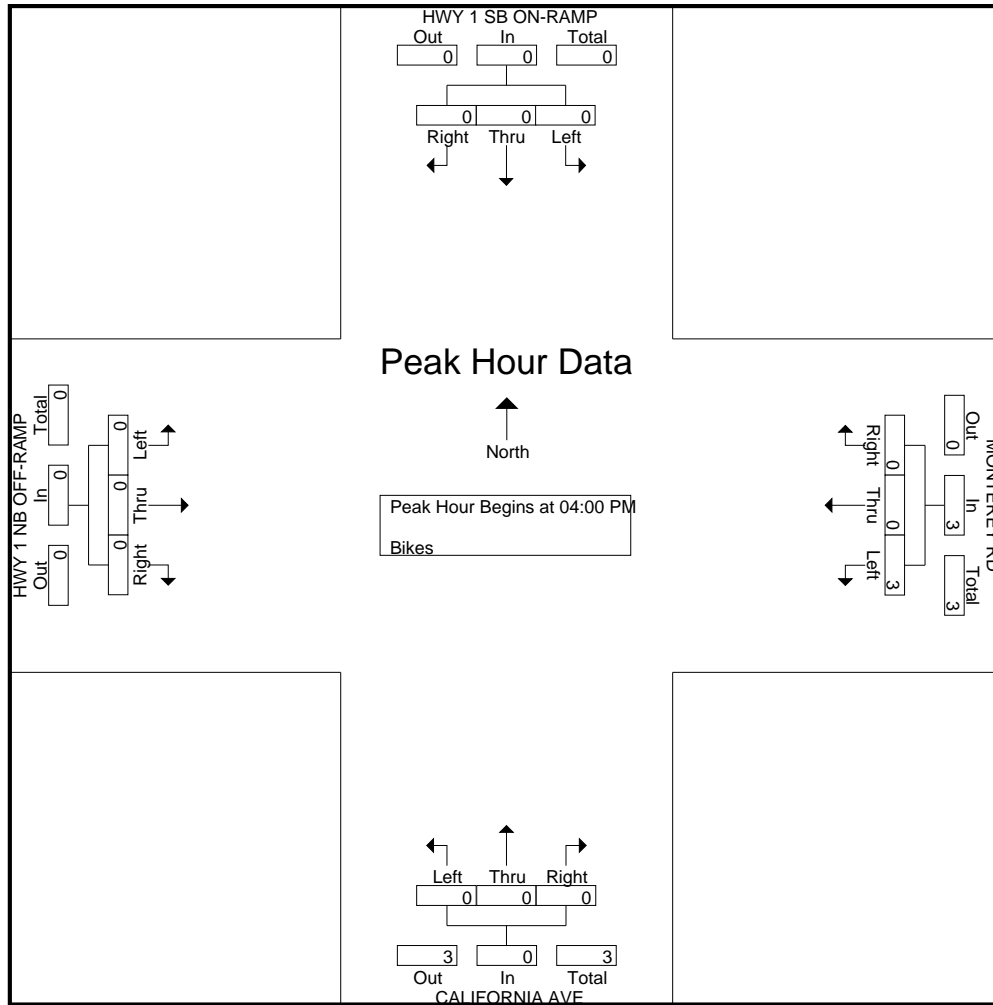



# Traffic Data Service

San Jose, CA  
 (408) 622-4787  
 tdsbay@cs.com

File Name : 22AM FINAL  
 Site Code : 00000022  
 Start Date : 4/25/2018  
 Page No : 1

## Groups Printed- Lights - Buses - Trucks

| Start Time  | Southbound |      |      |      |            | INTER-GARRISON RD<br>Westbound |      |      |      |            | 8TH AVE<br>Northbound |      |      |      |            | INTER-GARRISON RD<br>Eastbound |      |      |      |            | Int. Total |
|-------------|------------|------|------|------|------------|--------------------------------|------|------|------|------------|-----------------------|------|------|------|------------|--------------------------------|------|------|------|------------|------------|
|             | Right      | Thru | Left | Peds | App. Total | Right                          | Thru | Left | Peds | App. Total | Right                 | Thru | Left | Peds | App. Total | Right                          | Thru | Left | Peds | App. Total |            |
| 07:00 AM    | 0          | 0    | 0    | 0    | 0          | 0                              | 25   | 145  | 0    | 170        | 13                    | 0    | 0    | 0    | 13         | 2                              | 5    | 0    | 0    | 7          | 190        |
| 07:15 AM    | 0          | 0    | 0    | 0    | 0          | 0                              | 40   | 194  | 0    | 234        | 18                    | 0    | 0    | 0    | 18         | 1                              | 10   | 0    | 0    | 11         | 263        |
| 07:30 AM    | 0          | 0    | 0    | 0    | 0          | 0                              | 73   | 181  | 0    | 254        | 28                    | 0    | 0    | 0    | 28         | 2                              | 5    | 0    | 0    | 7          | 289        |
| 07:45 AM    | 0          | 0    | 0    | 0    | 0          | 0                              | 114  | 148  | 0    | 262        | 39                    | 0    | 0    | 0    | 39         | 7                              | 4    | 0    | 0    | 11         | 312        |
| Total       | 0          | 0    | 0    | 0    | 0          | 0                              | 252  | 668  | 0    | 920        | 98                    | 0    | 0    | 0    | 98         | 12                             | 24   | 0    | 0    | 36         | 1054       |
| 08:00 AM    | 0          | 0    | 0    | 0    | 0          | 0                              | 84   | 95   | 0    | 179        | 29                    | 0    | 2    | 0    | 31         | 1                              | 14   | 0    | 0    | 15         | 225        |
| 08:15 AM    | 0          | 0    | 0    | 0    | 0          | 0                              | 65   | 85   | 0    | 150        | 21                    | 0    | 2    | 1    | 24         | 4                              | 8    | 0    | 0    | 12         | 186        |
| 08:30 AM    | 0          | 0    | 0    | 0    | 0          | 0                              | 40   | 60   | 0    | 100        | 18                    | 0    | 3    | 0    | 21         | 4                              | 11   | 0    | 0    | 15         | 136        |
| 08:45 AM    | 0          | 0    | 0    | 0    | 0          | 0                              | 42   | 46   | 0    | 88         | 14                    | 0    | 0    | 1    | 15         | 3                              | 5    | 0    | 0    | 8          | 111        |
| Total       | 0          | 0    | 0    | 0    | 0          | 0                              | 231  | 286  | 0    | 517        | 82                    | 0    | 7    | 2    | 91         | 12                             | 38   | 0    | 0    | 50         | 658        |
| Grand Total | 0          | 0    | 0    | 0    | 0          | 0                              | 483  | 954  | 0    | 1437       | 180                   | 0    | 7    | 2    | 189        | 24                             | 62   | 0    | 0    | 86         | 1712       |
| Apprch %    | 0          | 0    | 0    | 0    | 0          | 0                              | 33.6 | 66.4 | 0    | 100        | 95.2                  | 0    | 3.7  | 1.1  | 100        | 27.9                           | 72.1 | 0    | 0    | 100        |            |
| Total %     | 0          | 0    | 0    | 0    | 0          | 0                              | 28.2 | 55.7 | 0    | 83.9       | 10.5                  | 0    | 0.4  | 0.1  | 11         | 1.4                            | 3.6  | 0    | 0    | 5          |            |
| Lights      | 0          | 0    | 0    | 0    | 0          | 0                              | 467  | 948  | 0    | 1415       | 178                   | 0    | 4    | 2    | 184        | 21                             | 48   | 0    | 0    | 69         | 1668       |
| % Lights    | 0          | 0    | 0    | 0    | 0          | 0                              | 96.7 | 99.4 | 0    | 98.5       | 98.9                  | 0    | 57.1 | 100  | 97.4       | 87.5                           | 77.4 | 0    | 0    | 80.2       | 97.4       |
| Buses       | 0          | 0    | 0    | 0    | 0          | 0                              | 11   | 3    | 0    | 14         | 1                     | 0    | 1    | 0    | 2          | 3                              | 10   | 0    | 0    | 13         | 29         |
| % Buses     | 0          | 0    | 0    | 0    | 0          | 0                              | 2.3  | 0.3  | 0    | 1          | 0.6                   | 0    | 14.3 | 0    | 1.1        | 12.5                           | 16.1 | 0    | 0    | 15.1       | 1.7        |
| Trucks      | 0          | 0    | 0    | 0    | 0          | 0                              | 5    | 3    | 0    | 8          | 1                     | 0    | 2    | 0    | 3          | 0                              | 4    | 0    | 0    | 4          | 15         |
| % Trucks    | 0          | 0    | 0    | 0    | 0          | 0                              | 1    | 0.3  | 0    | 0.6        | 0.6                   | 0    | 28.6 | 0    | 1.6        | 0                              | 6.5  | 0    | 0    | 4.7        | 0.9        |

| Start Time   | Southbound |      |      |            | INTER-GARRISON RD<br>Westbound |      |      |            | 8TH AVE<br>Northbound |      |      |            | INTER-GARRISON RD<br>Eastbound |      |      |            | Int. Total |
|--|------------|------|------|------------|--------------------------------|------|------|------------|-----------------------|------|------|------------|--------------------------------|------|------|------------|------------|
|  | Right      | Thru | Left | App. Total | Right                          | Thru | Left | App. Total | Right                 | Thru | Left | App. Total | Right                          | Thru | Left | App. Total |            |
| Peak Hour Analysis From 07:00 AM to 08:45 AM - Peak 1 of 1 |            |      |      |            |                                |      |      |            |                       |      |      |            |                                |      |      |            |            |
| Peak Hour for Entire Intersection Begins at 07:15 AM       |            |      |      |            |                                |      |      |            |                       |      |      |            |                                |      |      |            |            |
| 07:15 AM   | 0          | 0    | 0    | 0          | 0                              | 40   | 194  | 234        | 18                    | 0    | 0    | 18         | 1                              | 10   | 0    | 11         | 263        |
| 07:30 AM   | 0          | 0    | 0    | 0          | 0                              | 73   | 181  | 254        | 28                    | 0    | 0    | 28         | 2                              | 5    | 0    | 7          | 289        |
| 07:45 AM   | 0          | 0    | 0    | 0          | 0                              | 114  | 148  | 262        | 39                    | 0    | 0    | 39         | 7                              | 4    | 0    | 11         | 312        |
| 08:00 AM   | 0          | 0    | 0    | 0          | 0                              | 84   | 95   | 179        | 29                    | 0    | 2    | 31         | 1                              | 14   | 0    | 15         | 225        |
| Total Volume   | 0          | 0    | 0    | 0          | 0                              | 311  | 618  | 929        | 114                   | 0    | 2    | 116        | 11                             | 33   | 0    | 44         | 1089       |
| % App. Total   | 0          | 0    | 0    | 0          | 0                              | 33.5 | 66.5 | 100        | 98.3                  | 0    | 1.7  | 100        | 25                             | 75   | 0    | 100        |            |
| PHF  | .000       | .000 | .000 | .000       | .000                           | .682 | .796 | .886       | .731                  | .000 | .250 | .744       | .393                           | .589 | .000 | .733       | .873       |

# Traffic Data Service

San Jose, CA  
 (408) 622-4787  
 tdsbay@cs.com

File Name : 22AM FINAL  
 Site Code : 00000022  
 Start Date : 4/25/2018  
 Page No : 2

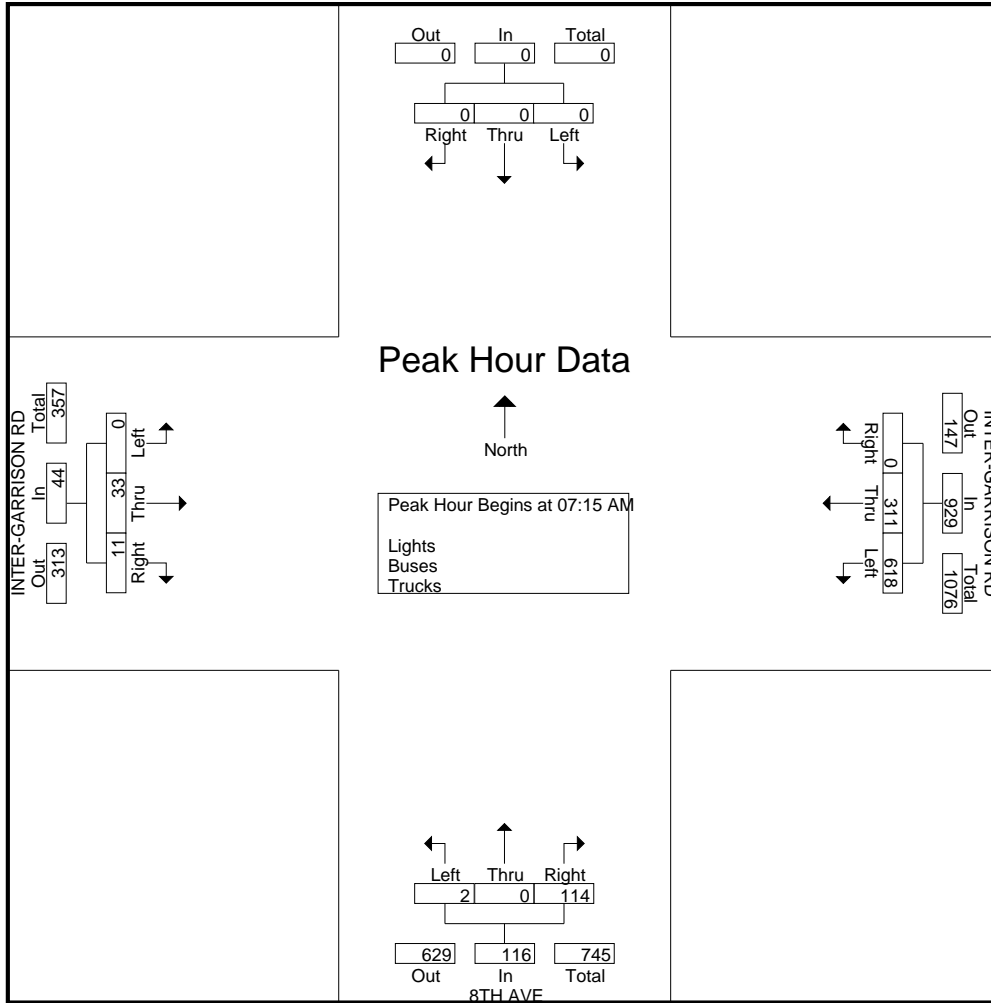

# Traffic Data Service

San Jose, CA  
 (408) 622-4787  
 tdsbay@cs.com

File Name : 22AM FINAL  
 Site Code : 00000022  
 Start Date : 4/25/2018  
 Page No : 1

Groups Printed- Bikes

| Start Time  | Southbound |      |      |      |            | INTER-GARRISON RD Westbound |      |      |      |            | 8TH AVE Northbound |      |      |      |            | INTER-GARRISON RD Eastbound |      |      |      |            | Int. Total |
|-------------|------------|------|------|------|------------|-----------------------------|------|------|------|------------|--------------------|------|------|------|------------|-----------------------------|------|------|------|------------|------------|
|             | Right      | Thru | Left | Peds | App. Total | Right                       | Thru | Left | Peds | App. Total | Right              | Thru | Left | Peds | App. Total | Right                       | Thru | Left | Peds | App. Total |            |
| 07:00 AM    | 0          | 0    | 0    | 0    | 0          | 0                           | 0    | 0    | 0    | 0          | 0                  | 0    | 0    | 0    | 0          | 1                           | 0    | 0    | 0    | 0          | 1          |
| 07:15 AM    | 0          | 0    | 0    | 0    | 0          | 0                           | 0    | 0    | 0    | 0          | 0                  | 0    | 0    | 0    | 0          | 0                           | 0    | 0    | 0    | 0          | 0          |
| 07:30 AM    | 0          | 0    | 0    | 0    | 0          | 0                           | 0    | 0    | 0    | 0          | 0                  | 0    | 0    | 0    | 0          | 0                           | 0    | 0    | 0    | 0          | 0          |
| 07:45 AM    | 0          | 0    | 0    | 0    | 0          | 0                           | 0    | 0    | 0    | 0          | 0                  | 0    | 0    | 0    | 0          | 0                           | 0    | 0    | 0    | 0          | 0          |
| Total       | 0          | 0    | 0    | 0    | 0          | 0                           | 0    | 0    | 0    | 0          | 0                  | 0    | 0    | 0    | 0          | 1                           | 0    | 0    | 0    | 0          | 1          |
| 08:00 AM    | 0          | 0    | 0    | 0    | 0          | 0                           | 0    | 0    | 0    | 0          | 0                  | 0    | 0    | 0    | 0          | 0                           | 0    | 0    | 0    | 0          | 0          |
| 08:15 AM    | 0          | 0    | 0    | 0    | 0          | 0                           | 0    | 0    | 0    | 0          | 0                  | 0    | 0    | 0    | 0          | 0                           | 0    | 0    | 0    | 0          | 0          |
| 08:30 AM    | 0          | 0    | 0    | 0    | 0          | 0                           | 0    | 0    | 0    | 0          | 0                  | 0    | 0    | 0    | 0          | 0                           | 0    | 0    | 0    | 0          | 0          |
| 08:45 AM    | 0          | 0    | 0    | 0    | 0          | 0                           | 1    | 0    | 0    | 1          | 0                  | 0    | 0    | 0    | 0          | 0                           | 0    | 0    | 0    | 0          | 1          |
| Total       | 0          | 0    | 0    | 0    | 0          | 0                           | 1    | 0    | 0    | 1          | 0                  | 0    | 0    | 0    | 0          | 0                           | 0    | 0    | 0    | 0          | 1          |
| Grand Total | 0          | 0    | 0    | 0    | 0          | 0                           | 1    | 0    | 0    | 1          | 0                  | 0    | 0    | 0    | 0          | 1                           | 0    | 0    | 0    | 0          | 2          |
| Apprch %    | 0          | 0    | 0    | 0    | 0          | 0                           | 100  | 0    | 0    | 100        | 0                  | 0    | 0    | 0    | 0          | 100                         | 0    | 0    | 0    | 0          |            |
| Total %     | 0          | 0    | 0    | 0    | 0          | 0                           | 50   | 0    | 0    | 50         | 0                  | 0    | 0    | 0    | 0          | 50                          | 0    | 0    | 0    | 50         |            |

| Start Time   | Southbound |      |      |      |            | INTER-GARRISON RD Westbound |      |      |      |            | 8TH AVE Northbound |      |      |      |            | INTER-GARRISON RD Eastbound |      |      |      |            | Int. Total |
|--------------|------------|------|------|------|------------|-----------------------------|------|------|------|------------|--------------------|------|------|------|------------|-----------------------------|------|------|------|------------|------------|
|              | Right      | Thru | Left | Peds | App. Total | Right                       | Thru | Left | Peds | App. Total | Right              | Thru | Left | Peds | App. Total | Right                       | Thru | Left | Peds | App. Total |            |
| 07:00 AM     | 0          | 0    | 0    | 0    | 0          | 0                           | 0    | 0    | 0    | 0          | 0                  | 0    | 0    | 0    | 0          | 1                           | 0    | 0    | 0    | 0          | 1          |
| 07:15 AM     | 0          | 0    | 0    | 0    | 0          | 0                           | 0    | 0    | 0    | 0          | 0                  | 0    | 0    | 0    | 0          | 0                           | 0    | 0    | 0    | 0          | 0          |
| 07:30 AM     | 0          | 0    | 0    | 0    | 0          | 0                           | 0    | 0    | 0    | 0          | 0                  | 0    | 0    | 0    | 0          | 0                           | 0    | 0    | 0    | 0          | 0          |
| 07:45 AM     | 0          | 0    | 0    | 0    | 0          | 0                           | 0    | 0    | 0    | 0          | 0                  | 0    | 0    | 0    | 0          | 0                           | 0    | 0    | 0    | 0          | 0          |
| Total Volume | 0          | 0    | 0    | 0    | 0          | 0                           | 0    | 0    | 0    | 0          | 0                  | 0    | 0    | 0    | 0          | 1                           | 0    | 0    | 0    | 0          | 1          |
| % App. Total | 0          | 0    | 0    | 0    | 0          | 0                           | 0    | 0    | 0    | 0          | 0                  | 0    | 0    | 0    | 0          | 100                         | 0    | 0    | 0    | 0          |            |
| PHF          | .000       | .000 | .000 | .000 | .000       | .000                        | .000 | .000 | .000 | .000       | .000               | .000 | .000 | .000 | .000       | .250                        | .000 | .000 | .250 | .250       |            |

Peak Hour Analysis From 07:00 AM to 08:45 AM - Peak 1 of 1  
 Peak Hour for Entire Intersection Begins at 07:00 AM

# Traffic Data Service

San Jose, CA  
(408) 622-4787  
tdsbay@cs.com

File Name : 22AM FINAL  
Site Code : 00000022  
Start Date : 4/25/2018  
Page No : 2

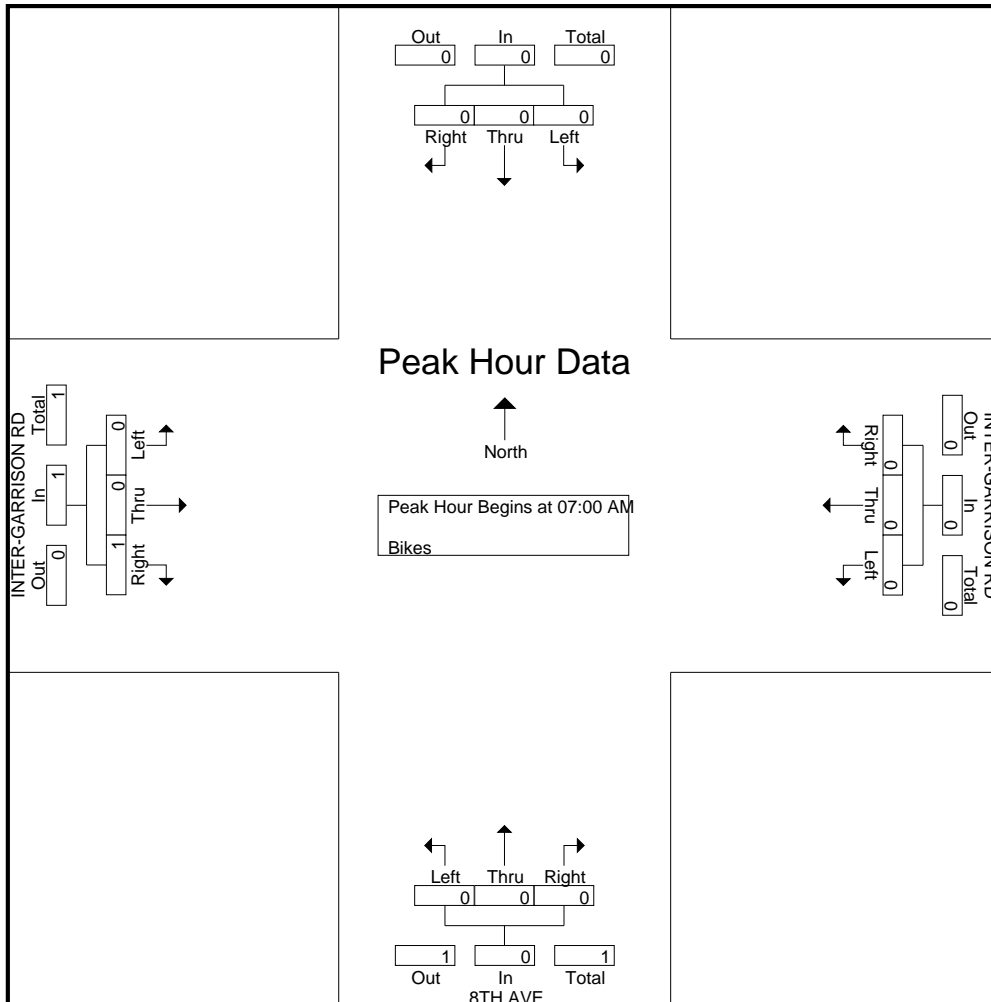

# Traffic Data Service

San Jose, CA  
 (408) 622-4787  
 tdsbay@cs.com

File Name : 22PM FINAL  
 Site Code : 00000022  
 Start Date : 4/25/2018  
 Page No : 1

## Groups Printed- Lights - Buses - Trucks

| Start Time   | Southbound |      |      |      |            | INTER-GARRISON RD<br>Westbound |      |      |      |            | 8TH AVE<br>Northbound |      |      |      |            | INTER-GARRISON RD<br>Eastbound |      |      |      |            | Int. Total |
|--------------|------------|------|------|------|------------|--------------------------------|------|------|------|------------|-----------------------|------|------|------|------------|--------------------------------|------|------|------|------------|------------|
|              | Right      | Thru | Left | Peds | App. Total | Right                          | Thru | Left | Peds | App. Total | Right                 | Thru | Left | Peds | App. Total | Right                          | Thru | Left | Peds | App. Total |            |
| 04:00 PM     | 0          | 0    | 0    | 0    | 0          | 0                              | 24   | 24   | 0    | 48         | 83                    | 0    | 3    | 2    | 88         | 1                              | 43   | 0    | 0    | 44         | 180        |
| 04:15 PM     | 0          | 0    | 0    | 0    | 0          | 0                              | 12   | 24   | 1    | 37         | 68                    | 0    | 2    | 2    | 72         | 1                              | 35   | 0    | 0    | 36         | 145        |
| 04:30 PM     | 0          | 0    | 0    | 0    | 0          | 0                              | 14   | 28   | 0    | 42         | 104                   | 0    | 3    | 0    | 107        | 2                              | 27   | 0    | 0    | 29         | 178        |
| 04:45 PM     | 0          | 0    | 0    | 0    | 0          | 0                              | 21   | 19   | 0    | 40         | 122                   | 0    | 3    | 0    | 125        | 0                              | 29   | 0    | 0    | 29         | 194        |
| <b>Total</b> | 0          | 0    | 0    | 0    | 0          | 0                              | 71   | 95   | 1    | 167        | 377                   | 0    | 11   | 4    | 392        | 4                              | 134  | 0    | 0    | 138        | 697        |
| 05:00 PM     | 0          | 0    | 0    | 0    | 0          | 0                              | 16   | 24   | 0    | 40         | 135                   | 0    | 1    | 1    | 137        | 1                              | 75   | 0    | 0    | 76         | 253        |
| 05:15 PM     | 0          | 0    | 0    | 0    | 0          | 0                              | 26   | 39   | 0    | 65         | 116                   | 0    | 3    | 1    | 120        | 2                              | 64   | 0    | 0    | 66         | 251        |
| 05:30 PM     | 0          | 0    | 0    | 0    | 0          | 0                              | 51   | 39   | 0    | 90         | 110                   | 0    | 2    | 1    | 113        | 0                              | 54   | 0    | 0    | 54         | 257        |
| 05:45 PM     | 0          | 0    | 0    | 0    | 0          | 0                              | 61   | 28   | 0    | 89         | 87                    | 0    | 1    | 2    | 90         | 3                              | 57   | 0    | 0    | 60         | 239        |
| <b>Total</b> | 0          | 0    | 0    | 0    | 0          | 0                              | 154  | 130  | 0    | 284        | 448                   | 0    | 7    | 5    | 460        | 6                              | 250  | 0    | 0    | 256        | 1000       |
| Grand Total  | 0          | 0    | 0    | 0    | 0          | 0                              | 225  | 225  | 1    | 451        | 825                   | 0    | 18   | 9    | 852        | 10                             | 384  | 0    | 0    | 394        | 1697       |
| Apprch %     | 0          | 0    | 0    | 0    | 0          | 0                              | 49.9 | 49.9 | 0.2  |            | 96.8                  | 0    | 2.1  | 1.1  |            | 2.5                            | 97.5 | 0    | 0    |            |            |
| Total %      | 0          | 0    | 0    | 0    | 0          | 0                              | 13.3 | 13.3 | 0.1  | 26.6       | 48.6                  | 0    | 1.1  | 0.5  | 50.2       | 0.6                            | 22.6 | 0    | 0    | 23.2       |            |
| Lights       | 0          | 0    | 0    | 0    | 0          | 0                              | 215  | 222  | 1    | 438        | 822                   | 0    | 18   | 9    | 849        | 10                             | 371  | 0    | 0    | 381        | 1668       |
| % Lights     | 0          | 0    | 0    | 0    | 0          | 0                              | 95.6 | 98.7 | 100  | 97.1       | 99.6                  | 0    | 100  | 100  | 99.6       | 100                            | 96.6 | 0    | 0    | 96.7       | 98.3       |
| Buses        | 0          | 0    | 0    | 0    | 0          | 0                              | 10   | 0    | 0    | 10         | 2                     | 0    | 0    | 0    | 2          | 0                              | 12   | 0    | 0    | 12         | 24         |
| % Buses      | 0          | 0    | 0    | 0    | 0          | 0                              | 4.4  | 0    | 0    | 2.2        | 0.2                   | 0    | 0    | 0    | 0.2        | 0                              | 3.1  | 0    | 0    | 3          | 1.4        |
| Trucks       | 0          | 0    | 0    | 0    | 0          | 0                              | 0    | 3    | 0    | 3          | 1                     | 0    | 0    | 0    | 1          | 0                              | 1    | 0    | 0    | 1          | 5          |
| % Trucks     | 0          | 0    | 0    | 0    | 0          | 0                              | 0    | 1.3  | 0    | 0.7        | 0.1                   | 0    | 0    | 0    | 0.1        | 0                              | 0.3  | 0    | 0    | 0.3        | 0.3        |

| Start Time   | Southbound |      |      |            | INTER-GARRISON RD<br>Westbound |      |      |            | 8TH AVE<br>Northbound |      |      |            | INTER-GARRISON RD<br>Eastbound |      |      |            | Int. Total |
|--|------------|------|------|------------|--------------------------------|------|------|------------|-----------------------|------|------|------------|--------------------------------|------|------|------------|------------|
|  | Right      | Thru | Left | App. Total | Right                          | Thru | Left | App. Total | Right                 | Thru | Left | App. Total | Right                          | Thru | Left | App. Total |            |
| Peak Hour Analysis From 04:00 PM to 05:45 PM - Peak 1 of 1 |            |      |      |            |                                |      |      |            |                       |      |      |            |                                |      |      |            |            |
| Peak Hour for Entire Intersection Begins at 05:00 PM       |            |      |      |            |                                |      |      |            |                       |      |      |            |                                |      |      |            |            |
| 05:00 PM   | 0          | 0    | 0    | 0          | 0                              | 16   | 24   | 40         | 135                   | 0    | 1    | 136        | 1                              | 75   | 0    | 76         | 252        |
| 05:15 PM   | 0          | 0    | 0    | 0          | 0                              | 26   | 39   | 65         | 116                   | 0    | 3    | 119        | 2                              | 64   | 0    | 66         | 250        |
| 05:30 PM   | 0          | 0    | 0    | 0          | 0                              | 51   | 39   | 90         | 110                   | 0    | 2    | 112        | 0                              | 54   | 0    | 54         | 256        |
| 05:45 PM   | 0          | 0    | 0    | 0          | 0                              | 61   | 28   | 89         | 87                    | 0    | 1    | 88         | 3                              | 57   | 0    | 60         | 237        |
| Total Volume   | 0          | 0    | 0    | 0          | 0                              | 154  | 130  | 284        | 448                   | 0    | 7    | 455        | 6                              | 250  | 0    | 256        | 995        |
| % App. Total   | 0          | 0    | 0    | 0          | 0                              | 54.2 | 45.8 |            | 98.5                  | 0    | 1.5  |            | 2.3                            | 97.7 | 0    |            |            |
| PHF  | .000       | .000 | .000 | .000       | .000                           | .631 | .833 | .789       | .830                  | .000 | .583 | .836       | .500                           | .833 | .000 | .842       | .972       |

# Traffic Data Service

San Jose, CA  
 (408) 622-4787  
 tdsbay@cs.com

File Name : 22PM FINAL  
 Site Code : 00000022  
 Start Date : 4/25/2018  
 Page No : 2

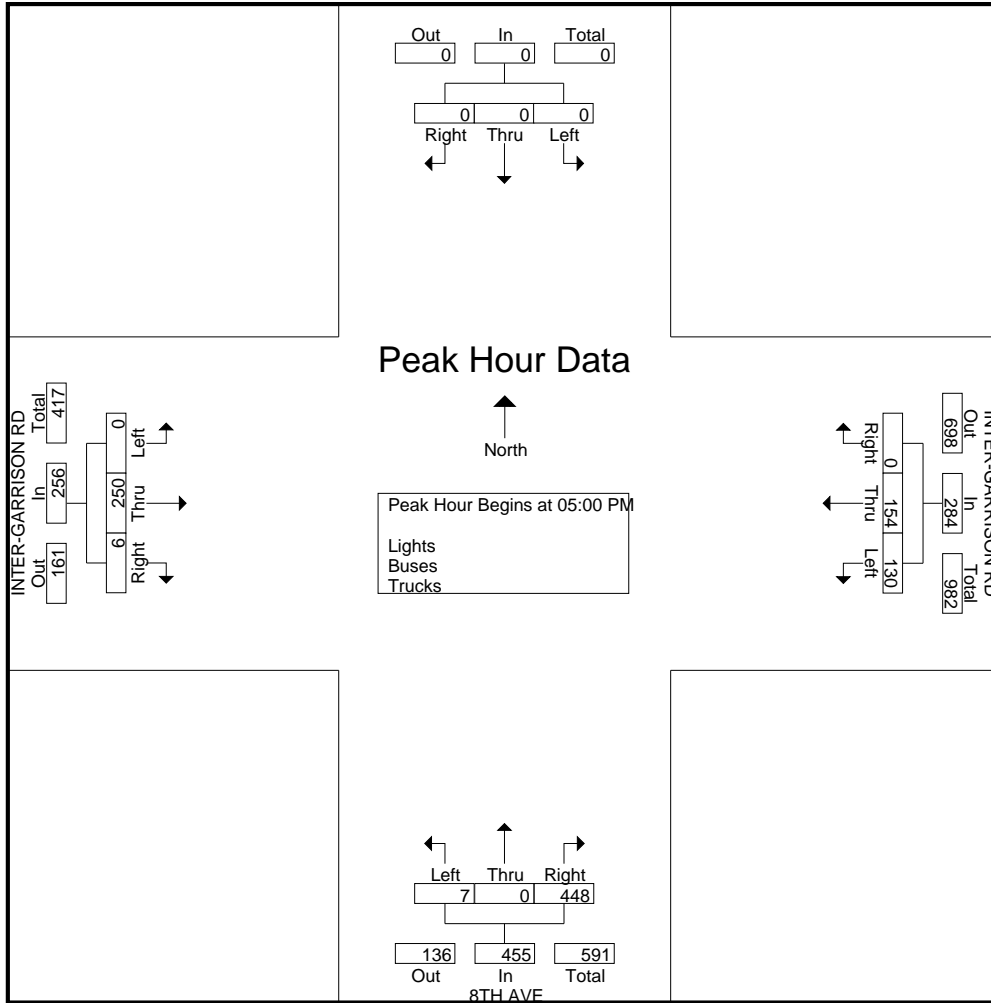

# Traffic Data Service

San Jose, CA  
(408) 622-4787  
tdsbay@cs.com

File Name : 22PM FINAL  
Site Code : 00000022  
Start Date : 4/25/2018  
Page No : 1

Groups Printed- Bikes

| Start Time   | Southbound |      |      |      |            | INTER-GARRISON RD<br>Westbound |      |      |      |            | 8TH AVE<br>Northbound |      |      |      |            | INTER-GARRISON RD<br>Eastbound |      |      |      |            | Int. Total |
|--------------|------------|------|------|------|------------|--------------------------------|------|------|------|------------|-----------------------|------|------|------|------------|--------------------------------|------|------|------|------------|------------|
|              | Right      | Thru | Left | Peds | App. Total | Right                          | Thru | Left | Peds | App. Total | Right                 | Thru | Left | Peds | App. Total | Right                          | Thru | Left | Peds | App. Total |            |
| 04:00 PM     | 0          | 0    | 0    | 0    | 0          | 0                              | 0    | 0    | 0    | 0          | 0                     | 0    | 0    | 0    | 0          | 0                              | 2    | 0    | 0    | 0          | 2          |
| 04:15 PM     | 0          | 0    | 0    | 0    | 0          | 0                              | 0    | 0    | 0    | 0          | 0                     | 0    | 0    | 0    | 0          | 0                              | 0    | 0    | 0    | 0          | 0          |
| 04:30 PM     | 0          | 0    | 0    | 0    | 0          | 0                              | 0    | 0    | 0    | 0          | 0                     | 0    | 0    | 0    | 0          | 0                              | 0    | 0    | 0    | 0          | 0          |
| 04:45 PM     | 0          | 0    | 0    | 0    | 0          | 0                              | 0    | 0    | 0    | 0          | 0                     | 0    | 0    | 0    | 0          | 0                              | 0    | 0    | 0    | 0          | 0          |
| <b>Total</b> | 0          | 0    | 0    | 0    | 0          | 0                              | 0    | 0    | 0    | 0          | 0                     | 0    | 0    | 0    | 0          | 0                              | 2    | 0    | 0    | 0          | 2          |
| 05:00 PM     | 0          | 0    | 0    | 0    | 0          | 0                              | 0    | 0    | 0    | 0          | 0                     | 0    | 0    | 0    | 0          | 0                              | 0    | 0    | 0    | 0          | 0          |
| 05:15 PM     | 0          | 0    | 0    | 0    | 0          | 0                              | 0    | 0    | 0    | 0          | 0                     | 0    | 0    | 0    | 0          | 0                              | 0    | 0    | 0    | 0          | 0          |
| 05:30 PM     | 0          | 0    | 0    | 0    | 0          | 0                              | 0    | 0    | 0    | 0          | 1                     | 0    | 0    | 0    | 1          | 0                              | 0    | 0    | 0    | 0          | 1          |
| 05:45 PM     | 0          | 0    | 0    | 0    | 0          | 0                              | 0    | 0    | 0    | 0          | 0                     | 0    | 0    | 0    | 0          | 0                              | 1    | 0    | 0    | 0          | 1          |
| <b>Total</b> | 0          | 0    | 0    | 0    | 0          | 0                              | 0    | 0    | 0    | 0          | 1                     | 0    | 0    | 0    | 1          | 0                              | 1    | 0    | 0    | 0          | 1          |
| Grand Total  | 0          | 0    | 0    | 0    | 0          | 0                              | 0    | 0    | 0    | 0          | 1                     | 0    | 0    | 0    | 1          | 0                              | 3    | 0    | 0    | 0          | 3          |
| Apprch %     | 0          | 0    | 0    | 0    | 0          | 0                              | 0    | 0    | 0    | 0          | 100                   | 0    | 0    | 0    | 0          | 0                              | 100  | 0    | 0    | 0          | 0          |
| Total %      | 0          | 0    | 0    | 0    | 0          | 0                              | 0    | 0    | 0    | 0          | 25                    | 0    | 0    | 0    | 25         | 0                              | 75   | 0    | 0    | 0          | 75         |

| Start Time   | Southbound |      |      |      |            | INTER-GARRISON RD<br>Westbound |      |      |      |            | 8TH AVE<br>Northbound |      |      |      |            | INTER-GARRISON RD<br>Eastbound |      |      |      |            | Int. Total |
|--|------------|------|------|------|------------|--------------------------------|------|------|------|------------|-----------------------|------|------|------|------------|--------------------------------|------|------|------|------------|------------|
|  | Right      | Thru | Left | Peds | App. Total | Right                          | Thru | Left | Peds | App. Total | Right                 | Thru | Left | Peds | App. Total | Right                          | Thru | Left | Peds | App. Total |            |
| Peak Hour Analysis From 04:00 PM to 05:45 PM - Peak 1 of 1 |            |      |      |      |            |                                |      |      |      |            |                       |      |      |      |            |                                |      |      |      |            |            |
| Peak Hour for Entire Intersection Begins at 04:00 PM       |            |      |      |      |            |                                |      |      |      |            |                       |      |      |      |            |                                |      |      |      |            |            |
| 04:00 PM   | 0          | 0    | 0    | 0    | 0          | 0                              | 0    | 0    | 0    | 0          | 0                     | 0    | 0    | 0    | 0          | 0                              | 2    | 0    | 0    | 0          | 2          |
| 04:15 PM   | 0          | 0    | 0    | 0    | 0          | 0                              | 0    | 0    | 0    | 0          | 0                     | 0    | 0    | 0    | 0          | 0                              | 0    | 0    | 0    | 0          | 0          |
| 04:30 PM   | 0          | 0    | 0    | 0    | 0          | 0                              | 0    | 0    | 0    | 0          | 0                     | 0    | 0    | 0    | 0          | 0                              | 0    | 0    | 0    | 0          | 0          |
| 04:45 PM   | 0          | 0    | 0    | 0    | 0          | 0                              | 0    | 0    | 0    | 0          | 0                     | 0    | 0    | 0    | 0          | 0                              | 0    | 0    | 0    | 0          | 0          |
| Total Volume   | 0          | 0    | 0    | 0    | 0          | 0                              | 0    | 0    | 0    | 0          | 0                     | 0    | 0    | 0    | 0          | 0                              | 2    | 0    | 0    | 0          | 2          |
| % App. Total   | 0          | 0    | 0    | 0    | 0          | 0                              | 0    | 0    | 0    | 0          | 0                     | 0    | 0    | 0    | 0          | 0                              | 100  | 0    | 0    | 0          | 0          |
| PHF  | .000       | .000 | .000 | .000 | .000       | .000                           | .000 | .000 | .000 | .000       | .000                  | .000 | .000 | .000 | .000       | .000                           | .250 | .000 | .000 | .250       | .250       |

# Traffic Data Service

San Jose, CA  
(408) 622-4787  
tdsbay@cs.com

File Name : 22PM FINAL  
Site Code : 00000022  
Start Date : 4/25/2018  
Page No : 2

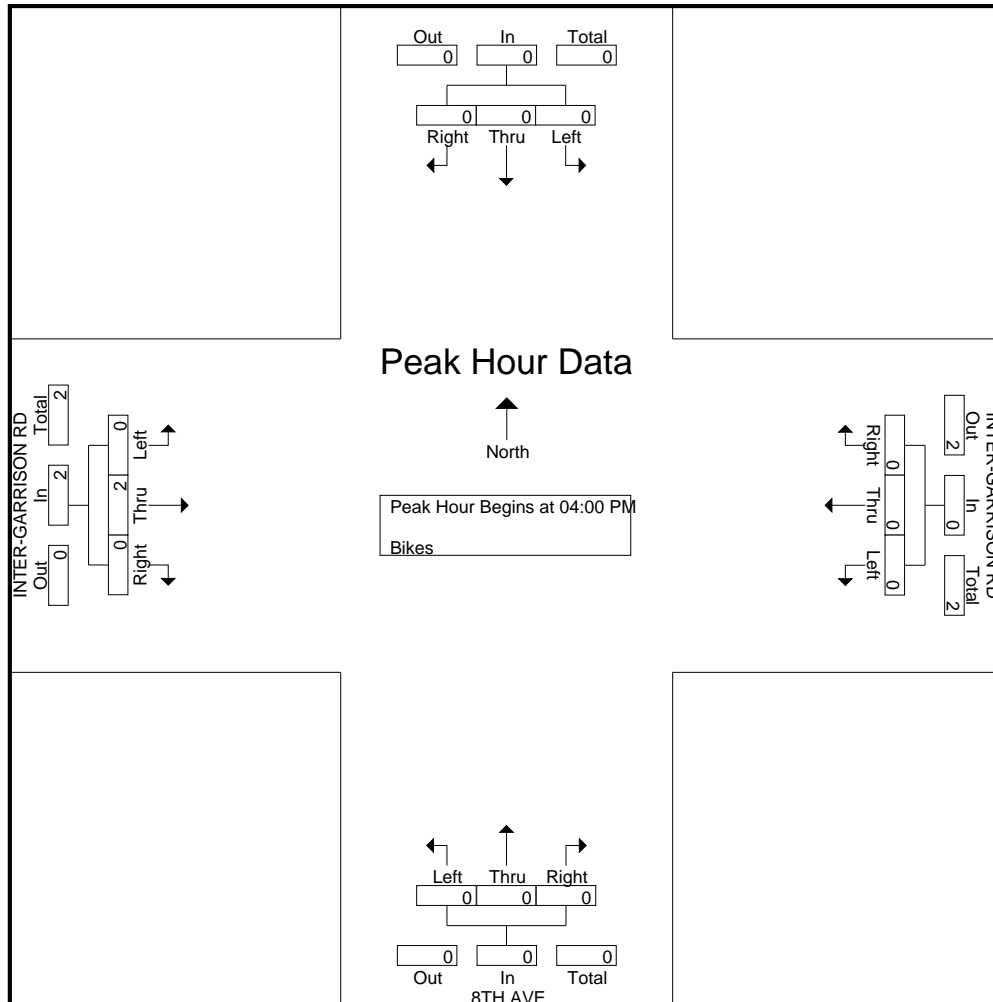



# Traffic Data Service

San Jose, CA  
(408) 622-4787  
tdsbay@cs.com

File Name : 23AM FINAL  
Site Code : 00000023  
Start Date : 4/25/2018  
Page No : 1

Groups Printed- Lights - Buses - Trucks

| Start Time   | 8TH ST Southbound |            |           |          |            | INTER-GARRISON RD Westbound |            |           |          |            | 7TH AVE Northbound |           |           |          |            | INTER-GARRISON RD Eastbound |           |          |          |            | Int. Total |
|--------------|-------------------|------------|-----------|----------|------------|-----------------------------|------------|-----------|----------|------------|--------------------|-----------|-----------|----------|------------|-----------------------------|-----------|----------|----------|------------|------------|
|              | Right             | Thru       | Left      | Peds     | App. Total | Right                       | Thru       | Left      | Peds     | App. Total | Right              | Thru      | Left      | Peds     | App. Total | Right                       | Thru      | Left     | Peds     | App. Total |            |
| 07:00 AM     | 0                 | 17         | 1         | 0        | 18         | 0                           | 17         | 5         | 0        | 22         | 0                  | 3         | 2         | 0        | 5          | 2                           | 6         | 0        | 0        | 8          | 53         |
| 07:15 AM     | 0                 | 11         | 3         | 0        | 14         | 2                           | 20         | 5         | 0        | 27         | 1                  | 3         | 3         | 0        | 7          | 1                           | 5         | 0        | 0        | 6          | 54         |
| 07:30 AM     | 0                 | 31         | 4         | 0        | 35         | 3                           | 31         | 7         | 0        | 41         | 1                  | 3         | 4         | 0        | 8          | 3                           | 6         | 0        | 0        | 9          | 93         |
| 07:45 AM     | 1                 | 42         | 2         | 0        | 45         | 3                           | 78         | 7         | 0        | 88         | 1                  | 10        | 6         | 1        | 18         | 1                           | 3         | 0        | 0        | 4          | 155        |
| <b>Total</b> | <b>1</b>          | <b>101</b> | <b>10</b> | <b>0</b> | <b>112</b> | <b>8</b>                    | <b>146</b> | <b>24</b> | <b>0</b> | <b>178</b> | <b>3</b>           | <b>19</b> | <b>15</b> | <b>1</b> | <b>38</b>  | <b>7</b>                    | <b>20</b> | <b>0</b> | <b>0</b> | <b>27</b>  | <b>355</b> |
| 08:00 AM     | 2                 | 38         | 6         | 0        | 46         | 11                          | 104        | 5         | 0        | 120        | 0                  | 9         | 9         | 1        | 19         | 4                           | 6         | 1        | 0        | 11         | 196        |
| 08:15 AM     | 0                 | 30         | 2         | 0        | 32         | 8                           | 68         | 3         | 0        | 79         | 2                  | 8         | 10        | 1        | 21         | 4                           | 12        | 2        | 0        | 18         | 150        |
| 08:30 AM     | 3                 | 20         | 5         | 0        | 28         | 8                           | 58         | 5         | 0        | 71         | 2                  | 1         | 15        | 0        | 18         | 6                           | 8         | 1        | 0        | 15         | 132        |
| 08:45 AM     | 1                 | 16         | 3         | 0        | 20         | 7                           | 26         | 4         | 0        | 37         | 1                  | 3         | 9         | 0        | 13         | 3                           | 9         | 0        | 0        | 12         | 82         |
| <b>Total</b> | <b>6</b>          | <b>104</b> | <b>16</b> | <b>0</b> | <b>126</b> | <b>34</b>                   | <b>256</b> | <b>17</b> | <b>0</b> | <b>307</b> | <b>5</b>           | <b>21</b> | <b>43</b> | <b>2</b> | <b>71</b>  | <b>17</b>                   | <b>35</b> | <b>4</b> | <b>0</b> | <b>56</b>  | <b>560</b> |
| Grand Total  | 7                 | 205        | 26        | 0        | 238        | 42                          | 402        | 41        | 0        | 485        | 8                  | 40        | 58        | 3        | 109        | 24                          | 55        | 4        | 0        | 83         | 915        |
| Apprch %     | 2.9               | 86.1       | 10.9      | 0        |            | 8.7                         | 82.9       | 8.5       | 0        |            | 7.3                | 36.7      | 53.2      | 2.8      |            | 28.9                        | 66.3      | 4.8      | 0        |            |            |
| Total %      | 0.8               | 22.4       | 2.8       | 0        | 26         | 4.6                         | 43.9       | 4.5       | 0        | 53         | 0.9                | 4.4       | 6.3       | 0.3      | 11.9       | 2.6                         | 6         | 0.4      | 0        | 9.1        |            |
| Lights       | 6                 | 194        | 22        | 0        | 222        | 37                          | 396        | 33        | 0        | 466        | 2                  | 31        | 52        | 3        | 88         | 23                          | 47        | 4        | 0        | 74         | 850        |
| % Lights     | 85.7              | 94.6       | 84.6      | 0        | 93.3       | 88.1                        | 98.5       | 80.5      | 0        | 96.1       | 25                 | 77.5      | 89.7      | 100      | 80.7       | 95.8                        | 85.5      | 100      | 0        | 89.2       | 92.9       |
| Buses        | 0                 | 1          | 0         | 0        | 1          | 1                           | 4          | 7         | 0        | 12         | 6                  | 1         | 2         | 0        | 9          | 0                           | 7         | 0        | 0        | 7          | 29         |
| % Buses      | 0                 | 0.5        | 0         | 0        | 0.4        | 2.4                         | 1          | 17.1      | 0        | 2.5        | 75                 | 2.5       | 3.4       | 0        | 8.3        | 0                           | 12.7      | 0        | 0        | 8.4        | 3.2        |
| Trucks       | 1                 | 10         | 4         | 0        | 15         | 4                           | 2          | 1         | 0        | 7          | 0                  | 8         | 4         | 0        | 12         | 1                           | 1         | 0        | 0        | 2          | 36         |
| % Trucks     | 14.3              | 4.9        | 15.4      | 0        | 6.3        | 9.5                         | 0.5        | 2.4       | 0        | 1.4        | 0                  | 20        | 6.9       | 0        | 11         | 4.2                         | 1.8       | 0        | 0        | 2.4        | 3.9        |

| Start Time   | 8TH ST Southbound |      |      |            | INTER-GARRISON RD Westbound |      |      |            | 7TH AVE Northbound |      |      |            | INTER-GARRISON RD Eastbound |      |      |            | Int. Total |
|--|-------------------|------|------|------------|-----------------------------|------|------|------------|--------------------|------|------|------------|-----------------------------|------|------|------------|------------|
|  | Right             | Thru | Left | App. Total | Right                       | Thru | Left | App. Total | Right              | Thru | Left | App. Total | Right                       | Thru | Left | App. Total |            |
| Peak Hour Analysis From 07:00 AM to 08:45 AM - Peak 1 of 1 |                   |      |      |            |                             |      |      |            |                    |      |      |            |                             |      |      |            |            |
| Peak Hour for Entire Intersection Begins at 07:45 AM       |                   |      |      |            |                             |      |      |            |                    |      |      |            |                             |      |      |            |            |
| 07:45 AM   | 1                 | 42   | 2    | 45         | 3                           | 78   | 7    | 88         | 1                  | 10   | 6    | 17         | 1                           | 3    | 0    | 4          | 154        |
| 08:00 AM   | 2                 | 38   | 6    | 46         | 11                          | 104  | 5    | 120        | 0                  | 9    | 9    | 18         | 4                           | 6    | 1    | 11         | 195        |
| 08:15 AM   | 0                 | 30   | 2    | 32         | 8                           | 68   | 3    | 79         | 2                  | 8    | 10   | 20         | 4                           | 12   | 2    | 18         | 149        |
| 08:30 AM   | 3                 | 20   | 5    | 28         | 8                           | 58   | 5    | 71         | 2                  | 1    | 15   | 18         | 6                           | 8    | 1    | 15         | 132        |
| Total Volume   | 6                 | 130  | 15   | 151        | 30                          | 308  | 20   | 358        | 5                  | 28   | 40   | 73         | 15                          | 29   | 4    | 48         | 630        |
| % App. Total   | 4                 | 86.1 | 9.9  |            | 8.4                         | 86   | 5.6  |            | 6.8                | 38.4 | 54.8 |            | 31.2                        | 60.4 | 8.3  |            |            |
| PHF  | .500              | .774 | .625 | .821       | .682                        | .740 | .714 | .746       | .625               | .700 | .667 | .913       | .625                        | .604 | .500 | .667       | .808       |

# Traffic Data Service

San Jose, CA  
 (408) 622-4787  
 tdsbay@cs.com

File Name : 23AM FINAL  
 Site Code : 00000023  
 Start Date : 4/25/2018  
 Page No : 2

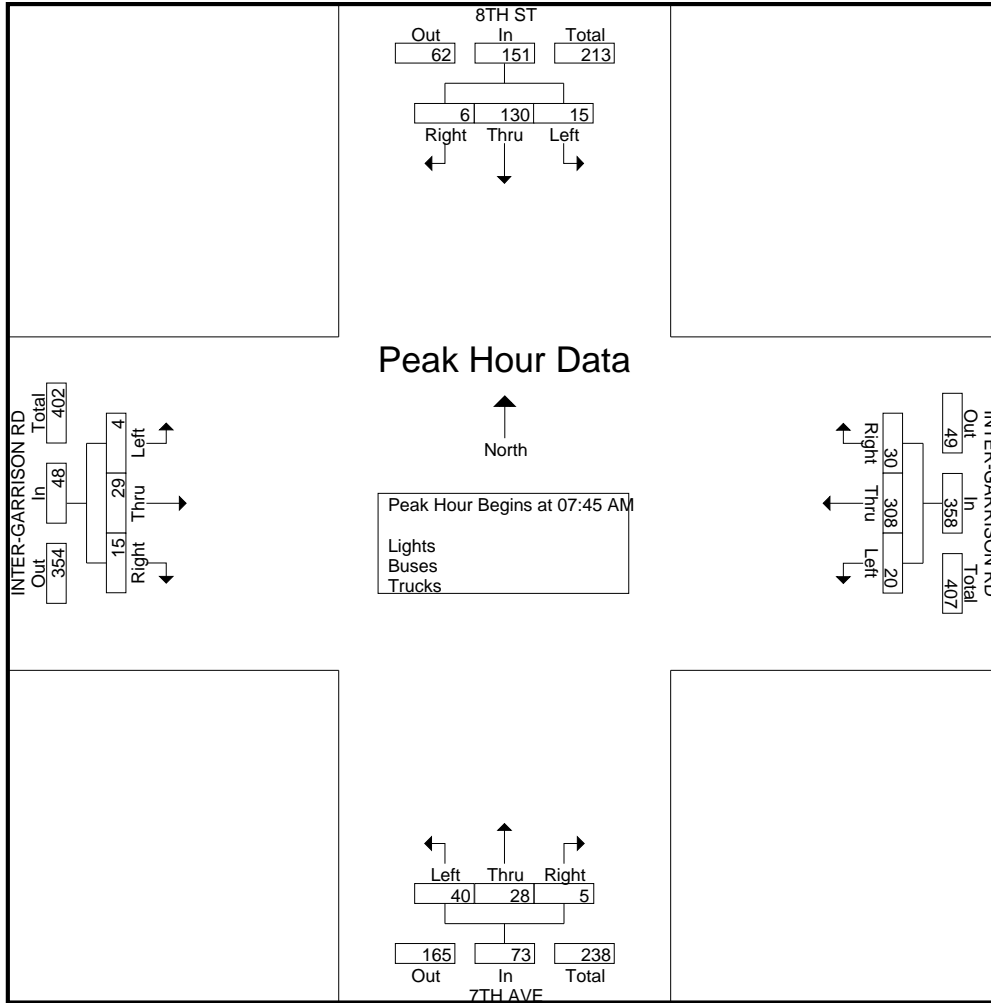

# Traffic Data Service

San Jose, CA  
 (408) 622-4787  
 tdsbay@cs.com

File Name : 23AM FINAL  
 Site Code : 00000023  
 Start Date : 4/25/2018  
 Page No : 1

Groups Printed- Bikes

| Start Time  | 8TH ST Southbound |      |      |      |            | INTER-GARRISON RD Westbound |      |      |      |            | 7TH AVE Northbound |      |      |      |            | INTER-GARRISON RD Eastbound |      |      |      |            | Int. Total |
|-------------|-------------------|------|------|------|------------|-----------------------------|------|------|------|------------|--------------------|------|------|------|------------|-----------------------------|------|------|------|------------|------------|
|             | Right             | Thru | Left | Peds | App. Total | Right                       | Thru | Left | Peds | App. Total | Right              | Thru | Left | Peds | App. Total | Right                       | Thru | Left | Peds | App. Total |            |
| 07:00 AM    | 0                 | 0    | 0    | 0    | 0          | 0                           | 0    | 0    | 0    | 0          | 0                  | 0    | 0    | 0    | 0          | 0                           | 0    | 0    | 0    | 0          | 0          |
| 07:15 AM    | 0                 | 0    | 0    | 0    | 0          | 0                           | 1    | 0    | 0    | 1          | 0                  | 0    | 0    | 0    | 0          | 0                           | 0    | 0    | 0    | 0          | 0          |
| 07:30 AM    | 0                 | 0    | 0    | 0    | 0          | 0                           | 0    | 0    | 0    | 0          | 0                  | 0    | 0    | 0    | 0          | 0                           | 0    | 0    | 0    | 0          | 0          |
| 07:45 AM    | 0                 | 0    | 0    | 0    | 0          | 0                           | 1    | 0    | 0    | 1          | 0                  | 0    | 0    | 0    | 0          | 0                           | 0    | 0    | 0    | 0          | 0          |
| Total       | 0                 | 0    | 0    | 0    | 0          | 0                           | 2    | 0    | 0    | 2          | 0                  | 0    | 0    | 0    | 0          | 0                           | 0    | 0    | 0    | 0          | 2          |
| 08:00 AM    | 0                 | 0    | 0    | 0    | 0          | 0                           | 0    | 0    | 0    | 0          | 0                  | 0    | 0    | 0    | 0          | 0                           | 0    | 0    | 0    | 0          | 0          |
| 08:15 AM    | 0                 | 0    | 0    | 0    | 0          | 0                           | 0    | 0    | 0    | 0          | 0                  | 0    | 0    | 0    | 0          | 0                           | 0    | 0    | 0    | 0          | 0          |
| 08:30 AM    | 0                 | 0    | 0    | 0    | 0          | 0                           | 0    | 1    | 0    | 1          | 0                  | 0    | 0    | 0    | 0          | 0                           | 0    | 0    | 0    | 0          | 1          |
| 08:45 AM    | 0                 | 0    | 0    | 0    | 0          | 0                           | 0    | 0    | 0    | 0          | 0                  | 0    | 0    | 0    | 0          | 1                           | 1    | 0    | 0    | 2          | 2          |
| Total       | 0                 | 0    | 0    | 0    | 0          | 0                           | 0    | 1    | 0    | 1          | 0                  | 0    | 0    | 0    | 0          | 1                           | 1    | 0    | 0    | 2          | 3          |
| Grand Total | 0                 | 0    | 0    | 0    | 0          | 0                           | 2    | 1    | 0    | 3          | 0                  | 0    | 0    | 0    | 0          | 1                           | 1    | 0    | 0    | 2          | 5          |
| Apprch %    | 0                 | 0    | 0    | 0    |            | 0                           | 66.7 | 33.3 | 0    |            | 0                  | 0    | 0    | 0    |            | 50                          | 50   | 0    | 0    |            |            |
| Total %     | 0                 | 0    | 0    | 0    |            | 0                           | 40   | 20   | 0    | 60         | 0                  | 0    | 0    | 0    |            | 20                          | 20   | 0    | 0    | 40         |            |

| Start Time   | 8TH ST Southbound |      |      |      |            | INTER-GARRISON RD Westbound |      |      |      |            | 7TH AVE Northbound |      |      |      |            | INTER-GARRISON RD Eastbound |      |      |      |            | Int. Total |
|--------------|-------------------|------|------|------|------------|-----------------------------|------|------|------|------------|--------------------|------|------|------|------------|-----------------------------|------|------|------|------------|------------|
|              | Right             | Thru | Left | Peds | App. Total | Right                       | Thru | Left | Peds | App. Total | Right              | Thru | Left | Peds | App. Total | Right                       | Thru | Left | Peds | App. Total |            |
| 08:00 AM     | 0                 | 0    | 0    | 0    | 0          | 0                           | 0    | 0    | 0    | 0          | 0                  | 0    | 0    | 0    | 0          | 0                           | 0    | 0    | 0    | 0          | 0          |
| 08:15 AM     | 0                 | 0    | 0    | 0    | 0          | 0                           | 0    | 0    | 0    | 0          | 0                  | 0    | 0    | 0    | 0          | 0                           | 0    | 0    | 0    | 0          | 0          |
| 08:30 AM     | 0                 | 0    | 0    | 0    | 0          | 0                           | 0    | 1    | 0    | 1          | 0                  | 0    | 0    | 0    | 0          | 0                           | 0    | 0    | 0    | 0          | 1          |
| 08:45 AM     | 0                 | 0    | 0    | 0    | 0          | 0                           | 0    | 0    | 0    | 0          | 0                  | 0    | 0    | 0    | 0          | 1                           | 1    | 0    | 0    | 2          | 2          |
| Total Volume | 0                 | 0    | 0    | 0    | 0          | 0                           | 0    | 1    | 0    | 1          | 0                  | 0    | 0    | 0    | 0          | 1                           | 1    | 0    | 0    | 2          | 3          |
| % App. Total | 0                 | 0    | 0    | 0    |            | 0                           | 0    | 100  | 0    |            | 0                  | 0    | 0    | 0    |            | 50                          | 50   | 0    | 0    |            |            |
| PHF          | .000              | .000 | .000 | .000 |            | .000                        | .000 | .250 | .250 |            | .000               | .000 | .000 | .000 |            | .250                        | .250 | .000 | .250 |            | .375       |

Peak Hour Analysis From 07:00 AM to 08:45 AM - Peak 1 of 1  
 Peak Hour for Entire Intersection Begins at 08:00 AM

# Traffic Data Service

San Jose, CA  
 (408) 622-4787  
 tdsbay@cs.com

File Name : 23AM FINAL  
 Site Code : 00000023  
 Start Date : 4/25/2018  
 Page No : 2

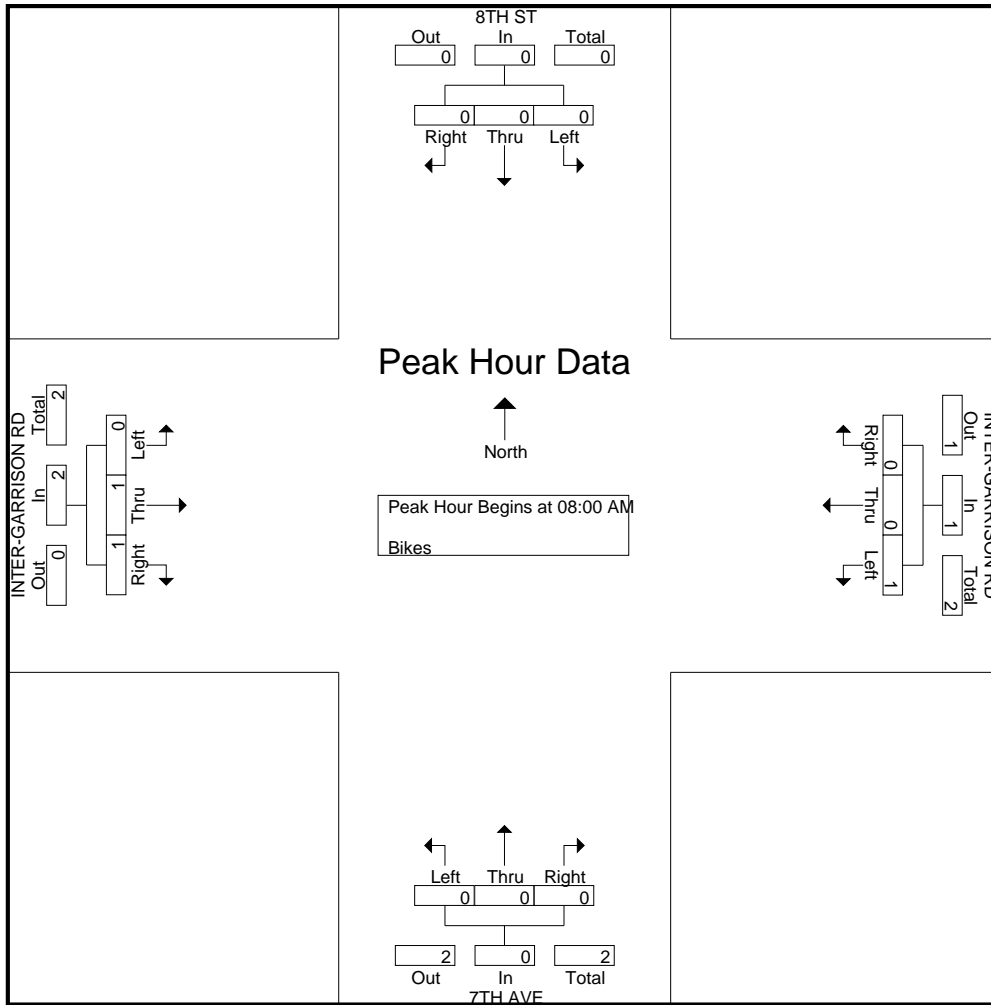

# Traffic Data Service

San Jose, CA  
 (408) 622-4787  
 tdsbay@cs.com

File Name : 23PM FINAL  
 Site Code : 00000023  
 Start Date : 4/25/2018  
 Page No : 1

## Groups Printed- Lights - Buses - Trucks

| Start Time   | 8TH ST Southbound |           |           |          |            | INTER-GARRISON RD Westbound |            |           |          |            | 7TH AVE Northbound |           |           |          |            | INTER-GARRISON RD Eastbound |            |          |          |            | Int. Total |
|--------------|-------------------|-----------|-----------|----------|------------|-----------------------------|------------|-----------|----------|------------|--------------------|-----------|-----------|----------|------------|-----------------------------|------------|----------|----------|------------|------------|
|              | Right             | Thru      | Left      | Peds     | App. Total | Right                       | Thru       | Left      | Peds     | App. Total | Right              | Thru      | Left      | Peds     | App. Total | Right                       | Thru       | Left     | Peds     | App. Total |            |
| 04:00 PM     | 0                 | 18        | 5         | 0        | 23         | 2                           | 30         | 10        | 0        | 42         | 2                  | 21        | 21        | 0        | 44         | 13                          | 41         | 6        | 0        | 60         | 169        |
| 04:15 PM     | 1                 | 14        | 4         | 0        | 19         | 7                           | 18         | 0         | 0        | 25         | 8                  | 15        | 6         | 2        | 31         | 8                           | 30         | 1        | 0        | 39         | 114        |
| 04:30 PM     | 1                 | 6         | 6         | 1        | 14         | 1                           | 9          | 2         | 0        | 12         | 2                  | 16        | 9         | 0        | 27         | 2                           | 23         | 1        | 0        | 26         | 79         |
| 04:45 PM     | 0                 | 5         | 2         | 1        | 8          | 3                           | 13         | 2         | 0        | 18         | 1                  | 21        | 3         | 0        | 25         | 3                           | 30         | 0        | 0        | 33         | 84         |
| <b>Total</b> | <b>2</b>          | <b>43</b> | <b>17</b> | <b>2</b> | <b>64</b>  | <b>13</b>                   | <b>70</b>  | <b>14</b> | <b>0</b> | <b>97</b>  | <b>13</b>          | <b>73</b> | <b>39</b> | <b>2</b> | <b>127</b> | <b>26</b>                   | <b>124</b> | <b>8</b> | <b>0</b> | <b>158</b> | <b>446</b> |
| 05:00 PM     | 0                 | 7         | 2         | 0        | 9          | 4                           | 18         | 1         | 0        | 23         | 3                  | 17        | 5         | 0        | 25         | 4                           | 28         | 6        | 0        | 38         | 95         |
| 05:15 PM     | 2                 | 7         | 4         | 0        | 13         | 3                           | 11         | 3         | 0        | 17         | 5                  | 15        | 4         | 3        | 27         | 3                           | 69         | 0        | 1        | 73         | 130        |
| 05:30 PM     | 0                 | 5         | 4         | 0        | 9          | 0                           | 28         | 5         | 0        | 33         | 7                  | 16        | 6         | 1        | 30         | 6                           | 49         | 2        | 0        | 57         | 129        |
| 05:45 PM     | 0                 | 2         | 3         | 0        | 5          | 2                           | 50         | 1         | 0        | 53         | 4                  | 9         | 8         | 0        | 21         | 5                           | 45         | 0        | 0        | 50         | 129        |
| <b>Total</b> | <b>2</b>          | <b>21</b> | <b>13</b> | <b>0</b> | <b>36</b>  | <b>9</b>                    | <b>107</b> | <b>10</b> | <b>0</b> | <b>126</b> | <b>19</b>          | <b>57</b> | <b>23</b> | <b>4</b> | <b>103</b> | <b>18</b>                   | <b>191</b> | <b>8</b> | <b>1</b> | <b>218</b> | <b>483</b> |
| Grand Total  | 4                 | 64        | 30        | 2        | 100        | 22                          | 177        | 24        | 0        | 223        | 32                 | 130       | 62        | 6        | 230        | 44                          | 315        | 16       | 1        | 376        | 929        |
| Apprch %     | 4                 | 64        | 30        | 2        |            | 9.9                         | 79.4       | 10.8      | 0        |            | 13.9               | 56.5      | 27        | 2.6      |            | 11.7                        | 83.8       | 4.3      | 0.3      |            |            |
| Total %      | 0.4               | 6.9       | 3.2       | 0.2      | 10.8       | 2.4                         | 19.1       | 2.6       | 0        | 24         | 3.4                | 14        | 6.7       | 0.6      | 24.8       | 4.7                         | 33.9       | 1.7      | 0.1      | 40.5       |            |
| Lights       | 4                 | 63        | 30        | 2        | 99         | 22                          | 174        | 18        | 0        | 214        | 24                 | 129       | 61        | 6        | 220        | 44                          | 310        | 16       | 1        | 371        | 904        |
| % Lights     | 100               | 98.4      | 100       | 100      | 99         | 100                         | 98.3       | 75        | 0        | 96         | 75                 | 99.2      | 98.4      | 100      | 95.7       | 100                         | 98.4       | 100      | 100      | 98.7       | 97.3       |
| Buses        | 0                 | 1         | 0         | 0        | 1          | 0                           | 3          | 6         | 0        | 9          | 8                  | 1         | 0         | 0        | 9          | 0                           | 4          | 0        | 0        | 4          | 23         |
| % Buses      | 0                 | 1.6       | 0         | 0        | 1          | 0                           | 1.7        | 25        | 0        | 4          | 25                 | 0.8       | 0         | 0        | 3.9        | 0                           | 1.3        | 0        | 0        | 1.1        | 2.5        |
| Trucks       | 0                 | 0         | 0         | 0        | 0          | 0                           | 0          | 0         | 0        | 0          | 0                  | 0         | 1         | 0        | 1          | 0                           | 1          | 0        | 0        | 1          | 2          |
| % Trucks     | 0                 | 0         | 0         | 0        | 0          | 0                           | 0          | 0         | 0        | 0          | 0                  | 0         | 1.6       | 0        | 0.4        | 0                           | 0.3        | 0        | 0        | 0.3        | 0.2        |

| Start Time   | 8TH ST Southbound |      |      |            | INTER-GARRISON RD Westbound |      |      |            | 7TH AVE Northbound |      |      |            | INTER-GARRISON RD Eastbound |      |      |            | Int. Total |
|--|-------------------|------|------|------------|-----------------------------|------|------|------------|--------------------|------|------|------------|-----------------------------|------|------|------------|------------|
|  | Right             | Thru | Left | App. Total | Right                       | Thru | Left | App. Total | Right              | Thru | Left | App. Total | Right                       | Thru | Left | App. Total |            |
| Peak Hour Analysis From 04:00 PM to 05:45 PM - Peak 1 of 1 |                   |      |      |            |                             |      |      |            |                    |      |      |            |                             |      |      |            |            |
| Peak Hour for Entire Intersection Begins at 05:00 PM       |                   |      |      |            |                             |      |      |            |                    |      |      |            |                             |      |      |            |            |
| 05:00 PM   | 0                 | 7    | 2    | 9          | 4                           | 18   | 1    | 23         | 3                  | 17   | 5    | 25         | 4                           | 28   | 6    | 38         | 95         |
| 05:15 PM   | 2                 | 7    | 4    | 13         | 3                           | 11   | 3    | 17         | 5                  | 15   | 4    | 24         | 3                           | 69   | 0    | 72         | 126        |
| 05:30 PM   | 0                 | 5    | 4    | 9          | 0                           | 28   | 5    | 33         | 7                  | 16   | 6    | 29         | 6                           | 49   | 2    | 57         | 128        |
| 05:45 PM   | 0                 | 2    | 3    | 5          | 2                           | 50   | 1    | 53         | 4                  | 9    | 8    | 21         | 5                           | 45   | 0    | 50         | 129        |
| Total Volume   | 2                 | 21   | 13   | 36         | 9                           | 107  | 10   | 126        | 19                 | 57   | 23   | 99         | 18                          | 191  | 8    | 217        | 478        |
| % App. Total   | 5.6               | 58.3 | 36.1 |            | 7.1                         | 84.9 | 7.9  |            | 19.2               | 57.6 | 23.2 |            | 8.3                         | 88   | 3.7  |            |            |
| PHF  | .250              | .750 | .813 | .692       | .563                        | .535 | .500 | .594       | .679               | .838 | .719 | .853       | .750                        | .692 | .333 | .753       | .926       |

# Traffic Data Service

San Jose, CA  
 (408) 622-4787  
 tdsbay@cs.com

File Name : 23PM FINAL  
 Site Code : 00000023  
 Start Date : 4/25/2018  
 Page No : 2

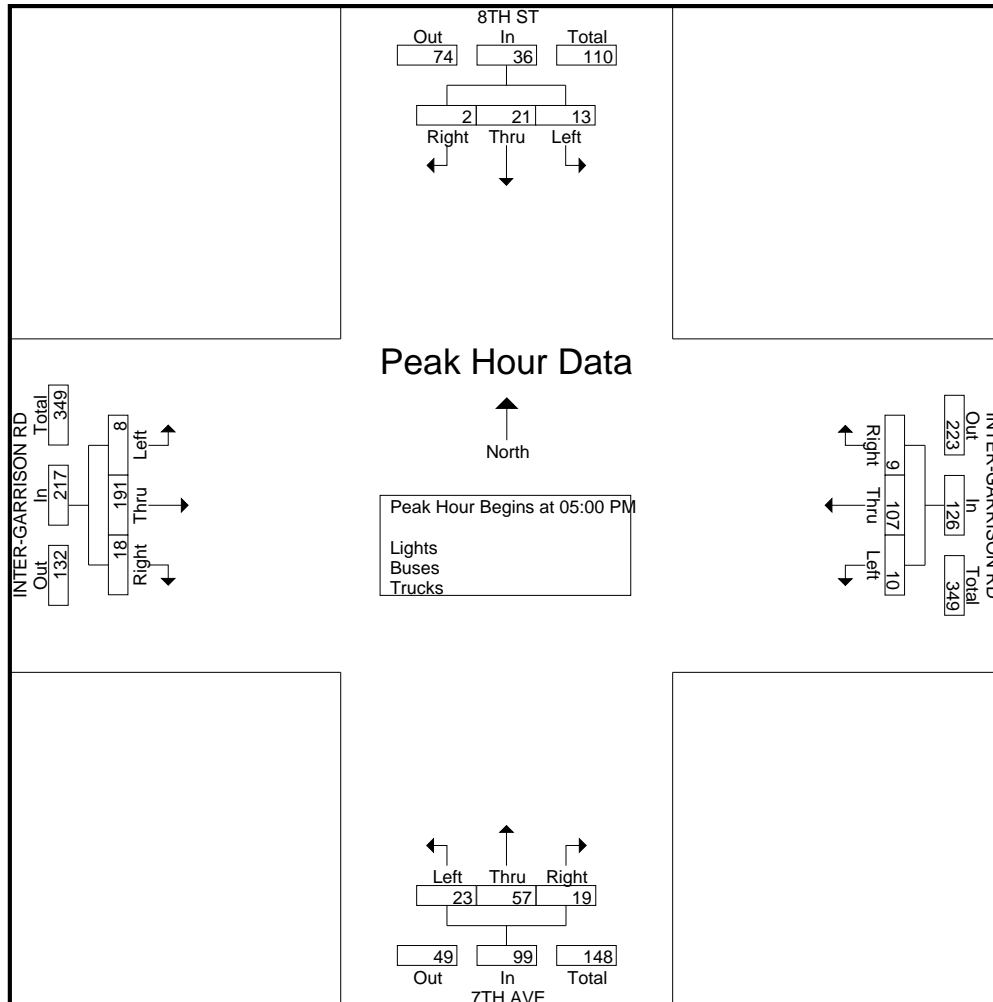

# Traffic Data Service

San Jose, CA  
 (408) 622-4787  
 tdsbay@cs.com

File Name : 23PM FINAL  
 Site Code : 00000023  
 Start Date : 4/25/2018  
 Page No : 1

Groups Printed- Bikes

| Start Time  | 8TH ST Southbound |      |      |      |            | INTER-GARRISON RD Westbound |      |      |      |            | 7TH AVE Northbound |      |      |      |            | INTER-GARRISON RD Eastbound |      |      |      |            | Int. Total |
|-------------|-------------------|------|------|------|------------|-----------------------------|------|------|------|------------|--------------------|------|------|------|------------|-----------------------------|------|------|------|------------|------------|
|             | Right             | Thru | Left | Peds | App. Total | Right                       | Thru | Left | Peds | App. Total | Right              | Thru | Left | Peds | App. Total | Right                       | Thru | Left | Peds | App. Total |            |
| 04:00 PM    | 0                 | 0    | 0    | 0    | 0          | 0                           | 1    | 0    | 0    | 1          | 0                  | 0    | 0    | 0    | 0          | 0                           | 0    | 0    | 0    | 0          | 0          |
| 04:15 PM    | 0                 | 0    | 0    | 0    | 0          | 0                           | 0    | 0    | 0    | 0          | 0                  | 0    | 0    | 0    | 0          | 0                           | 0    | 1    | 0    | 1          | 1          |
| 04:30 PM    | 0                 | 0    | 0    | 0    | 0          | 0                           | 0    | 0    | 0    | 0          | 0                  | 0    | 0    | 0    | 0          | 0                           | 1    | 0    | 0    | 1          | 1          |
| 04:45 PM    | 0                 | 0    | 0    | 0    | 0          | 0                           | 0    | 0    | 0    | 0          | 0                  | 0    | 0    | 0    | 0          | 0                           | 1    | 0    | 0    | 1          | 1          |
| Total       | 0                 | 0    | 0    | 0    | 0          | 0                           | 1    | 0    | 0    | 1          | 0                  | 0    | 0    | 0    | 0          | 0                           | 2    | 1    | 0    | 3          | 4          |
| 05:00 PM    | 0                 | 0    | 0    | 0    | 0          | 0                           | 0    | 0    | 0    | 0          | 0                  | 0    | 0    | 0    | 0          | 0                           | 0    | 0    | 0    | 0          | 0          |
| 05:15 PM    | 0                 | 0    | 0    | 0    | 0          | 0                           | 0    | 0    | 0    | 0          | 0                  | 0    | 0    | 0    | 0          | 0                           | 0    | 0    | 0    | 0          | 0          |
| 05:30 PM    | 0                 | 0    | 0    | 0    | 0          | 0                           | 0    | 0    | 0    | 0          | 0                  | 1    | 0    | 0    | 1          | 0                           | 0    | 0    | 0    | 0          | 1          |
| 05:45 PM    | 0                 | 0    | 0    | 0    | 0          | 0                           | 0    | 0    | 0    | 0          | 0                  | 0    | 0    | 0    | 0          | 0                           | 0    | 0    | 0    | 0          | 0          |
| Total       | 0                 | 0    | 0    | 0    | 0          | 0                           | 0    | 0    | 0    | 0          | 0                  | 1    | 0    | 0    | 1          | 0                           | 0    | 0    | 0    | 0          | 1          |
| Grand Total | 0                 | 0    | 0    | 0    | 0          | 0                           | 1    | 0    | 0    | 1          | 0                  | 1    | 0    | 0    | 1          | 0                           | 2    | 1    | 0    | 3          | 5          |
| Apprch %    | 0                 | 0    | 0    | 0    | 0          | 0                           | 100  | 0    | 0    | 100        | 0                  | 100  | 0    | 0    | 100        | 0                           | 66.7 | 33.3 | 0    | 0          |            |
| Total %     | 0                 | 0    | 0    | 0    | 0          | 0                           | 20   | 0    | 0    | 20         | 0                  | 20   | 0    | 0    | 20         | 0                           | 40   | 20   | 0    | 60         |            |

| Start Time   | 8TH ST Southbound |      |      |      |            | INTER-GARRISON RD Westbound |      |      |      |            | 7TH AVE Northbound |      |      |      |            | INTER-GARRISON RD Eastbound |      |      |      |            | Int. Total |
|--------------|-------------------|------|------|------|------------|-----------------------------|------|------|------|------------|--------------------|------|------|------|------------|-----------------------------|------|------|------|------------|------------|
|              | Right             | Thru | Left | Peds | App. Total | Right                       | Thru | Left | Peds | App. Total | Right              | Thru | Left | Peds | App. Total | Right                       | Thru | Left | Peds | App. Total |            |
| 04:00 PM     | 0                 | 0    | 0    | 0    | 0          | 0                           | 1    | 0    | 0    | 1          | 0                  | 0    | 0    | 0    | 0          | 0                           | 0    | 0    | 0    | 0          | 1          |
| 04:15 PM     | 0                 | 0    | 0    | 0    | 0          | 0                           | 0    | 0    | 0    | 0          | 0                  | 0    | 0    | 0    | 0          | 0                           | 0    | 1    | 0    | 1          | 1          |
| 04:30 PM     | 0                 | 0    | 0    | 0    | 0          | 0                           | 0    | 0    | 0    | 0          | 0                  | 0    | 0    | 0    | 0          | 0                           | 1    | 0    | 0    | 1          | 1          |
| 04:45 PM     | 0                 | 0    | 0    | 0    | 0          | 0                           | 0    | 0    | 0    | 0          | 0                  | 0    | 0    | 0    | 0          | 0                           | 1    | 0    | 0    | 1          | 1          |
| Total Volume | 0                 | 0    | 0    | 0    | 0          | 0                           | 1    | 0    | 0    | 1          | 0                  | 0    | 0    | 0    | 0          | 0                           | 2    | 1    | 0    | 3          | 4          |
| % App. Total | 0                 | 0    | 0    | 0    | 0          | 0                           | 100  | 0    | 0    | 100        | 0                  | 0    | 0    | 0    | 0          | 0                           | 66.7 | 33.3 | 0    | 0          |            |
| PHF          | .000              | .000 | .000 | .000 | .000       | .000                        | .250 | .000 | .250 | .250       | .000               | .000 | .000 | .000 | .000       | .000                        | .500 | .250 | .750 | .750       | 1.00       |

Peak Hour Analysis From 04:00 PM to 05:45 PM - Peak 1 of 1  
 Peak Hour for Entire Intersection Begins at 04:00 PM

# Traffic Data Service

San Jose, CA  
 (408) 622-4787  
 tdsbay@cs.com

File Name : 23PM FINAL  
 Site Code : 00000023  
 Start Date : 4/25/2018  
 Page No : 2

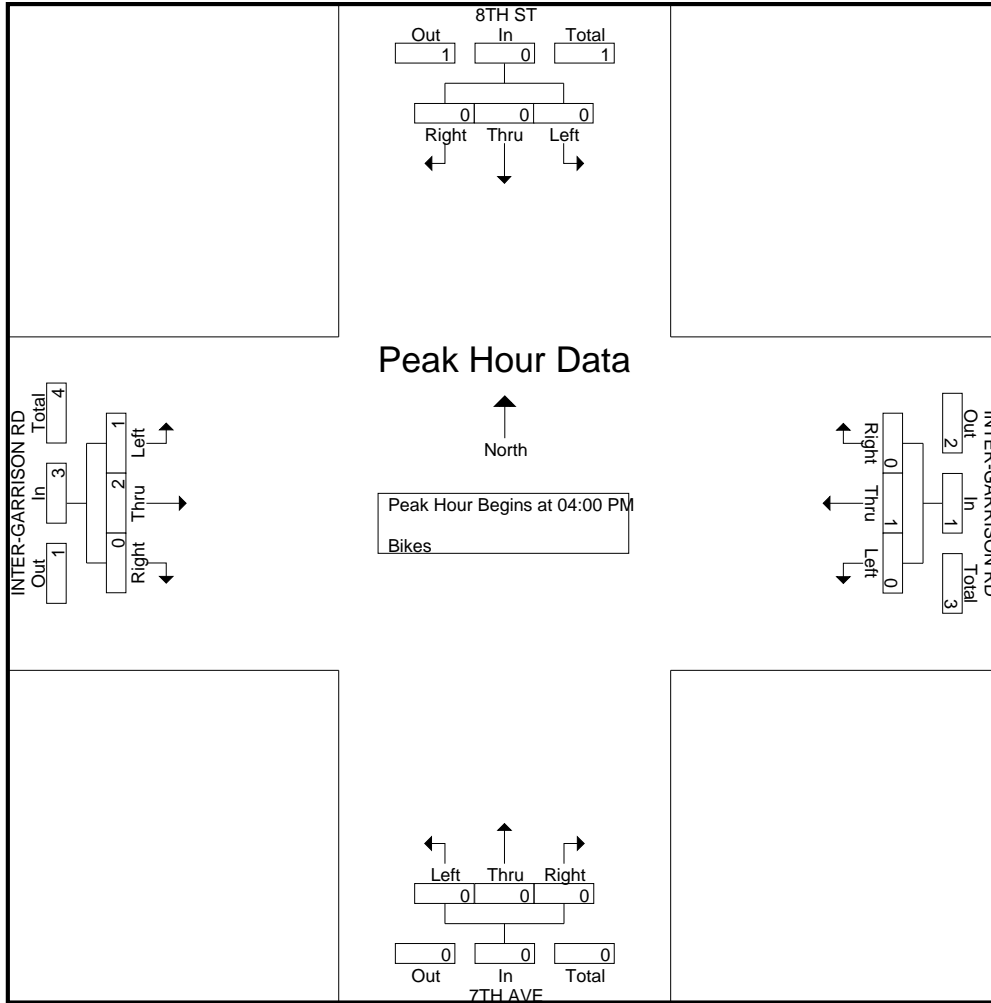



# Traffic Data Service

San Jose, CA  
 (408) 622-4787  
 tdsbay@cs.com

File Name : 24AM FINAL  
 Site Code : 00000024  
 Start Date : 4/25/2018  
 Page No : 1

Groups Printed- Lights - Buses - Trucks

| Start Time  | RESERVATION RD<br>Southbound |      |      |      |            | HWY 68 WB OFF-RAMP<br>Westbound |      |      |      |            | RIVER RD<br>Northbound |      |      |      |            | HWY 68 WB ON-RAMP<br>Eastbound |      |      |      |            | Int. Total |      |
|-------------|------------------------------|------|------|------|------------|---------------------------------|------|------|------|------------|------------------------|------|------|------|------------|--------------------------------|------|------|------|------------|------------|------|
|             | Right                        | Thru | Left | Peds | App. Total | Right                           | Thru | Left | Peds | App. Total | Right                  | Thru | Left | Peds | App. Total | Right                          | Thru | Left | Peds | App. Total |            |      |
| 07:00 AM    | 28                           | 57   | 0    | 0    | 85         | 72                              | 0    | 23   | 0    | 95         | 0                      | 90   | 47   | 0    | 137        | 0                              | 0    | 0    | 0    | 0          | 0          | 317  |
| 07:15 AM    | 15                           | 60   | 0    | 0    | 75         | 80                              | 0    | 32   | 0    | 112        | 0                      | 89   | 38   | 0    | 127        | 0                              | 0    | 0    | 0    | 0          | 0          | 314  |
| 07:30 AM    | 28                           | 91   | 0    | 0    | 119        | 75                              | 0    | 42   | 0    | 117        | 0                      | 104  | 37   | 0    | 141        | 0                              | 0    | 0    | 0    | 0          | 0          | 377  |
| 07:45 AM    | 29                           | 89   | 0    | 0    | 118        | 79                              | 0    | 63   | 0    | 142        | 0                      | 93   | 29   | 0    | 122        | 0                              | 0    | 0    | 0    | 0          | 0          | 382  |
| Total       | 100                          | 297  | 0    | 0    | 397        | 306                             | 0    | 160  | 0    | 466        | 0                      | 376  | 151  | 0    | 527        | 0                              | 0    | 0    | 0    | 0          | 0          | 1390 |
| 08:00 AM    | 24                           | 92   | 0    | 0    | 116        | 63                              | 0    | 80   | 0    | 143        | 0                      | 77   | 29   | 0    | 106        | 0                              | 0    | 0    | 0    | 0          | 0          | 365  |
| 08:15 AM    | 24                           | 63   | 0    | 0    | 87         | 76                              | 0    | 58   | 0    | 134        | 0                      | 81   | 28   | 0    | 109        | 0                              | 0    | 0    | 0    | 0          | 0          | 330  |
| 08:30 AM    | 26                           | 52   | 0    | 0    | 78         | 55                              | 0    | 46   | 0    | 101        | 0                      | 58   | 25   | 0    | 83         | 0                              | 0    | 0    | 0    | 0          | 0          | 262  |
| 08:45 AM    | 38                           | 48   | 0    | 0    | 86         | 36                              | 0    | 39   | 0    | 75         | 0                      | 63   | 28   | 0    | 91         | 0                              | 0    | 0    | 0    | 0          | 0          | 252  |
| Total       | 112                          | 255  | 0    | 0    | 367        | 230                             | 0    | 223  | 0    | 453        | 0                      | 279  | 110  | 0    | 389        | 0                              | 0    | 0    | 0    | 0          | 0          | 1209 |
| Grand Total | 212                          | 552  | 0    | 0    | 764        | 536                             | 0    | 383  | 0    | 919        | 0                      | 655  | 261  | 0    | 916        | 0                              | 0    | 0    | 0    | 0          | 0          | 2599 |
| Apprch %    | 27.7                         | 72.3 | 0    | 0    |            | 58.3                            | 0    | 41.7 | 0    |            | 0                      | 71.5 | 28.5 | 0    |            | 0                              | 0    | 0    | 0    | 0          | 0          |      |
| Total %     | 8.2                          | 21.2 | 0    | 0    | 29.4       | 20.6                            | 0    | 14.7 | 0    | 35.4       | 0                      | 25.2 | 10   | 0    | 35.2       | 0                              | 0    | 0    | 0    | 0          | 0          |      |
| Lights      | 205                          | 523  | 0    | 0    | 728        | 516                             | 0    | 366  | 0    | 882        | 0                      | 647  | 257  | 0    | 904        | 0                              | 0    | 0    | 0    | 0          | 0          | 2514 |
| % Lights    | 96.7                         | 94.7 | 0    | 0    | 95.3       | 96.3                            | 0    | 95.6 | 0    | 96         | 0                      | 98.8 | 98.5 | 0    | 98.7       | 0                              | 0    | 0    | 0    | 0          | 0          | 96.7 |
| Buses       | 2                            | 4    | 0    | 0    | 6          | 5                               | 0    | 3    | 0    | 8          | 0                      | 0    | 3    | 0    | 3          | 0                              | 0    | 0    | 0    | 0          | 0          | 17   |
| % Buses     | 0.9                          | 0.7  | 0    | 0    | 0.8        | 0.9                             | 0    | 0.8  | 0    | 0.9        | 0                      | 0    | 1.1  | 0    | 0.3        | 0                              | 0    | 0    | 0    | 0          | 0          | 0.7  |
| Trucks      | 5                            | 25   | 0    | 0    | 30         | 15                              | 0    | 14   | 0    | 29         | 0                      | 8    | 1    | 0    | 9          | 0                              | 0    | 0    | 0    | 0          | 0          | 68   |
| % Trucks    | 2.4                          | 4.5  | 0    | 0    | 3.9        | 2.8                             | 0    | 3.7  | 0    | 3.2        | 0                      | 1.2  | 0.4  | 0    | 1          | 0                              | 0    | 0    | 0    | 0          | 0          | 2.6  |

| Start Time   | RESERVATION RD<br>Southbound |      |      |            | HWY 68 WB OFF-RAMP<br>Westbound |      |      |            | RIVER RD<br>Northbound |      |      |            | HWY 68 WB ON-RAMP<br>Eastbound |      |      |            | Int. Total |
|--|------------------------------|------|------|------------|---------------------------------|------|------|------------|------------------------|------|------|------------|--------------------------------|------|------|------------|------------|
|  | Right                        | Thru | Left | App. Total | Right                           | Thru | Left | App. Total | Right                  | Thru | Left | App. Total | Right                          | Thru | Left | App. Total |            |
| Peak Hour Analysis From 07:00 AM to 08:45 AM - Peak 1 of 1 |                              |      |      |            |                                 |      |      |            |                        |      |      |            |                                |      |      |            |            |
| Peak Hour for Entire Intersection Begins at 07:30 AM       |                              |      |      |            |                                 |      |      |            |                        |      |      |            |                                |      |      |            |            |
| 07:30 AM   | 28                           | 91   | 0    | 119        | 75                              | 0    | 42   | 117        | 0                      | 104  | 37   | 141        | 0                              | 0    | 0    | 0          | 377        |
| 07:45 AM   | 29                           | 89   | 0    | 118        | 79                              | 0    | 63   | 142        | 0                      | 93   | 29   | 122        | 0                              | 0    | 0    | 0          | 382        |
| 08:00 AM   | 24                           | 92   | 0    | 116        | 63                              | 0    | 80   | 143        | 0                      | 77   | 29   | 106        | 0                              | 0    | 0    | 0          | 365        |
| 08:15 AM   | 24                           | 63   | 0    | 87         | 76                              | 0    | 58   | 134        | 0                      | 81   | 28   | 109        | 0                              | 0    | 0    | 0          | 330        |
| Total Volume   | 105                          | 335  | 0    | 440        | 293                             | 0    | 243  | 536        | 0                      | 355  | 123  | 478        | 0                              | 0    | 0    | 0          | 1454       |
| % App. Total   | 23.9                         | 76.1 | 0    |            | 54.7                            | 0    | 45.3 |            | 0                      | 74.3 | 25.7 |            | 0                              | 0    | 0    |            |            |
| PHF  | .905                         | .910 | .000 | .924       | .927                            | .000 | .759 | .937       | .000                   | .853 | .831 | .848       | .000                           | .000 | .000 | .000       | .952       |

# Traffic Data Service

San Jose, CA  
 (408) 622-4787  
 tdsbay@cs.com

File Name : 24AM FINAL  
 Site Code : 00000024  
 Start Date : 4/25/2018  
 Page No : 2

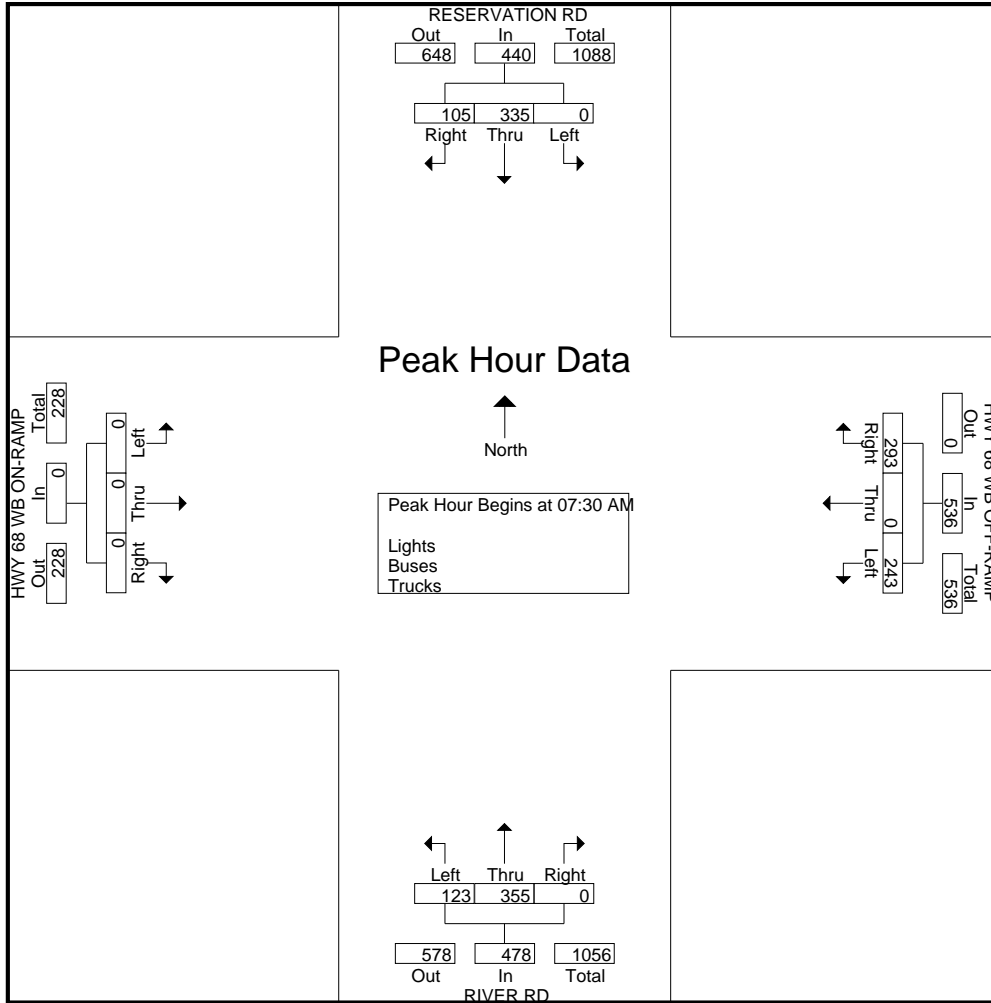

# Traffic Data Service

San Jose, CA  
 (408) 622-4787  
 tdsbay@cs.com

File Name : 24AM FINAL  
 Site Code : 00000024  
 Start Date : 4/25/2018  
 Page No : 1

Groups Printed- Bikes

| Start Time   | RESERVATION RD<br>Southbound |      |      |      |            | HWY 68 WB OFF-RAMP<br>Westbound |      |      |      |            | RIVER RD<br>Northbound |      |      |      |            | HWY 68 WB ON-RAMP<br>Eastbound |      |      |      |            | Int. Total |
|--------------|------------------------------|------|------|------|------------|---------------------------------|------|------|------|------------|------------------------|------|------|------|------------|--------------------------------|------|------|------|------------|------------|
|              | Right                        | Thru | Left | Peds | App. Total | Right                           | Thru | Left | Peds | App. Total | Right                  | Thru | Left | Peds | App. Total | Right                          | Thru | Left | Peds | App. Total |            |
| 07:00 AM     | 0                            | 1    | 0    | 0    | 1          | 0                               | 0    | 0    | 0    | 0          | 0                      | 0    | 0    | 0    | 0          | 0                              | 0    | 0    | 0    | 0          | 0          |
| 07:15 AM     | 0                            | 0    | 0    | 0    | 0          | 0                               | 0    | 0    | 0    | 0          | 0                      | 0    | 0    | 0    | 0          | 0                              | 0    | 0    | 0    | 0          | 0          |
| 07:30 AM     | 0                            | 0    | 0    | 0    | 0          | 0                               | 0    | 0    | 0    | 0          | 0                      | 0    | 0    | 0    | 0          | 0                              | 0    | 0    | 0    | 0          | 0          |
| 07:45 AM     | 0                            | 0    | 0    | 0    | 0          | 0                               | 0    | 0    | 0    | 0          | 0                      | 0    | 0    | 0    | 0          | 0                              | 0    | 0    | 0    | 0          | 0          |
| <b>Total</b> | 0                            | 1    | 0    | 0    | 1          | 0                               | 0    | 0    | 0    | 0          | 0                      | 0    | 0    | 0    | 0          | 0                              | 0    | 0    | 0    | 0          | 1          |
| 08:00 AM     | 0                            | 0    | 0    | 0    | 0          | 0                               | 0    | 0    | 0    | 0          | 0                      | 0    | 0    | 0    | 0          | 0                              | 0    | 0    | 0    | 0          | 0          |
| 08:15 AM     | 0                            | 0    | 0    | 0    | 0          | 0                               | 0    | 0    | 0    | 0          | 0                      | 0    | 0    | 0    | 0          | 0                              | 0    | 0    | 0    | 0          | 0          |
| 08:30 AM     | 0                            | 1    | 0    | 0    | 1          | 0                               | 0    | 0    | 0    | 0          | 0                      | 1    | 0    | 0    | 1          | 0                              | 0    | 0    | 0    | 0          | 2          |
| 08:45 AM     | 0                            | 0    | 0    | 0    | 0          | 0                               | 0    | 0    | 0    | 0          | 0                      | 0    | 0    | 0    | 0          | 0                              | 0    | 0    | 0    | 0          | 0          |
| <b>Total</b> | 0                            | 1    | 0    | 0    | 1          | 0                               | 0    | 0    | 0    | 0          | 0                      | 1    | 0    | 0    | 1          | 0                              | 0    | 0    | 0    | 0          | 2          |
| Grand Total  | 0                            | 2    | 0    | 0    | 2          | 0                               | 0    | 0    | 0    | 0          | 0                      | 1    | 0    | 0    | 1          | 0                              | 0    | 0    | 0    | 0          | 3          |
| Apprch %     | 0                            | 100  | 0    | 0    |            | 0                               | 0    | 0    | 0    |            | 0                      | 100  | 0    | 0    |            | 0                              | 0    | 0    | 0    |            |            |
| Total %      | 0                            | 66.7 | 0    | 0    | 66.7       | 0                               | 0    | 0    | 0    | 0          | 0                      | 33.3 | 0    | 0    | 33.3       | 0                              | 0    | 0    | 0    | 0          |            |

| Start Time   | RESERVATION RD<br>Southbound |      |      |            | HWY 68 WB OFF-RAMP<br>Westbound |      |      |            | RIVER RD<br>Northbound |      |      |            | HWY 68 WB ON-RAMP<br>Eastbound |      |      |            | Int. Total |
|--|------------------------------|------|------|------------|---------------------------------|------|------|------------|------------------------|------|------|------------|--------------------------------|------|------|------------|------------|
|  | Right                        | Thru | Left | App. Total | Right                           | Thru | Left | App. Total | Right                  | Thru | Left | App. Total | Right                          | Thru | Left | App. Total |            |
| Peak Hour Analysis From 07:00 AM to 08:45 AM - Peak 1 of 1 |                              |      |      |            |                                 |      |      |            |                        |      |      |            |                                |      |      |            |            |
| Peak Hour for Entire Intersection Begins at 07:45 AM       |                              |      |      |            |                                 |      |      |            |                        |      |      |            |                                |      |      |            |            |
| 07:45 AM   | 0                            | 0    | 0    | 0          | 0                               | 0    | 0    | 0          | 0                      | 0    | 0    | 0          | 0                              | 0    | 0    | 0          | 0          |
| 08:00 AM   | 0                            | 0    | 0    | 0          | 0                               | 0    | 0    | 0          | 0                      | 0    | 0    | 0          | 0                              | 0    | 0    | 0          | 0          |
| 08:15 AM   | 0                            | 0    | 0    | 0          | 0                               | 0    | 0    | 0          | 0                      | 0    | 0    | 0          | 0                              | 0    | 0    | 0          | 0          |
| 08:30 AM   | 0                            | 1    | 0    | 1          | 0                               | 0    | 0    | 0          | 0                      | 1    | 0    | 1          | 0                              | 0    | 0    | 0          | 2          |
| Total Volume   | 0                            | 1    | 0    | 1          | 0                               | 0    | 0    | 0          | 0                      | 1    | 0    | 1          | 0                              | 0    | 0    | 0          | 2          |
| % App. Total   | 0                            | 100  | 0    |            | 0                               | 0    | 0    |            | 0                      | 100  | 0    |            | 0                              | 0    | 0    |            |            |
| PHF  | .000                         | .250 | .000 | .250       | .000                            | .000 | .000 | .000       | .000                   | .250 | .000 | .250       | .000                           | .000 | .000 | .000       | .250       |

# Traffic Data Service

San Jose, CA  
(408) 622-4787  
tdsbay@cs.com

File Name : 24AM FINAL  
Site Code : 00000024  
Start Date : 4/25/2018  
Page No : 2

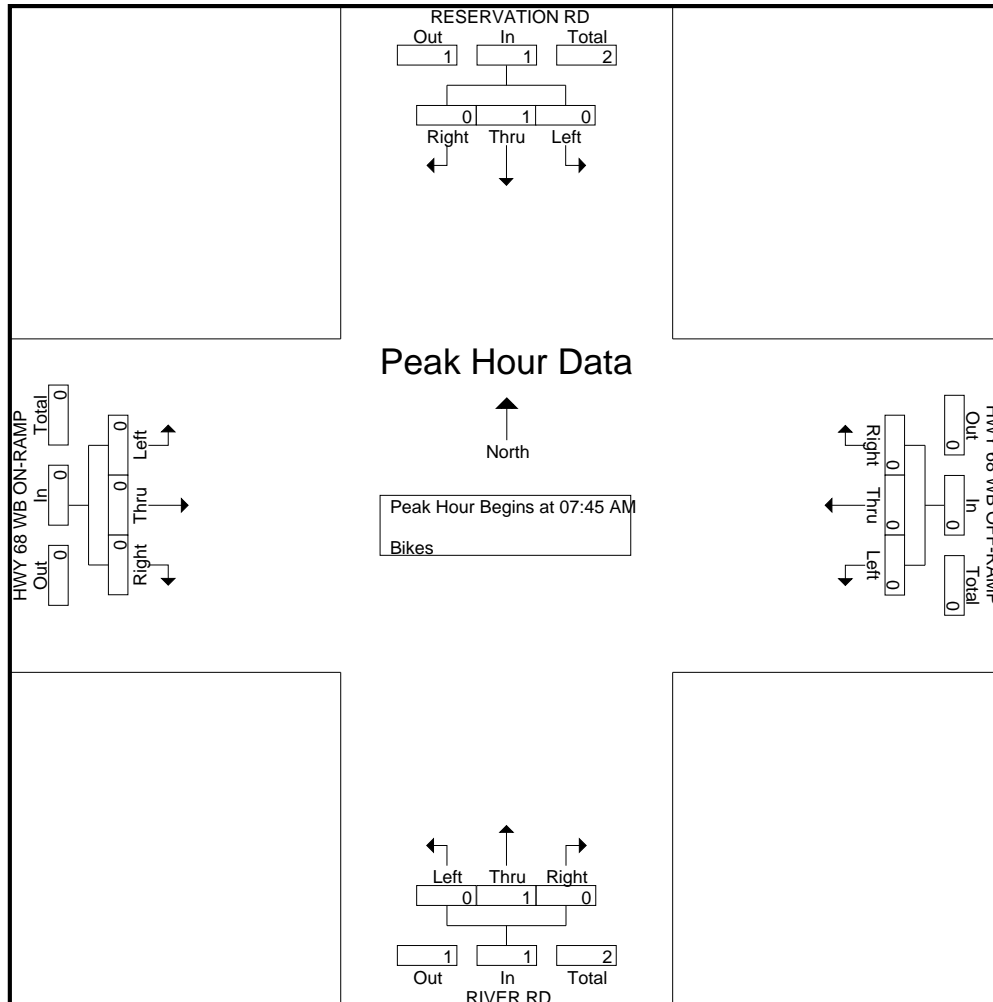

# Traffic Data Service

San Jose, CA  
**(408) 622-4787**  
*tdsbay@cs.com*

File Name : 24PM FINAL  
 Site Code : 00000024  
 Start Date : 4/25/2018  
 Page No : 1

Groups Printed- Lights - Buses - Trucks

| Start Time   | RESERVATION RD<br>Southbound |            |          |          |            | HWY 68 WB OFF-RAMP<br>Westbound |          |            |          |            | RIVER RD<br>Northbound |            |            |          |            | HWY 68 WB ON-RAMP<br>Eastbound |          |          |          |            | Int. Total |             |
|--------------|------------------------------|------------|----------|----------|------------|---------------------------------|----------|------------|----------|------------|------------------------|------------|------------|----------|------------|--------------------------------|----------|----------|----------|------------|------------|-------------|
|              | Right                        | Thru       | Left     | Peds     | App. Total | Right                           | Thru     | Left       | Peds     | App. Total | Right                  | Thru       | Left       | Peds     | App. Total | Right                          | Thru     | Left     | Peds     | App. Total |            |             |
| 04:00 PM     | 39                           | 113        | 0        | 0        | 152        | 52                              | 0        | 88         | 0        | 140        | 0                      | 51         | 30         | 0        | 81         | 0                              | 0        | 0        | 0        | 0          | 0          | 373         |
| 04:15 PM     | 35                           | 111        | 0        | 0        | 146        | 60                              | 0        | 101        | 0        | 161        | 0                      | 54         | 36         | 0        | 90         | 0                              | 0        | 0        | 0        | 0          | 0          | 397         |
| 04:30 PM     | 31                           | 120        | 0        | 0        | 151        | 53                              | 0        | 86         | 0        | 139        | 0                      | 49         | 38         | 0        | 87         | 0                              | 0        | 0        | 0        | 0          | 0          | 377         |
| 04:45 PM     | 37                           | 133        | 0        | 0        | 170        | 43                              | 0        | 74         | 0        | 117        | 0                      | 52         | 50         | 0        | 102        | 0                              | 0        | 0        | 0        | 0          | 0          | 389         |
| <b>Total</b> | <b>142</b>                   | <b>477</b> | <b>0</b> | <b>0</b> | <b>619</b> | <b>208</b>                      | <b>0</b> | <b>349</b> | <b>0</b> | <b>557</b> | <b>0</b>               | <b>206</b> | <b>154</b> | <b>0</b> | <b>360</b> | <b>0</b>                       | <b>0</b> | <b>0</b> | <b>0</b> | <b>0</b>   | <b>0</b>   | <b>1536</b> |
| 05:00 PM     | 27                           | 129        | 0        | 1        | 157        | 53                              | 0        | 118        | 0        | 171        | 0                      | 61         | 28         | 0        | 89         | 0                              | 0        | 0        | 1        | 1          | 1          | 418         |
| 05:15 PM     | 36                           | 118        | 0        | 0        | 154        | 75                              | 0        | 110        | 0        | 185        | 0                      | 58         | 34         | 0        | 92         | 0                              | 0        | 0        | 0        | 0          | 0          | 431         |
| 05:30 PM     | 25                           | 110        | 0        | 0        | 135        | 68                              | 0        | 109        | 0        | 177        | 0                      | 45         | 22         | 0        | 67         | 0                              | 0        | 0        | 0        | 0          | 0          | 379         |
| 05:45 PM     | 27                           | 111        | 0        | 0        | 138        | 49                              | 0        | 88         | 0        | 137        | 0                      | 37         | 23         | 0        | 60         | 0                              | 0        | 0        | 0        | 0          | 0          | 335         |
| <b>Total</b> | <b>115</b>                   | <b>468</b> | <b>0</b> | <b>1</b> | <b>584</b> | <b>245</b>                      | <b>0</b> | <b>425</b> | <b>0</b> | <b>670</b> | <b>0</b>               | <b>201</b> | <b>107</b> | <b>0</b> | <b>308</b> | <b>0</b>                       | <b>0</b> | <b>0</b> | <b>1</b> | <b>1</b>   | <b>1</b>   | <b>1563</b> |
| Grand Total  | 257                          | 945        | 0        | 1        | 1203       | 453                             | 0        | 774        | 0        | 1227       | 0                      | 407        | 261        | 0        | 668        | 0                              | 0        | 0        | 1        | 1          | 1          | 3099        |
| Apprch %     | 21.4                         | 78.6       | 0        | 0.1      |            | 36.9                            | 0        | 63.1       | 0        |            | 0                      | 60.9       | 39.1       | 0        |            | 0                              | 0        | 0        | 100      |            |            |             |
| Total %      | 8.3                          | 30.5       | 0        | 0        | 38.8       | 14.6                            | 0        | 25         | 0        | 39.6       | 0                      | 13.1       | 8.4        | 0        | 21.6       | 0                              | 0        | 0        | 0        | 0          | 0          |             |
| Lights       | 254                          | 905        | 0        | 1        | 1160       | 440                             | 0        | 754        | 0        | 1194       | 0                      | 392        | 260        | 0        | 652        | 0                              | 0        | 0        | 1        | 1          | 1          | 3007        |
| % Lights     | 98.8                         | 95.8       | 0        | 100      | 96.4       | 97.1                            | 0        | 97.4       | 0        | 97.3       | 0                      | 96.3       | 99.6       | 0        | 97.6       | 0                              | 0        | 0        | 100      | 100        | 100        | 97          |
| Buses        | 1                            | 6          | 0        | 0        | 7          | 0                               | 0        | 0          | 0        | 0          | 0                      | 0          | 0          | 0        | 0          | 0                              | 0        | 0        | 0        | 0          | 0          | 7           |
| % Buses      | 0.4                          | 0.6        | 0        | 0        | 0.6        | 0                               | 0        | 0          | 0        | 0          | 0                      | 0          | 0          | 0        | 0          | 0                              | 0        | 0        | 0        | 0          | 0          | 0.2         |
| Trucks       | 2                            | 34         | 0        | 0        | 36         | 13                              | 0        | 20         | 0        | 33         | 0                      | 15         | 1          | 0        | 16         | 0                              | 0        | 0        | 0        | 0          | 0          | 85          |
| % Trucks     | 0.8                          | 3.6        | 0        | 0        | 3          | 2.9                             | 0        | 2.6        | 0        | 2.7        | 0                      | 3.7        | 0.4        | 0        | 2.4        | 0                              | 0        | 0        | 0        | 0          | 0          | 2.7         |

| Start Time   | RESERVATION RD<br>Southbound |            |      |            | HWY 68 WB OFF-RAMP<br>Westbound |      |            |            | RIVER RD<br>Northbound |           |           |            | HWY 68 WB ON-RAMP<br>Eastbound |      |      |            | Int. Total |
|--|------------------------------|------------|------|------------|---------------------------------|------|------------|------------|------------------------|-----------|-----------|------------|--------------------------------|------|------|------------|------------|
|  | Right                        | Thru       | Left | App. Total | Right                           | Thru | Left       | App. Total | Right                  | Thru      | Left      | App. Total | Right                          | Thru | Left | App. Total |            |
| Peak Hour Analysis From 04:00 PM to 05:45 PM - Peak 1 of 1 |                              |            |      |            |                                 |      |            |            |                        |           |           |            |                                |      |      |            |            |
| Peak Hour for Entire Intersection Begins at 04:45 PM       |                              |            |      |            |                                 |      |            |            |                        |           |           |            |                                |      |      |            |            |
| 04:45 PM   | <b>37</b>                    | <b>133</b> | 0    | <b>170</b> | 43                              | 0    | 74         | 117        | 0                      | 52        | <b>50</b> | <b>102</b> | 0                              | 0    | 0    | 0          | 389        |
| 05:00 PM   | 27                           | 129        | 0    | 156        | 53                              | 0    | <b>118</b> | 171        | 0                      | <b>61</b> | 28        | 89         | 0                              | 0    | 0    | 0          | 416        |
| 05:15 PM   | 36                           | 118        | 0    | 154        | <b>75</b>                       | 0    | 110        | <b>185</b> | 0                      | 58        | 34        | 92         | 0                              | 0    | 0    | 0          | <b>431</b> |
| 05:30 PM   | 25                           | 110        | 0    | 135        | 68                              | 0    | 109        | 177        | 0                      | 45        | 22        | 67         | 0                              | 0    | 0    | 0          | 379        |
| Total Volume   | 125                          | 490        | 0    | 615        | 239                             | 0    | 411        | 650        | 0                      | 216       | 134       | 350        | 0                              | 0    | 0    | 0          | 1615       |
| % App. Total   | 20.3                         | 79.7       | 0    |            | 36.8                            | 0    | 63.2       |            | 0                      | 61.7      | 38.3      |            | 0                              | 0    | 0    |            |            |
| PHF  | .845                         | .921       | .000 | .904       | .797                            | .000 | .871       | .878       | .000                   | .885      | .670      | .858       | .000                           | .000 | .000 | .000       | .937       |

# Traffic Data Service

San Jose, CA  
 (408) 622-4787  
 tdsbay@cs.com

File Name : 24PM FINAL  
 Site Code : 00000024  
 Start Date : 4/25/2018  
 Page No : 2

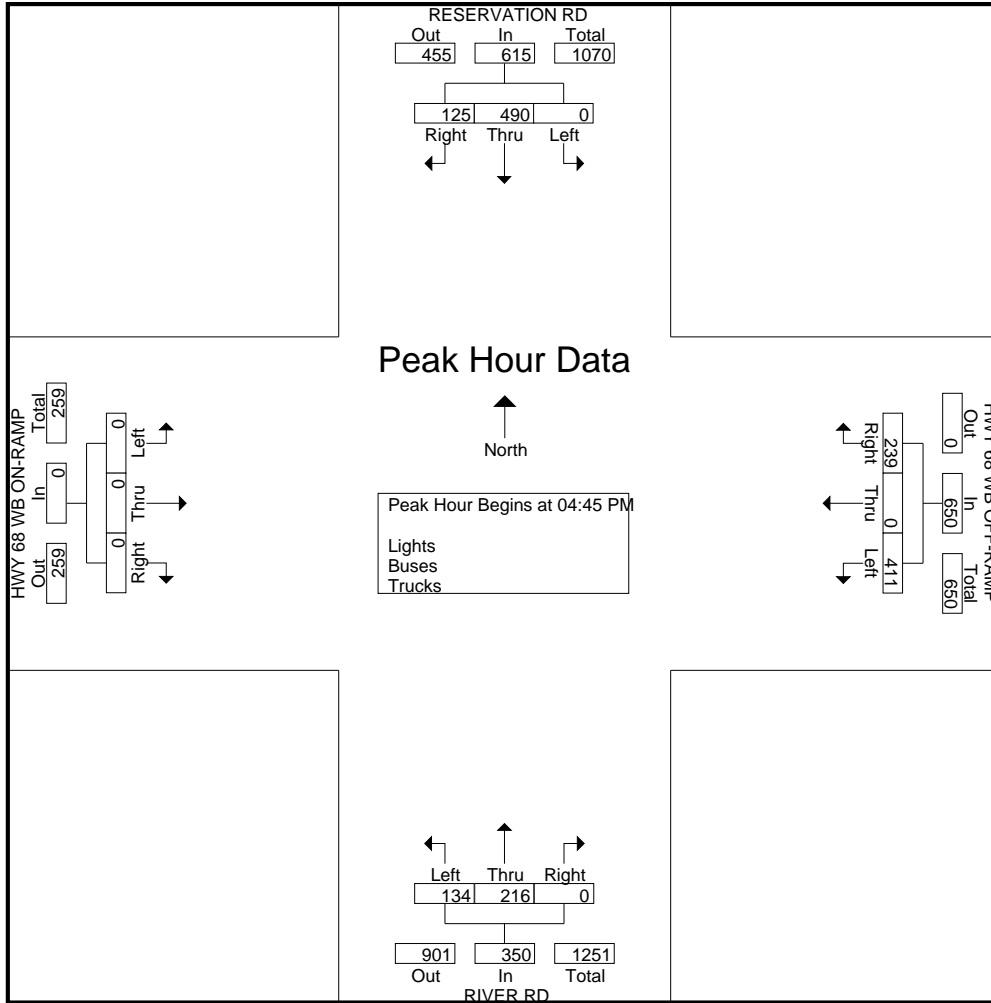

# Traffic Data Service

San Jose, CA  
 (408) 622-4787  
 tdsbay@cs.com

File Name : 24PM FINAL  
 Site Code : 00000024  
 Start Date : 4/25/2018  
 Page No : 1

Groups Printed- Bikes

| Start Time   | RESERVATION RD<br>Southbound |      |      |      |            | HWY 68 WB OFF-RAMP<br>Westbound |      |      |      |            | RIVER RD<br>Northbound |      |      |      |            | HWY 68 WB ON-RAMP<br>Eastbound |      |      |      |            | Int. Total |
|--------------|------------------------------|------|------|------|------------|---------------------------------|------|------|------|------------|------------------------|------|------|------|------------|--------------------------------|------|------|------|------------|------------|
|              | Right                        | Thru | Left | Peds | App. Total | Right                           | Thru | Left | Peds | App. Total | Right                  | Thru | Left | Peds | App. Total | Right                          | Thru | Left | Peds | App. Total |            |
| 04:00 PM     | 0                            | 0    | 0    | 0    | 0          | 0                               | 0    | 0    | 0    | 0          | 0                      | 0    | 0    | 0    | 0          | 0                              | 0    | 0    | 0    | 0          | 0          |
| 04:15 PM     | 0                            | 1    | 0    | 0    | 1          | 0                               | 0    | 0    | 0    | 0          | 0                      | 0    | 0    | 0    | 0          | 0                              | 0    | 0    | 0    | 0          | 0          |
| 04:30 PM     | 0                            | 0    | 0    | 0    | 0          | 0                               | 0    | 0    | 0    | 0          | 0                      | 0    | 0    | 0    | 0          | 0                              | 0    | 0    | 0    | 0          | 0          |
| 04:45 PM     | 0                            | 0    | 0    | 0    | 0          | 0                               | 0    | 0    | 0    | 0          | 0                      | 0    | 0    | 0    | 0          | 0                              | 0    | 0    | 0    | 0          | 0          |
| <b>Total</b> | 0                            | 1    | 0    | 0    | 1          | 0                               | 0    | 0    | 0    | 0          | 0                      | 0    | 0    | 0    | 0          | 0                              | 0    | 0    | 0    | 0          | 1          |
| 05:00 PM     | 0                            | 0    | 0    | 0    | 0          | 0                               | 0    | 0    | 0    | 0          | 0                      | 0    | 0    | 0    | 0          | 0                              | 0    | 0    | 0    | 0          | 0          |
| 05:15 PM     | 0                            | 0    | 0    | 0    | 0          | 0                               | 0    | 0    | 0    | 0          | 0                      | 0    | 0    | 0    | 0          | 0                              | 0    | 0    | 0    | 0          | 0          |
| 05:30 PM     | 0                            | 0    | 0    | 0    | 0          | 0                               | 0    | 0    | 0    | 0          | 0                      | 0    | 0    | 0    | 0          | 0                              | 0    | 0    | 0    | 0          | 0          |
| 05:45 PM     | 0                            | 0    | 0    | 0    | 0          | 0                               | 0    | 0    | 0    | 0          | 0                      | 0    | 0    | 0    | 0          | 0                              | 0    | 0    | 0    | 0          | 0          |
| <b>Total</b> | 0                            | 0    | 0    | 0    | 0          | 0                               | 0    | 0    | 0    | 0          | 0                      | 0    | 0    | 0    | 0          | 0                              | 0    | 0    | 0    | 0          | 0          |
| Grand Total  | 0                            | 1    | 0    | 0    | 1          | 0                               | 0    | 0    | 0    | 0          | 0                      | 0    | 0    | 0    | 0          | 0                              | 0    | 0    | 0    | 0          | 1          |
| Apprch %     | 0                            | 100  | 0    | 0    |            | 0                               | 0    | 0    | 0    |            | 0                      | 0    | 0    | 0    |            | 0                              | 0    | 0    | 0    |            |            |
| Total %      | 0                            | 100  | 0    | 0    | 100        | 0                               | 0    | 0    | 0    | 0          | 0                      | 0    | 0    | 0    | 0          | 0                              | 0    | 0    | 0    | 0          |            |

| Start Time   | RESERVATION RD<br>Southbound |      |      |            | HWY 68 WB OFF-RAMP<br>Westbound |      |      |            | RIVER RD<br>Northbound |      |      |            | HWY 68 WB ON-RAMP<br>Eastbound |      |      |            | Int. Total |
|--|------------------------------|------|------|------------|---------------------------------|------|------|------------|------------------------|------|------|------------|--------------------------------|------|------|------------|------------|
|  | Right                        | Thru | Left | App. Total | Right                           | Thru | Left | App. Total | Right                  | Thru | Left | App. Total | Right                          | Thru | Left | App. Total |            |
| Peak Hour Analysis From 04:00 PM to 05:45 PM - Peak 1 of 1 |                              |      |      |            |                                 |      |      |            |                        |      |      |            |                                |      |      |            |            |
| Peak Hour for Entire Intersection Begins at 04:00 PM       |                              |      |      |            |                                 |      |      |            |                        |      |      |            |                                |      |      |            |            |
| 04:00 PM   | 0                            | 0    | 0    | 0          | 0                               | 0    | 0    | 0          | 0                      | 0    | 0    | 0          | 0                              | 0    | 0    | 0          | 0          |
| 04:15 PM   | 0                            | 1    | 0    | 1          | 0                               | 0    | 0    | 0          | 0                      | 0    | 0    | 0          | 0                              | 0    | 0    | 0          | 1          |
| 04:30 PM   | 0                            | 0    | 0    | 0          | 0                               | 0    | 0    | 0          | 0                      | 0    | 0    | 0          | 0                              | 0    | 0    | 0          | 0          |
| 04:45 PM   | 0                            | 0    | 0    | 0          | 0                               | 0    | 0    | 0          | 0                      | 0    | 0    | 0          | 0                              | 0    | 0    | 0          | 0          |
| Total Volume   | 0                            | 1    | 0    | 1          | 0                               | 0    | 0    | 0          | 0                      | 0    | 0    | 0          | 0                              | 0    | 0    | 0          | 1          |
| % App. Total   | 0                            | 100  | 0    |            | 0                               | 0    | 0    |            | 0                      | 0    | 0    |            | 0                              | 0    | 0    |            |            |
| PHF  | .000                         | .250 | .000 | .250       | .000                            | .000 | .000 | .000       | .000                   | .000 | .000 | .000       | .000                           | .000 | .000 | .000       | .250       |

# Traffic Data Service

San Jose, CA  
 (408) 622-4787  
 tdsbay@cs.com

File Name : 24PM FINAL  
 Site Code : 00000024  
 Start Date : 4/25/2018  
 Page No : 2

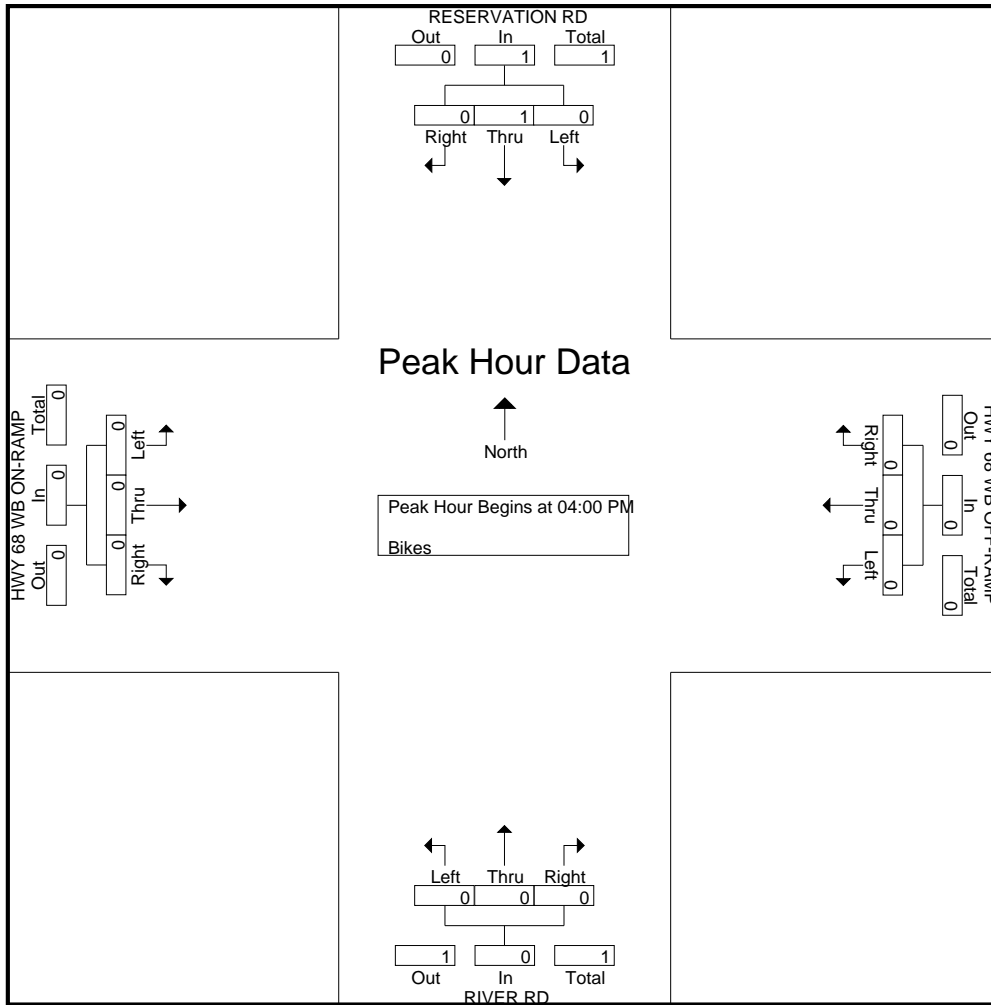



# Traffic Data Service

San Jose, CA  
 (408) 622-4787  
 tdsbay@cs.com

File Name : 25AM FINAL  
 Site Code : 00000025  
 Start Date : 4/25/2018  
 Page No : 1

Groups Printed- Lights - Buses - Trucks

| Start Time   | RIVER RD Southbound |      |      |      |            | HWY 68 EB ON-RAMP Westbound |      |      |      |            | RIVER RD Northbound |      |      |      |            | HWY 68 EB OFF-RAMP Eastbound |      |      |      |            | Int. Total |
|--------------|---------------------|------|------|------|------------|-----------------------------|------|------|------|------------|---------------------|------|------|------|------------|------------------------------|------|------|------|------------|------------|
|              | Right               | Thru | Left | Peds | App. Total | Right                       | Thru | Left | Peds | App. Total | Right               | Thru | Left | Peds | App. Total | Right                        | Thru | Left | Peds | App. Total |            |
| 07:00 AM     | 0                   | 53   | 27   | 0    | 80         | 0                           | 0    | 0    | 0    | 0          | 64                  | 117  | 0    | 0    | 181        | 30                           | 0    | 19   | 0    | 49         | 310        |
| 07:15 AM     | 0                   | 54   | 40   | 0    | 94         | 0                           | 0    | 0    | 0    | 0          | 115                 | 108  | 0    | 0    | 223        | 28                           | 0    | 26   | 0    | 54         | 371        |
| 07:30 AM     | 0                   | 65   | 59   | 0    | 124        | 0                           | 0    | 0    | 0    | 0          | 201                 | 109  | 0    | 0    | 310        | 30                           | 0    | 26   | 0    | 56         | 490        |
| 07:45 AM     | 0                   | 87   | 57   | 0    | 144        | 0                           | 0    | 0    | 0    | 0          | 158                 | 108  | 0    | 0    | 266        | 23                           | 0    | 17   | 0    | 40         | 450        |
| <b>Total</b> | 0                   | 259  | 183  | 0    | 442        | 0                           | 0    | 0    | 0    | 0          | 538                 | 442  | 0    | 0    | 980        | 111                          | 0    | 88   | 0    | 199        | 1621       |
| 08:00 AM     | 0                   | 118  | 65   | 0    | 183        | 0                           | 0    | 0    | 0    | 0          | 160                 | 85   | 0    | 0    | 245        | 24                           | 1    | 19   | 0    | 44         | 472        |
| 08:15 AM     | 0                   | 76   | 42   | 0    | 118        | 0                           | 0    | 0    | 0    | 0          | 145                 | 74   | 0    | 0    | 219        | 28                           | 0    | 34   | 0    | 62         | 399        |
| 08:30 AM     | 0                   | 62   | 35   | 0    | 97         | 0                           | 0    | 0    | 0    | 0          | 62                  | 62   | 0    | 1    | 125        | 29                           | 0    | 24   | 1    | 54         | 276        |
| 08:45 AM     | 0                   | 48   | 26   | 0    | 74         | 0                           | 0    | 0    | 0    | 0          | 61                  | 62   | 0    | 0    | 123        | 18                           | 0    | 25   | 0    | 43         | 240        |
| <b>Total</b> | 0                   | 304  | 168  | 0    | 472        | 0                           | 0    | 0    | 0    | 0          | 428                 | 283  | 0    | 1    | 712        | 99                           | 1    | 102  | 1    | 203        | 1387       |
| Grand Total  | 0                   | 563  | 351  | 0    | 914        | 0                           | 0    | 0    | 0    | 0          | 966                 | 725  | 0    | 1    | 1692       | 210                          | 1    | 190  | 1    | 402        | 3008       |
| Apprch %     | 0                   | 61.6 | 38.4 | 0    |            | 0                           | 0    | 0    | 0    |            | 57.1                | 42.8 | 0    | 0.1  |            | 52.2                         | 0.2  | 47.3 | 0.2  |            |            |
| Total %      | 0                   | 18.7 | 11.7 | 0    | 30.4       | 0                           | 0    | 0    | 0    | 0          | 32.1                | 24.1 | 0    | 0    | 56.2       | 7                            | 0    | 6.3  | 0    | 13.4       |            |
| Lights       | 0                   | 532  | 339  | 0    | 871        | 0                           | 0    | 0    | 0    | 0          | 948                 | 717  | 0    | 1    | 1666       | 205                          | 1    | 190  | 1    | 397        | 2934       |
| % Lights     | 0                   | 94.5 | 96.6 | 0    | 95.3       | 0                           | 0    | 0    | 0    | 0          | 98.1                | 98.9 | 0    | 100  | 98.5       | 97.6                         | 100  | 100  | 100  | 98.8       | 97.5       |
| Buses        | 0                   | 5    | 2    | 0    | 7          | 0                           | 0    | 0    | 0    | 0          | 7                   | 3    | 0    | 0    | 10         | 2                            | 0    | 0    | 0    | 2          | 19         |
| % Buses      | 0                   | 0.9  | 0.6  | 0    | 0.8        | 0                           | 0    | 0    | 0    | 0          | 0.7                 | 0.4  | 0    | 0    | 0.6        | 1                            | 0    | 0    | 0    | 0.5        | 0.6        |
| Trucks       | 0                   | 26   | 10   | 0    | 36         | 0                           | 0    | 0    | 0    | 0          | 11                  | 5    | 0    | 0    | 16         | 3                            | 0    | 0    | 0    | 3          | 55         |
| % Trucks     | 0                   | 4.6  | 2.8  | 0    | 3.9        | 0                           | 0    | 0    | 0    | 0          | 1.1                 | 0.7  | 0    | 0    | 0.9        | 1.4                          | 0    | 0    | 0    | 0.7        | 1.8        |

| Start Time   | RIVER RD Southbound |      |      |            | HWY 68 EB ON-RAMP Westbound |      |      |            | RIVER RD Northbound |      |      |            | HWY 68 EB OFF-RAMP Eastbound |      |      |            | Int. Total |
|--|---------------------|------|------|------------|-----------------------------|------|------|------------|---------------------|------|------|------------|------------------------------|------|------|------------|------------|
|  | Right               | Thru | Left | App. Total | Right                       | Thru | Left | App. Total | Right               | Thru | Left | App. Total | Right                        | Thru | Left | App. Total |            |
| Peak Hour Analysis From 07:00 AM to 08:45 AM - Peak 1 of 1 |                     |      |      |            |                             |      |      |            |                     |      |      |            |                              |      |      |            |            |
| Peak Hour for Entire Intersection Begins at 07:30 AM       |                     |      |      |            |                             |      |      |            |                     |      |      |            |                              |      |      |            |            |
| 07:30 AM   | 0                   | 65   | 59   | 124        | 0                           | 0    | 0    | 0          | 201                 | 109  | 0    | 310        | 30                           | 0    | 26   | 56         | 490        |
| 07:45 AM   | 0                   | 87   | 57   | 144        | 0                           | 0    | 0    | 0          | 158                 | 108  | 0    | 266        | 23                           | 0    | 17   | 40         | 450        |
| 08:00 AM   | 0                   | 118  | 65   | 183        | 0                           | 0    | 0    | 0          | 160                 | 85   | 0    | 245        | 24                           | 1    | 19   | 44         | 472        |
| 08:15 AM   | 0                   | 76   | 42   | 118        | 0                           | 0    | 0    | 0          | 145                 | 74   | 0    | 219        | 28                           | 0    | 34   | 62         | 399        |
| Total Volume   | 0                   | 346  | 223  | 569        | 0                           | 0    | 0    | 0          | 664                 | 376  | 0    | 1040       | 105                          | 1    | 96   | 202        | 1811       |
| % App. Total   | 0                   | 60.8 | 39.2 |            | 0                           | 0    | 0    |            | 63.8                | 36.2 | 0    |            | 52                           | 0.5  | 47.5 |            |            |
| PHF  | .000                | .733 | .858 | .777       | .000                        | .000 | .000 | .000       | .826                | .862 | .000 | .839       | .875                         | .250 | .706 | .815       | .924       |

# Traffic Data Service

San Jose, CA  
 (408) 622-4787  
 tdsbay@cs.com

File Name : 25AM FINAL  
 Site Code : 00000025  
 Start Date : 4/25/2018  
 Page No : 2

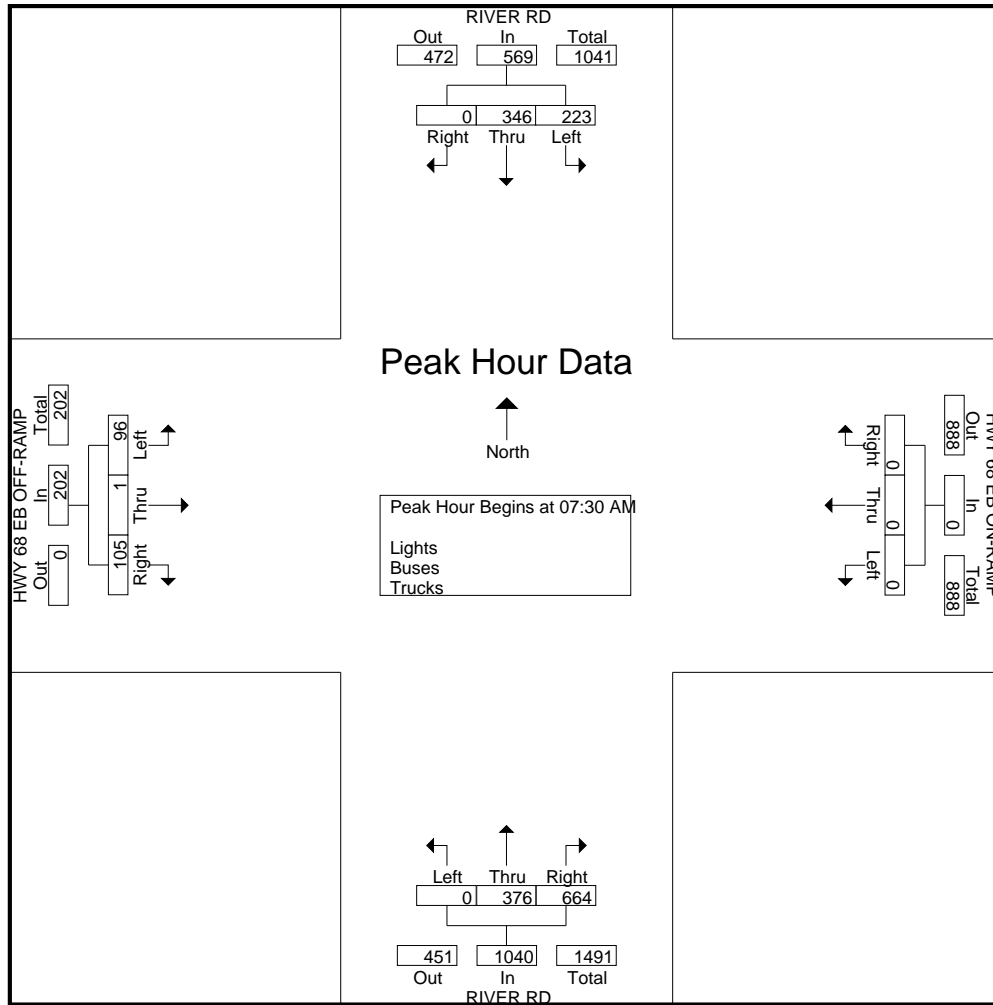

# Traffic Data Service

San Jose, CA  
 (408) 622-4787  
 tdsbay@cs.com

File Name : 25AM FINAL  
 Site Code : 00000025  
 Start Date : 4/25/2018  
 Page No : 1

Groups Printed- Bikes

| Start Time  | RIVER RD Southbound |      |      |      |            | HWY 68 EB ON-RAMP Westbound |      |      |      |            | RIVER RD Northbound |      |      |      |            | HWY 68 EB OFF-RAMP Eastbound |      |      |      |            | Int. Total |
|-------------|---------------------|------|------|------|------------|-----------------------------|------|------|------|------------|---------------------|------|------|------|------------|------------------------------|------|------|------|------------|------------|
|             | Right               | Thru | Left | Peds | App. Total | Right                       | Thru | Left | Peds | App. Total | Right               | Thru | Left | Peds | App. Total | Right                        | Thru | Left | Peds | App. Total |            |
| 07:00 AM    | 0                   | 1    | 0    | 0    | 1          | 0                           | 0    | 0    | 0    | 0          | 0                   | 0    | 0    | 0    | 0          | 0                            | 0    | 0    | 0    | 0          | 0          |
| 07:15 AM    | 0                   | 0    | 0    | 0    | 0          | 0                           | 0    | 0    | 0    | 0          | 0                   | 0    | 0    | 0    | 0          | 0                            | 0    | 0    | 0    | 0          | 0          |
| 07:30 AM    | 0                   | 0    | 0    | 0    | 0          | 0                           | 0    | 0    | 0    | 0          | 0                   | 0    | 0    | 0    | 0          | 0                            | 0    | 0    | 0    | 0          | 0          |
| 07:45 AM    | 0                   | 0    | 0    | 0    | 0          | 0                           | 0    | 0    | 0    | 0          | 0                   | 0    | 0    | 0    | 0          | 0                            | 0    | 0    | 0    | 0          | 0          |
| Total       | 0                   | 1    | 0    | 0    | 1          | 0                           | 0    | 0    | 0    | 0          | 0                   | 0    | 0    | 0    | 0          | 0                            | 0    | 0    | 0    | 0          | 1          |
| 08:00 AM    | 0                   | 0    | 0    | 0    | 0          | 0                           | 0    | 0    | 0    | 0          | 0                   | 0    | 0    | 0    | 0          | 0                            | 0    | 0    | 0    | 0          | 0          |
| 08:15 AM    | 0                   | 0    | 0    | 0    | 0          | 0                           | 0    | 0    | 0    | 0          | 0                   | 0    | 0    | 0    | 0          | 0                            | 0    | 0    | 0    | 0          | 0          |
| 08:30 AM    | 0                   | 0    | 0    | 0    | 0          | 0                           | 0    | 0    | 0    | 0          | 0                   | 0    | 0    | 0    | 0          | 0                            | 0    | 0    | 0    | 0          | 0          |
| 08:45 AM    | 0                   | 0    | 0    | 0    | 0          | 0                           | 0    | 0    | 0    | 0          | 0                   | 0    | 0    | 0    | 0          | 1                            | 0    | 0    | 0    | 1          | 1          |
| Total       | 0                   | 0    | 0    | 0    | 0          | 0                           | 0    | 0    | 0    | 0          | 0                   | 0    | 0    | 0    | 0          | 1                            | 0    | 0    | 0    | 1          | 1          |
| Grand Total | 0                   | 1    | 0    | 0    | 1          | 0                           | 0    | 0    | 0    | 0          | 0                   | 0    | 0    | 0    | 0          | 1                            | 0    | 0    | 0    | 1          | 2          |
| Apprch %    | 0                   | 100  | 0    | 0    |            | 0                           | 0    | 0    | 0    |            | 0                   | 0    | 0    | 0    |            | 100                          | 0    | 0    | 0    |            |            |
| Total %     | 0                   | 50   | 0    | 0    | 50         | 0                           | 0    | 0    | 0    | 0          | 0                   | 0    | 0    | 0    | 0          | 50                           | 0    | 0    | 0    | 50         |            |

| Start Time   | RIVER RD Southbound |      |      |      |            | HWY 68 EB ON-RAMP Westbound |      |      |      |            | RIVER RD Northbound |      |      |      |            | HWY 68 EB OFF-RAMP Eastbound |      |      |      |            | Int. Total |
|--------------|---------------------|------|------|------|------------|-----------------------------|------|------|------|------------|---------------------|------|------|------|------------|------------------------------|------|------|------|------------|------------|
|              | Right               | Thru | Left | Peds | App. Total | Right                       | Thru | Left | Peds | App. Total | Right               | Thru | Left | Peds | App. Total | Right                        | Thru | Left | Peds | App. Total |            |
| 07:00 AM     | 0                   | 1    | 0    | 0    | 1          | 0                           | 0    | 0    | 0    | 0          | 0                   | 0    | 0    | 0    | 0          | 0                            | 0    | 0    | 0    | 0          | 1          |
| 07:15 AM     | 0                   | 0    | 0    | 0    | 0          | 0                           | 0    | 0    | 0    | 0          | 0                   | 0    | 0    | 0    | 0          | 0                            | 0    | 0    | 0    | 0          | 0          |
| 07:30 AM     | 0                   | 0    | 0    | 0    | 0          | 0                           | 0    | 0    | 0    | 0          | 0                   | 0    | 0    | 0    | 0          | 0                            | 0    | 0    | 0    | 0          | 0          |
| 07:45 AM     | 0                   | 0    | 0    | 0    | 0          | 0                           | 0    | 0    | 0    | 0          | 0                   | 0    | 0    | 0    | 0          | 0                            | 0    | 0    | 0    | 0          | 0          |
| Total Volume | 0                   | 1    | 0    | 0    | 1          | 0                           | 0    | 0    | 0    | 0          | 0                   | 0    | 0    | 0    | 0          | 0                            | 0    | 0    | 0    | 0          | 1          |
| % App. Total | 0                   | 100  | 0    | 0    |            | 0                           | 0    | 0    | 0    |            | 0                   | 0    | 0    | 0    |            | 0                            | 0    | 0    | 0    |            |            |
| PHF          | .000                | .250 | .000 | .000 | .250       | .000                        | .000 | .000 | .000 | .000       | .000                | .000 | .000 | .000 | .000       | .000                         | .000 | .000 | .000 | .000       | .250       |

Peak Hour Analysis From 07:00 AM to 08:45 AM - Peak 1 of 1  
 Peak Hour for Entire Intersection Begins at 07:00 AM

# Traffic Data Service

San Jose, CA  
(408) 622-4787  
tdsbay@cs.com

File Name : 25AM FINAL  
Site Code : 00000025  
Start Date : 4/25/2018  
Page No : 2

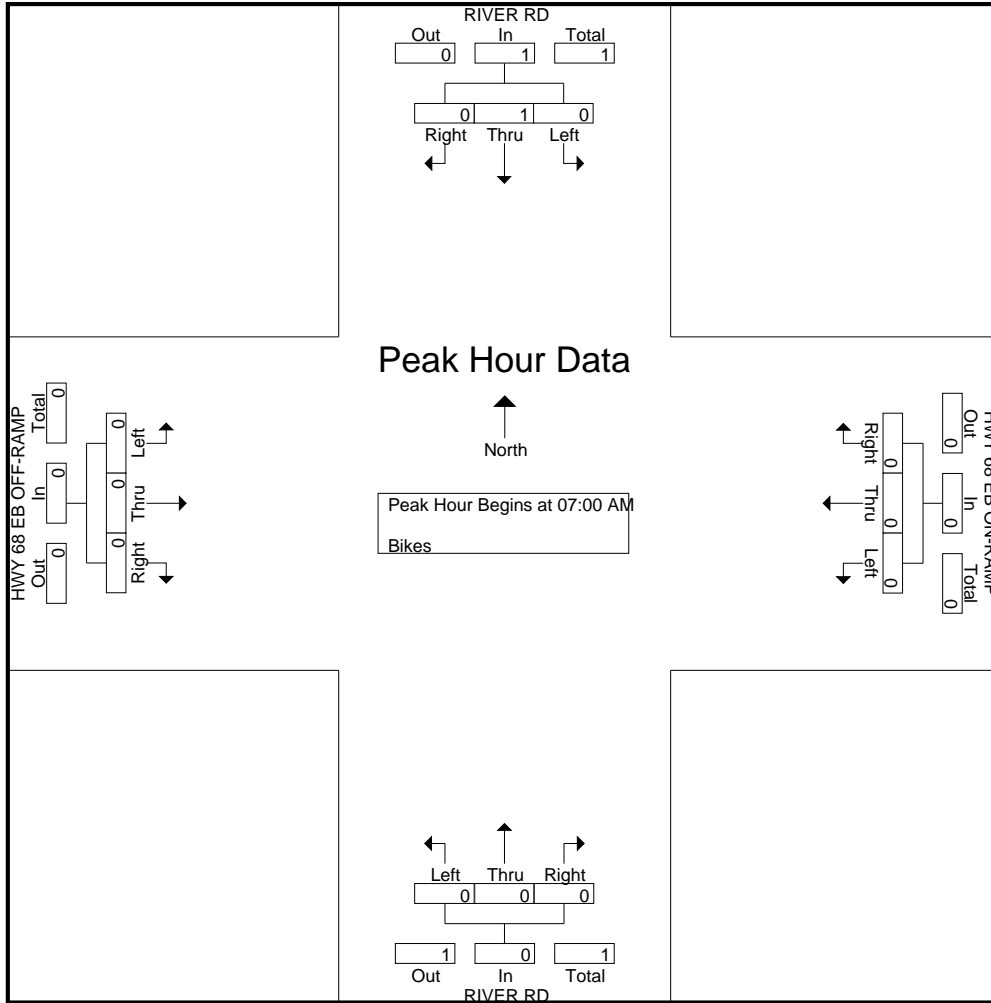

# Traffic Data Service

San Jose, CA  
 (408) 622-4787  
 tdsbay@cs.com

File Name : 25PM FINAL  
 Site Code : 00000025  
 Start Date : 4/25/2018  
 Page No : 1

Groups Printed- Lights - Buses - Trucks

| Start Time  | RIVER RD Southbound |      |      |      |            | HWY 68 EB ON-RAMP Westbound |      |      |      |            | RIVER RD Northbound |      |      |      |            | HWY 68 EB OFF-RAMP Eastbound |      |      |      |            | Int. Total |
|-------------|---------------------|------|------|------|------------|-----------------------------|------|------|------|------------|---------------------|------|------|------|------------|------------------------------|------|------|------|------------|------------|
|             | Right               | Thru | Left | Peds | App. Total | Right                       | Thru | Left | Peds | App. Total | Right               | Thru | Left | Peds | App. Total | Right                        | Thru | Left | Peds | App. Total |            |
| 04:00 PM    | 0                   | 135  | 63   | 0    | 198        | 0                           | 0    | 0    | 0    | 0          | 54                  | 57   | 0    | 0    | 111        | 47                           | 0    | 26   | 0    | 73         | 382        |
| 04:15 PM    | 0                   | 159  | 44   | 0    | 203        | 0                           | 0    | 0    | 0    | 0          | 48                  | 73   | 0    | 0    | 121        | 57                           | 0    | 21   | 0    | 78         | 402        |
| 04:30 PM    | 0                   | 153  | 65   | 0    | 218        | 0                           | 0    | 0    | 0    | 0          | 73                  | 77   | 0    | 0    | 150        | 48                           | 0    | 15   | 0    | 63         | 431        |
| 04:45 PM    | 0                   | 145  | 66   | 0    | 211        | 0                           | 0    | 0    | 0    | 0          | 57                  | 73   | 0    | 0    | 130        | 44                           | 0    | 23   | 0    | 67         | 408        |
| Total       | 0                   | 592  | 238  | 0    | 830        | 0                           | 0    | 0    | 0    | 0          | 232                 | 280  | 0    | 0    | 512        | 196                          | 0    | 85   | 0    | 281        | 1623       |
| 05:00 PM    | 0                   | 188  | 55   | 0    | 243        | 0                           | 0    | 0    | 0    | 0          | 89                  | 68   | 0    | 0    | 157        | 48                           | 1    | 21   | 0    | 70         | 470        |
| 05:15 PM    | 0                   | 173  | 56   | 0    | 229        | 0                           | 0    | 0    | 0    | 0          | 87                  | 73   | 0    | 0    | 160        | 49                           | 0    | 22   | 0    | 71         | 460        |
| 05:30 PM    | 0                   | 172  | 47   | 0    | 219        | 0                           | 0    | 0    | 0    | 0          | 83                  | 46   | 0    | 0    | 129        | 47                           | 0    | 17   | 0    | 64         | 412        |
| 05:45 PM    | 0                   | 152  | 52   | 0    | 204        | 0                           | 0    | 0    | 0    | 0          | 65                  | 52   | 0    | 0    | 117        | 47                           | 0    | 12   | 0    | 59         | 380        |
| Total       | 0                   | 685  | 210  | 0    | 895        | 0                           | 0    | 0    | 0    | 0          | 324                 | 239  | 0    | 0    | 563        | 191                          | 1    | 72   | 0    | 264        | 1722       |
| Grand Total | 0                   | 1277 | 448  | 0    | 1725       | 0                           | 0    | 0    | 0    | 0          | 556                 | 519  | 0    | 0    | 1075       | 387                          | 1    | 157  | 0    | 545        | 3345       |
| Apprch %    | 0                   | 74   | 26   | 0    |            | 0                           | 0    | 0    | 0    |            | 51.7                | 48.3 | 0    | 0    |            | 71                           | 0.2  | 28.8 | 0    |            |            |
| Total %     | 0                   | 38.2 | 13.4 | 0    | 51.6       | 0                           | 0    | 0    | 0    | 0          | 16.6                | 15.5 | 0    | 0    | 32.1       | 11.6                         | 0    | 4.7  | 0    | 16.3       |            |
| Lights      | 0                   | 1243 | 420  | 0    | 1663       | 0                           | 0    | 0    | 0    | 0          | 535                 | 504  | 0    | 0    | 1039       | 384                          | 1    | 153  | 0    | 538        | 3240       |
| % Lights    | 0                   | 97.3 | 93.8 | 0    | 96.4       | 0                           | 0    | 0    | 0    | 0          | 96.2                | 97.1 | 0    | 0    | 96.7       | 99.2                         | 100  | 97.5 | 0    | 98.7       | 96.9       |
| Buses       | 0                   | 2    | 5    | 0    | 7          | 0                           | 0    | 0    | 0    | 0          | 3                   | 0    | 0    | 0    | 3          | 0                            | 0    | 0    | 0    | 0          | 10         |
| % Buses     | 0                   | 0.2  | 1.1  | 0    | 0.4        | 0                           | 0    | 0    | 0    | 0          | 0.5                 | 0    | 0    | 0    | 0.3        | 0                            | 0    | 0    | 0    | 0          | 0.3        |
| Trucks      | 0                   | 32   | 23   | 0    | 55         | 0                           | 0    | 0    | 0    | 0          | 18                  | 15   | 0    | 0    | 33         | 3                            | 0    | 4    | 0    | 7          | 95         |
| % Trucks    | 0                   | 2.5  | 5.1  | 0    | 3.2        | 0                           | 0    | 0    | 0    | 0          | 3.2                 | 2.9  | 0    | 0    | 3.1        | 0.8                          | 0    | 2.5  | 0    | 1.3        | 2.8        |

| Start Time   | RIVER RD Southbound |      |      |            | HWY 68 EB ON-RAMP Westbound |      |      |            | RIVER RD Northbound |      |      |            | HWY 68 EB OFF-RAMP Eastbound |      |      |            | Int. Total |
|--|---------------------|------|------|------------|-----------------------------|------|------|------------|---------------------|------|------|------------|------------------------------|------|------|------------|------------|
|  | Right               | Thru | Left | App. Total | Right                       | Thru | Left | App. Total | Right               | Thru | Left | App. Total | Right                        | Thru | Left | App. Total |            |
| Peak Hour Analysis From 04:00 PM to 05:45 PM - Peak 1 of 1 |                     |      |      |            |                             |      |      |            |                     |      |      |            |                              |      |      |            |            |
| Peak Hour for Entire Intersection Begins at 04:30 PM       |                     |      |      |            |                             |      |      |            |                     |      |      |            |                              |      |      |            |            |
| 04:30 PM   | 0                   | 153  | 65   | 218        | 0                           | 0    | 0    | 0          | 73                  | 77   | 0    | 150        | 48                           | 0    | 15   | 63         | 431        |
| 04:45 PM   | 0                   | 145  | 66   | 211        | 0                           | 0    | 0    | 0          | 57                  | 73   | 0    | 130        | 44                           | 0    | 23   | 67         | 408        |
| 05:00 PM   | 0                   | 188  | 55   | 243        | 0                           | 0    | 0    | 0          | 89                  | 68   | 0    | 157        | 48                           | 1    | 21   | 70         | 470        |
| 05:15 PM   | 0                   | 173  | 56   | 229        | 0                           | 0    | 0    | 0          | 87                  | 73   | 0    | 160        | 49                           | 0    | 22   | 71         | 460        |
| Total Volume   | 0                   | 659  | 242  | 901        | 0                           | 0    | 0    | 0          | 306                 | 291  | 0    | 597        | 189                          | 1    | 81   | 271        | 1769       |
| % App. Total   | 0                   | 73.1 | 26.9 |            | 0                           | 0    | 0    |            | 51.3                | 48.7 | 0    |            | 69.7                         | 0.4  | 29.9 |            |            |
| PHF  | .000                | .876 | .917 | .927       | .000                        | .000 | .000 | .000       | .860                | .945 | .000 | .933       | .964                         | .250 | .880 | .954       | .941       |

# Traffic Data Service

San Jose, CA  
 (408) 622-4787  
 tdsbay@cs.com

File Name : 25PM FINAL  
 Site Code : 00000025  
 Start Date : 4/25/2018  
 Page No : 2

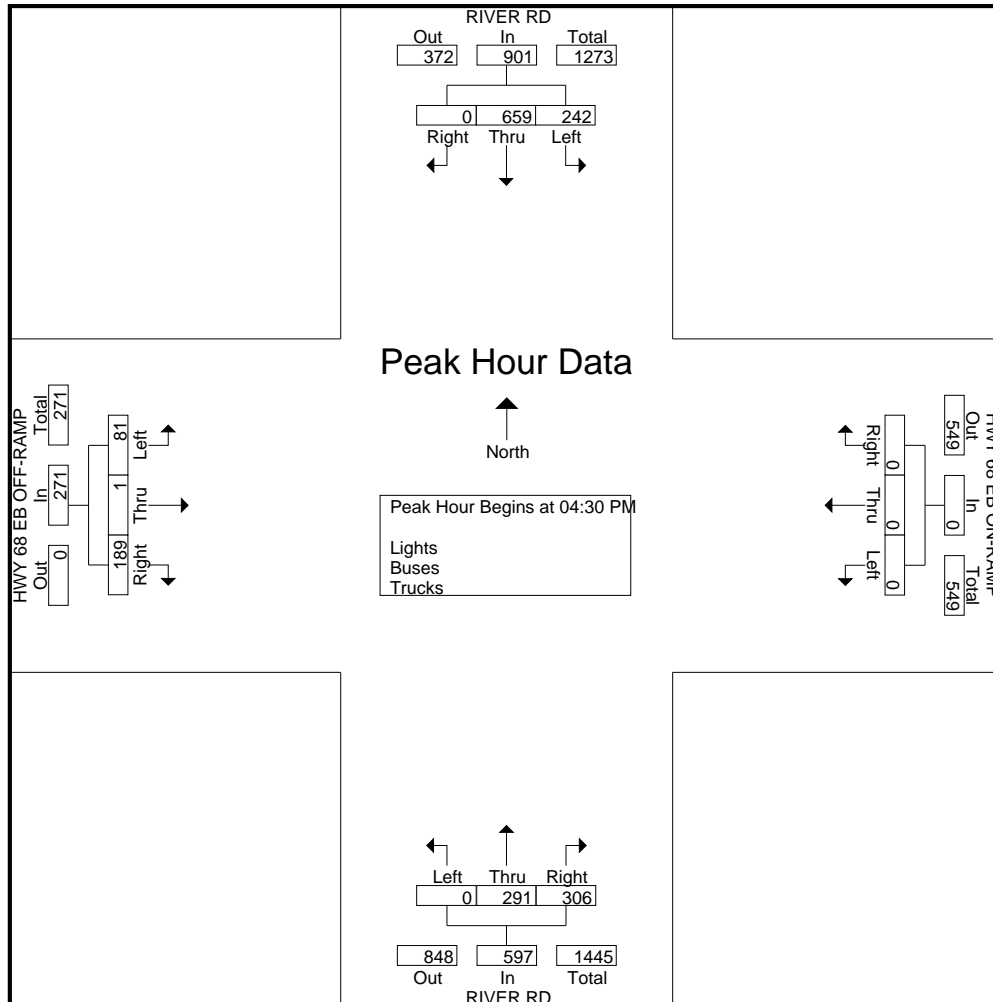

# Traffic Data Service

San Jose, CA  
 (408) 622-4787  
 tdsbay@cs.com

File Name : 25PM FINAL  
 Site Code : 00000025  
 Start Date : 4/25/2018  
 Page No : 1

Groups Printed- Bikes

| Start Time   | RIVER RD Southbound |      |      |      |            | HWY 68 EB ON-RAMP Westbound |      |      |      |            | RIVER RD Northbound |      |      |      |            | HWY 68 EB OFF-RAMP Eastbound |      |      |      |            | Int. Total |
|--------------|---------------------|------|------|------|------------|-----------------------------|------|------|------|------------|---------------------|------|------|------|------------|------------------------------|------|------|------|------------|------------|
|              | Right               | Thru | Left | Peds | App. Total | Right                       | Thru | Left | Peds | App. Total | Right               | Thru | Left | Peds | App. Total | Right                        | Thru | Left | Peds | App. Total |            |
| 04:00 PM     | 0                   | 0    | 0    | 0    | 0          | 0                           | 0    | 0    | 0    | 0          | 0                   | 0    | 0    | 0    | 0          | 0                            | 0    | 0    | 0    | 0          | 0          |
| 04:15 PM     | 0                   | 1    | 0    | 0    | 1          | 0                           | 0    | 0    | 0    | 0          | 0                   | 0    | 0    | 0    | 0          | 0                            | 0    | 0    | 0    | 0          | 0          |
| 04:30 PM     | 0                   | 0    | 0    | 0    | 0          | 0                           | 0    | 0    | 0    | 0          | 0                   | 0    | 0    | 0    | 0          | 0                            | 0    | 0    | 0    | 0          | 0          |
| 04:45 PM     | 0                   | 0    | 0    | 0    | 0          | 0                           | 0    | 0    | 0    | 0          | 0                   | 0    | 0    | 0    | 0          | 0                            | 0    | 0    | 0    | 0          | 0          |
| <b>Total</b> | 0                   | 1    | 0    | 0    | 1          | 0                           | 0    | 0    | 0    | 0          | 0                   | 0    | 0    | 0    | 0          | 0                            | 0    | 0    | 0    | 0          | 1          |
| 05:00 PM     | 0                   | 0    | 0    | 0    | 0          | 0                           | 0    | 0    | 0    | 0          | 0                   | 0    | 0    | 0    | 0          | 0                            | 0    | 0    | 0    | 0          | 0          |
| 05:15 PM     | 0                   | 0    | 1    | 0    | 1          | 0                           | 0    | 0    | 0    | 0          | 0                   | 0    | 0    | 0    | 0          | 0                            | 0    | 0    | 0    | 0          | 1          |
| 05:30 PM     | 0                   | 0    | 0    | 0    | 0          | 0                           | 0    | 0    | 0    | 0          | 0                   | 0    | 0    | 0    | 0          | 0                            | 0    | 0    | 0    | 0          | 0          |
| 05:45 PM     | 0                   | 0    | 0    | 0    | 0          | 0                           | 0    | 0    | 0    | 0          | 0                   | 0    | 0    | 0    | 0          | 0                            | 0    | 0    | 0    | 0          | 0          |
| <b>Total</b> | 0                   | 0    | 1    | 0    | 1          | 0                           | 0    | 0    | 0    | 0          | 0                   | 0    | 0    | 0    | 0          | 0                            | 0    | 0    | 0    | 0          | 1          |
| Grand Total  | 0                   | 1    | 1    | 0    | 2          | 0                           | 0    | 0    | 0    | 0          | 0                   | 0    | 0    | 0    | 0          | 0                            | 0    | 0    | 0    | 0          | 2          |
| Apprch %     | 0                   | 50   | 50   | 0    |            | 0                           | 0    | 0    | 0    |            | 0                   | 0    | 0    | 0    |            | 0                            | 0    | 0    | 0    |            |            |
| Total %      | 0                   | 50   | 50   | 0    | 100        | 0                           | 0    | 0    | 0    | 0          | 0                   | 0    | 0    | 0    | 0          | 0                            | 0    | 0    | 0    | 0          |            |

| Start Time   | RIVER RD Southbound |      |      |            | HWY 68 EB ON-RAMP Westbound |      |      |            | RIVER RD Northbound |      |      |            | HWY 68 EB OFF-RAMP Eastbound |      |      |            | Int. Total |
|--|---------------------|------|------|------------|-----------------------------|------|------|------------|---------------------|------|------|------------|------------------------------|------|------|------------|------------|
|  | Right               | Thru | Left | App. Total | Right                       | Thru | Left | App. Total | Right               | Thru | Left | App. Total | Right                        | Thru | Left | App. Total |            |
| Peak Hour Analysis From 04:00 PM to 05:45 PM - Peak 1 of 1 |                     |      |      |            |                             |      |      |            |                     |      |      |            |                              |      |      |            |            |
| Peak Hour for Entire Intersection Begins at 04:00 PM       |                     |      |      |            |                             |      |      |            |                     |      |      |            |                              |      |      |            |            |
| 04:00 PM   | 0                   | 0    | 0    | 0          | 0                           | 0    | 0    | 0          | 0                   | 0    | 0    | 0          | 0                            | 0    | 0    | 0          |            |
| 04:15 PM   | 0                   | 1    | 0    | 1          | 0                           | 0    | 0    | 0          | 0                   | 0    | 0    | 0          | 0                            | 0    | 0    | 0          |            |
| 04:30 PM   | 0                   | 0    | 0    | 0          | 0                           | 0    | 0    | 0          | 0                   | 0    | 0    | 0          | 0                            | 0    | 0    | 0          |            |
| 04:45 PM   | 0                   | 0    | 0    | 0          | 0                           | 0    | 0    | 0          | 0                   | 0    | 0    | 0          | 0                            | 0    | 0    | 0          |            |
| Total Volume   | 0                   | 1    | 0    | 1          | 0                           | 0    | 0    | 0          | 0                   | 0    | 0    | 0          | 0                            | 0    | 0    | 0          |            |
| % App. Total   | 0                   | 100  | 0    |            | 0                           | 0    | 0    |            | 0                   | 0    | 0    |            | 0                            | 0    | 0    |            |            |
| PHF  | .000                | .250 | .000 | .250       | .000                        | .000 | .000 | .000       | .000                | .000 | .000 | .000       | .000                         | .000 | .000 | .000       |            |

# Traffic Data Service

San Jose, CA  
(408) 622-4787  
tdsbay@cs.com

File Name : 25PM FINAL  
Site Code : 00000025  
Start Date : 4/25/2018  
Page No : 2

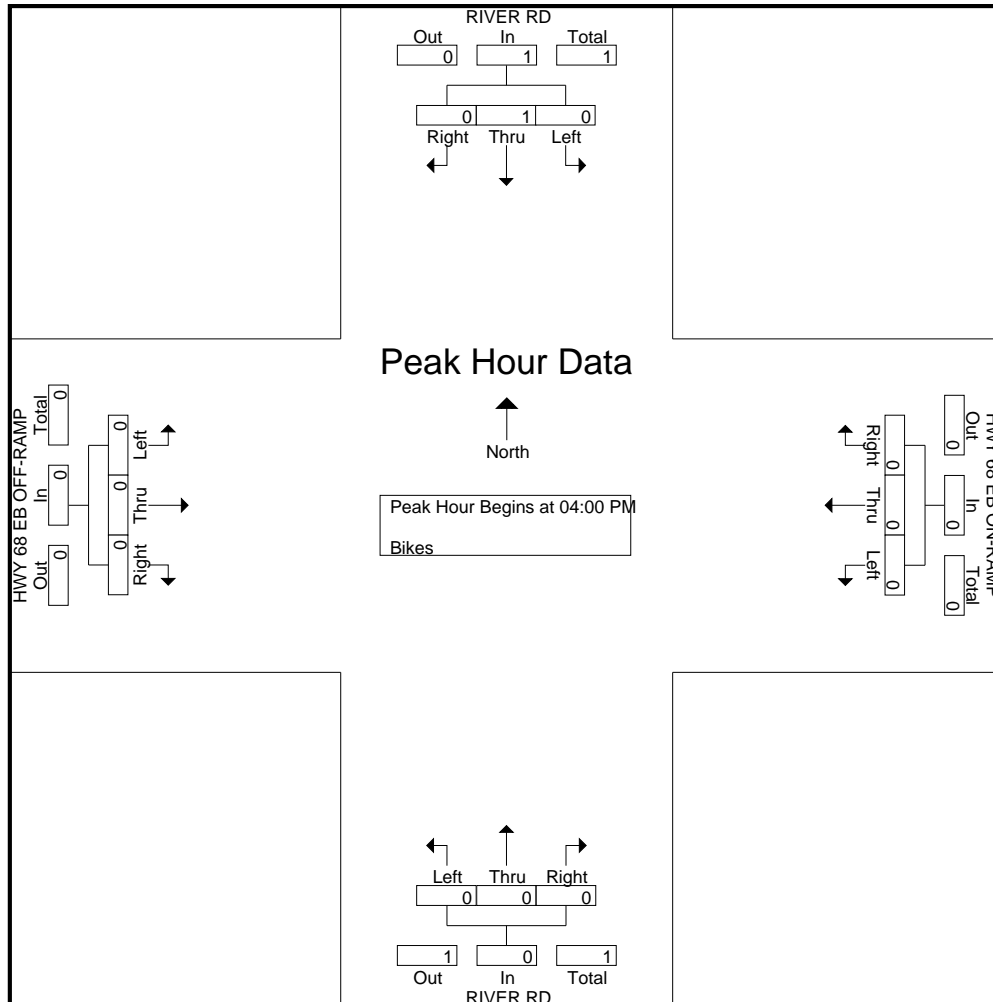



Study Name 101 - SB Cabrillo Hwy

Start Date 05/03/2017

Start Time 12:00 AM

Site Code 27

| Channel<br>Direction | Lights     | Buses | Trucks | Total |     |
|----------------------|------------|-------|--------|-------|-----|
|                      | Direction  |       |        |       |     |
|                      | Southbound |       |        |       |     |
| 12:00 AM             |            | 35    | 0      | 0     | 35  |
| 12:15 AM             |            | 26    | 0      | 0     | 26  |
| 12:30 AM             |            | 27    | 0      | 1     | 28  |
| 12:45 AM             |            | 25    | 0      | 0     | 25  |
| 1:00 AM              |            | 20    | 0      | 1     | 21  |
| 1:15 AM              |            | 12    | 0      | 2     | 14  |
| 1:30 AM              |            | 10    | 0      | 1     | 11  |
| 1:45 AM              |            | 14    | 0      | 0     | 14  |
| 2:00 AM              |            | 10    | 0      | 0     | 10  |
| 2:15 AM              |            | 10    | 0      | 0     | 10  |
| 2:30 AM              |            | 14    | 0      | 2     | 16  |
| 2:45 AM              |            | 19    | 0      | 0     | 19  |
| 3:00 AM              |            | 8     | 0      | 0     | 8   |
| 3:15 AM              |            | 12    | 0      | 1     | 13  |
| 3:30 AM              |            | 12    | 0      | 3     | 15  |
| 3:45 AM              |            | 21    | 0      | 2     | 23  |
| 4:00 AM              |            | 18    | 0      | 5     | 23  |
| 4:15 AM              |            | 39    | 0      | 4     | 43  |
| 4:30 AM              |            | 49    | 0      | 9     | 58  |
| 4:45 AM              |            | 51    | 0      | 8     | 59  |
| 5:00 AM              |            | 45    | 0      | 10    | 55  |
| 5:15 AM              |            | 89    | 0      | 12    | 101 |
| 5:30 AM              |            | 134   | 0      | 16    | 150 |
| 5:45 AM              |            | 180   | 0      | 32    | 212 |
| 6:00 AM              |            | 215   | 1      | 24    | 240 |
| 6:15 AM              |            | 309   | 1      | 20    | 330 |
| 6:30 AM              |            | 502   | 2      | 29    | 533 |
| 6:45 AM              |            | 584   | 1      | 22    | 607 |
| 7:00 AM              |            | 886   | 1      | 26    | 913 |
| 7:15 AM              |            | 687   | 1      | 33    | 721 |
| 7:30 AM              |            | 514   | 0      | 26    | 540 |
| 7:45 AM              |            | 517   | 0      | 21    | 538 |
| 8:00 AM              |            | 420   | 1      | 20    | 441 |

|          |     |   |    |     |
|----------|-----|---|----|-----|
| 8:15 AM  | 435 | 0 | 29 | 464 |
| 8:30 AM  | 469 | 3 | 30 | 502 |
| 8:45 AM  | 436 | 1 | 32 | 469 |
| 9:00 AM  | 375 | 1 | 27 | 403 |
| 9:15 AM  | 398 | 0 | 30 | 428 |
| 9:30 AM  | 448 | 3 | 24 | 475 |
| 9:45 AM  | 386 | 4 | 13 | 403 |
| 10:00 AM | 346 | 5 | 21 | 372 |
| 10:15 AM | 364 | 4 | 16 | 384 |
| 10:30 AM | 401 | 6 | 28 | 435 |
| 10:45 AM | 385 | 5 | 26 | 416 |
| 11:00 AM | 370 | 2 | 13 | 385 |
| 11:15 AM | 373 | 3 | 17 | 393 |
| 11:30 AM | 515 | 1 | 20 | 536 |
| 11:45 AM | 438 | 0 | 25 | 463 |
| 12:00 PM | 420 | 2 | 12 | 434 |
| 12:15 PM | 434 | 6 | 14 | 454 |
| 12:30 PM | 388 | 2 | 23 | 413 |
| 12:45 PM | 385 | 0 | 23 | 408 |
| 1:00 PM  | 399 | 1 | 20 | 420 |
| 1:15 PM  | 436 | 0 | 14 | 450 |
| 1:30 PM  | 412 | 1 | 10 | 423 |
| 1:45 PM  | 362 | 1 | 15 | 378 |
| 2:00 PM  | 403 | 2 | 11 | 416 |
| 2:15 PM  | 400 | 1 | 13 | 414 |
| 2:30 PM  | 384 | 2 | 5  | 391 |
| 2:45 PM  | 398 | 3 | 13 | 414 |
| 3:00 PM  | 350 | 2 | 10 | 362 |
| 3:15 PM  | 382 | 2 | 11 | 395 |
| 3:30 PM  | 378 | 2 | 20 | 400 |
| 3:45 PM  | 386 | 0 | 12 | 398 |
| 4:00 PM  | 364 | 1 | 6  | 371 |
| 4:15 PM  | 368 | 3 | 8  | 379 |
| 4:30 PM  | 335 | 1 | 9  | 345 |
| 4:45 PM  | 308 | 2 | 6  | 316 |
| 5:00 PM  | 345 | 0 | 1  | 346 |
| 5:15 PM  | 328 | 1 | 4  | 333 |
| 5:30 PM  | 372 | 0 | 2  | 374 |
| 5:45 PM  | 350 | 2 | 2  | 354 |
| 6:00 PM  | 339 | 0 | 4  | 343 |
| 6:15 PM  | 283 | 0 | 5  | 288 |
| 6:30 PM  | 342 | 0 | 3  | 345 |
| 6:45 PM  | 260 | 0 | 4  | 264 |
| 7:00 PM  | 247 | 0 | 1  | 248 |
| 7:15 PM  | 227 | 1 | 3  | 231 |
| 7:30 PM  | 202 | 0 | 0  | 202 |

|          |     |   |    |     |
|----------|-----|---|----|-----|
| 7:45 PM  | 211 | 0 | 0  | 211 |
| 8:00 PM  | 192 | 0 | 1  | 193 |
| 8:15 PM  | 175 | 0 | 2  | 177 |
| 8:30 PM  | 148 | 0 | 3  | 151 |
| 8:45 PM  | 129 | 0 | 1  | 130 |
| 9:00 PM  | 151 | 0 | 3  | 154 |
| 9:15 PM  | 163 | 0 | 0  | 163 |
| 9:30 PM  | 117 | 0 | 1  | 118 |
| 9:45 PM  | 140 | 0 | 1  | 141 |
| 10:00 PM | 94  | 0 | 0  | 94  |
| 10:15 PM | 93  | 0 | 2  | 95  |
| 10:30 PM | 88  | 1 | 0  | 89  |
| 10:45 PM | 94  | 0 | 0  | 94  |
| 11:00 PM | 79  | 0 | 2  | 81  |
| 11:15 PM | 68  | 0 | 0  | 68  |
| 11:30 PM | 57  | 0 | 1  | 58  |
| 11:45 PM | 45  | 0 | 0  | 45  |
| 12:00 AM | 34  | 0 | 0  | 34  |
| 12:15 AM | 29  | 0 | 0  | 29  |
| 12:30 AM | 13  | 0 | 1  | 14  |
| 12:45 AM | 29  | 0 | 1  | 30  |
| 1:00 AM  | 15  | 0 | 0  | 15  |
| 1:15 AM  | 13  | 0 | 3  | 16  |
| 1:30 AM  | 16  | 0 | 1  | 17  |
| 1:45 AM  | 10  | 0 | 1  | 11  |
| 2:00 AM  | 14  | 0 | 0  | 14  |
| 2:15 AM  | 16  | 0 | 0  | 16  |
| 2:30 AM  | 3   | 0 | 0  | 3   |
| 2:45 AM  | 8   | 0 | 1  | 9   |
| 3:00 AM  | 15  | 0 | 4  | 19  |
| 3:15 AM  | 13  | 0 | 4  | 17  |
| 3:30 AM  | 17  | 0 | 5  | 22  |
| 3:45 AM  | 21  | 0 | 3  | 24  |
| 4:00 AM  | 11  | 0 | 0  | 11  |
| 4:15 AM  | 36  | 0 | 7  | 43  |
| 4:30 AM  | 46  | 0 | 10 | 56  |
| 4:45 AM  | 43  | 0 | 6  | 49  |
| 5:00 AM  | 47  | 2 | 15 | 64  |
| 5:15 AM  | 83  | 2 | 7  | 92  |
| 5:30 AM  | 136 | 0 | 13 | 149 |
| 5:45 AM  | 183 | 0 | 19 | 202 |
| 6:00 AM  | 213 | 1 | 17 | 231 |
| 6:15 AM  | 308 | 0 | 23 | 331 |
| 6:30 AM  | 517 | 2 | 27 | 546 |
| 6:45 AM  | 616 | 1 | 37 | 654 |
| 7:00 AM  | 819 | 3 | 41 | 863 |

|          |     |   |    |     |
|----------|-----|---|----|-----|
| 7:15 AM  | 702 | 0 | 33 | 735 |
| 7:30 AM  | 546 | 0 | 31 | 577 |
| 7:45 AM  | 488 | 1 | 32 | 521 |
| 8:00 AM  | 479 | 0 | 24 | 503 |
| 8:15 AM  | 454 | 4 | 29 | 487 |
| 8:30 AM  | 473 | 0 | 28 | 501 |
| 8:45 AM  | 430 | 3 | 32 | 465 |
| 9:00 AM  | 437 | 3 | 21 | 461 |
| 9:15 AM  | 366 | 2 | 28 | 396 |
| 9:30 AM  | 472 | 2 | 33 | 507 |
| 9:45 AM  | 373 | 3 | 23 | 399 |
| 10:00 AM | 352 | 4 | 29 | 385 |
| 10:15 AM | 405 | 1 | 19 | 425 |
| 10:30 AM | 407 | 6 | 25 | 438 |
| 10:45 AM | 405 | 1 | 17 | 423 |
| 11:00 AM | 372 | 3 | 21 | 396 |
| 11:15 AM | 366 | 1 | 20 | 387 |
| 11:30 AM | 425 | 7 | 31 | 463 |
| 11:45 AM | 409 | 3 | 31 | 443 |
| 12:00 PM | 422 | 1 | 27 | 450 |
| 12:15 PM | 398 | 3 | 18 | 419 |
| 12:30 PM | 415 | 1 | 22 | 438 |
| 12:45 PM | 399 | 2 | 21 | 422 |
| 1:00 PM  | 372 | 1 | 15 | 388 |
| 1:15 PM  | 432 | 0 | 15 | 447 |
| 1:30 PM  | 456 | 0 | 13 | 469 |
| 1:45 PM  | 369 | 0 | 7  | 376 |
| 2:00 PM  | 386 | 1 | 17 | 404 |
| 2:15 PM  | 366 | 1 | 11 | 378 |
| 2:30 PM  | 436 | 2 | 13 | 451 |
| 2:45 PM  | 393 | 1 | 16 | 410 |
| 3:00 PM  | 367 | 1 | 10 | 378 |
| 3:15 PM  | 396 | 1 | 6  | 403 |
| 3:30 PM  | 396 | 0 | 11 | 407 |
| 3:45 PM  | 365 | 1 | 6  | 372 |
| 4:00 PM  | 283 | 2 | 6  | 291 |
| 4:15 PM  | 357 | 0 | 4  | 361 |
| 4:30 PM  | 336 | 2 | 4  | 342 |
| 4:45 PM  | 345 | 2 | 5  | 352 |
| 5:00 PM  | 371 | 0 | 4  | 375 |
| 5:15 PM  | 357 | 0 | 2  | 359 |
| 5:30 PM  | 350 | 0 | 6  | 356 |
| 5:45 PM  | 335 | 0 | 2  | 337 |
| 6:00 PM  | 346 | 0 | 5  | 351 |
| 6:15 PM  | 339 | 0 | 1  | 340 |
| 6:30 PM  | 315 | 2 | 2  | 319 |

|          |     |   |   |     |
|----------|-----|---|---|-----|
| 6:45 PM  | 295 | 0 | 5 | 300 |
| 7:00 PM  | 287 | 0 | 4 | 291 |
| 7:15 PM  | 246 | 2 | 2 | 250 |
| 7:30 PM  | 258 | 0 | 4 | 262 |
| 7:45 PM  | 215 | 1 | 2 | 218 |
| 8:00 PM  | 216 | 1 | 4 | 221 |
| 8:15 PM  | 194 | 0 | 1 | 195 |
| 8:30 PM  | 172 | 0 | 3 | 175 |
| 8:45 PM  | 161 | 0 | 4 | 165 |
| 9:00 PM  | 151 | 0 | 0 | 151 |
| 9:15 PM  | 137 | 0 | 0 | 137 |
| 9:30 PM  | 148 | 0 | 3 | 151 |
| 9:45 PM  | 131 | 1 | 0 | 132 |
| 10:00 PM | 105 | 0 | 1 | 106 |
| 10:15 PM | 88  | 0 | 3 | 91  |
| 10:30 PM | 94  | 0 | 1 | 95  |
| 10:45 PM | 73  | 0 | 1 | 74  |
| 11:00 PM | 56  | 1 | 1 | 58  |
| 11:15 PM | 56  | 1 | 1 | 58  |
| 11:30 PM | 48  | 0 | 1 | 49  |
| 11:45 PM | 47  | 0 | 0 | 47  |

Study Name 102 - SB 3006 CA-1

Start Date 05/03/2017

Start Time 12:00 AM

Site Code 28

| Channel<br>Direction | Lights     | Buses | Trucks | Total |      |
|----------------------|------------|-------|--------|-------|------|
|                      | Direction  |       |        |       |      |
|                      | Southbound |       |        |       |      |
| 12:00 AM             |            | 46    | 1      | 0     | 47   |
| 12:15 AM             |            | 34    | 0      | 1     | 35   |
| 12:30 AM             |            | 36    | 0      | 2     | 38   |
| 12:45 AM             |            | 38    | 0      | 0     | 38   |
| 1:00 AM              |            | 32    | 0      | 1     | 33   |
| 1:15 AM              |            | 17    | 0      | 2     | 19   |
| 1:30 AM              |            | 13    | 0      | 1     | 14   |
| 1:45 AM              |            | 20    | 0      | 2     | 22   |
| 2:00 AM              |            | 14    | 0      | 0     | 14   |
| 2:15 AM              |            | 15    | 0      | 0     | 15   |
| 2:30 AM              |            | 17    | 0      | 2     | 19   |
| 2:45 AM              |            | 23    | 0      | 3     | 26   |
| 3:00 AM              |            | 15    | 0      | 0     | 15   |
| 3:15 AM              |            | 15    | 0      | 2     | 17   |
| 3:30 AM              |            | 23    | 0      | 3     | 26   |
| 3:45 AM              |            | 34    | 0      | 1     | 35   |
| 4:00 AM              |            | 29    | 0      | 5     | 34   |
| 4:15 AM              |            | 48    | 0      | 7     | 55   |
| 4:30 AM              |            | 78    | 0      | 8     | 86   |
| 4:45 AM              |            | 78    | 0      | 12    | 90   |
| 5:00 AM              |            | 81    | 0      | 10    | 91   |
| 5:15 AM              |            | 137   | 0      | 14    | 151  |
| 5:30 AM              |            | 219   | 0      | 18    | 237  |
| 5:45 AM              |            | 257   | 0      | 29    | 286  |
| 6:00 AM              |            | 310   | 2      | 26    | 338  |
| 6:15 AM              |            | 443   | 2      | 26    | 471  |
| 6:30 AM              |            | 700   | 3      | 34    | 737  |
| 6:45 AM              |            | 822   | 3      | 39    | 864  |
| 7:00 AM              |            | 1211  | 4      | 29    | 1244 |
| 7:15 AM              |            | 1053  | 4      | 34    | 1091 |
| 7:30 AM              |            | 933   | 1      | 30    | 964  |
| 7:45 AM              |            | 775   | 2      | 29    | 806  |
| 8:00 AM              |            | 664   | 4      | 22    | 690  |

|          |     |    |    |     |
|----------|-----|----|----|-----|
| 8:15 AM  | 670 | 4  | 36 | 710 |
| 8:30 AM  | 694 | 12 | 35 | 741 |
| 8:45 AM  | 659 | 4  | 45 | 708 |
| 9:00 AM  | 554 | 2  | 26 | 582 |
| 9:15 AM  | 587 | 2  | 42 | 631 |
| 9:30 AM  | 658 | 3  | 29 | 690 |
| 9:45 AM  | 556 | 3  | 19 | 578 |
| 10:00 AM | 479 | 7  | 23 | 509 |
| 10:15 AM | 510 | 5  | 24 | 539 |
| 10:30 AM | 565 | 6  | 29 | 600 |
| 10:45 AM | 546 | 3  | 30 | 579 |
| 11:00 AM | 497 | 5  | 18 | 520 |
| 11:15 AM | 527 | 3  | 22 | 552 |
| 11:30 AM | 682 | 5  | 20 | 707 |
| 11:45 AM | 590 | 4  | 26 | 620 |
| 12:00 PM | 582 | 4  | 10 | 596 |
| 12:15 PM | 615 | 7  | 15 | 637 |
| 12:30 PM | 580 | 5  | 27 | 612 |
| 12:45 PM | 531 | 1  | 22 | 554 |
| 1:00 PM  | 590 | 3  | 24 | 617 |
| 1:15 PM  | 617 | 2  | 14 | 633 |
| 1:30 PM  | 616 | 3  | 11 | 630 |
| 1:45 PM  | 548 | 3  | 17 | 568 |
| 2:00 PM  | 547 | 3  | 18 | 568 |
| 2:15 PM  | 569 | 2  | 15 | 586 |
| 2:30 PM  | 558 | 7  | 10 | 575 |
| 2:45 PM  | 555 | 1  | 17 | 573 |
| 3:00 PM  | 525 | 3  | 14 | 542 |
| 3:15 PM  | 533 | 5  | 11 | 549 |
| 3:30 PM  | 549 | 2  | 19 | 570 |
| 3:45 PM  | 527 | 5  | 9  | 541 |
| 4:00 PM  | 552 | 5  | 12 | 569 |
| 4:15 PM  | 508 | 5  | 14 | 527 |
| 4:30 PM  | 515 | 2  | 10 | 527 |
| 4:45 PM  | 483 | 5  | 11 | 499 |
| 5:00 PM  | 501 | 4  | 0  | 505 |
| 5:15 PM  | 480 | 3  | 4  | 487 |
| 5:30 PM  | 557 | 1  | 4  | 562 |
| 5:45 PM  | 529 | 3  | 2  | 534 |
| 6:00 PM  | 476 | 0  | 4  | 480 |
| 6:15 PM  | 446 | 3  | 9  | 458 |
| 6:30 PM  | 469 | 2  | 5  | 476 |
| 6:45 PM  | 376 | 2  | 6  | 384 |
| 7:00 PM  | 376 | 0  | 1  | 377 |
| 7:15 PM  | 328 | 1  | 3  | 332 |
| 7:30 PM  | 314 | 0  | 1  | 315 |

|          |      |   |    |      |
|----------|------|---|----|------|
| 7:45 PM  | 311  | 1 | 0  | 312  |
| 8:00 PM  | 302  | 1 | 1  | 304  |
| 8:15 PM  | 256  | 0 | 4  | 260  |
| 8:30 PM  | 230  | 0 | 4  | 234  |
| 8:45 PM  | 221  | 0 | 6  | 227  |
| 9:00 PM  | 212  | 0 | 4  | 216  |
| 9:15 PM  | 211  | 0 | 1  | 212  |
| 9:30 PM  | 179  | 0 | 2  | 181  |
| 9:45 PM  | 194  | 0 | 3  | 197  |
| 10:00 PM | 145  | 0 | 0  | 145  |
| 10:15 PM | 146  | 0 | 2  | 148  |
| 10:30 PM | 128  | 0 | 0  | 128  |
| 10:45 PM | 178  | 0 | 0  | 178  |
| 11:00 PM | 118  | 0 | 3  | 121  |
| 11:15 PM | 89   | 0 | 3  | 92   |
| 11:30 PM | 70   | 0 | 1  | 71   |
| 11:45 PM | 62   | 0 | 1  | 63   |
| 12:00 AM | 55   | 0 | 0  | 55   |
| 12:15 AM | 38   | 0 | 0  | 38   |
| 12:30 AM | 22   | 0 | 1  | 23   |
| 12:45 AM | 42   | 0 | 1  | 43   |
| 1:00 AM  | 23   | 0 | 1  | 24   |
| 1:15 AM  | 19   | 0 | 3  | 22   |
| 1:30 AM  | 23   | 0 | 1  | 24   |
| 1:45 AM  | 16   | 0 | 1  | 17   |
| 2:00 AM  | 20   | 0 | 0  | 20   |
| 2:15 AM  | 21   | 0 | 0  | 21   |
| 2:30 AM  | 11   | 0 | 1  | 12   |
| 2:45 AM  | 11   | 0 | 1  | 12   |
| 3:00 AM  | 20   | 0 | 5  | 25   |
| 3:15 AM  | 21   | 0 | 5  | 26   |
| 3:30 AM  | 29   | 0 | 5  | 34   |
| 3:45 AM  | 37   | 0 | 4  | 41   |
| 4:00 AM  | 25   | 0 | 0  | 25   |
| 4:15 AM  | 57   | 0 | 8  | 65   |
| 4:30 AM  | 64   | 0 | 10 | 74   |
| 4:45 AM  | 64   | 0 | 6  | 70   |
| 5:00 AM  | 73   | 0 | 17 | 90   |
| 5:15 AM  | 134  | 0 | 9  | 143  |
| 5:30 AM  | 197  | 0 | 26 | 223  |
| 5:45 AM  | 271  | 0 | 34 | 305  |
| 6:00 AM  | 303  | 1 | 20 | 324  |
| 6:15 AM  | 432  | 3 | 22 | 457  |
| 6:30 AM  | 741  | 4 | 29 | 774  |
| 6:45 AM  | 912  | 5 | 40 | 957  |
| 7:00 AM  | 1219 | 8 | 44 | 1271 |



|          |      |    |    |      |
|----------|------|----|----|------|
| 7:15 AM  | 1054 | 1  | 37 | 1092 |
| 7:30 AM  | 744  | 2  | 34 | 780  |
| 7:45 AM  | 805  | 2  | 53 | 860  |
| 8:00 AM  | 679  | 2  | 31 | 712  |
| 8:15 AM  | 706  | 6  | 39 | 751  |
| 8:30 AM  | 721  | 7  | 37 | 765  |
| 8:45 AM  | 644  | 7  | 45 | 696  |
| 9:00 AM  | 598  | 3  | 27 | 628  |
| 9:15 AM  | 543  | 3  | 27 | 573  |
| 9:30 AM  | 606  | 7  | 33 | 646  |
| 9:45 AM  | 553  | 5  | 26 | 584  |
| 10:00 AM | 497  | 4  | 35 | 536  |
| 10:15 AM | 550  | 1  | 32 | 583  |
| 10:30 AM | 553  | 4  | 31 | 588  |
| 10:45 AM | 528  | 2  | 18 | 548  |
| 11:00 AM | 527  | 6  | 23 | 556  |
| 11:15 AM | 482  | 1  | 27 | 510  |
| 11:30 AM | 620  | 10 | 29 | 659  |
| 11:45 AM | 579  | 5  | 31 | 615  |
| 12:00 PM | 581  | 2  | 33 | 616  |
| 12:15 PM | 557  | 4  | 19 | 580  |
| 12:30 PM | 596  | 4  | 20 | 620  |
| 12:45 PM | 577  | 3  | 23 | 603  |
| 1:00 PM  | 523  | 1  | 19 | 543  |
| 1:15 PM  | 614  | 1  | 21 | 636  |
| 1:30 PM  | 616  | 1  | 15 | 632  |
| 1:45 PM  | 539  | 1  | 13 | 553  |
| 2:00 PM  | 581  | 2  | 18 | 601  |
| 2:15 PM  | 543  | 2  | 13 | 558  |
| 2:30 PM  | 619  | 5  | 17 | 641  |
| 2:45 PM  | 563  | 3  | 16 | 582  |
| 3:00 PM  | 529  | 3  | 9  | 541  |
| 3:15 PM  | 578  | 2  | 10 | 590  |
| 3:30 PM  | 587  | 3  | 9  | 599  |
| 3:45 PM  | 556  | 7  | 6  | 569  |
| 4:00 PM  | 450  | 6  | 8  | 464  |
| 4:15 PM  | 513  | 2  | 3  | 518  |
| 4:30 PM  | 522  | 3  | 4  | 529  |
| 4:45 PM  | 533  | 2  | 6  | 541  |
| 5:00 PM  | 515  | 3  | 5  | 523  |
| 5:15 PM  | 518  | 1  | 2  | 521  |
| 5:30 PM  | 530  | 0  | 7  | 537  |
| 5:45 PM  | 499  | 3  | 3  | 505  |
| 6:00 PM  | 502  | 0  | 4  | 506  |
| 6:15 PM  | 466  | 0  | 2  | 468  |
| 6:30 PM  | 458  | 2  | 2  | 462  |

|          |     |   |   |     |
|----------|-----|---|---|-----|
| 6:45 PM  | 436 | 1 | 6 | 443 |
| 7:00 PM  | 401 | 0 | 4 | 405 |
| 7:15 PM  | 346 | 4 | 2 | 352 |
| 7:30 PM  | 373 | 0 | 3 | 376 |
| 7:45 PM  | 340 | 3 | 4 | 347 |
| 8:00 PM  | 310 | 1 | 5 | 316 |
| 8:15 PM  | 304 | 0 | 2 | 306 |
| 8:30 PM  | 249 | 0 | 4 | 253 |
| 8:45 PM  | 234 | 0 | 6 | 240 |
| 9:00 PM  | 234 | 0 | 1 | 235 |
| 9:15 PM  | 194 | 0 | 0 | 194 |
| 9:30 PM  | 217 | 0 | 3 | 220 |
| 9:45 PM  | 173 | 1 | 1 | 175 |
| 10:00 PM | 158 | 0 | 3 | 161 |
| 10:15 PM | 144 | 0 | 2 | 146 |
| 10:30 PM | 174 | 0 | 2 | 176 |
| 10:45 PM | 120 | 0 | 1 | 121 |
| 11:00 PM | 80  | 1 | 1 | 82  |
| 11:15 PM | 91  | 0 | 1 | 92  |
| 11:30 PM | 69  | 0 | 2 | 71  |
| 11:45 PM | 63  | 0 | 1 | 64  |

Study Name 103 - SB Cabrillo Hwy  
 Start Date 05/03/2017  
 Start Time 12:00 AM  
 Site Code 29

| Channel<br>Direction | Lights     | Buses | Trucks | Total |      |
|----------------------|------------|-------|--------|-------|------|
|                      | Direction  |       |        |       |      |
|                      | Southbound |       |        |       |      |
| 12:00 AM             |            | 58    | 0      | 3     | 61   |
| 12:15 AM             |            | 39    | 0      | 1     | 40   |
| 12:30 AM             |            | 43    | 0      | 1     | 44   |
| 12:45 AM             |            | 37    | 0      | 1     | 38   |
| 1:00 AM              |            | 28    | 0      | 1     | 29   |
| 1:15 AM              |            | 25    | 0      | 1     | 26   |
| 1:30 AM              |            | 16    | 0      | 2     | 18   |
| 1:45 AM              |            | 20    | 0      | 2     | 22   |
| 2:00 AM              |            | 21    | 0      | 1     | 22   |
| 2:15 AM              |            | 16    | 0      | 1     | 17   |
| 2:30 AM              |            | 23    | 0      | 2     | 25   |
| 2:45 AM              |            | 24    | 0      | 1     | 25   |
| 3:00 AM              |            | 20    | 0      | 0     | 20   |
| 3:15 AM              |            | 22    | 0      | 1     | 23   |
| 3:30 AM              |            | 43    | 0      | 3     | 46   |
| 3:45 AM              |            | 49    | 0      | 0     | 49   |
| 4:00 AM              |            | 36    | 0      | 7     | 43   |
| 4:15 AM              |            | 67    | 0      | 6     | 73   |
| 4:30 AM              |            | 112   | 0      | 11    | 123  |
| 4:45 AM              |            | 143   | 0      | 12    | 155  |
| 5:00 AM              |            | 101   | 0      | 13    | 114  |
| 5:15 AM              |            | 142   | 0      | 12    | 154  |
| 5:30 AM              |            | 267   | 1      | 18    | 286  |
| 5:45 AM              |            | 360   | 0      | 24    | 384  |
| 6:00 AM              |            | 366   | 3      | 29    | 398  |
| 6:15 AM              |            | 569   | 3      | 27    | 599  |
| 6:30 AM              |            | 886   | 4      | 26    | 916  |
| 6:45 AM              |            | 1082  | 3      | 22    | 1107 |
| 7:00 AM              |            | 1308  | 4      | 36    | 1348 |
| 7:15 AM              |            | 1026  | 5      | 30    | 1061 |
| 7:30 AM              |            | 1013  | 3      | 46    | 1062 |
| 7:45 AM              |            | 893   | 3      | 35    | 931  |
| 8:00 AM              |            | 934   | 5      | 40    | 979  |

|          |     |    |    |     |
|----------|-----|----|----|-----|
| 8:15 AM  | 812 | 4  | 36 | 852 |
| 8:30 AM  | 883 | 12 | 40 | 935 |
| 8:45 AM  | 836 | 5  | 45 | 886 |
| 9:00 AM  | 713 | 2  | 39 | 754 |
| 9:15 AM  | 749 | 4  | 41 | 794 |
| 9:30 AM  | 755 | 4  | 32 | 791 |
| 9:45 AM  | 690 | 3  | 18 | 711 |
| 10:00 AM | 598 | 8  | 24 | 630 |
| 10:15 AM | 640 | 6  | 31 | 677 |
| 10:30 AM | 680 | 6  | 34 | 720 |
| 10:45 AM | 706 | 2  | 28 | 736 |
| 11:00 AM | 622 | 6  | 23 | 651 |
| 11:15 AM | 666 | 4  | 26 | 696 |
| 11:30 AM | 789 | 4  | 17 | 810 |
| 11:45 AM | 700 | 4  | 28 | 732 |
| 12:00 PM | 718 | 5  | 16 | 739 |
| 12:15 PM | 778 | 8  | 21 | 807 |
| 12:30 PM | 735 | 6  | 29 | 770 |
| 12:45 PM | 660 | 3  | 20 | 683 |
| 1:00 PM  | 724 | 3  | 32 | 759 |
| 1:15 PM  | 735 | 4  | 16 | 755 |
| 1:30 PM  | 742 | 3  | 10 | 755 |
| 1:45 PM  | 707 | 2  | 17 | 726 |
| 2:00 PM  | 687 | 2  | 15 | 704 |
| 2:15 PM  | 679 | 2  | 13 | 694 |
| 2:30 PM  | 717 | 8  | 11 | 736 |
| 2:45 PM  | 701 | 7  | 15 | 723 |
| 3:00 PM  | 648 | 1  | 15 | 664 |
| 3:15 PM  | 680 | 6  | 16 | 702 |
| 3:30 PM  | 704 | 2  | 21 | 727 |
| 3:45 PM  | 685 | 5  | 11 | 701 |
| 4:00 PM  | 702 | 3  | 16 | 721 |
| 4:15 PM  | 696 | 5  | 16 | 717 |
| 4:30 PM  | 690 | 2  | 5  | 697 |
| 4:45 PM  | 686 | 4  | 13 | 703 |
| 5:00 PM  | 658 | 1  | 10 | 669 |
| 5:15 PM  | 674 | 2  | 4  | 680 |
| 5:30 PM  | 771 | 1  | 8  | 780 |
| 5:45 PM  | 671 | 6  | 5  | 682 |
| 6:00 PM  | 612 | 0  | 4  | 616 |
| 6:15 PM  | 581 | 1  | 8  | 590 |
| 6:30 PM  | 572 | 1  | 9  | 582 |
| 6:45 PM  | 489 | 1  | 6  | 496 |
| 7:00 PM  | 450 | 0  | 1  | 451 |
| 7:15 PM  | 419 | 0  | 4  | 423 |
| 7:30 PM  | 409 | 1  | 1  | 411 |

|          |      |    |    |      |
|----------|------|----|----|------|
| 7:45 PM  | 377  | 1  | 1  | 379  |
| 8:00 PM  | 375  | 3  | 3  | 381  |
| 8:15 PM  | 324  | 0  | 3  | 327  |
| 8:30 PM  | 287  | 0  | 4  | 291  |
| 8:45 PM  | 237  | 0  | 5  | 242  |
| 9:00 PM  | 246  | 0  | 4  | 250  |
| 9:15 PM  | 206  | 0  | 2  | 208  |
| 9:30 PM  | 209  | 0  | 1  | 210  |
| 9:45 PM  | 202  | 0  | 3  | 205  |
| 10:00 PM | 169  | 0  | 1  | 170  |
| 10:15 PM | 167  | 0  | 2  | 169  |
| 10:30 PM | 150  | 0  | 0  | 150  |
| 10:45 PM | 174  | 0  | 1  | 175  |
| 11:00 PM | 116  | 0  | 3  | 119  |
| 11:15 PM | 92   | 0  | 2  | 94   |
| 11:30 PM | 76   | 0  | 1  | 77   |
| 11:45 PM | 53   | 0  | 0  | 53   |
| 12:00 AM | 56   | 0  | 0  | 56   |
| 12:15 AM | 44   | 0  | 0  | 44   |
| 12:30 AM | 27   | 1  | 0  | 28   |
| 12:45 AM | 47   | 1  | 0  | 48   |
| 1:00 AM  | 26   | 0  | 1  | 27   |
| 1:15 AM  | 23   | 0  | 2  | 25   |
| 1:30 AM  | 24   | 0  | 1  | 25   |
| 1:45 AM  | 21   | 0  | 1  | 22   |
| 2:00 AM  | 17   | 0  | 0  | 17   |
| 2:15 AM  | 25   | 0  | 0  | 25   |
| 2:30 AM  | 17   | 0  | 1  | 18   |
| 2:45 AM  | 12   | 0  | 1  | 13   |
| 3:00 AM  | 26   | 0  | 4  | 30   |
| 3:15 AM  | 24   | 0  | 6  | 30   |
| 3:30 AM  | 40   | 0  | 4  | 44   |
| 3:45 AM  | 51   | 0  | 2  | 53   |
| 4:00 AM  | 27   | 1  | 1  | 29   |
| 4:15 AM  | 63   | 1  | 7  | 71   |
| 4:30 AM  | 108  | 0  | 12 | 120  |
| 4:45 AM  | 118  | 0  | 7  | 125  |
| 5:00 AM  | 88   | 0  | 17 | 105  |
| 5:15 AM  | 142  | 0  | 9  | 151  |
| 5:30 AM  | 258  | 0  | 29 | 287  |
| 5:45 AM  | 343  | 0  | 28 | 371  |
| 6:00 AM  | 370  | 3  | 20 | 393  |
| 6:15 AM  | 562  | 4  | 25 | 591  |
| 6:30 AM  | 877  | 3  | 31 | 911  |
| 6:45 AM  | 1058 | 4  | 37 | 1099 |
| 7:00 AM  | 1350 | 10 | 35 | 1395 |

|          |      |   |    |      |
|----------|------|---|----|------|
| 7:15 AM  | 1116 | 4 | 27 | 1147 |
| 7:30 AM  | 1002 | 4 | 24 | 1030 |
| 7:45 AM  | 1090 | 2 | 52 | 1144 |
| 8:00 AM  | 836  | 3 | 31 | 870  |
| 8:15 AM  | 792  | 7 | 80 | 879  |
| 8:30 AM  | 871  | 8 | 35 | 914  |
| 8:45 AM  | 866  | 7 | 50 | 923  |
| 9:00 AM  | 772  | 4 | 33 | 809  |
| 9:15 AM  | 730  | 2 | 25 | 757  |
| 9:30 AM  | 732  | 9 | 40 | 781  |
| 9:45 AM  | 735  | 5 | 25 | 765  |
| 10:00 AM | 603  | 3 | 28 | 634  |
| 10:15 AM | 668  | 4 | 23 | 695  |
| 10:30 AM | 685  | 4 | 37 | 726  |
| 10:45 AM | 708  | 4 | 21 | 733  |
| 11:00 AM | 661  | 4 | 30 | 695  |
| 11:15 AM | 584  | 4 | 23 | 611  |
| 11:30 AM | 713  | 7 | 27 | 747  |
| 11:45 AM | 672  | 7 | 32 | 711  |
| 12:00 PM | 709  | 1 | 37 | 747  |
| 12:15 PM | 685  | 4 | 27 | 716  |
| 12:30 PM | 732  | 4 | 20 | 756  |
| 12:45 PM | 690  | 4 | 25 | 719  |
| 1:00 PM  | 609  | 2 | 20 | 631  |
| 1:15 PM  | 701  | 2 | 17 | 720  |
| 1:30 PM  | 750  | 0 | 16 | 766  |
| 1:45 PM  | 630  | 3 | 20 | 653  |
| 2:00 PM  | 688  | 2 | 17 | 707  |
| 2:15 PM  | 715  | 3 | 15 | 733  |
| 2:30 PM  | 783  | 5 | 17 | 805  |
| 2:45 PM  | 699  | 6 | 16 | 721  |
| 3:00 PM  | 679  | 2 | 13 | 694  |
| 3:15 PM  | 691  | 4 | 9  | 704  |
| 3:30 PM  | 732  | 2 | 18 | 752  |
| 3:45 PM  | 714  | 9 | 8  | 731  |
| 4:00 PM  | 611  | 4 | 9  | 624  |
| 4:15 PM  | 655  | 5 | 4  | 664  |
| 4:30 PM  | 657  | 5 | 6  | 668  |
| 4:45 PM  | 709  | 2 | 5  | 716  |
| 5:00 PM  | 705  | 0 | 8  | 713  |
| 5:15 PM  | 732  | 1 | 4  | 737  |
| 5:30 PM  | 710  | 1 | 6  | 717  |
| 5:45 PM  | 652  | 4 | 4  | 660  |
| 6:00 PM  | 650  | 0 | 7  | 657  |
| 6:15 PM  | 609  | 0 | 3  | 612  |
| 6:30 PM  | 583  | 3 | 3  | 589  |

|          |     |   |   |     |
|----------|-----|---|---|-----|
| 6:45 PM  | 531 | 2 | 8 | 541 |
| 7:00 PM  | 470 | 0 | 3 | 473 |
| 7:15 PM  | 460 | 2 | 3 | 465 |
| 7:30 PM  | 423 | 0 | 3 | 426 |
| 7:45 PM  | 370 | 3 | 4 | 377 |
| 8:00 PM  | 365 | 1 | 3 | 369 |
| 8:15 PM  | 373 | 0 | 3 | 376 |
| 8:30 PM  | 296 | 0 | 2 | 298 |
| 8:45 PM  | 291 | 0 | 4 | 295 |
| 9:00 PM  | 295 | 0 | 0 | 295 |
| 9:15 PM  | 235 | 0 | 3 | 238 |
| 9:30 PM  | 240 | 0 | 3 | 243 |
| 9:45 PM  | 213 | 0 | 2 | 215 |
| 10:00 PM | 171 | 0 | 1 | 172 |
| 10:15 PM | 169 | 0 | 2 | 171 |
| 10:30 PM | 185 | 0 | 3 | 188 |
| 10:45 PM | 127 | 0 | 3 | 130 |
| 11:00 PM | 105 | 0 | 4 | 109 |
| 11:15 PM | 110 | 0 | 3 | 113 |
| 11:30 PM | 80  | 0 | 2 | 82  |
| 11:45 PM | 73  | 0 | 1 | 74  |

Study Name 104 SB Cabrillo Hwy  
 Start Date 05/03/2017  
 Start Time 12:00 AM  
 Site Code 30

| Channel<br>Direction | Lights    | Buses | Trucks | Total |      |
|----------------------|-----------|-------|--------|-------|------|
|                      | Direction |       |        |       |      |
| 12:00 AM             |           | 58    | 0      | 1     | 59   |
| 12:15 AM             |           | 40    | 0      | 0     | 40   |
| 12:30 AM             |           | 47    | 0      | 3     | 50   |
| 12:45 AM             |           | 39    | 0      | 1     | 40   |
| 1:00 AM              |           | 30    | 0      | 1     | 31   |
| 1:15 AM              |           | 24    | 0      | 2     | 26   |
| 1:30 AM              |           | 26    | 0      | 2     | 28   |
| 1:45 AM              |           | 18    | 0      | 2     | 20   |
| 2:00 AM              |           | 24    | 0      | 1     | 25   |
| 2:15 AM              |           | 14    | 0      | 1     | 15   |
| 2:30 AM              |           | 20    | 0      | 2     | 22   |
| 2:45 AM              |           | 24    | 0      | 2     | 26   |
| 3:00 AM              |           | 20    | 0      | 0     | 20   |
| 3:15 AM              |           | 20    | 0      | 0     | 20   |
| 3:30 AM              |           | 46    | 0      | 0     | 46   |
| 3:45 AM              |           | 49    | 0      | 0     | 49   |
| 4:00 AM              |           | 37    | 0      | 7     | 44   |
| 4:15 AM              |           | 66    | 0      | 7     | 73   |
| 4:30 AM              |           | 113   | 0      | 13    | 126  |
| 4:45 AM              |           | 138   | 0      | 13    | 151  |
| 5:00 AM              |           | 102   | 5      | 0     | 107  |
| 5:15 AM              |           | 136   | 7      | 5     | 148  |
| 5:30 AM              |           | 216   | 7      | 15    | 238  |
| 5:45 AM              |           | 358   | 6      | 24    | 388  |
| 6:00 AM              |           | 344   | 5      | 27    | 376  |
| 6:15 AM              |           | 548   | 6      | 27    | 581  |
| 6:30 AM              |           | 846   | 6      | 25    | 877  |
| 6:45 AM              |           | 1108  | 5      | 23    | 1136 |
| 7:00 AM              |           | 1386  | 6      | 33    | 1425 |
| 7:15 AM              |           | 1150  | 5      | 20    | 1175 |
| 7:30 AM              |           | 1003  | 5      | 37    | 1045 |
| 7:45 AM              |           | 1043  | 2      | 43    | 1088 |
| 8:00 AM              |           | 976   | 6      | 50    | 1032 |



|          |     |    |    |      |
|----------|-----|----|----|------|
| 8:15 AM  | 998 | 3  | 56 | 1057 |
| 8:30 AM  | 877 | 11 | 49 | 937  |
| 8:45 AM  | 827 | 6  | 39 | 872  |
| 9:00 AM  | 745 | 3  | 36 | 784  |
| 9:15 AM  | 766 | 6  | 31 | 803  |
| 9:30 AM  | 719 | 4  | 33 | 756  |
| 9:45 AM  | 732 | 8  | 15 | 755  |
| 10:00 AM | 605 | 8  | 25 | 638  |
| 10:15 AM | 667 | 11 | 29 | 707  |
| 10:30 AM | 690 | 5  | 35 | 730  |
| 10:45 AM | 749 | 4  | 30 | 783  |
| 11:00 AM | 659 | 5  | 21 | 685  |
| 11:15 AM | 646 | 7  | 20 | 673  |
| 11:30 AM | 774 | 2  | 21 | 797  |
| 11:45 AM | 763 | 4  | 27 | 794  |
| 12:00 PM | 763 | 4  | 16 | 783  |
| 12:15 PM | 826 | 10 | 21 | 857  |
| 12:30 PM | 791 | 4  | 21 | 816  |
| 12:45 PM | 686 | 2  | 23 | 711  |
| 1:00 PM  | 752 | 3  | 27 | 782  |
| 1:15 PM  | 751 | 3  | 25 | 779  |
| 1:30 PM  | 792 | 2  | 12 | 806  |
| 1:45 PM  | 730 | 4  | 15 | 749  |
| 2:00 PM  | 734 | 3  | 17 | 754  |
| 2:15 PM  | 729 | 8  | 14 | 751  |
| 2:30 PM  | 721 | 9  | 13 | 743  |
| 2:45 PM  | 725 | 8  | 15 | 748  |
| 3:00 PM  | 693 | 2  | 17 | 712  |
| 3:15 PM  | 750 | 6  | 19 | 775  |
| 3:30 PM  | 740 | 4  | 17 | 761  |
| 3:45 PM  | 744 | 4  | 17 | 765  |
| 4:00 PM  | 798 | 2  | 13 | 813  |
| 4:15 PM  | 750 | 3  | 10 | 763  |
| 4:30 PM  | 773 | 1  | 3  | 777  |
| 4:45 PM  | 818 | 1  | 8  | 827  |
| 5:00 PM  | 749 | 1  | 9  | 759  |
| 5:15 PM  | 731 | 3  | 8  | 742  |
| 5:30 PM  | 801 | 0  | 7  | 808  |
| 5:45 PM  | 756 | 4  | 4  | 764  |
| 6:00 PM  | 658 | 1  | 4  | 663  |
| 6:15 PM  | 621 | 2  | 5  | 628  |
| 6:30 PM  | 594 | 1  | 8  | 603  |
| 6:45 PM  | 549 | 1  | 5  | 555  |
| 7:00 PM  | 505 | 0  | 2  | 507  |
| 7:15 PM  | 461 | 2  | 4  | 467  |
| 7:30 PM  | 425 | 1  | 1  | 427  |

|          |      |   |    |      |
|----------|------|---|----|------|
| 7:45 PM  | 440  | 0 | 0  | 440  |
| 8:00 PM  | 392  | 4 | 2  | 398  |
| 8:15 PM  | 357  | 0 | 2  | 359  |
| 8:30 PM  | 325  | 0 | 4  | 329  |
| 8:45 PM  | 245  | 0 | 5  | 250  |
| 9:00 PM  | 259  | 0 | 3  | 262  |
| 9:15 PM  | 213  | 0 | 3  | 216  |
| 9:30 PM  | 246  | 0 | 3  | 249  |
| 9:45 PM  | 213  | 0 | 2  | 215  |
| 10:00 PM | 198  | 0 | 1  | 199  |
| 10:15 PM | 166  | 1 | 1  | 168  |
| 10:30 PM | 182  | 1 | 2  | 185  |
| 10:45 PM | 172  | 1 | 1  | 174  |
| 11:00 PM | 110  | 1 | 1  | 112  |
| 11:15 PM | 95   | 1 | 2  | 98   |
| 11:30 PM | 87   | 0 | 1  | 88   |
| 11:45 PM | 66   | 0 | 0  | 66   |
| 12:00 AM | 49   | 0 | 0  | 49   |
| 12:15 AM | 52   | 0 | 0  | 52   |
| 12:30 AM | 25   | 0 | 1  | 26   |
| 12:45 AM | 44   | 0 | 1  | 45   |
| 1:00 AM  | 33   | 0 | 1  | 34   |
| 1:15 AM  | 22   | 0 | 2  | 24   |
| 1:30 AM  | 27   | 0 | 1  | 28   |
| 1:45 AM  | 19   | 0 | 2  | 21   |
| 2:00 AM  | 21   | 0 | 0  | 21   |
| 2:15 AM  | 21   | 0 | 1  | 22   |
| 2:30 AM  | 16   | 0 | 1  | 17   |
| 2:45 AM  | 10   | 0 | 0  | 10   |
| 3:00 AM  | 25   | 0 | 3  | 28   |
| 3:15 AM  | 23   | 0 | 7  | 30   |
| 3:30 AM  | 38   | 0 | 5  | 43   |
| 3:45 AM  | 54   | 0 | 3  | 57   |
| 4:00 AM  | 27   | 0 | 2  | 29   |
| 4:15 AM  | 48   | 0 | 8  | 56   |
| 4:30 AM  | 109  | 0 | 13 | 122  |
| 4:45 AM  | 114  | 0 | 8  | 122  |
| 5:00 AM  | 93   | 1 | 12 | 106  |
| 5:15 AM  | 154  | 1 | 8  | 163  |
| 5:30 AM  | 248  | 6 | 22 | 276  |
| 5:45 AM  | 331  | 3 | 27 | 361  |
| 6:00 AM  | 375  | 7 | 24 | 406  |
| 6:15 AM  | 531  | 4 | 20 | 555  |
| 6:30 AM  | 850  | 5 | 34 | 889  |
| 6:45 AM  | 1042 | 8 | 31 | 1081 |
| 7:00 AM  | 1304 | 5 | 39 | 1348 |

|          |      |    |    |      |
|----------|------|----|----|------|
| 7:15 AM  | 1083 | 6  | 30 | 1119 |
| 7:30 AM  | 1197 | 4  | 27 | 1228 |
| 7:45 AM  | 1086 | 2  | 38 | 1126 |
| 8:00 AM  | 963  | 2  | 51 | 1016 |
| 8:15 AM  | 982  | 8  | 51 | 1041 |
| 8:30 AM  | 866  | 6  | 33 | 905  |
| 8:45 AM  | 880  | 5  | 37 | 922  |
| 9:00 AM  | 761  | 6  | 40 | 807  |
| 9:15 AM  | 714  | 1  | 29 | 744  |
| 9:30 AM  | 673  | 8  | 44 | 725  |
| 9:45 AM  | 761  | 7  | 32 | 800  |
| 10:00 AM | 597  | 4  | 26 | 627  |
| 10:15 AM | 674  | 10 | 20 | 704  |
| 10:30 AM | 703  | 5  | 31 | 739  |
| 10:45 AM | 777  | 5  | 25 | 807  |
| 11:00 AM | 675  | 3  | 27 | 705  |
| 11:15 AM | 613  | 4  | 26 | 643  |
| 11:30 AM | 739  | 3  | 23 | 765  |
| 11:45 AM | 770  | 10 | 33 | 813  |
| 12:00 PM | 815  | 0  | 28 | 843  |
| 12:15 PM | 784  | 4  | 22 | 810  |
| 12:30 PM | 745  | 4  | 18 | 767  |
| 12:45 PM | 702  | 3  | 18 | 723  |
| 1:00 PM  | 634  | 1  | 24 | 659  |
| 1:15 PM  | 724  | 4  | 22 | 750  |
| 1:30 PM  | 785  | 0  | 22 | 807  |
| 1:45 PM  | 700  | 1  | 25 | 726  |
| 2:00 PM  | 716  | 2  | 20 | 738  |
| 2:15 PM  | 731  | 7  | 15 | 753  |
| 2:30 PM  | 792  | 7  | 14 | 813  |
| 2:45 PM  | 731  | 8  | 17 | 756  |
| 3:00 PM  | 765  | 3  | 17 | 785  |
| 3:15 PM  | 758  | 4  | 8  | 770  |
| 3:30 PM  | 780  | 4  | 15 | 799  |
| 3:45 PM  | 782  | 10 | 10 | 802  |
| 4:00 PM  | 684  | 7  | 7  | 698  |
| 4:15 PM  | 701  | 6  | 2  | 709  |
| 4:30 PM  | 729  | 4  | 3  | 736  |
| 4:45 PM  | 811  | 1  | 5  | 817  |
| 5:00 PM  | 813  | 3  | 9  | 825  |
| 5:15 PM  | 790  | 4  | 3  | 797  |
| 5:30 PM  | 769  | 1  | 7  | 777  |
| 5:45 PM  | 704  | 3  | 2  | 709  |
| 6:00 PM  | 710  | 0  | 4  | 714  |
| 6:15 PM  | 617  | 1  | 7  | 625  |
| 6:30 PM  | 614  | 1  | 2  | 617  |

|          |     |   |   |     |
|----------|-----|---|---|-----|
| 6:45 PM  | 536 | 0 | 6 | 542 |
| 7:00 PM  | 539 | 1 | 4 | 544 |
| 7:15 PM  | 457 | 3 | 5 | 465 |
| 7:30 PM  | 460 | 0 | 3 | 463 |
| 7:45 PM  | 396 | 1 | 3 | 400 |
| 8:00 PM  | 385 | 2 | 6 | 393 |
| 8:15 PM  | 384 | 0 | 3 | 387 |
| 8:30 PM  | 355 | 0 | 2 | 357 |
| 8:45 PM  | 385 | 0 | 4 | 389 |
| 9:00 PM  | 259 | 0 | 3 | 262 |
| 9:15 PM  | 269 | 0 | 0 | 269 |
| 9:30 PM  | 239 | 0 | 2 | 241 |
| 9:45 PM  | 223 | 0 | 3 | 226 |
| 10:00 PM | 192 | 0 | 2 | 194 |
| 10:15 PM | 192 | 1 | 3 | 196 |
| 10:30 PM | 188 | 1 | 2 | 191 |
| 10:45 PM | 123 | 0 | 3 | 126 |
| 11:00 PM | 102 | 0 | 8 | 110 |
| 11:15 PM | 95  | 1 | 3 | 99  |
| 11:30 PM | 80  | 0 | 5 | 85  |
| 11:45 PM | 69  | 0 | 2 | 71  |

Study Name 105 SB Cabrillo Hwy  
 Start Date 05/03/2017  
 Start Time 12:00 AM  
 Site Code 31

| Channel<br>Direction | lights     | buses | trucks | Total |      |
|----------------------|------------|-------|--------|-------|------|
|                      | Direction  |       |        |       |      |
|                      | Southbound |       |        |       |      |
| 12:00 AM             |            | 51    | 0      | 0     | 51   |
| 12:15 AM             |            | 35    | 0      | 0     | 35   |
| 12:30 AM             |            | 33    | 0      | 0     | 33   |
| 12:45 AM             |            | 36    | 0      | 0     | 36   |
| 1:00 AM              |            | 24    | 0      | 0     | 24   |
| 1:15 AM              |            | 21    | 0      | 1     | 22   |
| 1:30 AM              |            | 22    | 0      | 2     | 24   |
| 1:45 AM              |            | 14    | 0      | 2     | 16   |
| 2:00 AM              |            | 15    | 0      | 1     | 16   |
| 2:15 AM              |            | 10    | 0      | 1     | 11   |
| 2:30 AM              |            | 16    | 0      | 1     | 17   |
| 2:45 AM              |            | 19    | 0      | 1     | 20   |
| 3:00 AM              |            | 20    | 0      | 1     | 21   |
| 3:15 AM              |            | 14    | 0      | 1     | 15   |
| 3:30 AM              |            | 32    | 0      | 4     | 36   |
| 3:45 AM              |            | 32    | 0      | 1     | 33   |
| 4:00 AM              |            | 29    | 0      | 3     | 32   |
| 4:15 AM              |            | 56    | 2      | 6     | 64   |
| 4:30 AM              |            | 118   | 0      | 10    | 128  |
| 4:45 AM              |            | 128   | 0      | 10    | 138  |
| 5:00 AM              |            | 106   | 0      | 4     | 110  |
| 5:15 AM              |            | 144   | 0      | 9     | 153  |
| 5:30 AM              |            | 233   | 4      | 16    | 253  |
| 5:45 AM              |            | 332   | 3      | 19    | 354  |
| 6:00 AM              |            | 316   | 2      | 21    | 339  |
| 6:15 AM              |            | 492   | 4      | 23    | 519  |
| 6:30 AM              |            | 764   | 3      | 22    | 789  |
| 6:45 AM              |            | 990   | 3      | 19    | 1012 |
| 7:00 AM              |            | 990   | 4      | 18    | 1012 |
| 7:15 AM              |            | 972   | 2      | 18    | 992  |
| 7:30 AM              |            | 916   | 2      | 28    | 946  |
| 7:45 AM              |            | 871   | 1      | 21    | 893  |
| 8:00 AM              |            | 799   | 3      | 47    | 849  |

|          |     |    |    |     |
|----------|-----|----|----|-----|
| 8:15 AM  | 875 | 1  | 43 | 919 |
| 8:30 AM  | 802 | 8  | 43 | 853 |
| 8:45 AM  | 784 | 4  | 33 | 821 |
| 9:00 AM  | 676 | 4  | 32 | 712 |
| 9:15 AM  | 666 | 3  | 30 | 699 |
| 9:30 AM  | 668 | 3  | 39 | 710 |
| 9:45 AM  | 644 | 6  | 11 | 661 |
| 10:00 AM | 528 | 7  | 21 | 556 |
| 10:15 AM | 582 | 10 | 25 | 617 |
| 10:30 AM | 628 | 5  | 22 | 655 |
| 10:45 AM | 678 | 1  | 18 | 697 |
| 11:00 AM | 567 | 5  | 16 | 588 |
| 11:15 AM | 573 | 4  | 19 | 596 |
| 11:30 AM | 703 | 3  | 16 | 722 |
| 11:45 AM | 676 | 6  | 25 | 707 |
| 12:00 PM | 618 | 2  | 16 | 636 |
| 12:15 PM | 720 | 6  | 14 | 740 |
| 12:30 PM | 669 | 4  | 16 | 689 |
| 12:45 PM | 604 | 2  | 23 | 629 |
| 1:00 PM  | 617 | 0  | 20 | 637 |
| 1:15 PM  | 647 | 5  | 26 | 678 |
| 1:30 PM  | 660 | 2  | 14 | 676 |
| 1:45 PM  | 678 | 2  | 11 | 691 |
| 2:00 PM  | 661 | 2  | 8  | 671 |
| 2:15 PM  | 636 | 5  | 13 | 654 |
| 2:30 PM  | 652 | 5  | 10 | 667 |
| 2:45 PM  | 624 | 9  | 14 | 647 |
| 3:00 PM  | 604 | 4  | 10 | 618 |
| 3:15 PM  | 649 | 4  | 13 | 666 |
| 3:30 PM  | 613 | 5  | 8  | 626 |
| 3:45 PM  | 623 | 4  | 14 | 641 |
| 4:00 PM  | 612 | 4  | 10 | 626 |
| 4:15 PM  | 652 | 3  | 10 | 665 |
| 4:30 PM  | 646 | 3  | 4  | 653 |
| 4:45 PM  | 669 | 3  | 13 | 685 |
| 5:00 PM  | 588 | 3  | 3  | 594 |
| 5:15 PM  | 582 | 1  | 5  | 588 |
| 5:30 PM  | 639 | 1  | 4  | 644 |
| 5:45 PM  | 621 | 1  | 2  | 624 |
| 6:00 PM  | 550 | 4  | 3  | 557 |
| 6:15 PM  | 529 | 0  | 4  | 533 |
| 6:30 PM  | 495 | 0  | 2  | 497 |
| 6:45 PM  | 448 | 1  | 6  | 455 |
| 7:00 PM  | 413 | 1  | 0  | 414 |
| 7:15 PM  | 404 | 0  | 3  | 407 |
| 7:30 PM  | 346 | 1  | 0  | 347 |

|          |      |   |    |      |
|----------|------|---|----|------|
| 7:45 PM  | 336  | 0 | 0  | 336  |
| 8:00 PM  | 313  | 4 | 1  | 318  |
| 8:15 PM  | 281  | 0 | 1  | 282  |
| 8:30 PM  | 268  | 0 | 3  | 271  |
| 8:45 PM  | 231  | 0 | 3  | 234  |
| 9:00 PM  | 224  | 0 | 2  | 226  |
| 9:15 PM  | 208  | 0 | 3  | 211  |
| 9:30 PM  | 196  | 0 | 2  | 198  |
| 9:45 PM  | 191  | 0 | 1  | 192  |
| 10:00 PM | 177  | 0 | 1  | 178  |
| 10:15 PM | 143  | 0 | 1  | 144  |
| 10:30 PM | 141  | 0 | 1  | 142  |
| 10:45 PM | 126  | 0 | 0  | 126  |
| 11:00 PM | 106  | 0 | 1  | 107  |
| 11:15 PM | 72   | 0 | 0  | 72   |
| 11:30 PM | 76   | 0 | 0  | 76   |
| 11:45 PM | 47   | 0 | 0  | 47   |
| 12:00 AM | 42   | 0 | 0  | 42   |
| 12:15 AM | 46   | 0 | 0  | 46   |
| 12:30 AM | 25   | 0 | 1  | 26   |
| 12:45 AM | 37   | 0 | 0  | 37   |
| 1:00 AM  | 24   | 0 | 1  | 25   |
| 1:15 AM  | 20   | 0 | 1  | 21   |
| 1:30 AM  | 24   | 0 | 1  | 25   |
| 1:45 AM  | 10   | 0 | 1  | 11   |
| 2:00 AM  | 13   | 0 | 0  | 13   |
| 2:15 AM  | 17   | 0 | 0  | 17   |
| 2:30 AM  | 15   | 0 | 1  | 16   |
| 2:45 AM  | 11   | 0 | 0  | 11   |
| 3:00 AM  | 17   | 0 | 3  | 20   |
| 3:15 AM  | 16   | 0 | 6  | 22   |
| 3:30 AM  | 28   | 0 | 2  | 30   |
| 3:45 AM  | 31   | 0 | 4  | 35   |
| 4:00 AM  | 27   | 0 | 2  | 29   |
| 4:15 AM  | 50   | 3 | 3  | 56   |
| 4:30 AM  | 114  | 0 | 11 | 125  |
| 4:45 AM  | 116  | 0 | 6  | 122  |
| 5:00 AM  | 92   | 0 | 7  | 99   |
| 5:15 AM  | 142  | 0 | 5  | 147  |
| 5:30 AM  | 229  | 3 | 17 | 249  |
| 5:45 AM  | 309  | 4 | 15 | 328  |
| 6:00 AM  | 343  | 3 | 21 | 367  |
| 6:15 AM  | 476  | 4 | 13 | 493  |
| 6:30 AM  | 829  | 2 | 30 | 861  |
| 6:45 AM  | 900  | 4 | 29 | 933  |
| 7:00 AM  | 1009 | 5 | 29 | 1043 |

|          |      |   |    |      |
|----------|------|---|----|------|
| 7:15 AM  | 981  | 4 | 24 | 1009 |
| 7:30 AM  | 1053 | 1 | 22 | 1076 |
| 7:45 AM  | 852  | 1 | 41 | 894  |
| 8:00 AM  | 859  | 1 | 41 | 901  |
| 8:15 AM  | 872  | 5 | 38 | 915  |
| 8:30 AM  | 790  | 3 | 39 | 832  |
| 8:45 AM  | 827  | 4 | 27 | 858  |
| 9:00 AM  | 677  | 4 | 25 | 706  |
| 9:15 AM  | 647  | 1 | 26 | 674  |
| 9:30 AM  | 641  | 6 | 31 | 678  |
| 9:45 AM  | 665  | 8 | 22 | 695  |
| 10:00 AM | 515  | 4 | 26 | 545  |
| 10:15 AM | 612  | 9 | 23 | 644  |
| 10:30 AM | 600  | 4 | 25 | 629  |
| 10:45 AM | 665  | 3 | 21 | 689  |
| 11:00 AM | 609  | 4 | 20 | 633  |
| 11:15 AM | 526  | 2 | 17 | 545  |
| 11:30 AM | 628  | 2 | 24 | 654  |
| 11:45 AM | 672  | 7 | 26 | 705  |
| 12:00 PM | 692  | 0 | 25 | 717  |
| 12:15 PM | 610  | 0 | 16 | 626  |
| 12:30 PM | 688  | 5 | 16 | 709  |
| 12:45 PM | 614  | 1 | 19 | 634  |
| 1:00 PM  | 552  | 1 | 19 | 572  |
| 1:15 PM  | 648  | 2 | 18 | 668  |
| 1:30 PM  | 725  | 0 | 16 | 741  |
| 1:45 PM  | 602  | 0 | 16 | 618  |
| 2:00 PM  | 612  | 2 | 20 | 634  |
| 2:15 PM  | 630  | 3 | 10 | 643  |
| 2:30 PM  | 703  | 5 | 10 | 718  |
| 2:45 PM  | 657  | 6 | 17 | 680  |
| 3:00 PM  | 624  | 3 | 14 | 641  |
| 3:15 PM  | 643  | 2 | 8  | 653  |
| 3:30 PM  | 690  | 3 | 8  | 701  |
| 3:45 PM  | 652  | 9 | 10 | 671  |
| 4:00 PM  | 569  | 7 | 8  | 584  |
| 4:15 PM  | 596  | 6 | 2  | 604  |
| 4:30 PM  | 620  | 4 | 3  | 627  |
| 4:45 PM  | 300  | 3 | 0  | 303  |



Study Name 101 NB Cabrillo Hwy  
 Start Date 05/03/2017  
 Start Time 12:00 AM  
 Site Code 36

| Channel        | lights     | buses      | trucks   | Total     |            |
|----------------|------------|------------|----------|-----------|------------|
| Direction      | Direction  |            |          |           |            |
|                | Northbound |            |          |           |            |
| 12:00 AM       |            | 37         | 0        | 2         | 39         |
| 12:15 AM       |            | 26         | 0        | 0         | 26         |
| 12:30 AM       |            | 18         | 0        | 1         | 19         |
| 12:45 AM       |            | 23         | 0        | 1         | 24         |
| 1:00 AM        |            | 16         | 0        | 1         | 17         |
| 1:15 AM        |            | 16         | 0        | 1         | 17         |
| 1:30 AM        |            | 15         | 0        | 4         | 19         |
| 1:45 AM        |            | 16         | 0        | 4         | 20         |
| 2:00 AM        |            | 9          | 0        | 0         | 9          |
| 2:15 AM        |            | 15         | 0        | 1         | 16         |
| 2:30 AM        |            | 7          | 0        | 1         | 8          |
| 2:45 AM        |            | 16         | 0        | 1         | 17         |
| 3:00 AM        |            | 11         | 0        | 1         | 12         |
| 3:15 AM        |            | 18         | 0        | 0         | 18         |
| 3:30 AM        |            | 19         | 1        | 0         | 20         |
| 3:45 AM        |            | 42         | 0        | 0         | 42         |
| 4:00 AM        |            | 26         | 0        | 2         | 28         |
| 4:15 AM        |            | 33         | 0        | 2         | 35         |
| 4:30 AM        |            | 36         | 0        | 2         | 38         |
| 4:45 AM        |            | 54         | 0        | 4         | 58         |
| 5:00 AM        |            | 59         | 0        | 7         | 66         |
| 5:15 AM        |            | 85         | 0        | 6         | 91         |
| 5:30 AM        |            | 99         | 0        | 6         | 105        |
| 5:45 AM        |            | 121        | 0        | 10        | 131        |
| 6:00 AM        |            | 139        | 2        | 6         | 147        |
| 6:15 AM        |            | 165        | 0        | 8         | 173        |
| 6:30 AM        |            | 174        | 0        | 6         | 180        |
| 6:45 AM        |            | 194        | 3        | 7         | 204        |
| 7:00 AM        |            | 205        | 4        | 11        | 220        |
| 7:15 AM        |            | 255        | 0        | 11        | 266        |
| <b>7:30 AM</b> |            | <b>262</b> | <b>1</b> | <b>11</b> | <b>274</b> |
| 7:45 AM        |            | 302        | 0        | 13        | 315        |
| 8:00 AM        |            | 271        | 0        | 17        | 288        |

|          |     |   |    |     |
|----------|-----|---|----|-----|
| 8:15 AM  | 250 | 2 | 21 | 273 |
| 8:30 AM  | 203 | 0 | 20 | 223 |
| 8:45 AM  | 241 | 2 | 19 | 262 |
| 9:00 AM  | 233 | 2 | 26 | 261 |
| 9:15 AM  | 288 | 0 | 26 | 314 |
| 9:30 AM  | 245 | 1 | 18 | 264 |
| 9:45 AM  | 294 | 0 | 31 | 325 |
| 10:00 AM | 278 | 1 | 36 | 315 |
| 10:15 AM | 290 | 1 | 25 | 316 |
| 10:30 AM | 282 | 1 | 23 | 306 |
| 10:45 AM | 301 | 0 | 21 | 322 |
| 11:00 AM | 294 | 0 | 27 | 321 |
| 11:15 AM | 301 | 1 | 27 | 329 |
| 11:30 AM | 355 | 1 | 28 | 384 |
| 11:45 AM | 263 | 0 | 23 | 286 |
| 12:00 PM | 303 | 1 | 20 | 324 |
| 12:15 PM | 328 | 0 | 21 | 349 |
| 12:30 PM | 335 | 0 | 25 | 360 |
| 12:45 PM | 494 | 2 | 37 | 533 |
| 1:00 PM  | 434 | 3 | 26 | 463 |
| 1:15 PM  | 388 | 6 | 24 | 418 |
| 1:30 PM  | 388 | 2 | 26 | 416 |
| 1:45 PM  | 384 | 1 | 21 | 406 |
| 2:00 PM  | 417 | 5 | 35 | 457 |
| 2:15 PM  | 453 | 3 | 33 | 489 |
| 2:30 PM  | 419 | 1 | 29 | 449 |
| 2:45 PM  | 483 | 2 | 25 | 510 |
| 3:00 PM  | 506 | 5 | 26 | 537 |
| 3:15 PM  | 549 | 1 | 29 | 579 |
| 3:30 PM  | 643 | 3 | 25 | 671 |
| 3:45 PM  | 593 | 1 | 17 | 611 |
| 4:00 PM  | 620 | 3 | 22 | 645 |
| 4:15 PM  | 654 | 0 | 16 | 670 |
| 4:30 PM  | 611 | 1 | 15 | 627 |
| 4:45 PM  | 637 | 2 | 13 | 652 |
| 5:00 PM  | 689 | 1 | 11 | 701 |
| 5:15 PM  | 659 | 1 | 13 | 673 |
| 5:30 PM  | 628 | 1 | 16 | 645 |
| 5:45 PM  | 621 | 2 | 10 | 633 |
| 6:00 PM  | 516 | 2 | 12 | 530 |
| 6:15 PM  | 489 | 7 | 8  | 504 |
| 6:30 PM  | 408 | 0 | 11 | 419 |
| 6:45 PM  | 395 | 0 | 7  | 402 |
| 7:00 PM  | 332 | 1 | 4  | 337 |
| 7:15 PM  | 319 | 0 | 1  | 320 |
| 7:30 PM  | 314 | 1 | 5  | 320 |

|          |     |   |    |     |
|----------|-----|---|----|-----|
| 7:45 PM  | 297 | 0 | 7  | 304 |
| 8:00 PM  | 273 | 0 | 5  | 278 |
| 8:15 PM  | 285 | 0 | 1  | 286 |
| 8:30 PM  | 253 | 0 | 0  | 253 |
| 8:45 PM  | 239 | 0 | 5  | 244 |
| 9:00 PM  | 237 | 0 | 4  | 241 |
| 9:15 PM  | 188 | 0 | 4  | 192 |
| 9:30 PM  | 149 | 1 | 4  | 154 |
| 9:45 PM  | 144 | 0 | 1  | 145 |
| 10:00 PM | 141 | 0 | 0  | 141 |
| 10:15 PM | 112 | 1 | 0  | 113 |
| 10:30 PM | 84  | 0 | 0  | 84  |
| 10:45 PM | 66  | 0 | 1  | 67  |
| 11:00 PM | 68  | 0 | 2  | 70  |
| 11:15 PM | 56  | 0 | 2  | 58  |
| 11:30 PM | 30  | 0 | 1  | 31  |
| 11:45 PM | 34  | 0 | 2  | 36  |
| 12:00 AM | 39  | 0 | 1  | 40  |
| 12:15 AM | 30  | 0 | 1  | 31  |
| 12:30 AM | 18  | 0 | 2  | 20  |
| 12:45 AM | 34  | 0 | 0  | 34  |
| 1:00 AM  | 16  | 0 | 1  | 17  |
| 1:15 AM  | 14  | 0 | 4  | 18  |
| 1:30 AM  | 12  | 0 | 0  | 12  |
| 1:45 AM  | 16  | 0 | 2  | 18  |
| 2:00 AM  | 9   | 0 | 0  | 9   |
| 2:15 AM  | 17  | 0 | 2  | 19  |
| 2:30 AM  | 18  | 0 | 0  | 18  |
| 2:45 AM  | 17  | 0 | 1  | 18  |
| 3:00 AM  | 20  | 0 | 1  | 21  |
| 3:15 AM  | 19  | 0 | 0  | 19  |
| 3:30 AM  | 9   | 0 | 3  | 12  |
| 3:45 AM  | 22  | 0 | 2  | 24  |
| 4:00 AM  | 31  | 0 | 5  | 36  |
| 4:15 AM  | 42  | 0 | 3  | 45  |
| 4:30 AM  | 48  | 0 | 0  | 48  |
| 4:45 AM  | 52  | 0 | 3  | 55  |
| 5:00 AM  | 48  | 0 | 4  | 52  |
| 5:15 AM  | 68  | 0 | 4  | 72  |
| 5:30 AM  | 87  | 0 | 3  | 90  |
| 5:45 AM  | 113 | 0 | 4  | 117 |
| 6:00 AM  | 130 | 0 | 7  | 137 |
| 6:15 AM  | 171 | 1 | 10 | 182 |
| 6:30 AM  | 175 | 0 | 11 | 186 |
| 6:45 AM  | 152 | 0 | 10 | 162 |
| 7:00 AM  | 216 | 3 | 11 | 230 |

|          |     |   |    |     |
|----------|-----|---|----|-----|
| 7:15 AM  | 230 | 2 | 19 | 251 |
| 7:30 AM  | 272 | 1 | 18 | 291 |
| 7:45 AM  | 273 | 0 | 15 | 288 |
| 8:00 AM  | 265 | 1 | 22 | 288 |
| 8:15 AM  | 298 | 2 | 25 | 325 |
| 8:30 AM  | 261 | 0 | 18 | 279 |
| 8:45 AM  | 267 | 1 | 23 | 291 |
| 9:00 AM  | 267 | 1 | 36 | 304 |
| 9:15 AM  | 284 | 0 | 24 | 308 |
| 9:30 AM  | 291 | 1 | 29 | 321 |
| 9:45 AM  | 296 | 0 | 29 | 325 |
| 10:00 AM | 290 | 2 | 24 | 316 |
| 10:15 AM | 287 | 0 | 27 | 314 |
| 10:30 AM | 310 | 1 | 28 | 339 |
| 10:45 AM | 328 | 0 | 20 | 348 |
| 11:00 AM | 341 | 1 | 24 | 366 |
| 11:15 AM | 307 | 1 | 21 | 329 |
| 11:30 AM | 327 | 2 | 23 | 352 |
| 11:45 AM | 324 | 1 | 18 | 343 |
| 12:00 PM | 327 | 1 | 34 | 362 |
| 12:15 PM | 340 | 2 | 33 | 375 |
| 12:30 PM | 378 | 1 | 30 | 409 |
| 12:45 PM | 332 | 0 | 29 | 361 |
| 1:00 PM  | 274 | 1 | 26 | 301 |
| 1:15 PM  | 374 | 5 | 37 | 416 |
| 1:30 PM  | 399 | 0 | 31 | 430 |
| 1:45 PM  | 365 | 1 | 26 | 392 |
| 2:00 PM  | 393 | 1 | 25 | 419 |
| 2:15 PM  | 439 | 2 | 35 | 476 |
| 2:30 PM  | 443 | 3 | 35 | 481 |
| 2:45 PM  | 471 | 0 | 24 | 495 |
| 3:00 PM  | 504 | 7 | 24 | 535 |
| 3:15 PM  | 554 | 5 | 23 | 582 |
| 3:30 PM  | 657 | 3 | 22 | 682 |
| 3:45 PM  | 613 | 2 | 23 | 638 |
| 4:00 PM  | 593 | 2 | 22 | 617 |
| 4:15 PM  | 577 | 1 | 25 | 603 |
| 4:30 PM  | 620 | 1 | 15 | 636 |
| 4:45 PM  | 628 | 1 | 21 | 650 |
| 5:00 PM  | 639 | 0 | 12 | 651 |
| 5:15 PM  | 677 | 4 | 8  | 689 |
| 5:30 PM  | 670 | 2 | 9  | 681 |
| 5:45 PM  | 578 | 3 | 8  | 589 |
| 6:00 PM  | 606 | 0 | 7  | 613 |
| 6:15 PM  | 457 | 0 | 9  | 466 |
| 6:30 PM  | 374 | 1 | 7  | 382 |

|          |     |   |   |     |
|----------|-----|---|---|-----|
| 6:45 PM  | 351 | 0 | 4 | 355 |
| 7:00 PM  | 289 | 1 | 5 | 295 |
| 7:15 PM  | 291 | 0 | 6 | 297 |
| 7:30 PM  | 282 | 1 | 2 | 285 |
| 7:45 PM  | 280 | 0 | 2 | 282 |
| 8:00 PM  | 233 | 0 | 1 | 234 |
| 8:15 PM  | 245 | 0 | 4 | 249 |
| 8:30 PM  | 206 | 0 | 1 | 207 |
| 8:45 PM  | 210 | 0 | 0 | 210 |
| 9:00 PM  | 184 | 0 | 1 | 185 |
| 9:15 PM  | 204 | 0 | 4 | 208 |
| 9:30 PM  | 169 | 0 | 3 | 172 |
| 9:45 PM  | 151 | 0 | 2 | 153 |
| 10:00 PM | 142 | 0 | 1 | 143 |
| 10:15 PM | 142 | 0 | 0 | 142 |
| 10:30 PM | 76  | 0 | 0 | 76  |
| 10:45 PM | 87  | 0 | 0 | 87  |
| 11:00 PM | 70  | 0 | 1 | 71  |
| 11:15 PM | 70  | 0 | 1 | 71  |
| 11:30 PM | 47  | 0 | 0 | 47  |
| 11:45 PM | 55  | 0 | 1 | 56  |

Study Name 102 NB 3006 CA-1  
 Start Date 05/03/2017  
 Start Time 12:00 AM  
 Site Code 37

| Channel<br>Direction | lights     | buses | trucks | Total |     |
|----------------------|------------|-------|--------|-------|-----|
|                      | Direction  |       |        |       |     |
|                      | Northbound |       |        |       |     |
| 12:00 AM             |            | 70    | 0      | 0     | 70  |
| 12:15 AM             |            | 51    | 1      | 0     | 52  |
| 12:30 AM             |            | 37    | 0      | 2     | 39  |
| 12:45 AM             |            | 39    | 0      | 1     | 40  |
| 1:00 AM              |            | 21    | 0      | 3     | 24  |
| 1:15 AM              |            | 29    | 0      | 0     | 29  |
| 1:30 AM              |            | 31    | 0      | 1     | 32  |
| 1:45 AM              |            | 31    | 0      | 3     | 34  |
| 2:00 AM              |            | 19    | 0      | 1     | 20  |
| 2:15 AM              |            | 20    | 0      | 1     | 21  |
| 2:30 AM              |            | 11    | 0      | 2     | 13  |
| 2:45 AM              |            | 17    | 0      | 1     | 18  |
| 3:00 AM              |            | 15    | 0      | 2     | 17  |
| 3:15 AM              |            | 23    | 0      | 1     | 24  |
| 3:30 AM              |            | 28    | 0      | 2     | 30  |
| 3:45 AM              |            | 39    | 1      | 0     | 40  |
| 4:00 AM              |            | 37    | 0      | 2     | 39  |
| 4:15 AM              |            | 39    | 0      | 0     | 39  |
| 4:30 AM              |            | 50    | 0      | 1     | 51  |
| 4:45 AM              |            | 55    | 0      | 2     | 57  |
| 5:00 AM              |            | 72    | 0      | 7     | 79  |
| 5:15 AM              |            | 91    | 2      | 5     | 98  |
| 5:30 AM              |            | 112   | 0      | 8     | 120 |
| 5:45 AM              |            | 144   | 1      | 9     | 154 |
| 6:00 AM              |            | 170   | 2      | 6     | 178 |
| 6:15 AM              |            | 209   | 3      | 8     | 220 |
| 6:30 AM              |            | 210   | 5      | 7     | 222 |
| 6:45 AM              |            | 245   | 2      | 9     | 256 |
| 7:00 AM              |            | 269   | 5      | 12    | 286 |
| 7:15 AM              |            | 326   | 1      | 10    | 337 |
| 7:30 AM              |            | 381   | 4      | 13    | 398 |
| 7:45 AM              |            | 425   | 0      | 10    | 435 |
| 8:00 AM              |            | 432   | 5      | 23    | 460 |

|          |      |   |    |      |
|----------|------|---|----|------|
| 8:15 AM  | 349  | 7 | 23 | 379  |
| 8:30 AM  | 322  | 2 | 20 | 344  |
| 8:45 AM  | 328  | 5 | 21 | 354  |
| 9:00 AM  | 355  | 2 | 26 | 383  |
| 9:15 AM  | 388  | 1 | 32 | 421  |
| 9:30 AM  | 347  | 1 | 24 | 372  |
| 9:45 AM  | 387  | 1 | 34 | 422  |
| 10:00 AM | 407  | 1 | 40 | 448  |
| 10:15 AM | 407  | 1 | 19 | 427  |
| 10:30 AM | 420  | 0 | 30 | 450  |
| 10:45 AM | 431  | 1 | 21 | 453  |
| 11:00 AM | 457  | 2 | 28 | 487  |
| 11:15 AM | 478  | 6 | 29 | 513  |
| 11:30 AM | 515  | 1 | 31 | 547  |
| 11:45 AM | 459  | 2 | 23 | 484  |
| 12:00 PM | 493  | 3 | 27 | 523  |
| 12:15 PM | 512  | 3 | 24 | 539  |
| 12:30 PM | 529  | 2 | 31 | 562  |
| 12:45 PM | 721  | 7 | 38 | 766  |
| 1:00 PM  | 634  | 3 | 34 | 671  |
| 1:15 PM  | 618  | 6 | 24 | 648  |
| 1:30 PM  | 577  | 5 | 29 | 611  |
| 1:45 PM  | 575  | 3 | 24 | 602  |
| 2:00 PM  | 636  | 6 | 41 | 683  |
| 2:15 PM  | 687  | 7 | 36 | 730  |
| 2:30 PM  | 627  | 4 | 32 | 663  |
| 2:45 PM  | 698  | 1 | 28 | 727  |
| 3:00 PM  | 749  | 9 | 31 | 789  |
| 3:15 PM  | 821  | 3 | 31 | 855  |
| 3:30 PM  | 942  | 5 | 25 | 972  |
| 3:45 PM  | 904  | 1 | 20 | 925  |
| 4:00 PM  | 939  | 5 | 29 | 973  |
| 4:15 PM  | 968  | 1 | 20 | 989  |
| 4:30 PM  | 969  | 3 | 17 | 989  |
| 4:45 PM  | 984  | 3 | 19 | 1006 |
| 5:00 PM  | 1073 | 4 | 13 | 1090 |
| 5:15 PM  | 1072 | 6 | 17 | 1095 |
| 5:30 PM  | 1041 | 3 | 16 | 1060 |
| 5:45 PM  | 984  | 3 | 14 | 1001 |
| 6:00 PM  | 846  | 7 | 11 | 864  |
| 6:15 PM  | 811  | 4 | 15 | 830  |
| 6:30 PM  | 639  | 0 | 13 | 652  |
| 6:45 PM  | 599  | 1 | 7  | 607  |
| 7:00 PM  | 537  | 0 | 3  | 540  |
| 7:15 PM  | 532  | 1 | 1  | 534  |
| 7:30 PM  | 478  | 1 | 6  | 485  |

|          |     |   |    |     |
|----------|-----|---|----|-----|
| 7:45 PM  | 477 | 0 | 8  | 485 |
| 8:00 PM  | 466 | 0 | 4  | 470 |
| 8:15 PM  | 491 | 0 | 2  | 493 |
| 8:30 PM  | 407 | 0 | 1  | 408 |
| 8:45 PM  | 399 | 3 | 4  | 406 |
| 9:00 PM  | 366 | 0 | 3  | 369 |
| 9:15 PM  | 318 | 1 | 5  | 324 |
| 9:30 PM  | 248 | 1 | 5  | 254 |
| 9:45 PM  | 253 | 0 | 1  | 254 |
| 10:00 PM | 256 | 0 | 0  | 256 |
| 10:15 PM | 212 | 1 | 1  | 214 |
| 10:30 PM | 141 | 0 | 0  | 141 |
| 10:45 PM | 131 | 0 | 2  | 133 |
| 11:00 PM | 133 | 0 | 2  | 135 |
| 11:15 PM | 108 | 1 | 2  | 111 |
| 11:30 PM | 94  | 0 | 2  | 96  |
| 11:45 PM | 63  | 0 | 1  | 64  |
| 12:00 AM | 71  | 2 | 0  | 73  |
| 12:15 AM | 55  | 0 | 2  | 57  |
| 12:30 AM | 38  | 0 | 2  | 40  |
| 12:45 AM | 53  | 0 | 0  | 53  |
| 1:00 AM  | 27  | 0 | 1  | 28  |
| 1:15 AM  | 28  | 0 | 4  | 32  |
| 1:30 AM  | 33  | 0 | 1  | 34  |
| 1:45 AM  | 25  | 0 | 2  | 27  |
| 2:00 AM  | 19  | 0 | 0  | 19  |
| 2:15 AM  | 28  | 0 | 3  | 31  |
| 2:30 AM  | 24  | 0 | 0  | 24  |
| 2:45 AM  | 19  | 0 | 2  | 21  |
| 3:00 AM  | 23  | 0 | 1  | 24  |
| 3:15 AM  | 20  | 0 | 0  | 20  |
| 3:30 AM  | 13  | 0 | 2  | 15  |
| 3:45 AM  | 30  | 0 | 3  | 33  |
| 4:00 AM  | 38  | 0 | 4  | 42  |
| 4:15 AM  | 49  | 0 | 4  | 53  |
| 4:30 AM  | 56  | 0 | 2  | 58  |
| 4:45 AM  | 51  | 0 | 4  | 55  |
| 5:00 AM  | 57  | 0 | 6  | 63  |
| 5:15 AM  | 69  | 1 | 5  | 75  |
| 5:30 AM  | 106 | 0 | 3  | 109 |
| 5:45 AM  | 121 | 0 | 4  | 125 |
| 6:00 AM  | 166 | 1 | 10 | 177 |
| 6:15 AM  | 206 | 3 | 12 | 221 |
| 6:30 AM  | 221 | 6 | 16 | 243 |
| 6:45 AM  | 215 | 1 | 8  | 224 |
| 7:00 AM  | 277 | 4 | 12 | 293 |



|          |      |   |    |      |
|----------|------|---|----|------|
| 7:15 AM  | 300  | 3 | 20 | 323  |
| 7:30 AM  | 385  | 3 | 23 | 411  |
| 7:45 AM  | 427  | 1 | 16 | 444  |
| 8:00 AM  | 445  | 3 | 29 | 477  |
| 8:15 AM  | 409  | 8 | 25 | 442  |
| 8:30 AM  | 361  | 3 | 14 | 378  |
| 8:45 AM  | 351  | 2 | 31 | 384  |
| 9:00 AM  | 374  | 2 | 37 | 413  |
| 9:15 AM  | 399  | 2 | 24 | 425  |
| 9:30 AM  | 374  | 1 | 33 | 408  |
| 9:45 AM  | 410  | 1 | 34 | 445  |
| 10:00 AM | 404  | 1 | 25 | 430  |
| 10:15 AM | 430  | 1 | 28 | 459  |
| 10:30 AM | 427  | 0 | 37 | 464  |
| 10:45 AM | 510  | 2 | 23 | 535  |
| 11:00 AM | 504  | 3 | 30 | 537  |
| 11:15 AM | 467  | 4 | 22 | 493  |
| 11:30 AM | 529  | 4 | 23 | 556  |
| 11:45 AM | 528  | 2 | 26 | 556  |
| 12:00 PM | 527  | 2 | 34 | 563  |
| 12:15 PM | 532  | 3 | 42 | 577  |
| 12:30 PM | 555  | 3 | 34 | 592  |
| 12:45 PM | 511  | 2 | 33 | 546  |
| 1:00 PM  | 540  | 2 | 32 | 574  |
| 1:15 PM  | 568  | 7 | 36 | 611  |
| 1:30 PM  | 605  | 3 | 33 | 641  |
| 1:45 PM  | 616  | 3 | 31 | 650  |
| 2:00 PM  | 602  | 4 | 35 | 641  |
| 2:15 PM  | 686  | 8 | 41 | 735  |
| 2:30 PM  | 632  | 4 | 43 | 679  |
| 2:45 PM  | 714  | 2 | 30 | 746  |
| 3:00 PM  | 716  | 8 | 22 | 746  |
| 3:15 PM  | 850  | 6 | 21 | 877  |
| 3:30 PM  | 957  | 9 | 23 | 989  |
| 3:45 PM  | 938  | 7 | 22 | 967  |
| 4:00 PM  | 977  | 1 | 30 | 1008 |
| 4:15 PM  | 946  | 3 | 21 | 970  |
| 4:30 PM  | 936  | 3 | 13 | 952  |
| 4:45 PM  | 975  | 2 | 26 | 1003 |
| 5:00 PM  | 1049 | 2 | 12 | 1063 |
| 5:15 PM  | 1096 | 6 | 12 | 1114 |
| 5:30 PM  | 1012 | 4 | 12 | 1028 |
| 5:45 PM  | 933  | 3 | 9  | 945  |
| 6:00 PM  | 951  | 2 | 11 | 964  |
| 6:15 PM  | 683  | 1 | 8  | 692  |
| 6:30 PM  | 635  | 1 | 5  | 641  |

|          |     |   |   |     |
|----------|-----|---|---|-----|
| 6:45 PM  | 546 | 1 | 4 | 551 |
| 7:00 PM  | 481 | 1 | 7 | 489 |
| 7:15 PM  | 511 | 1 | 8 | 520 |
| 7:30 PM  | 463 | 1 | 1 | 465 |
| 7:45 PM  | 449 | 0 | 3 | 452 |
| 8:00 PM  | 394 | 1 | 3 | 398 |
| 8:15 PM  | 431 | 0 | 5 | 436 |
| 8:30 PM  | 369 | 1 | 1 | 371 |
| 8:45 PM  | 347 | 0 | 1 | 348 |
| 9:00 PM  | 360 | 0 | 2 | 362 |
| 9:15 PM  | 346 | 0 | 4 | 350 |
| 9:30 PM  | 299 | 1 | 3 | 303 |
| 9:45 PM  | 285 | 0 | 5 | 290 |
| 10:00 PM | 252 | 0 | 4 | 256 |
| 10:15 PM | 243 | 0 | 1 | 244 |
| 10:30 PM | 144 | 0 | 2 | 146 |
| 10:45 PM | 141 | 0 | 4 | 145 |
| 11:00 PM | 131 | 1 | 1 | 133 |
| 11:15 PM | 149 | 1 | 1 | 151 |
| 11:30 PM | 84  | 0 | 1 | 85  |
| 11:45 PM | 98  | 1 | 1 | 100 |

Study Name 103 - NB Cabrillo Hwy  
 Start Date 05/03/2017  
 Start Time 12:00 AM  
 Site Code 38

| Channel   | lights     | buses | trucks | Total |     |
|-----------|------------|-------|--------|-------|-----|
| Direction | Direction  |       |        |       |     |
|           | Northbound |       |        |       |     |
| 12:00 AM  |            | 80    | 1      | 4     | 85  |
| 12:15 AM  |            | 62    | 0      | 0     | 62  |
| 12:30 AM  |            | 69    | 0      | 2     | 71  |
| 12:45 AM  |            | 51    | 0      | 2     | 53  |
| 1:00 AM   |            | 34    | 0      | 3     | 37  |
| 1:15 AM   |            | 30    | 0      | 0     | 30  |
| 1:30 AM   |            | 42    | 0      | 1     | 43  |
| 1:45 AM   |            | 33    | 0      | 3     | 36  |
| 2:00 AM   |            | 27    | 0      | 1     | 28  |
| 2:15 AM   |            | 22    | 0      | 2     | 24  |
| 2:30 AM   |            | 21    | 0      | 0     | 21  |
| 2:45 AM   |            | 21    | 0      | 1     | 22  |
| 3:00 AM   |            | 18    | 0      | 1     | 19  |
| 3:15 AM   |            | 31    | 0      | 3     | 34  |
| 3:30 AM   |            | 27    | 0      | 0     | 27  |
| 3:45 AM   |            | 39    | 0      | 0     | 39  |
| 4:00 AM   |            | 36    | 0      | 1     | 37  |
| 4:15 AM   |            | 39    | 0      | 0     | 39  |
| 4:30 AM   |            | 65    | 0      | 1     | 66  |
| 4:45 AM   |            | 49    | 0      | 1     | 50  |
| 5:00 AM   |            | 81    | 0      | 6     | 87  |
| 5:15 AM   |            | 116   | 0      | 6     | 122 |
| 5:30 AM   |            | 127   | 1      | 7     | 135 |
| 5:45 AM   |            | 168   | 1      | 6     | 175 |
| 6:00 AM   |            | 210   | 3      | 5     | 218 |
| 6:15 AM   |            | 258   | 4      | 9     | 271 |
| 6:30 AM   |            | 287   | 7      | 7     | 301 |
| 6:45 AM   |            | 321   | 3      | 11    | 335 |
| 7:00 AM   |            | 410   | 8      | 13    | 431 |
| 7:15 AM   |            | 498   | 2      | 14    | 514 |
| 7:30 AM   |            | 601   | 5      | 15    | 621 |
| 7:45 AM   |            | 595   | 3      | 10    | 608 |
| 8:00 AM   |            | 615   | 7      | 19    | 641 |

|          |      |   |    |      |
|----------|------|---|----|------|
| 8:15 AM  | 479  | 6 | 21 | 506  |
| 8:30 AM  | 407  | 4 | 18 | 429  |
| 8:45 AM  | 446  | 2 | 24 | 472  |
| 9:00 AM  | 446  | 5 | 29 | 480  |
| 9:15 AM  | 465  | 1 | 33 | 499  |
| 9:30 AM  | 454  | 2 | 32 | 488  |
| 9:45 AM  | 447  | 2 | 38 | 487  |
| 10:00 AM | 477  | 2 | 35 | 514  |
| 10:15 AM | 489  | 3 | 22 | 514  |
| 10:30 AM | 505  | 2 | 23 | 530  |
| 10:45 AM | 505  | 3 | 23 | 531  |
| 11:00 AM | 501  | 3 | 33 | 537  |
| 11:15 AM | 529  | 3 | 35 | 567  |
| 11:30 AM | 564  | 3 | 44 | 611  |
| 11:45 AM | 533  | 2 | 28 | 563  |
| 12:00 PM | 563  | 5 | 23 | 591  |
| 12:15 PM | 586  | 6 | 16 | 608  |
| 12:30 PM | 635  | 1 | 31 | 667  |
| 12:45 PM | 909  | 9 | 39 | 957  |
| 1:00 PM  | 785  | 6 | 29 | 820  |
| 1:15 PM  | 743  | 7 | 30 | 780  |
| 1:30 PM  | 718  | 5 | 33 | 756  |
| 1:45 PM  | 722  | 4 | 26 | 752  |
| 2:00 PM  | 781  | 4 | 32 | 817  |
| 2:15 PM  | 810  | 6 | 31 | 847  |
| 2:30 PM  | 757  | 3 | 35 | 795  |
| 2:45 PM  | 860  | 3 | 27 | 890  |
| 3:00 PM  | 932  | 6 | 35 | 973  |
| 3:15 PM  | 1020 | 4 | 24 | 1048 |
| 3:30 PM  | 1110 | 6 | 27 | 1143 |
| 3:45 PM  | 1058 | 2 | 23 | 1083 |
| 4:00 PM  | 1163 | 6 | 23 | 1192 |
| 4:15 PM  | 1135 | 2 | 21 | 1158 |
| 4:30 PM  | 1176 | 4 | 15 | 1195 |
| 4:45 PM  | 1170 | 3 | 16 | 1189 |
| 5:00 PM  | 1235 | 5 | 12 | 1252 |
| 5:15 PM  | 1211 | 6 | 17 | 1234 |
| 5:30 PM  | 1202 | 3 | 21 | 1226 |
| 5:45 PM  | 1171 | 3 | 11 | 1185 |
| 6:00 PM  | 1009 | 8 | 13 | 1030 |
| 6:15 PM  | 988  | 2 | 14 | 1004 |
| 6:30 PM  | 781  | 0 | 12 | 793  |
| 6:45 PM  | 715  | 2 | 8  | 725  |
| 7:00 PM  | 709  | 1 | 4  | 714  |
| 7:15 PM  | 665  | 2 | 6  | 673  |
| 7:30 PM  | 602  | 2 | 8  | 612  |

|          |     |   |    |     |
|----------|-----|---|----|-----|
| 7:45 PM  | 596 | 0 | 7  | 603 |
| 8:00 PM  | 562 | 0 | 2  | 564 |
| 8:15 PM  | 555 | 0 | 4  | 559 |
| 8:30 PM  | 508 | 0 | 0  | 508 |
| 8:45 PM  | 471 | 1 | 5  | 477 |
| 9:00 PM  | 466 | 0 | 3  | 469 |
| 9:15 PM  | 385 | 0 | 4  | 389 |
| 9:30 PM  | 317 | 0 | 5  | 322 |
| 9:45 PM  | 312 | 0 | 2  | 314 |
| 10:00 PM | 322 | 1 | 1  | 324 |
| 10:15 PM | 247 | 1 | 0  | 248 |
| 10:30 PM | 192 | 0 | 0  | 192 |
| 10:45 PM | 175 | 1 | 3  | 179 |
| 11:00 PM | 171 | 1 | 1  | 173 |
| 11:15 PM | 150 | 0 | 3  | 153 |
| 11:30 PM | 117 | 0 | 3  | 120 |
| 11:45 PM | 99  | 0 | 1  | 100 |
| 12:00 AM | 94  | 0 | 2  | 96  |
| 12:15 AM | 71  | 0 | 2  | 73  |
| 12:30 AM | 57  | 0 | 3  | 60  |
| 12:45 AM | 67  | 0 | 0  | 67  |
| 1:00 AM  | 42  | 0 | 1  | 43  |
| 1:15 AM  | 36  | 0 | 4  | 40  |
| 1:30 AM  | 43  | 0 | 1  | 44  |
| 1:45 AM  | 24  | 0 | 2  | 26  |
| 2:00 AM  | 22  | 0 | 2  | 24  |
| 2:15 AM  | 35  | 0 | 1  | 36  |
| 2:30 AM  | 26  | 0 | 0  | 26  |
| 2:45 AM  | 23  | 0 | 0  | 23  |
| 3:00 AM  | 25  | 0 | 4  | 29  |
| 3:15 AM  | 14  | 0 | 6  | 20  |
| 3:30 AM  | 17  | 0 | 5  | 22  |
| 3:45 AM  | 31  | 0 | 10 | 41  |
| 4:00 AM  | 38  | 1 | 2  | 41  |
| 4:15 AM  | 47  | 1 | 3  | 51  |
| 4:30 AM  | 64  | 1 | 1  | 66  |
| 4:45 AM  | 60  | 0 | 4  | 64  |
| 5:00 AM  | 57  | 0 | 4  | 61  |
| 5:15 AM  | 86  | 0 | 6  | 92  |
| 5:30 AM  | 127 | 1 | 2  | 130 |
| 5:45 AM  | 154 | 0 | 5  | 159 |
| 6:00 AM  | 202 | 2 | 6  | 210 |
| 6:15 AM  | 247 | 4 | 13 | 264 |
| 6:30 AM  | 308 | 8 | 11 | 327 |
| 6:45 AM  | 266 | 1 | 9  | 276 |
| 7:00 AM  | 380 | 6 | 16 | 402 |

|          |      |    |    |      |
|----------|------|----|----|------|
| 7:15 AM  | 472  | 4  | 17 | 493  |
| 7:30 AM  | 594  | 3  | 16 | 613  |
| 7:45 AM  | 565  | 5  | 14 | 584  |
| 8:00 AM  | 631  | 8  | 25 | 664  |
| 8:15 AM  | 534  | 7  | 14 | 555  |
| 8:30 AM  | 500  | 3  | 19 | 522  |
| 8:45 AM  | 443  | 2  | 25 | 470  |
| 9:00 AM  | 458  | 2  | 36 | 496  |
| 9:15 AM  | 487  | 3  | 33 | 523  |
| 9:30 AM  | 465  | 3  | 36 | 504  |
| 9:45 AM  | 483  | 1  | 43 | 527  |
| 10:00 AM | 483  | 2  | 29 | 514  |
| 10:15 AM | 535  | 2  | 22 | 559  |
| 10:30 AM | 540  | 2  | 27 | 569  |
| 10:45 AM | 608  | 3  | 26 | 637  |
| 11:00 AM | 602  | 2  | 32 | 636  |
| 11:15 AM | 571  | 1  | 25 | 597  |
| 11:30 AM | 600  | 1  | 32 | 633  |
| 11:45 AM | 603  | 3  | 33 | 639  |
| 12:00 PM | 631  | 1  | 32 | 664  |
| 12:15 PM | 631  | 5  | 50 | 686  |
| 12:30 PM | 663  | 2  | 30 | 695  |
| 12:45 PM | 650  | 3  | 34 | 687  |
| 1:00 PM  | 633  | 0  | 34 | 667  |
| 1:15 PM  | 680  | 11 | 32 | 723  |
| 1:30 PM  | 736  | 3  | 30 | 769  |
| 1:45 PM  | 733  | 3  | 32 | 768  |
| 2:00 PM  | 738  | 5  | 31 | 774  |
| 2:15 PM  | 848  | 10 | 35 | 893  |
| 2:30 PM  | 799  | 8  | 38 | 845  |
| 2:45 PM  | 855  | 3  | 30 | 888  |
| 3:00 PM  | 878  | 10 | 23 | 911  |
| 3:15 PM  | 1069 | 6  | 23 | 1098 |
| 3:30 PM  | 1093 | 7  | 26 | 1126 |
| 3:45 PM  | 1037 | 5  | 29 | 1071 |
| 4:00 PM  | 1095 | 1  | 36 | 1132 |
| 4:15 PM  | 1082 | 4  | 21 | 1107 |
| 4:30 PM  | 1153 | 2  | 23 | 1178 |
| 4:45 PM  | 1125 | 2  | 20 | 1147 |
| 5:00 PM  | 1243 | 4  | 20 | 1267 |
| 5:15 PM  | 1274 | 8  | 13 | 1295 |
| 5:30 PM  | 1182 | 5  | 12 | 1199 |
| 5:45 PM  | 1080 | 5  | 13 | 1098 |
| 6:00 PM  | 1113 | 0  | 9  | 1122 |
| 6:15 PM  | 868  | 1  | 10 | 879  |
| 6:30 PM  | 782  | 1  | 3  | 786  |

|          |     |   |   |     |
|----------|-----|---|---|-----|
| 6:45 PM  | 685 | 2 | 4 | 691 |
| 7:00 PM  | 602 | 1 | 9 | 612 |
| 7:15 PM  | 669 | 0 | 5 | 674 |
| 7:30 PM  | 581 | 2 | 2 | 585 |
| 7:45 PM  | 520 | 0 | 4 | 524 |
| 8:00 PM  | 495 | 1 | 3 | 499 |
| 8:15 PM  | 532 | 1 | 4 | 537 |
| 8:30 PM  | 435 | 0 | 4 | 439 |
| 8:45 PM  | 416 | 0 | 5 | 421 |
| 9:00 PM  | 425 | 0 | 2 | 427 |
| 9:15 PM  | 417 | 0 | 3 | 420 |
| 9:30 PM  | 332 | 1 | 1 | 334 |
| 9:45 PM  | 325 | 0 | 3 | 328 |
| 10:00 PM | 291 | 0 | 2 | 293 |
| 10:15 PM | 312 | 0 | 2 | 314 |
| 10:30 PM | 208 | 0 | 4 | 212 |
| 10:45 PM | 181 | 0 | 3 | 184 |
| 11:00 PM | 178 | 0 | 1 | 179 |
| 11:15 PM | 162 | 1 | 1 | 164 |
| 11:30 PM | 130 | 0 | 1 | 131 |
| 11:45 PM | 137 | 0 | 2 | 139 |

Study Name 104 NB Cabrillo Hwy  
 Start Date 05/03/2017  
 Start Time 12:00 AM  
 Site Code 39

| Channel<br>Direction | lights     | buses | trucks | Total |
|----------------------|------------|-------|--------|-------|
|                      | Direction  |       |        |       |
|                      | Northbound |       |        |       |
| 12:00 AM             | 85         | 1     | 1      | 87    |
| 12:15 AM             | 63         | 0     | 0      | 63    |
| 12:30 AM             | 67         | 0     | 2      | 69    |
| 12:45 AM             | 51         | 0     | 2      | 53    |
| 1:00 AM              | 33         | 0     | 3      | 36    |
| 1:15 AM              | 27         | 0     | 1      | 28    |
| 1:30 AM              | 37         | 0     | 3      | 40    |
| 1:45 AM              | 33         | 0     | 2      | 35    |
| 2:00 AM              | 26         | 0     | 2      | 28    |
| 2:15 AM              | 27         | 0     | 1      | 28    |
| 2:30 AM              | 21         | 0     | 0      | 21    |
| 2:45 AM              | 26         | 0     | 0      | 26    |
| 3:00 AM              | 19         | 0     | 1      | 20    |
| 3:15 AM              | 32         | 0     | 2      | 34    |
| 3:30 AM              | 28         | 0     | 1      | 29    |
| 3:45 AM              | 33         | 0     | 1      | 34    |
| 4:00 AM              | 33         | 0     | 0      | 33    |
| 4:15 AM              | 38         | 0     | 0      | 38    |
| 4:30 AM              | 69         | 0     | 3      | 72    |
| 4:45 AM              | 49         | 1     | 0      | 50    |
| 5:00 AM              | 90         | 0     | 7      | 97    |
| 5:15 AM              | 120        | 0     | 5      | 125   |
| 5:30 AM              | 132        | 0     | 7      | 139   |
| 5:45 AM              | 170        | 1     | 7      | 178   |
| 6:00 AM              | 247        | 4     | 5      | 256   |
| 6:15 AM              | 280        | 2     | 13     | 295   |
| 6:30 AM              | 301        | 7     | 7      | 315   |
| 6:45 AM              | 345        | 3     | 14     | 362   |
| 7:00 AM              | 441        | 6     | 10     | 457   |
| 7:15 AM              | 570        | 2     | 16     | 588   |
| 7:30 AM              | 712        | 6     | 18     | 736   |
| 7:45 AM              | 694        | 7     | 11     | 712   |
| 8:00 AM              | 639        | 11    | 20     | 670   |



|          |      |    |    |      |
|----------|------|----|----|------|
| 8:15 AM  | 540  | 3  | 24 | 567  |
| 8:30 AM  | 447  | 2  | 17 | 466  |
| 8:45 AM  | 474  | 4  | 28 | 506  |
| 9:00 AM  | 461  | 3  | 27 | 491  |
| 9:15 AM  | 479  | 4  | 31 | 514  |
| 9:30 AM  | 501  | 3  | 30 | 534  |
| 9:45 AM  | 504  | 2  | 37 | 543  |
| 10:00 AM | 507  | 3  | 28 | 538  |
| 10:15 AM | 499  | 3  | 27 | 529  |
| 10:30 AM | 513  | 2  | 23 | 538  |
| 10:45 AM | 513  | 4  | 25 | 542  |
| 11:00 AM | 492  | 3  | 33 | 528  |
| 11:15 AM | 539  | 2  | 35 | 576  |
| 11:30 AM | 560  | 2  | 38 | 600  |
| 11:45 AM | 547  | 1  | 23 | 571  |
| 12:00 PM | 567  | 4  | 30 | 601  |
| 12:15 PM | 606  | 5  | 27 | 638  |
| 12:30 PM | 664  | 2  | 36 | 702  |
| 12:45 PM | 962  | 6  | 40 | 1008 |
| 1:00 PM  | 808  | 8  | 25 | 841  |
| 1:15 PM  | 765  | 10 | 24 | 799  |
| 1:30 PM  | 766  | 5  | 37 | 808  |
| 1:45 PM  | 752  | 4  | 28 | 784  |
| 2:00 PM  | 805  | 4  | 30 | 839  |
| 2:15 PM  | 812  | 6  | 38 | 856  |
| 2:30 PM  | 749  | 2  | 36 | 787  |
| 2:45 PM  | 842  | 3  | 26 | 871  |
| 3:00 PM  | 963  | 8  | 31 | 1002 |
| 3:15 PM  | 1030 | 4  | 27 | 1061 |
| 3:30 PM  | 1136 | 7  | 20 | 1163 |
| 3:45 PM  | 1057 | 2  | 30 | 1089 |
| 4:00 PM  | 1129 | 6  | 16 | 1151 |
| 4:15 PM  | 1114 | 3  | 18 | 1135 |
| 4:30 PM  | 1146 | 2  | 12 | 1160 |
| 4:45 PM  | 1138 | 1  | 19 | 1158 |
| 5:00 PM  | 1160 | 6  | 17 | 1183 |
| 5:15 PM  | 1148 | 4  | 19 | 1171 |
| 5:30 PM  | 1210 | 6  | 24 | 1240 |
| 5:45 PM  | 1154 | 8  | 10 | 1172 |
| 6:00 PM  | 1052 | 6  | 15 | 1073 |
| 6:15 PM  | 962  | 3  | 9  | 974  |
| 6:30 PM  | 783  | 0  | 11 | 794  |
| 6:45 PM  | 736  | 4  | 5  | 745  |
| 7:00 PM  | 699  | 3  | 7  | 709  |
| 7:15 PM  | 671  | 3  | 4  | 678  |
| 7:30 PM  | 624  | 4  | 5  | 633  |

|          |     |    |    |     |
|----------|-----|----|----|-----|
| 7:45 PM  | 609 | 1  | 7  | 617 |
| 8:00 PM  | 576 | 1  | 2  | 579 |
| 8:15 PM  | 526 | 0  | 2  | 528 |
| 8:30 PM  | 542 | 0  | 0  | 542 |
| 8:45 PM  | 448 | 5  | 4  | 457 |
| 9:00 PM  | 497 | 0  | 7  | 504 |
| 9:15 PM  | 373 | 0  | 5  | 378 |
| 9:30 PM  | 327 | 0  | 4  | 331 |
| 9:45 PM  | 312 | 0  | 3  | 315 |
| 10:00 PM | 318 | 0  | 0  | 318 |
| 10:15 PM | 240 | 1  | 0  | 241 |
| 10:30 PM | 204 | 1  | 1  | 206 |
| 10:45 PM | 159 | 1  | 2  | 162 |
| 11:00 PM | 185 | 0  | 4  | 189 |
| 11:15 PM | 146 | 0  | 4  | 150 |
| 11:30 PM | 133 | 1  | 0  | 134 |
| 11:45 PM | 106 | 1  | 0  | 107 |
| 12:00 AM | 101 | 1  | 0  | 102 |
| 12:15 AM | 71  | 1  | 1  | 73  |
| 12:30 AM | 59  | 0  | 3  | 62  |
| 12:45 AM | 61  | 2  | 0  | 63  |
| 1:00 AM  | 48  | 0  | 1  | 49  |
| 1:15 AM  | 33  | 0  | 3  | 36  |
| 1:30 AM  | 38  | 0  | 1  | 39  |
| 1:45 AM  | 26  | 0  | 3  | 29  |
| 2:00 AM  | 22  | 0  | 1  | 23  |
| 2:15 AM  | 33  | 0  | 1  | 34  |
| 2:30 AM  | 28  | 0  | 0  | 28  |
| 2:45 AM  | 26  | 0  | 2  | 28  |
| 3:00 AM  | 29  | 0  | 0  | 29  |
| 3:15 AM  | 23  | 0  | 0  | 23  |
| 3:30 AM  | 26  | 0  | 2  | 28  |
| 3:45 AM  | 28  | 0  | 3  | 31  |
| 4:00 AM  | 42  | 0  | 2  | 44  |
| 4:15 AM  | 42  | 0  | 3  | 45  |
| 4:30 AM  | 67  | 1  | 1  | 69  |
| 4:45 AM  | 55  | 0  | 3  | 58  |
| 5:00 AM  | 66  | 0  | 5  | 71  |
| 5:15 AM  | 90  | 1  | 6  | 97  |
| 5:30 AM  | 137 | 0  | 2  | 139 |
| 5:45 AM  | 158 | 0  | 5  | 163 |
| 6:00 AM  | 231 | 2  | 7  | 240 |
| 6:15 AM  | 262 | 4  | 12 | 278 |
| 6:30 AM  | 321 | 11 | 11 | 343 |
| 6:45 AM  | 288 | 4  | 13 | 305 |
| 7:00 AM  | 418 | 3  | 15 | 436 |

|          |      |    |    |      |
|----------|------|----|----|------|
| 7:15 AM  | 543  | 4  | 15 | 562  |
| 7:30 AM  | 689  | 7  | 17 | 713  |
| 7:45 AM  | 663  | 7  | 17 | 687  |
| 8:00 AM  | 652  | 10 | 25 | 687  |
| 8:15 AM  | 621  | 5  | 15 | 641  |
| 8:30 AM  | 535  | 5  | 18 | 558  |
| 8:45 AM  | 498  | 2  | 31 | 531  |
| 9:00 AM  | 503  | 2  | 35 | 540  |
| 9:15 AM  | 515  | 3  | 31 | 549  |
| 9:30 AM  | 533  | 1  | 41 | 575  |
| 9:45 AM  | 537  | 3  | 35 | 575  |
| 10:00 AM | 506  | 3  | 29 | 538  |
| 10:15 AM | 538  | 3  | 27 | 568  |
| 10:30 AM | 582  | 2  | 26 | 610  |
| 10:45 AM | 668  | 4  | 29 | 701  |
| 11:00 AM | 636  | 5  | 26 | 667  |
| 11:15 AM | 592  | 2  | 23 | 617  |
| 11:30 AM | 632  | 2  | 29 | 663  |
| 11:45 AM | 621  | 2  | 40 | 663  |
| 12:00 PM | 617  | 2  | 30 | 649  |
| 12:15 PM | 672  | 5  | 44 | 721  |
| 12:30 PM | 665  | 1  | 33 | 699  |
| 12:45 PM | 713  | 3  | 33 | 749  |
| 1:00 PM  | 695  | 2  | 40 | 737  |
| 1:15 PM  | 719  | 12 | 28 | 759  |
| 1:30 PM  | 795  | 4  | 38 | 837  |
| 1:45 PM  | 754  | 1  | 32 | 787  |
| 2:00 PM  | 765  | 6  | 29 | 800  |
| 2:15 PM  | 869  | 8  | 40 | 917  |
| 2:30 PM  | 793  | 7  | 45 | 845  |
| 2:45 PM  | 848  | 6  | 35 | 889  |
| 3:00 PM  | 896  | 10 | 23 | 929  |
| 3:15 PM  | 1129 | 9  | 23 | 1161 |
| 3:30 PM  | 1093 | 4  | 23 | 1120 |
| 3:45 PM  | 1012 | 7  | 26 | 1045 |
| 4:00 PM  | 1083 | 1  | 35 | 1119 |
| 4:15 PM  | 1075 | 5  | 18 | 1098 |
| 4:30 PM  | 1141 | 3  | 28 | 1172 |
| 4:45 PM  | 1081 | 3  | 24 | 1108 |
| 5:00 PM  | 1158 | 2  | 15 | 1175 |
| 5:15 PM  | 1193 | 7  | 21 | 1221 |
| 5:30 PM  | 1151 | 8  | 10 | 1169 |
| 5:45 PM  | 1103 | 7  | 13 | 1123 |
| 6:00 PM  | 1058 | 1  | 14 | 1073 |
| 6:15 PM  | 872  | 3  | 8  | 883  |
| 6:30 PM  | 806  | 1  | 3  | 810  |

|          |     |   |   |     |
|----------|-----|---|---|-----|
| 6:45 PM  | 677 | 4 | 4 | 685 |
| 7:00 PM  | 627 | 4 | 8 | 639 |
| 7:15 PM  | 685 | 1 | 4 | 690 |
| 7:30 PM  | 597 | 3 | 2 | 602 |
| 7:45 PM  | 536 | 1 | 5 | 542 |
| 8:00 PM  | 515 | 2 | 1 | 518 |
| 8:15 PM  | 496 | 1 | 1 | 498 |
| 8:30 PM  | 432 | 0 | 2 | 434 |
| 8:45 PM  | 430 | 0 | 2 | 432 |
| 9:00 PM  | 435 | 0 | 3 | 438 |
| 9:15 PM  | 418 | 1 | 2 | 421 |
| 9:30 PM  | 347 | 0 | 3 | 350 |
| 9:45 PM  | 343 | 0 | 3 | 346 |
| 10:00 PM | 277 | 0 | 3 | 280 |
| 10:15 PM | 303 | 0 | 1 | 304 |
| 10:30 PM | 225 | 0 | 4 | 229 |
| 10:45 PM | 190 | 0 | 1 | 191 |
| 11:00 PM | 186 | 0 | 6 | 192 |
| 11:15 PM | 160 | 1 | 2 | 163 |
| 11:30 PM | 146 | 0 | 2 | 148 |
| 11:45 PM | 142 | 0 | 1 | 143 |

Study Name 105 NB Cabrillo Hwy  
 Start Date 05/03/2017  
 Start Time 12:00 AM  
 Site Code 40

| Channel<br>Direction | lights     | buses | trucks | Total |     |
|----------------------|------------|-------|--------|-------|-----|
|                      | Direction  |       |        |       |     |
|                      | Northbound |       |        |       |     |
| 12:00 AM             |            | 72    | 1      | 1     | 74  |
| 12:15 AM             |            | 61    | 0      | 0     | 61  |
| 12:30 AM             |            | 57    | 0      | 2     | 59  |
| 12:45 AM             |            | 44    | 0      | 2     | 46  |
| 1:00 AM              |            | 22    | 0      | 0     | 22  |
| 1:15 AM              |            | 22    | 0      | 0     | 22  |
| 1:30 AM              |            | 35    | 0      | 2     | 37  |
| 1:45 AM              |            | 24    | 0      | 1     | 25  |
| 2:00 AM              |            | 16    | 0      | 1     | 17  |
| 2:15 AM              |            | 18    | 0      | 1     | 19  |
| 2:30 AM              |            | 17    | 0      | 1     | 18  |
| 2:45 AM              |            | 16    | 0      | 2     | 18  |
| 3:00 AM              |            | 17    | 0      | 2     | 19  |
| 3:15 AM              |            | 20    | 0      | 2     | 22  |
| 3:30 AM              |            | 22    | 0      | 3     | 25  |
| 3:45 AM              |            | 16    | 0      | 9     | 25  |
| 4:00 AM              |            | 23    | 0      | 1     | 24  |
| 4:15 AM              |            | 26    | 0      | 0     | 26  |
| 4:30 AM              |            | 55    | 0      | 1     | 56  |
| 4:45 AM              |            | 36    | 0      | 4     | 40  |
| 5:00 AM              |            | 65    | 0      | 10    | 75  |
| 5:15 AM              |            | 74    | 0      | 8     | 82  |
| 5:30 AM              |            | 97    | 0      | 7     | 104 |
| 5:45 AM              |            | 139   | 1      | 5     | 145 |
| 6:00 AM              |            | 190   | 4      | 1     | 195 |
| 6:15 AM              |            | 202   | 4      | 5     | 211 |
| 6:30 AM              |            | 229   | 7      | 4     | 240 |
| 6:45 AM              |            | 286   | 2      | 10    | 298 |
| 7:00 AM              |            | 356   | 4      | 6     | 366 |
| 7:15 AM              |            | 490   | 3      | 4     | 497 |
| 7:30 AM              |            | 631   | 7      | 5     | 643 |
| 7:45 AM              |            | 602   | 6      | 6     | 614 |
| 8:00 AM              |            | 554   | 9      | 12    | 575 |

|          |     |    |    |     |
|----------|-----|----|----|-----|
| 8:15 AM  | 501 | 1  | 21 | 523 |
| 8:30 AM  | 358 | 1  | 13 | 372 |
| 8:45 AM  | 353 | 2  | 8  | 363 |
| 9:00 AM  | 319 | 3  | 15 | 337 |
| 9:15 AM  | 331 | 4  | 18 | 353 |
| 9:30 AM  | 339 | 5  | 10 | 354 |
| 9:45 AM  | 328 | 2  | 26 | 356 |
| 10:00 AM | 348 | 3  | 16 | 367 |
| 10:15 AM | 341 | 1  | 19 | 361 |
| 10:30 AM | 325 | 1  | 16 | 342 |
| 10:45 AM | 315 | 4  | 16 | 335 |
| 11:00 AM | 305 | 2  | 18 | 325 |
| 11:15 AM | 308 | 0  | 22 | 330 |
| 11:30 AM | 329 | 0  | 20 | 349 |
| 11:45 AM | 334 | 0  | 11 | 345 |
| 12:00 PM | 346 | 2  | 19 | 367 |
| 12:15 PM | 357 | 1  | 16 | 374 |
| 12:30 PM | 373 | 0  | 21 | 394 |
| 12:45 PM | 739 | 6  | 27 | 772 |
| 1:00 PM  | 648 | 5  | 15 | 668 |
| 1:15 PM  | 667 | 5  | 15 | 687 |
| 1:30 PM  | 655 | 5  | 22 | 682 |
| 1:45 PM  | 659 | 2  | 17 | 678 |
| 2:00 PM  | 707 | 3  | 17 | 727 |
| 2:15 PM  | 680 | 4  | 30 | 714 |
| 2:30 PM  | 654 | 5  | 21 | 680 |
| 2:45 PM  | 720 | 7  | 26 | 753 |
| 3:00 PM  | 883 | 6  | 17 | 906 |
| 3:15 PM  | 915 | 2  | 17 | 934 |
| 3:30 PM  | 939 | 4  | 16 | 959 |
| 3:45 PM  | 848 | 2  | 14 | 864 |
| 4:00 PM  | 905 | 4  | 18 | 927 |
| 4:15 PM  | 879 | 1  | 23 | 903 |
| 4:30 PM  | 914 | 3  | 9  | 926 |
| 4:45 PM  | 891 | 1  | 15 | 907 |
| 5:00 PM  | 912 | 4  | 15 | 931 |
| 5:15 PM  | 887 | 5  | 16 | 908 |
| 5:30 PM  | 942 | 5  | 14 | 961 |
| 5:45 PM  | 928 | 7  | 10 | 945 |
| 6:00 PM  | 868 | 10 | 5  | 883 |
| 6:15 PM  | 736 | 3  | 13 | 752 |
| 6:30 PM  | 606 | 0  | 5  | 611 |
| 6:45 PM  | 575 | 3  | 6  | 584 |
| 7:00 PM  | 597 | 2  | 4  | 603 |
| 7:15 PM  | 533 | 0  | 6  | 539 |
| 7:30 PM  | 498 | 2  | 2  | 502 |

|          |     |   |   |     |
|----------|-----|---|---|-----|
| 7:45 PM  | 524 | 2 | 8 | 534 |
| 8:00 PM  | 421 | 1 | 3 | 425 |
| 8:15 PM  | 457 | 0 | 2 | 459 |
| 8:30 PM  | 389 | 0 | 1 | 390 |
| 8:45 PM  | 346 | 3 | 4 | 353 |
| 9:00 PM  | 429 | 2 | 2 | 433 |
| 9:15 PM  | 312 | 2 | 4 | 318 |
| 9:30 PM  | 264 | 0 | 4 | 268 |
| 9:45 PM  | 246 | 0 | 5 | 251 |
| 10:00 PM | 251 | 0 | 2 | 253 |
| 10:15 PM | 197 | 0 | 1 | 198 |
| 10:30 PM | 164 | 0 | 3 | 167 |
| 10:45 PM | 164 | 0 | 5 | 169 |
| 11:00 PM | 139 | 3 | 1 | 143 |
| 11:15 PM | 120 | 3 | 1 | 124 |
| 11:30 PM | 112 | 0 | 0 | 112 |
| 11:45 PM | 95  | 1 | 0 | 96  |
| 12:00 AM | 77  | 0 | 1 | 78  |
| 12:15 AM | 55  | 0 | 1 | 56  |
| 12:30 AM | 52  | 0 | 1 | 53  |
| 12:45 AM | 59  | 0 | 1 | 60  |
| 1:00 AM  | 40  | 0 | 1 | 41  |
| 1:15 AM  | 26  | 0 | 3 | 29  |
| 1:30 AM  | 38  | 0 | 1 | 39  |
| 1:45 AM  | 28  | 0 | 1 | 29  |
| 2:00 AM  | 13  | 0 | 0 | 13  |
| 2:15 AM  | 25  | 0 | 3 | 28  |
| 2:30 AM  | 23  | 0 | 2 | 25  |
| 2:45 AM  | 18  | 0 | 2 | 20  |
| 3:00 AM  | 21  | 0 | 2 | 23  |
| 3:15 AM  | 18  | 0 | 1 | 19  |
| 3:30 AM  | 22  | 0 | 2 | 24  |
| 3:45 AM  | 24  | 0 | 2 | 26  |
| 4:00 AM  | 28  | 1 | 1 | 30  |
| 4:15 AM  | 28  | 3 | 0 | 31  |
| 4:30 AM  | 44  | 1 | 1 | 46  |
| 4:45 AM  | 37  | 0 | 2 | 39  |
| 5:00 AM  | 48  | 0 | 5 | 53  |
| 5:15 AM  | 65  | 0 | 6 | 71  |
| 5:30 AM  | 100 | 0 | 4 | 104 |
| 5:45 AM  | 115 | 0 | 3 | 118 |
| 6:00 AM  | 183 | 3 | 5 | 191 |
| 6:15 AM  | 189 | 3 | 9 | 201 |
| 6:30 AM  | 268 | 6 | 4 | 278 |
| 6:45 AM  | 245 | 5 | 9 | 259 |
| 7:00 AM  | 337 | 3 | 9 | 349 |

|          |      |   |    |      |
|----------|------|---|----|------|
| 7:15 AM  | 460  | 3 | 13 | 476  |
| 7:30 AM  | 603  | 8 | 12 | 623  |
| 7:45 AM  | 602  | 9 | 14 | 625  |
| 8:00 AM  | 555  | 8 | 19 | 582  |
| 8:15 AM  | 527  | 4 | 9  | 540  |
| 8:30 AM  | 472  | 4 | 14 | 490  |
| 8:45 AM  | 432  | 1 | 23 | 456  |
| 9:00 AM  | 443  | 1 | 18 | 462  |
| 9:15 AM  | 465  | 4 | 17 | 486  |
| 9:30 AM  | 474  | 3 | 20 | 497  |
| 9:45 AM  | 464  | 1 | 28 | 493  |
| 10:00 AM | 477  | 1 | 24 | 502  |
| 10:15 AM | 442  | 2 | 16 | 460  |
| 10:30 AM | 475  | 1 | 26 | 502  |
| 10:45 AM | 587  | 6 | 22 | 615  |
| 11:00 AM | 541  | 4 | 16 | 561  |
| 11:15 AM | 504  | 1 | 18 | 523  |
| 11:30 AM | 574  | 2 | 21 | 597  |
| 11:45 AM | 576  | 1 | 23 | 600  |
| 12:00 PM | 557  | 1 | 27 | 585  |
| 12:15 PM | 589  | 3 | 23 | 615  |
| 12:30 PM | 595  | 1 | 28 | 624  |
| 12:45 PM | 612  | 2 | 23 | 637  |
| 1:00 PM  | 635  | 2 | 33 | 670  |
| 1:15 PM  | 636  | 9 | 26 | 671  |
| 1:30 PM  | 688  | 3 | 30 | 721  |
| 1:45 PM  | 644  | 1 | 26 | 671  |
| 2:00 PM  | 693  | 5 | 18 | 716  |
| 2:15 PM  | 764  | 9 | 35 | 808  |
| 2:30 PM  | 708  | 5 | 35 | 748  |
| 2:45 PM  | 753  | 4 | 29 | 786  |
| 3:00 PM  | 836  | 8 | 17 | 861  |
| 3:15 PM  | 1050 | 3 | 17 | 1070 |
| 3:30 PM  | 916  | 4 | 12 | 932  |
| 3:45 PM  | 872  | 5 | 24 | 901  |
| 4:00 PM  | 887  | 0 | 23 | 910  |
| 4:15 PM  | 843  | 2 | 11 | 856  |
| 4:30 PM  | 879  | 1 | 21 | 901  |
| 4:45 PM  | 368  | 0 | 11 | 379  |























## **APPENDIX E: INTERSECTION LEVEL OF SERVICE CALCULATIONS**



HCM 2010 Signalized Intersection Summary  
1: Del Monte Boulevard & Reindollar Avenue

Existing, AM  
06/11/2019

|                              |  |  |  |  |  |  |   |  |  |  |  |  |  |
|------------------------------|---|---|---|---|---|---|---|---|---|---|---|---|--|
| Movement                     | EBL   | EBT   | EBR   | WBL   | WBT   | WBR   | NBL   | NBT   | NBR   | SBL   | SBT   | SBR   |  |
| Lane Configurations          |   |   |   |  |  |   |  |  |  |  |  |  |  |
| Traffic Volume (veh/h)       | 0   | 0   | 0   | 430   | 0   | 58  | 5   | 289   | 105   | 65  | 939   | 0   |  |
| Future Volume (veh/h)        | 0   | 0   | 0   | 430   | 0   | 58  | 5   | 289   | 105   | 65  | 939   | 0   |  |
| Number                       |   |   |   | 3   | 8   | 18  | 1   | 6   | 16  | 5   | 2   | 12  |  |
| Initial Q (Qb), veh          |   |   |   | 0   | 0   | 0   | 0   | 0   | 0   | 0   | 0   | 0   |  |
| Ped-Bike Adj(A_pbT)          |   |   |   | 1.00  |   | 1.00  | 1.00  |   | 1.00  | 1.00  |   | 1.00  |  |
| Parking Bus, Adj             |   |   |   | 1.00  | 1.00  | 1.00  | 1.00  | 1.00  | 1.00  | 1.00  | 1.00  | 1.00  |  |
| Adj Sat Flow, veh/h/ln       |   |   |   | 1900  | 1900  | 1900  | 1863  | 1863  | 1863  | 1845  | 1845  | 0   |  |
| Adj Flow Rate, veh/h         |   |   |   | 504   | 0   | 0   | 6   | 325   | 51  | 73  | 1055  | 0   |  |
| Adj No. of Lanes             |   |   |   | 2   | 1   | 0   | 1   | 2   | 1   | 1   | 2   | 0   |  |
| Peak Hour Factor             |   |   |   | 0.89  | 0.89  | 0.89  | 0.89  | 0.89  | 0.89  | 0.89  | 0.89  | 0.89  |  |
| Percent Heavy Veh, %         |   |   |   | 0   | 0   | 0   | 2   | 2   | 2   | 3   | 3   | 0   |  |
| Cap, veh/h                   |   |   |   | 811   | 426   | 0   | 14  | 1394  | 622   | 119   | 1590  | 0   |  |
| Arrive On Green              |   |   |   | 0.22  | 0.00  | 0.00  | 0.01  | 0.39  | 0.39  | 0.07  | 0.45  | 0.00  |  |
| Sat Flow, veh/h              |   |   |   | 3619  | 1900  | 0   | 1774  | 3539  | 1579  | 1757  | 3597  | 0   |  |
| Grp Volume(v), veh/h         |   |   |   | 504   | 0   | 0   | 6   | 325   | 51  | 73  | 1055  | 0   |  |
| Grp Sat Flow(s),veh/h/ln     |   |   |   | 1810  | 1900  | 0   | 1774  | 1770  | 1579  | 1757  | 1752  | 0   |  |
| Q Serve(g_s), s              |   |   |   | 5.4   | 0.0   | 0.0   | 0.1   | 2.6   | 0.9   | 1.7   | 10.1  | 0.0   |  |
| Cycle Q Clear(g_c), s        |   |   |   | 5.4   | 0.0   | 0.0   | 0.1   | 2.6   | 0.9   | 1.7   | 10.1  | 0.0   |  |
| Prop In Lane                 |   |   |   | 1.00  |   | 0.00  | 1.00  |   | 1.00  | 1.00  |   | 0.00  |  |
| Lane Grp Cap(c), veh/h       |   |   |   | 811   | 426   | 0   | 14  | 1394  | 622   | 119   | 1590  | 0   |  |
| V/C Ratio(X)                 |   |   |   | 0.62  | 0.00  | 0.00  | 0.42  | 0.23  | 0.08  | 0.61  | 0.66  | 0.00  |  |
| Avail Cap(c_a), veh/h        |   |   |   | 2527  | 1327  | 0   | 1239  | 2472  | 1103  | 1227  | 2448  | 0   |  |
| HCM Platoon Ratio            |   |   |   | 1.00  | 1.00  | 1.00  | 1.00  | 1.00  | 1.00  | 1.00  | 1.00  | 1.00  |  |
| Upstream Filter(I)           |   |   |   | 1.00  | 0.00  | 0.00  | 1.00  | 1.00  | 1.00  | 1.00  | 1.00  | 0.00  |  |
| Uniform Delay (d), s/veh     |   |   |   | 15.0  | 0.0   | 0.0   | 21.2  | 8.7   | 8.2   | 19.5  | 9.2   | 0.0   |  |
| Incr Delay (d2), s/veh       |   |   |   | 0.8   | 0.0   | 0.0   | 18.5  | 0.1   | 0.1   | 5.1   | 0.5   | 0.0   |  |
| Initial Q Delay(d3),s/veh    |   |   |   | 0.0   | 0.0   | 0.0   | 0.0   | 0.0   | 0.0   | 0.0   | 0.0   | 0.0   |  |
| %ile BackOfQ(50%),veh/ln     |   |   |   | 2.7   | 0.0   | 0.0   | 0.1   | 1.3   | 0.4   | 1.0   | 4.9   | 0.0   |  |
| LnGrp Delay(d),s/veh         |   |   |   | 15.8  | 0.0   | 0.0   | 39.7  | 8.8   | 8.2   | 24.5  | 9.7   | 0.0   |  |
| LnGrp LOS                    |   |   |   | B   |   |   | D   | A   | A   | C   | A   |   |  |
| Approach Vol, veh/h          |   |   |   |   | 504   |   |   | 382   |   |   | 1128  |   |  |
| Approach Delay, s/veh        |   |   |   |   | 15.8  |   |   | 9.2   |   |   | 10.6  |   |  |
| Approach LOS                 |   |   |   |   | B   |   |   | A   |   |   | B   |   |  |
| Timer                        | 1   | 2   | 3   | 4   | 5   | 6   | 7   | 8   |   |   |   |   |  |
| Assigned Phs                 | 1   | 2   |   |   | 5   | 6   |   | 8   |   |   |   |   |  |
| Phs Duration (G+Y+Rc), s     | 3.8   | 24.5  |   |   | 6.4   | 21.9  |   | 14.6  |   |   |   |   |  |
| Change Period (Y+Rc), s      | 3.5   | 5.0   |   |   | 3.5   | 5.0   |   | 5.0   |   |   |   |   |  |
| Max Green Setting (Gmax), s  | 30.0  | 30.0  |   |   | 30.0  | 30.0  |   | 30.0  |   |   |   |   |  |
| Max Q Clear Time (g_c+I1), s | 2.1   | 12.1  |   |   | 3.7   | 4.6   |   | 7.4   |   |   |   |   |  |
| Green Ext Time (p_c), s      | 0.0   | 7.4   |   |   | 0.2   | 2.2   |   | 1.9   |   |   |   |   |  |
| <b>Intersection Summary</b>  |   |   |   |   |   |   |   |   |   |   |   |   |  |
| HCM 2010 Ctrl Delay          |   |   |   | 11.6  |   |   |   |   |   |   |   |   |  |
| HCM 2010 LOS                 |   |   |   | B   |   |   |   |   |   |   |   |   |  |
| <b>Notes</b>                 |   |   |   |   |   |   |   |   |   |   |   |   |  |

HCM 2010 Signalized Intersection Summary  
 3: SR 1 SB On-Ramp/SR 1 SB Off-Ramp & Imjin Parkway

Existing, AM  
 06/11/2019



| Movement                     | EBL | EBT | EBR | WBL  | WBT  | WBR  | NBL | NBT | NBR | SBL  | SBT  | SBR  |
|------------------------------|-----|-----|-----|------|------|------|-----|-----|-----|------|------|------|
| Lane Configurations          |     |     |     |      | ↕    |      |     |     |     |      | ↕    |      |
| Traffic Volume (veh/h)       | 0   | 0   | 0   | 959  | 0    | 0    | 0   | 0   | 0   | 409  | 5    | 0    |
| Future Volume (veh/h)        | 0   | 0   | 0   | 959  | 0    | 0    | 0   | 0   | 0   | 409  | 5    | 0    |
| Number                       |     |     |     | 1    | 6    | 16   |     |     |     | 7    | 4    | 14   |
| Initial Q (Qb), veh          |     |     |     | 0    | 0    | 0    |     |     |     | 0    | 0    | 0    |
| Ped-Bike Adj(A_pbT)          |     |     |     | 1.00 |      | 1.00 |     |     |     | 1.00 |      | 1.00 |
| Parking Bus, Adj             |     |     |     | 1.00 | 1.00 | 1.00 |     |     |     | 1.00 | 1.00 | 1.00 |
| Adj Sat Flow, veh/h/ln       |     |     |     | 1900 | 1845 | 0    |     |     |     | 1900 | 1845 | 0    |
| Adj Flow Rate, veh/h         |     |     |     | 1054 | 0    | 0    |     |     |     | 449  | 5    | 0    |
| Adj No. of Lanes             |     |     |     | 0    | 1    | 0    |     |     |     | 0    | 1    | 0    |
| Peak Hour Factor             |     |     |     | 0.91 | 0.91 | 0.91 |     |     |     | 0.91 | 0.91 | 0.91 |
| Percent Heavy Veh, %         |     |     |     | 3    | 3    | 0    |     |     |     | 3    | 3    | 0    |
| Cap, veh/h                   |     |     |     | 1123 | 0    | 0    |     |     |     | 502  | 6    | 0    |
| Arrive On Green              |     |     |     | 0.64 | 0.00 | 0.00 |     |     |     | 0.29 | 0.29 | 0.00 |
| Sat Flow, veh/h              |     |     |     | 1757 | 0    | 0    |     |     |     | 1738 | 19   | 0    |
| Grp Volume(v), veh/h         |     |     |     | 1054 | 0    | 0    |     |     |     | 454  | 0    | 0    |
| Grp Sat Flow(s),veh/h/ln     |     |     |     | 1757 | 0    | 0    |     |     |     | 1758 | 0    | 0    |
| Q Serve(g_s), s              |     |     |     | 65.8 | 0.0  | 0.0  |     |     |     | 30.1 | 0.0  | 0.0  |
| Cycle Q Clear(g_c), s        |     |     |     | 65.8 | 0.0  | 0.0  |     |     |     | 30.1 | 0.0  | 0.0  |
| Prop In Lane                 |     |     |     | 1.00 |      | 0.00 |     |     |     | 0.99 |      | 0.00 |
| Lane Grp Cap(c), veh/h       |     |     |     | 1123 | 0    | 0    |     |     |     | 508  | 0    | 0    |
| V/C Ratio(X)                 |     |     |     | 0.94 | 0.00 | 0.00 |     |     |     | 0.89 | 0.00 | 0.00 |
| Avail Cap(c_a), veh/h        |     |     |     | 1298 | 0    | 0    |     |     |     | 866  | 0    | 0    |
| HCM Platoon Ratio            |     |     |     | 1.00 | 1.00 | 1.00 |     |     |     | 1.00 | 1.00 | 1.00 |
| Upstream Filter(I)           |     |     |     | 1.00 | 0.00 | 0.00 |     |     |     | 1.00 | 0.00 | 0.00 |
| Uniform Delay (d), s/veh     |     |     |     | 19.6 | 0.0  | 0.0  |     |     |     | 41.3 | 0.0  | 0.0  |
| Incr Delay (d2), s/veh       |     |     |     | 12.1 | 0.0  | 0.0  |     |     |     | 6.7  | 0.0  | 0.0  |
| Initial Q Delay(d3),s/veh    |     |     |     | 0.0  | 0.0  | 0.0  |     |     |     | 0.0  | 0.0  | 0.0  |
| %ile BackOfQ(50%),veh/ln     |     |     |     | 35.4 | 0.0  | 0.0  |     |     |     | 15.6 | 0.0  | 0.0  |
| LnGrp Delay(d),s/veh         |     |     |     | 31.7 | 0.0  | 0.0  |     |     |     | 48.0 | 0.0  | 0.0  |
| LnGrp LOS                    |     |     |     | C    |      |      |     |     |     | D    |      |      |
| Approach Vol, veh/h          |     |     |     |      | 1054 |      |     |     |     |      | 454  |      |
| Approach Delay, s/veh        |     |     |     |      | 31.7 |      |     |     |     |      | 48.0 |      |
| Approach LOS                 |     |     |     |      | C    |      |     |     |     |      | D    |      |
| Timer                        | 1   | 2   | 3   | 4    | 5    | 6    | 7   | 8   |     |      |      |      |
| Assigned Phs                 |     |     |     | 4    |      | 6    |     |     |     |      |      |      |
| Phs Duration (G+Y+Rc), s     |     |     |     | 39.6 |      | 82.2 |     |     |     |      |      |      |
| Change Period (Y+Rc), s      |     |     |     | 4.4  |      | 4.4  |     |     |     |      |      |      |
| Max Green Setting (Gmax), s  |     |     |     | 60.0 |      | 90.0 |     |     |     |      |      |      |
| Max Q Clear Time (g_c+I1), s |     |     |     | 32.1 |      | 67.8 |     |     |     |      |      |      |
| Green Ext Time (p_c), s      |     |     |     | 3.0  |      | 10.0 |     |     |     |      |      |      |
| <b>Intersection Summary</b>  |     |     |     |      |      |      |     |     |     |      |      |      |
| HCM 2010 Ctrl Delay          |     |     |     | 36.6 |      |      |     |     |     |      |      |      |
| HCM 2010 LOS                 |     |     |     | D    |      |      |     |     |     |      |      |      |

| Intersection             |      |      |      |      |      |      |      |      |      |      |       |      |
|--------------------------|------|------|------|------|------|------|------|------|------|------|-------|------|
| Int Delay, s/veh         | 0    |      |      |      |      |      |      |      |      |      |       |      |
| Movement                 | EBL  | EBT  | EBR  | WBL  | WBT  | WBR  | NBL  | NBT  | NBR  | SBL  | SBT   | SBR  |
| Lane Configurations      |      | ↖    |      |      | ↑    | ↗    |      | ↖    | ↗    |      |       |      |
| Traffic Vol, veh/h       | 3    | 421  | 0    | 0    | 917  | 123  | 0    | 0    | 805  | 0    | 0     | 0    |
| Future Vol, veh/h        | 3    | 421  | 0    | 0    | 917  | 123  | 0    | 0    | 805  | 0    | 0     | 0    |
| Conflicting Peds, #/hr   | 0    | 0    | 3    | 3    | 0    | 0    | 0    | 0    | 0    | 0    | 0     | 0    |
| Sign Control             | Free | Free | Free | Free | Free | Free | Stop | Stop | Stop | Stop | Stop  | Stop |
| RT Channelized           | -    | -    | None | -    | -    | Free | -    | -    | Free | -    | -     | None |
| Storage Length           | -    | -    | -    | -    | -    | 0    | -    | -    | 800  | -    | -     | -    |
| Veh in Median Storage, # | -    | 0    | -    | -    | 0    | -    | -    | 0    | -    | -    | 16965 | -    |
| Grade, %                 | -    | 0    | -    | -    | 0    | -    | -    | 0    | -    | -    | 0     | -    |
| Peak Hour Factor         | 97   | 97   | 97   | 97   | 97   | 97   | 97   | 97   | 97   | 97   | 97    | 97   |
| Heavy Vehicles, %        | 3    | 3    | 3    | 3    | 3    | 3    | 2    | 2    | 2    | 2    | 2     | 2    |
| Mvmt Flow                | 3    | 434  | 0    | 0    | 945  | 127  | 0    | 0    | 830  | 0    | 0     | 0    |























| Major/Minor          | Major1 | Major2 | Minor1 |
|----------------------|--------|--------|--------|
| Conflicting Flow All | 945    | 0      | 0      |
| Stage 1              | -      | -      | -      |
| Stage 2              | -      | -      | -      |
| Critical Hdwy        | 4.13   | -      | -      |
| Critical Hdwy Stg 1  | -      | -      | -      |
| Critical Hdwy Stg 2  | -      | -      | -      |
| Follow-up Hdwy       | 2.227  | -      | -      |
| Pot Cap-1 Maneuver   | 722    | 0      | 0      |
| Stage 1              | -      | 0      | 0      |
| Stage 2              | -      | 0      | 0      |
| Platoon blocked, %   | -      | -      | -      |
| Mov Cap-1 Maneuver   | 722    | -      | -      |
| Mov Cap-2 Maneuver   | -      | -      | -      |
| Stage 1              | -      | -      | -      |
| Stage 2              | -      | -      | -      |

| Approach             | EB  | WB | NB |
|----------------------|-----|----|----|
| HCM Control Delay, s | 0.1 | 0  | 0  |
| HCM LOS              |     |    | A  |

| Minor Lane/Major Mvmt | NBLn1 | NBLn2 | EBL   | EBT | WBT |
|-----------------------|-------|-------|-------|-----|-----|
| Capacity (veh/h)      | -     | -     | 722   | -   | -   |
| HCM Lane V/C Ratio    | -     | -     | 0.004 | -   | -   |
| HCM Control Delay (s) | 0     | 0     | 10    | 0   | -   |
| HCM Lane LOS          | A     | A     | B     | A   | -   |
| HCM 95th %tile Q(veh) | -     | -     | 0     | -   | -   |

HCM 2010 Signalized Intersection Summary  
5: 2nd Avenue & Imjin Parkway

Existing, AM  
06/11/2019

|                              |  |  |  |  |  |  |  |  |  |  |  |  |
|------------------------------|---|---|---|---|---|---|--|---|---|---|---|---|
| Movement                     | EBL   | EBT   | EBR   | WBL   | WBT   | WBR   | NBL  | NBT   | NBR   | SBL   | SBT   | SBR   |
| Lane Configurations          |  |  |  |  |  |   |   |    |    |  |  |  |
| Traffic Volume (veh/h)       | 12  | 841   | 379   | 310   | 815   | 10  | 99   | 6   | 138   | 5   | 7   | 5   |
| Future Volume (veh/h)        | 12  | 841   | 379   | 310   | 815   | 10  | 99   | 6   | 138   | 5   | 7   | 5   |
| Number                       | 5   | 2   | 12  | 1   | 6   | 16  | 3  | 8   | 18  | 7   | 4   | 14  |
| Initial Q (Qb), veh          | 0   | 0   | 0   | 0   | 0   | 0   | 0  | 0   | 0   | 0   | 0   | 0   |
| Ped-Bike Adj(A_pbT)          | 1.00  |   | 1.00  | 1.00  |   | 1.00  | 1.00   |   | 1.00  | 1.00  |   | 1.00  |
| Parking Bus, Adj             | 1.00  | 1.00  | 1.00  | 1.00  | 1.00  | 1.00  | 1.00   | 1.00  | 1.00  | 1.00  | 1.00  | 1.00  |
| Adj Sat Flow, veh/h/ln       | 1863  | 1863  | 1863  | 1863  | 1863  | 1900  | 1810   | 1810  | 1810  | 1900  | 1900  | 1900  |
| Adj Flow Rate, veh/h         | 12  | 858   | 168   | 316   | 832   | 10  | 101  | 6   | 19  | 5   | 7   | 0   |
| Adj No. of Lanes             | 1   | 2   | 1   | 2   | 2   | 0   | 2  | 1   | 1   | 1   | 2   | 0   |
| Peak Hour Factor             | 0.98  | 0.98  | 0.98  | 0.98  | 0.98  | 0.98  | 0.98   | 0.98  | 0.98  | 0.98  | 0.98  | 0.98  |
| Percent Heavy Veh, %         | 2   | 2   | 2   | 2   | 2   | 2   | 5  | 5   | 5   | 0   | 0   | 0   |
| Cap, veh/h                   | 139   | 1083  | 484   | 483   | 1318  | 16  | 205  | 60  | 51  | 99  | 96  | 0   |
| Arrive On Green              | 0.08  | 0.31  | 0.31  | 0.14  | 0.37  | 0.37  | 0.06   | 0.03  | 0.03  | 0.05  | 0.03  | 0.00  |
| Sat Flow, veh/h              | 1774  | 3539  | 1583  | 3442  | 3582  | 43  | 3343   | 1810  | 1535  | 1810  | 3705  | 0   |
| Grp Volume(v), veh/h         | 12  | 858   | 168   | 316   | 411   | 431   | 101  | 6   | 19  | 5   | 7   | 0   |
| Grp Sat Flow(s),veh/h/ln     | 1774  | 1770  | 1583  | 1721  | 1770  | 1855  | 1672   | 1810  | 1535  | 1810  | 1805  | 0   |
| Q Serve(g_s), s              | 0.2   | 8.5   | 3.2   | 3.3   | 7.3   | 7.3   | 1.1  | 0.1   | 0.5   | 0.1   | 0.1   | 0.0   |
| Cycle Q Clear(g_c), s        | 0.2   | 8.5   | 3.2   | 3.3   | 7.3   | 7.3   | 1.1  | 0.1   | 0.5   | 0.1   | 0.1   | 0.0   |
| Prop In Lane                 | 1.00  |   | 1.00  | 1.00  |   | 0.02  | 1.00   |   | 1.00  | 1.00  |   | 0.00  |
| Lane Grp Cap(c), veh/h       | 139   | 1083  | 484   | 483   | 651   | 683   | 205  | 60  | 51  | 99  | 96  | 0   |
| V/C Ratio(X)                 | 0.09  | 0.79  | 0.35  | 0.65  | 0.63  | 0.63  | 0.49   | 0.10  | 0.37  | 0.05  | 0.07  | 0.00  |
| Avail Cap(c_a), veh/h        | 693   | 2764  | 1236  | 1344  | 1382  | 1449  | 1740   | 989   | 839   | 471   | 1973  | 0   |
| HCM Platoon Ratio            | 1.00  | 1.00  | 1.00  | 1.00  | 1.00  | 1.00  | 1.00   | 1.00  | 1.00  | 1.00  | 1.00  | 1.00  |
| Upstream Filter(I)           | 1.00  | 1.00  | 1.00  | 1.00  | 1.00  | 1.00  | 1.00   | 1.00  | 1.00  | 1.00  | 1.00  | 0.00  |
| Uniform Delay (d), s/veh     | 16.4  | 12.2  | 10.4  | 15.6  | 10.0  | 10.0  | 17.4   | 18.0  | 18.2  | 17.2  | 18.2  | 0.0   |
| Incr Delay (d2), s/veh       | 0.1   | 0.5   | 0.2   | 0.6   | 0.4   | 0.4   | 0.7  | 0.3   | 1.7   | 0.1   | 0.1   | 0.0   |
| Initial Q Delay(d3),s/veh    | 0.0   | 0.0   | 0.0   | 0.0   | 0.0   | 0.0   | 0.0  | 0.0   | 0.0   | 0.0   | 0.0   | 0.0   |
| %ile BackOfQ(50%),veh/ln     | 0.1   | 4.1   | 1.4   | 1.6   | 3.6   | 3.8   | 0.5  | 0.1   | 0.2   | 0.1   | 0.0   | 0.0   |
| LnGrp Delay(d),s/veh         | 16.5  | 12.7  | 10.5  | 16.2  | 10.4  | 10.4  | 18.1   | 18.3  | 19.8  | 17.3  | 18.4  | 0.0   |
| LnGrp LOS                    | B   | B   | B   | B   | B   | B   | B  | B   | B   | B   | B   | B   |
| Approach Vol, veh/h          |   | 1038  |   |   | 1158  |   |  | 126   |   |   |   | 12  |
| Approach Delay, s/veh        |   | 12.4  |   |   | 12.0  |   |  | 18.4  |   |   |   | 17.9  |
| Approach LOS                 |   | B   |   |   | B   |   |  | B   |   |   |   | B   |
| Timer                        | 1   | 2   | 3   | 4   | 5   | 6   | 7  | 8   |   |   |   |   |
| Assigned Phs                 | 1   | 2   | 3   | 4   | 5   | 6   | 7  | 8   |   |   |   |   |
| Phs Duration (G+Y+Rc), s     | 9.9   | 17.1  | 5.9   | 5.6   | 7.5   | 19.4  | 5.6  | 5.9   |   |   |   |   |
| Change Period (Y+Rc), s      | 4.5   | 5.3   | 3.5   | 4.6   | 4.5   | 5.3   | 3.5  | 4.6   |   |   |   |   |
| Max Green Setting (Gmax), s  | 15.0  | 30.0  | 20.0  | 21.0  | 15.0  | 30.0  | 10.0   | 21.0  |   |   |   |   |
| Max Q Clear Time (g_c+I1), s | 5.3   | 10.5  | 3.1   | 2.1   | 2.2   | 9.3   | 2.1  | 2.5   |   |   |   |   |
| Green Ext Time (p_c), s      | 0.0   | 1.2   | 0.0   | 0.0   | 0.0   | 0.9   | 0.0  | 0.0   |   |   |   |   |
| <b>Intersection Summary</b>  |   |   |   |   |   |   |  |   |   |   |   |   |
| HCM 2010 Ctrl Delay          |   |   | 12.5  |   |   |   |  |   |   |   |   |   |
| HCM 2010 LOS                 |   |   | B   |   |   |   |  |   |   |   |   |   |

| Intersection             |      |      |      |      |      |      |      |      |      |      |      |      |
|--------------------------|------|------|------|------|------|------|------|------|------|------|------|------|
| Int Delay, s/veh         | 3.7  |      |      |      |      |      |      |      |      |      |      |      |
| Movement                 | EBL  | EBT  | EBR  | WBL  | WBT  | WBR  | NBL  | NBT  | NBR  | SBL  | SBT  | SBR  |
| Lane Configurations      | ↖    | ↖↗   |      | ↖    | ↖↗   |      | ↖    | ↗    |      | ↖    | ↗    |      |
| Traffic Vol, veh/h       | 46   | 800  | 13   | 234  | 1208 | 24   | 3    | 1    | 16   | 6    | 3    | 31   |
| Future Vol, veh/h        | 46   | 800  | 13   | 234  | 1208 | 24   | 3    | 1    | 16   | 6    | 3    | 31   |
| Conflicting Peds, #/hr   | 1    | 0    | 1    | 1    | 0    | 1    | 0    | 0    | 2    | 2    | 0    | 0    |
| Sign Control             | Free | Free | Free | Free | Free | Free | Stop | Stop | Stop | Stop | Stop | Stop |
| RT Channelized           | -    | -    | None | -    | -    | None | -    | -    | None | -    | -    | None |
| Storage Length           | 300  | -    | -    | 300  | -    | -    | 85   | -    | -    | 25   | -    | -    |
| Veh in Median Storage, # | -    | 0    | -    | -    | 0    | -    | -    | 0    | -    | -    | 0    | -    |
| Grade, %                 | -    | 0    | -    | -    | 0    | -    | -    | 0    | -    | -    | 0    | -    |
| Peak Hour Factor         | 96   | 96   | 96   | 96   | 96   | 96   | 96   | 96   | 96   | 96   | 96   | 96   |
| Heavy Vehicles, %        | 2    | 2    | 2    | 2    | 2    | 2    | 5    | 5    | 5    | 2    | 2    | 2    |
| Mvmt Flow                | 48   | 833  | 14   | 244  | 1258 | 25   | 3    | 1    | 17   | 6    | 3    | 32   |

| Major/Minor          | Major1 |   | Major2 |      | Minor1 |   | Minor2 |      |      |      |      |      |
|----------------------|--------|---|--------|------|--------|---|--------|------|------|------|------|------|
| Conflicting Flow All | 1284   | 0 | 0      | 848  | 0      | 0 | 2056   | 2709 | 427  | 2275 | 2704 | 643  |
| Stage 1              | -      | - | -      | -    | -      | - | 937    | 937  | -    | 1760 | 1760 | -    |
| Stage 2              | -      | - | -      | -    | -      | - | 1119   | 1772 | -    | 515  | 944  | -    |
| Critical Hdwy        | 4.14   | - | -      | 4.14 | -      | - | 7.6    | 6.6  | 7    | 7.54 | 6.54 | 6.94 |
| Critical Hdwy Stg 1  | -      | - | -      | -    | -      | - | 6.6    | 5.6  | -    | 6.54 | 5.54 | -    |
| Critical Hdwy Stg 2  | -      | - | -      | -    | -      | - | 6.6    | 5.6  | -    | 6.54 | 5.54 | -    |
| Follow-up Hdwy       | 2.22   | - | -      | 2.22 | -      | - | 3.55   | 4.05 | 3.35 | 3.52 | 4.02 | 3.32 |
| Pot Cap-1 Maneuver   | 536    | - | -      | 785  | -      | - | 31     | 20   | 568  | 22   | 21   | 416  |
| Stage 1              | -      | - | -      | -    | -      | - | 279    | 335  | -    | 88   | 136  | -    |
| Stage 2              | -      | - | -      | -    | -      | - | 215    | 130  | -    | 511  | 339  | -    |
| Platoon blocked, %   | -      | - | -      | -    | -      | - | -      | -    | -    | -    | -    | -    |
| Mov Cap-1 Maneuver   | 535    | - | -      | 784  | -      | - | 17     | 13   | 566  | 14   | 13   | 416  |
| Mov Cap-2 Maneuver   | -      | - | -      | -    | -      | - | 17     | 13   | -    | 14   | 13   | -    |
| Stage 1              | -      | - | -      | -    | -      | - | 254    | 305  | -    | 80   | 94   | -    |
| Stage 2              | -      | - | -      | -    | -      | - | 132    | 89   | -    | 449  | 308  | -    |

| Approach             | EB  | WB  | NB   | SB    |
|----------------------|-----|-----|------|-------|
| HCM Control Delay, s | 0.7 | 1.9 | 64.3 | 103.6 |
| HCM LOS              |     |     | F    | F     |

| Minor Lane/Major Mvmt | NBLn1 | NBLn2 | EBL  | EBT | EBR | WBL   | WBT | WBR | SBLn1 | SBLn2 |
|-----------------------|-------|-------|------|-----|-----|-------|-----|-----|-------|-------|
| Capacity (veh/h)      | 17    | 162   | 535  | -   | -   | 784   | -   | -   | 14    | 111   |
| HCM Lane V/C Ratio    | 0.184 | 0.109 | 0.09 | -   | -   | 0.311 | -   | -   | 0.446 | 0.319 |
| HCM Control Delay (s) | 259.5 | 29.9  | 12.4 | -   | -   | 11.7  | -   | -   | 396.8 | 51.9  |
| HCM Lane LOS          | F     | D     | B    | -   | -   | B     | -   | -   | F     | F     |
| HCM 95th %tile Q(veh) | 0.5   | 0.4   | 0.3  | -   | -   | 1.3   | -   | -   | 1.1   | 1.2   |

| Intersection             |      |      |      |      |      |      |      |      |      |      |      |      |
|--------------------------|------|------|------|------|------|------|------|------|------|------|------|------|
| Int Delay, s/veh         | 0.4  |      |      |      |      |      |      |      |      |      |      |      |
| Movement                 | EBL  | EBT  | EBR  | WBL  | WBT  | WBR  | NBL  | NBT  | NBR  | SBL  | SBT  | SBR  |
| Lane Configurations      | ↙    | ↕    |      | ↙    | ↕    |      |      | ↕    |      |      | ↕    |      |
| Traffic Vol, veh/h       | 2    | 886  | 19   | 5    | 1407 | 8    | 3    | 0    | 1    | 3    | 1    | 2    |
| Future Vol, veh/h        | 2    | 886  | 19   | 5    | 1407 | 8    | 3    | 0    | 1    | 3    | 1    | 2    |
| Conflicting Peds, #/hr   | 1    | 0    | 1    | 1    | 0    | 1    | 0    | 0    | 0    | 0    | 0    | 0    |
| Sign Control             | Free | Free | Free | Free | Free | Free | Stop | Stop | Stop | Stop | Stop | Stop |
| RT Channelized           | -    | -    | None | -    | -    | None | -    | -    | None | -    | -    | Stop |
| Storage Length           | 330  | -    | -    | 330  | -    | -    | -    | -    | -    | -    | -    | -    |
| Veh in Median Storage, # | -    | 0    | -    | -    | 0    | -    | -    | 0    | -    | -    | 0    | -    |
| Grade, %                 | -    | 0    | -    | -    | 0    | -    | -    | 0    | -    | -    | 0    | -    |
| Peak Hour Factor         | 96   | 96   | 96   | 96   | 96   | 96   | 96   | 96   | 96   | 96   | 96   | 96   |
| Heavy Vehicles, %        | 2    | 2    | 2    | 2    | 2    | 2    | 50   | 50   | 50   | 0    | 0    | 0    |
| Mvmt Flow                | 2    | 923  | 20   | 5    | 1466 | 8    | 3    | 0    | 1    | 3    | 1    | 2    |



















| Major/Minor          | Major1 |   |   | Major2 |   |   | Minor1 |      |     | Minor2 |      |     |
|----------------------|--------|---|---|--------|---|---|--------|------|-----|--------|------|-----|
| Conflicting Flow All | 1475   | 0 | 0 | 944    | 0 | 0 | 1682   | 2423 | 473 | 1947   | 2429 | 738 |
| Stage 1              | -      | - | - | -      | - | - | 938    | 938  | -   | 1481   | 1481 | -   |
| Stage 2              | -      | - | - | -      | - | - | 744    | 1485 | -   | 466    | 948  | -   |
| Critical Hdwy        | 4.14   | - | - | 4.14   | - | - | 8.5    | 7.5  | 7.9 | 7.5    | 6.5  | 6.9 |
| Critical Hdwy Stg 1  | -      | - | - | -      | - | - | 7.5    | 6.5  | -   | 6.5    | 5.5  | -   |
| Critical Hdwy Stg 2  | -      | - | - | -      | - | - | 7.5    | 6.5  | -   | 6.5    | 5.5  | -   |
| Follow-up Hdwy       | 2.22   | - | - | 2.22   | - | - | 4      | 4.5  | 3.8 | 3.5    | 4    | 3.3 |
| Pot Cap-1 Maneuver   | 453    | - | - | 722    | - | - | 37     | 16   | 426 | 40     | 32   | 365 |
| Stage 1              | -      | - | - | -      | - | - | 205    | 250  | -   | 134    | 191  | -   |
| Stage 2              | -      | - | - | -      | - | - | 281    | 121  | -   | 551    | 342  | -   |
| Platoon blocked, %   | -      | - | - | -      | - | - | -      | -    | -   | -      | -    | -   |
| Mov Cap-1 Maneuver   | 453    | - | - | 721    | - | - | 36     | 16   | 426 | 40     | 32   | 365 |
| Mov Cap-2 Maneuver   | -      | - | - | -      | - | - | 36     | 16   | -   | 40     | 32   | -   |
| Stage 1              | -      | - | - | -      | - | - | 204    | 249  | -   | 133    | 189  | -   |
| Stage 2              | -      | - | - | -      | - | - | 276    | 120  | -   | 547    | 340  | -   |

| Approach             | EB |  |  | WB |  |  | NB   |  |  | SB   |  |  |
|----------------------|----|--|--|----|--|--|------|--|--|------|--|--|
| HCM Control Delay, s | 0  |  |  | 0  |  |  | 88.9 |  |  | 77.2 |  |  |
| HCM LOS              |    |  |  |    |  |  | F    |  |  | F    |  |  |

| Minor Lane/Major Mvmt | NBLn1 | EBL   | EBT | EBR | WBL   | WBT | WBR | SBLn1 |
|-----------------------|-------|-------|-----|-----|-------|-----|-----|-------|
| Capacity (veh/h)      | 47    | 453   | -   | -   | 721   | -   | -   | 56    |
| HCM Lane V/C Ratio    | 0.089 | 0.005 | -   | -   | 0.007 | -   | -   | 0.112 |
| HCM Control Delay (s) | 88.9  | 13    | -   | -   | 10    | -   | -   | 77.2  |
| HCM Lane LOS          | F     | B     | -   | -   | B     | -   | -   | F     |
| HCM 95th %tile Q(veh) | 0.3   | 0     | -   | -   | 0     | -   | -   | 0.4   |

HCM 2010 Signalized Intersection Summary  
 8: 5th Avenue/California Avenue & Imjin Parkway

Existing, AM  
 06/11/2019

|                              |  |  |  |  |  |  |  |  |  |  |  |  |
|------------------------------|---|---|---|---|---|---|--|---|---|---|---|---|
| Movement                     | EBL   | EBT   | EBR   | WBL   | WBT   | WBR   | NBL  | NBT   | NBR   | SBL   | SBT   | SBR   |
| Lane Configurations          |  |  |   |  |  |   |  |  |   |   |  |   |
| Traffic Volume (veh/h)       | 113   | 761   | 20  | 4   | 931   | 58  | 12   | 10  | 1   | 70  | 146   | 389   |
| Future Volume (veh/h)        | 113   | 761   | 20  | 4   | 931   | 58  | 12   | 10  | 1   | 70  | 146   | 389   |
| Number                       | 5   | 2   | 12  | 1   | 6   | 16  | 3  | 8   | 18  | 7   | 4   | 14  |
| Initial Q (Qb), veh          | 0   | 0   | 0   | 0   | 0   | 0   | 0  | 0   | 0   | 0   | 0   | 0   |
| Ped-Bike Adj(A_pbT)          | 1.00  |   | 0.98  | 1.00  |   | 1.00  | 1.00   |   | 1.00  | 1.00  |   | 1.00  |
| Parking Bus, Adj             | 1.00  | 1.00  | 1.00  | 1.00  | 1.00  | 1.00  | 1.00   | 1.00  | 1.00  | 1.00  | 1.00  | 1.00  |
| Adj Sat Flow, veh/h/ln       | 1881  | 1881  | 1900  | 1863  | 1863  | 1900  | 1900   | 1624  | 1900  | 1900  | 1881  | 1900  |
| Adj Flow Rate, veh/h         | 119   | 801   | 19  | 4   | 980   | 55  | 13   | 11  | 0   | 74  | 154   | 335   |
| Adj No. of Lanes             | 1   | 2   | 0   | 1   | 2   | 0   | 0  | 1   | 0   | 0   | 1   | 0   |
| Peak Hour Factor             | 0.95  | 0.95  | 0.95  | 0.95  | 0.95  | 0.95  | 0.95   | 0.95  | 0.95  | 0.95  | 0.95  | 0.95  |
| Percent Heavy Veh, %         | 1   | 1   | 1   | 2   | 2   | 2   | 17   | 17  | 17  | 1   | 1   | 1   |
| Cap, veh/h                   | 153   | 1441  | 34  | 6   | 1097  | 62  | 223  | 153   | 0   | 127   | 183   | 349   |
| Arrive On Green              | 0.09  | 0.40  | 0.40  | 0.00  | 0.32  | 0.32  | 0.37   | 0.35  | 0.00  | 0.37  | 0.35  | 0.35  |
| Sat Flow, veh/h              | 1792  | 3567  | 85  | 1774  | 3407  | 191   | 352  | 431   | 0   | 155   | 515   | 984   |
| Grp Volume(v), veh/h         | 119   | 401   | 419   | 4   | 509   | 526   | 24   | 0   | 0   | 563   | 0   | 0   |
| Grp Sat Flow(s),veh/h/ln     | 1792  | 1787  | 1864  | 1774  | 1770  | 1829  | 782  | 0   | 0   | 1654  | 0   | 0   |
| Q Serve(g_s), s              | 3.7   | 9.7   | 9.7   | 0.1   | 15.4  | 15.4  | 0.0  | 0.0   | 0.0   | 12.7  | 0.0   | 0.0   |
| Cycle Q Clear(g_c), s        | 3.7   | 9.7   | 9.7   | 0.1   | 15.4  | 15.4  | 0.5  | 0.0   | 0.0   | 18.4  | 0.0   | 0.0   |
| Prop In Lane                 | 1.00  |   | 0.05  | 1.00  |   | 0.10  | 0.54   |   | 0.00  | 0.13  |   | 0.60  |
| Lane Grp Cap(c), veh/h       | 153   | 722   | 753   | 6   | 570   | 589   | 385  | 0   | 0   | 677   | 0   | 0   |
| V/C Ratio(X)                 | 0.78  | 0.56  | 0.56  | 0.70  | 0.89  | 0.89  | 0.06   | 0.00  | 0.00  | 0.83  | 0.00  | 0.00  |
| Avail Cap(c_a), veh/h        | 477   | 951   | 992   | 472   | 942   | 974   | 385  | 0   | 0   | 677   | 0   | 0   |
| HCM Platoon Ratio            | 1.00  | 1.00  | 1.00  | 1.00  | 1.00  | 1.00  | 1.00   | 1.00  | 1.00  | 1.00  | 1.00  | 1.00  |
| Upstream Filter(I)           | 1.00  | 1.00  | 1.00  | 1.00  | 1.00  | 1.00  | 1.00   | 0.00  | 0.00  | 1.00  | 0.00  | 0.00  |
| Uniform Delay (d), s/veh     | 25.3  | 12.9  | 12.9  | 28.1  | 18.2  | 18.2  | 11.8   | 0.0   | 0.0   | 17.6  | 0.0   | 0.0   |
| Incr Delay (d2), s/veh       | 3.2   | 0.2   | 0.2   | 43.9  | 3.8   | 3.7   | 0.0  | 0.0   | 0.0   | 8.2   | 0.0   | 0.0   |
| Initial Q Delay(d3),s/veh    | 0.0   | 0.0   | 0.0   | 0.0   | 0.0   | 0.0   | 0.0  | 0.0   | 0.0   | 0.0   | 0.0   | 0.0   |
| %ile BackOfQ(50%),veh/ln     | 2.0   | 4.8   | 5.1   | 0.1   | 8.1   | 8.3   | 0.2  | 0.0   | 0.0   | 9.7   | 0.0   | 0.0   |
| LnGrp Delay(d),s/veh         | 28.5  | 13.2  | 13.1  | 71.9  | 21.9  | 21.8  | 11.8   | 0.0   | 0.0   | 25.8  | 0.0   | 0.0   |
| LnGrp LOS                    | C   | B   | B   | E   | C   | C   | B  |   |   | C   |   |   |
| Approach Vol, veh/h          |   | 939   |   |   | 1039  |   |  | 24  |   |   | 563   |   |
| Approach Delay, s/veh        |   | 15.1  |   |   | 22.1  |   |  | 11.8  |   |   | 25.8  |   |
| Approach LOS                 |   | B   |   |   | C   |   |  | B   |   |   | C   |   |
| Timer                        | 1   | 2   | 3   | 4   | 5   | 6   | 7  | 8   |   |   |   |   |
| Assigned Phs                 | 1   | 2   |   | 4   | 5   | 6   |  | 8   |   |   |   |   |
| Phs Duration (G+Y+Rc), s     | 3.7   | 28.1  |   | 24.6  | 8.3   | 23.4  |  | 24.6  |   |   |   |   |
| Change Period (Y+Rc), s      | 3.5   | 5.3   |   | 4.6   | 3.5   | 5.3   |  | 4.6   |   |   |   |   |
| Max Green Setting (Gmax), s  | 15.0  | 30.0  |   | 20.0  | 15.0  | 30.0  |  | 20.0  |   |   |   |   |
| Max Q Clear Time (g_c+I1), s | 2.1   | 11.7  |   | 20.4  | 5.7   | 17.4  |  | 2.5   |   |   |   |   |
| Green Ext Time (p_c), s      | 0.0   | 0.6   |   | 0.0   | 0.0   | 0.7   |  | 0.0   |   |   |   |   |
| <b>Intersection Summary</b>  |   |   |   |   |   |   |  |   |   |   |   |   |
| HCM 2010 Ctrl Delay          |   |   |   | 20.2  |   |   |  |   |   |   |   |   |
| HCM 2010 LOS                 |   |   |   | C   |   |   |  |   |   |   |   |   |



| Intersection             |      |      |      |      |      |      |
|--------------------------|------|------|------|------|------|------|
| Int Delay, s/veh         | 1.4  |      |      |      |      |      |
| Movement                 | EBL  | EBR  | NBL  | NBT  | SBT  | SBR  |
| Lane Configurations      | Y    |      | Y    | ↑    | ↑    |      |
| Traffic Vol, veh/h       | 29   | 28   | 27   | 188  | 574  | 74   |
| Future Vol, veh/h        | 29   | 28   | 27   | 188  | 574  | 74   |
| Conflicting Peds, #/hr   | 0    | 0    | 0    | 0    | 0    | 0    |
| Sign Control             | Stop | Stop | Free | Free | Free | Free |
| RT Channelized           | -    | None | -    | None | -    | None |
| Storage Length           | 0    | -    | 155  | -    | -    | -    |
| Veh in Median Storage, # | 0    | -    | -    | 0    | 0    | -    |
| Grade, %                 | 0    | -    | -    | 0    | 0    | -    |
| Peak Hour Factor         | 92   | 92   | 92   | 92   | 92   | 92   |
| Heavy Vehicles, %        | 2    | 2    | 2    | 2    | 2    | 2    |
| Mvmt Flow                | 32   | 30   | 29   | 204  | 624  | 80   |











| Major/Minor          | Minor2 | Major1 | Major2 |   |   |   |
|----------------------|--------|--------|--------|---|---|---|
| Conflicting Flow All | 926    | 664    | 704    | 0 | - | 0 |
| Stage 1              | 664    | -      | -      | - | - | - |
| Stage 2              | 262    | -      | -      | - | - | - |
| Critical Hdwy        | 6.42   | 6.22   | 4.12   | - | - | - |
| Critical Hdwy Stg 1  | 5.42   | -      | -      | - | - | - |
| Critical Hdwy Stg 2  | 5.42   | -      | -      | - | - | - |
| Follow-up Hdwy       | 3.518  | 3.318  | 2.218  | - | - | - |
| Pot Cap-1 Maneuver   | 298    | 461    | 894    | - | - | - |
| Stage 1              | 512    | -      | -      | - | - | - |
| Stage 2              | 782    | -      | -      | - | - | - |
| Platoon blocked, %   |        |        |        | - | - | - |
| Mov Cap-1 Maneuver   | 288    | 461    | 894    | - | - | - |
| Mov Cap-2 Maneuver   | 288    | -      | -      | - | - | - |
| Stage 1              | 496    | -      | -      | - | - | - |
| Stage 2              | 782    | -      | -      | - | - | - |

| Approach             | EB   | NB  | SB |
|----------------------|------|-----|----|
| HCM Control Delay, s | 17.4 | 1.2 | 0  |
| HCM LOS              | C    |     |    |

| Minor Lane/Major Mvmt | NBL   | NBT | EBLn1 | SBT | SBR |
|-----------------------|-------|-----|-------|-----|-----|
| Capacity (veh/h)      | 894   | -   | 353   | -   | -   |
| HCM Lane V/C Ratio    | 0.033 | -   | 0.176 | -   | -   |
| HCM Control Delay (s) | 9.2   | -   | 17.4  | -   | -   |
| HCM Lane LOS          | A     | -   | C     | -   | -   |
| HCM 95th %tile Q(veh) | 0.1   | -   | 0.6   | -   | -   |

HCM 2010 Signalized Intersection Summary  
 10: Imjin Road & Imjin Parkway

Existing, AM  
 06/11/2019

|                              |  |  |  |  |  |  |   |      |
|------------------------------|---|---|---|---|---|---|---|------|
| Movement                     | EBT   | EBR   | WBL   | WBT   | NBL   | NBR   |   |      |
| Lane Configurations          |  |   |  |  |  |  |   |      |
| Traffic Volume (veh/h)       | 737   | 130   | 216   | 974   | 20  | 41  |   |      |
| Future Volume (veh/h)        | 737   | 130   | 216   | 974   | 20  | 41  |   |      |
| Number                       | 2   | 12  | 1   | 6   | 3   | 18  |   |      |
| Initial Q (Qb), veh          | 0   | 0   | 0   | 0   | 0   | 0   |   |      |
| Ped-Bike Adj(A_pbT)          |   | 1.00  | 1.00  |   | 1.00  | 1.00  |   |      |
| Parking Bus, Adj             | 1.00  | 1.00  | 1.00  | 1.00  | 1.00  | 1.00  |   |      |
| Adj Sat Flow, veh/h/ln       | 1863  | 1900  | 1845  | 1845  | 1810  | 1810  |   |      |
| Adj Flow Rate, veh/h         | 776   | 124   | 227   | 1025  | 21  | 43  |   |      |
| Adj No. of Lanes             | 2   | 0   | 1   | 2   | 1   | 2   |   |      |
| Peak Hour Factor             | 0.95  | 0.95  | 0.95  | 0.95  | 0.95  | 0.95  |   |      |
| Percent Heavy Veh, %         | 2   | 2   | 3   | 3   | 5   | 5   |   |      |
| Cap, veh/h                   | 974   | 156   | 287   | 2296  | 71  | 127   |   |      |
| Arrive On Green              | 0.32  | 0.32  | 0.16  | 0.66  | 0.04  | 0.04  |   |      |
| Sat Flow, veh/h              | 3151  | 489   | 1757  | 3597  | 1723  | 3076  |   |      |
| Grp Volume(v), veh/h         | 449   | 451   | 227   | 1025  | 21  | 43  |   |      |
| Grp Sat Flow(s),veh/h/ln     | 1770  | 1777  | 1757  | 1752  | 1723  | 1538  |   |      |
| Q Serve(g_s), s              | 7.1   | 7.1   | 3.8   | 4.4   | 0.4   | 0.4   |   |      |
| Cycle Q Clear(g_c), s        | 7.1   | 7.1   | 3.8   | 4.4   | 0.4   | 0.4   |   |      |
| Prop In Lane                 |   | 0.27  | 1.00  |   | 1.00  | 1.00  |   |      |
| Lane Grp Cap(c), veh/h       | 564   | 566   | 287   | 2296  | 71  | 127   |   |      |
| V/C Ratio(X)                 | 0.80  | 0.80  | 0.79  | 0.45  | 0.30  | 0.34  |   |      |
| Avail Cap(c_a), veh/h        | 1734  | 1741  | 1148  | 3435  | 1239  | 2211  |   |      |
| HCM Platoon Ratio            | 1.00  | 1.00  | 1.00  | 1.00  | 1.00  | 1.00  |   |      |
| Upstream Filter(I)           | 1.00  | 1.00  | 1.00  | 1.00  | 1.00  | 1.00  |   |      |
| Uniform Delay (d), s/veh     | 9.5   | 9.5   | 12.3  | 2.6   | 14.2  | 14.3  |   |      |
| Incr Delay (d2), s/veh       | 1.0   | 1.0   | 1.9   | 0.1   | 0.9   | 0.6   |   |      |
| Initial Q Delay(d3),s/veh    | 0.0   | 0.0   | 0.0   | 0.0   | 0.0   | 0.0   |   |      |
| %ile BackOfQ(50%),veh/ln     | 3.5   | 3.5   | 2.0   | 2.0   | 0.2   | 0.2   |   |      |
| LnGrp Delay(d),s/veh         | 10.5  | 10.5  | 14.2  | 2.6   | 15.1  | 14.9  |   |      |
| LnGrp LOS                    | B   | B   | B   | A   | B   | B   |   |      |
| Approach Vol, veh/h          | 900   |   |   | 1252  | 64  |   |   |      |
| Approach Delay, s/veh        | 10.5  |   |   | 4.7   | 14.9  |   |   |      |
| Approach LOS                 | B   |   |   | A   | B   |   |   |      |
| Timer                        | 1   | 2   | 3   | 4   | 5   | 6   | 7 | 8    |
| Assigned Phs                 | 1   | 2   |   |   |   | 6   |   | 8    |
| Phs Duration (G+Y+Rc), s     | 10.3  | 15.1  |   |   |   | 25.4  |   | 5.3  |
| Change Period (Y+Rc), s      | 5.3   | * 5.3   |   |   |   | 5.3   |   | 4.0  |
| Max Green Setting (Gmax), s  | 20.0  | * 30  |   |   |   | 30.0  |   | 22.0 |
| Max Q Clear Time (g_c+I1), s | 5.8   | 9.1   |   |   |   | 6.4   |   | 2.4  |
| Green Ext Time (p_c), s      | 0.0   | 0.7   |   |   |   | 1.2   |   | 0.0  |
| <b>Intersection Summary</b>  |   |   |   |   |   |   |   |      |
| HCM 2010 Ctrl Delay          |   |   | 7.4   |   |   |   |   |      |
| HCM 2010 LOS                 |   |   | A   |   |   |   |   |      |
| <b>Notes</b>                 |   |   |   |   |   |   |   |      |

HCM 2010 Signalized Intersection Summary  
 11: Abrams Drive & Imjin Parkway

Existing, AM  
 06/11/2019



| Movement                     | EBL  | EBT  | EBR  | WBL  | WBT  | WBR  | NBL  | NBT  | NBR  | SBL  | SBT  | SBR  |
|------------------------------|------|------|------|------|------|------|------|------|------|------|------|------|
| Lane Configurations          |      |      |      |      |      |      |      |      |      |      |      |      |
| Traffic Volume (veh/h)       | 35   | 647  | 31   | 78   | 914  | 17   | 127  | 18   | 113  | 33   | 42   | 187  |
| Future Volume (veh/h)        | 35   | 647  | 31   | 78   | 914  | 17   | 127  | 18   | 113  | 33   | 42   | 187  |
| Number                       | 5    | 2    | 12   | 1    | 6    | 16   | 3    | 8    | 18   | 7    | 4    | 14   |
| Initial Q (Qb), veh          | 0    | 0    | 0    | 0    | 0    | 0    | 0    | 0    | 0    | 0    | 0    | 0    |
| Ped-Bike Adj(A_pbT)          | 1.00 |      | 1.00 | 1.00 |      | 1.00 | 1.00 |      | 1.00 | 1.00 |      | 1.00 |
| Parking Bus, Adj             | 1.00 | 1.00 | 1.00 | 1.00 | 1.00 | 1.00 | 1.00 | 1.00 | 1.00 | 1.00 | 1.00 | 1.00 |
| Adj Sat Flow, veh/h/ln       | 1881 | 1881 | 1881 | 1863 | 1863 | 1863 | 1900 | 1845 | 1845 | 1900 | 1863 | 1863 |
| Adj Flow Rate, veh/h         | 38   | 696  | 0    | 84   | 983  | 0    | 137  | 19   | 0    | 35   | 45   | 0    |
| Adj No. of Lanes             | 1    | 1    | 1    | 1    | 1    | 1    | 0    | 1    | 1    | 0    | 1    | 1    |
| Peak Hour Factor             | 0.93 | 0.93 | 0.93 | 0.93 | 0.93 | 0.93 | 0.93 | 0.93 | 0.93 | 0.93 | 0.93 | 0.93 |
| Percent Heavy Veh, %         | 1    | 1    | 1    | 2    | 2    | 2    | 3    | 3    | 3    | 2    | 2    | 2    |
| Cap, veh/h                   | 82   | 1151 | 978  | 108  | 1153 | 980  | 277  | 24   | 207  | 153  | 161  | 209  |
| Arrive On Green              | 0.05 | 0.61 | 0.00 | 0.06 | 0.62 | 0.00 | 0.13 | 0.13 | 0.00 | 0.13 | 0.13 | 0.00 |
| Sat Flow, veh/h              | 1792 | 1881 | 1599 | 1774 | 1863 | 1583 | 1316 | 182  | 1568 | 557  | 1224 | 1583 |
| Grp Volume(v), veh/h         | 38   | 696  | 0    | 84   | 983  | 0    | 156  | 0    | 0    | 80   | 0    | 0    |
| Grp Sat Flow(s),veh/h/ln     | 1792 | 1881 | 1599 | 1774 | 1863 | 1583 | 1498 | 0    | 1568 | 1781 | 0    | 1583 |
| Q Serve(g_s), s              | 1.4  | 14.9 | 0.0  | 3.1  | 27.8 | 0.0  | 3.9  | 0.0  | 0.0  | 0.0  | 0.0  | 0.0  |
| Cycle Q Clear(g_c), s        | 1.4  | 14.9 | 0.0  | 3.1  | 27.8 | 0.0  | 6.4  | 0.0  | 0.0  | 2.6  | 0.0  | 0.0  |
| Prop In Lane                 | 1.00 |      | 1.00 | 1.00 |      | 1.00 | 0.88 |      | 1.00 | 0.44 |      | 1.00 |
| Lane Grp Cap(c), veh/h       | 82   | 1151 | 978  | 108  | 1153 | 980  | 301  | 0    | 207  | 314  | 0    | 209  |
| V/C Ratio(X)                 | 0.46 | 0.60 | 0.00 | 0.78 | 0.85 | 0.00 | 0.52 | 0.00 | 0.00 | 0.25 | 0.00 | 0.00 |
| Avail Cap(c_a), veh/h        | 548  | 1438 | 1223 | 543  | 1424 | 1211 | 754  | 0    | 719  | 843  | 0    | 726  |
| HCM Platoon Ratio            | 1.00 | 1.00 | 1.00 | 1.00 | 1.00 | 1.00 | 1.00 | 1.00 | 1.00 | 1.00 | 1.00 | 1.00 |
| Upstream Filter(I)           | 1.00 | 1.00 | 0.00 | 1.00 | 1.00 | 0.00 | 1.00 | 0.00 | 0.00 | 1.00 | 0.00 | 0.00 |
| Uniform Delay (d), s/veh     | 30.4 | 7.8  | 0.0  | 30.3 | 10.1 | 0.0  | 27.2 | 0.0  | 0.0  | 25.7 | 0.0  | 0.0  |
| Incr Delay (d2), s/veh       | 1.5  | 0.2  | 0.0  | 4.6  | 3.7  | 0.0  | 0.5  | 0.0  | 0.0  | 0.2  | 0.0  | 0.0  |
| Initial Q Delay(d3),s/veh    | 0.0  | 0.0  | 0.0  | 0.0  | 0.0  | 0.0  | 0.0  | 0.0  | 0.0  | 0.0  | 0.0  | 0.0  |
| %ile BackOfQ(50%),veh/ln     | 0.7  | 7.6  | 0.0  | 1.6  | 15.1 | 0.0  | 2.8  | 0.0  | 0.0  | 1.3  | 0.0  | 0.0  |
| LnGrp Delay(d),s/veh         | 31.9 | 8.0  | 0.0  | 34.8 | 13.7 | 0.0  | 27.8 | 0.0  | 0.0  | 25.9 | 0.0  | 0.0  |
| LnGrp LOS                    | C    | A    |      | C    | B    |      | C    |      |      | C    |      |      |
| Approach Vol, veh/h          |      | 734  |      |      | 1067 |      |      | 156  |      |      | 80   |      |
| Approach Delay, s/veh        |      | 9.3  |      |      | 15.4 |      |      | 27.8 |      |      | 25.9 |      |
| Approach LOS                 |      | A    |      |      | B    |      |      | C    |      |      | C    |      |
| Timer                        | 1    | 2    | 3    | 4    | 5    | 6    | 7    | 8    |      |      |      |      |
| Assigned Phs                 | 1    | 2    |      | 4    | 5    | 6    |      | 8    |      |      |      |      |
| Phs Duration (G+Y+Rc), s     | 7.5  | 45.3 |      | 12.6 | 7.0  | 45.8 |      | 12.6 |      |      |      |      |
| Change Period (Y+Rc), s      | 3.5  | 5.3  |      | 4.0  | 4.0  | 5.3  |      | 4.0  |      |      |      |      |
| Max Green Setting (Gmax), s  | 20.0 | 50.0 |      | 30.0 | 20.0 | 50.0 |      | 30.0 |      |      |      |      |
| Max Q Clear Time (g_c+15), s | 15.0 | 16.9 |      | 4.6  | 3.4  | 29.8 |      | 8.4  |      |      |      |      |
| Green Ext Time (p_c), s      | 0.0  | 0.5  |      | 0.1  | 0.0  | 0.8  |      | 0.1  |      |      |      |      |
| <b>Intersection Summary</b>  |      |      |      |      |      |      |      |      |      |      |      |      |
| HCM 2010 Ctrl Delay          |      |      |      | 14.5 |      |      |      |      |      |      |      |      |
| HCM 2010 LOS                 |      |      |      | B    |      |      |      |      |      |      |      |      |

HCM 2010 Signalized Intersection Summary  
 12: Reservation Road & Imjin Parkway

Existing, AM  
 06/11/2019



| Movement                    | EBL  | EBT   | EBR  | WBL  | WBT  | WBR   | NBL  | NBT  | NBR  | SBL  | SBT  | SBR  |
|-----------------------------|------|-------|------|------|------|-------|------|------|------|------|------|------|
| Lane Configurations         |      |       |      |      |      |       |      |      |      |      |      |      |
| Traffic Volume (veh/h)      | 115  | 28    | 729  | 3    | 7    | 15    | 897  | 623  | 19   | 36   | 542  | 84   |
| Future Volume (veh/h)       | 115  | 28    | 729  | 3    | 7    | 15    | 897  | 623  | 19   | 36   | 542  | 84   |
| Number                      | 3    | 8     | 18   | 7    | 4    | 14    | 1    | 6    | 16   | 5    | 2    | 12   |
| Initial Q (Qb), veh         | 0    | 0     | 0    | 0    | 0    | 0     | 0    | 0    | 0    | 0    | 0    | 0    |
| Ped-Bike Adj(A_pbT)         | 1.00 |       | 1.00 | 1.00 |      | 0.99  | 1.00 |      | 1.00 | 1.00 |      | 0.97 |
| Parking Bus, Adj            | 1.00 | 1.00  | 1.00 | 1.00 | 1.00 | 1.00  | 1.00 | 1.00 | 1.00 | 1.00 | 1.00 | 1.00 |
| Adj Sat Flow, veh/h/ln      | 1863 | 1863  | 1863 | 1638 | 1638 | 1638  | 1863 | 1863 | 1863 | 1863 | 1863 | 1863 |
| Adj Flow Rate, veh/h        | 77   | 96    | 370  | 3    | 8    | 3     | 965  | 670  | 14   | 39   | 583  | 27   |
| Adj No. of Lanes            | 1    | 1     | 2    | 1    | 1    | 1     | 2    | 2    | 1    | 2    | 2    | 1    |
| Peak Hour Factor            | 0.93 | 0.93  | 0.93 | 0.93 | 0.93 | 0.93  | 0.93 | 0.93 | 0.93 | 0.93 | 0.93 | 0.93 |
| Percent Heavy Veh, %        | 2    | 2     | 2    | 16   | 16   | 16    | 2    | 2    | 2    | 2    | 2    | 2    |
| Cap, veh/h                  | 213  | 223   | 1356 | 27   | 29   | 24    | 1062 | 2012 | 898  | 100  | 1022 | 445  |
| Arrive On Green             | 0.12 | 0.12  | 0.12 | 0.02 | 0.02 | 0.02  | 0.31 | 0.57 | 0.57 | 0.03 | 0.29 | 0.29 |
| Sat Flow, veh/h             | 1774 | 1863  | 3153 | 1560 | 1638 | 1384  | 3442 | 3539 | 1581 | 3442 | 3539 | 1542 |
| Grp Volume(v), veh/h        | 77   | 96    | 370  | 3    | 8    | 3     | 965  | 670  | 14   | 39   | 583  | 27   |
| Grp Sat Flow(s),veh/h/ln    | 1774 | 1863  | 1577 | 1560 | 1638 | 1384  | 1721 | 1770 | 1581 | 1721 | 1770 | 1542 |
| Q Serve(g_s), s             | 3.1  | 3.8   | 6.0  | 0.1  | 0.4  | 0.2   | 21.1 | 7.9  | 0.3  | 0.9  | 11.0 | 1.0  |
| Cycle Q Clear(g_c), s       | 3.1  | 3.8   | 6.0  | 0.1  | 0.4  | 0.2   | 21.1 | 7.9  | 0.3  | 0.9  | 11.0 | 1.0  |
| Prop In Lane                | 1.00 |       | 1.00 | 1.00 |      | 1.00  | 1.00 |      | 1.00 | 1.00 |      | 1.00 |
| Lane Grp Cap(c), veh/h      | 213  | 223   | 1356 | 27   | 29   | 24    | 1062 | 2012 | 898  | 100  | 1022 | 445  |
| V/C Ratio(X)                | 0.36 | 0.43  | 0.27 | 0.11 | 0.28 | 0.12  | 0.91 | 0.33 | 0.02 | 0.39 | 0.57 | 0.06 |
| Avail Cap(c_a), veh/h       | 791  | 830   | 2383 | 616  | 647  | 546   | 1534 | 2254 | 1007 | 877  | 2705 | 1178 |
| HCM Platoon Ratio           | 1.00 | 1.00  | 1.00 | 1.00 | 1.00 | 1.00  | 1.00 | 1.00 | 1.00 | 1.00 | 1.00 | 1.00 |
| Upstream Filter(I)          | 1.00 | 1.00  | 1.00 | 1.00 | 1.00 | 1.00  | 1.00 | 1.00 | 1.00 | 1.00 | 1.00 | 1.00 |
| Uniform Delay (d), s/veh    | 31.8 | 32.1  | 14.5 | 38.0 | 38.1 | 38.0  | 26.1 | 9.0  | 7.4  | 37.4 | 23.8 | 20.2 |
| Incr Delay (d2), s/veh      | 0.4  | 0.5   | 0.0  | 0.6  | 1.9  | 0.8   | 4.8  | 0.3  | 0.0  | 0.9  | 1.4  | 0.2  |
| Initial Q Delay(d3),s/veh   | 0.0  | 0.0   | 0.0  | 0.0  | 0.0  | 0.0   | 0.0  | 0.0  | 0.0  | 0.0  | 0.0  | 0.0  |
| %ile BackOfQ(50%),veh/ln    | 1.6  | 2.0   | 2.6  | 0.1  | 0.2  | 0.1   | 10.8 | 3.9  | 0.1  | 0.4  | 5.5  | 0.4  |
| LnGrp Delay(d),s/veh        | 32.2 | 32.5  | 14.6 | 38.6 | 40.0 | 38.8  | 30.9 | 9.3  | 7.4  | 38.3 | 25.2 | 20.4 |
| LnGrp LOS                   | C    | C     | B    | D    | D    | D     | C    | A    | A    | D    | C    | C    |
| Approach Vol, veh/h         |      | 543   |      |      | 14   |       |      | 1649 |      |      | 649  |      |
| Approach Delay, s/veh       |      | 20.2  |      |      | 39.4 |       |      | 21.9 |      |      | 25.7 |      |
| Approach LOS                |      | C     |      |      | D    |       |      | C    |      |      | C    |      |
| Timer                       | 1    | 2     | 3    | 4    | 5    | 6     | 7    | 8    |      |      |      |      |
| Assigned Phs                | 1    | 2     |      | 4    | 5    | 6     |      | 8    |      |      |      |      |
| Phs Duration (G+Y+Rc), s    | 28.3 |       |      | 6.4  | 6.4  | 50.8  |      | 14.9 |      |      |      |      |
| Change Period (Y+Rc), s     | 4.1  | * 6.2 |      | 5.0  | 4.1  | * 6.2 |      | 5.5  |      |      |      |      |
| Max Green Setting (Gmax), s | 35.0 | * 60  |      | 31.0 | 20.0 | * 50  |      | 35.0 |      |      |      |      |
| Max Q Clear Time (g_c+T), s | 23.1 | 13.0  |      | 2.4  | 2.9  | 9.9   |      | 8.0  |      |      |      |      |
| Green Ext Time (p_c), s     | 1.1  | 9.6   |      | 0.0  | 0.0  | 10.8  |      | 1.2  |      |      |      |      |
| <b>Intersection Summary</b> |      |       |      |      |      |       |      |      |      |      |      |      |
| HCM 2010 Ctrl Delay         |      |       | 22.5 |      |      |       |      |      |      |      |      |      |
| HCM 2010 LOS                |      |       | C    |      |      |       |      |      |      |      |      |      |
| <b>Notes</b>                |      |       |      |      |      |       |      |      |      |      |      |      |

HCM 2010 Signalized Intersection Summary  
 13: Reservation Road & Blanco Road

Existing, AM  
 06/11/2019

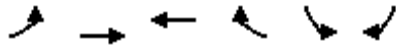

| Movement                     | EBL  | EBT  | WBT  | WBR  | SBL  | SBR  |   |   |
|------------------------------|------|------|------|------|------|------|---|---|
| Lane Configurations          | ↶↷   | ↶↷   | ↶    | ↷    | ↶↷   | ↶↷   |   |   |
| Traffic Volume (veh/h)       | 1048 | 260  | 372  | 26   | 28   | 1165 |   |   |
| Future Volume (veh/h)        | 1048 | 260  | 372  | 26   | 28   | 1165 |   |   |
| Number                       | 5    | 2    | 6    | 16   | 7    | 14   |   |   |
| Initial Q (Qb), veh          | 0    | 0    | 0    | 0    | 0    | 0    |   |   |
| Ped-Bike Adj(A_pbT)          | 1.00 |      |      | 1.00 | 1.00 | 1.00 |   |   |
| Parking Bus, Adj             | 1.00 | 1.00 | 1.00 | 1.00 | 1.00 | 1.00 |   |   |
| Adj Sat Flow, veh/h/ln       | 1863 | 1863 | 1845 | 1845 | 1845 | 1845 |   |   |
| Adj Flow Rate, veh/h         | 1127 | 280  | 400  | 9    | 30   | 0    |   |   |
| Adj No. of Lanes             | 2    | 2    | 1    | 1    | 2    | 2    |   |   |
| Peak Hour Factor             | 0.93 | 0.93 | 0.93 | 0.93 | 0.93 | 0.93 |   |   |
| Percent Heavy Veh, %         | 2    | 2    | 3    | 3    | 3    | 3    |   |   |
| Cap, veh/h                   | 1265 | 2720 | 517  | 439  | 95   | 77   |   |   |
| Arrive On Green              | 0.37 | 0.77 | 0.28 | 0.28 | 0.03 | 0.00 |   |   |
| Sat Flow, veh/h              | 3442 | 3632 | 1845 | 1568 | 3408 | 2760 |   |   |
| Grp Volume(v), veh/h         | 1127 | 280  | 400  | 9    | 30   | 0    |   |   |
| Grp Sat Flow(s),veh/h/ln     | 1721 | 1770 | 1845 | 1568 | 1704 | 1380 |   |   |
| Q Serve(g_s), s              | 14.0 | 0.9  | 9.1  | 0.2  | 0.4  | 0.0  |   |   |
| Cycle Q Clear(g_c), s        | 14.0 | 0.9  | 9.1  | 0.2  | 0.4  | 0.0  |   |   |
| Prop In Lane                 | 1.00 |      |      | 1.00 | 1.00 | 1.00 |   |   |
| Lane Grp Cap(c), veh/h       | 1265 | 2720 | 517  | 439  | 95   | 77   |   |   |
| V/C Ratio(X)                 | 0.89 | 0.10 | 0.77 | 0.02 | 0.32 | 0.00 |   |   |
| Avail Cap(c_a), veh/h        | 3017 | 4654 | 2426 | 2062 | 2017 | 1633 |   |   |
| HCM Platoon Ratio            | 1.00 | 1.00 | 1.00 | 1.00 | 1.00 | 1.00 |   |   |
| Upstream Filter(I)           | 1.00 | 1.00 | 1.00 | 1.00 | 1.00 | 0.00 |   |   |
| Uniform Delay (d), s/veh     | 13.6 | 1.3  | 15.1 | 11.9 | 21.8 | 0.0  |   |   |
| Incr Delay (d2), s/veh       | 0.9  | 0.0  | 1.9  | 0.0  | 0.7  | 0.0  |   |   |
| Initial Q Delay(d3),s/veh    | 0.0  | 0.0  | 0.0  | 0.0  | 0.0  | 0.0  |   |   |
| %ile BackOfQ(50%),veh/ln     | 6.7  | 0.4  | 4.8  | 0.1  | 0.2  | 0.0  |   |   |
| LnGrp Delay(d),s/veh         | 14.5 | 1.3  | 17.0 | 11.9 | 22.5 | 0.0  |   |   |
| LnGrp LOS                    | B    | A    | B    | B    | C    |      |   |   |
| Approach Vol, veh/h          |      | 1407 | 409  |      | 30   |      |   |   |
| Approach Delay, s/veh        |      | 11.9 | 16.8 |      | 22.5 |      |   |   |
| Approach LOS                 |      | B    | B    |      | C    |      |   |   |
| Timer                        | 1    | 2    | 3    | 4    | 5    | 6    | 7 | 8 |
| Assigned Phs                 |      | 2    |      | 4    | 5    | 6    |   |   |
| Phs Duration (G+Y+Rc), s     |      | 40.9 |      | 4.8  | 22.3 | 18.6 |   |   |
| Change Period (Y+Rc), s      |      | 5.8  |      | 3.5  | 5.5  | 5.8  |   |   |
| Max Green Setting (Gmax), s  |      | 60.0 |      | 27.0 | 40.0 | 60.0 |   |   |
| Max Q Clear Time (g_c+I1), s |      | 2.9  |      | 2.4  | 16.0 | 11.1 |   |   |
| Green Ext Time (p_c), s      |      | 1.3  |      | 0.0  | 0.7  | 1.7  |   |   |
| <b>Intersection Summary</b>  |      |      |      |      |      |      |   |   |
| HCM 2010 Ctrl Delay          |      |      | 13.1 |      |      |      |   |   |
| HCM 2010 LOS                 |      |      | B    |      |      |      |   |   |

HCM 2010 Signalized Intersection Summary  
 14: Reservation Road & Inter-Garrison Road

Existing, AM  
 06/11/2019



| Movement                     | EBL  | EBR  | NBL  | NBT  | SBT  | SBR  |   |      |
|------------------------------|------|------|------|------|------|------|---|------|
| Lane Configurations          |      |      |      |      |      |      |   |      |
| Traffic Volume (veh/h)       | 53   | 90   | 373  | 371  | 232  | 40   |   |      |
| Future Volume (veh/h)        | 53   | 90   | 373  | 371  | 232  | 40   |   |      |
| Number                       | 3    | 18   | 1    | 6    | 2    | 12   |   |      |
| Initial Q (Qb), veh          | 0    | 0    | 0    | 0    | 0    | 0    |   |      |
| Ped-Bike Adj(A_pbT)          | 1.00 | 1.00 | 1.00 |      |      | 1.00 |   |      |
| Parking Bus, Adj             | 1.00 | 1.00 | 1.00 | 1.00 | 1.00 | 1.00 |   |      |
| Adj Sat Flow, veh/h/ln       | 1845 | 1845 | 1863 | 1863 | 1845 | 1900 |   |      |
| Adj Flow Rate, veh/h         | 56   | 57   | 397  | 395  | 247  | 27   |   |      |
| Adj No. of Lanes             | 1    | 1    | 1    | 2    | 2    | 0    |   |      |
| Peak Hour Factor             | 0.94 | 0.94 | 0.94 | 0.94 | 0.94 | 0.94 |   |      |
| Percent Heavy Veh, %         | 3    | 3    | 2    | 2    | 3    | 3    |   |      |
| Cap, veh/h                   | 196  | 599  | 481  | 2103 | 626  | 68   |   |      |
| Arrive On Green              | 0.11 | 0.11 | 0.27 | 0.59 | 0.20 | 0.20 |   |      |
| Sat Flow, veh/h              | 1757 | 1568 | 1774 | 3632 | 3283 | 346  |   |      |
| Grp Volume(v), veh/h         | 56   | 57   | 397  | 395  | 135  | 139  |   |      |
| Grp Sat Flow(s),veh/h/ln     | 1757 | 1568 | 1774 | 1770 | 1752 | 1784 |   |      |
| Q Serve(g_s), s              | 1.1  | 0.9  | 7.8  | 1.9  | 2.5  | 2.5  |   |      |
| Cycle Q Clear(g_c), s        | 1.1  | 0.9  | 7.8  | 1.9  | 2.5  | 2.5  |   |      |
| Prop In Lane                 | 1.00 | 1.00 | 1.00 |      |      | 0.19 |   |      |
| Lane Grp Cap(c), veh/h       | 196  | 599  | 481  | 2103 | 344  | 350  |   |      |
| V/C Ratio(X)                 | 0.29 | 0.10 | 0.83 | 0.19 | 0.39 | 0.40 |   |      |
| Avail Cap(c_a), veh/h        | 1282 | 1569 | 959  | 5738 | 2841 | 2892 |   |      |
| HCM Platoon Ratio            | 1.00 | 1.00 | 1.00 | 1.00 | 1.00 | 1.00 |   |      |
| Upstream Filter(I)           | 1.00 | 1.00 | 1.00 | 1.00 | 1.00 | 1.00 |   |      |
| Uniform Delay (d), s/veh     | 15.1 | 7.3  | 12.7 | 3.4  | 13.0 | 13.0 |   |      |
| Incr Delay (d2), s/veh       | 0.8  | 0.1  | 1.4  | 0.1  | 1.4  | 1.4  |   |      |
| Initial Q Delay(d3),s/veh    | 0.0  | 0.0  | 0.0  | 0.0  | 0.0  | 0.0  |   |      |
| %ile BackOfQ(50%),veh/ln     | 0.6  | 0.4  | 3.9  | 0.9  | 1.3  | 1.4  |   |      |
| LnGrp Delay(d),s/veh         | 15.9 | 7.4  | 14.1 | 3.5  | 14.3 | 14.3 |   |      |
| LnGrp LOS                    | B    | A    | B    | A    | B    | B    |   |      |
| Approach Vol, veh/h          | 113  |      |      | 792  | 274  |      |   |      |
| Approach Delay, s/veh        | 11.6 |      |      | 8.8  | 14.3 |      |   |      |
| Approach LOS                 | B    |      |      | A    | B    |      |   |      |
| Timer                        | 1    | 2    | 3    | 4    | 5    | 6    | 7 | 8    |
| Assigned Phs                 | 1    | 2    |      |      |      | 6    |   | 8    |
| Phs Duration (G+Y+Rc), s     | 4.7  | 13.7 |      |      |      | 28.4 |   | 8.6  |
| Change Period (Y+Rc), s      | 4.7  | 6.4  |      |      |      | 6.4  |   | 4.5  |
| Max Green Setting (Gmax), s  | 20   | 60.0 |      |      |      | 60.0 |   | 27.0 |
| Max Q Clear Time (g_c+19), s | 4.5  |      |      |      |      | 3.9  |   | 3.1  |
| Green Ext Time (p_c), s      | 0.4  | 2.7  |      |      |      | 4.5  |   | 0.3  |
| <b>Intersection Summary</b>  |      |      |      |      |      |      |   |      |
| HCM 2010 Ctrl Delay          |      |      | 10.4 |      |      |      |   |      |
| HCM 2010 LOS                 |      |      | B    |      |      |      |   |      |
| <b>Notes</b>                 |      |      |      |      |      |      |   |      |

| Intersection              |      |  |  |  |  |  |  |  |  |  |  |  |
|---------------------------|------|--|--|--|--|--|--|--|--|--|--|--|
| Intersection Delay, s/veh | 21.9 |  |  |  |  |  |  |  |  |  |  |  |
| Intersection LOS          | C    |  |  |  |  |  |  |  |  |  |  |  |

| Movement            | EBL  | EBT  | EBR  | WBL  | WBT  | WBR  | NBL  | NBT  | NBR  | SBL  | SBT  | SBR  |
|---------------------|------|------|------|------|------|------|------|------|------|------|------|------|
| Lane Configurations |      | ↖    | ↗    |      | ↕    |      | ↖    | ↗    |      |      | ↖    | ↗    |
| Traffic Vol, veh/h  | 36   | 1    | 43   | 242  | 10   | 3    | 6    | 120  | 4    | 2    | 459  | 22   |
| Future Vol, veh/h   | 36   | 1    | 43   | 242  | 10   | 3    | 6    | 120  | 4    | 2    | 459  | 22   |
| Peak Hour Factor    | 0.94 | 0.94 | 0.94 | 0.94 | 0.94 | 0.94 | 0.94 | 0.94 | 0.94 | 0.94 | 0.94 | 0.94 |
| Heavy Vehicles, %   | 1    | 1    | 1    | 0    | 0    | 0    | 1    | 1    | 1    | 2    | 2    | 2    |
| Mvmt Flow           | 38   | 1    | 46   | 257  | 11   | 3    | 6    | 128  | 4    | 2    | 488  | 23   |
| Number of Lanes     | 0    | 1    | 1    | 0    | 1    | 0    | 1    | 1    | 0    | 0    | 1    | 1    |

| Approach                   | EB   | WB   | NB   | SB   |
|----------------------------|------|------|------|------|
| Opposing Approach          | WB   | EB   | SB   | NB   |
| Opposing Lanes             | 1    | 2    | 2    | 2    |
| Conflicting Approach Left  | SB   | NB   | EB   | WB   |
| Conflicting Lanes Left     | 2    | 2    | 2    | 1    |
| Conflicting Approach Right | NB   | SB   | WB   | EB   |
| Conflicting Lanes Right    | 2    | 2    | 1    | 2    |
| HCM Control Delay          | 10.3 | 16.9 | 11.3 | 29.3 |
| HCM LOS                    | B    | C    | B    | D    |

| Lane                   | NBLn1 | NBLn2 | EBLn1 | EBLn2 | WBLn1 | SBLn1 | SBLn2 |
|------------------------|-------|-------|-------|-------|-------|-------|-------|
| Vol Left, %            | 100%  | 0%    | 97%   | 0%    | 95%   | 0%    | 0%    |
| Vol Thru, %            | 0%    | 97%   | 3%    | 0%    | 4%    | 100%  | 0%    |
| Vol Right, %           | 0%    | 3%    | 0%    | 100%  | 1%    | 0%    | 100%  |
| Sign Control           | Stop  | Stop  | Stop  | Stop  | Stop  | Stop  | Stop  |
| Traffic Vol by Lane    | 6     | 124   | 37    | 43    | 255   | 461   | 22    |
| LT Vol                 | 6     | 0     | 36    | 0     | 242   | 2     | 0     |
| Through Vol            | 0     | 120   | 1     | 0     | 10    | 459   | 0     |
| RT Vol                 | 0     | 4     | 0     | 43    | 3     | 0     | 22    |
| Lane Flow Rate         | 6     | 132   | 39    | 46    | 271   | 490   | 23    |
| Geometry Grp           | 7     | 7     | 7     | 7     | 6     | 7     | 7     |
| Degree of Util (X)     | 0.013 | 0.24  | 0.083 | 0.081 | 0.512 | 0.818 | 0.034 |
| Departure Headway (Hd) | 7.086 | 6.552 | 7.577 | 6.365 | 6.795 | 6.002 | 5.29  |
| Convergence, Y/N       | Yes   | Yes   | Yes   | Yes   | Yes   | Yes   | Yes   |
| Cap                    | 502   | 545   | 470   | 558   | 529   | 603   | 674   |
| Service Time           | 4.87  | 4.335 | 5.374 | 4.161 | 4.868 | 3.76  | 3.048 |
| HCM Lane V/C Ratio     | 0.012 | 0.242 | 0.083 | 0.082 | 0.512 | 0.813 | 0.034 |
| HCM Control Delay      | 10    | 11.4  | 11.1  | 9.7   | 16.9  | 30.3  | 8.2   |
| HCM Lane LOS           | A     | B     | B     | A     | C     | D     | A     |
| HCM 95th-tile Q        | 0     | 0.9   | 0.3   | 0.3   | 2.9   | 8.3   | 0.1   |

**Intersection**

Intersection Delay, s/veh 56.3

Intersection LOS F

| Movement            | EBL  | EBT  | EBR  | WBL  | WBT  | WBR  | NBL  | NBT  | NBR  | SBL  | SBT  | SBR  |
|---------------------|------|------|------|------|------|------|------|------|------|------|------|------|
| Lane Configurations | ↙    | ↑    | ↗    |      | ↖    | ↗    | ↙    | ↑    | ↗    | ↙    | ↗    |      |
| Traffic Vol, veh/h  | 0    | 0    | 1    | 3    | 0    | 2    | 1    | 127  | 2    | 15   | 734  | 0    |
| Future Vol, veh/h   | 0    | 0    | 1    | 3    | 0    | 2    | 1    | 127  | 2    | 15   | 734  | 0    |
| Peak Hour Factor    | 0.95 | 0.95 | 0.95 | 0.95 | 0.95 | 0.95 | 0.95 | 0.95 | 0.95 | 0.95 | 0.95 | 0.95 |
| Heavy Vehicles, %   | 0    | 0    | 0    | 20   | 20   | 20   | 2    | 2    | 2    | 1    | 1    | 1    |
| Mvmt Flow           | 0    | 0    | 1    | 3    | 0    | 2    | 1    | 134  | 2    | 16   | 773  | 0    |
| Number of Lanes     | 1    | 1    | 1    | 0    | 1    | 1    | 1    | 1    | 1    | 1    | 1    | 0    |

| Approach                   | EB  | WB   | NB   | SB   |
|----------------------------|-----|------|------|------|
| Opposing Approach          | WB  | EB   | SB   | NB   |
| Opposing Lanes             | 2   | 3    | 2    | 3    |
| Conflicting Approach Left  | SB  | NB   | EB   | WB   |
| Conflicting Lanes Left     | 2   | 3    | 3    | 2    |
| Conflicting Approach Right | NB  | SB   | WB   | EB   |
| Conflicting Lanes Right    | 3   | 2    | 2    | 3    |
| HCM Control Delay          | 9.1 | 10.1 | 10.6 | 64.6 |
| HCM LOS                    | A   | B    | B    | F    |

| Lane                   | NBLn1 | NBLn2 | NBLn3 | EBLn1 | EBLn2 | EBLn3 | WBLn1 | WBLn2 | SBLn1 | SBLn2 |
|------------------------|-------|-------|-------|-------|-------|-------|-------|-------|-------|-------|
| Vol Left, %            | 100%  | 0%    | 0%    | 0%    | 0%    | 0%    | 100%  | 0%    | 100%  | 0%    |
| Vol Thru, %            | 0%    | 100%  | 0%    | 100%  | 100%  | 0%    | 0%    | 0%    | 0%    | 100%  |
| Vol Right, %           | 0%    | 0%    | 100%  | 0%    | 0%    | 100%  | 0%    | 100%  | 0%    | 0%    |
| Sign Control           | Stop  | Stop  | Stop  | Stop  | Stop  | Stop  | Stop  | Stop  | Stop  | Stop  |
| Traffic Vol by Lane    | 1     | 127   | 2     | 0     | 0     | 1     | 3     | 2     | 15    | 734   |
| LT Vol                 | 1     | 0     | 0     | 0     | 0     | 0     | 3     | 0     | 15    | 0     |
| Through Vol            | 0     | 127   | 0     | 0     | 0     | 0     | 0     | 0     | 0     | 734   |
| RT Vol                 | 0     | 0     | 2     | 0     | 0     | 1     | 0     | 2     | 0     | 0     |
| Lane Flow Rate         | 1     | 134   | 2     | 0     | 0     | 1     | 3     | 2     | 16    | 773   |
| Geometry Grp           | 8     | 8     | 8     | 8     | 8     | 8     | 8     | 8     | 8     | 8     |
| Degree of Util (X)     | 0.002 | 0.225 | 0.003 | 0     | 0     | 0.002 | 0.007 | 0.004 | 0.023 | 1.042 |
| Departure Headway (Hd) | 6.666 | 6.163 | 5.359 | 7.046 | 7.046 | 6.34  | 7.871 | 6.663 | 5.356 | 4.856 |
| Convergence, Y/N       | Yes   | Yes   | Yes   | Yes   | Yes   | Yes   | Yes   | Yes   | Yes   | Yes   |
| Cap                    | 540   | 586   | 660   | 0     | 0     | 568   | 457   | 540   | 669   | 749   |
| Service Time           | 4.366 | 3.863 | 3.158 | 4.746 | 4.746 | 4.04  | 5.571 | 4.363 | 3.086 | 2.585 |
| HCM Lane V/C Ratio     | 0.002 | 0.229 | 0.003 | 0     | 0     | 0.002 | 0.007 | 0.004 | 0.024 | 1.032 |
| HCM Control Delay      | 9.4   | 10.6  | 8.2   | 9.7   | 9.7   | 9.1   | 10.6  | 9.4   | 8.2   | 65.8  |
| HCM Lane LOS           | A     | B     | A     | N     | N     | A     | B     | A     | A     | F     |
| HCM 95th-tile Q        | 0     | 0.9   | 0     | 0     | 0     | 0     | 0     | 0     | 0.1   | 19    |



| Intersection              |      |  |  |  |  |  |  |  |  |  |  |  |
|---------------------------|------|--|--|--|--|--|--|--|--|--|--|--|
| Intersection Delay, s/veh | 17.9 |  |  |  |  |  |  |  |  |  |  |  |
| Intersection LOS          | C    |  |  |  |  |  |  |  |  |  |  |  |

| Movement            | EBL  | EBT  | EBR  | WBL  | WBT  | WBR  | NBL  | NBT  | NBR  | SBL  | SBT  | SBR  |
|---------------------|------|------|------|------|------|------|------|------|------|------|------|------|
| Lane Configurations |      |      |      |      |      |      |      |      |      |      |      |      |
| Traffic Vol, veh/h  | 7    | 162  | 2    | 6    | 9    | 48   | 0    | 7    | 29   | 337  | 6    | 5    |
| Future Vol, veh/h   | 7    | 162  | 2    | 6    | 9    | 48   | 0    | 7    | 29   | 337  | 6    | 5    |
| Peak Hour Factor    | 0.81 | 0.81 | 0.81 | 0.81 | 0.81 | 0.81 | 0.81 | 0.81 | 0.81 | 0.81 | 0.81 | 0.81 |
| Heavy Vehicles, %   | 3    | 3    | 3    | 5    | 5    | 5    | 0    | 0    | 0    | 1    | 1    | 1    |
| Mvmt Flow           | 9    | 200  | 2    | 7    | 11   | 59   | 0    | 9    | 36   | 416  | 7    | 6    |
| Number of Lanes     | 1    | 1    | 0    | 1    | 1    | 1    | 0    | 1    | 0    | 0    | 1    | 1    |

| Approach                   | EB   | WB  | NB  | SB   |
|----------------------------|------|-----|-----|------|
| Opposing Approach          | WB   | EB  | SB  | NB   |
| Opposing Lanes             | 3    | 2   | 2   | 1    |
| Conflicting Approach Left  | SB   | NB  | EB  | WB   |
| Conflicting Lanes Left     | 2    | 1   | 2   | 3    |
| Conflicting Approach Right | NB   | SB  | WB  | EB   |
| Conflicting Lanes Right    | 1    | 2   | 3   | 2    |
| HCM Control Delay          | 12.7 | 9.7 | 9.3 | 22.9 |
| HCM LOS                    | B    | A   | A   | C    |

| Lane                   | NBLn1 | EBLn1 | EBLn2 | WBLn1 | WBLn2 | WBLn3 | SBLn1 | SBLn2 |
|------------------------|-------|-------|-------|-------|-------|-------|-------|-------|
| Vol Left, %            | 0%    | 100%  | 0%    | 100%  | 0%    | 0%    | 98%   | 0%    |
| Vol Thru, %            | 19%   | 0%    | 99%   | 0%    | 100%  | 0%    | 2%    | 0%    |
| Vol Right, %           | 81%   | 0%    | 1%    | 0%    | 0%    | 100%  | 0%    | 100%  |
| Sign Control           | Stop  | Stop  | Stop  | Stop  | Stop  | Stop  | Stop  | Stop  |
| Traffic Vol by Lane    | 36    | 7     | 164   | 6     | 9     | 48    | 343   | 5     |
| LT Vol                 | 0     | 7     | 0     | 6     | 0     | 0     | 337   | 0     |
| Through Vol            | 7     | 0     | 162   | 0     | 9     | 0     | 6     | 0     |
| RT Vol                 | 29    | 0     | 2     | 0     | 0     | 48    | 0     | 5     |
| Lane Flow Rate         | 44    | 9     | 202   | 7     | 11    | 59    | 423   | 6     |
| Geometry Grp           | 8     | 8     | 8     | 8     | 8     | 8     | 8     | 8     |
| Degree of Util (X)     | 0.075 | 0.017 | 0.362 | 0.015 | 0.021 | 0.101 | 0.72  | 0.008 |
| Departure Headway (Hd) | 6.049 | 6.952 | 6.434 | 7.337 | 6.828 | 6.115 | 6.125 | 4.931 |
| Convergence, Y/N       | Yes   | Yes   | Yes   | Yes   | Yes   | Yes   | Yes   | Yes   |
| Cap                    | 591   | 515   | 559   | 487   | 523   | 584   | 593   | 726   |
| Service Time           | 3.798 | 4.696 | 4.178 | 5.091 | 4.582 | 3.869 | 3.853 | 2.659 |
| HCM Lane V/C Ratio     | 0.074 | 0.017 | 0.361 | 0.014 | 0.021 | 0.101 | 0.713 | 0.008 |
| HCM Control Delay      | 9.3   | 9.8   | 12.8  | 10.2  | 9.7   | 9.6   | 23.1  | 7.7   |
| HCM Lane LOS           | A     | A     | B     | B     | A     | A     | C     | A     |
| HCM 95th-tile Q        | 0.2   | 0.1   | 1.6   | 0     | 0.1   | 0.3   | 6     | 0     |

**Intersection**

|                           |      |
|---------------------------|------|
| Intersection Delay, s/veh | 26.5 |
| Intersection LOS          | D    |

| Movement            | WBL  | WBR  | NBT  | NBR  | SBL  | SBT  |
|---------------------|------|------|------|------|------|------|
| Lane Configurations |      |      |      |      |      |      |
| Traffic Vol, veh/h  | 9    | 19   | 96   | 29   | 83   | 644  |
| Future Vol, veh/h   | 9    | 19   | 96   | 29   | 83   | 644  |
| Peak Hour Factor    | 0.93 | 0.93 | 0.93 | 0.93 | 0.93 | 0.93 |
| Heavy Vehicles, %   | 0    | 0    | 1    | 1    | 1    | 1    |
| Mvmt Flow           | 10   | 20   | 103  | 31   | 89   | 692  |
| Number of Lanes     | 1    | 1    | 1    | 1    | 1    | 1    |

| Approach                   | WB  | NB  | SB   |
|----------------------------|-----|-----|------|
| Opposing Approach          |     | SB  | NB   |
| Opposing Lanes             | 0   | 2   | 2    |
| Conflicting Approach Left  | NB  |     | WB   |
| Conflicting Lanes Left     | 2   | 0   | 2    |
| Conflicting Approach Right | SB  | WB  |      |
| Conflicting Lanes Right    | 2   | 2   | 0    |
| HCM Control Delay          | 9.2 | 8.6 | 30.2 |
| HCM LOS                    | A   | A   | D    |

| Lane                   | NBLn1 | NBLn2 | WBLn1 | WBLn2 | SBLn1 | SBLn2 |
|------------------------|-------|-------|-------|-------|-------|-------|
| Vol Left, %            | 0%    | 0%    | 100%  | 0%    | 100%  | 0%    |
| Vol Thru, %            | 100%  | 0%    | 0%    | 0%    | 0%    | 100%  |
| Vol Right, %           | 0%    | 100%  | 0%    | 100%  | 0%    | 0%    |
| Sign Control           | Stop  | Stop  | Stop  | Stop  | Stop  | Stop  |
| Traffic Vol by Lane    | 96    | 29    | 9     | 19    | 83    | 644   |
| LT Vol                 | 0     | 0     | 9     | 0     | 83    | 0     |
| Through Vol            | 96    | 0     | 0     | 0     | 0     | 644   |
| RT Vol                 | 0     | 29    | 0     | 19    | 0     | 0     |
| Lane Flow Rate         | 103   | 31    | 10    | 20    | 89    | 692   |
| Geometry Grp           | 7     | 7     | 7     | 7     | 7     | 7     |
| Degree of Util (X)     | 0.15  | 0.039 | 0.019 | 0.033 | 0.127 | 0.892 |
| Departure Headway (Hd) | 5.245 | 4.54  | 7.052 | 5.84  | 5.137 | 4.637 |
| Convergence, Y/N       | Yes   | Yes   | Yes   | Yes   | Yes   | Yes   |
| Cap                    | 686   | 791   | 510   | 616   | 690   | 769   |
| Service Time           | 2.957 | 2.253 | 4.764 | 3.551 | 2.929 | 2.428 |
| HCM Lane V/C Ratio     | 0.15  | 0.039 | 0.02  | 0.032 | 0.129 | 0.9   |
| HCM Control Delay      | 8.9   | 7.4   | 9.9   | 8.8   | 8.7   | 33    |
| HCM Lane LOS           | A     | A     | A     | A     | A     | D     |
| HCM 95th-tile Q        | 0.5   | 0.1   | 0.1   | 0.1   | 0.4   | 11.6  |

| Intersection              |     |
|---------------------------|-----|
| Intersection Delay, s/veh | 8.5 |
| Intersection LOS          | A   |

| Movement            | EBL  | EBT  | EBR  | WBL  | WBT  | WBR  | NBL  | NBT  | NBR  | SBL  | SBT  | SBR  |
|---------------------|------|------|------|------|------|------|------|------|------|------|------|------|
| Lane Configurations |      | ↕    |      |      | ↕    |      |      | ↕    |      |      | ↕    |      |
| Traffic Vol, veh/h  | 0    | 78   | 16   | 85   | 93   | 28   | 7    | 5    | 64   | 2    | 6    | 6    |
| Future Vol, veh/h   | 0    | 78   | 16   | 85   | 93   | 28   | 7    | 5    | 64   | 2    | 6    | 6    |
| Peak Hour Factor    | 0.85 | 0.85 | 0.85 | 0.85 | 0.85 | 0.85 | 0.85 | 0.85 | 0.85 | 0.85 | 0.85 | 0.85 |
| Heavy Vehicles, %   | 6    | 6    | 6    | 2    | 2    | 2    | 4    | 4    | 4    | 0    | 0    | 0    |
| Mvmt Flow           | 0    | 92   | 19   | 100  | 109  | 33   | 8    | 6    | 75   | 2    | 7    | 7    |
| Number of Lanes     | 0    | 1    | 0    | 0    | 1    | 0    | 0    | 1    | 0    | 0    | 1    | 0    |

| Approach                   | EB  | WB | NB  | SB  |
|----------------------------|-----|----|-----|-----|
| Opposing Approach          | WB  | EB | SB  | NB  |
| Opposing Lanes             | 1   | 1  | 1   | 1   |
| Conflicting Approach Left  | SB  | NB | EB  | WB  |
| Conflicting Lanes Left     | 1   | 1  | 1   | 1   |
| Conflicting Approach Right | NB  | SB | WB  | EB  |
| Conflicting Lanes Right    | 1   | 1  | 1   | 1   |
| HCM Control Delay          | 8.1 | 9  | 7.8 | 7.7 |
| HCM LOS                    | A   | A  | A   | A   |

| Lane                   | NBLn1 | EBLn1 | WBLn1 | SBLn1 |
|------------------------|-------|-------|-------|-------|
| Vol Left, %            | 9%    | 0%    | 41%   | 14%   |
| Vol Thru, %            | 7%    | 83%   | 45%   | 43%   |
| Vol Right, %           | 84%   | 17%   | 14%   | 43%   |
| Sign Control           | Stop  | Stop  | Stop  | Stop  |
| Traffic Vol by Lane    | 76    | 94    | 206   | 14    |
| LT Vol                 | 7     | 0     | 85    | 2     |
| Through Vol            | 5     | 78    | 93    | 6     |
| RT Vol                 | 64    | 16    | 28    | 6     |
| Lane Flow Rate         | 89    | 111   | 242   | 16    |
| Geometry Grp           | 1     | 1     | 1     | 1     |
| Degree of Util (X)     | 0.106 | 0.135 | 0.283 | 0.021 |
| Departure Headway (Hd) | 4.285 | 4.389 | 4.204 | 4.562 |
| Convergence, Y/N       | Yes   | Yes   | Yes   | Yes   |
| Cap                    | 840   | 821   | 841   | 787   |
| Service Time           | 2.293 | 2.399 | 2.303 | 2.574 |
| HCM Lane V/C Ratio     | 0.106 | 0.135 | 0.288 | 0.02  |
| HCM Control Delay      | 7.8   | 8.1   | 9     | 7.7   |
| HCM Lane LOS           | A     | A     | A     | A     |
| HCM 95th-tile Q        | 0.4   | 0.5   | 1.2   | 0.1   |

| Intersection              |      |  |  |  |  |  |  |  |  |  |  |  |
|---------------------------|------|--|--|--|--|--|--|--|--|--|--|--|
| Intersection Delay, s/veh | 12.9 |  |  |  |  |  |  |  |  |  |  |  |
| Intersection LOS          | B    |  |  |  |  |  |  |  |  |  |  |  |

| Movement            | EBL  | EBT  | EBR  | WBL  | WBT  | WBR  | NBL  | NBT  | NBR  | SBL  | SBT  | SBR  |
|---------------------|------|------|------|------|------|------|------|------|------|------|------|------|
| Lane Configurations |      | ↕    |      |      | ↕    |      |      | ↕    |      |      | ↕    | ↕    |
| Traffic Vol, veh/h  | 4    | 29   | 15   | 20   | 308  | 30   | 40   | 28   | 5    | 15   | 130  | 6    |
| Future Vol, veh/h   | 4    | 29   | 15   | 20   | 308  | 30   | 40   | 28   | 5    | 15   | 130  | 6    |
| Peak Hour Factor    | 0.81 | 0.81 | 0.81 | 0.81 | 0.81 | 0.81 | 0.81 | 0.81 | 0.81 | 0.81 | 0.81 | 0.81 |
| Heavy Vehicles, %   | 8    | 8    | 8    | 3    | 3    | 3    | 19   | 19   | 19   | 7    | 7    | 7    |
| Mvmt Flow           | 5    | 36   | 19   | 25   | 380  | 37   | 49   | 35   | 6    | 19   | 160  | 7    |
| Number of Lanes     | 0    | 1    | 0    | 0    | 1    | 0    | 0    | 1    | 0    | 0    | 1    | 1    |

| Approach                   | EB  | WB   | NB   | SB   |
|----------------------------|-----|------|------|------|
| Opposing Approach          | WB  | EB   | SB   | NB   |
| Opposing Lanes             | 1   | 1    | 2    | 1    |
| Conflicting Approach Left  | SB  | NB   | EB   | WB   |
| Conflicting Lanes Left     | 2   | 1    | 1    | 1    |
| Conflicting Approach Right | NB  | SB   | WB   | EB   |
| Conflicting Lanes Right    | 1   | 2    | 1    | 1    |
| HCM Control Delay          | 8.9 | 14.6 | 10.1 | 11.4 |
| HCM LOS                    | A   | B    | B    | B    |

| Lane                   | NBLn1 | EBLn1 | WBLn1 | SBLn1 | SBLn2 |
|------------------------|-------|-------|-------|-------|-------|
| Vol Left, %            | 55%   | 8%    | 6%    | 10%   | 0%    |
| Vol Thru, %            | 38%   | 60%   | 86%   | 90%   | 0%    |
| Vol Right, %           | 7%    | 31%   | 8%    | 0%    | 100%  |
| Sign Control           | Stop  | Stop  | Stop  | Stop  | Stop  |
| Traffic Vol by Lane    | 73    | 48    | 358   | 145   | 6     |
| LT Vol                 | 40    | 4     | 20    | 15    | 0     |
| Through Vol            | 28    | 29    | 308   | 130   | 0     |
| RT Vol                 | 5     | 15    | 30    | 0     | 6     |
| Lane Flow Rate         | 90    | 59    | 442   | 179   | 7     |
| Geometry Grp           | 5     | 2     | 2     | 7     | 7     |
| Degree of Util (X)     | 0.152 | 0.088 | 0.588 | 0.304 | 0.011 |
| Departure Headway (Hd) | 6.054 | 5.352 | 4.786 | 6.12  | 5.359 |
| Convergence, Y/N       | Yes   | Yes   | Yes   | Yes   | Yes   |
| Cap                    | 595   | 671   | 747   | 591   | 671   |
| Service Time           | 4.064 | 3.372 | 2.875 | 3.828 | 3.066 |
| HCM Lane V/C Ratio     | 0.151 | 0.088 | 0.592 | 0.303 | 0.01  |
| HCM Control Delay      | 10.1  | 8.9   | 14.6  | 11.5  | 8.1   |
| HCM Lane LOS           | B     | A     | B     | B     | A     |
| HCM 95th-tile Q        | 0.5   | 0.3   | 3.9   | 1.3   | 0     |

| Intersection                |       |       |       |
|-----------------------------|-------|-------|-------|
| Intersection Delay, s/veh   | 32.1  |       |       |
| Intersection LOS            | D     |       |       |
| Approach                    | EB    | WB    | NB    |
| Entry Lanes                 | 1     | 1     | 1     |
| Conflicting Circle Lanes    | 1     | 1     | 1     |
| Adj Approach Flow, veh/h    | 51    | 1067  | 133   |
| Demand Flow Rate, veh/h     | 64    | 1078  | 137   |
| Vehicles Circulating, veh/h | 717   | 2     | 47    |
| Vehicles Exiting, veh/h     | 363   | 182   | 733   |
| Follow-Up Headway, s        | 3.186 | 3.186 | 3.186 |
| Ped Vol Crossing Leg, #/h   | 0     | 0     | 0     |
| Ped Cap Adj                 | 1.000 | 1.000 | 1.000 |
| Approach Delay, s/veh       | 9.8   | 36.6  | 4.6   |
| Approach LOS                | A     | E     | A     |
| Lane                        | Left  | Left  | Left  |
| Designated Moves            | TR    | LT    | LR    |
| Assumed Moves               | TR    | LT    | LR    |
| RT Channelized              |       |       |       |
| Lane Util                   | 1.000 | 1.000 | 1.000 |
| Critical Headway, s         | 5.193 | 5.193 | 5.193 |
| Entry Flow, veh/h           | 64    | 1078  | 137   |
| Cap Entry Lane, veh/h       | 552   | 1128  | 1078  |
| Entry HV Adj Factor         | 0.803 | 0.990 | 0.971 |
| Flow Entry, veh/h           | 51    | 1067  | 133   |
| Cap Entry, veh/h            | 443   | 1117  | 1047  |
| V/C Ratio                   | 0.116 | 0.956 | 0.127 |
| Control Delay, s/veh        | 9.8   | 36.6  | 4.6   |
| LOS                         | A     | E     | A     |
| 95th %tile Queue, veh       | 0     | 17    | 0     |

| Intersection              |      |
|---------------------------|------|
| Intersection Delay, s/veh | 60.3 |
| Intersection LOS          | F    |

| Movement            | EBL  | EBT  | WBT  | WBR  | SBL  | SBR  |
|---------------------|------|------|------|------|------|------|
| Lane Configurations | ↘    | ↑    | ↑    | ↗    | ↘    | ↗    |
| Traffic Vol, veh/h  | 54   | 64   | 580  | 12   | 10   | 279  |
| Future Vol, veh/h   | 54   | 64   | 580  | 12   | 10   | 279  |
| Peak Hour Factor    | 0.85 | 0.85 | 0.85 | 0.85 | 0.85 | 0.85 |
| Heavy Vehicles, %   | 8    | 8    | 1    | 1    | 1    | 1    |
| Mvmt Flow           | 64   | 75   | 682  | 14   | 12   | 328  |
| Number of Lanes     | 1    | 1    | 1    | 1    | 1    | 1    |

| Approach                   | EB   | WB   | SB |
|----------------------------|------|------|----|
| Opposing Approach          | WB   | EB   |    |
| Opposing Lanes             | 2    | 2    | 0  |
| Conflicting Approach Left  | SB   |      | WB |
| Conflicting Lanes Left     | 2    | 0    | 2  |
| Conflicting Approach Right |      | SB   | EB |
| Conflicting Lanes Right    | 0    | 2    | 2  |
| HCM Control Delay          | 10.8 | 91.8 | 16 |
| HCM LOS                    | B    | F    | C  |

| Lane                   | EBLn1 | EBLn2 | WBLn1 | WBLn2 | SBLn1 | SBLn2 |
|------------------------|-------|-------|-------|-------|-------|-------|
| Vol Left, %            | 100%  | 0%    | 0%    | 0%    | 100%  | 0%    |
| Vol Thru, %            | 0%    | 100%  | 100%  | 0%    | 0%    | 0%    |
| Vol Right, %           | 0%    | 0%    | 0%    | 100%  | 0%    | 100%  |
| Sign Control           | Stop  | Stop  | Stop  | Stop  | Stop  | Stop  |
| Traffic Vol by Lane    | 54    | 64    | 580   | 12    | 10    | 279   |
| LT Vol                 | 54    | 0     | 0     | 0     | 10    | 0     |
| Through Vol            | 0     | 64    | 580   | 0     | 0     | 0     |
| RT Vol                 | 0     | 0     | 0     | 12    | 0     | 279   |
| Lane Flow Rate         | 64    | 75    | 682   | 14    | 12    | 328   |
| Geometry Grp           | 7     | 7     | 7     | 7     | 7     | 7     |
| Degree of Util (X)     | 0.125 | 0.138 | 1.112 | 0.02  | 0.024 | 0.546 |
| Departure Headway (Hd) | 7.323 | 6.811 | 5.865 | 5.156 | 7.466 | 6.249 |
| Convergence, Y/N       | Yes   | Yes   | Yes   | Yes   | Yes   | Yes   |
| Cap                    | 492   | 529   | 621   | 698   | 482   | 581   |
| Service Time           | 5.023 | 4.511 | 3.569 | 2.859 | 5.166 | 3.949 |
| HCM Lane V/C Ratio     | 0.13  | 0.142 | 1.098 | 0.02  | 0.025 | 0.565 |
| HCM Control Delay      | 11.1  | 10.6  | 93.5  | 8     | 10.3  | 16.2  |
| HCM Lane LOS           | B     | B     | F     | A     | B     | C     |
| HCM 95th-tile Q        | 0.4   | 0.5   | 20.9  | 0.1   | 0.1   | 3.3   |

| Intersection              |      |
|---------------------------|------|
| Intersection Delay, s/veh | 20.8 |
| Intersection LOS          | C    |

| Movement            | EBL  | EBT  | WBT  | WBR  | SBL  | SBR  |
|---------------------|------|------|------|------|------|------|
| Lane Configurations |      |      |      |      |      |      |
| Traffic Vol, veh/h  | 12   | 61   | 442  | 15   | 35   | 146  |
| Future Vol, veh/h   | 12   | 61   | 442  | 15   | 35   | 146  |
| Peak Hour Factor    | 0.79 | 0.79 | 0.79 | 0.79 | 0.79 | 0.79 |
| Heavy Vehicles, %   | 5    | 5    | 1    | 1    | 3    | 3    |
| Mvmt Flow           | 15   | 77   | 559  | 19   | 44   | 185  |
| Number of Lanes     | 1    | 1    | 1    | 1    | 1    | 1    |

| Approach                   | EB  | WB   | SB   |
|----------------------------|-----|------|------|
| Opposing Approach          | WB  | EB   |      |
| Opposing Lanes             | 2   | 2    | 0    |
| Conflicting Approach Left  | SB  |      | WB   |
| Conflicting Lanes Left     | 2   | 0    | 2    |
| Conflicting Approach Right |     | SB   | EB   |
| Conflicting Lanes Right    | 0   | 2    | 2    |
| HCM Control Delay          | 9.5 | 26.7 | 10.5 |
| HCM LOS                    | A   | D    | B    |

| Lane                   | EBLn1 | EBLn2 | WBLn1 | WBLn2 | SBLn1 | SBLn2 |
|------------------------|-------|-------|-------|-------|-------|-------|
| Vol Left, %            | 100%  | 0%    | 0%    | 0%    | 100%  | 0%    |
| Vol Thru, %            | 0%    | 100%  | 100%  | 0%    | 0%    | 0%    |
| Vol Right, %           | 0%    | 0%    | 0%    | 100%  | 0%    | 100%  |
| Sign Control           | Stop  | Stop  | Stop  | Stop  | Stop  | Stop  |
| Traffic Vol by Lane    | 12    | 61    | 442   | 15    | 35    | 146   |
| LT Vol                 | 12    | 0     | 0     | 0     | 35    | 0     |
| Through Vol            | 0     | 61    | 442   | 0     | 0     | 0     |
| RT Vol                 | 0     | 0     | 0     | 15    | 0     | 146   |
| Lane Flow Rate         | 15    | 77    | 559   | 19    | 44    | 185   |
| Geometry Grp           | 7     | 7     | 7     | 7     | 7     | 7     |
| Degree of Util (X)     | 0.027 | 0.127 | 0.816 | 0.024 | 0.084 | 0.289 |
| Departure Headway (Hd) | 6.441 | 5.934 | 5.25  | 4.545 | 6.849 | 5.638 |
| Convergence, Y/N       | Yes   | Yes   | Yes   | Yes   | Yes   | Yes   |
| Cap                    | 558   | 606   | 683   | 776   | 526   | 641   |
| Service Time           | 4.155 | 3.648 | 3.044 | 2.338 | 4.549 | 3.338 |
| HCM Lane V/C Ratio     | 0.027 | 0.127 | 0.818 | 0.024 | 0.084 | 0.289 |
| HCM Control Delay      | 9.3   | 9.5   | 27.3  | 7.5   | 10.2  | 10.6  |
| HCM Lane LOS           | A     | A     | D     | A     | B     | B     |
| HCM 95th-tile Q        | 0.1   | 0.4   | 8.6   | 0.1   | 0.3   | 1.2   |

**Intersection**

Intersection Delay, s/veh 11.8

Intersection LOS B

| Movement            | EBL  | EBT  | WBT  | WBR  | SBL  | SBR  |
|---------------------|------|------|------|------|------|------|
| Lane Configurations |      | ↔    | ↔    |      | ↔    | ↔    |
| Traffic Vol, veh/h  | 84   | 10   | 77   | 18   | 13   | 390  |
| Future Vol, veh/h   | 84   | 10   | 77   | 18   | 13   | 390  |
| Peak Hour Factor    | 0.82 | 0.82 | 0.82 | 0.82 | 0.82 | 0.82 |
| Heavy Vehicles, %   | 5    | 5    | 1    | 1    | 0    | 0    |
| Mvmt Flow           | 102  | 12   | 94   | 22   | 16   | 476  |
| Number of Lanes     | 0    | 1    | 1    | 0    | 1    | 1    |

| Approach                   | EB  | WB  | SB |
|----------------------------|-----|-----|----|
| Opposing Approach          | WB  | EB  |    |
| Opposing Lanes             | 1   | 1   | 0  |
| Conflicting Approach Left  | SB  |     | WB |
| Conflicting Lanes Left     | 2   | 0   | 1  |
| Conflicting Approach Right |     | SB  | EB |
| Conflicting Lanes Right    | 0   | 2   | 1  |
| HCM Control Delay          | 9.6 | 9.1 | 13 |
| HCM LOS                    | A   | A   | B  |

| Lane                   | EBLn1 | WBLn1 | SBLn1 | SBLn2 |
|------------------------|-------|-------|-------|-------|
| Vol Left, %            | 89%   | 0%    | 100%  | 0%    |
| Vol Thru, %            | 11%   | 81%   | 0%    | 0%    |
| Vol Right, %           | 0%    | 19%   | 0%    | 100%  |
| Sign Control           | Stop  | Stop  | Stop  | Stop  |
| Traffic Vol by Lane    | 94    | 95    | 13    | 390   |
| LT Vol                 | 84    | 0     | 13    | 0     |
| Through Vol            | 10    | 77    | 0     | 0     |
| RT Vol                 | 0     | 18    | 0     | 390   |
| Lane Flow Rate         | 115   | 116   | 16    | 476   |
| Geometry Grp           | 2     | 2     | 7     | 7     |
| Degree of Util (X)     | 0.173 | 0.163 | 0.025 | 0.581 |
| Departure Headway (Hd) | 5.433 | 5.079 | 5.606 | 4.4   |
| Convergence, Y/N       | Yes   | Yes   | Yes   | Yes   |
| Cap                    | 657   | 701   | 638   | 818   |
| Service Time           | 3.498 | 3.145 | 3.343 | 2.136 |
| HCM Lane V/C Ratio     | 0.175 | 0.165 | 0.025 | 0.582 |
| HCM Control Delay      | 9.6   | 9.1   | 8.5   | 13.1  |
| HCM Lane LOS           | A     | A     | A     | B     |
| HCM 95th-tile Q        | 0.6   | 0.6   | 0.1   | 3.8   |



HCM 2010 Signalized Intersection Summary  
 26: East Garrison Road & Reservation Road



















Existing, AM  
 06/11/2019



| Movement                    | EBL  | EBT  | EBR  | WBL  | WBT  | WBR  | NBL  | NBT  | NBR  | SBL | SBT | SBR |
|-----------------------------|------|------|------|------|------|------|------|------|------|-----|-----|-----|
| Lane Configurations         | ↖    | ↗    |      | ↖    | ↗    |      | ↖    |      | ↗    |     |     |     |
| Traffic Volume (veh/h)      | 0    | 322  | 8    | 38   | 753  | 0    | 33   | 0    | 72   | 0   | 0   | 0   |
| Future Volume (veh/h)       | 0    | 322  | 8    | 38   | 753  | 0    | 33   | 0    | 72   | 0   | 0   | 0   |
| Number                      | 5    | 2    | 12   | 1    | 6    | 16   | 3    | 8    | 18   |     |     |     |
| Initial Q (Qb), veh         | 0    | 0    | 0    | 0    | 0    | 0    | 0    | 0    | 0    |     |     |     |
| Ped-Bike Adj(A_pbT)         | 1.00 |      | 1.00 | 1.00 |      | 1.00 | 1.00 |      | 1.00 |     |     |     |
| Parking Bus, Adj            | 1.00 | 1.00 | 1.00 | 1.00 | 1.00 | 1.00 | 1.00 | 1.00 | 1.00 |     |     |     |
| Adj Sat Flow, veh/h/ln      | 1827 | 1827 | 1900 | 1863 | 1863 | 0    | 1881 | 0    | 1881 |     |     |     |
| Adj Flow Rate, veh/h        | 0    | 362  | 7    | 43   | 846  | 0    | 37   | 0    | 9    |     |     |     |
| Adj No. of Lanes            | 1    | 2    | 0    | 1    | 2    | 0    | 1    | 0    | 1    |     |     |     |
| Peak Hour Factor            | 0.89 | 0.89 | 0.89 | 0.89 | 0.89 | 0.89 | 0.89 | 0.89 | 0.89 |     |     |     |
| Percent Heavy Veh, %        | 4    | 4    | 4    | 2    | 2    | 0    | 1    | 0    | 1    |     |     |     |
| Cap, veh/h                  | 7    | 1195 | 23   | 92   | 1920 | 0    | 79   | 0    | 70   |     |     |     |
| Arrive On Green             | 0.00 | 0.34 | 0.34 | 0.05 | 0.54 | 0.00 | 0.04 | 0.00 | 0.04 |     |     |     |
| Sat Flow, veh/h             | 1740 | 3483 | 67   | 1774 | 3632 | 0    | 1792 | 0    | 1599 |     |     |     |
| Grp Volume(v), veh/h        | 0    | 180  | 189  | 43   | 846  | 0    | 37   | 0    | 9    |     |     |     |
| Grp Sat Flow(s),veh/h/ln    | 1740 | 1736 | 1815 | 1774 | 1770 | 0    | 1792 | 0    | 1599 |     |     |     |
| Q Serve(g_s), s             | 0.0  | 1.9  | 1.9  | 0.6  | 3.5  | 0.0  | 0.5  | 0.0  | 0.1  |     |     |     |
| Cycle Q Clear(g_c), s       | 0.0  | 1.9  | 1.9  | 0.6  | 3.5  | 0.0  | 0.5  | 0.0  | 0.1  |     |     |     |
| Prop In Lane                | 1.00 |      | 0.04 | 1.00 |      | 0.00 | 1.00 |      | 1.00 |     |     |     |
| Lane Grp Cap(c), veh/h      | 7    | 596  | 623  | 92   | 1920 | 0    | 79   | 0    | 70   |     |     |     |
| V/C Ratio(X)                | 0.00 | 0.30 | 0.30 | 0.47 | 0.44 | 0.00 | 0.47 | 0.00 | 0.13 |     |     |     |
| Avail Cap(c_a), veh/h       | 1425 | 4265 | 4460 | 1453 | 8697 | 0    | 1981 | 0    | 1768 |     |     |     |
| HCM Platoon Ratio           | 1.00 | 1.00 | 1.00 | 1.00 | 1.00 | 1.00 | 1.00 | 1.00 | 1.00 |     |     |     |
| Upstream Filter(I)          | 0.00 | 1.00 | 1.00 | 1.00 | 1.00 | 0.00 | 1.00 | 0.00 | 1.00 |     |     |     |
| Uniform Delay (d), s/veh    | 0.0  | 5.9  | 5.9  | 11.2 | 3.4  | 0.0  | 11.4 | 0.0  | 11.2 |     |     |     |
| Incr Delay (d2), s/veh      | 0.0  | 0.5  | 0.5  | 1.4  | 0.2  | 0.0  | 1.6  | 0.0  | 0.3  |     |     |     |
| Initial Q Delay(d3),s/veh   | 0.0  | 0.0  | 0.0  | 0.0  | 0.0  | 0.0  | 0.0  | 0.0  | 0.0  |     |     |     |
| %ile BackOfQ(50%),veh/ln    | 0.0  | 0.9  | 1.0  | 0.3  | 1.7  | 0.0  | 0.3  | 0.0  | 0.1  |     |     |     |
| LnGrp Delay(d),s/veh        | 0.0  | 6.4  | 6.4  | 12.6 | 3.6  | 0.0  | 13.0 | 0.0  | 11.5 |     |     |     |
| LnGrp LOS                   |      | A    | A    | B    | A    |      | B    |      | B    |     |     |     |
| Approach Vol, veh/h         |      | 369  |      |      | 889  |      |      | 46   |      |     |     |     |
| Approach Delay, s/veh       |      | 6.4  |      |      | 4.0  |      |      | 12.7 |      |     |     |     |
| Approach LOS                |      | A    |      |      | A    |      |      | B    |      |     |     |     |
| Timer                       | 1    | 2    | 3    | 4    | 5    | 6    | 7    | 8    |      |     |     |     |
| Assigned Phs                | 1    | 2    |      |      | 5    | 6    |      | 8    |      |     |     |     |
| Phs Duration (G+Y+Rc), s    | 4.9  | 13.8 |      |      | 0.0  | 18.6 |      | 5.8  |      |     |     |     |
| Change Period (Y+Rc), s     | 3.6  | 5.4  |      |      | 3.5  | 5.4  |      | 4.7  |      |     |     |     |
| Max Green Setting (Gmax)    | 20   | 60.0 |      |      | 20.0 | 60.0 |      | 27.0 |      |     |     |     |
| Max Q Clear Time (g_c+12)   | 12.6 | 3.9  |      |      | 0.0  | 5.5  |      | 2.5  |      |     |     |     |
| Green Ext Time (p_c), s     | 0.0  | 3.8  |      |      | 0.0  | 7.7  |      | 0.0  |      |     |     |     |
| <b>Intersection Summary</b> |      |      |      |      |      |      |      |      |      |     |     |     |
| HCM 2010 Ctrl Delay         |      |      |      | 5.0  |      |      |      |      |      |     |     |     |
| HCM 2010 LOS                |      |      |      | A    |      |      |      |      |      |     |     |     |
| <b>Notes</b>                |      |      |      |      |      |      |      |      |      |     |     |     |

HCM 2010 Signalized Intersection Summary  
28: Davis Road & Reservation Road

Existing, AM  
06/11/2019

|                              |  |  |  |  |  |  |  |  |  |  |  |  |
|------------------------------|---|---|---|---|---|---|--|---|---|---|---|---|
| Movement                     | EBL   | EBT   | EBR   | WBL   | WBT   | WBR   | NBL  | NBT   | NBR   | SBL   | SBT   | SBR   |
| Lane Configurations          |  |  |   |  |  |   |  |  |   |   |  |  |
| Traffic Volume (veh/h)       | 132   | 261   | 1   | 1   | 489   | 104   | 3  | 6   | 4   | 145   | 3   | 301   |
| Future Volume (veh/h)        | 132   | 261   | 1   | 1   | 489   | 104   | 3  | 6   | 4   | 145   | 3   | 301   |
| Number                       | 5   | 2   | 12  | 1   | 6   | 16  | 3  | 8   | 18  | 7   | 4   | 14  |
| Initial Q (Qb), veh          | 0   | 0   | 0   | 0   | 0   | 0   | 0  | 0   | 0   | 0   | 0   | 0   |
| Ped-Bike Adj(A_pbT)          | 1.00  |   | 1.00  | 1.00  |   | 1.00  | 1.00   |   | 1.00  | 1.00  |   | 1.00  |
| Parking Bus, Adj             | 1.00  | 1.00  | 1.00  | 1.00  | 1.00  | 1.00  | 1.00   | 1.00  | 1.00  | 1.00  | 1.00  | 1.00  |
| Adj Sat Flow, veh/h/ln       | 1863  | 1863  | 1900  | 1863  | 1863  | 1900  | 1900   | 1900  | 1900  | 1900  | 1845  | 1845  |
| Adj Flow Rate, veh/h         | 143   | 284   | 1   | 1   | 569   | 113   | 3  | 7   | 2   | 169   | 3   | 108   |
| Adj No. of Lanes             | 1   | 1   | 0   | 1   | 1   | 0   | 0  | 1   | 0   | 0   | 1   | 1   |
| Peak Hour Factor             | 0.92  | 0.92  | 0.92  | 0.86  | 0.86  | 0.92  | 0.86   | 0.86  | 0.86  | 0.86  | 0.86  | 0.86  |
| Percent Heavy Veh, %         | 2   | 2   | 2   | 2   | 2   | 2   | 0  | 0   | 0   | 3   | 3   | 3   |
| Cap, veh/h                   | 181   | 1062  | 4   | 3   | 714   | 142   | 7  | 16  | 5   | 225   | 4   | 364   |
| Arrive On Green              | 0.10  | 0.57  | 0.57  | 0.00  | 0.47  | 0.47  | 0.02   | 0.02  | 0.02  | 0.13  | 0.13  | 0.13  |
| Sat Flow, veh/h              | 1774  | 1855  | 7   | 1774  | 1510  | 300   | 456  | 1064  | 304   | 1728  | 31  | 1568  |
| Grp Volume(v), veh/h         | 143   | 0   | 285   | 1   | 0   | 682   | 12   | 0   | 0   | 172   | 0   | 108   |
| Grp Sat Flow(s),veh/h/ln     | 1774  | 0   | 1862  | 1774  | 0   | 1810  | 1824   | 0   | 0   | 1758  | 0   | 1568  |
| Q Serve(g_s), s              | 5.0   | 0.0   | 4.9   | 0.0   | 0.0   | 20.3  | 0.4  | 0.0   | 0.0   | 6.0   | 0.0   | 3.6   |
| Cycle Q Clear(g_c), s        | 5.0   | 0.0   | 4.9   | 0.0   | 0.0   | 20.3  | 0.4  | 0.0   | 0.0   | 6.0   | 0.0   | 3.6   |
| Prop In Lane                 | 1.00  |   | 0.00  | 1.00  |   | 0.17  | 0.25   |   | 0.17  | 0.98  |   | 1.00  |
| Lane Grp Cap(c), veh/h       | 181   | 0   | 1065  | 3   | 0   | 856   | 27   | 0   | 0   | 229   | 0   | 364   |
| V/C Ratio(X)                 | 0.79  | 0.00  | 0.27  | 0.36  | 0.00  | 0.80  | 0.44   | 0.00  | 0.00  | 0.75  | 0.00  | 0.30  |
| Avail Cap(c_a), veh/h        | 837   | 0   | 1757  | 837   | 0   | 1708  | 860  | 0   | 0   | 830   | 0   | 900   |
| HCM Platoon Ratio            | 1.00  | 1.00  | 1.00  | 1.00  | 1.00  | 1.00  | 1.00   | 1.00  | 1.00  | 1.00  | 1.00  | 1.00  |
| Upstream Filter(I)           | 1.00  | 0.00  | 1.00  | 1.00  | 0.00  | 1.00  | 1.00   | 0.00  | 0.00  | 1.00  | 0.00  | 1.00  |
| Uniform Delay (d), s/veh     | 27.9  | 0.0   | 6.9   | 31.7  | 0.0   | 14.2  | 31.1   | 0.0   | 0.0   | 26.7  | 0.0   | 20.1  |
| Incr Delay (d2), s/veh       | 2.9   | 0.0   | 0.2   | 26.4  | 0.0   | 2.7   | 4.0  | 0.0   | 0.0   | 1.9   | 0.0   | 0.2   |
| Initial Q Delay(d3),s/veh    | 0.0   | 0.0   | 0.0   | 0.0   | 0.0   | 0.0   | 0.0  | 0.0   | 0.0   | 0.0   | 0.0   | 0.0   |
| %ile BackOfQ(50%),veh/ln     | 2.6   | 0.0   | 2.5   | 0.0   | 0.0   | 10.7  | 0.2  | 0.0   | 0.0   | 3.0   | 0.0   | 1.6   |
| LnGrp Delay(d),s/veh         | 30.8  | 0.0   | 7.1   | 58.1  | 0.0   | 16.9  | 35.1   | 0.0   | 0.0   | 28.6  | 0.0   | 20.3  |
| LnGrp LOS                    | C   |   | A   | E   |   | B   | D  |   |   | C   |   | C   |
| Approach Vol, veh/h          |   | 428   |   |   | 683   |   |  | 12  |   |   | 280   |   |
| Approach Delay, s/veh        |   | 15.0  |   |   | 17.0  |   |  | 35.1  |   |   | 25.4  |   |
| Approach LOS                 |   | B   |   |   | B   |   |  | D   |   |   | C   |   |
| Timer                        | 1   | 2   | 3   | 4   | 5   | 6   | 7  | 8   |   |   |   |   |
| Assigned Phs                 | 1   | 2   |   | 4   | 5   | 6   |  | 8   |   |   |   |   |
| Phs Duration (G+Y+Rc), s     | 4.0   | 41.4  |   | 13.3  | 10.3  | 35.1  |  | 5.0   |   |   |   |   |
| Change Period (Y+Rc), s      | * 3.9   | 5.0   |   | 5.0   | * 3.8   | 5.0   |  | 4.0   |   |   |   |   |
| Max Green Setting (Gmax), s  | * 30  | 60.0  |   | 30.0  | * 30  | 60.0  |  | 30.0  |   |   |   |   |
| Max Q Clear Time (g_c+I1), s | 2.0   | 6.9   |   | 8.0   | 7.0   | 22.3  |  | 2.4   |   |   |   |   |
| Green Ext Time (p_c), s      | 0.0   | 2.6   |   | 0.3   | 0.0   | 7.8   |  | 0.0   |   |   |   |   |
| <b>Intersection Summary</b>  |   |   |   |   |   |   |  |   |   |   |   |   |
| HCM 2010 Ctrl Delay          |   |   | 18.2  |   |   |   |  |   |   |   |   |   |
| HCM 2010 LOS                 |   |   | B   |   |   |   |  |   |   |   |   |   |
| <b>Notes</b>                 |   |   |   |   |   |   |  |   |   |   |   |   |

| Intersection              |      |  |  |  |  |  |  |  |  |  |  |  |
|---------------------------|------|--|--|--|--|--|--|--|--|--|--|--|
| Intersection Delay, s/veh | 31.1 |  |  |  |  |  |  |  |  |  |  |  |
| Intersection LOS          | D    |  |  |  |  |  |  |  |  |  |  |  |

| Movement            | EBL  | EBT  | EBR  | WBL  | WBT  | WBR  | NBL  | NBT  | NBR  | SBL  | SBT  | SBR  |
|---------------------|------|------|------|------|------|------|------|------|------|------|------|------|
| Lane Configurations |      | ↔    |      |      | ↔    | ↔    | ↔    | ↔    |      | ↔    | ↔    | ↔    |
| Traffic Vol, veh/h  | 1    | 5    | 1    | 7    | 1    | 2    | 18   | 122  | 13   | 32   | 609  | 13   |
| Future Vol, veh/h   | 1    | 5    | 1    | 7    | 1    | 2    | 18   | 122  | 13   | 32   | 609  | 13   |
| Peak Hour Factor    | 0.91 | 0.91 | 0.91 | 0.91 | 0.91 | 0.91 | 0.91 | 0.91 | 0.91 | 0.91 | 0.91 | 0.91 |
| Heavy Vehicles, %   | 14   | 14   | 14   | 0    | 0    | 0    | 2    | 2    | 2    | 1    | 1    | 1    |
| Mvmt Flow           | 1    | 5    | 1    | 8    | 1    | 2    | 20   | 134  | 14   | 35   | 669  | 14   |
| Number of Lanes     | 0    | 1    | 0    | 0    | 1    | 1    | 1    | 2    | 0    | 1    | 1    | 1    |

| Approach                   | EB  | WB  | NB  | SB   |
|----------------------------|-----|-----|-----|------|
| Opposing Approach          | WB  | EB  | SB  | NB   |
| Opposing Lanes             | 2   | 1   | 3   | 3    |
| Conflicting Approach Left  | SB  | NB  | EB  | WB   |
| Conflicting Lanes Left     | 3   | 3   | 1   | 2    |
| Conflicting Approach Right | NB  | SB  | WB  | EB   |
| Conflicting Lanes Right    | 3   | 3   | 2   | 1    |
| HCM Control Delay          | 9.9 | 9.9 | 9.6 | 36.7 |
| HCM LOS                    | A   | A   | A   | E    |

| Lane                   | NBLn1 | NBLn2 | NBLn3 | EBLn1 | WBLn1 | WBLn2 | SBLn1 | SBLn2 | SBLn3 |
|------------------------|-------|-------|-------|-------|-------|-------|-------|-------|-------|
| Vol Left, %            | 100%  | 0%    | 0%    | 14%   | 88%   | 0%    | 100%  | 0%    | 0%    |
| Vol Thru, %            | 0%    | 100%  | 76%   | 71%   | 12%   | 0%    | 0%    | 100%  | 0%    |
| Vol Right, %           | 0%    | 0%    | 24%   | 14%   | 0%    | 100%  | 0%    | 0%    | 100%  |
| Sign Control           | Stop  | Stop  | Stop  | Stop  | Stop  | Stop  | Stop  | Stop  | Stop  |
| Traffic Vol by Lane    | 18    | 81    | 54    | 7     | 8     | 2     | 32    | 609   | 13    |
| LT Vol                 | 18    | 0     | 0     | 1     | 7     | 0     | 32    | 0     | 0     |
| Through Vol            | 0     | 81    | 41    | 5     | 1     | 0     | 0     | 609   | 0     |
| RT Vol                 | 0     | 0     | 13    | 1     | 0     | 2     | 0     | 0     | 13    |
| Lane Flow Rate         | 20    | 89    | 59    | 8     | 9     | 2     | 35    | 669   | 14    |
| Geometry Grp           | 8     | 8     | 8     | 8     | 8     | 8     | 8     | 8     | 8     |
| Degree of Util (X)     | 0.036 | 0.148 | 0.095 | 0.015 | 0.018 | 0.004 | 0.053 | 0.921 | 0.017 |
| Departure Headway (Hd) | 6.478 | 5.978 | 5.808 | 6.958 | 7.179 | 6.043 | 5.455 | 4.955 | 4.254 |
| Convergence, Y/N       | Yes   | Yes   | Yes   | Yes   | Yes   | Yes   | Yes   | Yes   | Yes   |
| Cap                    | 551   | 597   | 614   | 510   | 495   | 586   | 655   | 729   | 838   |
| Service Time           | 4.241 | 3.74  | 3.57  | 4.758 | 4.979 | 3.843 | 3.197 | 2.696 | 1.996 |
| HCM Lane V/C Ratio     | 0.036 | 0.149 | 0.096 | 0.016 | 0.018 | 0.003 | 0.053 | 0.918 | 0.017 |
| HCM Control Delay      | 9.5   | 9.8   | 9.2   | 9.9   | 10.1  | 8.9   | 8.5   | 38.8  | 7.1   |
| HCM Lane LOS           | A     | A     | A     | A     | B     | A     | A     | E     | A     |
| HCM 95th-tile Q        | 0.1   | 0.5   | 0.3   | 0     | 0.1   | 0     | 0.2   | 12.6  | 0.1   |

|                           |     |  |  |  |  |  |  |  |  |  |  |  |
|---------------------------|-----|--|--|--|--|--|--|--|--|--|--|--|
| <b>Intersection</b>       |     |  |  |  |  |  |  |  |  |  |  |  |
| Intersection Delay, s/veh | 9.1 |  |  |  |  |  |  |  |  |  |  |  |
| Intersection LOS          | A   |  |  |  |  |  |  |  |  |  |  |  |

| Movement            | EBL  | EBT  | EBR  | WBL  | WBT  | WBR  | NBL  | NBT  | NBR  | SBL  | SBT  | SBR  |
|---------------------|------|------|------|------|------|------|------|------|------|------|------|------|
| Lane Configurations |      | ↕    |      |      | ↕    |      | ↕    | ↕    |      | ↕    | ↕    |      |
| Traffic Vol, veh/h  | 7    | 44   | 5    | 57   | 8    | 18   | 9    | 122  | 62   | 12   | 136  | 2    |
| Future Vol, veh/h   | 7    | 44   | 5    | 57   | 8    | 18   | 9    | 122  | 62   | 12   | 136  | 2    |
| Peak Hour Factor    | 0.91 | 0.91 | 0.91 | 0.91 | 0.91 | 0.91 | 0.91 | 0.91 | 0.91 | 0.91 | 0.91 | 0.91 |
| Heavy Vehicles, %   | 0    | 0    | 0    | 1    | 1    | 1    | 2    | 2    | 2    | 1    | 1    | 1    |
| Mvmt Flow           | 8    | 48   | 5    | 63   | 9    | 20   | 10   | 134  | 68   | 13   | 149  | 2    |
| Number of Lanes     | 0    | 1    | 0    | 0    | 1    | 0    | 1    | 1    | 0    | 1    | 1    | 0    |

| Approach                   | EB  | WB  | NB  | SB  |
|----------------------------|-----|-----|-----|-----|
| Opposing Approach          | WB  | EB  | SB  | NB  |
| Opposing Lanes             | 1   | 1   | 2   | 2   |
| Conflicting Approach Left  | SB  | NB  | EB  | WB  |
| Conflicting Lanes Left     | 2   | 2   | 1   | 1   |
| Conflicting Approach Right | NB  | SB  | WB  | EB  |
| Conflicting Lanes Right    | 2   | 2   | 1   | 1   |
| HCM Control Delay          | 8.4 | 8.7 | 9.4 | 9.1 |
| HCM LOS                    | A   | A   | A   | A   |

| Lane                   | NBLn1 | NBLn2 | EBLn1 | WBLn1 | SBLn1 | SBLn2 |
|------------------------|-------|-------|-------|-------|-------|-------|
| Vol Left, %            | 100%  | 0%    | 12%   | 69%   | 100%  | 0%    |
| Vol Thru, %            | 0%    | 66%   | 79%   | 10%   | 0%    | 99%   |
| Vol Right, %           | 0%    | 34%   | 9%    | 22%   | 0%    | 1%    |
| Sign Control           | Stop  | Stop  | Stop  | Stop  | Stop  | Stop  |
| Traffic Vol by Lane    | 9     | 184   | 56    | 83    | 12    | 138   |
| LT Vol                 | 9     | 0     | 7     | 57    | 12    | 0     |
| Through Vol            | 0     | 122   | 44    | 8     | 0     | 136   |
| RT Vol                 | 0     | 62    | 5     | 18    | 0     | 2     |
| Lane Flow Rate         | 10    | 202   | 62    | 91    | 13    | 152   |
| Geometry Grp           | 7     | 7     | 2     | 2     | 7     | 7     |
| Degree of Util (X)     | 0.015 | 0.271 | 0.084 | 0.125 | 0.02  | 0.214 |
| Departure Headway (Hd) | 5.571 | 4.831 | 4.911 | 4.92  | 5.588 | 5.075 |
| Convergence, Y/N       | Yes   | Yes   | Yes   | Yes   | Yes   | Yes   |
| Cap                    | 642   | 742   | 728   | 728   | 640   | 707   |
| Service Time           | 3.306 | 2.566 | 2.951 | 2.957 | 3.324 | 2.811 |
| HCM Lane V/C Ratio     | 0.016 | 0.272 | 0.085 | 0.125 | 0.02  | 0.215 |
| HCM Control Delay      | 8.4   | 9.4   | 8.4   | 8.7   | 8.4   | 9.2   |
| HCM Lane LOS           | A     | A     | A     | A     | A     | A     |
| HCM 95th-tile Q        | 0     | 1.1   | 0.3   | 0.4   | 0.1   | 0.8   |

HCM 2010 Signalized Intersection Summary  
 31: 1st Avenue & Lightfighter Drive

Existing, AM  
 06/11/2019



| Movement                     | EBL  | EBT  | EBR  | WBL  | WBT  | WBR  | NBL  | NBT  | NBR  | SBL  | SBT  | SBR  |
|------------------------------|------|------|------|------|------|------|------|------|------|------|------|------|
| Lane Configurations          |      | ↑↑   | ↑    | ↑    | ↑↑   |      | ↑    |      | ↑    | ↑    | ↑    | ↑    |
| Traffic Volume (veh/h)       | 0    | 748  | 126  | 20   | 754  | 0    | 158  | 0    | 16   | 14   | 4    | 18   |
| Future Volume (veh/h)        | 0    | 748  | 126  | 20   | 754  | 0    | 158  | 0    | 16   | 14   | 4    | 18   |
| Number                       | 7    | 4    | 14   | 3    | 8    | 18   | 5    | 2    | 12   | 1    | 6    | 16   |
| Initial Q (Qb), veh          | 0    | 0    | 0    | 0    | 0    | 0    | 0    | 0    | 0    | 0    | 0    | 0    |
| Ped-Bike Adj(A_pbT)          | 1.00 |      | 1.00 | 1.00 |      | 1.00 | 1.00 |      | 1.00 | 1.00 |      | 1.00 |
| Parking Bus, Adj             | 1.00 | 1.00 | 1.00 | 1.00 | 1.00 | 1.00 | 1.00 | 1.00 | 1.00 | 1.00 | 1.00 | 1.00 |
| Adj Sat Flow, veh/h/ln       | 0    | 1863 | 1863 | 1863 | 1863 | 0    | 1863 | 0    | 1863 | 1792 | 1792 | 1792 |
| Adj Flow Rate, veh/h         | 0    | 890  | 0    | 24   | 898  | 0    | 188  | 0    | 5    | 17   | 5    | 2    |
| Adj No. of Lanes             | 0    | 2    | 1    | 1    | 2    | 0    | 1    | 0    | 1    | 1    | 1    | 1    |
| Peak Hour Factor             | 0.84 | 0.84 | 0.84 | 0.84 | 0.84 | 0.84 | 0.84 | 0.84 | 0.84 | 0.84 | 0.84 | 0.84 |
| Percent Heavy Veh, %         | 0    | 2    | 2    | 2    | 2    | 0    | 2    | 0    | 2    | 6    | 6    | 6    |
| Cap, veh/h                   | 0    | 1998 | 894  | 26   | 2446 | 0    | 0    | 0    | 0    | 24   | 25   | 21   |
| Arrive On Green              | 0.00 | 0.56 | 0.00 | 0.01 | 0.69 | 0.00 | 0.00 | 0.00 | 0.00 | 0.01 | 0.01 | 0.01 |
| Sat Flow, veh/h              | 0    | 3632 | 1583 | 1774 | 3632 | 0    | 0    | 0    | 1707 | 1792 | 1524 |      |
| Grp Volume(v), veh/h         | 0    | 890  | 0    | 24   | 898  | 0    | 0.0  | 0.0  | 17   | 5    | 2    |      |
| Grp Sat Flow(s),veh/h/ln     | 0    | 1770 | 1583 | 1774 | 1770 | 0    | 0.0  | 0.0  | 1707 | 1792 | 1524 |      |
| Q Serve(g_s), s              | 0.0  | 4.6  | 0.0  | 0.4  | 3.3  | 0.0  | 0.0  | 0.0  | 0.3  | 0.1  | 0.0  |      |
| Cycle Q Clear(g_c), s        | 0.0  | 4.6  | 0.0  | 0.4  | 3.3  | 0.0  | 0.0  | 0.0  | 0.3  | 0.1  | 0.0  |      |
| Prop In Lane                 | 0.00 |      | 1.00 | 1.00 |      | 0.00 |      |      | 1.00 |      | 1.00 |      |
| Lane Grp Cap(c), veh/h       | 0    | 1998 | 894  | 26   | 2446 | 0    | 0    | 0    | 24   | 25   | 21   |      |
| V/C Ratio(X)                 | 0.00 | 0.45 | 0.00 | 0.92 | 0.37 | 0.00 | 0.00 | 0.00 | 0.71 | 0.20 | 0.09 |      |
| Avail Cap(c_a), veh/h        | 0    | 5102 | 2283 | 1137 | 5102 | 0    | 0    | 0    | 1367 | 1436 | 1220 |      |
| HCM Platoon Ratio            | 1.00 | 1.00 | 1.00 | 1.00 | 1.00 | 1.00 | 1.00 | 1.00 | 1.00 | 1.00 | 1.00 |      |
| Upstream Filter(I)           | 0.00 | 1.00 | 0.00 | 1.00 | 1.00 | 0.00 | 0.00 | 0.00 | 1.00 | 1.00 | 1.00 |      |
| Uniform Delay (d), s/veh     | 0.0  | 4.0  | 0.0  | 15.4 | 2.0  | 0.0  | 0.0  | 0.0  | 15.3 | 15.2 | 15.2 |      |
| Incr Delay (d2), s/veh       | 0.0  | 0.2  | 0.0  | 33.8 | 0.1  | 0.0  | 0.0  | 0.0  | 13.4 | 1.4  | 0.7  |      |
| Initial Q Delay(d3),s/veh    | 0.0  | 0.0  | 0.0  | 0.0  | 0.0  | 0.0  | 0.0  | 0.0  | 0.0  | 0.0  | 0.0  |      |
| %ile BackOfQ(50%),veh/ln     | 0.0  | 2.2  | 0.0  | 0.4  | 1.5  | 0.0  | 0.0  | 0.0  | 0.2  | 0.1  | 0.0  |      |
| LnGrp Delay(d),s/veh         | 0.0  | 4.2  | 0.0  | 49.2 | 2.1  | 0.0  | 0.0  | 0.0  | 28.8 | 16.6 | 15.9 |      |
| LnGrp LOS                    |      | A    |      | D    | A    |      |      |      | C    | B    | B    |      |
| Approach Vol, veh/h          |      | 890  |      |      | 922  |      |      |      |      |      | 24   |      |
| Approach Delay, s/veh        |      | 4.2  |      |      | 3.4  |      |      |      |      |      | 25.2 |      |
| Approach LOS                 |      | A    |      |      | A    |      |      |      |      |      | C    |      |
| Timer                        | 1    | 2    | 3    | 4    | 5    | 6    | 7    | 8    |      |      |      |      |
| Assigned Phs                 |      |      | 3    | 4    |      | 6    |      | 8    |      |      |      |      |
| Phs Duration (G+Y+Rc), s     |      |      | 4.0  | 22.2 |      | 5.0  |      | 26.2 |      |      |      |      |
| Change Period (Y+Rc), s      |      |      | 3.5  | 4.6  |      | 4.6  |      | 4.6  |      |      |      |      |
| Max Green Setting (Gmax), s  |      |      | 20.0 | 45.0 |      | 25.0 |      | 45.0 |      |      |      |      |
| Max Q Clear Time (g_c+I1), s |      |      | 2.4  | 6.6  |      | 2.3  |      | 5.3  |      |      |      |      |
| Green Ext Time (p_c), s      |      |      | 0.0  | 11.1 |      | 0.0  |      | 10.4 |      |      |      |      |
| <b>Intersection Summary</b>  |      |      |      |      |      |      |      |      |      |      |      |      |
| HCM 2010 Ctrl Delay          |      |      | 4.0  |      |      |      |      |      |      |      |      |      |
| HCM 2010 LOS                 |      |      | A    |      |      |      |      |      |      |      |      |      |

HCM 2010 Signalized Intersection Summary  
 32: 2nd Avenue & Lightfighter Drive

Existing, AM  
 06/11/2019



| Movement                    | EBL  | EBT  | EBR  | WBL  | WBT  | WBR  | NBL  | NBT  | NBR  | SBL  | SBT  | SBR  |
|-----------------------------|------|------|------|------|------|------|------|------|------|------|------|------|
| Lane Configurations         |      |      |      |      |      |      |      |      |      |      |      |      |
| Traffic Volume (veh/h)      | 78   | 696  | 2    | 5    | 424  | 68   | 2    | 1    | 1    | 272  | 4    | 343  |
| Future Volume (veh/h)       | 78   | 696  | 2    | 5    | 424  | 68   | 2    | 1    | 1    | 272  | 4    | 343  |
| Number                      | 5    | 2    | 12   | 1    | 6    | 16   | 3    | 8    | 18   | 7    | 4    | 14   |
| Initial Q (Qb), veh         | 0    | 0    | 0    | 0    | 0    | 0    | 0    | 0    | 0    | 0    | 0    | 0    |
| Ped-Bike Adj(A_pbT)         | 1.00 |      | 1.00 | 1.00 |      | 1.00 | 1.00 |      | 1.00 | 1.00 |      | 1.00 |
| Parking Bus, Adj            | 1.00 | 1.00 | 1.00 | 1.00 | 1.00 | 1.00 | 1.00 | 1.00 | 1.00 | 1.00 | 1.00 | 1.00 |
| Adj Sat Flow, veh/h/ln      | 1863 | 1863 | 1900 | 1827 | 1827 | 1900 | 1900 | 1900 | 1900 | 1881 | 1881 | 1881 |
| Adj Flow Rate, veh/h        | 87   | 773  | 2    | 6    | 471  | 67   | 2    | 1    | 0    | 302  | 4    | 105  |
| Adj No. of Lanes            | 1    | 2    | 0    | 1    | 2    | 0    | 0    | 1    | 0    | 1    | 1    | 1    |
| Peak Hour Factor            | 0.90 | 0.90 | 0.90 | 0.90 | 0.90 | 0.90 | 0.90 | 0.90 | 0.90 | 0.90 | 0.90 | 0.90 |
| Percent Heavy Veh, %        | 2    | 2    | 2    | 4    | 4    | 4    | 0    | 0    | 0    | 1    | 1    | 1    |
| Cap, veh/h                  | 111  | 2281 | 6    | 11   | 1752 | 248  | 276  | 126  | 0    | 403  | 436  | 371  |
| Arrive On Green             | 0.06 | 0.63 | 0.63 | 0.01 | 0.57 | 0.57 | 0.24 | 0.23 | 0.00 | 0.23 | 0.23 | 0.23 |
| Sat Flow, veh/h             | 1774 | 3621 | 9    | 1740 | 3054 | 432  | 930  | 545  | 0    | 1424 | 1881 | 1599 |
| Grp Volume(v), veh/h        | 87   | 378  | 397  | 6    | 267  | 271  | 3    | 0    | 0    | 302  | 4    | 105  |
| Grp Sat Flow(s),veh/h/ln    | 1774 | 1770 | 1861 | 1740 | 1736 | 1751 | 1476 | 0    | 0    | 1424 | 1881 | 1599 |
| Q Serve(g_s), s             | 4.8  | 10.0 | 10.0 | 0.3  | 7.7  | 7.8  | 0.0  | 0.0  | 0.0  | 20.5 | 0.2  | 5.4  |
| Cycle Q Clear(g_c), s       | 4.8  | 10.0 | 10.0 | 0.3  | 7.7  | 7.8  | 0.1  | 0.0  | 0.0  | 20.6 | 0.2  | 5.4  |
| Prop In Lane                | 1.00 |      | 0.01 | 1.00 |      | 0.25 | 0.67 |      | 0.00 | 1.00 |      | 1.00 |
| Lane Grp Cap(c), veh/h      | 111  | 1115 | 1172 | 11   | 995  | 1004 | 411  | 0    | 0    | 403  | 436  | 371  |
| V/C Ratio(X)                | 0.79 | 0.34 | 0.34 | 0.56 | 0.27 | 0.27 | 0.01 | 0.00 | 0.00 | 0.75 | 0.01 | 0.28 |
| Avail Cap(c_a), veh/h       | 220  | 1115 | 1172 | 216  | 995  | 1004 | 662  | 0    | 0    | 648  | 760  | 646  |
| HCM Platoon Ratio           | 1.00 | 1.00 | 1.00 | 1.00 | 1.00 | 1.00 | 1.00 | 1.00 | 1.00 | 1.00 | 1.00 | 1.00 |
| Upstream Filter(I)          | 0.87 | 0.87 | 0.87 | 0.82 | 0.82 | 0.82 | 1.00 | 0.00 | 0.00 | 1.00 | 1.00 | 1.00 |
| Uniform Delay (d), s/veh    | 46.2 | 8.7  | 8.7  | 49.6 | 10.7 | 10.8 | 29.4 | 0.0  | 0.0  | 37.4 | 29.6 | 31.6 |
| Incr Delay (d2), s/veh      | 4.0  | 0.7  | 0.7  | 13.3 | 0.5  | 0.5  | 0.0  | 0.0  | 0.0  | 1.1  | 0.0  | 0.2  |
| Initial Q Delay(d3),s/veh   | 0.0  | 0.0  | 0.0  | 0.0  | 0.0  | 0.0  | 0.0  | 0.0  | 0.0  | 0.0  | 0.0  | 0.0  |
| %ile BackOfQ(50%),veh/ln    | 2.5  | 5.0  | 5.3  | 0.2  | 3.9  | 3.9  | 0.1  | 0.0  | 0.0  | 8.3  | 0.1  | 2.4  |
| LnGrp Delay(d),s/veh        | 50.2 | 9.4  | 9.4  | 62.9 | 11.3 | 11.3 | 29.4 | 0.0  | 0.0  | 38.5 | 29.6 | 31.7 |
| LnGrp LOS                   | D    | A    | A    | E    | B    | B    | C    |      |      | D    | C    | C    |
| Approach Vol, veh/h         |      | 862  |      |      | 544  |      |      | 3    |      |      | 411  |      |
| Approach Delay, s/veh       |      | 13.5 |      |      | 11.9 |      |      | 29.4 |      |      | 36.7 |      |
| Approach LOS                |      | B    |      |      | B    |      |      | C    |      |      | D    |      |
| Timer                       | 1    | 2    | 3    | 4    | 5    | 6    | 7    | 8    |      |      |      |      |
| Assigned Phs                | 1    | 2    |      | 4    | 5    | 6    |      | 8    |      |      |      |      |
| Phs Duration (G+Y+Rc), s    | 4.6  | 67.6 |      | 27.8 | 10.2 | 62.0 |      | 27.8 |      |      |      |      |
| Change Period (Y+Rc), s     | 4.0  | 4.6  |      | 4.6  | 4.0  | 4.6  |      | 4.6  |      |      |      |      |
| Max Green Setting (Gmax), s | 2.4  | 34.0 |      | 40.4 | 12.4 | 24.4 |      | 40.4 |      |      |      |      |
| Max Q Clear Time (g_c+1), s | 2.3  | 12.0 |      | 22.6 | 6.8  | 9.8  |      | 2.1  |      |      |      |      |
| Green Ext Time (p_c), s     | 0.0  | 2.8  |      | 0.6  | 0.0  | 1.7  |      | 0.0  |      |      |      |      |
| <b>Intersection Summary</b> |      |      |      |      |      |      |      |      |      |      |      |      |
| HCM 2010 Ctrl Delay         |      |      | 18.3 |      |      |      |      |      |      |      |      |      |
| HCM 2010 LOS                |      |      | B    |      |      |      |      |      |      |      |      |      |

HCM 2010 Signalized Intersection Summary  
 33: General Jim Moore Boulevard & Lightfighter Drive

Existing, AM  
 06/11/2019



| Movement                     | EBL  | EBT  | EBR  | WBL  | WBT  | WBR  | NBL  | NBT  | NBR  | SBL  | SBT  | SBR  |
|------------------------------|------|------|------|------|------|------|------|------|------|------|------|------|
| Lane Configurations          |      |      |      |      |      |      |      |      |      |      |      |      |
| Traffic Volume (veh/h)       | 123  | 127  | 710  | 21   | 187  | 10   | 250  | 90   | 2    | 10   | 179  | 59   |
| Future Volume (veh/h)        | 123  | 127  | 710  | 21   | 187  | 10   | 250  | 90   | 2    | 10   | 179  | 59   |
| Number                       | 3    | 8    | 18   | 7    | 4    | 14   | 1    | 6    | 16   | 5    | 2    | 12   |
| Initial Q (Qb), veh          | 0    | 0    | 0    | 0    | 0    | 0    | 0    | 0    | 0    | 0    | 0    | 0    |
| Ped-Bike Adj(A_pbT)          | 1.00 |      | 1.00 | 1.00 |      | 0.99 | 1.00 |      | 1.00 | 1.00 |      | 1.00 |
| Parking Bus, Adj             | 1.00 | 1.00 | 1.00 | 1.00 | 1.00 | 1.00 | 1.00 | 1.00 | 1.00 | 1.00 | 1.00 | 1.00 |
| Adj Sat Flow, veh/h/ln       | 1863 | 1863 | 1863 | 1792 | 1792 | 1900 | 1881 | 1881 | 1900 | 1863 | 1863 | 1900 |
| Adj Flow Rate, veh/h         | 138  | 143  | 0    | 24   | 210  | 9    | 281  | 101  | 1    | 11   | 201  | 66   |
| Adj No. of Lanes             | 1    | 1    | 1    | 1    | 1    | 0    | 2    | 1    | 0    | 1    | 2    | 0    |
| Peak Hour Factor             | 0.89 | 0.89 | 0.89 | 0.89 | 0.89 | 0.89 | 0.89 | 0.89 | 0.89 | 0.89 | 0.89 | 0.89 |
| Percent Heavy Veh, %         | 2    | 2    | 2    | 6    | 6    | 6    | 1    | 1    | 1    | 2    | 2    | 2    |
| Cap, veh/h                   | 183  | 493  | 419  | 39   | 314  | 13   | 682  | 633  | 6    | 20   | 411  | 131  |
| Arrive On Green              | 0.10 | 0.26 | 0.00 | 0.02 | 0.18 | 0.18 | 0.20 | 0.34 | 0.34 | 0.01 | 0.16 | 0.16 |
| Sat Flow, veh/h              | 1774 | 1863 | 1583 | 1707 | 1706 | 73   | 3476 | 1859 | 18   | 1774 | 2639 | 841  |
| Grp Volume(v), veh/h         | 138  | 143  | 0    | 24   | 0    | 219  | 281  | 0    | 102  | 11   | 133  | 134  |
| Grp Sat Flow(s),veh/h/ln     | 1774 | 1863 | 1583 | 1707 | 0    | 1779 | 1738 | 0    | 1878 | 1774 | 1770 | 1710 |
| Q Serve(g_s), s              | 3.8  | 3.1  | 0.0  | 0.7  | 0.0  | 5.7  | 3.5  | 0.0  | 1.9  | 0.3  | 3.4  | 3.6  |
| Cycle Q Clear(g_c), s        | 3.8  | 3.1  | 0.0  | 0.7  | 0.0  | 5.7  | 3.5  | 0.0  | 1.9  | 0.3  | 3.4  | 3.6  |
| Prop In Lane                 | 1.00 |      | 1.00 | 1.00 |      | 0.04 | 1.00 |      | 0.01 | 1.00 |      | 0.49 |
| Lane Grp Cap(c), veh/h       | 183  | 493  | 419  | 39   | 0    | 328  | 682  | 0    | 640  | 20   | 275  | 266  |
| V/C Ratio(X)                 | 0.75 | 0.29 | 0.00 | 0.62 | 0.00 | 0.67 | 0.41 | 0.00 | 0.16 | 0.55 | 0.48 | 0.50 |
| Avail Cap(c_a), veh/h        | 711  | 1120 | 952  | 684  | 0    | 1069 | 696  | 0    | 1129 | 533  | 1064 | 1028 |
| HCM Platoon Ratio            | 1.00 | 1.00 | 1.00 | 1.00 | 1.00 | 1.00 | 1.00 | 1.00 | 1.00 | 1.00 | 1.00 | 1.00 |
| Upstream Filter(I)           | 1.00 | 1.00 | 0.00 | 1.00 | 0.00 | 1.00 | 1.00 | 0.00 | 1.00 | 1.00 | 1.00 | 1.00 |
| Uniform Delay (d), s/veh     | 21.8 | 14.6 | 0.0  | 24.2 | 0.0  | 18.9 | 17.5 | 0.0  | 11.5 | 24.5 | 19.2 | 19.3 |
| Incr Delay (d2), s/veh       | 6.1  | 0.4  | 0.0  | 5.9  | 0.0  | 2.8  | 0.3  | 0.0  | 0.2  | 8.3  | 1.6  | 1.8  |
| Initial Q Delay(d3),s/veh    | 0.0  | 0.0  | 0.0  | 0.0  | 0.0  | 0.0  | 0.0  | 0.0  | 0.0  | 0.0  | 0.0  | 0.0  |
| %ile BackOfQ(50%),veh/ln     | 2.2  | 1.6  | 0.0  | 0.4  | 0.0  | 3.1  | 1.7  | 0.0  | 1.0  | 0.2  | 1.8  | 1.8  |
| LnGrp Delay(d),s/veh         | 27.9 | 15.0 | 0.0  | 30.0 | 0.0  | 21.8 | 17.8 | 0.0  | 11.7 | 32.9 | 20.8 | 21.1 |
| LnGrp LOS                    | C    | B    |      | C    |      | C    | B    |      | B    | C    | C    | C    |
| Approach Vol, veh/h          |      | 281  |      |      | 243  |      |      | 383  |      |      | 278  |      |
| Approach Delay, s/veh        |      | 21.3 |      |      | 22.6 |      |      | 16.2 |      |      | 21.4 |      |
| Approach LOS                 |      | C    |      |      | C    |      |      | B    |      |      | C    |      |
| Timer                        | 1    | 2    | 3    | 4    | 5    | 6    | 7    | 8    |      |      |      |      |
| Assigned Phs                 | 1    | 2    | 3    | 4    | 5    | 6    | 7    | 8    |      |      |      |      |
| Phs Duration (G+Y+Rc), s     | 4.3  | 12.3 | 9.7  | 13.7 | 5.1  | 21.5 | 5.6  | 17.7 |      |      |      |      |
| Change Period (Y+Rc), s      | 4.5  | 4.5  | 4.5  | 4.5  | 4.5  | 4.5  | 4.5  | 4.5  |      |      |      |      |
| Max Green Setting (Gmax), s  | 30.0 | 30.0 | 20.0 | 30.0 | 15.0 | 30.0 | 20.0 | 30.0 |      |      |      |      |
| Max Q Clear Time (g_c+15), s | 5.6  | 5.6  | 5.8  | 7.7  | 2.3  | 3.9  | 2.7  | 5.1  |      |      |      |      |
| Green Ext Time (p_c), s      | 0.3  | 1.8  | 0.3  | 1.5  | 0.0  | 0.9  | 0.0  | 0.8  |      |      |      |      |
| <b>Intersection Summary</b>  |      |      |      |      |      |      |      |      |      |      |      |      |
| HCM 2010 Ctrl Delay          |      |      |      | 20.0 |      |      |      |      |      |      |      |      |
| HCM 2010 LOS                 |      |      |      | B    |      |      |      |      |      |      |      |      |

| Intersection              |     |
|---------------------------|-----|
| Intersection Delay, s/veh | 9.9 |
| Intersection LOS          | A   |

| Movement            | WBL  | WBR  | NBT  | NBR  | SBL  | SBT  |
|---------------------|------|------|------|------|------|------|
| Lane Configurations |      |      |      |      |      |      |
| Traffic Vol, veh/h  | 12   | 260  | 58   | 3    | 138  | 29   |
| Future Vol, veh/h   | 12   | 260  | 58   | 3    | 138  | 29   |
| Peak Hour Factor    | 0.77 | 0.77 | 0.77 | 0.77 | 0.77 | 0.77 |
| Heavy Vehicles, %   | 4    | 4    | 3    | 3    | 2    | 2    |
| Mvmt Flow           | 16   | 338  | 75   | 4    | 179  | 38   |
| Number of Lanes     | 1    | 0    | 1    | 0    | 0    | 1    |

| Approach                   | WB | NB  | SB   |
|----------------------------|----|-----|------|
| Opposing Approach          |    | SB  | NB   |
| Opposing Lanes             | 0  | 1   | 1    |
| Conflicting Approach Left  | NB |     | WB   |
| Conflicting Lanes Left     | 1  | 0   | 1    |
| Conflicting Approach Right | SB | WB  |      |
| Conflicting Lanes Right    | 1  | 1   | 0    |
| HCM Control Delay          | 10 | 8.6 | 10.1 |
| HCM LOS                    | A  | A   | B    |

| Lane                   | NBLn1 | WBLn1 | SBLn1 |
|------------------------|-------|-------|-------|
| Vol Left, %            | 0%    | 4%    | 83%   |
| Vol Thru, %            | 95%   | 0%    | 17%   |
| Vol Right, %           | 5%    | 96%   | 0%    |
| Sign Control           | Stop  | Stop  | Stop  |
| Traffic Vol by Lane    | 61    | 272   | 167   |
| LT Vol                 | 0     | 12    | 138   |
| Through Vol            | 58    | 0     | 29    |
| RT Vol                 | 3     | 260   | 0     |
| Lane Flow Rate         | 79    | 353   | 217   |
| Geometry Grp           | 1     | 1     | 1     |
| Degree of Util (X)     | 0.109 | 0.407 | 0.299 |
| Departure Headway (Hd) | 4.964 | 4.145 | 4.96  |
| Convergence, Y/N       | Yes   | Yes   | Yes   |
| Cap                    | 718   | 869   | 722   |
| Service Time           | 3.025 | 2.175 | 3.013 |
| HCM Lane V/C Ratio     | 0.11  | 0.406 | 0.301 |
| HCM Control Delay      | 8.6   | 10    | 10.1  |
| HCM Lane LOS           | A     | A     | B     |
| HCM 95th-tile Q        | 0.4   | 2     | 1.3   |



| Intersection             |      |      |      |      |      |      |
|--------------------------|------|------|------|------|------|------|
| Int Delay, s/veh         | 0.4  |      |      |      |      |      |
| Movement                 | EBT  | EBR  | WBL  | WBT  | NBL  | NBR  |
| Lane Configurations      |      |      |      |      |      |      |
| Traffic Vol, veh/h       | 76   | 17   | 8    | 277  | 7    | 3    |
| Future Vol, veh/h        | 76   | 17   | 8    | 277  | 7    | 3    |
| Conflicting Peds, #/hr   | 0    | 0    | 0    | 0    | 0    | 0    |
| Sign Control             | Free | Free | Free | Free | Stop | Stop |
| RT Channelized           | -    | None | -    | None | -    | None |
| Storage Length           | -    | -    | -    | -    | 0    | -    |
| Veh in Median Storage, # | 0    | -    | -    | 0    | 0    | -    |
| Grade, %                 | 0    | -    | -    | 0    | 0    | -    |
| Peak Hour Factor         | 78   | 78   | 78   | 78   | 78   | 78   |
| Heavy Vehicles, %        | 5    | 5    | 4    | 4    | 0    | 0    |
| Mvmt Flow                | 97   | 22   | 10   | 355  | 9    | 4    |

| Major/Minor          | Major1 | Major2 | Minor1 |   |     |
|----------------------|--------|--------|--------|---|-----|
| Conflicting Flow All | 0      | 0      | 119    | 0 | 483 |
| Stage 1              | -      | -      | -      | - | 108 |
| Stage 2              | -      | -      | -      | - | 375 |
| Critical Hdwy        | -      | -      | 4.14   | - | 6.4 |
| Critical Hdwy Stg 1  | -      | -      | -      | - | 5.4 |
| Critical Hdwy Stg 2  | -      | -      | -      | - | 5.4 |
| Follow-up Hdwy       | -      | -      | 2.236  | - | 3.5 |
| Pot Cap-1 Maneuver   | -      | -      | 1457   | - | 546 |
| Stage 1              | -      | -      | -      | - | 921 |
| Stage 2              | -      | -      | -      | - | 699 |
| Platoon blocked, %   | -      | -      | -      | - | -   |
| Mov Cap-1 Maneuver   | -      | -      | 1457   | - | 541 |
| Mov Cap-2 Maneuver   | -      | -      | -      | - | 541 |
| Stage 1              | -      | -      | -      | - | 913 |
| Stage 2              | -      | -      | -      | - | 699 |

| Approach             | EB | WB  | NB   |
|----------------------|----|-----|------|
| HCM Control Delay, s | 0  | 0.2 | 10.9 |
| HCM LOS              |    |     | B    |

| Minor Lane/Major Mvmt | NBLn1 | EBT | EBR | WBL   | WBT |
|-----------------------|-------|-----|-----|-------|-----|
| Capacity (veh/h)      | 621   | -   | -   | 1457  | -   |
| HCM Lane V/C Ratio    | 0.021 | -   | -   | 0.007 | -   |
| HCM Control Delay (s) | 10.9  | -   | -   | 7.5   | 0   |
| HCM Lane LOS          | B     | -   | -   | A     | A   |
| HCM 95th %tile Q(veh) | 0.1   | -   | -   | 0     | -   |

| Intersection              |     |
|---------------------------|-----|
| Intersection Delay, s/veh | 8.9 |
| Intersection LOS          | A   |

| Movement            | EBL  | EBT  | EBR  | WBL  | WBT  | WBR  | NBL  | NBT  | NBR  | SBL  | SBT  | SBR  |
|---------------------|------|------|------|------|------|------|------|------|------|------|------|------|
| Lane Configurations |      | ↕    |      |      | ↕    |      |      | ↕    |      |      | ↕    |      |
| Traffic Vol, veh/h  | 14   | 45   | 23   | 10   | 230  | 0    | 1    | 7    | 2    | 0    | 5    | 53   |
| Future Vol, veh/h   | 14   | 45   | 23   | 10   | 230  | 0    | 1    | 7    | 2    | 0    | 5    | 53   |
| Peak Hour Factor    | 0.79 | 0.79 | 0.79 | 0.79 | 0.79 | 0.79 | 0.79 | 0.79 | 0.79 | 0.79 | 0.79 | 0.79 |
| Heavy Vehicles, %   | 6    | 6    | 6    | 4    | 4    | 4    | 20   | 20   | 20   | 2    | 2    | 2    |
| Mvmt Flow           | 18   | 57   | 29   | 13   | 291  | 0    | 1    | 9    | 3    | 0    | 6    | 67   |
| Number of Lanes     | 0    | 1    | 0    | 0    | 1    | 0    | 0    | 1    | 0    | 0    | 1    | 0    |

| Approach                   | EB | WB  | NB  | SB  |
|----------------------------|----|-----|-----|-----|
| Opposing Approach          | WB | EB  | SB  | NB  |
| Opposing Lanes             | 1  | 1   | 1   | 1   |
| Conflicting Approach Left  | SB | NB  | EB  | WB  |
| Conflicting Lanes Left     | 1  | 1   | 1   | 1   |
| Conflicting Approach Right | NB | SB  | WB  | EB  |
| Conflicting Lanes Right    | 1  | 1   | 1   | 1   |
| HCM Control Delay          | 8  | 9.6 | 8.2 | 7.7 |
| HCM LOS                    | A  | A   | A   | A   |

| Lane                   | NBLn1 | EBLn1 | WBLn1 | SBLn1 |
|------------------------|-------|-------|-------|-------|
| Vol Left, %            | 10%   | 17%   | 4%    | 0%    |
| Vol Thru, %            | 70%   | 55%   | 96%   | 9%    |
| Vol Right, %           | 20%   | 28%   | 0%    | 91%   |
| Sign Control           | Stop  | Stop  | Stop  | Stop  |
| Traffic Vol by Lane    | 10    | 82    | 240   | 58    |
| LT Vol                 | 1     | 14    | 10    | 0     |
| Through Vol            | 7     | 45    | 230   | 5     |
| RT Vol                 | 2     | 23    | 0     | 53    |
| Lane Flow Rate         | 13    | 104   | 304   | 73    |
| Geometry Grp           | 1     | 1     | 1     | 1     |
| Degree of Util (X)     | 0.018 | 0.126 | 0.355 | 0.088 |
| Departure Headway (Hd) | 5.139 | 4.374 | 4.205 | 4.307 |
| Convergence, Y/N       | Yes   | Yes   | Yes   | Yes   |
| Cap                    | 699   | 822   | 842   | 835   |
| Service Time           | 3.15  | 2.387 | 2.294 | 2.313 |
| HCM Lane V/C Ratio     | 0.019 | 0.127 | 0.361 | 0.087 |
| HCM Control Delay      | 8.2   | 8     | 9.6   | 7.7   |
| HCM Lane LOS           | A     | A     | A     | A     |
| HCM 95th-tile Q        | 0.1   | 0.4   | 1.6   | 0.3   |

| Intersection             |      |      |      |      |      |      |      |      |      |      |      |      |
|--------------------------|------|------|------|------|------|------|------|------|------|------|------|------|
| Int Delay, s/veh         | 6.6  |      |      |      |      |      |      |      |      |      |      |      |
| Movement                 | EBL  | EBT  | EBR  | WBL  | WBT  | WBR  | NBL  | NBT  | NBR  | SBL  | SBT  | SBR  |
| Lane Configurations      |      | ↕    |      |      | ↕    |      |      | ↕    |      |      | ↕    |      |
| Traffic Vol, veh/h       | 19   | 37   | 1    | 2    | 157  | 0    | 0    | 20   | 0    | 0    | 97   | 60   |
| Future Vol, veh/h        | 19   | 37   | 1    | 2    | 157  | 0    | 0    | 20   | 0    | 0    | 97   | 60   |
| Conflicting Peds, #/hr   | 0    | 0    | 0    | 0    | 0    | 0    | 0    | 0    | 1    | 1    | 0    | 0    |
| Sign Control             | Stop | Stop | Stop | Stop | Stop | Stop | Free | Free | Free | Free | Free | Free |
| RT Channelized           | -    | -    | None | -    | -    | None | -    | -    | None | -    | -    | None |
| Storage Length           | -    | -    | -    | -    | -    | -    | -    | -    | -    | -    | -    | -    |
| Veh in Median Storage, # | -    | 0    | -    | -    | 0    | -    | -    | 0    | -    | -    | 0    | -    |
| Grade, %                 | -    | 0    | -    | -    | 0    | -    | -    | 0    | -    | -    | 0    | -    |
| Peak Hour Factor         | 82   | 82   | 82   | 82   | 82   | 82   | 82   | 82   | 82   | 82   | 82   | 82   |
| Heavy Vehicles, %        | 12   | 12   | 12   | 0    | 0    | 0    | 10   | 10   | 10   | 10   | 10   | 10   |
| Mvmt Flow                | 23   | 45   | 1    | 2    | 191  | 0    | 0    | 24   | 0    | 0    | 118  | 73   |

| Major/Minor          | Minor2 |       | Minor1 |     | Major1 |      |      | Major2 |   |      |   |   |
|----------------------|--------|-------|--------|-----|--------|------|------|--------|---|------|---|---|
| Conflicting Flow All | 275    | 180   | 155    | 203 | 216    | 25   | 191  | 0      | 0 | 25   | 0 | 0 |
| Stage 1              | 155    | 155   | -      | 25  | 25     | -    | -    | -      | - | -    | - | - |
| Stage 2              | 120    | 25    | -      | 178 | 191    | -    | -    | -      | - | -    | - | - |
| Critical Hdwy        | 7.22   | 6.62  | 6.32   | 7.1 | 6.5    | 6.2  | 4.2  | -      | - | 4.2  | - | - |
| Critical Hdwy Stg 1  | 6.22   | 5.62  | -      | 6.1 | 5.5    | -    | -    | -      | - | -    | - | - |
| Critical Hdwy Stg 2  | 6.22   | 5.62  | -      | 6.1 | 5.5    | -    | -    | -      | - | -    | - | - |
| Follow-up Hdwy       | 3.608  | 4.108 | 3.408  | 3.5 | 4      | 3.3  | 2.29 | -      | - | 2.29 | - | - |
| Pot Cap-1 Maneuver   | 658    | 696   | 865    | 759 | 685    | 1057 | 1336 | -      | - | 1539 | - | - |
| Stage 1              | 824    | 751   | -      | 998 | 878    | -    | -    | -      | - | -    | - | - |
| Stage 2              | 861    | 855   | -      | 828 | 746    | -    | -    | -      | - | -    | - | - |
| Platoon blocked, %   |        |       |        |     |        |      |      | -      | - | -    | - | - |
| Mov Cap-1 Maneuver   | 516    | 695   | 865    | 720 | 684    | 1056 | 1336 | -      | - | 1538 | - | - |
| Mov Cap-2 Maneuver   | 516    | 695   | -      | 720 | 684    | -    | -    | -      | - | -    | - | - |
| Stage 1              | 824    | 751   | -      | 997 | 877    | -    | -    | -      | - | -    | - | - |
| Stage 2              | 673    | 854   | -      | 777 | 746    | -    | -    | -      | - | -    | - | - |

| Approach             | EB   |  | WB   |  | NB |  | SB |  |
|----------------------|------|--|------|--|----|--|----|--|
| HCM Control Delay, s | 11.5 |  | 12.3 |  | 0  |  | 0  |  |
| HCM LOS              | B    |  | B    |  |    |  |    |  |

| Minor Lane/Major Mvmt | NBL  | NBT | NBR | EBLn1 | WBLn1 | SBL  | SBT | SBR |
|-----------------------|------|-----|-----|-------|-------|------|-----|-----|
| Capacity (veh/h)      | 1336 | -   | -   | 625   | 684   | 1538 | -   | -   |
| HCM Lane V/C Ratio    | -    | -   | -   | 0.111 | 0.283 | -    | -   | -   |
| HCM Control Delay (s) | 0    | -   | -   | 11.5  | 12.3  | 0    | -   | -   |
| HCM Lane LOS          | A    | -   | -   | B     | B     | A    | -   | -   |
| HCM 95th %tile Q(veh) | 0    | -   | -   | 0.4   | 1.2   | 0    | -   | -   |

| Intersection             |      |      |      |      |      |      |
|--------------------------|------|------|------|------|------|------|
| Int Delay, s/veh         | 0.6  |      |      |      |      |      |
| Movement                 | EBL  | EBR  | NBL  | NBT  | SBT  | SBR  |
| Lane Configurations      | T    |      | T    |      | T    |      |
| Traffic Vol, veh/h       | 31   | 0    | 0    | 88   | 409  | 176  |
| Future Vol, veh/h        | 31   | 0    | 0    | 88   | 409  | 176  |
| Conflicting Peds, #/hr   | 0    | 0    | 0    | 0    | 0    | 0    |
| Sign Control             | Stop | Stop | Free | Free | Free | Free |
| RT Channelized           | -    | None | -    | None | -    | None |
| Storage Length           | 0    | -    | -    | -    | -    | -    |
| Veh in Median Storage, # | 0    | -    | -    | 0    | 0    | -    |
| Grade, %                 | 0    | -    | -    | 0    | 0    | -    |
| Peak Hour Factor         | 89   | 89   | 89   | 89   | 89   | 89   |
| Heavy Vehicles, %        | 13   | 13   | 2    | 2    | 0    | 0    |
| Mvmt Flow                | 35   | 0    | 0    | 99   | 460  | 198  |























| Major/Minor          | Minor2 | Major1 | Major2 |   |   |   |
|----------------------|--------|--------|--------|---|---|---|
| Conflicting Flow All | 658    | 559    | 658    | 0 | - | 0 |
| Stage 1              | 559    | -      | -      | - | - | - |
| Stage 2              | 99     | -      | -      | - | - | - |
| Critical Hdwy        | 6.53   | 6.33   | 4.12   | - | - | - |
| Critical Hdwy Stg 1  | 5.53   | -      | -      | - | - | - |
| Critical Hdwy Stg 2  | 5.53   | -      | -      | - | - | - |
| Follow-up Hdwy       | 3.617  | 3.417  | 2.218  | - | - | - |
| Pot Cap-1 Maneuver   | 412    | 508    | 930    | - | - | - |
| Stage 1              | 551    | -      | -      | - | - | - |
| Stage 2              | 898    | -      | -      | - | - | - |
| Platoon blocked, %   |        |        |        | - | - | - |
| Mov Cap-1 Maneuver   | 412    | 508    | 930    | - | - | - |
| Mov Cap-2 Maneuver   | 412    | -      | -      | - | - | - |
| Stage 1              | 551    | -      | -      | - | - | - |
| Stage 2              | 898    | -      | -      | - | - | - |

| Approach             | EB   | NB | SB |
|----------------------|------|----|----|
| HCM Control Delay, s | 14.5 | 0  | 0  |
| HCM LOS              | B    |    |    |

| Minor Lane/Major Mvmt | NBL | NBT | EBLn1 | SBT | SBR |
|-----------------------|-----|-----|-------|-----|-----|
| Capacity (veh/h)      | 930 | -   | 412   | -   | -   |
| HCM Lane V/C Ratio    | -   | -   | 0.085 | -   | -   |
| HCM Control Delay (s) | 0   | -   | 14.5  | -   | -   |
| HCM Lane LOS          | A   | -   | B     | -   | -   |
| HCM 95th %tile Q(veh) | 0   | -   | 0.3   | -   | -   |

HCM 2010 Signalized Intersection Summary  
 39: General Jim Moore Boulevard & Gigling Road

Existing, AM  
 06/11/2019

|                              |  |  |  |  |  |  |   |  |  |  |  |  |
|------------------------------|---|---|---|---|---|---|---|---|---|---|---|---|
| Movement                     | EBL   | EBT   | EBR   | WBL   | WBT   | WBR   | NBL   | NBT   | NBR   | SBL   | SBT   | SBR   |
| Lane Configurations          |  |  |   |  |  |  |  |  |  |  |  |  |
| Traffic Volume (veh/h)       | 22  | 94  | 75  | 361   | 31  | 46  | 47  | 317   | 178   | 162   | 717   | 46  |
| Future Volume (veh/h)        | 22  | 94  | 75  | 361   | 31  | 46  | 47  | 317   | 178   | 162   | 717   | 46  |
| Number                       | 3   | 8   | 18  | 7   | 4   | 14  | 1   | 6   | 16  | 5   | 2   | 12  |
| Initial Q (Qb), veh          | 0   | 0   | 0   | 0   | 0   | 0   | 0   | 0   | 0   | 0   | 0   | 0   |
| Ped-Bike Adj(A_pbT)          | 1.00  |   | 1.00  | 1.00  |   | 1.00  | 1.00  |   | 1.00  | 1.00  |   | 1.00  |
| Parking Bus, Adj             | 1.00  | 1.00  | 1.00  | 1.00  | 1.00  | 1.00  | 1.00  | 1.00  | 1.00  | 1.00  | 1.00  | 1.00  |
| Adj Sat Flow, veh/h/ln       | 1810  | 1810  | 1900  | 1863  | 1863  | 1863  | 1881  | 1881  | 1881  | 1863  | 1863  | 1863  |
| Adj Flow Rate, veh/h         | 25  | 108   | 54  | 415   | 36  | 0   | 54  | 364   | 0   | 186   | 824   | 0   |
| Adj No. of Lanes             | 1   | 1   | 0   | 1   | 1   | 1   | 1   | 2   | 1   | 1   | 2   | 1   |
| Peak Hour Factor             | 0.87  | 0.87  | 0.87  | 0.87  | 0.87  | 0.87  | 0.87  | 0.87  | 0.87  | 0.87  | 0.87  | 0.87  |
| Percent Heavy Veh, %         | 5   | 5   | 5   | 2   | 2   | 2   | 1   | 1   | 1   | 2   | 2   | 2   |
| Cap, veh/h                   | 49  | 144   | 72  | 460   | 667   | 567   | 88  | 683   | 306   | 229   | 961   | 430   |
| Arrive On Green              | 0.03  | 0.13  | 0.13  | 0.26  | 0.36  | 0.00  | 0.05  | 0.19  | 0.00  | 0.13  | 0.27  | 0.00  |
| Sat Flow, veh/h              | 1723  | 1138  | 569   | 1774  | 1863  | 1583  | 1792  | 3574  | 1599  | 1774  | 3539  | 1583  |
| Grp Volume(v), veh/h         | 25  | 0   | 162   | 415   | 36  | 0   | 54  | 364   | 0   | 186   | 824   | 0   |
| Grp Sat Flow(s),veh/h/ln     | 1723  | 0   | 1707  | 1774  | 1863  | 1583  | 1792  | 1787  | 1599  | 1774  | 1770  | 1583  |
| Q Serve(g_s), s              | 0.9   | 0.0   | 5.6   | 13.9  | 0.8   | 0.0   | 1.8   | 5.6   | 0.0   | 6.3   | 13.6  | 0.0   |
| Cycle Q Clear(g_c), s        | 0.9   | 0.0   | 5.6   | 13.9  | 0.8   | 0.0   | 1.8   | 5.6   | 0.0   | 6.3   | 13.6  | 0.0   |
| Prop In Lane                 | 1.00  |   | 0.33  | 1.00  |   | 1.00  | 1.00  |   | 1.00  | 1.00  |   | 1.00  |
| Lane Grp Cap(c), veh/h       | 49  | 0   | 217   | 460   | 667   | 567   | 88  | 683   | 306   | 229   | 961   | 430   |
| V/C Ratio(X)                 | 0.51  | 0.00  | 0.75  | 0.90  | 0.05  | 0.00  | 0.62  | 0.53  | 0.00  | 0.81  | 0.86  | 0.00  |
| Avail Cap(c_a), veh/h        | 295   | 0   | 862   | 592   | 1243  | 1057  | 160   | 1455  | 651   | 448   | 2017  | 902   |
| HCM Platoon Ratio            | 1.00  | 1.00  | 1.00  | 1.00  | 1.00  | 1.00  | 1.00  | 1.00  | 1.00  | 1.00  | 1.00  | 1.00  |
| Upstream Filter(I)           | 1.00  | 0.00  | 1.00  | 1.00  | 1.00  | 0.00  | 1.00  | 1.00  | 0.00  | 1.00  | 1.00  | 0.00  |
| Uniform Delay (d), s/veh     | 29.4  | 0.0   | 25.9  | 22.0  | 12.9  | 0.0   | 28.6  | 22.4  | 0.0   | 26.0  | 21.2  | 0.0   |
| Incr Delay (d2), s/veh       | 3.1   | 0.0   | 1.9   | 12.5  | 0.0   | 0.0   | 2.6   | 0.2   | 0.0   | 2.6   | 0.9   | 0.0   |
| Initial Q Delay(d3),s/veh    | 0.0   | 0.0   | 0.0   | 0.0   | 0.0   | 0.0   | 0.0   | 0.0   | 0.0   | 0.0   | 0.0   | 0.0   |
| %ile BackOfQ(50%),veh/ln     | 0.5   | 0.0   | 2.8   | 8.4   | 0.4   | 0.0   | 1.0   | 2.8   | 0.0   | 3.2   | 6.8   | 0.0   |
| LnGrp Delay(d),s/veh         | 32.5  | 0.0   | 27.8  | 34.5  | 12.9  | 0.0   | 31.2  | 22.6  | 0.0   | 28.6  | 22.1  | 0.0   |
| LnGrp LOS                    | C   |   | C   | C   | B   |   | C   | C   |   | C   | C   |   |
| Approach Vol, veh/h          |   | 187   |   |   | 451   |   |   | 418   |   |   | 1010  |   |
| Approach Delay, s/veh        |   | 28.4  |   |   | 32.8  |   |   | 23.7  |   |   | 23.3  |   |
| Approach LOS                 |   | C   |   |   | C   |   |   | C   |   |   | C   |   |
| Timer                        | 1   | 2   | 3   | 4   | 5   | 6   | 7   | 8   |   |   |   |   |
| Assigned Phs                 | 1   | 2   | 3   | 4   | 5   | 6   | 7   | 8   |   |   |   |   |
| Phs Duration (G+Y+Rc), s     | 7.5   | 21.2  | 6.2   | 26.5  | 12.4  | 16.2  | 20.4  | 12.3  |   |   |   |   |
| Change Period (Y+Rc), s      | 4.5   | 4.5   | 4.5   | 4.5   | 4.5   | 4.5   | 4.5   | 4.5   |   |   |   |   |
| Max Green Setting (Gmax), s  | 5.5   | 35.0  | 10.5  | 41.0  | 15.5  | 25.0  | 20.5  | 31.0  |   |   |   |   |
| Max Q Clear Time (g_c+I1), s | 3.8   | 15.6  | 2.9   | 2.8   | 8.3   | 7.6   | 15.9  | 7.6   |   |   |   |   |
| Green Ext Time (p_c), s      | 0.0   | 1.1   | 0.0   | 0.0   | 0.0   | 0.4   | 0.1   | 0.1   |   |   |   |   |
| <b>Intersection Summary</b>  |   |   |   |   |   |   |   |   |   |   |   |   |
| HCM 2010 Ctrl Delay          |   |   | 25.9  |   |   |   |   |   |   |   |   |   |
| HCM 2010 LOS                 |   |   | C   |   |   |   |   |   |   |   |   |   |
| <b>Notes</b>                 |   |   |   |   |   |   |   |   |   |   |   |   |

| Intersection             |      |      |      |      |      |      |      |      |      |      |      |      |
|--------------------------|------|------|------|------|------|------|------|------|------|------|------|------|
| Int Delay, s/veh         | 3.7  |      |      |      |      |      |      |      |      |      |      |      |
| Movement                 | EBL  | EBT  | EBR  | WBL  | WBT  | WBR  | NBL  | NBT  | NBR  | SBL  | SBT  | SBR  |
| Lane Configurations      |      | ↕    |      |      | ↕    |      |      | ↕    |      |      | ↕    |      |
| Traffic Vol, veh/h       | 3    | 353  | 16   | 13   | 382  | 15   | 30   | 45   | 7    | 30   | 9    | 13   |
| Future Vol, veh/h        | 3    | 353  | 16   | 13   | 382  | 15   | 30   | 45   | 7    | 30   | 9    | 13   |
| Conflicting Peds, #/hr   | 0    | 0    | 1    | 1    | 0    | 0    | 0    | 0    | 0    | 0    | 0    | 0    |
| Sign Control             | Free | Free | Free | Free | Free | Free | Stop | Stop | Stop | Stop | Stop | Stop |
| RT Channelized           | -    | -    | None | -    | -    | None | -    | -    | None | -    | -    | None |
| Storage Length           | -    | -    | -    | -    | -    | -    | -    | -    | -    | -    | -    | -    |
| Veh in Median Storage, # | -    | 0    | -    | -    | 0    | -    | -    | 0    | -    | -    | 0    | -    |
| Grade, %                 | -    | 0    | -    | -    | 0    | -    | -    | 0    | -    | -    | 0    | -    |
| Peak Hour Factor         | 88   | 88   | 88   | 88   | 88   | 88   | 88   | 88   | 88   | 88   | 88   | 88   |
| Heavy Vehicles, %        | 3    | 3    | 3    | 3    | 3    | 3    | 2    | 2    | 2    | 4    | 4    | 4    |
| Mvmt Flow                | 3    | 401  | 18   | 15   | 434  | 17   | 34   | 51   | 8    | 34   | 10   | 15   |

| Major/Minor          | Major1 |   |   | Major2 |   |   | Minor1 |       |       | Minor2 |       |       |
|----------------------|--------|---|---|--------|---|---|--------|-------|-------|--------|-------|-------|
| Conflicting Flow All | 451    | 0 | 0 | 420    | 0 | 0 | 902    | 898   | 411   | 919    | 899   | 443   |
| Stage 1              | -      | - | - | -      | - | - | 417    | 417   | -     | 473    | 473   | -     |
| Stage 2              | -      | - | - | -      | - | - | 485    | 481   | -     | 446    | 426   | -     |
| Critical Hdwy        | 4.13   | - | - | 4.13   | - | - | 7.12   | 6.52  | 6.22  | 7.14   | 6.54  | 6.24  |
| Critical Hdwy Stg 1  | -      | - | - | -      | - | - | 6.12   | 5.52  | -     | 6.14   | 5.54  | -     |
| Critical Hdwy Stg 2  | -      | - | - | -      | - | - | 6.12   | 5.52  | -     | 6.14   | 5.54  | -     |
| Follow-up Hdwy       | 2.227  | - | - | 2.227  | - | - | 3.518  | 4.018 | 3.318 | 3.536  | 4.036 | 3.336 |
| Pot Cap-1 Maneuver   | 1104   | - | - | 1134   | - | - | 259    | 279   | 641   | 250    | 277   | 611   |
| Stage 1              | -      | - | - | -      | - | - | 613    | 591   | -     | 568    | 555   | -     |
| Stage 2              | -      | - | - | -      | - | - | 563    | 554   | -     | 588    | 582   | -     |
| Platoon blocked, %   |        | - | - |        | - | - |        |       |       |        |       |       |
| Mov Cap-1 Maneuver   | 1104   | - | - | 1133   | - | - | 241    | 273   | 640   | 208    | 271   | 611   |
| Mov Cap-2 Maneuver   | -      | - | - | -      | - | - | 241    | 273   | -     | 208    | 271   | -     |
| Stage 1              | -      | - | - | -      | - | - | 610    | 588   | -     | 566    | 545   | -     |
| Stage 2              | -      | - | - | -      | - | - | 529    | 544   | -     | 528    | 579   | -     |

| Approach             | EB  |  |  | WB  |  |  | NB   |  |  | SB   |  |  |
|----------------------|-----|--|--|-----|--|--|------|--|--|------|--|--|
| HCM Control Delay, s | 0.1 |  |  | 0.3 |  |  | 24.9 |  |  | 22.7 |  |  |
| HCM LOS              |     |  |  |     |  |  | C    |  |  | C    |  |  |

| Minor Lane/Major Mvmt | NBLn1 | EBL   | EBT | EBR | WBL   | WBT | WBR | SBLn1 |
|-----------------------|-------|-------|-----|-----|-------|-----|-----|-------|
| Capacity (veh/h)      | 273   | 1104  | -   | -   | 1133  | -   | -   | 262   |
| HCM Lane V/C Ratio    | 0.341 | 0.003 | -   | -   | 0.013 | -   | -   | 0.226 |
| HCM Control Delay (s) | 24.9  | 8.3   | 0   | -   | 8.2   | 0   | -   | 22.7  |
| HCM Lane LOS          | C     | A     | A   | -   | A     | A   | -   | C     |
| HCM 95th %tile Q(veh) | 1.5   | 0     | -   | -   | 0     | -   | -   | 0.8   |

| Intersection             |      |      |      |      |      |      |      |      |      |      |      |      |
|--------------------------|------|------|------|------|------|------|------|------|------|------|------|------|
| Int Delay, s/veh         | 2    |      |      |      |      |      |      |      |      |      |      |      |
| Movement                 | EBL  | EBT  | EBR  | WBL  | WBT  | WBR  | NBL  | NBT  | NBR  | SBL  | SBT  | SBR  |
| Lane Configurations      |      | ↕    |      |      | ↕    |      |      | ↕    | ↕    |      | ↕    |      |
| Traffic Vol, veh/h       | 5    | 285  | 91   | 41   | 381  | 0    | 17   | 9    | 31   | 7    | 11   | 0    |
| Future Vol, veh/h        | 5    | 285  | 91   | 41   | 381  | 0    | 17   | 9    | 31   | 7    | 11   | 0    |
| Conflicting Peds, #/hr   | 0    | 0    | 0    | 0    | 0    | 0    | 0    | 0    | 0    | 0    | 0    | 0    |
| Sign Control             | Free | Free | Free | Free | Free | Free | Stop | Stop | Stop | Stop | Stop | Stop |
| RT Channelized           | -    | -    | None | -    | -    | None | -    | -    | None | -    | -    | None |
| Storage Length           | -    | -    | -    | -    | -    | -    | -    | -    | 135  | -    | -    | -    |
| Veh in Median Storage, # | -    | 0    | -    | -    | 0    | -    | -    | 0    | -    | -    | 0    | -    |
| Grade, %                 | -    | 0    | -    | -    | 0    | -    | -    | 0    | -    | -    | 0    | -    |
| Peak Hour Factor         | 84   | 84   | 84   | 84   | 84   | 84   | 84   | 84   | 84   | 84   | 84   | 84   |
| Heavy Vehicles, %        | 3    | 3    | 3    | 2    | 2    | 2    | 2    | 2    | 2    | 0    | 0    | 0    |
| Mvmt Flow                | 6    | 339  | 108  | 49   | 454  | 0    | 20   | 11   | 37   | 8    | 13   | 0    |

| Major/Minor          | Major1 |   |   | Major2 |   |   | Minor1 |       |       | Minor2 |      |     |
|----------------------|--------|---|---|--------|---|---|--------|-------|-------|--------|------|-----|
| Conflicting Flow All | 454    | 0 | 0 | 447    | 0 | 0 | 964    | 957   | 393   | 981    | 1011 | 454 |
| Stage 1              | -      | - | - | -      | - | - | 405    | 405   | -     | 552    | 552  | -   |
| Stage 2              | -      | - | - | -      | - | - | 559    | 552   | -     | 429    | 459  | -   |
| Critical Hdwy        | 4.13   | - | - | 4.12   | - | - | 7.12   | 6.52  | 6.22  | 7.1    | 6.5  | 6.2 |
| Critical Hdwy Stg 1  | -      | - | - | -      | - | - | 6.12   | 5.52  | -     | 6.1    | 5.5  | -   |
| Critical Hdwy Stg 2  | -      | - | - | -      | - | - | 6.12   | 5.52  | -     | 6.1    | 5.5  | -   |
| Follow-up Hdwy       | 2.227  | - | - | 2.218  | - | - | 3.518  | 4.018 | 3.318 | 3.5    | 4    | 3.3 |
| Pot Cap-1 Maneuver   | 1101   | - | - | 1113   | - | - | 235    | 258   | 656   | 231    | 241  | 610 |
| Stage 1              | -      | - | - | -      | - | - | 622    | 598   | -     | 522    | 518  | -   |
| Stage 2              | -      | - | - | -      | - | - | 513    | 515   | -     | 608    | 570  | -   |
| Platoon blocked, %   |        | - | - |        | - | - |        |       |       |        |      |     |
| Mov Cap-1 Maneuver   | 1101   | - | - | 1113   | - | - | 213    | 241   | 656   | 200    | 225  | 610 |
| Mov Cap-2 Maneuver   | -      | - | - | -      | - | - | 213    | 241   | -     | 200    | 225  | -   |
| Stage 1              | -      | - | - | -      | - | - | 618    | 594   | -     | 518    | 487  | -   |
| Stage 2              | -      | - | - | -      | - | - | 470    | 485   | -     | 560    | 566  | -   |

| Approach             | EB  |  |  | WB  |  |  | NB   |  |  | SB   |  |  |
|----------------------|-----|--|--|-----|--|--|------|--|--|------|--|--|
| HCM Control Delay, s | 0.1 |  |  | 0.8 |  |  | 16.7 |  |  | 23.6 |  |  |
| HCM LOS              |     |  |  |     |  |  | C    |  |  | C    |  |  |

| Minor Lane/Major Mvmt | NBLn1 | NBLn2 | EBL   | EBT | EBR | WBL   | WBT | WBR | SBLn1 |
|-----------------------|-------|-------|-------|-----|-----|-------|-----|-----|-------|
| Capacity (veh/h)      | 222   | 656   | 1101  | -   | -   | 1113  | -   | -   | 215   |
| HCM Lane V/C Ratio    | 0.139 | 0.056 | 0.005 | -   | -   | 0.044 | -   | -   | 0.1   |
| HCM Control Delay (s) | 23.8  | 10.8  | 8.3   | 0   | -   | 8.4   | 0   | -   | 23.6  |
| HCM Lane LOS          | C     | B     | A     | A   | -   | A     | A   | -   | C     |
| HCM 95th %tile Q(veh) | 0.5   | 0.2   | 0     | -   | -   | 0.1   | -   | -   | 0.3   |

| Intersection              |      |
|---------------------------|------|
| Intersection Delay, s/veh | 13.3 |
| Intersection LOS          | B    |

| Movement            | EBL  | EBT  | EBR  | WBL  | WBT  | WBR  | NBL  | NBT  | NBR  | SBL  | SBT  | SBR  |
|---------------------|------|------|------|------|------|------|------|------|------|------|------|------|
| Lane Configurations |      | ↕    |      |      | ↕    |      |      | ↕    | ↕    |      | ↕    |      |
| Traffic Vol, veh/h  | 9    | 133  | 41   | 75   | 408  | 2    | 0    | 1    | 2    | 0    | 36   | 13   |
| Future Vol, veh/h   | 9    | 133  | 41   | 75   | 408  | 2    | 0    | 1    | 2    | 0    | 36   | 13   |
| Peak Hour Factor    | 0.89 | 0.89 | 0.89 | 0.89 | 0.89 | 0.89 | 0.89 | 0.89 | 0.89 | 0.89 | 0.89 | 0.89 |
| Heavy Vehicles, %   | 3    | 3    | 3    | 2    | 2    | 2    | 33   | 33   | 33   | 2    | 2    | 2    |
| Mvmt Flow           | 10   | 149  | 46   | 84   | 458  | 2    | 0    | 1    | 2    | 0    | 40   | 15   |
| Number of Lanes     | 0    | 1    | 0    | 0    | 1    | 0    | 0    | 1    | 1    | 0    | 1    | 0    |

| Approach                   | EB  | WB   | NB  | SB  |
|----------------------------|-----|------|-----|-----|
| Opposing Approach          | WB  | EB   | SB  | NB  |
| Opposing Lanes             | 1   | 1    | 1   | 2   |
| Conflicting Approach Left  | SB  | NB   | EB  | WB  |
| Conflicting Lanes Left     | 1   | 2    | 1   | 1   |
| Conflicting Approach Right | NB  | SB   | WB  | EB  |
| Conflicting Lanes Right    | 2   | 1    | 1   | 1   |
| HCM Control Delay          | 9.2 | 15.3 | 9.1 | 9.1 |
| HCM LOS                    | A   | C    | A   | A   |

| Lane                   | NBLn1 | NBLn2 | EBLn1 | WBLn1 | SBLn1 |
|------------------------|-------|-------|-------|-------|-------|
| Vol Left, %            | 0%    | 0%    | 5%    | 15%   | 0%    |
| Vol Thru, %            | 100%  | 0%    | 73%   | 84%   | 73%   |
| Vol Right, %           | 0%    | 100%  | 22%   | 0%    | 27%   |
| Sign Control           | Stop  | Stop  | Stop  | Stop  | Stop  |
| Traffic Vol by Lane    | 1     | 2     | 183   | 485   | 49    |
| LT Vol                 | 0     | 0     | 9     | 75    | 0     |
| Through Vol            | 1     | 0     | 133   | 408   | 36    |
| RT Vol                 | 0     | 2     | 41    | 2     | 13    |
| Lane Flow Rate         | 1     | 2     | 206   | 545   | 55    |
| Geometry Grp           | 7     | 7     | 2     | 2     | 5     |
| Degree of Util (X)     | 0.002 | 0.004 | 0.26  | 0.657 | 0.084 |
| Departure Headway (Hd) | 6.803 | 6.092 | 4.545 | 4.341 | 5.522 |
| Convergence, Y/N       | Yes   | Yes   | Yes   | Yes   | Yes   |
| Cap                    | 525   | 585   | 790   | 834   | 647   |
| Service Time           | 4.563 | 3.851 | 2.574 | 2.364 | 3.572 |
| HCM Lane V/C Ratio     | 0.002 | 0.003 | 0.261 | 0.653 | 0.085 |
| HCM Control Delay      | 9.6   | 8.9   | 9.2   | 15.3  | 9.1   |
| HCM Lane LOS           | A     | A     | A     | C     | A     |
| HCM 95th-tile Q        | 0     | 0     | 1     | 5     | 0.3   |



| Intersection             |      |      |      |      |      |      |
|--------------------------|------|------|------|------|------|------|
| Int Delay, s/veh         | 2.1  |      |      |      |      |      |
| Movement                 | EBL  | EBT  | WBT  | WBR  | SBL  | SBR  |
| Lane Configurations      |      | ↕    | ↕    |      | ↕    |      |
| Traffic Vol, veh/h       | 16   | 103  | 409  | 0    | 1    | 90   |
| Future Vol, veh/h        | 16   | 103  | 409  | 0    | 1    | 90   |
| Conflicting Peds, #/hr   | 0    | 0    | 0    | 0    | 0    | 0    |
| Sign Control             | Free | Free | Free | Free | Stop | Stop |
| RT Channelized           | -    | None | -    | None | -    | None |
| Storage Length           | -    | -    | -    | -    | 0    | -    |
| Veh in Median Storage, # | -    | 0    | 0    | -    | 0    | -    |
| Grade, %                 | -    | 0    | 0    | -    | 0    | -    |
| Peak Hour Factor         | 86   | 86   | 86   | 86   | 86   | 86   |
| Heavy Vehicles, %        | 3    | 3    | 0    | 0    | 8    | 8    |
| Mvmt Flow                | 19   | 120  | 476  | 0    | 1    | 105  |

| Major/Minor          | Major1 | Major2 | Minor2 |   |             |
|----------------------|--------|--------|--------|---|-------------|
| Conflicting Flow All | 476    | 0      | -      | 0 | 634 476     |
| Stage 1              | -      | -      | -      | - | 476 -       |
| Stage 2              | -      | -      | -      | - | 158 -       |
| Critical Hdwy        | 4.13   | -      | -      | - | 6.48 6.28   |
| Critical Hdwy Stg 1  | -      | -      | -      | - | 5.48 -      |
| Critical Hdwy Stg 2  | -      | -      | -      | - | 5.48 -      |
| Follow-up Hdwy       | 2.227  | -      | -      | - | 3.572 3.372 |
| Pot Cap-1 Maneuver   | 1081   | -      | -      | - | 434 577     |
| Stage 1              | -      | -      | -      | - | 613 -       |
| Stage 2              | -      | -      | -      | - | 856 -       |
| Platoon blocked, %   |        | -      | -      | - |             |
| Mov Cap-1 Maneuver   | 1081   | -      | -      | - | 426 577     |
| Mov Cap-2 Maneuver   | -      | -      | -      | - | 426 -       |
| Stage 1              | -      | -      | -      | - | 601 -       |
| Stage 2              | -      | -      | -      | - | 856 -       |

| Approach             | EB  | WB | SB   |
|----------------------|-----|----|------|
| HCM Control Delay, s | 1.1 | 0  | 12.7 |
| HCM LOS              |     |    | B    |

| Minor Lane/Major Mvmt | EBL   | EBT | WBT | WBR | SBLn1 |
|-----------------------|-------|-----|-----|-----|-------|
| Capacity (veh/h)      | 1081  | -   | -   | -   | 575   |
| HCM Lane V/C Ratio    | 0.017 | -   | -   | -   | 0.184 |
| HCM Control Delay (s) | 8.4   | 0   | -   | -   | 12.7  |
| HCM Lane LOS          | A     | A   | -   | -   | B     |
| HCM 95th %tile Q(veh) | 0.1   | -   | -   | -   | 0.7   |

| Intersection              |     |
|---------------------------|-----|
| Intersection Delay, s/veh | 9.9 |
| Intersection LOS          | A   |

| Movement            | EBL  | EBT  | EBR  | WBL  | WBT  | WBR  | NBL  | NBT  | NBR  | SBL  | SBT  | SBR  |
|---------------------|------|------|------|------|------|------|------|------|------|------|------|------|
| Lane Configurations |      | ↕    |      |      | ↕    |      |      | ↕    |      |      | ↕    |      |
| Traffic Vol, veh/h  | 88   | 2    | 13   | 0    | 0    | 0    | 1    | 0    | 0    | 1    | 3    | 408  |
| Future Vol, veh/h   | 88   | 2    | 13   | 0    | 0    | 0    | 1    | 0    | 0    | 1    | 3    | 408  |
| Peak Hour Factor    | 0.85 | 0.85 | 0.85 | 0.85 | 0.85 | 0.85 | 0.85 | 0.85 | 0.85 | 0.85 | 0.85 | 0.85 |
| Heavy Vehicles, %   | 2    | 2    | 2    | 2    | 2    | 2    | 0    | 0    | 0    | 0    | 0    | 0    |
| Mvmt Flow           | 104  | 2    | 15   | 0    | 0    | 0    | 1    | 0    | 0    | 1    | 4    | 480  |
| Number of Lanes     | 0    | 1    | 0    | 0    | 1    | 0    | 0    | 1    | 0    | 0    | 1    | 0    |

| Approach                   | EB | WB | NB  | SB   |
|----------------------------|----|----|-----|------|
| Opposing Approach          | WB | EB | SB  | NB   |
| Opposing Lanes             | 1  | 1  | 1   | 1    |
| Conflicting Approach Left  | SB | NB | EB  | WB   |
| Conflicting Lanes Left     | 1  | 1  | 1   | 1    |
| Conflicting Approach Right | NB | SB | WB  | EB   |
| Conflicting Lanes Right    | 1  | 1  | 1   | 1    |
| HCM Control Delay          | 9  | 0  | 7.9 | 10.1 |
| HCM LOS                    | A  | -  | A   | B    |

| Lane                   | NBLn1 | EBLn1 | WBLn1 | SBLn1 |
|------------------------|-------|-------|-------|-------|
| Vol Left, %            | 100%  | 85%   | 0%    | 0%    |
| Vol Thru, %            | 0%    | 2%    | 100%  | 1%    |
| Vol Right, %           | 0%    | 13%   | 0%    | 99%   |
| Sign Control           | Stop  | Stop  | Stop  | Stop  |
| Traffic Vol by Lane    | 1     | 103   | 0     | 412   |
| LT Vol                 | 1     | 88    | 0     | 1     |
| Through Vol            | 0     | 2     | 0     | 3     |
| RT Vol                 | 0     | 13    | 0     | 408   |
| Lane Flow Rate         | 1     | 121   | 0     | 485   |
| Geometry Grp           | 1     | 1     | 1     | 1     |
| Degree of Util (X)     | 0.002 | 0.168 | 0     | 0.489 |
| Departure Headway (Hd) | 4.853 | 4.988 | 5.037 | 3.63  |
| Convergence, Y/N       | Yes   | Yes   | Yes   | Yes   |
| Cap                    | 738   | 723   | 0     | 998   |
| Service Time           | 2.875 | 2.988 | 3.072 | 1.638 |
| HCM Lane V/C Ratio     | 0.001 | 0.167 | 0     | 0.486 |
| HCM Control Delay      | 7.9   | 9     | 8.1   | 10.1  |
| HCM Lane LOS           | A     | A     | N     | B     |
| HCM 95th-tile Q        | 0     | 0.6   | 0     | 2.8   |

HCM 2010 Signalized Intersection Summary  
 46: General Jim Moore Boulevard & Normandy Road

Existing, AM  
 06/11/2019



| Movement                     | EBL  | EBT  | EBR  | WBL  | WBT  | WBR  | NBL  | NBT  | NBR  | SBL  | SBT  | SBR  |
|------------------------------|------|------|------|------|------|------|------|------|------|------|------|------|
| Lane Configurations          |      | ↕    |      |      | ↕    |      | ↕    | ↕↕   |      | ↕    | ↕↕   | ↕    |
| Traffic Volume (veh/h)       | 65   | 78   | 118  | 141  | 70   | 35   | 122  | 330  | 105  | 74   | 759  | 149  |
| Future Volume (veh/h)        | 65   | 78   | 118  | 141  | 70   | 35   | 122  | 330  | 105  | 74   | 759  | 149  |
| Number                       | 3    | 8    | 18   | 7    | 4    | 14   | 1    | 6    | 16   | 5    | 2    | 12   |
| Initial Q (Qb), veh          | 0    | 0    | 0    | 0    | 0    | 0    | 0    | 0    | 0    | 0    | 0    | 0    |
| Ped-Bike Adj(A_pbT)          | 0.98 |      | 0.97 | 0.99 |      | 0.97 | 1.00 |      | 0.98 | 1.00 |      | 0.99 |
| Parking Bus, Adj             | 1.00 | 1.00 | 1.00 | 1.00 | 1.00 | 1.00 | 1.00 | 1.00 | 1.00 | 1.00 | 1.00 | 1.00 |
| Adj Sat Flow, veh/h/ln       | 1900 | 1881 | 1900 | 1900 | 1863 | 1900 | 1881 | 1881 | 1900 | 1863 | 1863 | 1863 |
| Adj Flow Rate, veh/h         | 83   | 100  | 122  | 181  | 90   | 41   | 156  | 423  | 108  | 95   | 973  | 122  |
| Adj No. of Lanes             | 0    | 1    | 0    | 0    | 1    | 0    | 1    | 2    | 0    | 1    | 2    | 1    |
| Peak Hour Factor             | 0.78 | 0.78 | 0.78 | 0.78 | 0.78 | 0.78 | 0.78 | 0.78 | 0.78 | 0.78 | 0.78 | 0.78 |
| Percent Heavy Veh, %         | 1    | 1    | 1    | 2    | 2    | 2    | 1    | 1    | 1    | 2    | 2    | 2    |
| Cap, veh/h                   | 194  | 230  | 232  | 350  | 164  | 64   | 196  | 579  | 146  | 383  | 1105 | 489  |
| Arrive On Green              | 0.36 | 0.35 | 0.35 | 0.36 | 0.35 | 0.35 | 0.11 | 0.21 | 0.21 | 0.22 | 0.31 | 0.31 |
| Sat Flow, veh/h              | 334  | 649  | 655  | 722  | 463  | 179  | 1792 | 2816 | 712  | 1774 | 3539 | 1566 |
| Grp Volume(v), veh/h         | 305  | 0    | 0    | 312  | 0    | 0    | 156  | 267  | 264  | 95   | 973  | 122  |
| Grp Sat Flow(s),veh/h/ln     | 1637 | 0    | 0    | 1365 | 0    | 0    | 1792 | 1787 | 1741 | 1774 | 1770 | 1566 |
| Q Serve(g_s), s              | 0.0  | 0.0  | 0.0  | 2.8  | 0.0  | 0.0  | 5.1  | 8.4  | 8.6  | 2.7  | 15.7 | 3.5  |
| Cycle Q Clear(g_c), s        | 8.3  | 0.0  | 0.0  | 11.1 | 0.0  | 0.0  | 5.1  | 8.4  | 8.6  | 2.7  | 15.7 | 3.5  |
| Prop In Lane                 | 0.27 |      | 0.40 | 0.58 |      | 0.13 | 1.00 |      | 0.41 | 1.00 |      | 1.00 |
| Lane Grp Cap(c), veh/h       | 670  | 0    | 0    | 590  | 0    | 0    | 196  | 367  | 358  | 383  | 1105 | 489  |
| V/C Ratio(X)                 | 0.46 | 0.00 | 0.00 | 0.53 | 0.00 | 0.00 | 0.80 | 0.73 | 0.74 | 0.25 | 0.88 | 0.25 |
| Avail Cap(c_a), veh/h        | 967  | 0    | 0    | 847  | 0    | 0    | 238  | 756  | 736  | 383  | 1497 | 662  |
| HCM Platoon Ratio            | 1.00 | 1.00 | 1.00 | 1.00 | 1.00 | 1.00 | 1.00 | 1.00 | 1.00 | 1.00 | 1.00 | 1.00 |
| Upstream Filter(I)           | 1.00 | 0.00 | 0.00 | 1.00 | 0.00 | 0.00 | 1.00 | 1.00 | 1.00 | 1.00 | 1.00 | 1.00 |
| Uniform Delay (d), s/veh     | 15.2 | 0.0  | 0.0  | 15.8 | 0.0  | 0.0  | 26.2 | 22.4 | 22.4 | 19.6 | 19.7 | 15.5 |
| Incr Delay (d2), s/veh       | 0.2  | 0.0  | 0.0  | 0.3  | 0.0  | 0.0  | 11.6 | 1.0  | 1.1  | 0.1  | 4.0  | 0.1  |
| Initial Q Delay(d3),s/veh    | 0.0  | 0.0  | 0.0  | 0.0  | 0.0  | 0.0  | 0.0  | 0.0  | 0.0  | 0.0  | 0.0  | 0.0  |
| %ile BackOfQ(50%),veh/ln     | 3.9  | 0.0  | 0.0  | 4.3  | 0.0  | 0.0  | 3.1  | 4.3  | 4.2  | 1.3  | 8.2  | 1.5  |
| LnGrp Delay(d),s/veh         | 15.3 | 0.0  | 0.0  | 16.1 | 0.0  | 0.0  | 37.8 | 23.4 | 23.6 | 19.7 | 23.7 | 15.6 |
| LnGrp LOS                    | B    |      |      | B    |      |      | D    | C    | C    | B    | C    | B    |
| Approach Vol, veh/h          |      | 305  |      |      | 312  |      |      | 687  |      |      | 1190 |      |
| Approach Delay, s/veh        |      | 15.3 |      |      | 16.1 |      |      | 26.7 |      |      | 22.5 |      |
| Approach LOS                 |      | B    |      |      | B    |      |      | C    |      |      | C    |      |
| Timer                        | 1    | 2    | 3    | 4    | 5    | 6    | 7    | 8    |      |      |      |      |
| Assigned Phs                 | 1    | 2    |      | 4    | 5    | 6    |      | 8    |      |      |      |      |
| Phs Duration (G+Y+Rc), s     | 11.1 | 23.3 |      | 25.9 | 17.5 | 16.9 |      | 25.9 |      |      |      |      |
| Change Period (Y+Rc), s      | 4.5  | 4.5  |      | 4.5  | 4.5  | 4.5  |      | 4.5  |      |      |      |      |
| Max Green Setting (Gmax), s  | 30.0 | 25.5 |      | 33.0 | 8.0  | 25.5 |      | 33.0 |      |      |      |      |
| Max Q Clear Time (g_c+11), s | 17.7 | 17.7 |      | 13.1 | 4.7  | 10.6 |      | 10.3 |      |      |      |      |
| Green Ext Time (p_c), s      | 0.0  | 1.1  |      | 0.5  | 0.0  | 0.5  |      | 0.4  |      |      |      |      |
| <b>Intersection Summary</b>  |      |      |      |      |      |      |      |      |      |      |      |      |
| HCM 2010 Ctrl Delay          |      |      | 22.0 |      |      |      |      |      |      |      |      |      |
| HCM 2010 LOS                 |      |      | C    |      |      |      |      |      |      |      |      |      |

| Intersection              |      |
|---------------------------|------|
| Intersection Delay, s/veh | 92.2 |
| Intersection LOS          | F    |

| Movement            | EBL  | EBR  | NBL  | NBT  | SBT  | SBR  |
|---------------------|------|------|------|------|------|------|
| Lane Configurations |      |      |      |      |      |      |
| Traffic Vol, veh/h  | 114  | 430  | 221  | 339  | 874  | 135  |
| Future Vol, veh/h   | 114  | 430  | 221  | 339  | 874  | 135  |
| Peak Hour Factor    | 0.90 | 0.90 | 0.90 | 0.90 | 0.90 | 0.90 |
| Heavy Vehicles, %   | 1    | 1    | 1    | 1    | 2    | 2    |
| Mvmt Flow           | 127  | 478  | 246  | 377  | 971  | 150  |
| Number of Lanes     | 1    | 1    | 1    | 2    | 2    | 1    |

| Approach                   | EB    | NB | SB    |
|----------------------------|-------|----|-------|
| Opposing Approach          |       | SB | NB    |
| Opposing Lanes             | 0     | 3  | 3     |
| Conflicting Approach Left  | SB    |    |       |
| Conflicting Lanes Left     | 3     | 2  | 0     |
| Conflicting Approach Right | NB    |    | EB    |
| Conflicting Lanes Right    | 3     | 0  | 2     |
| HCM Control Delay          | 115.7 | 25 | 116.8 |
| HCM LOS                    | F     | C  | F     |

| Lane                   | NBLn1 | NBLn2  | NBLn3 | EBLn1  | EBLn2 | SBLn1 | SBLn2 | SBLn3 |
|------------------------|-------|--------|-------|--------|-------|-------|-------|-------|
| Vol Left, %            | 100%  | 0%     | 0%    | 100%   | 0%    | 0%    | 0%    | 0%    |
| Vol Thru, %            | 0%    | 100%   | 100%  | 0%     | 0%    | 100%  | 100%  | 0%    |
| Vol Right, %           | 0%    | 0%     | 0%    | 0%     | 100%  | 0%    | 0%    | 100%  |
| Sign Control           | Stop  | Stop   | Stop  | Stop   | Stop  | Stop  | Stop  | Stop  |
| Traffic Vol by Lane    | 221   | 170    | 170   | 114    | 430   | 437   | 437   | 135   |
| LT Vol                 | 221   | 0      | 0     | 114    | 0     | 0     | 0     | 0     |
| Through Vol            | 0     | 170    | 170   | 0      | 0     | 437   | 437   | 0     |
| RT Vol                 | 0     | 0      | 0     | 0      | 430   | 0     | 0     | 135   |
| Lane Flow Rate         | 246   | 188    | 188   | 127    | 478   | 486   | 486   | 150   |
| Geometry Grp           | 8     | 8      | 8     | 8      | 8     | 8     | 8     | 8     |
| Degree of Util (X)     | 0.671 | 0.489  | 0.399 | 0.36   | 1.199 | 1.178 | 1.178 | 0.263 |
| Departure Headway (Hd) | 10.89 | 10.366 | 8.565 | 10.689 | 9.47  | 9.334 | 9.334 | 6.786 |
| Convergence, Y/N       | Yes   | Yes    | Yes   | Yes    | Yes   | Yes   | Yes   | Yes   |
| Cap                    | 334   | 350    | 424   | 338    | 387   | 393   | 393   | 533   |
| Service Time           | 8.59  | 8.066  | 6.265 | 8.389  | 7.17  | 7.034 | 7.034 | 4.486 |
| HCM Lane V/C Ratio     | 0.737 | 0.537  | 0.443 | 0.376  | 1.235 | 1.237 | 1.237 | 0.281 |
| HCM Control Delay      | 33.2  | 22.6   | 16.8  | 19.3   | 141.3 | 133   | 133   | 11.9  |
| HCM Lane LOS           | D     | C      | C     | C      | F     | F     | F     | B     |
| HCM 95th-tile Q        | 4.6   | 2.6    | 1.9   | 1.6    | 18.6  | 18    | 18    | 1     |

HCM 2010 Signalized Intersection Summary  
 48: Fremont Boulevard/Hwy 1 SB Off-Ramp/ NB On-Ramp & Monterey Road

Existing, AM  
 06/11/2019



| Movement                      | EBL  | EBT  | EBR  | WBL   | WBT   | WBR   | NBL  | NBT  | NBR  | SBL  | SBT  | SBR  |
|-------------------------------|------|------|------|-------|-------|-------|------|------|------|------|------|------|
| Lane Configurations           | ↖    | ↗    | ↘    |       | ↕     |       | ↖    | ↗    |      | ↖    | ↗    | ↘    |
| Traffic Volume (veh/h)        | 69   | 136  | 94   | 113   | 283   | 19    | 193  | 506  | 140  | 93   | 804  | 153  |
| Future Volume (veh/h)         | 69   | 136  | 94   | 113   | 283   | 19    | 193  | 506  | 140  | 93   | 804  | 153  |
| Number                        | 7    | 4    | 14   | 3     | 8     | 18    | 5    | 2    | 12   | 1    | 6    | 16   |
| Initial Q (Qb), veh           | 0    | 0    | 0    | 0     | 0     | 0     | 0    | 0    | 0    | 0    | 0    | 0    |
| Ped-Bike Adj(A_pbT)           | 1.00 |      | 0.96 | 1.00  |       | 0.97  | 1.00 |      | 0.98 | 1.00 |      | 0.98 |
| Parking Bus, Adj              | 1.00 | 1.00 | 1.00 | 1.00  | 1.00  | 1.00  | 1.00 | 1.00 | 1.00 | 1.00 | 1.00 | 1.00 |
| Adj Sat Flow, veh/h/ln        | 1845 | 1845 | 1845 | 1900  | 1881  | 1900  | 1827 | 1827 | 1900 | 1827 | 1827 | 1827 |
| Adj Flow Rate, veh/h          | 76   | 149  | 14   | 124   | 311   | 19    | 212  | 556  | 139  | 102  | 884  | 101  |
| Adj No. of Lanes              | 1    | 1    | 1    | 0     | 1     | 0     | 1    | 2    | 0    | 1    | 2    | 1    |
| Peak Hour Factor              | 0.91 | 0.91 | 0.91 | 0.91  | 0.91  | 0.91  | 0.91 | 0.91 | 0.91 | 0.91 | 0.91 | 0.91 |
| Percent Heavy Veh, %          | 3    | 3    | 3    | 1     | 1     | 1     | 4    | 4    | 4    | 4    | 4    | 4    |
| Cap, veh/h                    | 230  | 241  | 196  | 113   | 282   | 17    | 398  | 1150 | 286  | 125  | 880  | 388  |
| Arrive On Green               | 0.13 | 0.13 | 0.13 | 0.22  | 0.22  | 0.22  | 0.23 | 0.42 | 0.42 | 0.07 | 0.25 | 0.25 |
| Sat Flow, veh/h               | 1757 | 1845 | 1501 | 502   | 1260  | 77    | 1740 | 2745 | 684  | 1740 | 3471 | 1529 |
| Grp Volume(v), veh/h          | 76   | 149  | 14   | 454   | 0     | 0     | 212  | 351  | 344  | 102  | 884  | 101  |
| Grp Sat Flow(s),veh/h/ln      | 1757 | 1845 | 1501 | 1840  | 0     | 0     | 1740 | 1736 | 1694 | 1740 | 1736 | 1529 |
| Q Serve(g_s), s               | 4.9  | 9.5  | 1.0  | 28.0  | 0.0   | 0.0   | 13.4 | 18.4 | 18.5 | 7.2  | 31.7 | 6.6  |
| Cycle Q Clear(g_c), s         | 4.9  | 9.5  | 1.0  | 28.0  | 0.0   | 0.0   | 13.4 | 18.4 | 18.5 | 7.2  | 31.7 | 6.6  |
| Prop In Lane                  | 1.00 |      | 1.00 | 0.27  |       | 0.04  | 1.00 |      | 0.40 | 1.00 |      | 1.00 |
| Lane Grp Cap(c), veh/h        | 230  | 241  | 196  | 412   | 0     | 0     | 398  | 727  | 709  | 125  | 880  | 388  |
| V/C Ratio(X)                  | 0.33 | 0.62 | 0.07 | 1.10  | 0.00  | 0.00  | 0.53 | 0.48 | 0.49 | 0.81 | 1.00 | 0.26 |
| Avail Cap(c_a), veh/h         | 436  | 457  | 372  | 412   | 0     | 0     | 398  | 727  | 709  | 209  | 880  | 388  |
| HCM Platoon Ratio             | 1.00 | 1.00 | 1.00 | 1.00  | 1.00  | 1.00  | 1.00 | 1.00 | 1.00 | 1.00 | 1.00 | 1.00 |
| Upstream Filter(I)            | 0.78 | 0.78 | 0.78 | 1.00  | 0.00  | 0.00  | 1.00 | 1.00 | 1.00 | 1.00 | 1.00 | 1.00 |
| Uniform Delay (d), s/veh      | 49.4 | 51.4 | 47.7 | 48.5  | 0.0   | 0.0   | 42.4 | 26.4 | 26.5 | 57.2 | 46.7 | 37.3 |
| Incr Delay (d2), s/veh        | 0.7  | 2.0  | 0.1  | 74.8  | 0.0   | 0.0   | 0.7  | 2.3  | 2.4  | 4.8  | 31.4 | 1.6  |
| Initial Q Delay(d3),s/veh     | 0.0  | 0.0  | 0.0  | 0.0   | 0.0   | 0.0   | 0.0  | 0.0  | 0.0  | 0.0  | 0.0  | 0.0  |
| %ile BackOfQ(50%),veh/ln      | 2.4  | 5.0  | 0.4  | 22.8  | 0.0   | 0.0   | 6.5  | 9.2  | 9.1  | 3.7  | 19.0 | 3.0  |
| LnGrp Delay(d),s/veh          | 50.0 | 53.4 | 47.8 | 123.3 | 0.0   | 0.0   | 43.1 | 28.7 | 28.9 | 61.9 | 78.0 | 38.9 |
| LnGrp LOS                     | D    | D    | D    | F     |       |       | D    | C    | C    | E    | F    | D    |
| Approach Vol, veh/h           |      | 239  |      |       | 454   |       |      | 907  |      |      | 1087 |      |
| Approach Delay, s/veh         |      | 52.0 |      |       | 123.3 |       |      | 32.1 |      |      | 72.9 |      |
| Approach LOS                  |      | D    |      |       | F     |       |      | C    |      |      | E    |      |
| Timer                         | 1    | 2    | 3    | 4     | 5     | 6     | 7    | 8    |      |      |      |      |
| Assigned Phs                  | 1    | 2    |      | 4     | 5     | 6     |      | 8    |      |      |      |      |
| Phs Duration (G+Y+Rc), s      | 3.2  | 57.7 |      | 21.0  | 33.9  | 37.0  |      | 33.1 |      |      |      |      |
| Change Period (Y+Rc), s       | 4.2  | 5.3  |      | * 4.7 | 5.3   | * 5.3 |      | 5.1  |      |      |      |      |
| Max Green Setting (Gmax), s   | 15   | 31.7 |      | * 31  | 15.0  | * 32  |      | 28.0 |      |      |      |      |
| Max Q Clear Time (g_c+1/2), s | 19.2 | 20.5 |      | 11.5  | 15.4  | 33.7  |      | 30.0 |      |      |      |      |
| Green Ext Time (p_c), s       | 0.1  | 2.7  |      | 1.0   | 0.0   | 0.0   |      | 0.0  |      |      |      |      |

| Intersection Summary |      |  |  |  |  |  |  |  |  |  |  |  |
|----------------------|------|--|--|--|--|--|--|--|--|--|--|--|
| HCM 2010 Ctrl Delay  | 65.8 |  |  |  |  |  |  |  |  |  |  |  |
| HCM 2010 LOS         | E    |  |  |  |  |  |  |  |  |  |  |  |

Notes

HCM 2010 Signalized Intersection Summary  
 49: Highway 1 SB On-Ramp & Highway 1 NB Off-Ramp/Monterey Road

Existing, AM  
 06/11/2019



| Movement                     | EBL  | EBT  | EBR  | WBL   | WBT  | WBR   | NBL  | NBT   | NBR  | SBL  | SBT  | SBR  |
|------------------------------|------|------|------|-------|------|-------|------|-------|------|------|------|------|
| Lane Configurations          |      | ↕↕   | ↗    | ↖     |      | ↗     |      | ↕     | ↗    |      | ↕    |      |
| Traffic Volume (veh/h)       | 2    | 198  | 100  | 225   | 0    | 416   | 0    | 41    | 109  | 0    | 1    | 0    |
| Future Volume (veh/h)        | 2    | 198  | 100  | 225   | 0    | 416   | 0    | 41    | 109  | 0    | 1    | 0    |
| Number                       | 1    | 6    | 16   | 5     | 2    | 12    | 7    | 4     | 14   | 3    | 8    | 18   |
| Initial Q (Qb), veh          | 0    | 0    | 0    | 0     | 0    | 0     | 0    | 0     | 0    | 0    | 0    | 0    |
| Ped-Bike Adj(A_pbT)          | 1.00 |      | 1.00 | 1.00  |      | 1.00  | 1.00 |       | 1.00 | 1.00 |      | 1.00 |
| Parking Bus, Adj             | 1.00 | 1.00 | 1.00 | 1.00  | 1.00 | 1.00  | 1.00 | 1.00  | 1.00 | 1.00 | 1.00 | 1.00 |
| Adj Sat Flow, veh/h/ln       | 1900 | 1845 | 1845 | 1863  | 0    | 1863  | 0    | 1845  | 1845 | 1900 | 1900 | 0    |
| Adj Flow Rate, veh/h         | 2    | 204  | 9    | 232   | 0    | 290   | 0    | 42    | 9    | 0    | 1    | 0    |
| Adj No. of Lanes             | 0    | 2    | 1    | 1     | 0    | 1     | 0    | 1     | 1    | 0    | 1    | 0    |
| Peak Hour Factor             | 0.97 | 0.97 | 0.97 | 0.97  | 0.97 | 0.97  | 0.97 | 0.97  | 0.97 | 0.97 | 0.97 | 0.97 |
| Percent Heavy Veh, %         | 3    | 3    | 3    | 2     | 0    | 2     | 0    | 3     | 3    | 0    | 0    | 0    |
| Cap, veh/h                   | 29   | 3079 | 1354 | 0     | 0    | 0     | 0    | 110   | 94   | 0    | 114  | 0    |
| Arrive On Green              | 0.86 | 0.86 | 0.86 | 0.00  | 0.00 | 0.00  | 0.00 | 0.06  | 0.06 | 0.00 | 0.06 | 0.00 |
| Sat Flow, veh/h              | 33   | 3562 | 1566 |       |      |       | 0    | 1845  | 1568 | 0    | 1900 | 0    |
| Grp Volume(v), veh/h         | 110  | 96   | 9    |       | 0.0  |       | 0    | 42    | 9    | 0    | 1    | 0    |
| Grp Sat Flow(s),veh/h/ln     | 1843 | 1752 | 1566 |       |      |       | 0    | 1845  | 1568 | 0    | 1900 | 0    |
| Q Serve(g_s), s              | 1.1  | 1.0  | 0.1  |       |      |       | 0.0  | 2.7   | 0.7  | 0.0  | 0.1  | 0.0  |
| Cycle Q Clear(g_c), s        | 1.1  | 1.0  | 0.1  |       |      |       | 0.0  | 2.7   | 0.7  | 0.0  | 0.1  | 0.0  |
| Prop In Lane                 | 0.02 |      | 1.00 |       |      |       | 0.00 |       | 1.00 | 0.00 |      | 0.00 |
| Lane Grp Cap(c), veh/h       | 1593 | 1515 | 1354 |       |      |       | 0    | 110   | 94   | 0    | 114  | 0    |
| V/C Ratio(X)                 | 0.07 | 0.06 | 0.01 |       |      |       | 0.00 | 0.38  | 0.10 | 0.00 | 0.01 | 0.00 |
| Avail Cap(c_a), veh/h        | 1593 | 1515 | 1354 |       |      |       | 0    | 148   | 125  | 0    | 152  | 0    |
| HCM Platoon Ratio            | 1.00 | 1.00 | 1.00 |       |      |       | 1.00 | 1.00  | 1.00 | 1.00 | 1.00 | 1.00 |
| Upstream Filter(I)           | 1.00 | 1.00 | 1.00 |       |      |       | 0.00 | 1.00  | 1.00 | 0.00 | 1.00 | 0.00 |
| Uniform Delay (d), s/veh     | 1.2  | 1.2  | 1.2  |       |      |       | 0.0  | 56.5  | 55.6 | 0.0  | 55.3 | 0.0  |
| Incr Delay (d2), s/veh       | 0.0  | 0.0  | 0.0  |       |      |       | 0.0  | 0.8   | 0.2  | 0.0  | 0.0  | 0.0  |
| Initial Q Delay(d3),s/veh    | 0.0  | 0.0  | 0.0  |       |      |       | 0.0  | 0.0   | 0.0  | 0.0  | 0.0  | 0.0  |
| %ile BackOfQ(50%),veh/ln     | 0.6  | 0.5  | 0.0  |       |      |       | 0.0  | 1.4   | 0.3  | 0.0  | 0.0  | 0.0  |
| LnGrp Delay(d),s/veh         | 1.2  | 1.2  | 1.2  |       |      |       | 0.0  | 57.3  | 55.7 | 0.0  | 55.3 | 0.0  |
| LnGrp LOS                    | A    | A    | A    |       |      |       |      | E     | E    |      | E    |      |
| Approach Vol, veh/h          |      | 215  |      |       |      |       |      | 51    |      |      | 1    |      |
| Approach Delay, s/veh        |      | 1.2  |      |       |      |       |      | 57.1  |      |      | 55.3 |      |
| Approach LOS                 |      | A    |      |       |      |       |      | E     |      |      | E    |      |
| Timer                        | 1    | 2    | 3    | 4     | 5    | 6     | 7    | 8     |      |      |      |      |
| Assigned Phs                 |      |      |      | 4     |      | 6     |      | 8     |      |      |      |      |
| Phs Duration (G+Y+Rc), s     |      |      |      | 11.7  |      | 113.3 |      | 11.7  |      |      |      |      |
| Change Period (Y+Rc), s      |      |      |      | * 4.2 |      | 5.3   |      | * 4.2 |      |      |      |      |
| Max Green Setting (Gmax), s  |      |      |      | * 10  |      | 21.0  |      | * 10  |      |      |      |      |
| Max Q Clear Time (g_c+I1), s |      |      |      | 4.7   |      | 3.1   |      | 2.1   |      |      |      |      |
| Green Ext Time (p_c), s      |      |      |      | 0.0   |      | 0.7   |      | 0.0   |      |      |      |      |
| <b>Intersection Summary</b>  |      |      |      |       |      |       |      |       |      |      |      |      |
| HCM 2010 Ctrl Delay          |      |      |      | 12.1  |      |       |      |       |      |      |      |      |
| HCM 2010 LOS                 |      |      |      | B     |      |       |      |       |      |      |      |      |
| <b>Notes</b>                 |      |      |      |       |      |       |      |       |      |      |      |      |

HCM 2010 Signalized Intersection Summary  
 50: Reservation Road & SR 68 WB On Ramp/SR 68 WB Off Ramp

Existing, AM  
 06/11/2019



| Movement                     | EBL  | EBT  | EBR | WBL  | WBT  | WBR  | NBL  | NBT  | NBR  | SBL  | SBT  | SBR  |
|------------------------------|------|------|-----|------|------|------|------|------|------|------|------|------|
| Lane Configurations          |      |      |     |      | ↕    | ↕    | ↕    | ↑    |      |      | ↕    |      |
| Traffic Volume (veh/h)       | 0    | 0    | 0   | 243  | 0    | 293  | 123  | 355  | 0    | 0    | 335  | 105  |
| Future Volume (veh/h)        | 0    | 0    | 0   | 243  | 0    | 293  | 123  | 355  | 0    | 0    | 335  | 105  |
| Number                       |      |      |     | 7    | 4    | 14   | 1    | 6    | 16   | 5    | 2    | 12   |
| Initial Q (Qb), veh          |      |      |     | 0    | 0    | 0    | 0    | 0    | 0    | 0    | 0    | 0    |
| Ped-Bike Adj(A_pbT)          |      |      |     | 1.00 |      | 1.00 | 1.00 |      | 1.00 | 1.00 |      | 1.00 |
| Parking Bus, Adj             |      |      |     | 1.00 | 1.00 | 1.00 | 1.00 | 1.00 | 1.00 | 1.00 | 1.00 | 1.00 |
| Adj Sat Flow, veh/h/ln       |      |      |     | 1900 | 1827 | 1827 | 1863 | 1863 | 0    | 0    | 1827 | 1900 |
| Adj Flow Rate, veh/h         |      |      |     | 256  | 0    | 56   | 129  | 374  | 0    | 0    | 353  | 102  |
| Adj No. of Lanes             |      |      |     | 0    | 1    | 1    | 1    | 1    | 0    | 0    | 1    | 0    |
| Peak Hour Factor             |      |      |     | 0.95 | 0.95 | 0.95 | 0.95 | 0.95 | 0.95 | 0.95 | 0.95 | 0.95 |
| Percent Heavy Veh, %         |      |      |     | 4    | 4    | 4    | 2    | 2    | 0    | 0    | 4    | 4    |
| Cap, veh/h                   |      |      |     | 374  | 0    | 334  | 223  | 1004 | 0    | 0    | 456  | 132  |
| Arrive On Green              |      |      |     | 0.22 | 0.00 | 0.22 | 0.13 | 0.54 | 0.00 | 0.00 | 0.33 | 0.33 |
| Sat Flow, veh/h              |      |      |     | 1740 | 0    | 1553 | 1774 | 1863 | 0    | 0    | 1363 | 394  |
| Grp Volume(v), veh/h         |      |      |     | 256  | 0    | 56   | 129  | 374  | 0    | 0    | 0    | 455  |
| Grp Sat Flow(s),veh/h/ln     |      |      |     | 1740 | 0    | 1553 | 1774 | 1863 | 0    | 0    | 0    | 1757 |
| Q Serve(g_s), s              |      |      |     | 6.0  | 0.0  | 1.3  | 3.0  | 5.1  | 0.0  | 0.0  | 0.0  | 10.3 |
| Cycle Q Clear(g_c), s        |      |      |     | 6.0  | 0.0  | 1.3  | 3.0  | 5.1  | 0.0  | 0.0  | 0.0  | 10.3 |
| Prop In Lane                 |      |      |     | 1.00 |      | 1.00 | 1.00 |      | 0.00 | 0.00 |      | 0.22 |
| Lane Grp Cap(c), veh/h       |      |      |     | 374  | 0    | 334  | 223  | 1004 | 0    | 0    | 0    | 587  |
| V/C Ratio(X)                 |      |      |     | 0.68 | 0.00 | 0.17 | 0.58 | 0.37 | 0.00 | 0.00 | 0.00 | 0.77 |
| Avail Cap(c_a), veh/h        |      |      |     | 1571 | 0    | 1402 | 1041 | 1598 | 0    | 0    | 0    | 1507 |
| HCM Platoon Ratio            |      |      |     | 1.00 | 1.00 | 1.00 | 1.00 | 1.00 | 1.00 | 1.00 | 1.00 | 1.00 |
| Upstream Filter(I)           |      |      |     | 1.00 | 0.00 | 1.00 | 1.00 | 1.00 | 0.00 | 0.00 | 0.00 | 1.00 |
| Uniform Delay (d), s/veh     |      |      |     | 16.0 | 0.0  | 14.2 | 18.3 | 5.9  | 0.0  | 0.0  | 0.0  | 13.3 |
| Incr Delay (d2), s/veh       |      |      |     | 2.2  | 0.0  | 0.2  | 0.9  | 0.2  | 0.0  | 0.0  | 0.0  | 2.2  |
| Initial Q Delay(d3),s/veh    |      |      |     | 0.0  | 0.0  | 0.0  | 0.0  | 0.0  | 0.0  | 0.0  | 0.0  | 0.0  |
| %ile BackOfQ(50%),veh/ln     |      |      |     | 3.1  | 0.0  | 0.6  | 1.5  | 2.7  | 0.0  | 0.0  | 0.0  | 5.3  |
| LnGrp Delay(d),s/veh         |      |      |     | 18.2 | 0.0  | 14.4 | 19.1 | 6.1  | 0.0  | 0.0  | 0.0  | 15.5 |
| LnGrp LOS                    |      |      |     | B    |      | B    | B    | A    |      |      |      | B    |
| Approach Vol, veh/h          |      |      |     |      | 312  |      |      | 503  |      |      | 455  |      |
| Approach Delay, s/veh        |      |      |     |      | 17.5 |      |      | 9.5  |      |      | 15.5 |      |
| Approach LOS                 |      |      |     |      | B    |      |      | A    |      |      | B    |      |
| Timer                        | 1    | 2    | 3   | 4    | 5    | 6    | 7    | 8    |      |      |      |      |
| Assigned Phs                 | 1    | 2    |     | 4    |      | 6    |      |      |      |      |      |      |
| Phs Duration (G+Y+Rc), s     | 9.1  | 20.8 |     | 14.4 |      | 29.9 |      |      |      |      |      |      |
| Change Period (Y+Rc), s      | 3.5  | 6.0  |     | 4.9  |      | 6.0  |      |      |      |      |      |      |
| Max Green Setting (Gmax), s  | 26.0 | 38.0 |     | 40.0 |      | 38.0 |      |      |      |      |      |      |
| Max Q Clear Time (g_c+15), s | 15.0 | 12.3 |     | 8.0  |      | 7.1  |      |      |      |      |      |      |
| Green Ext Time (p_c), s      | 0.1  | 2.5  |     | 1.7  |      | 2.0  |      |      |      |      |      |      |
| <b>Intersection Summary</b>  |      |      |     |      |      |      |      |      |      |      |      |      |
| HCM 2010 Ctrl Delay          |      |      |     | 13.6 |      |      |      |      |      |      |      |      |
| HCM 2010 LOS                 |      |      |     | B    |      |      |      |      |      |      |      |      |

HCM 2010 Signalized Intersection Summary  
 51: River Road/Reservation Road & SR 68 Off Ramp/SR 68 EB On Ramp

Existing, AM  
 06/11/2019























| Movement                     | EBL  | EBT  | EBR  | WBL | WBT  | WBR  | NBL  | NBT  | NBR  | SBL  | SBT  | SBR  |
|------------------------------|------|------|------|-----|------|------|------|------|------|------|------|------|
| Lane Configurations          |      | ↖    | ↗    |     |      |      |      | ↑    | ↖    | ↗    | ↑    |      |
| Traffic Volume (veh/h)       | 96   | 1    | 105  | 0   | 0    | 0    | 0    | 376  | 664  | 223  | 346  | 0    |
| Future Volume (veh/h)        | 96   | 1    | 105  | 0   | 0    | 0    | 0    | 376  | 664  | 223  | 346  | 0    |
| Number                       | 3    | 8    | 18   |     |      |      | 1    | 6    | 16   | 5    | 2    | 12   |
| Initial Q (Qb), veh          | 0    | 0    | 0    |     |      |      | 0    | 0    | 0    | 0    | 0    | 0    |
| Ped-Bike Adj(A_pbT)          | 1.00 |      | 1.00 |     |      |      | 1.00 |      | 1.00 | 1.00 |      | 1.00 |
| Parking Bus, Adj             | 1.00 | 1.00 | 1.00 |     |      |      | 1.00 | 1.00 | 1.00 | 1.00 | 1.00 | 1.00 |
| Adj Sat Flow, veh/h/ln       | 1900 | 1881 | 1881 |     |      |      | 0    | 1881 | 1881 | 1827 | 1827 | 0    |
| Adj Flow Rate, veh/h         | 104  | 1    | 13   |     |      |      | 0    | 409  | 393  | 242  | 376  | 0    |
| Adj No. of Lanes             | 0    | 1    | 1    |     |      |      | 0    | 1    | 1    | 1    | 1    | 0    |
| Peak Hour Factor             | 0.92 | 0.92 | 0.92 |     |      |      | 0.92 | 0.92 | 0.92 | 0.92 | 0.92 | 0.92 |
| Percent Heavy Veh, %         | 1    | 1    | 1    |     |      |      | 0    | 1    | 1    | 4    | 4    | 0    |
| Cap, veh/h                   | 151  | 1    | 136  |     |      |      | 0    | 664  | 564  | 330  | 1163 | 0    |
| Arrive On Green              | 0.09 | 0.09 | 0.09 |     |      |      | 0.00 | 0.35 | 0.35 | 0.19 | 0.64 | 0.00 |
| Sat Flow, veh/h              | 1775 | 17   | 1599 |     |      |      | 0    | 1881 | 1599 | 1740 | 1827 | 0    |
| Grp Volume(v), veh/h         | 105  | 0    | 13   |     |      |      | 0    | 409  | 393  | 242  | 376  | 0    |
| Grp Sat Flow(s),veh/h/ln     | 1792 | 0    | 1599 |     |      |      | 0    | 1881 | 1599 | 1740 | 1827 | 0    |
| Q Serve(g_s), s              | 2.2  | 0.0  | 0.3  |     |      |      | 0.0  | 7.0  | 8.3  | 5.1  | 3.7  | 0.0  |
| Cycle Q Clear(g_c), s        | 2.2  | 0.0  | 0.3  |     |      |      | 0.0  | 7.0  | 8.3  | 5.1  | 3.7  | 0.0  |
| Prop In Lane                 | 0.99 |      | 1.00 |     |      |      | 0.00 |      | 1.00 | 1.00 |      | 0.00 |
| Lane Grp Cap(c), veh/h       | 152  | 0    | 136  |     |      |      | 0    | 664  | 564  | 330  | 1163 | 0    |
| V/C Ratio(X)                 | 0.69 | 0.00 | 0.10 |     |      |      | 0.00 | 0.62 | 0.70 | 0.73 | 0.32 | 0.00 |
| Avail Cap(c_a), veh/h        | 1830 | 0    | 1632 |     |      |      | 0    | 1776 | 1510 | 1066 | 1725 | 0    |
| HCM Platoon Ratio            | 1.00 | 1.00 | 1.00 |     |      |      | 1.00 | 1.00 | 1.00 | 1.00 | 1.00 | 1.00 |
| Upstream Filter(I)           | 1.00 | 0.00 | 1.00 |     |      |      | 0.00 | 1.00 | 1.00 | 1.00 | 1.00 | 0.00 |
| Uniform Delay (d), s/veh     | 17.4 | 0.0  | 16.5 |     |      |      | 0.0  | 10.5 | 10.9 | 14.9 | 3.3  | 0.0  |
| Incr Delay (d2), s/veh       | 2.1  | 0.0  | 0.1  |     |      |      | 0.0  | 0.9  | 1.6  | 3.2  | 0.2  | 0.0  |
| Initial Q Delay(d3),s/veh    | 0.0  | 0.0  | 0.0  |     |      |      | 0.0  | 0.0  | 0.0  | 0.0  | 0.0  | 0.0  |
| %ile BackOfQ(50%),veh/ln     | 1.2  | 0.0  | 0.1  |     |      |      | 0.0  | 3.8  | 3.8  | 2.7  | 1.8  | 0.0  |
| LnGrp Delay(d),s/veh         | 19.5 | 0.0  | 16.6 |     |      |      | 0.0  | 11.4 | 12.4 | 18.1 | 3.4  | 0.0  |
| LnGrp LOS                    | B    |      | B    |     |      |      |      | B    | B    | B    | A    |      |
| Approach Vol, veh/h          |      | 118  |      |     |      |      |      | 802  |      |      | 618  |      |
| Approach Delay, s/veh        |      | 19.2 |      |     |      |      |      | 11.9 |      |      | 9.2  |      |
| Approach LOS                 |      | B    |      |     |      |      |      | B    |      |      | A    |      |
| Timer                        | 1    | 2    | 3    | 4   | 5    | 6    | 7    | 8    |      |      |      |      |
| Assigned Phs                 |      | 2    |      |     | 5    | 6    |      | 8    |      |      |      |      |
| Phs Duration (G+Y+Rc), s     |      | 31.0 |      |     | 11.1 | 19.8 |      | 8.2  |      |      |      |      |
| Change Period (Y+Rc), s      |      | 6.0  |      |     | 3.7  | 6.0  |      | 4.9  |      |      |      |      |
| Max Green Setting (Gmax), s  |      | 37.0 |      |     | 24.0 | 37.0 |      | 40.0 |      |      |      |      |
| Max Q Clear Time (g_c+I1), s |      | 5.7  |      |     | 7.1  | 10.3 |      | 4.2  |      |      |      |      |
| Green Ext Time (p_c), s      |      | 2.1  |      |     | 0.6  | 3.6  |      | 0.4  |      |      |      |      |
| <b>Intersection Summary</b>  |      |      |      |     |      |      |      |      |      |      |      |      |
| HCM 2010 Ctrl Delay          |      |      | 11.4 |     |      |      |      |      |      |      |      |      |
| HCM 2010 LOS                 |      |      | B    |     |      |      |      |      |      |      |      |      |



HCM 2010 Signalized Intersection Summary  
1: Del Monte Boulevard & Reindollar Avenue

Existing, PM  
06/11/2019

|                              |  |  |  |  |  |  |   |  |  |  |  |  |
|------------------------------|---|---|---|---|---|---|---|---|---|---|---|---|
| Movement                     | EBL   | EBT   | EBR   | WBL   | WBT   | WBR   | NBL   | NBT   | NBR   | SBL   | SBT   | SBR   |
| Lane Configurations          |   |   |   |  |  |   |  |  |  |  |  |  |
| Traffic Volume (veh/h)       | 0   | 0   | 0   | 171   | 0   | 85  | 4   | 1010  | 318   | 73  | 475   | 0   |
| Future Volume (veh/h)        | 0   | 0   | 0   | 171   | 0   | 85  | 4   | 1010  | 318   | 73  | 475   | 0   |
| Number                       |   |   |   | 3   | 8   | 18  | 1   | 6   | 16  | 5   | 2   | 12  |
| Initial Q (Qb), veh          |   |   |   | 0   | 0   | 0   | 0   | 0   | 0   | 0   | 0   | 0   |
| Ped-Bike Adj(A_pbT)          |   |   |   | 1.00  |   | 1.00  | 1.00  |   | 1.00  | 1.00  |   | 1.00  |
| Parking Bus, Adj             |   |   |   | 1.00  | 1.00  | 1.00  | 1.00  | 1.00  | 1.00  | 1.00  | 1.00  | 1.00  |
| Adj Sat Flow, veh/h/ln       |   |   |   | 1881  | 1881  | 1900  | 1881  | 1881  | 1881  | 1881  | 1881  | 0   |
| Adj Flow Rate, veh/h         |   |   |   | 194   | 0   | 0   | 4   | 1052  | 248   | 76  | 495   | 0   |
| Adj No. of Lanes             |   |   |   | 2   | 1   | 0   | 1   | 2   | 1   | 1   | 2   | 0   |
| Peak Hour Factor             |   |   |   | 0.96  | 0.96  | 0.96  | 0.96  | 0.96  | 0.96  | 0.96  | 0.96  | 0.96  |
| Percent Heavy Veh, %         |   |   |   | 1   | 1   | 1   | 1   | 1   | 1   | 1   | 1   | 0   |
| Cap, veh/h                   |   |   |   | 453   | 238   | 0   | 10  | 1683  | 753   | 127   | 1917  | 0   |
| Arrive On Green              |   |   |   | 0.13  | 0.00  | 0.00  | 0.01  | 0.47  | 0.47  | 0.07  | 0.54  | 0.00  |
| Sat Flow, veh/h              |   |   |   | 3583  | 1881  | 0   | 1792  | 3574  | 1599  | 1792  | 3668  | 0   |
| Grp Volume(v), veh/h         |   |   |   | 194   | 0   | 0   | 4   | 1052  | 248   | 76  | 495   | 0   |
| Grp Sat Flow(s),veh/h/ln     |   |   |   | 1792  | 1881  | 0   | 1792  | 1787  | 1599  | 1792  | 1787  | 0   |
| Q Serve(g_s), s              |   |   |   | 2.0   | 0.0   | 0.0   | 0.1   | 9.0   | 4.0   | 1.7   | 3.0   | 0.0   |
| Cycle Q Clear(g_c), s        |   |   |   | 2.0   | 0.0   | 0.0   | 0.1   | 9.0   | 4.0   | 1.7   | 3.0   | 0.0   |
| Prop In Lane                 |   |   |   | 1.00  |   | 0.00  | 1.00  |   | 1.00  | 1.00  |   | 0.00  |
| Lane Grp Cap(c), veh/h       |   |   |   | 453   | 238   | 0   | 10  | 1683  | 753   | 127   | 1917  | 0   |
| V/C Ratio(X)                 |   |   |   | 0.43  | 0.00  | 0.00  | 0.41  | 0.63  | 0.33  | 0.60  | 0.26  | 0.00  |
| Avail Cap(c_a), veh/h        |   |   |   | 2642  | 1387  | 0   | 1321  | 2636  | 1179  | 1321  | 2636  | 0   |
| HCM Platoon Ratio            |   |   |   | 1.00  | 1.00  | 1.00  | 1.00  | 1.00  | 1.00  | 1.00  | 1.00  | 1.00  |
| Upstream Filter(I)           |   |   |   | 1.00  | 0.00  | 0.00  | 1.00  | 1.00  | 1.00  | 1.00  | 1.00  | 0.00  |
| Uniform Delay (d), s/veh     |   |   |   | 16.4  | 0.0   | 0.0   | 20.2  | 8.1   | 6.7   | 18.3  | 5.1   | 0.0   |
| Incr Delay (d2), s/veh       |   |   |   | 0.6   | 0.0   | 0.0   | 25.4  | 0.4   | 0.3   | 4.5   | 0.1   | 0.0   |
| Initial Q Delay(d3),s/veh    |   |   |   | 0.0   | 0.0   | 0.0   | 0.0   | 0.0   | 0.0   | 0.0   | 0.0   | 0.0   |
| %ile BackOfQ(50%),veh/ln     |   |   |   | 1.0   | 0.0   | 0.0   | 0.1   | 4.5   | 1.8   | 1.0   | 1.5   | 0.0   |
| LnGrp Delay(d),s/veh         |   |   |   | 17.1  | 0.0   | 0.0   | 45.6  | 8.5   | 7.0   | 22.8  | 5.1   | 0.0   |
| LnGrp LOS                    |   |   |   | B   |   |   | D   | A   | A   | C   | A   |   |
| Approach Vol, veh/h          |   |   |   |   | 194   |   |   | 1304  |   |   | 571   |   |
| Approach Delay, s/veh        |   |   |   |   | 17.1  |   |   | 8.3   |   |   | 7.5   |   |
| Approach LOS                 |   |   |   |   | B   |   |   | A   |   |   | A   |   |
| Timer                        | 1   | 2   | 3   | 4   | 5   | 6   | 7   | 8   |   |   |   |   |
| Assigned Phs                 | 1   | 2   |   |   | 5   | 6   |   | 8   |   |   |   |   |
| Phs Duration (G+Y+Rc), s     | 3.7   | 26.8  |   |   | 6.4   | 24.2  |   | 10.1  |   |   |   |   |
| Change Period (Y+Rc), s      | 3.5   | 5.0   |   |   | 3.5   | 5.0   |   | 5.0   |   |   |   |   |
| Max Green Setting (Gmax), s  | 30.0  | 30.0  |   |   | 30.0  | 30.0  |   | 30.0  |   |   |   |   |
| Max Q Clear Time (g_c+I1), s | 2.1   | 5.0   |   |   | 3.7   | 11.0  |   | 4.0   |   |   |   |   |
| Green Ext Time (p_c), s      | 0.0   | 3.4   |   |   | 0.2   | 8.2   |   | 0.7   |   |   |   |   |
| <b>Intersection Summary</b>  |   |   |   |   |   |   |   |   |   |   |   |   |
| HCM 2010 Ctrl Delay          |   |   |   | 8.9   |   |   |   |   |   |   |   |   |
| HCM 2010 LOS                 |   |   |   | A   |   |   |   |   |   |   |   |   |
| <b>Notes</b>                 |   |   |   |   |   |   |   |   |   |   |   |   |

HCM 2010 Signalized Intersection Summary  
 3: SR 1 SB On-Ramp/SR 1 SB Off-Ramp & Imjin Parkway

Existing, PM  
 06/11/2019



| Movement                     | EBL | EBT | EBR | WBL  | WBT  | WBR  | NBL | NBT | NBR | SBL  | SBT  | SBR  |
|------------------------------|-----|-----|-----|------|------|------|-----|-----|-----|------|------|------|
| Lane Configurations          |     |     |     |      | ↕    |      |     |     |     |      | ↕    |      |
| Traffic Volume (veh/h)       | 0   | 0   | 0   | 992  | 0    | 0    | 0   | 0   | 0   | 260  | 1    | 0    |
| Future Volume (veh/h)        | 0   | 0   | 0   | 992  | 0    | 0    | 0   | 0   | 0   | 260  | 1    | 0    |
| Number                       |     |     |     | 1    | 6    | 16   |     |     |     | 7    | 4    | 14   |
| Initial Q (Qb), veh          |     |     |     | 0    | 0    | 0    |     |     |     | 0    | 0    | 0    |
| Ped-Bike Adj(A_pbT)          |     |     |     | 1.00 |      | 1.00 |     |     |     | 1.00 |      | 1.00 |
| Parking Bus, Adj             |     |     |     | 1.00 | 1.00 | 1.00 |     |     |     | 1.00 | 1.00 | 1.00 |
| Adj Sat Flow, veh/h/ln       |     |     |     | 1900 | 1881 | 0    |     |     |     | 1900 | 1863 | 0    |
| Adj Flow Rate, veh/h         |     |     |     | 1090 | 0    | 0    |     |     |     | 286  | 1    | 0    |
| Adj No. of Lanes             |     |     |     | 0    | 1    | 0    |     |     |     | 0    | 1    | 0    |
| Peak Hour Factor             |     |     |     | 0.91 | 0.91 | 0.91 |     |     |     | 0.91 | 0.91 | 0.91 |
| Percent Heavy Veh, %         |     |     |     | 1    | 1    | 0    |     |     |     | 2    | 2    | 0    |
| Cap, veh/h                   |     |     |     | 1233 | 0    | 0    |     |     |     | 357  | 1    | 0    |
| Arrive On Green              |     |     |     | 0.69 | 0.00 | 0.00 |     |     |     | 0.21 | 0.20 | 0.00 |
| Sat Flow, veh/h              |     |     |     | 1792 | 0    | 0    |     |     |     | 1768 | 6    | 0    |
| Grp Volume(v), veh/h         |     |     |     | 1090 | 0    | 0    |     |     |     | 287  | 0    | 0    |
| Grp Sat Flow(s),veh/h/ln     |     |     |     | 1792 | 0    | 0    |     |     |     | 1774 | 0    | 0    |
| Q Serve(g_s), s              |     |     |     | 38.5 | 0.0  | 0.0  |     |     |     | 12.3 | 0.0  | 0.0  |
| Cycle Q Clear(g_c), s        |     |     |     | 38.5 | 0.0  | 0.0  |     |     |     | 12.3 | 0.0  | 0.0  |
| Prop In Lane                 |     |     |     | 1.00 |      | 0.00 |     |     |     | 1.00 |      | 0.00 |
| Lane Grp Cap(c), veh/h       |     |     |     | 1233 | 0    | 0    |     |     |     | 358  | 0    | 0    |
| V/C Ratio(X)                 |     |     |     | 0.88 | 0.00 | 0.00 |     |     |     | 0.80 | 0.00 | 0.00 |
| Avail Cap(c_a), veh/h        |     |     |     | 2020 | 0    | 0    |     |     |     | 1334 | 0    | 0    |
| HCM Platoon Ratio            |     |     |     | 1.00 | 1.00 | 1.00 |     |     |     | 1.00 | 1.00 | 1.00 |
| Upstream Filter(I)           |     |     |     | 1.00 | 0.00 | 0.00 |     |     |     | 1.00 | 0.00 | 0.00 |
| Uniform Delay (d), s/veh     |     |     |     | 9.7  | 0.0  | 0.0  |     |     |     | 30.1 | 0.0  | 0.0  |
| Incr Delay (d2), s/veh       |     |     |     | 2.9  | 0.0  | 0.0  |     |     |     | 4.2  | 0.0  | 0.0  |
| Initial Q Delay(d3),s/veh    |     |     |     | 0.0  | 0.0  | 0.0  |     |     |     | 0.0  | 0.0  | 0.0  |
| %ile BackOfQ(50%),veh/ln     |     |     |     | 19.4 | 0.0  | 0.0  |     |     |     | 6.4  | 0.0  | 0.0  |
| LnGrp Delay(d),s/veh         |     |     |     | 12.7 | 0.0  | 0.0  |     |     |     | 34.3 | 0.0  | 0.0  |
| LnGrp LOS                    |     |     |     | B    |      |      |     |     |     | C    |      |      |
| Approach Vol, veh/h          |     |     |     |      | 1090 |      |     |     |     |      | 287  |      |
| Approach Delay, s/veh        |     |     |     |      | 12.7 |      |     |     |     |      | 34.3 |      |
| Approach LOS                 |     |     |     |      | B    |      |     |     |     |      | C    |      |
| Timer                        | 1   | 2   | 3   | 4    | 5    | 6    | 7   | 8   |     |      |      |      |
| Assigned Phs                 |     |     |     | 4    |      | 6    |     |     |     |      |      |      |
| Phs Duration (G+Y+Rc), s     |     |     |     | 20.5 |      | 59.3 |     |     |     |      |      |      |
| Change Period (Y+Rc), s      |     |     |     | 4.4  |      | 4.4  |     |     |     |      |      |      |
| Max Green Setting (Gmax), s  |     |     |     | 60.0 |      | 90.0 |     |     |     |      |      |      |
| Max Q Clear Time (g_c+I1), s |     |     |     | 14.3 |      | 40.5 |     |     |     |      |      |      |
| Green Ext Time (p_c), s      |     |     |     | 1.8  |      | 14.4 |     |     |     |      |      |      |
| <b>Intersection Summary</b>  |     |     |     |      |      |      |     |     |     |      |      |      |
| HCM 2010 Ctrl Delay          |     |     |     | 17.2 |      |      |     |     |     |      |      |      |
| HCM 2010 LOS                 |     |     |     | B    |      |      |     |     |     |      |      |      |

| Intersection             |      |      |      |      |      |      |      |      |      |      |       |      |
|--------------------------|------|------|------|------|------|------|------|------|------|------|-------|------|
| Int Delay, s/veh         | 0.2  |      |      |      |      |      |      |      |      |      |       |      |
| Movement                 | EBL  | EBT  | EBR  | WBL  | WBT  | WBR  | NBL  | NBT  | NBR  | SBL  | SBT   | SBR  |
| Lane Configurations      |      | ↔    |      |      | ↑    | ↗    |      | ↔    | ↗    |      |       |      |
| Traffic Vol, veh/h       | 7    | 247  | 0    | 0    | 995  | 422  | 4    | 2    | 1186 | 0    | 0     | 0    |
| Future Vol, veh/h        | 7    | 247  | 0    | 0    | 995  | 422  | 4    | 2    | 1186 | 0    | 0     | 0    |
| Conflicting Peds, #/hr   | 0    | 0    | 1    | 1    | 0    | 0    | 0    | 0    | 0    | 0    | 0     | 0    |
| Sign Control             | Free | Free | Free | Free | Free | Free | Stop | Stop | Stop | Stop | Stop  | Stop |
| RT Channelized           | -    | -    | None | -    | -    | Free | -    | -    | Free | -    | -     | None |
| Storage Length           | -    | -    | -    | -    | -    | 0    | -    | -    | 800  | -    | -     | -    |
| Veh in Median Storage, # | -    | 0    | -    | -    | 0    | -    | -    | 0    | -    | -    | 16965 | -    |
| Grade, %                 | -    | 0    | -    | -    | 0    | -    | -    | 0    | -    | -    | 0     | -    |
| Peak Hour Factor         | 95   | 95   | 95   | 95   | 95   | 95   | 95   | 95   | 95   | 95   | 95    | 95   |
| Heavy Vehicles, %        | 2    | 2    | 2    | 1    | 1    | 1    | 1    | 1    | 1    | 2    | 2     | 2    |
| Mvmt Flow                | 7    | 260  | 0    | 0    | 1047 | 444  | 4    | 2    | 1248 | 0    | 0     | 0    |























| Major/Minor          | Major1 | Major2 |   |   | Minor1 |       |       |     |   |
|----------------------|--------|--------|---|---|--------|-------|-------|-----|---|
| Conflicting Flow All | 1047   | 0      | - | - | 0      | 1321  | 1321  | -   |   |
| Stage 1              | -      | -      | - | - | -      | 274   | 274   | -   |   |
| Stage 2              | -      | -      | - | - | -      | 1047  | 1047  | -   |   |
| Critical Hdwy        | 4.12   | -      | - | - | -      | 6.41  | 6.51  | -   |   |
| Critical Hdwy Stg 1  | -      | -      | - | - | -      | 5.41  | 5.51  | -   |   |
| Critical Hdwy Stg 2  | -      | -      | - | - | -      | 5.41  | 5.51  | -   |   |
| Follow-up Hdwy       | 2.218  | -      | - | - | -      | 3.509 | 4.009 | -   |   |
| Pot Cap-1 Maneuver   | 665    | -      | 0 | 0 | -      | 0     | 174   | 157 | 0 |
| Stage 1              | -      | -      | 0 | 0 | -      | 0     | 774   | 685 | 0 |
| Stage 2              | -      | -      | 0 | 0 | -      | 0     | 339   | 306 | 0 |
| Platoon blocked, %   | -      | -      | - | - | -      | -     | -     | -   | - |
| Mov Cap-1 Maneuver   | 665    | -      | - | - | -      | 172   | 0     | -   |   |
| Mov Cap-2 Maneuver   | -      | -      | - | - | -      | 172   | 0     | -   |   |
| Stage 1              | -      | -      | - | - | -      | 765   | 0     | -   |   |
| Stage 2              | -      | -      | - | - | -      | 339   | 0     | -   |   |

| Approach             | EB  | WB | NB   |
|----------------------|-----|----|------|
| HCM Control Delay, s | 0.3 | 0  | 26.7 |
| HCM LOS              |     |    | D    |

| Minor Lane/Major Mvmt | NBLn1 | NBLn2 | EBL   | EBT | WBT |
|-----------------------|-------|-------|-------|-----|-----|
| Capacity (veh/h)      | 172   | -     | 665   | -   | -   |
| HCM Lane V/C Ratio    | 0.037 | -     | 0.011 | -   | -   |
| HCM Control Delay (s) | 26.7  | 0     | 10.5  | 0   | -   |
| HCM Lane LOS          | D     | A     | B     | A   | -   |
| HCM 95th %tile Q(veh) | 0.1   | -     | 0     | -   | -   |

HCM 2010 Signalized Intersection Summary  
5: 2nd Avenue & Imjin Parkway

Existing, PM  
06/11/2019

|                              |  |  |  |  |  |  |  |  |  |  |  |  |
|------------------------------|---|---|---|---|---|---|--|---|---|---|---|---|
| Movement                     | EBL   | EBT   | EBR   | WBL   | WBT   | WBR   | NBL  | NBT   | NBR   | SBL   | SBT   | SBR   |
| Lane Configurations          |  |  |  |  |  |   |  |  |  |  |  |  |
| Traffic Volume (veh/h)       | 6   | 1002  | 326   | 248   | 941   | 3   | 412  | 2   | 295   | 9   | 12  | 34  |
| Future Volume (veh/h)        | 6   | 1002  | 326   | 248   | 941   | 3   | 412  | 2   | 295   | 9   | 12  | 34  |
| Number                       | 5   | 2   | 12  | 1   | 6   | 16  | 3  | 8   | 18  | 7   | 4   | 14  |
| Initial Q (Qb), veh          | 0   | 0   | 0   | 0   | 0   | 0   | 0  | 0   | 0   | 0   | 0   | 0   |
| Ped-Bike Adj(A_pbT)          | 1.00  |   | 1.00  | 1.00  |   | 0.99  | 1.00   |   | 0.98  | 1.00  |   | 0.96  |
| Parking Bus, Adj             | 1.00  | 1.00  | 1.00  | 1.00  | 1.00  | 1.00  | 1.00   | 1.00  | 1.00  | 1.00  | 1.00  | 1.00  |
| Adj Sat Flow, veh/h/ln       | 1881  | 1881  | 1881  | 1881  | 1881  | 1900  | 1900   | 1900  | 1900  | 1900  | 1900  | 1900  |
| Adj Flow Rate, veh/h         | 6   | 1044  | 140   | 258   | 980   | 3   | 429  | 2   | 73  | 9   | 12  | 4   |
| Adj No. of Lanes             | 1   | 2   | 1   | 2   | 2   | 0   | 2  | 1   | 1   | 1   | 2   | 0   |
| Peak Hour Factor             | 0.96  | 0.96  | 0.96  | 0.96  | 0.96  | 0.96  | 0.96   | 0.96  | 0.96  | 0.96  | 0.96  | 0.96  |
| Percent Heavy Veh, %         | 1   | 1   | 1   | 1   | 1   | 1   | 0  | 0   | 0   | 0   | 0   | 0   |
| Cap, veh/h                   | 107   | 1225  | 545   | 388   | 1443  | 4   | 555  | 247   | 207   | 108   | 85  | 27  |
| Arrive On Green              | 0.06  | 0.34  | 0.34  | 0.11  | 0.39  | 0.39  | 0.16   | 0.13  | 0.13  | 0.06  | 0.03  | 0.03  |
| Sat Flow, veh/h              | 1792  | 3574  | 1592  | 3476  | 3655  | 11  | 3510   | 1900  | 1589  | 1810  | 2683  | 838   |
| Grp Volume(v), veh/h         | 6   | 1044  | 140   | 258   | 479   | 504   | 429  | 2   | 73  | 9   | 8   | 8   |
| Grp Sat Flow(s),veh/h/ln     | 1792  | 1787  | 1592  | 1738  | 1787  | 1879  | 1755   | 1900  | 1589  | 1810  | 1805  | 1716  |
| Q Serve(g_s), s              | 0.2   | 13.6  | 3.2   | 3.6   | 11.2  | 11.2  | 5.9  | 0.0   | 2.1   | 0.2   | 0.2   | 0.2   |
| Cycle Q Clear(g_c), s        | 0.2   | 13.6  | 3.2   | 3.6   | 11.2  | 11.2  | 5.9  | 0.0   | 2.1   | 0.2   | 0.2   | 0.2   |
| Prop In Lane                 | 1.00  |   | 1.00  | 1.00  |   | 0.01  | 1.00   |   | 1.00  | 1.00  |   | 0.49  |
| Lane Grp Cap(c), veh/h       | 107   | 1225  | 545   | 388   | 705   | 742   | 555  | 247   | 207   | 108   | 57  | 54  |
| V/C Ratio(X)                 | 0.06  | 0.85  | 0.26  | 0.66  | 0.68  | 0.68  | 0.77   | 0.01  | 0.35  | 0.08  | 0.14  | 0.15  |
| Avail Cap(c_a), veh/h        | 534   | 2132  | 950   | 1037  | 1066  | 1121  | 1396   | 793   | 663   | 360   | 754   | 717   |
| HCM Platoon Ratio            | 1.00  | 1.00  | 1.00  | 1.00  | 1.00  | 1.00  | 1.00   | 1.00  | 1.00  | 1.00  | 1.00  | 1.00  |
| Upstream Filter(I)           | 1.00  | 1.00  | 1.00  | 1.00  | 1.00  | 1.00  | 1.00   | 1.00  | 1.00  | 1.00  | 1.00  | 1.00  |
| Uniform Delay (d), s/veh     | 22.3  | 15.4  | 11.9  | 21.4  | 12.6  | 12.6  | 20.3   | 19.0  | 19.9  | 22.4  | 23.7  | 23.7  |
| Incr Delay (d2), s/veh       | 0.1   | 0.7   | 0.1   | 0.7   | 0.4   | 0.4   | 0.9  | 0.0   | 0.4   | 0.1   | 0.4   | 0.5   |
| Initial Q Delay(d3),s/veh    | 0.0   | 0.0   | 0.0   | 0.0   | 0.0   | 0.0   | 0.0  | 0.0   | 0.0   | 0.0   | 0.0   | 0.0   |
| %ile BackOfQ(50%),veh/ln     | 0.1   | 6.8   | 1.4   | 1.8   | 5.5   | 5.8   | 2.9  | 0.0   | 0.9   | 0.1   | 0.1   | 0.1   |
| LnGrp Delay(d),s/veh         | 22.4  | 16.0  | 12.0  | 22.2  | 13.0  | 13.0  | 21.2   | 19.0  | 20.3  | 22.5  | 24.1  | 24.2  |
| LnGrp LOS                    | C   | B   | B   | C   | B   | B   | C  | B   | C   | C   | C   | C   |
| Approach Vol, veh/h          |   | 1190  |   |   | 1241  |   |  | 504   |   |   | 25  |   |
| Approach Delay, s/veh        |   | 15.6  |   |   | 14.9  |   |  | 21.1  |   |   | 23.5  |   |
| Approach LOS                 |   | B   |   |   | B   |   |  | C   |   |   | C   |   |
| Timer                        | 1   | 2   | 3   | 4   | 5   | 6   | 7  | 8   |   |   |   |   |
| Assigned Phs                 | 1   | 2   | 3   | 4   | 5   | 6   | 7  | 8   |   |   |   |   |
| Phs Duration (G+Y+Rc), s     | 10.1  | 22.5  | 11.5  | 6.2   | 7.5   | 25.2  | 6.5  | 11.1  |   |   |   |   |
| Change Period (Y+Rc), s      | 4.5   | 5.3   | 3.5   | 4.6   | 4.5   | 5.3   | 3.5  | 4.6   |   |   |   |   |
| Max Green Setting (Gmax), s  | 15.0  | 30.0  | 20.0  | 21.0  | 15.0  | 30.0  | 10.0   | 21.0  |   |   |   |   |
| Max Q Clear Time (g_c+I1), s | 5.6   | 15.6  | 7.9   | 2.2   | 2.2   | 13.2  | 2.2  | 4.1   |   |   |   |   |
| Green Ext Time (p_c), s      | 0.0   | 1.5   | 0.1   | 0.0   | 0.0   | 1.0   | 0.0  | 0.0   |   |   |   |   |
| <b>Intersection Summary</b>  |   |   |   |   |   |   |  |   |   |   |   |   |
| HCM 2010 Ctrl Delay          |   |   | 16.3  |   |   |   |  |   |   |   |   |   |
| HCM 2010 LOS                 |   |   | B   |   |   |   |  |   |   |   |   |   |

| Intersection             |      |      |      |      |      |      |      |      |      |      |      |      |
|--------------------------|------|------|------|------|------|------|------|------|------|------|------|------|
| Int Delay, s/veh         | 1.3  |      |      |      |      |      |      |      |      |      |      |      |
| Movement                 | EBL  | EBT  | EBR  | WBL  | WBT  | WBR  | NBL  | NBT  | NBR  | SBL  | SBT  | SBR  |
| Lane Configurations      | ↖    | ↖↗   |      | ↖    | ↖↗   |      | ↖    | ↗    |      | ↖    | ↗    |      |
| Traffic Vol, veh/h       | 50   | 1290 | 8    | 21   | 1144 | 12   | 4    | 1    | 23   | 4    | 1    | 42   |
| Future Vol, veh/h        | 50   | 1290 | 8    | 21   | 1144 | 12   | 4    | 1    | 23   | 4    | 1    | 42   |
| Conflicting Peds, #/hr   | 2    | 0    | 1    | 1    | 0    | 2    | 1    | 0    | 0    | 0    | 0    | 1    |
| Sign Control             | Free | Free | Free | Free | Free | Free | Stop | Stop | Stop | Stop | Stop | Stop |
| RT Channelized           | -    | -    | None | -    | -    | None | -    | -    | None | -    | -    | None |
| Storage Length           | 300  | -    | -    | 300  | -    | -    | 85   | -    | -    | 25   | -    | -    |
| Veh in Median Storage, # | -    | 0    | -    | -    | 0    | -    | -    | 0    | -    | -    | 0    | -    |
| Grade, %                 | -    | 0    | -    | -    | 0    | -    | -    | 0    | -    | -    | 0    | -    |
| Peak Hour Factor         | 98   | 98   | 98   | 98   | 98   | 98   | 98   | 98   | 98   | 98   | 98   | 98   |
| Heavy Vehicles, %        | 1    | 1    | 1    | 1    | 1    | 1    | 0    | 0    | 0    | 0    | 0    | 0    |
| Mvmt Flow                | 51   | 1316 | 8    | 21   | 1167 | 12   | 4    | 1    | 23   | 4    | 1    | 43   |

| Major/Minor          | Major1 |   |   | Major2 |   |   | Minor1 |      |     | Minor2 |      |     |
|----------------------|--------|---|---|--------|---|---|--------|------|-----|--------|------|-----|
| Conflicting Flow All | 1181   | 0 | 0 | 1325   | 0 | 0 | 2050   | 2646 | 663 | 1978   | 2644 | 593 |
| Stage 1              | -      | - | - | -      | - | - | 1423   | 1423 | -   | 1217   | 1217 | -   |
| Stage 2              | -      | - | - | -      | - | - | 627    | 1223 | -   | 761    | 1427 | -   |
| Critical Hdwy        | 4.12   | - | - | 4.12   | - | - | 7.5    | 6.5  | 6.9 | 7.5    | 6.5  | 6.9 |
| Critical Hdwy Stg 1  | -      | - | - | -      | - | - | 6.5    | 5.5  | -   | 6.5    | 5.5  | -   |
| Critical Hdwy Stg 2  | -      | - | - | -      | - | - | 6.5    | 5.5  | -   | 6.5    | 5.5  | -   |
| Follow-up Hdwy       | 2.21   | - | - | 2.21   | - | - | 3.5    | 4    | 3.3 | 3.5    | 4    | 3.3 |
| Pot Cap-1 Maneuver   | 593    | - | - | 522    | - | - | 33     | 24   | 409 | 38     | 24   | 454 |
| Stage 1              | -      | - | - | -      | - | - | 145    | 204  | -   | 195    | 256  | -   |
| Stage 2              | -      | - | - | -      | - | - | 443    | 254  | -   | 368    | 203  | -   |
| Platoon blocked, %   | -      | - | - | -      | - | - | -      | -    | -   | -      | -    | -   |
| Mov Cap-1 Maneuver   | 592    | - | - | 522    | - | - | 26     | 21   | 409 | 31     | 21   | 453 |
| Mov Cap-2 Maneuver   | -      | - | - | -      | - | - | 26     | 21   | -   | 31     | 21   | -   |
| Stage 1              | -      | - | - | -      | - | - | 132    | 186  | -   | 178    | 245  | -   |
| Stage 2              | -      | - | - | -      | - | - | 383    | 243  | -   | 315    | 185  | -   |

| Approach             | EB  |  |  | WB  |  |  | NB   |  |  | SB   |  |  |
|----------------------|-----|--|--|-----|--|--|------|--|--|------|--|--|
| HCM Control Delay, s | 0.4 |  |  | 0.2 |  |  | 43.2 |  |  | 28.9 |  |  |
| HCM LOS              |     |  |  |     |  |  | E    |  |  | D    |  |  |

| Minor Lane/Major Mvmt | NBLn1 | NBLn2 | EBL   | EBT | EBR | WBL   | WBT | WBR | SBLn1 | SBLn2 |
|-----------------------|-------|-------|-------|-----|-----|-------|-----|-----|-------|-------|
| Capacity (veh/h)      | 26    | 231   | 592   | -   | -   | 522   | -   | -   | 31    | 306   |
| HCM Lane V/C Ratio    | 0.157 | 0.106 | 0.086 | -   | -   | 0.041 | -   | -   | 0.132 | 0.143 |
| HCM Control Delay (s) | 167.7 | 22.4  | 11.7  | -   | -   | 12.2  | -   | -   | 138   | 18.7  |
| HCM Lane LOS          | F     | C     | B     | -   | -   | B     | -   | -   | F     | C     |
| HCM 95th %tile Q(veh) | 0.5   | 0.4   | 0.3   | -   | -   | 0.1   | -   | -   | 0.4   | 0.5   |

| Intersection             |      |      |      |      |      |      |      |      |      |      |      |      |
|--------------------------|------|------|------|------|------|------|------|------|------|------|------|------|
| Int Delay, s/veh         | 1.4  |      |      |      |      |      |      |      |      |      |      |      |
| Movement                 | EBL  | EBT  | EBR  | WBL  | WBT  | WBR  | NBL  | NBT  | NBR  | SBL  | SBT  | SBR  |
| Lane Configurations      | ↖    | ↕    |      | ↖    | ↕    |      |      | ↕    |      |      | ↕    |      |
| Traffic Vol, veh/h       | 2    | 1406 | 7    | 0    | 1156 | 1    | 14   | 0    | 2    | 8    | 0    | 0    |
| Future Vol, veh/h        | 2    | 1406 | 7    | 0    | 1156 | 1    | 14   | 0    | 2    | 8    | 0    | 0    |
| Conflicting Peds, #/hr   | 2    | 0    | 0    | 0    | 0    | 2    | 0    | 0    | 0    | 0    | 0    | 0    |
| Sign Control             | Free | Free | Free | Free | Free | Free | Stop | Stop | Stop | Stop | Stop | Stop |
| RT Channelized           | -    | -    | None | -    | -    | None | -    | -    | None | -    | -    | Stop |
| Storage Length           | 330  | -    | -    | 330  | -    | -    | -    | -    | -    | -    | -    | -    |
| Veh in Median Storage, # | -    | 0    | -    | -    | 0    | -    | -    | 0    | -    | -    | 0    | -    |
| Grade, %                 | -    | 0    | -    | -    | 0    | -    | -    | 0    | -    | -    | 0    | -    |
| Peak Hour Factor         | 97   | 97   | 97   | 97   | 97   | 97   | 97   | 97   | 97   | 97   | 97   | 97   |
| Heavy Vehicles, %        | 1    | 1    | 1    | 1    | 1    | 1    | 0    | 0    | 0    | 0    | 0    | 0    |
| Mvmt Flow                | 2    | 1449 | 7    | 0    | 1192 | 1    | 14   | 0    | 2    | 8    | 0    | 0    |



















| Major/Minor          | Major1 |   |   | Major2 |   |   | Minor1 |      |     | Minor2 |      |     |
|----------------------|--------|---|---|--------|---|---|--------|------|-----|--------|------|-----|
| Conflicting Flow All | 1195   | 0 | 0 | 1456   | 0 | 0 | 2053   | 2652 | 728 | 1924   | 2655 | 599 |
| Stage 1              | -      | - | - | -      | - | - | 1457   | 1457 | -   | 1195   | 1195 | -   |
| Stage 2              | -      | - | - | -      | - | - | 596    | 1195 | -   | 729    | 1460 | -   |
| Critical Hdwy        | 4.12   | - | - | 4.12   | - | - | 7.5    | 6.5  | 6.9 | 7.5    | 6.5  | 6.9 |
| Critical Hdwy Stg 1  | -      | - | - | -      | - | - | 6.5    | 5.5  | -   | 6.5    | 5.5  | -   |
| Critical Hdwy Stg 2  | -      | - | - | -      | - | - | 6.5    | 5.5  | -   | 6.5    | 5.5  | -   |
| Follow-up Hdwy       | 2.21   | - | - | 2.21   | - | - | 3.5    | 4    | 3.3 | 3.5    | 4    | 3.3 |
| Pot Cap-1 Maneuver   | 586    | - | - | 466    | - | - | 33     | 23   | 370 | 41     | 23   | 450 |
| Stage 1              | -      | - | - | -      | - | - | 139    | 196  | -   | 201    | 262  | -   |
| Stage 2              | -      | - | - | -      | - | - | 462    | 262  | -   | 385    | 196  | -   |
| Platoon blocked, %   | -      | - | - | -      | - | - | -      | -    | -   | -      | -    | -   |
| Mov Cap-1 Maneuver   | 585    | - | - | 466    | - | - | 33     | 23   | 370 | 41     | 23   | 449 |
| Mov Cap-2 Maneuver   | -      | - | - | -      | - | - | 33     | 23   | -   | 41     | 23   | -   |
| Stage 1              | -      | - | - | -      | - | - | 139    | 195  | -   | 200    | 261  | -   |
| Stage 2              | -      | - | - | -      | - | - | 462    | 261  | -   | 382    | 195  | -   |

| Approach             | EB |  |  | WB |  |  | NB    |  |  | SB    |  |  |
|----------------------|----|--|--|----|--|--|-------|--|--|-------|--|--|
| HCM Control Delay, s | 0  |  |  | 0  |  |  | 164.9 |  |  | 113.7 |  |  |
| HCM LOS              |    |  |  |    |  |  | F     |  |  | F     |  |  |

| Minor Lane/Major Mvmt | NBLn1 | EBL   | EBT | EBR | WBL | WBT | WBR | SBLn1 |
|-----------------------|-------|-------|-----|-----|-----|-----|-----|-------|
| Capacity (veh/h)      | 37    | 585   | -   | -   | 466 | -   | -   | 41    |
| HCM Lane V/C Ratio    | 0.446 | 0.004 | -   | -   | -   | -   | -   | 0.201 |
| HCM Control Delay (s) | 164.9 | 11.2  | -   | -   | 0   | -   | -   | 113.7 |
| HCM Lane LOS          | F     | B     | -   | -   | A   | -   | -   | F     |
| HCM 95th %tile Q(veh) | 1.5   | 0     | -   | -   | 0   | -   | -   | 0.7   |

HCM 2010 Signalized Intersection Summary  
 8: 5th Avenue/California Avenue & Imjin Parkway

Existing, PM  
 06/11/2019

|                              |  |  |  |  |  |  |  |  |  |  |  |  |
|------------------------------|---|---|---|---|---|---|--|---|---|---|---|---|
| Movement                     | EBL   | EBT   | EBR   | WBL   | WBT   | WBR   | NBL  | NBT   | NBR   | SBL   | SBT   | SBR   |
| Lane Configurations          |  |  |   |  |  |   |  |  |   |   |  |   |
| Traffic Volume (veh/h)       | 255   | 1053  | 4   | 2   | 995   | 68  | 12   | 38  | 4   | 37  | 25  | 200   |
| Future Volume (veh/h)        | 255   | 1053  | 4   | 2   | 995   | 68  | 12   | 38  | 4   | 37  | 25  | 200   |
| Number                       | 5   | 2   | 12  | 1   | 6   | 16  | 3  | 8   | 18  | 7   | 4   | 14  |
| Initial Q (Qb), veh          | 0   | 0   | 0   | 0   | 0   | 0   | 0  | 0   | 0   | 0   | 0   | 0   |
| Ped-Bike Adj(A_pbT)          | 1.00  |   | 1.00  | 1.00  |   | 1.00  | 1.00   |   | 1.00  | 1.00  |   | 0.98  |
| Parking Bus, Adj             | 1.00  | 1.00  | 1.00  | 1.00  | 1.00  | 1.00  | 1.00   | 1.00  | 1.00  | 1.00  | 1.00  | 1.00  |
| Adj Sat Flow, veh/h/ln       | 1881  | 1881  | 1900  | 1881  | 1881  | 1900  | 1900   | 1900  | 1900  | 1900  | 1881  | 1900  |
| Adj Flow Rate, veh/h         | 263   | 1086  | 4   | 2   | 1026  | 64  | 12   | 39  | 1   | 38  | 26  | 37  |
| Adj No. of Lanes             | 1   | 2   | 0   | 1   | 2   | 0   | 0  | 1   | 0   | 0   | 1   | 0   |
| Peak Hour Factor             | 0.97  | 0.97  | 0.97  | 0.97  | 0.97  | 0.97  | 0.97   | 0.97  | 0.97  | 0.97  | 0.97  | 0.97  |
| Percent Heavy Veh, %         | 1   | 1   | 1   | 1   | 1   | 1   | 0  | 0   | 0   | 1   | 1   | 1   |
| Cap, veh/h                   | 328   | 1963  | 7   | 5   | 1217  | 76  | 153  | 135   | 3   | 191   | 41  | 56  |
| Arrive On Green              | 0.18  | 0.54  | 0.54  | 0.00  | 0.36  | 0.36  | 0.11   | 0.09  | 0.09  | 0.11  | 0.09  | 0.09  |
| Sat Flow, veh/h              | 1792  | 3652  | 13  | 1792  | 3417  | 213   | 338  | 1438  | 35  | 585   | 440   | 592   |
| Grp Volume(v), veh/h         | 263   | 531   | 559   | 2   | 537   | 553   | 52   | 0   | 0   | 101   | 0   | 0   |
| Grp Sat Flow(s),veh/h/ln     | 1792  | 1787  | 1879  | 1792  | 1787  | 1843  | 1811   | 0   | 0   | 1617  | 0   | 0   |
| Q Serve(g_s), s              | 5.1   | 7.2   | 7.2   | 0.0   | 10.1  | 10.1  | 0.0  | 0.0   | 0.0   | 1.2   | 0.0   | 0.0   |
| Cycle Q Clear(g_c), s        | 5.1   | 7.2   | 7.2   | 0.0   | 10.1  | 10.1  | 0.9  | 0.0   | 0.0   | 2.1   | 0.0   | 0.0   |
| Prop In Lane                 | 1.00  |   | 0.01  | 1.00  |   | 0.12  | 0.23   |   | 0.02  | 0.38  |   | 0.37  |
| Lane Grp Cap(c), veh/h       | 328   | 960   | 1010  | 5   | 636   | 656   | 322  | 0   | 0   | 314   | 0   | 0   |
| V/C Ratio(X)                 | 0.80  | 0.55  | 0.55  | 0.41  | 0.84  | 0.84  | 0.16   | 0.00  | 0.00  | 0.32  | 0.00  | 0.00  |
| Avail Cap(c_a), veh/h        | 736   | 1468  | 1543  | 736   | 1468  | 1513  | 1108   | 0   | 0   | 1018  | 0   | 0   |
| HCM Platoon Ratio            | 1.00  | 1.00  | 1.00  | 1.00  | 1.00  | 1.00  | 1.00   | 1.00  | 1.00  | 1.00  | 1.00  | 1.00  |
| Upstream Filter(I)           | 1.00  | 1.00  | 1.00  | 1.00  | 1.00  | 1.00  | 1.00   | 0.00  | 0.00  | 1.00  | 0.00  | 0.00  |
| Uniform Delay (d), s/veh     | 14.3  | 5.6   | 5.6   | 18.2  | 10.8  | 10.8  | 15.3   | 0.0   | 0.0   | 15.8  | 0.0   | 0.0   |
| Incr Delay (d2), s/veh       | 1.7   | 0.2   | 0.2   | 18.9  | 1.2   | 1.2   | 0.1  | 0.0   | 0.0   | 0.2   | 0.0   | 0.0   |
| Initial Q Delay(d3),s/veh    | 0.0   | 0.0   | 0.0   | 0.0   | 0.0   | 0.0   | 0.0  | 0.0   | 0.0   | 0.0   | 0.0   | 0.0   |
| %ile BackOfQ(50%),veh/ln     | 2.6   | 3.4   | 3.6   | 0.0   | 5.1   | 5.3   | 0.5  | 0.0   | 0.0   | 1.0   | 0.0   | 0.0   |
| LnGrp Delay(d),s/veh         | 16.0  | 5.7   | 5.7   | 37.1  | 12.0  | 12.0  | 15.4   | 0.0   | 0.0   | 16.0  | 0.0   | 0.0   |
| LnGrp LOS                    | B   | A   | A   | D   | B   | B   | B  |   |   | B   |   |   |
| Approach Vol, veh/h          |   | 1353  |   |   | 1092  |   |  | 52  |   |   | 101   |   |
| Approach Delay, s/veh        |   | 7.7   |   |   | 12.0  |   |  | 15.4  |   |   | 16.0  |   |
| Approach LOS                 |   | A   |   |   | B   |   |  | B   |   |   | B   |   |
| Timer                        | 1   | 2   | 3   | 4   | 5   | 6   | 7  | 8   |   |   |   |   |
| Assigned Phs                 | 1   | 2   |   | 4   | 5   | 6   |  | 8   |   |   |   |   |
| Phs Duration (G+Y+Rc), s     | 3.6   | 24.9  |   | 8.0   | 10.2  | 18.3  |  | 8.0   |   |   |   |   |
| Change Period (Y+Rc), s      | 3.5   | 5.3   |   | 4.6   | 3.5   | 5.3   |  | 4.6   |   |   |   |   |
| Max Green Setting (Gmax), s  | 15.0  | 30.0  |   | 20.0  | 15.0  | 30.0  |  | 20.0  |   |   |   |   |
| Max Q Clear Time (g_c+I1), s | 2.0   | 9.2   |   | 4.1   | 7.1   | 12.1  |  | 2.9   |   |   |   |   |
| Green Ext Time (p_c), s      | 0.0   | 0.8   |   | 0.1   | 0.0   | 0.8   |  | 0.0   |   |   |   |   |
| <b>Intersection Summary</b>  |   |   |   |   |   |   |  |   |   |   |   |   |
| HCM 2010 Ctrl Delay          |   |   | 10.0  |   |   |   |  |   |   |   |   |   |
| HCM 2010 LOS                 |   |   | B   |   |   |   |  |   |   |   |   |   |

| Intersection             |      |      |      |      |      |      |
|--------------------------|------|------|------|------|------|------|
| Int Delay, s/veh         | 0.4  |      |      |      |      |      |
| Movement                 | EBL  | EBR  | NBL  | NBT  | SBT  | SBR  |
| Lane Configurations      | ↔    |      | ↔    | ↑    | ↑    |      |
| Traffic Vol, veh/h       | 2    | 8    | 15   | 378  | 211  | 2    |
| Future Vol, veh/h        | 2    | 8    | 15   | 378  | 211  | 2    |
| Conflicting Peds, #/hr   | 0    | 0    | 0    | 0    | 0    | 0    |
| Sign Control             | Stop | Stop | Free | Free | Free | Free |
| RT Channelized           | -    | None | -    | None | -    | None |
| Storage Length           | 0    | -    | 155  | -    | -    | -    |
| Veh in Median Storage, # | 0    | -    | -    | 0    | 0    | -    |
| Grade, %                 | 0    | -    | -    | 0    | 0    | -    |
| Peak Hour Factor         | 92   | 92   | 92   | 92   | 92   | 92   |
| Heavy Vehicles, %        | 2    | 2    | 2    | 2    | 2    | 2    |
| Mvmt Flow                | 2    | 9    | 16   | 411  | 229  | 2    |

| Major/Minor          | Minor2 | Major1 | Major2 |   |   |   |
|----------------------|--------|--------|--------|---|---|---|
| Conflicting Flow All | 673    | 230    | 231    | 0 | - | 0 |
| Stage 1              | 230    | -      | -      | - | - | - |
| Stage 2              | 443    | -      | -      | - | - | - |
| Critical Hdwy        | 6.42   | 6.22   | 4.12   | - | - | - |
| Critical Hdwy Stg 1  | 5.42   | -      | -      | - | - | - |
| Critical Hdwy Stg 2  | 5.42   | -      | -      | - | - | - |
| Follow-up Hdwy       | 3.518  | 3.318  | 2.218  | - | - | - |
| Pot Cap-1 Maneuver   | 421    | 809    | 1337   | - | - | - |
| Stage 1              | 808    | -      | -      | - | - | - |
| Stage 2              | 647    | -      | -      | - | - | - |
| Platoon blocked, %   |        |        |        | - | - | - |
| Mov Cap-1 Maneuver   | 416    | 809    | 1337   | - | - | - |
| Mov Cap-2 Maneuver   | 416    | -      | -      | - | - | - |
| Stage 1              | 798    | -      | -      | - | - | - |
| Stage 2              | 647    | -      | -      | - | - | - |















| Approach             | EB   | NB  | SB |
|----------------------|------|-----|----|
| HCM Control Delay, s | 10.4 | 0.3 | 0  |
| HCM LOS              | B    |     |    |

| Minor Lane/Major Mvmt | NBL   | NBT | EBLn1 | SBT | SBR |
|-----------------------|-------|-----|-------|-----|-----|
| Capacity (veh/h)      | 1337  | -   | 680   | -   | -   |
| HCM Lane V/C Ratio    | 0.012 | -   | 0.016 | -   | -   |
| HCM Control Delay (s) | 7.7   | -   | 10.4  | -   | -   |
| HCM Lane LOS          | A     | -   | B     | -   | -   |
| HCM 95th %tile Q(veh) | 0     | -   | 0     | -   | -   |



HCM 2010 Signalized Intersection Summary  
 10: Imjin Road & Imjin Parkway

Existing, PM  
 06/11/2019

|                              |    |  |  |    |    |  |   |      |
|------------------------------|---|---|---|---|---|---|---|------|
| Movement                     | EBT   | EBR   | WBL   | WBT   | NBL   | NBR   |   |      |
| Lane Configurations          |   |   |  |   |    |  |   |      |
| Traffic Volume (veh/h)       | 1036  | 54  | 74  | 901   | 136   | 94  |   |      |
| Future Volume (veh/h)        | 1036  | 54  | 74  | 901   | 136   | 94  |   |      |
| Number                       | 2   | 12  | 1   | 6   | 3   | 18  |   |      |
| Initial Q (Qb), veh          | 0   | 0   | 0   | 0   | 0   | 0   |   |      |
| Ped-Bike Adj(A_pbT)          |   | 1.00  | 1.00  |   | 1.00  | 1.00  |   |      |
| Parking Bus, Adj             | 1.00  | 1.00  | 1.00  | 1.00  | 1.00  | 1.00  |   |      |
| Adj Sat Flow, veh/h/ln       | 1881  | 1900  | 1881  | 1881  | 1881  | 1881  |   |      |
| Adj Flow Rate, veh/h         | 1091  | 54  | 78  | 948   | 143   | 33  |   |      |
| Adj No. of Lanes             | 2   | 0   | 1   | 2   | 2   | 1   |   |      |
| Peak Hour Factor             | 0.95  | 0.95  | 0.95  | 0.95  | 0.95  | 0.95  |   |      |
| Percent Heavy Veh, %         | 1   | 1   | 1   | 1   | 1   | 1   |   |      |
| Cap, veh/h                   | 1315  | 65  | 94  | 2176  | 291   | 130   |   |      |
| Arrive On Green              | 0.38  | 0.38  | 0.05  | 0.61  | 0.08  | 0.08  |   |      |
| Sat Flow, veh/h              | 3561  | 172   | 1792  | 3668  | 3583  | 1599  |   |      |
| Grp Volume(v), veh/h         | 562   | 583   | 78  | 948   | 143   | 33  |   |      |
| Grp Sat Flow(s),veh/h/ln     | 1787  | 1851  | 1792  | 1787  | 1792  | 1599  |   |      |
| Q Serve(g_s), s              | 8.5   | 8.6   | 1.3   | 4.2   | 1.1   | 0.6   |   |      |
| Cycle Q Clear(g_c), s        | 8.5   | 8.6   | 1.3   | 4.2   | 1.1   | 0.6   |   |      |
| Prop In Lane                 |   | 0.09  | 1.00  |   | 1.00  | 1.00  |   |      |
| Lane Grp Cap(c), veh/h       | 678   | 702   | 94  | 2176  | 291   | 130   |   |      |
| V/C Ratio(X)                 | 0.83  | 0.83  | 0.83  | 0.44  | 0.49  | 0.25  |   |      |
| Avail Cap(c_a), veh/h        | 1787  | 1851  | 1194  | 3574  | 2628  | 1173  |   |      |
| HCM Platoon Ratio            | 1.00  | 1.00  | 1.00  | 1.00  | 1.00  | 1.00  |   |      |
| Upstream Filter(I)           | 1.00  | 1.00  | 1.00  | 1.00  | 1.00  | 1.00  |   |      |
| Uniform Delay (d), s/veh     | 8.4   | 8.4   | 14.1  | 3.1   | 13.2  | 12.9  |   |      |
| Incr Delay (d2), s/veh       | 1.0   | 1.0   | 6.7   | 0.1   | 0.5   | 0.4   |   |      |
| Initial Q Delay(d3),s/veh    | 0.0   | 0.0   | 0.0   | 0.0   | 0.0   | 0.0   |   |      |
| %ile BackOfQ(50%),veh/ln     | 4.3   | 4.4   | 0.8   | 2.0   | 0.6   | 0.3   |   |      |
| LnGrp Delay(d),s/veh         | 9.4   | 9.4   | 20.8  | 3.2   | 13.7  | 13.3  |   |      |
| LnGrp LOS                    | A   | A   | C   | A   | B   | B   |   |      |
| Approach Vol, veh/h          | 1145  |   |   | 1026  | 176   |   |   |      |
| Approach Delay, s/veh        | 9.4   |   |   | 4.5   | 13.6  |   |   |      |
| Approach LOS                 | A   |   |   | A   | B   |   |   |      |
| Timer                        | 1   | 2   | 3   | 4   | 5   | 6   | 7 | 8    |
| Assigned Phs                 | 1   | 2   |   |   |   | 6   |   | 8    |
| Phs Duration (G+Y+Rc), s     | 6.9   | 16.7  |   |   |   | 23.6  |   | 6.4  |
| Change Period (Y+Rc), s      | 5.3   | * 5.3   |   |   |   | 5.3   |   | 4.0  |
| Max Green Setting (Gmax), s  | 20.0  | * 30  |   |   |   | 30.0  |   | 22.0 |
| Max Q Clear Time (g_c+I1), s | 3.3   | 10.6  |   |   |   | 6.2   |   | 3.1  |
| Green Ext Time (p_c), s      | 0.0   | 0.8   |   |   |   | 1.0   |   | 0.0  |
| <b>Intersection Summary</b>  |   |   |   |   |   |   |   |      |
| HCM 2010 Ctrl Delay          |   |   | 7.6   |   |   |   |   |      |
| HCM 2010 LOS                 |   |   | A   |   |   |   |   |      |
| <b>Notes</b>                 |   |   |   |   |   |   |   |      |

HCM 2010 Signalized Intersection Summary  
 11: Abrams Drive & Imjin Parkway

Existing, PM  
 06/11/2019



| Movement                      | EBL  | EBT  | EBR  | WBL  | WBT  | WBR  | NBL  | NBT  | NBR  | SBL  | SBT  | SBR  |
|-------------------------------|------|------|------|------|------|------|------|------|------|------|------|------|
| Lane Configurations           |      |      |      |      |      |      |      |      |      |      |      |      |
| Traffic Volume (veh/h)        | 92   | 880  | 114  | 159  | 796  | 53   | 109  | 20   | 161  | 24   | 14   | 84   |
| Future Volume (veh/h)         | 92   | 880  | 114  | 159  | 796  | 53   | 109  | 20   | 161  | 24   | 14   | 84   |
| Number                        | 5    | 2    | 12   | 1    | 6    | 16   | 3    | 8    | 18   | 7    | 4    | 14   |
| Initial Q (Qb), veh           | 0    | 0    | 0    | 0    | 0    | 0    | 0    | 0    | 0    | 0    | 0    | 0    |
| Ped-Bike Adj(A_pbT)           | 1.00 |      | 1.00 | 1.00 |      | 1.00 | 1.00 |      | 1.00 | 1.00 |      | 1.00 |
| Parking Bus, Adj              | 1.00 | 1.00 | 1.00 | 1.00 | 1.00 | 1.00 | 1.00 | 1.00 | 1.00 | 1.00 | 1.00 | 1.00 |
| Adj Sat Flow, veh/h/ln        | 1881 | 1881 | 1881 | 1881 | 1881 | 1881 | 1900 | 1881 | 1881 | 1900 | 1863 | 1863 |
| Adj Flow Rate, veh/h          | 99   | 946  | 0    | 171  | 856  | 0    | 117  | 22   | 0    | 26   | 15   | 0    |
| Adj No. of Lanes              | 1    | 1    | 1    | 1    | 1    | 1    | 0    | 1    | 1    | 0    | 1    | 1    |
| Peak Hour Factor              | 0.93 | 0.93 | 0.93 | 0.93 | 0.93 | 0.93 | 0.93 | 0.93 | 0.93 | 0.93 | 0.93 | 0.93 |
| Percent Heavy Veh, %          | 1    | 1    | 1    | 1    | 1    | 1    | 1    | 1    | 1    | 2    | 2    | 2    |
| Cap, veh/h                    | 132  | 1090 | 926  | 211  | 1159 | 985  | 246  | 28   | 188  | 193  | 93   | 186  |
| Arrive On Green               | 0.07 | 0.58 | 0.00 | 0.12 | 0.62 | 0.00 | 0.12 | 0.12 | 0.00 | 0.12 | 0.12 | 0.00 |
| Sat Flow, veh/h               | 1792 | 1881 | 1599 | 1792 | 1881 | 1599 | 1280 | 241  | 1599 | 922  | 792  | 1583 |
| Grp Volume(v), veh/h          | 99   | 946  | 0    | 171  | 856  | 0    | 139  | 0    | 0    | 41   | 0    | 0    |
| Grp Sat Flow(s),veh/h/ln      | 1792 | 1881 | 1599 | 1792 | 1881 | 1599 | 1520 | 0    | 1599 | 1714 | 0    | 1583 |
| Q Serve(g_s), s               | 3.7  | 29.4 | 0.0  | 6.4  | 22.1 | 0.0  | 4.7  | 0.0  | 0.0  | 0.0  | 0.0  | 0.0  |
| Cycle Q Clear(g_c), s         | 3.7  | 29.4 | 0.0  | 6.4  | 22.1 | 0.0  | 6.0  | 0.0  | 0.0  | 1.4  | 0.0  | 0.0  |
| Prop In Lane                  | 1.00 |      | 1.00 | 1.00 |      | 1.00 | 0.84 |      | 1.00 | 0.63 |      | 1.00 |
| Lane Grp Cap(c), veh/h        | 132  | 1090 | 926  | 211  | 1159 | 985  | 275  | 0    | 188  | 287  | 0    | 186  |
| V/C Ratio(X)                  | 0.75 | 0.87 | 0.00 | 0.81 | 0.74 | 0.00 | 0.51 | 0.00 | 0.00 | 0.14 | 0.00 | 0.00 |
| Avail Cap(c_a), veh/h         | 519  | 1362 | 1158 | 519  | 1362 | 1158 | 738  | 0    | 695  | 770  | 0    | 688  |
| HCM Platoon Ratio             | 1.00 | 1.00 | 1.00 | 1.00 | 1.00 | 1.00 | 1.00 | 1.00 | 1.00 | 1.00 | 1.00 | 1.00 |
| Upstream Filter(I)            | 1.00 | 1.00 | 0.00 | 1.00 | 1.00 | 0.00 | 1.00 | 0.00 | 0.00 | 1.00 | 0.00 | 0.00 |
| Uniform Delay (d), s/veh      | 31.3 | 12.3 | 0.0  | 29.7 | 9.3  | 0.0  | 29.4 | 0.0  | 0.0  | 27.5 | 0.0  | 0.0  |
| Incr Delay (d2), s/veh        | 3.1  | 4.4  | 0.0  | 2.8  | 1.4  | 0.0  | 0.5  | 0.0  | 0.0  | 0.1  | 0.0  | 0.0  |
| Initial Q Delay(d3),s/veh     | 0.0  | 0.0  | 0.0  | 0.0  | 0.0  | 0.0  | 0.0  | 0.0  | 0.0  | 0.0  | 0.0  | 0.0  |
| %ile BackOfQ(50%),veh/ln      | 2.0  | 16.3 | 0.0  | 3.3  | 11.6 | 0.0  | 2.6  | 0.0  | 0.0  | 0.7  | 0.0  | 0.0  |
| LnGrp Delay(d),s/veh          | 34.5 | 16.7 | 0.0  | 32.5 | 10.7 | 0.0  | 30.0 | 0.0  | 0.0  | 27.6 | 0.0  | 0.0  |
| LnGrp LOS                     | C    | B    |      | C    | B    |      | C    |      |      | C    |      |      |
| Approach Vol, veh/h           |      | 1045 |      |      | 1027 |      |      | 139  |      |      | 41   |      |
| Approach Delay, s/veh         |      | 18.4 |      |      | 14.3 |      |      | 30.0 |      |      | 27.6 |      |
| Approach LOS                  |      | B    |      |      | B    |      |      | C    |      |      | C    |      |
| Timer                         | 1    | 2    | 3    | 4    | 5    | 6    | 7    | 8    |      |      |      |      |
| Assigned Phs                  | 1    | 2    |      | 4    | 5    | 6    |      | 8    |      |      |      |      |
| Phs Duration (G+Y+Rc), s      | 1.6  | 45.3 |      | 12.1 | 9.1  | 47.8 |      | 12.1 |      |      |      |      |
| Change Period (Y+Rc), s       | 3.5  | 5.3  |      | 4.0  | 4.0  | 5.3  |      | 4.0  |      |      |      |      |
| Max Green Setting (Gmax), s   | 20.0 | 50.0 |      | 30.0 | 20.0 | 50.0 |      | 30.0 |      |      |      |      |
| Max Q Clear Time (g_c+1/3), s | 13.4 | 31.4 |      | 3.4  | 5.7  | 24.1 |      | 8.0  |      |      |      |      |
| Green Ext Time (p_c), s       | 0.0  | 0.7  |      | 0.0  | 0.0  | 0.7  |      | 0.1  |      |      |      |      |
| <b>Intersection Summary</b>   |      |      |      |      |      |      |      |      |      |      |      |      |
| HCM 2010 Ctrl Delay           |      |      |      | 17.4 |      |      |      |      |      |      |      |      |
| HCM 2010 LOS                  |      |      |      | B    |      |      |      |      |      |      |      |      |

HCM 2010 Signalized Intersection Summary  
 12: Reservation Road & Imjin Parkway

Existing, PM  
 06/11/2019



| Movement                     | EBL  | EBT   | EBR  | WBL  | WBT  | WBR   | NBL  | NBT  | NBR  | SBL  | SBT  | SBR  |
|------------------------------|------|-------|------|------|------|-------|------|------|------|------|------|------|
| Lane Configurations          |      |       |      |      |      |       |      |      |      |      |      |      |
| Traffic Volume (veh/h)       | 100  | 6     | 982  | 7    | 21   | 22    | 849  | 542  | 4    | 7    | 644  | 175  |
| Future Volume (veh/h)        | 100  | 6     | 982  | 7    | 21   | 22    | 849  | 542  | 4    | 7    | 644  | 175  |
| Number                       | 3    | 8     | 18   | 7    | 4    | 14    | 1    | 6    | 16   | 5    | 2    | 12   |
| Initial Q (Qb), veh          | 0    | 0     | 0    | 0    | 0    | 0     | 0    | 0    | 0    | 0    | 0    | 0    |
| Ped-Bike Adj(A_pbT)          | 1.00 |       | 0.99 | 1.00 |      | 0.98  | 1.00 |      | 1.00 | 1.00 |      | 1.00 |
| Parking Bus, Adj             | 1.00 | 1.00  | 1.00 | 1.00 | 1.00 | 1.00  | 1.00 | 1.00 | 1.00 | 1.00 | 1.00 | 1.00 |
| Adj Sat Flow, veh/h/ln       | 1881 | 1881  | 1881 | 1827 | 1827 | 1827  | 1881 | 1881 | 1881 | 1881 | 1881 | 1881 |
| Adj Flow Rate, veh/h         | 117  | 0     | 702  | 8    | 24   | 3     | 954  | 609  | 3    | 8    | 724  | 63   |
| Adj No. of Lanes             | 2    | 0     | 2    | 1    | 1    | 1     | 2    | 2    | 1    | 2    | 2    | 1    |
| Peak Hour Factor             | 0.89 | 0.89  | 0.89 | 0.89 | 0.89 | 0.89  | 0.89 | 0.89 | 0.89 | 0.89 | 0.89 | 0.89 |
| Percent Heavy Veh, %         | 1    | 1     | 1    | 4    | 4    | 4     | 1    | 1    | 1    | 1    | 1    | 1    |
| Cap, veh/h                   | 665  | 0     | 1522 | 55   | 58   | 48    | 1013 | 2102 | 940  | 27   | 1089 | 487  |
| Arrive On Green              | 0.19 | 0.00  | 0.19 | 0.03 | 0.03 | 0.03  | 0.29 | 0.59 | 0.59 | 0.01 | 0.30 | 0.30 |
| Sat Flow, veh/h              | 3583 | 0     | 3181 | 1740 | 1827 | 1527  | 3476 | 3574 | 1599 | 3476 | 3574 | 1599 |
| Grp Volume(v), veh/h         | 117  | 0     | 702  | 8    | 24   | 3     | 954  | 609  | 3    | 8    | 724  | 63   |
| Grp Sat Flow(s),veh/h/ln     | 1792 | 0     | 1590 | 1740 | 1827 | 1527  | 1738 | 1787 | 1599 | 1738 | 1787 | 1599 |
| Q Serve(g_s), s              | 3.1  | 0.0   | 16.5 | 0.5  | 1.4  | 0.2   | 29.9 | 9.4  | 0.1  | 0.3  | 19.7 | 3.2  |
| Cycle Q Clear(g_c), s        | 3.1  | 0.0   | 16.5 | 0.5  | 1.4  | 0.2   | 29.9 | 9.4  | 0.1  | 0.3  | 19.7 | 3.2  |
| Prop In Lane                 | 1.00 |       | 1.00 | 1.00 |      | 1.00  | 1.00 |      | 1.00 | 1.00 |      | 1.00 |
| Lane Grp Cap(c), veh/h       | 665  | 0     | 1522 | 55   | 58   | 48    | 1013 | 2102 | 940  | 27   | 1089 | 487  |
| V/C Ratio(X)                 | 0.18 | 0.00  | 0.46 | 0.15 | 0.41 | 0.06  | 0.94 | 0.29 | 0.00 | 0.29 | 0.66 | 0.13 |
| Avail Cap(c_a), veh/h        | 1126 | 0     | 1931 | 484  | 508  | 425   | 1092 | 2102 | 940  | 624  | 1925 | 861  |
| HCM Platoon Ratio            | 1.00 | 1.00  | 1.00 | 1.00 | 1.00 | 1.00  | 1.00 | 1.00 | 1.00 | 1.00 | 1.00 | 1.00 |
| Upstream Filter(I)           | 1.00 | 0.00  | 1.00 | 1.00 | 1.00 | 1.00  | 1.00 | 1.00 | 1.00 | 1.00 | 1.00 | 1.00 |
| Uniform Delay (d), s/veh     | 38.2 | 0.0   | 19.6 | 52.5 | 52.9 | 52.3  | 38.5 | 11.4 | 9.5  | 54.9 | 33.8 | 28.0 |
| Incr Delay (d2), s/veh       | 0.0  | 0.0   | 0.1  | 0.4  | 1.8  | 0.2   | 14.3 | 0.2  | 0.0  | 2.2  | 1.9  | 0.3  |
| Initial Q Delay(d3),s/veh    | 0.0  | 0.0   | 0.0  | 0.0  | 0.0  | 0.0   | 0.0  | 0.0  | 0.0  | 0.0  | 0.0  | 0.0  |
| %ile BackOfQ(50%),veh/ln     | 1.5  | 0.0   | 7.3  | 0.2  | 0.8  | 0.1   | 16.3 | 4.7  | 0.0  | 0.1  | 9.9  | 1.4  |
| LnGrp Delay(d),s/veh         | 38.2 | 0.0   | 19.6 | 52.9 | 54.7 | 52.5  | 52.9 | 11.6 | 9.5  | 57.1 | 35.7 | 28.4 |
| LnGrp LOS                    | D    |       | B    | D    | D    | D     | D    | B    | A    | E    | D    | C    |
| Approach Vol, veh/h          |      | 819   |      |      | 35   |       |      | 1566 |      |      | 795  |      |
| Approach Delay, s/veh        |      | 22.3  |      |      | 54.1 |       |      | 36.7 |      |      | 35.3 |      |
| Approach LOS                 |      | C     |      |      | D    |       |      | D    |      |      | D    |      |
| Timer                        | 1    | 2     | 3    | 4    | 5    | 6     | 7    | 8    |      |      |      |      |
| Assigned Phs                 | 1    | 2     |      | 4    | 5    | 6     |      | 8    |      |      |      |      |
| Phs Duration (G+Y+Rc), s     | 36.5 | 40.1  |      | 8.5  | 5.0  | 71.7  |      | 26.2 |      |      |      |      |
| Change Period (Y+Rc), s      | 4.1  | * 6.2 |      | 5.0  | 4.1  | * 6.2 |      | 5.5  |      |      |      |      |
| Max Green Setting (Gmax), s  | 35.0 | * 60  |      | 31.0 | 20.0 | * 50  |      | 35.0 |      |      |      |      |
| Max Q Clear Time (g_c+Q1), s | 31.5 | 21.7  |      | 3.4  | 2.3  | 11.4  |      | 18.5 |      |      |      |      |
| Green Ext Time (p_c), s      | 0.6  | 12.3  |      | 0.1  | 0.0  | 9.4   |      | 1.7  |      |      |      |      |
| <b>Intersection Summary</b>  |      |       |      |      |      |       |      |      |      |      |      |      |
| HCM 2010 Ctrl Delay          |      |       | 32.9 |      |      |       |      |      |      |      |      |      |
| HCM 2010 LOS                 |      |       | C    |      |      |       |      |      |      |      |      |      |
| <b>Notes</b>                 |      |       |      |      |      |       |      |      |      |      |      |      |

HCM 2010 Signalized Intersection Summary  
 13: Reservation Road & Blanco Road

Existing, PM  
 06/11/2019

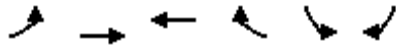

| Movement                     | EBL  | EBT  | WBT  | WBR  | SBL  | SBR  |   |   |
|------------------------------|------|------|------|------|------|------|---|---|
| Lane Configurations          | ↖↗   | ↑↑   | ↑    | ↑    | ↖↗   | ↖↗   |   |   |
| Traffic Volume (veh/h)       | 1094 | 461  | 325  | 33   | 21   | 1085 |   |   |
| Future Volume (veh/h)        | 1094 | 461  | 325  | 33   | 21   | 1085 |   |   |
| Number                       | 5    | 2    | 6    | 16   | 7    | 14   |   |   |
| Initial Q (Qb), veh          | 0    | 0    | 0    | 0    | 0    | 0    |   |   |
| Ped-Bike Adj(A_pbT)          | 1.00 |      |      | 1.00 | 1.00 | 1.00 |   |   |
| Parking Bus, Adj             | 1.00 | 1.00 | 1.00 | 1.00 | 1.00 | 1.00 |   |   |
| Adj Sat Flow, veh/h/ln       | 1881 | 1881 | 1863 | 1863 | 1863 | 1863 |   |   |
| Adj Flow Rate, veh/h         | 1164 | 490  | 346  | 11   | 22   | 0    |   |   |
| Adj No. of Lanes             | 2    | 2    | 1    | 1    | 2    | 2    |   |   |
| Peak Hour Factor             | 0.94 | 0.94 | 0.94 | 0.94 | 0.94 | 0.94 |   |   |
| Percent Heavy Veh, %         | 1    | 1    | 2    | 2    | 2    | 2    |   |   |
| Cap, veh/h                   | 1314 | 2714 | 469  | 399  | 74   | 60   |   |   |
| Arrive On Green              | 0.38 | 0.76 | 0.25 | 0.25 | 0.02 | 0.00 |   |   |
| Sat Flow, veh/h              | 3476 | 3668 | 1863 | 1583 | 3442 | 2787 |   |   |
| Grp Volume(v), veh/h         | 1164 | 490  | 346  | 11   | 22   | 0    |   |   |
| Grp Sat Flow(s),veh/h/ln     | 1738 | 1787 | 1863 | 1583 | 1721 | 1393 |   |   |
| Q Serve(g_s), s              | 13.3 | 1.6  | 7.2  | 0.2  | 0.3  | 0.0  |   |   |
| Cycle Q Clear(g_c), s        | 13.3 | 1.6  | 7.2  | 0.2  | 0.3  | 0.0  |   |   |
| Prop In Lane                 | 1.00 |      |      | 1.00 | 1.00 | 1.00 |   |   |
| Lane Grp Cap(c), veh/h       | 1314 | 2714 | 469  | 399  | 74   | 60   |   |   |
| V/C Ratio(X)                 | 0.89 | 0.18 | 0.74 | 0.03 | 0.30 | 0.00 |   |   |
| Avail Cap(c_a), veh/h        | 3276 | 5054 | 2634 | 2239 | 2190 | 1773 |   |   |
| HCM Platoon Ratio            | 1.00 | 1.00 | 1.00 | 1.00 | 1.00 | 1.00 |   |   |
| Upstream Filter(I)           | 1.00 | 1.00 | 1.00 | 1.00 | 1.00 | 0.00 |   |   |
| Uniform Delay (d), s/veh     | 12.3 | 1.4  | 14.6 | 12.0 | 20.4 | 0.0  |   |   |
| Incr Delay (d2), s/veh       | 0.8  | 0.0  | 1.7  | 0.0  | 0.8  | 0.0  |   |   |
| Initial Q Delay(d3),s/veh    | 0.0  | 0.0  | 0.0  | 0.0  | 0.0  | 0.0  |   |   |
| %ile BackOfQ(50%),veh/ln     | 6.5  | 0.8  | 3.9  | 0.1  | 0.1  | 0.0  |   |   |
| LnGrp Delay(d),s/veh         | 13.2 | 1.4  | 16.3 | 12.0 | 21.3 | 0.0  |   |   |
| LnGrp LOS                    | B    | A    | B    | B    | C    |      |   |   |
| Approach Vol, veh/h          |      | 1654 | 357  |      | 22   |      |   |   |
| Approach Delay, s/veh        |      | 9.7  | 16.2 |      | 21.3 |      |   |   |
| Approach LOS                 |      | A    | B    |      | C    |      |   |   |
| Timer                        | 1    | 2    | 3    | 4    | 5    | 6    | 7 | 8 |
| Assigned Phs                 |      | 2    |      | 4    | 5    | 6    |   |   |
| Phs Duration (G+Y+Rc), s     |      | 38.0 |      | 4.4  | 21.5 | 16.5 |   |   |
| Change Period (Y+Rc), s      |      | 5.8  |      | 3.5  | 5.5  | 5.8  |   |   |
| Max Green Setting (Gmax), s  |      | 60.0 |      | 27.0 | 40.0 | 60.0 |   |   |
| Max Q Clear Time (g_c+I1), s |      | 3.6  |      | 2.3  | 15.3 | 9.2  |   |   |
| Green Ext Time (p_c), s      |      | 2.4  |      | 0.0  | 0.7  | 1.4  |   |   |
| <b>Intersection Summary</b>  |      |      |      |      |      |      |   |   |
| HCM 2010 Ctrl Delay          |      |      | 11.0 |      |      |      |   |   |
| HCM 2010 LOS                 |      |      | B    |      |      |      |   |   |

HCM 2010 Signalized Intersection Summary  
 14: Reservation Road & Inter-Garrison Road

Existing, PM  
 06/11/2019



| Movement                    | EBL  | EBR  | NBL  | NBT  | SBT  | SBR  |   |      |
|-----------------------------|------|------|------|------|------|------|---|------|
| Lane Configurations         |      |      |      |      |      |      |   |      |
| Traffic Volume (veh/h)      | 45   | 301  | 78   | 327  | 433  | 45   |   |      |
| Future Volume (veh/h)       | 45   | 301  | 78   | 327  | 433  | 45   |   |      |
| Number                      | 3    | 18   | 1    | 6    | 2    | 12   |   |      |
| Initial Q (Qb), veh         | 0    | 0    | 0    | 0    | 0    | 0    |   |      |
| Ped-Bike Adj(A_pbT)         | 1.00 | 1.00 | 1.00 |      |      | 1.00 |   |      |
| Parking Bus, Adj            | 1.00 | 1.00 | 1.00 | 1.00 | 1.00 | 1.00 |   |      |
| Adj Sat Flow, veh/h/ln      | 1881 | 1881 | 1845 | 1845 | 1881 | 1900 |   |      |
| Adj Flow Rate, veh/h        | 55   | 212  | 95   | 399  | 528  | 46   |   |      |
| Adj No. of Lanes            | 1    | 1    | 1    | 2    | 2    | 0    |   |      |
| Peak Hour Factor            | 0.82 | 0.82 | 0.82 | 0.82 | 0.82 | 0.82 |   |      |
| Percent Heavy Veh, %        | 1    | 1    | 3    | 3    | 1    | 1    |   |      |
| Cap, veh/h                  | 310  | 433  | 172  | 1937 | 1119 | 97   |   |      |
| Arrive On Green             | 0.17 | 0.17 | 0.10 | 0.55 | 0.34 | 0.34 |   |      |
| Sat Flow, veh/h             | 1792 | 1599 | 1757 | 3597 | 3422 | 289  |   |      |
| Grp Volume(v), veh/h        | 55   | 212  | 95   | 399  | 283  | 291  |   |      |
| Grp Sat Flow(s),veh/h/ln    | 1792 | 1599 | 1757 | 1752 | 1787 | 1830 |   |      |
| Q Serve(g_s), s             | 1.0  | 4.4  | 2.0  | 2.3  | 5.0  | 5.0  |   |      |
| Cycle Q Clear(g_c), s       | 1.0  | 4.4  | 2.0  | 2.3  | 5.0  | 5.0  |   |      |
| Prop In Lane                | 1.00 | 1.00 | 1.00 |      |      | 0.16 |   |      |
| Lane Grp Cap(c), veh/h      | 310  | 433  | 172  | 1937 | 601  | 616  |   |      |
| V/C Ratio(X)                | 0.18 | 0.49 | 0.55 | 0.21 | 0.47 | 0.47 |   |      |
| Avail Cap(c_a), veh/h       | 1217 | 1243 | 884  | 5292 | 2698 | 2763 |   |      |
| HCM Platoon Ratio           | 1.00 | 1.00 | 1.00 | 1.00 | 1.00 | 1.00 |   |      |
| Upstream Filter(I)          | 1.00 | 1.00 | 1.00 | 1.00 | 1.00 | 1.00 |   |      |
| Uniform Delay (d), s/veh    | 14.0 | 12.2 | 17.1 | 4.5  | 10.4 | 10.4 |   |      |
| Incr Delay (d2), s/veh      | 0.3  | 0.9  | 1.0  | 0.1  | 1.1  | 1.1  |   |      |
| Initial Q Delay(d3),s/veh   | 0.0  | 0.0  | 0.0  | 0.0  | 0.0  | 0.0  |   |      |
| %ile BackOfQ(50%),veh/ln    | 0.5  | 2.0  | 1.0  | 1.1  | 2.6  | 2.7  |   |      |
| LnGrp Delay(d),s/veh        | 14.3 | 13.0 | 18.1 | 4.6  | 11.5 | 11.5 |   |      |
| LnGrp LOS                   | B    | B    | B    | A    | B    | B    |   |      |
| Approach Vol, veh/h         | 267  |      |      | 494  | 574  |      |   |      |
| Approach Delay, s/veh       | 13.3 |      |      | 7.2  | 11.5 |      |   |      |
| Approach LOS                | B    |      |      | A    | B    |      |   |      |
| Timer                       | 1    | 2    | 3    | 4    | 5    | 6    | 7 | 8    |
| Assigned Phs                | 1    | 2    |      |      |      | 6    |   | 8    |
| Phs Duration (G+Y+Rc), s    | 8.6  | 19.8 |      |      |      | 28.4 |   | 11.4 |
| Change Period (Y+Rc), s     | 4.7  | 6.4  |      |      |      | 6.4  |   | 4.5  |
| Max Green Setting (Gmax)    | 20   | 60.0 |      |      |      | 60.0 |   | 27.0 |
| Max Q Clear Time (g_c+14)   | 14.5 | 7.0  |      |      |      | 4.3  |   | 6.4  |
| Green Ext Time (p_c), s     | 0.1  | 6.4  |      |      |      | 4.6  |   | 0.8  |
| <b>Intersection Summary</b> |      |      |      |      |      |      |   |      |
| HCM 2010 Ctrl Delay         |      |      | 10.2 |      |      |      |   |      |
| HCM 2010 LOS                |      |      | B    |      |      |      |   |      |
| <b>Notes</b>                |      |      |      |      |      |      |   |      |

Intersection

Intersection Delay, s/veh 11.4

Intersection LOS B

| Movement            | EBL  | EBT  | EBR  | WBL  | WBT  | WBR  | NBL  | NBT  | NBR  | SBL  | SBT  | SBR  |
|---------------------|------|------|------|------|------|------|------|------|------|------|------|------|
| Lane Configurations |      | ↕    | ↗    |      | ↕    |      | ↕    | ↗    |      |      | ↕    | ↗    |
| Traffic Vol, veh/h  | 26   | 0    | 10   | 10   | 2    | 3    | 19   | 327  | 25   | 3    | 209  | 30   |
| Future Vol, veh/h   | 26   | 0    | 10   | 10   | 2    | 3    | 19   | 327  | 25   | 3    | 209  | 30   |
| Peak Hour Factor    | 0.91 | 0.91 | 0.91 | 0.91 | 0.91 | 0.91 | 0.91 | 0.91 | 0.91 | 0.91 | 0.91 | 0.91 |
| Heavy Vehicles, %   | 0    | 0    | 0    | 0    | 0    | 0    | 1    | 1    | 1    | 4    | 4    | 4    |
| Mvmt Flow           | 29   | 0    | 11   | 11   | 2    | 3    | 21   | 359  | 27   | 3    | 230  | 33   |
| Number of Lanes     | 0    | 1    | 1    | 0    | 1    | 0    | 1    | 1    | 0    | 0    | 1    | 1    |

| Approach                   | EB  | WB  | NB   | SB  |
|----------------------------|-----|-----|------|-----|
| Opposing Approach          | WB  | EB  | SB   | NB  |
| Opposing Lanes             | 1   | 2   | 2    | 2   |
| Conflicting Approach Left  | SB  | NB  | EB   | WB  |
| Conflicting Lanes Left     | 2   | 2   | 2    | 1   |
| Conflicting Approach Right | NB  | SB  | WB   | EB  |
| Conflicting Lanes Right    | 2   | 2   | 1    | 2   |
| HCM Control Delay          | 9.3 | 9.4 | 12.6 | 9.9 |
| HCM LOS                    | A   | A   | B    | A   |

| Lane                   | NBLn1 | NBLn2 | EBLn1 | EBLn2 | WBLn1 | SBLn1 | SBLn2 |
|------------------------|-------|-------|-------|-------|-------|-------|-------|
| Vol Left, %            | 100%  | 0%    | 100%  | 0%    | 67%   | 1%    | 0%    |
| Vol Thru, %            | 0%    | 93%   | 0%    | 0%    | 13%   | 99%   | 0%    |
| Vol Right, %           | 0%    | 7%    | 0%    | 100%  | 20%   | 0%    | 100%  |
| Sign Control           | Stop  | Stop  | Stop  | Stop  | Stop  | Stop  | Stop  |
| Traffic Vol by Lane    | 19    | 352   | 26    | 10    | 15    | 212   | 30    |
| LT Vol                 | 19    | 0     | 26    | 0     | 10    | 3     | 0     |
| Through Vol            | 0     | 327   | 0     | 0     | 2     | 209   | 0     |
| RT Vol                 | 0     | 25    | 0     | 10    | 3     | 0     | 30    |
| Lane Flow Rate         | 21    | 387   | 29    | 11    | 16    | 233   | 33    |
| Geometry Grp           | 7     | 7     | 7     | 7     | 6     | 7     | 7     |
| Degree of Util (X)     | 0.031 | 0.522 | 0.052 | 0.016 | 0.028 | 0.328 | 0.04  |
| Departure Headway (Hd) | 5.406 | 4.855 | 6.594 | 5.382 | 6.151 | 5.071 | 4.361 |
| Convergence, Y/N       | Yes   | Yes   | Yes   | Yes   | Yes   | Yes   | Yes   |
| Cap                    | 663   | 743   | 542   | 663   | 580   | 711   | 821   |
| Service Time           | 3.13  | 2.579 | 4.348 | 3.135 | 4.209 | 2.799 | 2.088 |
| HCM Lane V/C Ratio     | 0.032 | 0.521 | 0.054 | 0.017 | 0.028 | 0.328 | 0.04  |
| HCM Control Delay      | 8.3   | 12.8  | 9.7   | 8.2   | 9.4   | 10.3  | 7.3   |
| HCM Lane LOS           | A     | B     | A     | A     | A     | B     | A     |
| HCM 95th-tile Q        | 0.1   | 3.1   | 0.2   | 0     | 0.1   | 1.4   | 0.1   |

**Intersection**

Intersection Delay, s/veh 12.8

Intersection LOS B

| Movement            | EBL  | EBT  | EBR  | WBL  | WBT  | WBR  | NBL  | NBT  | NBR  | SBL  | SBT  | SBR  |
|---------------------|------|------|------|------|------|------|------|------|------|------|------|------|
| Lane Configurations | ↙    | ↑    | ↗    |      | ↖    | ↗    | ↙    | ↑    | ↗    | ↙    | ↗    |      |
| Traffic Vol, veh/h  | 2    | 0    | 1    | 5    | 0    | 3    | 3    | 365  | 5    | 2    | 231  | 2    |
| Future Vol, veh/h   | 2    | 0    | 1    | 5    | 0    | 3    | 3    | 365  | 5    | 2    | 231  | 2    |
| Peak Hour Factor    | 0.94 | 0.94 | 0.94 | 0.94 | 0.94 | 0.94 | 0.94 | 0.94 | 0.94 | 0.94 | 0.94 | 0.94 |
| Heavy Vehicles, %   | 0    | 0    | 0    | 0    | 0    | 0    | 1    | 1    | 1    | 4    | 4    | 4    |
| Mvmt Flow           | 2    | 0    | 1    | 5    | 0    | 3    | 3    | 388  | 5    | 2    | 246  | 2    |
| Number of Lanes     | 1    | 1    | 1    | 0    | 1    | 1    | 1    | 1    | 1    | 1    | 1    | 0    |

| Approach                   | EB  | WB  | NB   | SB   |
|----------------------------|-----|-----|------|------|
| Opposing Approach          | WB  | EB  | SB   | NB   |
| Opposing Lanes             | 2   | 3   | 2    | 3    |
| Conflicting Approach Left  | SB  | NB  | EB   | WB   |
| Conflicting Lanes Left     | 2   | 3   | 3    | 2    |
| Conflicting Approach Right | NB  | SB  | WB   | EB   |
| Conflicting Lanes Right    | 3   | 2   | 2    | 3    |
| HCM Control Delay          | 9.2 | 9.2 | 13.8 | 11.3 |
| HCM LOS                    | A   | A   | B    | B    |

| Lane                   | NBLn1 | NBLn2 | NBLn3 | EBLn1 | EBLn2 | EBLn3 | WBLn1 | WBLn2 | SBLn1 | SBLn2 |
|------------------------|-------|-------|-------|-------|-------|-------|-------|-------|-------|-------|
| Vol Left, %            | 100%  | 0%    | 0%    | 100%  | 0%    | 0%    | 100%  | 0%    | 100%  | 0%    |
| Vol Thru, %            | 0%    | 100%  | 0%    | 0%    | 100%  | 0%    | 0%    | 0%    | 0%    | 99%   |
| Vol Right, %           | 0%    | 0%    | 100%  | 0%    | 0%    | 100%  | 0%    | 100%  | 0%    | 1%    |
| Sign Control           | Stop  | Stop  | Stop  | Stop  | Stop  | Stop  | Stop  | Stop  | Stop  | Stop  |
| Traffic Vol by Lane    | 3     | 365   | 5     | 2     | 0     | 1     | 5     | 3     | 2     | 233   |
| LT Vol                 | 3     | 0     | 0     | 2     | 0     | 0     | 5     | 0     | 2     | 0     |
| Through Vol            | 0     | 365   | 0     | 0     | 0     | 0     | 0     | 0     | 0     | 231   |
| RT Vol                 | 0     | 0     | 5     | 0     | 0     | 1     | 0     | 3     | 0     | 2     |
| Lane Flow Rate         | 3     | 388   | 5     | 2     | 0     | 1     | 5     | 3     | 2     | 248   |
| Geometry Grp           | 8     | 8     | 8     | 8     | 8     | 8     | 8     | 8     | 8     | 8     |
| Degree of Util (X)     | 0.005 | 0.549 | 0.006 | 0.004 | 0     | 0.002 | 0.01  | 0.005 | 0.003 | 0.371 |
| Departure Headway (Hd) | 5.595 | 5.094 | 4.392 | 6.769 | 6.265 | 5.561 | 6.755 | 5.548 | 5.898 | 5.392 |
| Convergence, Y/N       | Yes   | Yes   | Yes   | Yes   | Yes   | Yes   | Yes   | Yes   | Yes   | Yes   |
| Cap                    | 639   | 707   | 813   | 526   | 0     | 638   | 527   | 640   | 606   | 667   |
| Service Time           | 3.33  | 2.829 | 2.127 | 4.55  | 4.046 | 3.341 | 4.535 | 3.327 | 3.639 | 3.133 |
| HCM Lane V/C Ratio     | 0.005 | 0.549 | 0.006 | 0.004 | 0     | 0.002 | 0.009 | 0.005 | 0.003 | 0.372 |
| HCM Control Delay      | 8.4   | 13.9  | 7.2   | 9.6   | 9     | 8.4   | 9.6   | 8.4   | 8.7   | 11.3  |
| HCM Lane LOS           | A     | B     | A     | A     | N     | A     | A     | A     | A     | B     |
| HCM 95th-tile Q        | 0     | 3.4   | 0     | 0     | 0     | 0     | 0     | 0     | 0     | 1.7   |

| Intersection              |     |
|---------------------------|-----|
| Intersection Delay, s/veh | 9.3 |
| Intersection LOS          | A   |

| Movement            | EBL  | EBT  | EBR  | WBL  | WBT  | WBR  | NBL  | NBT  | NBR  | SBL  | SBT  | SBR  |
|---------------------|------|------|------|------|------|------|------|------|------|------|------|------|
| Lane Configurations |      |      |      |      |      |      |      |      |      |      |      |      |
| Traffic Vol, veh/h  | 2    | 24   | 6    | 43   | 42   | 203  | 2    | 27   | 41   | 106  | 16   | 3    |
| Future Vol, veh/h   | 2    | 24   | 6    | 43   | 42   | 203  | 2    | 27   | 41   | 106  | 16   | 3    |
| Peak Hour Factor    | 0.91 | 0.91 | 0.91 | 0.91 | 0.91 | 0.91 | 0.91 | 0.91 | 0.91 | 0.91 | 0.91 | 0.91 |
| Heavy Vehicles, %   | 3    | 3    | 3    | 1    | 1    | 1    | 0    | 0    | 0    | 2    | 2    | 2    |
| Mvmt Flow           | 2    | 26   | 7    | 47   | 46   | 223  | 2    | 30   | 45   | 116  | 18   | 3    |
| Number of Lanes     | 1    | 1    | 0    | 1    | 1    | 1    | 0    | 1    | 0    | 0    | 1    | 1    |

| Approach                   | EB  | WB | NB  | SB   |
|----------------------------|-----|----|-----|------|
| Opposing Approach          | WB  | EB | SB  | NB   |
| Opposing Lanes             | 3   | 2  | 2   | 1    |
| Conflicting Approach Left  | SB  | NB | EB  | WB   |
| Conflicting Lanes Left     | 2   | 1  | 2   | 3    |
| Conflicting Approach Right | NB  | SB | WB  | EB   |
| Conflicting Lanes Right    | 1   | 2  | 3   | 2    |
| HCM Control Delay          | 8.8 | 9  | 8.8 | 10.4 |
| HCM LOS                    | A   | A  | A   | B    |

| Lane                   | NBLn1 | EBLn1 | EBLn2 | WBLn1 | WBLn2 | WBLn3 | SBLn1 | SBLn2 |
|------------------------|-------|-------|-------|-------|-------|-------|-------|-------|
| Vol Left, %            |       | 3%    | 100%  | 0%    | 100%  | 0%    | 0%    | 87%   |
| Vol Thru, %            |       | 39%   | 0%    | 80%   | 0%    | 100%  | 0%    | 13%   |
| Vol Right, %           |       | 59%   | 0%    | 20%   | 0%    | 0%    | 100%  | 0%    |
| Sign Control           |       | Stop  | Stop  | Stop  | Stop  | Stop  | Stop  | Stop  |
| Traffic Vol by Lane    |       | 70    | 2     | 30    | 43    | 42    | 203   | 122   |
| LT Vol                 |       | 2     | 2     | 0     | 43    | 0     | 0     | 106   |
| Through Vol            |       | 27    | 0     | 24    | 0     | 42    | 0     | 16    |
| RT Vol                 |       | 41    | 0     | 6     | 0     | 0     | 203   | 0     |
| Lane Flow Rate         |       | 77    | 2     | 33    | 47    | 46    | 223   | 134   |
| Geometry Grp           |       | 8     | 8     | 8     | 8     | 8     | 8     | 8     |
| Degree of Util (X)     |       | 0.113 | 0.004 | 0.052 | 0.076 | 0.068 | 0.283 | 0.223 |
| Departure Headway (Hd) |       | 5.308 | 6.324 | 5.678 | 5.779 | 5.277 | 4.573 | 6     |
| Convergence, Y/N       |       | Yes   | Yes   | Yes   | Yes   | Yes   | Yes   | Yes   |
| Cap                    |       | 670   | 562   | 626   | 619   | 677   | 783   | 595   |
| Service Time           |       | 3.081 | 4.102 | 3.456 | 3.525 | 3.022 | 2.318 | 3.769 |
| HCM Lane V/C Ratio     |       | 0.115 | 0.004 | 0.053 | 0.076 | 0.068 | 0.285 | 0.225 |
| HCM Control Delay      |       | 8.8   | 9.1   | 8.8   | 9     | 8.4   | 9.1   | 10.5  |
| HCM Lane LOS           |       | A     | A     | A     | A     | A     | A     | B     |
| HCM 95th-tile Q        |       | 0.4   | 0     | 0.2   | 0.2   | 0.2   | 1.2   | 0.8   |



| Intersection              |     |
|---------------------------|-----|
| Intersection Delay, s/veh | 9.8 |
| Intersection LOS          | A   |

| Movement            | WBL  | WBR  | NBT  | NBR  | SBL  | SBT  |
|---------------------|------|------|------|------|------|------|
| Lane Configurations |      |      |      |      |      |      |
| Traffic Vol, veh/h  | 66   | 97   | 243  | 31   | 85   | 143  |
| Future Vol, veh/h   | 66   | 97   | 243  | 31   | 85   | 143  |
| Peak Hour Factor    | 0.97 | 0.97 | 0.97 | 0.97 | 0.97 | 0.97 |
| Heavy Vehicles, %   | 0    | 0    | 1    | 1    | 2    | 2    |
| Mvmt Flow           | 68   | 100  | 251  | 32   | 88   | 147  |
| Number of Lanes     | 1    | 1    | 1    | 1    | 1    | 1    |

| Approach                   | WB  | NB   | SB  |
|----------------------------|-----|------|-----|
| Opposing Approach          |     | SB   | NB  |
| Opposing Lanes             | 0   | 2    | 2   |
| Conflicting Approach Left  | NB  |      | WB  |
| Conflicting Lanes Left     | 2   | 0    | 2   |
| Conflicting Approach Right | SB  | WB   |     |
| Conflicting Lanes Right    | 2   | 2    | 0   |
| HCM Control Delay          | 9.1 | 10.5 | 9.5 |
| HCM LOS                    | A   | B    | A   |

| Lane                   | NBLn1 | NBLn2 | WBLn1 | WBLn2 | SBLn1 | SBLn2 |
|------------------------|-------|-------|-------|-------|-------|-------|
| Vol Left, %            | 0%    | 0%    | 100%  | 0%    | 100%  | 0%    |
| Vol Thru, %            | 100%  | 0%    | 0%    | 0%    | 0%    | 100%  |
| Vol Right, %           | 0%    | 100%  | 0%    | 100%  | 0%    | 0%    |
| Sign Control           | Stop  | Stop  | Stop  | Stop  | Stop  | Stop  |
| Traffic Vol by Lane    | 243   | 31    | 66    | 97    | 85    | 143   |
| LT Vol                 | 0     | 0     | 66    | 0     | 85    | 0     |
| Through Vol            | 243   | 0     | 0     | 0     | 0     | 143   |
| RT Vol                 | 0     | 31    | 0     | 97    | 0     | 0     |
| Lane Flow Rate         | 251   | 32    | 68    | 100   | 88    | 147   |
| Geometry Grp           | 7     | 7     | 7     | 7     | 7     | 7     |
| Degree of Util (X)     | 0.363 | 0.04  | 0.118 | 0.14  | 0.14  | 0.215 |
| Departure Headway (Hd) | 5.21  | 4.505 | 6.256 | 5.048 | 5.757 | 5.253 |
| Convergence, Y/N       | Yes   | Yes   | Yes   | Yes   | Yes   | Yes   |
| Cap                    | 689   | 790   | 571   | 706   | 620   | 680   |
| Service Time           | 2.963 | 2.258 | 4.016 | 2.807 | 3.513 | 3.009 |
| HCM Lane V/C Ratio     | 0.364 | 0.041 | 0.119 | 0.142 | 0.142 | 0.216 |
| HCM Control Delay      | 10.9  | 7.4   | 9.9   | 8.6   | 9.5   | 9.5   |
| HCM Lane LOS           | B     | A     | A     | A     | A     | A     |
| HCM 95th-tile Q        | 1.7   | 0.1   | 0.4   | 0.5   | 0.5   | 0.8   |

| Intersection              |     |  |  |  |  |  |  |  |  |  |  |  |
|---------------------------|-----|--|--|--|--|--|--|--|--|--|--|--|
| Intersection Delay, s/veh | 9.9 |  |  |  |  |  |  |  |  |  |  |  |
| Intersection LOS          | A   |  |  |  |  |  |  |  |  |  |  |  |

| Movement            | EBL  | EBT  | EBR  | WBL  | WBT  | WBR  | NBL  | NBT  | NBR  | SBL  | SBT  | SBR  |
|---------------------|------|------|------|------|------|------|------|------|------|------|------|------|
| Lane Configurations |      | ↕    |      |      | ↕    |      |      | ↕    |      |      | ↕    |      |
| Traffic Vol, veh/h  | 6    | 125  | 8    | 93   | 85   | 19   | 37   | 23   | 155  | 21   | 17   | 5    |
| Future Vol, veh/h   | 6    | 125  | 8    | 93   | 85   | 19   | 37   | 23   | 155  | 21   | 17   | 5    |
| Peak Hour Factor    | 0.82 | 0.82 | 0.82 | 0.82 | 0.82 | 0.82 | 0.82 | 0.82 | 0.82 | 0.82 | 0.82 | 0.82 |
| Heavy Vehicles, %   | 1    | 1    | 1    | 1    | 1    | 1    | 3    | 3    | 3    | 0    | 0    | 0    |
| Mvmt Flow           | 7    | 152  | 10   | 113  | 104  | 23   | 45   | 28   | 189  | 26   | 21   | 6    |
| Number of Lanes     | 0    | 1    | 0    | 0    | 1    | 0    | 0    | 1    | 0    | 0    | 1    | 0    |

| Approach                   | EB  | WB   | NB | SB  |
|----------------------------|-----|------|----|-----|
| Opposing Approach          | WB  | EB   | SB | NB  |
| Opposing Lanes             | 1   | 1    | 1  | 1   |
| Conflicting Approach Left  | SB  | NB   | EB | WB  |
| Conflicting Lanes Left     | 1   | 1    | 1  | 1   |
| Conflicting Approach Right | NB  | SB   | WB | EB  |
| Conflicting Lanes Right    | 1   | 1    | 1  | 1   |
| HCM Control Delay          | 9.5 | 10.4 | 10 | 8.8 |
| HCM LOS                    | A   | B    | A  | A   |

| Lane                   | NBLn1 | EBLn1 | WBLn1 | SBLn1 |
|------------------------|-------|-------|-------|-------|
| Vol Left, %            | 17%   | 4%    | 47%   | 49%   |
| Vol Thru, %            | 11%   | 90%   | 43%   | 40%   |
| Vol Right, %           | 72%   | 6%    | 10%   | 12%   |
| Sign Control           | Stop  | Stop  | Stop  | Stop  |
| Traffic Vol by Lane    | 215   | 139   | 197   | 43    |
| LT Vol                 | 37    | 6     | 93    | 21    |
| Through Vol            | 23    | 125   | 85    | 17    |
| RT Vol                 | 155   | 8     | 19    | 5     |
| Lane Flow Rate         | 262   | 170   | 240   | 52    |
| Geometry Grp           | 1     | 1     | 1     | 1     |
| Degree of Util (X)     | 0.336 | 0.233 | 0.328 | 0.077 |
| Departure Headway (Hd) | 4.618 | 4.945 | 4.914 | 5.27  |
| Convergence, Y/N       | Yes   | Yes   | Yes   | Yes   |
| Cap                    | 773   | 719   | 726   | 672   |
| Service Time           | 2.685 | 3.023 | 2.987 | 3.362 |
| HCM Lane V/C Ratio     | 0.339 | 0.236 | 0.331 | 0.077 |
| HCM Control Delay      | 10    | 9.5   | 10.4  | 8.8   |
| HCM Lane LOS           | A     | A     | B     | A     |
| HCM 95th-tile Q        | 1.5   | 0.9   | 1.4   | 0.2   |

| Intersection              |     |
|---------------------------|-----|
| Intersection Delay, s/veh | 8.9 |
| Intersection LOS          | A   |

| Movement            | EBL  | EBT  | EBR  | WBL  | WBT  | WBR  | NBL  | NBT  | NBR  | SBL  | SBT  | SBR  |
|---------------------|------|------|------|------|------|------|------|------|------|------|------|------|
| Lane Configurations |      | ↕    |      |      | ↕    |      |      | ↕    |      |      | ↕    | ↕    |
| Traffic Vol, veh/h  | 8    | 191  | 18   | 10   | 107  | 9    | 23   | 57   | 19   | 13   | 21   | 2    |
| Future Vol, veh/h   | 8    | 191  | 18   | 10   | 107  | 9    | 23   | 57   | 19   | 13   | 21   | 2    |
| Peak Hour Factor    | 0.93 | 0.93 | 0.93 | 0.93 | 0.93 | 0.93 | 0.93 | 0.93 | 0.93 | 0.93 | 0.93 | 0.93 |
| Heavy Vehicles, %   | 1    | 1    | 1    | 4    | 4    | 4    | 5    | 5    | 5    | 0    | 0    | 0    |
| Mvmt Flow           | 9    | 205  | 19   | 11   | 115  | 10   | 25   | 61   | 20   | 14   | 23   | 2    |
| Number of Lanes     | 0    | 1    | 0    | 0    | 1    | 0    | 0    | 1    | 0    | 0    | 1    | 1    |

| Approach                   | EB  | WB  | NB  | SB  |
|----------------------------|-----|-----|-----|-----|
| Opposing Approach          | WB  | EB  | SB  | NB  |
| Opposing Lanes             | 1   | 1   | 2   | 1   |
| Conflicting Approach Left  | SB  | NB  | EB  | WB  |
| Conflicting Lanes Left     | 2   | 1   | 1   | 1   |
| Conflicting Approach Right | NB  | SB  | WB  | EB  |
| Conflicting Lanes Right    | 1   | 2   | 1   | 1   |
| HCM Control Delay          | 9.2 | 8.6 | 8.8 | 8.6 |
| HCM LOS                    | A   | A   | A   | A   |

| Lane                   | NBLn1 | EBLn1 | WBLn1 | SBLn1 | SBLn2 |
|------------------------|-------|-------|-------|-------|-------|
| Vol Left, %            | 23%   | 4%    | 8%    | 38%   | 0%    |
| Vol Thru, %            | 58%   | 88%   | 85%   | 62%   | 0%    |
| Vol Right, %           | 19%   | 8%    | 7%    | 0%    | 100%  |
| Sign Control           | Stop  | Stop  | Stop  | Stop  | Stop  |
| Traffic Vol by Lane    | 99    | 217   | 126   | 34    | 2     |
| LT Vol                 | 23    | 8     | 10    | 13    | 0     |
| Through Vol            | 57    | 191   | 107   | 21    | 0     |
| RT Vol                 | 19    | 18    | 9     | 0     | 2     |
| Lane Flow Rate         | 106   | 233   | 135   | 37    | 2     |
| Geometry Grp           | 5     | 2     | 2     | 7     | 7     |
| Degree of Util (X)     | 0.145 | 0.285 | 0.172 | 0.057 | 0.003 |
| Departure Headway (Hd) | 4.913 | 4.402 | 4.57  | 5.646 | 4.747 |
| Convergence, Y/N       | Yes   | Yes   | Yes   | Yes   | Yes   |
| Cap                    | 729   | 817   | 784   | 634   | 752   |
| Service Time           | 2.949 | 2.426 | 2.598 | 3.387 | 2.488 |
| HCM Lane V/C Ratio     | 0.145 | 0.285 | 0.172 | 0.058 | 0.003 |
| HCM Control Delay      | 8.8   | 9.2   | 8.6   | 8.7   | 7.5   |
| HCM Lane LOS           | A     | A     | A     | A     | A     |
| HCM 95th-tile Q        | 0.5   | 1.2   | 0.6   | 0.2   | 0     |

| Intersection                |       |       |       |
|-----------------------------|-------|-------|-------|
| Intersection Delay, s/veh   | 8.6   |       |       |
| Intersection LOS            | A     |       |       |
| Approach                    | EB    | WB    | NB    |
| Entry Lanes                 | 1     | 1     | 1     |
| Conflicting Circle Lanes    | 1     | 1     | 1     |
| Adj Approach Flow, veh/h    | 264   | 293   | 469   |
| Demand Flow Rate, veh/h     | 269   | 299   | 469   |
| Vehicles Circulating, veh/h | 137   | 7     | 263   |
| Vehicles Exiting, veh/h     | 169   | 725   | 143   |
| Follow-Up Headway, s        | 3.186 | 3.186 | 3.186 |
| Ped Vol Crossing Leg, #/h   | 0     | 0     | 0     |
| Ped Cap Adj                 | 1.000 | 1.000 | 1.000 |
| Approach Delay, s/veh       | 6.5   | 5.8   | 11.6  |
| Approach LOS                | A     | A     | B     |
| Lane                        | Left  | Left  | Left  |
| Designated Moves            | TR    | LT    | LR    |
| Assumed Moves               | TR    | LT    | LR    |
| RT Channelized              |       |       |       |
| Lane Util                   | 1.000 | 1.000 | 1.000 |
| Critical Headway, s         | 5.193 | 5.193 | 5.193 |
| Entry Flow, veh/h           | 269   | 299   | 469   |
| Cap Entry Lane, veh/h       | 985   | 1122  | 869   |
| Entry HV Adj Factor         | 0.981 | 0.979 | 1.000 |
| Flow Entry, veh/h           | 264   | 293   | 469   |
| Cap Entry, veh/h            | 966   | 1099  | 869   |
| V/C Ratio                   | 0.273 | 0.266 | 0.540 |
| Control Delay, s/veh        | 6.5   | 5.8   | 11.6  |
| LOS                         | A     | A     | B     |
| 95th %tile Queue, veh       | 1     | 1     | 3     |

| Intersection              |      |
|---------------------------|------|
| Intersection Delay, s/veh | 12.8 |
| Intersection LOS          | B    |

| Movement            | EBL  | EBT  | WBT  | WBR  | SBL  | SBR  |
|---------------------|------|------|------|------|------|------|
| Lane Configurations |      |      |      |      |      |      |
| Traffic Vol, veh/h  | 251  | 412  | 91   | 17   | 15   | 108  |
| Future Vol, veh/h   | 251  | 412  | 91   | 17   | 15   | 108  |
| Peak Hour Factor    | 0.95 | 0.95 | 0.95 | 0.95 | 0.95 | 0.95 |
| Heavy Vehicles, %   | 2    | 2    | 6    | 6    | 4    | 4    |
| Mvmt Flow           | 264  | 434  | 96   | 18   | 16   | 114  |
| Number of Lanes     | 1    | 1    | 1    | 1    | 1    | 1    |

| Approach                   | EB | WB  | SB  |
|----------------------------|----|-----|-----|
| Opposing Approach          | WB | EB  |     |
| Opposing Lanes             | 2  | 2   | 0   |
| Conflicting Approach Left  | SB |     | WB  |
| Conflicting Lanes Left     | 2  | 0   | 2   |
| Conflicting Approach Right |    | SB  | EB  |
| Conflicting Lanes Right    | 0  | 2   | 2   |
| HCM Control Delay          | 14 | 9.2 | 9.7 |
| HCM LOS                    | B  | A   | A   |

| Lane                   | EBLn1 | EBLn2 | WBLn1 | WBLn2 | SBLn1 | SBLn2 |
|------------------------|-------|-------|-------|-------|-------|-------|
| Vol Left, %            | 100%  | 0%    | 0%    | 0%    | 100%  | 0%    |
| Vol Thru, %            | 0%    | 100%  | 100%  | 0%    | 0%    | 0%    |
| Vol Right, %           | 0%    | 0%    | 0%    | 100%  | 0%    | 100%  |
| Sign Control           | Stop  | Stop  | Stop  | Stop  | Stop  | Stop  |
| Traffic Vol by Lane    | 251   | 412   | 91    | 17    | 15    | 108   |
| LT Vol                 | 251   | 0     | 0     | 0     | 15    | 0     |
| Through Vol            | 0     | 412   | 91    | 0     | 0     | 0     |
| RT Vol                 | 0     | 0     | 0     | 17    | 0     | 108   |
| Lane Flow Rate         | 264   | 434   | 96    | 18    | 16    | 114   |
| Geometry Grp           | 7     | 7     | 7     | 7     | 7     | 7     |
| Degree of Util (X)     | 0.405 | 0.604 | 0.152 | 0.025 | 0.03  | 0.179 |
| Departure Headway (Hd) | 5.513 | 5.01  | 5.695 | 4.988 | 6.889 | 5.679 |
| Convergence, Y/N       | Yes   | Yes   | Yes   | Yes   | Yes   | Yes   |
| Cap                    | 650   | 720   | 626   | 711   | 518   | 629   |
| Service Time           | 3.263 | 2.761 | 3.471 | 2.764 | 4.655 | 3.444 |
| HCM Lane V/C Ratio     | 0.406 | 0.603 | 0.153 | 0.025 | 0.031 | 0.181 |
| HCM Control Delay      | 12    | 15.2  | 9.5   | 7.9   | 9.9   | 9.7   |
| HCM Lane LOS           | B     | C     | A     | A     | A     | A     |
| HCM 95th-tile Q        | 2     | 4.1   | 0.5   | 0.1   | 0.1   | 0.6   |

| Intersection              |      |
|---------------------------|------|
| Intersection Delay, s/veh | 11.1 |
| Intersection LOS          | B    |

| Movement            | EBL  | EBT  | WBT  | WBR  | SBL  | SBR  |
|---------------------|------|------|------|------|------|------|
| Lane Configurations |      |      |      |      |      |      |
| Traffic Vol, veh/h  | 94   | 353  | 89   | 13   | 11   | 24   |
| Future Vol, veh/h   | 94   | 353  | 89   | 13   | 11   | 24   |
| Peak Hour Factor    | 0.86 | 0.86 | 0.86 | 0.86 | 0.86 | 0.86 |
| Heavy Vehicles, %   | 1    | 1    | 5    | 5    | 17   | 17   |
| Mvmt Flow           | 109  | 410  | 103  | 15   | 13   | 28   |
| Number of Lanes     | 1    | 1    | 1    | 1    | 1    | 1    |

| Approach                   | EB   | WB  | SB  |
|----------------------------|------|-----|-----|
| Opposing Approach          | WB   | EB  |     |
| Opposing Lanes             | 2    | 2   | 0   |
| Conflicting Approach Left  | SB   |     | WB  |
| Conflicting Lanes Left     | 2    | 0   | 2   |
| Conflicting Approach Right |      | SB  | EB  |
| Conflicting Lanes Right    | 0    | 2   | 2   |
| HCM Control Delay          | 11.9 | 8.5 | 8.8 |
| HCM LOS                    | B    | A   | A   |

| Lane                   | EBLn1 | EBLn2 | WBLn1 | WBLn2 | SBLn1 | SBLn2 |
|------------------------|-------|-------|-------|-------|-------|-------|
| Vol Left, %            | 100%  | 0%    | 0%    | 0%    | 100%  | 0%    |
| Vol Thru, %            | 0%    | 100%  | 100%  | 0%    | 0%    | 0%    |
| Vol Right, %           | 0%    | 0%    | 0%    | 100%  | 0%    | 100%  |
| Sign Control           | Stop  | Stop  | Stop  | Stop  | Stop  | Stop  |
| Traffic Vol by Lane    | 94    | 353   | 89    | 13    | 11    | 24    |
| LT Vol                 | 94    | 0     | 0     | 0     | 11    | 0     |
| Through Vol            | 0     | 353   | 89    | 0     | 0     | 0     |
| RT Vol                 | 0     | 0     | 0     | 13    | 0     | 24    |
| Lane Flow Rate         | 109   | 410   | 103   | 15    | 13    | 28    |
| Geometry Grp           | 7     | 7     | 7     | 7     | 7     | 7     |
| Degree of Util (X)     | 0.156 | 0.53  | 0.148 | 0.019 | 0.024 | 0.043 |
| Departure Headway (Hd) | 5.147 | 4.646 | 5.144 | 4.44  | 6.748 | 5.54  |
| Convergence, Y/N       | Yes   | Yes   | Yes   | Yes   | Yes   | Yes   |
| Cap                    | 688   | 763   | 700   | 809   | 533   | 649   |
| Service Time           | 2.946 | 2.445 | 2.855 | 2.152 | 4.459 | 3.25  |
| HCM Lane V/C Ratio     | 0.158 | 0.537 | 0.147 | 0.019 | 0.024 | 0.043 |
| HCM Control Delay      | 8.9   | 12.7  | 8.7   | 7.2   | 9.6   | 8.5   |
| HCM Lane LOS           | A     | B     | A     | A     | A     | A     |
| HCM 95th-tile Q        | 0.6   | 3.2   | 0.5   | 0.1   | 0.1   | 0.1   |

**Intersection**

Intersection Delay, s/veh 11.1  
 Intersection LOS B

| Movement            | EBL  | EBT  | WBT  | WBR  | SBL  | SBR  |
|---------------------|------|------|------|------|------|------|
| Lane Configurations |      | ↶    | ↷    |      | ↶    | ↷    |
| Traffic Vol, veh/h  | 328  | 43   | 21   | 15   | 12   | 75   |
| Future Vol, veh/h   | 328  | 43   | 21   | 15   | 12   | 75   |
| Peak Hour Factor    | 0.87 | 0.87 | 0.87 | 0.87 | 0.87 | 0.87 |
| Heavy Vehicles, %   | 1    | 1    | 6    | 6    | 3    | 3    |
| Mvmt Flow           | 377  | 49   | 24   | 17   | 14   | 86   |
| Number of Lanes     | 0    | 1    | 1    | 0    | 1    | 1    |

| Approach                   | EB   | WB  | SB  |
|----------------------------|------|-----|-----|
| Opposing Approach          | WB   | EB  |     |
| Opposing Lanes             | 1    | 1   | 0   |
| Conflicting Approach Left  | SB   |     | WB  |
| Conflicting Lanes Left     | 2    | 0   | 1   |
| Conflicting Approach Right |      | SB  | EB  |
| Conflicting Lanes Right    | 0    | 2   | 1   |
| HCM Control Delay          | 12.1 | 7.7 | 8.4 |
| HCM LOS                    | B    | A   | A   |

| Lane                   | EBLn1 | WBLn1 | SBLn1 | SBLn2 |
|------------------------|-------|-------|-------|-------|
| Vol Left, %            | 88%   | 0%    | 100%  | 0%    |
| Vol Thru, %            | 12%   | 58%   | 0%    | 0%    |
| Vol Right, %           | 0%    | 42%   | 0%    | 100%  |
| Sign Control           | Stop  | Stop  | Stop  | Stop  |
| Traffic Vol by Lane    | 371   | 36    | 12    | 75    |
| LT Vol                 | 328   | 0     | 12    | 0     |
| Through Vol            | 43    | 21    | 0     | 0     |
| RT Vol                 | 0     | 15    | 0     | 75    |
| Lane Flow Rate         | 426   | 41    | 14    | 86    |
| Geometry Grp           | 2     | 2     | 7     | 7     |
| Degree of Util (X)     | 0.523 | 0.051 | 0.024 | 0.118 |
| Departure Headway (Hd) | 4.411 | 4.459 | 6.134 | 4.923 |
| Convergence, Y/N       | Yes   | Yes   | Yes   | Yes   |
| Cap                    | 823   | 802   | 584   | 728   |
| Service Time           | 2.411 | 2.49  | 3.864 | 2.653 |
| HCM Lane V/C Ratio     | 0.518 | 0.051 | 0.024 | 0.118 |
| HCM Control Delay      | 12.1  | 7.7   | 9     | 8.3   |
| HCM Lane LOS           | B     | A     | A     | A     |
| HCM 95th-tile Q        | 3.1   | 0.2   | 0.1   | 0.4   |

HCM 2010 Signalized Intersection Summary  
 26: East Garrison Road & Reservation Road

Existing, PM  
 06/11/2019





















| Movement                     | EBL  | EBT  | EBR  | WBL  | WBT  | WBR  | NBL  | NBT  | NBR  | SBL | SBT | SBR |
|------------------------------|------|------|------|------|------|------|------|------|------|-----|-----|-----|
| Lane Configurations          | ↖    | ↗    |      | ↖    | ↗    |      | ↖    |      | ↗    |     |     |     |
| Traffic Volume (veh/h)       | 1    | 681  | 24   | 51   | 430  | 0    | 9    | 0    | 30   | 0   | 0   | 0   |
| Future Volume (veh/h)        | 1    | 681  | 24   | 51   | 430  | 0    | 9    | 0    | 30   | 0   | 0   | 0   |
| Number                       | 5    | 2    | 12   | 1    | 6    | 16   | 3    | 8    | 18   |     |     |     |
| Initial Q (Qb), veh          | 0    | 0    | 0    | 0    | 0    | 0    | 0    | 0    | 0    |     |     |     |
| Ped-Bike Adj(A_pbT)          | 1.00 |      | 1.00 | 1.00 |      | 1.00 | 1.00 |      | 1.00 |     |     |     |
| Parking Bus, Adj             | 1.00 | 1.00 | 1.00 | 1.00 | 1.00 | 1.00 | 1.00 | 1.00 | 1.00 |     |     |     |
| Adj Sat Flow, veh/h/ln       | 1863 | 1863 | 1900 | 1881 | 1881 | 0    | 1845 | 0    | 1845 |     |     |     |
| Adj Flow Rate, veh/h         | 1    | 702  | 23   | 53   | 443  | 0    | 9    | 0    | 2    |     |     |     |
| Adj No. of Lanes             | 1    | 2    | 0    | 1    | 2    | 0    | 1    | 0    | 1    |     |     |     |
| Peak Hour Factor             | 0.97 | 0.97 | 0.97 | 0.97 | 0.97 | 0.97 | 0.97 | 0.97 | 0.97 |     |     |     |
| Percent Heavy Veh, %         | 2    | 2    | 2    | 1    | 1    | 0    | 3    | 0    | 3    |     |     |     |
| Cap, veh/h                   | 6    | 1677 | 55   | 106  | 1933 | 0    | 21   | 0    | 18   |     |     |     |
| Arrive On Green              | 0.00 | 0.48 | 0.48 | 0.06 | 0.54 | 0.00 | 0.01 | 0.00 | 0.01 |     |     |     |
| Sat Flow, veh/h              | 1774 | 3498 | 115  | 1792 | 3668 | 0    | 1757 | 0    | 1568 |     |     |     |
| Grp Volume(v), veh/h         | 1    | 355  | 370  | 53   | 443  | 0    | 9    | 0    | 2    |     |     |     |
| Grp Sat Flow(s),veh/h/ln     | 1774 | 1770 | 1843 | 1792 | 1787 | 0    | 1757 | 0    | 1568 |     |     |     |
| Q Serve(g_s), s              | 0.0  | 4.0  | 4.0  | 0.9  | 2.0  | 0.0  | 0.2  | 0.0  | 0.0  |     |     |     |
| Cycle Q Clear(g_c), s        | 0.0  | 4.0  | 4.0  | 0.9  | 2.0  | 0.0  | 0.2  | 0.0  | 0.0  |     |     |     |
| Prop In Lane                 | 1.00 |      | 0.06 | 1.00 |      | 0.00 | 1.00 |      | 1.00 |     |     |     |
| Lane Grp Cap(c), veh/h       | 6    | 848  | 883  | 106  | 1933 | 0    | 21   | 0    | 18   |     |     |     |
| V/C Ratio(X)                 | 0.17 | 0.42 | 0.42 | 0.50 | 0.23 | 0.00 | 0.44 | 0.00 | 0.11 |     |     |     |
| Avail Cap(c_a), veh/h        | 1165 | 3485 | 3629 | 1176 | 7039 | 0    | 1557 | 0    | 1390 |     |     |     |
| HCM Platoon Ratio            | 1.00 | 1.00 | 1.00 | 1.00 | 1.00 | 1.00 | 1.00 | 1.00 | 1.00 |     |     |     |
| Upstream Filter(I)           | 1.00 | 1.00 | 1.00 | 1.00 | 1.00 | 0.00 | 1.00 | 0.00 | 1.00 |     |     |     |
| Uniform Delay (d), s/veh     | 15.2 | 5.2  | 5.2  | 13.9 | 3.7  | 0.0  | 15.0 | 0.0  | 14.9 |     |     |     |
| Incr Delay (d2), s/veh       | 5.1  | 0.6  | 0.6  | 1.3  | 0.1  | 0.0  | 5.4  | 0.0  | 1.0  |     |     |     |
| Initial Q Delay(d3),s/veh    | 0.0  | 0.0  | 0.0  | 0.0  | 0.0  | 0.0  | 0.0  | 0.0  | 0.0  |     |     |     |
| %ile BackOfQ(50%),veh/ln     | 0.0  | 2.0  | 2.1  | 0.5  | 0.9  | 0.0  | 0.1  | 0.0  | 0.0  |     |     |     |
| LnGrp Delay(d),s/veh         | 20.2 | 5.8  | 5.8  | 15.2 | 3.7  | 0.0  | 20.3 | 0.0  | 15.9 |     |     |     |
| LnGrp LOS                    | C    | A    | A    | B    | A    |      | C    |      | B    |     |     |     |
| Approach Vol, veh/h          |      | 726  |      |      | 496  |      |      | 11   |      |     |     |     |
| Approach Delay, s/veh        |      | 5.8  |      |      | 5.0  |      |      | 19.5 |      |     |     |     |
| Approach LOS                 |      | A    |      |      | A    |      |      | B    |      |     |     |     |
| Timer                        | 1    | 2    | 3    | 4    | 5    | 6    | 7    | 8    |      |     |     |     |
| Assigned Phs                 | 1    | 2    |      |      | 5    | 6    |      | 8    |      |     |     |     |
| Phs Duration (G+Y+Rc), s     | 5.4  | 20.0 |      |      | 3.5  | 21.9 |      | 5.1  |      |     |     |     |
| Change Period (Y+Rc), s      | 3.6  | 5.4  |      |      | 3.5  | 5.4  |      | 4.7  |      |     |     |     |
| Max Green Setting (Gmax), s  | 20   | 60.0 |      |      | 20.0 | 60.0 |      | 27.0 |      |     |     |     |
| Max Q Clear Time (g_c+11), s | 2.5  | 6.0  |      |      | 2.0  | 4.0  |      | 2.2  |      |     |     |     |
| Green Ext Time (p_c), s      | 0.0  | 8.6  |      |      | 0.0  | 3.5  |      | 0.0  |      |     |     |     |
| <b>Intersection Summary</b>  |      |      |      |      |      |      |      |      |      |     |     |     |
| HCM 2010 Ctrl Delay          |      |      |      | 5.6  |      |      |      |      |      |     |     |     |
| HCM 2010 LOS                 |      |      |      | A    |      |      |      |      |      |     |     |     |
| <b>Notes</b>                 |      |      |      |      |      |      |      |      |      |     |     |     |



HCM 2010 Signalized Intersection Summary  
28: Davis Road & Reservation Road

Existing, PM  
06/11/2019

|                              |  |  |  |  |  |  |  |  |  |  |  |  |
|------------------------------|---|---|---|---|---|---|--|---|---|---|---|---|
| Movement                     | EBL   | EBT   | EBR   | WBL   | WBT   | WBR   | NBL  | NBT   | NBR   | SBL   | SBT   | SBR   |
| Lane Configurations          |  |  |   |  |  |   |  |  |   |   |  |  |
| Traffic Volume (veh/h)       | 301   | 431   | 2   | 5   | 298   | 109   | 2  | 1   | 3   | 113   | 3   | 182   |
| Future Volume (veh/h)        | 301   | 431   | 2   | 5   | 298   | 109   | 2  | 1   | 3   | 113   | 3   | 182   |
| Number                       | 5   | 2   | 12  | 1   | 6   | 16  | 3  | 8   | 18  | 7   | 4   | 14  |
| Initial Q (Qb), veh          | 0   | 0   | 0   | 0   | 0   | 0   | 0  | 0   | 0   | 0   | 0   | 0   |
| Ped-Bike Adj(A_pbT)          | 1.00  |   | 1.00  | 1.00  |   | 1.00  | 1.00   |   | 1.00  | 1.00  |   | 1.00  |
| Parking Bus, Adj             | 1.00  | 1.00  | 1.00  | 1.00  | 1.00  | 1.00  | 1.00   | 1.00  | 1.00  | 1.00  | 1.00  | 1.00  |
| Adj Sat Flow, veh/h/ln       | 1863  | 1863  | 1900  | 1827  | 1837  | 1900  | 1900   | 1900  | 1900  | 1900  | 1881  | 1881  |
| Adj Flow Rate, veh/h         | 327   | 468   | 2   | 5   | 317   | 118   | 2  | 1   | 1   | 120   | 3   | 59  |
| Adj No. of Lanes             | 1   | 1   | 0   | 1   | 1   | 0   | 0  | 1   | 0   | 0   | 1   | 1   |
| Peak Hour Factor             | 0.92  | 0.92  | 0.92  | 0.94  | 0.94  | 0.92  | 0.94   | 0.94  | 0.94  | 0.94  | 0.94  | 0.94  |
| Percent Heavy Veh, %         | 2   | 2   | 2   | 4   | 4   | 4   | 0  | 0   | 0   | 1   | 1   | 1   |
| Cap, veh/h                   | 382   | 1015  | 4   | 9   | 434   | 161   | 5  | 2   | 2   | 176   | 4   | 505   |
| Arrive On Green              | 0.22  | 0.55  | 0.55  | 0.01  | 0.34  | 0.34  | 0.02   | 0.01  | 0.01  | 0.12  | 0.10  | 0.10  |
| Sat Flow, veh/h              | 1774  | 1853  | 8   | 1740  | 1277  | 475   | 889  | 444   | 444   | 1750  | 44  | 1599  |
| Grp Volume(v), veh/h         | 327   | 0   | 470   | 5   | 0   | 435   | 4  | 0   | 0   | 123   | 0   | 59  |
| Grp Sat Flow(s),veh/h/ln     | 1774  | 0   | 1861  | 1740  | 0   | 1753  | 1777   | 0   | 0   | 1794  | 0   | 1599  |
| Q Serve(g_s), s              | 9.3   | 0.0   | 8.0   | 0.2   | 0.0   | 11.4  | 0.1  | 0.0   | 0.0   | 3.5   | 0.0   | 1.4   |
| Cycle Q Clear(g_c), s        | 9.3   | 0.0   | 8.0   | 0.2   | 0.0   | 11.4  | 0.1  | 0.0   | 0.0   | 3.5   | 0.0   | 1.4   |
| Prop In Lane                 | 1.00  |   | 0.00  | 1.00  |   | 0.27  | 0.50   |   | 0.25  | 0.98  |   | 1.00  |
| Lane Grp Cap(c), veh/h       | 382   | 0   | 1020  | 9   | 0   | 595   | 10   | 0   | 0   | 180   | 0   | 505   |
| V/C Ratio(X)                 | 0.86  | 0.00  | 0.46  | 0.54  | 0.00  | 0.73  | 0.42   | 0.00  | 0.00  | 0.68  | 0.00  | 0.12  |
| Avail Cap(c_a), veh/h        | 1014  | 0   | 2127  | 994   | 0   | 2003  | 1016   | 0   | 0   | 1025  | 0   | 1258  |
| HCM Platoon Ratio            | 1.00  | 1.00  | 1.00  | 1.00  | 1.00  | 1.00  | 1.00   | 1.00  | 1.00  | 1.00  | 1.00  | 1.00  |
| Upstream Filter(I)           | 1.00  | 0.00  | 1.00  | 1.00  | 0.00  | 1.00  | 1.00   | 0.00  | 0.00  | 1.00  | 0.00  | 1.00  |
| Uniform Delay (d), s/veh     | 19.8  | 0.0   | 7.2   | 26.0  | 0.0   | 15.2  | 25.8   | 0.0   | 0.0   | 22.3  | 0.0   | 12.8  |
| Incr Delay (d2), s/veh       | 2.2   | 0.0   | 0.5   | 16.6  | 0.0   | 2.8   | 10.3   | 0.0   | 0.0   | 1.7   | 0.0   | 0.0   |
| Initial Q Delay(d3),s/veh    | 0.0   | 0.0   | 0.0   | 0.0   | 0.0   | 0.0   | 0.0  | 0.0   | 0.0   | 0.0   | 0.0   | 0.0   |
| %ile BackOfQ(50%),veh/ln     | 4.8   | 0.0   | 4.2   | 0.1   | 0.0   | 5.9   | 0.1  | 0.0   | 0.0   | 1.8   | 0.0   | 0.6   |
| LnGrp Delay(d),s/veh         | 22.0  | 0.0   | 7.7   | 42.6  | 0.0   | 18.0  | 36.1   | 0.0   | 0.0   | 24.0  | 0.0   | 12.8  |
| LnGrp LOS                    | C   |   | A   | D   |   | B   | D  |   |   | C   |   | B   |
| Approach Vol, veh/h          |   | 797   |   |   | 440   |   |  | 4   |   |   |   | 182   |
| Approach Delay, s/veh        |   | 13.6  |   |   | 18.3  |   |  | 36.1  |   |   |   | 20.4  |
| Approach LOS                 |   | B   |   |   | B   |   |  | D   |   |   |   | C   |
| Timer                        | 1   | 2   | 3   | 4   | 5   | 6   | 7  | 8   |   |   |   |   |
| Assigned Phs                 | 1   | 2   |   | 4   | 5   | 6   |  | 8   |   |   |   |   |
| Phs Duration (G+Y+Rc), s     | 4.2   | 33.8  |   | 10.3  | 15.1  | 22.8  |  | 4.3   |   |   |   |   |
| Change Period (Y+Rc), s      | * 3.9   | 5.0   |   | 5.0   | * 3.8   | 5.0   |  | 4.0   |   |   |   |   |
| Max Green Setting (Gmax), s  | * 30  | 60.0  |   | 30.0  | * 30  | 60.0  |  | 30.0  |   |   |   |   |
| Max Q Clear Time (g_c+I1), s | 2.2   | 10.0  |   | 5.5   | 11.3  | 13.4  |  | 2.1   |   |   |   |   |
| Green Ext Time (p_c), s      | 0.0   | 4.7   |   | 0.2   | 0.1   | 4.4   |  | 0.0   |   |   |   |   |
| <b>Intersection Summary</b>  |   |   |   |   |   |   |  |   |   |   |   |   |
| HCM 2010 Ctrl Delay          |   |   | 15.9  |   |   |   |  |   |   |   |   |   |
| HCM 2010 LOS                 |   |   | B   |   |   |   |  |   |   |   |   |   |
| <b>Notes</b>                 |   |   |   |   |   |   |  |   |   |   |   |   |

| Intersection              |     |  |  |  |  |  |  |  |  |  |  |  |
|---------------------------|-----|--|--|--|--|--|--|--|--|--|--|--|
| Intersection Delay, s/veh | 9.4 |  |  |  |  |  |  |  |  |  |  |  |
| Intersection LOS          | A   |  |  |  |  |  |  |  |  |  |  |  |

| Movement            | EBL  | EBT  | EBR  | WBL  | WBT  | WBR  | NBL  | NBT  | NBR  | SBL  | SBT  | SBR  |
|---------------------|------|------|------|------|------|------|------|------|------|------|------|------|
| Lane Configurations |      | ↕    |      |      | ↕    | ↕    | ↕    | ↕    |      | ↕    | ↕    | ↕    |
| Traffic Vol, veh/h  | 5    | 0    | 2    | 27   | 4    | 39   | 8    | 226  | 4    | 10   | 191  | 8    |
| Future Vol, veh/h   | 5    | 0    | 2    | 27   | 4    | 39   | 8    | 226  | 4    | 10   | 191  | 8    |
| Peak Hour Factor    | 0.94 | 0.94 | 0.94 | 0.94 | 0.94 | 0.94 | 0.94 | 0.94 | 0.94 | 0.94 | 0.94 | 0.94 |
| Heavy Vehicles, %   | 0    | 0    | 0    | 0    | 0    | 0    | 0    | 0    | 0    | 1    | 1    | 1    |
| Mvmt Flow           | 5    | 0    | 2    | 29   | 4    | 41   | 9    | 240  | 4    | 11   | 203  | 9    |
| Number of Lanes     | 0    | 1    | 0    | 0    | 1    | 1    | 1    | 2    | 0    | 1    | 1    | 1    |

| Approach                   | EB  | WB  | NB  | SB |
|----------------------------|-----|-----|-----|----|
| Opposing Approach          | WB  | EB  | SB  | NB |
| Opposing Lanes             | 2   | 1   | 3   | 3  |
| Conflicting Approach Left  | SB  | NB  | EB  | WB |
| Conflicting Lanes Left     | 3   | 3   | 1   | 2  |
| Conflicting Approach Right | NB  | SB  | WB  | EB |
| Conflicting Lanes Right    | 3   | 3   | 2   | 1  |
| HCM Control Delay          | 8.9 | 8.6 | 9.2 | 10 |
| HCM LOS                    | A   | A   | A   | A  |

| Lane                   | NBLn1 | NBLn2 | NBLn3 | EBLn1 | WBLn1 | WBLn2 | SBLn1 | SBLn2 | SBLn3 |
|------------------------|-------|-------|-------|-------|-------|-------|-------|-------|-------|
| Vol Left, %            | 100%  | 0%    | 0%    | 71%   | 87%   | 0%    | 100%  | 0%    | 0%    |
| Vol Thru, %            | 0%    | 100%  | 95%   | 0%    | 13%   | 0%    | 0%    | 100%  | 0%    |
| Vol Right, %           | 0%    | 0%    | 5%    | 29%   | 0%    | 100%  | 0%    | 0%    | 100%  |
| Sign Control           | Stop  | Stop  | Stop  | Stop  | Stop  | Stop  | Stop  | Stop  | Stop  |
| Traffic Vol by Lane    | 8     | 151   | 79    | 7     | 31    | 39    | 10    | 191   | 8     |
| LT Vol                 | 8     | 0     | 0     | 5     | 27    | 0     | 10    | 0     | 0     |
| Through Vol            | 0     | 151   | 75    | 0     | 4     | 0     | 0     | 191   | 0     |
| RT Vol                 | 0     | 0     | 4     | 2     | 0     | 39    | 0     | 0     | 8     |
| Lane Flow Rate         | 9     | 160   | 84    | 7     | 33    | 41    | 11    | 203   | 9     |
| Geometry Grp           | 8     | 8     | 8     | 8     | 8     | 8     | 8     | 8     | 8     |
| Degree of Util (X)     | 0.013 | 0.232 | 0.121 | 0.012 | 0.057 | 0.058 | 0.017 | 0.297 | 0.011 |
| Departure Headway (Hd) | 5.71  | 5.208 | 5.173 | 6.039 | 6.172 | 5.038 | 5.771 | 5.269 | 4.567 |
| Convergence, Y/N       | Yes   | Yes   | Yes   | Yes   | Yes   | Yes   | Yes   | Yes   | Yes   |
| Cap                    | 626   | 688   | 691   | 589   | 578   | 707   | 619   | 681   | 781   |
| Service Time           | 3.454 | 2.952 | 2.917 | 3.813 | 3.932 | 2.799 | 3.515 | 3.013 | 2.311 |
| HCM Lane V/C Ratio     | 0.014 | 0.233 | 0.122 | 0.012 | 0.057 | 0.058 | 0.018 | 0.298 | 0.012 |
| HCM Control Delay      | 8.5   | 9.5   | 8.6   | 8.9   | 9.3   | 8.1   | 8.6   | 10.2  | 7.4   |
| HCM Lane LOS           | A     | A     | A     | A     | A     | A     | A     | B     | A     |
| HCM 95th-tile Q        | 0     | 0.9   | 0.4   | 0     | 0.2   | 0.2   | 0.1   | 1.2   | 0     |

| Intersection              |      |  |  |  |  |  |  |  |  |  |  |  |
|---------------------------|------|--|--|--|--|--|--|--|--|--|--|--|
| Intersection Delay, s/veh | 10.2 |  |  |  |  |  |  |  |  |  |  |  |
| Intersection LOS          | B    |  |  |  |  |  |  |  |  |  |  |  |

| Movement            | EBL  | EBT  | EBR  | WBL  | WBT  | WBR  | NBL  | NBT  | NBR  | SBL  | SBT  | SBR  |
|---------------------|------|------|------|------|------|------|------|------|------|------|------|------|
| Lane Configurations |      | ↕    |      |      | ↕    |      | ↕    | ↕    |      | ↕    | ↕    |      |
| Traffic Vol, veh/h  | 4    | 13   | 8    | 63   | 47   | 118  | 17   | 160  | 25   | 11   | 118  | 4    |
| Future Vol, veh/h   | 4    | 13   | 8    | 63   | 47   | 118  | 17   | 160  | 25   | 11   | 118  | 4    |
| Peak Hour Factor    | 0.85 | 0.85 | 0.85 | 0.85 | 0.85 | 0.85 | 0.85 | 0.85 | 0.85 | 0.85 | 0.85 | 0.85 |
| Heavy Vehicles, %   | 0    | 0    | 0    | 1    | 1    | 1    | 0    | 0    | 0    | 1    | 1    | 1    |
| Mvmt Flow           | 5    | 15   | 9    | 74   | 55   | 139  | 20   | 188  | 29   | 13   | 139  | 5    |
| Number of Lanes     | 0    | 1    | 0    | 0    | 1    | 0    | 1    | 1    | 0    | 1    | 1    | 0    |

| Approach                   | EB  | WB   | NB   | SB  |
|----------------------------|-----|------|------|-----|
| Opposing Approach          | WB  | EB   | SB   | NB  |
| Opposing Lanes             | 1   | 1    | 2    | 2   |
| Conflicting Approach Left  | SB  | NB   | EB   | WB  |
| Conflicting Lanes Left     | 2   | 2    | 1    | 1   |
| Conflicting Approach Right | NB  | SB   | WB   | EB  |
| Conflicting Lanes Right    | 2   | 2    | 1    | 1   |
| HCM Control Delay          | 8.4 | 10.3 | 10.5 | 9.7 |
| HCM LOS                    | A   | B    | B    | A   |

| Lane                   | NBLn1 | NBLn2 | EBLn1 | WBLn1 | SBLn1 | SBLn2 |
|------------------------|-------|-------|-------|-------|-------|-------|
| Vol Left, %            | 100%  | 0%    | 16%   | 28%   | 100%  | 0%    |
| Vol Thru, %            | 0%    | 86%   | 52%   | 21%   | 0%    | 97%   |
| Vol Right, %           | 0%    | 14%   | 32%   | 52%   | 0%    | 3%    |
| Sign Control           | Stop  | Stop  | Stop  | Stop  | Stop  | Stop  |
| Traffic Vol by Lane    | 17    | 185   | 25    | 228   | 11    | 122   |
| LT Vol                 | 17    | 0     | 4     | 63    | 11    | 0     |
| Through Vol            | 0     | 160   | 13    | 47    | 0     | 118   |
| RT Vol                 | 0     | 25    | 8     | 118   | 0     | 4     |
| Lane Flow Rate         | 20    | 218   | 29    | 268   | 13    | 144   |
| Geometry Grp           | 7     | 7     | 2     | 2     | 7     | 7     |
| Degree of Util (X)     | 0.033 | 0.32  | 0.042 | 0.351 | 0.022 | 0.218 |
| Departure Headway (Hd) | 5.894 | 5.293 | 5.114 | 4.706 | 5.999 | 5.47  |
| Convergence, Y/N       | Yes   | Yes   | Yes   | Yes   | Yes   | Yes   |
| Cap                    | 603   | 673   | 692   | 759   | 592   | 650   |
| Service Time           | 3.673 | 3.072 | 3.206 | 2.764 | 3.783 | 3.255 |
| HCM Lane V/C Ratio     | 0.033 | 0.324 | 0.042 | 0.353 | 0.022 | 0.222 |
| HCM Control Delay      | 8.9   | 10.6  | 8.4   | 10.3  | 8.9   | 9.8   |
| HCM Lane LOS           | A     | B     | A     | B     | A     | A     |
| HCM 95th-tile Q        | 0.1   | 1.4   | 0.1   | 1.6   | 0.1   | 0.8   |

HCM 2010 Signalized Intersection Summary  
 31: 1st Avenue & Lightfighter Drive

Existing, PM  
 06/11/2019



| Movement                     | EBL  | EBT  | EBR  | WBL  | WBT  | WBR  | NBL  | NBT  | NBR  | SBL  | SBT  | SBR  |
|------------------------------|------|------|------|------|------|------|------|------|------|------|------|------|
| Lane Configurations          |      | ↑↑   | ↑    | ↑    | ↑↑   |      | ↑    |      | ↑    | ↑    | ↑    | ↑    |
| Traffic Volume (veh/h)       | 0    | 453  | 103  | 14   | 971  | 0    | 195  | 0    | 22   | 1    | 0    | 20   |
| Future Volume (veh/h)        | 0    | 453  | 103  | 14   | 971  | 0    | 195  | 0    | 22   | 1    | 0    | 20   |
| Number                       | 7    | 4    | 14   | 3    | 8    | 18   | 5    | 2    | 12   | 1    | 6    | 16   |
| Initial Q (Qb), veh          | 0    | 0    | 0    | 0    | 0    | 0    | 0    | 0    | 0    | 0    | 0    | 0    |
| Ped-Bike Adj(A_pbT)          | 1.00 |      | 1.00 | 1.00 |      | 1.00 | 1.00 |      | 1.00 | 1.00 |      | 1.00 |
| Parking Bus, Adj             | 1.00 | 1.00 | 1.00 | 1.00 | 1.00 | 1.00 | 1.00 | 1.00 | 1.00 | 1.00 | 1.00 | 1.00 |
| Adj Sat Flow, veh/h/ln       | 0    | 1881 | 1881 | 1881 | 1881 | 0    | 1881 | 0    | 1881 | 1810 | 1810 | 1810 |
| Adj Flow Rate, veh/h         | 0    | 477  | 0    | 15   | 1022 | 0    | 205  | 0    | 5    | 1    | 0    | 1    |
| Adj No. of Lanes             | 0    | 2    | 1    | 1    | 2    | 0    | 1    | 0    | 1    | 1    | 1    | 1    |
| Peak Hour Factor             | 0.95 | 0.95 | 0.95 | 0.95 | 0.95 | 0.95 | 0.95 | 0.95 | 0.95 | 0.95 | 0.95 | 0.95 |
| Percent Heavy Veh, %         | 0    | 1    | 1    | 1    | 1    | 0    | 1    | 0    | 1    | 5    | 5    | 5    |
| Cap, veh/h                   | 0    | 1878 | 840  | 16   | 2367 | 0    | 0    | 0    | 0    | 6    | 7    | 6    |
| Arrive On Green              | 0.00 | 0.53 | 0.00 | 0.01 | 0.66 | 0.00 | 0.00 | 0.00 | 0.00 | 0.00 | 0.00 | 0.00 |
| Sat Flow, veh/h              | 0    | 3668 | 1599 | 1792 | 3668 | 0    | 0    | 0    | 1723 | 1810 | 1538 |      |
| Grp Volume(v), veh/h         | 0    | 477  | 0    | 15   | 1022 | 0    | 0.0  | 0.0  | 0.0  | 1    | 0    | 1    |
| Grp Sat Flow(s),veh/h/ln     | 0    | 1787 | 1599 | 1792 | 1787 | 0    | 0.0  | 0.0  | 0.0  | 1723 | 1810 | 1538 |
| Q Serve(g_s), s              | 0.0  | 2.0  | 0.0  | 0.2  | 3.7  | 0.0  | 0.0  | 0.0  | 0.0  | 0.0  | 0.0  | 0.0  |
| Cycle Q Clear(g_c), s        | 0.0  | 2.0  | 0.0  | 0.2  | 3.7  | 0.0  | 0.0  | 0.0  | 0.0  | 0.0  | 0.0  | 0.0  |
| Prop In Lane                 | 0.00 |      | 1.00 | 1.00 |      | 0.00 |      |      |      | 1.00 |      | 1.00 |
| Lane Grp Cap(c), veh/h       | 0    | 1878 | 840  | 16   | 2367 | 0    | 0    | 0    | 0    | 6    | 7    | 6    |
| V/C Ratio(X)                 | 0.00 | 0.25 | 0.00 | 0.95 | 0.43 | 0.00 | 0.00 | 0.00 | 0.00 | 0.16 | 0.00 | 0.18 |
| Avail Cap(c_a), veh/h        | 0    | 5884 | 2632 | 1311 | 5884 | 0    | 0    | 0    | 0    | 1576 | 1655 | 1407 |
| HCM Platoon Ratio            | 1.00 | 1.00 | 1.00 | 1.00 | 1.00 | 1.00 | 1.00 | 1.00 | 1.00 | 1.00 | 1.00 | 1.00 |
| Upstream Filter(I)           | 0.00 | 1.00 | 0.00 | 1.00 | 1.00 | 0.00 | 0.00 | 0.00 | 0.00 | 1.00 | 0.00 | 1.00 |
| Uniform Delay (d), s/veh     | 0.0  | 3.6  | 0.0  | 13.5 | 2.2  | 0.0  | 0.0  | 0.0  | 0.0  | 13.6 | 0.0  | 13.6 |
| Incr Delay (d2), s/veh       | 0.0  | 0.1  | 0.0  | 52.7 | 0.2  | 0.0  | 0.0  | 0.0  | 0.0  | 4.3  | 0.0  | 5.5  |
| Initial Q Delay(d3),s/veh    | 0.0  | 0.0  | 0.0  | 0.0  | 0.0  | 0.0  | 0.0  | 0.0  | 0.0  | 0.0  | 0.0  | 0.0  |
| %ile BackOfQ(50%),veh/ln     | 0.0  | 1.0  | 0.0  | 0.3  | 1.8  | 0.0  | 0.0  | 0.0  | 0.0  | 0.0  | 0.0  | 0.0  |
| LnGrp Delay(d),s/veh         | 0.0  | 3.7  | 0.0  | 66.2 | 2.4  | 0.0  | 0.0  | 0.0  | 0.0  | 17.9 | 0.0  | 19.1 |
| LnGrp LOS                    |      | A    |      | E    | A    |      |      |      |      | B    |      | B    |
| Approach Vol, veh/h          |      | 477  |      |      | 1037 |      |      |      |      |      | 2    |      |
| Approach Delay, s/veh        |      | 3.7  |      |      | 3.3  |      |      |      |      |      | 18.5 |      |
| Approach LOS                 |      | A    |      |      | A    |      |      |      |      |      | B    |      |
| Timer                        | 1    | 2    | 3    | 4    | 5    | 6    | 7    | 8    |      |      |      |      |
| Assigned Phs                 |      |      | 3    | 4    |      | 6    |      | 8    |      |      |      |      |
| Phs Duration (G+Y+Rc), s     |      |      | 3.7  | 19.0 |      | 4.6  |      | 22.7 |      |      |      |      |
| Change Period (Y+Rc), s      |      |      | 3.5  | 4.6  |      | 4.6  |      | 4.6  |      |      |      |      |
| Max Green Setting (Gmax), s  |      |      | 20.0 | 45.0 |      | 25.0 |      | 45.0 |      |      |      |      |
| Max Q Clear Time (g_c+I1), s |      |      | 2.2  | 4.0  |      | 2.0  |      | 5.7  |      |      |      |      |
| Green Ext Time (p_c), s      |      |      | 0.0  | 5.1  |      | 0.0  |      | 12.4 |      |      |      |      |
| <b>Intersection Summary</b>  |      |      |      |      |      |      |      |      |      |      |      |      |
| HCM 2010 Ctrl Delay          |      |      | 3.4  |      |      |      |      |      |      |      |      |      |
| HCM 2010 LOS                 |      |      | A    |      |      |      |      |      |      |      |      |      |

HCM 2010 Signalized Intersection Summary  
 32: 2nd Avenue & Lightfighter Drive

Existing, PM  
 06/11/2019



| Movement                      | EBL  | EBT  | EBR  | WBL  | WBT  | WBR  | NBL  | NBT  | NBR  | SBL  | SBT  | SBR  |
|-------------------------------|------|------|------|------|------|------|------|------|------|------|------|------|
| Lane Configurations           |      |      |      |      |      |      |      |      |      |      |      |      |
| Traffic Volume (veh/h)        | 145  | 322  | 1    | 2    | 868  | 126  | 5    | 1    | 8    | 78   | 5    | 113  |
| Future Volume (veh/h)         | 145  | 322  | 1    | 2    | 868  | 126  | 5    | 1    | 8    | 78   | 5    | 113  |
| Number                        | 5    | 2    | 12   | 1    | 6    | 16   | 3    | 8    | 18   | 7    | 4    | 14   |
| Initial Q (Qb), veh           | 0    | 0    | 0    | 0    | 0    | 0    | 0    | 0    | 0    | 0    | 0    | 0    |
| Ped-Bike Adj(A_pbT)           | 1.00 |      | 1.00 | 1.00 |      | 1.00 | 0.99 |      | 0.99 | 0.99 |      | 0.99 |
| Parking Bus, Adj              | 1.00 | 1.00 | 1.00 | 1.00 | 1.00 | 1.00 | 1.00 | 1.00 | 1.00 | 1.00 | 1.00 | 1.00 |
| Adj Sat Flow, veh/h/ln        | 1881 | 1881 | 1900 | 1881 | 1881 | 1900 | 1900 | 1900 | 1900 | 1845 | 1845 | 1845 |
| Adj Flow Rate, veh/h          | 153  | 339  | 1    | 2    | 914  | 128  | 5    | 1    | 2    | 82   | 5    | 16   |
| Adj No. of Lanes              | 1    | 2    | 0    | 1    | 2    | 0    | 0    | 1    | 0    | 1    | 1    | 1    |
| Peak Hour Factor              | 0.95 | 0.95 | 0.95 | 0.95 | 0.95 | 0.95 | 0.95 | 0.95 | 0.95 | 0.95 | 0.95 | 0.95 |
| Percent Heavy Veh, %          | 1    | 1    | 1    | 1    | 1    | 1    | 0    | 0    | 0    | 3    | 3    | 3    |
| Cap, veh/h                    | 184  | 2832 | 8    | 4    | 2124 | 297  | 133  | 30   | 35   | 199  | 168  | 141  |
| Arrive On Green               | 0.10 | 0.77 | 0.77 | 0.00 | 0.67 | 0.67 | 0.10 | 0.09 | 0.09 | 0.09 | 0.09 | 0.09 |
| Sat Flow, veh/h               | 1792 | 3656 | 11   | 1792 | 3149 | 441  | 818  | 330  | 383  | 1376 | 1845 | 1547 |
| Grp Volume(v), veh/h          | 153  | 166  | 174  | 2    | 519  | 523  | 8    | 0    | 0    | 82   | 5    | 16   |
| Grp Sat Flow(s),veh/h/ln      | 1792 | 1787 | 1879 | 1792 | 1787 | 1803 | 1531 | 0    | 0    | 1376 | 1845 | 1547 |
| Q Serve(g_s), s               | 8.4  | 2.3  | 2.3  | 0.1  | 13.3 | 13.3 | 0.0  | 0.0  | 0.0  | 5.2  | 0.2  | 0.9  |
| Cycle Q Clear(g_c), s         | 8.4  | 2.3  | 2.3  | 0.1  | 13.3 | 13.3 | 0.4  | 0.0  | 0.0  | 5.6  | 0.2  | 0.9  |
| Prop In Lane                  | 1.00 |      | 0.01 | 1.00 |      | 0.24 | 0.62 |      | 0.25 | 1.00 |      | 1.00 |
| Lane Grp Cap(c), veh/h        | 184  | 1385 | 1456 | 4    | 1205 | 1216 | 207  | 0    | 0    | 199  | 168  | 141  |
| V/C Ratio(X)                  | 0.83 | 0.12 | 0.12 | 0.52 | 0.43 | 0.43 | 0.04 | 0.00 | 0.00 | 0.41 | 0.03 | 0.11 |
| Avail Cap(c_a), veh/h         | 222  | 1385 | 1456 | 222  | 1205 | 1216 | 674  | 0    | 0    | 629  | 745  | 625  |
| HCM Platoon Ratio             | 1.00 | 1.00 | 1.00 | 1.00 | 1.00 | 1.00 | 1.00 | 1.00 | 1.00 | 1.00 | 1.00 | 1.00 |
| Upstream Filter(I)            | 0.98 | 0.98 | 0.98 | 0.37 | 0.37 | 0.37 | 1.00 | 0.00 | 0.00 | 1.00 | 1.00 | 1.00 |
| Uniform Delay (d), s/veh      | 44.0 | 2.8  | 2.8  | 49.8 | 7.5  | 7.5  | 41.3 | 0.0  | 0.0  | 43.8 | 41.4 | 41.7 |
| Incr Delay (d2), s/veh        | 16.7 | 0.2  | 0.2  | 13.7 | 0.4  | 0.4  | 0.0  | 0.0  | 0.0  | 0.5  | 0.0  | 0.1  |
| Initial Q Delay(d3),s/veh     | 0.0  | 0.0  | 0.0  | 0.0  | 0.0  | 0.0  | 0.0  | 0.0  | 0.0  | 0.0  | 0.0  | 0.0  |
| %ile BackOfQ(50%),veh/ln      | 6.0  | 1.2  | 1.2  | 0.1  | 6.6  | 6.7  | 0.2  | 0.0  | 0.0  | 2.2  | 0.1  | 0.4  |
| LnGrp Delay(d),s/veh          | 60.7 | 3.0  | 3.0  | 63.5 | 7.9  | 7.9  | 41.3 | 0.0  | 0.0  | 44.3 | 41.4 | 41.9 |
| LnGrp LOS                     | E    | A    | A    | E    | A    | A    | D    |      |      | D    | D    | D    |
| Approach Vol, veh/h           |      | 493  |      |      | 1044 |      |      | 8    |      |      | 103  |      |
| Approach Delay, s/veh         |      | 20.9 |      |      | 8.0  |      |      | 41.3 |      |      | 43.8 |      |
| Approach LOS                  |      | C    |      |      | A    |      |      | D    |      |      | D    |      |
| Timer                         | 1    | 2    | 3    | 4    | 5    | 6    | 7    | 8    |      |      |      |      |
| Assigned Phs                  | 1    | 2    |      | 4    | 5    | 6    |      | 8    |      |      |      |      |
| Phs Duration (G+Y+Rc), s      | 4.2  | 82.1 |      | 13.7 | 14.3 | 72.0 |      | 13.7 |      |      |      |      |
| Change Period (Y+Rc), s       | 4.0  | 4.6  |      | 4.6  | 4.0  | 4.6  |      | 4.6  |      |      |      |      |
| Max Green Setting (Gmax), s   | 4.4  | 34.0 |      | 40.4 | 12.4 | 24.4 |      | 40.4 |      |      |      |      |
| Max Q Clear Time (g_c+1/2), s | 4.3  | 4.3  |      | 7.6  | 10.4 | 15.3 |      | 2.4  |      |      |      |      |
| Green Ext Time (p_c), s       | 0.0  | 1.1  |      | 0.1  | 0.0  | 3.0  |      | 0.0  |      |      |      |      |
| <b>Intersection Summary</b>   |      |      |      |      |      |      |      |      |      |      |      |      |
| HCM 2010 Ctrl Delay           |      |      | 14.2 |      |      |      |      |      |      |      |      |      |
| HCM 2010 LOS                  |      |      | B    |      |      |      |      |      |      |      |      |      |

HCM 2010 Signalized Intersection Summary  
 33: General Jim Moore Boulevard & Lightfighter Drive

Existing, PM  
 06/11/2019



| Movement                    | EBL  | EBT  | EBR  | WBL  | WBT  | WBR  | NBL  | NBT  | NBR  | SBL  | SBT  | SBR  |
|-----------------------------|------|------|------|------|------|------|------|------|------|------|------|------|
| Lane Configurations         |      |      |      |      |      |      |      |      |      |      |      |      |
| Traffic Volume (veh/h)      | 66   | 138  | 200  | 8    | 213  | 7    | 649  | 108  | 7    | 7    | 86   | 137  |
| Future Volume (veh/h)       | 66   | 138  | 200  | 8    | 213  | 7    | 649  | 108  | 7    | 7    | 86   | 137  |
| Number                      | 3    | 8    | 18   | 7    | 4    | 14   | 1    | 6    | 16   | 5    | 2    | 12   |
| Initial Q (Qb), veh         | 0    | 0    | 0    | 0    | 0    | 0    | 0    | 0    | 0    | 0    | 0    | 0    |
| Ped-Bike Adj(A_pbT)         | 1.00 |      | 1.00 | 1.00 |      | 1.00 | 1.00 |      | 1.00 | 1.00 |      | 1.00 |
| Parking Bus, Adj            | 1.00 | 1.00 | 1.00 | 1.00 | 1.00 | 1.00 | 1.00 | 1.00 | 1.00 | 1.00 | 1.00 | 1.00 |
| Adj Sat Flow, veh/h/ln      | 1881 | 1881 | 1881 | 1900 | 1900 | 1900 | 1881 | 1881 | 1900 | 1900 | 1900 | 1900 |
| Adj Flow Rate, veh/h        | 69   | 144  | 0    | 8    | 222  | 6    | 676  | 112  | 5    | 7    | 90   | 31   |
| Adj No. of Lanes            | 1    | 1    | 1    | 1    | 1    | 0    | 2    | 1    | 0    | 1    | 2    | 0    |
| Peak Hour Factor            | 0.96 | 0.96 | 0.96 | 0.96 | 0.96 | 0.96 | 0.96 | 0.96 | 0.96 | 0.96 | 0.96 | 0.96 |
| Percent Heavy Veh, %        | 1    | 1    | 1    | 0    | 0    | 0    | 1    | 1    | 1    | 0    | 0    | 0    |
| Cap, veh/h                  | 92   | 438  | 372  | 15   | 349  | 9    | 776  | 625  | 28   | 13   | 357  | 118  |
| Arrive On Green             | 0.05 | 0.23 | 0.00 | 0.01 | 0.19 | 0.19 | 0.22 | 0.35 | 0.35 | 0.01 | 0.13 | 0.13 |
| Sat Flow, veh/h             | 1792 | 1881 | 1599 | 1810 | 1841 | 50   | 3476 | 1787 | 80   | 1810 | 2669 | 880  |
| Grp Volume(v), veh/h        | 69   | 144  | 0    | 8    | 0    | 228  | 676  | 0    | 117  | 7    | 60   | 61   |
| Grp Sat Flow(s),veh/h/ln    | 1792 | 1881 | 1599 | 1810 | 0    | 1891 | 1738 | 0    | 1867 | 1810 | 1805 | 1745 |
| Q Serve(g_s), s             | 1.7  | 2.8  | 0.0  | 0.2  | 0.0  | 5.0  | 8.4  | 0.0  | 1.9  | 0.2  | 1.3  | 1.4  |
| Cycle Q Clear(g_c), s       | 1.7  | 2.8  | 0.0  | 0.2  | 0.0  | 5.0  | 8.4  | 0.0  | 1.9  | 0.2  | 1.3  | 1.4  |
| Prop In Lane                | 1.00 |      | 1.00 | 1.00 |      | 0.03 | 1.00 |      | 0.04 | 1.00 |      | 0.50 |
| Lane Grp Cap(c), veh/h      | 92   | 438  | 372  | 15   | 0    | 359  | 776  | 0    | 653  | 13   | 242  | 234  |
| V/C Ratio(X)                | 0.75 | 0.33 | 0.00 | 0.52 | 0.00 | 0.64 | 0.87 | 0.00 | 0.18 | 0.52 | 0.25 | 0.26 |
| Avail Cap(c_a), veh/h       | 800  | 1260 | 1071 | 808  | 0    | 1266 | 776  | 0    | 1250 | 606  | 1209 | 1168 |
| HCM Platoon Ratio           | 1.00 | 1.00 | 1.00 | 1.00 | 1.00 | 1.00 | 1.00 | 1.00 | 1.00 | 1.00 | 1.00 | 1.00 |
| Upstream Filter(I)          | 1.00 | 1.00 | 0.00 | 1.00 | 0.00 | 1.00 | 1.00 | 0.00 | 1.00 | 1.00 | 1.00 | 1.00 |
| Uniform Delay (d), s/veh    | 21.0 | 14.3 | 0.0  | 22.1 | 0.0  | 16.7 | 16.8 | 0.0  | 10.1 | 22.2 | 17.4 | 17.4 |
| Incr Delay (d2), s/veh      | 11.4 | 0.5  | 0.0  | 9.8  | 0.0  | 2.3  | 10.4 | 0.0  | 0.3  | 11.0 | 0.6  | 0.7  |
| Initial Q Delay(d3),s/veh   | 0.0  | 0.0  | 0.0  | 0.0  | 0.0  | 0.0  | 0.0  | 0.0  | 0.0  | 0.0  | 0.0  | 0.0  |
| %ile BackOfQ(50%),veh/ln    | 1.1  | 1.5  | 0.0  | 0.1  | 0.0  | 2.8  | 5.2  | 0.0  | 1.1  | 0.1  | 0.7  | 0.7  |
| LnGrp Delay(d),s/veh        | 32.4 | 14.8 | 0.0  | 32.0 | 0.0  | 19.0 | 27.2 | 0.0  | 10.4 | 33.1 | 18.0 | 18.1 |
| LnGrp LOS                   | C    | B    |      | C    |      | B    | C    |      | B    | C    | B    | B    |
| Approach Vol, veh/h         |      | 213  |      |      | 236  |      |      | 793  |      |      | 128  |      |
| Approach Delay, s/veh       |      | 20.5 |      |      | 19.4 |      |      | 24.7 |      |      | 18.9 |      |
| Approach LOS                |      | C    |      |      | B    |      |      | C    |      |      | B    |      |
| Timer                       | 1    | 2    | 3    | 4    | 5    | 6    | 7    | 8    |      |      |      |      |
| Assigned Phs                | 1    | 2    | 3    | 4    | 5    | 6    | 7    | 8    |      |      |      |      |
| Phs Duration (G+Y+Rc), s    | 4.5  | 10.5 | 6.8  | 13.0 | 4.8  | 20.2 | 4.9  | 14.9 |      |      |      |      |
| Change Period (Y+Rc), s     | 4.5  | 4.5  | 4.5  | 4.5  | 4.5  | 4.5  | 4.5  | 4.5  |      |      |      |      |
| Max Green Setting (Gmax), s | 30.0 | 30.0 | 20.0 | 30.0 | 15.0 | 30.0 | 20.0 | 30.0 |      |      |      |      |
| Max Q Clear Time (g_c+1), s | 3.4  | 3.7  | 7.0  | 2.2  | 3.9  | 2.2  | 4.8  |      |      |      |      |      |
| Green Ext Time (p_c), s     | 0.0  | 0.7  | 0.1  | 1.6  | 0.0  | 1.1  | 0.0  | 0.8  |      |      |      |      |
| <b>Intersection Summary</b> |      |      |      |      |      |      |      |      |      |      |      |      |
| HCM 2010 Ctrl Delay         |      |      |      | 22.6 |      |      |      |      |      |      |      |      |
| HCM 2010 LOS                |      |      |      | C    |      |      |      |      |      |      |      |      |

| Intersection              |     |
|---------------------------|-----|
| Intersection Delay, s/veh | 8.3 |
| Intersection LOS          | A   |

| Movement            | WBL  | WBR  | NBT  | NBR  | SBL  | SBT  |
|---------------------|------|------|------|------|------|------|
| Lane Configurations |      |      |      |      |      |      |
| Traffic Vol, veh/h  | 6    | 167  | 45   | 5    | 115  | 37   |
| Future Vol, veh/h   | 6    | 167  | 45   | 5    | 115  | 37   |
| Peak Hour Factor    | 0.88 | 0.88 | 0.88 | 0.88 | 0.88 | 0.88 |
| Heavy Vehicles, %   | 0    | 0    | 2    | 2    | 1    | 1    |
| Mvmt Flow           | 7    | 190  | 51   | 6    | 131  | 42   |
| Number of Lanes     | 1    | 0    | 1    | 0    | 0    | 1    |

| Approach                   | WB  | NB  | SB  |
|----------------------------|-----|-----|-----|
| Opposing Approach          |     | SB  | NB  |
| Opposing Lanes             | 0   | 1   | 1   |
| Conflicting Approach Left  | NB  |     | WB  |
| Conflicting Lanes Left     | 1   | 0   | 1   |
| Conflicting Approach Right | SB  | WB  |     |
| Conflicting Lanes Right    | 1   | 1   | 0   |
| HCM Control Delay          | 7.9 | 7.8 | 8.8 |
| HCM LOS                    | A   | A   | A   |

| Lane                   | NBLn1 | WBLn1 | SBLn1 |
|------------------------|-------|-------|-------|
| Vol Left, %            | 0%    | 3%    | 76%   |
| Vol Thru, %            | 90%   | 0%    | 24%   |
| Vol Right, %           | 10%   | 97%   | 0%    |
| Sign Control           | Stop  | Stop  | Stop  |
| Traffic Vol by Lane    | 50    | 173   | 152   |
| LT Vol                 | 0     | 6     | 115   |
| Through Vol            | 45    | 0     | 37    |
| RT Vol                 | 5     | 167   | 0     |
| Lane Flow Rate         | 57    | 197   | 173   |
| Geometry Grp           | 1     | 1     | 1     |
| Degree of Util (X)     | 0.071 | 0.211 | 0.214 |
| Departure Headway (Hd) | 4.471 | 3.868 | 4.46  |
| Convergence, Y/N       | Yes   | Yes   | Yes   |
| Cap                    | 803   | 934   | 793   |
| Service Time           | 2.487 | 1.871 | 2.551 |
| HCM Lane V/C Ratio     | 0.071 | 0.211 | 0.218 |
| HCM Control Delay      | 7.8   | 7.9   | 8.8   |
| HCM Lane LOS           | A     | A     | A     |
| HCM 95th-tile Q        | 0.2   | 0.8   | 0.8   |

| Intersection             |      |      |      |      |      |      |
|--------------------------|------|------|------|------|------|------|
| Int Delay, s/veh         | 1.1  |      |      |      |      |      |
| Movement                 | EBT  | EBR  | WBL  | WBT  | NBL  | NBR  |
| Lane Configurations      |      |      |      |      |      |      |
| Traffic Vol, veh/h       | 101  | 4    | 2    | 136  | 24   | 4    |
| Future Vol, veh/h        | 101  | 4    | 2    | 136  | 24   | 4    |
| Conflicting Peds, #/hr   | 0    | 0    | 0    | 0    | 0    | 0    |
| Sign Control             | Free | Free | Free | Free | Stop | Stop |
| RT Channelized           | -    | None | -    | None | -    | None |
| Storage Length           | -    | -    | -    | -    | 0    | -    |
| Veh in Median Storage, # | 0    | -    | -    | 0    | 0    | -    |
| Grade, %                 | 0    | -    | -    | 0    | 0    | -    |
| Peak Hour Factor         | 85   | 85   | 85   | 85   | 85   | 85   |
| Heavy Vehicles, %        | 0    | 0    | 0    | 0    | 0    | 0    |
| Mvmt Flow                | 119  | 5    | 2    | 160  | 28   | 5    |

| Major/Minor          | Major1 | Major2 | Minor1 |   |     |
|----------------------|--------|--------|--------|---|-----|
| Conflicting Flow All | 0      | 0      | 124    | 0 | 286 |
| Stage 1              | -      | -      | -      | - | 122 |
| Stage 2              | -      | -      | -      | - | 164 |
| Critical Hdwy        | -      | -      | 4.1    | - | 6.4 |
| Critical Hdwy Stg 1  | -      | -      | -      | - | 5.4 |
| Critical Hdwy Stg 2  | -      | -      | -      | - | 5.4 |
| Follow-up Hdwy       | -      | -      | 2.2    | - | 3.5 |
| Pot Cap-1 Maneuver   | -      | -      | 1475   | - | 709 |
| Stage 1              | -      | -      | -      | - | 908 |
| Stage 2              | -      | -      | -      | - | 870 |
| Platoon blocked, %   | -      | -      | -      | - | -   |
| Mov Cap-1 Maneuver   | -      | -      | 1475   | - | 708 |
| Mov Cap-2 Maneuver   | -      | -      | -      | - | 708 |
| Stage 1              | -      | -      | -      | - | 907 |
| Stage 2              | -      | -      | -      | - | 870 |

| Approach             | EB | WB  | NB   |
|----------------------|----|-----|------|
| HCM Control Delay, s | 0  | 0.1 | 10.1 |
| HCM LOS              |    |     | B    |

| Minor Lane/Major Mvmt | NBLn1 | EBT | EBR | WBL   | WBT |
|-----------------------|-------|-----|-----|-------|-----|
| Capacity (veh/h)      | 733   | -   | -   | 1475  | -   |
| HCM Lane V/C Ratio    | 0.045 | -   | -   | 0.002 | -   |
| HCM Control Delay (s) | 10.1  | -   | -   | 7.4   | 0   |
| HCM Lane LOS          | B     | -   | -   | A     | A   |
| HCM 95th %tile Q(veh) | 0.1   | -   | -   | 0     | -   |



| Intersection              |     |
|---------------------------|-----|
| Intersection Delay, s/veh | 7.8 |
| Intersection LOS          | A   |

| Movement            | EBL  | EBT  | EBR  | WBL  | WBT  | WBR  | NBL  | NBT  | NBR  | SBL  | SBT  | SBR  |
|---------------------|------|------|------|------|------|------|------|------|------|------|------|------|
| Lane Configurations |      | ↕    |      |      | ↕    |      |      | ↕    |      |      | ↕    |      |
| Traffic Vol, veh/h  | 13   | 91   | 0    | 0    | 71   | 0    | 30   | 15   | 5    | 1    | 14   | 38   |
| Future Vol, veh/h   | 13   | 91   | 0    | 0    | 71   | 0    | 30   | 15   | 5    | 1    | 14   | 38   |
| Peak Hour Factor    | 0.82 | 0.82 | 0.82 | 0.82 | 0.82 | 0.82 | 0.82 | 0.82 | 0.82 | 0.82 | 0.82 | 0.82 |
| Heavy Vehicles, %   | 0    | 0    | 0    | 0    | 0    | 0    | 2    | 2    | 2    | 0    | 0    | 0    |
| Mvmt Flow           | 16   | 111  | 0    | 0    | 87   | 0    | 37   | 18   | 6    | 1    | 17   | 46   |
| Number of Lanes     | 0    | 1    | 0    | 0    | 1    | 0    | 0    | 1    | 0    | 0    | 1    | 0    |

| Approach                   | EB  | WB  | NB  | SB  |
|----------------------------|-----|-----|-----|-----|
| Opposing Approach          | WB  | EB  | SB  | NB  |
| Opposing Lanes             | 1   | 1   | 1   | 1   |
| Conflicting Approach Left  | SB  | NB  | EB  | WB  |
| Conflicting Lanes Left     | 1   | 1   | 1   | 1   |
| Conflicting Approach Right | NB  | SB  | WB  | EB  |
| Conflicting Lanes Right    | 1   | 1   | 1   | 1   |
| HCM Control Delay          | 8.1 | 7.8 | 7.9 | 7.3 |
| HCM LOS                    | A   | A   | A   | A   |

| Lane                   | NBLn1 | EBLn1 | WBLn1 | SBLn1 |
|------------------------|-------|-------|-------|-------|
| Vol Left, %            | 60%   | 12%   | 0%    | 2%    |
| Vol Thru, %            | 30%   | 88%   | 100%  | 26%   |
| Vol Right, %           | 10%   | 0%    | 0%    | 72%   |
| Sign Control           | Stop  | Stop  | Stop  | Stop  |
| Traffic Vol by Lane    | 50    | 104   | 71    | 53    |
| LT Vol                 | 30    | 13    | 0     | 1     |
| Through Vol            | 15    | 91    | 71    | 14    |
| RT Vol                 | 5     | 0     | 0     | 38    |
| Lane Flow Rate         | 61    | 127   | 87    | 65    |
| Geometry Grp           | 1     | 1     | 1     | 1     |
| Degree of Util (X)     | 0.077 | 0.148 | 0.104 | 0.072 |
| Departure Headway (Hd) | 4.539 | 4.209 | 4.322 | 4.021 |
| Convergence, Y/N       | Yes   | Yes   | Yes   | Yes   |
| Cap                    | 793   | 838   | 834   | 895   |
| Service Time           | 2.547 | 2.307 | 2.322 | 2.028 |
| HCM Lane V/C Ratio     | 0.077 | 0.152 | 0.104 | 0.073 |
| HCM Control Delay      | 7.9   | 8.1   | 7.8   | 7.3   |
| HCM Lane LOS           | A     | A     | A     | A     |
| HCM 95th-tile Q        | 0.2   | 0.5   | 0.3   | 0.2   |

| Intersection             |      |      |      |      |      |      |      |      |      |      |      |      |
|--------------------------|------|------|------|------|------|------|------|------|------|------|------|------|
| Int Delay, s/veh         | 7    |      |      |      |      |      |      |      |      |      |      |      |
| Movement                 | EBL  | EBT  | EBR  | WBL  | WBT  | WBR  | NBL  | NBT  | NBR  | SBL  | SBT  | SBR  |
| Lane Configurations      |      | ↕    |      |      | ↕    |      |      | ↕    |      |      | ↕    |      |
| Traffic Vol, veh/h       | 17   | 85   | 1    | 0    | 50   | 0    | 0    | 36   | 0    | 0    | 23   | 14   |
| Future Vol, veh/h        | 17   | 85   | 1    | 0    | 50   | 0    | 0    | 36   | 0    | 0    | 23   | 14   |
| Conflicting Peds, #/hr   | 0    | 0    | 0    | 0    | 0    | 0    | 0    | 0    | 0    | 0    | 0    | 0    |
| Sign Control             | Stop | Stop | Stop | Stop | Stop | Stop | Free | Free | Free | Free | Free | Free |
| RT Channelized           | -    | -    | None | -    | -    | None | -    | -    | None | -    | -    | None |
| Storage Length           | -    | -    | -    | -    | -    | -    | -    | -    | -    | -    | -    | -    |
| Veh in Median Storage, # | -    | 0    | -    | -    | 0    | -    | -    | 0    | -    | -    | 0    | -    |
| Grade, %                 | -    | 0    | -    | -    | 0    | -    | -    | 0    | -    | -    | 0    | -    |
| Peak Hour Factor         | 74   | 74   | 74   | 74   | 74   | 74   | 74   | 74   | 74   | 74   | 74   | 74   |
| Heavy Vehicles, %        | 3    | 3    | 3    | 2    | 2    | 2    | 3    | 3    | 3    | 8    | 8    | 8    |
| Mvmt Flow                | 23   | 115  | 1    | 0    | 68   | 0    | 0    | 49   | 0    | 0    | 31   | 19   |

| Major/Minor          | Minor2 |       | Minor1 |       | Major1 |       |       | Major2 |   |       |   |   |
|----------------------|--------|-------|--------|-------|--------|-------|-------|--------|---|-------|---|---|
| Conflicting Flow All | 124    | 90    | 41     | 148   | 99     | 49    | 50    | 0      | 0 | 49    | 0 | 0 |
| Stage 1              | 41     | 41    | -      | 49    | 49     | -     | -     | -      | - | -     | - | - |
| Stage 2              | 83     | 49    | -      | 99    | 50     | -     | -     | -      | - | -     | - | - |
| Critical Hdwy        | 7.13   | 6.53  | 6.23   | 7.12  | 6.52   | 6.22  | 4.13  | -      | - | 4.18  | - | - |
| Critical Hdwy Stg 1  | 6.13   | 5.53  | -      | 6.12  | 5.52   | -     | -     | -      | - | -     | - | - |
| Critical Hdwy Stg 2  | 6.13   | 5.53  | -      | 6.12  | 5.52   | -     | -     | -      | - | -     | - | - |
| Follow-up Hdwy       | 3.527  | 4.027 | 3.327  | 3.518 | 4.018  | 3.318 | 2.227 | -      | - | 2.272 | - | - |
| Pot Cap-1 Maneuver   | 848    | 798   | 1027   | 820   | 791    | 1020  | 1550  | -      | - | 1520  | - | - |
| Stage 1              | 971    | 859   | -      | 964   | 854    | -     | -     | -      | - | -     | - | - |
| Stage 2              | 923    | 852   | -      | 907   | 853    | -     | -     | -      | - | -     | - | - |
| Platoon blocked, %   |        |       |        |       |        |       |       | -      | - | -     | - | - |
| Mov Cap-1 Maneuver   | 793    | 798   | 1027   | 728   | 791    | 1020  | 1550  | -      | - | 1520  | - | - |
| Mov Cap-2 Maneuver   | 793    | 798   | -      | 728   | 791    | -     | -     | -      | - | -     | - | - |
| Stage 1              | 971    | 859   | -      | 964   | 854    | -     | -     | -      | - | -     | - | - |
| Stage 2              | 850    | 852   | -      | 785   | 853    | -     | -     | -      | - | -     | - | - |

| Approach             | EB   |  | WB |  | NB |  | SB |  |
|----------------------|------|--|----|--|----|--|----|--|
| HCM Control Delay, s | 10.5 |  | 10 |  | 0  |  | 0  |  |
| HCM LOS              | B    |  | B  |  |    |  |    |  |

| Minor Lane/Major Mvmt | NBL  | NBT | NBR | EBLn1 | WBLn1 | SBL  | SBT | SBR |
|-----------------------|------|-----|-----|-------|-------|------|-----|-----|
| Capacity (veh/h)      | 1550 | -   | -   | 799   | 791   | 1520 | -   | -   |
| HCM Lane V/C Ratio    | -    | -   | -   | 0.174 | 0.085 | -    | -   | -   |
| HCM Control Delay (s) | 0    | -   | -   | 10.5  | 10    | 0    | -   | -   |
| HCM Lane LOS          | A    | -   | -   | B     | B     | A    | -   | -   |
| HCM 95th %tile Q(veh) | 0    | -   | -   | 0.6   | 0.3   | 0    | -   | -   |

| Intersection             |      |      |      |      |      |      |
|--------------------------|------|------|------|------|------|------|
| Int Delay, s/veh         | 2    |      |      |      |      |      |
| Movement                 | EBL  | EBR  | NBL  | NBT  | SBT  | SBR  |
| Lane Configurations      | T    |      |      | T    |      |      |
| Traffic Vol, veh/h       | 86   | 1    | 0    | 340  | 117  | 54   |
| Future Vol, veh/h        | 86   | 1    | 0    | 340  | 117  | 54   |
| Conflicting Peds, #/hr   | 0    | 0    | 0    | 0    | 0    | 0    |
| Sign Control             | Stop | Stop | Free | Free | Free | Free |
| RT Channelized           | -    | None | -    | None | -    | None |
| Storage Length           | 0    | -    | -    | -    | -    | -    |
| Veh in Median Storage, # | 0    | -    | -    | 0    | 0    | -    |
| Grade, %                 | 0    | -    | -    | 0    | 0    | -    |
| Peak Hour Factor         | 88   | 88   | 88   | 88   | 88   | 88   |
| Heavy Vehicles, %        | 0    | 0    | 2    | 2    | 1    | 1    |
| Mvmt Flow                | 98   | 1    | 0    | 386  | 133  | 61   |























| Major/Minor          | Minor2 | Major1 |       | Major2 |   |
|----------------------|--------|--------|-------|--------|---|
| Conflicting Flow All | 550    | 164    | 194   | 0      | 0 |
| Stage 1              | 164    | -      | -     | -      | - |
| Stage 2              | 386    | -      | -     | -      | - |
| Critical Hdwy        | 6.4    | 6.2    | 4.12  | -      | - |
| Critical Hdwy Stg 1  | 5.4    | -      | -     | -      | - |
| Critical Hdwy Stg 2  | 5.4    | -      | -     | -      | - |
| Follow-up Hdwy       | 3.5    | 3.3    | 2.218 | -      | - |
| Pot Cap-1 Maneuver   | 500    | 886    | 1379  | -      | - |
| Stage 1              | 870    | -      | -     | -      | - |
| Stage 2              | 691    | -      | -     | -      | - |
| Platoon blocked, %   |        |        |       | -      | - |
| Mov Cap-1 Maneuver   | 500    | 886    | 1379  | -      | - |
| Mov Cap-2 Maneuver   | 500    | -      | -     | -      | - |
| Stage 1              | 870    | -      | -     | -      | - |
| Stage 2              | 691    | -      | -     | -      | - |

| Approach             | EB   | NB | SB |
|----------------------|------|----|----|
| HCM Control Delay, s | 13.9 | 0  | 0  |
| HCM LOS              | B    |    |    |

| Minor Lane/Major Mvmt | NBL  | NBT | EBLn1 | SBT | SBR |
|-----------------------|------|-----|-------|-----|-----|
| Capacity (veh/h)      | 1379 | -   | 503   | -   | -   |
| HCM Lane V/C Ratio    | -    | -   | 0.197 | -   | -   |
| HCM Control Delay (s) | 0    | -   | 13.9  | -   | -   |
| HCM Lane LOS          | A    | -   | B     | -   | -   |
| HCM 95th %tile Q(veh) | 0    | -   | 0.7   | -   | -   |

HCM 2010 Signalized Intersection Summary  
 39: General Jim Moore Boulevard & Gigling Road

Existing, PM  
 06/11/2019

|                              |  |  |  |  |  |  |   |  |  |  |  |  |
|------------------------------|---|---|---|---|---|---|---|---|---|---|---|---|
| Movement                     | EBL   | EBT   | EBR   | WBL   | WBT   | WBR   | NBL   | NBT   | NBR   | SBL   | SBT   | SBR   |
| Lane Configurations          |  |  |   |  |  |  |  |  |  |  |  |  |
| Traffic Volume (veh/h)       | 18  | 12  | 27  | 167   | 42  | 218   | 57  | 554   | 308   | 67  | 234   | 46  |
| Future Volume (veh/h)        | 18  | 12  | 27  | 167   | 42  | 218   | 57  | 554   | 308   | 67  | 234   | 46  |
| Number                       | 3   | 8   | 18  | 7   | 4   | 14  | 1   | 6   | 16  | 5   | 2   | 12  |
| Initial Q (Qb), veh          | 0   | 0   | 0   | 0   | 0   | 0   | 0   | 0   | 0   | 0   | 0   | 0   |
| Ped-Bike Adj(A_pbT)          | 1.00  |   | 1.00  | 1.00  |   | 1.00  | 1.00  |   | 1.00  | 1.00  |   | 1.00  |
| Parking Bus, Adj             | 1.00  | 1.00  | 1.00  | 1.00  | 1.00  | 1.00  | 1.00  | 1.00  | 1.00  | 1.00  | 1.00  | 1.00  |
| Adj Sat Flow, veh/h/ln       | 1776  | 1776  | 1900  | 1881  | 1881  | 1881  | 1863  | 1863  | 1863  | 1863  | 1863  | 1863  |
| Adj Flow Rate, veh/h         | 20  | 13  | -1  | 188   | 47  | 0   | 64  | 622   | 0   | 75  | 263   | 0   |
| Adj No. of Lanes             | 1   | 1   | 0   | 1   | 1   | 1   | 1   | 2   | 1   | 1   | 2   | 1   |
| Peak Hour Factor             | 0.89  | 0.89  | 0.89  | 0.89  | 0.89  | 0.89  | 0.89  | 0.89  | 0.89  | 0.89  | 0.89  | 0.89  |
| Percent Heavy Veh, %         | 7   | 7   | 7   | 1   | 1   | 1   | 2   | 2   | 2   | 2   | 2   | 2   |
| Cap, veh/h                   | 42  | 153   | 0   | 240   | 366   | 311   | 114   | 856   | 383   | 127   | 881   | 394   |
| Arrive On Green              | 0.03  | 0.09  | 0.00  | 0.13  | 0.19  | 0.00  | 0.06  | 0.24  | 0.00  | 0.07  | 0.25  | 0.00  |
| Sat Flow, veh/h              | 1691  | 1776  | 0   | 1792  | 1881  | 1599  | 1774  | 3539  | 1583  | 1774  | 3539  | 1583  |
| Grp Volume(v), veh/h         | 20  | 12  | 0   | 188   | 47  | 0   | 64  | 622   | 0   | 75  | 263   | 0   |
| Grp Sat Flow(s),veh/h/ln     | 1691  | 1776  | 0   | 1792  | 1881  | 1599  | 1774  | 1770  | 1583  | 1774  | 1770  | 1583  |
| Q Serve(g_s), s              | 0.4   | 0.2   | 0.0   | 3.9   | 0.8   | 0.0   | 1.3   | 6.2   | 0.0   | 1.6   | 2.3   | 0.0   |
| Cycle Q Clear(g_c), s        | 0.4   | 0.2   | 0.0   | 3.9   | 0.8   | 0.0   | 1.3   | 6.2   | 0.0   | 1.6   | 2.3   | 0.0   |
| Prop In Lane                 | 1.00  |   | 0.00  | 1.00  |   | 1.00  | 1.00  |   | 1.00  | 1.00  |   | 1.00  |
| Lane Grp Cap(c), veh/h       | 42  | 153   | 0   | 240   | 366   | 311   | 114   | 856   | 383   | 127   | 881   | 394   |
| V/C Ratio(X)                 | 0.47  | 0.08  | 0.00  | 0.78  | 0.13  | 0.00  | 0.56  | 0.73  | 0.00  | 0.59  | 0.30  | 0.00  |
| Avail Cap(c_a), veh/h        | 899   | 1405  | 0   | 953   | 1488  | 1265  | 483   | 2341  | 1047  | 483   | 2341  | 1047  |
| HCM Platoon Ratio            | 1.00  | 1.00  | 1.00  | 1.00  | 1.00  | 1.00  | 1.00  | 1.00  | 1.00  | 1.00  | 1.00  | 1.00  |
| Upstream Filter(I)           | 1.00  | 1.00  | 0.00  | 1.00  | 1.00  | 0.00  | 1.00  | 1.00  | 0.00  | 1.00  | 1.00  | 0.00  |
| Uniform Delay (d), s/veh     | 18.5  | 16.2  | 0.0   | 16.2  | 12.8  | 0.0   | 17.5  | 13.4  | 0.0   | 17.3  | 11.7  | 0.0   |
| Incr Delay (d2), s/veh       | 3.0   | 0.1   | 0.0   | 2.1   | 0.1   | 0.0   | 1.6   | 0.4   | 0.0   | 1.6   | 0.1   | 0.0   |
| Initial Q Delay(d3),s/veh    | 0.0   | 0.0   | 0.0   | 0.0   | 0.0   | 0.0   | 0.0   | 0.0   | 0.0   | 0.0   | 0.0   | 0.0   |
| %ile BackOfQ(50%),veh/ln     | 0.2   | 0.1   | 0.0   | 2.1   | 0.4   | 0.0   | 0.7   | 3.1   | 0.0   | 0.8   | 1.1   | 0.0   |
| LnGrp Delay(d),s/veh         | 21.6  | 16.3  | 0.0   | 18.3  | 12.9  | 0.0   | 19.1  | 13.9  | 0.0   | 19.0  | 11.8  | 0.0   |
| LnGrp LOS                    | C   | B   |   | B   | B   |   | B   | B   |   | B   | B   |   |
| Approach Vol, veh/h          |   | 32  |   |   | 235   |   |   | 686   |   |   | 338   |   |
| Approach Delay, s/veh        |   | 19.6  |   |   | 17.2  |   |   | 14.4  |   |   | 13.4  |   |
| Approach LOS                 |   | B   |   |   | B   |   |   | B   |   |   | B   |   |
| Timer                        | 1   | 2   | 3   | 4   | 5   | 6   | 7   | 8   |   |   |   |   |
| Assigned Phs                 | 1   | 2   | 3   | 4   | 5   | 6   | 7   | 8   |   |   |   |   |
| Phs Duration (G+Y+Rc), s     | 7.0   | 14.1  | 5.5   | 12.0  | 7.3   | 13.8  | 9.7   | 7.8   |   |   |   |   |
| Change Period (Y+Rc), s      | 4.5   | 4.5   | 4.5   | 4.5   | 4.5   | 4.5   | 4.5   | 4.5   |   |   |   |   |
| Max Green Setting (Gmax), s  | 10.5  | 25.5  | 20.5  | 30.5  | 10.5  | 25.5  | 20.5  | 30.5  |   |   |   |   |
| Max Q Clear Time (g_c+I1), s | 3.3   | 4.3   | 2.4   | 2.8   | 3.6   | 8.2   | 5.9   | 2.2   |   |   |   |   |
| Green Ext Time (p_c), s      | 0.0   | 0.3   | 0.0   | 0.0   | 0.0   | 0.8   | 0.0   | 0.0   |   |   |   |   |
| <b>Intersection Summary</b>  |   |   |   |   |   |   |   |   |   |   |   |   |
| HCM 2010 Ctrl Delay          |   |   | 14.8  |   |   |   |   |   |   |   |   |   |
| HCM 2010 LOS                 |   |   | B   |   |   |   |   |   |   |   |   |   |
| <b>Notes</b>                 |   |   |   |   |   |   |   |   |   |   |   |   |

| Intersection             |      |      |      |      |      |      |      |      |      |      |      |      |
|--------------------------|------|------|------|------|------|------|------|------|------|------|------|------|
| Int Delay, s/veh         | 2    |      |      |      |      |      |      |      |      |      |      |      |
| Movement                 | EBL  | EBT  | EBR  | WBL  | WBT  | WBR  | NBL  | NBT  | NBR  | SBL  | SBT  | SBR  |
| Lane Configurations      |      | ↕    |      |      | ↕    |      |      | ↕    |      |      | ↕    |      |
| Traffic Vol, veh/h       | 3    | 340  | 39   | 12   | 312  | 13   | 12   | 25   | 6    | 9    | 27   | 5    |
| Future Vol, veh/h        | 3    | 340  | 39   | 12   | 312  | 13   | 12   | 25   | 6    | 9    | 27   | 5    |
| Conflicting Peds, #/hr   | 1    | 0    | 2    | 2    | 0    | 1    | 0    | 0    | 0    | 0    | 0    | 0    |
| Sign Control             | Free | Free | Free | Free | Free | Free | Stop | Stop | Stop | Stop | Stop | Stop |
| RT Channelized           | -    | -    | None | -    | -    | None | -    | -    | None | -    | -    | None |
| Storage Length           | -    | -    | -    | -    | -    | -    | -    | -    | -    | -    | -    | -    |
| Veh in Median Storage, # | -    | 0    | -    | -    | 0    | -    | -    | 0    | -    | -    | 0    | -    |
| Grade, %                 | -    | 0    | -    | -    | 0    | -    | -    | 0    | -    | -    | 0    | -    |
| Peak Hour Factor         | 91   | 91   | 91   | 91   | 91   | 91   | 91   | 91   | 91   | 91   | 91   | 91   |
| Heavy Vehicles, %        | 2    | 2    | 2    | 1    | 1    | 1    | 0    | 0    | 0    | 5    | 5    | 5    |
| Mvmt Flow                | 3    | 374  | 43   | 13   | 343  | 14   | 13   | 27   | 7    | 10   | 30   | 5    |

| Major/Minor          | Major1 |   |   | Major2 |   |   | Minor1 |     |     | Minor2 |       |       |
|----------------------|--------|---|---|--------|---|---|--------|-----|-----|--------|-------|-------|
| Conflicting Flow All | 358    | 0 | 0 | 419    | 0 | 0 | 798    | 788 | 398 | 796    | 802   | 351   |
| Stage 1              | -      | - | - | -      | - | - | 404    | 404 | -   | 377    | 377   | -     |
| Stage 2              | -      | - | - | -      | - | - | 394    | 384 | -   | 419    | 425   | -     |
| Critical Hdwy        | 4.12   | - | - | 4.11   | - | - | 7.1    | 6.5 | 6.2 | 7.15   | 6.55  | 6.25  |
| Critical Hdwy Stg 1  | -      | - | - | -      | - | - | 6.1    | 5.5 | -   | 6.15   | 5.55  | -     |
| Critical Hdwy Stg 2  | -      | - | - | -      | - | - | 6.1    | 5.5 | -   | 6.15   | 5.55  | -     |
| Follow-up Hdwy       | 2.218  | - | - | 2.209  | - | - | 3.5    | 4   | 3.3 | 3.545  | 4.045 | 3.345 |
| Pot Cap-1 Maneuver   | 1201   | - | - | 1145   | - | - | 306    | 326 | 656 | 301    | 314   | 686   |
| Stage 1              | -      | - | - | -      | - | - | 627    | 603 | -   | 638    | 611   | -     |
| Stage 2              | -      | - | - | -      | - | - | 635    | 615 | -   | 606    | 581   | -     |
| Platoon blocked, %   | -      | - | - | -      | - | - | -      | -   | -   | -      | -     | -     |
| Mov Cap-1 Maneuver   | 1200   | - | - | 1143   | - | - | 277    | 319 | 655 | 275    | 308   | 685   |
| Mov Cap-2 Maneuver   | -      | - | - | -      | - | - | 277    | 319 | -   | 275    | 308   | -     |
| Stage 1              | -      | - | - | -      | - | - | 624    | 600 | -   | 635    | 602   | -     |
| Stage 2              | -      | - | - | -      | - | - | 590    | 606 | -   | 571    | 578   | -     |

| Approach             | EB  |  | WB  |  | NB   |  | SB |  |
|----------------------|-----|--|-----|--|------|--|----|--|
| HCM Control Delay, s | 0.1 |  | 0.3 |  | 17.8 |  | 18 |  |
| HCM LOS              |     |  |     |  | C    |  | C  |  |

| Minor Lane/Major Mvmt | NBLn1 | EBL   | EBT | EBR | WBL   | WBT | WBR | SBLn1 |
|-----------------------|-------|-------|-----|-----|-------|-----|-----|-------|
| Capacity (veh/h)      | 329   | 1200  | -   | -   | 1143  | -   | -   | 321   |
| HCM Lane V/C Ratio    | 0.144 | 0.003 | -   | -   | 0.012 | -   | -   | 0.14  |
| HCM Control Delay (s) | 17.8  | 8     | 0   | -   | 8.2   | 0   | -   | 18    |
| HCM Lane LOS          | C     | A     | A   | -   | A     | A   | -   | C     |
| HCM 95th %tile Q(veh) | 0.5   | 0     | -   | -   | 0     | -   | -   | 0.5   |

| Intersection             |      |      |      |      |      |      |      |      |      |      |      |      |
|--------------------------|------|------|------|------|------|------|------|------|------|------|------|------|
| Int Delay, s/veh         | 2.8  |      |      |      |      |      |      |      |      |      |      |      |
| Movement                 | EBL  | EBT  | EBR  | WBL  | WBT  | WBR  | NBL  | NBT  | NBR  | SBL  | SBT  | SBR  |
| Lane Configurations      |      | ↕    |      |      | ↕    |      |      | ↕    | ↕    |      | ↕    |      |
| Traffic Vol, veh/h       | 2    | 316  | 8    | 12   | 284  | 2    | 65   | 21   | 21   | 0    | 3    | 0    |
| Future Vol, veh/h        | 2    | 316  | 8    | 12   | 284  | 2    | 65   | 21   | 21   | 0    | 3    | 0    |
| Conflicting Peds, #/hr   | 3    | 0    | 0    | 0    | 0    | 3    | 2    | 0    | 0    | 0    | 0    | 2    |
| Sign Control             | Free | Free | Free | Free | Free | Free | Stop | Stop | Stop | Stop | Stop | Stop |
| RT Channelized           | -    | -    | None | -    | -    | None | -    | -    | None | -    | -    | None |
| Storage Length           | -    | -    | -    | -    | -    | -    | -    | -    | 135  | -    | -    | -    |
| Veh in Median Storage, # | -    | 0    | -    | -    | 0    | -    | -    | 0    | -    | -    | 0    | -    |
| Grade, %                 | -    | 0    | -    | -    | 0    | -    | -    | 0    | -    | -    | 0    | -    |
| Peak Hour Factor         | 89   | 89   | 89   | 89   | 89   | 89   | 89   | 89   | 89   | 89   | 89   | 89   |
| Heavy Vehicles, %        | 2    | 2    | 2    | 1    | 1    | 1    | 0    | 0    | 0    | 0    | 0    | 0    |
| Mvmt Flow                | 2    | 355  | 9    | 13   | 319  | 2    | 73   | 24   | 24   | 0    | 3    | 0    |

| Major/Minor          | Major1 |   |   | Major2 |   |   | Minor1 |     |     | Minor2 |     |     |
|----------------------|--------|---|---|--------|---|---|--------|-----|-----|--------|-----|-----|
| Conflicting Flow All | 324    | 0 | 0 | 364    | 0 | 0 | 714    | 714 | 360 | 737    | 717 | 325 |
| Stage 1              | -      | - | - | -      | - | - | 364    | 364 | -   | 349    | 349 | -   |
| Stage 2              | -      | - | - | -      | - | - | 350    | 350 | -   | 388    | 368 | -   |
| Critical Hdwy        | 4.12   | - | - | 4.11   | - | - | 7.1    | 6.5 | 6.2 | 7.1    | 6.5 | 6.2 |
| Critical Hdwy Stg 1  | -      | - | - | -      | - | - | 6.1    | 5.5 | -   | 6.1    | 5.5 | -   |
| Critical Hdwy Stg 2  | -      | - | - | -      | - | - | 6.1    | 5.5 | -   | 6.1    | 5.5 | -   |
| Follow-up Hdwy       | 2.218  | - | - | 2.209  | - | - | 3.5    | 4   | 3.3 | 3.5    | 4   | 3.3 |
| Pot Cap-1 Maneuver   | 1236   | - | - | 1200   | - | - | 349    | 359 | 689 | 337    | 358 | 721 |
| Stage 1              | -      | - | - | -      | - | - | 659    | 627 | -   | 671    | 637 | -   |
| Stage 2              | -      | - | - | -      | - | - | 671    | 636 | -   | 640    | 625 | -   |
| Platoon blocked, %   |        | - | - |        | - | - |        |     |     |        |     |     |
| Mov Cap-1 Maneuver   | 1232   | - | - | 1200   | - | - | 342    | 353 | 689 | 304    | 352 | 718 |
| Mov Cap-2 Maneuver   | -      | - | - | -      | - | - | 342    | 353 | -   | 304    | 352 | -   |
| Stage 1              | -      | - | - | -      | - | - | 658    | 626 | -   | 668    | 627 | -   |
| Stage 2              | -      | - | - | -      | - | - | 657    | 626 | -   | 594    | 624 | -   |

| Approach             | EB |  |  | WB  |  |  | NB   |  |  | SB   |  |  |
|----------------------|----|--|--|-----|--|--|------|--|--|------|--|--|
| HCM Control Delay, s | 0  |  |  | 0.3 |  |  | 17.6 |  |  | 15.3 |  |  |
| HCM LOS              |    |  |  |     |  |  | C    |  |  | C    |  |  |

| Minor Lane/Major Mvmt | NBLn1 | NBLn2 | EBL   | EBT | EBR | WBL   | WBT | WBR | SBLn1 |
|-----------------------|-------|-------|-------|-----|-----|-------|-----|-----|-------|
| Capacity (veh/h)      | 345   | 689   | 1232  | -   | -   | 1200  | -   | -   | 352   |
| HCM Lane V/C Ratio    | 0.28  | 0.034 | 0.002 | -   | -   | 0.011 | -   | -   | 0.01  |
| HCM Control Delay (s) | 19.4  | 10.4  | 7.9   | 0   | -   | 8     | 0   | -   | 15.3  |
| HCM Lane LOS          | C     | B     | A     | A   | -   | A     | A   | -   | C     |
| HCM 95th %tile Q(veh) | 1.1   | 0.1   | 0     | -   | -   | 0     | -   | -   | 0     |

| Intersection              |      |
|---------------------------|------|
| Intersection Delay, s/veh | 10.2 |
| Intersection LOS          | B    |

| Movement            | EBL  | EBT  | EBR  | WBL  | WBT  | WBR  | NBL  | NBT  | NBR  | SBL  | SBT  | SBR  |
|---------------------|------|------|------|------|------|------|------|------|------|------|------|------|
| Lane Configurations |      | ↔    |      |      | ↔    |      |      | ↔    | ↔    |      | ↔    |      |
| Traffic Vol, veh/h  | 13   | 327  | 0    | 1    | 132  | 2    | 49   | 34   | 52   | 0    | 0    | 15   |
| Future Vol, veh/h   | 13   | 327  | 0    | 1    | 132  | 2    | 49   | 34   | 52   | 0    | 0    | 15   |
| Peak Hour Factor    | 0.95 | 0.95 | 0.95 | 0.95 | 0.95 | 0.95 | 0.95 | 0.95 | 0.95 | 0.95 | 0.95 | 0.95 |
| Heavy Vehicles, %   | 1    | 1    | 1    | 2    | 2    | 2    | 0    | 0    | 0    | 0    | 0    | 0    |
| Mvmt Flow           | 14   | 344  | 0    | 1    | 139  | 2    | 52   | 36   | 55   | 0    | 0    | 16   |
| Number of Lanes     | 0    | 1    | 0    | 0    | 1    | 0    | 0    | 1    | 1    | 0    | 1    | 0    |

| Approach                   | EB   | WB  | NB  | SB  |
|----------------------------|------|-----|-----|-----|
| Opposing Approach          | WB   | EB  | SB  | NB  |
| Opposing Lanes             | 1    | 1   | 1   | 2   |
| Conflicting Approach Left  | SB   | NB  | EB  | WB  |
| Conflicting Lanes Left     | 1    | 2   | 1   | 1   |
| Conflicting Approach Right | NB   | SB  | WB  | EB  |
| Conflicting Lanes Right    | 2    | 1   | 1   | 1   |
| HCM Control Delay          | 11.2 | 8.9 | 9.1 | 7.9 |
| HCM LOS                    | B    | A   | A   | A   |

| Lane                   | NBLn1 | NBLn2 | EBLn1 | WBLn1 | SBLn1 |
|------------------------|-------|-------|-------|-------|-------|
| Vol Left, %            | 59%   | 0%    | 4%    | 1%    | 0%    |
| Vol Thru, %            | 41%   | 0%    | 96%   | 98%   | 0%    |
| Vol Right, %           | 0%    | 100%  | 0%    | 1%    | 100%  |
| Sign Control           | Stop  | Stop  | Stop  | Stop  | Stop  |
| Traffic Vol by Lane    | 83    | 52    | 340   | 135   | 15    |
| LT Vol                 | 49    | 0     | 13    | 1     | 0     |
| Through Vol            | 34    | 0     | 327   | 132   | 0     |
| RT Vol                 | 0     | 52    | 0     | 2     | 15    |
| Lane Flow Rate         | 87    | 55    | 358   | 142   | 16    |
| Geometry Grp           | 7     | 7     | 2     | 2     | 5     |
| Degree of Util (X)     | 0.145 | 0.075 | 0.448 | 0.187 | 0.021 |
| Departure Headway (Hd) | 5.957 | 4.951 | 4.508 | 4.745 | 4.765 |
| Convergence, Y/N       | Yes   | Yes   | Yes   | Yes   | Yes   |
| Cap                    | 600   | 720   | 798   | 753   | 745   |
| Service Time           | 3.713 | 2.707 | 2.543 | 2.791 | 2.835 |
| HCM Lane V/C Ratio     | 0.145 | 0.076 | 0.449 | 0.189 | 0.021 |
| HCM Control Delay      | 9.7   | 8.1   | 11.2  | 8.9   | 7.9   |
| HCM Lane LOS           | A     | A     | B     | A     | A     |
| HCM 95th-tile Q        | 0.5   | 0.2   | 2.3   | 0.7   | 0.1   |

| Intersection             |      |      |      |      |      |      |
|--------------------------|------|------|------|------|------|------|
| Int Delay, s/veh         | 0.9  |      |      |      |      |      |
| Movement                 | EBL  | EBT  | WBT  | WBR  | SBL  | SBR  |
| Lane Configurations      |      | ↕    | ↕    |      | ↕    |      |
| Traffic Vol, veh/h       | 30   | 353  | 116  | 1    | 0    | 24   |
| Future Vol, veh/h        | 30   | 353  | 116  | 1    | 0    | 24   |
| Conflicting Peds, #/hr   | 0    | 0    | 0    | 0    | 0    | 1    |
| Sign Control             | Free | Free | Free | Free | Stop | Stop |
| RT Channelized           | -    | None | -    | None | -    | None |
| Storage Length           | -    | -    | -    | -    | 0    | -    |
| Veh in Median Storage, # | -    | 0    | 0    | -    | 0    | -    |
| Grade, %                 | -    | 0    | 0    | -    | 0    | -    |
| Peak Hour Factor         | 96   | 96   | 96   | 96   | 96   | 96   |
| Heavy Vehicles, %        | 2    | 2    | 1    | 1    | 4    | 4    |
| Mvmt Flow                | 31   | 368  | 121  | 1    | 0    | 25   |

| Major/Minor          | Major1 | Major2 | Minor2 |   |             |
|----------------------|--------|--------|--------|---|-------------|
| Conflicting Flow All | 122    | 0      | -      | 0 | 552 123     |
| Stage 1              | -      | -      | -      | - | 122 -       |
| Stage 2              | -      | -      | -      | - | 430 -       |
| Critical Hdwy        | 4.12   | -      | -      | - | 6.44 6.24   |
| Critical Hdwy Stg 1  | -      | -      | -      | - | 5.44 -      |
| Critical Hdwy Stg 2  | -      | -      | -      | - | 5.44 -      |
| Follow-up Hdwy       | 2.218  | -      | -      | - | 3.536 3.336 |
| Pot Cap-1 Maneuver   | 1465   | -      | -      | - | 491 923     |
| Stage 1              | -      | -      | -      | - | 898 -       |
| Stage 2              | -      | -      | -      | - | 652 -       |
| Platoon blocked, %   |        | -      | -      | - |             |
| Mov Cap-1 Maneuver   | 1465   | -      | -      | - | 478 922     |
| Mov Cap-2 Maneuver   | -      | -      | -      | - | 478 -       |
| Stage 1              | -      | -      | -      | - | 874 -       |
| Stage 2              | -      | -      | -      | - | 652 -       |

| Approach             | EB  | WB | SB |
|----------------------|-----|----|----|
| HCM Control Delay, s | 0.6 | 0  | 9  |
| HCM LOS              |     |    | A  |

| Minor Lane/Major Mvmt | EBL   | EBT | WBT | WBR | SBLn1 |
|-----------------------|-------|-----|-----|-----|-------|
| Capacity (veh/h)      | 1465  | -   | -   | -   | 922   |
| HCM Lane V/C Ratio    | 0.021 | -   | -   | -   | 0.027 |
| HCM Control Delay (s) | 7.5   | 0   | -   | -   | 9     |
| HCM Lane LOS          | A     | A   | -   | -   | A     |
| HCM 95th %tile Q(veh) | 0.1   | -   | -   | -   | 0.1   |



| Intersection              |      |
|---------------------------|------|
| Intersection Delay, s/veh | 10.3 |
| Intersection LOS          | B    |

| Movement            | EBL  | EBT  | EBR  | WBL  | WBT  | WBR  | NBL  | NBT  | NBR  | SBL  | SBT  | SBR  |
|---------------------|------|------|------|------|------|------|------|------|------|------|------|------|
| Lane Configurations |      | ↕    |      |      | ↕    |      |      | ↕    |      |      | ↕    |      |
| Traffic Vol, veh/h  | 340  | 0    | 5    | 0    | 0    | 0    | 2    | 0    | 0    | 0    | 0    | 114  |
| Future Vol, veh/h   | 340  | 0    | 5    | 0    | 0    | 0    | 2    | 0    | 0    | 0    | 0    | 114  |
| Peak Hour Factor    | 0.91 | 0.91 | 0.91 | 0.91 | 0.91 | 0.91 | 0.91 | 0.91 | 0.91 | 0.91 | 0.91 | 0.91 |
| Heavy Vehicles, %   | 2    | 2    | 2    | 2    | 2    | 2    | 0    | 0    | 0    | 1    | 1    | 1    |
| Mvmt Flow           | 374  | 0    | 5    | 0    | 0    | 0    | 2    | 0    | 0    | 0    | 0    | 125  |
| Number of Lanes     | 0    | 1    | 0    | 0    | 1    | 0    | 0    | 1    | 0    | 0    | 1    | 0    |

| Approach                   | EB   | WB | NB  | SB  |
|----------------------------|------|----|-----|-----|
| Opposing Approach          | WB   | EB | SB  | NB  |
| Opposing Lanes             | 1    | 1  | 1   | 1   |
| Conflicting Approach Left  | SB   | NB | EB  | WB  |
| Conflicting Lanes Left     | 1    | 1  | 1   | 1   |
| Conflicting Approach Right | NB   | SB | WB  | EB  |
| Conflicting Lanes Right    | 1    | 1  | 1   | 1   |
| HCM Control Delay          | 11.1 | 0  | 8.2 | 7.9 |
| HCM LOS                    | B    | -  | A   | A   |

| Lane                   | NBLn1 | EBLn1 | WBLn1 | SBLn1 |
|------------------------|-------|-------|-------|-------|
| Vol Left, %            | 100%  | 99%   | 0%    | 0%    |
| Vol Thru, %            | 0%    | 0%    | 100%  | 0%    |
| Vol Right, %           | 0%    | 1%    | 0%    | 100%  |
| Sign Control           | Stop  | Stop  | Stop  | Stop  |
| Traffic Vol by Lane    | 2     | 345   | 0     | 114   |
| LT Vol                 | 2     | 340   | 0     | 0     |
| Through Vol            | 0     | 0     | 0     | 0     |
| RT Vol                 | 0     | 5     | 0     | 114   |
| Lane Flow Rate         | 2     | 379   | 0     | 125   |
| Geometry Grp           | 1     | 1     | 1     | 1     |
| Degree of Util (X)     | 0.003 | 0.457 | 0     | 0.147 |
| Departure Headway (Hd) | 5.145 | 4.343 | 4.619 | 4.216 |
| Convergence, Y/N       | Yes   | Yes   | Yes   | Yes   |
| Cap                    | 699   | 823   | 0     | 856   |
| Service Time           | 3.154 | 2.416 | 2.638 | 2.216 |
| HCM Lane V/C Ratio     | 0.003 | 0.461 | 0     | 0.146 |
| HCM Control Delay      | 8.2   | 11.1  | 7.6   | 7.9   |
| HCM Lane LOS           | A     | B     | N     | A     |
| HCM 95th-tile Q        | 0     | 2.4   | 0     | 0.5   |

HCM 2010 Signalized Intersection Summary  
 46: General Jim Moore Boulevard & Normandy Road

Existing, PM  
 06/11/2019



| Movement                      | EBL  | EBT  | EBR  | WBL  | WBT  | WBR  | NBL  | NBT  | NBR  | SBL  | SBT  | SBR   |
|-------------------------------|------|------|------|------|------|------|------|------|------|------|------|-------|
| Lane Configurations           |      | ↕    |      |      | ↕    |      | ↕    | ↕↕   |      | ↕    | ↕↕   | ↕     |
| Traffic Volume (veh/h)        | 45   | 27   | 33   | 44   | 28   | 6    | 49   | 729  | 67   | 31   | 361  | 45    |
| Future Volume (veh/h)         | 45   | 27   | 33   | 44   | 28   | 6    | 49   | 729  | 67   | 31   | 361  | 45    |
| Number                        | 3    | 8    | 18   | 7    | 4    | 14   | 1    | 6    | 16   | 5    | 2    | 12    |
| Initial Q (Qb), veh           | 0    | 0    | 0    | 0    | 0    | 0    | 0    | 0    | 0    | 0    | 0    | 0     |
| Ped-Bike Adj(A_pbT)           | 1.00 |      | 1.00 | 1.00 |      | 1.00 | 1.00 |      | 1.00 | 1.00 |      | 1.00  |
| Parking Bus, Adj              | 1.00 | 1.00 | 1.00 | 1.00 | 1.00 | 1.00 | 1.00 | 1.00 | 1.00 | 1.00 | 1.00 | 1.00  |
| Adj Sat Flow, veh/h/ln        | 1900 | 1863 | 1900 | 1900 | 1881 | 1900 | 1881 | 1881 | 1900 | 1900 | 1900 | 1900  |
| Adj Flow Rate, veh/h          | 49   | 29   | 11   | 48   | 30   | 4    | 53   | 792  | 50   | 34   | 392  | -10   |
| Adj No. of Lanes              | 0    | 1    | 0    | 0    | 1    | 0    | 1    | 2    | 0    | 1    | 2    | 1     |
| Peak Hour Factor              | 0.92 | 0.92 | 0.92 | 0.92 | 0.92 | 0.92 | 0.92 | 0.92 | 0.92 | 0.92 | 0.92 | 0.92  |
| Percent Heavy Veh, %          | 2    | 2    | 2    | 1    | 1    | 1    | 1    | 1    | 1    | 0    | 0    | 0     |
| Cap, veh/h                    | 316  | 105  | 31   | 329  | 119  | 12   | 290  | 1065 | 67   | 75   | 692  | 310   |
| Arrive On Green               | 0.18 | 0.16 | 0.16 | 0.18 | 0.16 | 0.16 | 0.16 | 0.31 | 0.31 | 0.04 | 0.19 | 0.00  |
| Sat Flow, veh/h               | 723  | 667  | 196  | 776  | 756  | 79   | 1792 | 3414 | 216  | 1810 | 3610 | 1615  |
| Grp Volume(v), veh/h          | 89   | 0    | 0    | 82   | 0    | 0    | 53   | 414  | 428  | 34   | 392  | -10   |
| Grp Sat Flow(s),veh/h/ln      | 1586 | 0    | 0    | 1611 | 0    | 0    | 1792 | 1787 | 1843 | 1810 | 1805 | 1615  |
| Q Serve(g_s), s               | 0.1  | 0.0  | 0.0  | 0.0  | 0.0  | 0.0  | 0.7  | 5.7  | 5.7  | 0.5  | 2.7  | 0.0   |
| Cycle Q Clear(g_c), s         | 1.2  | 0.0  | 0.0  | 1.1  | 0.0  | 0.0  | 0.7  | 5.7  | 5.7  | 0.5  | 2.7  | 0.0   |
| Prop In Lane                  | 0.55 |      | 0.12 | 0.59 |      | 0.05 | 1.00 |      | 0.12 | 1.00 |      | 1.00  |
| Lane Grp Cap(c), veh/h        | 480  | 0    | 0    | 489  | 0    | 0    | 290  | 558  | 575  | 75   | 692  | 310   |
| V/C Ratio(X)                  | 0.19 | 0.00 | 0.00 | 0.17 | 0.00 | 0.00 | 0.18 | 0.74 | 0.74 | 0.45 | 0.57 | -0.03 |
| Avail Cap(c_a), veh/h         | 2062 | 0    | 0    | 2082 | 0    | 0    | 520  | 1652 | 1704 | 525  | 3337 | 1493  |
| HCM Platoon Ratio             | 1.00 | 1.00 | 1.00 | 1.00 | 1.00 | 1.00 | 1.00 | 1.00 | 1.00 | 1.00 | 1.00 | 1.00  |
| Upstream Filter(l)            | 1.00 | 0.00 | 0.00 | 1.00 | 0.00 | 0.00 | 1.00 | 1.00 | 1.00 | 1.00 | 1.00 | 0.00  |
| Uniform Delay (d), s/veh      | 10.2 | 0.0  | 0.0  | 10.1 | 0.0  | 0.0  | 10.0 | 8.5  | 8.5  | 12.9 | 10.1 | 0.0   |
| Incr Delay (d2), s/veh        | 0.1  | 0.0  | 0.0  | 0.1  | 0.0  | 0.0  | 0.1  | 0.7  | 0.7  | 1.6  | 0.3  | 0.0   |
| Initial Q Delay(d3),s/veh     | 0.0  | 0.0  | 0.0  | 0.0  | 0.0  | 0.0  | 0.0  | 0.0  | 0.0  | 0.0  | 0.0  | 0.0   |
| %ile BackOfQ(50%),veh/ln      | 0.6  | 0.0  | 0.0  | 0.5  | 0.0  | 0.0  | 0.3  | 2.9  | 3.0  | 0.3  | 1.3  | 0.0   |
| LnGrp Delay(d),s/veh          | 10.2 | 0.0  | 0.0  | 10.2 | 0.0  | 0.0  | 10.1 | 9.2  | 9.2  | 14.5 | 10.4 | 0.0   |
| LnGrp LOS                     | B    |      |      | B    |      |      | B    | A    | A    | B    | B    |       |
| Approach Vol, veh/h           |      | 89   |      |      | 82   |      |      | 895  |      |      | 416  |       |
| Approach Delay, s/veh         |      | 10.2 |      |      | 10.2 |      |      | 9.3  |      |      | 11.0 |       |
| Approach LOS                  |      | B    |      |      | B    |      |      | A    |      |      | B    |       |
| Timer                         | 1    | 2    | 3    | 4    | 5    | 6    | 7    | 8    |      |      |      |       |
| Assigned Phs                  | 1    | 2    |      | 4    | 5    | 6    |      | 8    |      |      |      |       |
| Phs Duration (G+Y+Rc), s      | 9.0  | 9.8  |      | 8.8  | 5.6  | 13.1 |      | 8.8  |      |      |      |       |
| Change Period (Y+Rc), s       | 4.5  | 4.5  |      | 4.5  | 4.5  | 4.5  |      | 4.5  |      |      |      |       |
| Max Green Setting (Gmax), s   | 25.5 | 25.5 |      | 33.0 | 8.0  | 25.5 |      | 33.0 |      |      |      |       |
| Max Q Clear Time (g_c+1/2), s | 4.7  | 4.7  |      | 3.1  | 2.5  | 7.7  |      | 3.2  |      |      |      |       |
| Green Ext Time (p_c), s       | 0.0  | 0.5  |      | 0.1  | 0.0  | 0.8  |      | 0.1  |      |      |      |       |
| <b>Intersection Summary</b>   |      |      |      |      |      |      |      |      |      |      |      |       |
| HCM 2010 Ctrl Delay           |      |      |      | 9.9  |      |      |      |      |      |      |      |       |
| HCM 2010 LOS                  |      |      |      | A    |      |      |      |      |      |      |      |       |

**Intersection**

Intersection Delay, s/veh 18.4

Intersection LOS C

| Movement            | EBL  | EBR  | NBL  | NBT  | SBT  | SBR  |
|---------------------|------|------|------|------|------|------|
| Lane Configurations |      |      |      |      |      |      |
| Traffic Vol, veh/h  | 53   | 97   | 153  | 838  | 308  | 85   |
| Future Vol, veh/h   | 53   | 97   | 153  | 838  | 308  | 85   |
| Peak Hour Factor    | 0.89 | 0.89 | 0.89 | 0.89 | 0.89 | 0.89 |
| Heavy Vehicles, %   | 1    | 1    | 1    | 1    | 1    | 1    |
| Mvmt Flow           | 60   | 109  | 172  | 942  | 346  | 96   |
| Number of Lanes     | 1    | 1    | 1    | 2    | 2    | 1    |

| Approach                   | EB   | NB   | SB   |
|----------------------------|------|------|------|
| Opposing Approach          |      | SB   | NB   |
| Opposing Lanes             | 0    | 3    | 3    |
| Conflicting Approach Left  | SB   | EB   |      |
| Conflicting Lanes Left     | 3    | 2    | 0    |
| Conflicting Approach Right | NB   |      | EB   |
| Conflicting Lanes Right    | 3    | 0    | 2    |
| HCM Control Delay          | 12.6 | 21.5 | 12.7 |
| HCM LOS                    | B    | C    | B    |

| Lane                   | NBLn1 | NBLn2 | NBLn3 | EBLn1 | EBLn2 | SBLn1 | SBLn2 | SBLn3 |
|------------------------|-------|-------|-------|-------|-------|-------|-------|-------|
| Vol Left, %            | 100%  | 0%    | 0%    | 100%  | 0%    | 0%    | 0%    | 0%    |
| Vol Thru, %            | 0%    | 100%  | 100%  | 0%    | 0%    | 100%  | 100%  | 0%    |
| Vol Right, %           | 0%    | 0%    | 0%    | 0%    | 100%  | 0%    | 0%    | 100%  |
| Sign Control           | Stop  | Stop  | Stop  | Stop  | Stop  | Stop  | Stop  | Stop  |
| Traffic Vol by Lane    | 153   | 419   | 419   | 53    | 97    | 154   | 154   | 85    |
| LT Vol                 | 153   | 0     | 0     | 53    | 0     | 0     | 0     | 0     |
| Through Vol            | 0     | 419   | 419   | 0     | 0     | 154   | 154   | 0     |
| RT Vol                 | 0     | 0     | 0     | 0     | 97    | 0     | 0     | 85    |
| Lane Flow Rate         | 172   | 471   | 471   | 60    | 109   | 173   | 173   | 96    |
| Geometry Grp           | 8     | 8     | 8     | 8     | 8     | 8     | 8     | 8     |
| Degree of Util (X)     | 0.325 | 0.823 | 0.596 | 0.144 | 0.226 | 0.352 | 0.352 | 0.126 |
| Departure Headway (Hd) | 6.801 | 6.295 | 4.558 | 8.682 | 7.472 | 7.319 | 7.319 | 4.767 |
| Convergence, Y/N       | Yes   | Yes   | Yes   | Yes   | Yes   | Yes   | Yes   | Yes   |
| Cap                    | 524   | 570   | 782   | 415   | 483   | 495   | 495   | 741   |
| Service Time           | 4.598 | 4.091 | 2.353 | 6.396 | 5.186 | 5.019 | 5.019 | 2.567 |
| HCM Lane V/C Ratio     | 0.328 | 0.826 | 0.602 | 0.145 | 0.226 | 0.349 | 0.349 | 0.13  |
| HCM Control Delay      | 12.9  | 32.1  | 14    | 12.9  | 12.4  | 13.9  | 13.9  | 8.3   |
| HCM Lane LOS           | B     | D     | B     | B     | B     | B     | B     | A     |
| HCM 95th-tile Q        | 1.4   | 8.4   | 4     | 0.5   | 0.9   | 1.6   | 1.6   | 0.4   |

HCM 2010 Signalized Intersection Summary  
 48: Fremont Boulevard/Hwy 1 SB Off-Ramp/ NB On-Ramp & Monterey Road

Existing, PM  
 06/11/2019



| Movement                    | EBL  | EBT  | EBR  | WBL   | WBT  | WBR   | NBL  | NBT  | NBR  | SBL  | SBT  | SBR  |
|-----------------------------|------|------|------|-------|------|-------|------|------|------|------|------|------|
| Lane Configurations         |      |      |      |       |      |       |      |      |      |      |      |      |
| Traffic Volume (veh/h)      | 213  | 223  | 57   | 89    | 161  | 55    | 111  | 972  | 226  | 78   | 576  | 198  |
| Future Volume (veh/h)       | 213  | 223  | 57   | 89    | 161  | 55    | 111  | 972  | 226  | 78   | 576  | 198  |
| Number                      | 7    | 4    | 14   | 3     | 8    | 18    | 5    | 2    | 12   | 1    | 6    | 16   |
| Initial Q (Qb), veh         | 0    | 0    | 0    | 0     | 0    | 0     | 0    | 0    | 0    | 0    | 0    | 0    |
| Ped-Bike Adj(A_pbT)         | 1.00 |      | 0.98 | 1.00  |      | 0.99  | 1.00 |      | 0.99 | 1.00 |      | 0.99 |
| Parking Bus, Adj            | 1.00 | 1.00 | 1.00 | 1.00  | 1.00 | 1.00  | 1.00 | 1.00 | 1.00 | 1.00 | 1.00 | 1.00 |
| Adj Sat Flow, veh/h/ln      | 1881 | 1881 | 1881 | 1900  | 1900 | 1900  | 1881 | 1881 | 1900 | 1863 | 1863 | 1863 |
| Adj Flow Rate, veh/h        | 220  | 230  | 12   | 92    | 166  | 51    | 114  | 1002 | 221  | 80   | 594  | 132  |
| Adj No. of Lanes            | 1    | 1    | 1    | 0     | 1    | 0     | 1    | 2    | 0    | 1    | 2    | 1    |
| Peak Hour Factor            | 0.97 | 0.97 | 0.97 | 0.97  | 0.97 | 0.97  | 0.97 | 0.97 | 0.97 | 0.97 | 0.97 | 0.97 |
| Percent Heavy Veh, %        | 1    | 1    | 1    | 0     | 0    | 0     | 1    | 1    | 1    | 2    | 2    | 2    |
| Cap, veh/h                  | 284  | 298  | 248  | 101   | 182  | 56    | 542  | 1291 | 284  | 101  | 671  | 297  |
| Arrive On Green             | 0.16 | 0.16 | 0.16 | 0.19  | 0.19 | 0.19  | 0.30 | 0.44 | 0.44 | 0.06 | 0.19 | 0.19 |
| Sat Flow, veh/h             | 1792 | 1881 | 1566 | 541   | 977  | 300   | 1792 | 2910 | 640  | 1774 | 3539 | 1568 |
| Grp Volume(v), veh/h        | 220  | 230  | 12   | 309   | 0    | 0     | 114  | 614  | 609  | 80   | 594  | 132  |
| Grp Sat Flow(s),veh/h/ln    | 1792 | 1881 | 1566 | 1818  | 0    | 0     | 1792 | 1787 | 1763 | 1774 | 1770 | 1568 |
| Q Serve(g_s), s             | 14.7 | 14.7 | 0.8  | 20.8  | 0.0  | 0.0   | 5.9  | 36.4 | 36.7 | 5.6  | 20.4 | 9.3  |
| Cycle Q Clear(g_c), s       | 14.7 | 14.7 | 0.8  | 20.8  | 0.0  | 0.0   | 5.9  | 36.4 | 36.7 | 5.6  | 20.4 | 9.3  |
| Prop In Lane                | 1.00 |      | 1.00 | 0.30  |      | 0.17  | 1.00 |      | 0.36 | 1.00 |      | 1.00 |
| Lane Grp Cap(c), veh/h      | 284  | 298  | 248  | 339   | 0    | 0     | 542  | 793  | 782  | 101  | 671  | 297  |
| V/C Ratio(X)                | 0.78 | 0.77 | 0.05 | 0.91  | 0.00 | 0.00  | 0.21 | 0.77 | 0.78 | 0.79 | 0.89 | 0.44 |
| Avail Cap(c_a), veh/h       | 573  | 602  | 501  | 364   | 0    | 0     | 542  | 793  | 782  | 241  | 671  | 297  |
| HCM Platoon Ratio           | 1.00 | 1.00 | 1.00 | 1.00  | 1.00 | 1.00  | 1.00 | 1.00 | 1.00 | 1.00 | 1.00 | 1.00 |
| Upstream Filter(I)          | 0.68 | 0.68 | 0.68 | 1.00  | 0.00 | 0.00  | 1.00 | 1.00 | 1.00 | 1.00 | 1.00 | 1.00 |
| Uniform Delay (d), s/veh    | 50.5 | 50.5 | 44.6 | 49.8  | 0.0  | 0.0   | 32.5 | 29.5 | 29.5 | 58.2 | 49.3 | 44.8 |
| Incr Delay (d2), s/veh      | 3.1  | 2.9  | 0.1  | 26.1  | 0.0  | 0.0   | 0.1  | 7.3  | 7.5  | 5.1  | 15.8 | 4.7  |
| Initial Q Delay(d3),s/veh   | 0.0  | 0.0  | 0.0  | 0.0   | 0.0  | 0.0   | 0.0  | 0.0  | 0.0  | 0.0  | 0.0  | 0.0  |
| %ile BackOfQ(50%),veh/ln    | 7.5  | 7.8  | 0.4  | 12.9  | 0.0  | 0.0   | 3.0  | 19.5 | 19.4 | 2.9  | 11.5 | 4.4  |
| LnGrp Delay(d),s/veh        | 53.6 | 53.4 | 44.7 | 75.9  | 0.0  | 0.0   | 32.6 | 36.8 | 37.1 | 63.2 | 65.2 | 49.6 |
| LnGrp LOS                   | D    | D    | D    | E     |      |       | C    | D    | D    | E    | E    | D    |
| Approach Vol, veh/h         |      | 462  |      |       | 309  |       |      | 1337 |      |      | 806  |      |
| Approach Delay, s/veh       |      | 53.3 |      |       | 75.9 |       |      | 36.5 |      |      | 62.4 |      |
| Approach LOS                |      | D    |      |       | E    |       |      | D    |      |      | E    |      |
| Timer                       | 1    | 2    | 3    | 4     | 5    | 6     | 7    | 8    |      |      |      |      |
| Assigned Phs                | 1    | 2    |      | 4     | 5    | 6     |      | 8    |      |      |      |      |
| Phs Duration (G+Y+Rc), s    | 1.3  | 60.8 |      | 24.5  | 43.1 | 29.0  |      | 28.4 |      |      |      |      |
| Change Period (Y+Rc), s     | 4.2  | 5.3  |      | * 4.7 | 5.3  | * 5.3 |      | 5.1  |      |      |      |      |
| Max Green Setting (Gmax), s | 13   | 23.7 |      | * 40  | 17.0 | * 24  |      | 25.0 |      |      |      |      |
| Max Q Clear Time (g_c+1), s | 13   | 38.7 |      | 16.7  | 7.9  | 22.4  |      | 22.8 |      |      |      |      |
| Green Ext Time (p_c), s     | 0.1  | 0.0  |      | 2.0   | 0.1  | 0.5   |      | 0.5  |      |      |      |      |

Intersection Summary

|                     |      |
|---------------------|------|
| HCM 2010 Ctrl Delay | 50.5 |
| HCM 2010 LOS        | D    |

Notes

HCM 2010 Signalized Intersection Summary  
 49: Highway 1 SB On-Ramp & Highway 1 NB Off-Ramp/Monterey Road

Existing, PM  
 06/11/2019



| Movement                     | EBL  | EBT  | EBR  | WBL   | WBT  | WBR   | NBL  | NBT   | NBR  | SBL  | SBT  | SBR  |
|------------------------------|------|------|------|-------|------|-------|------|-------|------|------|------|------|
| Lane Configurations          |      | ↕↕   | ↗    | ↖     |      | ↗     |      | ↕     | ↗    |      | ↕    |      |
| Traffic Volume (veh/h)       | 0    | 204  | 120  | 272   | 0    | 190   | 0    | 112   | 285  | 1    | 1    | 0    |
| Future Volume (veh/h)        | 0    | 204  | 120  | 272   | 0    | 190   | 0    | 112   | 285  | 1    | 1    | 0    |
| Number                       | 1    | 6    | 16   | 5     | 2    | 12    | 7    | 4     | 14   | 3    | 8    | 18   |
| Initial Q (Qb), veh          | 0    | 0    | 0    | 0     | 0    | 0     | 0    | 0     | 0    | 0    | 0    | 0    |
| Ped-Bike Adj(A_pbT)          | 1.00 |      | 1.00 | 1.00  |      | 1.00  | 1.00 |       | 1.00 | 1.00 |      | 1.00 |
| Parking Bus, Adj             | 1.00 | 1.00 | 1.00 | 1.00  | 1.00 | 1.00  | 1.00 | 1.00  | 1.00 | 1.00 | 1.00 | 1.00 |
| Adj Sat Flow, veh/h/ln       | 1900 | 1863 | 1863 | 1900  | 0    | 1900  | 0    | 1881  | 1881 | 1900 | 1900 | 0    |
| Adj Flow Rate, veh/h         | 0    | 224  | 14   | 299   | 0    | 135   | 0    | 123   | 34   | 1    | 1    | 0    |
| Adj No. of Lanes             | 0    | 2    | 1    | 1     | 0    | 1     | 0    | 1     | 1    | 0    | 1    | 0    |
| Peak Hour Factor             | 0.91 | 0.91 | 0.91 | 0.91  | 0.91 | 0.91  | 0.91 | 0.91  | 0.91 | 0.91 | 0.91 | 0.91 |
| Percent Heavy Veh, %         | 2    | 2    | 2    | 0     | 0    | 0     | 0    | 1     | 1    | 0    | 0    | 0    |
| Cap, veh/h                   | 0    | 2980 | 1331 | 0     | 0    | 0     | 0    | 154   | 131  | 59   | 44   | 0    |
| Arrive On Green              | 0.00 | 0.84 | 0.84 | 0.00  | 0.00 | 0.00  | 0.00 | 0.08  | 0.08 | 0.09 | 0.08 | 0.00 |
| Sat Flow, veh/h              | 0    | 3632 | 1581 |       | 0    |       | 0    | 1881  | 1599 | 190  | 536  | 0    |
| Grp Volume(v), veh/h         | 0    | 224  | 14   |       | 0.0  |       | 0    | 123   | 34   | 2    | 0    | 0    |
| Grp Sat Flow(s),veh/h/ln     | 0    | 1770 | 1581 |       |      |       | 0    | 1881  | 1599 | 726  | 0    | 0    |
| Q Serve(g_s), s              | 0.0  | 1.3  | 0.2  |       |      |       | 0.0  | 8.0   | 2.5  | 0.0  | 0.0  | 0.0  |
| Cycle Q Clear(g_c), s        | 0.0  | 1.3  | 0.2  |       |      |       | 0.0  | 8.0   | 2.5  | 8.0  | 0.0  | 0.0  |
| Prop In Lane                 | 0.00 |      | 1.00 |       |      |       | 0.00 |       | 1.00 | 0.50 |      | 0.00 |
| Lane Grp Cap(c), veh/h       | 0    | 2980 | 1331 |       |      |       | 0    | 154   | 131  | 106  | 0    | 0    |
| V/C Ratio(X)                 | 0.00 | 0.08 | 0.01 |       |      |       | 0.00 | 0.80  | 0.26 | 0.02 | 0.00 | 0.00 |
| Avail Cap(c_a), veh/h        | 0    | 2980 | 1331 |       |      |       | 0    | 271   | 230  | 139  | 0    | 0    |
| HCM Platoon Ratio            | 1.00 | 1.00 | 1.00 |       |      |       | 1.00 | 1.00  | 1.00 | 1.00 | 1.00 | 1.00 |
| Upstream Filter(I)           | 0.00 | 1.00 | 1.00 |       |      |       | 0.00 | 1.00  | 1.00 | 1.00 | 0.00 | 0.00 |
| Uniform Delay (d), s/veh     | 0.0  | 1.7  | 1.6  |       |      |       | 0.0  | 56.4  | 53.8 | 52.8 | 0.0  | 0.0  |
| Incr Delay (d2), s/veh       | 0.0  | 0.0  | 0.0  |       |      |       | 0.0  | 3.6   | 0.4  | 0.0  | 0.0  | 0.0  |
| Initial Q Delay(d3),s/veh    | 0.0  | 0.0  | 0.0  |       |      |       | 0.0  | 0.0   | 0.0  | 0.0  | 0.0  | 0.0  |
| %ile BackOfQ(50%),veh/ln     | 0.0  | 0.7  | 0.1  |       |      |       | 0.0  | 4.3   | 1.1  | 0.1  | 0.0  | 0.0  |
| LnGrp Delay(d),s/veh         | 0.0  | 1.7  | 1.6  |       |      |       | 0.0  | 59.9  | 54.2 | 52.8 | 0.0  | 0.0  |
| LnGrp LOS                    |      | A    | A    |       |      |       |      | E     | D    | D    |      |      |
| Approach Vol, veh/h          |      | 238  |      |       |      |       |      | 157   |      |      | 2    |      |
| Approach Delay, s/veh        |      | 1.7  |      |       |      |       |      | 58.7  |      |      | 52.8 |      |
| Approach LOS                 |      | A    |      |       |      |       |      | E     |      |      | D    |      |
| Timer                        | 1    | 2    | 3    | 4     | 5    | 6     | 7    | 8     |      |      |      |      |
| Assigned Phs                 |      |      |      | 4     |      | 6     |      | 8     |      |      |      |      |
| Phs Duration (G+Y+Rc), s     |      |      |      | 14.4  |      | 110.6 |      | 14.4  |      |      |      |      |
| Change Period (Y+Rc), s      |      |      |      | * 4.2 |      | 5.3   |      | * 4.2 |      |      |      |      |
| Max Green Setting (Gmax), s  |      |      |      | * 18  |      | 21.0  |      | * 13  |      |      |      |      |
| Max Q Clear Time (g_c+I1), s |      |      |      | 10.0  |      | 3.3   |      | 10.0  |      |      |      |      |
| Green Ext Time (p_c), s      |      |      |      | 0.3   |      | 0.9   |      | 0.0   |      |      |      |      |
| <b>Intersection Summary</b>  |      |      |      |       |      |       |      |       |      |      |      |      |
| HCM 2010 Ctrl Delay          |      |      | 24.5 |       |      |       |      |       |      |      |      |      |
| HCM 2010 LOS                 |      |      | C    |       |      |       |      |       |      |      |      |      |
| <b>Notes</b>                 |      |      |      |       |      |       |      |       |      |      |      |      |

HCM 2010 Signalized Intersection Summary  
 50: Reservation Road & SR 68 WB On Ramp/SR 68 WB Off Ramp

Existing, PM  
 06/11/2019



| Movement                      | EBL | EBT  | EBR | WBL  | WBT  | WBR  | NBL  | NBT  | NBR  | SBL  | SBT  | SBR  |
|-------------------------------|-----|------|-----|------|------|------|------|------|------|------|------|------|
| Lane Configurations           |     |      |     |      | ↕    | ↕    | ↕    | ↑    |      |      | ↕    |      |
| Traffic Volume (veh/h)        | 0   | 0    | 0   | 411  | 0    | 239  | 134  | 216  | 0    | 0    | 490  | 125  |
| Future Volume (veh/h)         | 0   | 0    | 0   | 411  | 0    | 239  | 134  | 216  | 0    | 0    | 490  | 125  |
| Number                        |     |      |     | 7    | 4    | 14   | 1    | 6    | 16   | 5    | 2    | 12   |
| Initial Q (Qb), veh           |     |      |     | 0    | 0    | 0    | 0    | 0    | 0    | 0    | 0    | 0    |
| Ped-Bike Adj(A_pbT)           |     |      |     | 1.00 |      | 1.00 | 1.00 |      | 1.00 | 1.00 |      | 1.00 |
| Parking Bus, Adj              |     |      |     | 1.00 | 1.00 | 1.00 | 1.00 | 1.00 | 1.00 | 1.00 | 1.00 | 1.00 |
| Adj Sat Flow, veh/h/ln        |     |      |     | 1900 | 1863 | 1863 | 1845 | 1845 | 0    | 0    | 1827 | 1900 |
| Adj Flow Rate, veh/h          |     |      |     | 437  | 0    | 72   | 143  | 230  | 0    | 0    | 521  | 123  |
| Adj No. of Lanes              |     |      |     | 0    | 1    | 1    | 1    | 1    | 0    | 0    | 1    | 0    |
| Peak Hour Factor              |     |      |     | 0.94 | 0.94 | 0.94 | 0.94 | 0.94 | 0.94 | 0.94 | 0.94 | 0.94 |
| Percent Heavy Veh, %          |     |      |     | 2    | 2    | 2    | 3    | 3    | 0    | 0    | 4    | 4    |
| Cap, veh/h                    |     |      |     | 488  | 0    | 435  | 178  | 1100 | 0    | 0    | 649  | 153  |
| Arrive On Green               |     |      |     | 0.29 | 0.00 | 0.28 | 0.03 | 0.20 | 0.00 | 0.00 | 0.45 | 0.45 |
| Sat Flow, veh/h               |     |      |     | 1774 | 0    | 1580 | 1757 | 1845 | 0    | 0    | 1430 | 338  |
| Grp Volume(v), veh/h          |     |      |     | 437  | 0    | 72   | 143  | 230  | 0    | 0    | 0    | 644  |
| Grp Sat Flow(s),veh/h/ln      |     |      |     | 1774 | 0    | 1580 | 1757 | 1845 | 0    | 0    | 0    | 1767 |
| Q Serve(g_s), s               |     |      |     | 20.1 | 0.0  | 2.9  | 6.9  | 8.9  | 0.0  | 0.0  | 0.0  | 26.6 |
| Cycle Q Clear(g_c), s         |     |      |     | 20.1 | 0.0  | 2.9  | 6.9  | 8.9  | 0.0  | 0.0  | 0.0  | 26.6 |
| Prop In Lane                  |     |      |     | 1.00 |      | 1.00 | 1.00 |      | 0.00 | 0.00 |      | 0.19 |
| Lane Grp Cap(c), veh/h        |     |      |     | 488  | 0    | 435  | 178  | 1100 | 0    | 0    | 0    | 803  |
| V/C Ratio(X)                  |     |      |     | 0.90 | 0.00 | 0.17 | 0.80 | 0.21 | 0.00 | 0.00 | 0.00 | 0.80 |
| Avail Cap(c_a), veh/h         |     |      |     | 564  | 0    | 502  | 248  | 1100 | 0    | 0    | 0    | 803  |
| HCM Platoon Ratio             |     |      |     | 1.00 | 1.00 | 1.00 | 0.33 | 0.33 | 1.00 | 1.00 | 1.00 | 1.00 |
| Upstream Filter(I)            |     |      |     | 1.00 | 0.00 | 1.00 | 0.96 | 0.96 | 0.00 | 0.00 | 0.00 | 1.00 |
| Uniform Delay (d), s/veh      |     |      |     | 29.2 | 0.0  | 23.4 | 40.2 | 17.3 | 0.0  | 0.0  | 0.0  | 19.9 |
| Incr Delay (d2), s/veh        |     |      |     | 15.4 | 0.0  | 0.2  | 8.0  | 0.4  | 0.0  | 0.0  | 0.0  | 8.3  |
| Initial Q Delay(d3),s/veh     |     |      |     | 0.0  | 0.0  | 0.0  | 0.0  | 0.0  | 0.0  | 0.0  | 0.0  | 0.0  |
| %ile BackOfQ(50%),veh/ln      |     |      |     | 11.9 | 0.0  | 1.3  | 3.7  | 4.7  | 0.0  | 0.0  | 0.0  | 14.7 |
| LnGrp Delay(d),s/veh          |     |      |     | 44.6 | 0.0  | 23.6 | 48.3 | 17.7 | 0.0  | 0.0  | 0.0  | 28.3 |
| LnGrp LOS                     |     |      |     | D    |      | C    | D    | B    |      |      |      | C    |
| Approach Vol, veh/h           |     |      |     |      | 509  |      |      | 373  |      |      | 644  |      |
| Approach Delay, s/veh         |     |      |     |      | 41.6 |      |      | 29.4 |      |      | 28.3 |      |
| Approach LOS                  |     |      |     |      | D    |      |      | C    |      |      | C    |      |
| Timer                         | 1   | 2    | 3   | 4    | 5    | 6    | 7    | 8    |      |      |      |      |
| Assigned Phs                  | 1   | 2    |     | 4    |      | 6    |      |      |      |      |      |      |
| Phs Duration (G+Y+Rc), s      | 2.1 | 44.6 |     | 28.3 |      | 56.7 |      |      |      |      |      |      |
| Change Period (Y+Rc), s       | 3.5 | 6.0  |     | 4.9  |      | 6.0  |      |      |      |      |      |      |
| Max Green Setting (Gmax), s   | 2.0 | 31.6 |     | 27.0 |      | 47.1 |      |      |      |      |      |      |
| Max Q Clear Time (g_c+1/3), s | 2.0 | 28.6 |     | 22.1 |      | 10.9 |      |      |      |      |      |      |
| Green Ext Time (p_c), s       | 0.0 | 1.1  |     | 1.3  |      | 1.1  |      |      |      |      |      |      |
| <b>Intersection Summary</b>   |     |      |     |      |      |      |      |      |      |      |      |      |
| HCM 2010 Ctrl Delay           |     |      |     | 33.0 |      |      |      |      |      |      |      |      |
| HCM 2010 LOS                  |     |      |     | C    |      |      |      |      |      |      |      |      |

HCM 2010 Signalized Intersection Summary  
 51: River Road/Reservation Road & SR 68 Off Ramp/SR 68 EB On Ramp





















Existing, PM  
 06/11/2019



| Movement                     | EBL  | EBT  | EBR  | WBL | WBT  | WBR  | NBL  | NBT  | NBR  | SBL  | SBT  | SBR  |
|------------------------------|------|------|------|-----|------|------|------|------|------|------|------|------|
| Lane Configurations          |      | ↕    | ↗    |     |      |      |      | ↑    | ↗    | ↘    | ↑    |      |
| Traffic Volume (veh/h)       | 81   | 1    | 189  | 0   | 0    | 0    | 0    | 291  | 306  | 242  | 659  | 0    |
| Future Volume (veh/h)        | 81   | 1    | 189  | 0   | 0    | 0    | 0    | 291  | 306  | 242  | 659  | 0    |
| Number                       | 3    | 8    | 18   |     |      |      | 1    | 6    | 16   | 5    | 2    | 12   |
| Initial Q (Qb), veh          | 0    | 0    | 0    |     |      |      | 0    | 0    | 0    | 0    | 0    | 0    |
| Ped-Bike Adj(A_pbT)          | 1.00 |      | 1.00 |     |      |      | 1.00 |      | 1.00 | 1.00 |      | 1.00 |
| Parking Bus, Adj             | 1.00 | 1.00 | 1.00 |     |      |      | 1.00 | 1.00 | 1.00 | 1.00 | 1.00 | 1.00 |
| Adj Sat Flow, veh/h/ln       | 1900 | 1863 | 1863 |     |      |      | 0    | 1845 | 1845 | 1827 | 1827 | 0    |
| Adj Flow Rate, veh/h         | 86   | 1    | 22   |     |      |      | 0    | 310  | 187  | 257  | 701  | 0    |
| Adj No. of Lanes             | 0    | 1    | 1    |     |      |      | 0    | 1    | 1    | 1    | 1    | 0    |
| Peak Hour Factor             | 0.94 | 0.94 | 0.94 |     |      |      | 0.94 | 0.94 | 0.94 | 0.94 | 0.94 | 0.94 |
| Percent Heavy Veh, %         | 2    | 2    | 2    |     |      |      | 0    | 3    | 3    | 4    | 4    | 0    |
| Cap, veh/h                   | 123  | 1    | 111  |     |      |      | 0    | 1092 | 928  | 288  | 1464 | 0    |
| Arrive On Green              | 0.08 | 0.07 | 0.07 |     |      |      | 0.00 | 0.59 | 0.59 | 0.33 | 1.00 | 0.00 |
| Sat Flow, veh/h              | 1755 | 20   | 1583 |     |      |      | 0    | 1845 | 1568 | 1740 | 1827 | 0    |
| Grp Volume(v), veh/h         | 87   | 0    | 22   |     |      |      | 0    | 310  | 187  | 257  | 701  | 0    |
| Grp Sat Flow(s),veh/h/ln     | 1755 | 0    | 1583 |     |      |      | 0    | 1845 | 1568 | 1740 | 1827 | 0    |
| Q Serve(g_s), s              | 4.1  | 0.0  | 1.1  |     |      |      | 0.0  | 7.0  | 4.7  | 11.9 | 0.0  | 0.0  |
| Cycle Q Clear(g_c), s        | 4.1  | 0.0  | 1.1  |     |      |      | 0.0  | 7.0  | 4.7  | 11.9 | 0.0  | 0.0  |
| Prop In Lane                 | 0.99 |      | 1.00 |     |      |      | 0.00 |      | 1.00 | 1.00 |      | 0.00 |
| Lane Grp Cap(c), veh/h       | 125  | 0    | 111  |     |      |      | 0    | 1092 | 928  | 288  | 1464 | 0    |
| V/C Ratio(X)                 | 0.70 | 0.00 | 0.20 |     |      |      | 0.00 | 0.28 | 0.20 | 0.89 | 0.48 | 0.00 |
| Avail Cap(c_a), veh/h        | 522  | 0    | 466  |     |      |      | 0    | 1092 | 928  | 348  | 1464 | 0    |
| HCM Platoon Ratio            | 1.00 | 1.00 | 1.00 |     |      |      | 1.00 | 1.00 | 1.00 | 2.00 | 2.00 | 1.00 |
| Upstream Filter(I)           | 1.00 | 0.00 | 1.00 |     |      |      | 0.00 | 1.00 | 1.00 | 0.39 | 0.39 | 0.00 |
| Uniform Delay (d), s/veh     | 38.2 | 0.0  | 37.3 |     |      |      | 0.0  | 8.5  | 8.0  | 27.7 | 0.0  | 0.0  |
| Incr Delay (d2), s/veh       | 6.8  | 0.0  | 0.9  |     |      |      | 0.0  | 0.7  | 0.5  | 9.8  | 0.4  | 0.0  |
| Initial Q Delay(d3),s/veh    | 0.0  | 0.0  | 0.0  |     |      |      | 0.0  | 0.0  | 0.0  | 0.0  | 0.0  | 0.0  |
| %ile BackOfQ(50%),veh/ln     | 2.2  | 0.0  | 0.5  |     |      |      | 0.0  | 3.7  | 2.2  | 6.4  | 0.2  | 0.0  |
| LnGrp Delay(d),s/veh         | 45.0 | 0.0  | 38.1 |     |      |      | 0.0  | 9.2  | 8.5  | 37.4 | 0.4  | 0.0  |
| LnGrp LOS                    | D    |      | D    |     |      |      |      | A    | A    | D    | A    |      |
| Approach Vol, veh/h          |      | 109  |      |     |      |      |      | 497  |      |      | 958  |      |
| Approach Delay, s/veh        |      | 43.6 |      |     |      |      |      | 8.9  |      |      | 10.4 |      |
| Approach LOS                 |      | D    |      |     |      |      |      | A    |      |      | B    |      |
| Timer                        | 1    | 2    | 3    | 4   | 5    | 6    | 7    | 8    |      |      |      |      |
| Assigned Phs                 |      | 2    |      |     | 5    | 6    |      | 8    |      |      |      |      |
| Phs Duration (G+Y+Rc), s     |      | 74.1 |      |     | 17.8 | 56.3 |      | 10.9 |      |      |      |      |
| Change Period (Y+Rc), s      |      | 6.0  |      |     | 3.7  | 6.0  |      | 4.9  |      |      |      |      |
| Max Green Setting (Gmax), s  |      | 43.1 |      |     | 17.0 | 28.4 |      | 25.0 |      |      |      |      |
| Max Q Clear Time (g_c+I1), s |      | 2.0  |      |     | 13.9 | 9.0  |      | 6.1  |      |      |      |      |
| Green Ext Time (p_c), s      |      | 4.8  |      |     | 0.2  | 2.0  |      | 0.4  |      |      |      |      |
| <b>Intersection Summary</b>  |      |      |      |     |      |      |      |      |      |      |      |      |
| HCM 2010 Ctrl Delay          |      |      | 12.2 |     |      |      |      |      |      |      |      |      |
| HCM 2010 LOS                 |      |      | B    |     |      |      |      |      |      |      |      |      |

HCM 2010 Signalized Intersection Summary  
1: Del Monte Boulevard & Reindollar Avenue

Existing with Project, AM  
06/11/2019

|                              |  |  |  |  |  |  |   |  |  |  |  |  |
|------------------------------|---|---|---|---|---|---|---|---|---|---|---|---|
| Movement                     | EBL   | EBT   | EBR   | WBL   | WBT   | WBR   | NBL   | NBT   | NBR   | SBL   | SBT   | SBR   |
| Lane Configurations          |   |   |   |  |  |   |  |  |  |  |  |  |
| Traffic Volume (veh/h)       | 0   | 0   | 0   | 430   | 0   | 60  | 10  | 300   | 110   | 70  | 950   | 0   |
| Future Volume (veh/h)        | 0   | 0   | 0   | 430   | 0   | 60  | 10  | 300   | 110   | 70  | 950   | 0   |
| Number                       |   |   |   | 3   | 8   | 18  | 1   | 6   | 16  | 5   | 2   | 12  |
| Initial Q (Qb), veh          |   |   |   | 0   | 0   | 0   | 0   | 0   | 0   | 0   | 0   | 0   |
| Ped-Bike Adj(A_pbT)          |   |   |   | 1.00  |   | 1.00  | 1.00  |   | 1.00  | 1.00  |   | 1.00  |
| Parking Bus, Adj             |   |   |   | 1.00  | 1.00  | 1.00  | 1.00  | 1.00  | 1.00  | 1.00  | 1.00  | 1.00  |
| Adj Sat Flow, veh/h/ln       |   |   |   | 1900  | 1900  | 1900  | 1863  | 1863  | 1863  | 1845  | 1845  | 0   |
| Adj Flow Rate, veh/h         |   |   |   | 506   | 0   | 0   | 11  | 337   | 57  | 79  | 1067  | 0   |
| Adj No. of Lanes             |   |   |   | 2   | 1   | 0   | 1   | 2   | 1   | 1   | 2   | 0   |
| Peak Hour Factor             |   |   |   | 0.89  | 0.89  | 0.89  | 0.89  | 0.89  | 0.89  | 0.89  | 0.89  | 0.89  |
| Percent Heavy Veh, %         |   |   |   | 0   | 0   | 0   | 2   | 2   | 2   | 3   | 3   | 0   |
| Cap, veh/h                   |   |   |   | 808   | 424   | 0   | 25  | 1407  | 628   | 124   | 1591  | 0   |
| Arrive On Green              |   |   |   | 0.22  | 0.00  | 0.00  | 0.01  | 0.40  | 0.40  | 0.07  | 0.45  | 0.00  |
| Sat Flow, veh/h              |   |   |   | 3619  | 1900  | 0   | 1774  | 3539  | 1579  | 1757  | 3597  | 0   |
| Grp Volume(v), veh/h         |   |   |   | 506   | 0   | 0   | 11  | 337   | 57  | 79  | 1067  | 0   |
| Grp Sat Flow(s),veh/h/ln     |   |   |   | 1810  | 1900  | 0   | 1774  | 1770  | 1579  | 1757  | 1752  | 0   |
| Q Serve(g_s), s              |   |   |   | 5.5   | 0.0   | 0.0   | 0.3   | 2.8   | 1.0   | 1.9   | 10.5  | 0.0   |
| Cycle Q Clear(g_c), s        |   |   |   | 5.5   | 0.0   | 0.0   | 0.3   | 2.8   | 1.0   | 1.9   | 10.5  | 0.0   |
| Prop In Lane                 |   |   |   | 1.00  |   | 0.00  | 1.00  |   | 1.00  | 1.00  |   | 0.00  |
| Lane Grp Cap(c), veh/h       |   |   |   | 808   | 424   | 0   | 25  | 1407  | 628   | 124   | 1591  | 0   |
| V/C Ratio(X)                 |   |   |   | 0.63  | 0.00  | 0.00  | 0.43  | 0.24  | 0.09  | 0.64  | 0.67  | 0.00  |
| Avail Cap(c_a), veh/h        |   |   |   | 2482  | 1303  | 0   | 1217  | 2427  | 1083  | 1205  | 2404  | 0   |
| HCM Platoon Ratio            |   |   |   | 1.00  | 1.00  | 1.00  | 1.00  | 1.00  | 1.00  | 1.00  | 1.00  | 1.00  |
| Upstream Filter(l)           |   |   |   | 1.00  | 0.00  | 0.00  | 1.00  | 1.00  | 1.00  | 1.00  | 1.00  | 0.00  |
| Uniform Delay (d), s/veh     |   |   |   | 15.3  | 0.0   | 0.0   | 21.4  | 8.8   | 8.2   | 19.8  | 9.4   | 0.0   |
| Incr Delay (d2), s/veh       |   |   |   | 0.8   | 0.0   | 0.0   | 11.2  | 0.1   | 0.1   | 5.3   | 0.5   | 0.0   |
| Initial Q Delay(d3),s/veh    |   |   |   | 0.0   | 0.0   | 0.0   | 0.0   | 0.0   | 0.0   | 0.0   | 0.0   | 0.0   |
| %ile BackOfQ(50%),veh/ln     |   |   |   | 2.8   | 0.0   | 0.0   | 0.2   | 1.4   | 0.4   | 1.1   | 5.0   | 0.0   |
| LnGrp Delay(d),s/veh         |   |   |   | 16.1  | 0.0   | 0.0   | 32.6  | 8.9   | 8.3   | 25.1  | 9.9   | 0.0   |
| LnGrp LOS                    |   |   |   | B   |   |   | C   | A   | A   | C   | A   |   |
| Approach Vol, veh/h          |   |   |   |   | 506   |   |   | 405   |   |   | 1146  |   |
| Approach Delay, s/veh        |   |   |   |   | 16.1  |   |   | 9.4   |   |   | 10.9  |   |
| Approach LOS                 |   |   |   |   | B   |   |   | A   |   |   | B   |   |
| Timer                        | 1   | 2   | 3   | 4   | 5   | 6   | 7   | 8   |   |   |   |   |
| Assigned Phs                 | 1   | 2   |   |   | 5   | 6   |   | 8   |   |   |   |   |
| Phs Duration (G+Y+Rc), s     | 4.1   | 24.9  |   |   | 6.6   | 22.4  |   | 14.8  |   |   |   |   |
| Change Period (Y+Rc), s      | 3.5   | 5.0   |   |   | 3.5   | 5.0   |   | 5.0   |   |   |   |   |
| Max Green Setting (Gmax), s  | 30.0  | 30.0  |   |   | 30.0  | 30.0  |   | 30.0  |   |   |   |   |
| Max Q Clear Time (g_c+I1), s | 2.3   | 12.5  |   |   | 3.9   | 4.8   |   | 7.5   |   |   |   |   |
| Green Ext Time (p_c), s      | 0.0   | 7.4   |   |   | 0.2   | 2.3   |   | 1.9   |   |   |   |   |
| <b>Intersection Summary</b>  |   |   |   |   |   |   |   |   |   |   |   |   |
| HCM 2010 Ctrl Delay          |   |   |   | 11.9  |   |   |   |   |   |   |   |   |
| HCM 2010 LOS                 |   |   |   | B   |   |   |   |   |   |   |   |   |
| <b>Notes</b>                 |   |   |   |   |   |   |   |   |   |   |   |   |



HCM 2010 Signalized Intersection Summary  
 3: SR 1 SB On-Ramp/SR 1 SB Off-Ramp & Imjin Parkway

Existing with Project, AM  
 06/11/2019



| Movement                     | EBL | EBT | EBR | WBL  | WBT  | WBR  | NBL | NBT | NBR | SBL  | SBT  | SBR  |
|------------------------------|-----|-----|-----|------|------|------|-----|-----|-----|------|------|------|
| Lane Configurations          |     |     |     |      | ↔    |      |     |     |     |      | ↔    |      |
| Traffic Volume (veh/h)       | 0   | 0   | 0   | 940  | 0    | 0    | 0   | 0   | 0   | 520  | 10   | 0    |
| Future Volume (veh/h)        | 0   | 0   | 0   | 940  | 0    | 0    | 0   | 0   | 0   | 520  | 10   | 0    |
| Number                       |     |     |     | 1    | 6    | 16   |     |     |     | 7    | 4    | 14   |
| Initial Q (Qb), veh          |     |     |     | 0    | 0    | 0    |     |     |     | 0    | 0    | 0    |
| Ped-Bike Adj(A_pbT)          |     |     |     | 1.00 |      | 1.00 |     |     |     | 1.00 |      | 1.00 |
| Parking Bus, Adj             |     |     |     | 1.00 | 1.00 | 1.00 |     |     |     | 1.00 | 1.00 | 1.00 |
| Adj Sat Flow, veh/h/ln       |     |     |     | 1900 | 1845 | 0    |     |     |     | 1900 | 1845 | 0    |
| Adj Flow Rate, veh/h         |     |     |     | 1033 | 0    | 0    |     |     |     | 571  | 11   | 0    |
| Adj No. of Lanes             |     |     |     | 0    | 1    | 0    |     |     |     | 0    | 1    | 0    |
| Peak Hour Factor             |     |     |     | 0.91 | 0.91 | 0.91 |     |     |     | 0.91 | 0.91 | 0.91 |
| Percent Heavy Veh, %         |     |     |     | 3    | 3    | 0    |     |     |     | 3    | 3    | 0    |
| Cap, veh/h                   |     |     |     | 1038 | 0    | 0    |     |     |     | 606  | 12   | 0    |
| Arrive On Green              |     |     |     | 0.59 | 0.00 | 0.00 |     |     |     | 0.35 | 0.35 | 0.00 |
| Sat Flow, veh/h              |     |     |     | 1757 | 0    | 0    |     |     |     | 1725 | 33   | 0    |
| Grp Volume(v), veh/h         |     |     |     | 1033 | 0    | 0    |     |     |     | 582  | 0    | 0    |
| Grp Sat Flow(s),veh/h/ln     |     |     |     | 1757 | 0    | 0    |     |     |     | 1758 | 0    | 0    |
| Q Serve(g_s), s              |     |     |     | 88.8 | 0.0  | 0.0  |     |     |     | 48.9 | 0.0  | 0.0  |
| Cycle Q Clear(g_c), s        |     |     |     | 88.8 | 0.0  | 0.0  |     |     |     | 48.9 | 0.0  | 0.0  |
| Prop In Lane                 |     |     |     | 1.00 |      | 0.00 |     |     |     | 0.98 |      | 0.00 |
| Lane Grp Cap(c), veh/h       |     |     |     | 1038 | 0    | 0    |     |     |     | 617  | 0    | 0    |
| V/C Ratio(X)                 |     |     |     | 0.99 | 0.00 | 0.00 |     |     |     | 0.94 | 0.00 | 0.00 |
| Avail Cap(c_a), veh/h        |     |     |     | 1038 | 0    | 0    |     |     |     | 693  | 0    | 0    |
| HCM Platoon Ratio            |     |     |     | 1.00 | 1.00 | 1.00 |     |     |     | 1.00 | 1.00 | 1.00 |
| Upstream Filter(I)           |     |     |     | 1.00 | 0.00 | 0.00 |     |     |     | 1.00 | 0.00 | 0.00 |
| Uniform Delay (d), s/veh     |     |     |     | 30.9 | 0.0  | 0.0  |     |     |     | 47.9 | 0.0  | 0.0  |
| Incr Delay (d2), s/veh       |     |     |     | 26.6 | 0.0  | 0.0  |     |     |     | 20.2 | 0.0  | 0.0  |
| Initial Q Delay(d3),s/veh    |     |     |     | 0.0  | 0.0  | 0.0  |     |     |     | 0.0  | 0.0  | 0.0  |
| %ile BackOfQ(50%),veh/ln     |     |     |     | 50.4 | 0.0  | 0.0  |     |     |     | 27.2 | 0.0  | 0.0  |
| LnGrp Delay(d),s/veh         |     |     |     | 57.5 | 0.0  | 0.0  |     |     |     | 68.1 | 0.0  | 0.0  |
| LnGrp LOS                    |     |     |     | E    |      |      |     |     |     | E    |      |      |
| Approach Vol, veh/h          |     |     |     |      | 1033 |      |     |     |     |      | 582  |      |
| Approach Delay, s/veh        |     |     |     |      | 57.5 |      |     |     |     |      | 68.1 |      |
| Approach LOS                 |     |     |     |      | E    |      |     |     |     |      | E    |      |
| Timer                        | 1   | 2   | 3   | 4    | 5    | 6    | 7   | 8   |     |      |      |      |
| Assigned Phs                 |     |     |     | 4    |      | 6    |     |     |     |      |      |      |
| Phs Duration (G+Y+Rc), s     |     |     |     | 57.9 |      | 94.4 |     |     |     |      |      |      |
| Change Period (Y+Rc), s      |     |     |     | 4.4  |      | 4.4  |     |     |     |      |      |      |
| Max Green Setting (Gmax), s  |     |     |     | 60.0 |      | 90.0 |     |     |     |      |      |      |
| Max Q Clear Time (g_c+I1), s |     |     |     | 50.9 |      | 90.8 |     |     |     |      |      |      |
| Green Ext Time (p_c), s      |     |     |     | 2.6  |      | 0.0  |     |     |     |      |      |      |
| <b>Intersection Summary</b>  |     |     |     |      |      |      |     |     |     |      |      |      |
| HCM 2010 Ctrl Delay          |     |     |     | 61.3 |      |      |     |     |     |      |      |      |
| HCM 2010 LOS                 |     |     |     | E    |      |      |     |     |     |      |      |      |

| Intersection             |      |      |      |      |      |      |      |      |      |      |       |      |
|--------------------------|------|------|------|------|------|------|------|------|------|------|-------|------|
| Int Delay, s/veh         | 0.6  |      |      |      |      |      |      |      |      |      |       |      |
| Movement                 | EBL  | EBT  | EBR  | WBL  | WBT  | WBR  | NBL  | NBT  | NBR  | SBL  | SBT   | SBR  |
| Lane Configurations      |      | ↖    |      |      | ↑    | ↗    |      | ↖    | ↗    |      |       |      |
| Traffic Vol, veh/h       | 10   | 530  | 0    | 0    | 900  | 180  | 10   | 10   | 810  | 0    | 0     | 0    |
| Future Vol, veh/h        | 10   | 530  | 0    | 0    | 900  | 180  | 10   | 10   | 810  | 0    | 0     | 0    |
| Conflicting Peds, #/hr   | 0    | 0    | 3    | 3    | 0    | 0    | 0    | 0    | 0    | 0    | 0     | 0    |
| Sign Control             | Free | Free | Free | Free | Free | Free | Stop | Stop | Stop | Stop | Stop  | Stop |
| RT Channelized           | -    | -    | None | -    | -    | Free | -    | -    | Free | -    | -     | None |
| Storage Length           | -    | -    | -    | -    | -    | 0    | -    | -    | 800  | -    | -     | -    |
| Veh in Median Storage, # | -    | 0    | -    | -    | 0    | -    | -    | 0    | -    | -    | 16965 | -    |
| Grade, %                 | -    | 0    | -    | -    | 0    | -    | -    | 0    | -    | -    | 0     | -    |
| Peak Hour Factor         | 97   | 97   | 97   | 97   | 97   | 97   | 97   | 97   | 97   | 97   | 97    | 97   |
| Heavy Vehicles, %        | 3    | 3    | 3    | 3    | 3    | 3    | 2    | 2    | 2    | 2    | 2     | 2    |
| Mvmt Flow                | 10   | 546  | 0    | 0    | 928  | 186  | 10   | 10   | 835  | 0    | 0     | 0    |























| Major/Minor          | Major1 | Major2 | Minor1 |
|----------------------|--------|--------|--------|
| Conflicting Flow All | 928    | 0      | 0      |
| Stage 1              | -      | -      | -      |
| Stage 2              | -      | -      | -      |
| Critical Hdwy        | 4.13   | -      | -      |
| Critical Hdwy Stg 1  | -      | -      | -      |
| Critical Hdwy Stg 2  | -      | -      | -      |
| Follow-up Hdwy       | 2.227  | -      | -      |
| Pot Cap-1 Maneuver   | 733    | 0      | 0      |
| Stage 1              | -      | 0      | 0      |
| Stage 2              | -      | 0      | 0      |
| Platoon blocked, %   | -      | -      | -      |
| Mov Cap-1 Maneuver   | 733    | -      | -      |
| Mov Cap-2 Maneuver   | -      | -      | -      |
| Stage 1              | -      | -      | -      |
| Stage 2              | -      | -      | -      |

| Approach             | EB  | WB | NB |
|----------------------|-----|----|----|
| HCM Control Delay, s | 0.2 | 0  | 37 |
| HCM LOS              |     |    | E  |

| Minor Lane/Major Mvmt | NBLn1 | NBLn2 | EBL   | EBT | WBT |
|-----------------------|-------|-------|-------|-----|-----|
| Capacity (veh/h)      | 133   | -     | 733   | -   | -   |
| HCM Lane V/C Ratio    | 0.155 | -     | 0.014 | -   | -   |
| HCM Control Delay (s) | 37    | 0     | 10    | 0   | -   |
| HCM Lane LOS          | E     | A     | A     | A   | -   |
| HCM 95th %tile Q(veh) | 0.5   | -     | 0     | -   | -   |

HCM 2010 Signalized Intersection Summary  
5: 2nd Avenue & Imjin Parkway

Existing with Project, AM  
06/11/2019

|                              |  |  |  |  |  |  |  |  |  |  |  |  |
|------------------------------|---|---|---|---|---|---|--|---|---|---|---|---|
| Movement                     | EBL   | EBT   | EBR   | WBL   | WBT   | WBR   | NBL  | NBT   | NBR   | SBL   | SBT   | SBR   |
| Lane Configurations          |  |  |  |  |  |   |  |  |  |  |  |  |
| Traffic Volume (veh/h)       | 20  | 910   | 430   | 330   | 840   | 20  | 110  | 10  | 140   | 10  | 10  | 10  |
| Future Volume (veh/h)        | 20  | 910   | 430   | 330   | 840   | 20  | 110  | 10  | 140   | 10  | 10  | 10  |
| Number                       | 5   | 2   | 12  | 1   | 6   | 16  | 3  | 8   | 18  | 7   | 4   | 14  |
| Initial Q (Qb), veh          | 0   | 0   | 0   | 0   | 0   | 0   | 0  | 0   | 0   | 0   | 0   | 0   |
| Ped-Bike Adj(A_pbT)          | 1.00  |   | 1.00  | 1.00  |   | 1.00  | 1.00   |   | 1.00  | 1.00  |   | 1.00  |
| Parking Bus, Adj             | 1.00  | 1.00  | 1.00  | 1.00  | 1.00  | 1.00  | 1.00   | 1.00  | 1.00  | 1.00  | 1.00  | 1.00  |
| Adj Sat Flow, veh/h/ln       | 1863  | 1863  | 1863  | 1863  | 1863  | 1900  | 1810   | 1810  | 1810  | 1900  | 1900  | 1900  |
| Adj Flow Rate, veh/h         | 20  | 929   | 220   | 337   | 857   | 20  | 112  | 10  | 21  | 10  | 10  | 5   |
| Adj No. of Lanes             | 1   | 2   | 1   | 2   | 2   | 0   | 2  | 1   | 1   | 1   | 2   | 0   |
| Peak Hour Factor             | 0.98  | 0.98  | 0.98  | 0.98  | 0.98  | 0.98  | 0.98   | 0.98  | 0.98  | 0.98  | 0.98  | 0.98  |
| Percent Heavy Veh, %         | 2   | 2   | 2   | 2   | 2   | 2   | 5  | 5   | 5   | 0   | 0   | 0   |
| Cap, veh/h                   | 130   | 1141  | 510   | 493   | 1386  | 32  | 225  | 71  | 60  | 105   | 71  | 33  |
| Arrive On Green              | 0.07  | 0.32  | 0.32  | 0.14  | 0.39  | 0.39  | 0.07   | 0.04  | 0.04  | 0.06  | 0.03  | 0.03  |
| Sat Flow, veh/h              | 1774  | 3539  | 1583  | 3442  | 3535  | 83  | 3343   | 1810  | 1534  | 1810  | 2398  | 1107  |
| Grp Volume(v), veh/h         | 20  | 929   | 220   | 337   | 429   | 448   | 112  | 10  | 21  | 10  | 7   | 8   |
| Grp Sat Flow(s),veh/h/ln     | 1774  | 1770  | 1583  | 1721  | 1770  | 1848  | 1672   | 1810  | 1534  | 1810  | 1805  | 1699  |
| Q Serve(g_s), s              | 0.4   | 9.9   | 4.5   | 3.8   | 8.0   | 8.0   | 1.3  | 0.2   | 0.5   | 0.2   | 0.2   | 0.2   |
| Cycle Q Clear(g_c), s        | 0.4   | 9.9   | 4.5   | 3.8   | 8.0   | 8.0   | 1.3  | 0.2   | 0.5   | 0.2   | 0.2   | 0.2   |
| Prop In Lane                 | 1.00  |   | 1.00  | 1.00  |   | 0.04  | 1.00   |   | 1.00  | 1.00  |   | 0.65  |
| Lane Grp Cap(c), veh/h       | 130   | 1141  | 510   | 493   | 694   | 725   | 225  | 71  | 60  | 105   | 54  | 50  |
| V/C Ratio(X)                 | 0.15  | 0.81  | 0.43  | 0.68  | 0.62  | 0.62  | 0.50   | 0.14  | 0.35  | 0.10  | 0.14  | 0.15  |
| Avail Cap(c_a), veh/h        | 651   | 2596  | 1161  | 1262  | 1298  | 1355  | 1635   | 929   | 788   | 442   | 927   | 872   |
| HCM Platoon Ratio            | 1.00  | 1.00  | 1.00  | 1.00  | 1.00  | 1.00  | 1.00   | 1.00  | 1.00  | 1.00  | 1.00  | 1.00  |
| Upstream Filter(I)           | 1.00  | 1.00  | 1.00  | 1.00  | 1.00  | 1.00  | 1.00   | 1.00  | 1.00  | 1.00  | 1.00  | 1.00  |
| Uniform Delay (d), s/veh     | 17.8  | 12.7  | 10.9  | 16.6  | 10.0  | 10.0  | 18.4   | 19.0  | 19.1  | 18.3  | 19.3  | 19.3  |
| Incr Delay (d2), s/veh       | 0.2   | 0.5   | 0.2   | 0.6   | 0.3   | 0.3   | 0.6  | 0.3   | 1.3   | 0.1   | 0.4   | 0.5   |
| Initial Q Delay(d3),s/veh    | 0.0   | 0.0   | 0.0   | 0.0   | 0.0   | 0.0   | 0.0  | 0.0   | 0.0   | 0.0   | 0.0   | 0.0   |
| %ile BackOfQ(50%),veh/ln     | 0.2   | 4.9   | 2.0   | 1.8   | 3.9   | 4.0   | 0.6  | 0.1   | 0.3   | 0.1   | 0.1   | 0.1   |
| LnGrp Delay(d),s/veh         | 18.0  | 13.3  | 11.1  | 17.3  | 10.3  | 10.3  | 19.0   | 19.3  | 20.4  | 18.4  | 19.8  | 19.9  |
| LnGrp LOS                    | B   | B   | B   | B   | B   | B   | B  | B   | C   | B   | B   | B   |
| Approach Vol, veh/h          |   | 1169  |   |   | 1214  |   |  | 143   |   |   | 25  |   |
| Approach Delay, s/veh        |   | 13.0  |   |   | 12.2  |   |  | 19.3  |   |   | 19.2  |   |
| Approach LOS                 |   | B   |   |   | B   |   |  | B   |   |   | B   |   |
| Timer                        | 1   | 2   | 3   | 4   | 5   | 6   | 7  | 8   |   |   |   |   |
| Assigned Phs                 | 1   | 2   | 3   | 4   | 5   | 6   | 7  | 8   |   |   |   |   |
| Phs Duration (G+Y+Rc), s     | 10.4  | 18.5  | 6.3   | 5.8   | 7.5   | 21.3  | 5.9  | 6.2   |   |   |   |   |
| Change Period (Y+Rc), s      | 4.5   | 5.3   | 3.5   | 4.6   | 4.5   | 5.3   | 3.5  | 4.6   |   |   |   |   |
| Max Green Setting (Gmax), s  | 15.0  | 30.0  | 20.0  | 21.0  | 15.0  | 30.0  | 10.0   | 21.0  |   |   |   |   |
| Max Q Clear Time (g_c+I1), s | 5.8   | 11.9  | 3.3   | 2.2   | 2.4   | 10.0  | 2.2  | 2.5   |   |   |   |   |
| Green Ext Time (p_c), s      | 0.1   | 1.3   | 0.0   | 0.0   | 0.0   | 0.9   | 0.0  | 0.0   |   |   |   |   |
| <b>Intersection Summary</b>  |   |   |   |   |   |   |  |   |   |   |   |   |
| HCM 2010 Ctrl Delay          |   |   | 13.0  |   |   |   |  |   |   |   |   |   |
| HCM 2010 LOS                 |   |   | B   |   |   |   |  |   |   |   |   |   |

| Intersection             |      |      |      |      |      |      |      |      |      |      |      |      |
|--------------------------|------|------|------|------|------|------|------|------|------|------|------|------|
| Int Delay, s/veh         | 1.4  |      |      |      |      |      |      |      |      |      |      |      |
| Movement                 | EBL  | EBT  | EBR  | WBL  | WBT  | WBR  | NBL  | NBT  | NBR  | SBL  | SBT  | SBR  |
| Lane Configurations      | ↖    | ↕    |      | ↖    | ↕    |      | ↖    | ↕    |      | ↖    | ↕    |      |
| Traffic Vol, veh/h       | 50   | 870  | 20   | 240  | 1250 | 30   | 10   | 10   | 20   | 10   | 10   | 40   |
| Future Vol, veh/h        | 50   | 870  | 20   | 240  | 1250 | 30   | 10   | 10   | 20   | 10   | 10   | 40   |
| Conflicting Peds, #/hr   | 1    | 0    | 1    | 1    | 0    | 1    | 0    | 0    | 2    | 2    | 0    | 0    |
| Sign Control             | Free | Free | Free | Free | Free | Free | Stop | Stop | Stop | Stop | Stop | Stop |
| RT Channelized           | -    | -    | None | -    | -    | None | -    | -    | None | -    | -    | None |
| Storage Length           | 300  | -    | -    | 300  | -    | -    | 85   | -    | -    | 25   | -    | -    |
| Veh in Median Storage, # | -    | 0    | -    | -    | 0    | -    | -    | 0    | -    | -    | 0    | -    |
| Grade, %                 | -    | 0    | -    | -    | 0    | -    | -    | 0    | -    | -    | 0    | -    |
| Peak Hour Factor         | 96   | 96   | 96   | 96   | 96   | 96   | 96   | 96   | 96   | 96   | 96   | 96   |
| Heavy Vehicles, %        | 2    | 2    | 2    | 2    | 2    | 2    | 5    | 5    | 5    | 2    | 2    | 2    |
| Mvmt Flow                | 52   | 906  | 21   | 250  | 1302 | 31   | 10   | 10   | 21   | 10   | 10   | 42   |

| Major/Minor          | Major1 |   |   | Major2 |   |   | Minor1 |      |      | Minor2 |      |      |
|----------------------|--------|---|---|--------|---|---|--------|------|------|--------|------|------|
| Conflicting Flow All | 1334   | 0 | 0 | 928    | 0 | 0 | 2178   | 2856 | 467  | 2383   | 2851 | 668  |
| Stage 1              | -      | - | - | -      | - | - | 1022   | 1022 | -    | 1819   | 1819 | -    |
| Stage 2              | -      | - | - | -      | - | - | 1156   | 1834 | -    | 564    | 1032 | -    |
| Critical Hdwy        | 4.14   | - | - | 4.14   | - | - | 7.6    | 6.6  | 7    | 7.54   | 6.54 | 6.94 |
| Critical Hdwy Stg 1  | -      | - | - | -      | - | - | 6.6    | 5.6  | -    | 6.54   | 5.54 | -    |
| Critical Hdwy Stg 2  | -      | - | - | -      | - | - | 6.6    | 5.6  | -    | 6.54   | 5.54 | -    |
| Follow-up Hdwy       | 2.22   | - | - | 2.22   | - | - | 3.55   | 4.05 | 3.35 | 3.52   | 4.02 | 3.32 |
| Pot Cap-1 Maneuver   | 513    | - | - | 733    | - | - | 25     | 16   | 534  | 18     | 17   | 401  |
| Stage 1              | -      | - | - | -      | - | - | 247    | 305  | -    | 80     | 127  | -    |
| Stage 2              | -      | - | - | -      | - | - | 204    | 121  | -    | 478    | 308  | -    |
| Platoon blocked, %   | -      | - | - | -      | - | - | -      | -    | -    | -      | -    | -    |
| Mov Cap-1 Maneuver   | 513    | - | - | 732    | - | - | ~9     | 532  | -    | ~10    | 401  | -    |
| Mov Cap-2 Maneuver   | -      | - | - | -      | - | - | ~9     | -    | -    | ~10    | -    | -    |
| Stage 1              | -      | - | - | -      | - | - | 222    | 274  | -    | 72     | 83   | -    |
| Stage 2              | -      | - | - | -      | - | - | 105    | 79   | -    | 396    | 277  | -    |

| Approach             | EB  | WB | NB | SB |
|----------------------|-----|----|----|----|
| HCM Control Delay, s | 0.7 | 2  |    |    |
| HCM LOS              |     |    | -  | -  |

| Minor Lane/Major Mvmt | NBLn1 | NBLn2    | EBL   | EBT | EBR | WBL   | WBT | WBR | SBLn1 | SBLn2    |
|-----------------------|-------|----------|-------|-----|-----|-------|-----|-----|-------|----------|
| Capacity (veh/h)      | -     | 26       | 513   | -   | -   | 732   | -   | -   | -     | 45       |
| HCM Lane V/C Ratio    | -     | 1.202    | 0.102 | -   | -   | 0.342 | -   | -   | -     | 1.157    |
| HCM Control Delay (s) | -     | \$ 466.3 | 12.8  | -   | -   | 12.4  | -   | -   | -     | \$ 327.6 |
| HCM Lane LOS          | -     | F        | B     | -   | -   | B     | -   | -   | -     | F        |
| HCM 95th %tile Q(veh) | -     | 3.8      | 0.3   | -   | -   | 1.5   | -   | -   | -     | 4.9      |

Notes  
 ~: Volume exceeds capacity    \$: Delay exceeds 300s    +: Computation Not Defined    \*: All major volume in platoon

| Intersection             |      |      |      |      |      |      |      |      |      |      |      |      |
|--------------------------|------|------|------|------|------|------|------|------|------|------|------|------|
| Int Delay, s/veh         | 17.3 |      |      |      |      |      |      |      |      |      |      |      |
| Movement                 | EBL  | EBT  | EBR  | WBL  | WBT  | WBR  | NBL  | NBT  | NBR  | SBL  | SBT  | SBR  |
| Lane Configurations      | ↖    | ↗    |      | ↖    | ↗    |      |      | ↕    |      |      | ↕    |      |
| Traffic Vol, veh/h       | 10   | 960  | 20   | 10   | 1440 | 10   | 10   | 10   | 10   | 10   | 10   | 10   |
| Future Vol, veh/h        | 10   | 960  | 20   | 10   | 1440 | 10   | 10   | 10   | 10   | 10   | 10   | 10   |
| Conflicting Peds, #/hr   | 1    | 0    | 1    | 1    | 0    | 1    | 0    | 0    | 0    | 0    | 0    | 0    |
| Sign Control             | Free | Free | Free | Free | Free | Free | Stop | Stop | Stop | Stop | Stop | Stop |
| RT Channelized           | -    | -    | None | -    | -    | None | -    | -    | None | -    | -    | Stop |
| Storage Length           | 330  | -    | -    | 330  | -    | -    | -    | -    | -    | -    | -    | -    |
| Veh in Median Storage, # | -    | 0    | -    | -    | 0    | -    | -    | 0    | -    | -    | 0    | -    |
| Grade, %                 | -    | 0    | -    | -    | 0    | -    | -    | 0    | -    | -    | 0    | -    |
| Peak Hour Factor         | 96   | 96   | 96   | 96   | 96   | 96   | 96   | 96   | 96   | 96   | 96   | 96   |
| Heavy Vehicles, %        | 2    | 2    | 2    | 2    | 2    | 2    | 50   | 50   | 50   | 0    | 0    | 0    |
| Mvmt Flow                | 10   | 1000 | 21   | 10   | 1500 | 10   | 10   | 10   | 10   | 10   | 10   | 10   |

| Major/Minor          | Major1 |   |   | Major2 |   |   | Minor1 |      |     | Minor2 |      |     |
|----------------------|--------|---|---|--------|---|---|--------|------|-----|--------|------|-----|
| Conflicting Flow All | 1511   | 0 | 0 | 1022   | 0 | 0 | 1807   | 2563 | 512 | 2051   | 2568 | 756 |
| Stage 1              | -      | - | - | -      | - | - | 1032   | 1032 | -   | 1526   | 1526 | -   |
| Stage 2              | -      | - | - | -      | - | - | 775    | 1531 | -   | 525    | 1042 | -   |
| Critical Hdwy        | 4.14   | - | - | 4.14   | - | - | 8.5    | 7.5  | 7.9 | 7.5    | 6.5  | 6.9 |
| Critical Hdwy Stg 1  | -      | - | - | -      | - | - | 7.5    | 6.5  | -   | 6.5    | 5.5  | -   |
| Critical Hdwy Stg 2  | -      | - | - | -      | - | - | 7.5    | 6.5  | -   | 6.5    | 5.5  | -   |
| Follow-up Hdwy       | 2.22   | - | - | 2.22   | - | - | 4      | 4.5  | 3.8 | 3.5    | 4    | 3.3 |
| Pot Cap-1 Maneuver   | 439    | - | - | 675    | - | - | 29     | 13   | 399 | 33     | 26   | 355 |
| Stage 1              | -      | - | - | -      | - | - | 176    | 221  | -   | 126    | 182  | -   |
| Stage 2              | -      | - | - | -      | - | - | 267    | 113  | -   | 509    | 309  | -   |
| Platoon blocked, %   | -      | - | - | -      | - | - | -      | -    | -   | -      | -    | -   |
| Mov Cap-1 Maneuver   | 439    | - | - | 674    | - | - | 18     | 12   | 399 | ~ 8    | 25   | 355 |
| Mov Cap-2 Maneuver   | -      | - | - | -      | - | - | 18     | 12   | -   | ~ 8    | 25   | -   |
| Stage 1              | -      | - | - | -      | - | - | 172    | 216  | -   | 123    | 179  | -   |
| Stage 2              | -      | - | - | -      | - | - | 240    | 111  | -   | 461    | 302  | -   |



















| Approach             | EB  |  |  | WB  |  |  | NB       |  |  | SB       |  |  |
|----------------------|-----|--|--|-----|--|--|----------|--|--|----------|--|--|
| HCM Control Delay, s | 0.1 |  |  | 0.1 |  |  | \$ 642.4 |  |  | \$ 799.2 |  |  |
| HCM LOS              |     |  |  |     |  |  | F        |  |  | F        |  |  |

| Minor Lane/Major Mvmt | NBLn1    | EBL   | EBT | EBR | WBL   | WBT | WBR | SBLn1    |
|-----------------------|----------|-------|-----|-----|-------|-----|-----|----------|
| Capacity (veh/h)      | 21       | 439   | -   | -   | 674   | -   | -   | 18       |
| HCM Lane V/C Ratio    | 1.488    | 0.024 | -   | -   | 0.015 | -   | -   | 1.736    |
| HCM Control Delay (s) | \$ 642.4 | 13.4  | -   | -   | 10.4  | -   | -   | \$ 799.2 |
| HCM Lane LOS          | F        | B     | -   | -   | B     | -   | -   | F        |
| HCM 95th %tile Q(veh) | 4.1      | 0.1   | -   | -   | 0     | -   | -   | 4.4      |

Notes  
 ~: Volume exceeds capacity    \$: Delay exceeds 300s    +: Computation Not Defined    \*: All major volume in platoon

HCM 2010 Signalized Intersection Summary  
 8: 5th Avenue/California Avenue & Imjin Parkway

Existing with Project, AM  
 06/11/2019

|                              |  |  |  |  |  |  |  |  |  |  |  |  |
|------------------------------|---|---|---|---|---|---|--|---|---|---|---|---|
| Movement                     | EBL   | EBT   | EBR   | WBL   | WBT   | WBR   | NBL  | NBT   | NBR   | SBL   | SBT   | SBR   |
| Lane Configurations          |  |  |   |  |  |   |  |  |   |   |  |  |
| Traffic Volume (veh/h)       | 120   | 830   | 20  | 10  | 970   | 80  | 20   | 20  | 10  | 100   | 150   | 400   |
| Future Volume (veh/h)        | 120   | 830   | 20  | 10  | 970   | 80  | 20   | 20  | 10  | 100   | 150   | 400   |
| Number                       | 5   | 2   | 12  | 1   | 6   | 16  | 3  | 8   | 18  | 7   | 4   | 14  |
| Initial Q (Qb), veh          | 0   | 0   | 0   | 0   | 0   | 0   | 0  | 0   | 0   | 0   | 0   | 0   |
| Ped-Bike Adj(A_pbT)          | 1.00  |   | 0.98  | 1.00  |   | 1.00  | 1.00   |   | 0.99  | 1.00  |   | 1.00  |
| Parking Bus, Adj             | 1.00  | 1.00  | 1.00  | 1.00  | 1.00  | 1.00  | 1.00   | 1.00  | 1.00  | 1.00  | 1.00  | 1.00  |
| Adj Sat Flow, veh/h/ln       | 1881  | 1881  | 1900  | 1863  | 1863  | 1900  | 1900   | 1624  | 1900  | 1900  | 1881  | 1900  |
| Adj Flow Rate, veh/h         | 126   | 874   | 19  | 11  | 1021  | 78  | 21   | 21  | 10  | 105   | 158   | 347   |
| Adj No. of Lanes             | 1   | 2   | 0   | 1   | 2   | 0   | 0  | 1   | 0   | 0   | 1   | 0   |
| Peak Hour Factor             | 0.95  | 0.95  | 0.95  | 0.95  | 0.95  | 0.95  | 0.95   | 0.95  | 0.95  | 0.95  | 0.95  | 0.95  |
| Percent Heavy Veh, %         | 1   | 1   | 1   | 2   | 2   | 2   | 17   | 17  | 17  | 1   | 1   | 1   |
| Cap, veh/h                   | 161   | 1505  | 33  | 15  | 1131  | 86  | 183  | 160   | 61  | 148   | 165   | 318   |
| Arrive On Green              | 0.09  | 0.42  | 0.42  | 0.01  | 0.34  | 0.34  | 0.34   | 0.34  | 0.34  | 0.34  | 0.34  | 0.34  |
| Sat Flow, veh/h              | 1792  | 3575  | 78  | 1774  | 3333  | 255   | 282  | 468   | 178   | 223   | 482   | 930   |
| Grp Volume(v), veh/h         | 126   | 437   | 456   | 11  | 542   | 557   | 52   | 0   | 0   | 610   | 0   | 0   |
| Grp Sat Flow(s),veh/h/ln     | 1792  | 1787  | 1866  | 1774  | 1770  | 1818  | 928  | 0   | 0   | 1635  | 0   | 0   |
| Q Serve(g_s), s              | 4.0   | 11.0  | 11.0  | 0.4   | 17.1  | 17.1  | 0.0  | 0.0   | 0.0   | 16.0  | 0.0   | 0.0   |
| Cycle Q Clear(g_c), s        | 4.0   | 11.0  | 11.0  | 0.4   | 17.1  | 17.1  | 1.3  | 0.0   | 0.0   | 20.0  | 0.0   | 0.0   |
| Prop In Lane                 | 1.00  |   | 0.04  | 1.00  |   | 0.14  | 0.40   |   | 0.19  | 0.17  |   | 0.57  |
| Lane Grp Cap(c), veh/h       | 161   | 752   | 785   | 15  | 600   | 617   | 404  | 0   | 0   | 631   | 0   | 0   |
| V/C Ratio(X)                 | 0.78  | 0.58  | 0.58  | 0.74  | 0.90  | 0.90  | 0.13   | 0.00  | 0.00  | 0.97  | 0.00  | 0.00  |
| Avail Cap(c_a), veh/h        | 459   | 916   | 956   | 455   | 907   | 932   | 404  | 0   | 0   | 631   | 0   | 0   |
| HCM Platoon Ratio            | 1.00  | 1.00  | 1.00  | 1.00  | 1.00  | 1.00  | 1.00   | 1.00  | 1.00  | 1.00  | 1.00  | 1.00  |
| Upstream Filter(I)           | 1.00  | 1.00  | 1.00  | 1.00  | 1.00  | 1.00  | 1.00   | 0.00  | 0.00  | 1.00  | 0.00  | 0.00  |
| Uniform Delay (d), s/veh     | 26.1  | 13.0  | 13.0  | 29.0  | 18.4  | 18.4  | 13.1   | 0.0   | 0.0   | 20.0  | 0.0   | 0.0   |
| Incr Delay (d2), s/veh       | 3.1   | 0.3   | 0.3   | 22.9  | 6.3   | 6.2   | 0.1  | 0.0   | 0.0   | 27.5  | 0.0   | 0.0   |
| Initial Q Delay(d3),s/veh    | 0.0   | 0.0   | 0.0   | 0.0   | 0.0   | 0.0   | 0.0  | 0.0   | 0.0   | 0.0   | 0.0   | 0.0   |
| %ile BackOfQ(50%),veh/ln     | 2.1   | 5.4   | 5.6   | 0.3   | 9.3   | 9.6   | 0.6  | 0.0   | 0.0   | 14.5  | 0.0   | 0.0   |
| LnGrp Delay(d),s/veh         | 29.2  | 13.3  | 13.2  | 51.8  | 24.7  | 24.6  | 13.2   | 0.0   | 0.0   | 47.5  | 0.0   | 0.0   |
| LnGrp LOS                    | C   | B   | B   | D   | C   | C   | B  |   |   | D   |   |   |
| Approach Vol, veh/h          |   | 1019  |   |   | 1110  |   |  | 52  |   |   | 610   |   |
| Approach Delay, s/veh        |   | 15.2  |   |   | 24.9  |   |  | 13.2  |   |   | 47.5  |   |
| Approach LOS                 |   | B   |   |   | C   |   |  | B   |   |   | D   |   |
| Timer                        | 1   | 2   | 3   | 4   | 5   | 6   | 7  | 8   |   |   |   |   |
| Assigned Phs                 | 1   | 2   |   | 4   | 5   | 6   |  | 8   |   |   |   |   |
| Phs Duration (G+Y+Rc), s     | 4.0   | 29.9  |   | 24.6  | 8.8   | 25.2  |  | 24.6  |   |   |   |   |
| Change Period (Y+Rc), s      | 3.5   | 5.3   |   | 4.6   | 3.5   | 5.3   |  | 4.6   |   |   |   |   |
| Max Green Setting (Gmax), s  | 15.0  | 30.0  |   | 20.0  | 15.0  | 30.0  |  | 20.0  |   |   |   |   |
| Max Q Clear Time (g_c+I1), s | 2.4   | 13.0  |   | 22.0  | 6.0   | 19.1  |  | 3.3   |   |   |   |   |
| Green Ext Time (p_c), s      | 0.0   | 0.6   |   | 0.0   | 0.0   | 0.8   |  | 0.0   |   |   |   |   |
| <b>Intersection Summary</b>  |   |   |   |   |   |   |  |   |   |   |   |   |
| HCM 2010 Ctrl Delay          |   |   |   | 26.1  |   |   |  |   |   |   |   |   |
| HCM 2010 LOS                 |   |   |   | C   |   |   |  |   |   |   |   |   |

| Intersection             |      |      |      |      |      |      |
|--------------------------|------|------|------|------|------|------|
| Int Delay, s/veh         | 1.4  |      |      |      |      |      |
| Movement                 | EBL  | EBR  | NBL  | NBT  | SBT  | SBR  |
| Lane Configurations      |      |      |      |      |      |      |
| Traffic Vol, veh/h       | 30   | 30   | 30   | 210  | 600  | 80   |
| Future Vol, veh/h        | 30   | 30   | 30   | 210  | 600  | 80   |
| Conflicting Peds, #/hr   | 0    | 0    | 0    | 0    | 0    | 0    |
| Sign Control             | Stop | Stop | Free | Free | Free | Free |
| RT Channelized           | -    | None | -    | None | -    | None |
| Storage Length           | 0    | -    | 155  | -    | -    | -    |
| Veh in Median Storage, # | 0    | -    | -    | 0    | 0    | -    |
| Grade, %                 | 0    | -    | -    | 0    | 0    | -    |
| Peak Hour Factor         | 92   | 92   | 92   | 92   | 92   | 92   |
| Heavy Vehicles, %        | 2    | 2    | 2    | 2    | 2    | 2    |
| Mvmt Flow                | 33   | 33   | 33   | 228  | 652  | 87   |











| Major/Minor          | Minor2 | Major1 | Major2 |   |   |   |
|----------------------|--------|--------|--------|---|---|---|
| Conflicting Flow All | 990    | 696    | 739    | 0 | - | 0 |
| Stage 1              | 696    | -      | -      | - | - | - |
| Stage 2              | 294    | -      | -      | - | - | - |
| Critical Hdwy        | 6.42   | 6.22   | 4.12   | - | - | - |
| Critical Hdwy Stg 1  | 5.42   | -      | -      | - | - | - |
| Critical Hdwy Stg 2  | 5.42   | -      | -      | - | - | - |
| Follow-up Hdwy       | 3.518  | 3.318  | 2.218  | - | - | - |
| Pot Cap-1 Maneuver   | 273    | 442    | 867    | - | - | - |
| Stage 1              | 495    | -      | -      | - | - | - |
| Stage 2              | 756    | -      | -      | - | - | - |
| Platoon blocked, %   |        |        |        | - | - | - |
| Mov Cap-1 Maneuver   | 263    | 442    | 867    | - | - | - |
| Mov Cap-2 Maneuver   | 263    | -      | -      | - | - | - |
| Stage 1              | 476    | -      | -      | - | - | - |
| Stage 2              | 756    | -      | -      | - | - | - |

| Approach             | EB   | NB  | SB |
|----------------------|------|-----|----|
| HCM Control Delay, s | 18.6 | 1.2 | 0  |
| HCM LOS              | C    |     |    |

| Minor Lane/Major Mvmt | NBL   | NBT | EBLn1 | SBT | SBR |
|-----------------------|-------|-----|-------|-----|-----|
| Capacity (veh/h)      | 867   | -   | 330   | -   | -   |
| HCM Lane V/C Ratio    | 0.038 | -   | 0.198 | -   | -   |
| HCM Control Delay (s) | 9.3   | -   | 18.6  | -   | -   |
| HCM Lane LOS          | A     | -   | C     | -   | -   |
| HCM 95th %tile Q(veh) | 0.1   | -   | 0.7   | -   | -   |

HCM 2010 Signalized Intersection Summary  
 10: Imjin Road & Imjin Parkway

Existing with Project, AM  
 06/11/2019

|                              |  |  |  |  |  |  |   |      |
|------------------------------|---|---|---|---|---|---|---|------|
| Movement                     | EBT   | EBR   | WBL   | WBT   | NBL   | NBR   |   |      |
| Lane Configurations          |  |   |  |  |  |  |   |      |
| Traffic Volume (veh/h)       | 750   | 210   | 410   | 960   | 80  | 100   |   |      |
| Future Volume (veh/h)        | 750   | 210   | 410   | 960   | 80  | 100   |   |      |
| Number                       | 2   | 12  | 1   | 6   | 3   | 18  |   |      |
| Initial Q (Qb), veh          | 0   | 0   | 0   | 0   | 0   | 0   |   |      |
| Ped-Bike Adj(A_pbT)          |   | 1.00  | 1.00  |   | 1.00  | 1.00  |   |      |
| Parking Bus, Adj             | 1.00  | 1.00  | 1.00  | 1.00  | 1.00  | 1.00  |   |      |
| Adj Sat Flow, veh/h/ln       | 1863  | 1900  | 1845  | 1845  | 1810  | 1810  |   |      |
| Adj Flow Rate, veh/h         | 789   | 208   | 432   | 1011  | 63  | 127   |   |      |
| Adj No. of Lanes             | 2   | 0   | 1   | 2   | 1   | 2   |   |      |
| Peak Hour Factor             | 0.95  | 0.95  | 0.95  | 0.95  | 0.95  | 0.95  |   |      |
| Percent Heavy Veh, %         | 2   | 2   | 3   | 3   | 5   | 5   |   |      |
| Cap, veh/h                   | 908   | 239   | 490   | 2529  | 132   | 235   |   |      |
| Arrive On Green              | 0.33  | 0.33  | 0.28  | 0.72  | 0.08  | 0.08  |   |      |
| Sat Flow, veh/h              | 2866  | 731   | 1757  | 3597  | 1723  | 3076  |   |      |
| Grp Volume(v), veh/h         | 504   | 493   | 432   | 1011  | 63  | 127   |   |      |
| Grp Sat Flow(s),veh/h/ln     | 1770  | 1734  | 1757  | 1752  | 1723  | 1538  |   |      |
| Q Serve(g_s), s              | 12.3  | 12.3  | 10.8  | 5.2   | 1.6   | 1.8   |   |      |
| Cycle Q Clear(g_c), s        | 12.3  | 12.3  | 10.8  | 5.2   | 1.6   | 1.8   |   |      |
| Prop In Lane                 |   | 0.42  | 1.00  |   | 1.00  | 1.00  |   |      |
| Lane Grp Cap(c), veh/h       | 579   | 568   | 490   | 2529  | 132   | 235   |   |      |
| V/C Ratio(X)                 | 0.87  | 0.87  | 0.88  | 0.40  | 0.48  | 0.54  |   |      |
| Avail Cap(c_a), veh/h        | 1152  | 1129  | 763   | 2529  | 823   | 1469  |   |      |
| HCM Platoon Ratio            | 1.00  | 1.00  | 1.00  | 1.00  | 1.00  | 1.00  |   |      |
| Upstream Filter(I)           | 1.00  | 1.00  | 1.00  | 1.00  | 1.00  | 1.00  |   |      |
| Uniform Delay (d), s/veh     | 14.6  | 14.6  | 15.9  | 2.5   | 20.4  | 20.5  |   |      |
| Incr Delay (d2), s/veh       | 1.6   | 1.6   | 5.0   | 0.0   | 1.0   | 0.7   |   |      |
| Initial Q Delay(d3),s/veh    | 0.0   | 0.0   | 0.0   | 0.0   | 0.0   | 0.0   |   |      |
| %ile BackOfQ(50%),veh/ln     | 6.1   | 6.0   | 5.8   | 2.4   | 0.8   | 0.8   |   |      |
| LnGrp Delay(d),s/veh         | 16.2  | 16.2  | 20.9  | 2.5   | 21.4  | 21.2  |   |      |
| LnGrp LOS                    | B   | B   | C   | A   | C   | C   |   |      |
| Approach Vol, veh/h          | 997   |   |   | 1443  | 190   |   |   |      |
| Approach Delay, s/veh        | 16.2  |   |   | 8.0   | 21.3  |   |   |      |
| Approach LOS                 | B   |   |   | A   | C   |   |   |      |
| Timer                        | 1   | 2   | 3   | 4   | 5   | 6   | 7 | 8    |
| Assigned Phs                 | 1   | 2   |   |   |   | 6   |   | 8    |
| Phs Duration (G+Y+Rc), s     | 18.2  | 20.4  |   |   |   | 38.5  |   | 7.5  |
| Change Period (Y+Rc), s      | 5.3   | * 5.3   |   |   |   | 5.3   |   | 4.0  |
| Max Green Setting (Gmax), s  | 20.0  | * 30  |   |   |   | 30.0  |   | 22.0 |
| Max Q Clear Time (g_c+I1), s | 12.8  | 14.3  |   |   |   | 7.2   |   | 3.8  |
| Green Ext Time (p_c), s      | 0.1   | 0.8   |   |   |   | 1.1   |   | 0.0  |
| <b>Intersection Summary</b>  |   |   |   |   |   |   |   |      |
| HCM 2010 Ctrl Delay          |   |   | 12.1  |   |   |   |   |      |
| HCM 2010 LOS                 |   |   | B   |   |   |   |   |      |
| <b>Notes</b>                 |   |   |   |   |   |   |   |      |



HCM 2010 Signalized Intersection Summary  
 11: Abrams Drive & Imjin Parkway

Existing with Project, AM  
 06/11/2019



| Movement                     | EBL  | EBT  | EBR  | WBL  | WBT  | WBR  | NBL  | NBT  | NBR  | SBL  | SBT  | SBR  |
|------------------------------|------|------|------|------|------|------|------|------|------|------|------|------|
| Lane Configurations          |      |      |      |      |      |      |      |      |      |      |      |      |
| Traffic Volume (veh/h)       | 40   | 680  | 70   | 80   | 900  | 20   | 320  | 20   | 60   | 40   | 50   | 190  |
| Future Volume (veh/h)        | 40   | 680  | 70   | 80   | 900  | 20   | 320  | 20   | 60   | 40   | 50   | 190  |
| Number                       | 5    | 2    | 12   | 1    | 6    | 16   | 3    | 8    | 18   | 7    | 4    | 14   |
| Initial Q (Qb), veh          | 0    | 0    | 0    | 0    | 0    | 0    | 0    | 0    | 0    | 0    | 0    | 0    |
| Ped-Bike Adj(A_pbT)          | 1.00 |      | 1.00 | 1.00 |      | 1.00 | 1.00 |      | 1.00 | 1.00 |      | 1.00 |
| Parking Bus, Adj             | 1.00 | 1.00 | 1.00 | 1.00 | 1.00 | 1.00 | 1.00 | 1.00 | 1.00 | 1.00 | 1.00 | 1.00 |
| Adj Sat Flow, veh/h/ln       | 1881 | 1881 | 1881 | 1863 | 1863 | 1863 | 1900 | 1845 | 1845 | 1900 | 1863 | 1863 |
| Adj Flow Rate, veh/h         | 43   | 731  | 0    | 86   | 968  | 0    | 344  | 22   | 0    | 43   | 54   | 0    |
| Adj No. of Lanes             | 1    | 1    | 1    | 1    | 1    | 1    | 0    | 1    | 1    | 0    | 1    | 1    |
| Peak Hour Factor             | 0.93 | 0.93 | 0.93 | 0.93 | 0.93 | 0.93 | 0.93 | 0.93 | 0.93 | 0.93 | 0.93 | 0.93 |
| Percent Heavy Veh, %         | 1    | 1    | 1    | 2    | 2    | 2    | 3    | 3    | 3    | 2    | 2    | 2    |
| Cap, veh/h                   | 79   | 978  | 831  | 110  | 992  | 843  | 444  | 23   | 433  | 255  | 300  | 438  |
| Arrive On Green              | 0.04 | 0.52 | 0.00 | 0.06 | 0.53 | 0.00 | 0.28 | 0.28 | 0.00 | 0.28 | 0.28 | 0.00 |
| Sat Flow, veh/h              | 1792 | 1881 | 1599 | 1774 | 1863 | 1583 | 1327 | 85   | 1568 | 714  | 1085 | 1583 |
| Grp Volume(v), veh/h         | 43   | 731  | 0    | 86   | 968  | 0    | 366  | 0    | 0    | 97   | 0    | 0    |
| Grp Sat Flow(s),veh/h/ln     | 1792 | 1881 | 1599 | 1774 | 1863 | 1583 | 1412 | 0    | 1568 | 1799 | 0    | 1583 |
| Q Serve(g_s), s              | 2.1  | 27.5 | 0.0  | 4.3  | 45.7 | 0.0  | 19.1 | 0.0  | 0.0  | 0.0  | 0.0  | 0.0  |
| Cycle Q Clear(g_c), s        | 2.1  | 27.5 | 0.0  | 4.3  | 45.7 | 0.0  | 22.7 | 0.0  | 0.0  | 3.6  | 0.0  | 0.0  |
| Prop In Lane                 | 1.00 |      | 1.00 | 1.00 |      | 1.00 | 0.94 |      | 1.00 | 0.44 |      | 1.00 |
| Lane Grp Cap(c), veh/h       | 79   | 978  | 831  | 110  | 992  | 843  | 468  | 0    | 433  | 555  | 0    | 438  |
| V/C Ratio(X)                 | 0.55 | 0.75 | 0.00 | 0.78 | 0.98 | 0.00 | 0.78 | 0.00 | 0.00 | 0.17 | 0.00 | 0.00 |
| Avail Cap(c_a), veh/h        | 397  | 1042 | 886  | 393  | 1032 | 877  | 544  | 0    | 521  | 645  | 0    | 526  |
| HCM Platoon Ratio            | 1.00 | 1.00 | 1.00 | 1.00 | 1.00 | 1.00 | 1.00 | 1.00 | 1.00 | 1.00 | 1.00 | 1.00 |
| Upstream Filter(I)           | 1.00 | 1.00 | 0.00 | 1.00 | 1.00 | 0.00 | 1.00 | 0.00 | 0.00 | 1.00 | 0.00 | 0.00 |
| Uniform Delay (d), s/veh     | 42.3 | 17.0 | 0.0  | 41.7 | 20.5 | 0.0  | 31.4 | 0.0  | 0.0  | 24.9 | 0.0  | 0.0  |
| Incr Delay (d2), s/veh       | 2.2  | 2.4  | 0.0  | 4.5  | 21.8 | 0.0  | 5.2  | 0.0  | 0.0  | 0.1  | 0.0  | 0.0  |
| Initial Q Delay(d3),s/veh    | 0.0  | 0.0  | 0.0  | 0.0  | 0.0  | 0.0  | 0.0  | 0.0  | 0.0  | 0.0  | 0.0  | 0.0  |
| %ile BackOfQ(50%),veh/ln     | 1.1  | 14.9 | 0.0  | 2.2  | 29.1 | 0.0  | 9.5  | 0.0  | 0.0  | 1.8  | 0.0  | 0.0  |
| LnGrp Delay(d),s/veh         | 44.5 | 19.4 | 0.0  | 46.2 | 42.3 | 0.0  | 36.7 | 0.0  | 0.0  | 25.0 | 0.0  | 0.0  |
| LnGrp LOS                    | D    | B    |      | D    | D    |      | D    |      |      | C    |      |      |
| Approach Vol, veh/h          |      | 774  |      |      | 1054 |      |      | 366  |      |      | 97   |      |
| Approach Delay, s/veh        |      | 20.8 |      |      | 42.6 |      |      | 36.7 |      |      | 25.0 |      |
| Approach LOS                 |      | C    |      |      | D    |      |      | D    |      |      | C    |      |
| Timer                        | 1    | 2    | 3    | 4    | 5    | 6    | 7    | 8    |      |      |      |      |
| Assigned Phs                 | 1    | 2    |      | 4    | 5    | 6    |      | 8    |      |      |      |      |
| Phs Duration (G+Y+Rc), s     | 9.1  | 52.2 |      | 28.9 | 8.0  | 53.3 |      | 28.9 |      |      |      |      |
| Change Period (Y+Rc), s      | 3.5  | 5.3  |      | 4.0  | 4.0  | 5.3  |      | 4.0  |      |      |      |      |
| Max Green Setting (Gmax), s  | 20.0 | 50.0 |      | 30.0 | 20.0 | 50.0 |      | 30.0 |      |      |      |      |
| Max Q Clear Time (g_c+10), s | 10.3 | 29.5 |      | 5.6  | 4.1  | 47.7 |      | 24.7 |      |      |      |      |
| Green Ext Time (p_c), s      | 0.0  | 0.5  |      | 0.1  | 0.0  | 0.4  |      | 0.2  |      |      |      |      |
| <b>Intersection Summary</b>  |      |      |      |      |      |      |      |      |      |      |      |      |
| HCM 2010 Ctrl Delay          |      |      |      | 33.6 |      |      |      |      |      |      |      |      |
| HCM 2010 LOS                 |      |      |      | C    |      |      |      |      |      |      |      |      |

HCM 2010 Signalized Intersection Summary  
 12: Reservation Road & Imjin Parkway

Existing with Project, AM  
 06/11/2019



| Movement                    | EBL  | EBT   | EBR  | WBL  | WBT  | WBR   | NBL  | NBT  | NBR  | SBL  | SBT  | SBR  |
|-----------------------------|------|-------|------|------|------|-------|------|------|------|------|------|------|
| Lane Configurations         |      |       |      |      |      |       |      |      |      |      |      |      |
| Traffic Volume (veh/h)      | 130  | 30    | 690  | 10   | 10   | 20    | 880  | 620  | 20   | 40   | 540  | 90   |
| Future Volume (veh/h)       | 130  | 30    | 690  | 10   | 10   | 20    | 880  | 620  | 20   | 40   | 540  | 90   |
| Number                      | 3    | 8     | 18   | 7    | 4    | 14    | 1    | 6    | 16   | 5    | 2    | 12   |
| Initial Q (Qb), veh         | 0    | 0     | 0    | 0    | 0    | 0     | 0    | 0    | 0    | 0    | 0    | 0    |
| Ped-Bike Adj(A_pbT)         | 1.00 |       | 1.00 | 1.00 |      | 0.99  | 1.00 |      | 1.00 | 1.00 |      | 0.97 |
| Parking Bus, Adj            | 1.00 | 1.00  | 1.00 | 1.00 | 1.00 | 1.00  | 1.00 | 1.00 | 1.00 | 1.00 | 1.00 | 1.00 |
| Adj Sat Flow, veh/h/ln      | 1863 | 1863  | 1863 | 1638 | 1638 | 1638  | 1863 | 1863 | 1863 | 1863 | 1863 | 1863 |
| Adj Flow Rate, veh/h        | 163  | 0     | 328  | 11   | 11   | 9     | 946  | 667  | 16   | 43   | 581  | 34   |
| Adj No. of Lanes            | 2    | 0     | 2    | 1    | 1    | 1     | 2    | 2    | 1    | 2    | 2    | 1    |
| Peak Hour Factor            | 0.93 | 0.93  | 0.93 | 0.93 | 0.93 | 0.93  | 0.93 | 0.93 | 0.93 | 0.93 | 0.93 | 0.93 |
| Percent Heavy Veh, %        | 2    | 2     | 2    | 16   | 16   | 16    | 2    | 2    | 2    | 2    | 2    | 2    |
| Cap, veh/h                  | 390  | 0     | 1308 | 46   | 48   | 40    | 1044 | 1991 | 889  | 107  | 1027 | 447  |
| Arrive On Green             | 0.11 | 0.00  | 0.11 | 0.03 | 0.03 | 0.03  | 0.30 | 0.56 | 0.56 | 0.03 | 0.29 | 0.29 |
| Sat Flow, veh/h             | 3548 | 0     | 3152 | 1560 | 1638 | 1384  | 3442 | 3539 | 1581 | 3442 | 3539 | 1542 |
| Grp Volume(v), veh/h        | 163  | 0     | 328  | 11   | 11   | 9     | 946  | 667  | 16   | 43   | 581  | 34   |
| Grp Sat Flow(s),veh/h/ln    | 1774 | 0     | 1576 | 1560 | 1638 | 1384  | 1721 | 1770 | 1581 | 1721 | 1770 | 1542 |
| Q Serve(g_s), s             | 3.3  | 0.0   | 5.3  | 0.5  | 0.5  | 0.5   | 20.6 | 7.9  | 0.3  | 1.0  | 10.9 | 1.2  |
| Cycle Q Clear(g_c), s       | 3.3  | 0.0   | 5.3  | 0.5  | 0.5  | 0.5   | 20.6 | 7.9  | 0.3  | 1.0  | 10.9 | 1.2  |
| Prop In Lane                | 1.00 |       | 1.00 | 1.00 |      | 1.00  | 1.00 |      | 1.00 | 1.00 |      | 1.00 |
| Lane Grp Cap(c), veh/h      | 390  | 0     | 1308 | 46   | 48   | 40    | 1044 | 1991 | 889  | 107  | 1027 | 447  |
| V/C Ratio(X)                | 0.42 | 0.00  | 0.25 | 0.24 | 0.23 | 0.22  | 0.91 | 0.34 | 0.02 | 0.40 | 0.57 | 0.08 |
| Avail Cap(c_a), veh/h       | 1595 | 0     | 2378 | 621  | 652  | 551   | 1548 | 2273 | 1015 | 884  | 2728 | 1188 |
| HCM Platoon Ratio           | 1.00 | 1.00  | 1.00 | 1.00 | 1.00 | 1.00  | 1.00 | 1.00 | 1.00 | 1.00 | 1.00 | 1.00 |
| Upstream Filter(I)          | 1.00 | 0.00  | 1.00 | 1.00 | 1.00 | 1.00  | 1.00 | 1.00 | 1.00 | 1.00 | 1.00 | 1.00 |
| Uniform Delay (d), s/veh    | 32.3 | 0.0   | 14.9 | 36.9 | 36.9 | 36.9  | 26.0 | 9.2  | 7.5  | 37.0 | 23.5 | 20.1 |
| Incr Delay (d2), s/veh      | 0.3  | 0.0   | 0.0  | 1.0  | 0.9  | 1.0   | 4.3  | 0.3  | 0.0  | 0.9  | 1.4  | 0.2  |
| Initial Q Delay(d3),s/veh   | 0.0  | 0.0   | 0.0  | 0.0  | 0.0  | 0.0   | 0.0  | 0.0  | 0.0  | 0.0  | 0.0  | 0.0  |
| %ile BackOfQ(50%),veh/ln    | 1.6  | 0.0   | 2.3  | 0.2  | 0.2  | 0.2   | 10.3 | 3.9  | 0.2  | 0.5  | 5.4  | 0.6  |
| LnGrp Delay(d),s/veh        | 32.6 | 0.0   | 15.0 | 37.9 | 37.8 | 37.9  | 30.3 | 9.5  | 7.5  | 37.9 | 24.8 | 20.3 |
| LnGrp LOS                   | C    |       | B    | D    | D    | D     | C    | A    | A    | D    | C    | C    |
| Approach Vol, veh/h         |      | 491   |      |      | 31   |       |      | 1629 |      |      | 658  |      |
| Approach Delay, s/veh       |      | 20.8  |      |      | 37.9 |       |      | 21.6 |      |      | 25.4 |      |
| Approach LOS                |      | C     |      |      | D    |       |      | C    |      |      | C    |      |
| Timer                       | 1    | 2     | 3    | 4    | 5    | 6     | 7    | 8    |      |      |      |      |
| Assigned Phs                | 1    | 2     |      | 4    | 5    | 6     |      | 8    |      |      |      |      |
| Phs Duration (G+Y+Rc), s    | 27.7 |       |      | 7.3  | 6.5  | 50.0  |      | 14.1 |      |      |      |      |
| Change Period (Y+Rc), s     | 4.1  | * 6.2 |      | 5.0  | 4.1  | * 6.2 |      | 5.5  |      |      |      |      |
| Max Green Setting (Gmax), s | 35.0 | * 60  |      | 31.0 | 20.0 | * 50  |      | 35.0 |      |      |      |      |
| Max Q Clear Time (g_c+T), s | 22.6 | 12.9  |      | 2.5  | 3.0  | 9.9   |      | 7.3  |      |      |      |      |
| Green Ext Time (p_c), s     | 1.1  | 9.6   |      | 0.0  | 0.0  | 10.7  |      | 1.0  |      |      |      |      |
| <b>Intersection Summary</b> |      |       |      |      |      |       |      |      |      |      |      |      |
| HCM 2010 Ctrl Delay         |      |       | 22.5 |      |      |       |      |      |      |      |      |      |
| HCM 2010 LOS                |      |       | C    |      |      |       |      |      |      |      |      |      |
| <b>Notes</b>                |      |       |      |      |      |       |      |      |      |      |      |      |

HCM 2010 Signalized Intersection Summary  
 13: Reservation Road & Blanco Road

Existing with Project, AM  
 06/11/2019

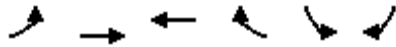

| Movement                     | EBL  | EBT  | WBT  | WBR  | SBL  | SBR  |   |   |
|------------------------------|------|------|------|------|------|------|---|---|
| Lane Configurations          | ↖↗   | ↑↑   | ↑    | ↗    | ↖↗   | ↖↗   |   |   |
| Traffic Volume (veh/h)       | 1000 | 270  | 390  | 30   | 30   | 1140 |   |   |
| Future Volume (veh/h)        | 1000 | 270  | 390  | 30   | 30   | 1140 |   |   |
| Number                       | 5    | 2    | 6    | 16   | 7    | 14   |   |   |
| Initial Q (Qb), veh          | 0    | 0    | 0    | 0    | 0    | 0    |   |   |
| Ped-Bike Adj(A_pbT)          | 1.00 |      |      | 1.00 | 1.00 | 1.00 |   |   |
| Parking Bus, Adj             | 1.00 | 1.00 | 1.00 | 1.00 | 1.00 | 1.00 |   |   |
| Adj Sat Flow, veh/h/ln       | 1863 | 1863 | 1845 | 1845 | 1845 | 1845 |   |   |
| Adj Flow Rate, veh/h         | 1075 | 290  | 419  | 13   | 32   | 0    |   |   |
| Adj No. of Lanes             | 2    | 2    | 1    | 1    | 2    | 2    |   |   |
| Peak Hour Factor             | 0.93 | 0.93 | 0.93 | 0.93 | 0.93 | 0.93 |   |   |
| Percent Heavy Veh, %         | 2    | 2    | 3    | 3    | 3    | 3    |   |   |
| Cap, veh/h                   | 1215 | 2711 | 538  | 458  | 100  | 81   |   |   |
| Arrive On Green              | 0.35 | 0.77 | 0.29 | 0.29 | 0.03 | 0.00 |   |   |
| Sat Flow, veh/h              | 3442 | 3632 | 1845 | 1568 | 3408 | 2760 |   |   |
| Grp Volume(v), veh/h         | 1075 | 290  | 419  | 13   | 32   | 0    |   |   |
| Grp Sat Flow(s),veh/h/ln     | 1721 | 1770 | 1845 | 1568 | 1704 | 1380 |   |   |
| Q Serve(g_s), s              | 13.3 | 0.9  | 9.5  | 0.3  | 0.4  | 0.0  |   |   |
| Cycle Q Clear(g_c), s        | 13.3 | 0.9  | 9.5  | 0.3  | 0.4  | 0.0  |   |   |
| Prop In Lane                 | 1.00 |      |      | 1.00 | 1.00 | 1.00 |   |   |
| Lane Grp Cap(c), veh/h       | 1215 | 2711 | 538  | 458  | 100  | 81   |   |   |
| V/C Ratio(X)                 | 0.88 | 0.11 | 0.78 | 0.03 | 0.32 | 0.00 |   |   |
| Avail Cap(c_a), veh/h        | 3032 | 4676 | 2437 | 2072 | 2027 | 1641 |   |   |
| HCM Platoon Ratio            | 1.00 | 1.00 | 1.00 | 1.00 | 1.00 | 1.00 |   |   |
| Upstream Filter(I)           | 1.00 | 1.00 | 1.00 | 1.00 | 1.00 | 0.00 |   |   |
| Uniform Delay (d), s/veh     | 13.8 | 1.4  | 14.7 | 11.5 | 21.6 | 0.0  |   |   |
| Incr Delay (d2), s/veh       | 0.9  | 0.0  | 1.8  | 0.0  | 0.7  | 0.0  |   |   |
| Initial Q Delay(d3),s/veh    | 0.0  | 0.0  | 0.0  | 0.0  | 0.0  | 0.0  |   |   |
| %ile BackOfQ(50%),veh/ln     | 6.4  | 0.4  | 5.0  | 0.1  | 0.2  | 0.0  |   |   |
| LnGrp Delay(d),s/veh         | 14.7 | 1.4  | 16.6 | 11.5 | 22.3 | 0.0  |   |   |
| LnGrp LOS                    | B    | A    | B    | B    | C    |      |   |   |
| Approach Vol, veh/h          |      | 1365 | 432  |      | 32   |      |   |   |
| Approach Delay, s/veh        |      | 11.9 | 16.4 |      | 22.3 |      |   |   |
| Approach LOS                 |      | B    | B    |      | C    |      |   |   |
| Timer                        | 1    | 2    | 3    | 4    | 5    | 6    | 7 | 8 |
| Assigned Phs                 |      | 2    |      | 4    | 5    | 6    |   |   |
| Phs Duration (G+Y+Rc), s     |      | 40.6 |      | 4.8  | 21.5 | 19.1 |   |   |
| Change Period (Y+Rc), s      |      | 5.8  |      | 3.5  | 5.5  | 5.8  |   |   |
| Max Green Setting (Gmax), s  |      | 60.0 |      | 27.0 | 40.0 | 60.0 |   |   |
| Max Q Clear Time (g_c+I1), s |      | 2.9  |      | 2.4  | 15.3 | 11.5 |   |   |
| Green Ext Time (p_c), s      |      | 1.3  |      | 0.0  | 0.7  | 1.8  |   |   |
| <b>Intersection Summary</b>  |      |      |      |      |      |      |   |   |
| HCM 2010 Ctrl Delay          |      |      | 13.1 |      |      |      |   |   |
| HCM 2010 LOS                 |      |      | B    |      |      |      |   |   |

HCM 2010 Signalized Intersection Summary  
 14: Reservation Road & Inter-Garrison Road

Existing with Project, AM  
 06/11/2019



| Movement                       | EBL  | EBR  | NBL  | NBT  | SBT  | SBR  |   |      |
|--------------------------------|------|------|------|------|------|------|---|------|
| Lane Configurations            |      |      |      |      |      |      |   |      |
| Traffic Volume (veh/h)         | 60   | 240  | 500  | 390  | 240  | 50   |   |      |
| Future Volume (veh/h)          | 60   | 240  | 500  | 390  | 240  | 50   |   |      |
| Number                         | 3    | 18   | 1    | 6    | 2    | 12   |   |      |
| Initial Q (Qb), veh            | 0    | 0    | 0    | 0    | 0    | 0    |   |      |
| Ped-Bike Adj(A_pbT)            | 1.00 | 1.00 | 1.00 |      |      | 1.00 |   |      |
| Parking Bus, Adj               | 1.00 | 1.00 | 1.00 | 1.00 | 1.00 | 1.00 |   |      |
| Adj Sat Flow, veh/h/ln         | 1845 | 1845 | 1863 | 1863 | 1845 | 1900 |   |      |
| Adj Flow Rate, veh/h           | 64   | 216  | 532  | 415  | 255  | 37   |   |      |
| Adj No. of Lanes               | 1    | 1    | 1    | 2    | 2    | 0    |   |      |
| Peak Hour Factor               | 0.94 | 0.94 | 0.94 | 0.94 | 0.94 | 0.94 |   |      |
| Percent Heavy Veh, %           | 3    | 3    | 2    | 2    | 3    | 3    |   |      |
| Cap, veh/h                     | 249  | 750  | 597  | 2198 | 561  | 80   |   |      |
| Arrive On Green                | 0.14 | 0.14 | 0.34 | 0.62 | 0.18 | 0.18 |   |      |
| Sat Flow, veh/h                | 1757 | 1568 | 1774 | 3632 | 3170 | 441  |   |      |
| Grp Volume(v), veh/h           | 64   | 216  | 532  | 415  | 144  | 148  |   |      |
| Grp Sat Flow(s),veh/h/ln       | 1757 | 1568 | 1774 | 1770 | 1752 | 1767 |   |      |
| Q Serve(g_s), s                | 1.5  | 3.8  | 13.1 | 2.3  | 3.4  | 3.4  |   |      |
| Cycle Q Clear(g_c), s          | 1.5  | 3.8  | 13.1 | 2.3  | 3.4  | 3.4  |   |      |
| Prop In Lane                   | 1.00 | 1.00 | 1.00 |      |      | 0.25 |   |      |
| Lane Grp Cap(c), veh/h         | 249  | 750  | 597  | 2198 | 319  | 322  |   |      |
| V/C Ratio(X)                   | 0.26 | 0.29 | 0.89 | 0.19 | 0.45 | 0.46 |   |      |
| Avail Cap(c_a), veh/h          | 1031 | 1448 | 771  | 4617 | 2286 | 2305 |   |      |
| HCM Platoon Ratio              | 1.00 | 1.00 | 1.00 | 1.00 | 1.00 | 1.00 |   |      |
| Upstream Filter(I)             | 1.00 | 1.00 | 1.00 | 1.00 | 1.00 | 1.00 |   |      |
| Uniform Delay (d), s/veh       | 17.6 | 7.3  | 14.5 | 3.7  | 16.8 | 16.8 |   |      |
| Incr Delay (d2), s/veh         | 0.5  | 0.2  | 8.9  | 0.1  | 1.8  | 1.9  |   |      |
| Initial Q Delay(d3),s/veh      | 0.0  | 0.0  | 0.0  | 0.0  | 0.0  | 0.0  |   |      |
| %ile BackOfQ(50%),veh/ln       | 0.7  | 1.7  | 7.8  | 1.1  | 1.8  | 1.9  |   |      |
| LnGrp Delay(d),s/veh           | 18.1 | 7.5  | 23.4 | 3.8  | 18.6 | 18.7 |   |      |
| LnGrp LOS                      | B    | A    | C    | A    | B    | B    |   |      |
| Approach Vol, veh/h            | 280  |      |      | 947  | 292  |      |   |      |
| Approach Delay, s/veh          | 9.9  |      |      | 14.8 | 18.6 |      |   |      |
| Approach LOS                   | A    |      |      | B    | B    |      |   |      |
| Timer                          | 1    | 2    | 3    | 4    | 5    | 6    | 7 | 8    |
| Assigned Phs                   | 1    | 2    |      |      |      | 6    |   | 8    |
| Phs Duration (G+Y+Rc), s       | 20.2 | 14.8 |      |      |      | 35.0 |   | 11.0 |
| Change Period (Y+Rc), s        | 4.7  | 6.4  |      |      |      | 6.4  |   | 4.5  |
| Max Green Setting (Gmax), s    | 20   | 60.0 |      |      |      | 60.0 |   | 27.0 |
| Max Q Clear Time (g_c+11.5, s) | 11.5 | 5.4  |      |      |      | 4.3  |   | 5.8  |
| Green Ext Time (p_c), s        | 0.4  | 2.9  |      |      |      | 4.8  |   | 0.9  |
| <b>Intersection Summary</b>    |      |      |      |      |      |      |   |      |
| HCM 2010 Ctrl Delay            |      |      | 14.6 |      |      |      |   |      |
| HCM 2010 LOS                   |      |      | B    |      |      |      |   |      |
| <b>Notes</b>                   |      |      |      |      |      |      |   |      |

**Intersection**

Intersection Delay, s/veh 39.4

Intersection LOS E

| Movement            | EBL  | EBT  | EBR  | WBL  | WBT  | WBR  | NBL  | NBT  | NBR  | SBL  | SBT  | SBR  |
|---------------------|------|------|------|------|------|------|------|------|------|------|------|------|
| Lane Configurations |      | ↔    | ↔    |      | ↔    |      | ↔    | ↔    |      |      | ↔    | ↔    |
| Traffic Vol, veh/h  | 40   | 10   | 50   | 250  | 10   | 10   | 10   | 140  | 10   | 10   | 520  | 30   |
| Future Vol, veh/h   | 40   | 10   | 50   | 250  | 10   | 10   | 10   | 140  | 10   | 10   | 520  | 30   |
| Peak Hour Factor    | 0.94 | 0.94 | 0.94 | 0.94 | 0.94 | 0.94 | 0.94 | 0.94 | 0.94 | 0.94 | 0.94 | 0.94 |
| Heavy Vehicles, %   | 1    | 1    | 1    | 0    | 0    | 0    | 1    | 1    | 1    | 2    | 2    | 2    |
| Mvmt Flow           | 43   | 11   | 53   | 266  | 11   | 11   | 11   | 149  | 11   | 11   | 553  | 32   |
| Number of Lanes     | 0    | 1    | 1    | 0    | 1    | 0    | 1    | 1    | 0    | 0    | 1    | 1    |

| Approach                   | EB   | WB   | NB   | SB   |
|----------------------------|------|------|------|------|
| Opposing Approach          | WB   | EB   | SB   | NB   |
| Opposing Lanes             | 1    | 2    | 2    | 2    |
| Conflicting Approach Left  | SB   | NB   | EB   | WB   |
| Conflicting Lanes Left     | 2    | 2    | 2    | 1    |
| Conflicting Approach Right | NB   | SB   | WB   | EB   |
| Conflicting Lanes Right    | 2    | 2    | 1    | 2    |
| HCM Control Delay          | 11.4 | 20.4 | 12.9 | 61.1 |
| HCM LOS                    | B    | C    | B    | F    |

| Lane                   | NBLn1 | NBLn2 | EBLn1 | EBLn2 | WBLn1 | SBLn1 | SBLn2 |
|------------------------|-------|-------|-------|-------|-------|-------|-------|
| Vol Left, %            | 100%  | 0%    | 80%   | 0%    | 93%   | 2%    | 0%    |
| Vol Thru, %            | 0%    | 93%   | 20%   | 0%    | 4%    | 98%   | 0%    |
| Vol Right, %           | 0%    | 7%    | 0%    | 100%  | 4%    | 0%    | 100%  |
| Sign Control           | Stop  | Stop  | Stop  | Stop  | Stop  | Stop  | Stop  |
| Traffic Vol by Lane    | 10    | 150   | 50    | 50    | 270   | 530   | 30    |
| LT Vol                 | 10    | 0     | 40    | 0     | 250   | 10    | 0     |
| Through Vol            | 0     | 140   | 10    | 0     | 10    | 520   | 0     |
| RT Vol                 | 0     | 10    | 0     | 50    | 10    | 0     | 30    |
| Lane Flow Rate         | 11    | 160   | 53    | 53    | 287   | 564   | 32    |
| Geometry Grp           | 7     | 7     | 7     | 7     | 6     | 7     | 7     |
| Degree of Util (X)     | 0.023 | 0.314 | 0.121 | 0.104 | 0.587 | 1.005 | 0.05  |
| Departure Headway (Hd) | 7.644 | 7.082 | 8.177 | 7.046 | 7.351 | 6.416 | 5.694 |
| Convergence, Y/N       | Yes   | Yes   | Yes   | Yes   | Yes   | Yes   | Yes   |
| Cap                    | 467   | 506   | 437   | 506   | 491   | 569   | 633   |
| Service Time           | 5.405 | 4.842 | 5.95  | 4.818 | 5.407 | 4.116 | 3.394 |
| HCM Lane V/C Ratio     | 0.024 | 0.316 | 0.121 | 0.105 | 0.585 | 0.991 | 0.051 |
| HCM Control Delay      | 10.6  | 13.1  | 12.1  | 10.6  | 20.4  | 64.1  | 8.7   |
| HCM Lane LOS           | B     | B     | B     | B     | C     | F     | A     |
| HCM 95th-tile Q        | 0.1   | 1.3   | 0.4   | 0.3   | 3.7   | 14.7  | 0.2   |

| Intersection              |      |  |  |  |  |  |  |  |  |  |  |  |
|---------------------------|------|--|--|--|--|--|--|--|--|--|--|--|
| Intersection Delay, s/veh | 69.8 |  |  |  |  |  |  |  |  |  |  |  |
| Intersection LOS          | F    |  |  |  |  |  |  |  |  |  |  |  |

| Movement            | EBL  | EBT  | EBR  | WBL  | WBT  | WBR  | NBL  | NBT  | NBR  | SBL  | SBT  | SBR  |
|---------------------|------|------|------|------|------|------|------|------|------|------|------|------|
| Lane Configurations |      |      |      |      |      |      |      |      |      |      |      |      |
| Traffic Vol, veh/h  | 10   | 10   | 10   | 270  | 10   | 30   | 10   | 210  | 130  | 60   | 770  | 10   |
| Future Vol, veh/h   | 10   | 10   | 10   | 270  | 10   | 30   | 10   | 210  | 130  | 60   | 770  | 10   |
| Peak Hour Factor    | 0.95 | 0.95 | 0.95 | 0.95 | 0.95 | 0.95 | 0.95 | 0.95 | 0.95 | 0.95 | 0.95 | 0.95 |
| Heavy Vehicles, %   | 0    | 0    | 0    | 20   | 20   | 20   | 2    | 2    | 2    | 1    | 1    | 1    |
| Mvmt Flow           | 11   | 11   | 11   | 284  | 11   | 32   | 11   | 221  | 137  | 63   | 811  | 11   |
| Number of Lanes     | 1    | 1    | 1    | 0    | 1    | 1    | 1    | 1    | 1    | 1    | 1    | 0    |

| Approach                   | EB   | WB   | NB | SB    |
|----------------------------|------|------|----|-------|
| Opposing Approach          | WB   | EB   | SB | NB    |
| Opposing Lanes             | 2    | 3    | 2  | 3     |
| Conflicting Approach Left  | SB   | NB   | EB | WB    |
| Conflicting Lanes Left     | 2    | 3    | 3  | 2     |
| Conflicting Approach Right | NB   | SB   | WB | EB    |
| Conflicting Lanes Right    | 3    | 2    | 2  | 3     |
| HCM Control Delay          | 13.3 | 30.2 | 17 | 290.5 |
| HCM LOS                    | B    | D    | C  | F     |

| Lane                   | NBLn1 | NBLn2 | NBLn3 | EBLn1 | EBLn2  | EBLn3 | WBLn1 | WBLn2 | SBLn1 | SBLn2 |
|------------------------|-------|-------|-------|-------|--------|-------|-------|-------|-------|-------|
| Vol Left, %            | 100%  | 0%    | 0%    | 100%  | 0%     | 0%    | 96%   | 0%    | 100%  | 0%    |
| Vol Thru, %            | 0%    | 100%  | 0%    | 0%    | 100%   | 0%    | 4%    | 0%    | 0%    | 99%   |
| Vol Right, %           | 0%    | 0%    | 100%  | 0%    | 0%     | 100%  | 0%    | 100%  | 0%    | 1%    |
| Sign Control           | Stop  | Stop  | Stop  | Stop  | Stop   | Stop  | Stop  | Stop  | Stop  | Stop  |
| Traffic Vol by Lane    | 10    | 210   | 130   | 10    | 10     | 10    | 280   | 30    | 60    | 780   |
| LT Vol                 | 10    | 0     | 0     | 10    | 0      | 0     | 270   | 0     | 60    | 0     |
| Through Vol            | 0     | 210   | 0     | 0     | 10     | 0     | 10    | 0     | 0     | 770   |
| RT Vol                 | 0     | 0     | 130   | 0     | 0      | 10    | 0     | 30    | 0     | 10    |
| Lane Flow Rate         | 11    | 221   | 137   | 11    | 11     | 11    | 295   | 32    | 63    | 821   |
| Geometry Grp           | 8     | 8     | 8     | 8     | 8      | 8     | 8     | 8     | 8     | 8     |
| Degree of Util (X)     | 0.024 | 0.476 | 0.268 | 0.028 | 0.026  | 0.024 | 0.701 | 0.065 | 0.135 | 1.632 |
| Departure Headway (Hd) | 9.317 | 8.802 | 8.08  | 10.88 | 10.357 | 9.624 | 9.69  | 8.48  | 7.672 | 7.157 |
| Convergence, Y/N       | Yes   | Yes   | Yes   | Yes   | Yes    | Yes   | Yes   | Yes   | Yes   | Yes   |
| Cap                    | 387   | 413   | 447   | 331   | 348    | 374   | 377   | 425   | 467   | 509   |
| Service Time           | 7.017 | 6.502 | 5.78  | 8.58  | 8.057  | 7.324 | 7.39  | 6.18  | 5.434 | 4.918 |
| HCM Lane V/C Ratio     | 0.028 | 0.535 | 0.306 | 0.033 | 0.032  | 0.029 | 0.782 | 0.075 | 0.135 | 1.613 |
| HCM Control Delay      | 12.2  | 19.2  | 13.7  | 13.9  | 13.3   | 12.6  | 32.2  | 11.8  | 11.6  | 311.9 |
| HCM Lane LOS           | B     | C     | B     | B     | B      | B     | D     | B     | B     | F     |
| HCM 95th-tile Q        | 0.1   | 2.5   | 1.1   | 0.1   | 0.1    | 0.1   | 5.1   | 0.2   | 0.5   | 46    |

**Intersection**

Intersection Delay, s/veh 12.5  
 Intersection LOS B

| Movement            | EBT  | EBR  | WBL  | WBT  | NBL  | NBR  |
|---------------------|------|------|------|------|------|------|
| Lane Configurations | ↑    | ↗    | ↖    | ↑    | ↖    | ↗    |
| Traffic Vol, veh/h  | 130  | 60   | 290  | 270  | 30   | 180  |
| Future Vol, veh/h   | 130  | 60   | 290  | 270  | 30   | 180  |
| Peak Hour Factor    | 0.92 | 0.92 | 0.92 | 0.92 | 0.92 | 0.92 |
| Heavy Vehicles, %   | 2    | 2    | 2    | 2    | 2    | 2    |
| Mvmt Flow           | 141  | 65   | 315  | 293  | 33   | 196  |
| Number of Lanes     | 1    | 1    | 1    | 1    | 1    | 1    |

| Approach                   | EB | WB   | NB   |
|----------------------------|----|------|------|
| Opposing Approach          | WB | EB   |      |
| Opposing Lanes             | 2  | 2    | 0    |
| Conflicting Approach Left  |    | NB   | EB   |
| Conflicting Lanes Left     | 0  | 2    | 2    |
| Conflicting Approach Right | NB |      | WB   |
| Conflicting Lanes Right    | 2  | 0    | 2    |
| HCM Control Delay          | 10 | 13.9 | 11.1 |
| HCM LOS                    | A  | B    | B    |

| Lane                   | NBLn1 | NBLn2 | EBLn1 | EBLn2 | WBLn1 | WBLn2 |
|------------------------|-------|-------|-------|-------|-------|-------|
| Vol Left, %            | 100%  | 0%    | 0%    | 0%    | 100%  | 0%    |
| Vol Thru, %            | 0%    | 0%    | 100%  | 0%    | 0%    | 100%  |
| Vol Right, %           | 0%    | 100%  | 0%    | 100%  | 0%    | 0%    |
| Sign Control           | Stop  | Stop  | Stop  | Stop  | Stop  | Stop  |
| Traffic Vol by Lane    | 30    | 180   | 130   | 60    | 290   | 270   |
| LT Vol                 | 30    | 0     | 0     | 0     | 290   | 0     |
| Through Vol            | 0     | 0     | 130   | 0     | 0     | 270   |
| RT Vol                 | 0     | 180   | 0     | 60    | 0     | 0     |
| Lane Flow Rate         | 33    | 196   | 141   | 65    | 315   | 293   |
| Geometry Grp           | 7     | 7     | 7     | 7     | 7     | 7     |
| Degree of Util (X)     | 0.064 | 0.316 | 0.236 | 0.096 | 0.526 | 0.449 |
| Departure Headway (Hd) | 7.033 | 5.82  | 6.015 | 5.306 | 6.008 | 5.503 |
| Convergence, Y/N       | Yes   | Yes   | Yes   | Yes   | Yes   | Yes   |
| Cap                    | 510   | 618   | 598   | 676   | 602   | 657   |
| Service Time           | 4.763 | 3.55  | 3.745 | 3.035 | 3.728 | 3.223 |
| HCM Lane V/C Ratio     | 0.065 | 0.317 | 0.236 | 0.096 | 0.523 | 0.446 |
| HCM Control Delay      | 10.2  | 11.2  | 10.6  | 8.6   | 15.2  | 12.6  |
| HCM Lane LOS           | B     | B     | B     | A     | C     | B     |
| HCM 95th-tile Q        | 0.2   | 1.4   | 0.9   | 0.3   | 3.1   | 2.3   |

| Intersection              |      |  |  |  |  |  |  |  |  |  |  |  |
|---------------------------|------|--|--|--|--|--|--|--|--|--|--|--|
| Intersection Delay, s/veh | 37.3 |  |  |  |  |  |  |  |  |  |  |  |
| Intersection LOS          | E    |  |  |  |  |  |  |  |  |  |  |  |

| Movement            | EBL  | EBT  | EBR  | WBL  | WBT  | WBR  | NBL  | NBT  | NBR  | SBL  | SBT  | SBR  |
|---------------------|------|------|------|------|------|------|------|------|------|------|------|------|
| Lane Configurations |      |      |      |      |      |      |      |      |      |      |      |      |
| Traffic Vol, veh/h  | 50   | 70   | 10   | 10   | 90   | 170  | 10   | 20   | 10   | 420  | 10   | 190  |
| Future Vol, veh/h   | 50   | 70   | 10   | 10   | 90   | 170  | 10   | 20   | 10   | 420  | 10   | 190  |
| Peak Hour Factor    | 0.81 | 0.81 | 0.81 | 0.81 | 0.81 | 0.81 | 0.81 | 0.81 | 0.81 | 0.81 | 0.81 | 0.81 |
| Heavy Vehicles, %   | 3    | 3    | 3    | 5    | 5    | 5    | 0    | 0    | 0    | 1    | 1    | 1    |
| Mvmt Flow           | 62   | 86   | 12   | 12   | 111  | 210  | 12   | 25   | 12   | 519  | 12   | 235  |
| Number of Lanes     | 1    | 1    | 0    | 1    | 1    | 1    | 0    | 1    | 0    | 0    | 1    | 1    |

| Approach                   | EB | WB   | NB | SB   |
|----------------------------|----|------|----|------|
| Opposing Approach          | WB | EB   | SB | NB   |
| Opposing Lanes             | 3  | 2    | 2  | 1    |
| Conflicting Approach Left  | SB | NB   | EB | WB   |
| Conflicting Lanes Left     | 2  | 1    | 2  | 3    |
| Conflicting Approach Right | NB | SB   | WB | EB   |
| Conflicting Lanes Right    | 1  | 2    | 3  | 2    |
| HCM Control Delay          | 13 | 13.8 | 12 | 54.2 |
| HCM LOS                    | B  | B    | B  | F    |

| Lane                   | NBLn1 | EBLn1 | EBLn2 | WBLn1 | WBLn2 | WBLn3 | SBLn1 | SBLn2 |
|------------------------|-------|-------|-------|-------|-------|-------|-------|-------|
| Vol Left, %            | 25%   | 100%  | 0%    | 100%  | 0%    | 0%    | 98%   | 0%    |
| Vol Thru, %            | 50%   | 0%    | 88%   | 0%    | 100%  | 0%    | 2%    | 0%    |
| Vol Right, %           | 25%   | 0%    | 12%   | 0%    | 0%    | 100%  | 0%    | 100%  |
| Sign Control           | Stop  | Stop  | Stop  | Stop  | Stop  | Stop  | Stop  | Stop  |
| Traffic Vol by Lane    | 40    | 50    | 80    | 10    | 90    | 170   | 430   | 190   |
| LT Vol                 | 10    | 50    | 0     | 10    | 0     | 0     | 420   | 0     |
| Through Vol            | 20    | 0     | 70    | 0     | 90    | 0     | 10    | 0     |
| RT Vol                 | 10    | 0     | 10    | 0     | 0     | 170   | 0     | 190   |
| Lane Flow Rate         | 49    | 62    | 99    | 12    | 111   | 210   | 531   | 235   |
| Geometry Grp           | 8     | 8     | 8     | 8     | 8     | 8     | 8     | 8     |
| Degree of Util (X)     | 0.111 | 0.145 | 0.219 | 0.028 | 0.237 | 0.406 | 1.026 | 0.376 |
| Departure Headway (Hd) | 8.278 | 8.734 | 8.126 | 8.301 | 7.789 | 7.071 | 6.961 | 5.764 |
| Convergence, Y/N       | Yes   | Yes   | Yes   | Yes   | Yes   | Yes   | Yes   | Yes   |
| Cap                    | 436   | 413   | 444   | 434   | 463   | 512   | 520   | 619   |
| Service Time           | 5.978 | 6.434 | 5.826 | 6.001 | 5.489 | 4.771 | 4.746 | 3.548 |
| HCM Lane V/C Ratio     | 0.112 | 0.15  | 0.223 | 0.028 | 0.24  | 0.41  | 1.021 | 0.38  |
| HCM Control Delay      | 12    | 12.9  | 13.1  | 11.2  | 12.9  | 14.5  | 72.9  | 12    |
| HCM Lane LOS           | B     | B     | B     | B     | B     | B     | F     | B     |
| HCM 95th-tile Q        | 0.4   | 0.5   | 0.8   | 0.1   | 0.9   | 1.9   | 14.9  | 1.7   |



**Intersection**

Intersection Delay, s/veh 192.8

Intersection LOS F

| Movement            | WBL  | WBR  | NBT  | NBR  | SBL  | SBT  |
|---------------------|------|------|------|------|------|------|
| Lane Configurations | ↘    | ↗    | ↑    | ↗    | ↘    | ↑    |
| Traffic Vol, veh/h  | 30   | 10   | 340  | 40   | 10   | 1030 |
| Future Vol, veh/h   | 30   | 10   | 340  | 40   | 10   | 1030 |
| Peak Hour Factor    | 0.93 | 0.93 | 0.93 | 0.93 | 0.93 | 0.93 |
| Heavy Vehicles, %   | 0    | 0    | 1    | 1    | 1    | 1    |
| Mvmt Flow           | 32   | 11   | 366  | 43   | 11   | 1108 |
| Number of Lanes     | 1    | 1    | 1    | 1    | 1    | 1    |

| Approach                      | WB   | NB   | SB    |
|-------------------------------|------|------|-------|
| Opposing Approach             |      | SB   | NB    |
| Opposing Lanes                | 0    | 2    | 2     |
| Conflicting Approach Left NB  |      |      | WB    |
| Conflicting Lanes Left        | 2    | 0    | 2     |
| Conflicting Approach Right SB |      | WB   |       |
| Conflicting Lanes Right       | 2    | 2    | 0     |
| HCM Control Delay             | 11.4 | 13.6 | 265.3 |
| HCM LOS                       | B    | B    | F     |

| Lane                   | NBLn1 | NBLn2 | WBLn1 | WBLn2 | SBLn1 | SBLn2 |
|------------------------|-------|-------|-------|-------|-------|-------|
| Vol Left, %            | 0%    | 0%    | 100%  | 0%    | 100%  | 0%    |
| Vol Thru, %            | 100%  | 0%    | 0%    | 0%    | 0%    | 100%  |
| Vol Right, %           | 0%    | 100%  | 0%    | 100%  | 0%    | 0%    |
| Sign Control           | Stop  | Stop  | Stop  | Stop  | Stop  | Stop  |
| Traffic Vol by Lane    | 340   | 40    | 30    | 10    | 10    | 1030  |
| LT Vol                 | 0     | 0     | 30    | 0     | 10    | 0     |
| Through Vol            | 340   | 0     | 0     | 0     | 0     | 1030  |
| RT Vol                 | 0     | 40    | 0     | 10    | 0     | 0     |
| Lane Flow Rate         | 366   | 43    | 32    | 11    | 11    | 1108  |
| Geometry Grp           | 7     | 7     | 7     | 7     | 7     | 7     |
| Degree of Util (X)     | 0.523 | 0.054 | 0.068 | 0.019 | 0.017 | 1.548 |
| Departure Headway (Hd) | 5.62  | 4.912 | 8.515 | 7.28  | 5.536 | 5.033 |
| Convergence, Y/N       | Yes   | Yes   | Yes   | Yes   | Yes   | Yes   |
| Cap                    | 647   | 733   | 423   | 495   | 649   | 731   |
| Service Time           | 3.32  | 2.612 | 6.215 | 4.98  | 3.244 | 2.741 |
| HCM Lane V/C Ratio     | 0.566 | 0.059 | 0.076 | 0.022 | 0.017 | 1.516 |
| HCM Control Delay      | 14.3  | 7.9   | 11.8  | 10.1  | 8.3   | 267.8 |
| HCM Lane LOS           | B     | A     | B     | B     | A     | F     |
| HCM 95th-tile Q        | 3     | 0.2   | 0.2   | 0.1   | 0.1   | 56.3  |

| Intersection              |     |  |  |  |  |  |  |  |  |  |  |  |
|---------------------------|-----|--|--|--|--|--|--|--|--|--|--|--|
| Intersection Delay, s/veh | 8.9 |  |  |  |  |  |  |  |  |  |  |  |
| Intersection LOS          | A   |  |  |  |  |  |  |  |  |  |  |  |

| Movement            | EBL  | EBT  | EBR  | WBL  | WBT  | WBR  | NBL  | NBT  | NBR  | SBL  | SBT  | SBR  |
|---------------------|------|------|------|------|------|------|------|------|------|------|------|------|
| Lane Configurations |      | ↕    |      |      | ↕    |      |      | ↕    |      |      | ↕    |      |
| Traffic Vol, veh/h  | 10   | 10   | 10   | 10   | 10   | 30   | 10   | 170  | 10   | 30   | 150  | 10   |
| Future Vol, veh/h   | 10   | 10   | 10   | 10   | 10   | 30   | 10   | 170  | 10   | 30   | 150  | 10   |
| Peak Hour Factor    | 0.85 | 0.85 | 0.85 | 0.85 | 0.85 | 0.85 | 0.85 | 0.85 | 0.85 | 0.85 | 0.85 | 0.85 |
| Heavy Vehicles, %   | 6    | 6    | 6    | 2    | 2    | 2    | 4    | 4    | 4    | 0    | 0    | 0    |
| Mvmt Flow           | 12   | 12   | 12   | 12   | 12   | 35   | 12   | 200  | 12   | 35   | 176  | 12   |
| Number of Lanes     | 0    | 1    | 0    | 0    | 1    | 0    | 0    | 1    | 0    | 0    | 1    | 0    |

| Approach                   | EB  | WB  | NB  | SB |
|----------------------------|-----|-----|-----|----|
| Opposing Approach          | WB  | EB  | SB  | NB |
| Opposing Lanes             | 1   | 1   | 1   | 1  |
| Conflicting Approach Left  | SB  | NB  | EB  | WB |
| Conflicting Lanes Left     | 1   | 1   | 1   | 1  |
| Conflicting Approach Right | NB  | SB  | WB  | EB |
| Conflicting Lanes Right    | 1   | 1   | 1   | 1  |
| HCM Control Delay          | 8.2 | 8.1 | 9.1 | 9  |
| HCM LOS                    | A   | A   | A   | A  |

| Lane                   | NBLn1 | EBLn1 | WBLn1 | SBLn1 |
|------------------------|-------|-------|-------|-------|
| Vol Left, %            | 5%    | 33%   | 20%   | 16%   |
| Vol Thru, %            | 89%   | 33%   | 20%   | 79%   |
| Vol Right, %           | 5%    | 33%   | 60%   | 5%    |
| Sign Control           | Stop  | Stop  | Stop  | Stop  |
| Traffic Vol by Lane    | 190   | 30    | 50    | 190   |
| LT Vol                 | 10    | 10    | 10    | 30    |
| Through Vol            | 170   | 10    | 10    | 150   |
| RT Vol                 | 10    | 10    | 30    | 10    |
| Lane Flow Rate         | 224   | 35    | 59    | 224   |
| Geometry Grp           | 1     | 1     | 1     | 1     |
| Degree of Util (X)     | 0.274 | 0.048 | 0.076 | 0.271 |
| Departure Headway (Hd) | 4.409 | 4.938 | 4.652 | 4.365 |
| Convergence, Y/N       | Yes   | Yes   | Yes   | Yes   |
| Cap                    | 816   | 725   | 769   | 825   |
| Service Time           | 2.429 | 2.972 | 2.683 | 2.384 |
| HCM Lane V/C Ratio     | 0.275 | 0.048 | 0.077 | 0.272 |
| HCM Control Delay      | 9.1   | 8.2   | 8.1   | 9     |
| HCM Lane LOS           | A     | A     | A     | A     |
| HCM 95th-tile Q        | 1.1   | 0.2   | 0.2   | 1.1   |

| Intersection              |      |
|---------------------------|------|
| Intersection Delay, s/veh | 98.4 |
| Intersection LOS          | F    |

| Movement            | EBL  | EBT  | EBR  | WBL  | WBT  | WBR  | NBL  | NBT  | NBR  | SBL  | SBT  | SBR  |
|---------------------|------|------|------|------|------|------|------|------|------|------|------|------|
| Lane Configurations |      | ↕    |      |      | ↕    |      |      | ↕    |      |      | ↕    | ↕    |
| Traffic Vol, veh/h  | 10   | 50   | 20   | 310  | 150  | 30   | 30   | 170  | 110  | 170  | 200  | 10   |
| Future Vol, veh/h   | 10   | 50   | 20   | 310  | 150  | 30   | 30   | 170  | 110  | 170  | 200  | 10   |
| Peak Hour Factor    | 0.81 | 0.81 | 0.81 | 0.81 | 0.81 | 0.81 | 0.81 | 0.81 | 0.81 | 0.81 | 0.81 | 0.81 |
| Heavy Vehicles, %   | 8    | 8    | 8    | 3    | 3    | 3    | 19   | 19   | 19   | 7    | 7    | 7    |
| Mvmt Flow           | 12   | 62   | 25   | 383  | 185  | 37   | 37   | 210  | 136  | 210  | 247  | 12   |
| Number of Lanes     | 0    | 1    | 0    | 0    | 1    | 0    | 0    | 1    | 0    | 0    | 1    | 1    |

| Approach                   | EB   | WB    | NB | SB   |
|----------------------------|------|-------|----|------|
| Opposing Approach          | WB   | EB    | SB | NB   |
| Opposing Lanes             | 1    | 1     | 2  | 1    |
| Conflicting Approach Left  | SB   | NB    | EB | WB   |
| Conflicting Lanes Left     | 2    | 1     | 1  | 1    |
| Conflicting Approach Right | NB   | SB    | WB | EB   |
| Conflicting Lanes Right    | 1    | 2     | 1  | 1    |
| HCM Control Delay          | 16.5 | 157.6 | 42 | 85.2 |
| HCM LOS                    | C    | F     | E  | F    |

| Lane                   | NBLn1 | EBLn1 | WBLn1 | SBLn1 | SBLn2 |
|------------------------|-------|-------|-------|-------|-------|
| Vol Left, %            | 10%   | 12%   | 63%   | 46%   | 0%    |
| Vol Thru, %            | 55%   | 62%   | 31%   | 54%   | 0%    |
| Vol Right, %           | 35%   | 25%   | 6%    | 0%    | 100%  |
| Sign Control           | Stop  | Stop  | Stop  | Stop  | Stop  |
| Traffic Vol by Lane    | 310   | 80    | 490   | 370   | 10    |
| LT Vol                 | 30    | 10    | 310   | 170   | 0     |
| Through Vol            | 170   | 50    | 150   | 200   | 0     |
| RT Vol                 | 110   | 20    | 30    | 0     | 10    |
| Lane Flow Rate         | 383   | 99    | 605   | 457   | 12    |
| Geometry Grp           | 5     | 2     | 2     | 7     | 7     |
| Degree of Util (X)     | 0.827 | 0.251 | 1.26  | 1.043 | 0.025 |
| Departure Headway (Hd) | 8.783 | 10.11 | 7.733 | 9.031 | 8.064 |
| Convergence, Y/N       | Yes   | Yes   | Yes   | Yes   | Yes   |
| Cap                    | 417   | 358   | 472   | 407   | 447   |
| Service Time           | 6.783 | 8.11  | 5.733 | 6.731 | 5.764 |
| HCM Lane V/C Ratio     | 0.918 | 0.277 | 1.282 | 1.123 | 0.027 |
| HCM Control Delay      | 42    | 16.5  | 157.6 | 87.2  | 11    |
| HCM Lane LOS           | E     | C     | F     | F     | B     |
| HCM 95th-tile Q        | 7.7   | 1     | 24.2  | 13.6  | 0.1   |

| Intersection                |       |       |       |
|-----------------------------|-------|-------|-------|
| Intersection Delay, s/veh   | 114.3 |       |       |
| Intersection LOS            | F     |       |       |
| Approach                    | EB    | WB    | NB    |
| Entry Lanes                 | 1     | 1     | 1     |
| Conflicting Circle Lanes    | 1     | 1     | 1     |
| Adj Approach Flow, veh/h    | 379   | 1414  | 287   |
| Demand Flow Rate, veh/h     | 474   | 1428  | 295   |
| Vehicles Circulating, veh/h | 847   | 11    | 259   |
| Vehicles Exiting, veh/h     | 592   | 543   | 1062  |
| Follow-Up Headway, s        | 3.186 | 3.186 | 3.186 |
| Ped Vol Crossing Leg, #/h   | 0     | 0     | 0     |
| Ped Cap Adj                 | 1.000 | 1.000 | 1.000 |
| Approach Delay, s/veh       | 73.5  | 146.7 | 8.1   |
| Approach LOS                | F     | F     | A     |
| Lane                        | Left  | Left  | Left  |
| Designated Moves            | TR    | LT    | LR    |
| Assumed Moves               | TR    | LT    | LR    |
| RT Channelized              |       |       |       |
| Lane Util                   | 1.000 | 1.000 | 1.000 |
| Critical Headway, s         | 5.193 | 5.193 | 5.193 |
| Entry Flow, veh/h           | 474   | 1428  | 295   |
| Cap Entry Lane, veh/h       | 484   | 1118  | 872   |
| Entry HV Adj Factor         | 0.800 | 0.990 | 0.973 |
| Flow Entry, veh/h           | 379   | 1414  | 287   |
| Cap Entry, veh/h            | 388   | 1107  | 848   |
| V/C Ratio                   | 0.979 | 1.278 | 0.338 |
| Control Delay, s/veh        | 73.5  | 146.7 | 8.1   |
| LOS                         | F     | F     | A     |
| 95th %tile Queue, veh       | 11    | 49    | 2     |

| Intersection              |       |
|---------------------------|-------|
| Intersection Delay, s/veh | 202.6 |
| Intersection LOS          | F     |

| Movement            | EBL  | EBT  | WBT  | WBR  | SBL  | SBR  |
|---------------------|------|------|------|------|------|------|
| Lane Configurations | ↘    | ↗    | ↗    | ↘    | ↘    | ↘    |
| Traffic Vol, veh/h  | 210  | 200  | 740  | 10   | 30   | 490  |
| Future Vol, veh/h   | 210  | 200  | 740  | 10   | 30   | 490  |
| Peak Hour Factor    | 0.85 | 0.85 | 0.85 | 0.85 | 0.85 | 0.85 |
| Heavy Vehicles, %   | 8    | 8    | 1    | 1    | 1    | 1    |
| Mvmt Flow           | 247  | 235  | 871  | 12   | 35   | 576  |
| Number of Lanes     | 1    | 1    | 1    | 1    | 1    | 1    |

| Approach                   | EB   | WB    | SB   |
|----------------------------|------|-------|------|
| Opposing Approach          | WB   | EB    |      |
| Opposing Lanes             | 2    | 2     | 0    |
| Conflicting Approach Left  | SB   |       | WB   |
| Conflicting Lanes Left     | 2    | 0     | 2    |
| Conflicting Approach Right |      | SB    | EB   |
| Conflicting Lanes Right    | 0    | 2     | 2    |
| HCM Control Delay          | 22.5 | 381.7 | 86.4 |
| HCM LOS                    | C    | F     | F    |

| Lane                   | EBLn1 | EBLn2 | WBLn1 | WBLn2 | SBLn1 | SBLn2 |
|------------------------|-------|-------|-------|-------|-------|-------|
| Vol Left, %            | 100%  | 0%    | 0%    | 0%    | 100%  | 0%    |
| Vol Thru, %            | 0%    | 100%  | 100%  | 0%    | 0%    | 0%    |
| Vol Right, %           | 0%    | 0%    | 0%    | 100%  | 0%    | 100%  |
| Sign Control           | Stop  | Stop  | Stop  | Stop  | Stop  | Stop  |
| Traffic Vol by Lane    | 210   | 200   | 740   | 10    | 30    | 490   |
| LT Vol                 | 210   | 0     | 0     | 0     | 30    | 0     |
| Through Vol            | 0     | 200   | 740   | 0     | 0     | 0     |
| RT Vol                 | 0     | 0     | 0     | 10    | 0     | 490   |
| Lane Flow Rate         | 247   | 235   | 871   | 12    | 35    | 576   |
| Geometry Grp           | 7     | 7     | 7     | 7     | 7     | 7     |
| Degree of Util (X)     | 0.566 | 0.506 | 1.799 | 0.022 | 0.077 | 1.074 |
| Departure Headway (Hd) | 9.666 | 9.138 | 7.771 | 7.047 | 9.071 | 7.822 |
| Convergence, Y/N       | Yes   | Yes   | Yes   | Yes   | Yes   | Yes   |
| Cap                    | 376   | 398   | 479   | 511   | 397   | 467   |
| Service Time           | 7.366 | 6.838 | 5.471 | 4.747 | 6.771 | 5.522 |
| HCM Lane V/C Ratio     | 0.657 | 0.59  | 1.818 | 0.023 | 0.088 | 1.233 |
| HCM Control Delay      | 24.2  | 20.8  | 386.7 | 9.9   | 12.5  | 90.9  |
| HCM Lane LOS           | C     | C     | F     | A     | B     | F     |
| HCM 95th-tile Q        | 3.4   | 2.8   | 52.2  | 0.1   | 0.2   | 15.9  |

| Intersection              |      |  |  |  |  |  |
|---------------------------|------|--|--|--|--|--|
| Intersection Delay, s/veh | 79.1 |  |  |  |  |  |
| Intersection LOS          | F    |  |  |  |  |  |

| Movement            | EBL  | EBT  | WBT  | WBR  | SBL  | SBR  |
|---------------------|------|------|------|------|------|------|
| Lane Configurations |      |      |      |      |      |      |
| Traffic Vol, veh/h  | 30   | 200  | 590  | 10   | 50   | 160  |
| Future Vol, veh/h   | 30   | 200  | 590  | 10   | 50   | 160  |
| Peak Hour Factor    | 0.79 | 0.79 | 0.79 | 0.79 | 0.79 | 0.79 |
| Heavy Vehicles, %   | 5    | 5    | 1    | 1    | 3    | 3    |
| Mvmt Flow           | 38   | 253  | 747  | 13   | 63   | 203  |
| Number of Lanes     | 1    | 1    | 1    | 1    | 1    | 1    |

| Approach                   | EB   | WB    | SB   |
|----------------------------|------|-------|------|
| Opposing Approach          | WB   | EB    |      |
| Opposing Lanes             | 2    | 2     | 0    |
| Conflicting Approach Left  | SB   |       | WB   |
| Conflicting Lanes Left     | 2    | 0     | 2    |
| Conflicting Approach Right |      | SB    | EB   |
| Conflicting Lanes Right    | 0    | 2     | 2    |
| HCM Control Delay          | 13.7 | 127.4 | 12.7 |
| HCM LOS                    | B    | F     | B    |

| Lane                   | EBLn1 | EBLn2 | WBLn1 | WBLn2 | SBLn1 | SBLn2 |
|------------------------|-------|-------|-------|-------|-------|-------|
| Vol Left, %            | 100%  | 0%    | 0%    | 0%    | 100%  | 0%    |
| Vol Thru, %            | 0%    | 100%  | 100%  | 0%    | 0%    | 0%    |
| Vol Right, %           | 0%    | 0%    | 0%    | 100%  | 0%    | 100%  |
| Sign Control           | Stop  | Stop  | Stop  | Stop  | Stop  | Stop  |
| Traffic Vol by Lane    | 30    | 200   | 590   | 10    | 50    | 160   |
| LT Vol                 | 30    | 0     | 0     | 0     | 50    | 0     |
| Through Vol            | 0     | 200   | 590   | 0     | 0     | 0     |
| RT Vol                 | 0     | 0     | 0     | 10    | 0     | 160   |
| Lane Flow Rate         | 38    | 253   | 747   | 13    | 63    | 203   |
| Geometry Grp           | 7     | 7     | 7     | 7     | 7     | 7     |
| Degree of Util (X)     | 0.071 | 0.439 | 1.21  | 0.018 | 0.131 | 0.352 |
| Departure Headway (Hd) | 7.017 | 6.506 | 5.831 | 5.121 | 7.954 | 6.729 |
| Convergence, Y/N       | Yes   | Yes   | Yes   | Yes   | Yes   | Yes   |
| Cap                    | 514   | 557   | 627   | 702   | 454   | 539   |
| Service Time           | 4.717 | 4.206 | 3.539 | 2.829 | 5.654 | 4.429 |
| HCM Lane V/C Ratio     | 0.074 | 0.454 | 1.191 | 0.019 | 0.139 | 0.377 |
| HCM Control Delay      | 10.3  | 14.2  | 129.4 | 7.9   | 11.8  | 13    |
| HCM Lane LOS           | B     | B     | F     | A     | B     | B     |
| HCM 95th-tile Q        | 0.2   | 2.2   | 26.7  | 0.1   | 0.4   | 1.6   |

**Intersection**

|                           |    |
|---------------------------|----|
| Intersection Delay, s/veh | 27 |
| Intersection LOS          | D  |

| Movement            | EBL  | EBT  | WBT  | WBR  | SBL  | SBR  |
|---------------------|------|------|------|------|------|------|
| Lane Configurations |      | ↔    | ↔    |      | ↔    | ↔    |
| Traffic Vol, veh/h  | 240  | 10   | 80   | 20   | 20   | 520  |
| Future Vol, veh/h   | 240  | 10   | 80   | 20   | 20   | 520  |
| Peak Hour Factor    | 0.82 | 0.82 | 0.82 | 0.82 | 0.82 | 0.82 |
| Heavy Vehicles, %   | 5    | 5    | 1    | 1    | 0    | 0    |
| Mvmt Flow           | 293  | 12   | 98   | 24   | 24   | 634  |
| Number of Lanes     | 0    | 1    | 1    | 0    | 1    | 1    |

| Approach                   | EB   | WB   | SB   |
|----------------------------|------|------|------|
| Opposing Approach          | WB   | EB   |      |
| Opposing Lanes             | 1    | 1    | 0    |
| Conflicting Approach Left  | SB   |      | WB   |
| Conflicting Lanes Left     | 2    | 0    | 1    |
| Conflicting Approach Right |      | SB   | EB   |
| Conflicting Lanes Right    | 0    | 2    | 1    |
| HCM Control Delay          | 15.7 | 10.8 | 35.3 |
| HCM LOS                    | C    | B    | E    |

| Lane                   | EBLn1 | WBLn1 | SBLn1 | SBLn2 |
|------------------------|-------|-------|-------|-------|
| Vol Left, %            | 96%   | 0%    | 100%  | 0%    |
| Vol Thru, %            | 4%    | 80%   | 0%    | 0%    |
| Vol Right, %           | 0%    | 20%   | 0%    | 100%  |
| Sign Control           | Stop  | Stop  | Stop  | Stop  |
| Traffic Vol by Lane    | 250   | 100   | 20    | 520   |
| LT Vol                 | 240   | 0     | 20    | 0     |
| Through Vol            | 10    | 80    | 0     | 0     |
| RT Vol                 | 0     | 20    | 0     | 520   |
| Lane Flow Rate         | 305   | 122   | 24    | 634   |
| Geometry Grp           | 2     | 2     | 7     | 7     |
| Degree of Util (X)     | 0.521 | 0.208 | 0.043 | 0.9   |
| Departure Headway (Hd) | 6.148 | 6.138 | 6.32  | 5.107 |
| Convergence, Y/N       | Yes   | Yes   | Yes   | Yes   |
| Cap                    | 585   | 582   | 566   | 710   |
| Service Time           | 4.201 | 4.203 | 4.062 | 2.849 |
| HCM Lane V/C Ratio     | 0.521 | 0.21  | 0.042 | 0.893 |
| HCM Control Delay      | 15.7  | 10.8  | 9.3   | 36.3  |
| HCM Lane LOS           | C     | B     | A     | E     |
| HCM 95th-tile Q        | 3     | 0.8   | 0.1   | 11.6  |

HCM 2010 Signalized Intersection Summary  
 26: East Garrison Road & Reservation Road

Existing with Project, AM  
 06/11/2019























| Movement                    | EBL  | EBT  | EBR  | WBL  | WBT  | WBR  | NBL  | NBT  | NBR  | SBL | SBT | SBR |
|-----------------------------|------|------|------|------|------|------|------|------|------|-----|-----|-----|
| Lane Configurations         | ↖    | ↗    |      | ↖    | ↗    |      | ↖    |      | ↗    |     |     |     |
| Traffic Volume (veh/h)      | 0    | 480  | 10   | 40   | 890  | 0    | 40   | 0    | 80   | 0   | 0   | 0   |
| Future Volume (veh/h)       | 0    | 480  | 10   | 40   | 890  | 0    | 40   | 0    | 80   | 0   | 0   | 0   |
| Number                      | 5    | 2    | 12   | 1    | 6    | 16   | 3    | 8    | 18   |     |     |     |
| Initial Q (Qb), veh         | 0    | 0    | 0    | 0    | 0    | 0    | 0    | 0    | 0    |     |     |     |
| Ped-Bike Adj(A_pbT)         | 1.00 |      | 1.00 | 1.00 |      | 1.00 | 1.00 |      | 1.00 |     |     |     |
| Parking Bus, Adj            | 1.00 | 1.00 | 1.00 | 1.00 | 1.00 | 1.00 | 1.00 | 1.00 | 1.00 |     |     |     |
| Adj Sat Flow, veh/h/ln      | 1827 | 1827 | 1900 | 1863 | 1863 | 0    | 1881 | 0    | 1881 |     |     |     |
| Adj Flow Rate, veh/h        | 0    | 539  | 9    | 45   | 1000 | 0    | 45   | 0    | 18   |     |     |     |
| Adj No. of Lanes            | 1    | 2    | 0    | 1    | 2    | 0    | 1    | 0    | 1    |     |     |     |
| Peak Hour Factor            | 0.89 | 0.89 | 0.89 | 0.89 | 0.89 | 0.89 | 0.89 | 0.89 | 0.89 |     |     |     |
| Percent Heavy Veh, %        | 4    | 4    | 4    | 2    | 2    | 0    | 1    | 0    | 1    |     |     |     |
| Cap, veh/h                  | 6    | 1411 | 24   | 94   | 2070 | 0    | 99   | 0    | 88   |     |     |     |
| Arrive On Green             | 0.00 | 0.40 | 0.40 | 0.05 | 0.58 | 0.00 | 0.06 | 0.00 | 0.06 |     |     |     |
| Sat Flow, veh/h             | 1740 | 3494 | 58   | 1774 | 3632 | 0    | 1792 | 0    | 1599 |     |     |     |
| Grp Volume(v), veh/h        | 0    | 268  | 280  | 45   | 1000 | 0    | 45   | 0    | 18   |     |     |     |
| Grp Sat Flow(s),veh/h/ln    | 1740 | 1736 | 1817 | 1774 | 1770 | 0    | 1792 | 0    | 1599 |     |     |     |
| Q Serve(g_s), s             | 0.0  | 3.1  | 3.1  | 0.7  | 4.6  | 0.0  | 0.7  | 0.0  | 0.3  |     |     |     |
| Cycle Q Clear(g_c), s       | 0.0  | 3.1  | 3.1  | 0.7  | 4.6  | 0.0  | 0.7  | 0.0  | 0.3  |     |     |     |
| Prop In Lane                | 1.00 |      | 0.03 | 1.00 |      | 0.00 | 1.00 |      | 1.00 |     |     |     |
| Lane Grp Cap(c), veh/h      | 6    | 701  | 734  | 94   | 2070 | 0    | 99   | 0    | 88   |     |     |     |
| V/C Ratio(X)                | 0.00 | 0.38 | 0.38 | 0.48 | 0.48 | 0.00 | 0.45 | 0.00 | 0.20 |     |     |     |
| Avail Cap(c_a), veh/h       | 1240 | 3710 | 3883 | 1264 | 7566 | 0    | 1723 | 0    | 1538 |     |     |     |
| HCM Platoon Ratio           | 1.00 | 1.00 | 1.00 | 1.00 | 1.00 | 1.00 | 1.00 | 1.00 | 1.00 |     |     |     |
| Upstream Filter(I)          | 0.00 | 1.00 | 1.00 | 1.00 | 1.00 | 0.00 | 1.00 | 0.00 | 1.00 |     |     |     |
| Uniform Delay (d), s/veh    | 0.0  | 5.9  | 5.9  | 12.9 | 3.4  | 0.0  | 12.8 | 0.0  | 12.7 |     |     |     |
| Incr Delay (d2), s/veh      | 0.0  | 0.6  | 0.6  | 1.4  | 0.2  | 0.0  | 1.2  | 0.0  | 0.4  |     |     |     |
| Initial Q Delay(d3),s/veh   | 0.0  | 0.0  | 0.0  | 0.0  | 0.0  | 0.0  | 0.0  | 0.0  | 0.0  |     |     |     |
| %ile BackOfQ(50%),veh/ln    | 0.0  | 1.5  | 1.6  | 0.4  | 2.1  | 0.0  | 0.4  | 0.0  | 0.1  |     |     |     |
| LnGrp Delay(d),s/veh        | 0.0  | 6.5  | 6.5  | 14.3 | 3.6  | 0.0  | 14.0 | 0.0  | 13.1 |     |     |     |
| LnGrp LOS                   |      | A    | A    | B    | A    |      | B    |      | B    |     |     |     |
| Approach Vol, veh/h         |      | 548  |      |      | 1045 |      |      | 63   |      |     |     |     |
| Approach Delay, s/veh       |      | 6.5  |      |      | 4.1  |      |      | 13.8 |      |     |     |     |
| Approach LOS                |      | A    |      |      | A    |      |      | B    |      |     |     |     |
| Timer                       | 1    | 2    | 3    | 4    | 5    | 6    | 7    | 8    |      |     |     |     |
| Assigned Phs                | 1    | 2    |      |      | 5    | 6    |      | 8    |      |     |     |     |
| Phs Duration (G+Y+Rc), s    | 5.1  | 16.7 |      |      | 0.0  | 21.8 |      | 6.3  |      |     |     |     |
| Change Period (Y+Rc), s     | 3.6  | 5.4  |      |      | 3.5  | 5.4  |      | 4.7  |      |     |     |     |
| Max Green Setting (Gmax)    | 20   | 60.0 |      |      | 20.0 | 60.0 |      | 27.0 |      |     |     |     |
| Max Q Clear Time (g_c+1)    | 2.5  | 5.1  |      |      | 0.0  | 6.6  |      | 2.7  |      |     |     |     |
| Green Ext Time (p_c), s     | 0.0  | 6.0  |      |      | 0.0  | 9.8  |      | 0.0  |      |     |     |     |
| <b>Intersection Summary</b> |      |      |      |      |      |      |      |      |      |     |     |     |
| HCM 2010 Ctrl Delay         |      |      |      |      | 5.2  |      |      |      |      |     |     |     |
| HCM 2010 LOS                |      |      |      |      | A    |      |      |      |      |     |     |     |
| <b>Notes</b>                |      |      |      |      |      |      |      |      |      |     |     |     |



HCM 2010 Signalized Intersection Summary  
 28: Davis Road & Reservation Road

Existing with Project, AM  
 06/11/2019

|                              |  |  |  |  |  |  |  |  |  |  |  |  |  |
|------------------------------|---|---|---|---|---|---|--|---|---|---|---|---|---|
| Movement                     | EBL   | EBT   | EBR   | WBL   | WBT   | WBR   | NBL  | NBT   | NBR   | SBL   | SBT   | SBR   |   |
| Lane Configurations          |  |  |   |  |  |   |  |  |   |   |   |  |  |
| Traffic Volume (veh/h)       | 280   | 280   | 10  | 10  | 500   | 110   | 10   | 10  | 10  | 150   | 10  | 430   |   |
| Future Volume (veh/h)        | 280   | 280   | 10  | 10  | 500   | 110   | 10   | 10  | 10  | 150   | 10  | 430   |   |
| Number                       | 5   | 2   | 12  | 1   | 6   | 16  | 3  | 8   | 18  | 7   | 4   | 14  |   |
| Initial Q (Qb), veh          | 0   | 0   | 0   | 0   | 0   | 0   | 0  | 0   | 0   | 0   | 0   | 0   |   |
| Ped-Bike Adj(A_pbT)          | 1.00  |   | 1.00  | 1.00  |   | 1.00  | 1.00   |   | 1.00  | 1.00  |   | 1.00  |   |
| Parking Bus, Adj             | 1.00  | 1.00  | 1.00  | 1.00  | 1.00  | 1.00  | 1.00   | 1.00  | 1.00  | 1.00  | 1.00  | 1.00  |   |
| Adj Sat Flow, veh/h/ln       | 1863  | 1863  | 1900  | 1863  | 1863  | 1900  | 1900   | 1900  | 1900  | 1900  | 1845  | 1845  |   |
| Adj Flow Rate, veh/h         | 304   | 304   | 11  | 12  | 581   | 120   | 12   | 12  | 9   | 174   | 12  | 258   |   |
| Adj No. of Lanes             | 1   | 1   | 0   | 1   | 1   | 0   | 0  | 1   | 0   | 0   | 1   | 1   |   |
| Peak Hour Factor             | 0.92  | 0.92  | 0.92  | 0.86  | 0.86  | 0.92  | 0.86   | 0.86  | 0.86  | 0.86  | 0.86  | 0.86  |   |
| Percent Heavy Veh, %         | 2   | 2   | 2   | 2   | 2   | 2   | 0  | 0   | 0   | 3   | 3   | 3   |   |
| Cap, veh/h                   | 335   | 1110  | 40  | 20  | 666   | 138   | 20   | 20  | 15  | 254   | 18  | 538   |   |
| Arrive On Green              | 0.19  | 0.62  | 0.62  | 0.01  | 0.44  | 0.44  | 0.03   | 0.03  | 0.03  | 0.15  | 0.15  | 0.15  |   |
| Sat Flow, veh/h              | 1774  | 1787  | 65  | 1774  | 1499  | 310   | 648  | 648   | 486   | 1649  | 114   | 1568  |   |
| Grp Volume(v), veh/h         | 304   | 0   | 315   | 12  | 0   | 701   | 33   | 0   | 0   | 186   | 0   | 258   |   |
| Grp Sat Flow(s),veh/h/ln     | 1774  | 0   | 1851  | 1774  | 0   | 1808  | 1782   | 0   | 0   | 1762  | 0   | 1568  |   |
| Q Serve(g_s), s              | 16.4  | 0.0   | 7.6   | 0.7   | 0.0   | 34.4  | 1.8  | 0.0   | 0.0   | 9.8   | 0.0   | 12.6  |   |
| Cycle Q Clear(g_c), s        | 16.4  | 0.0   | 7.6   | 0.7   | 0.0   | 34.4  | 1.8  | 0.0   | 0.0   | 9.8   | 0.0   | 12.6  |   |
| Prop In Lane                 | 1.00  |   | 0.03  | 1.00  |   | 0.17  | 0.36   |   | 0.27  | 0.94  |   | 1.00  |   |
| Lane Grp Cap(c), veh/h       | 335   | 0   | 1150  | 20  | 0   | 804   | 54   | 0   | 0   | 272   | 0   | 538   |   |
| V/C Ratio(X)                 | 0.91  | 0.00  | 0.27  | 0.59  | 0.00  | 0.87  | 0.61   | 0.00  | 0.00  | 0.68  | 0.00  | 0.48  |   |
| Avail Cap(c_a), veh/h        | 545   | 0   | 1150  | 545   | 0   | 1110  | 547  | 0   | 0   | 541   | 0   | 778   |   |
| HCM Platoon Ratio            | 1.00  | 1.00  | 1.00  | 1.00  | 1.00  | 1.00  | 1.00   | 1.00  | 1.00  | 1.00  | 1.00  | 1.00  |   |
| Upstream Filter(I)           | 1.00  | 0.00  | 1.00  | 1.00  | 0.00  | 1.00  | 1.00   | 0.00  | 0.00  | 1.00  | 0.00  | 1.00  |   |
| Uniform Delay (d), s/veh     | 38.8  | 0.0   | 8.5   | 48.1  | 0.0   | 24.6  | 46.8   | 0.0   | 0.0   | 39.1  | 0.0   | 25.2  |   |
| Incr Delay (d2), s/veh       | 8.2   | 0.0   | 0.2   | 9.9   | 0.0   | 7.0   | 4.1  | 0.0   | 0.0   | 1.1   | 0.0   | 0.2   |   |
| Initial Q Delay(d3),s/veh    | 0.0   | 0.0   | 0.0   | 0.0   | 0.0   | 0.0   | 0.0  | 0.0   | 0.0   | 0.0   | 0.0   | 0.0   |   |
| %ile BackOfQ(50%),veh/ln     | 8.8   | 0.0   | 3.9   | 0.4   | 0.0   | 18.7  | 0.9  | 0.0   | 0.0   | 4.8   | 0.0   | 5.5   |   |
| LnGrp Delay(d),s/veh         | 46.9  | 0.0   | 8.7   | 58.0  | 0.0   | 31.7  | 50.9   | 0.0   | 0.0   | 40.2  | 0.0   | 25.5  |   |
| LnGrp LOS                    | D   |   | A   | E   |   | C   | D  |   |   | D   |   | C   |   |
| Approach Vol, veh/h          |   | 619   |   |   | 713   |   |  | 33  |   |   |   | 444   |   |
| Approach Delay, s/veh        |   | 27.4  |   |   | 32.1  |   |  | 50.9  |   |   |   | 31.7  |   |
| Approach LOS                 |   | C   |   |   | C   |   |  | D   |   |   |   | C   |   |
| Timer                        | 1   | 2   | 3   | 4   | 5   | 6   | 7  | 8   |   |   |   |   |   |
| Assigned Phs                 | 1   | 2   |   | 4   | 5   | 6   |  | 8   |   |   |   |   |   |
| Phs Duration (G+Y+Rc), s     | 5.0   | 65.7  |   | 20.1  | 22.3  | 48.4  |  | 7.0   |   |   |   |   |   |
| Change Period (Y+Rc), s      | * 3.9   | 5.0   |   | 5.0   | * 3.8   | 5.0   |  | 4.0   |   |   |   |   |   |
| Max Green Setting (Gmax), s  | * 30  | 60.0  |   | 30.0  | * 30  | 60.0  |  | 30.0  |   |   |   |   |   |
| Max Q Clear Time (g_c+I1), s | 2.7   | 9.6   |   | 14.6  | 18.4  | 36.4  |  | 3.8   |   |   |   |   |   |
| Green Ext Time (p_c), s      | 0.0   | 2.9   |   | 0.4   | 0.1   | 7.0   |  | 0.0   |   |   |   |   |   |
| <b>Intersection Summary</b>  |   |   |   |   |   |   |  |   |   |   |   |   |   |
| HCM 2010 Ctrl Delay          |   |   | 30.7  |   |   |   |  |   |   |   |   |   |   |
| HCM 2010 LOS                 |   |   | C   |   |   |   |  |   |   |   |   |   |   |
| <b>Notes</b>                 |   |   |   |   |   |   |  |   |   |   |   |   |   |

| Intersection              |      |  |  |  |  |  |  |  |  |  |  |  |
|---------------------------|------|--|--|--|--|--|--|--|--|--|--|--|
| Intersection Delay, s/veh | 12.9 |  |  |  |  |  |  |  |  |  |  |  |
| Intersection LOS          | F    |  |  |  |  |  |  |  |  |  |  |  |

| Movement            | EBL  | EBT  | EBR  | WBL  | WBT  | WBR  | NBL  | NBT  | NBR  | SBL  | SBT  | SBR  |
|---------------------|------|------|------|------|------|------|------|------|------|------|------|------|
| Lane Configurations |      | ↕    |      |      | ↕    | ↕    | ↕    | ↕    |      | ↕    | ↕    | ↕    |
| Traffic Vol, veh/h  | 10   | 10   | 10   | 70   | 10   | 10   | 10   | 370  | 120  | 10   | 1040 | 10   |
| Future Vol, veh/h   | 10   | 10   | 10   | 70   | 10   | 10   | 10   | 370  | 120  | 10   | 1040 | 10   |
| Peak Hour Factor    | 0.91 | 0.91 | 0.91 | 0.91 | 0.91 | 0.91 | 0.91 | 0.91 | 0.91 | 0.91 | 0.91 | 0.91 |
| Heavy Vehicles, %   | 14   | 14   | 14   | 0    | 0    | 0    | 2    | 2    | 2    | 1    | 1    | 1    |
| Mvmt Flow           | 11   | 11   | 11   | 77   | 11   | 11   | 11   | 407  | 132  | 11   | 1143 | 11   |
| Number of Lanes     | 0    | 1    | 0    | 0    | 1    | 1    | 1    | 2    | 0    | 1    | 1    | 1    |

| Approach                   | EB   | WB   | NB | SB    |
|----------------------------|------|------|----|-------|
| Opposing Approach          | WB   | EB   | SB | NB    |
| Opposing Lanes             | 2    | 1    | 3  | 3     |
| Conflicting Approach Left  | SB   | NB   | EB | WB    |
| Conflicting Lanes Left     | 3    | 3    | 1  | 2     |
| Conflicting Approach Right | NB   | SB   | WB | EB    |
| Conflicting Lanes Right    | 3    | 3    | 2  | 1     |
| HCM Control Delay          | 13.7 | 15.1 | 18 | 485.7 |
| HCM LOS                    | B    | C    | C  | F     |

| Lane                   | NBLn1 | NBLn2 | NBLn3 | EBLn1  | WBLn1  | WBLn2 | SBLn1 | SBLn2 | SBLn3 |
|------------------------|-------|-------|-------|--------|--------|-------|-------|-------|-------|
| Vol Left, %            | 100%  | 0%    | 0%    | 33%    | 88%    | 0%    | 100%  | 0%    | 0%    |
| Vol Thru, %            | 0%    | 100%  | 51%   | 33%    | 12%    | 0%    | 0%    | 100%  | 0%    |
| Vol Right, %           | 0%    | 0%    | 49%   | 33%    | 0%     | 100%  | 0%    | 0%    | 100%  |
| Sign Control           | Stop  | Stop  | Stop  | Stop   | Stop   | Stop  | Stop  | Stop  | Stop  |
| Traffic Vol by Lane    | 10    | 247   | 243   | 30     | 80     | 10    | 10    | 1040  | 10    |
| LT Vol                 | 10    | 0     | 0     | 10     | 70     | 0     | 10    | 0     | 0     |
| Through Vol            | 0     | 247   | 123   | 10     | 10     | 0     | 0     | 1040  | 0     |
| RT Vol                 | 0     | 0     | 120   | 10     | 0      | 10    | 0     | 0     | 10    |
| Lane Flow Rate         | 11    | 271   | 267   | 33     | 88     | 11    | 11    | 1143  | 11    |
| Geometry Grp           | 8     | 8     | 8     | 8      | 8      | 8     | 8     | 8     | 8     |
| Degree of Util (X)     | 0.022 | 0.498 | 0.465 | 0.076  | 0.203  | 0.022 | 0.021 | 2.052 | 0.018 |
| Departure Headway (Hd) | 8.795 | 8.286 | 7.935 | 10.179 | 10.226 | 9.053 | 6.97  | 6.465 | 5.758 |
| Convergence, Y/N       | Yes   | Yes   | Yes   | Yes    | Yes    | Yes   | Yes   | Yes   | Yes   |
| Cap                    | 409   | 439   | 457   | 354    | 353    | 398   | 517   | 571   | 625   |
| Service Time           | 6.495 | 5.986 | 5.635 | 7.879  | 7.926  | 6.753 | 4.67  | 4.165 | 3.458 |
| HCM Lane V/C Ratio     | 0.027 | 0.617 | 0.584 | 0.093  | 0.249  | 0.028 | 0.021 | 2.002 | 0.018 |
| HCM Control Delay      | 11.7  | 18.9  | 17.3  | 13.7   | 15.5   | 12    | 9.8   | 494.9 | 8.6   |
| HCM Lane LOS           | B     | C     | C     | B      | C      | B     | A     | F     | A     |
| HCM 95th-tile Q        | 0.1   | 2.7   | 2.4   | 0.2    | 0.7    | 0.1   | 0.1   | 78.7  | 0.1   |

|                           |     |  |  |  |  |  |  |  |  |  |  |  |
|---------------------------|-----|--|--|--|--|--|--|--|--|--|--|--|
| <b>Intersection</b>       |     |  |  |  |  |  |  |  |  |  |  |  |
| Intersection Delay, s/veh | 8.8 |  |  |  |  |  |  |  |  |  |  |  |
| Intersection LOS          | A   |  |  |  |  |  |  |  |  |  |  |  |

| Movement            | EBL  | EBT  | EBR  | WBL  | WBT  | WBR  | NBL  | NBT  | NBR  | SBL  | SBT  | SBR  |
|---------------------|------|------|------|------|------|------|------|------|------|------|------|------|
| Lane Configurations |      | ↕    |      |      | ↕    |      | ↕    | ↕    |      | ↕    | ↕    |      |
| Traffic Vol, veh/h  | 10   | 10   | 10   | 10   | 10   | 20   | 10   | 160  | 10   | 20   | 140  | 10   |
| Future Vol, veh/h   | 10   | 10   | 10   | 10   | 10   | 20   | 10   | 160  | 10   | 20   | 140  | 10   |
| Peak Hour Factor    | 0.91 | 0.91 | 0.91 | 0.91 | 0.91 | 0.91 | 0.91 | 0.91 | 0.91 | 0.91 | 0.91 | 0.91 |
| Heavy Vehicles, %   | 0    | 0    | 0    | 1    | 1    | 1    | 2    | 2    | 2    | 1    | 1    | 1    |
| Mvmt Flow           | 11   | 11   | 11   | 11   | 11   | 22   | 11   | 176  | 11   | 22   | 154  | 11   |
| Number of Lanes     | 0    | 1    | 0    | 0    | 1    | 0    | 1    | 1    | 0    | 1    | 1    | 0    |

| Approach                   | EB | WB  | NB  | SB  |
|----------------------------|----|-----|-----|-----|
| Opposing Approach          | WB | EB  | SB  | NB  |
| Opposing Lanes             | 1  | 1   | 2   | 2   |
| Conflicting Approach Left  | SB | NB  | EB  | WB  |
| Conflicting Lanes Left     | 2  | 2   | 1   | 1   |
| Conflicting Approach Right | NB | SB  | WB  | EB  |
| Conflicting Lanes Right    | 2  | 2   | 1   | 1   |
| HCM Control Delay          | 8  | 7.9 | 9.1 | 8.8 |
| HCM LOS                    | A  | A   | A   | A   |

| Lane                   | NBLn1 | NBLn2 | EBLn1 | WBLn1 | SBLn1 | SBLn2 |
|------------------------|-------|-------|-------|-------|-------|-------|
| Vol Left, %            | 100%  | 0%    | 33%   | 25%   | 100%  | 0%    |
| Vol Thru, %            | 0%    | 94%   | 33%   | 25%   | 0%    | 93%   |
| Vol Right, %           | 0%    | 6%    | 33%   | 50%   | 0%    | 7%    |
| Sign Control           | Stop  | Stop  | Stop  | Stop  | Stop  | Stop  |
| Traffic Vol by Lane    | 10    | 170   | 30    | 40    | 20    | 150   |
| LT Vol                 | 10    | 0     | 10    | 10    | 20    | 0     |
| Through Vol            | 0     | 160   | 10    | 10    | 0     | 140   |
| RT Vol                 | 0     | 10    | 10    | 20    | 0     | 10    |
| Lane Flow Rate         | 11    | 187   | 33    | 44    | 22    | 165   |
| Geometry Grp           | 7     | 7     | 2     | 2     | 7     | 7     |
| Degree of Util (X)     | 0.016 | 0.251 | 0.043 | 0.056 | 0.033 | 0.22  |
| Departure Headway (Hd) | 5.371 | 4.828 | 4.738 | 4.624 | 5.361 | 4.812 |
| Convergence, Y/N       | Yes   | Yes   | Yes   | Yes   | Yes   | Yes   |
| Cap                    | 669   | 745   | 757   | 775   | 670   | 748   |
| Service Time           | 3.086 | 2.543 | 2.762 | 2.647 | 3.075 | 2.527 |
| HCM Lane V/C Ratio     | 0.016 | 0.251 | 0.044 | 0.057 | 0.033 | 0.221 |
| HCM Control Delay      | 8.2   | 9.2   | 8     | 7.9   | 8.3   | 8.9   |
| HCM Lane LOS           | A     | A     | A     | A     | A     | A     |
| HCM 95th-tile Q        | 0     | 1     | 0.1   | 0.2   | 0.1   | 0.8   |

HCM 2010 Signalized Intersection Summary  
 31: 1st Avenue & Lightfighter Drive

Existing with Project, AM  
 06/11/2019



| Movement                     | EBL  | EBT  | EBR  | WBL  | WBT  | WBR  | NBL  | NBT  | NBR  | SBL  | SBT  | SBR  |
|------------------------------|------|------|------|------|------|------|------|------|------|------|------|------|
| Lane Configurations          |      | ↑↑   | ↑    | ↑    | ↑↑   |      | ↑    |      | ↑    | ↑    | ↑    | ↑    |
| Traffic Volume (veh/h)       | 0    | 860  | 130  | 30   | 890  | 0    | 160  | 0    | 20   | 20   | 10   | 20   |
| Future Volume (veh/h)        | 0    | 860  | 130  | 30   | 890  | 0    | 160  | 0    | 20   | 20   | 10   | 20   |
| Number                       | 7    | 4    | 14   | 3    | 8    | 18   | 5    | 2    | 12   | 1    | 6    | 16   |
| Initial Q (Qb), veh          | 0    | 0    | 0    | 0    | 0    | 0    | 0    | 0    | 0    | 0    | 0    | 0    |
| Ped-Bike Adj(A_pbT)          | 1.00 |      | 1.00 | 1.00 |      | 1.00 | 1.00 |      | 1.00 | 1.00 |      | 1.00 |
| Parking Bus, Adj             | 1.00 | 1.00 | 1.00 | 1.00 | 1.00 | 1.00 | 1.00 | 1.00 | 1.00 | 1.00 | 1.00 | 1.00 |
| Adj Sat Flow, veh/h/ln       | 0    | 1863 | 1863 | 1863 | 1863 | 0    | 1863 | 0    | 1863 | 1792 | 1792 | 1792 |
| Adj Flow Rate, veh/h         | 0    | 1024 | 0    | 36   | 1060 | 0    | 190  | 0    | 10   | 24   | 12   | 5    |
| Adj No. of Lanes             | 0    | 2    | 1    | 1    | 2    | 0    | 1    | 0    | 1    | 1    | 1    | 1    |
| Peak Hour Factor             | 0.84 | 0.84 | 0.84 | 0.84 | 0.84 | 0.84 | 0.84 | 0.84 | 0.84 | 0.84 | 0.84 | 0.84 |
| Percent Heavy Veh, %         | 0    | 2    | 2    | 2    | 2    | 0    | 2    | 0    | 2    | 6    | 6    | 6    |
| Cap, veh/h                   | 0    | 2104 | 941  | 41   | 2535 | 0    | 0    | 0    | 0    | 41   | 43   | 36   |
| Arrive On Green              | 0.00 | 0.59 | 0.00 | 0.02 | 0.72 | 0.00 | 0.00 | 0.00 | 0.00 | 0.02 | 0.02 | 0.02 |
| Sat Flow, veh/h              | 0    | 3632 | 1583 | 1774 | 3632 | 0    | 0    | 0    | 1707 | 1792 | 1524 |      |
| Grp Volume(v), veh/h         | 0    | 1024 | 0    | 36   | 1060 | 0    | 0    | 0    | 24   | 12   | 5    |      |
| Grp Sat Flow(s),veh/h/ln     | 0    | 1770 | 1583 | 1774 | 1770 | 0    | 0    | 0    | 1707 | 1792 | 1524 |      |
| Q Serve(g_s), s              | 0.0  | 5.8  | 0.0  | 0.7  | 4.3  | 0.0  | 0.0  | 0.0  | 0.5  | 0.2  | 0.1  |      |
| Cycle Q Clear(g_c), s        | 0.0  | 5.8  | 0.0  | 0.7  | 4.3  | 0.0  | 0.0  | 0.0  | 0.5  | 0.2  | 0.1  |      |
| Prop In Lane                 | 0.00 |      | 1.00 | 1.00 |      | 0.00 |      |      | 1.00 |      | 1.00 |      |
| Lane Grp Cap(c), veh/h       | 0    | 2104 | 941  | 41   | 2535 | 0    | 0    | 0    | 41   | 43   | 36   |      |
| V/C Ratio(X)                 | 0.00 | 0.49 | 0.00 | 0.88 | 0.42 | 0.00 | 0.00 | 0.00 | 0.59 | 0.28 | 0.14 |      |
| Avail Cap(c_a), veh/h        | 0    | 4499 | 2013 | 1002 | 4499 | 0    | 0    | 0    | 1206 | 1266 | 1076 |      |
| HCM Platoon Ratio            | 1.00 | 1.00 | 1.00 | 1.00 | 1.00 | 1.00 | 1.00 | 1.00 | 1.00 | 1.00 | 1.00 |      |
| Upstream Filter(I)           | 0.00 | 1.00 | 0.00 | 1.00 | 1.00 | 0.00 | 0.00 | 0.00 | 1.00 | 1.00 | 1.00 |      |
| Uniform Delay (d), s/veh     | 0.0  | 4.1  | 0.0  | 17.2 | 2.0  | 0.0  | 0.0  | 0.0  | 17.1 | 17.0 | 16.9 |      |
| Incr Delay (d2), s/veh       | 0.0  | 0.2  | 0.0  | 19.1 | 0.2  | 0.0  | 0.0  | 0.0  | 5.0  | 1.3  | 0.6  |      |
| Initial Q Delay(d3),s/veh    | 0.0  | 0.0  | 0.0  | 0.0  | 0.0  | 0.0  | 0.0  | 0.0  | 0.0  | 0.0  | 0.0  |      |
| %ile BackOfQ(50%),veh/lr0.0  | 0.0  | 2.8  | 0.0  | 0.6  | 2.0  | 0.0  | 0.0  | 0.0  | 0.3  | 0.1  | 0.1  |      |
| LnGrp Delay(d),s/veh         | 0.0  | 4.3  | 0.0  | 36.3 | 2.2  | 0.0  | 0.0  | 0.0  | 22.1 | 18.3 | 17.6 |      |
| LnGrp LOS                    |      | A    |      | D    | A    |      |      |      | C    | B    | B    |      |
| Approach Vol, veh/h          |      | 1024 |      |      | 1096 |      |      |      |      |      | 41   |      |
| Approach Delay, s/veh        |      | 4.3  |      |      | 3.3  |      |      |      |      |      | 20.4 |      |
| Approach LOS                 |      | A    |      |      | A    |      |      |      |      |      | C    |      |
| Timer                        | 1    | 2    | 3    | 4    | 5    | 6    | 7    | 8    |      |      |      |      |
| Assigned Phs                 |      |      | 3    | 4    |      | 6    |      | 8    |      |      |      |      |
| Phs Duration (G+Y+Rc), s     |      |      | 4.3  | 25.6 |      | 5.4  |      | 30.0 |      |      |      |      |
| Change Period (Y+Rc), s      |      |      | 3.5  | 4.6  |      | 4.6  |      | 4.6  |      |      |      |      |
| Max Green Setting (Gmax), s  |      |      | 20.0 | 45.0 |      | 25.0 |      | 45.0 |      |      |      |      |
| Max Q Clear Time (g_c+I1), s |      |      | 2.7  | 7.8  |      | 2.5  |      | 6.3  |      |      |      |      |
| Green Ext Time (p_c), s      |      |      | 0.0  | 13.2 |      | 0.0  |      | 13.0 |      |      |      |      |
| <b>Intersection Summary</b>  |      |      |      |      |      |      |      |      |      |      |      |      |
| HCM 2010 Ctrl Delay          |      |      | 4.1  |      |      |      |      |      |      |      |      |      |
| HCM 2010 LOS                 |      |      | A    |      |      |      |      |      |      |      |      |      |

# HCM 2010 Signalized Intersection Summary

## 32: 2nd Avenue & Lightfighter Drive

Existing with Project, AM  
06/11/2019



| Movement                       | EBL  | EBT  | EBR  | WBL  | WBT  | WBR  | NBL  | NBT  | NBR  | SBL  | SBT  | SBR  |
|--------------------------------|------|------|------|------|------|------|------|------|------|------|------|------|
| Lane Configurations            |      |      |      |      |      |      |      |      |      |      |      |      |
| Traffic Volume (veh/h)         | 80   | 810  | 10   | 10   | 560  | 70   | 10   | 10   | 10   | 280  | 10   | 350  |
| Future Volume (veh/h)          | 80   | 810  | 10   | 10   | 560  | 70   | 10   | 10   | 10   | 280  | 10   | 350  |
| Number                         | 5    | 2    | 12   | 1    | 6    | 16   | 3    | 8    | 18   | 7    | 4    | 14   |
| Initial Q (Qb), veh            | 0    | 0    | 0    | 0    | 0    | 0    | 0    | 0    | 0    | 0    | 0    | 0    |
| Ped-Bike Adj(A_pbT)            | 1.00 |      | 1.00 | 1.00 |      | 1.00 | 1.00 |      | 1.00 | 1.00 |      | 1.00 |
| Parking Bus, Adj               | 1.00 | 1.00 | 1.00 | 1.00 | 1.00 | 1.00 | 1.00 | 1.00 | 1.00 | 1.00 | 1.00 | 1.00 |
| Adj Sat Flow, veh/h/ln         | 1863 | 1863 | 1900 | 1827 | 1827 | 1900 | 1900 | 1900 | 1900 | 1881 | 1881 | 1881 |
| Adj Flow Rate, veh/h           | 89   | 900  | 11   | 11   | 622  | 69   | 11   | 11   | 10   | 311  | 11   | 113  |
| Adj No. of Lanes               | 1    | 2    | 0    | 1    | 2    | 0    | 0    | 1    | 0    | 1    | 1    | 1    |
| Peak Hour Factor               | 0.90 | 0.90 | 0.90 | 0.90 | 0.90 | 0.90 | 0.90 | 0.90 | 0.90 | 0.90 | 0.90 | 0.90 |
| Percent Heavy Veh, %           | 2    | 2    | 2    | 4    | 4    | 4    | 0    | 0    | 0    | 1    | 1    | 1    |
| Cap, veh/h                     | 113  | 2215 | 27   | 18   | 1782 | 197  | 156  | 155  | 119  | 412  | 450  | 382  |
| Arrive On Green                | 0.06 | 0.62 | 0.62 | 0.01 | 0.57 | 0.57 | 0.24 | 0.24 | 0.24 | 0.24 | 0.24 | 0.24 |
| Sat Flow, veh/h                | 1774 | 3581 | 44   | 1740 | 3152 | 349  | 451  | 647  | 499  | 1399 | 1881 | 1599 |
| Grp Volume(v), veh/h           | 89   | 445  | 466  | 11   | 342  | 349  | 32   | 0    | 0    | 311  | 11   | 113  |
| Grp Sat Flow(s),veh/h/ln       | 1774 | 1770 | 1855 | 1740 | 1736 | 1765 | 1597 | 0    | 0    | 1399 | 1881 | 1599 |
| Q Serve(g_s), s                | 4.9  | 12.8 | 12.8 | 0.6  | 10.7 | 10.7 | 0.0  | 0.0  | 0.0  | 19.9 | 0.4  | 5.8  |
| Cycle Q Clear(g_c), s          | 4.9  | 12.8 | 12.8 | 0.6  | 10.7 | 10.7 | 1.4  | 0.0  | 0.0  | 21.3 | 0.4  | 5.8  |
| Prop In Lane                   | 1.00 |      | 0.02 | 1.00 |      | 0.20 | 0.34 |      | 0.31 | 1.00 |      | 1.00 |
| Lane Grp Cap(c), veh/h         | 113  | 1095 | 1147 | 18   | 981  | 998  | 430  | 0    | 0    | 412  | 450  | 382  |
| V/C Ratio(X)                   | 0.79 | 0.41 | 0.41 | 0.60 | 0.35 | 0.35 | 0.07 | 0.00 | 0.00 | 0.76 | 0.02 | 0.30 |
| Avail Cap(c_a), veh/h          | 220  | 1095 | 1147 | 216  | 981  | 998  | 687  | 0    | 0    | 643  | 760  | 646  |
| HCM Platoon Ratio              | 1.00 | 1.00 | 1.00 | 1.00 | 1.00 | 1.00 | 1.00 | 1.00 | 1.00 | 1.00 | 1.00 | 1.00 |
| Upstream Filter(I)             | 0.83 | 0.83 | 0.83 | 0.68 | 0.68 | 0.68 | 1.00 | 0.00 | 0.00 | 1.00 | 1.00 | 1.00 |
| Uniform Delay (d), s/veh       | 46.1 | 9.7  | 9.7  | 49.3 | 11.8 | 11.8 | 29.5 | 0.0  | 0.0  | 36.9 | 29.1 | 31.2 |
| Incr Delay (d2), s/veh         | 3.8  | 0.9  | 0.9  | 7.7  | 0.7  | 0.7  | 0.0  | 0.0  | 0.0  | 1.1  | 0.0  | 0.2  |
| Initial Q Delay(d3),s/veh      | 0.0  | 0.0  | 0.0  | 0.0  | 0.0  | 0.0  | 0.0  | 0.0  | 0.0  | 0.0  | 0.0  | 0.0  |
| %ile BackOfQ(50%),veh/ln       | 2.5  | 6.5  | 6.8  | 0.3  | 5.2  | 5.3  | 0.7  | 0.0  | 0.0  | 8.5  | 0.2  | 2.6  |
| LnGrp Delay(d),s/veh           | 49.9 | 10.7 | 10.6 | 57.0 | 12.4 | 12.4 | 29.5 | 0.0  | 0.0  | 37.9 | 29.1 | 31.3 |
| LnGrp LOS                      | D    | B    | B    | E    | B    | B    | C    |      |      | D    | C    | C    |
| Approach Vol, veh/h            |      | 1000 |      |      | 702  |      |      | 32   |      |      | 435  |      |
| Approach Delay, s/veh          |      | 14.1 |      |      | 13.1 |      |      | 29.5 |      |      | 36.0 |      |
| Approach LOS                   |      | B    |      |      | B    |      |      | C    |      |      | D    |      |
| Timer                          | 1    | 2    | 3    | 4    | 5    | 6    | 7    | 8    |      |      |      |      |
| Assigned Phs                   | 1    | 2    |      | 4    | 5    | 6    |      | 8    |      |      |      |      |
| Phs Duration (G+Y+Rc), s       | 5.1  | 66.5 |      | 28.5 | 10.4 | 61.1 |      | 28.5 |      |      |      |      |
| Change Period (Y+Rc), s        | 4.0  | 4.6  |      | 4.6  | 4.0  | 4.6  |      | 4.6  |      |      |      |      |
| Max Green Setting (Gmax), s    | 12.4 | 34.0 |      | 40.4 | 12.4 | 24.4 |      | 40.4 |      |      |      |      |
| Max Q Clear Time (g_c+12.6), s | 12.6 | 14.8 |      | 23.3 | 6.9  | 12.7 |      | 3.4  |      |      |      |      |
| Green Ext Time (p_c), s        | 0.0  | 3.3  |      | 0.6  | 0.0  | 2.1  |      | 0.1  |      |      |      |      |
| <b>Intersection Summary</b>    |      |      |      |      |      |      |      |      |      |      |      |      |
| HCM 2010 Ctrl Delay            |      |      |      | 18.4 |      |      |      |      |      |      |      |      |
| HCM 2010 LOS                   |      |      |      | B    |      |      |      |      |      |      |      |      |

HCM 2010 Signalized Intersection Summary  
 33: General Jim Moore Boulevard & Lightfighter Drive

Existing with Project, AM  
 06/11/2019



| Movement                      | EBL  | EBT  | EBR  | WBL  | WBT  | WBR  | NBL  | NBT  | NBR  | SBL  | SBT  | SBR  |
|-------------------------------|------|------|------|------|------|------|------|------|------|------|------|------|
| Lane Configurations           | ↖    | ↑    | ↗    | ↖    | ↗    |      | ↖↗   | ↗    |      | ↖    | ↗↖   |      |
| Traffic Volume (veh/h)        | 10   | 170  | 750  | 10   | 70   | 20   | 540  | 30   | 10   | 20   | 20   | 10   |
| Future Volume (veh/h)         | 10   | 170  | 750  | 10   | 70   | 20   | 540  | 30   | 10   | 20   | 20   | 10   |
| Number                        | 3    | 8    | 18   | 7    | 4    | 14   | 1    | 6    | 16   | 5    | 2    | 12   |
| Initial Q (Qb), veh           | 0    | 0    | 0    | 0    | 0    | 0    | 0    | 0    | 0    | 0    | 0    | 0    |
| Ped-Bike Adj(A_pbT)           | 1.00 |      | 1.00 | 1.00 |      | 0.99 | 1.00 |      | 1.00 | 1.00 |      | 1.00 |
| Parking Bus, Adj              | 1.00 | 1.00 | 1.00 | 1.00 | 1.00 | 1.00 | 1.00 | 1.00 | 1.00 | 1.00 | 1.00 | 1.00 |
| Adj Sat Flow, veh/h/ln        | 1863 | 1863 | 1863 | 1792 | 1792 | 1900 | 1881 | 1881 | 1900 | 1863 | 1863 | 1900 |
| Adj Flow Rate, veh/h          | 11   | 191  | 0    | 11   | 79   | 20   | 607  | 34   | 10   | 22   | 22   | 11   |
| Adj No. of Lanes              | 1    | 1    | 1    | 1    | 1    | 0    | 2    | 1    | 0    | 1    | 2    | 0    |
| Peak Hour Factor              | 0.89 | 0.89 | 0.89 | 0.89 | 0.89 | 0.89 | 0.89 | 0.89 | 0.89 | 0.89 | 0.89 | 0.89 |
| Percent Heavy Veh, %          | 2    | 2    | 2    | 6    | 6    | 6    | 1    | 1    | 1    | 2    | 2    | 2    |
| Cap, veh/h                    | 20   | 308  | 262  | 20   | 228  | 58   | 832  | 517  | 152  | 38   | 359  | 166  |
| Arrive On Green               | 0.01 | 0.17 | 0.00 | 0.01 | 0.17 | 0.17 | 0.24 | 0.37 | 0.37 | 0.02 | 0.15 | 0.15 |
| Sat Flow, veh/h               | 1774 | 1863 | 1583 | 1707 | 1379 | 349  | 3476 | 1397 | 411  | 1774 | 2349 | 1087 |
| Grp Volume(v), veh/h          | 11   | 191  | 0    | 11   | 0    | 99   | 607  | 0    | 44   | 22   | 16   | 17   |
| Grp Sat Flow(s),veh/h/ln      | 1774 | 1863 | 1583 | 1707 | 0    | 1728 | 1738 | 0    | 1808 | 1774 | 1770 | 1666 |
| Q Serve(g_s), s               | 0.3  | 4.0  | 0.0  | 0.3  | 0.0  | 2.1  | 6.7  | 0.0  | 0.7  | 0.5  | 0.3  | 0.4  |
| Cycle Q Clear(g_c), s         | 0.3  | 4.0  | 0.0  | 0.3  | 0.0  | 2.1  | 6.7  | 0.0  | 0.7  | 0.5  | 0.3  | 0.4  |
| Prop In Lane                  | 1.00 |      | 1.00 | 1.00 |      | 0.20 | 1.00 |      | 0.23 | 1.00 |      | 0.65 |
| Lane Grp Cap(c), veh/h        | 20   | 308  | 262  | 20   | 0    | 286  | 832  | 0    | 670  | 38   | 270  | 254  |
| V/C Ratio(X)                  | 0.54 | 0.62 | 0.00 | 0.56 | 0.00 | 0.35 | 0.73 | 0.00 | 0.07 | 0.57 | 0.06 | 0.07 |
| Avail Cap(c_a), veh/h         | 850  | 1338 | 1138 | 818  | 0    | 1242 | 832  | 0    | 1299 | 637  | 1271 | 1197 |
| HCM Platoon Ratio             | 1.00 | 1.00 | 1.00 | 1.00 | 1.00 | 1.00 | 1.00 | 1.00 | 1.00 | 1.00 | 1.00 | 1.00 |
| Upstream Filter(I)            | 1.00 | 1.00 | 0.00 | 1.00 | 0.00 | 1.00 | 1.00 | 0.00 | 1.00 | 1.00 | 1.00 | 1.00 |
| Uniform Delay (d), s/veh      | 20.5 | 16.2 | 0.0  | 20.5 | 0.0  | 15.4 | 14.6 | 0.0  | 8.5  | 20.2 | 15.1 | 15.1 |
| Incr Delay (d2), s/veh        | 20.4 | 2.4  | 0.0  | 9.0  | 0.0  | 0.9  | 3.1  | 0.0  | 0.1  | 5.0  | 0.1  | 0.1  |
| Initial Q Delay(d3),s/veh     | 0.0  | 0.0  | 0.0  | 0.0  | 0.0  | 0.0  | 0.0  | 0.0  | 0.0  | 0.0  | 0.0  | 0.0  |
| %ile BackOfQ(50%),veh/ln      | 0.2  | 2.2  | 0.0  | 0.2  | 0.0  | 1.1  | 3.6  | 0.0  | 0.3  | 0.3  | 0.2  | 0.2  |
| LnGrp Delay(d),s/veh          | 41.0 | 18.6 | 0.0  | 29.5 | 0.0  | 16.3 | 17.7 | 0.0  | 8.6  | 25.2 | 15.2 | 15.3 |
| LnGrp LOS                     | D    | B    |      | C    |      | B    | B    |      | A    | C    | B    | B    |
| Approach Vol, veh/h           |      | 202  |      |      | 110  |      |      | 651  |      |      | 55   |      |
| Approach Delay, s/veh         |      | 19.9 |      |      | 17.6 |      |      | 17.1 |      |      | 19.2 |      |
| Approach LOS                  |      | B    |      |      | B    |      |      | B    |      |      | B    |      |
| Timer                         | 1    | 2    | 3    | 4    | 5    | 6    | 7    | 8    |      |      |      |      |
| Assigned Phs                  | 1    | 2    | 3    | 4    | 5    | 6    | 7    | 8    |      |      |      |      |
| Phs Duration (G+Y+Rc), s      | 4.5  | 10.9 | 5.0  | 11.4 | 5.4  | 20.0 | 5.0  | 11.4 |      |      |      |      |
| Change Period (Y+Rc), s       | 4.5  | 4.5  | 4.5  | 4.5  | 4.5  | 4.5  | 4.5  | 4.5  |      |      |      |      |
| Max Green Setting (Gmax), s   | 30.0 | 30.0 | 20.0 | 30.0 | 15.0 | 30.0 | 20.0 | 30.0 |      |      |      |      |
| Max Q Clear Time (g_c+1/3), s | 2.4  | 2.4  | 2.3  | 4.1  | 2.5  | 2.7  | 2.3  | 6.0  |      |      |      |      |
| Green Ext Time (p_c), s       | 0.3  | 0.1  | 0.0  | 0.6  | 0.0  | 0.3  | 0.0  | 1.1  |      |      |      |      |
| <b>Intersection Summary</b>   |      |      |      |      |      |      |      |      |      |      |      |      |
| HCM 2010 Ctrl Delay           |      |      | 17.8 |      |      |      |      |      |      |      |      |      |
| HCM 2010 LOS                  |      |      | B    |      |      |      |      |      |      |      |      |      |

| Intersection              |     |
|---------------------------|-----|
| Intersection Delay, s/veh | 8.7 |
| Intersection LOS          | A   |

| Movement            | WBL  | WBR  | NBT  | NBR  | SBL  | SBT  |
|---------------------|------|------|------|------|------|------|
| Lane Configurations |      |      |      |      |      |      |
| Traffic Vol, veh/h  | 20   | 70   | 20   | 10   | 150  | 40   |
| Future Vol, veh/h   | 20   | 70   | 20   | 10   | 150  | 40   |
| Peak Hour Factor    | 0.77 | 0.77 | 0.77 | 0.77 | 0.77 | 0.77 |
| Heavy Vehicles, %   | 4    | 4    | 3    | 3    | 2    | 2    |
| Mvmt Flow           | 26   | 91   | 26   | 13   | 195  | 52   |
| Number of Lanes     | 1    | 0    | 1    | 0    | 0    | 1    |

| Approach                   | WB  | NB  | SB  |
|----------------------------|-----|-----|-----|
| Opposing Approach          |     | SB  | NB  |
| Opposing Lanes             | 0   | 1   | 1   |
| Conflicting Approach Left  | NB  |     | WB  |
| Conflicting Lanes Left     | 1   | 0   | 1   |
| Conflicting Approach Right | SB  | WB  |     |
| Conflicting Lanes Right    | 1   | 1   | 0   |
| HCM Control Delay          | 7.9 | 7.5 | 9.3 |
| HCM LOS                    | A   | A   | A   |

| Lane                   | NBLn1 | WBLn1 | SBLn1 |
|------------------------|-------|-------|-------|
| Vol Left, %            | 0%    | 22%   | 79%   |
| Vol Thru, %            | 67%   | 0%    | 21%   |
| Vol Right, %           | 33%   | 78%   | 0%    |
| Sign Control           | Stop  | Stop  | Stop  |
| Traffic Vol by Lane    | 30    | 90    | 190   |
| LT Vol                 | 0     | 20    | 150   |
| Through Vol            | 20    | 0     | 40    |
| RT Vol                 | 10    | 70    | 0     |
| Lane Flow Rate         | 39    | 117   | 247   |
| Geometry Grp           | 1     | 1     | 1     |
| Degree of Util (X)     | 0.046 | 0.136 | 0.297 |
| Departure Headway (Hd) | 4.272 | 4.203 | 4.328 |
| Convergence, Y/N       | Yes   | Yes   | Yes   |
| Cap                    | 841   | 858   | 822   |
| Service Time           | 2.283 | 2.204 | 2.402 |
| HCM Lane V/C Ratio     | 0.046 | 0.136 | 0.3   |
| HCM Control Delay      | 7.5   | 7.9   | 9.3   |
| HCM Lane LOS           | A     | A     | A     |
| HCM 95th-tile Q        | 0.1   | 0.5   | 1.2   |

| Intersection             |      |      |      |      |      |      |
|--------------------------|------|------|------|------|------|------|
| Int Delay, s/veh         | 1.1  |      |      |      |      |      |
| Movement                 | EBT  | EBR  | WBL  | WBT  | NBL  | NBR  |
| Lane Configurations      |      |      |      |      |      |      |
| Traffic Vol, veh/h       | 130  | 20   | 10   | 80   | 10   | 10   |
| Future Vol, veh/h        | 130  | 20   | 10   | 80   | 10   | 10   |
| Conflicting Peds, #/hr   | 0    | 0    | 0    | 0    | 0    | 0    |
| Sign Control             | Free | Free | Free | Free | Stop | Stop |
| RT Channelized           | -    | None | -    | None | -    | None |
| Storage Length           | -    | -    | -    | -    | 0    | -    |
| Veh in Median Storage, # | 0    | -    | -    | 0    | 0    | -    |
| Grade, %                 | 0    | -    | -    | 0    | 0    | -    |
| Peak Hour Factor         | 78   | 78   | 78   | 78   | 78   | 78   |
| Heavy Vehicles, %        | 5    | 5    | 4    | 4    | 0    | 0    |
| Mvmt Flow                | 167  | 26   | 13   | 103  | 13   | 13   |

| Major/Minor          | Major1 | Major2 | Minor1 | Minor2 | Minor3 |
|----------------------|--------|--------|--------|--------|--------|
| Conflicting Flow All | 0      | 0      | 193    | 0      | 309    |
| Stage 1              | -      | -      | -      | -      | 180    |
| Stage 2              | -      | -      | -      | -      | 129    |
| Critical Hdwy        | -      | -      | 4.14   | -      | 6.4    |
| Critical Hdwy Stg 1  | -      | -      | -      | -      | 5.4    |
| Critical Hdwy Stg 2  | -      | -      | -      | -      | 5.4    |
| Follow-up Hdwy       | -      | -      | 2.236  | -      | 3.5    |
| Pot Cap-1 Maneuver   | -      | -      | 1368   | -      | 687    |
| Stage 1              | -      | -      | -      | -      | 856    |
| Stage 2              | -      | -      | -      | -      | 902    |
| Platoon blocked, %   | -      | -      | -      | -      | -      |
| Mov Cap-1 Maneuver   | -      | -      | 1368   | -      | 680    |
| Mov Cap-2 Maneuver   | -      | -      | -      | -      | 680    |
| Stage 1              | -      | -      | -      | -      | 847    |
| Stage 2              | -      | -      | -      | -      | 902    |

| Approach             | EB | WB  | NB  |
|----------------------|----|-----|-----|
| HCM Control Delay, s | 0  | 0.9 | 9.9 |
| HCM LOS              |    |     | A   |

| Minor Lane/Major Mvmt | NBLn1 | EBT | EBR | WBL   | WBT |
|-----------------------|-------|-----|-----|-------|-----|
| Capacity (veh/h)      | 763   | -   | -   | 1368  | -   |
| HCM Lane V/C Ratio    | 0.034 | -   | -   | 0.009 | -   |
| HCM Control Delay (s) | 9.9   | -   | -   | 7.7   | 0   |
| HCM Lane LOS          | A     | -   | -   | A     | A   |
| HCM 95th %tile Q(veh) | 0.1   | -   | -   | 0     | -   |



| Intersection              |     |
|---------------------------|-----|
| Intersection Delay, s/veh | 9.9 |
| Intersection LOS          | A   |

| Movement            | EBL  | EBT  | EBR  | WBL  | WBT  | WBR  | NBL  | NBT  | NBR  | SBL  | SBT  | SBR  |
|---------------------|------|------|------|------|------|------|------|------|------|------|------|------|
| Lane Configurations |      | ↕    |      |      | ↕    |      |      | ↕    |      |      | ↕    |      |
| Traffic Vol, veh/h  | 10   | 120  | 10   | 10   | 80   | 10   | 10   | 140  | 10   | 10   | 120  | 10   |
| Future Vol, veh/h   | 10   | 120  | 10   | 10   | 80   | 10   | 10   | 140  | 10   | 10   | 120  | 10   |
| Peak Hour Factor    | 0.79 | 0.79 | 0.79 | 0.79 | 0.79 | 0.79 | 0.79 | 0.79 | 0.79 | 0.79 | 0.79 | 0.79 |
| Heavy Vehicles, %   | 6    | 6    | 6    | 4    | 4    | 4    | 20   | 20   | 20   | 2    | 2    | 2    |
| Mvmt Flow           | 13   | 152  | 13   | 13   | 101  | 13   | 13   | 177  | 13   | 13   | 152  | 13   |
| Number of Lanes     | 0    | 1    | 0    | 0    | 1    | 0    | 0    | 1    | 0    | 0    | 1    | 0    |

| Approach                   | EB  | WB  | NB   | SB  |
|----------------------------|-----|-----|------|-----|
| Opposing Approach          | WB  | EB  | SB   | NB  |
| Opposing Lanes             | 1   | 1   | 1    | 1   |
| Conflicting Approach Left  | SB  | NB  | EB   | WB  |
| Conflicting Lanes Left     | 1   | 1   | 1    | 1   |
| Conflicting Approach Right | NB  | SB  | WB   | EB  |
| Conflicting Lanes Right    | 1   | 1   | 1    | 1   |
| HCM Control Delay          | 9.9 | 9.4 | 10.5 | 9.6 |
| HCM LOS                    | A   | A   | B    | A   |

| Lane                   | NBLn1 | EBLn1 | WBLn1 | SBLn1 |
|------------------------|-------|-------|-------|-------|
| Vol Left, %            | 6%    | 7%    | 10%   | 7%    |
| Vol Thru, %            | 88%   | 86%   | 80%   | 86%   |
| Vol Right, %           | 6%    | 7%    | 10%   | 7%    |
| Sign Control           | Stop  | Stop  | Stop  | Stop  |
| Traffic Vol by Lane    | 160   | 140   | 100   | 140   |
| LT Vol                 | 10    | 10    | 10    | 10    |
| Through Vol            | 140   | 120   | 80    | 120   |
| RT Vol                 | 10    | 10    | 10    | 10    |
| Lane Flow Rate         | 203   | 177   | 127   | 177   |
| Geometry Grp           | 1     | 1     | 1     | 1     |
| Degree of Util (X)     | 0.293 | 0.251 | 0.18  | 0.244 |
| Departure Headway (Hd) | 5.209 | 5.098 | 5.126 | 4.948 |
| Convergence, Y/N       | Yes   | Yes   | Yes   | Yes   |
| Cap                    | 683   | 698   | 692   | 718   |
| Service Time           | 3.291 | 3.182 | 3.217 | 3.031 |
| HCM Lane V/C Ratio     | 0.297 | 0.254 | 0.184 | 0.247 |
| HCM Control Delay      | 10.5  | 9.9   | 9.4   | 9.6   |
| HCM Lane LOS           | B     | A     | A     | A     |
| HCM 95th-tile Q        | 1.2   | 1     | 0.7   | 1     |

| Intersection             |      |      |      |      |      |      |      |      |      |      |      |      |
|--------------------------|------|------|------|------|------|------|------|------|------|------|------|------|
| Int Delay, s/veh         | 6.9  |      |      |      |      |      |      |      |      |      |      |      |
| Movement                 | EBL  | EBT  | EBR  | WBL  | WBT  | WBR  | NBL  | NBT  | NBR  | SBL  | SBT  | SBR  |
| Lane Configurations      |      | ↕    |      |      | ↕    |      |      | ↕    |      |      | ↕    |      |
| Traffic Vol, veh/h       | 20   | 40   | 70   | 10   | 50   | 10   | 30   | 100  | 10   | 0    | 0    | 0    |
| Future Vol, veh/h        | 20   | 40   | 70   | 10   | 50   | 10   | 30   | 100  | 10   | 0    | 0    | 0    |
| Conflicting Peds, #/hr   | 0    | 0    | 0    | 0    | 0    | 0    | 0    | 0    | 1    | 1    | 0    | 0    |
| Sign Control             | Stop | Stop | Stop | Stop | Stop | Stop | Free | Free | Free | Free | Free | Free |
| RT Channelized           | -    | -    | None | -    | -    | None | -    | -    | None | -    | -    | None |
| Storage Length           | -    | -    | -    | -    | -    | -    | -    | -    | -    | -    | -    | -    |
| Veh in Median Storage, # | -    | 0    | -    | -    | 0    | -    | -    | 0    | -    | -    | 0    | -    |
| Grade, %                 | -    | 0    | -    | -    | 0    | -    | -    | 0    | -    | -    | 0    | -    |
| Peak Hour Factor         | 82   | 82   | 82   | 82   | 82   | 82   | 82   | 82   | 82   | 82   | 82   | 82   |
| Heavy Vehicles, %        | 12   | 12   | 12   | 0    | 0    | 0    | 10   | 10   | 10   | 10   | 10   | 10   |
| Mvmt Flow                | 24   | 49   | 85   | 12   | 61   | 12   | 37   | 122  | 12   | 0    | 0    | 0    |

| Major/Minor          | Minor2 |       | Minor1 |     | Major1 |     |      | Major2 |   |      |   |   |
|----------------------|--------|-------|--------|-----|--------|-----|------|--------|---|------|---|---|
| Conflicting Flow All | 240    | 210   | 1      | 271 | 204    | 129 | 1    | 0      | 0 | 135  | 0 | 0 |
| Stage 1              | 1      | 1     | -      | 203 | 203    | -   | -    | -      | - | -    | - | - |
| Stage 2              | 239    | 209   | -      | 68  | 1      | -   | -    | -      | - | -    | - | - |
| Critical Hdwy        | 7.22   | 6.62  | 6.32   | 7.1 | 6.5    | 6.2 | 4.2  | -      | - | 4.2  | - | - |
| Critical Hdwy Stg 1  | 6.22   | 5.62  | -      | 6.1 | 5.5    | -   | -    | -      | - | -    | - | - |
| Critical Hdwy Stg 2  | 6.22   | 5.62  | -      | 6.1 | 5.5    | -   | -    | -      | - | -    | - | - |
| Follow-up Hdwy       | 3.608  | 4.108 | 3.408  | 3.5 | 4      | 3.3 | 2.29 | -      | - | 2.29 | - | - |
| Pot Cap-1 Maneuver   | 694    | 670   | 1055   | 686 | 696    | 926 | 1571 | -      | - | 1401 | - | - |
| Stage 1              | 997    | 875   | -      | 804 | 737    | -   | -    | -      | - | -    | - | - |
| Stage 2              | 742    | 711   | -      | 947 | 899    | -   | -    | -      | - | -    | - | - |
| Platoon blocked, %   |        |       |        |     |        |     |      | -      | - | -    | - | - |
| Mov Cap-1 Maneuver   | 626    | 653   | 1055   | 582 | 678    | 925 | 1571 | -      | - | 1400 | - | - |
| Mov Cap-2 Maneuver   | 626    | 653   | -      | 582 | 678    | -   | -    | -      | - | -    | - | - |
| Stage 1              | 972    | 875   | -      | 783 | 718    | -   | -    | -      | - | -    | - | - |
| Stage 2              | 653    | 693   | -      | 822 | 899    | -   | -    | -      | - | -    | - | - |

| Approach             | EB   |  | WB |  | NB  |  | SB |  |
|----------------------|------|--|----|--|-----|--|----|--|
| HCM Control Delay, s | 10.5 |  | 11 |  | 1.6 |  | 0  |  |
| HCM LOS              | B    |  | B  |  |     |  |    |  |

| Minor Lane/Major Mvmt | NBL   | NBT | NBR | EBLn1WBLn1 | SBL   | SBT  | SBR |
|-----------------------|-------|-----|-----|------------|-------|------|-----|
| Capacity (veh/h)      | 1571  | -   | -   | 815        | 688   | 1400 | -   |
| HCM Lane V/C Ratio    | 0.023 | -   | -   | 0.195      | 0.124 | -    | -   |
| HCM Control Delay (s) | 7.3   | 0   | -   | 10.5       | 11    | 0    | -   |
| HCM Lane LOS          | A     | A   | -   | B          | B     | A    | -   |
| HCM 95th %tile Q(veh) | 0.1   | -   | -   | 0.7        | 0.4   | 0    | -   |

| Intersection             |      |      |      |      |      |      |
|--------------------------|------|------|------|------|------|------|
| Int Delay, s/veh         | 1.3  |      |      |      |      |      |
| Movement                 | EBL  | EBR  | NBL  | NBT  | SBT  | SBR  |
| Lane Configurations      | T    |      |      | T    |      | T    |
| Traffic Vol, veh/h       | 40   | 10   | 10   | 110  | 720  | 50   |
| Future Vol, veh/h        | 40   | 10   | 10   | 110  | 720  | 50   |
| Conflicting Peds, #/hr   | 0    | 0    | 0    | 0    | 0    | 0    |
| Sign Control             | Stop | Stop | Free | Free | Free | Free |
| RT Channelized           | -    | None | -    | None | -    | None |
| Storage Length           | 0    | -    | -    | -    | -    | -    |
| Veh in Median Storage, # | 0    | -    | -    | 0    | 0    | -    |
| Grade, %                 | 0    | -    | -    | 0    | 0    | -    |
| Peak Hour Factor         | 89   | 89   | 89   | 89   | 89   | 89   |
| Heavy Vehicles, %        | 13   | 13   | 2    | 2    | 0    | 0    |
| Mvmt Flow                | 45   | 11   | 11   | 124  | 809  | 56   |























| Major/Minor          | Minor2 | Major1 | Major2 |   |   |   |
|----------------------|--------|--------|--------|---|---|---|
| Conflicting Flow All | 983    | 837    | 865    | 0 | - | 0 |
| Stage 1              | 837    | -      | -      | - | - | - |
| Stage 2              | 146    | -      | -      | - | - | - |
| Critical Hdwy        | 6.53   | 6.33   | 4.12   | - | - | - |
| Critical Hdwy Stg 1  | 5.53   | -      | -      | - | - | - |
| Critical Hdwy Stg 2  | 5.53   | -      | -      | - | - | - |
| Follow-up Hdwy       | 3.617  | 3.417  | 2.218  | - | - | - |
| Pot Cap-1 Maneuver   | 263    | 350    | 778    | - | - | - |
| Stage 1              | 407    | -      | -      | - | - | - |
| Stage 2              | 855    | -      | -      | - | - | - |
| Platoon blocked, %   |        |        |        | - | - | - |
| Mov Cap-1 Maneuver   | 259    | 350    | 778    | - | - | - |
| Mov Cap-2 Maneuver   | 259    | -      | -      | - | - | - |
| Stage 1              | 401    | -      | -      | - | - | - |
| Stage 2              | 855    | -      | -      | - | - | - |

| Approach             | EB   | NB  | SB |
|----------------------|------|-----|----|
| HCM Control Delay, s | 21.6 | 0.8 | 0  |
| HCM LOS              | C    |     |    |

| Minor Lane/Major Mvmt | NBL   | NBT | EBLn1 | SBT | SBR |
|-----------------------|-------|-----|-------|-----|-----|
| Capacity (veh/h)      | 778   | -   | 273   | -   | -   |
| HCM Lane V/C Ratio    | 0.014 | -   | 0.206 | -   | -   |
| HCM Control Delay (s) | 9.7   | 0   | 21.6  | -   | -   |
| HCM Lane LOS          | A     | A   | C     | -   | -   |
| HCM 95th %tile Q(veh) | 0     | -   | 0.8   | -   | -   |

HCM 2010 Signalized Intersection Summary  
 39: General Jim Moore Boulevard & Gigling Road

Existing with Project, AM  
 06/11/2019

|                              |  |  |  |  |  |  |  |  |  |  |  |  |
|------------------------------|---|---|---|---|---|---|--|---|---|---|---|---|
| Movement                     | EBL   | EBT   | EBR   | WBL   | WBT   | WBR   | NBL  | NBT   | NBR   | SBL   | SBT   | SBR   |
| Lane Configurations          |  |  |   |  |  |  |  |  |  |  |  |  |
| Traffic Volume (veh/h)       | 30  | 100   | 80  | 440   | 40  | 60  | 50   | 330   | 220   | 170   | 690   | 50  |
| Future Volume (veh/h)        | 30  | 100   | 80  | 440   | 40  | 60  | 50   | 330   | 220   | 170   | 690   | 50  |
| Number                       | 3   | 8   | 18  | 7   | 4   | 14  | 1  | 6   | 16  | 5   | 2   | 12  |
| Initial Q (Qb), veh          | 0   | 0   | 0   | 0   | 0   | 0   | 0  | 0   | 0   | 0   | 0   | 0   |
| Ped-Bike Adj(A_pbT)          | 1.00  |   | 1.00  | 1.00  |   | 1.00  | 1.00   |   | 1.00  | 1.00  |   | 1.00  |
| Parking Bus, Adj             | 1.00  | 1.00  | 1.00  | 1.00  | 1.00  | 1.00  | 1.00   | 1.00  | 1.00  | 1.00  | 1.00  | 1.00  |
| Adj Sat Flow, veh/h/ln       | 1810  | 1810  | 1900  | 1863  | 1863  | 1863  | 1881   | 1881  | 1881  | 1863  | 1863  | 1863  |
| Adj Flow Rate, veh/h         | 34  | 115   | 60  | 506   | 46  | 0   | 57   | 379   | 0   | 195   | 793   | 0   |
| Adj No. of Lanes             | 1   | 1   | 0   | 1   | 1   | 1   | 1  | 2   | 1   | 1   | 2   | 1   |
| Peak Hour Factor             | 0.87  | 0.87  | 0.87  | 0.87  | 0.87  | 0.87  | 0.87   | 0.87  | 0.87  | 0.87  | 0.87  | 0.87  |
| Percent Heavy Veh, %         | 5   | 5   | 5   | 2   | 2   | 2   | 1  | 1   | 1   | 2   | 2   | 2   |
| Cap, veh/h                   | 60  | 148   | 77  | 530   | 738   | 628   | 86   | 620   | 277   | 236   | 915   | 409   |
| Arrive On Green              | 0.03  | 0.13  | 0.13  | 0.30  | 0.40  | 0.00  | 0.05   | 0.17  | 0.00  | 0.13  | 0.26  | 0.00  |
| Sat Flow, veh/h              | 1723  | 1120  | 585   | 1774  | 1863  | 1583  | 1792   | 3574  | 1599  | 1774  | 3539  | 1583  |
| Grp Volume(v), veh/h         | 34  | 0   | 175   | 506   | 46  | 0   | 57   | 379   | 0   | 195   | 793   | 0   |
| Grp Sat Flow(s),veh/h/ln     | 1723  | 0   | 1705  | 1774  | 1863  | 1583  | 1792   | 1787  | 1599  | 1774  | 1770  | 1583  |
| Q Serve(g_s), s              | 1.3   | 0.0   | 6.8   | 19.2  | 1.0   | 0.0   | 2.1  | 6.7   | 0.0   | 7.3   | 14.7  | 0.0   |
| Cycle Q Clear(g_c), s        | 1.3   | 0.0   | 6.8   | 19.2  | 1.0   | 0.0   | 2.1  | 6.7   | 0.0   | 7.3   | 14.7  | 0.0   |
| Prop In Lane                 | 1.00  |   | 0.34  | 1.00  |   | 1.00  | 1.00   |   | 1.00  | 1.00  |   | 1.00  |
| Lane Grp Cap(c), veh/h       | 60  | 0   | 226   | 530   | 738   | 628   | 86   | 620   | 277   | 236   | 915   | 409   |
| V/C Ratio(X)                 | 0.57  | 0.00  | 0.77  | 0.96  | 0.06  | 0.00  | 0.66   | 0.61  | 0.00  | 0.82  | 0.87  | 0.00  |
| Avail Cap(c_a), veh/h        | 264   | 0   | 770   | 530   | 1112  | 946   | 144  | 1301  | 582   | 401   | 1804  | 807   |
| HCM Platoon Ratio            | 1.00  | 1.00  | 1.00  | 1.00  | 1.00  | 1.00  | 1.00   | 1.00  | 1.00  | 1.00  | 1.00  | 1.00  |
| Upstream Filter(I)           | 1.00  | 0.00  | 1.00  | 1.00  | 1.00  | 0.00  | 1.00   | 1.00  | 0.00  | 1.00  | 1.00  | 0.00  |
| Uniform Delay (d), s/veh     | 32.6  | 0.0   | 28.8  | 23.6  | 12.8  | 0.0   | 32.1   | 26.2  | 0.0   | 29.0  | 24.3  | 0.0   |
| Incr Delay (d2), s/veh       | 3.1   | 0.0   | 2.1   | 27.9  | 0.0   | 0.0   | 3.2  | 0.4   | 0.0   | 2.8   | 1.0   | 0.0   |
| Initial Q Delay(d3),s/veh    | 0.0   | 0.0   | 0.0   | 0.0   | 0.0   | 0.0   | 0.0  | 0.0   | 0.0   | 0.0   | 0.0   | 0.0   |
| %ile BackOfQ(50%),veh/ln     | 0.7   | 0.0   | 3.3   | 13.5  | 0.5   | 0.0   | 1.1  | 3.3   | 0.0   | 3.8   | 7.3   | 0.0   |
| LnGrp Delay(d),s/veh         | 35.7  | 0.0   | 30.9  | 51.5  | 12.8  | 0.0   | 35.3   | 26.6  | 0.0   | 31.7  | 25.3  | 0.0   |
| LnGrp LOS                    | D   |   | C   | D   | B   |   | D  | C   |   | C   | C   |   |
| Approach Vol, veh/h          |   | 209   |   |   | 552   |   |  | 436   |   |   | 988   |   |
| Approach Delay, s/veh        |   | 31.7  |   |   | 48.3  |   |  | 27.7  |   |   | 26.6  |   |
| Approach LOS                 |   | C   |   |   | D   |   |  | C   |   |   | C   |   |
| Timer                        | 1   | 2   | 3   | 4   | 5   | 6   | 7  | 8   |   |   |   |   |
| Assigned Phs                 | 1   | 2   | 3   | 4   | 5   | 6   | 7  | 8   |   |   |   |   |
| Phs Duration (G+Y+Rc), s     | 7.8   | 22.2  | 6.9   | 31.7  | 13.6  | 16.4  | 25.0   | 13.6  |   |   |   |   |
| Change Period (Y+Rc), s      | 4.5   | 4.5   | 4.5   | 4.5   | 4.5   | 4.5   | 4.5  | 4.5   |   |   |   |   |
| Max Green Setting (Gmax), s  | 5.5   | 35.0  | 10.5  | 41.0  | 15.5  | 25.0  | 20.5   | 31.0  |   |   |   |   |
| Max Q Clear Time (g_c+I1), s | 4.1   | 16.7  | 3.3   | 3.0   | 9.3   | 8.7   | 21.2   | 8.8   |   |   |   |   |
| Green Ext Time (p_c), s      | 0.0   | 1.0   | 0.0   | 0.0   | 0.0   | 0.4   | 0.0  | 0.2   |   |   |   |   |
| <b>Intersection Summary</b>  |   |   |   |   |   |   |  |   |   |   |   |   |
| HCM 2010 Ctrl Delay          |   |   | 32.8  |   |   |   |  |   |   |   |   |   |
| HCM 2010 LOS                 |   |   | C   |   |   |   |  |   |   |   |   |   |
| <b>Notes</b>                 |   |   |   |   |   |   |  |   |   |   |   |   |

| Intersection             |      |      |      |      |      |      |      |      |      |      |      |      |
|--------------------------|------|------|------|------|------|------|------|------|------|------|------|------|
| Int Delay, s/veh         | 5.4  |      |      |      |      |      |      |      |      |      |      |      |
| Movement                 | EBL  | EBT  | EBR  | WBL  | WBT  | WBR  | NBL  | NBT  | NBR  | SBL  | SBT  | SBR  |
| Lane Configurations      |      | ↕    |      |      | ↕    |      |      | ↕    |      |      | ↕    |      |
| Traffic Vol, veh/h       | 10   | 460  | 50   | 10   | 860  | 10   | 20   | 10   | 10   | 10   | 30   | 20   |
| Future Vol, veh/h        | 10   | 460  | 50   | 10   | 860  | 10   | 20   | 10   | 10   | 10   | 30   | 20   |
| Conflicting Peds, #/hr   | 0    | 0    | 1    | 1    | 0    | 0    | 0    | 0    | 0    | 0    | 0    | 0    |
| Sign Control             | Free | Free | Free | Free | Free | Free | Stop | Stop | Stop | Stop | Stop | Stop |
| RT Channelized           | -    | -    | None | -    | -    | None | -    | -    | None | -    | -    | None |
| Storage Length           | -    | -    | -    | -    | -    | -    | -    | -    | -    | -    | -    | -    |
| Veh in Median Storage, # | -    | 0    | -    | -    | 0    | -    | -    | 0    | -    | -    | 0    | -    |
| Grade, %                 | -    | 0    | -    | -    | 0    | -    | -    | 0    | -    | -    | 0    | -    |
| Peak Hour Factor         | 88   | 88   | 88   | 88   | 88   | 88   | 88   | 88   | 88   | 88   | 88   | 88   |
| Heavy Vehicles, %        | 3    | 3    | 3    | 3    | 3    | 3    | 2    | 2    | 2    | 4    | 4    | 4    |
| Mvmt Flow                | 11   | 523  | 57   | 11   | 977  | 11   | 23   | 11   | 11   | 11   | 34   | 23   |

| Major/Minor          | Major1 |   |   | Major2 |   |   | Minor1 |       |       | Minor2 |       |       |
|----------------------|--------|---|---|--------|---|---|--------|-------|-------|--------|-------|-------|
| Conflicting Flow All | 988    | 0 | 0 | 581    | 0 | 0 | 1608   | 1585  | 553   | 1590   | 1608  | 983   |
| Stage 1              | -      | - | - | -      | - | - | 575    | 575   | -     | 1005   | 1005  | -     |
| Stage 2              | -      | - | - | -      | - | - | 1033   | 1010  | -     | 585    | 603   | -     |
| Critical Hdwy        | 4.13   | - | - | 4.13   | - | - | 7.12   | 6.52  | 6.22  | 7.14   | 6.54  | 6.24  |
| Critical Hdwy Stg 1  | -      | - | - | -      | - | - | 6.12   | 5.52  | -     | 6.14   | 5.54  | -     |
| Critical Hdwy Stg 2  | -      | - | - | -      | - | - | 6.12   | 5.52  | -     | 6.14   | 5.54  | -     |
| Follow-up Hdwy       | 2.227  | - | - | 2.227  | - | - | 3.518  | 4.018 | 3.318 | 3.536  | 4.036 | 3.336 |
| Pot Cap-1 Maneuver   | 696    | - | - | 988    | - | - | 84     | 108   | 533   | 86     | 104   | 299   |
| Stage 1              | -      | - | - | -      | - | - | 503    | 503   | -     | 289    | 317   | -     |
| Stage 2              | -      | - | - | -      | - | - | 281    | 317   | -     | 494    | 485   | -     |
| Platoon blocked, %   | -      | - | - | -      | - | - | -      | -     | -     | -      | -     | -     |
| Mov Cap-1 Maneuver   | 696    | - | - | 987    | - | - | 55     | 103   | 532   | 74     | 99    | 299   |
| Mov Cap-2 Maneuver   | -      | - | - | -      | - | - | 55     | 103   | -     | 74     | 99    | -     |
| Stage 1              | -      | - | - | -      | - | - | 490    | 490   | -     | 282    | 309   | -     |
| Stage 2              | -      | - | - | -      | - | - | 225    | 309   | -     | 461    | 473   | -     |

| Approach             | EB  |  |  | WB  |  |  | NB   |  |  | SB   |  |  |
|----------------------|-----|--|--|-----|--|--|------|--|--|------|--|--|
| HCM Control Delay, s | 0.2 |  |  | 0.1 |  |  | 91.7 |  |  | 69.7 |  |  |
| HCM LOS              |     |  |  |     |  |  | F    |  |  | F    |  |  |

| Minor Lane/Major Mvmt | NBLn1 | EBL   | EBT | EBR | WBL   | WBT | WBR | SBLn1 |
|-----------------------|-------|-------|-----|-----|-------|-----|-----|-------|
| Capacity (veh/h)      | 83    | 696   | -   | -   | 987   | -   | -   | 119   |
| HCM Lane V/C Ratio    | 0.548 | 0.016 | -   | -   | 0.012 | -   | -   | 0.573 |
| HCM Control Delay (s) | 91.7  | 10.3  | 0   | -   | 8.7   | 0   | -   | 69.7  |
| HCM Lane LOS          | F     | B     | A   | -   | A     | A   | -   | F     |
| HCM 95th %tile Q(veh) | 2.4   | 0.1   | -   | -   | 0     | -   | -   | 2.8   |

| Intersection             |      |      |      |      |      |      |      |      |      |      |      |      |
|--------------------------|------|------|------|------|------|------|------|------|------|------|------|------|
| Int Delay, s/veh         | 8.9  |      |      |      |      |      |      |      |      |      |      |      |
| Movement                 | EBL  | EBT  | EBR  | WBL  | WBT  | WBR  | NBL  | NBT  | NBR  | SBL  | SBT  | SBR  |
| Lane Configurations      |      | ↕    |      |      | ↕    |      |      | ↕    | ↕    |      | ↕    |      |
| Traffic Vol, veh/h       | 10   | 370  | 110  | 20   | 830  | 10   | 50   | 10   | 10   | 10   | 10   | 10   |
| Future Vol, veh/h        | 10   | 370  | 110  | 20   | 830  | 10   | 50   | 10   | 10   | 10   | 10   | 10   |
| Conflicting Peds, #/hr   | 0    | 0    | 0    | 0    | 0    | 0    | 0    | 0    | 0    | 0    | 0    | 0    |
| Sign Control             | Free | Free | Free | Free | Free | Free | Stop | Stop | Stop | Stop | Stop | Stop |
| RT Channelized           | -    | -    | None | -    | -    | None | -    | -    | None | -    | -    | None |
| Storage Length           | -    | -    | -    | -    | -    | -    | -    | -    | 135  | -    | -    | -    |
| Veh in Median Storage, # | -    | 0    | -    | -    | 0    | -    | -    | 0    | -    | -    | 0    | -    |
| Grade, %                 | -    | 0    | -    | -    | 0    | -    | -    | 0    | -    | -    | 0    | -    |
| Peak Hour Factor         | 84   | 84   | 84   | 84   | 84   | 84   | 84   | 84   | 84   | 84   | 84   | 84   |
| Heavy Vehicles, %        | 3    | 3    | 3    | 2    | 2    | 2    | 2    | 2    | 2    | 0    | 0    | 0    |
| Mvmt Flow                | 12   | 440  | 131  | 24   | 988  | 12   | 60   | 12   | 12   | 12   | 12   | 12   |

| Major/Minor          | Major1 |   |   | Major2 |   |   | Minor1 |       |       | Minor2 |      |     |
|----------------------|--------|---|---|--------|---|---|--------|-------|-------|--------|------|-----|
| Conflicting Flow All | 1000   | 0 | 0 | 571    | 0 | 0 | 1584   | 1578  | 506   | 1584   | 1637 | 994 |
| Stage 1              | -      | - | - | -      | - | - | 530    | 530   | -     | 1042   | 1042 | -   |
| Stage 2              | -      | - | - | -      | - | - | 1054   | 1048  | -     | 542    | 595  | -   |
| Critical Hdwy        | 4.13   | - | - | 4.12   | - | - | 7.12   | 6.52  | 6.22  | 7.1    | 6.5  | 6.2 |
| Critical Hdwy Stg 1  | -      | - | - | -      | - | - | 6.12   | 5.52  | -     | 6.1    | 5.5  | -   |
| Critical Hdwy Stg 2  | -      | - | - | -      | - | - | 6.12   | 5.52  | -     | 6.1    | 5.5  | -   |
| Follow-up Hdwy       | 2.227  | - | - | 2.218  | - | - | 3.518  | 4.018 | 3.318 | 3.5    | 4    | 3.3 |
| Pot Cap-1 Maneuver   | 688    | - | - | 1002   | - | - | 88     | 109   | 566   | 89     | 102  | 300 |
| Stage 1              | -      | - | - | -      | - | - | 533    | 527   | -     | 280    | 309  | -   |
| Stage 2              | -      | - | - | -      | - | - | 273    | 305   | -     | 528    | 496  | -   |
| Platoon blocked, %   | -      | - | - | -      | - | - | -      | -     | -     | -      | -    | -   |
| Mov Cap-1 Maneuver   | 688    | - | - | 1002   | - | - | 72     | 100   | 566   | 74     | 94   | 300 |
| Mov Cap-2 Maneuver   | -      | - | - | -      | - | - | 72     | 100   | -     | 74     | 94   | -   |
| Stage 1              | -      | - | - | -      | - | - | 519    | 513   | -     | 273    | 292  | -   |
| Stage 2              | -      | - | - | -      | - | - | 238    | 289   | -     | 492    | 483  | -   |

| Approach             | EB  |  |  | WB  |  |  | NB    |  |  | SB   |  |  |
|----------------------|-----|--|--|-----|--|--|-------|--|--|------|--|--|
| HCM Control Delay, s | 0.2 |  |  | 0.2 |  |  | 156.8 |  |  | 53.3 |  |  |
| HCM LOS              |     |  |  |     |  |  | F     |  |  | F    |  |  |

| Minor Lane/Major Mvmt | NBLn1 | NBLn2 | EBL   | EBT | EBR | WBL   | WBT | WBR | SBLn1 |
|-----------------------|-------|-------|-------|-----|-----|-------|-----|-----|-------|
| Capacity (veh/h)      | 76    | 566   | 688   | -   | -   | 1002  | -   | -   | 109   |
| HCM Lane V/C Ratio    | 0.94  | 0.021 | 0.017 | -   | -   | 0.024 | -   | -   | 0.328 |
| HCM Control Delay (s) | 181   | 11.5  | 10.3  | 0   | -   | 8.7   | 0   | -   | 53.3  |
| HCM Lane LOS          | F     | B     | B     | A   | -   | A     | A   | -   | F     |
| HCM 95th %tile Q(veh) | 4.9   | 0.1   | 0.1   | -   | -   | 0.1   | -   | -   | 1.3   |

| Intersection              |      |
|---------------------------|------|
| Intersection Delay, s/veh | 86.8 |
| Intersection LOS          | F    |

| Movement            | EBL  | EBT  | EBR  | WBL  | WBT  | WBR  | NBL  | NBT  | NBR  | SBL  | SBT  | SBR  |
|---------------------|------|------|------|------|------|------|------|------|------|------|------|------|
| Lane Configurations |      | ↕    |      |      | ↕    |      |      | ↕    | ↕    |      | ↕    |      |
| Traffic Vol, veh/h  | 140  | 250  | 10   | 10   | 730  | 10   | 10   | 10   | 10   | 10   | 10   | 120  |
| Future Vol, veh/h   | 140  | 250  | 10   | 10   | 730  | 10   | 10   | 10   | 10   | 10   | 10   | 120  |
| Peak Hour Factor    | 0.89 | 0.89 | 0.89 | 0.89 | 0.89 | 0.89 | 0.89 | 0.89 | 0.89 | 0.89 | 0.89 | 0.89 |
| Heavy Vehicles, %   | 3    | 3    | 3    | 2    | 2    | 2    | 33   | 33   | 33   | 2    | 2    | 2    |
| Mvmt Flow           | 157  | 281  | 11   | 11   | 820  | 11   | 11   | 11   | 11   | 11   | 11   | 135  |
| Number of Lanes     | 0    | 1    | 0    | 0    | 1    | 0    | 0    | 1    | 1    | 0    | 1    | 0    |

| Approach                   | EB   | WB    | NB   | SB   |
|----------------------------|------|-------|------|------|
| Opposing Approach          | WB   | EB    | SB   | NB   |
| Opposing Lanes             | 1    | 1     | 1    | 2    |
| Conflicting Approach Left  | SB   | NB    | EB   | WB   |
| Conflicting Lanes Left     | 1    | 2     | 1    | 1    |
| Conflicting Approach Right | NB   | SB    | WB   | EB   |
| Conflicting Lanes Right    | 2    | 1     | 1    | 1    |
| HCM Control Delay          | 21.1 | 138.6 | 11.9 | 12.6 |
| HCM LOS                    | C    | F     | B    | B    |

| Lane                   | NBLn1 | NBLn2 | EBLn1 | WBLn1 | SBLn1 |
|------------------------|-------|-------|-------|-------|-------|
| Vol Left, %            | 50%   | 0%    | 35%   | 1%    | 7%    |
| Vol Thru, %            | 50%   | 0%    | 62%   | 97%   | 7%    |
| Vol Right, %           | 0%    | 100%  | 3%    | 1%    | 86%   |
| Sign Control           | Stop  | Stop  | Stop  | Stop  | Stop  |
| Traffic Vol by Lane    | 20    | 10    | 400   | 750   | 140   |
| LT Vol                 | 10    | 0     | 140   | 10    | 10    |
| Through Vol            | 10    | 0     | 250   | 730   | 10    |
| RT Vol                 | 0     | 10    | 10    | 10    | 120   |
| Lane Flow Rate         | 22    | 11    | 449   | 843   | 157   |
| Geometry Grp           | 7     | 7     | 2     | 2     | 5     |
| Degree of Util (X)     | 0.053 | 0.024 | 0.69  | 1.239 | 0.28  |
| Departure Headway (Hd) | 9.136 | 8.152 | 5.941 | 5.291 | 6.918 |
| Convergence, Y/N       | Yes   | Yes   | Yes   | Yes   | Yes   |
| Cap                    | 394   | 442   | 611   | 691   | 522   |
| Service Time           | 6.836 | 5.852 | 3.941 | 3.304 | 4.918 |
| HCM Lane V/C Ratio     | 0.056 | 0.025 | 0.735 | 1.22  | 0.301 |
| HCM Control Delay      | 12.3  | 11.1  | 21.1  | 138.6 | 12.6  |
| HCM Lane LOS           | B     | B     | C     | F     | B     |
| HCM 95th-tile Q        | 0.2   | 0.1   | 5.4   | 30.6  | 1.1   |

| Intersection             |      |      |      |      |      |      |
|--------------------------|------|------|------|------|------|------|
| Int Delay, s/veh         | 1.5  |      |      |      |      |      |
| Movement                 | EBL  | EBT  | WBT  | WBR  | SBL  | SBR  |
| Lane Configurations      |      | ↕    | ↕    |      | ↕    |      |
| Traffic Vol, veh/h       | 100  | 110  | 720  | 10   | 10   | 10   |
| Future Vol, veh/h        | 100  | 110  | 720  | 10   | 10   | 10   |
| Conflicting Peds, #/hr   | 0    | 0    | 0    | 0    | 0    | 0    |
| Sign Control             | Free | Free | Free | Free | Stop | Stop |
| RT Channelized           | -    | None | -    | None | -    | None |
| Storage Length           | -    | -    | -    | -    | 0    | -    |
| Veh in Median Storage, # | -    | 0    | 0    | -    | 0    | -    |
| Grade, %                 | -    | 0    | 0    | -    | 0    | -    |
| Peak Hour Factor         | 86   | 86   | 86   | 86   | 86   | 86   |
| Heavy Vehicles, %        | 3    | 3    | 0    | 0    | 8    | 8    |
| Mvmt Flow                | 116  | 128  | 837  | 12   | 12   | 12   |

| Major/Minor          | Major1 | Major2 | Minor2 |   |             |
|----------------------|--------|--------|--------|---|-------------|
| Conflicting Flow All | 849    | 0      | -      | 0 | 1203 843    |
| Stage 1              | -      | -      | -      | - | 843 -       |
| Stage 2              | -      | -      | -      | - | 360 -       |
| Critical Hdwy        | 4.13   | -      | -      | - | 6.48 6.28   |
| Critical Hdwy Stg 1  | -      | -      | -      | - | 5.48 -      |
| Critical Hdwy Stg 2  | -      | -      | -      | - | 5.48 -      |
| Follow-up Hdwy       | 2.227  | -      | -      | - | 3.572 3.372 |
| Pot Cap-1 Maneuver   | 785    | -      | -      | - | 198 355     |
| Stage 1              | -      | -      | -      | - | 412 -       |
| Stage 2              | -      | -      | -      | - | 693 -       |
| Platoon blocked, %   |        | -      | -      | - |             |
| Mov Cap-1 Maneuver   | 785    | -      | -      | - | 167 355     |
| Mov Cap-2 Maneuver   | -      | -      | -      | - | 167 -       |
| Stage 1              | -      | -      | -      | - | 346 -       |
| Stage 2              | -      | -      | -      | - | 693 -       |

| Approach             | EB  | WB | SB   |
|----------------------|-----|----|------|
| HCM Control Delay, s | 4.9 | 0  | 22.7 |
| HCM LOS              |     |    | C    |

| Minor Lane/Major Mvmt | EBL   | EBT | WBT | WBR | SBLn1 |
|-----------------------|-------|-----|-----|-----|-------|
| Capacity (veh/h)      | 785   | -   | -   | -   | 227   |
| HCM Lane V/C Ratio    | 0.148 | -   | -   | -   | 0.102 |
| HCM Control Delay (s) | 10.4  | 0   | -   | -   | 22.7  |
| HCM Lane LOS          | B     | A   | -   | -   | C     |
| HCM 95th %tile Q(veh) | 0.5   | -   | -   | -   | 0.3   |



| Intersection              |      |
|---------------------------|------|
| Intersection Delay, s/veh | 32.8 |
| Intersection LOS          | D    |

| Movement            | EBL  | EBT  | EBR  | WBL  | WBT  | WBR  | NBL  | NBT  | NBR  | SBL  | SBT  | SBR  |
|---------------------|------|------|------|------|------|------|------|------|------|------|------|------|
| Lane Configurations |      | ↕    |      |      | ↕    |      |      | ↕    |      |      | ↕    |      |
| Traffic Vol, veh/h  | 110  | 10   | 10   | 10   | 10   | 10   | 10   | 10   | 10   | 10   | 10   | 720  |
| Future Vol, veh/h   | 110  | 10   | 10   | 10   | 10   | 10   | 10   | 10   | 10   | 10   | 10   | 720  |
| Peak Hour Factor    | 0.85 | 0.85 | 0.85 | 0.85 | 0.85 | 0.85 | 0.85 | 0.85 | 0.85 | 0.85 | 0.85 | 0.85 |
| Heavy Vehicles, %   | 2    | 2    | 2    | 2    | 2    | 2    | 0    | 0    | 0    | 0    | 0    | 0    |
| Mvmt Flow           | 129  | 12   | 12   | 12   | 12   | 12   | 12   | 12   | 12   | 12   | 12   | 847  |
| Number of Lanes     | 0    | 1    | 0    | 0    | 1    | 0    | 0    | 1    | 0    | 0    | 1    | 0    |

| Approach                   | EB   | WB  | NB  | SB   |
|----------------------------|------|-----|-----|------|
| Opposing Approach          | WB   | EB  | SB  | NB   |
| Opposing Lanes             | 1    | 1   | 1   | 1    |
| Conflicting Approach Left  | SB   | NB  | EB  | WB   |
| Conflicting Lanes Left     | 1    | 1   | 1   | 1    |
| Conflicting Approach Right | NB   | SB  | WB  | EB   |
| Conflicting Lanes Right    | 1    | 1   | 1   | 1    |
| HCM Control Delay          | 11.2 | 9.4 | 8.6 | 38.5 |
| HCM LOS                    | B    | A   | A   | E    |

| Lane                   | NBLn1 | EBLn1 | WBLn1 | SBLn1 |
|------------------------|-------|-------|-------|-------|
| Vol Left, %            | 33%   | 85%   | 33%   | 1%    |
| Vol Thru, %            | 33%   | 8%    | 33%   | 1%    |
| Vol Right, %           | 33%   | 8%    | 33%   | 97%   |
| Sign Control           | Stop  | Stop  | Stop  | Stop  |
| Traffic Vol by Lane    | 30    | 130   | 30    | 740   |
| LT Vol                 | 10    | 110   | 10    | 10    |
| Through Vol            | 10    | 10    | 10    | 10    |
| RT Vol                 | 10    | 10    | 10    | 720   |
| Lane Flow Rate         | 35    | 153   | 35    | 871   |
| Geometry Grp           | 1     | 1     | 1     | 1     |
| Degree of Util (X)     | 0.052 | 0.258 | 0.059 | 0.95  |
| Departure Headway (Hd) | 5.312 | 6.065 | 6.059 | 3.929 |
| Convergence, Y/N       | Yes   | Yes   | Yes   | Yes   |
| Cap                    | 678   | 595   | 594   | 914   |
| Service Time           | 3.312 | 4.067 | 4.068 | 1.977 |
| HCM Lane V/C Ratio     | 0.052 | 0.257 | 0.059 | 0.953 |
| HCM Control Delay      | 8.6   | 11.2  | 9.4   | 38.5  |
| HCM Lane LOS           | A     | B     | A     | E     |
| HCM 95th-tile Q        | 0.2   | 1     | 0.2   | 15.4  |

HCM 2010 Signalized Intersection Summary  
 46: General Jim Moore Boulevard & Normandy Road

Existing with Project, AM  
 06/11/2019



| Movement                      | EBL  | EBT  | EBR  | WBL  | WBT  | WBR  | NBL  | NBT  | NBR  | SBL  | SBT  | SBR  |
|-------------------------------|------|------|------|------|------|------|------|------|------|------|------|------|
| Lane Configurations           |      | ↕    |      |      | ↕    |      | ↕    | ↕↕   |      | ↕    | ↕↕   | ↕    |
| Traffic Volume (veh/h)        | 70   | 80   | 120  | 150  | 70   | 40   | 130  | 370  | 110  | 80   | 790  | 150  |
| Future Volume (veh/h)         | 70   | 80   | 120  | 150  | 70   | 40   | 130  | 370  | 110  | 80   | 790  | 150  |
| Number                        | 3    | 8    | 18   | 7    | 4    | 14   | 1    | 6    | 16   | 5    | 2    | 12   |
| Initial Q (Qb), veh           | 0    | 0    | 0    | 0    | 0    | 0    | 0    | 0    | 0    | 0    | 0    | 0    |
| Ped-Bike Adj(A_pbT)           | 0.99 |      | 0.98 | 0.99 |      | 0.98 | 1.00 |      | 0.98 | 1.00 |      | 0.99 |
| Parking Bus, Adj              | 1.00 | 1.00 | 1.00 | 1.00 | 1.00 | 1.00 | 1.00 | 1.00 | 1.00 | 1.00 | 1.00 | 1.00 |
| Adj Sat Flow, veh/h/ln        | 1900 | 1881 | 1900 | 1900 | 1863 | 1900 | 1881 | 1881 | 1900 | 1863 | 1863 | 1863 |
| Adj Flow Rate, veh/h          | 90   | 103  | 125  | 192  | 90   | 47   | 167  | 474  | 114  | 103  | 1013 | 123  |
| Adj No. of Lanes              | 0    | 1    | 0    | 0    | 1    | 0    | 1    | 2    | 0    | 1    | 2    | 1    |
| Peak Hour Factor              | 0.78 | 0.78 | 0.78 | 0.78 | 0.78 | 0.78 | 0.78 | 0.78 | 0.78 | 0.78 | 0.78 | 0.78 |
| Percent Heavy Veh, %          | 1    | 1    | 1    | 2    | 2    | 2    | 1    | 1    | 1    | 2    | 2    | 2    |
| Cap, veh/h                    | 197  | 225  | 228  | 340  | 152  | 68   | 207  | 613  | 146  | 389  | 1128 | 499  |
| Arrive On Green               | 0.36 | 0.36 | 0.36 | 0.36 | 0.36 | 0.36 | 0.12 | 0.21 | 0.21 | 0.22 | 0.32 | 0.32 |
| Sat Flow, veh/h               | 353  | 626  | 634  | 702  | 423  | 187  | 1792 | 2853 | 681  | 1774 | 3539 | 1566 |
| Grp Volume(v), veh/h          | 318  | 0    | 0    | 329  | 0    | 0    | 167  | 296  | 292  | 103  | 1013 | 123  |
| Grp Sat Flow(s),veh/h/ln      | 1613 | 0    | 0    | 1312 | 0    | 0    | 1792 | 1787 | 1748 | 1774 | 1770 | 1566 |
| Q Serve(g_s), s               | 0.0  | 0.0  | 0.0  | 4.4  | 0.0  | 0.0  | 6.0  | 10.2 | 10.4 | 3.2  | 18.0 | 3.8  |
| Cycle Q Clear(g_c), s         | 9.8  | 0.0  | 0.0  | 14.2 | 0.0  | 0.0  | 6.0  | 10.2 | 10.4 | 3.2  | 18.0 | 3.8  |
| Prop In Lane                  | 0.28 |      | 0.39 | 0.58 |      | 0.14 | 1.00 |      | 0.39 | 1.00 |      | 1.00 |
| Lane Grp Cap(c), veh/h        | 651  | 0    | 0    | 559  | 0    | 0    | 207  | 384  | 376  | 389  | 1128 | 499  |
| V/C Ratio(X)                  | 0.49 | 0.00 | 0.00 | 0.59 | 0.00 | 0.00 | 0.81 | 0.77 | 0.78 | 0.26 | 0.90 | 0.25 |
| Avail Cap(c_a), veh/h         | 869  | 0    | 0    | 747  | 0    | 0    | 218  | 693  | 678  | 389  | 1373 | 607  |
| HCM Platoon Ratio             | 1.00 | 1.00 | 1.00 | 1.00 | 1.00 | 1.00 | 1.00 | 1.00 | 1.00 | 1.00 | 1.00 | 1.00 |
| Upstream Filter(I)            | 1.00 | 0.00 | 0.00 | 1.00 | 0.00 | 0.00 | 1.00 | 1.00 | 1.00 | 1.00 | 1.00 | 1.00 |
| Uniform Delay (d), s/veh      | 16.5 | 0.0  | 0.0  | 17.9 | 0.0  | 0.0  | 28.4 | 24.3 | 24.3 | 21.3 | 21.4 | 16.6 |
| Incr Delay (d2), s/veh        | 0.2  | 0.0  | 0.0  | 0.4  | 0.0  | 0.0  | 17.2 | 1.2  | 1.3  | 0.1  | 6.4  | 0.1  |
| Initial Q Delay(d3),s/veh     | 0.0  | 0.0  | 0.0  | 0.0  | 0.0  | 0.0  | 0.0  | 0.0  | 0.0  | 0.0  | 0.0  | 0.0  |
| %ile BackOfQ(50%),veh/ln      | 4.5  | 0.0  | 0.0  | 5.1  | 0.0  | 0.0  | 4.0  | 5.1  | 5.1  | 1.6  | 9.7  | 1.7  |
| LnGrp Delay(d),s/veh          | 16.7 | 0.0  | 0.0  | 18.2 | 0.0  | 0.0  | 45.6 | 25.5 | 25.7 | 21.4 | 27.8 | 16.6 |
| LnGrp LOS                     | B    |      |      | B    |      |      | D    | C    | C    | C    | C    | B    |
| Approach Vol, veh/h           |      | 318  |      |      | 329  |      |      | 755  |      |      | 1239 |      |
| Approach Delay, s/veh         |      | 16.7 |      |      | 18.2 |      |      | 30.0 |      |      | 26.1 |      |
| Approach LOS                  |      | B    |      |      | B    |      |      | C    |      |      | C    |      |
| Timer                         | 1    | 2    | 3    | 4    | 5    | 6    | 7    | 8    |      |      |      |      |
| Assigned Phs                  | 1    | 2    |      | 4    | 5    | 6    |      | 8    |      |      |      |      |
| Phs Duration (G+Y+Rc), s      | 2.1  | 25.5 |      | 28.2 | 18.9 | 18.6 |      | 28.2 |      |      |      |      |
| Change Period (Y+Rc), s       | 4.5  | 4.5  |      | 4.5  | 4.5  | 4.5  |      | 4.5  |      |      |      |      |
| Max Green Setting (Gmax), s   | 30.0 | 25.5 |      | 33.0 | 8.0  | 25.5 |      | 33.0 |      |      |      |      |
| Max Q Clear Time (g_c+1/3), s | 10.0 | 20.0 |      | 16.2 | 5.2  | 12.4 |      | 11.8 |      |      |      |      |
| Green Ext Time (p_c), s       | 0.0  | 1.0  |      | 0.5  | 0.0  | 0.5  |      | 0.5  |      |      |      |      |
| <b>Intersection Summary</b>   |      |      |      |      |      |      |      |      |      |      |      |      |
| HCM 2010 Ctrl Delay           |      |      |      | 25.1 |      |      |      |      |      |      |      |      |
| HCM 2010 LOS                  |      |      |      | C    |      |      |      |      |      |      |      |      |

| Intersection              |       |
|---------------------------|-------|
| Intersection Delay, s/veh | 103.2 |
| Intersection LOS          | F     |

| Movement            | EBL  | EBR  | NBL  | NBT  | SBT  | SBR  |
|---------------------|------|------|------|------|------|------|
| Lane Configurations |      |      |      |      |      |      |
| Traffic Vol, veh/h  | 120  | 430  | 230  | 370  | 900  | 140  |
| Future Vol, veh/h   | 120  | 430  | 230  | 370  | 900  | 140  |
| Peak Hour Factor    | 0.90 | 0.90 | 0.90 | 0.90 | 0.90 | 0.90 |
| Heavy Vehicles, %   | 1    | 1    | 1    | 1    | 2    | 2    |
| Mvmt Flow           | 133  | 478  | 256  | 411  | 1000 | 156  |
| Number of Lanes     | 1    | 1    | 1    | 2    | 2    | 1    |

| Approach                   | EB    | NB   | SB    |
|----------------------------|-------|------|-------|
| Opposing Approach          |       | SB   | NB    |
| Opposing Lanes             | 0     | 3    | 3     |
| Conflicting Approach Left  | SB    |      |       |
| Conflicting Lanes Left     | 3     | 2    | 0     |
| Conflicting Approach Right | NB    |      | EB    |
| Conflicting Lanes Right    | 3     | 0    | 2     |
| HCM Control Delay          | 124.3 | 27.2 | 135.9 |
| HCM LOS                    | F     | D    | F     |

| Lane                   | NBLn1  | NBLn2  | NBLn3 | EBLn1 | EBLn2 | SBLn1 | SBLn2 | SBLn3 |
|------------------------|--------|--------|-------|-------|-------|-------|-------|-------|
| Vol Left, %            | 100%   | 0%     | 0%    | 100%  | 0%    | 0%    | 0%    | 0%    |
| Vol Thru, %            | 0%     | 100%   | 100%  | 0%    | 0%    | 100%  | 100%  | 0%    |
| Vol Right, %           | 0%     | 0%     | 0%    | 0%    | 100%  | 0%    | 0%    | 100%  |
| Sign Control           | Stop   | Stop   | Stop  | Stop  | Stop  | Stop  | Stop  | Stop  |
| Traffic Vol by Lane    | 230    | 185    | 185   | 120   | 430   | 450   | 450   | 140   |
| LT Vol                 | 230    | 0      | 0     | 120   | 0     | 0     | 0     | 0     |
| Through Vol            | 0      | 185    | 185   | 0     | 0     | 450   | 450   | 0     |
| RT Vol                 | 0      | 0      | 0     | 0     | 430   | 0     | 0     | 140   |
| Lane Flow Rate         | 256    | 206    | 206   | 133   | 478   | 500   | 500   | 156   |
| Geometry Grp           | 8      | 8      | 8     | 8     | 8     | 8     | 8     | 8     |
| Degree of Util (X)     | 0.702  | 0.537  | 0.439 | 0.387 | 1.227 | 1.235 | 1.235 | 0.279 |
| Departure Headway (Hd) | 11.131 | 10.607 | 8.806 | 11.06 | 9.84  | 9.546 | 9.546 | 6.996 |
| Convergence, Y/N       | Yes    | Yes    | Yes   | Yes   | Yes   | Yes   | Yes   | Yes   |
| Cap                    | 327    | 343    | 411   | 328   | 373   | 385   | 385   | 516   |
| Service Time           | 8.831  | 8.307  | 6.506 | 8.76  | 7.54  | 7.246 | 7.246 | 4.696 |
| HCM Lane V/C Ratio     | 0.783  | 0.601  | 0.501 | 0.405 | 1.282 | 1.299 | 1.299 | 0.302 |
| HCM Control Delay      | 36.3   | 25     | 18.2  | 20.6  | 153.3 | 155.1 | 155.1 | 12.4  |
| HCM Lane LOS           | E      | C      | C     | C     | F     | F     | F     | B     |
| HCM 95th-tile Q        | 5      | 3      | 2.2   | 1.8   | 19.2  | 19.9  | 19.9  | 1.1   |



| Movement                      | EBL  | EBT  | EBR  | WBL   | WBT   | WBR   | NBL  | NBT  | NBR  | SBL  | SBT  | SBR  |
|-------------------------------|------|------|------|-------|-------|-------|------|------|------|------|------|------|
| Lane Configurations           |      |      |      |       |       |       |      |      |      |      |      |      |
| Traffic Volume (veh/h)        | 70   | 140  | 100  | 120   | 280   | 20    | 200  | 520  | 140  | 100  | 820  | 160  |
| Future Volume (veh/h)         | 70   | 140  | 100  | 120   | 280   | 20    | 200  | 520  | 140  | 100  | 820  | 160  |
| Number                        | 7    | 4    | 14   | 3     | 8     | 18    | 5    | 2    | 12   | 1    | 6    | 16   |
| Initial Q (Qb), veh           | 0    | 0    | 0    | 0     | 0     | 0     | 0    | 0    | 0    | 0    | 0    | 0    |
| Ped-Bike Adj(A_pbT)           | 1.00 |      | 0.96 | 1.00  |       | 0.97  | 1.00 |      | 0.98 | 1.00 |      | 0.98 |
| Parking Bus, Adj              | 1.00 | 1.00 | 1.00 | 1.00  | 1.00  | 1.00  | 1.00 | 1.00 | 1.00 | 1.00 | 1.00 | 1.00 |
| Adj Sat Flow, veh/h/ln        | 1845 | 1845 | 1845 | 1900  | 1881  | 1900  | 1827 | 1827 | 1900 | 1827 | 1827 | 1827 |
| Adj Flow Rate, veh/h          | 77   | 154  | 21   | 132   | 308   | 20    | 220  | 571  | 139  | 110  | 901  | 109  |
| Adj No. of Lanes              | 1    | 1    | 1    | 0     | 1     | 0     | 1    | 2    | 0    | 1    | 2    | 1    |
| Peak Hour Factor              | 0.91 | 0.91 | 0.91 | 0.91  | 0.91  | 0.91  | 0.91 | 0.91 | 0.91 | 0.91 | 0.91 | 0.91 |
| Percent Heavy Veh, %          | 3    | 3    | 3    | 1     | 1     | 1     | 4    | 4    | 4    | 4    | 4    | 4    |
| Cap, veh/h                    | 234  | 245  | 200  | 118   | 276   | 18    | 394  | 1137 | 276  | 134  | 880  | 388  |
| Arrive On Green               | 0.13 | 0.13 | 0.13 | 0.22  | 0.22  | 0.22  | 0.23 | 0.41 | 0.41 | 0.08 | 0.25 | 0.25 |
| Sat Flow, veh/h               | 1757 | 1845 | 1502 | 527   | 1230  | 80    | 1740 | 2762 | 670  | 1740 | 3471 | 1529 |
| Grp Volume(v), veh/h          | 77   | 154  | 21   | 460   | 0     | 0     | 220  | 358  | 352  | 110  | 901  | 109  |
| Grp Sat Flow(s),veh/h/ln      | 1757 | 1845 | 1502 | 1838  | 0     | 0     | 1740 | 1736 | 1696 | 1740 | 1736 | 1529 |
| Q Serve(g_s), s               | 5.0  | 9.9  | 1.5  | 28.0  | 0.0   | 0.0   | 14.0 | 19.1 | 19.3 | 7.8  | 31.7 | 7.2  |
| Cycle Q Clear(g_c), s         | 5.0  | 9.9  | 1.5  | 28.0  | 0.0   | 0.0   | 14.0 | 19.1 | 19.3 | 7.8  | 31.7 | 7.2  |
| Prop In Lane                  | 1.00 |      | 1.00 | 0.29  |       | 0.04  | 1.00 |      | 0.40 | 1.00 |      | 1.00 |
| Lane Grp Cap(c), veh/h        | 234  | 245  | 200  | 412   | 0     | 0     | 394  | 714  | 698  | 134  | 880  | 388  |
| V/C Ratio(X)                  | 0.33 | 0.63 | 0.11 | 1.12  | 0.00  | 0.00  | 0.56 | 0.50 | 0.50 | 0.82 | 1.02 | 0.28 |
| Avail Cap(c_a), veh/h         | 436  | 457  | 372  | 412   | 0     | 0     | 394  | 714  | 698  | 209  | 880  | 388  |
| HCM Platoon Ratio             | 1.00 | 1.00 | 1.00 | 1.00  | 1.00  | 1.00  | 1.00 | 1.00 | 1.00 | 1.00 | 1.00 | 1.00 |
| Upstream Filter(I)            | 0.77 | 0.77 | 0.77 | 1.00  | 0.00  | 0.00  | 1.00 | 1.00 | 1.00 | 1.00 | 1.00 | 1.00 |
| Uniform Delay (d), s/veh      | 49.1 | 51.3 | 47.6 | 48.5  | 0.0   | 0.0   | 42.8 | 27.3 | 27.3 | 56.8 | 46.7 | 37.5 |
| Incr Delay (d2), s/veh        | 0.6  | 2.0  | 0.2  | 80.3  | 0.0   | 0.0   | 1.1  | 2.5  | 2.6  | 7.3  | 36.4 | 1.8  |
| Initial Q Delay(d3),s/veh     | 0.0  | 0.0  | 0.0  | 0.0   | 0.0   | 0.0   | 0.0  | 0.0  | 0.0  | 0.0  | 0.0  | 0.0  |
| %ile BackOfQ(50%),veh/ln      | 2.5  | 5.2  | 0.6  | 23.4  | 0.0   | 0.0   | 6.8  | 9.7  | 9.5  | 4.0  | 19.6 | 3.2  |
| LnGrp Delay(d),s/veh          | 49.8 | 53.3 | 47.8 | 128.8 | 0.0   | 0.0   | 43.9 | 29.8 | 29.9 | 64.2 | 83.1 | 39.3 |
| LnGrp LOS                     | D    | D    | D    | F     |       |       | D    | C    | C    | E    | F    | D    |
| Approach Vol, veh/h           |      | 252  |      |       | 460   |       |      | 930  |      |      | 1120 |      |
| Approach Delay, s/veh         |      | 51.8 |      |       | 128.8 |       |      | 33.2 |      |      | 77.0 |      |
| Approach LOS                  |      | D    |      |       | F     |       |      | C    |      |      | E    |      |
| Timer                         | 1    | 2    | 3    | 4     | 5     | 6     | 7    | 8    |      |      |      |      |
| Assigned Phs                  | 1    | 2    |      | 4     | 5     | 6     |      | 8    |      |      |      |      |
| Phs Duration (G+Y+Rc), s      | 3.8  | 56.7 |      | 21.3  | 33.6  | 37.0  |      | 33.1 |      |      |      |      |
| Change Period (Y+Rc), s       | 4.2  | 5.3  |      | * 4.7 | 5.3   | * 5.3 |      | 5.1  |      |      |      |      |
| Max Green Setting (Gmax), s   | 15   | 31.7 |      | * 31  | 15.0  | * 32  |      | 28.0 |      |      |      |      |
| Max Q Clear Time (g_c+1/9), s | 19.8 | 21.3 |      | 11.9  | 16.0  | 33.7  |      | 30.0 |      |      |      |      |
| Green Ext Time (p_c), s       | 0.1  | 2.7  |      | 1.0   | 0.0   | 0.0   |      | 0.0  |      |      |      |      |

Intersection Summary

|                     |      |
|---------------------|------|
| HCM 2010 Ctrl Delay | 68.5 |
| HCM 2010 LOS        | E    |

Notes



| Movement                     | EBL  | EBT  | EBR  | WBL   | WBT  | WBR   | NBL  | NBT   | NBR  | SBL  | SBT  | SBR  |
|------------------------------|------|------|------|-------|------|-------|------|-------|------|------|------|------|
| Lane Configurations          |      | ↕↕   | ↗    | ↖     |      | ↗     |      | ↕     | ↗    |      | ↕    |      |
| Traffic Volume (veh/h)       | 10   | 200  | 110  | 230   | 0    | 420   | 0    | 50    | 110  | 10   | 10   | 0    |
| Future Volume (veh/h)        | 10   | 200  | 110  | 230   | 0    | 420   | 0    | 50    | 110  | 10   | 10   | 0    |
| Number                       | 1    | 6    | 16   | 5     | 2    | 12    | 7    | 4     | 14   | 3    | 8    | 18   |
| Initial Q (Qb), veh          | 0    | 0    | 0    | 0     | 0    | 0     | 0    | 0     | 0    | 0    | 0    | 0    |
| Ped-Bike Adj(A_pbT)          | 1.00 |      | 1.00 | 1.00  |      | 1.00  | 1.00 |       | 1.00 | 1.00 |      | 1.00 |
| Parking Bus, Adj             | 1.00 | 1.00 | 1.00 | 1.00  | 1.00 | 1.00  | 1.00 | 1.00  | 1.00 | 1.00 | 1.00 | 1.00 |
| Adj Sat Flow, veh/h/ln       | 1900 | 1845 | 1845 | 1863  | 0    | 1863  | 0    | 1845  | 1845 | 1900 | 1900 | 0    |
| Adj Flow Rate, veh/h         | 10   | 206  | 19   | 237   | 0    | 294   | 0    | 52    | 10   | 10   | 10   | 0    |
| Adj No. of Lanes             | 0    | 2    | 1    | 1     | 0    | 1     | 0    | 1     | 1    | 0    | 1    | 0    |
| Peak Hour Factor             | 0.97 | 0.97 | 0.97 | 0.97  | 0.97 | 0.97  | 0.97 | 0.97  | 0.97 | 0.97 | 0.97 | 0.97 |
| Percent Heavy Veh, %         | 3    | 3    | 3    | 2     | 0    | 2     | 0    | 3     | 3    | 0    | 0    | 0    |
| Cap, veh/h                   | 137  | 2951 | 1347 | 0     | 0    | 0     | 0    | 117   | 100  | 72   | 57   | 0    |
| Arrive On Green              | 0.86 | 0.86 | 0.86 | 0.00  | 0.00 | 0.00  | 0.00 | 0.06  | 0.06 | 0.06 | 0.06 | 0.00 |
| Sat Flow, veh/h              | 159  | 3430 | 1566 |       |      |       | 0    | 1845  | 1568 | 455  | 902  | 0    |
| Grp Volume(v), veh/h         | 116  | 100  | 19   |       | 0.0  |       | 0    | 52    | 10   | 20   | 0    | 0    |
| Grp Sat Flow(s),veh/h/ln     | 1837 | 1752 | 1566 |       |      |       | 0    | 1845  | 1568 | 1357 | 0    | 0    |
| Q Serve(g_s), s              | 1.2  | 1.1  | 0.2  |       |      |       | 0.0  | 3.4   | 0.8  | 0.0  | 0.0  | 0.0  |
| Cycle Q Clear(g_c), s        | 1.2  | 1.1  | 0.2  |       |      |       | 0.0  | 3.4   | 0.8  | 3.4  | 0.0  | 0.0  |
| Prop In Lane                 | 0.09 |      | 1.00 |       |      |       | 0.00 |       | 1.00 | 0.50 |      | 0.00 |
| Lane Grp Cap(c), veh/h       | 1580 | 1508 | 1347 |       |      |       | 0    | 117   | 100  | 130  | 0    | 0    |
| V/C Ratio(X)                 | 0.07 | 0.07 | 0.01 |       |      |       | 0.00 | 0.44  | 0.10 | 0.15 | 0.00 | 0.00 |
| Avail Cap(c_a), veh/h        | 1580 | 1508 | 1347 |       |      |       | 0    | 148   | 125  | 155  | 0    | 0    |
| HCM Platoon Ratio            | 1.00 | 1.00 | 1.00 |       |      |       | 1.00 | 1.00  | 1.00 | 1.00 | 1.00 | 1.00 |
| Upstream Filter(I)           | 1.00 | 1.00 | 1.00 |       |      |       | 0.00 | 1.00  | 1.00 | 1.00 | 0.00 | 0.00 |
| Uniform Delay (d), s/veh     | 1.3  | 1.3  | 1.2  |       |      |       | 0.0  | 56.4  | 55.2 | 55.4 | 0.0  | 0.0  |
| Incr Delay (d2), s/veh       | 0.0  | 0.0  | 0.0  |       |      |       | 0.0  | 1.0   | 0.2  | 0.2  | 0.0  | 0.0  |
| Initial Q Delay(d3),s/veh    | 0.0  | 0.0  | 0.0  |       |      |       | 0.0  | 0.0   | 0.0  | 0.0  | 0.0  | 0.0  |
| %ile BackOfQ(50%),veh/ln     | 0.6  | 0.5  | 0.1  |       |      |       | 0.0  | 1.8   | 0.3  | 0.7  | 0.0  | 0.0  |
| LnGrp Delay(d),s/veh         | 1.3  | 1.3  | 1.2  |       |      |       | 0.0  | 57.4  | 55.3 | 55.6 | 0.0  | 0.0  |
| LnGrp LOS                    | A    | A    | A    |       |      |       |      | E     | E    | E    |      |      |
| Approach Vol, veh/h          |      | 235  |      |       |      |       |      | 62    |      |      | 20   |      |
| Approach Delay, s/veh        |      | 1.3  |      |       |      |       |      | 57.0  |      |      | 55.6 |      |
| Approach LOS                 |      | A    |      |       |      |       |      | E     |      |      | E    |      |
| Timer                        | 1    | 2    | 3    | 4     | 5    | 6     | 7    | 8     |      |      |      |      |
| Assigned Phs                 |      |      |      | 4     |      | 6     |      | 8     |      |      |      |      |
| Phs Duration (G+Y+Rc), s     |      |      |      | 12.2  |      | 112.8 |      | 12.2  |      |      |      |      |
| Change Period (Y+Rc), s      |      |      |      | * 4.2 |      | 5.3   |      | * 4.2 |      |      |      |      |
| Max Green Setting (Gmax), s  |      |      |      | * 10  |      | 21.0  |      | * 10  |      |      |      |      |
| Max Q Clear Time (g_c+I1), s |      |      |      | 5.4   |      | 3.2   |      | 5.4   |      |      |      |      |
| Green Ext Time (p_c), s      |      |      |      | 0.0   |      | 0.7   |      | 0.0   |      |      |      |      |
| <b>Intersection Summary</b>  |      |      |      |       |      |       |      |       |      |      |      |      |
| HCM 2010 Ctrl Delay          |      |      | 15.6 |       |      |       |      |       |      |      |      |      |
| HCM 2010 LOS                 |      |      | B    |       |      |       |      |       |      |      |      |      |
| <b>Notes</b>                 |      |      |      |       |      |       |      |       |      |      |      |      |

HCM 2010 Signalized Intersection Summary  
 50: Reservation Road & SR 68 WB On Ramp/SR 68 WB Off Ramp

Existing with Project, AM  
 06/11/2019























| Movement                    | EBL  | EBT  | EBR | WBL  | WBT  | WBR  | NBL  | NBT  | NBR  | SBL  | SBT  | SBR  |
|-----------------------------|------|------|-----|------|------|------|------|------|------|------|------|------|
| Lane Configurations         |      |      |     |      | ↕    | ↕    | ↕    | ↕    |      |      | ↕    |      |
| Traffic Volume (veh/h)      | 0    | 0    | 0   | 250  | 10   | 300  | 130  | 370  | 0    | 0    | 340  | 110  |
| Future Volume (veh/h)       | 0    | 0    | 0   | 250  | 10   | 300  | 130  | 370  | 0    | 0    | 340  | 110  |
| Number                      |      |      |     | 7    | 4    | 14   | 1    | 6    | 16   | 5    | 2    | 12   |
| Initial Q (Qb), veh         |      |      |     | 0    | 0    | 0    | 0    | 0    | 0    | 0    | 0    | 0    |
| Ped-Bike Adj(A_pbT)         |      |      |     | 1.00 |      | 1.00 | 1.00 |      | 1.00 | 1.00 |      | 1.00 |
| Parking Bus, Adj            |      |      |     | 1.00 | 1.00 | 1.00 | 1.00 | 1.00 | 1.00 | 1.00 | 1.00 | 1.00 |
| Adj Sat Flow, veh/h/ln      |      |      |     | 1900 | 1827 | 1827 | 1863 | 1863 | 0    | 0    | 1827 | 1900 |
| Adj Flow Rate, veh/h        |      |      |     | 263  | 11   | 64   | 137  | 389  | 0    | 0    | 358  | 107  |
| Adj No. of Lanes            |      |      |     | 0    | 1    | 1    | 1    | 1    | 0    | 0    | 1    | 0    |
| Peak Hour Factor            |      |      |     | 0.95 | 0.95 | 0.95 | 0.95 | 0.95 | 0.95 | 0.95 | 0.95 | 0.95 |
| Percent Heavy Veh, %        |      |      |     | 4    | 4    | 4    | 2    | 2    | 0    | 0    | 4    | 4    |
| Cap, veh/h                  |      |      |     | 377  | 16   | 350  | 222  | 1003 | 0    | 0    | 456  | 136  |
| Arrive On Green             |      |      |     | 0.23 | 0.23 | 0.23 | 0.13 | 0.54 | 0.00 | 0.00 | 0.34 | 0.34 |
| Sat Flow, veh/h             |      |      |     | 1673 | 70   | 1553 | 1774 | 1863 | 0    | 0    | 1352 | 404  |
| Grp Volume(v), veh/h        |      |      |     | 274  | 0    | 64   | 137  | 389  | 0    | 0    | 0    | 465  |
| Grp Sat Flow(s),veh/h/ln    |      |      |     | 1743 | 0    | 1553 | 1774 | 1863 | 0    | 0    | 0    | 1756 |
| Q Serve(g_s), s             |      |      |     | 6.7  | 0.0  | 1.5  | 3.4  | 5.6  | 0.0  | 0.0  | 0.0  | 11.0 |
| Cycle Q Clear(g_c), s       |      |      |     | 6.7  | 0.0  | 1.5  | 3.4  | 5.6  | 0.0  | 0.0  | 0.0  | 11.0 |
| Prop In Lane                |      |      |     | 0.96 |      | 1.00 | 1.00 |      | 0.00 | 0.00 |      | 0.23 |
| Lane Grp Cap(c), veh/h      |      |      |     | 393  | 0    | 350  | 222  | 1003 | 0    | 0    | 0    | 592  |
| V/C Ratio(X)                |      |      |     | 0.70 | 0.00 | 0.18 | 0.62 | 0.39 | 0.00 | 0.00 | 0.00 | 0.79 |
| Avail Cap(c_a), veh/h       |      |      |     | 1509 | 0    | 1344 | 998  | 1532 | 0    | 0    | 0    | 1444 |
| HCM Platoon Ratio           |      |      |     | 1.00 | 1.00 | 1.00 | 1.00 | 1.00 | 1.00 | 1.00 | 1.00 | 1.00 |
| Upstream Filter(I)          |      |      |     | 1.00 | 0.00 | 1.00 | 1.00 | 1.00 | 0.00 | 0.00 | 0.00 | 1.00 |
| Uniform Delay (d), s/veh    |      |      |     | 16.4 | 0.0  | 14.5 | 19.2 | 6.2  | 0.0  | 0.0  | 0.0  | 13.8 |
| Incr Delay (d2), s/veh      |      |      |     | 2.2  | 0.0  | 0.2  | 1.0  | 0.2  | 0.0  | 0.0  | 0.0  | 2.3  |
| Initial Q Delay(d3),s/veh   |      |      |     | 0.0  | 0.0  | 0.0  | 0.0  | 0.0  | 0.0  | 0.0  | 0.0  | 0.0  |
| %ile BackOfQ(50%),veh/ln    |      |      |     | 3.4  | 0.0  | 0.7  | 1.7  | 2.9  | 0.0  | 0.0  | 0.0  | 5.7  |
| LnGrp Delay(d),s/veh        |      |      |     | 18.7 | 0.0  | 14.7 | 20.2 | 6.5  | 0.0  | 0.0  | 0.0  | 16.1 |
| LnGrp LOS                   |      |      |     | B    |      | B    | C    | A    |      |      |      | B    |
| Approach Vol, veh/h         |      |      |     |      | 338  |      |      | 526  |      |      | 465  |      |
| Approach Delay, s/veh       |      |      |     |      | 17.9 |      |      | 10.0 |      |      | 16.1 |      |
| Approach LOS                |      |      |     |      | B    |      |      | B    |      |      | B    |      |
| Timer                       | 1    | 2    | 3   | 4    | 5    | 6    | 7    | 8    |      |      |      |      |
| Assigned Phs                | 1    | 2    |     | 4    |      | 6    |      |      |      |      |      |      |
| Phs Duration (G+Y+Rc), s    | 9.3  | 21.6 |     | 15.3 |      | 30.9 |      |      |      |      |      |      |
| Change Period (Y+Rc), s     | 3.5  | 6.0  |     | 4.9  |      | 6.0  |      |      |      |      |      |      |
| Max Green Setting (Gmax), s | 26.0 | 38.0 |     | 40.0 |      | 38.0 |      |      |      |      |      |      |
| Max Q Clear Time (g_c+1), s | 15.4 | 13.0 |     | 8.7  |      | 7.6  |      |      |      |      |      |      |
| Green Ext Time (p_c), s     | 0.1  | 2.6  |     | 1.9  |      | 2.0  |      |      |      |      |      |      |
| <b>Intersection Summary</b> |      |      |     |      |      |      |      |      |      |      |      |      |
| HCM 2010 Ctrl Delay         |      |      |     | 14.2 |      |      |      |      |      |      |      |      |
| HCM 2010 LOS                |      |      |     | B    |      |      |      |      |      |      |      |      |



| Movement                     | EBL  | EBT  | EBR  | WBL | WBT  | WBR  | NBL  | NBT  | NBR  | SBL  | SBT  | SBR  |
|------------------------------|------|------|------|-----|------|------|------|------|------|------|------|------|
| Lane Configurations          |      | ↖    | ↗    |     |      |      |      | ↑    | ↗    | ↖    | ↑    |      |
| Traffic Volume (veh/h)       | 100  | 10   | 110  | 0   | 0    | 0    | 0    | 380  | 670  | 230  | 350  | 0    |
| Future Volume (veh/h)        | 100  | 10   | 110  | 0   | 0    | 0    | 0    | 380  | 670  | 230  | 350  | 0    |
| Number                       | 3    | 8    | 18   |     |      |      | 1    | 6    | 16   | 5    | 2    | 12   |
| Initial Q (Qb), veh          | 0    | 0    | 0    |     |      |      | 0    | 0    | 0    | 0    | 0    | 0    |
| Ped-Bike Adj(A_pbT)          | 1.00 |      | 1.00 |     |      |      | 1.00 |      | 1.00 | 1.00 |      | 1.00 |
| Parking Bus, Adj             | 1.00 | 1.00 | 1.00 |     |      |      | 1.00 | 1.00 | 1.00 | 1.00 | 1.00 | 1.00 |
| Adj Sat Flow, veh/h/ln       | 1900 | 1881 | 1881 |     |      |      | 0    | 1881 | 1881 | 1827 | 1827 | 0    |
| Adj Flow Rate, veh/h         | 109  | 11   | 19   |     |      |      | 0    | 413  | 399  | 250  | 380  | 0    |
| Adj No. of Lanes             | 0    | 1    | 1    |     |      |      | 0    | 1    | 1    | 1    | 1    | 0    |
| Peak Hour Factor             | 0.92 | 0.92 | 0.92 |     |      |      | 0.92 | 0.92 | 0.92 | 0.92 | 0.92 | 0.92 |
| Percent Heavy Veh, %         | 1    | 1    | 1    |     |      |      | 0    | 1    | 1    | 4    | 4    | 0    |
| Cap, veh/h                   | 161  | 16   | 158  |     |      |      | 0    | 665  | 565  | 328  | 1156 | 0    |
| Arrive On Green              | 0.10 | 0.10 | 0.10 |     |      |      | 0.00 | 0.35 | 0.35 | 0.19 | 0.63 | 0.00 |
| Sat Flow, veh/h              | 1635 | 165  | 1599 |     |      |      | 0    | 1881 | 1599 | 1740 | 1827 | 0    |
| Grp Volume(v), veh/h         | 120  | 0    | 19   |     |      |      | 0    | 413  | 399  | 250  | 380  | 0    |
| Grp Sat Flow(s),veh/h/ln     | 1799 | 0    | 1599 |     |      |      | 0    | 1881 | 1599 | 1740 | 1827 | 0    |
| Q Serve(g_s), s              | 2.6  | 0.0  | 0.4  |     |      |      | 0.0  | 7.4  | 8.7  | 5.5  | 3.9  | 0.0  |
| Cycle Q Clear(g_c), s        | 2.6  | 0.0  | 0.4  |     |      |      | 0.0  | 7.4  | 8.7  | 5.5  | 3.9  | 0.0  |
| Prop In Lane                 | 0.91 |      | 1.00 |     |      |      | 0.00 |      | 1.00 | 1.00 |      | 0.00 |
| Lane Grp Cap(c), veh/h       | 177  | 0    | 158  |     |      |      | 0    | 665  | 565  | 328  | 1156 | 0    |
| V/C Ratio(X)                 | 0.68 | 0.00 | 0.12 |     |      |      | 0.00 | 0.62 | 0.71 | 0.76 | 0.33 | 0.00 |
| Avail Cap(c_a), veh/h        | 1774 | 0    | 1577 |     |      |      | 0    | 1716 | 1458 | 1029 | 1666 | 0    |
| HCM Platoon Ratio            | 1.00 | 1.00 | 1.00 |     |      |      | 1.00 | 1.00 | 1.00 | 1.00 | 1.00 | 1.00 |
| Upstream Filter(I)           | 1.00 | 0.00 | 1.00 |     |      |      | 0.00 | 1.00 | 1.00 | 1.00 | 1.00 | 0.00 |
| Uniform Delay (d), s/veh     | 17.7 | 0.0  | 16.7 |     |      |      | 0.0  | 10.9 | 11.3 | 15.6 | 3.5  | 0.0  |
| Incr Delay (d2), s/veh       | 1.7  | 0.0  | 0.1  |     |      |      | 0.0  | 1.0  | 1.6  | 3.7  | 0.2  | 0.0  |
| Initial Q Delay(d3),s/veh    | 0.0  | 0.0  | 0.0  |     |      |      | 0.0  | 0.0  | 0.0  | 0.0  | 0.0  | 0.0  |
| %ile BackOfQ(50%),veh/ln     | 1.4  | 0.0  | 0.2  |     |      |      | 0.0  | 4.0  | 4.0  | 3.0  | 2.0  | 0.0  |
| LnGrp Delay(d),s/veh         | 19.3 | 0.0  | 16.8 |     |      |      | 0.0  | 11.8 | 12.9 | 19.3 | 3.6  | 0.0  |
| LnGrp LOS                    | B    |      | B    |     |      |      |      | B    | B    | B    | A    |      |
| Approach Vol, veh/h          |      | 139  |      |     |      |      |      | 812  |      |      | 630  |      |
| Approach Delay, s/veh        |      | 19.0 |      |     |      |      |      | 12.4 |      |      | 9.8  |      |
| Approach LOS                 |      | B    |      |     |      |      |      | B    |      |      | A    |      |
| Timer                        | 1    | 2    | 3    | 4   | 5    | 6    | 7    | 8    |      |      |      |      |
| Assigned Phs                 |      | 2    |      |     | 5    | 6    |      | 8    |      |      |      |      |
| Phs Duration (G+Y+Rc), s     |      | 31.7 |      |     | 11.3 | 20.3 |      | 8.9  |      |      |      |      |
| Change Period (Y+Rc), s      |      | 6.0  |      |     | 3.7  | 6.0  |      | 4.9  |      |      |      |      |
| Max Green Setting (Gmax), s  |      | 37.0 |      |     | 24.0 | 37.0 |      | 40.0 |      |      |      |      |
| Max Q Clear Time (g_c+I1), s |      | 5.9  |      |     | 7.5  | 10.7 |      | 4.6  |      |      |      |      |
| Green Ext Time (p_c), s      |      | 2.1  |      |     | 0.6  | 3.6  |      | 0.4  |      |      |      |      |
| <b>Intersection Summary</b>  |      |      |      |     |      |      |      |      |      |      |      |      |
| HCM 2010 Ctrl Delay          |      |      | 11.9 |     |      |      |      |      |      |      |      |      |
| HCM 2010 LOS                 |      |      | B    |     |      |      |      |      |      |      |      |      |

HCM 2010 Signalized Intersection Summary  
 1: Del Monte Boulevard & Reindollar Avenue

Existing with Project, PM  
 06/11/2019

|                              |  |  |  |  |  |  |   |  |  |  |  |  |
|------------------------------|---|---|---|---|---|---|---|---|---|---|---|---|
| Movement                     | EBL   | EBT   | EBR   | WBL   | WBT   | WBR   | NBL   | NBT   | NBR   | SBL   | SBT   | SBR   |
| Lane Configurations          |   |   |   |  |  |   |  |  |  |  |  |  |
| Traffic Volume (veh/h)       | 0   | 0   | 0   | 180   | 0   | 90  | 10  | 1020  | 320   | 70  | 490   | 0   |
| Future Volume (veh/h)        | 0   | 0   | 0   | 180   | 0   | 90  | 10  | 1020  | 320   | 70  | 490   | 0   |
| Number                       |   |   |   | 3   | 8   | 18  | 1   | 6   | 16  | 5   | 2   | 12  |
| Initial Q (Qb), veh          |   |   |   | 0   | 0   | 0   | 0   | 0   | 0   | 0   | 0   | 0   |
| Ped-Bike Adj(A_pbT)          |   |   |   | 1.00  |   | 1.00  | 1.00  |   | 1.00  | 1.00  |   | 1.00  |
| Parking Bus, Adj             |   |   |   | 1.00  | 1.00  | 1.00  | 1.00  | 1.00  | 1.00  | 1.00  | 1.00  | 1.00  |
| Adj Sat Flow, veh/h/ln       |   |   |   | 1881  | 1881  | 1900  | 1881  | 1881  | 1881  | 1881  | 1881  | 0   |
| Adj Flow Rate, veh/h         |   |   |   | 209   | 0   | 0   | 10  | 1062  | 250   | 73  | 510   | 0   |
| Adj No. of Lanes             |   |   |   | 2   | 1   | 0   | 1   | 2   | 1   | 1   | 2   | 0   |
| Peak Hour Factor             |   |   |   | 0.96  | 0.96  | 0.96  | 0.96  | 0.96  | 0.96  | 0.96  | 0.96  | 0.96  |
| Percent Heavy Veh, %         |   |   |   | 1   | 1   | 1   | 1   | 1   | 1   | 1   | 1   | 0   |
| Cap, veh/h                   |   |   |   | 459   | 241   | 0   | 24  | 1691  | 756   | 123   | 1890  | 0   |
| Arrive On Green              |   |   |   | 0.13  | 0.00  | 0.00  | 0.01  | 0.47  | 0.47  | 0.07  | 0.53  | 0.00  |
| Sat Flow, veh/h              |   |   |   | 3583  | 1881  | 0   | 1792  | 3574  | 1599  | 1792  | 3668  | 0   |
| Grp Volume(v), veh/h         |   |   |   | 209   | 0   | 0   | 10  | 1062  | 250   | 73  | 510   | 0   |
| Grp Sat Flow(s),veh/h/ln     |   |   |   | 1792  | 1881  | 0   | 1792  | 1787  | 1599  | 1792  | 1787  | 0   |
| Q Serve(g_s), s              |   |   |   | 2.2   | 0.0   | 0.0   | 0.2   | 9.1   | 4.0   | 1.6   | 3.2   | 0.0   |
| Cycle Q Clear(g_c), s        |   |   |   | 2.2   | 0.0   | 0.0   | 0.2   | 9.1   | 4.0   | 1.6   | 3.2   | 0.0   |
| Prop In Lane                 |   |   |   | 1.00  |   | 0.00  | 1.00  |   | 1.00  | 1.00  |   | 0.00  |
| Lane Grp Cap(c), veh/h       |   |   |   | 459   | 241   | 0   | 24  | 1691  | 756   | 123   | 1890  | 0   |
| V/C Ratio(X)                 |   |   |   | 0.46  | 0.00  | 0.00  | 0.43  | 0.63  | 0.33  | 0.59  | 0.27  | 0.00  |
| Avail Cap(c_a), veh/h        |   |   |   | 2628  | 1380  | 0   | 1314  | 2622  | 1173  | 1314  | 2622  | 0   |
| HCM Platoon Ratio            |   |   |   | 1.00  | 1.00  | 1.00  | 1.00  | 1.00  | 1.00  | 1.00  | 1.00  | 1.00  |
| Upstream Filter(I)           |   |   |   | 1.00  | 0.00  | 0.00  | 1.00  | 1.00  | 1.00  | 1.00  | 1.00  | 0.00  |
| Uniform Delay (d), s/veh     |   |   |   | 16.5  | 0.0   | 0.0   | 20.0  | 8.1   | 6.7   | 18.5  | 5.3   | 0.0   |
| Incr Delay (d2), s/veh       |   |   |   | 0.7   | 0.0   | 0.0   | 11.7  | 0.4   | 0.3   | 4.5   | 0.1   | 0.0   |
| Initial Q Delay(d3),s/veh    |   |   |   | 0.0   | 0.0   | 0.0   | 0.0   | 0.0   | 0.0   | 0.0   | 0.0   | 0.0   |
| %ile BackOfQ(50%),veh/ln     |   |   |   | 1.1   | 0.0   | 0.0   | 0.2   | 4.5   | 1.8   | 0.9   | 1.6   | 0.0   |
| LnGrp Delay(d),s/veh         |   |   |   | 17.2  | 0.0   | 0.0   | 31.7  | 8.5   | 7.0   | 22.9  | 5.4   | 0.0   |
| LnGrp LOS                    |   |   |   | B   |   |   | C   | A   | A   | C   | A   |   |
| Approach Vol, veh/h          |   |   |   |   | 209   |   |   | 1322  |   |   | 583   |   |
| Approach Delay, s/veh        |   |   |   |   | 17.2  |   |   | 8.4   |   |   | 7.6   |   |
| Approach LOS                 |   |   |   |   | B   |   |   | A   |   |   | A   |   |
| Timer                        | 1   | 2   | 3   | 4   | 5   | 6   | 7   | 8   |   |   |   |   |
| Assigned Phs                 | 1   | 2   |   |   | 5   | 6   |   | 8   |   |   |   |   |
| Phs Duration (G+Y+Rc), s     | 4.0   | 26.6  |   |   | 6.3   | 24.3  |   | 10.2  |   |   |   |   |
| Change Period (Y+Rc), s      | 3.5   | 5.0   |   |   | 3.5   | 5.0   |   | 5.0   |   |   |   |   |
| Max Green Setting (Gmax), s  | 30.0  | 30.0  |   |   | 30.0  | 30.0  |   | 30.0  |   |   |   |   |
| Max Q Clear Time (g_c+I1), s | 2.2   | 5.2   |   |   | 3.6   | 11.1  |   | 4.2   |   |   |   |   |
| Green Ext Time (p_c), s      | 0.0   | 3.6   |   |   | 0.2   | 8.2   |   | 0.7   |   |   |   |   |
| <b>Intersection Summary</b>  |   |   |   |   |   |   |   |   |   |   |   |   |
| HCM 2010 Ctrl Delay          |   |   |   | 9.0   |   |   |   |   |   |   |   |   |
| HCM 2010 LOS                 |   |   |   | A   |   |   |   |   |   |   |   |   |
| <b>Notes</b>                 |   |   |   |   |   |   |   |   |   |   |   |   |



HCM 2010 Signalized Intersection Summary  
 3: SR 1 SB On-Ramp/SR 1 SB Off-Ramp & Imjin Parkway

Existing with Project, PM  
 06/11/2019



| Movement                     | EBL | EBT | EBR | WBL  | WBT  | WBR  | NBL | NBT | NBR | SBL  | SBT  | SBR  |
|------------------------------|-----|-----|-----|------|------|------|-----|-----|-----|------|------|------|
| Lane Configurations          |     |     |     |      | ↕    |      |     |     |     |      | ↕    |      |
| Traffic Volume (veh/h)       | 0   | 0   | 0   | 970  | 0    | 0    | 0   | 0   | 0   | 290  | 10   | 0    |
| Future Volume (veh/h)        | 0   | 0   | 0   | 970  | 0    | 0    | 0   | 0   | 0   | 290  | 10   | 0    |
| Number                       |     |     |     | 1    | 6    | 16   |     |     |     | 7    | 4    | 14   |
| Initial Q (Qb), veh          |     |     |     | 0    | 0    | 0    |     |     |     | 0    | 0    | 0    |
| Ped-Bike Adj(A_pbT)          |     |     |     | 1.00 |      | 1.00 |     |     |     | 1.00 |      | 1.00 |
| Parking Bus, Adj             |     |     |     | 1.00 | 1.00 | 1.00 |     |     |     | 1.00 | 1.00 | 1.00 |
| Adj Sat Flow, veh/h/ln       |     |     |     | 1900 | 1881 | 0    |     |     |     | 1900 | 1863 | 0    |
| Adj Flow Rate, veh/h         |     |     |     | 1066 | 0    | 0    |     |     |     | 319  | 11   | 0    |
| Adj No. of Lanes             |     |     |     | 0    | 1    | 0    |     |     |     | 0    | 1    | 0    |
| Peak Hour Factor             |     |     |     | 0.91 | 0.91 | 0.91 |     |     |     | 0.91 | 0.91 | 0.91 |
| Percent Heavy Veh, %         |     |     |     | 1    | 1    | 0    |     |     |     | 2    | 2    | 0    |
| Cap, veh/h                   |     |     |     | 1200 | 0    | 0    |     |     |     | 388  | 13   | 0    |
| Arrive On Green              |     |     |     | 0.67 | 0.00 | 0.00 |     |     |     | 0.23 | 0.23 | 0.00 |
| Sat Flow, veh/h              |     |     |     | 1792 | 0    | 0    |     |     |     | 1718 | 59   | 0    |
| Grp Volume(v), veh/h         |     |     |     | 1066 | 0    | 0    |     |     |     | 330  | 0    | 0    |
| Grp Sat Flow(s),veh/h/ln     |     |     |     | 1792 | 0    | 0    |     |     |     | 1777 | 0    | 0    |
| Q Serve(g_s), s              |     |     |     | 40.9 | 0.0  | 0.0  |     |     |     | 14.9 | 0.0  | 0.0  |
| Cycle Q Clear(g_c), s        |     |     |     | 40.9 | 0.0  | 0.0  |     |     |     | 14.9 | 0.0  | 0.0  |
| Prop In Lane                 |     |     |     | 1.00 |      | 0.00 |     |     |     | 0.97 |      | 0.00 |
| Lane Grp Cap(c), veh/h       |     |     |     | 1200 | 0    | 0    |     |     |     | 401  | 0    | 0    |
| V/C Ratio(X)                 |     |     |     | 0.89 | 0.00 | 0.00 |     |     |     | 0.82 | 0.00 | 0.00 |
| Avail Cap(c_a), veh/h        |     |     |     | 1913 | 0    | 0    |     |     |     | 1265 | 0    | 0    |
| HCM Platoon Ratio            |     |     |     | 1.00 | 1.00 | 1.00 |     |     |     | 1.00 | 1.00 | 1.00 |
| Upstream Filter(I)           |     |     |     | 1.00 | 0.00 | 0.00 |     |     |     | 1.00 | 0.00 | 0.00 |
| Uniform Delay (d), s/veh     |     |     |     | 11.3 | 0.0  | 0.0  |     |     |     | 31.0 | 0.0  | 0.0  |
| Incr Delay (d2), s/veh       |     |     |     | 3.4  | 0.0  | 0.0  |     |     |     | 4.3  | 0.0  | 0.0  |
| Initial Q Delay(d3),s/veh    |     |     |     | 0.0  | 0.0  | 0.0  |     |     |     | 0.0  | 0.0  | 0.0  |
| %ile BackOfQ(50%),veh/ln     |     |     |     | 21.0 | 0.0  | 0.0  |     |     |     | 7.7  | 0.0  | 0.0  |
| LnGrp Delay(d),s/veh         |     |     |     | 14.8 | 0.0  | 0.0  |     |     |     | 35.3 | 0.0  | 0.0  |
| LnGrp LOS                    |     |     |     | B    |      |      |     |     |     | D    |      |      |
| Approach Vol, veh/h          |     |     |     |      | 1066 |      |     |     |     |      | 330  |      |
| Approach Delay, s/veh        |     |     |     |      | 14.8 |      |     |     |     |      | 35.3 |      |
| Approach LOS                 |     |     |     |      | B    |      |     |     |     |      | D    |      |
| Timer                        | 1   | 2   | 3   | 4    | 5    | 6    | 7   | 8   |     |      |      |      |
| Assigned Phs                 |     |     |     | 4    |      | 6    |     |     |     |      |      |      |
| Phs Duration (G+Y+Rc), s     |     |     |     | 23.4 |      | 60.8 |     |     |     |      |      |      |
| Change Period (Y+Rc), s      |     |     |     | 4.4  |      | 4.4  |     |     |     |      |      |      |
| Max Green Setting (Gmax), s  |     |     |     | 60.0 |      | 90.0 |     |     |     |      |      |      |
| Max Q Clear Time (g_c+I1), s |     |     |     | 16.9 |      | 42.9 |     |     |     |      |      |      |
| Green Ext Time (p_c), s      |     |     |     | 2.2  |      | 13.5 |     |     |     |      |      |      |
| <b>Intersection Summary</b>  |     |     |     |      |      |      |     |     |     |      |      |      |
| HCM 2010 Ctrl Delay          |     |     |     | 19.6 |      |      |     |     |     |      |      |      |
| HCM 2010 LOS                 |     |     |     | B    |      |      |     |     |     |      |      |      |

| Intersection             |      |      |      |      |      |      |      |      |      |      |       |      |
|--------------------------|------|------|------|------|------|------|------|------|------|------|-------|------|
| Int Delay, s/veh         | 0.5  |      |      |      |      |      |      |      |      |      |       |      |
| Movement                 | EBL  | EBT  | EBR  | WBL  | WBT  | WBR  | NBL  | NBT  | NBR  | SBL  | SBT   | SBR  |
| Lane Configurations      |      | ↔    |      |      | ↑    | ↗    |      | ↖    | ↗    |      |       |      |
| Traffic Vol, veh/h       | 10   | 270  | 0    | 0    | 970  | 550  | 10   | 10   | 1150 | 0    | 0     | 0    |
| Future Vol, veh/h        | 10   | 270  | 0    | 0    | 970  | 550  | 10   | 10   | 1150 | 0    | 0     | 0    |
| Conflicting Peds, #/hr   | 0    | 0    | 1    | 1    | 0    | 0    | 0    | 0    | 0    | 0    | 0     | 0    |
| Sign Control             | Free | Free | Free | Free | Free | Free | Stop | Stop | Stop | Stop | Stop  | Stop |
| RT Channelized           | -    | -    | None | -    | -    | Free | -    | -    | Free | -    | -     | None |
| Storage Length           | -    | -    | -    | -    | -    | 0    | -    | -    | 800  | -    | -     | -    |
| Veh in Median Storage, # | -    | 0    | -    | -    | 0    | -    | -    | 0    | -    | -    | 16965 | -    |
| Grade, %                 | -    | 0    | -    | -    | 0    | -    | -    | 0    | -    | -    | 0     | -    |
| Peak Hour Factor         | 95   | 95   | 95   | 95   | 95   | 95   | 95   | 95   | 95   | 95   | 95    | 95   |
| Heavy Vehicles, %        | 2    | 2    | 2    | 1    | 1    | 1    | 1    | 1    | 1    | 2    | 2     | 2    |
| Mvmt Flow                | 11   | 284  | 0    | 0    | 1021 | 579  | 11   | 11   | 1211 | 0    | 0     | 0    |























| Major/Minor          | Major1 | Major2 | Minor1 |
|----------------------|--------|--------|--------|
| Conflicting Flow All | 1021   | 0      | -      |
| Stage 1              | -      | -      | -      |
| Stage 2              | -      | -      | -      |
| Critical Hdwy        | 4.12   | -      | -      |
| Critical Hdwy Stg 1  | -      | -      | -      |
| Critical Hdwy Stg 2  | -      | -      | -      |
| Follow-up Hdwy       | 2.218  | -      | -      |
| Pot Cap-1 Maneuver   | 680    | 0      | 0      |
| Stage 1              | -      | 0      | 0      |
| Stage 2              | -      | 0      | 0      |
| Platoon blocked, %   | -      | -      | -      |
| Mov Cap-1 Maneuver   | 680    | -      | -      |
| Mov Cap-2 Maneuver   | -      | -      | -      |
| Stage 1              | -      | -      | -      |
| Stage 2              | -      | -      | -      |

| Approach             | EB  | WB | NB   |
|----------------------|-----|----|------|
| HCM Control Delay, s | 0.4 | 0  | 29.3 |
| HCM LOS              |     |    | D    |

| Minor Lane/Major Mvmt | NBLn1 | NBLn2 | EBL   | EBT | WBT |
|-----------------------|-------|-------|-------|-----|-----|
| Capacity (veh/h)      | 169   | -     | 680   | -   | -   |
| HCM Lane V/C Ratio    | 0.125 | -     | 0.015 | -   | -   |
| HCM Control Delay (s) | 29.3  | 0     | 10.4  | 0   | -   |
| HCM Lane LOS          | D     | A     | B     | A   | -   |
| HCM 95th %tile Q(veh) | 0.4   | -     | 0     | -   | -   |

HCM 2010 Signalized Intersection Summary  
 5: 2nd Avenue & Imjin Parkway

Existing with Project, PM  
 06/11/2019

|                              |  |  |  |  |  |  |  |  |  |  |  |  |
|------------------------------|---|---|---|---|---|---|--|---|---|---|---|---|
| Movement                     | EBL   | EBT   | EBR   | WBL   | WBT   | WBR   | NBL  | NBT   | NBR   | SBL   | SBT   | SBR   |
| Lane Configurations          |  |  |  |  |  |   |  |  |  |  |  |  |
| Traffic Volume (veh/h)       | 10  | 960   | 360   | 250   | 980   | 10  | 470  | 10  | 300   | 20  | 20  | 40  |
| Future Volume (veh/h)        | 10  | 960   | 360   | 250   | 980   | 10  | 470  | 10  | 300   | 20  | 20  | 40  |
| Number                       | 5   | 2   | 12  | 1   | 6   | 16  | 3  | 8   | 18  | 7   | 4   | 14  |
| Initial Q (Qb), veh          | 0   | 0   | 0   | 0   | 0   | 0   | 0  | 0   | 0   | 0   | 0   | 0   |
| Ped-Bike Adj(A_pbT)          | 1.00  |   | 1.00  | 1.00  |   | 0.99  | 1.00   |   | 0.99  | 1.00  |   | 0.96  |
| Parking Bus, Adj             | 1.00  | 1.00  | 1.00  | 1.00  | 1.00  | 1.00  | 1.00   | 1.00  | 1.00  | 1.00  | 1.00  | 1.00  |
| Adj Sat Flow, veh/h/ln       | 1881  | 1881  | 1881  | 1881  | 1881  | 1900  | 1900   | 1900  | 1900  | 1900  | 1900  | 1900  |
| Adj Flow Rate, veh/h         | 10  | 1000  | 175   | 260   | 1021  | 10  | 490  | 10  | 78  | 21  | 21  | 11  |
| Adj No. of Lanes             | 1   | 2   | 1   | 2   | 2   | 0   | 2  | 1   | 1   | 1   | 2   | 0   |
| Peak Hour Factor             | 0.96  | 0.96  | 0.96  | 0.96  | 0.96  | 0.96  | 0.96   | 0.96  | 0.96  | 0.96  | 0.96  | 0.96  |
| Percent Heavy Veh, %         | 1   | 1   | 1   | 1   | 1   | 1   | 0  | 0   | 0   | 0   | 0   | 0   |
| Cap, veh/h                   | 104   | 1174  | 523   | 386   | 1385  | 14  | 611  | 298   | 250   | 105   | 95  | 45  |
| Arrive On Green              | 0.06  | 0.33  | 0.33  | 0.11  | 0.38  | 0.38  | 0.17   | 0.16  | 0.16  | 0.06  | 0.04  | 0.04  |
| Sat Flow, veh/h              | 1792  | 3574  | 1592  | 3476  | 3626  | 36  | 3510   | 1900  | 1593  | 1810  | 2345  | 1114  |
| Grp Volume(v), veh/h         | 10  | 1000  | 175   | 260   | 503   | 528   | 490  | 10  | 78  | 21  | 16  | 16  |
| Grp Sat Flow(s),veh/h/ln     | 1792  | 1787  | 1592  | 1738  | 1787  | 1875  | 1755   | 1900  | 1593  | 1810  | 1805  | 1654  |
| Q Serve(g_s), s              | 0.3   | 13.5  | 4.3   | 3.7   | 12.5  | 12.5  | 6.9  | 0.2   | 2.2   | 0.6   | 0.4   | 0.5   |
| Cycle Q Clear(g_c), s        | 0.3   | 13.5  | 4.3   | 3.7   | 12.5  | 12.5  | 6.9  | 0.2   | 2.2   | 0.6   | 0.4   | 0.5   |
| Prop In Lane                 | 1.00  |   | 1.00  | 1.00  |   | 0.02  | 1.00   |   | 1.00  | 1.00  |   | 0.67  |
| Lane Grp Cap(c), veh/h       | 104   | 1174  | 523   | 386   | 682   | 716   | 611  | 298   | 250   | 105   | 73  | 67  |
| V/C Ratio(X)                 | 0.10  | 0.85  | 0.33  | 0.67  | 0.74  | 0.74  | 0.80   | 0.03  | 0.31  | 0.20  | 0.21  | 0.24  |
| Avail Cap(c_a), veh/h        | 519   | 2071  | 922   | 1007  | 1035  | 1086  | 1356   | 771   | 646   | 349   | 732   | 671   |
| HCM Platoon Ratio            | 1.00  | 1.00  | 1.00  | 1.00  | 1.00  | 1.00  | 1.00   | 1.00  | 1.00  | 1.00  | 1.00  | 1.00  |
| Upstream Filter(I)           | 1.00  | 1.00  | 1.00  | 1.00  | 1.00  | 1.00  | 1.00   | 1.00  | 1.00  | 1.00  | 1.00  | 1.00  |
| Uniform Delay (d), s/veh     | 23.1  | 16.2  | 13.1  | 22.1  | 13.8  | 13.8  | 20.5   | 18.5  | 19.4  | 23.2  | 24.0  | 24.1  |
| Incr Delay (d2), s/veh       | 0.1   | 0.7   | 0.1   | 0.8   | 0.6   | 0.6   | 0.9  | 0.0   | 0.3   | 0.3   | 0.5   | 0.7   |
| Initial Q Delay(d3),s/veh    | 0.0   | 0.0   | 0.0   | 0.0   | 0.0   | 0.0   | 0.0  | 0.0   | 0.0   | 0.0   | 0.0   | 0.0   |
| %ile BackOfQ(50%),veh/ln     | 0.1   | 6.6   | 1.9   | 1.8   | 6.3   | 6.6   | 3.4  | 0.1   | 1.0   | 0.3   | 0.2   | 0.2   |
| LnGrp Delay(d),s/veh         | 23.3  | 16.9  | 13.3  | 22.9  | 14.4  | 14.3  | 21.5   | 18.5  | 19.6  | 23.6  | 24.6  | 24.8  |
| LnGrp LOS                    | C   | B   | B   | C   | B   | B   | C  | B   | B   | C   | C   | C   |
| Approach Vol, veh/h          |   | 1185  |   |   | 1291  |   |  | 578   |   |   | 53  |   |
| Approach Delay, s/veh        |   | 16.4  |   |   | 16.1  |   |  | 21.2  |   |   | 24.2  |   |
| Approach LOS                 |   | B   |   |   | B   |   |  | C   |   |   | C   |   |
| Timer                        | 1   | 2   | 3   | 4   | 5   | 6   | 7  | 8   |   |   |   |   |
| Assigned Phs                 | 1   | 2   | 3   | 4   | 5   | 6   | 7  | 8   |   |   |   |   |
| Phs Duration (G+Y+Rc), s     | 10.3  | 22.3  | 12.5  | 6.7   | 7.5   | 25.1  | 6.5  | 12.7  |   |   |   |   |
| Change Period (Y+Rc), s      | 4.5   | 5.3   | 3.5   | 4.6   | 4.5   | 5.3   | 3.5  | 4.6   |   |   |   |   |
| Max Green Setting (Gmax), s  | 15.0  | 30.0  | 20.0  | 21.0  | 15.0  | 30.0  | 10.0   | 21.0  |   |   |   |   |
| Max Q Clear Time (g_c+I1), s | 5.7   | 15.5  | 8.9   | 2.5   | 2.3   | 14.5  | 2.6  | 4.2   |   |   |   |   |
| Green Ext Time (p_c), s      | 0.0   | 1.4   | 0.1   | 0.0   | 0.0   | 1.1   | 0.0  | 0.0   |   |   |   |   |
| <b>Intersection Summary</b>  |   |   |   |   |   |   |  |   |   |   |   |   |
| HCM 2010 Ctrl Delay          |   |   | 17.3  |   |   |   |  |   |   |   |   |   |
| HCM 2010 LOS                 |   |   | B   |   |   |   |  |   |   |   |   |   |

| Intersection             |      |      |      |      |      |      |      |      |      |      |      |      |
|--------------------------|------|------|------|------|------|------|------|------|------|------|------|------|
| Int Delay, s/veh         | 7.1  |      |      |      |      |      |      |      |      |      |      |      |
| Movement                 | EBL  | EBT  | EBR  | WBL  | WBT  | WBR  | NBL  | NBT  | NBR  | SBL  | SBT  | SBR  |
| Lane Configurations      | ↖    | ↕    |      | ↖    | ↕    |      | ↖    | ↕    |      | ↖    | ↕    |      |
| Traffic Vol, veh/h       | 50   | 1250 | 10   | 30   | 1180 | 20   | 10   | 10   | 30   | 10   | 10   | 50   |
| Future Vol, veh/h        | 50   | 1250 | 10   | 30   | 1180 | 20   | 10   | 10   | 30   | 10   | 10   | 50   |
| Conflicting Peds, #/hr   | 2    | 0    | 1    | 1    | 0    | 2    | 1    | 0    | 0    | 0    | 0    | 1    |
| Sign Control             | Free | Free | Free | Free | Free | Free | Stop | Stop | Stop | Stop | Stop | Stop |
| RT Channelized           | -    | -    | None | -    | -    | None | -    | -    | None | -    | -    | None |
| Storage Length           | 300  | -    | -    | 300  | -    | -    | 85   | -    | -    | 25   | -    | -    |
| Veh in Median Storage, # | -    | 0    | -    | -    | 0    | -    | -    | 0    | -    | -    | 0    | -    |
| Grade, %                 | -    | 0    | -    | -    | 0    | -    | -    | 0    | -    | -    | 0    | -    |
| Peak Hour Factor         | 98   | 98   | 98   | 98   | 98   | 98   | 98   | 98   | 98   | 98   | 98   | 98   |
| Heavy Vehicles, %        | 1    | 1    | 1    | 1    | 1    | 1    | 0    | 0    | 0    | 0    | 0    | 0    |
| Mvmt Flow                | 51   | 1276 | 10   | 31   | 1204 | 20   | 10   | 10   | 31   | 10   | 10   | 51   |

| Major/Minor          | Major1 |   |   | Major2 |   |   | Minor1 |      |     | Minor2 |      |     |
|----------------------|--------|---|---|--------|---|---|--------|------|-----|--------|------|-----|
| Conflicting Flow All | 1226   | 0 | 0 | 1287   | 0 | 0 | 2054   | 2672 | 644 | 2023   | 2667 | 615 |
| Stage 1              | -      | - | - | -      | - | - | 1384   | 1384 | -   | 1278   | 1278 | -   |
| Stage 2              | -      | - | - | -      | - | - | 670    | 1288 | -   | 745    | 1389 | -   |
| Critical Hdwy        | 4.12   | - | - | 4.12   | - | - | 7.5    | 6.5  | 6.9 | 7.5    | 6.5  | 6.9 |
| Critical Hdwy Stg 1  | -      | - | - | -      | - | - | 6.5    | 5.5  | -   | 6.5    | 5.5  | -   |
| Critical Hdwy Stg 2  | -      | - | - | -      | - | - | 6.5    | 5.5  | -   | 6.5    | 5.5  | -   |
| Follow-up Hdwy       | 2.21   | - | - | 2.21   | - | - | 3.5    | 4    | 3.3 | 3.5    | 4    | 3.3 |
| Pot Cap-1 Maneuver   | 570    | - | - | 540    | - | - | 33     | 23   | 420 | 35     | 23   | 439 |
| Stage 1              | -      | - | - | -      | - | - | 154    | 213  | -   | 179    | 239  | -   |
| Stage 2              | -      | - | - | -      | - | - | 417    | 237  | -   | 377    | 212  | -   |
| Platoon blocked, %   | -      | - | - | -      | - | - | -      | -    | -   | -      | -    | -   |
| Mov Cap-1 Maneuver   | 569    | - | - | 539    | - | - | 16     | 20   | 420 | 17     | 20   | 438 |
| Mov Cap-2 Maneuver   | -      | - | - | -      | - | - | 16     | 20   | -   | 17     | 20   | -   |
| Stage 1              | -      | - | - | -      | - | - | 140    | 194  | -   | 163    | 225  | -   |
| Stage 2              | -      | - | - | -      | - | - | 331    | 223  | -   | 301    | 193  | -   |

| Approach             | EB  |  |  | WB  |  |  | NB    |  |  | SB    |  |  |
|----------------------|-----|--|--|-----|--|--|-------|--|--|-------|--|--|
| HCM Control Delay, s | 0.5 |  |  | 0.3 |  |  | 172.6 |  |  | 131.2 |  |  |
| HCM LOS              |     |  |  |     |  |  | F     |  |  | F     |  |  |

| Minor Lane/Major Mvmt | NBLn1    | NBLn2 | EBL  | EBT | EBR | WBL   | WBT | WBR | SBLn1    | SBLn2 |
|-----------------------|----------|-------|------|-----|-----|-------|-----|-----|----------|-------|
| Capacity (veh/h)      | 16       | 70    | 569  | -   | -   | 539   | -   | -   | 17       | 98    |
| HCM Lane V/C Ratio    | 0.638    | 0.583 | 0.09 | -   | -   | 0.057 | -   | -   | 0.6      | 0.625 |
| HCM Control Delay (s) | \$ 415.4 | 111.9 | 11.9 | -   | -   | 12.1  | -   | -   | \$ 382.3 | 89.4  |
| HCM Lane LOS          | F        | F     | B    | -   | -   | B     | -   | -   | F        | F     |
| HCM 95th %tile Q(veh) | 1.6      | 2.5   | 0.3  | -   | -   | 0.2   | -   | -   | 1.6      | 3     |

| Intersection             |      |      |      |      |      |      |      |      |      |      |      |      |
|--------------------------|------|------|------|------|------|------|------|------|------|------|------|------|
| Int Delay, s/veh         | 13.1 |      |      |      |      |      |      |      |      |      |      |      |
| Movement                 | EBL  | EBT  | EBR  | WBL  | WBT  | WBR  | NBL  | NBT  | NBR  | SBL  | SBT  | SBR  |
| Lane Configurations      | ↖    | ↕    |      | ↖    | ↕    |      |      | ↕    |      |      | ↕    | ↕    |
| Traffic Vol, veh/h       | 10   | 1370 | 10   | 10   | 1190 | 10   | 20   | 10   | 10   | 10   | 10   | 10   |
| Future Vol, veh/h        | 10   | 1370 | 10   | 10   | 1190 | 10   | 20   | 10   | 10   | 10   | 10   | 10   |
| Conflicting Peds, #/hr   | 2    | 0    | 0    | 0    | 0    | 2    | 0    | 0    | 0    | 0    | 0    | 0    |
| Sign Control             | Free | Free | Free | Free | Free | Free | Stop | Stop | Stop | Stop | Stop | Stop |
| RT Channelized           | -    | -    | None | -    | -    | None | -    | -    | None | -    | -    | Stop |
| Storage Length           | 330  | -    | -    | 330  | -    | -    | -    | -    | -    | -    | -    | -    |
| Veh in Median Storage, # | -    | 0    | -    | -    | 0    | -    | -    | 0    | -    | -    | 0    | -    |
| Grade, %                 | -    | 0    | -    | -    | 0    | -    | -    | 0    | -    | -    | 0    | -    |
| Peak Hour Factor         | 97   | 97   | 97   | 97   | 97   | 97   | 97   | 97   | 97   | 97   | 97   | 97   |
| Heavy Vehicles, %        | 1    | 1    | 1    | 1    | 1    | 1    | 0    | 0    | 0    | 0    | 0    | 0    |
| Mvmt Flow                | 10   | 1412 | 10   | 10   | 1227 | 10   | 21   | 10   | 10   | 10   | 10   | 10   |

| Major/Minor          | Major1 |   |   | Major2 |   |   | Minor1 |      |     | Minor2 |      |     |
|----------------------|--------|---|---|--------|---|---|--------|------|-----|--------|------|-----|
| Conflicting Flow All | 1239   | 0 | 0 | 1422   | 0 | 0 | 2076   | 2696 | 711 | 1985   | 2696 | 621 |
| Stage 1              | -      | - | - | -      | - | - | 1437   | 1437 | -   | 1254   | 1254 | -   |
| Stage 2              | -      | - | - | -      | - | - | 639    | 1259 | -   | 731    | 1442 | -   |
| Critical Hdwy        | 4.12   | - | - | 4.12   | - | - | 7.5    | 6.5  | 6.9 | 7.5    | 6.5  | 6.9 |
| Critical Hdwy Stg 1  | -      | - | - | -      | - | - | 6.5    | 5.5  | -   | 6.5    | 5.5  | -   |
| Critical Hdwy Stg 2  | -      | - | - | -      | - | - | 6.5    | 5.5  | -   | 6.5    | 5.5  | -   |
| Follow-up Hdwy       | 2.21   | - | - | 2.21   | - | - | 3.5    | 4    | 3.3 | 3.5    | 4    | 3.3 |
| Pot Cap-1 Maneuver   | 563    | - | - | 480    | - | - | 32     | 22   | 380 | 37     | 22   | 435 |
| Stage 1              | -      | - | - | -      | - | - | 143    | 201  | -   | 185    | 246  | -   |
| Stage 2              | -      | - | - | -      | - | - | 436    | 244  | -   | 384    | 199  | -   |
| Platoon blocked, %   | -      | - | - | -      | - | - | -      | -    | -   | -      | -    | -   |
| Mov Cap-1 Maneuver   | 562    | - | - | 480    | - | - | ~ 19   | 21   | 380 | 21     | 21   | 434 |
| Mov Cap-2 Maneuver   | -      | - | - | -      | - | - | ~ 19   | 21   | -   | 21     | 21   | -   |
| Stage 1              | -      | - | - | -      | - | - | 140    | 197  | -   | 181    | 240  | -   |
| Stage 2              | -      | - | - | -      | - | - | 399    | 238  | -   | 348    | 195  | -   |



















| Approach             | EB  |  |  | WB  |  |  | NB       |  |  | SB       |  |  |
|----------------------|-----|--|--|-----|--|--|----------|--|--|----------|--|--|
| HCM Control Delay, s | 0.1 |  |  | 0.1 |  |  | \$ 616.2 |  |  | \$ 331.3 |  |  |
| HCM LOS              |     |  |  |     |  |  | F        |  |  | F        |  |  |

| Minor Lane/Major Mvmt | NBLn1    | EBL   | EBT | EBR | WBL   | WBT | WBR | SBLn1    |
|-----------------------|----------|-------|-----|-----|-------|-----|-----|----------|
| Capacity (veh/h)      | 26       | 562   | -   | -   | 480   | -   | -   | 32       |
| HCM Lane V/C Ratio    | 1.586    | 0.018 | -   | -   | 0.021 | -   | -   | 0.966    |
| HCM Control Delay (s) | \$ 616.2 | 11.5  | -   | -   | 12.7  | -   | -   | \$ 331.3 |
| HCM Lane LOS          | F        | B     | -   | -   | B     | -   | -   | F        |
| HCM 95th %tile Q(veh) | 5        | 0.1   | -   | -   | 0.1   | -   | -   | 3.3      |

Notes  
 ~: Volume exceeds capacity    \$: Delay exceeds 300s    +: Computation Not Defined    \*: All major volume in platoon

HCM 2010 Signalized Intersection Summary  
 8: 5th Avenue/California Avenue & Imjin Parkway

Existing with Project, PM  
 06/11/2019

|                              |  |  |  |  |  |  |  |  |  |  |  |  |
|------------------------------|---|---|---|---|---|---|--|---|---|---|---|---|
| Movement                     | EBL   | EBT   | EBR   | WBL   | WBT   | WBR   | NBL  | NBT   | NBR   | SBL   | SBT   | SBR   |
| Lane Configurations          |  |  |   |  |  |   |  |  |   |   |  |   |
| Traffic Volume (veh/h)       | 260   | 1020  | 10  | 10  | 1030  | 100   | 20   | 40  | 10  | 70  | 30  | 200   |
| Future Volume (veh/h)        | 260   | 1020  | 10  | 10  | 1030  | 100   | 20   | 40  | 10  | 70  | 30  | 200   |
| Number                       | 5   | 2   | 12  | 1   | 6   | 16  | 3  | 8   | 18  | 7   | 4   | 14  |
| Initial Q (Qb), veh          | 0   | 0   | 0   | 0   | 0   | 0   | 0  | 0   | 0   | 0   | 0   | 0   |
| Ped-Bike Adj(A_pbT)          | 1.00  |   | 1.00  | 1.00  |   | 1.00  | 1.00   |   | 1.00  | 1.00  |   | 0.98  |
| Parking Bus, Adj             | 1.00  | 1.00  | 1.00  | 1.00  | 1.00  | 1.00  | 1.00   | 1.00  | 1.00  | 1.00  | 1.00  | 1.00  |
| Adj Sat Flow, veh/h/ln       | 1881  | 1881  | 1900  | 1881  | 1881  | 1900  | 1900   | 1900  | 1900  | 1900  | 1881  | 1900  |
| Adj Flow Rate, veh/h         | 268   | 1052  | 10  | 10  | 1062  | 97  | 21   | 41  | 7   | 72  | 31  | 37  |
| Adj No. of Lanes             | 1   | 2   | 0   | 1   | 2   | 0   | 0  | 1   | 0   | 0   | 1   | 0   |
| Peak Hour Factor             | 0.97  | 0.97  | 0.97  | 0.97  | 0.97  | 0.97  | 0.97   | 0.97  | 0.97  | 0.97  | 0.97  | 0.97  |
| Percent Heavy Veh, %         | 1   | 1   | 1   | 1   | 1   | 1   | 0  | 0   | 0   | 1   | 1   | 1   |
| Cap, veh/h                   | 330   | 1976  | 19  | 14  | 1220  | 111   | 159  | 155   | 23  | 224   | 53  | 52  |
| Arrive On Green              | 0.18  | 0.54  | 0.54  | 0.01  | 0.37  | 0.37  | 0.12   | 0.12  | 0.12  | 0.12  | 0.12  | 0.12  |
| Sat Flow, veh/h              | 1792  | 3628  | 34  | 1792  | 3311  | 302   | 368  | 1248  | 182   | 747   | 425   | 421   |
| Grp Volume(v), veh/h         | 268   | 518   | 544   | 10  | 573   | 586   | 69   | 0   | 0   | 140   | 0   | 0   |
| Grp Sat Flow(s),veh/h/ln     | 1792  | 1787  | 1875  | 1792  | 1787  | 1826  | 1799   | 0   | 0   | 1592  | 0   | 0   |
| Q Serve(g_s), s              | 6.0   | 7.7   | 7.7   | 0.2   | 12.4  | 12.4  | 0.0  | 0.0   | 0.0   | 2.0   | 0.0   | 0.0   |
| Cycle Q Clear(g_c), s        | 6.0   | 7.7   | 7.7   | 0.2   | 12.4  | 12.4  | 1.4  | 0.0   | 0.0   | 3.4   | 0.0   | 0.0   |
| Prop In Lane                 | 1.00  |   | 0.02  | 1.00  |   | 0.17  | 0.30   |   | 0.10  | 0.51  |   | 0.26  |
| Lane Grp Cap(c), veh/h       | 330   | 974   | 1021  | 14  | 659   | 673   | 337  | 0   | 0   | 330   | 0   | 0   |
| V/C Ratio(X)                 | 0.81  | 0.53  | 0.53  | 0.71  | 0.87  | 0.87  | 0.20   | 0.00  | 0.00  | 0.42  | 0.00  | 0.00  |
| Avail Cap(c_a), veh/h        | 648   | 1292  | 1355  | 648   | 1292  | 1320  | 932  | 0   | 0   | 869   | 0   | 0   |
| HCM Platoon Ratio            | 1.00  | 1.00  | 1.00  | 1.00  | 1.00  | 1.00  | 1.00   | 1.00  | 1.00  | 1.00  | 1.00  | 1.00  |
| Upstream Filter(I)           | 1.00  | 1.00  | 1.00  | 1.00  | 1.00  | 1.00  | 1.00   | 0.00  | 0.00  | 1.00  | 0.00  | 0.00  |
| Uniform Delay (d), s/veh     | 16.2  | 6.1   | 6.1   | 20.5  | 12.2  | 12.2  | 16.5   | 0.0   | 0.0   | 17.3  | 0.0   | 0.0   |
| Incr Delay (d2), s/veh       | 1.9   | 0.2   | 0.2   | 21.4  | 1.4   | 1.4   | 0.1  | 0.0   | 0.0   | 0.3   | 0.0   | 0.0   |
| Initial Q Delay(d3),s/veh    | 0.0   | 0.0   | 0.0   | 0.0   | 0.0   | 0.0   | 0.0  | 0.0   | 0.0   | 0.0   | 0.0   | 0.0   |
| %ile BackOfQ(50%),veh/ln     | 3.1   | 3.8   | 4.0   | 0.2   | 6.3   | 6.4   | 0.7  | 0.0   | 0.0   | 1.5   | 0.0   | 0.0   |
| LnGrp Delay(d),s/veh         | 18.1  | 6.2   | 6.2   | 41.9  | 13.6  | 13.6  | 16.6   | 0.0   | 0.0   | 17.6  | 0.0   | 0.0   |
| LnGrp LOS                    | B   | A   | A   | D   | B   | B   | B  |   |   | B   |   |   |
| Approach Vol, veh/h          |   | 1330  |   |   | 1169  |   |  | 69  |   |   |   | 140   |
| Approach Delay, s/veh        |   | 8.6   |   |   | 13.8  |   |  | 16.6  |   |   |   | 17.6  |
| Approach LOS                 |   | A   |   |   | B   |   |  | B   |   |   |   | B   |
| Timer                        | 1   | 2   | 3   | 4   | 5   | 6   | 7  | 8   |   |   |   |   |
| Assigned Phs                 | 1   | 2   |   | 4   | 5   | 6   |  | 8   |   |   |   |   |
| Phs Duration (G+Y+Rc), s     | 3.8   | 27.9  |   | 9.8   | 11.1  | 20.6  |  | 9.8   |   |   |   |   |
| Change Period (Y+Rc), s      | 3.5   | 5.3   |   | 4.6   | 3.5   | 5.3   |  | 4.6   |   |   |   |   |
| Max Green Setting (Gmax), s  | 15.0  | 30.0  |   | 20.0  | 15.0  | 30.0  |  | 20.0  |   |   |   |   |
| Max Q Clear Time (g_c+I1), s | 2.2   | 9.7   |   | 5.4   | 8.0   | 14.4  |  | 3.4   |   |   |   |   |
| Green Ext Time (p_c), s      | 0.0   | 0.7   |   | 0.1   | 0.0   | 0.9   |  | 0.0   |   |   |   |   |
| <b>Intersection Summary</b>  |   |   |   |   |   |   |  |   |   |   |   |   |
| HCM 2010 Ctrl Delay          |   |   |   | 11.5  |   |   |  |   |   |   |   |   |
| HCM 2010 LOS                 |   |   |   | B   |   |   |  |   |   |   |   |   |

| Intersection             |      |      |      |      |      |      |
|--------------------------|------|------|------|------|------|------|
| Int Delay, s/veh         | 0.6  |      |      |      |      |      |
| Movement                 | EBL  | EBR  | NBL  | NBT  | SBT  | SBR  |
| Lane Configurations      | ↔    |      | ↔    | ↑    | ↑    |      |
| Traffic Vol, veh/h       | 10   | 10   | 20   | 410  | 240  | 10   |
| Future Vol, veh/h        | 10   | 10   | 20   | 410  | 240  | 10   |
| Conflicting Peds, #/hr   | 0    | 0    | 0    | 0    | 0    | 0    |
| Sign Control             | Stop | Stop | Free | Free | Free | Free |
| RT Channelized           | -    | None | -    | None | -    | None |
| Storage Length           | 0    | -    | 155  | -    | -    | -    |
| Veh in Median Storage, # | 0    | -    | -    | 0    | 0    | -    |
| Grade, %                 | 0    | -    | -    | 0    | 0    | -    |
| Peak Hour Factor         | 92   | 92   | 92   | 92   | 92   | 92   |
| Heavy Vehicles, %        | 2    | 2    | 2    | 2    | 2    | 2    |
| Mvmt Flow                | 11   | 11   | 22   | 446  | 261  | 11   |















| Major/Minor          | Minor2 | Major1 | Major2 |   |   |   |
|----------------------|--------|--------|--------|---|---|---|
| Conflicting Flow All | 757    | 267    | 272    | 0 | - | 0 |
| Stage 1              | 267    | -      | -      | - | - | - |
| Stage 2              | 490    | -      | -      | - | - | - |
| Critical Hdwy        | 6.42   | 6.22   | 4.12   | - | - | - |
| Critical Hdwy Stg 1  | 5.42   | -      | -      | - | - | - |
| Critical Hdwy Stg 2  | 5.42   | -      | -      | - | - | - |
| Follow-up Hdwy       | 3.518  | 3.318  | 2.218  | - | - | - |
| Pot Cap-1 Maneuver   | 375    | 772    | 1291   | - | - | - |
| Stage 1              | 778    | -      | -      | - | - | - |
| Stage 2              | 616    | -      | -      | - | - | - |
| Platoon blocked, %   |        |        |        | - | - | - |
| Mov Cap-1 Maneuver   | 369    | 772    | 1291   | - | - | - |
| Mov Cap-2 Maneuver   | 369    | -      | -      | - | - | - |
| Stage 1              | 765    | -      | -      | - | - | - |
| Stage 2              | 616    | -      | -      | - | - | - |

| Approach             | EB   | NB  | SB |
|----------------------|------|-----|----|
| HCM Control Delay, s | 12.5 | 0.4 | 0  |
| HCM LOS              | B    |     |    |

| Minor Lane/Major Mvmt | NBL   | NBT | EBLn1 | SBT | SBR |
|-----------------------|-------|-----|-------|-----|-----|
| Capacity (veh/h)      | 1291  | -   | 499   | -   | -   |
| HCM Lane V/C Ratio    | 0.017 | -   | 0.044 | -   | -   |
| HCM Control Delay (s) | 7.8   | -   | 12.5  | -   | -   |
| HCM Lane LOS          | A     | -   | B     | -   | -   |
| HCM 95th %tile Q(veh) | 0.1   | -   | 0.1   | -   | -   |

HCM 2010 Signalized Intersection Summary  
 10: Imjin Road & Imjin Parkway

Existing with Project, PM  
 06/11/2019

|                              |    |  |  |    |    |  |   |      |
|------------------------------|---|---|---|---|---|---|---|------|
| Movement                     | EBT   | EBR   | WBL   | WBT   | NBL   | NBR   |   |      |
| Lane Configurations          |   |   |  |   |    |  |   |      |
| Traffic Volume (veh/h)       | 970   | 110   | 200   | 870   | 240   | 390   |   |      |
| Future Volume (veh/h)        | 970   | 110   | 200   | 870   | 240   | 390   |   |      |
| Number                       | 2   | 12  | 1   | 6   | 3   | 18  |   |      |
| Initial Q (Qb), veh          | 0   | 0   | 0   | 0   | 0   | 0   |   |      |
| Ped-Bike Adj(A_pbT)          |   | 1.00  | 1.00  |   | 1.00  | 1.00  |   |      |
| Parking Bus, Adj             | 1.00  | 1.00  | 1.00  | 1.00  | 1.00  | 1.00  |   |      |
| Adj Sat Flow, veh/h/ln       | 1881  | 1900  | 1881  | 1881  | 1881  | 1881  |   |      |
| Adj Flow Rate, veh/h         | 1021  | 113   | 211   | 916   | 199   | 402   |   |      |
| Adj No. of Lanes             | 2   | 0   | 1   | 2   | 1   | 2   |   |      |
| Peak Hour Factor             | 0.95  | 0.95  | 0.95  | 0.95  | 0.95  | 0.95  |   |      |
| Percent Heavy Veh, %         | 1   | 1   | 1   | 1   | 1   | 1   |   |      |
| Cap, veh/h                   | 1163  | 129   | 265   | 2233  | 299   | 533   |   |      |
| Arrive On Green              | 0.36  | 0.36  | 0.15  | 0.62  | 0.17  | 0.17  |   |      |
| Sat Flow, veh/h              | 3340  | 359   | 1792  | 3668  | 1792  | 3198  |   |      |
| Grp Volume(v), veh/h         | 562   | 572   | 211   | 916   | 199   | 402   |   |      |
| Grp Sat Flow(s),veh/h/ln     | 1787  | 1818  | 1792  | 1787  | 1792  | 1599  |   |      |
| Q Serve(g_s), s              | 13.1  | 13.2  | 5.1   | 5.8   | 4.6   | 5.3   |   |      |
| Cycle Q Clear(g_c), s        | 13.1  | 13.2  | 5.1   | 5.8   | 4.6   | 5.3   |   |      |
| Prop In Lane                 |   | 0.20  | 1.00  |   | 1.00  | 1.00  |   |      |
| Lane Grp Cap(c), veh/h       | 640   | 651   | 265   | 2233  | 299   | 533   |   |      |
| V/C Ratio(X)                 | 0.88  | 0.88  | 0.80  | 0.41  | 0.67  | 0.75  |   |      |
| Avail Cap(c_a), veh/h        | 1202  | 1222  | 803   | 2403  | 883   | 1577  |   |      |
| HCM Platoon Ratio            | 1.00  | 1.00  | 1.00  | 1.00  | 1.00  | 1.00  |   |      |
| Upstream Filter(I)           | 1.00  | 1.00  | 1.00  | 1.00  | 1.00  | 1.00  |   |      |
| Uniform Delay (d), s/veh     | 13.4  | 13.4  | 18.4  | 4.2   | 17.4  | 17.7  |   |      |
| Incr Delay (d2), s/veh       | 1.6   | 1.6   | 2.1   | 0.0   | 1.0   | 0.8   |   |      |
| Initial Q Delay(d3),s/veh    | 0.0   | 0.0   | 0.0   | 0.0   | 0.0   | 0.0   |   |      |
| %ile BackOfQ(50%),veh/ln     | 6.7   | 6.8   | 2.7   | 2.8   | 2.3   | 2.4   |   |      |
| LnGrp Delay(d),s/veh         | 15.0  | 15.0  | 20.4  | 4.3   | 18.4  | 18.5  |   |      |
| LnGrp LOS                    | B   | B   | C   | A   | B   | B   |   |      |
| Approach Vol, veh/h          | 1134  |   |   | 1127  | 601   |   |   |      |
| Approach Delay, s/veh        | 15.0  |   |   | 7.3   | 18.5  |   |   |      |
| Approach LOS                 | B   |   |   | A   | B   |   |   |      |
| Timer                        | 1   | 2   | 3   | 4   | 5   | 6   | 7 | 8    |
| Assigned Phs                 | 1   | 2   |   |   |   | 6   |   | 8    |
| Phs Duration (G+Y+Rc), s     | 11.9  | 21.3  |   |   |   | 33.2  |   | 11.4 |
| Change Period (Y+Rc), s      | 5.3   | * 5.3   |   |   |   | 5.3   |   | 4.0  |
| Max Green Setting (Gmax), s  | 20.0  | * 30  |   |   |   | 30.0  |   | 22.0 |
| Max Q Clear Time (g_c+I1), s | 7.1   | 15.2  |   |   |   | 7.8   |   | 7.3  |
| Green Ext Time (p_c), s      | 0.0   | 0.8   |   |   |   | 1.0   |   | 0.1  |
| <b>Intersection Summary</b>  |   |   |   |   |   |   |   |      |
| HCM 2010 Ctrl Delay          |   |   | 12.7  |   |   |   |   |      |
| HCM 2010 LOS                 |   |   | B   |   |   |   |   |      |
| <b>Notes</b>                 |   |   |   |   |   |   |   |      |



HCM 2010 Signalized Intersection Summary  
 11: Abrams Drive & Imjin Parkway

Existing with Project, PM  
 06/11/2019



| Movement                      | EBL  | EBT  | EBR  | WBL  | WBT  | WBR  | NBL  | NBT  | NBR  | SBL  | SBT  | SBR  |
|-------------------------------|------|------|------|------|------|------|------|------|------|------|------|------|
| Lane Configurations           |      |      |      |      |      |      |      |      |      |      |      |      |
| Traffic Volume (veh/h)        | 100  | 960  | 250  | 170  | 830  | 60   | 160  | 20   | 160  | 30   | 20   | 90   |
| Future Volume (veh/h)         | 100  | 960  | 250  | 170  | 830  | 60   | 160  | 20   | 160  | 30   | 20   | 90   |
| Number                        | 5    | 2    | 12   | 1    | 6    | 16   | 3    | 8    | 18   | 7    | 4    | 14   |
| Initial Q (Qb), veh           | 0    | 0    | 0    | 0    | 0    | 0    | 0    | 0    | 0    | 0    | 0    | 0    |
| Ped-Bike Adj(A_pbT)           | 1.00 |      | 1.00 | 1.00 |      | 1.00 | 1.00 |      | 1.00 | 1.00 |      | 1.00 |
| Parking Bus, Adj              | 1.00 | 1.00 | 1.00 | 1.00 | 1.00 | 1.00 | 1.00 | 1.00 | 1.00 | 1.00 | 1.00 | 1.00 |
| Adj Sat Flow, veh/h/ln        | 1881 | 1881 | 1881 | 1881 | 1881 | 1881 | 1900 | 1881 | 1881 | 1900 | 1863 | 1863 |
| Adj Flow Rate, veh/h          | 108  | 1032 | 0    | 183  | 892  | 0    | 172  | 22   | 0    | 32   | 22   | 0    |
| Adj No. of Lanes              | 1    | 1    | 1    | 1    | 1    | 1    | 0    | 1    | 1    | 0    | 1    | 1    |
| Peak Hour Factor              | 0.93 | 0.93 | 0.93 | 0.93 | 0.93 | 0.93 | 0.93 | 0.93 | 0.93 | 0.93 | 0.93 | 0.93 |
| Percent Heavy Veh, %          | 1    | 1    | 1    | 1    | 1    | 1    | 1    | 1    | 1    | 2    | 2    | 2    |
| Cap, veh/h                    | 138  | 1060 | 901  | 220  | 1136 | 965  | 288  | 26   | 245  | 208  | 126  | 242  |
| Arrive On Green               | 0.08 | 0.56 | 0.00 | 0.12 | 0.60 | 0.00 | 0.15 | 0.15 | 0.00 | 0.15 | 0.15 | 0.00 |
| Sat Flow, veh/h               | 1792 | 1881 | 1599 | 1792 | 1881 | 1599 | 1329 | 170  | 1599 | 893  | 822  | 1583 |
| Grp Volume(v), veh/h          | 108  | 1032 | 0    | 183  | 892  | 0    | 194  | 0    | 0    | 54   | 0    | 0    |
| Grp Sat Flow(s),veh/h/ln      | 1792 | 1881 | 1599 | 1792 | 1881 | 1599 | 1498 | 0    | 1599 | 1715 | 0    | 1583 |
| Q Serve(g_s), s               | 4.7  | 42.4 | 0.0  | 8.0  | 28.5 | 0.0  | 7.9  | 0.0  | 0.0  | 0.0  | 0.0  | 0.0  |
| Cycle Q Clear(g_c), s         | 4.7  | 42.4 | 0.0  | 8.0  | 28.5 | 0.0  | 10.0 | 0.0  | 0.0  | 2.1  | 0.0  | 0.0  |
| Prop In Lane                  | 1.00 |      | 1.00 | 1.00 |      | 1.00 | 0.89 |      | 1.00 | 0.59 |      | 1.00 |
| Lane Grp Cap(c), veh/h        | 138  | 1060 | 901  | 220  | 1136 | 965  | 314  | 0    | 245  | 334  | 0    | 242  |
| V/C Ratio(X)                  | 0.78 | 0.97 | 0.00 | 0.83 | 0.79 | 0.00 | 0.62 | 0.00 | 0.00 | 0.16 | 0.00 | 0.00 |
| Avail Cap(c_a), veh/h         | 448  | 1177 | 1001 | 448  | 1177 | 1001 | 634  | 0    | 600  | 678  | 0    | 595  |
| HCM Platoon Ratio             | 1.00 | 1.00 | 1.00 | 1.00 | 1.00 | 1.00 | 1.00 | 1.00 | 1.00 | 1.00 | 1.00 | 1.00 |
| Upstream Filter(I)            | 1.00 | 1.00 | 0.00 | 1.00 | 1.00 | 0.00 | 1.00 | 0.00 | 0.00 | 1.00 | 0.00 | 0.00 |
| Uniform Delay (d), s/veh      | 36.2 | 16.8 | 0.0  | 34.2 | 11.9 | 0.0  | 32.7 | 0.0  | 0.0  | 29.5 | 0.0  | 0.0  |
| Incr Delay (d2), s/veh        | 3.7  | 18.7 | 0.0  | 3.1  | 3.1  | 0.0  | 0.7  | 0.0  | 0.0  | 0.1  | 0.0  | 0.0  |
| Initial Q Delay(d3),s/veh     | 0.0  | 0.0  | 0.0  | 0.0  | 0.0  | 0.0  | 0.0  | 0.0  | 0.0  | 0.0  | 0.0  | 0.0  |
| %ile BackOfQ(50%),veh/ln      | 2.5  | 27.3 | 0.0  | 4.1  | 15.6 | 0.0  | 4.2  | 0.0  | 0.0  | 1.0  | 0.0  | 0.0  |
| LnGrp Delay(d),s/veh          | 39.9 | 35.5 | 0.0  | 37.3 | 15.0 | 0.0  | 33.4 | 0.0  | 0.0  | 29.6 | 0.0  | 0.0  |
| LnGrp LOS                     | D    | D    |      | D    | B    |      | C    |      |      | C    |      |      |
| Approach Vol, veh/h           |      | 1140 |      |      | 1075 |      |      | 194  |      |      | 54   |      |
| Approach Delay, s/veh         |      | 35.9 |      |      | 18.8 |      |      | 33.4 |      |      | 29.6 |      |
| Approach LOS                  |      | D    |      |      | B    |      |      | C    |      |      | C    |      |
| Timer                         | 1    | 2    | 3    | 4    | 5    | 6    | 7    | 8    |      |      |      |      |
| Assigned Phs                  | 1    | 2    |      | 4    | 5    | 6    |      | 8    |      |      |      |      |
| Phs Duration (G+Y+Rc), s      | 3.3  | 50.3 |      | 16.2 | 10.1 | 53.5 |      | 16.2 |      |      |      |      |
| Change Period (Y+Rc), s       | 3.5  | 5.3  |      | 4.0  | 4.0  | 5.3  |      | 4.0  |      |      |      |      |
| Max Green Setting (Gmax), s   | 20.0 | 50.0 |      | 30.0 | 20.0 | 50.0 |      | 30.0 |      |      |      |      |
| Max Q Clear Time (g_c+110), s | 11.0 | 44.4 |      | 4.1  | 6.7  | 30.5 |      | 12.0 |      |      |      |      |
| Green Ext Time (p_c), s       | 0.0  | 0.7  |      | 0.0  | 0.0  | 0.7  |      | 0.2  |      |      |      |      |
| <b>Intersection Summary</b>   |      |      |      |      |      |      |      |      |      |      |      |      |
| HCM 2010 Ctrl Delay           |      |      |      | 28.1 |      |      |      |      |      |      |      |      |
| HCM 2010 LOS                  |      |      |      | C    |      |      |      |      |      |      |      |      |

| Movement                    | EBL  | EBT   | EBR  | WBL  | WBT  | WBR   | NBL  | NBT  | NBR  | SBL  | SBT  | SBR  |
|-----------------------------|------|-------|------|------|------|-------|------|------|------|------|------|------|
| Lane Configurations         |      |       |      |      |      |       |      |      |      |      |      |      |
| Traffic Volume (veh/h)      | 100  | 10    | 1070 | 10   | 30   | 30    | 890  | 540  | 10   | 10   | 650  | 190  |
| Future Volume (veh/h)       | 100  | 10    | 1070 | 10   | 30   | 30    | 890  | 540  | 10   | 10   | 650  | 190  |
| Number                      | 3    | 8     | 18   | 7    | 4    | 14    | 1    | 6    | 16   | 5    | 2    | 12   |
| Initial Q (Qb), veh         | 0    | 0     | 0    | 0    | 0    | 0     | 0    | 0    | 0    | 0    | 0    | 0    |
| Ped-Bike Adj(A_pbT)         | 1.00 |       | 1.00 | 1.00 |      | 0.98  | 1.00 |      | 1.00 | 1.00 |      | 1.00 |
| Parking Bus, Adj            | 1.00 | 1.00  | 1.00 | 1.00 | 1.00 | 1.00  | 1.00 | 1.00 | 1.00 | 1.00 | 1.00 | 1.00 |
| Adj Sat Flow, veh/h/ln      | 1881 | 1881  | 1881 | 1827 | 1827 | 1827  | 1881 | 1881 | 1881 | 1881 | 1881 | 1881 |
| Adj Flow Rate, veh/h        | 120  | 0     | 801  | 11   | 34   | 12    | 1000 | 607  | 10   | 11   | 730  | 79   |
| Adj No. of Lanes            | 2    | 0     | 2    | 1    | 1    | 1     | 2    | 2    | 1    | 2    | 2    | 1    |
| Peak Hour Factor            | 0.89 | 0.89  | 0.89 | 0.89 | 0.89 | 0.89  | 0.89 | 0.89 | 0.89 | 0.89 | 0.89 | 0.89 |
| Percent Heavy Veh, %        | 1    | 1     | 1    | 4    | 4    | 4     | 1    | 1    | 1    | 1    | 1    | 1    |
| Cap, veh/h                  | 735  | 0     | 1573 | 66   | 70   | 58    | 1001 | 2057 | 920  | 35   | 1065 | 476  |
| Arrive On Green             | 0.21 | 0.00  | 0.21 | 0.04 | 0.04 | 0.04  | 0.29 | 0.58 | 0.58 | 0.01 | 0.30 | 0.30 |
| Sat Flow, veh/h             | 3583 | 0     | 3182 | 1740 | 1827 | 1528  | 3476 | 3574 | 1599 | 3476 | 3574 | 1599 |
| Grp Volume(v), veh/h        | 120  | 0     | 801  | 11   | 34   | 12    | 1000 | 607  | 10   | 11   | 730  | 79   |
| Grp Sat Flow(s),veh/h/ln    | 1792 | 0     | 1591 | 1740 | 1827 | 1528  | 1738 | 1787 | 1599 | 1738 | 1787 | 1599 |
| Q Serve(g_s), s             | 3.3  | 0.0   | 20.7 | 0.7  | 2.2  | 0.9   | 35.0 | 10.6 | 0.3  | 0.4  | 21.9 | 4.4  |
| Cycle Q Clear(g_c), s       | 3.3  | 0.0   | 20.7 | 0.7  | 2.2  | 0.9   | 35.0 | 10.6 | 0.3  | 0.4  | 21.9 | 4.4  |
| Prop In Lane                | 1.00 |       | 1.00 | 1.00 |      | 1.00  | 1.00 |      | 1.00 | 1.00 |      | 1.00 |
| Lane Grp Cap(c), veh/h      | 735  | 0     | 1573 | 66   | 70   | 58    | 1001 | 2057 | 920  | 35   | 1065 | 476  |
| V/C Ratio(X)                | 0.16 | 0.00  | 0.51 | 0.17 | 0.49 | 0.21  | 1.00 | 0.30 | 0.01 | 0.31 | 0.69 | 0.17 |
| Avail Cap(c_a), veh/h       | 1032 | 0     | 1837 | 444  | 466  | 390   | 1001 | 2057 | 920  | 572  | 1764 | 789  |
| HCM Platoon Ratio           | 1.00 | 1.00  | 1.00 | 1.00 | 1.00 | 1.00  | 1.00 | 1.00 | 1.00 | 1.00 | 1.00 | 1.00 |
| Upstream Filter(I)          | 1.00 | 0.00  | 1.00 | 1.00 | 1.00 | 1.00  | 1.00 | 1.00 | 1.00 | 1.00 | 1.00 | 1.00 |
| Uniform Delay (d), s/veh    | 39.7 | 0.0   | 20.9 | 56.6 | 57.3 | 56.7  | 43.3 | 13.2 | 11.0 | 59.7 | 37.7 | 31.5 |
| Incr Delay (d2), s/veh      | 0.0  | 0.0   | 0.1  | 0.4  | 2.0  | 0.6   | 28.3 | 0.2  | 0.0  | 1.8  | 2.2  | 0.4  |
| Initial Q Delay(d3),s/veh   | 0.0  | 0.0   | 0.0  | 0.0  | 0.0  | 0.0   | 0.0  | 0.0  | 0.0  | 0.0  | 0.0  | 0.0  |
| %ile BackOfQ(50%),veh/ln    | 1.7  | 0.0   | 9.1  | 0.4  | 1.2  | 0.4   | 20.6 | 5.3  | 0.1  | 0.2  | 11.2 | 2.0  |
| LnGrp Delay(d),s/veh        | 39.8 | 0.0   | 21.0 | 57.0 | 59.3 | 57.3  | 71.6 | 13.4 | 11.0 | 61.6 | 39.8 | 32.0 |
| LnGrp LOS                   | D    |       | C    | E    | E    | E     | E    | B    | B    | E    | D    | C    |
| Approach Vol, veh/h         |      | 921   |      |      | 57   |       |      | 1617 |      |      | 820  |      |
| Approach Delay, s/veh       |      | 23.4  |      |      | 58.4 |       |      | 49.4 |      |      | 39.4 |      |
| Approach LOS                |      | C     |      |      | E    |       |      | D    |      |      | D    |      |
| Timer                       | 1    | 2     | 3    | 4    | 5    | 6     | 7    | 8    |      |      |      |      |
| Assigned Phs                | 1    | 2     |      | 4    | 5    | 6     |      | 8    |      |      |      |      |
| Phs Duration (G+Y+Rc), s    | 39.1 | 42.4  |      | 9.6  | 5.3  | 76.2  |      | 30.4 |      |      |      |      |
| Change Period (Y+Rc), s     | 4.1  | * 6.2 |      | 5.0  | 4.1  | * 6.2 |      | 5.5  |      |      |      |      |
| Max Green Setting (Gmax), s | 35.0 | * 60  |      | 31.0 | 20.0 | * 50  |      | 35.0 |      |      |      |      |
| Max Q Clear Time (g_c+Q), s | 37.0 | 23.9  |      | 4.2  | 2.4  | 12.6  |      | 22.7 |      |      |      |      |
| Green Ext Time (p_c), s     | 0.0  | 12.3  |      | 0.1  | 0.0  | 9.3   |      | 1.8  |      |      |      |      |
| <b>Intersection Summary</b> |      |       |      |      |      |       |      |      |      |      |      |      |
| HCM 2010 Ctrl Delay         | 40.1 |       |      |      |      |       |      |      |      |      |      |      |
| HCM 2010 LOS                | D    |       |      |      |      |       |      |      |      |      |      |      |
| <b>Notes</b>                |      |       |      |      |      |       |      |      |      |      |      |      |

HCM 2010 Signalized Intersection Summary  
 13: Reservation Road & Blanco Road

Existing with Project, PM  
 06/11/2019

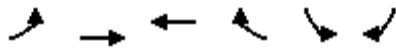

| Movement                     | EBL  | EBT  | WBT  | WBR  | SBL  | SBR  |   |   |
|------------------------------|------|------|------|------|------|------|---|---|
| Lane Configurations          | ↶↷   | ↶↷   | ↶    | ↶    | ↶↷   | ↶↷   |   |   |
| Traffic Volume (veh/h)       | 1080 | 560  | 340  | 40   | 30   | 1110 |   |   |
| Future Volume (veh/h)        | 1080 | 560  | 340  | 40   | 30   | 1110 |   |   |
| Number                       | 5    | 2    | 6    | 16   | 7    | 14   |   |   |
| Initial Q (Qb), veh          | 0    | 0    | 0    | 0    | 0    | 0    |   |   |
| Ped-Bike Adj(A_pbT)          | 1.00 |      |      | 1.00 | 1.00 | 1.00 |   |   |
| Parking Bus, Adj             | 1.00 | 1.00 | 1.00 | 1.00 | 1.00 | 1.00 |   |   |
| Adj Sat Flow, veh/h/ln       | 1881 | 1881 | 1863 | 1863 | 1863 | 1863 |   |   |
| Adj Flow Rate, veh/h         | 1149 | 596  | 362  | 19   | 32   | 0    |   |   |
| Adj No. of Lanes             | 2    | 2    | 1    | 1    | 2    | 2    |   |   |
| Peak Hour Factor             | 0.94 | 0.94 | 0.94 | 0.94 | 0.94 | 0.94 |   |   |
| Percent Heavy Veh, %         | 1    | 1    | 2    | 2    | 2    | 2    |   |   |
| Cap, veh/h                   | 1295 | 2708 | 483  | 411  | 101  | 82   |   |   |
| Arrive On Green              | 0.37 | 0.76 | 0.26 | 0.26 | 0.03 | 0.00 |   |   |
| Sat Flow, veh/h              | 3476 | 3668 | 1863 | 1583 | 3442 | 2787 |   |   |
| Grp Volume(v), veh/h         | 1149 | 596  | 362  | 19   | 32   | 0    |   |   |
| Grp Sat Flow(s),veh/h/ln     | 1738 | 1787 | 1863 | 1583 | 1721 | 1393 |   |   |
| Q Serve(g_s), s              | 13.5 | 2.1  | 7.8  | 0.4  | 0.4  | 0.0  |   |   |
| Cycle Q Clear(g_c), s        | 13.5 | 2.1  | 7.8  | 0.4  | 0.4  | 0.0  |   |   |
| Prop In Lane                 | 1.00 |      |      | 1.00 | 1.00 | 1.00 |   |   |
| Lane Grp Cap(c), veh/h       | 1295 | 2708 | 483  | 411  | 101  | 82   |   |   |
| V/C Ratio(X)                 | 0.89 | 0.22 | 0.75 | 0.05 | 0.32 | 0.00 |   |   |
| Avail Cap(c_a), veh/h        | 3181 | 4907 | 2557 | 2174 | 2126 | 1721 |   |   |
| HCM Platoon Ratio            | 1.00 | 1.00 | 1.00 | 1.00 | 1.00 | 1.00 |   |   |
| Upstream Filter(I)           | 1.00 | 1.00 | 1.00 | 1.00 | 1.00 | 0.00 |   |   |
| Uniform Delay (d), s/veh     | 12.9 | 1.5  | 14.9 | 12.1 | 20.8 | 0.0  |   |   |
| Incr Delay (d2), s/veh       | 0.9  | 0.0  | 1.8  | 0.0  | 0.7  | 0.0  |   |   |
| Initial Q Delay(d3),s/veh    | 0.0  | 0.0  | 0.0  | 0.0  | 0.0  | 0.0  |   |   |
| %ile BackOfQ(50%),veh/ln     | 6.5  | 1.0  | 4.2  | 0.2  | 0.2  | 0.0  |   |   |
| LnGrp Delay(d),s/veh         | 13.7 | 1.6  | 16.6 | 12.2 | 21.4 | 0.0  |   |   |
| LnGrp LOS                    | B    | A    | B    | B    | C    |      |   |   |
| Approach Vol, veh/h          |      | 1745 | 381  |      | 32   |      |   |   |
| Approach Delay, s/veh        |      | 9.6  | 16.4 |      | 21.4 |      |   |   |
| Approach LOS                 |      | A    | B    |      | C    |      |   |   |
| Timer                        | 1    | 2    | 3    | 4    | 5    | 6    | 7 | 8 |
| Assigned Phs                 |      | 2    |      | 4    | 5    | 6    |   |   |
| Phs Duration (G+Y+Rc), s     |      | 38.9 |      | 4.8  | 21.8 | 17.1 |   |   |
| Change Period (Y+Rc), s      |      | 5.8  |      | 3.5  | 5.5  | 5.8  |   |   |
| Max Green Setting (Gmax), s  |      | 60.0 |      | 27.0 | 40.0 | 60.0 |   |   |
| Max Q Clear Time (g_c+I1), s |      | 4.1  |      | 2.4  | 15.5 | 9.8  |   |   |
| Green Ext Time (p_c), s      |      | 3.0  |      | 0.0  | 0.7  | 1.5  |   |   |
| <b>Intersection Summary</b>  |      |      |      |      |      |      |   |   |
| HCM 2010 Ctrl Delay          |      |      | 11.0 |      |      |      |   |   |
| HCM 2010 LOS                 |      |      | B    |      |      |      |   |   |

HCM 2010 Signalized Intersection Summary  
 14: Reservation Road & Inter-Garrison Road

Existing with Project, PM  
 06/11/2019



| Movement                     | EBL  | EBR  | NBL  | NBT  | SBT  | SBR  |   |      |
|------------------------------|------|------|------|------|------|------|---|------|
| Lane Configurations          |      |      |      |      |      |      |   |      |
| Traffic Volume (veh/h)       | 50   | 350  | 200  | 340  | 530  | 50   |   |      |
| Future Volume (veh/h)        | 50   | 350  | 200  | 340  | 530  | 50   |   |      |
| Number                       | 3    | 18   | 1    | 6    | 2    | 12   |   |      |
| Initial Q (Qb), veh          | 0    | 0    | 0    | 0    | 0    | 0    |   |      |
| Ped-Bike Adj(A_pbT)          | 1.00 | 1.00 | 1.00 |      |      | 1.00 |   |      |
| Parking Bus, Adj             | 1.00 | 1.00 | 1.00 | 1.00 | 1.00 | 1.00 |   |      |
| Adj Sat Flow, veh/h/ln       | 1881 | 1881 | 1845 | 1845 | 1881 | 1900 |   |      |
| Adj Flow Rate, veh/h         | 61   | 272  | 244  | 415  | 646  | 52   |   |      |
| Adj No. of Lanes             | 1    | 1    | 1    | 2    | 2    | 0    |   |      |
| Peak Hour Factor             | 0.82 | 0.82 | 0.82 | 0.82 | 0.82 | 0.82 |   |      |
| Percent Heavy Veh, %         | 1    | 1    | 3    | 3    | 1    | 1    |   |      |
| Cap, veh/h                   | 336  | 573  | 300  | 2128 | 1164 | 94   |   |      |
| Arrive On Green              | 0.19 | 0.19 | 0.17 | 0.61 | 0.35 | 0.35 |   |      |
| Sat Flow, veh/h              | 1792 | 1599 | 1757 | 3597 | 3445 | 269  |   |      |
| Grp Volume(v), veh/h         | 61   | 272  | 244  | 415  | 344  | 354  |   |      |
| Grp Sat Flow(s),veh/h/ln     | 1792 | 1599 | 1757 | 1752 | 1787 | 1834 |   |      |
| Q Serve(g_s), s              | 1.5  | 7.0  | 7.1  | 2.8  | 8.3  | 8.3  |   |      |
| Cycle Q Clear(g_c), s        | 1.5  | 7.0  | 7.1  | 2.8  | 8.3  | 8.3  |   |      |
| Prop In Lane                 | 1.00 | 1.00 | 1.00 |      |      | 0.15 |   |      |
| Lane Grp Cap(c), veh/h       | 336  | 573  | 300  | 2128 | 621  | 637  |   |      |
| V/C Ratio(X)                 | 0.18 | 0.47 | 0.81 | 0.20 | 0.55 | 0.56 |   |      |
| Avail Cap(c_a), veh/h        | 912  | 1087 | 662  | 3965 | 2022 | 2074 |   |      |
| HCM Platoon Ratio            | 1.00 | 1.00 | 1.00 | 1.00 | 1.00 | 1.00 |   |      |
| Upstream Filter(I)           | 1.00 | 1.00 | 1.00 | 1.00 | 1.00 | 1.00 |   |      |
| Uniform Delay (d), s/veh     | 18.1 | 13.2 | 21.2 | 4.6  | 14.0 | 14.0 |   |      |
| Incr Delay (d2), s/veh       | 0.3  | 0.6  | 2.0  | 0.1  | 1.4  | 1.4  |   |      |
| Initial Q Delay(d3),s/veh    | 0.0  | 0.0  | 0.0  | 0.0  | 0.0  | 0.0  |   |      |
| %ile BackOfQ(50%),veh/ln     | 0.8  | 3.1  | 3.6  | 1.4  | 4.3  | 4.4  |   |      |
| LnGrp Delay(d),s/veh         | 18.4 | 13.8 | 23.2 | 4.7  | 15.4 | 15.4 |   |      |
| LnGrp LOS                    | B    | B    | C    | A    | B    | B    |   |      |
| Approach Vol, veh/h          | 333  |      |      | 659  | 698  |      |   |      |
| Approach Delay, s/veh        | 14.6 |      |      | 11.6 | 15.4 |      |   |      |
| Approach LOS                 | B    |      |      | B    | B    |      |   |      |
| Timer                        | 1    | 2    | 3    | 4    | 5    | 6    | 7 | 8    |
| Assigned Phs                 | 1    | 2    |      |      |      | 6    |   | 8    |
| Phs Duration (G+Y+Rc), s     | 3.8  | 24.8 |      |      |      | 38.6 |   | 14.4 |
| Change Period (Y+Rc), s      | 4.7  | 6.4  |      |      |      | 6.4  |   | 4.5  |
| Max Green Setting (Gmax), s  | 20   | 60.0 |      |      |      | 60.0 |   | 27.0 |
| Max Q Clear Time (g_c+19), s | 10.3 |      |      |      |      | 4.8  |   | 9.0  |
| Green Ext Time (p_c), s      | 0.2  | 8.2  |      |      |      | 4.8  |   | 1.0  |
| <b>Intersection Summary</b>  |      |      |      |      |      |      |   |      |
| HCM 2010 Ctrl Delay          |      |      | 13.8 |      |      |      |   |      |
| HCM 2010 LOS                 |      |      | B    |      |      |      |   |      |
| <b>Notes</b>                 |      |      |      |      |      |      |   |      |

| Intersection              |      |  |  |  |  |  |  |  |  |  |  |  |
|---------------------------|------|--|--|--|--|--|--|--|--|--|--|--|
| Intersection Delay, s/veh | 14.3 |  |  |  |  |  |  |  |  |  |  |  |
| Intersection LOS          | B    |  |  |  |  |  |  |  |  |  |  |  |

| Movement            | EBL  | EBT  | EBR  | WBL  | WBT  | WBR  | NBL  | NBT  | NBR  | SBL  | SBT  | SBR  |
|---------------------|------|------|------|------|------|------|------|------|------|------|------|------|
| Lane Configurations |      | ↖    | ↗    |      | ↕    |      | ↖    | ↗    |      |      | ↖    | ↗    |
| Traffic Vol, veh/h  | 30   | 10   | 10   | 10   | 10   | 10   | 20   | 400  | 30   | 10   | 260  | 30   |
| Future Vol, veh/h   | 30   | 10   | 10   | 10   | 10   | 10   | 20   | 400  | 30   | 10   | 260  | 30   |
| Peak Hour Factor    | 0.91 | 0.91 | 0.91 | 0.91 | 0.91 | 0.91 | 0.91 | 0.91 | 0.91 | 0.91 | 0.91 | 0.91 |
| Heavy Vehicles, %   | 0    | 0    | 0    | 0    | 0    | 0    | 1    | 1    | 1    | 4    | 4    | 4    |
| Mvmt Flow           | 33   | 11   | 11   | 11   | 11   | 11   | 22   | 440  | 33   | 11   | 286  | 33   |
| Number of Lanes     | 0    | 1    | 1    | 0    | 1    | 0    | 1    | 1    | 0    | 0    | 1    | 1    |

| Approach                   | EB | WB  | NB   | SB   |
|----------------------------|----|-----|------|------|
| Opposing Approach          | WB | EB  | SB   | NB   |
| Opposing Lanes             | 1  | 2   | 2    | 2    |
| Conflicting Approach Left  | SB | NB  | EB   | WB   |
| Conflicting Lanes Left     | 2  | 2   | 2    | 1    |
| Conflicting Approach Right | NB | SB  | WB   | EB   |
| Conflicting Lanes Right    | 2  | 2   | 1    | 2    |
| HCM Control Delay          | 10 | 9.9 | 16.8 | 11.6 |
| HCM LOS                    | A  | A   | C    | B    |

| Lane                   | NBLn1 | NBLn2 | EBLn1 | EBLn2 | WBLn1 | SBLn1 | SBLn2 |
|------------------------|-------|-------|-------|-------|-------|-------|-------|
| Vol Left, %            | 100%  | 0%    | 75%   | 0%    | 33%   | 4%    | 0%    |
| Vol Thru, %            | 0%    | 93%   | 25%   | 0%    | 33%   | 96%   | 0%    |
| Vol Right, %           | 0%    | 7%    | 0%    | 100%  | 33%   | 0%    | 100%  |
| Sign Control           | Stop  | Stop  | Stop  | Stop  | Stop  | Stop  | Stop  |
| Traffic Vol by Lane    | 20    | 430   | 40    | 10    | 30    | 270   | 30    |
| LT Vol                 | 20    | 0     | 30    | 0     | 10    | 10    | 0     |
| Through Vol            | 0     | 400   | 10    | 0     | 10    | 260   | 0     |
| RT Vol                 | 0     | 30    | 0     | 10    | 10    | 0     | 30    |
| Lane Flow Rate         | 22    | 473   | 44    | 11    | 33    | 297   | 33    |
| Geometry Grp           | 7     | 7     | 7     | 7     | 6     | 7     | 7     |
| Degree of Util (X)     | 0.034 | 0.661 | 0.085 | 0.018 | 0.06  | 0.436 | 0.042 |
| Departure Headway (Hd) | 5.591 | 5.039 | 6.966 | 5.875 | 6.519 | 5.294 | 4.571 |
| Convergence, Y/N       | Yes   | Yes   | Yes   | Yes   | Yes   | Yes   | Yes   |
| Cap                    | 638   | 714   | 517   | 613   | 553   | 676   | 777   |
| Service Time           | 3.35  | 2.798 | 4.668 | 3.576 | 4.52  | 3.059 | 2.335 |
| HCM Lane V/C Ratio     | 0.034 | 0.662 | 0.085 | 0.018 | 0.06  | 0.439 | 0.042 |
| HCM Control Delay      | 8.5   | 17.2  | 10.3  | 8.7   | 9.9   | 12.1  | 7.5   |
| HCM Lane LOS           | A     | C     | B     | A     | A     | B     | A     |
| HCM 95th-tile Q        | 0.1   | 5     | 0.3   | 0.1   | 0.2   | 2.2   | 0.1   |

| Intersection              |      |  |  |  |  |  |  |  |  |  |  |  |
|---------------------------|------|--|--|--|--|--|--|--|--|--|--|--|
| Intersection Delay, s/veh | 23.3 |  |  |  |  |  |  |  |  |  |  |  |
| Intersection LOS          | C    |  |  |  |  |  |  |  |  |  |  |  |

| Movement            | EBL  | EBT  | EBR  | WBL  | WBT  | WBR  | NBL  | NBT  | NBR  | SBL  | SBT  | SBR  |
|---------------------|------|------|------|------|------|------|------|------|------|------|------|------|
| Lane Configurations | ↖    | ↑    | ↗    |      | ↖    | ↗    | ↖    | ↑    | ↗    | ↖    | ↗    |      |
| Traffic Vol, veh/h  | 10   | 10   | 10   | 180  | 10   | 50   | 10   | 400  | 160  | 50   | 310  | 10   |
| Future Vol, veh/h   | 10   | 10   | 10   | 180  | 10   | 50   | 10   | 400  | 160  | 50   | 310  | 10   |
| Peak Hour Factor    | 0.94 | 0.94 | 0.94 | 0.94 | 0.94 | 0.94 | 0.94 | 0.94 | 0.94 | 0.94 | 0.94 | 0.94 |
| Heavy Vehicles, %   | 0    | 0    | 0    | 0    | 0    | 0    | 1    | 1    | 1    | 4    | 4    | 4    |
| Mvmt Flow           | 11   | 11   | 11   | 191  | 11   | 53   | 11   | 426  | 170  | 53   | 330  | 11   |
| Number of Lanes     | 1    | 1    | 1    | 0    | 1    | 1    | 1    | 1    | 1    | 1    | 1    | 0    |

| Approach                   | EB   | WB   | NB   | SB   |
|----------------------------|------|------|------|------|
| Opposing Approach          | WB   | EB   | SB   | NB   |
| Opposing Lanes             | 2    | 3    | 2    | 3    |
| Conflicting Approach Left  | SB   | NB   | EB   | WB   |
| Conflicting Lanes Left     | 2    | 3    | 3    | 2    |
| Conflicting Approach Right | NB   | SB   | WB   | EB   |
| Conflicting Lanes Right    | 3    | 2    | 2    | 3    |
| HCM Control Delay          | 11.6 | 16.5 | 27.1 | 22.7 |
| HCM LOS                    | B    | C    | D    | C    |

| Lane                   | NBLn1 | NBLn2 | NBLn3 | EBLn1 | EBLn2 | EBLn3 | WBLn1 | WBLn2 | SBLn1 | SBLn2 |
|------------------------|-------|-------|-------|-------|-------|-------|-------|-------|-------|-------|
| Vol Left, %            | 100%  | 0%    | 0%    | 100%  | 0%    | 0%    | 95%   | 0%    | 100%  | 0%    |
| Vol Thru, %            | 0%    | 100%  | 0%    | 0%    | 100%  | 0%    | 5%    | 0%    | 0%    | 97%   |
| Vol Right, %           | 0%    | 0%    | 100%  | 0%    | 0%    | 100%  | 0%    | 100%  | 0%    | 3%    |
| Sign Control           | Stop  | Stop  | Stop  | Stop  | Stop  | Stop  | Stop  | Stop  | Stop  | Stop  |
| Traffic Vol by Lane    | 10    | 400   | 160   | 10    | 10    | 10    | 190   | 50    | 50    | 320   |
| LT Vol                 | 10    | 0     | 0     | 10    | 0     | 0     | 180   | 0     | 50    | 0     |
| Through Vol            | 0     | 400   | 0     | 0     | 10    | 0     | 10    | 0     | 0     | 310   |
| RT Vol                 | 0     | 0     | 160   | 0     | 0     | 10    | 0     | 50    | 0     | 10    |
| Lane Flow Rate         | 11    | 426   | 170   | 11    | 11    | 11    | 202   | 53    | 53    | 340   |
| Geometry Grp           | 8     | 8     | 8     | 8     | 8     | 8     | 8     | 8     | 8     | 8     |
| Degree of Util (X)     | 0.022 | 0.817 | 0.293 | 0.027 | 0.026 | 0.024 | 0.464 | 0.104 | 0.115 | 0.686 |
| Departure Headway (Hd) | 7.42  | 6.914 | 6.205 | 9.22  | 8.706 | 7.985 | 8.257 | 7.063 | 7.783 | 7.255 |
| Convergence, Y/N       | Yes   | Yes   | Yes   | Yes   | Yes   | Yes   | Yes   | Yes   | Yes   | Yes   |
| Cap                    | 483   | 523   | 579   | 388   | 411   | 447   | 437   | 507   | 461   | 497   |
| Service Time           | 5.161 | 4.654 | 3.945 | 6.985 | 6.47  | 5.75  | 6.001 | 4.807 | 5.525 | 4.998 |
| HCM Lane V/C Ratio     | 0.023 | 0.815 | 0.294 | 0.028 | 0.027 | 0.025 | 0.462 | 0.105 | 0.115 | 0.684 |
| HCM Control Delay      | 10.3  | 33.7  | 11.5  | 12.2  | 11.7  | 10.9  | 18    | 10.6  | 11.5  | 24.5  |
| HCM Lane LOS           | B     | D     | B     | B     | B     | B     | C     | B     | B     | C     |
| HCM 95th-tile Q        | 0.1   | 8     | 1.2   | 0.1   | 0.1   | 0.1   | 2.4   | 0.3   | 0.4   | 5.2   |

**Intersection**

Intersection Delay, s/veh 12.3

Intersection LOS B

| Movement            | EBT  | EBR  | WBL  | WBT  | NBL  | NBR  |
|---------------------|------|------|------|------|------|------|
| Lane Configurations | ↑    | ↗    | ↖    | ↑    | ↖    | ↗    |
| Traffic Vol, veh/h  | 170  | 50   | 220  | 180  | 50   | 270  |
| Future Vol, veh/h   | 170  | 50   | 220  | 180  | 50   | 270  |
| Peak Hour Factor    | 0.92 | 0.92 | 0.92 | 0.92 | 0.92 | 0.92 |
| Heavy Vehicles, %   | 2    | 2    | 2    | 2    | 2    | 2    |
| Mvmt Flow           | 185  | 54   | 239  | 196  | 54   | 293  |
| Number of Lanes     | 1    | 1    | 1    | 1    | 1    | 1    |

| Approach                   | EB   | WB   | NB   |
|----------------------------|------|------|------|
| Opposing Approach          | WB   | EB   |      |
| Opposing Lanes             | 2    | 2    | 0    |
| Conflicting Approach Left  |      | NB   | EB   |
| Conflicting Lanes Left     | 0    | 2    | 2    |
| Conflicting Approach Right | NB   |      | WB   |
| Conflicting Lanes Right    | 2    | 0    | 2    |
| HCM Control Delay          | 11.1 | 12.7 | 12.7 |
| HCM LOS                    | B    | B    | B    |

| Lane                   | NBLn1 | NBLn2 | EBLn1 | EBLn2 | WBLn1 | WBLn2 |
|------------------------|-------|-------|-------|-------|-------|-------|
| Vol Left, %            | 100%  | 0%    | 0%    | 0%    | 100%  | 0%    |
| Vol Thru, %            | 0%    | 0%    | 100%  | 0%    | 0%    | 100%  |
| Vol Right, %           | 0%    | 100%  | 0%    | 100%  | 0%    | 0%    |
| Sign Control           | Stop  | Stop  | Stop  | Stop  | Stop  | Stop  |
| Traffic Vol by Lane    | 50    | 270   | 170   | 50    | 220   | 180   |
| LT Vol                 | 50    | 0     | 0     | 0     | 220   | 0     |
| Through Vol            | 0     | 0     | 170   | 0     | 0     | 180   |
| RT Vol                 | 0     | 270   | 0     | 50    | 0     | 0     |
| Lane Flow Rate         | 54    | 293   | 185   | 54    | 239   | 196   |
| Geometry Grp           | 7     | 7     | 7     | 7     | 7     | 7     |
| Degree of Util (X)     | 0.103 | 0.459 | 0.318 | 0.083 | 0.426 | 0.321 |
| Departure Headway (Hd) | 6.838 | 5.626 | 6.19  | 5.478 | 6.411 | 5.904 |
| Convergence, Y/N       | Yes   | Yes   | Yes   | Yes   | Yes   | Yes   |
| Cap                    | 524   | 640   | 580   | 653   | 562   | 608   |
| Service Time           | 4.578 | 3.365 | 3.931 | 3.219 | 4.147 | 3.64  |
| HCM Lane V/C Ratio     | 0.103 | 0.458 | 0.319 | 0.083 | 0.425 | 0.322 |
| HCM Control Delay      | 10.4  | 13.1  | 11.8  | 8.7   | 13.8  | 11.4  |
| HCM Lane LOS           | B     | B     | B     | A     | B     | B     |
| HCM 95th-tile Q        | 0.3   | 2.4   | 1.4   | 0.3   | 2.1   | 1.4   |

| Intersection              |      |  |  |  |  |  |  |  |  |  |  |  |
|---------------------------|------|--|--|--|--|--|--|--|--|--|--|--|
| Intersection Delay, s/veh | 21.7 |  |  |  |  |  |  |  |  |  |  |  |
| Intersection LOS          | C    |  |  |  |  |  |  |  |  |  |  |  |

| Movement            | EBL  | EBT  | EBR  | WBL  | WBT  | WBR  | NBL  | NBT  | NBR  | SBL  | SBT  | SBR  |
|---------------------|------|------|------|------|------|------|------|------|------|------|------|------|
| Lane Configurations |      |      |      |      |      |      |      |      |      |      |      |      |
| Traffic Vol, veh/h  | 190  | 60   | 20   | 10   | 50   | 370  | 20   | 20   | 20   | 260  | 20   | 90   |
| Future Vol, veh/h   | 190  | 60   | 20   | 10   | 50   | 370  | 20   | 20   | 20   | 260  | 20   | 90   |
| Peak Hour Factor    | 0.91 | 0.91 | 0.91 | 0.91 | 0.91 | 0.91 | 0.91 | 0.91 | 0.91 | 0.91 | 0.91 | 0.91 |
| Heavy Vehicles, %   | 3    | 3    | 3    | 1    | 1    | 1    | 0    | 0    | 0    | 2    | 2    | 2    |
| Mvmt Flow           | 209  | 66   | 22   | 11   | 55   | 407  | 22   | 22   | 22   | 286  | 22   | 99   |
| Number of Lanes     | 1    | 1    | 0    | 1    | 1    | 1    | 0    | 1    | 0    | 0    | 1    | 1    |

| Approach                   | EB   | WB   | NB   | SB   |
|----------------------------|------|------|------|------|
| Opposing Approach          | WB   | EB   | SB   | NB   |
| Opposing Lanes             | 3    | 2    | 2    | 1    |
| Conflicting Approach Left  | SB   | NB   | EB   | WB   |
| Conflicting Lanes Left     | 2    | 1    | 2    | 3    |
| Conflicting Approach Right | NB   | SB   | WB   | EB   |
| Conflicting Lanes Right    | 1    | 2    | 3    | 2    |
| HCM Control Delay          | 16.8 | 25.3 | 12.9 | 22.6 |
| HCM LOS                    | C    | D    | B    | C    |

| Lane                   | NBLn1 | EBLn1 | EBLn2 | WBLn1 | WBLn2 | WBLn3 | SBLn1 | SBLn2 |
|------------------------|-------|-------|-------|-------|-------|-------|-------|-------|
| Vol Left, %            |       | 33%   | 100%  | 0%    | 100%  | 0%    | 0%    | 93%   |
| Vol Thru, %            |       | 33%   | 0%    | 75%   | 0%    | 100%  | 0%    | 7%    |
| Vol Right, %           |       | 33%   | 0%    | 25%   | 0%    | 0%    | 100%  | 0%    |
| Sign Control           |       | Stop  | Stop  | Stop  | Stop  | Stop  | Stop  | Stop  |
| Traffic Vol by Lane    |       | 60    | 190   | 80    | 10    | 50    | 370   | 280   |
| LT Vol                 |       | 20    | 190   | 0     | 10    | 0     | 0     | 260   |
| Through Vol            |       | 20    | 0     | 60    | 0     | 50    | 0     | 20    |
| RT Vol                 |       | 20    | 0     | 20    | 0     | 0     | 370   | 0     |
| Lane Flow Rate         |       | 66    | 209   | 88    | 11    | 55    | 407   | 308   |
| Geometry Grp           |       | 8     | 8     | 8     | 8     | 8     | 8     | 8     |
| Degree of Util (X)     |       | 0.156 | 0.484 | 0.187 | 0.024 | 0.113 | 0.758 | 0.682 |
| Departure Headway (Hd) |       | 8.543 | 8.34  | 7.644 | 7.941 | 7.429 | 6.712 | 7.984 |
| Convergence, Y/N       |       | Yes   | Yes   | Yes   | Yes   | Yes   | Yes   | Yes   |
| Cap                    |       | 418   | 432   | 469   | 450   | 481   | 537   | 452   |
| Service Time           |       | 6.331 | 6.108 | 5.411 | 5.7   | 5.188 | 4.471 | 5.748 |
| HCM Lane V/C Ratio     |       | 0.158 | 0.484 | 0.188 | 0.024 | 0.114 | 0.758 | 0.681 |
| HCM Control Delay      |       | 12.9  | 18.7  | 12.2  | 10.9  | 11.1  | 27.6  | 26.3  |
| HCM Lane LOS           |       | B     | C     | B     | B     | B     | D     | D     |
| HCM 95th-tile Q        |       | 0.5   | 2.6   | 0.7   | 0.1   | 0.4   | 6.6   | 5     |



| Intersection              |      |
|---------------------------|------|
| Intersection Delay, s/veh | 22.3 |
| Intersection LOS          | C    |

| Movement            | WBL  | WBR  | NBT  | NBR  | SBL  | SBT  |
|---------------------|------|------|------|------|------|------|
| Lane Configurations |      |      |      |      |      |      |
| Traffic Vol, veh/h  | 40   | 10   | 550  | 30   | 10   | 490  |
| Future Vol, veh/h   | 40   | 10   | 550  | 30   | 10   | 490  |
| Peak Hour Factor    | 0.97 | 0.97 | 0.97 | 0.97 | 0.97 | 0.97 |
| Heavy Vehicles, %   | 0    | 0    | 1    | 1    | 2    | 2    |
| Mvmt Flow           | 41   | 10   | 567  | 31   | 10   | 505  |
| Number of Lanes     | 1    | 1    | 1    | 1    | 1    | 1    |

| Approach                   | WB   | NB   | SB   |
|----------------------------|------|------|------|
| Opposing Approach          |      | SB   | NB   |
| Opposing Lanes             | 0    | 2    | 2    |
| Conflicting Approach Left  | NB   |      | WB   |
| Conflicting Lanes Left     | 2    | 0    | 2    |
| Conflicting Approach Right | SB   | WB   |      |
| Conflicting Lanes Right    | 2    | 2    | 0    |
| HCM Control Delay          | 10.7 | 24.8 | 20.6 |
| HCM LOS                    | B    | C    | C    |

| Lane                   | NBLn1 | NBLn2 | WBLn1 | WBLn2 | SBLn1 | SBLn2 |
|------------------------|-------|-------|-------|-------|-------|-------|
| Vol Left, %            | 0%    | 0%    | 100%  | 0%    | 100%  | 0%    |
| Vol Thru, %            | 100%  | 0%    | 0%    | 0%    | 0%    | 100%  |
| Vol Right, %           | 0%    | 100%  | 0%    | 100%  | 0%    | 0%    |
| Sign Control           | Stop  | Stop  | Stop  | Stop  | Stop  | Stop  |
| Traffic Vol by Lane    | 550   | 30    | 40    | 10    | 10    | 490   |
| LT Vol                 | 0     | 0     | 40    | 0     | 10    | 0     |
| Through Vol            | 550   | 0     | 0     | 0     | 0     | 490   |
| RT Vol                 | 0     | 30    | 0     | 10    | 0     | 0     |
| Lane Flow Rate         | 567   | 31    | 41    | 10    | 10    | 505   |
| Geometry Grp           | 7     | 7     | 7     | 7     | 7     | 7     |
| Degree of Util (X)     | 0.807 | 0.038 | 0.087 | 0.018 | 0.016 | 0.73  |
| Departure Headway (Hd) | 5.124 | 4.419 | 7.631 | 6.406 | 5.709 | 5.205 |
| Convergence, Y/N       | Yes   | Yes   | Yes   | Yes   | Yes   | Yes   |
| Cap                    | 703   | 806   | 473   | 562   | 625   | 692   |
| Service Time           | 2.876 | 2.171 | 5.331 | 4.106 | 3.466 | 2.962 |
| HCM Lane V/C Ratio     | 0.807 | 0.038 | 0.087 | 0.018 | 0.016 | 0.73  |
| HCM Control Delay      | 25.8  | 7.3   | 11.1  | 9.2   | 8.6   | 20.8  |
| HCM Lane LOS           | D     | A     | B     | A     | A     | C     |
| HCM 95th-tile Q        | 8.4   | 0.1   | 0.3   | 0.1   | 0     | 6.4   |

|                           |     |  |  |  |  |  |  |  |  |  |  |  |
|---------------------------|-----|--|--|--|--|--|--|--|--|--|--|--|
| <b>Intersection</b>       |     |  |  |  |  |  |  |  |  |  |  |  |
| Intersection Delay, s/veh | 7.9 |  |  |  |  |  |  |  |  |  |  |  |
| Intersection LOS          | A   |  |  |  |  |  |  |  |  |  |  |  |

| Movement            | EBL  | EBT  | EBR  | WBL  | WBT  | WBR  | NBL  | NBT  | NBR  | SBL  | SBT  | SBR  |
|---------------------|------|------|------|------|------|------|------|------|------|------|------|------|
| Lane Configurations |      | ↕    |      |      | ↕    |      |      | ↕    |      |      | ↕    |      |
| Traffic Vol, veh/h  | 10   | 10   | 10   | 10   | 10   | 20   | 10   | 80   | 10   | 20   | 90   | 10   |
| Future Vol, veh/h   | 10   | 10   | 10   | 10   | 10   | 20   | 10   | 80   | 10   | 20   | 90   | 10   |
| Peak Hour Factor    | 0.82 | 0.82 | 0.82 | 0.82 | 0.82 | 0.82 | 0.82 | 0.82 | 0.82 | 0.82 | 0.82 | 0.82 |
| Heavy Vehicles, %   | 1    | 1    | 1    | 1    | 1    | 1    | 3    | 3    | 3    | 0    | 0    | 0    |
| Mvmt Flow           | 12   | 12   | 12   | 12   | 12   | 24   | 12   | 98   | 12   | 24   | 110  | 12   |
| Number of Lanes     | 0    | 1    | 0    | 0    | 1    | 0    | 0    | 1    | 0    | 0    | 1    | 0    |

| Approach                   | EB  | WB  | NB | SB  |
|----------------------------|-----|-----|----|-----|
| Opposing Approach          | WB  | EB  | SB | NB  |
| Opposing Lanes             | 1   | 1   | 1  | 1   |
| Conflicting Approach Left  | SB  | NB  | EB | WB  |
| Conflicting Lanes Left     | 1   | 1   | 1  | 1   |
| Conflicting Approach Right | NB  | SB  | WB | EB  |
| Conflicting Lanes Right    | 1   | 1   | 1  | 1   |
| HCM Control Delay          | 7.6 | 7.6 | 8  | 8.1 |
| HCM LOS                    | A   | A   | A  | A   |

| Lane                   | NBLn1 | EBLn1 | WBLn1 | SBLn1 |
|------------------------|-------|-------|-------|-------|
| Vol Left, %            | 10%   | 33%   | 25%   | 17%   |
| Vol Thru, %            | 80%   | 33%   | 25%   | 75%   |
| Vol Right, %           | 10%   | 33%   | 50%   | 8%    |
| Sign Control           | Stop  | Stop  | Stop  | Stop  |
| Traffic Vol by Lane    | 100   | 30    | 40    | 120   |
| LT Vol                 | 10    | 10    | 10    | 20    |
| Through Vol            | 80    | 10    | 10    | 90    |
| RT Vol                 | 10    | 10    | 20    | 10    |
| Lane Flow Rate         | 122   | 37    | 49    | 146   |
| Geometry Grp           | 1     | 1     | 1     | 1     |
| Degree of Util (X)     | 0.141 | 0.045 | 0.058 | 0.168 |
| Departure Headway (Hd) | 4.172 | 4.428 | 4.298 | 4.125 |
| Convergence, Y/N       | Yes   | Yes   | Yes   | Yes   |
| Cap                    | 848   | 813   | 838   | 858   |
| Service Time           | 2.259 | 2.43  | 2.299 | 2.207 |
| HCM Lane V/C Ratio     | 0.144 | 0.046 | 0.058 | 0.17  |
| HCM Control Delay      | 8     | 7.6   | 7.6   | 8.1   |
| HCM Lane LOS           | A     | A     | A     | A     |
| HCM 95th-tile Q        | 0.5   | 0.1   | 0.2   | 0.6   |

| Intersection              |      |
|---------------------------|------|
| Intersection Delay, s/veh | 51.6 |
| Intersection LOS          | F    |

| Movement            | EBL  | EBT  | EBR  | WBL  | WBT  | WBR  | NBL  | NBT  | NBR  | SBL  | SBT  | SBR  |
|---------------------|------|------|------|------|------|------|------|------|------|------|------|------|
| Lane Configurations |      | ↕    |      |      | ↕    |      |      | ↕    |      |      | ↕    | ↕    |
| Traffic Vol, veh/h  | 10   | 140  | 10   | 180  | 80   | 30   | 10   | 270  | 300  | 80   | 140  | 10   |
| Future Vol, veh/h   | 10   | 140  | 10   | 180  | 80   | 30   | 10   | 270  | 300  | 80   | 140  | 10   |
| Peak Hour Factor    | 0.93 | 0.93 | 0.93 | 0.93 | 0.93 | 0.93 | 0.93 | 0.93 | 0.93 | 0.93 | 0.93 | 0.93 |
| Heavy Vehicles, %   | 1    | 1    | 1    | 4    | 4    | 4    | 5    | 5    | 5    | 0    | 0    | 0    |
| Mvmt Flow           | 11   | 151  | 11   | 194  | 86   | 32   | 11   | 290  | 323  | 86   | 151  | 11   |
| Number of Lanes     | 0    | 1    | 0    | 0    | 1    | 0    | 0    | 1    | 0    | 0    | 1    | 1    |

| Approach                   | EB   | WB   | NB   | SB   |
|----------------------------|------|------|------|------|
| Opposing Approach          | WB   | EB   | SB   | NB   |
| Opposing Lanes             | 1    | 1    | 2    | 1    |
| Conflicting Approach Left  | SB   | NB   | EB   | WB   |
| Conflicting Lanes Left     | 2    | 1    | 1    | 1    |
| Conflicting Approach Right | NB   | SB   | WB   | EB   |
| Conflicting Lanes Right    | 1    | 2    | 1    | 1    |
| HCM Control Delay          | 15.3 | 22.2 | 89.7 | 17.7 |
| HCM LOS                    | C    | C    | F    | C    |

| Lane                   | NBLn1 | EBLn1 | WBLn1 | SBLn1 | SBLn2 |
|------------------------|-------|-------|-------|-------|-------|
| Vol Left, %            | 2%    | 6%    | 62%   | 36%   | 0%    |
| Vol Thru, %            | 47%   | 88%   | 28%   | 64%   | 0%    |
| Vol Right, %           | 52%   | 6%    | 10%   | 0%    | 100%  |
| Sign Control           | Stop  | Stop  | Stop  | Stop  | Stop  |
| Traffic Vol by Lane    | 580   | 160   | 290   | 220   | 10    |
| LT Vol                 | 10    | 10    | 180   | 80    | 0     |
| Through Vol            | 270   | 140   | 80    | 140   | 0     |
| RT Vol                 | 300   | 10    | 30    | 0     | 10    |
| Lane Flow Rate         | 624   | 172   | 312   | 237   | 11    |
| Geometry Grp           | 5     | 2     | 2     | 7     | 7     |
| Degree of Util (X)     | 1.093 | 0.36  | 0.623 | 0.497 | 0.02  |
| Departure Headway (Hd) | 6.307 | 7.928 | 7.523 | 7.89  | 6.98  |
| Convergence, Y/N       | Yes   | Yes   | Yes   | Yes   | Yes   |
| Cap                    | 580   | 456   | 483   | 459   | 516   |
| Service Time           | 4.307 | 5.928 | 5.523 | 5.59  | 4.68  |
| HCM Lane V/C Ratio     | 1.076 | 0.377 | 0.646 | 0.516 | 0.021 |
| HCM Control Delay      | 89.7  | 15.3  | 22.2  | 18.1  | 9.8   |
| HCM Lane LOS           | F     | C     | C     | C     | A     |
| HCM 95th-tile Q        | 19    | 1.6   | 4.2   | 2.7   | 0.1   |

| Intersection                |       |       |       |
|-----------------------------|-------|-------|-------|
| Intersection Delay, s/veh   | 25.9  |       |       |
| Intersection LOS            | D     |       |       |
| Approach                    | EB    | WB    | NB    |
| Entry Lanes                 | 1     | 1     | 1     |
| Conflicting Circle Lanes    | 1     | 1     | 1     |
| Adj Approach Flow, veh/h    | 547   | 691   | 639   |
| Demand Flow Rate, veh/h     | 558   | 705   | 639   |
| Vehicles Circulating, veh/h | 410   | 10    | 505   |
| Vehicles Exiting, veh/h     | 305   | 1134  | 463   |
| Follow-Up Headway, s        | 3.186 | 3.186 | 3.186 |
| Ped Vol Crossing Leg, #/h   | 0     | 0     | 0     |
| Ped Cap Adj                 | 1.000 | 1.000 | 1.000 |
| Approach Delay, s/veh       | 21.4  | 11.9  | 45.1  |
| Approach LOS                | C     | B     | E     |
| Lane                        | Left  | Left  | Left  |
| Designated Moves            | TR    | LT    | LR    |
| Assumed Moves               | TR    | LT    | LR    |
| RT Channelized              |       |       |       |
| Lane Util                   | 1.000 | 1.000 | 1.000 |
| Critical Headway, s         | 5.193 | 5.193 | 5.193 |
| Entry Flow, veh/h           | 558   | 705   | 639   |
| Cap Entry Lane, veh/h       | 750   | 1119  | 682   |
| Entry HV Adj Factor         | 0.980 | 0.980 | 1.000 |
| Flow Entry, veh/h           | 547   | 691   | 639   |
| Cap Entry, veh/h            | 735   | 1097  | 682   |
| V/C Ratio                   | 0.744 | 0.630 | 0.937 |
| Control Delay, s/veh        | 21.4  | 11.9  | 45.1  |
| LOS                         | C     | B     | E     |
| 95th %tile Queue, veh       | 7     | 5     | 13    |

**Intersection**

Intersection Delay, s/veh 78.8

Intersection LOS F

| Movement            | EBL  | EBT  | WBT  | WBR  | SBL  | SBR  |
|---------------------|------|------|------|------|------|------|
| Lane Configurations |      |      |      |      |      |      |
| Traffic Vol, veh/h  | 540  | 550  | 260  | 20   | 10   | 420  |
| Future Vol, veh/h   | 540  | 550  | 260  | 20   | 10   | 420  |
| Peak Hour Factor    | 0.95 | 0.95 | 0.95 | 0.95 | 0.95 | 0.95 |
| Heavy Vehicles, %   | 2    | 2    | 6    | 6    | 4    | 4    |
| Mvmt Flow           | 568  | 579  | 274  | 21   | 11   | 442  |
| Number of Lanes     | 1    | 1    | 1    | 1    | 1    | 1    |

| Approach                   | EB    | WB   | SB   |
|----------------------------|-------|------|------|
| Opposing Approach          | WB    | EB   |      |
| Opposing Lanes             | 2     | 2    | 0    |
| Conflicting Approach Left  | SB    |      | WB   |
| Conflicting Lanes Left     | 2     | 0    | 2    |
| Conflicting Approach Right |       | SB   | EB   |
| Conflicting Lanes Right    | 0     | 2    | 2    |
| HCM Control Delay          | 110.4 | 20.3 | 36.6 |
| HCM LOS                    | F     | C    | E    |

| Lane                   | EBLn1 | EBLn2 | WBLn1 | WBLn2 | SBLn1 | SBLn2 |
|------------------------|-------|-------|-------|-------|-------|-------|
| Vol Left, %            | 100%  | 0%    | 0%    | 0%    | 100%  | 0%    |
| Vol Thru, %            | 0%    | 100%  | 100%  | 0%    | 0%    | 0%    |
| Vol Right, %           | 0%    | 0%    | 0%    | 100%  | 0%    | 100%  |
| Sign Control           | Stop  | Stop  | Stop  | Stop  | Stop  | Stop  |
| Traffic Vol by Lane    | 540   | 550   | 260   | 20    | 10    | 420   |
| LT Vol                 | 540   | 0     | 0     | 0     | 10    | 0     |
| Through Vol            | 0     | 550   | 260   | 0     | 0     | 0     |
| RT Vol                 | 0     | 0     | 0     | 20    | 0     | 420   |
| Lane Flow Rate         | 568   | 579   | 274   | 21    | 11    | 442   |
| Geometry Grp           | 7     | 7     | 7     | 7     | 7     | 7     |
| Degree of Util (X)     | 1.172 | 1.111 | 0.584 | 0.041 | 0.024 | 0.841 |
| Departure Headway (Hd) | 7.424 | 6.911 | 7.917 | 7.194 | 8.362 | 7.137 |
| Convergence, Y/N       | Yes   | Yes   | Yes   | Yes   | Yes   | Yes   |
| Cap                    | 495   | 527   | 460   | 501   | 431   | 513   |
| Service Time           | 5.137 | 4.624 | 5.617 | 4.894 | 6.062 | 4.837 |
| HCM Lane V/C Ratio     | 1.147 | 1.099 | 0.596 | 0.042 | 0.026 | 0.862 |
| HCM Control Delay      | 122.5 | 98.5  | 21.1  | 10.2  | 11.3  | 37.2  |
| HCM Lane LOS           | F     | F     | C     | B     | B     | E     |
| HCM 95th-tile Q        | 20.7  | 18.8  | 3.6   | 0.1   | 0.1   | 8.6   |

| Intersection              |      |
|---------------------------|------|
| Intersection Delay, s/veh | 13.9 |
| Intersection LOS          | B    |

| Movement            | EBL  | EBT  | WBT  | WBR  | SBL  | SBR  |
|---------------------|------|------|------|------|------|------|
| Lane Configurations |      |      |      |      |      |      |
| Traffic Vol, veh/h  | 150  | 410  | 210  | 30   | 10   | 70   |
| Future Vol, veh/h   | 150  | 410  | 210  | 30   | 10   | 70   |
| Peak Hour Factor    | 0.86 | 0.86 | 0.86 | 0.86 | 0.86 | 0.86 |
| Heavy Vehicles, %   | 1    | 1    | 5    | 5    | 17   | 17   |
| Mvmt Flow           | 174  | 477  | 244  | 35   | 12   | 81   |
| Number of Lanes     | 1    | 1    | 1    | 1    | 1    | 1    |

| Approach                   | EB   | WB   | SB |
|----------------------------|------|------|----|
| Opposing Approach          | WB   | EB   |    |
| Opposing Lanes             | 2    | 2    | 0  |
| Conflicting Approach Left  | SB   |      | WB |
| Conflicting Lanes Left     | 2    | 0    | 2  |
| Conflicting Approach Right |      | SB   | EB |
| Conflicting Lanes Right    | 0    | 2    | 2  |
| HCM Control Delay          | 15.6 | 11.1 | 10 |
| HCM LOS                    | C    | B    | A  |

| Lane                   | EBLn1 | EBLn2 | WBLn1 | WBLn2 | SBLn1 | SBLn2 |
|------------------------|-------|-------|-------|-------|-------|-------|
| Vol Left, %            | 100%  | 0%    | 0%    | 0%    | 100%  | 0%    |
| Vol Thru, %            | 0%    | 100%  | 100%  | 0%    | 0%    | 0%    |
| Vol Right, %           | 0%    | 0%    | 0%    | 100%  | 0%    | 100%  |
| Sign Control           | Stop  | Stop  | Stop  | Stop  | Stop  | Stop  |
| Traffic Vol by Lane    | 150   | 410   | 210   | 30    | 10    | 70    |
| LT Vol                 | 150   | 0     | 0     | 0     | 10    | 0     |
| Through Vol            | 0     | 410   | 210   | 0     | 0     | 0     |
| RT Vol                 | 0     | 0     | 0     | 30    | 0     | 70    |
| Lane Flow Rate         | 174   | 477   | 244   | 35    | 12    | 81    |
| Geometry Grp           | 7     | 7     | 7     | 7     | 7     | 7     |
| Degree of Util (X)     | 0.269 | 0.669 | 0.374 | 0.047 | 0.024 | 0.139 |
| Departure Headway (Hd) | 5.557 | 5.054 | 5.507 | 4.801 | 7.352 | 6.137 |
| Convergence, Y/N       | Yes   | Yes   | Yes   | Yes   | Yes   | Yes   |
| Cap                    | 644   | 710   | 650   | 740   | 484   | 580   |
| Service Time           | 3.315 | 2.812 | 3.279 | 2.572 | 5.145 | 3.929 |
| HCM Lane V/C Ratio     | 0.27  | 0.672 | 0.375 | 0.047 | 0.025 | 0.14  |
| HCM Control Delay      | 10.4  | 17.5  | 11.6  | 7.8   | 10.3  | 9.9   |
| HCM Lane LOS           | B     | C     | B     | A     | B     | A     |
| HCM 95th-tile Q        | 1.1   | 5.2   | 1.7   | 0.1   | 0.1   | 0.5   |

**Intersection**

Intersection Delay, s/veh 13.7

Intersection LOS B

| Movement            | EBL  | EBT  | WBT  | WBR  | SBL  | SBR  |
|---------------------|------|------|------|------|------|------|
| Lane Configurations |      | ↔    | ↔    |      | ↔    | ↔    |
| Traffic Vol, veh/h  | 370  | 50   | 30   | 20   | 20   | 190  |
| Future Vol, veh/h   | 370  | 50   | 30   | 20   | 20   | 190  |
| Peak Hour Factor    | 0.87 | 0.87 | 0.87 | 0.87 | 0.87 | 0.87 |
| Heavy Vehicles, %   | 1    | 1    | 6    | 6    | 3    | 3    |
| Mvmt Flow           | 425  | 57   | 34   | 23   | 23   | 218  |
| Number of Lanes     | 0    | 1    | 1    | 0    | 1    | 1    |

| Approach                   | EB   | WB  | SB   |
|----------------------------|------|-----|------|
| Opposing Approach          | WB   | EB  |      |
| Opposing Lanes             | 1    | 1   | 0    |
| Conflicting Approach Left  | SB   |     | WB   |
| Conflicting Lanes Left     | 2    | 0   | 1    |
| Conflicting Approach Right |      | SB  | EB   |
| Conflicting Lanes Right    | 0    | 2   | 1    |
| HCM Control Delay          | 16.1 | 8.5 | 10.2 |
| HCM LOS                    | C    | A   | B    |

| Lane                   | EBLn1 | WBLn1 | SBLn1 | SBLn2 |
|------------------------|-------|-------|-------|-------|
| Vol Left, %            | 88%   | 0%    | 100%  | 0%    |
| Vol Thru, %            | 12%   | 60%   | 0%    | 0%    |
| Vol Right, %           | 0%    | 40%   | 0%    | 100%  |
| Sign Control           | Stop  | Stop  | Stop  | Stop  |
| Traffic Vol by Lane    | 420   | 50    | 20    | 190   |
| LT Vol                 | 370   | 0     | 20    | 0     |
| Through Vol            | 50    | 30    | 0     | 0     |
| RT Vol                 | 0     | 20    | 0     | 190   |
| Lane Flow Rate         | 483   | 57    | 23    | 218   |
| Geometry Grp           | 2     | 2     | 7     | 7     |
| Degree of Util (X)     | 0.641 | 0.079 | 0.041 | 0.313 |
| Departure Headway (Hd) | 4.783 | 4.973 | 6.367 | 5.154 |
| Convergence, Y/N       | Yes   | Yes   | Yes   | Yes   |
| Cap                    | 753   | 713   | 560   | 692   |
| Service Time           | 2.837 | 3.058 | 4.136 | 2.922 |
| HCM Lane V/C Ratio     | 0.641 | 0.08  | 0.041 | 0.315 |
| HCM Control Delay      | 16.1  | 8.5   | 9.4   | 10.3  |
| HCM Lane LOS           | C     | A     | A     | B     |
| HCM 95th-tile Q        | 4.7   | 0.3   | 0.1   | 1.3   |



| Movement                    | EBL  | EBT  | EBR  | WBL  | WBT  | WBR  | NBL  | NBT  | NBR  | SBL | SBT | SBR |
|-----------------------------|------|------|------|------|------|------|------|------|------|-----|-----|-----|
| Lane Configurations         | ↖    | ↗    |      | ↖    | ↗    |      | ↖    |      | ↗    |     |     |     |
| Traffic Volume (veh/h)      | 0    | 820  | 30   | 60   | 550  | 0    | 10   | 0    | 30   | 0   | 0   | 0   |
| Future Volume (veh/h)       | 0    | 820  | 30   | 60   | 550  | 0    | 10   | 0    | 30   | 0   | 0   | 0   |
| Number                      | 5    | 2    | 12   | 1    | 6    | 16   | 3    | 8    | 18   |     |     |     |
| Initial Q (Qb), veh         | 0    | 0    | 0    | 0    | 0    | 0    | 0    | 0    | 0    |     |     |     |
| Ped-Bike Adj(A_pbT)         | 1.00 |      | 1.00 | 1.00 |      | 1.00 | 1.00 |      | 1.00 |     |     |     |
| Parking Bus, Adj            | 1.00 | 1.00 | 1.00 | 1.00 | 1.00 | 1.00 | 1.00 | 1.00 | 1.00 |     |     |     |
| Adj Sat Flow, veh/h/ln      | 1863 | 1863 | 1900 | 1881 | 1881 | 0    | 1845 | 0    | 1845 |     |     |     |
| Adj Flow Rate, veh/h        | 0    | 845  | 29   | 62   | 567  | 0    | 10   | 0    | 2    |     |     |     |
| Adj No. of Lanes            | 1    | 2    | 0    | 1    | 2    | 0    | 1    | 0    | 1    |     |     |     |
| Peak Hour Factor            | 0.97 | 0.97 | 0.97 | 0.97 | 0.97 | 0.97 | 0.97 | 0.97 | 0.97 |     |     |     |
| Percent Heavy Veh, %        | 2    | 2    | 2    | 1    | 1    | 0    | 3    | 0    | 3    |     |     |     |
| Cap, veh/h                  | 5    | 1849 | 63   | 116  | 2493 | 0    | 22   | 0    | 20   |     |     |     |
| Arrive On Green             | 0.00 | 0.53 | 0.53 | 0.06 | 0.70 | 0.00 | 0.01 | 0.00 | 0.01 |     |     |     |
| Sat Flow, veh/h             | 1774 | 3491 | 120  | 1792 | 3668 | 0    | 1757 | 0    | 1568 |     |     |     |
| Grp Volume(v), veh/h        | 0    | 428  | 446  | 62   | 567  | 0    | 10   | 0    | 2    |     |     |     |
| Grp Sat Flow(s),veh/h/ln    | 1774 | 1770 | 1842 | 1792 | 1787 | 0    | 1757 | 0    | 1568 |     |     |     |
| Q Serve(g_s), s             | 0.0  | 5.2  | 5.2  | 1.2  | 2.0  | 0.0  | 0.2  | 0.0  | 0.0  |     |     |     |
| Cycle Q Clear(g_c), s       | 0.0  | 5.2  | 5.2  | 1.2  | 2.0  | 0.0  | 0.2  | 0.0  | 0.0  |     |     |     |
| Prop In Lane                | 1.00 |      | 0.07 | 1.00 |      | 0.00 | 1.00 |      | 1.00 |     |     |     |
| Lane Grp Cap(c), veh/h      | 5    | 937  | 975  | 116  | 2493 | 0    | 22   | 0    | 20   |     |     |     |
| V/C Ratio(X)                | 0.00 | 0.46 | 0.46 | 0.53 | 0.23 | 0.00 | 0.45 | 0.00 | 0.10 |     |     |     |
| Avail Cap(c_a), veh/h       | 1018 | 3047 | 3171 | 1028 | 6155 | 0    | 1361 | 0    | 1215 |     |     |     |
| HCM Platoon Ratio           | 1.00 | 1.00 | 1.00 | 1.00 | 1.00 | 1.00 | 1.00 | 1.00 | 1.00 |     |     |     |
| Upstream Filter(I)          | 0.00 | 1.00 | 1.00 | 1.00 | 1.00 | 0.00 | 1.00 | 0.00 | 1.00 |     |     |     |
| Uniform Delay (d), s/veh    | 0.0  | 5.1  | 5.1  | 15.8 | 1.9  | 0.0  | 17.1 | 0.0  | 17.0 |     |     |     |
| Incr Delay (d2), s/veh      | 0.0  | 0.7  | 0.6  | 1.4  | 0.1  | 0.0  | 5.3  | 0.0  | 0.8  |     |     |     |
| Initial Q Delay(d3),s/veh   | 0.0  | 0.0  | 0.0  | 0.0  | 0.0  | 0.0  | 0.0  | 0.0  | 0.0  |     |     |     |
| %ile BackOfQ(50%),veh/ln    | 0.0  | 2.7  | 2.8  | 0.6  | 1.0  | 0.0  | 0.1  | 0.0  | 0.0  |     |     |     |
| LnGrp Delay(d),s/veh        | 0.0  | 5.7  | 5.7  | 17.2 | 2.0  | 0.0  | 22.3 | 0.0  | 17.8 |     |     |     |
| LnGrp LOS                   |      | A    | A    | B    | A    |      | C    |      | B    |     |     |     |
| Approach Vol, veh/h         |      | 874  |      |      | 629  |      |      | 12   |      |     |     |     |
| Approach Delay, s/veh       |      | 5.7  |      |      | 3.5  |      |      | 21.6 |      |     |     |     |
| Approach LOS                |      | A    |      |      | A    |      |      | C    |      |     |     |     |
| Timer                       | 1    | 2    | 3    | 4    | 5    | 6    | 7    | 8    |      |     |     |     |
| Assigned Phs                | 1    | 2    |      |      | 5    | 6    |      | 8    |      |     |     |     |
| Phs Duration (G+Y+Rc), s    | 5.9  | 23.8 |      |      | 0.0  | 29.7 |      | 5.1  |      |     |     |     |
| Change Period (Y+Rc), s     | 3.6  | 5.4  |      |      | 3.5  | 5.4  |      | 4.7  |      |     |     |     |
| Max Green Setting (Gmax), s | 20   | 60.0 |      |      | 20.0 | 60.0 |      | 27.0 |      |     |     |     |
| Max Q Clear Time (g_c+1), s | 3    | 7.2  |      |      | 0.0  | 4.0  |      | 2.2  |      |     |     |     |
| Green Ext Time (p_c), s     | 0.0  | 11.2 |      |      | 0.0  | 4.6  |      | 0.0  |      |     |     |     |
| <b>Intersection Summary</b> |      |      |      |      |      |      |      |      |      |     |     |     |
| HCM 2010 Ctrl Delay         |      |      |      | 4.9  |      |      |      |      |      |     |     |     |
| HCM 2010 LOS                |      |      |      | A    |      |      |      |      |      |     |     |     |
| <b>Notes</b>                |      |      |      |      |      |      |      |      |      |     |     |     |



HCM 2010 Signalized Intersection Summary  
28: Davis Road & Reservation Road

Existing with Project, PM  
06/11/2019

| Movement                     | EBL   | EBT  | EBR  | WBL  | WBT   | WBR  | NBL  | NBT  | NBR  | SBL  | SBT  | SBR  |
|------------------------------|-------|------|------|------|-------|------|------|------|------|------|------|------|
| Lane Configurations          |       |      |      |      |       |      |      |      |      |      |      |      |
| Traffic Volume (veh/h)       | 430   | 440  | 10   | 10   | 320   | 110  | 10   | 10   | 10   | 120  | 10   | 290  |
| Future Volume (veh/h)        | 430   | 440  | 10   | 10   | 320   | 110  | 10   | 10   | 10   | 120  | 10   | 290  |
| Number                       | 5     | 2    | 12   | 1    | 6     | 16   | 3    | 8    | 18   | 7    | 4    | 14   |
| Initial Q (Qb), veh          | 0     | 0    | 0    | 0    | 0     | 0    | 0    | 0    | 0    | 0    | 0    | 0    |
| Ped-Bike Adj(A_pbT)          | 1.00  |      | 1.00 | 1.00 |       | 1.00 | 1.00 |      | 1.00 | 1.00 |      | 1.00 |
| Parking Bus, Adj             | 1.00  | 1.00 | 1.00 | 1.00 | 1.00  | 1.00 | 1.00 | 1.00 | 1.00 | 1.00 | 1.00 | 1.00 |
| Adj Sat Flow, veh/h/ln       | 1863  | 1863 | 1900 | 1827 | 1836  | 1900 | 1900 | 1900 | 1900 | 1900 | 1881 | 1881 |
| Adj Flow Rate, veh/h         | 467   | 478  | 11   | 11   | 340   | 120  | 11   | 11   | 9    | 128  | 11   | 174  |
| Adj No. of Lanes             | 1     | 1    | 0    | 1    | 1     | 0    | 0    | 1    | 0    | 0    | 1    | 1    |
| Peak Hour Factor             | 0.92  | 0.92 | 0.92 | 0.94 | 0.94  | 0.92 | 0.94 | 0.94 | 0.94 | 0.94 | 0.94 | 0.94 |
| Percent Heavy Veh, %         | 2     | 2    | 2    | 4    | 4     | 4    | 0    | 0    | 0    | 1    | 1    | 1    |
| Cap, veh/h                   | 506   | 1093 | 25   | 19   | 428   | 151  | 20   | 20   | 17   | 176  | 15   | 626  |
| Arrive On Green              | 0.29  | 0.60 | 0.60 | 0.01 | 0.33  | 0.33 | 0.03 | 0.03 | 0.03 | 0.11 | 0.11 | 0.11 |
| Sat Flow, veh/h              | 1774  | 1814 | 42   | 1740 | 1297  | 458  | 631  | 631  | 516  | 1656 | 142  | 1599 |
| Grp Volume(v), veh/h         | 467   | 0    | 489  | 11   | 0     | 460  | 31   | 0    | 0    | 139  | 0    | 174  |
| Grp Sat Flow(s),veh/h/ln     | 1774  | 0    | 1855 | 1740 | 0     | 1755 | 1777 | 0    | 0    | 1798 | 0    | 1599 |
| Q Serve(g_s), s              | 18.4  | 0.0  | 10.3 | 0.5  | 0.0   | 17.2 | 1.2  | 0.0  | 0.0  | 5.4  | 0.0  | 5.4  |
| Cycle Q Clear(g_c), s        | 18.4  | 0.0  | 10.3 | 0.5  | 0.0   | 17.2 | 1.2  | 0.0  | 0.0  | 5.4  | 0.0  | 5.4  |
| Prop In Lane                 | 1.00  |      | 0.02 | 1.00 |       | 0.26 | 0.35 |      | 0.29 | 0.92 |      | 1.00 |
| Lane Grp Cap(c), veh/h       | 506   | 0    | 1118 | 19   | 0     | 579  | 57   | 0    | 0    | 192  | 0    | 626  |
| V/C Ratio(X)                 | 0.92  | 0.00 | 0.44 | 0.58 | 0.00  | 0.79 | 0.54 | 0.00 | 0.00 | 0.73 | 0.00 | 0.28 |
| Avail Cap(c_a), veh/h        | 737   | 0    | 1541 | 723  | 0     | 1458 | 738  | 0    | 0    | 747  | 0    | 1120 |
| HCM Platoon Ratio            | 1.00  | 1.00 | 1.00 | 1.00 | 1.00  | 1.00 | 1.00 | 1.00 | 1.00 | 1.00 | 1.00 | 1.00 |
| Upstream Filter(I)           | 1.00  | 0.00 | 1.00 | 1.00 | 0.00  | 1.00 | 1.00 | 0.00 | 0.00 | 1.00 | 0.00 | 1.00 |
| Uniform Delay (d), s/veh     | 25.1  | 0.0  | 7.7  | 35.5 | 0.0   | 22.0 | 34.4 | 0.0  | 0.0  | 31.2 | 0.0  | 15.0 |
| Incr Delay (d2), s/veh       | 10.7  | 0.0  | 0.4  | 9.8  | 0.0   | 3.9  | 3.0  | 0.0  | 0.0  | 2.0  | 0.0  | 0.1  |
| Initial Q Delay(d3),s/veh    | 0.0   | 0.0  | 0.0  | 0.0  | 0.0   | 0.0  | 0.0  | 0.0  | 0.0  | 0.0  | 0.0  | 0.0  |
| %ile BackOfQ(50%),veh/ln     | 10.5  | 0.0  | 5.3  | 0.3  | 0.0   | 8.9  | 0.7  | 0.0  | 0.0  | 2.8  | 0.0  | 2.4  |
| LnGrp Delay(d),s/veh         | 35.8  | 0.0  | 8.2  | 45.3 | 0.0   | 25.9 | 37.4 | 0.0  | 0.0  | 33.2 | 0.0  | 15.1 |
| LnGrp LOS                    | D     |      | A    | D    |       | C    | D    |      |      | C    |      | B    |
| Approach Vol, veh/h          |       | 956  |      |      | 471   |      |      | 31   |      |      |      | 313  |
| Approach Delay, s/veh        |       | 21.6 |      |      | 26.4  |      |      | 37.4 |      |      |      | 23.1 |
| Approach LOS                 |       | C    |      |      | C     |      |      | D    |      |      |      | C    |
| Timer                        | 1     | 2    | 3    | 4    | 5     | 6    | 7    | 8    |      |      |      |      |
| Assigned Phs                 | 1     | 2    |      | 4    | 5     | 6    |      | 8    |      |      |      |      |
| Phs Duration (G+Y+Rc), s     | 4.7   | 48.5 |      | 12.7 | 24.4  | 28.8 |      | 6.3  |      |      |      |      |
| Change Period (Y+Rc), s      | * 3.9 | 5.0  |      | 5.0  | * 3.8 | 5.0  |      | 4.0  |      |      |      |      |
| Max Green Setting (Gmax), s  | * 30  | 60.0 |      | 30.0 | * 30  | 60.0 |      | 30.0 |      |      |      |      |
| Max Q Clear Time (g_c+I1), s | 2.5   | 12.3 |      | 7.4  | 20.4  | 19.2 |      | 3.2  |      |      |      |      |
| Green Ext Time (p_c), s      | 0.0   | 5.0  |      | 0.3  | 0.1   | 4.6  |      | 0.0  |      |      |      |      |
| <b>Intersection Summary</b>  |       |      |      |      |       |      |      |      |      |      |      |      |
| HCM 2010 Ctrl Delay          |       |      | 23.4 |      |       |      |      |      |      |      |      |      |
| HCM 2010 LOS                 |       |      | C    |      |       |      |      |      |      |      |      |      |
| <b>Notes</b>                 |       |      |      |      |       |      |      |      |      |      |      |      |

| Intersection              |      |  |  |  |  |  |  |  |  |  |  |  |
|---------------------------|------|--|--|--|--|--|--|--|--|--|--|--|
| Intersection Delay, s/veh | 50.9 |  |  |  |  |  |  |  |  |  |  |  |
| Intersection LOS          | F    |  |  |  |  |  |  |  |  |  |  |  |

| Movement            | EBL  | EBT  | EBR  | WBL  | WBT  | WBR  | NBL  | NBT  | NBR  | SBL  | SBT  | SBR  |
|---------------------|------|------|------|------|------|------|------|------|------|------|------|------|
| Lane Configurations |      | ↕    |      |      | ↕    | ↕    | ↕    | ↕    |      | ↕    | ↕    | ↕    |
| Traffic Vol, veh/h  | 10   | 10   | 10   | 130  | 10   | 10   | 10   | 580  | 110  | 10   | 520  | 10   |
| Future Vol, veh/h   | 10   | 10   | 10   | 130  | 10   | 10   | 10   | 580  | 110  | 10   | 520  | 10   |
| Peak Hour Factor    | 0.94 | 0.94 | 0.94 | 0.94 | 0.94 | 0.94 | 0.94 | 0.94 | 0.94 | 0.94 | 0.94 | 0.94 |
| Heavy Vehicles, %   | 0    | 0    | 0    | 0    | 0    | 0    | 0    | 0    | 0    | 1    | 1    | 1    |
| Mvmt Flow           | 11   | 11   | 11   | 138  | 11   | 11   | 11   | 617  | 117  | 11   | 553  | 11   |
| Number of Lanes     | 0    | 1    | 0    | 0    | 1    | 1    | 1    | 2    | 0    | 1    | 1    | 1    |

| Approach                   | EB   | WB   | NB   | SB   |
|----------------------------|------|------|------|------|
| Opposing Approach          | WB   | EB   | SB   | NB   |
| Opposing Lanes             | 2    | 1    | 3    | 3    |
| Conflicting Approach Left  | SB   | NB   | EB   | WB   |
| Conflicting Lanes Left     | 3    | 3    | 1    | 2    |
| Conflicting Approach Right | NB   | SB   | WB   | EB   |
| Conflicting Lanes Right    | 3    | 3    | 2    | 1    |
| HCM Control Delay          | 12.6 | 16.5 | 26.3 | 94.6 |
| HCM LOS                    | B    | C    | D    | F    |

| Lane                   | NBLn1 | NBLn2 | NBLn3 | EBLn1 | WBLn1 | WBLn2 | SBLn1 | SBLn2 | SBLn3 |
|------------------------|-------|-------|-------|-------|-------|-------|-------|-------|-------|
| Vol Left, %            | 100%  | 0%    | 0%    | 33%   | 93%   | 0%    | 100%  | 0%    | 0%    |
| Vol Thru, %            | 0%    | 100%  | 64%   | 33%   | 7%    | 0%    | 0%    | 100%  | 0%    |
| Vol Right, %           | 0%    | 0%    | 36%   | 33%   | 0%    | 100%  | 0%    | 0%    | 100%  |
| Sign Control           | Stop  | Stop  | Stop  | Stop  | Stop  | Stop  | Stop  | Stop  | Stop  |
| Traffic Vol by Lane    | 10    | 387   | 303   | 30    | 140   | 10    | 10    | 520   | 10    |
| LT Vol                 | 10    | 0     | 0     | 10    | 130   | 0     | 10    | 0     | 0     |
| Through Vol            | 0     | 387   | 193   | 10    | 10    | 0     | 0     | 520   | 0     |
| RT Vol                 | 0     | 0     | 110   | 10    | 0     | 10    | 0     | 0     | 10    |
| Lane Flow Rate         | 11    | 411   | 323   | 32    | 149   | 11    | 11    | 553   | 11    |
| Geometry Grp           | 8     | 8     | 8     | 8     | 8     | 8     | 8     | 8     | 8     |
| Degree of Util (X)     | 0.022 | 0.792 | 0.599 | 0.078 | 0.363 | 0.023 | 0.023 | 1.104 | 0.019 |
| Departure Headway (Hd) | 7.721 | 7.211 | 6.953 | 9.153 | 9.111 | 7.923 | 7.691 | 7.182 | 6.471 |
| Convergence, Y/N       | Yes   | Yes   | Yes   | Yes   | Yes   | Yes   | Yes   | Yes   | Yes   |
| Cap                    | 466   | 506   | 523   | 394   | 398   | 455   | 462   | 503   | 548   |
| Service Time           | 5.421 | 4.911 | 4.653 | 6.853 | 6.811 | 5.623 | 5.487 | 4.978 | 4.266 |
| HCM Lane V/C Ratio     | 0.024 | 0.812 | 0.618 | 0.081 | 0.374 | 0.024 | 0.024 | 1.099 | 0.02  |
| HCM Control Delay      | 10.6  | 32.1  | 19.5  | 12.6  | 16.9  | 10.8  | 10.7  | 97.9  | 9.4   |
| HCM Lane LOS           | B     | D     | C     | B     | C     | B     | B     | F     | A     |
| HCM 95th-tile Q        | 0.1   | 7.3   | 3.9   | 0.3   | 1.6   | 0.1   | 0.1   | 17.9  | 0.1   |

| Intersection              |   |
|---------------------------|---|
| Intersection Delay, s/veh | 8 |
| Intersection LOS          | A |

| Movement            | EBL  | EBT  | EBR  | WBL  | WBT  | WBR  | NBL  | NBT  | NBR  | SBL  | SBT  | SBR  |
|---------------------|------|------|------|------|------|------|------|------|------|------|------|------|
| Lane Configurations |      | ↕    |      |      | ↕    |      | ↕    | ↕    |      | ↕    | ↕    |      |
| Traffic Vol, veh/h  | 10   | 10   | 10   | 10   | 10   | 10   | 10   | 80   | 10   | 10   | 80   | 10   |
| Future Vol, veh/h   | 10   | 10   | 10   | 10   | 10   | 10   | 10   | 80   | 10   | 10   | 80   | 10   |
| Peak Hour Factor    | 0.85 | 0.85 | 0.85 | 0.85 | 0.85 | 0.85 | 0.85 | 0.85 | 0.85 | 0.85 | 0.85 | 0.85 |
| Heavy Vehicles, %   | 0    | 0    | 0    | 1    | 1    | 1    | 0    | 0    | 0    | 1    | 1    | 1    |
| Mvmt Flow           | 12   | 12   | 12   | 12   | 12   | 12   | 12   | 94   | 12   | 12   | 94   | 12   |
| Number of Lanes     | 0    | 1    | 0    | 0    | 1    | 0    | 1    | 1    | 0    | 1    | 1    | 0    |

| Approach                   | EB  | WB  | NB  | SB  |
|----------------------------|-----|-----|-----|-----|
| Opposing Approach          | WB  | EB  | SB  | NB  |
| Opposing Lanes             | 1   | 1   | 2   | 2   |
| Conflicting Approach Left  | SB  | NB  | EB  | WB  |
| Conflicting Lanes Left     | 2   | 2   | 1   | 1   |
| Conflicting Approach Right | NB  | SB  | WB  | EB  |
| Conflicting Lanes Right    | 2   | 2   | 1   | 1   |
| HCM Control Delay          | 7.6 | 7.6 | 8.1 | 8.1 |
| HCM LOS                    | A   | A   | A   | A   |

| Lane                   | NBLn1 | NBLn2 | EBLn1 | WBLn1 | SBLn1 | SBLn2 |
|------------------------|-------|-------|-------|-------|-------|-------|
| Vol Left, %            | 100%  | 0%    | 33%   | 33%   | 100%  | 0%    |
| Vol Thru, %            | 0%    | 89%   | 33%   | 33%   | 0%    | 89%   |
| Vol Right, %           | 0%    | 11%   | 33%   | 33%   | 0%    | 11%   |
| Sign Control           | Stop  | Stop  | Stop  | Stop  | Stop  | Stop  |
| Traffic Vol by Lane    | 10    | 90    | 30    | 30    | 10    | 90    |
| LT Vol                 | 10    | 0     | 10    | 10    | 10    | 0     |
| Through Vol            | 0     | 80    | 10    | 10    | 0     | 80    |
| RT Vol                 | 0     | 10    | 10    | 10    | 0     | 10    |
| Lane Flow Rate         | 12    | 106   | 35    | 35    | 12    | 106   |
| Geometry Grp           | 7     | 7     | 2     | 2     | 7     | 7     |
| Degree of Util (X)     | 0.017 | 0.135 | 0.043 | 0.043 | 0.017 | 0.136 |
| Departure Headway (Hd) | 5.183 | 4.604 | 4.367 | 4.384 | 5.2   | 4.621 |
| Convergence, Y/N       | Yes   | Yes   | Yes   | Yes   | Yes   | Yes   |
| Cap                    | 684   | 771   | 824   | 821   | 682   | 768   |
| Service Time           | 2.962 | 2.383 | 2.369 | 2.386 | 2.978 | 2.399 |
| HCM Lane V/C Ratio     | 0.018 | 0.137 | 0.042 | 0.043 | 0.018 | 0.138 |
| HCM Control Delay      | 8.1   | 8.1   | 7.6   | 7.6   | 8.1   | 8.1   |
| HCM Lane LOS           | A     | A     | A     | A     | A     | A     |
| HCM 95th-tile Q        | 0.1   | 0.5   | 0.1   | 0.1   | 0.1   | 0.5   |

HCM 2010 Signalized Intersection Summary  
 31: 1st Avenue & Lightfighter Drive

Existing with Project, PM  
 06/11/2019



| Movement                     | EBL  | EBT  | EBR  | WBL  | WBT  | WBR  | NBL  | NBT  | NBR  | SBL  | SBT  | SBR  |
|------------------------------|------|------|------|------|------|------|------|------|------|------|------|------|
| Lane Configurations          |      | ↑↑   | ↑    | ↑    | ↑↑   |      | ↑    |      | ↑    | ↑    | ↑    | ↑    |
| Traffic Volume (veh/h)       | 0    | 620  | 110  | 20   | 1120 | 0    | 200  | 0    | 30   | 10   | 10   | 30   |
| Future Volume (veh/h)        | 0    | 620  | 110  | 20   | 1120 | 0    | 200  | 0    | 30   | 10   | 10   | 30   |
| Number                       | 7    | 4    | 14   | 3    | 8    | 18   | 5    | 2    | 12   | 1    | 6    | 16   |
| Initial Q (Qb), veh          | 0    | 0    | 0    | 0    | 0    | 0    | 0    | 0    | 0    | 0    | 0    | 0    |
| Ped-Bike Adj(A_pbT)          | 1.00 |      | 1.00 | 1.00 |      | 1.00 | 1.00 |      | 1.00 | 1.00 |      | 1.00 |
| Parking Bus, Adj             | 1.00 | 1.00 | 1.00 | 1.00 | 1.00 | 1.00 | 1.00 | 1.00 | 1.00 | 1.00 | 1.00 | 1.00 |
| Adj Sat Flow, veh/h/ln       | 0    | 1881 | 1881 | 1881 | 1881 | 0    | 1881 | 0    | 1881 | 1810 | 1810 | 1810 |
| Adj Flow Rate, veh/h         | 0    | 653  | 0    | 21   | 1179 | 0    | 211  | 0    | 14   | 11   | 11   | 12   |
| Adj No. of Lanes             | 0    | 2    | 1    | 1    | 2    | 0    | 1    | 0    | 1    | 1    | 1    | 1    |
| Peak Hour Factor             | 0.95 | 0.95 | 0.95 | 0.95 | 0.95 | 0.95 | 0.95 | 0.95 | 0.95 | 0.95 | 0.95 | 0.95 |
| Percent Heavy Veh, %         | 0    | 1    | 1    | 1    | 1    | 0    | 1    | 0    | 1    | 5    | 5    | 5    |
| Cap, veh/h                   | 0    | 2027 | 907  | 23   | 2468 | 0    | 0    | 0    | 0    | 32   | 34   | 29   |
| Arrive On Green              | 0.00 | 0.57 | 0.00 | 0.01 | 0.69 | 0.00 | 0.00 | 0.00 | 0.00 | 0.02 | 0.02 | 0.02 |
| Sat Flow, veh/h              | 0    | 3668 | 1599 | 1792 | 3668 | 0    |      | 0    |      | 1723 | 1810 | 1538 |
| Grp Volume(v), veh/h         | 0    | 653  | 0    | 21   | 1179 | 0    |      | 0.0  |      | 11   | 11   | 12   |
| Grp Sat Flow(s),veh/h/ln     | 0    | 1787 | 1599 | 1792 | 1787 | 0    |      |      |      | 1723 | 1810 | 1538 |
| Q Serve(g_s), s              | 0.0  | 3.1  | 0.0  | 0.4  | 4.8  | 0.0  |      |      |      | 0.2  | 0.2  | 0.2  |
| Cycle Q Clear(g_c), s        | 0.0  | 3.1  | 0.0  | 0.4  | 4.8  | 0.0  |      |      |      | 0.2  | 0.2  | 0.2  |
| Prop In Lane                 | 0.00 |      | 1.00 | 1.00 |      | 0.00 |      |      |      | 1.00 |      | 1.00 |
| Lane Grp Cap(c), veh/h       | 0    | 2027 | 907  | 23   | 2468 | 0    |      |      |      | 32   | 34   | 29   |
| V/C Ratio(X)                 | 0.00 | 0.32 | 0.00 | 0.92 | 0.48 | 0.00 |      |      |      | 0.34 | 0.33 | 0.42 |
| Avail Cap(c_a), veh/h        | 0    | 5087 | 2276 | 1133 | 5087 | 0    |      |      |      | 1363 | 1431 | 1216 |
| HCM Platoon Ratio            | 1.00 | 1.00 | 1.00 | 1.00 | 1.00 | 1.00 |      |      |      | 1.00 | 1.00 | 1.00 |
| Upstream Filter(I)           | 0.00 | 1.00 | 0.00 | 1.00 | 1.00 | 0.00 |      |      |      | 1.00 | 1.00 | 1.00 |
| Uniform Delay (d), s/veh     | 0.0  | 3.6  | 0.0  | 15.6 | 2.3  | 0.0  |      |      |      | 15.3 | 15.3 | 15.3 |
| Incr Delay (d2), s/veh       | 0.0  | 0.1  | 0.0  | 37.2 | 0.2  | 0.0  |      |      |      | 2.3  | 2.1  | 3.6  |
| Initial Q Delay(d3),s/veh    | 0.0  | 0.0  | 0.0  | 0.0  | 0.0  | 0.0  |      |      |      | 0.0  | 0.0  | 0.0  |
| %ile BackOfQ(50%),veh/ln     | 0.0  | 1.5  | 0.0  | 0.4  | 2.4  | 0.0  |      |      |      | 0.1  | 0.1  | 0.1  |
| LnGrp Delay(d),s/veh         | 0.0  | 3.8  | 0.0  | 52.8 | 2.5  | 0.0  |      |      |      | 17.6 | 17.4 | 18.9 |
| LnGrp LOS                    |      | A    |      | D    | A    |      |      |      |      | B    | B    | B    |
| Approach Vol, veh/h          |      | 653  |      |      | 1200 |      |      |      |      |      | 34   |      |
| Approach Delay, s/veh        |      | 3.8  |      |      | 3.3  |      |      |      |      |      | 18.0 |      |
| Approach LOS                 |      | A    |      |      | A    |      |      |      |      |      | B    |      |
| Timer                        | 1    | 2    | 3    | 4    | 5    | 6    | 7    | 8    |      |      |      |      |
| Assigned Phs                 |      |      | 3    | 4    |      | 6    |      | 8    |      |      |      |      |
| Phs Duration (G+Y+Rc), s     |      |      | 3.9  | 22.5 |      | 5.2  |      | 26.4 |      |      |      |      |
| Change Period (Y+Rc), s      |      |      | 3.5  | 4.6  |      | 4.6  |      | 4.6  |      |      |      |      |
| Max Green Setting (Gmax), s  |      |      | 20.0 | 45.0 |      | 25.0 |      | 45.0 |      |      |      |      |
| Max Q Clear Time (g_c+I1), s |      |      | 2.4  | 5.1  |      | 2.2  |      | 6.8  |      |      |      |      |
| Green Ext Time (p_c), s      |      |      | 0.0  | 7.5  |      | 0.0  |      | 15.0 |      |      |      |      |
| <b>Intersection Summary</b>  |      |      |      |      |      |      |      |      |      |      |      |      |
| HCM 2010 Ctrl Delay          |      |      | 3.8  |      |      |      |      |      |      |      |      |      |
| HCM 2010 LOS                 |      |      | A    |      |      |      |      |      |      |      |      |      |

HCM 2010 Signalized Intersection Summary  
 32: 2nd Avenue & Lightfighter Drive

Existing with Project, PM  
 06/11/2019



| Movement                    | EBL  | EBT  | EBR  | WBL  | WBT  | WBR  | NBL  | NBT  | NBR  | SBL  | SBT  | SBR  |
|-----------------------------|------|------|------|------|------|------|------|------|------|------|------|------|
| Lane Configurations         | ↖    | ↗    |      | ↖    | ↗    |      |      | ↕    |      | ↖    | ↗    | ↗    |
| Traffic Volume (veh/h)      | 150  | 480  | 10   | 10   | 1020 | 130  | 10   | 10   | 10   | 80   | 10   | 120  |
| Future Volume (veh/h)       | 150  | 480  | 10   | 10   | 1020 | 130  | 10   | 10   | 10   | 80   | 10   | 120  |
| Number                      | 5    | 2    | 12   | 1    | 6    | 16   | 3    | 8    | 18   | 7    | 4    | 14   |
| Initial Q (Qb), veh         | 0    | 0    | 0    | 0    | 0    | 0    | 0    | 0    | 0    | 0    | 0    | 0    |
| Ped-Bike Adj(A_pbT)         | 1.00 |      | 1.00 | 1.00 |      | 1.00 | 0.99 |      | 0.99 | 0.99 |      | 0.99 |
| Parking Bus, Adj            | 1.00 | 1.00 | 1.00 | 1.00 | 1.00 | 1.00 | 1.00 | 1.00 | 1.00 | 1.00 | 1.00 | 1.00 |
| Adj Sat Flow, veh/h/ln      | 1881 | 1881 | 1900 | 1881 | 1881 | 1900 | 1900 | 1900 | 1900 | 1845 | 1845 | 1845 |
| Adj Flow Rate, veh/h        | 158  | 505  | 11   | 11   | 1074 | 132  | 11   | 11   | 5    | 84   | 11   | 23   |
| Adj No. of Lanes            | 1    | 2    | 0    | 1    | 2    | 0    | 0    | 1    | 0    | 1    | 1    | 1    |
| Peak Hour Factor            | 0.95 | 0.95 | 0.95 | 0.95 | 0.95 | 0.95 | 0.95 | 0.95 | 0.95 | 0.95 | 0.95 | 0.95 |
| Percent Heavy Veh, %        | 1    | 1    | 1    | 1    | 1    | 1    | 0    | 0    | 0    | 3    | 3    | 3    |
| Cap, veh/h                  | 189  | 2736 | 60   | 19   | 2147 | 264  | 94   | 83   | 29   | 203  | 171  | 143  |
| Arrive On Green             | 0.11 | 0.76 | 0.76 | 0.01 | 0.67 | 0.67 | 0.09 | 0.09 | 0.09 | 0.09 | 0.09 | 0.09 |
| Sat Flow, veh/h             | 1792 | 3577 | 78   | 1792 | 3205 | 393  | 465  | 893  | 308  | 1362 | 1845 | 1548 |
| Grp Volume(v), veh/h        | 158  | 252  | 264  | 11   | 598  | 608  | 27   | 0    | 0    | 84   | 11   | 23   |
| Grp Sat Flow(s),veh/h/ln    | 1792 | 1787 | 1867 | 1792 | 1787 | 1811 | 1666 | 0    | 0    | 1362 | 1845 | 1548 |
| Q Serve(g_s), s             | 8.7  | 3.9  | 3.9  | 0.6  | 16.6 | 16.7 | 0.0  | 0.0  | 0.0  | 4.2  | 0.5  | 1.4  |
| Cycle Q Clear(g_c), s       | 8.7  | 3.9  | 3.9  | 0.6  | 16.6 | 16.7 | 1.4  | 0.0  | 0.0  | 5.6  | 0.5  | 1.4  |
| Prop In Lane                | 1.00 |      | 0.04 | 1.00 |      | 0.22 | 0.41 |      | 0.19 | 1.00 |      | 1.00 |
| Lane Grp Cap(c), veh/h      | 189  | 1367 | 1428 | 19   | 1197 | 1214 | 205  | 0    | 0    | 203  | 171  | 143  |
| V/C Ratio(X)                | 0.84 | 0.18 | 0.18 | 0.58 | 0.50 | 0.50 | 0.13 | 0.00 | 0.00 | 0.41 | 0.06 | 0.16 |
| Avail Cap(c_a), veh/h       | 222  | 1367 | 1428 | 222  | 1197 | 1214 | 702  | 0    | 0    | 627  | 745  | 625  |
| HCM Platoon Ratio           | 1.00 | 1.00 | 1.00 | 1.00 | 1.00 | 1.00 | 1.00 | 1.00 | 1.00 | 1.00 | 1.00 | 1.00 |
| Upstream Filter(I)          | 0.95 | 0.95 | 0.95 | 0.77 | 0.77 | 0.77 | 1.00 | 0.00 | 0.00 | 1.00 | 1.00 | 1.00 |
| Uniform Delay (d), s/veh    | 43.9 | 3.2  | 3.2  | 49.3 | 8.2  | 8.2  | 41.8 | 0.0  | 0.0  | 43.6 | 41.4 | 41.8 |
| Incr Delay (d2), s/veh      | 17.6 | 0.3  | 0.3  | 7.9  | 1.2  | 1.1  | 0.1  | 0.0  | 0.0  | 0.5  | 0.1  | 0.2  |
| Initial Q Delay(d3),s/veh   | 0.0  | 0.0  | 0.0  | 0.0  | 0.0  | 0.0  | 0.0  | 0.0  | 0.0  | 0.0  | 0.0  | 0.0  |
| %ile BackOfQ(50%),veh/ln    | 5.2  | 2.0  | 2.1  | 0.3  | 8.5  | 8.7  | 0.7  | 0.0  | 0.0  | 2.3  | 0.3  | 0.6  |
| LnGrp Delay(d),s/veh        | 61.4 | 3.5  | 3.5  | 57.2 | 9.3  | 9.3  | 41.9 | 0.0  | 0.0  | 44.1 | 41.5 | 42.0 |
| LnGrp LOS                   | E    | A    | A    | E    | A    | A    | D    |      |      | D    | D    | D    |
| Approach Vol, veh/h         |      | 674  |      |      | 1217 |      |      | 27   |      |      | 118  |      |
| Approach Delay, s/veh       |      | 17.1 |      |      | 9.8  |      |      | 41.9 |      |      | 43.4 |      |
| Approach LOS                |      | B    |      |      | A    |      |      | D    |      |      | D    |      |
| Timer                       | 1    | 2    | 3    | 4    | 5    | 6    | 7    | 8    |      |      |      |      |
| Assigned Phs                | 1    | 2    |      | 4    | 5    | 6    |      | 8    |      |      |      |      |
| Phs Duration (G+Y+Rc), s    | 5.1  | 81.1 |      | 13.9 | 14.5 | 71.6 |      | 13.9 |      |      |      |      |
| Change Period (Y+Rc), s     | 4.0  | 4.6  |      | 4.6  | 4.0  | 4.6  |      | 4.6  |      |      |      |      |
| Max Green Setting (Gmax), s | 2.4  | 34.0 |      | 40.4 | 12.4 | 24.4 |      | 40.4 |      |      |      |      |
| Max Q Clear Time (g_c+I), s | 12.6 | 5.9  |      | 7.6  | 10.7 | 18.7 |      | 3.4  |      |      |      |      |
| Green Ext Time (p_c), s     | 0.0  | 1.8  |      | 0.2  | 0.0  | 2.6  |      | 0.1  |      |      |      |      |
| <b>Intersection Summary</b> |      |      |      |      |      |      |      |      |      |      |      |      |
| HCM 2010 Ctrl Delay         |      |      |      | 14.6 |      |      |      |      |      |      |      |      |
| HCM 2010 LOS                |      |      |      | B    |      |      |      |      |      |      |      |      |

HCM 2010 Signalized Intersection Summary  
 33: General Jim Moore Boulevard & Lightfighter Drive

Existing with Project, PM  
 06/11/2019



| Movement                      | EBL  | EBT  | EBR  | WBL  | WBT  | WBR  | NBL  | NBT  | NBR  | SBL  | SBT   | SBR  |
|-------------------------------|------|------|------|------|------|------|------|------|------|------|-------|------|
| Lane Configurations           | ↖    | ↑    | ↗    | ↖    | ↗    |      | ↖↗   | ↑    |      | ↖    | ↗     |      |
| Traffic Volume (veh/h)        | 10   | 140  | 460  | 10   | 170  | 10   | 510  | 30   | 10   | 10   | 30    | 10   |
| Future Volume (veh/h)         | 10   | 140  | 460  | 10   | 170  | 10   | 510  | 30   | 10   | 10   | 30    | 10   |
| Number                        | 3    | 8    | 18   | 7    | 4    | 14   | 1    | 6    | 16   | 5    | 2     | 12   |
| Initial Q (Qb), veh           | 0    | 0    | 0    | 0    | 0    | 0    | 0    | 0    | 0    | 0    | 0     | 0    |
| Ped-Bike Adj(A_pbT)           | 1.00 |      | 1.00 | 1.00 |      | 1.00 | 1.00 |      | 1.00 | 1.00 |       | 1.00 |
| Parking Bus, Adj              | 1.00 | 1.00 | 1.00 | 1.00 | 1.00 | 1.00 | 1.00 | 1.00 | 1.00 | 1.00 | 1.00  | 1.00 |
| Adj Sat Flow, veh/h/ln        | 1881 | 1881 | 1881 | 1900 | 1900 | 1900 | 1881 | 1881 | 1900 | 1900 | 1900  | 1900 |
| Adj Flow Rate, veh/h          | 10   | 146  | 0    | 10   | 177  | 9    | 531  | 31   | 8    | 10   | 31    | -102 |
| Adj No. of Lanes              | 1    | 1    | 1    | 1    | 1    | 0    | 2    | 1    | 0    | 1    | 2     | 0    |
| Peak Hour Factor              | 0.96 | 0.96 | 0.96 | 0.96 | 0.96 | 0.96 | 0.96 | 0.96 | 0.96 | 0.96 | 0.96  | 0.96 |
| Percent Heavy Veh, %          | 1    | 1    | 1    | 0    | 0    | 0    | 1    | 1    | 1    | 0    | 0     | 0    |
| Cap, veh/h                    | 19   | 334  | 284  | 19   | 318  | 16   | 989  | 413  | 107  | 19   | 22    | 429  |
| Arrive On Green               | 0.01 | 0.18 | 0.00 | 0.01 | 0.18 | 0.18 | 0.28 | 0.29 | 0.29 | 0.01 | 0.01  | 0.00 |
| Sat Flow, veh/h               | 1792 | 1881 | 1599 | 1810 | 1793 | 91   | 3476 | 1443 | 372  | 1810 | 3705  | 0    |
| Grp Volume(v), veh/h          | 10   | 146  | 0    | 10   | 0    | 186  | 531  | 0    | 39   | 10   | -71   | -102 |
| Grp Sat Flow(s),veh/h/ln      | 1792 | 1881 | 1599 | 1810 | 0    | 1884 | 1738 | 0    | 1815 | 1810 | 1805  | 1615 |
| Q Serve(g_s), s               | 0.2  | 2.4  | 0.0  | 0.2  | 0.0  | 3.1  | 4.5  | 0.0  | 0.5  | 0.2  | 0.0   | 0.0  |
| Cycle Q Clear(g_c), s         | 0.2  | 2.4  | 0.0  | 0.2  | 0.0  | 3.1  | 4.5  | 0.0  | 0.5  | 0.2  | 0.0   | 0.0  |
| Prop In Lane                  | 1.00 |      | 1.00 | 1.00 |      | 0.05 | 1.00 |      | 0.21 | 1.00 |       | 0.00 |
| Lane Grp Cap(c), veh/h        | 19   | 334  | 284  | 19   | 0    | 334  | 989  | 0    | 520  | 19   | 22    | 0    |
| V/C Ratio(X)                  | 0.53 | 0.44 | 0.00 | 0.52 | 0.00 | 0.56 | 0.54 | 0.00 | 0.08 | 0.52 | -3.21 | 0.00 |
| Avail Cap(c_a), veh/h         | 1025 | 1615 | 1373 | 1036 | 0    | 1617 | 995  | 0    | 1559 | 777  | 1550  | 0    |
| HCM Platoon Ratio             | 1.00 | 1.00 | 1.00 | 1.00 | 1.00 | 1.00 | 1.00 | 1.00 | 1.00 | 1.00 | 1.00  | 1.00 |
| Upstream Filter(I)            | 1.00 | 1.00 | 0.00 | 1.00 | 0.00 | 1.00 | 1.00 | 0.00 | 1.00 | 1.00 | 0.00  | 0.00 |
| Uniform Delay (d), s/veh      | 17.2 | 12.8 | 0.0  | 17.2 | 0.0  | 13.1 | 10.6 | 0.0  | 9.1  | 17.2 | 0.0   | 0.0  |
| Incr Delay (d2), s/veh        | 20.8 | 1.1  | 0.0  | 7.9  | 0.0  | 1.7  | 0.5  | 0.0  | 0.1  | 7.9  | 0.0   | 0.0  |
| Initial Q Delay(d3),s/veh     | 0.0  | 0.0  | 0.0  | 0.0  | 0.0  | 0.0  | 0.0  | 0.0  | 0.0  | 0.0  | 0.0   | 0.0  |
| %ile BackOfQ(50%),veh/ln      | 0.2  | 1.4  | 0.0  | 0.1  | 0.0  | 1.8  | 2.2  | 0.0  | 0.3  | 0.1  | 0.0   | 0.0  |
| LnGrp Delay(d),s/veh          | 38.0 | 13.9 | 0.0  | 25.1 | 0.0  | 14.9 | 11.0 | 0.0  | 9.2  | 25.1 | 0.0   | 0.0  |
| LnGrp LOS                     | D    | B    |      | C    |      | B    | B    |      | A    | C    |       |      |
| Approach Vol, veh/h           |      | 156  |      |      | 196  |      |      | 570  |      |      | -163  |      |
| Approach Delay, s/veh         |      | 15.4 |      |      | 15.4 |      |      | 10.9 |      |      | -1.5  |      |
| Approach LOS                  |      | B    |      |      | B    |      |      | B    |      |      | A     |      |
| Timer                         | 1    | 2    | 3    | 4    | 5    | 6    | 7    | 8    |      |      |       |      |
| Assigned Phs                  | 1    | 2    | 3    | 4    | 5    | 6    | 7    | 8    |      |      |       |      |
| Phs Duration (G+Y+Rc), s      | 4.4  | 4.9  | 4.9  | 10.7 | 4.9  | 14.5 | 4.9  | 10.7 |      |      |       |      |
| Change Period (Y+Rc), s       | 4.5  | 4.5  | 4.5  | 4.5  | 4.5  | 4.5  | 4.5  | 4.5  |      |      |       |      |
| Max Green Setting (Gmax), s   | 30.0 | 30.0 | 20.0 | 30.0 | 15.0 | 30.0 | 20.0 | 30.0 |      |      |       |      |
| Max Q Clear Time (g_c+1/5), s | 0.0  | 0.0  | 2.2  | 5.1  | 2.2  | 2.5  | 2.2  | 4.4  |      |      |       |      |
| Green Ext Time (p_c), s       | 0.6  | 0.0  | 0.0  | 1.3  | 0.0  | 0.3  | 0.0  | 0.8  |      |      |       |      |
| <b>Intersection Summary</b>   |      |      |      |      |      |      |      |      |      |      |       |      |
| HCM 2010 Ctrl Delay           |      |      | 15.7 |      |      |      |      |      |      |      |       |      |
| HCM 2010 LOS                  |      |      | B    |      |      |      |      |      |      |      |       |      |

| Intersection              |     |
|---------------------------|-----|
| Intersection Delay, s/veh | 8.2 |
| Intersection LOS          | A   |

| Movement            | WBL  | WBR  | NBT  | NBR  | SBL  | SBT  |
|---------------------|------|------|------|------|------|------|
| Lane Configurations |      |      |      |      |      |      |
| Traffic Vol, veh/h  | 10   | 120  | 60   | 10   | 120  | 40   |
| Future Vol, veh/h   | 10   | 120  | 60   | 10   | 120  | 40   |
| Peak Hour Factor    | 0.88 | 0.88 | 0.88 | 0.88 | 0.88 | 0.88 |
| Heavy Vehicles, %   | 0    | 0    | 2    | 2    | 1    | 1    |
| Mvmt Flow           | 11   | 136  | 68   | 11   | 136  | 45   |
| Number of Lanes     | 1    | 0    | 1    | 0    | 0    | 1    |

| Approach                   | WB  | NB  | SB  |
|----------------------------|-----|-----|-----|
| Opposing Approach          |     | SB  | NB  |
| Opposing Lanes             | 0   | 1   | 1   |
| Conflicting Approach Left  | NB  |     | WB  |
| Conflicting Lanes Left     | 1   | 0   | 1   |
| Conflicting Approach Right | SB  | WB  |     |
| Conflicting Lanes Right    | 1   | 1   | 0   |
| HCM Control Delay          | 7.7 | 7.8 | 8.7 |
| HCM LOS                    | A   | A   | A   |

| Lane                   | NBLn1 | WBLn1 | SBLn1 |
|------------------------|-------|-------|-------|
| Vol Left, %            | 0%    | 8%    | 75%   |
| Vol Thru, %            | 86%   | 0%    | 25%   |
| Vol Right, %           | 14%   | 92%   | 0%    |
| Sign Control           | Stop  | Stop  | Stop  |
| Traffic Vol by Lane    | 70    | 130   | 160   |
| LT Vol                 | 0     | 10    | 120   |
| Through Vol            | 60    | 0     | 40    |
| RT Vol                 | 10    | 120   | 0     |
| Lane Flow Rate         | 80    | 148   | 182   |
| Geometry Grp           | 1     | 1     | 1     |
| Degree of Util (X)     | 0.096 | 0.163 | 0.222 |
| Departure Headway (Hd) | 4.355 | 3.962 | 4.389 |
| Convergence, Y/N       | Yes   | Yes   | Yes   |
| Cap                    | 825   | 910   | 807   |
| Service Time           | 2.37  | 1.965 | 2.476 |
| HCM Lane V/C Ratio     | 0.097 | 0.163 | 0.226 |
| HCM Control Delay      | 7.8   | 7.7   | 8.7   |
| HCM Lane LOS           | A     | A     | A     |
| HCM 95th-tile Q        | 0.3   | 0.6   | 0.8   |

| Intersection             |      |      |      |      |      |      |
|--------------------------|------|------|------|------|------|------|
| Int Delay, s/veh         | 1.3  |      |      |      |      |      |
| Movement                 | EBT  | EBR  | WBL  | WBT  | NBL  | NBR  |
| Lane Configurations      |      |      |      |      |      |      |
| Traffic Vol, veh/h       | 110  | 20   | 10   | 110  | 20   | 10   |
| Future Vol, veh/h        | 110  | 20   | 10   | 110  | 20   | 10   |
| Conflicting Peds, #/hr   | 0    | 0    | 0    | 0    | 0    | 0    |
| Sign Control             | Free | Free | Free | Free | Stop | Stop |
| RT Channelized           | -    | None | -    | None | -    | None |
| Storage Length           | -    | -    | -    | -    | 0    | -    |
| Veh in Median Storage, # | 0    | -    | -    | 0    | 0    | -    |
| Grade, %                 | 0    | -    | -    | 0    | 0    | -    |
| Peak Hour Factor         | 85   | 85   | 85   | 85   | 85   | 85   |
| Heavy Vehicles, %        | 0    | 0    | 0    | 0    | 0    | 0    |
| Mvmt Flow                | 129  | 24   | 12   | 129  | 24   | 12   |

| Major/Minor          | Major1 | Major2 | Minor1 | Minor2 | Minor3 |
|----------------------|--------|--------|--------|--------|--------|
| Conflicting Flow All | 0      | 0      | 153    | 0      | 294    |
| Stage 1              | -      | -      | -      | -      | 141    |
| Stage 2              | -      | -      | -      | -      | 153    |
| Critical Hdwy        | -      | -      | 4.1    | -      | 6.4    |
| Critical Hdwy Stg 1  | -      | -      | -      | -      | 5.4    |
| Critical Hdwy Stg 2  | -      | -      | -      | -      | 5.4    |
| Follow-up Hdwy       | -      | -      | 2.2    | -      | 3.5    |
| Pot Cap-1 Maneuver   | -      | -      | 1440   | -      | 701    |
| Stage 1              | -      | -      | -      | -      | 891    |
| Stage 2              | -      | -      | -      | -      | 880    |
| Platoon blocked, %   | -      | -      | -      | -      | -      |
| Mov Cap-1 Maneuver   | -      | -      | 1440   | -      | 695    |
| Mov Cap-2 Maneuver   | -      | -      | -      | -      | 695    |
| Stage 1              | -      | -      | -      | -      | 883    |
| Stage 2              | -      | -      | -      | -      | 880    |

| Approach             | EB | WB  | NB |
|----------------------|----|-----|----|
| HCM Control Delay, s | 0  | 0.6 | 10 |
| HCM LOS              |    |     | B  |

| Minor Lane/Major Mvmt | NBLn1 | EBT | EBR | WBL   | WBT |
|-----------------------|-------|-----|-----|-------|-----|
| Capacity (veh/h)      | 755   | -   | -   | 1440  | -   |
| HCM Lane V/C Ratio    | 0.047 | -   | -   | 0.008 | -   |
| HCM Control Delay (s) | 10    | -   | -   | 7.5   | 0   |
| HCM Lane LOS          | B     | -   | -   | A     | A   |
| HCM 95th %tile Q(veh) | 0.1   | -   | -   | 0     | -   |



| Intersection              |      |
|---------------------------|------|
| Intersection Delay, s/veh | 10.6 |
| Intersection LOS          | B    |

| Movement            | EBL  | EBT  | EBR  | WBL  | WBT  | WBR  | NBL  | NBT  | NBR  | SBL  | SBT  | SBR  |
|---------------------|------|------|------|------|------|------|------|------|------|------|------|------|
| Lane Configurations |      | ↕    |      |      | ↕    |      |      | ↕    |      |      | ↕    |      |
| Traffic Vol, veh/h  | 10   | 100  | 10   | 10   | 100  | 10   | 10   | 180  | 10   | 10   | 200  | 10   |
| Future Vol, veh/h   | 10   | 100  | 10   | 10   | 100  | 10   | 10   | 180  | 10   | 10   | 200  | 10   |
| Peak Hour Factor    | 0.82 | 0.82 | 0.82 | 0.82 | 0.82 | 0.82 | 0.82 | 0.82 | 0.82 | 0.82 | 0.82 | 0.82 |
| Heavy Vehicles, %   | 0    | 0    | 0    | 0    | 0    | 0    | 2    | 2    | 2    | 0    | 0    | 0    |
| Mvmt Flow           | 12   | 122  | 12   | 12   | 122  | 12   | 12   | 220  | 12   | 12   | 244  | 12   |
| Number of Lanes     | 0    | 1    | 0    | 0    | 1    | 0    | 0    | 1    | 0    | 0    | 1    | 0    |

| Approach                   | EB | WB | NB   | SB   |
|----------------------------|----|----|------|------|
| Opposing Approach          | WB | EB | SB   | NB   |
| Opposing Lanes             | 1  | 1  | 1    | 1    |
| Conflicting Approach Left  | SB | NB | EB   | WB   |
| Conflicting Lanes Left     | 1  | 1  | 1    | 1    |
| Conflicting Approach Right | NB | SB | WB   | EB   |
| Conflicting Lanes Right    | 1  | 1  | 1    | 1    |
| HCM Control Delay          | 10 | 10 | 10.9 | 11.1 |
| HCM LOS                    | A  | A  | B    | B    |

| Lane                   | NBLn1 | EBLn1 | WBLn1 | SBLn1 |
|------------------------|-------|-------|-------|-------|
| Vol Left, %            | 5%    | 8%    | 8%    | 5%    |
| Vol Thru, %            | 90%   | 83%   | 83%   | 91%   |
| Vol Right, %           | 5%    | 8%    | 8%    | 5%    |
| Sign Control           | Stop  | Stop  | Stop  | Stop  |
| Traffic Vol by Lane    | 200   | 120   | 120   | 220   |
| LT Vol                 | 10    | 10    | 10    | 10    |
| Through Vol            | 180   | 100   | 100   | 200   |
| RT Vol                 | 10    | 10    | 10    | 10    |
| Lane Flow Rate         | 244   | 146   | 146   | 268   |
| Geometry Grp           | 1     | 1     | 1     | 1     |
| Degree of Util (X)     | 0.347 | 0.221 | 0.221 | 0.377 |
| Departure Headway (Hd) | 5.122 | 5.442 | 5.442 | 5.059 |
| Convergence, Y/N       | Yes   | Yes   | Yes   | Yes   |
| Cap                    | 702   | 660   | 660   | 711   |
| Service Time           | 3.151 | 3.476 | 3.476 | 3.086 |
| HCM Lane V/C Ratio     | 0.348 | 0.221 | 0.221 | 0.377 |
| HCM Control Delay      | 10.9  | 10    | 10    | 11.1  |
| HCM Lane LOS           | B     | A     | A     | B     |
| HCM 95th-tile Q        | 1.6   | 0.8   | 0.8   | 1.8   |

| Intersection             |      |      |      |      |      |      |      |      |      |      |      |      |
|--------------------------|------|------|------|------|------|------|------|------|------|------|------|------|
| Int Delay, s/veh         | 6.5  |      |      |      |      |      |      |      |      |      |      |      |
| Movement                 | EBL  | EBT  | EBR  | WBL  | WBT  | WBR  | NBL  | NBT  | NBR  | SBL  | SBT  | SBR  |
| Lane Configurations      |      | ↕    |      |      | ↕    |      |      | ↕    |      |      | ↕    |      |
| Traffic Vol, veh/h       | 20   | 60   | 20   | 10   | 30   | 10   | 70   | 160  | 10   | 0    | 0    | 0    |
| Future Vol, veh/h        | 20   | 60   | 20   | 10   | 30   | 10   | 70   | 160  | 10   | 0    | 0    | 0    |
| Conflicting Peds, #/hr   | 0    | 0    | 0    | 0    | 0    | 0    | 0    | 0    | 0    | 0    | 0    | 0    |
| Sign Control             | Stop | Stop | Stop | Stop | Stop | Stop | Free | Free | Free | Free | Free | Free |
| RT Channelized           | -    | -    | None | -    | -    | None | -    | -    | None | -    | -    | None |
| Storage Length           | -    | -    | -    | -    | -    | -    | -    | -    | -    | -    | -    | -    |
| Veh in Median Storage, # | -    | 0    | -    | -    | 0    | -    | -    | 0    | -    | -    | 0    | -    |
| Grade, %                 | -    | 0    | -    | -    | 0    | -    | -    | 0    | -    | -    | 0    | -    |
| Peak Hour Factor         | 74   | 74   | 74   | 74   | 74   | 74   | 74   | 74   | 74   | 74   | 74   | 74   |
| Heavy Vehicles, %        | 3    | 3    | 3    | 2    | 2    | 2    | 3    | 3    | 3    | 8    | 8    | 8    |
| Mvmt Flow                | 27   | 81   | 27   | 14   | 41   | 14   | 95   | 216  | 14   | 0    | 0    | 0    |

| Major/Minor          | Minor2 |       | Minor1 |       | Major1 |       |       | Major2 |   |       |   |   |
|----------------------|--------|-------|--------|-------|--------|-------|-------|--------|---|-------|---|---|
| Conflicting Flow All | 442    | 421   | 1      | 468   | 414    | 223   | 1     | 0      | 0 | 230   | 0 | 0 |
| Stage 1              | 1      | 1     | -      | 413   | 413    | -     | -     | -      | - | -     | - | - |
| Stage 2              | 441    | 420   | -      | 55    | 1      | -     | -     | -      | - | -     | - | - |
| Critical Hdwy        | 7.13   | 6.53  | 6.23   | 7.12  | 6.52   | 6.22  | 4.13  | -      | - | 4.18  | - | - |
| Critical Hdwy Stg 1  | 6.13   | 5.53  | -      | 6.12  | 5.52   | -     | -     | -      | - | -     | - | - |
| Critical Hdwy Stg 2  | 6.13   | 5.53  | -      | 6.12  | 5.52   | -     | -     | -      | - | -     | - | - |
| Follow-up Hdwy       | 3.527  | 4.027 | 3.327  | 3.518 | 4.018  | 3.318 | 2.227 | -      | - | 2.272 | - | - |
| Pot Cap-1 Maneuver   | 524    | 522   | 1081   | 505   | 529    | 817   | 1615  | -      | - | 1303  | - | - |
| Stage 1              | 1019   | 893   | -      | 616   | 594    | -     | -     | -      | - | -     | - | - |
| Stage 2              | 593    | 588   | -      | 957   | 895    | -     | -     | -      | - | -     | - | - |
| Platoon blocked, %   |        |       |        |       |        |       |       | -      | - | -     | - | - |
| Mov Cap-1 Maneuver   | 458    | 487   | 1081   | 408   | 493    | 817   | 1615  | -      | - | 1303  | - | - |
| Mov Cap-2 Maneuver   | 458    | 487   | -      | 408   | 493    | -     | -     | -      | - | -     | - | - |
| Stage 1              | 950    | 893   | -      | 574   | 554    | -     | -     | -      | - | -     | - | - |
| Stage 2              | 504    | 548   | -      | 848   | 895    | -     | -     | -      | - | -     | - | - |

| Approach             | EB   |  | WB   |  | NB  |  | SB |  |
|----------------------|------|--|------|--|-----|--|----|--|
| HCM Control Delay, s | 13.9 |  | 13.1 |  | 2.1 |  | 0  |  |
| HCM LOS              | B    |  | B    |  |     |  |    |  |

| Minor Lane/Major Mvmt | NBL   | NBT | NBR | EBLn1WBLn1 | SBL   | SBT  | SBR |
|-----------------------|-------|-----|-----|------------|-------|------|-----|
| Capacity (veh/h)      | 1615  | -   | -   | 539        | 512   | 1303 | -   |
| HCM Lane V/C Ratio    | 0.059 | -   | -   | 0.251      | 0.132 | -    | -   |
| HCM Control Delay (s) | 7.4   | 0   | -   | 13.9       | 13.1  | 0    | -   |
| HCM Lane LOS          | A     | A   | -   | B          | B     | A    | -   |
| HCM 95th %tile Q(veh) | 0.2   | -   | -   | 1          | 0.5   | 0    | -   |

| Intersection             |      |      |      |      |      |      |
|--------------------------|------|------|------|------|------|------|
| Int Delay, s/veh         | 1.6  |      |      |      |      |      |
| Movement                 | EBL  | EBR  | NBL  | NBT  | SBT  | SBR  |
| Lane Configurations      | T    |      |      | T    |      | T    |
| Traffic Vol, veh/h       | 60   | 10   | 10   | 360  | 330  | 30   |
| Future Vol, veh/h        | 60   | 10   | 10   | 360  | 330  | 30   |
| Conflicting Peds, #/hr   | 0    | 0    | 0    | 0    | 0    | 0    |
| Sign Control             | Stop | Stop | Free | Free | Free | Free |
| RT Channelized           | -    | None | -    | None | -    | None |
| Storage Length           | 0    | -    | -    | -    | -    | -    |
| Veh in Median Storage, # | 0    | -    | -    | 0    | 0    | -    |
| Grade, %                 | 0    | -    | -    | 0    | 0    | -    |
| Peak Hour Factor         | 88   | 88   | 88   | 88   | 88   | 88   |
| Heavy Vehicles, %        | 0    | 0    | 2    | 2    | 1    | 1    |
| Mvmt Flow                | 68   | 11   | 11   | 409  | 375  | 34   |

| Major/Minor          | Minor2 | Major1 |       | Major2 |   |
|----------------------|--------|--------|-------|--------|---|
| Conflicting Flow All | 823    | 392    | 409   | 0      | 0 |
| Stage 1              | 392    | -      | -     | -      | - |
| Stage 2              | 431    | -      | -     | -      | - |
| Critical Hdwy        | 6.4    | 6.2    | 4.12  | -      | - |
| Critical Hdwy Stg 1  | 5.4    | -      | -     | -      | - |
| Critical Hdwy Stg 2  | 5.4    | -      | -     | -      | - |
| Follow-up Hdwy       | 3.5    | 3.3    | 2.218 | -      | - |
| Pot Cap-1 Maneuver   | 346    | 661    | 1150  | -      | - |
| Stage 1              | 687    | -      | -     | -      | - |
| Stage 2              | 660    | -      | -     | -      | - |
| Platoon blocked, %   |        |        |       | -      | - |
| Mov Cap-1 Maneuver   | 342    | 661    | 1150  | -      | - |
| Mov Cap-2 Maneuver   | 342    | -      | -     | -      | - |
| Stage 1              | 679    | -      | -     | -      | - |
| Stage 2              | 660    | -      | -     | -      | - |

| Approach             | EB   | NB  | SB |
|----------------------|------|-----|----|
| HCM Control Delay, s | 17.5 | 0.2 | 0  |
| HCM LOS              | C    |     |    |

| Minor Lane/Major Mvmt | NBL  | NBT | EBLn1 | SBT | SBR |
|-----------------------|------|-----|-------|-----|-----|
| Capacity (veh/h)      | 1150 | -   | 367   | -   | -   |
| HCM Lane V/C Ratio    | 0.01 | -   | 0.217 | -   | -   |
| HCM Control Delay (s) | 8.2  | 0   | 17.5  | -   | -   |
| HCM Lane LOS          | A    | A   | C     | -   | -   |
| HCM 95th %tile Q(veh) | 0    | -   | 0.8   | -   | -   |

HCM 2010 Signalized Intersection Summary  
 39: General Jim Moore Boulevard & Gigling Road

Existing with Project, PM  
 06/11/2019

| Movement                     | EBL  | EBT  | EBR  | WBL  | WBT  | WBR  | NBL  | NBT  | NBR  | SBL  | SBT  | SBR  |
|------------------------------|------|------|------|------|------|------|------|------|------|------|------|------|
| Lane Configurations          |      |      |      |      |      |      |      |      |      |      |      |      |
| Traffic Volume (veh/h)       | 20   | 20   | 30   | 220  | 50   | 220  | 60   | 490  | 150  | 100  | 240  | 50   |
| Future Volume (veh/h)        | 20   | 20   | 30   | 220  | 50   | 220  | 60   | 490  | 150  | 100  | 240  | 50   |
| Number                       | 3    | 8    | 18   | 7    | 4    | 14   | 1    | 6    | 16   | 5    | 2    | 12   |
| Initial Q (Qb), veh          | 0    | 0    | 0    | 0    | 0    | 0    | 0    | 0    | 0    | 0    | 0    | 0    |
| Ped-Bike Adj(A_pbT)          | 1.00 |      | 0.99 | 1.00 |      | 1.00 | 1.00 |      | 1.00 | 1.00 |      | 1.00 |
| Parking Bus, Adj             | 1.00 | 1.00 | 1.00 | 1.00 | 1.00 | 1.00 | 1.00 | 1.00 | 1.00 | 1.00 | 1.00 | 1.00 |
| Adj Sat Flow, veh/h/ln       | 1776 | 1776 | 1900 | 1881 | 1881 | 1881 | 1863 | 1863 | 1863 | 1863 | 1863 | 1863 |
| Adj Flow Rate, veh/h         | 22   | 22   | 3    | 247  | 56   | 0    | 67   | 551  | 0    | 112  | 270  | 0    |
| Adj No. of Lanes             | 1    | 1    | 0    | 1    | 1    | 1    | 1    | 2    | 1    | 1    | 2    | 1    |
| Peak Hour Factor             | 0.89 | 0.89 | 0.89 | 0.89 | 0.89 | 0.89 | 0.89 | 0.89 | 0.89 | 0.89 | 0.89 | 0.89 |
| Percent Heavy Veh, %         | 7    | 7    | 7    | 1    | 1    | 1    | 2    | 2    | 2    | 2    | 2    | 2    |
| Cap, veh/h                   | 46   | 145  | 20   | 307  | 450  | 382  | 115  | 767  | 343  | 154  | 846  | 378  |
| Arrive On Green              | 0.03 | 0.09 | 0.09 | 0.17 | 0.24 | 0.00 | 0.06 | 0.22 | 0.00 | 0.09 | 0.24 | 0.00 |
| Sat Flow, veh/h              | 1691 | 1529 | 209  | 1792 | 1881 | 1599 | 1774 | 3539 | 1583 | 1774 | 3539 | 1583 |
| Grp Volume(v), veh/h         | 22   | 0    | 25   | 247  | 56   | 0    | 67   | 551  | 0    | 112  | 270  | 0    |
| Grp Sat Flow(s),veh/h/ln     | 1691 | 0    | 1738 | 1792 | 1881 | 1599 | 1774 | 1770 | 1583 | 1774 | 1770 | 1583 |
| Q Serve(g_s), s              | 0.5  | 0.0  | 0.6  | 5.5  | 1.0  | 0.0  | 1.5  | 6.0  | 0.0  | 2.6  | 2.6  | 0.0  |
| Cycle Q Clear(g_c), s        | 0.5  | 0.0  | 0.6  | 5.5  | 1.0  | 0.0  | 1.5  | 6.0  | 0.0  | 2.6  | 2.6  | 0.0  |
| Prop In Lane                 | 1.00 |      | 0.12 | 1.00 |      | 1.00 | 1.00 |      | 1.00 | 1.00 |      | 1.00 |
| Lane Grp Cap(c), veh/h       | 46   | 0    | 165  | 307  | 450  | 382  | 115  | 767  | 343  | 154  | 846  | 378  |
| V/C Ratio(X)                 | 0.48 | 0.00 | 0.15 | 0.80 | 0.12 | 0.00 | 0.58 | 0.72 | 0.00 | 0.73 | 0.32 | 0.00 |
| Avail Cap(c_a), veh/h        | 829  | 0    | 1267 | 878  | 1371 | 1166 | 445  | 2157 | 965  | 445  | 2157 | 965  |
| HCM Platoon Ratio            | 1.00 | 1.00 | 1.00 | 1.00 | 1.00 | 1.00 | 1.00 | 1.00 | 1.00 | 1.00 | 1.00 | 1.00 |
| Upstream Filter(I)           | 1.00 | 0.00 | 1.00 | 1.00 | 1.00 | 0.00 | 1.00 | 1.00 | 0.00 | 1.00 | 1.00 | 0.00 |
| Uniform Delay (d), s/veh     | 20.1 | 0.0  | 17.4 | 16.7 | 12.5 | 0.0  | 19.0 | 15.2 | 0.0  | 18.6 | 13.1 | 0.0  |
| Incr Delay (d2), s/veh       | 2.9  | 0.0  | 0.2  | 1.9  | 0.0  | 0.0  | 1.7  | 0.5  | 0.0  | 2.4  | 0.1  | 0.0  |
| Initial Q Delay(d3),s/veh    | 0.0  | 0.0  | 0.0  | 0.0  | 0.0  | 0.0  | 0.0  | 0.0  | 0.0  | 0.0  | 0.0  | 0.0  |
| %ile BackOfQ(50%),veh/ln     | 0.3  | 0.0  | 0.3  | 2.9  | 0.5  | 0.0  | 0.8  | 3.0  | 0.0  | 1.3  | 1.3  | 0.0  |
| LnGrp Delay(d),s/veh         | 23.0 | 0.0  | 17.5 | 18.6 | 12.5 | 0.0  | 20.8 | 15.7 | 0.0  | 21.0 | 13.2 | 0.0  |
| LnGrp LOS                    | C    |      | B    | B    | B    |      | C    | B    |      | C    | B    |      |
| Approach Vol, veh/h          |      | 47   |      |      | 303  |      |      | 618  |      |      | 382  |      |
| Approach Delay, s/veh        |      | 20.1 |      |      | 17.4 |      |      | 16.2 |      |      | 15.5 |      |
| Approach LOS                 |      | C    |      |      | B    |      |      | B    |      |      | B    |      |
| Timer                        | 1    | 2    | 3    | 4    | 5    | 6    | 7    | 8    |      |      |      |      |
| Assigned Phs                 | 1    | 2    | 3    | 4    | 5    | 6    | 7    | 8    |      |      |      |      |
| Phs Duration (G+Y+Rc), s     | 7.2  | 14.5 | 5.6  | 14.5 | 8.1  | 13.6 | 11.7 | 8.5  |      |      |      |      |
| Change Period (Y+Rc), s      | 4.5  | 4.5  | 4.5  | 4.5  | 4.5  | 4.5  | 4.5  | 4.5  |      |      |      |      |
| Max Green Setting (Gmax), s  | 10.5 | 25.5 | 20.5 | 30.5 | 10.5 | 25.5 | 20.5 | 30.5 |      |      |      |      |
| Max Q Clear Time (g_c+I1), s | 3.5  | 4.6  | 2.5  | 3.0  | 4.6  | 8.0  | 7.5  | 2.6  |      |      |      |      |
| Green Ext Time (p_c), s      | 0.0  | 0.3  | 0.0  | 0.0  | 0.0  | 0.7  | 0.1  | 0.0  |      |      |      |      |
| <b>Intersection Summary</b>  |      |      |      |      |      |      |      |      |      |      |      |      |
| HCM 2010 Ctrl Delay          |      |      | 16.4 |      |      |      |      |      |      |      |      |      |
| HCM 2010 LOS                 |      |      | B    |      |      |      |      |      |      |      |      |      |
| <b>Notes</b>                 |      |      |      |      |      |      |      |      |      |      |      |      |

| Intersection             |      |      |      |      |      |      |      |      |      |      |      |      |
|--------------------------|------|------|------|------|------|------|------|------|------|------|------|------|
| Int Delay, s/veh         | 5.1  |      |      |      |      |      |      |      |      |      |      |      |
| Movement                 | EBL  | EBT  | EBR  | WBL  | WBT  | WBR  | NBL  | NBT  | NBR  | SBL  | SBT  | SBR  |
| Lane Configurations      |      | ↕    |      |      | ↕    |      |      | ↕    |      |      | ↕    |      |
| Traffic Vol, veh/h       | 10   | 590  | 10   | 10   | 530  | 30   | 30   | 30   | 20   | 30   | 10   | 10   |
| Future Vol, veh/h        | 10   | 590  | 10   | 10   | 530  | 30   | 30   | 30   | 20   | 30   | 10   | 10   |
| Conflicting Peds, #/hr   | 1    | 0    | 2    | 2    | 0    | 1    | 0    | 0    | 0    | 0    | 0    | 0    |
| Sign Control             | Free | Free | Free | Free | Free | Free | Stop | Stop | Stop | Stop | Stop | Stop |
| RT Channelized           | -    | -    | None | -    | -    | None | -    | -    | None | -    | -    | None |
| Storage Length           | -    | -    | -    | -    | -    | -    | -    | -    | -    | -    | -    | -    |
| Veh in Median Storage, # | -    | 0    | -    | -    | 0    | -    | -    | 0    | -    | -    | 0    | -    |
| Grade, %                 | -    | 0    | -    | -    | 0    | -    | -    | 0    | -    | -    | 0    | -    |
| Peak Hour Factor         | 91   | 91   | 91   | 91   | 91   | 91   | 91   | 91   | 91   | 91   | 91   | 91   |
| Heavy Vehicles, %        | 2    | 2    | 2    | 1    | 1    | 1    | 0    | 0    | 0    | 5    | 5    | 5    |
| Mvmt Flow                | 11   | 648  | 11   | 11   | 582  | 33   | 33   | 33   | 22   | 33   | 11   | 11   |

| Major/Minor          | Major1 |   |   | Major2 |   |   | Minor1 |      |     | Minor2 |       |       |
|----------------------|--------|---|---|--------|---|---|--------|------|-----|--------|-------|-------|
| Conflicting Flow All | 616    | 0 | 0 | 661    | 0 | 0 | 1310   | 1316 | 656 | 1325   | 1305  | 600   |
| Stage 1              | -      | - | - | -      | - | - | 678    | 678  | -   | 622    | 622   | -     |
| Stage 2              | -      | - | - | -      | - | - | 632    | 638  | -   | 703    | 683   | -     |
| Critical Hdwy        | 4.12   | - | - | 4.11   | - | - | 7.1    | 6.5  | 6.2 | 7.15   | 6.55  | 6.25  |
| Critical Hdwy Stg 1  | -      | - | - | -      | - | - | 6.1    | 5.5  | -   | 6.15   | 5.55  | -     |
| Critical Hdwy Stg 2  | -      | - | - | -      | - | - | 6.1    | 5.5  | -   | 6.15   | 5.55  | -     |
| Follow-up Hdwy       | 2.218  | - | - | 2.209  | - | - | 3.5    | 4    | 3.3 | 3.545  | 4.045 | 3.345 |
| Pot Cap-1 Maneuver   | 964    | - | - | 932    | - | - | 137    | 159  | 469 | 131    | 158   | 495   |
| Stage 1              | -      | - | - | -      | - | - | 445    | 455  | -   | 469    | 474   | -     |
| Stage 2              | -      | - | - | -      | - | - | 472    | 474  | -   | 423    | 445   | -     |
| Platoon blocked, %   | -      | - | - | -      | - | - | -      | -    | -   | -      | -     | -     |
| Mov Cap-1 Maneuver   | 963    | - | - | 930    | - | - | 123    | 153  | 468 | 101    | 152   | 495   |
| Mov Cap-2 Maneuver   | -      | - | - | -      | - | - | 123    | 153  | -   | 101    | 152   | -     |
| Stage 1              | -      | - | - | -      | - | - | 436    | 446  | -   | 460    | 465   | -     |
| Stage 2              | -      | - | - | -      | - | - | 443    | 465  | -   | 367    | 436   | -     |

| Approach             | EB  |  |  | WB  |  |  | NB   |  |  | SB |  |  |
|----------------------|-----|--|--|-----|--|--|------|--|--|----|--|--|
| HCM Control Delay, s | 0.1 |  |  | 0.2 |  |  | 48.8 |  |  | 51 |  |  |
| HCM LOS              |     |  |  |     |  |  | E    |  |  | F  |  |  |

| Minor Lane/Major Mvmt | NBLn1 | EBL   | EBT | EBR | WBL   | WBT | WBR | SBLn1 |
|-----------------------|-------|-------|-----|-----|-------|-----|-----|-------|
| Capacity (veh/h)      | 166   | 963   | -   | -   | 930   | -   | -   | 131   |
| HCM Lane V/C Ratio    | 0.53  | 0.011 | -   | -   | 0.012 | -   | -   | 0.419 |
| HCM Control Delay (s) | 48.8  | 8.8   | 0   | -   | 8.9   | 0   | -   | 51    |
| HCM Lane LOS          | E     | A     | A   | -   | A     | A   | -   | F     |
| HCM 95th %tile Q(veh) | 2.7   | 0     | -   | -   | 0     | -   | -   | 1.8   |

| Intersection             |      |      |      |      |      |      |      |      |      |      |      |      |
|--------------------------|------|------|------|------|------|------|------|------|------|------|------|------|
| Int Delay, s/veh         | 9.1  |      |      |      |      |      |      |      |      |      |      |      |
| Movement                 | EBL  | EBT  | EBR  | WBL  | WBT  | WBR  | NBL  | NBT  | NBR  | SBL  | SBT  | SBR  |
| Lane Configurations      |      | ↕    |      |      | ↕    |      |      | ↕    | ↕    |      | ↕    |      |
| Traffic Vol, veh/h       | 10   | 610  | 20   | 20   | 490  | 20   | 80   | 10   | 50   | 10   | 10   | 10   |
| Future Vol, veh/h        | 10   | 610  | 20   | 20   | 490  | 20   | 80   | 10   | 50   | 10   | 10   | 10   |
| Conflicting Peds, #/hr   | 3    | 0    | 0    | 0    | 0    | 3    | 2    | 0    | 0    | 0    | 0    | 2    |
| Sign Control             | Free | Free | Free | Free | Free | Free | Stop | Stop | Stop | Stop | Stop | Stop |
| RT Channelized           | -    | -    | None | -    | -    | None | -    | -    | None | -    | -    | None |
| Storage Length           | -    | -    | -    | -    | -    | -    | -    | -    | 135  | -    | -    | -    |
| Veh in Median Storage, # | -    | 0    | -    | -    | 0    | -    | -    | 0    | -    | -    | 0    | -    |
| Grade, %                 | -    | 0    | -    | -    | 0    | -    | -    | 0    | -    | -    | 0    | -    |
| Peak Hour Factor         | 89   | 89   | 89   | 89   | 89   | 89   | 89   | 89   | 89   | 89   | 89   | 89   |
| Heavy Vehicles, %        | 2    | 2    | 2    | 1    | 1    | 1    | 0    | 0    | 0    | 0    | 0    | 0    |
| Mvmt Flow                | 11   | 685  | 22   | 22   | 551  | 22   | 90   | 11   | 56   | 11   | 11   | 11   |

| Major/Minor          | Major1 |   |   | Major2 |   |   | Minor1 |      |     | Minor2 |      |     |
|----------------------|--------|---|---|--------|---|---|--------|------|-----|--------|------|-----|
| Conflicting Flow All | 576    | 0 | 0 | 707    | 0 | 0 | 1337   | 1338 | 696 | 1361   | 1338 | 567 |
| Stage 1              | -      | - | - | -      | - | - | 718    | 718  | -   | 609    | 609  | -   |
| Stage 2              | -      | - | - | -      | - | - | 619    | 620  | -   | 752    | 729  | -   |
| Critical Hdwy        | 4.12   | - | - | 4.11   | - | - | 7.1    | 6.5  | 6.2 | 7.1    | 6.5  | 6.2 |
| Critical Hdwy Stg 1  | -      | - | - | -      | - | - | 6.1    | 5.5  | -   | 6.1    | 5.5  | -   |
| Critical Hdwy Stg 2  | -      | - | - | -      | - | - | 6.1    | 5.5  | -   | 6.1    | 5.5  | -   |
| Follow-up Hdwy       | 2.218  | - | - | 2.209  | - | - | 3.5    | 4    | 3.3 | 3.5    | 4    | 3.3 |
| Pot Cap-1 Maneuver   | 997    | - | - | 896    | - | - | 132    | 154  | 445 | 127    | 154  | 527 |
| Stage 1              | -      | - | - | -      | - | - | 423    | 436  | -   | 486    | 488  | -   |
| Stage 2              | -      | - | - | -      | - | - | 480    | 483  | -   | 405    | 431  | -   |
| Platoon blocked, %   |        | - | - | -      | - | - |        |      |     |        |      |     |
| Mov Cap-1 Maneuver   | 994    | - | - | 896    | - | - | 116    | 145  | 445 | 100    | 145  | 524 |
| Mov Cap-2 Maneuver   | -      | - | - | -      | - | - | 116    | 145  | -   | 100    | 145  | -   |
| Stage 1              | -      | - | - | -      | - | - | 415    | 428  | -   | 476    | 469  | -   |
| Stage 2              | -      | - | - | -      | - | - | 441    | 464  | -   | 338    | 423  | -   |

| Approach             | EB  |  |  | WB  |  |  | NB   |  |  | SB   |  |  |
|----------------------|-----|--|--|-----|--|--|------|--|--|------|--|--|
| HCM Control Delay, s | 0.1 |  |  | 0.3 |  |  | 78.5 |  |  | 33.4 |  |  |
| HCM LOS              |     |  |  |     |  |  | F    |  |  | D    |  |  |

| Minor Lane/Major Mvmt | NBLn1 | NBLn2 | EBL   | EBT | EBR | WBL   | WBT | WBR | SBLn1 |
|-----------------------|-------|-------|-------|-----|-----|-------|-----|-----|-------|
| Capacity (veh/h)      | 119   | 445   | 994   | -   | -   | 896   | -   | -   | 160   |
| HCM Lane V/C Ratio    | 0.85  | 0.126 | 0.011 | -   | -   | 0.025 | -   | -   | 0.211 |
| HCM Control Delay (s) | 114.2 | 14.3  | 8.7   | 0   | -   | 9.1   | 0   | -   | 33.4  |
| HCM Lane LOS          | F     | B     | A     | A   | -   | A     | A   | -   | D     |
| HCM 95th %tile Q(veh) | 5.1   | 0.4   | 0     | -   | -   | 0.1   | -   | -   | 0.8   |

| Intersection              |      |
|---------------------------|------|
| Intersection Delay, s/veh | 55.1 |
| Intersection LOS          | F    |

| Movement            | EBL  | EBT  | EBR  | WBL  | WBT  | WBR  | NBL  | NBT  | NBR  | SBL  | SBT  | SBR  |
|---------------------|------|------|------|------|------|------|------|------|------|------|------|------|
| Lane Configurations |      | ↕    |      |      | ↕    |      |      | ↕    | ↕    |      | ↕    |      |
| Traffic Vol, veh/h  | 180  | 500  | 10   | 10   | 320  | 10   | 10   | 10   | 20   | 10   | 10   | 200  |
| Future Vol, veh/h   | 180  | 500  | 10   | 10   | 320  | 10   | 10   | 10   | 20   | 10   | 10   | 200  |
| Peak Hour Factor    | 0.95 | 0.95 | 0.95 | 0.95 | 0.95 | 0.95 | 0.95 | 0.95 | 0.95 | 0.95 | 0.95 | 0.95 |
| Heavy Vehicles, %   | 1    | 1    | 1    | 2    | 2    | 2    | 0    | 0    | 0    | 0    | 0    | 0    |
| Mvmt Flow           | 189  | 526  | 11   | 11   | 337  | 11   | 11   | 11   | 21   | 11   | 11   | 211  |
| Number of Lanes     | 0    | 1    | 0    | 0    | 1    | 0    | 0    | 1    | 1    | 0    | 1    | 0    |

| Approach                   | EB   | WB | NB | SB   |
|----------------------------|------|----|----|------|
| Opposing Approach          | WB   | EB | SB | NB   |
| Opposing Lanes             | 1    | 1  | 1  | 2    |
| Conflicting Approach Left  | SB   | NB | EB | WB   |
| Conflicting Lanes Left     | 1    | 2  | 1  | 1    |
| Conflicting Approach Right | NB   | SB | WB | EB   |
| Conflicting Lanes Right    | 2    | 1  | 1  | 1    |
| HCM Control Delay          | 89.6 | 17 | 11 | 13.8 |
| HCM LOS                    | F    | C  | B  | B    |

| Lane                   | NBLn1 | NBLn2 | EBLn1 | WBLn1 | SBLn1 |
|------------------------|-------|-------|-------|-------|-------|
| Vol Left, %            | 50%   | 0%    | 26%   | 3%    | 5%    |
| Vol Thru, %            | 50%   | 0%    | 72%   | 94%   | 5%    |
| Vol Right, %           | 0%    | 100%  | 1%    | 3%    | 91%   |
| Sign Control           | Stop  | Stop  | Stop  | Stop  | Stop  |
| Traffic Vol by Lane    | 20    | 20    | 690   | 340   | 220   |
| LT Vol                 | 10    | 0     | 180   | 10    | 10    |
| Through Vol            | 10    | 0     | 500   | 320   | 10    |
| RT Vol                 | 0     | 20    | 10    | 10    | 200   |
| Lane Flow Rate         | 21    | 21    | 726   | 358   | 232   |
| Geometry Grp           | 7     | 7     | 2     | 2     | 5     |
| Degree of Util (X)     | 0.047 | 0.041 | 1.105 | 0.579 | 0.4   |
| Departure Headway (Hd) | 8.386 | 7.404 | 5.479 | 6.043 | 6.512 |
| Convergence, Y/N       | Yes   | Yes   | Yes   | Yes   | Yes   |
| Cap                    | 430   | 487   | 661   | 601   | 556   |
| Service Time           | 6.086 | 5.104 | 3.509 | 4.043 | 4.512 |
| HCM Lane V/C Ratio     | 0.049 | 0.043 | 1.098 | 0.596 | 0.417 |
| HCM Control Delay      | 11.5  | 10.4  | 89.6  | 17    | 13.8  |
| HCM Lane LOS           | B     | B     | F     | C     | B     |
| HCM 95th-tile Q        | 0.1   | 0.1   | 21.3  | 3.7   | 1.9   |

| Intersection             |      |      |      |      |      |      |
|--------------------------|------|------|------|------|------|------|
| Int Delay, s/veh         | 1.9  |      |      |      |      |      |
| Movement                 | EBL  | EBT  | WBT  | WBR  | SBL  | SBR  |
| Lane Configurations      |      | ↶    | ↷    |      | ↶    |      |
| Traffic Vol, veh/h       | 160  | 360  | 330  | 10   | 10   | 10   |
| Future Vol, veh/h        | 160  | 360  | 330  | 10   | 10   | 10   |
| Conflicting Peds, #/hr   | 0    | 0    | 0    | 0    | 0    | 1    |
| Sign Control             | Free | Free | Free | Free | Stop | Stop |
| RT Channelized           | -    | None | -    | None | -    | None |
| Storage Length           | -    | -    | -    | -    | 0    | -    |
| Veh in Median Storage, # | -    | 0    | 0    | -    | 0    | -    |
| Grade, %                 | -    | 0    | 0    | -    | 0    | -    |
| Peak Hour Factor         | 96   | 96   | 96   | 96   | 96   | 96   |
| Heavy Vehicles, %        | 2    | 2    | 1    | 1    | 4    | 4    |
| Mvmt Flow                | 167  | 375  | 344  | 10   | 10   | 10   |

| Major/Minor          | Major1 | Major2 | Minor2 |   |             |
|----------------------|--------|--------|--------|---|-------------|
| Conflicting Flow All | 354    | 0      | -      | 0 | 1058 350    |
| Stage 1              | -      | -      | -      | - | 349 -       |
| Stage 2              | -      | -      | -      | - | 709 -       |
| Critical Hdwy        | 4.12   | -      | -      | - | 6.44 6.24   |
| Critical Hdwy Stg 1  | -      | -      | -      | - | 5.44 -      |
| Critical Hdwy Stg 2  | -      | -      | -      | - | 5.44 -      |
| Follow-up Hdwy       | 2.218  | -      | -      | - | 3.536 3.336 |
| Pot Cap-1 Maneuver   | 1205   | -      | -      | - | 247 689     |
| Stage 1              | -      | -      | -      | - | 710 -       |
| Stage 2              | -      | -      | -      | - | 484 -       |
| Platoon blocked, %   |        | -      | -      | - |             |
| Mov Cap-1 Maneuver   | 1205   | -      | -      | - | 204 688     |
| Mov Cap-2 Maneuver   | -      | -      | -      | - | 204 -       |
| Stage 1              | -      | -      | -      | - | 586 -       |
| Stage 2              | -      | -      | -      | - | 484 -       |

| Approach             | EB  | WB | SB   |
|----------------------|-----|----|------|
| HCM Control Delay, s | 2.6 | 0  | 17.2 |
| HCM LOS              |     |    | C    |

| Minor Lane/Major Mvmt | EBL   | EBT | WBT | WBR | SBLn1 |
|-----------------------|-------|-----|-----|-----|-------|
| Capacity (veh/h)      | 1205  | -   | -   | -   | 315   |
| HCM Lane V/C Ratio    | 0.138 | -   | -   | -   | 0.066 |
| HCM Control Delay (s) | 8.5   | 0   | -   | -   | 17.2  |
| HCM Lane LOS          | A     | A   | -   | -   | C     |
| HCM 95th %tile Q(veh) | 0.5   | -   | -   | -   | 0.2   |



| Intersection              |      |
|---------------------------|------|
| Intersection Delay, s/veh | 13.6 |
| Intersection LOS          | B    |

| Movement            | EBL  | EBT  | EBR  | WBL  | WBT  | WBR  | NBL  | NBT  | NBR  | SBL  | SBT  | SBR  |
|---------------------|------|------|------|------|------|------|------|------|------|------|------|------|
| Lane Configurations |      | ↕    |      |      | ↕    |      |      | ↕    |      |      | ↕    |      |
| Traffic Vol, veh/h  | 360  | 10   | 10   | 10   | 10   | 10   | 10   | 10   | 10   | 10   | 10   | 330  |
| Future Vol, veh/h   | 360  | 10   | 10   | 10   | 10   | 10   | 10   | 10   | 10   | 10   | 10   | 330  |
| Peak Hour Factor    | 0.91 | 0.91 | 0.91 | 0.91 | 0.91 | 0.91 | 0.91 | 0.91 | 0.91 | 0.91 | 0.91 | 0.91 |
| Heavy Vehicles, %   | 2    | 2    | 2    | 2    | 2    | 2    | 0    | 0    | 0    | 1    | 1    | 1    |
| Mvmt Flow           | 396  | 11   | 11   | 11   | 11   | 11   | 11   | 11   | 11   | 11   | 11   | 363  |
| Number of Lanes     | 0    | 1    | 0    | 0    | 1    | 0    | 0    | 1    | 0    | 0    | 1    | 0    |

| Approach                   | EB   | WB  | NB  | SB   |
|----------------------------|------|-----|-----|------|
| Opposing Approach          | WB   | EB  | SB  | NB   |
| Opposing Lanes             | 1    | 1   | 1   | 1    |
| Conflicting Approach Left  | SB   | NB  | EB  | WB   |
| Conflicting Lanes Left     | 1    | 1   | 1   | 1    |
| Conflicting Approach Right | NB   | SB  | WB  | EB   |
| Conflicting Lanes Right    | 1    | 1   | 1   | 1    |
| HCM Control Delay          | 15.8 | 8.8 | 8.9 | 12.1 |
| HCM LOS                    | C    | A   | A   | B    |

| Lane                   | NBLn1 | EBLn1 | WBLn1 | SBLn1 |
|------------------------|-------|-------|-------|-------|
| Vol Left, %            | 33%   | 95%   | 33%   | 3%    |
| Vol Thru, %            | 33%   | 3%    | 33%   | 3%    |
| Vol Right, %           | 33%   | 3%    | 33%   | 94%   |
| Sign Control           | Stop  | Stop  | Stop  | Stop  |
| Traffic Vol by Lane    | 30    | 380   | 30    | 350   |
| LT Vol                 | 10    | 360   | 10    | 10    |
| Through Vol            | 10    | 10    | 10    | 10    |
| RT Vol                 | 10    | 10    | 10    | 330   |
| Lane Flow Rate         | 33    | 418   | 33    | 385   |
| Geometry Grp           | 1     | 1     | 1     | 1     |
| Degree of Util (X)     | 0.051 | 0.604 | 0.05  | 0.489 |
| Departure Headway (Hd) | 5.558 | 5.203 | 5.485 | 4.578 |
| Convergence, Y/N       | Yes   | Yes   | Yes   | Yes   |
| Cap                    | 645   | 697   | 655   | 777   |
| Service Time           | 3.586 | 3.205 | 3.5   | 2.67  |
| HCM Lane V/C Ratio     | 0.051 | 0.6   | 0.05  | 0.495 |
| HCM Control Delay      | 8.9   | 15.8  | 8.8   | 12.1  |
| HCM Lane LOS           | A     | C     | A     | B     |
| HCM 95th-tile Q        | 0.2   | 4.1   | 0.2   | 2.7   |



| Movement                      | EBL  | EBT  | EBR  | WBL  | WBT  | WBR  | NBL  | NBT  | NBR  | SBL  | SBT  | SBR   |
|-------------------------------|------|------|------|------|------|------|------|------|------|------|------|-------|
| Lane Configurations           |      | ↕    |      |      | ↕    |      | ↕    | ↕↕   |      | ↕    | ↕↕   | ↕     |
| Traffic Volume (veh/h)        | 50   | 30   | 40   | 50   | 30   | 10   | 50   | 780  | 70   | 30   | 410  | 50    |
| Future Volume (veh/h)         | 50   | 30   | 40   | 50   | 30   | 10   | 50   | 780  | 70   | 30   | 410  | 50    |
| Number                        | 3    | 8    | 18   | 7    | 4    | 14   | 1    | 6    | 16   | 5    | 2    | 12    |
| Initial Q (Qb), veh           | 0    | 0    | 0    | 0    | 0    | 0    | 0    | 0    | 0    | 0    | 0    | 0     |
| Ped-Bike Adj(A_pbT)           | 1.00 |      | 0.99 | 1.00 |      | 0.99 | 1.00 |      | 1.00 | 1.00 |      | 1.00  |
| Parking Bus, Adj              | 1.00 | 1.00 | 1.00 | 1.00 | 1.00 | 1.00 | 1.00 | 1.00 | 1.00 | 1.00 | 1.00 | 1.00  |
| Adj Sat Flow, veh/h/ln        | 1900 | 1863 | 1900 | 1900 | 1881 | 1900 | 1881 | 1881 | 1900 | 1900 | 1900 | 1900  |
| Adj Flow Rate, veh/h          | 54   | 33   | 18   | 54   | 33   | 8    | 54   | 848  | 53   | 33   | 446  | -5    |
| Adj No. of Lanes              | 0    | 1    | 0    | 0    | 1    | 0    | 1    | 2    | 0    | 1    | 2    | 1     |
| Peak Hour Factor              | 0.92 | 0.92 | 0.92 | 0.92 | 0.92 | 0.92 | 0.92 | 0.92 | 0.92 | 0.92 | 0.92 | 0.92  |
| Percent Heavy Veh, %          | 2    | 2    | 2    | 1    | 1    | 1    | 1    | 1    | 1    | 0    | 0    | 0     |
| Cap, veh/h                    | 298  | 109  | 45   | 318  | 122  | 22   | 288  | 1111 | 69   | 73   | 738  | 330   |
| Arrive On Green               | 0.16 | 0.16 | 0.16 | 0.16 | 0.16 | 0.16 | 0.16 | 0.33 | 0.33 | 0.04 | 0.20 | 0.00  |
| Sat Flow, veh/h               | 660  | 667  | 275  | 739  | 750  | 137  | 1792 | 3417 | 214  | 1810 | 3610 | 1615  |
| Grp Volume(v), veh/h          | 105  | 0    | 0    | 95   | 0    | 0    | 54   | 444  | 457  | 33   | 446  | -5    |
| Grp Sat Flow(s),veh/h/ln      | 1601 | 0    | 0    | 1625 | 0    | 0    | 1792 | 1787 | 1843 | 1810 | 1805 | 1615  |
| Q Serve(g_s), s               | 0.2  | 0.0  | 0.0  | 0.0  | 0.0  | 0.0  | 0.7  | 6.4  | 6.4  | 0.5  | 3.2  | 0.0   |
| Cycle Q Clear(g_c), s         | 1.5  | 0.0  | 0.0  | 1.3  | 0.0  | 0.0  | 0.7  | 6.4  | 6.4  | 0.5  | 3.2  | 0.0   |
| Prop In Lane                  | 0.51 |      | 0.17 | 0.57 |      | 0.08 | 1.00 |      | 0.12 | 1.00 |      | 1.00  |
| Lane Grp Cap(c), veh/h        | 452  | 0    | 0    | 463  | 0    | 0    | 288  | 581  | 599  | 73   | 738  | 330   |
| V/C Ratio(X)                  | 0.23 | 0.00 | 0.00 | 0.21 | 0.00 | 0.00 | 0.19 | 0.76 | 0.76 | 0.45 | 0.60 | -0.02 |
| Avail Cap(c_a), veh/h         | 1956 | 0    | 0    | 1967 | 0    | 0    | 500  | 1591 | 1641 | 505  | 3213 | 1437  |
| HCM Platoon Ratio             | 1.00 | 1.00 | 1.00 | 1.00 | 1.00 | 1.00 | 1.00 | 1.00 | 1.00 | 1.00 | 1.00 | 1.00  |
| Upstream Filter(I)            | 1.00 | 0.00 | 0.00 | 1.00 | 0.00 | 0.00 | 1.00 | 1.00 | 1.00 | 1.00 | 1.00 | 0.00  |
| Uniform Delay (d), s/veh      | 10.6 | 0.0  | 0.0  | 10.6 | 0.0  | 0.0  | 10.4 | 8.7  | 8.7  | 13.4 | 10.3 | 0.0   |
| Incr Delay (d2), s/veh        | 0.1  | 0.0  | 0.0  | 0.1  | 0.0  | 0.0  | 0.1  | 0.8  | 0.8  | 1.6  | 0.3  | 0.0   |
| Initial Q Delay(d3),s/veh     | 0.0  | 0.0  | 0.0  | 0.0  | 0.0  | 0.0  | 0.0  | 0.0  | 0.0  | 0.0  | 0.0  | 0.0   |
| %ile BackOfQ(50%),veh/ln      | 0.7  | 0.0  | 0.0  | 0.7  | 0.0  | 0.0  | 0.4  | 3.2  | 3.3  | 0.3  | 1.6  | 0.0   |
| LnGrp Delay(d),s/veh          | 10.7 | 0.0  | 0.0  | 10.7 | 0.0  | 0.0  | 10.5 | 9.5  | 9.4  | 15.1 | 10.6 | 0.0   |
| LnGrp LOS                     | B    |      |      | B    |      |      | B    | A    | A    | B    | B    |       |
| Approach Vol, veh/h           |      | 105  |      |      | 95   |      |      | 955  |      |      | 474  |       |
| Approach Delay, s/veh         |      | 10.7 |      |      | 10.7 |      |      | 9.5  |      |      | 11.1 |       |
| Approach LOS                  |      | B    |      |      | B    |      |      | A    |      |      | B    |       |
| Timer                         | 1    | 2    | 3    | 4    | 5    | 6    | 7    | 8    |      |      |      |       |
| Assigned Phs                  | 1    | 2    |      | 4    | 5    | 6    |      | 8    |      |      |      |       |
| Phs Duration (G+Y+Rc), s      | 9.1  | 10.4 |      | 9.2  | 5.7  | 13.8 |      | 9.2  |      |      |      |       |
| Change Period (Y+Rc), s       | 4.5  | 4.5  |      | 4.5  | 4.5  | 4.5  |      | 4.5  |      |      |      |       |
| Max Green Setting (Gmax), s   | 25.5 | 25.5 |      | 33.0 | 8.0  | 25.5 |      | 33.0 |      |      |      |       |
| Max Q Clear Time (g_c+1/2), s | 5.2  | 5.2  |      | 3.3  | 2.5  | 8.4  |      | 3.5  |      |      |      |       |
| Green Ext Time (p_c), s       | 0.0  | 0.5  |      | 0.1  | 0.0  | 0.8  |      | 0.1  |      |      |      |       |
| <b>Intersection Summary</b>   |      |      |      |      |      |      |      |      |      |      |      |       |
| HCM 2010 Ctrl Delay           |      |      |      | 10.1 |      |      |      |      |      |      |      |       |
| HCM 2010 LOS                  |      |      |      | B    |      |      |      |      |      |      |      |       |

| Intersection              |    |
|---------------------------|----|
| Intersection Delay, s/veh | 23 |
| Intersection LOS          | C  |

| Movement            | EBL  | EBR  | NBL  | NBT  | SBT  | SBR  |
|---------------------|------|------|------|------|------|------|
| Lane Configurations |      |      |      |      |      |      |
| Traffic Vol, veh/h  | 60   | 100  | 160  | 880  | 350  | 90   |
| Future Vol, veh/h   | 60   | 100  | 160  | 880  | 350  | 90   |
| Peak Hour Factor    | 0.89 | 0.89 | 0.89 | 0.89 | 0.89 | 0.89 |
| Heavy Vehicles, %   | 1    | 1    | 1    | 1    | 1    | 1    |
| Mvmt Flow           | 67   | 112  | 180  | 989  | 393  | 101  |
| Number of Lanes     | 1    | 1    | 1    | 2    | 2    | 1    |

| Approach                   | EB   | NB   | SB   |
|----------------------------|------|------|------|
| Opposing Approach          |      | SB   | NB   |
| Opposing Lanes             | 0    | 3    | 3    |
| Conflicting Approach Left  | SB   | EB   |      |
| Conflicting Lanes Left     | 3    | 2    | 0    |
| Conflicting Approach Right | NB   |      | EB   |
| Conflicting Lanes Right    | 3    | 0    | 2    |
| HCM Control Delay          | 13.3 | 28.3 | 14.1 |
| HCM LOS                    | B    | D    | B    |

| Lane                   | NBLn1 | NBLn2 | NBLn3 | EBLn1 | EBLn2 | SBLn1 | SBLn2 | SBLn3 |
|------------------------|-------|-------|-------|-------|-------|-------|-------|-------|
| Vol Left, %            | 100%  | 0%    | 0%    | 100%  | 0%    | 0%    | 0%    | 0%    |
| Vol Thru, %            | 0%    | 100%  | 100%  | 0%    | 0%    | 100%  | 100%  | 0%    |
| Vol Right, %           | 0%    | 0%    | 0%    | 0%    | 100%  | 0%    | 0%    | 100%  |
| Sign Control           | Stop  | Stop  | Stop  | Stop  | Stop  | Stop  | Stop  | Stop  |
| Traffic Vol by Lane    | 160   | 440   | 440   | 60    | 100   | 175   | 175   | 90    |
| LT Vol                 | 160   | 0     | 0     | 60    | 0     | 0     | 0     | 0     |
| Through Vol            | 0     | 440   | 440   | 0     | 0     | 175   | 175   | 0     |
| RT Vol                 | 0     | 0     | 0     | 0     | 100   | 0     | 0     | 90    |
| Lane Flow Rate         | 180   | 494   | 494   | 67    | 112   | 197   | 197   | 101   |
| Geometry Grp           | 8     | 8     | 8     | 8     | 8     | 8     | 8     | 8     |
| Degree of Util (X)     | 0.356 | 0.91  | 0.671 | 0.169 | 0.244 | 0.411 | 0.411 | 0.142 |
| Departure Headway (Hd) | 7.135 | 6.628 | 4.887 | 9.02  | 7.808 | 7.522 | 7.522 | 5.067 |
| Convergence, Y/N       | Yes   | Yes   | Yes   | Yes   | Yes   | Yes   | Yes   | Yes   |
| Cap                    | 507   | 549   | 747   | 397   | 460   | 478   | 478   | 705   |
| Service Time           | 4.835 | 4.328 | 2.587 | 6.782 | 5.569 | 5.273 | 5.273 | 2.817 |
| HCM Lane V/C Ratio     | 0.355 | 0.9   | 0.661 | 0.169 | 0.243 | 0.412 | 0.412 | 0.143 |
| HCM Control Delay      | 13.7  | 45    | 17    | 13.6  | 13.1  | 15.5  | 15.5  | 8.7   |
| HCM Lane LOS           | B     | E     | C     | B     | B     | C     | C     | A     |
| HCM 95th-tile Q        | 1.6   | 10.9  | 5.2   | 0.6   | 0.9   | 2     | 2     | 0.5   |



| Movement                     | EBL  | EBT  | EBR  | WBL   | WBT  | WBR   | NBL  | NBT  | NBR  | SBL  | SBT  | SBR  |
|------------------------------|------|------|------|-------|------|-------|------|------|------|------|------|------|
| Lane Configurations          |      |      |      |       |      |       |      |      |      |      |      |      |
| Traffic Volume (veh/h)       | 220  | 230  | 60   | 90    | 170  | 60    | 110  | 1000 | 230  | 100  | 570  | 220  |
| Future Volume (veh/h)        | 220  | 230  | 60   | 90    | 170  | 60    | 110  | 1000 | 230  | 100  | 570  | 220  |
| Number                       | 7    | 4    | 14   | 3     | 8    | 18    | 5    | 2    | 12   | 1    | 6    | 16   |
| Initial Q (Qb), veh          | 0    | 0    | 0    | 0     | 0    | 0     | 0    | 0    | 0    | 0    | 0    | 0    |
| Ped-Bike Adj(A_pbT)          | 1.00 |      | 0.98 | 1.00  |      | 0.99  | 1.00 |      | 0.99 | 1.00 |      | 0.99 |
| Parking Bus, Adj             | 1.00 | 1.00 | 1.00 | 1.00  | 1.00 | 1.00  | 1.00 | 1.00 | 1.00 | 1.00 | 1.00 | 1.00 |
| Adj Sat Flow, veh/h/ln       | 1881 | 1881 | 1881 | 1900  | 1900 | 1900  | 1881 | 1881 | 1900 | 1863 | 1863 | 1863 |
| Adj Flow Rate, veh/h         | 227  | 237  | 15   | 93    | 175  | 56    | 113  | 1031 | 225  | 103  | 588  | 155  |
| Adj No. of Lanes             | 1    | 1    | 1    | 0     | 1    | 0     | 1    | 2    | 0    | 1    | 2    | 1    |
| Peak Hour Factor             | 0.97 | 0.97 | 0.97 | 0.97  | 0.97 | 0.97  | 0.97 | 0.97 | 0.97 | 0.97 | 0.97 | 0.97 |
| Percent Heavy Veh, %         | 1    | 1    | 1    | 0     | 0    | 0     | 1    | 1    | 1    | 2    | 2    | 2    |
| Cap, veh/h                   | 291  | 305  | 254  | 101   | 190  | 61    | 522  | 1220 | 265  | 127  | 671  | 297  |
| Arrive On Green              | 0.16 | 0.16 | 0.16 | 0.19  | 0.19 | 0.19  | 0.29 | 0.42 | 0.42 | 0.07 | 0.19 | 0.19 |
| Sat Flow, veh/h              | 1792 | 1881 | 1566 | 521   | 981  | 314   | 1792 | 2917 | 634  | 1774 | 3539 | 1568 |
| Grp Volume(v), veh/h         | 227  | 237  | 15   | 324   | 0    | 0     | 113  | 630  | 626  | 103  | 588  | 155  |
| Grp Sat Flow(s),veh/h/ln     | 1792 | 1881 | 1566 | 1816  | 0    | 0     | 1792 | 1787 | 1764 | 1774 | 1770 | 1568 |
| Q Serve(g_s), s              | 15.2 | 15.1 | 1.0  | 21.9  | 0.0  | 0.0   | 6.0  | 39.6 | 40.0 | 7.2  | 20.2 | 11.1 |
| Cycle Q Clear(g_c), s        | 15.2 | 15.1 | 1.0  | 21.9  | 0.0  | 0.0   | 6.0  | 39.6 | 40.0 | 7.2  | 20.2 | 11.1 |
| Prop In Lane                 | 1.00 |      | 1.00 | 0.29  |      | 0.17  | 1.00 |      | 0.36 | 1.00 |      | 1.00 |
| Lane Grp Cap(c), veh/h       | 291  | 305  | 254  | 351   | 0    | 0     | 522  | 748  | 738  | 127  | 671  | 297  |
| V/C Ratio(X)                 | 0.78 | 0.78 | 0.06 | 0.92  | 0.00 | 0.00  | 0.22 | 0.84 | 0.85 | 0.81 | 0.88 | 0.52 |
| Avail Cap(c_a), veh/h        | 573  | 602  | 501  | 363   | 0    | 0     | 522  | 748  | 738  | 241  | 671  | 297  |
| HCM Platoon Ratio            | 1.00 | 1.00 | 1.00 | 1.00  | 1.00 | 1.00  | 1.00 | 1.00 | 1.00 | 1.00 | 1.00 | 1.00 |
| Upstream Filter(I)           | 0.67 | 0.67 | 0.67 | 1.00  | 0.00 | 0.00  | 1.00 | 1.00 | 1.00 | 1.00 | 1.00 | 1.00 |
| Uniform Delay (d), s/veh     | 50.2 | 50.2 | 44.3 | 49.5  | 0.0  | 0.0   | 33.5 | 32.7 | 32.8 | 57.2 | 49.2 | 45.5 |
| Incr Delay (d2), s/veh       | 3.1  | 2.9  | 0.1  | 28.5  | 0.0  | 0.0   | 0.1  | 11.2 | 11.6 | 4.6  | 15.0 | 6.4  |
| Initial Q Delay(d3),s/veh    | 0.0  | 0.0  | 0.0  | 0.0   | 0.0  | 0.0   | 0.0  | 0.0  | 0.0  | 0.0  | 0.0  | 0.0  |
| %ile BackOfQ(50%),veh/ln     | 7.8  | 8.1  | 0.4  | 13.8  | 0.0  | 0.0   | 3.0  | 21.8 | 21.8 | 3.7  | 11.3 | 5.4  |
| LnGrp Delay(d),s/veh         | 53.3 | 53.1 | 44.4 | 78.0  | 0.0  | 0.0   | 33.6 | 43.9 | 44.4 | 61.8 | 64.2 | 51.9 |
| LnGrp LOS                    | D    | D    | D    | E     |      |       | C    | D    | D    | E    | E    | D    |
| Approach Vol, veh/h          |      | 479  |      |       | 324  |       |      | 1369 |      |      | 846  |      |
| Approach Delay, s/veh        |      | 52.9 |      |       | 78.0 |       |      | 43.3 |      |      | 61.7 |      |
| Approach LOS                 |      | D    |      |       | E    |       |      | D    |      |      | E    |      |
| Timer                        | 1    | 2    | 3    | 4     | 5    | 6     | 7    | 8    |      |      |      |      |
| Assigned Phs                 | 1    | 2    |      | 4     | 5    | 6     |      | 8    |      |      |      |      |
| Phs Duration (G+Y+Rc), s     | 3.2  | 57.6 |      | 25.0  | 41.7 | 29.0  |      | 29.3 |      |      |      |      |
| Change Period (Y+Rc), s      | 4.2  | 5.3  |      | * 4.7 | 5.3  | * 5.3 |      | 5.1  |      |      |      |      |
| Max Green Setting (Gmax), s  | 13   | 23.7 |      | * 40  | 17.0 | * 24  |      | 25.0 |      |      |      |      |
| Max Q Clear Time (g_c+19), s | 19   | 42.0 |      | 17.2  | 8.0  | 22.2  |      | 23.9 |      |      |      |      |
| Green Ext Time (p_c), s      | 0.1  | 0.0  |      | 2.1   | 0.1  | 0.6   |      | 0.3  |      |      |      |      |
| <b>Intersection Summary</b>  |      |      |      |       |      |       |      |      |      |      |      |      |
| HCM 2010 Ctrl Delay          |      |      | 53.7 |       |      |       |      |      |      |      |      |      |
| HCM 2010 LOS                 |      |      | D    |       |      |       |      |      |      |      |      |      |
| <b>Notes</b>                 |      |      |      |       |      |       |      |      |      |      |      |      |

HCM 2010 Signalized Intersection Summary  
 49: Highway 1 SB On-Ramp & Highway 1 NB Off-Ramp/Monterey Road

Existing with Project, PM  
 06/11/2019



| Movement                     | EBL  | EBT  | EBR  | WBL   | WBT  | WBR   | NBL  | NBT   | NBR  | SBL  | SBT  | SBR  |
|------------------------------|------|------|------|-------|------|-------|------|-------|------|------|------|------|
| Lane Configurations          |      | ↕↕   | ↗    | ↖     |      | ↗     |      | ↕     | ↗    |      | ↕    |      |
| Traffic Volume (veh/h)       | 10   | 200  | 120  | 280   | 0    | 190   | 0    | 120   | 290  | 10   | 10   | 0    |
| Future Volume (veh/h)        | 10   | 200  | 120  | 280   | 0    | 190   | 0    | 120   | 290  | 10   | 10   | 0    |
| Number                       | 1    | 6    | 16   | 5     | 2    | 12    | 7    | 4     | 14   | 3    | 8    | 18   |
| Initial Q (Qb), veh          | 0    | 0    | 0    | 0     | 0    | 0     | 0    | 0     | 0    | 0    | 0    | 0    |
| Ped-Bike Adj(A_pbT)          | 1.00 |      | 1.00 | 1.00  |      | 1.00  | 1.00 |       | 1.00 | 1.00 |      | 1.00 |
| Parking Bus, Adj             | 1.00 | 1.00 | 1.00 | 1.00  | 1.00 | 1.00  | 1.00 | 1.00  | 1.00 | 1.00 | 1.00 | 1.00 |
| Adj Sat Flow, veh/h/ln       | 1900 | 1863 | 1863 | 1900  | 0    | 1900  | 0    | 1881  | 1881 | 1900 | 1900 | 0    |
| Adj Flow Rate, veh/h         | 11   | 220  | 14   | 308   | 0    | 135   | 0    | 132   | 40   | 11   | 11   | 0    |
| Adj No. of Lanes             | 0    | 2    | 1    | 1     | 0    | 1     | 0    | 1     | 1    | 0    | 1    | 0    |
| Peak Hour Factor             | 0.91 | 0.91 | 0.91 | 0.91  | 0.91 | 0.91  | 0.91 | 0.91  | 0.91 | 0.91 | 0.91 | 0.91 |
| Percent Heavy Veh, %         | 2    | 2    | 2    | 0     | 0    | 0     | 0    | 1     | 1    | 0    | 0    | 0    |
| Cap, veh/h                   | 138  | 2896 | 1323 | 0     | 0    | 0     | 0    | 163   | 139  | 57   | 43   | 0    |
| Arrive On Green              | 0.84 | 0.84 | 0.84 | 0.00  | 0.00 | 0.00  | 0.00 | 0.09  | 0.09 | 0.09 | 0.09 | 0.00 |
| Sat Flow, veh/h              | 165  | 3459 | 1580 |       |      |       | 0    | 1881  | 1599 | 154  | 496  | 0    |
| Grp Volume(v), veh/h         | 124  | 107  | 14   |       | 0.0  |       | 0    | 132   | 40   | 22   | 0    | 0    |
| Grp Sat Flow(s),veh/h/ln     | 1855 | 1770 | 1580 |       |      |       | 0    | 1881  | 1599 | 651  | 0    | 0    |
| Q Serve(g_s), s              | 1.5  | 1.3  | 0.2  |       |      |       | 0.0  | 8.6   | 2.9  | 0.1  | 0.0  | 0.0  |
| Cycle Q Clear(g_c), s        | 1.5  | 1.3  | 0.2  |       |      |       | 0.0  | 8.6   | 2.9  | 8.7  | 0.0  | 0.0  |
| Prop In Lane                 | 0.09 |      | 1.00 |       |      |       | 0.00 |       | 1.00 | 0.50 |      | 0.00 |
| Lane Grp Cap(c), veh/h       | 1552 | 1481 | 1323 |       |      |       | 0    | 163   | 139  | 100  | 0    | 0    |
| V/C Ratio(X)                 | 0.08 | 0.07 | 0.01 |       |      |       | 0.00 | 0.81  | 0.29 | 0.22 | 0.00 | 0.00 |
| Avail Cap(c_a), veh/h        | 1552 | 1481 | 1323 |       |      |       | 0    | 271   | 230  | 125  | 0    | 0    |
| HCM Platoon Ratio            | 1.00 | 1.00 | 1.00 |       |      |       | 1.00 | 1.00  | 1.00 | 1.00 | 1.00 | 1.00 |
| Upstream Filter(I)           | 1.00 | 1.00 | 1.00 |       |      |       | 0.00 | 1.00  | 1.00 | 1.00 | 0.00 | 0.00 |
| Uniform Delay (d), s/veh     | 1.8  | 1.8  | 1.7  |       |      |       | 0.0  | 56.0  | 53.5 | 52.9 | 0.0  | 0.0  |
| Incr Delay (d2), s/veh       | 0.0  | 0.0  | 0.0  |       |      |       | 0.0  | 3.6   | 0.4  | 0.4  | 0.0  | 0.0  |
| Initial Q Delay(d3),s/veh    | 0.0  | 0.0  | 0.0  |       |      |       | 0.0  | 0.0   | 0.0  | 0.0  | 0.0  | 0.0  |
| %ile BackOfQ(50%),veh/lnr0.7 | 0.6  | 0.1  |      |       |      |       | 0.0  | 4.6   | 1.3  | 0.7  | 0.0  | 0.0  |
| LnGrp Delay(d),s/veh         | 1.8  | 1.8  | 1.7  |       |      |       | 0.0  | 59.6  | 53.9 | 53.3 | 0.0  | 0.0  |
| LnGrp LOS                    | A    | A    | A    |       |      |       |      | E     | D    | D    |      |      |
| Approach Vol, veh/h          |      | 245  |      |       |      |       |      | 172   |      |      | 22   |      |
| Approach Delay, s/veh        |      | 1.8  |      |       |      |       |      | 58.3  |      |      | 53.3 |      |
| Approach LOS                 |      | A    |      |       |      |       |      | E     |      |      | D    |      |
| Timer                        | 1    | 2    | 3    | 4     | 5    | 6     | 7    | 8     |      |      |      |      |
| Assigned Phs                 |      |      |      | 4     |      | 6     |      | 8     |      |      |      |      |
| Phs Duration (G+Y+Rc), s     |      |      |      | 15.1  |      | 109.9 |      | 15.1  |      |      |      |      |
| Change Period (Y+Rc), s      |      |      |      | * 4.2 |      | 5.3   |      | * 4.2 |      |      |      |      |
| Max Green Setting (Gmax), s  |      |      |      | * 18  |      | 21.0  |      | * 13  |      |      |      |      |
| Max Q Clear Time (g_c+I1), s |      |      |      | 10.6  |      | 3.5   |      | 10.7  |      |      |      |      |
| Green Ext Time (p_c), s      |      |      |      | 0.3   |      | 0.8   |      | 0.0   |      |      |      |      |
| <b>Intersection Summary</b>  |      |      |      |       |      |       |      |       |      |      |      |      |
| HCM 2010 Ctrl Delay          |      |      | 26.5 |       |      |       |      |       |      |      |      |      |
| HCM 2010 LOS                 |      |      | C    |       |      |       |      |       |      |      |      |      |
| <b>Notes</b>                 |      |      |      |       |      |       |      |       |      |      |      |      |

HCM 2010 Signalized Intersection Summary  
 50: Reservation Road & SR 68 WB On Ramp/SR 68 WB Off Ramp





















Existing with Project, PM  
 06/11/2019



| Movement                     | EBL  | EBT  | EBR | WBL  | WBT  | WBR  | NBL  | NBT  | NBR  | SBL  | SBT  | SBR  |
|------------------------------|------|------|-----|------|------|------|------|------|------|------|------|------|
| Lane Configurations          |      |      |     |      | ↕    | ↕    | ↕    | ↕    |      |      | ↕    |      |
| Traffic Volume (veh/h)       | 0    | 0    | 0   | 420  | 10   | 250  | 140  | 230  | 0    | 0    | 500  | 130  |
| Future Volume (veh/h)        | 0    | 0    | 0   | 420  | 10   | 250  | 140  | 230  | 0    | 0    | 500  | 130  |
| Number                       |      |      |     | 7    | 4    | 14   | 1    | 6    | 16   | 5    | 2    | 12   |
| Initial Q (Qb), veh          |      |      |     | 0    | 0    | 0    | 0    | 0    | 0    | 0    | 0    | 0    |
| Ped-Bike Adj(A_pbT)          |      |      |     | 1.00 |      | 1.00 | 1.00 |      | 1.00 | 1.00 |      | 1.00 |
| Parking Bus, Adj             |      |      |     | 1.00 | 1.00 | 1.00 | 1.00 | 1.00 | 1.00 | 1.00 | 1.00 | 1.00 |
| Adj Sat Flow, veh/h/ln       |      |      |     | 1900 | 1863 | 1863 | 1845 | 1845 | 0    | 0    | 1827 | 1900 |
| Adj Flow Rate, veh/h         |      |      |     | 447  | 11   | 84   | 149  | 245  | 0    | 0    | 532  | 128  |
| Adj No. of Lanes             |      |      |     | 0    | 1    | 1    | 1    | 1    | 0    | 0    | 1    | 0    |
| Peak Hour Factor             |      |      |     | 0.94 | 0.94 | 0.94 | 0.94 | 0.94 | 0.94 | 0.94 | 0.94 | 0.94 |
| Percent Heavy Veh, %         |      |      |     | 2    | 2    | 2    | 3    | 3    | 0    | 0    | 4    | 4    |
| Cap, veh/h                   |      |      |     | 495  | 12   | 451  | 185  | 1082 | 0    | 0    | 627  | 151  |
| Arrive On Green              |      |      |     | 0.29 | 0.29 | 0.29 | 0.03 | 0.19 | 0.00 | 0.00 | 0.44 | 0.44 |
| Sat Flow, veh/h              |      |      |     | 1733 | 43   | 1581 | 1757 | 1845 | 0    | 0    | 1424 | 343  |
| Grp Volume(v), veh/h         |      |      |     | 458  | 0    | 84   | 149  | 245  | 0    | 0    | 0    | 660  |
| Grp Sat Flow(s),veh/h/ln     |      |      |     | 1776 | 0    | 1581 | 1757 | 1845 | 0    | 0    | 0    | 1766 |
| Q Serve(g_s), s              |      |      |     | 21.1 | 0.0  | 3.4  | 7.2  | 9.5  | 0.0  | 0.0  | 0.0  | 28.4 |
| Cycle Q Clear(g_c), s        |      |      |     | 21.1 | 0.0  | 3.4  | 7.2  | 9.5  | 0.0  | 0.0  | 0.0  | 28.4 |
| Prop In Lane                 |      |      |     | 0.98 |      | 1.00 | 1.00 |      | 0.00 | 0.00 |      | 0.19 |
| Lane Grp Cap(c), veh/h       |      |      |     | 507  | 0    | 451  | 185  | 1082 | 0    | 0    | 0    | 777  |
| V/C Ratio(X)                 |      |      |     | 0.90 | 0.00 | 0.19 | 0.81 | 0.23 | 0.00 | 0.00 | 0.00 | 0.85 |
| Avail Cap(c_a), veh/h        |      |      |     | 564  | 0    | 502  | 248  | 1082 | 0    | 0    | 0    | 777  |
| HCM Platoon Ratio            |      |      |     | 1.00 | 1.00 | 1.00 | 0.33 | 0.33 | 1.00 | 1.00 | 1.00 | 1.00 |
| Upstream Filter(I)           |      |      |     | 1.00 | 0.00 | 1.00 | 0.95 | 0.95 | 0.00 | 0.00 | 0.00 | 1.00 |
| Uniform Delay (d), s/veh     |      |      |     | 29.2 | 0.0  | 22.9 | 40.2 | 18.0 | 0.0  | 0.0  | 0.0  | 21.3 |
| Incr Delay (d2), s/veh       |      |      |     | 16.9 | 0.0  | 0.2  | 9.3  | 0.5  | 0.0  | 0.0  | 0.0  | 11.2 |
| Initial Q Delay(d3),s/veh    |      |      |     | 0.0  | 0.0  | 0.0  | 0.0  | 0.0  | 0.0  | 0.0  | 0.0  | 0.0  |
| %ile BackOfQ(50%),veh/ln     |      |      |     | 12.7 | 0.0  | 1.5  | 4.0  | 5.0  | 0.0  | 0.0  | 0.0  | 16.2 |
| LnGrp Delay(d),s/veh         |      |      |     | 46.1 | 0.0  | 23.1 | 49.5 | 18.5 | 0.0  | 0.0  | 0.0  | 32.4 |
| LnGrp LOS                    |      |      |     | D    |      | C    | D    | B    |      |      |      | C    |
| Approach Vol, veh/h          |      |      |     |      | 542  |      |      | 394  |      |      | 660  |      |
| Approach Delay, s/veh        |      |      |     |      | 42.6 |      |      | 30.2 |      |      | 32.4 |      |
| Approach LOS                 |      |      |     |      | D    |      |      | C    |      |      | C    |      |
| Timer                        | 1    | 2    | 3   | 4    | 5    | 6    | 7    | 8    |      |      |      |      |
| Assigned Phs                 | 1    | 2    |     | 4    |      | 6    |      |      |      |      |      |      |
| Phs Duration (G+Y+Rc), s     | 2.4  | 43.4 |     | 29.2 |      | 55.8 |      |      |      |      |      |      |
| Change Period (Y+Rc), s      | 3.5  | 6.0  |     | 4.9  |      | 6.0  |      |      |      |      |      |      |
| Max Green Setting (Gmax), s  | 2.0  | 31.6 |     | 27.0 |      | 47.1 |      |      |      |      |      |      |
| Max Q Clear Time (g_c+19), s | 19.2 | 30.4 |     | 23.1 |      | 11.5 |      |      |      |      |      |      |
| Green Ext Time (p_c), s      | 0.0  | 0.5  |     | 1.2  |      | 1.2  |      |      |      |      |      |      |
| <b>Intersection Summary</b>  |      |      |     |      |      |      |      |      |      |      |      |      |
| HCM 2010 Ctrl Delay          |      |      |     | 35.3 |      |      |      |      |      |      |      |      |
| HCM 2010 LOS                 |      |      |     | D    |      |      |      |      |      |      |      |      |

HCM 2010 Signalized Intersection Summary  
 1: Del Monte Boulevard & Reindollar Avenue

Cumulative, AM  
 06/11/2019

|                              |  |  |  |  |  |  |   |  |  |  |  |  |  |
|------------------------------|---|---|---|---|---|---|---|---|---|---|---|---|--|
| Movement                     | EBL   | EBT   | EBR   | WBL   | WBT   | WBR   | NBL   | NBT   | NBR   | SBL   | SBT   | SBR   |  |
| Lane Configurations          |   |   |   |  |  |   |  |  |  |  |  |  |  |
| Traffic Volume (veh/h)       | 0   | 0   | 0   | 450   | 0   | 420   | 10  | 640   | 120   | 410   | 1160  | 0   |  |
| Future Volume (veh/h)        | 0   | 0   | 0   | 450   | 0   | 420   | 10  | 640   | 120   | 410   | 1160  | 0   |  |
| Number                       |   |   |   | 3   | 8   | 18  | 1   | 6   | 16  | 5   | 2   | 12  |  |
| Initial Q (Qb), veh          |   |   |   | 0   | 0   | 0   | 0   | 0   | 0   | 0   | 0   | 0   |  |
| Ped-Bike Adj(A_pbT)          |   |   |   | 1.00  |   | 0.99  | 1.00  |   | 1.00  | 1.00  |   | 1.00  |  |
| Parking Bus, Adj             |   |   |   | 1.00  | 1.00  | 1.00  | 1.00  | 1.00  | 1.00  | 1.00  | 1.00  | 1.00  |  |
| Adj Sat Flow, veh/h/ln       |   |   |   | 1900  | 1900  | 1900  | 1863  | 1863  | 1863  | 1845  | 1845  | 0   |  |
| Adj Flow Rate, veh/h         |   |   |   | 468   | 54  | 429   | 11  | 719   | 68  | 461   | 1303  | 0   |  |
| Adj No. of Lanes             |   |   |   | 1   | 1   | 0   | 1   | 2   | 1   | 1   | 2   | 0   |  |
| Peak Hour Factor             |   |   |   | 0.89  | 0.89  | 0.89  | 0.89  | 0.89  | 0.89  | 0.89  | 0.89  | 0.89  |  |
| Percent Heavy Veh, %         |   |   |   | 0   | 0   | 0   | 2   | 2   | 2   | 3   | 3   | 0   |  |
| Cap, veh/h                   |   |   |   | 575   | 58  | 461   | 24  | 892   | 397   | 499   | 1832  | 0   |  |
| Arrive On Green              |   |   |   | 0.32  | 0.32  | 0.32  | 0.01  | 0.25  | 0.25  | 0.28  | 0.52  | 0.00  |  |
| Sat Flow, veh/h              |   |   |   | 1810  | 183   | 1451  | 1774  | 3539  | 1577  | 1757  | 3597  | 0   |  |
| Grp Volume(v), veh/h         |   |   |   | 468   | 0   | 483   | 11  | 719   | 68  | 461   | 1303  | 0   |  |
| Grp Sat Flow(s),veh/h/ln     |   |   |   | 1810  | 0   | 1634  | 1774  | 1770  | 1577  | 1757  | 1752  | 0   |  |
| Q Serve(g_s), s              |   |   |   | 21.9  | 0.0   | 26.4  | 0.6   | 17.6  | 3.1   | 23.5  | 26.0  | 0.0   |  |
| Cycle Q Clear(g_c), s        |   |   |   | 21.9  | 0.0   | 26.4  | 0.6   | 17.6  | 3.1   | 23.5  | 26.0  | 0.0   |  |
| Prop In Lane                 |   |   |   | 1.00  |   | 0.89  | 1.00  |   | 1.00  | 1.00  |   | 0.00  |  |
| Lane Grp Cap(c), veh/h       |   |   |   | 575   | 0   | 519   | 24  | 892   | 397   | 499   | 1832  | 0   |  |
| V/C Ratio(X)                 |   |   |   | 0.81  | 0.00  | 0.93  | 0.47  | 0.81  | 0.17  | 0.92  | 0.71  | 0.00  |  |
| Avail Cap(c_a), veh/h        |   |   |   | 589   | 0   | 532   | 578   | 1153  | 514   | 572   | 1832  | 0   |  |
| HCM Platoon Ratio            |   |   |   | 1.00  | 1.00  | 1.00  | 1.00  | 1.00  | 1.00  | 1.00  | 1.00  | 1.00  |  |
| Upstream Filter(I)           |   |   |   | 1.00  | 0.00  | 1.00  | 1.00  | 1.00  | 1.00  | 1.00  | 1.00  | 0.00  |  |
| Uniform Delay (d), s/veh     |   |   |   | 28.9  | 0.0   | 30.5  | 45.1  | 32.3  | 26.9  | 32.0  | 16.7  | 0.0   |  |
| Incr Delay (d2), s/veh       |   |   |   | 8.5   | 0.0   | 23.0  | 13.6  | 3.3   | 0.2   | 19.4  | 1.3   | 0.0   |  |
| Initial Q Delay(d3),s/veh    |   |   |   | 0.0   | 0.0   | 0.0   | 0.0   | 0.0   | 0.0   | 0.0   | 0.0   | 0.0   |  |
| %ile BackOfQ(50%),veh/ln     |   |   |   | 12.3  | 0.0   | 15.1  | 0.4   | 9.0   | 1.4   | 14.1  | 12.8  | 0.0   |  |
| LnGrp Delay(d),s/veh         |   |   |   | 37.4  | 0.0   | 53.4  | 58.7  | 35.7  | 27.1  | 51.5  | 18.0  | 0.0   |  |
| LnGrp LOS                    |   |   |   | D   |   | D   | E   | D   | C   | D   | B   |   |  |
| Approach Vol, veh/h          |   |   |   |   | 951   |   |   | 798   |   |   | 1764  |   |  |
| Approach Delay, s/veh        |   |   |   |   | 45.5  |   |   | 35.3  |   |   | 26.8  |   |  |
| Approach LOS                 |   |   |   |   | D   |   |   | D   |   |   | C   |   |  |
| Timer                        | 1   | 2   | 3   | 4   | 5   | 6   | 7   | 8   |   |   |   |   |  |
| Assigned Phs                 | 1   | 2   |   |   | 5   | 6   |   | 8   |   |   |   |   |  |
| Phs Duration (G+Y+Rc), s     | 4.7   | 53.1  |   |   | 29.7  | 28.2  |   | 34.2  |   |   |   |   |  |
| Change Period (Y+Rc), s      | 3.5   | 5.0   |   |   | 3.5   | 5.0   |   | 5.0   |   |   |   |   |  |
| Max Green Setting (Gmax), s  | 30.0  | 30.0  |   |   | 30.0  | 30.0  |   | 30.0  |   |   |   |   |  |
| Max Q Clear Time (g_c+I1), s | 2.6   | 28.0  |   |   | 25.5  | 19.6  |   | 28.4  |   |   |   |   |  |
| Green Ext Time (p_c), s      | 0.0   | 1.5   |   |   | 0.7   | 3.6   |   | 0.9   |   |   |   |   |  |
| <b>Intersection Summary</b>  |   |   |   |   |   |   |   |   |   |   |   |   |  |
| HCM 2010 Ctrl Delay          |   |   |   | 33.8  |   |   |   |   |   |   |   |   |  |
| HCM 2010 LOS                 |   |   |   | C   |   |   |   |   |   |   |   |   |  |
| <b>Notes</b>                 |   |   |   |   |   |   |   |   |   |   |   |   |  |

HCM 2010 Signalized Intersection Summary  
 2: 2nd Avenue & Patton Parkway

Cumulative, AM  
 06/11/2019



| Movement                    | EBL  | EBT  | EBR  | WBL  | WBT  | WBR  | NBL  | NBT  | NBR  | SBL  | SBT  | SBR  |
|-----------------------------|------|------|------|------|------|------|------|------|------|------|------|------|
| Lane Configurations         |      |      |      |      |      |      |      |      |      |      |      |      |
| Traffic Volume (veh/h)      | 50   | 90   | 60   | 30   | 90   | 100  | 70   | 220  | 100  | 90   | 200  | 50   |
| Future Volume (veh/h)       | 50   | 90   | 60   | 30   | 90   | 100  | 70   | 220  | 100  | 90   | 200  | 50   |
| Number                      | 7    | 4    | 14   | 3    | 8    | 18   | 5    | 2    | 12   | 1    | 6    | 16   |
| Initial Q (Qb), veh         | 0    | 0    | 0    | 0    | 0    | 0    | 0    | 0    | 0    | 0    | 0    | 0    |
| Ped-Bike Adj(A_pbT)         | 1.00 |      | 1.00 | 1.00 |      | 1.00 | 1.00 |      | 1.00 | 1.00 |      | 1.00 |
| Parking Bus, Adj            | 1.00 | 1.00 | 1.00 | 1.00 | 1.00 | 1.00 | 1.00 | 1.00 | 1.00 | 1.00 | 1.00 | 1.00 |
| Adj Sat Flow, veh/h/ln      | 1863 | 1863 | 1900 | 1863 | 1863 | 1900 | 1863 | 1863 | 1900 | 1863 | 1863 | 1900 |
| Adj Flow Rate, veh/h        | 54   | 98   | 65   | 33   | 98   | 109  | 76   | 239  | 109  | 98   | 217  | 54   |
| Adj No. of Lanes            | 1    | 1    | 0    | 1    | 1    | 0    | 1    | 1    | 0    | 1    | 1    | 0    |
| Peak Hour Factor            | 0.92 | 0.92 | 0.92 | 0.92 | 0.92 | 0.92 | 0.92 | 0.92 | 0.92 | 0.92 | 0.92 | 0.92 |
| Percent Heavy Veh, %        | 2    | 2    | 2    | 2    | 2    | 2    | 2    | 2    | 2    | 2    | 2    | 2    |
| Cap, veh/h                  | 97   | 247  | 164  | 67   | 177  | 197  | 121  | 330  | 151  | 139  | 407  | 101  |
| Arrive On Green             | 0.05 | 0.24 | 0.24 | 0.04 | 0.22 | 0.22 | 0.07 | 0.27 | 0.27 | 0.08 | 0.28 | 0.28 |
| Sat Flow, veh/h             | 1774 | 1046 | 694  | 1774 | 807  | 897  | 1774 | 1212 | 553  | 1774 | 1441 | 359  |
| Grp Volume(v), veh/h        | 54   | 0    | 163  | 33   | 0    | 207  | 76   | 0    | 348  | 98   | 0    | 271  |
| Grp Sat Flow(s),veh/h/ln    | 1774 | 0    | 1740 | 1774 | 0    | 1704 | 1774 | 0    | 1765 | 1774 | 0    | 1799 |
| Q Serve(g_s), s             | 1.3  | 0.0  | 3.6  | 0.8  | 0.0  | 4.9  | 1.9  | 0.0  | 8.1  | 2.4  | 0.0  | 5.8  |
| Cycle Q Clear(g_c), s       | 1.3  | 0.0  | 3.6  | 0.8  | 0.0  | 4.9  | 1.9  | 0.0  | 8.1  | 2.4  | 0.0  | 5.8  |
| Prop In Lane                | 1.00 |      | 0.40 | 1.00 |      | 0.53 | 1.00 |      | 0.31 | 1.00 |      | 0.20 |
| Lane Grp Cap(c), veh/h      | 97   | 0    | 411  | 67   | 0    | 374  | 121  | 0    | 481  | 139  | 0    | 509  |
| V/C Ratio(X)                | 0.56 | 0.00 | 0.40 | 0.50 | 0.00 | 0.55 | 0.63 | 0.00 | 0.72 | 0.71 | 0.00 | 0.53 |
| Avail Cap(c_a), veh/h       | 235  | 0    | 1364 | 235  | 0    | 1336 | 235  | 0    | 1384 | 235  | 0    | 1411 |
| HCM Platoon Ratio           | 1.00 | 1.00 | 1.00 | 1.00 | 1.00 | 1.00 | 1.00 | 1.00 | 1.00 | 1.00 | 1.00 | 1.00 |
| Upstream Filter(I)          | 1.00 | 0.00 | 1.00 | 1.00 | 0.00 | 1.00 | 1.00 | 0.00 | 1.00 | 1.00 | 0.00 | 1.00 |
| Uniform Delay (d), s/veh    | 20.9 | 0.0  | 14.6 | 21.4 | 0.0  | 15.7 | 20.5 | 0.0  | 14.9 | 20.4 | 0.0  | 13.7 |
| Incr Delay (d2), s/veh      | 5.0  | 0.0  | 0.6  | 5.6  | 0.0  | 1.3  | 5.3  | 0.0  | 2.1  | 6.4  | 0.0  | 0.9  |
| Initial Q Delay(d3),s/veh   | 0.0  | 0.0  | 0.0  | 0.0  | 0.0  | 0.0  | 0.0  | 0.0  | 0.0  | 0.0  | 0.0  | 0.0  |
| %ile BackOfQ(50%),veh/ln    | 0.8  | 0.0  | 1.8  | 0.5  | 0.0  | 2.4  | 1.1  | 0.0  | 4.1  | 1.4  | 0.0  | 3.0  |
| LnGrp Delay(d),s/veh        | 25.9 | 0.0  | 15.2 | 27.0 | 0.0  | 17.0 | 25.9 | 0.0  | 17.0 | 26.8 | 0.0  | 14.6 |
| LnGrp LOS                   | C    |      | B    | C    |      | B    | C    |      | B    | C    |      | B    |
| Approach Vol, veh/h         |      | 217  |      |      | 240  |      |      | 424  |      |      | 369  |      |
| Approach Delay, s/veh       |      | 17.8 |      |      | 18.4 |      |      | 18.6 |      |      | 17.8 |      |
| Approach LOS                |      | B    |      |      | B    |      |      | B    |      |      | B    |      |
| Timer                       | 1    | 2    | 3    | 4    | 5    | 6    | 7    | 8    |      |      |      |      |
| Assigned Phs                | 1    | 2    | 3    | 4    | 5    | 6    | 7    | 8    |      |      |      |      |
| Phs Duration (G+Y+Rc), s    | 7.5  | 16.8 | 5.7  | 15.2 | 7.1  | 17.3 | 6.5  | 14.4 |      |      |      |      |
| Change Period (Y+Rc), s     | 4.0  | 4.5  | 4.0  | 4.5  | 4.0  | 4.5  | 4.0  | 4.5  |      |      |      |      |
| Max Green Setting (Gmax), s | 6.0  | 35.5 | 6.0  | 35.5 | 6.0  | 35.5 | 6.0  | 35.5 |      |      |      |      |
| Max Q Clear Time (g_c+1), s | 14.4 | 10.1 | 2.8  | 5.6  | 3.9  | 7.8  | 3.3  | 6.9  |      |      |      |      |
| Green Ext Time (p_c), s     | 0.0  | 2.2  | 0.0  | 1.0  | 0.0  | 1.7  | 0.0  | 1.3  |      |      |      |      |
| <b>Intersection Summary</b> |      |      |      |      |      |      |      |      |      |      |      |      |
| HCM 2010 Ctrl Delay         |      |      | 18.2 |      |      |      |      |      |      |      |      |      |
| HCM 2010 LOS                |      |      | B    |      |      |      |      |      |      |      |      |      |



HCM 2010 Signalized Intersection Summary  
 3: SR 1 SB On-Ramp/SR 1 SB Off-Ramp & Imjin Parkway

Cumulative, AM  
 06/11/2019



| Movement                     | EBL | EBT | EBR | WBL   | WBT   | WBR  | NBL | NBT | NBR | SBL   | SBT   | SBR  |
|------------------------------|-----|-----|-----|-------|-------|------|-----|-----|-----|-------|-------|------|
| Lane Configurations          |     |     |     |       | ↕     |      |     |     |     |       | ↕     |      |
| Traffic Volume (veh/h)       | 0   | 0   | 0   | 1170  | 0     | 0    | 0   | 0   | 0   | 910   | 10    | 0    |
| Future Volume (veh/h)        | 0   | 0   | 0   | 1170  | 0     | 0    | 0   | 0   | 0   | 910   | 10    | 0    |
| Number                       |     |     |     | 1     | 6     | 16   |     |     |     | 7     | 4     | 14   |
| Initial Q (Qb), veh          |     |     |     | 0     | 0     | 0    |     |     |     | 0     | 0     | 0    |
| Ped-Bike Adj(A_pbT)          |     |     |     | 1.00  |       | 1.00 |     |     |     | 1.00  |       | 1.00 |
| Parking Bus, Adj             |     |     |     | 1.00  | 1.00  | 1.00 |     |     |     | 1.00  | 1.00  | 1.00 |
| Adj Sat Flow, veh/h/ln       |     |     |     | 1900  | 1845  | 0    |     |     |     | 1900  | 1845  | 0    |
| Adj Flow Rate, veh/h         |     |     |     | 1286  | 0     | 0    |     |     |     | 1000  | 11    | 0    |
| Adj No. of Lanes             |     |     |     | 0     | 1     | 0    |     |     |     | 0     | 1     | 0    |
| Peak Hour Factor             |     |     |     | 0.91  | 0.91  | 0.91 |     |     |     | 0.91  | 0.91  | 0.91 |
| Percent Heavy Veh, %         |     |     |     | 3     | 3     | 0    |     |     |     | 3     | 3     | 0    |
| Cap, veh/h                   |     |     |     | 996   | 0     | 0    |     |     |     | 657   | 7     | 0    |
| Arrive On Green              |     |     |     | 0.57  | 0.00  | 0.00 |     |     |     | 0.38  | 0.38  | 0.00 |
| Sat Flow, veh/h              |     |     |     | 1757  | 0     | 0    |     |     |     | 1739  | 19    | 0    |
| Grp Volume(v), veh/h         |     |     |     | 1286  | 0     | 0    |     |     |     | 1011  | 0     | 0    |
| Grp Sat Flow(s),veh/h/ln     |     |     |     | 1757  | 0     | 0    |     |     |     | 1758  | 0     | 0    |
| Q Serve(g_s), s              |     |     |     | 90.0  | 0.0   | 0.0  |     |     |     | 60.0  | 0.0   | 0.0  |
| Cycle Q Clear(g_c), s        |     |     |     | 90.0  | 0.0   | 0.0  |     |     |     | 60.0  | 0.0   | 0.0  |
| Prop In Lane                 |     |     |     | 1.00  |       | 0.00 |     |     |     | 0.99  |       | 0.00 |
| Lane Grp Cap(c), veh/h       |     |     |     | 996   | 0     | 0    |     |     |     | 664   | 0     | 0    |
| V/C Ratio(X)                 |     |     |     | 1.29  | 0.00  | 0.00 |     |     |     | 1.52  | 0.00  | 0.00 |
| Avail Cap(c_a), veh/h        |     |     |     | 996   | 0     | 0    |     |     |     | 664   | 0     | 0    |
| HCM Platoon Ratio            |     |     |     | 1.00  | 1.00  | 1.00 |     |     |     | 1.00  | 1.00  | 1.00 |
| Upstream Filter(I)           |     |     |     | 1.00  | 0.00  | 0.00 |     |     |     | 1.00  | 0.00  | 0.00 |
| Uniform Delay (d), s/veh     |     |     |     | 34.2  | 0.0   | 0.0  |     |     |     | 49.2  | 0.0   | 0.0  |
| Incr Delay (d2), s/veh       |     |     |     | 138.8 | 0.0   | 0.0  |     |     |     | 242.7 | 0.0   | 0.0  |
| Initial Q Delay(d3),s/veh    |     |     |     | 0.0   | 0.0   | 0.0  |     |     |     | 0.0   | 0.0   | 0.0  |
| %ile BackOfQ(50%),veh/ln     |     |     |     | 81.8  | 0.0   | 0.0  |     |     |     | 73.7  | 0.0   | 0.0  |
| LnGrp Delay(d),s/veh         |     |     |     | 173.0 | 0.0   | 0.0  |     |     |     | 291.9 | 0.0   | 0.0  |
| LnGrp LOS                    |     |     |     | F     |       |      |     |     |     | F     |       |      |
| Approach Vol, veh/h          |     |     |     |       | 1286  |      |     |     |     |       | 1011  |      |
| Approach Delay, s/veh        |     |     |     |       | 173.0 |      |     |     |     |       | 291.9 |      |
| Approach LOS                 |     |     |     |       | F     |      |     |     |     |       | F     |      |
| Timer                        | 1   | 2   | 3   | 4     | 5     | 6    | 7   | 8   |     |       |       |      |
| Assigned Phs                 |     |     |     | 4     |       | 6    |     |     |     |       |       |      |
| Phs Duration (G+Y+Rc), s     |     |     |     | 64.4  |       | 94.4 |     |     |     |       |       |      |
| Change Period (Y+Rc), s      |     |     |     | 4.4   |       | 4.4  |     |     |     |       |       |      |
| Max Green Setting (Gmax), s  |     |     |     | 60.0  |       | 90.0 |     |     |     |       |       |      |
| Max Q Clear Time (g_c+I1), s |     |     |     | 62.0  |       | 92.0 |     |     |     |       |       |      |
| Green Ext Time (p_c), s      |     |     |     | 0.0   |       | 0.0  |     |     |     |       |       |      |
| <b>Intersection Summary</b>  |     |     |     |       |       |      |     |     |     |       |       |      |
| HCM 2010 Ctrl Delay          |     |     |     | 225.3 |       |      |     |     |     |       |       |      |
| HCM 2010 LOS                 |     |     |     | F     |       |      |     |     |     |       |       |      |

| Intersection             |      |      |      |      |      |      |      |      |      |      |       |      |
|--------------------------|------|------|------|------|------|------|------|------|------|------|-------|------|
| Int Delay, s/veh         | 1.1  |      |      |      |      |      |      |      |      |      |       |      |
| Movement                 | EBL  | EBT  | EBR  | WBL  | WBT  | WBR  | NBL  | NBT  | NBR  | SBL  | SBT   | SBR  |
| Lane Configurations      |      | ↕    |      |      | ↑    | ↗    |      | ↕    | ↗    |      |       |      |
| Traffic Vol, veh/h       | 10   | 920  | 0    | 0    | 1120 | 410  | 10   | 10   | 1060 | 0    | 0     | 0    |
| Future Vol, veh/h        | 10   | 920  | 0    | 0    | 1120 | 410  | 10   | 10   | 1060 | 0    | 0     | 0    |
| Conflicting Peds, #/hr   | 0    | 0    | 3    | 3    | 0    | 0    | 0    | 0    | 0    | 0    | 0     | 0    |
| Sign Control             | Free | Free | Free | Free | Free | Free | Stop | Stop | Stop | Stop | Stop  | Stop |
| RT Channelized           | -    | -    | None | -    | -    | Free | -    | -    | Free | -    | -     | None |
| Storage Length           | -    | -    | -    | -    | -    | 0    | -    | -    | 800  | -    | -     | -    |
| Veh in Median Storage, # | -    | 0    | -    | -    | 0    | -    | -    | 0    | -    | -    | 16965 | -    |
| Grade, %                 | -    | 0    | -    | -    | 0    | -    | -    | 0    | -    | -    | 0     | -    |
| Peak Hour Factor         | 97   | 97   | 97   | 97   | 97   | 97   | 97   | 97   | 97   | 97   | 97    | 97   |
| Heavy Vehicles, %        | 3    | 3    | 3    | 3    | 3    | 3    | 2    | 2    | 2    | 2    | 2     | 2    |
| Mvmt Flow                | 10   | 948  | 0    | 0    | 1155 | 423  | 10   | 10   | 1093 | 0    | 0     | 0    |























| Major/Minor          | Major1 | Major2 |   | Minor1 |   |       |       |     |
|----------------------|--------|--------|---|--------|---|-------|-------|-----|
| Conflicting Flow All | 1155   | 0      | - | -      | 0 | 2123  | 2123  | -   |
| Stage 1              | -      | -      | - | -      | - | 968   | 968   | -   |
| Stage 2              | -      | -      | - | -      | - | 1155  | 1155  | -   |
| Critical Hdwy        | 4.13   | -      | - | -      | - | 6.42  | 6.52  | -   |
| Critical Hdwy Stg 1  | -      | -      | - | -      | - | 5.42  | 5.52  | -   |
| Critical Hdwy Stg 2  | -      | -      | - | -      | - | 5.42  | 5.52  | -   |
| Follow-up Hdwy       | 2.227  | -      | - | -      | - | 3.518 | 4.018 | -   |
| Pot Cap-1 Maneuver   | 601    | -      | 0 | 0      | - | 0     | 55    | 50  |
| Stage 1              | -      | -      | 0 | 0      | - | 0     | 368   | 332 |
| Stage 2              | -      | -      | 0 | 0      | - | 0     | 300   | 271 |
| Platoon blocked, %   |        | -      |   |        | - |       |       |     |
| Mov Cap-1 Maneuver   | 601    | -      | - | -      | - | 53    | 0     | -   |
| Mov Cap-2 Maneuver   | -      | -      | - | -      | - | 53    | 0     | -   |
| Stage 1              | -      | -      | - | -      | - | 355   | 0     | -   |
| Stage 2              | -      | -      | - | -      | - | 300   | 0     | -   |

| Approach             | EB  | WB | NB    |
|----------------------|-----|----|-------|
| HCM Control Delay, s | 0.1 | 0  | 110.9 |
| HCM LOS              |     |    | F     |

| Minor Lane/Major Mvmt | NBLn1 | NBLn2 | EBL   | EBT | WBT |
|-----------------------|-------|-------|-------|-----|-----|
| Capacity (veh/h)      | 53    | -     | 601   | -   | -   |
| HCM Lane V/C Ratio    | 0.389 | -     | 0.017 | -   | -   |
| HCM Control Delay (s) | 110.9 | 0     | 11.1  | 0   | -   |
| HCM Lane LOS          | F     | A     | B     | A   | -   |
| HCM 95th %tile Q(veh) | 1.4   | -     | 0.1   | -   | -   |

HCM 2010 Signalized Intersection Summary  
5: 2nd Avenue & Imjin Parkway

Cumulative, AM  
06/11/2019

|                              |  |  |  |  |  |  |  |  |  |  |  |  |
|------------------------------|---|---|---|---|---|---|--|---|---|---|---|---|
| Movement                     | EBL   | EBT   | EBR   | WBL   | WBT   | WBR   | NBL  | NBT   | NBR   | SBL   | SBT   | SBR   |
| Lane Configurations          |  |  |  |  |  |   |  |  |  |  |  |  |
| Traffic Volume (veh/h)       | 180   | 1110  | 850   | 480   | 970   | 120   | 370  | 90  | 200   | 50  | 100   | 210   |
| Future Volume (veh/h)        | 180   | 1110  | 850   | 480   | 970   | 120   | 370  | 90  | 200   | 50  | 100   | 210   |
| Number                       | 5   | 2   | 12  | 1   | 6   | 16  | 3  | 8   | 18  | 7   | 4   | 14  |
| Initial Q (Qb), veh          | 0   | 0   | 0   | 0   | 0   | 0   | 0  | 0   | 0   | 0   | 0   | 0   |
| Ped-Bike Adj(A_pbT)          | 1.00  |   | 1.00  | 1.00  |   | 1.00  | 1.00   |   | 1.00  | 1.00  |   | 1.00  |
| Parking Bus, Adj             | 1.00  | 1.00  | 1.00  | 1.00  | 1.00  | 1.00  | 1.00   | 1.00  | 1.00  | 1.00  | 1.00  | 1.00  |
| Adj Sat Flow, veh/h/ln       | 1863  | 1863  | 1863  | 1863  | 1863  | 1900  | 1810   | 1810  | 1810  | 1900  | 1900  | 1900  |
| Adj Flow Rate, veh/h         | 184   | 1133  | 648   | 490   | 990   | 122   | 378  | 92  | 82  | 51  | 102   | 209   |
| Adj No. of Lanes             | 1   | 2   | 1   | 2   | 2   | 0   | 2  | 1   | 1   | 1   | 2   | 0   |
| Peak Hour Factor             | 0.98  | 0.98  | 0.98  | 0.98  | 0.98  | 0.98  | 0.98   | 0.98  | 0.98  | 0.98  | 0.98  | 0.98  |
| Percent Heavy Veh, %         | 2   | 2   | 2   | 2   | 2   | 2   | 5  | 5   | 5   | 0   | 0   | 0   |
| Cap, veh/h                   | 221   | 1220  | 546   | 559   | 1214  | 149   | 448  | 428   | 364   | 91  | 277   | 247   |
| Arrive On Green              | 0.12  | 0.34  | 0.34  | 0.16  | 0.38  | 0.38  | 0.13   | 0.24  | 0.24  | 0.05  | 0.15  | 0.15  |
| Sat Flow, veh/h              | 1774  | 3539  | 1583  | 3442  | 3173  | 391   | 3343   | 1810  | 1536  | 1810  | 1805  | 1612  |
| Grp Volume(v), veh/h         | 184   | 1133  | 648   | 490   | 552   | 560   | 378  | 92  | 82  | 51  | 102   | 209   |
| Grp Sat Flow(s),veh/h/ln     | 1774  | 1770  | 1583  | 1721  | 1770  | 1794  | 1672   | 1810  | 1536  | 1810  | 1805  | 1612  |
| Q Serve(g_s), s              | 8.8   | 26.8  | 30.0  | 12.1  | 24.4  | 24.4  | 9.6  | 3.6   | 3.7   | 2.4   | 4.4   | 11.0  |
| Cycle Q Clear(g_c), s        | 8.8   | 26.8  | 30.0  | 12.1  | 24.4  | 24.4  | 9.6  | 3.6   | 3.7   | 2.4   | 4.4   | 11.0  |
| Prop In Lane                 | 1.00  |   | 1.00  | 1.00  |   | 0.22  | 1.00   |   | 1.00  | 1.00  |   | 1.00  |
| Lane Grp Cap(c), veh/h       | 221   | 1220  | 546   | 559   | 677   | 686   | 448  | 428   | 364   | 91  | 277   | 247   |
| V/C Ratio(X)                 | 0.83  | 0.93  | 1.19  | 0.88  | 0.82  | 0.82  | 0.84   | 0.21  | 0.23  | 0.56  | 0.37  | 0.85  |
| Avail Cap(c_a), veh/h        | 306   | 1220  | 546   | 593   | 677   | 686   | 768  | 437   | 371   | 208   | 436   | 389   |
| HCM Platoon Ratio            | 1.00  | 1.00  | 1.00  | 1.00  | 1.00  | 1.00  | 1.00   | 1.00  | 1.00  | 1.00  | 1.00  | 1.00  |
| Upstream Filter(I)           | 1.00  | 1.00  | 1.00  | 1.00  | 1.00  | 1.00  | 1.00   | 1.00  | 1.00  | 1.00  | 1.00  | 1.00  |
| Uniform Delay (d), s/veh     | 37.2  | 27.5  | 28.5  | 35.6  | 24.1  | 24.1  | 36.8   | 26.7  | 26.8  | 40.4  | 33.1  | 35.8  |
| Incr Delay (d2), s/veh       | 9.6   | 12.1  | 101.5   | 12.7  | 7.1   | 7.1   | 1.7  | 0.1   | 0.1   | 2.0   | 0.3   | 5.5   |
| Initial Q Delay(d3),s/veh    | 0.0   | 0.0   | 0.0   | 0.0   | 0.0   | 0.0   | 0.0  | 0.0   | 0.0   | 0.0   | 0.0   | 0.0   |
| %ile BackOfQ(50%),veh/ln     | 4.9   | 15.1  | 28.4  | 6.7   | 13.2  | 13.3  | 4.5  | 1.8   | 1.6   | 1.3   | 2.2   | 5.3   |
| LnGrp Delay(d),s/veh         | 46.8  | 39.6  | 130.0   | 48.3  | 31.3  | 31.2  | 38.5   | 26.8  | 26.9  | 42.3  | 33.4  | 41.4  |
| LnGrp LOS                    | D   | D   | F   | D   | C   | C   | D  | C   | C   | D   | C   | D   |
| Approach Vol, veh/h          |   | 1965  |   |   | 1602  |   |  | 552   |   |   | 362   |   |
| Approach Delay, s/veh        |   | 70.1  |   |   | 36.5  |   |  | 34.8  |   |   | 39.2  |   |
| Approach LOS                 |   | E   |   |   | D   |   |  | C   |   |   | D   |   |
| Timer                        | 1   | 2   | 3   | 4   | 5   | 6   | 7  | 8   |   |   |   |   |
| Assigned Phs                 | 1   | 2   | 3   | 4   | 5   | 6   | 7  | 8   |   |   |   |   |
| Phs Duration (G+Y+Rc), s     | 18.6  | 35.3  | 15.2  | 17.9  | 15.3  | 38.6  | 7.9  | 25.2  |   |   |   |   |
| Change Period (Y+Rc), s      | 4.5   | 5.3   | 3.5   | 4.6   | 4.5   | 5.3   | 3.5  | 4.6   |   |   |   |   |
| Max Green Setting (Gmax), s  | 15.0  | 30.0  | 20.0  | 21.0  | 15.0  | 30.0  | 10.0   | 21.0  |   |   |   |   |
| Max Q Clear Time (g_c+I1), s | 14.1  | 32.0  | 11.6  | 13.0  | 10.8  | 26.4  | 4.4  | 5.7   |   |   |   |   |
| Green Ext Time (p_c), s      | 0.0   | 0.0   | 0.1   | 0.3   | 0.0   | 0.7   | 0.0  | 0.1   |   |   |   |   |
| <b>Intersection Summary</b>  |   |   |   |   |   |   |  |   |   |   |   |   |
| HCM 2010 Ctrl Delay          |   |   | 51.2  |   |   |   |  |   |   |   |   |   |
| HCM 2010 LOS                 |   |   | D   |   |   |   |  |   |   |   |   |   |

HCM 2010 Signalized Intersection Summary  
 6: 3rd Avenue & Imjin Parkway

Cumulative, AM  
 06/11/2019



| Movement                    | EBL  | EBT  | EBR  | WBL  | WBT  | WBR  | NBL  | NBT  | NBR  | SBL  | SBT  | SBR  |
|-----------------------------|------|------|------|------|------|------|------|------|------|------|------|------|
| Lane Configurations         | ↖    | ↗    |      | ↖    | ↗    |      | ↖    | ↗    |      | ↖    | ↗    |      |
| Traffic Volume (veh/h)      | 50   | 960  | 230  | 350  | 1420 | 30   | 130  | 10   | 70   | 10   | 10   | 40   |
| Future Volume (veh/h)       | 50   | 960  | 230  | 350  | 1420 | 30   | 130  | 10   | 70   | 10   | 10   | 40   |
| Number                      | 5    | 2    | 12   | 1    | 6    | 16   | 3    | 8    | 18   | 7    | 4    | 14   |
| Initial Q (Qb), veh         | 0    | 0    | 0    | 0    | 0    | 0    | 0    | 0    | 0    | 0    | 0    | 0    |
| Ped-Bike Adj(A_pbT)         | 1.00 |      | 1.00 | 1.00 |      | 1.00 | 1.00 |      | 1.00 | 1.00 |      | 1.00 |
| Parking Bus, Adj            | 1.00 | 1.00 | 1.00 | 1.00 | 1.00 | 1.00 | 1.00 | 1.00 | 1.00 | 1.00 | 1.00 | 1.00 |
| Adj Sat Flow, veh/h/ln      | 1863 | 1863 | 1900 | 1863 | 1863 | 1900 | 1810 | 1810 | 1900 | 1863 | 1863 | 1900 |
| Adj Flow Rate, veh/h        | 52   | 1000 | 211  | 365  | 1479 | 30   | 135  | 10   | 19   | 10   | 10   | 7    |
| Adj No. of Lanes            | 1    | 2    | 0    | 1    | 2    | 0    | 1    | 1    | 0    | 1    | 1    | 0    |
| Peak Hour Factor            | 0.96 | 0.96 | 0.96 | 0.96 | 0.96 | 0.96 | 0.96 | 0.96 | 0.96 | 0.96 | 0.96 | 0.96 |
| Percent Heavy Veh, %        | 2    | 2    | 2    | 2    | 2    | 2    | 5    | 5    | 5    | 2    | 2    | 2    |
| Cap, veh/h                  | 64   | 1124 | 237  | 382  | 2007 | 41   | 319  | 81   | 154  | 313  | 148  | 104  |
| Arrive On Green             | 0.04 | 0.39 | 0.39 | 0.22 | 0.57 | 0.57 | 0.15 | 0.15 | 0.15 | 0.15 | 0.15 | 0.15 |
| Sat Flow, veh/h             | 1774 | 2910 | 613  | 1774 | 3548 | 72   | 1345 | 558  | 1060 | 1370 | 1020 | 714  |
| Grp Volume(v), veh/h        | 52   | 607  | 604  | 365  | 737  | 772  | 135  | 0    | 29   | 10   | 0    | 17   |
| Grp Sat Flow(s),veh/h/ln    | 1774 | 1770 | 1754 | 1774 | 1770 | 1850 | 1345 | 0    | 1617 | 1370 | 0    | 1733 |
| Q Serve(g_s), s             | 1.6  | 17.1 | 17.2 | 10.8 | 16.5 | 16.6 | 5.1  | 0.0  | 0.8  | 0.3  | 0.0  | 0.5  |
| Cycle Q Clear(g_c), s       | 1.6  | 17.1 | 17.2 | 10.8 | 16.5 | 16.6 | 5.6  | 0.0  | 0.8  | 1.2  | 0.0  | 0.5  |
| Prop In Lane                | 1.00 |      | 0.35 | 1.00 |      | 0.04 | 1.00 |      | 0.66 | 1.00 |      | 0.41 |
| Lane Grp Cap(c), veh/h      | 64   | 683  | 677  | 382  | 1001 | 1047 | 319  | 0    | 235  | 313  | 0    | 252  |
| V/C Ratio(X)                | 0.82 | 0.89 | 0.89 | 0.95 | 0.74 | 0.74 | 0.42 | 0.00 | 0.12 | 0.03 | 0.00 | 0.07 |
| Avail Cap(c_a), veh/h       | 382  | 1077 | 1068 | 382  | 1077 | 1126 | 817  | 0    | 833  | 819  | 0    | 893  |
| HCM Platoon Ratio           | 1.00 | 1.00 | 1.00 | 1.00 | 1.00 | 1.00 | 1.00 | 1.00 | 1.00 | 1.00 | 1.00 | 1.00 |
| Upstream Filter(I)          | 1.00 | 1.00 | 1.00 | 1.00 | 1.00 | 1.00 | 1.00 | 0.00 | 1.00 | 1.00 | 0.00 | 1.00 |
| Uniform Delay (d), s/veh    | 25.6 | 15.3 | 15.3 | 20.7 | 8.6  | 8.6  | 22.1 | 0.0  | 19.8 | 20.4 | 0.0  | 19.7 |
| Incr Delay (d2), s/veh      | 9.2  | 3.8  | 4.1  | 34.1 | 2.1  | 2.0  | 0.3  | 0.0  | 0.1  | 0.0  | 0.0  | 0.0  |
| Initial Q Delay(d3),s/veh   | 0.0  | 0.0  | 0.0  | 0.0  | 0.0  | 0.0  | 0.0  | 0.0  | 0.0  | 0.0  | 0.0  | 0.0  |
| %ile BackOfQ(50%),veh/ln    | 0.9  | 9.0  | 9.0  | 8.9  | 8.6  | 8.9  | 1.9  | 0.0  | 0.4  | 0.1  | 0.0  | 0.2  |
| LnGrp Delay(d),s/veh        | 34.7 | 19.2 | 19.4 | 54.8 | 10.7 | 10.6 | 22.4 | 0.0  | 19.9 | 20.4 | 0.0  | 19.7 |
| LnGrp LOS                   | C    | B    | B    | D    | B    | B    | C    |      | B    | C    |      | B    |
| Approach Vol, veh/h         |      | 1263 |      |      | 1874 |      |      | 164  |      |      | 27   |      |
| Approach Delay, s/veh       |      | 19.9 |      |      | 19.3 |      |      | 22.0 |      |      | 20.0 |      |
| Approach LOS                |      | B    |      |      | B    |      |      | C    |      |      | B    |      |
| Timer                       | 1    | 2    | 3    | 4    | 5    | 6    | 7    | 8    |      |      |      |      |
| Assigned Phs                | 1    | 2    |      | 4    | 5    | 6    |      | 8    |      |      |      |      |
| Phs Duration (G+Y+Rc), s    | 5.0  | 26.1 |      | 12.3 | 5.4  | 35.7 |      | 12.3 |      |      |      |      |
| Change Period (Y+Rc), s     | 3.5  | 5.5  |      | 4.5  | 3.5  | 5.5  |      | 4.5  |      |      |      |      |
| Max Green Setting (Gmax), s | 1.5  | 32.5 |      | 27.5 | 11.5 | 32.5 |      | 27.5 |      |      |      |      |
| Max Q Clear Time (g_c+1), s | 12.8 | 19.2 |      | 3.2  | 3.6  | 18.6 |      | 7.6  |      |      |      |      |
| Green Ext Time (p_c), s     | 0.0  | 1.4  |      | 0.0  | 0.0  | 1.1  |      | 0.0  |      |      |      |      |
| <b>Intersection Summary</b> |      |      |      |      |      |      |      |      |      |      |      |      |
| HCM 2010 Ctrl Delay         |      |      | 19.6 |      |      |      |      |      |      |      |      |      |
| HCM 2010 LOS                |      |      | B    |      |      |      |      |      |      |      |      |      |

HCM 2010 Signalized Intersection Summary  
7: 4th Avenue & Imjin Parkway

Cumulative, AM  
06/11/2019



| Movement                    | EBL  | EBT  | EBR  | WBL  | WBT  | WBR  | NBL  | NBT  | NBR  | SBL  | SBT  | SBR  |
|-----------------------------|------|------|------|------|------|------|------|------|------|------|------|------|
| Lane Configurations         | ↖    | ↗    |      | ↖    | ↗    |      |      | ↕    |      |      | ↕    |      |
| Traffic Volume (veh/h)      | 10   | 1060 | 20   | 10   | 1730 | 10   | 10   | 10   | 10   | 10   | 10   | 10   |
| Future Volume (veh/h)       | 10   | 1060 | 20   | 10   | 1730 | 10   | 10   | 10   | 10   | 10   | 10   | 10   |
| Number                      | 5    | 2    | 12   | 1    | 6    | 16   | 3    | 8    | 18   | 7    | 4    | 14   |
| Initial Q (Qb), veh         | 0    | 0    | 0    | 0    | 0    | 0    | 0    | 0    | 0    | 0    | 0    | 0    |
| Ped-Bike Adj(A_pbT)         | 1.00 |      | 1.00 | 1.00 |      | 1.00 | 1.00 |      | 1.00 | 1.00 |      | 1.00 |
| Parking Bus, Adj            | 1.00 | 1.00 | 1.00 | 1.00 | 1.00 | 1.00 | 1.00 | 1.00 | 1.00 | 1.00 | 1.00 | 1.00 |
| Adj Sat Flow, veh/h/ln      | 1863 | 1863 | 1900 | 1863 | 1863 | 1900 | 1900 | 1267 | 1900 | 1900 | 1900 | 1900 |
| Adj Flow Rate, veh/h        | 10   | 1104 | 20   | 10   | 1802 | 9    | 10   | 10   | 9    | 10   | 10   | 10   |
| Adj No. of Lanes            | 1    | 2    | 0    | 1    | 2    | 0    | 0    | 1    | 0    | 0    | 1    | 0    |
| Peak Hour Factor            | 0.96 | 0.96 | 0.96 | 0.96 | 0.96 | 0.96 | 0.96 | 0.96 | 0.96 | 0.96 | 0.96 | 0.96 |
| Percent Heavy Veh, %        | 2    | 2    | 2    | 2    | 2    | 2    | 50   | 50   | 50   | 0    | 0    | 0    |
| Cap, veh/h                  | 14   | 1956 | 35   | 14   | 1986 | 10   | 160  | 19   | 17   | 168  | 29   | 29   |
| Arrive On Green             | 0.01 | 0.55 | 0.55 | 0.01 | 0.55 | 0.55 | 0.06 | 0.05 | 0.05 | 0.06 | 0.05 | 0.05 |
| Sat Flow, veh/h             | 1774 | 3556 | 64   | 1774 | 3611 | 18   | 386  | 386  | 347  | 570  | 570  | 570  |
| Grp Volume(v), veh/h        | 10   | 549  | 575  | 10   | 882  | 929  | 29   | 0    | 0    | 30   | 0    | 0    |
| Grp Sat Flow(s),veh/h/ln    | 1774 | 1770 | 1851 | 1774 | 1770 | 1860 | 1119 | 0    | 0    | 1711 | 0    | 0    |
| Q Serve(g_s), s             | 0.2  | 7.0  | 7.0  | 0.2  | 15.4 | 15.5 | 0.3  | 0.0  | 0.0  | 0.0  | 0.0  | 0.0  |
| Cycle Q Clear(g_c), s       | 0.2  | 7.0  | 7.0  | 0.2  | 15.4 | 15.5 | 0.8  | 0.0  | 0.0  | 0.5  | 0.0  | 0.0  |
| Prop In Lane                | 1.00 |      | 0.03 | 1.00 |      | 0.01 | 0.34 |      | 0.31 | 0.33 |      | 0.33 |
| Lane Grp Cap(c), veh/h      | 14   | 973  | 1018 | 14   | 973  | 1022 | 213  | 0    | 0    | 250  | 0    | 0    |
| V/C Ratio(X)                | 0.71 | 0.56 | 0.56 | 0.71 | 0.91 | 0.91 | 0.14 | 0.00 | 0.00 | 0.12 | 0.00 | 0.00 |
| Avail Cap(c_a), veh/h       | 593  | 1670 | 1748 | 593  | 1670 | 1755 | 1021 | 0    | 0    | 1463 | 0    | 0    |
| HCM Platoon Ratio           | 1.00 | 1.00 | 1.00 | 1.00 | 1.00 | 1.00 | 1.00 | 1.00 | 1.00 | 1.00 | 1.00 | 1.00 |
| Upstream Filter(I)          | 1.00 | 1.00 | 1.00 | 1.00 | 1.00 | 1.00 | 1.00 | 0.00 | 0.00 | 1.00 | 0.00 | 0.00 |
| Uniform Delay (d), s/veh    | 17.0 | 5.1  | 5.1  | 17.0 | 7.0  | 7.0  | 15.8 | 0.0  | 0.0  | 15.7 | 0.0  | 0.0  |
| Incr Delay (d2), s/veh      | 21.4 | 0.2  | 0.2  | 21.4 | 2.3  | 2.2  | 0.1  | 0.0  | 0.0  | 0.1  | 0.0  | 0.0  |
| Initial Q Delay(d3),s/veh   | 0.0  | 0.0  | 0.0  | 0.0  | 0.0  | 0.0  | 0.0  | 0.0  | 0.0  | 0.0  | 0.0  | 0.0  |
| %ile BackOfQ(50%),veh/ln    | 0.2  | 3.4  | 3.6  | 0.2  | 7.7  | 8.1  | 0.3  | 0.0  | 0.0  | 0.3  | 0.0  | 0.0  |
| LnGrp Delay(d),s/veh        | 38.5 | 5.3  | 5.2  | 38.5 | 9.2  | 9.2  | 15.9 | 0.0  | 0.0  | 15.8 | 0.0  | 0.0  |
| LnGrp LOS                   | D    | A    | A    | D    | A    | A    | B    |      |      | B    |      |      |
| Approach Vol, veh/h         |      | 1134 |      |      | 1821 |      |      | 29   |      |      | 30   |      |
| Approach Delay, s/veh       |      | 5.5  |      |      | 9.4  |      |      | 15.9 |      |      | 15.8 |      |
| Approach LOS                |      | A    |      |      | A    |      |      | B    |      |      | B    |      |
| Timer                       | 1    | 2    | 3    | 4    | 5    | 6    | 7    | 8    |      |      |      |      |
| Assigned Phs                | 1    | 2    |      | 4    | 5    | 6    |      | 8    |      |      |      |      |
| Phs Duration (G+Y+Rc), s    | 3.8  | 24.4 |      | 6.2  | 3.8  | 24.4 |      | 6.2  |      |      |      |      |
| Change Period (Y+Rc), s     | 3.5  | 5.5  |      | 4.5  | 3.5  | 5.5  |      | 4.5  |      |      |      |      |
| Max Green Setting (Gmax), s | 1.5  | 32.5 |      | 27.5 | 11.5 | 32.5 |      | 27.5 |      |      |      |      |
| Max Q Clear Time (g_c+1), s | 12.2 | 9.0  |      | 2.5  | 2.2  | 17.5 |      | 2.8  |      |      |      |      |
| Green Ext Time (p_c), s     | 0.0  | 0.8  |      | 0.0  | 0.0  | 1.5  |      | 0.0  |      |      |      |      |
| <b>Intersection Summary</b> |      |      |      |      |      |      |      |      |      |      |      |      |
| HCM 2010 Ctrl Delay         |      |      |      | 8.0  |      |      |      |      |      |      |      |      |
| HCM 2010 LOS                |      |      |      | A    |      |      |      |      |      |      |      |      |

HCM 2010 Signalized Intersection Summary  
 8: 5th Avenue/California Avenue & Imjin Parkway

Cumulative, AM  
 06/11/2019



| Movement                    | EBL  | EBT  | EBR  | WBL  | WBT  | WBR  | NBL  | NBT  | NBR  | SBL   | SBT   | SBR  |
|-----------------------------|------|------|------|------|------|------|------|------|------|-------|-------|------|
| Lane Configurations         |      |      |      |      |      |      |      |      |      |       |       |      |
| Traffic Volume (veh/h)      | 140  | 970  | 20   | 10   | 1130 | 70   | 20   | 10   | 10   | 90    | 150   | 460  |
| Future Volume (veh/h)       | 140  | 970  | 20   | 10   | 1130 | 70   | 20   | 10   | 10   | 90    | 150   | 460  |
| Number                      | 5    | 2    | 12   | 1    | 6    | 16   | 3    | 8    | 18   | 7     | 4     | 14   |
| Initial Q (Qb), veh         | 0    | 0    | 0    | 0    | 0    | 0    | 0    | 0    | 0    | 0     | 0     | 0    |
| Ped-Bike Adj(A_pbT)         | 1.00 |      | 0.98 | 1.00 |      | 1.00 | 1.00 |      | 0.99 | 1.00  |       | 1.00 |
| Parking Bus, Adj            | 1.00 | 1.00 | 1.00 | 1.00 | 1.00 | 1.00 | 1.00 | 1.00 | 1.00 | 1.00  | 1.00  | 1.00 |
| Adj Sat Flow, veh/h/ln      | 1881 | 1881 | 1900 | 1863 | 1863 | 1900 | 1900 | 1624 | 1900 | 1900  | 1881  | 1900 |
| Adj Flow Rate, veh/h        | 147  | 1021 | 19   | 11   | 1189 | 68   | 21   | 11   | 10   | 95    | 158   | 410  |
| Adj No. of Lanes            | 1    | 2    | 0    | 1    | 2    | 0    | 0    | 1    | 0    | 0     | 1     | 0    |
| Peak Hour Factor            | 0.95 | 0.95 | 0.95 | 0.95 | 0.95 | 0.95 | 0.95 | 0.95 | 0.95 | 0.95  | 0.95  | 0.95 |
| Percent Heavy Veh, %        | 1    | 1    | 1    | 2    | 2    | 2    | 17   | 17   | 17   | 1     | 1     | 1    |
| Cap, veh/h                  | 185  | 1697 | 32   | 15   | 1286 | 73   | 178  | 85   | 56   | 122   | 136   | 314  |
| Arrive On Green             | 0.10 | 0.47 | 0.47 | 0.01 | 0.38 | 0.38 | 0.32 | 0.31 | 0.31 | 0.32  | 0.31  | 0.31 |
| Sat Flow, veh/h             | 1792 | 3588 | 67   | 1774 | 3404 | 194  | 303  | 273  | 180  | 187   | 437   | 1011 |
| Grp Volume(v), veh/h        | 147  | 509  | 531  | 11   | 618  | 639  | 42   | 0    | 0    | 663   | 0     | 0    |
| Grp Sat Flow(s),veh/h/ln    | 1792 | 1787 | 1868 | 1774 | 1770 | 1828 | 756  | 0    | 0    | 1636  | 0     | 0    |
| Q Serve(g_s), s             | 5.2  | 13.5 | 13.5 | 0.4  | 21.5 | 21.5 | 0.0  | 0.0  | 0.0  | 16.6  | 0.0   | 0.0  |
| Cycle Q Clear(g_c), s       | 5.2  | 13.5 | 13.5 | 0.4  | 21.5 | 21.5 | 1.2  | 0.0  | 0.0  | 20.6  | 0.0   | 0.0  |
| Prop In Lane                | 1.00 |      | 0.04 | 1.00 |      | 0.11 | 0.50 |      | 0.24 | 0.14  |       | 0.62 |
| Lane Grp Cap(c), veh/h      | 185  | 845  | 884  | 15   | 669  | 691  | 326  | 0    | 0    | 587   | 0     | 0    |
| V/C Ratio(X)                | 0.79 | 0.60 | 0.60 | 0.75 | 0.92 | 0.93 | 0.13 | 0.00 | 0.00 | 1.13  | 0.00  | 0.00 |
| Avail Cap(c_a), veh/h       | 417  | 845  | 884  | 413  | 824  | 852  | 326  | 0    | 0    | 587   | 0     | 0    |
| HCM Platoon Ratio           | 1.00 | 1.00 | 1.00 | 1.00 | 1.00 | 1.00 | 1.00 | 1.00 | 1.00 | 1.00  | 1.00  | 1.00 |
| Upstream Filter(I)          | 1.00 | 1.00 | 1.00 | 1.00 | 1.00 | 1.00 | 1.00 | 0.00 | 0.00 | 1.00  | 0.00  | 0.00 |
| Uniform Delay (d), s/veh    | 28.2 | 12.5 | 12.5 | 31.9 | 19.1 | 19.2 | 15.6 | 0.0  | 0.0  | 23.4  | 0.0   | 0.0  |
| Incr Delay (d2), s/veh      | 2.9  | 0.9  | 0.8  | 23.6 | 12.8 | 12.7 | 0.1  | 0.0  | 0.0  | 78.1  | 0.0   | 0.0  |
| Initial Q Delay(d3),s/veh   | 0.0  | 0.0  | 0.0  | 0.0  | 0.0  | 0.0  | 0.0  | 0.0  | 0.0  | 0.0   | 0.0   | 0.0  |
| %ile BackOfQ(50%),veh/ln    | 2.7  | 6.8  | 7.1  | 0.3  | 12.8 | 13.3 | 0.5  | 0.0  | 0.0  | 22.9  | 0.0   | 0.0  |
| LnGrp Delay(d),s/veh        | 31.1 | 13.4 | 13.3 | 55.5 | 31.9 | 31.8 | 15.7 | 0.0  | 0.0  | 101.6 | 0.0   | 0.0  |
| LnGrp LOS                   | C    | B    | B    | E    | C    | C    | B    |      |      | F     |       |      |
| Approach Vol, veh/h         |      | 1187 |      |      | 1268 |      |      | 42   |      |       | 663   |      |
| Approach Delay, s/veh       |      | 15.5 |      |      | 32.1 |      |      | 15.7 |      |       | 101.6 |      |
| Approach LOS                |      | B    |      |      | C    |      |      | B    |      |       | F     |      |
| Timer                       | 1    | 2    | 3    | 4    | 5    | 6    | 7    | 8    |      |       |       |      |
| Assigned Phs                | 1    | 2    |      | 4    | 5    | 6    |      | 8    |      |       |       |      |
| Phs Duration (G+Y+Rc), s    | 4.0  | 35.8 |      | 24.6 | 10.2 | 29.6 |      | 24.6 |      |       |       |      |
| Change Period (Y+Rc), s     | 3.5  | 5.3  |      | 4.6  | 3.5  | 5.3  |      | 4.6  |      |       |       |      |
| Max Green Setting (Gmax), s | 5.0  | 30.0 |      | 20.0 | 15.0 | 30.0 |      | 20.0 |      |       |       |      |
| Max Q Clear Time (g_c+1), s | 12.4 | 15.5 |      | 22.6 | 7.2  | 23.5 |      | 3.2  |      |       |       |      |
| Green Ext Time (p_c), s     | 0.0  | 0.7  |      | 0.0  | 0.0  | 0.8  |      | 0.0  |      |       |       |      |
| <b>Intersection Summary</b> |      |      |      |      |      |      |      |      |      |       |       |      |
| HCM 2010 Ctrl Delay         |      |      | 40.2 |      |      |      |      |      |      |       |       |      |
| HCM 2010 LOS                |      |      | D    |      |      |      |      |      |      |       |       |      |

| Intersection             |      |      |      |      |      |      |
|--------------------------|------|------|------|------|------|------|
| Int Delay, s/veh         | 1.4  |      |      |      |      |      |
| Movement                 | EBL  | EBR  | NBL  | NBT  | SBT  | SBR  |
| Lane Configurations      | ↔    |      | ↔    | ↑    | ↑    |      |
| Traffic Vol, veh/h       | 30   | 30   | 30   | 210  | 610  | 80   |
| Future Vol, veh/h        | 30   | 30   | 30   | 210  | 610  | 80   |
| Conflicting Peds, #/hr   | 0    | 0    | 0    | 0    | 0    | 0    |
| Sign Control             | Stop | Stop | Free | Free | Free | Free |
| RT Channelized           | -    | None | -    | None | -    | None |
| Storage Length           | 0    | -    | 155  | -    | -    | -    |
| Veh in Median Storage, # | 0    | -    | -    | 0    | 0    | -    |
| Grade, %                 | 0    | -    | -    | 0    | 0    | -    |
| Peak Hour Factor         | 92   | 92   | 92   | 92   | 92   | 92   |
| Heavy Vehicles, %        | 2    | 2    | 2    | 2    | 2    | 2    |
| Mvmt Flow                | 33   | 33   | 33   | 228  | 663  | 87   |











| Major/Minor          | Minor2 | Major1 | Major2 |   |   |   |
|----------------------|--------|--------|--------|---|---|---|
| Conflicting Flow All | 1001   | 707    | 750    | 0 | - | 0 |
| Stage 1              | 707    | -      | -      | - | - | - |
| Stage 2              | 294    | -      | -      | - | - | - |
| Critical Hdwy        | 6.42   | 6.22   | 4.12   | - | - | - |
| Critical Hdwy Stg 1  | 5.42   | -      | -      | - | - | - |
| Critical Hdwy Stg 2  | 5.42   | -      | -      | - | - | - |
| Follow-up Hdwy       | 3.518  | 3.318  | 2.218  | - | - | - |
| Pot Cap-1 Maneuver   | 269    | 435    | 859    | - | - | - |
| Stage 1              | 489    | -      | -      | - | - | - |
| Stage 2              | 756    | -      | -      | - | - | - |
| Platoon blocked, %   |        |        |        | - | - | - |
| Mov Cap-1 Maneuver   | 259    | 435    | 859    | - | - | - |
| Mov Cap-2 Maneuver   | 259    | -      | -      | - | - | - |
| Stage 1              | 470    | -      | -      | - | - | - |
| Stage 2              | 756    | -      | -      | - | - | - |

| Approach             | EB   | NB  | SB |
|----------------------|------|-----|----|
| HCM Control Delay, s | 18.8 | 1.2 | 0  |
| HCM LOS              | C    |     |    |

| Minor Lane/Major Mvmt | NBL   | NBT | EBLn1 | SBT | SBR |
|-----------------------|-------|-----|-------|-----|-----|
| Capacity (veh/h)      | 859   | -   | 325   | -   | -   |
| HCM Lane V/C Ratio    | 0.038 | -   | 0.201 | -   | -   |
| HCM Control Delay (s) | 9.4   | -   | 18.8  | -   | -   |
| HCM Lane LOS          | A     | -   | C     | -   | -   |
| HCM 95th %tile Q(veh) | 0.1   | -   | 0.7   | -   | -   |

HCM 2010 Signalized Intersection Summary  
 10: Imjin Road & Imjin Parkway

Cumulative, AM  
 06/11/2019

|                              |  |  |  |  |  |  |   |      |
|------------------------------|---|---|---|---|---|---|---|------|
| Movement                     | EBT   | EBR   | WBL   | WBT   | NBL   | NBR   |   |      |
| Lane Configurations          |  |   |  |  |  |  |   |      |
| Traffic Volume (veh/h)       | 900   | 190   | 430   | 1140  | 60  | 120   |   |      |
| Future Volume (veh/h)        | 900   | 190   | 430   | 1140  | 60  | 120   |   |      |
| Number                       | 2   | 12  | 1   | 6   | 3   | 18  |   |      |
| Initial Q (Qb), veh          | 0   | 0   | 0   | 0   | 0   | 0   |   |      |
| Ped-Bike Adj(A_pbT)          |   | 1.00  | 1.00  |   | 1.00  | 1.00  |   |      |
| Parking Bus, Adj             | 1.00  | 1.00  | 1.00  | 1.00  | 1.00  | 1.00  |   |      |
| Adj Sat Flow, veh/h/ln       | 1863  | 1900  | 1845  | 1845  | 1810  | 1810  |   |      |
| Adj Flow Rate, veh/h         | 947   | 187   | 453   | 1200  | 63  | 126   |   |      |
| Adj No. of Lanes             | 2   | 0   | 1   | 2   | 1   | 2   |   |      |
| Peak Hour Factor             | 0.95  | 0.95  | 0.95  | 0.95  | 0.95  | 0.95  |   |      |
| Percent Heavy Veh, %         | 2   | 2   | 3   | 3   | 5   | 5   |   |      |
| Cap, veh/h                   | 1057  | 209   | 505   | 2621  | 127   | 226   |   |      |
| Arrive On Green              | 0.36  | 0.36  | 0.29  | 0.75  | 0.07  | 0.07  |   |      |
| Sat Flow, veh/h              | 3041  | 582   | 1757  | 3597  | 1723  | 3076  |   |      |
| Grp Volume(v), veh/h         | 568   | 566   | 453   | 1200  | 63  | 126   |   |      |
| Grp Sat Flow(s),veh/h/ln     | 1770  | 1760  | 1757  | 1752  | 1723  | 1538  |   |      |
| Q Serve(g_s), s              | 15.8  | 15.8  | 12.9  | 6.8   | 1.8   | 2.1   |   |      |
| Cycle Q Clear(g_c), s        | 15.8  | 15.8  | 12.9  | 6.8   | 1.8   | 2.1   |   |      |
| Prop In Lane                 |   | 0.33  | 1.00  |   | 1.00  | 1.00  |   |      |
| Lane Grp Cap(c), veh/h       | 635   | 631   | 505   | 2621  | 127   | 226   |   |      |
| V/C Ratio(X)                 | 0.90  | 0.90  | 0.90  | 0.46  | 0.50  | 0.56  |   |      |
| Avail Cap(c_a), veh/h        | 1021  | 1015  | 675   | 2621  | 729   | 1301  |   |      |
| HCM Platoon Ratio            | 1.00  | 1.00  | 1.00  | 1.00  | 1.00  | 1.00  |   |      |
| Upstream Filter(I)           | 1.00  | 1.00  | 1.00  | 1.00  | 1.00  | 1.00  |   |      |
| Uniform Delay (d), s/veh     | 15.8  | 15.8  | 17.8  | 2.5   | 23.2  | 23.3  |   |      |
| Incr Delay (d2), s/veh       | 4.1   | 4.2   | 10.1  | 0.0   | 1.1   | 0.8   |   |      |
| Initial Q Delay(d3),s/veh    | 0.0   | 0.0   | 0.0   | 0.0   | 0.0   | 0.0   |   |      |
| %ile BackOfQ(50%),veh/ln     | 8.3   | 8.3   | 7.6   | 3.2   | 0.9   | 0.9   |   |      |
| LnGrp Delay(d),s/veh         | 19.9  | 20.0  | 27.9  | 2.6   | 24.3  | 24.1  |   |      |
| LnGrp LOS                    | B   | B   | C   | A   | C   | C   |   |      |
| Approach Vol, veh/h          | 1134  |   |   | 1653  | 189   |   |   |      |
| Approach Delay, s/veh        | 19.9  |   |   | 9.5   | 24.2  |   |   |      |
| Approach LOS                 | B   |   |   | A   | C   |   |   |      |
| Timer                        | 1   | 2   | 3   | 4   | 5   | 6   | 7 | 8    |
| Assigned Phs                 | 1   | 2   |   |   |   | 6   |   | 8    |
| Phs Duration (G+Y+Rc), s     | 20.2  | 24.0  |   |   |   | 44.2  |   | 7.8  |
| Change Period (Y+Rc), s      | 5.3   | * 5.3   |   |   |   | 5.3   |   | 4.0  |
| Max Green Setting (Gmax), s  | 20.0  | * 30  |   |   |   | 30.0  |   | 22.0 |
| Max Q Clear Time (g_c+I1), s | 14.9  | 17.8  |   |   |   | 8.8   |   | 4.1  |
| Green Ext Time (p_c), s      | 0.1   | 0.8   |   |   |   | 1.4   |   | 0.0  |
| <b>Intersection Summary</b>  |   |   |   |   |   |   |   |      |
| HCM 2010 Ctrl Delay          |   |   | 14.4  |   |   |   |   |      |
| HCM 2010 LOS                 |   |   | B   |   |   |   |   |      |
| <b>Notes</b>                 |   |   |   |   |   |   |   |      |



HCM 2010 Signalized Intersection Summary  
 11: Abrams Drive & Imjin Parkway

Cumulative, AM  
 06/11/2019



| Movement                     | EBL  | EBT  | EBR  | WBL  | WBT  | WBR  | NBL  | NBT  | NBR  | SBL  | SBT  | SBR  |
|------------------------------|------|------|------|------|------|------|------|------|------|------|------|------|
| Lane Configurations          | ↖↗   | ↗    |      | ↖↗   | ↗    |      | ↖    | ↗    | ↗    | ↖    | ↗    | ↗    |
| Traffic Volume (veh/h)       | 50   | 810  | 60   | 80   | 1200 | 70   | 220  | 30   | 110  | 90   | 50   | 250  |
| Future Volume (veh/h)        | 50   | 810  | 60   | 80   | 1200 | 70   | 220  | 30   | 110  | 90   | 50   | 250  |
| Number                       | 5    | 2    | 12   | 1    | 6    | 16   | 3    | 8    | 18   | 7    | 4    | 14   |
| Initial Q (Qb), veh          | 0    | 0    | 0    | 0    | 0    | 0    | 0    | 0    | 0    | 0    | 0    | 0    |
| Ped-Bike Adj(A_pbT)          | 1.00 |      | 1.00 | 1.00 |      | 1.00 | 1.00 |      | 1.00 | 1.00 |      | 1.00 |
| Parking Bus, Adj             | 1.00 | 1.00 | 1.00 | 1.00 | 1.00 | 1.00 | 1.00 | 1.00 | 1.00 | 1.00 | 1.00 | 1.00 |
| Adj Sat Flow, veh/h/ln       | 1881 | 1881 | 1900 | 1863 | 1863 | 1900 | 1845 | 1845 | 1845 | 1863 | 1863 | 1863 |
| Adj Flow Rate, veh/h         | 54   | 871  | 53   | 86   | 1290 | 70   | 237  | 32   | 0    | 97   | 54   | 0    |
| Adj No. of Lanes             | 2    | 2    | 0    | 2    | 2    | 0    | 1    | 1    | 1    | 1    | 1    | 1    |
| Peak Hour Factor             | 0.93 | 0.93 | 0.93 | 0.93 | 0.93 | 0.93 | 0.93 | 0.93 | 0.93 | 0.93 | 0.93 | 0.93 |
| Percent Heavy Veh, %         | 1    | 1    | 1    | 2    | 2    | 2    | 3    | 3    | 3    | 2    | 2    | 2    |
| Cap, veh/h                   | 189  | 1915 | 116  | 147  | 1847 | 100  | 365  | 415  | 352  | 386  | 419  | 356  |
| Arrive On Green              | 0.05 | 0.56 | 0.54 | 0.04 | 0.54 | 0.52 | 0.22 | 0.22 | 0.00 | 0.22 | 0.22 | 0.00 |
| Sat Flow, veh/h              | 3476 | 3423 | 208  | 3442 | 3415 | 185  | 1330 | 1845 | 1568 | 1370 | 1863 | 1583 |
| Grp Volume(v), veh/h         | 54   | 455  | 469  | 86   | 668  | 692  | 237  | 32   | 0    | 97   | 54   | 0    |
| Grp Sat Flow(s),veh/h/ln     | 1738 | 1787 | 1844 | 1721 | 1770 | 1830 | 1330 | 1845 | 1568 | 1370 | 1863 | 1583 |
| Q Serve(g_s), s              | 1.1  | 11.1 | 11.2 | 1.8  | 20.6 | 20.7 | 12.8 | 1.0  | 0.0  | 4.4  | 1.7  | 0.0  |
| Cycle Q Clear(g_c), s        | 1.1  | 11.1 | 11.2 | 1.8  | 20.6 | 20.7 | 14.5 | 1.0  | 0.0  | 5.5  | 1.7  | 0.0  |
| Prop In Lane                 | 1.00 |      | 0.11 | 1.00 |      | 0.10 | 1.00 |      | 1.00 | 1.00 |      | 1.00 |
| Lane Grp Cap(c), veh/h       | 189  | 1000 | 1031 | 147  | 957  | 990  | 365  | 415  | 352  | 386  | 419  | 356  |
| V/C Ratio(X)                 | 0.29 | 0.45 | 0.45 | 0.58 | 0.70 | 0.70 | 0.65 | 0.08 | 0.00 | 0.25 | 0.13 | 0.00 |
| Avail Cap(c_a), veh/h        | 940  | 1209 | 1247 | 931  | 1197 | 1238 | 606  | 748  | 636  | 634  | 756  | 642  |
| HCM Platoon Ratio            | 1.00 | 1.00 | 1.00 | 1.00 | 1.00 | 1.00 | 1.00 | 1.00 | 1.00 | 1.00 | 1.00 | 1.00 |
| Upstream Filter(I)           | 1.00 | 1.00 | 1.00 | 1.00 | 1.00 | 1.00 | 1.00 | 1.00 | 0.00 | 1.00 | 1.00 | 0.00 |
| Uniform Delay (d), s/veh     | 33.6 | 9.6  | 9.7  | 34.7 | 12.5 | 12.6 | 28.7 | 22.6 | 0.0  | 24.8 | 22.9 | 0.0  |
| Incr Delay (d2), s/veh       | 0.3  | 0.1  | 0.1  | 1.4  | 0.8  | 0.8  | 0.7  | 0.0  | 0.0  | 0.1  | 0.1  | 0.0  |
| Initial Q Delay(d3),s/veh    | 0.0  | 0.0  | 0.0  | 0.0  | 0.0  | 0.0  | 0.0  | 0.0  | 0.0  | 0.0  | 0.0  | 0.0  |
| %ile BackOfQ(50%),veh/ln     | 0.5  | 5.5  | 5.7  | 0.9  | 10.0 | 10.6 | 4.7  | 0.5  | 0.0  | 1.7  | 0.9  | 0.0  |
| LnGrp Delay(d),s/veh         | 33.9 | 9.8  | 9.8  | 36.1 | 13.3 | 13.4 | 29.4 | 22.6 | 0.0  | 24.9 | 22.9 | 0.0  |
| LnGrp LOS                    | C    | A    | A    | D    | B    | B    | C    | C    |      | C    | C    |      |
| Approach Vol, veh/h          |      | 978  |      |      | 1446 |      |      | 269  |      |      | 151  |      |
| Approach Delay, s/veh        |      | 11.1 |      |      | 14.7 |      |      | 28.6 |      |      | 24.2 |      |
| Approach LOS                 |      | B    |      |      | B    |      |      | C    |      |      | C    |      |
| Timer                        | 1    | 2    | 3    | 4    | 5    | 6    | 7    | 8    |      |      |      |      |
| Assigned Phs                 | 1    | 2    |      | 4    | 5    | 6    |      | 8    |      |      |      |      |
| Phs Duration (G+Y+Rc), s     | 6.7  | 46.7 |      | 20.6 | 8.0  | 45.3 |      | 20.6 |      |      |      |      |
| Change Period (Y+Rc), s      | 3.5  | 5.3  |      | 4.0  | 4.0  | 5.3  |      | 4.0  |      |      |      |      |
| Max Green Setting (Gmax), s  | 20.0 | 50.0 |      | 30.0 | 20.0 | 50.0 |      | 30.0 |      |      |      |      |
| Max Q Clear Time (g_c+13), s | 13.8 | 13.2 |      | 7.5  | 3.1  | 22.7 |      | 16.5 |      |      |      |      |
| Green Ext Time (p_c), s      | 0.0  | 0.7  |      | 0.0  | 0.0  | 1.0  |      | 0.1  |      |      |      |      |
| <b>Intersection Summary</b>  |      |      |      |      |      |      |      |      |      |      |      |      |
| HCM 2010 Ctrl Delay          |      |      |      | 15.3 |      |      |      |      |      |      |      |      |
| HCM 2010 LOS                 |      |      |      | B    |      |      |      |      |      |      |      |      |

HCM 2010 Signalized Intersection Summary  
 12: Reservation Road & Imjin Parkway

Cumulative, AM  
 06/11/2019



| Movement                    | EBL  | EBT   | EBR  | WBL  | WBT  | WBR   | NBL  | NBT  | NBR  | SBL  | SBT  | SBR  |
|-----------------------------|------|-------|------|------|------|-------|------|------|------|------|------|------|
| Lane Configurations         | ↖↗   | ↑     | ↖↗   | ↖    | ↑    | ↖     | ↖↗   | ↑↑   | ↖    | ↖↗   | ↑↑   | ↖    |
| Traffic Volume (veh/h)      | 170  | 50    | 820  | 10   | 20   | 30    | 1180 | 890  | 20   | 60   | 590  | 90   |
| Future Volume (veh/h)       | 170  | 50    | 820  | 10   | 20   | 30    | 1180 | 890  | 20   | 60   | 590  | 90   |
| Number                      | 3    | 8     | 18   | 7    | 4    | 14    | 1    | 6    | 16   | 5    | 2    | 12   |
| Initial Q (Qb), veh         | 0    | 0     | 0    | 0    | 0    | 0     | 0    | 0    | 0    | 0    | 0    | 0    |
| Ped-Bike Adj(A_pbT)         | 1.00 |       | 1.00 | 1.00 |      | 0.99  | 1.00 |      | 1.00 | 1.00 |      | 0.98 |
| Parking Bus, Adj            | 1.00 | 1.00  | 1.00 | 1.00 | 1.00 | 1.00  | 1.00 | 1.00 | 1.00 | 1.00 | 1.00 | 1.00 |
| Adj Sat Flow, veh/h/ln      | 1863 | 1863  | 1863 | 1638 | 1638 | 1638  | 1863 | 1863 | 1863 | 1863 | 1863 | 1863 |
| Adj Flow Rate, veh/h        | 183  | 54    | 468  | 11   | 22   | 19    | 1269 | 957  | 16   | 65   | 634  | 34   |
| Adj No. of Lanes            | 2    | 1     | 2    | 1    | 1    | 1     | 2    | 2    | 1    | 2    | 2    | 1    |
| Peak Hour Factor            | 0.93 | 0.93  | 0.93 | 0.93 | 0.93 | 0.93  | 0.93 | 0.93 | 0.93 | 0.93 | 0.93 | 0.93 |
| Percent Heavy Veh, %        | 2    | 2     | 2    | 16   | 16   | 16    | 2    | 2    | 2    | 2    | 2    | 2    |
| Cap, veh/h                  | 487  | 264   | 1347 | 53   | 56   | 47    | 1178 | 2081 | 930  | 113  | 987  | 434  |
| Arrive On Green             | 0.14 | 0.14  | 0.14 | 0.03 | 0.03 | 0.03  | 0.34 | 0.59 | 0.59 | 0.03 | 0.28 | 0.28 |
| Sat Flow, veh/h             | 3442 | 1863  | 2777 | 1560 | 1638 | 1382  | 3442 | 3539 | 1581 | 3442 | 3539 | 1558 |
| Grp Volume(v), veh/h        | 183  | 54    | 468  | 11   | 22   | 19    | 1269 | 957  | 16   | 65   | 634  | 34   |
| Grp Sat Flow(s),veh/h/ln    | 1721 | 1863  | 1388 | 1560 | 1638 | 1382  | 1721 | 1770 | 1581 | 1721 | 1770 | 1558 |
| Q Serve(g_s), s             | 4.9  | 2.6   | 10.7 | 0.7  | 1.3  | 1.4   | 35.0 | 15.6 | 0.4  | 1.9  | 16.1 | 1.6  |
| Cycle Q Clear(g_c), s       | 4.9  | 2.6   | 10.7 | 0.7  | 1.3  | 1.4   | 35.0 | 15.6 | 0.4  | 1.9  | 16.1 | 1.6  |
| Prop In Lane                | 1.00 |       | 1.00 | 1.00 |      | 1.00  | 1.00 |      | 1.00 | 1.00 |      | 1.00 |
| Lane Grp Cap(c), veh/h      | 487  | 264   | 1347 | 53   | 56   | 47    | 1178 | 2081 | 930  | 113  | 987  | 434  |
| V/C Ratio(X)                | 0.38 | 0.20  | 0.35 | 0.21 | 0.39 | 0.40  | 1.08 | 0.46 | 0.02 | 0.57 | 0.64 | 0.08 |
| Avail Cap(c_a), veh/h       | 1178 | 637   | 1904 | 473  | 496  | 419   | 1178 | 2081 | 930  | 673  | 2076 | 914  |
| HCM Platoon Ratio           | 1.00 | 1.00  | 1.00 | 1.00 | 1.00 | 1.00  | 1.00 | 1.00 | 1.00 | 1.00 | 1.00 | 1.00 |
| Upstream Filter(I)          | 1.00 | 1.00  | 1.00 | 1.00 | 1.00 | 1.00  | 1.00 | 1.00 | 1.00 | 1.00 | 1.00 | 1.00 |
| Uniform Delay (d), s/veh    | 39.8 | 38.8  | 16.4 | 48.1 | 48.4 | 48.4  | 33.6 | 11.9 | 8.8  | 48.8 | 32.4 | 27.2 |
| Incr Delay (d2), s/veh      | 0.2  | 0.1   | 0.1  | 0.7  | 1.7  | 2.1   | 49.8 | 0.4  | 0.0  | 1.7  | 1.9  | 0.2  |
| Initial Q Delay(d3),s/veh   | 0.0  | 0.0   | 0.0  | 0.0  | 0.0  | 0.0   | 0.0  | 0.0  | 0.0  | 0.0  | 0.0  | 0.0  |
| %ile BackOfQ(50%),veh/ln    | 2.4  | 1.4   | 4.1  | 0.3  | 0.6  | 0.6   | 24.7 | 7.7  | 0.2  | 0.9  | 8.1  | 0.7  |
| LnGrp Delay(d),s/veh        | 40.0 | 39.0  | 16.5 | 48.8 | 50.0 | 50.4  | 83.5 | 12.3 | 8.8  | 50.4 | 34.3 | 27.4 |
| LnGrp LOS                   | D    | D     | B    | D    | D    | D     | F    | B    | A    | D    | C    | C    |
| Approach Vol, veh/h         |      | 705   |      |      | 52   |       |      | 2242 |      |      | 733  |      |
| Approach Delay, s/veh       |      | 24.3  |      |      | 49.9 |       |      | 52.6 |      |      | 35.4 |      |
| Approach LOS                |      | C     |      |      | D    |       |      | D    |      |      | D    |      |
| Timer                       | 1    | 2     | 3    | 4    | 5    | 6     | 7    | 8    |      |      |      |      |
| Assigned Phs                | 1    | 2     |      | 4    | 5    | 6     |      | 8    |      |      |      |      |
| Phs Duration (G+Y+Rc), s    | 39.1 | 34.7  |      | 8.5  | 7.5  | 66.4  |      | 20.0 |      |      |      |      |
| Change Period (Y+Rc), s     | 4.1  | * 6.2 |      | 5.0  | 4.1  | * 6.2 |      | 5.5  |      |      |      |      |
| Max Green Setting (Gmax), s | 35.0 | * 60  |      | 31.0 | 20.0 | * 50  |      | 35.0 |      |      |      |      |
| Max Q Clear Time (g_c+Q), s | 17.0 | 18.1  |      | 3.4  | 3.9  | 17.6  |      | 12.7 |      |      |      |      |
| Green Ext Time (p_c), s     | 0.0  | 10.4  |      | 0.1  | 0.0  | 15.2  |      | 1.5  |      |      |      |      |
| <b>Intersection Summary</b> |      |       |      |      |      |       |      |      |      |      |      |      |
| HCM 2010 Ctrl Delay         |      |       | 43.8 |      |      |       |      |      |      |      |      |      |
| HCM 2010 LOS                |      |       | D    |      |      |       |      |      |      |      |      |      |
| <b>Notes</b>                |      |       |      |      |      |       |      |      |      |      |      |      |

HCM 2010 Signalized Intersection Summary  
 13: Reservation Road & Blanco Road

Cumulative, AM  
 06/11/2019

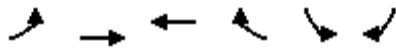

| Movement                     | EBL  | EBT  | WBT  | WBR  | SBL  | SBR  |   |   |
|------------------------------|------|------|------|------|------|------|---|---|
| Lane Configurations          |      |      |      |      |      |      |   |   |
| Traffic Volume (veh/h)       | 1070 | 370  | 680  | 40   | 40   | 1410 |   |   |
| Future Volume (veh/h)        | 1070 | 370  | 680  | 40   | 40   | 1410 |   |   |
| Number                       | 5    | 2    | 6    | 16   | 7    | 14   |   |   |
| Initial Q (Qb), veh          | 0    | 0    | 0    | 0    | 0    | 0    |   |   |
| Ped-Bike Adj(A_pbT)          | 1.00 |      |      | 1.00 | 1.00 | 1.00 |   |   |
| Parking Bus, Adj             | 1.00 | 1.00 | 1.00 | 1.00 | 1.00 | 1.00 |   |   |
| Adj Sat Flow, veh/h/ln       | 1863 | 1863 | 1845 | 1845 | 1845 | 1845 |   |   |
| Adj Flow Rate, veh/h         | 1151 | 398  | 731  | 24   | 43   | 0    |   |   |
| Adj No. of Lanes             | 2    | 2    | 1    | 1    | 2    | 2    |   |   |
| Peak Hour Factor             | 0.93 | 0.93 | 0.93 | 0.93 | 0.93 | 0.93 |   |   |
| Percent Heavy Veh, %         | 2    | 2    | 3    | 3    | 3    | 3    |   |   |
| Cap, veh/h                   | 1225 | 3039 | 806  | 685  | 103  | 83   |   |   |
| Arrive On Green              | 0.36 | 0.86 | 0.44 | 0.44 | 0.03 | 0.00 |   |   |
| Sat Flow, veh/h              | 3442 | 3632 | 1845 | 1568 | 3408 | 2760 |   |   |
| Grp Volume(v), veh/h         | 1151 | 398  | 731  | 24   | 43   | 0    |   |   |
| Grp Sat Flow(s),veh/h/ln     | 1721 | 1770 | 1845 | 1568 | 1704 | 1380 |   |   |
| Q Serve(g_s), s              | 27.1 | 1.5  | 30.9 | 0.7  | 1.0  | 0.0  |   |   |
| Cycle Q Clear(g_c), s        | 27.1 | 1.5  | 30.9 | 0.7  | 1.0  | 0.0  |   |   |
| Prop In Lane                 | 1.00 |      |      | 1.00 | 1.00 | 1.00 |   |   |
| Lane Grp Cap(c), veh/h       | 1225 | 3039 | 806  | 685  | 103  | 83   |   |   |
| V/C Ratio(X)                 | 0.94 | 0.13 | 0.91 | 0.04 | 0.42 | 0.00 |   |   |
| Avail Cap(c_a), veh/h        | 1645 | 3039 | 1322 | 1124 | 1099 | 890  |   |   |
| HCM Platoon Ratio            | 1.00 | 1.00 | 1.00 | 1.00 | 1.00 | 1.00 |   |   |
| Upstream Filter(I)           | 1.00 | 1.00 | 1.00 | 1.00 | 1.00 | 0.00 |   |   |
| Uniform Delay (d), s/veh     | 26.1 | 0.9  | 22.0 | 13.5 | 39.9 | 0.0  |   |   |
| Incr Delay (d2), s/veh       | 7.9  | 0.0  | 4.9  | 0.0  | 1.0  | 0.0  |   |   |
| Initial Q Delay(d3),s/veh    | 0.0  | 0.0  | 0.0  | 0.0  | 0.0  | 0.0  |   |   |
| %ile BackOfQ(50%),veh/ln     | 4.1  | 0.7  | 16.7 | 0.3  | 0.5  | 0.0  |   |   |
| LnGrp Delay(d),s/veh         | 34.0 | 1.0  | 26.8 | 13.5 | 40.9 | 0.0  |   |   |
| LnGrp LOS                    | C    | A    | C    | B    | D    |      |   |   |
| Approach Vol, veh/h          |      | 1549 | 755  |      | 43   |      |   |   |
| Approach Delay, s/veh        |      | 25.5 | 26.4 |      | 40.9 |      |   |   |
| Approach LOS                 |      | C    | C    |      | D    |      |   |   |
| Timer                        | 1    | 2    | 3    | 4    | 5    | 6    | 7 | 8 |
| Assigned Phs                 |      | 2    |      | 4    | 5    | 6    |   |   |
| Phs Duration (G+Y+Rc), s     |      | 77.7 |      | 6.0  | 35.3 | 42.4 |   |   |
| Change Period (Y+Rc), s      |      | 5.8  |      | 3.5  | 5.5  | 5.8  |   |   |
| Max Green Setting (Gmax), s  |      | 60.0 |      | 27.0 | 40.0 | 60.0 |   |   |
| Max Q Clear Time (g_c+I1), s |      | 3.5  |      | 3.0  | 29.1 | 32.9 |   |   |
| Green Ext Time (p_c), s      |      | 1.9  |      | 0.0  | 0.7  | 3.6  |   |   |
| <b>Intersection Summary</b>  |      |      |      |      |      |      |   |   |
| HCM 2010 Ctrl Delay          |      |      | 26.1 |      |      |      |   |   |
| HCM 2010 LOS                 |      |      | C    |      |      |      |   |   |

HCM 2010 Signalized Intersection Summary  
 14: Reservation Road & Inter-Garrison Road

Cumulative, AM  
 06/11/2019



| Movement                     | EBL  | EBR  | NBL  | NBT  | SBT  | SBR  |   |      |
|------------------------------|------|------|------|------|------|------|---|------|
| Lane Configurations          |      |      |      |      |      |      |   |      |
| Traffic Volume (veh/h)       | 190  | 280  | 510  | 560  | 310  | 190  |   |      |
| Future Volume (veh/h)        | 190  | 280  | 510  | 560  | 310  | 190  |   |      |
| Number                       | 3    | 18   | 1    | 6    | 2    | 12   |   |      |
| Initial Q (Qb), veh          | 0    | 0    | 0    | 0    | 0    | 0    |   |      |
| Ped-Bike Adj(A_pbT)          | 1.00 | 1.00 | 1.00 |      |      | 1.00 |   |      |
| Parking Bus, Adj             | 1.00 | 1.00 | 1.00 | 1.00 | 1.00 | 1.00 |   |      |
| Adj Sat Flow, veh/h/ln       | 1845 | 1845 | 1863 | 1863 | 1845 | 1900 |   |      |
| Adj Flow Rate, veh/h         | 202  | 259  | 543  | 596  | 330  | 186  |   |      |
| Adj No. of Lanes             | 1    | 1    | 1    | 2    | 2    | 0    |   |      |
| Peak Hour Factor             | 0.94 | 0.94 | 0.94 | 0.94 | 0.94 | 0.94 |   |      |
| Percent Heavy Veh, %         | 3    | 3    | 2    | 2    | 3    | 3    |   |      |
| Cap, veh/h                   | 289  | 764  | 573  | 2334 | 568  | 314  |   |      |
| Arrive On Green              | 0.16 | 0.16 | 0.32 | 0.66 | 0.26 | 0.26 |   |      |
| Sat Flow, veh/h              | 1757 | 1568 | 1774 | 3632 | 2273 | 1204 |   |      |
| Grp Volume(v), veh/h         | 202  | 259  | 543  | 596  | 264  | 252  |   |      |
| Grp Sat Flow(s),veh/h/ln     | 1757 | 1568 | 1774 | 1770 | 1752 | 1632 |   |      |
| Q Serve(g_s), s              | 6.7  | 6.3  | 18.5 | 4.3  | 8.1  | 8.4  |   |      |
| Cycle Q Clear(g_c), s        | 6.7  | 6.3  | 18.5 | 4.3  | 8.1  | 8.4  |   |      |
| Prop In Lane                 | 1.00 | 1.00 | 1.00 |      |      | 0.74 |   |      |
| Lane Grp Cap(c), veh/h       | 289  | 764  | 573  | 2334 | 456  | 425  |   |      |
| V/C Ratio(X)                 | 0.70 | 0.34 | 0.95 | 0.26 | 0.58 | 0.59 |   |      |
| Avail Cap(c_a), veh/h        | 766  | 1191 | 573  | 3431 | 1699 | 1582 |   |      |
| HCM Platoon Ratio            | 1.00 | 1.00 | 1.00 | 1.00 | 1.00 | 1.00 |   |      |
| Upstream Filter(I)           | 1.00 | 1.00 | 1.00 | 1.00 | 1.00 | 1.00 |   |      |
| Uniform Delay (d), s/veh     | 24.4 | 9.7  | 20.4 | 4.3  | 19.9 | 20.0 |   |      |
| Incr Delay (d2), s/veh       | 3.1  | 0.3  | 24.8 | 0.1  | 2.2  | 2.5  |   |      |
| Initial Q Delay(d3),s/veh    | 0.0  | 0.0  | 0.0  | 0.0  | 0.0  | 0.0  |   |      |
| %ile BackOfQ(50%),veh/ln     | 3.5  | 2.8  | 12.9 | 2.1  | 4.2  | 4.0  |   |      |
| LnGrp Delay(d),s/veh         | 27.5 | 10.0 | 45.3 | 4.4  | 22.1 | 22.5 |   |      |
| LnGrp LOS                    | C    | A    | D    | A    | C    | C    |   |      |
| Approach Vol, veh/h          | 461  |      |      | 1139 | 516  |      |   |      |
| Approach Delay, s/veh        | 17.7 |      |      | 23.9 | 22.3 |      |   |      |
| Approach LOS                 | B    |      |      | C    | C    |      |   |      |
| Timer                        | 1    | 2    | 3    | 4    | 5    | 6    | 7 | 8    |
| Assigned Phs                 | 1    | 2    |      |      |      | 6    |   | 8    |
| Phs Duration (G+Y+Rc), s     | 24.7 | 22.5 |      |      |      | 47.2 |   | 14.7 |
| Change Period (Y+Rc), s      | 4.7  | 6.4  |      |      |      | 6.4  |   | 4.5  |
| Max Green Setting (Gmax), s  | 26   | 60.0 |      |      |      | 60.0 |   | 27.0 |
| Max Q Clear Time (g_c+20), s | 20.5 | 10.4 |      |      |      | 6.3  |   | 8.7  |
| Green Ext Time (p_c), s      | 0.0  | 5.8  |      |      |      | 7.4  |   | 1.5  |
| <b>Intersection Summary</b>  |      |      |      |      |      |      |   |      |
| HCM 2010 Ctrl Delay          |      |      | 22.1 |      |      |      |   |      |
| HCM 2010 LOS                 |      |      | C    |      |      |      |   |      |
| <b>Notes</b>                 |      |      |      |      |      |      |   |      |

HCM 2010 Signalized Intersection Summary  
 15: 2nd Avenue & 9th Street

Cumulative, AM  
 06/11/2019



| Movement                     | EBL  | EBT    | EBR   | WBL  | WBT  | WBR  | NBL  | NBT  | NBR  | SBL  | SBT  | SBR  |
|------------------------------|------|--------|-------|------|------|------|------|------|------|------|------|------|
| Lane Configurations          |      | ↕      | ↗     |      | ↕    |      | ↖    | ↕↗   |      | ↖    | ↕↗   |      |
| Traffic Volume (veh/h)       | 10   | 10     | 10    | 260  | 10   | 20   | 20   | 360  | 30   | 40   | 830  | 10   |
| Future Volume (veh/h)        | 10   | 10     | 10    | 260  | 10   | 20   | 20   | 360  | 30   | 40   | 830  | 10   |
| Number                       | 5    | 2      | 12    | 1    | 6    | 16   | 3    | 8    | 18   | 7    | 4    | 14   |
| Initial Q (Qb), veh          | 0    | 0      | 0     | 0    | 0    | 0    | 0    | 0    | 0    | 0    | 0    | 0    |
| Ped-Bike Adj(A_pbT)          | 0.99 |        | 1.00  | 1.00 |      | 0.99 | 1.00 |      | 0.99 | 1.00 |      | 0.99 |
| Parking Bus, Adj             | 1.00 | 1.00   | 1.00  | 1.00 | 1.00 | 1.00 | 1.00 | 1.00 | 1.00 | 1.00 | 1.00 | 1.00 |
| Adj Sat Flow, veh/h/ln       | 1900 | 1881   | 1881  | 1900 | 1900 | 1900 | 1881 | 1881 | 1900 | 1863 | 1863 | 1900 |
| Adj Flow Rate, veh/h         | 11   | 11     | -24   | 277  | 11   | 20   | 21   | 383  | 27   | 43   | 883  | 4    |
| Adj No. of Lanes             | 0    | 1      | 1     | 0    | 1    | 0    | 1    | 2    | 0    | 1    | 2    | 0    |
| Peak Hour Factor             | 0.94 | 0.94   | 0.94  | 0.94 | 0.94 | 0.94 | 0.94 | 0.94 | 0.94 | 0.94 | 0.94 | 0.94 |
| Percent Heavy Veh, %         | 1    | 1      | 1     | 0    | 0    | 0    | 1    | 1    | 1    | 2    | 2    | 2    |
| Cap, veh/h                   | 325  | 282    | 450   | 524  | 15   | 27   | 46   | 1252 | 88   | 82   | 1410 | 6    |
| Arrive On Green              | 0.30 | 0.28   | 0.00  | 0.30 | 0.28 | 0.28 | 0.03 | 0.37 | 0.37 | 0.05 | 0.39 | 0.39 |
| Sat Flow, veh/h              | 726  | 1001   | 1599  | 1318 | 52   | 95   | 1792 | 3386 | 238  | 1774 | 3613 | 16   |
| Grp Volume(v), veh/h         | 22   | 0      | -24   | 308  | 0    | 0    | 21   | 201  | 209  | 43   | 432  | 455  |
| Grp Sat Flow(s),veh/h/ln     | 1727 | 0      | 1599  | 1465 | 0    | 0    | 1792 | 1787 | 1837 | 1774 | 1770 | 1860 |
| Q Serve(g_s), s              | 0.0  | 0.0    | 0.0   | 7.9  | 0.0  | 0.0  | 0.5  | 3.6  | 3.6  | 1.1  | 8.8  | 8.8  |
| Cycle Q Clear(g_c), s        | 0.4  | 0.0    | 0.0   | 8.2  | 0.0  | 0.0  | 0.5  | 3.6  | 3.6  | 1.1  | 8.8  | 8.8  |
| Prop In Lane                 | 0.50 |        | 1.00  | 0.90 |      | 0.06 | 1.00 |      | 0.13 | 1.00 |      | 0.01 |
| Lane Grp Cap(c), veh/h       | 646  | 0      | 450   | 599  | 0    | 0    | 46   | 661  | 679  | 82   | 691  | 726  |
| V/C Ratio(X)                 | 0.03 | 0.00   | -0.05 | 0.51 | 0.00 | 0.00 | 0.46 | 0.30 | 0.31 | 0.52 | 0.63 | 0.63 |
| Avail Cap(c_a), veh/h        | 1267 | 0      | 1074  | 1167 | 0    | 0    | 462  | 1801 | 1852 | 457  | 1784 | 1875 |
| HCM Platoon Ratio            | 1.00 | 1.00   | 1.00  | 1.00 | 1.00 | 1.00 | 1.00 | 1.00 | 1.00 | 1.00 | 1.00 | 1.00 |
| Upstream Filter(I)           | 1.00 | 0.00   | 0.00  | 1.00 | 0.00 | 0.00 | 1.00 | 1.00 | 1.00 | 1.00 | 1.00 | 1.00 |
| Uniform Delay (d), s/veh     | 11.5 | 0.0    | 0.0   | 14.0 | 0.0  | 0.0  | 21.4 | 10.0 | 10.0 | 20.8 | 11.0 | 11.0 |
| Incr Delay (d2), s/veh       | 0.0  | 0.0    | 0.0   | 0.7  | 0.0  | 0.0  | 6.9  | 0.3  | 0.3  | 5.1  | 0.9  | 0.9  |
| Initial Q Delay(d3),s/veh    | 0.0  | 0.0    | 0.0   | 0.0  | 0.0  | 0.0  | 0.0  | 0.0  | 0.0  | 0.0  | 0.0  | 0.0  |
| %ile BackOfQ(50%),veh/ln     | 0.2  | 0.0    | 0.0   | 3.3  | 0.0  | 0.0  | 0.3  | 1.8  | 1.8  | 0.6  | 4.4  | 4.6  |
| LnGrp Delay(d),s/veh         | 11.5 | 0.0    | 0.0   | 14.7 | 0.0  | 0.0  | 28.3 | 10.3 | 10.3 | 25.9 | 11.9 | 11.9 |
| LnGrp LOS                    | B    |        |       | B    |      |      | C    | B    | B    | C    | B    | B    |
| Approach Vol, veh/h          |      | -2     |       |      | 308  |      |      | 431  |      |      | 930  |      |
| Approach Delay, s/veh        |      | -126.4 |       |      | 14.7 |      |      | 11.1 |      |      | 12.5 |      |
| Approach LOS                 |      | A      |       |      | B    |      |      | B    |      |      | B    |      |
| Timer                        | 1    | 2      | 3     | 4    | 5    | 6    | 7    | 8    |      |      |      |      |
| Assigned Phs                 |      | 2      | 3     | 4    |      | 6    | 7    | 8    |      |      |      |      |
| Phs Duration (G+Y+Rc), s     |      | 17.6   | 4.6   | 22.4 |      | 17.6 | 5.6  | 21.5 |      |      |      |      |
| Change Period (Y+Rc), s      |      | 5.0    | 3.5   | 5.0  |      | 5.0  | 3.5  | 5.0  |      |      |      |      |
| Max Green Setting (Gmax), s  |      | 30.0   | 11.5  | 45.0 |      | 30.0 | 11.5 | 45.0 |      |      |      |      |
| Max Q Clear Time (g_c+I1), s |      | 2.4    | 2.5   | 10.8 |      | 10.2 | 3.1  | 5.6  |      |      |      |      |
| Green Ext Time (p_c), s      |      | 0.1    | 0.0   | 6.3  |      | 1.7  | 0.0  | 2.5  |      |      |      |      |
| <b>Intersection Summary</b>  |      |        |       |      |      |      |      |      |      |      |      |      |
| HCM 2010 Ctrl Delay          |      |        |       | 12.7 |      |      |      |      |      |      |      |      |
| HCM 2010 LOS                 |      |        |       | B    |      |      |      |      |      |      |      |      |

HCM 2010 Signalized Intersection Summary  
 16: 2nd Avenue & 8th Street

Cumulative, AM  
 06/11/2019



| Movement                     | WBL  | WBR  | NBT  | NBR  | SBL  | SBT  |      |      |
|------------------------------|------|------|------|------|------|------|------|------|
| Lane Configurations          |      |      |      |      |      |      |      |      |
| Traffic Volume (veh/h)       | 340  | 20   | 510  | 130  | 50   | 1060 |      |      |
| Future Volume (veh/h)        | 340  | 20   | 510  | 130  | 50   | 1060 |      |      |
| Number                       | 1    | 16   | 8    | 18   | 7    | 4    |      |      |
| Initial Q (Qb), veh          | 0    | 0    | 0    | 0    | 0    | 0    |      |      |
| Ped-Bike Adj(A_pbT)          | 1.00 | 1.00 |      | 1.00 | 1.00 |      |      |      |
| Parking Bus, Adj             | 1.00 | 1.00 | 1.00 | 1.00 | 1.00 | 1.00 |      |      |
| Adj Sat Flow, veh/h/ln       | 1583 | 1583 | 1863 | 1900 | 1881 | 1881 |      |      |
| Adj Flow Rate, veh/h         | 358  | 5    | 537  | 121  | 53   | 1116 |      |      |
| Adj No. of Lanes             | 1    | 1    | 2    | 0    | 1    | 2    |      |      |
| Peak Hour Factor             | 0.95 | 0.95 | 0.95 | 0.95 | 0.95 | 0.95 |      |      |
| Percent Heavy Veh, %         | 20   | 20   | 2    | 2    | 1    | 1    |      |      |
| Cap, veh/h                   | 431  | 385  | 1057 | 237  | 96   | 1777 |      |      |
| Arrive On Green              | 0.29 | 0.29 | 0.37 | 0.37 | 0.05 | 0.50 |      |      |
| Sat Flow, veh/h              | 1508 | 1346 | 2967 | 645  | 1792 | 3668 |      |      |
| Grp Volume(v), veh/h         | 358  | 5    | 330  | 328  | 53   | 1116 |      |      |
| Grp Sat Flow(s),veh/h/ln     | 1508 | 1346 | 1770 | 1749 | 1792 | 1787 |      |      |
| Q Serve(g_s), s              | 10.2 | 0.1  | 6.7  | 6.7  | 1.3  | 10.5 |      |      |
| Cycle Q Clear(g_c), s        | 10.2 | 0.1  | 6.7  | 6.7  | 1.3  | 10.5 |      |      |
| Prop In Lane                 | 1.00 | 1.00 |      | 0.37 | 1.00 |      |      |      |
| Lane Grp Cap(c), veh/h       | 431  | 385  | 651  | 643  | 96   | 1777 |      |      |
| V/C Ratio(X)                 | 0.83 | 0.01 | 0.51 | 0.51 | 0.55 | 0.63 |      |      |
| Avail Cap(c_a), veh/h        | 982  | 876  | 1728 | 1708 | 447  | 4653 |      |      |
| HCM Platoon Ratio            | 1.00 | 1.00 | 1.00 | 1.00 | 1.00 | 1.00 |      |      |
| Upstream Filter(I)           | 1.00 | 1.00 | 1.00 | 1.00 | 1.00 | 1.00 |      |      |
| Uniform Delay (d), s/veh     | 15.4 | 11.8 | 11.3 | 11.3 | 21.3 | 8.5  |      |      |
| Incr Delay (d2), s/veh       | 4.2  | 0.0  | 0.6  | 0.6  | 4.9  | 0.4  |      |      |
| Initial Q Delay(d3),s/veh    | 0.0  | 0.0  | 0.0  | 0.0  | 0.0  | 0.0  |      |      |
| %ile BackOfQ(50%),veh/ln     | 4.7  | 0.1  | 3.3  | 3.3  | 0.8  | 5.2  |      |      |
| LnGrp Delay(d),s/veh         | 19.6 | 11.8 | 11.9 | 12.0 | 26.2 | 8.8  |      |      |
| LnGrp LOS                    | B    | B    | B    | B    | C    | A    |      |      |
| Approach Vol, veh/h          | 363  |      | 658  |      |      | 1169 |      |      |
| Approach Delay, s/veh        | 19.5 |      | 11.9 |      |      | 9.6  |      |      |
| Approach LOS                 | B    |      | B    |      |      | A    |      |      |
| Timer                        | 1    | 2    | 3    | 4    | 5    | 6    | 7    | 8    |
| Assigned Phs                 |      |      |      | 4    |      | 6    | 7    | 8    |
| Phs Duration (G+Y+Rc), s     |      |      |      | 27.9 |      | 18.2 | 6.0  | 22.0 |
| Change Period (Y+Rc), s      |      |      |      | 5.0  |      | 5.0  | 3.5  | 5.0  |
| Max Green Setting (Gmax), s  |      |      |      | 60.0 |      | 30.0 | 11.5 | 45.0 |
| Max Q Clear Time (g_c+I1), s |      |      |      | 12.5 |      | 12.2 | 3.3  | 8.7  |
| Green Ext Time (p_c), s      |      |      |      | 10.4 |      | 1.1  | 0.0  | 4.4  |
| <b>Intersection Summary</b>  |      |      |      |      |      |      |      |      |
| HCM 2010 Ctrl Delay          |      |      | 12.0 |      |      |      |      |      |
| HCM 2010 LOS                 |      |      | B    |      |      |      |      |      |

| Intersection              |      |
|---------------------------|------|
| Intersection Delay, s/veh | 11.7 |
| Intersection LOS          | B    |

| Movement            | EBT  | EBR  | WBL  | WBT  | NBL  | NBR  |
|---------------------|------|------|------|------|------|------|
| Lane Configurations | ↑    | ↑    | ↑    | ↑    | ↑    | ↑    |
| Traffic Vol, veh/h  | 130  | 50   | 190  | 350  | 20   | 110  |
| Future Vol, veh/h   | 130  | 50   | 190  | 350  | 20   | 110  |
| Peak Hour Factor    | 0.92 | 0.92 | 0.92 | 0.92 | 0.92 | 0.92 |
| Heavy Vehicles, %   | 2    | 2    | 2    | 2    | 2    | 2    |
| Mvmt Flow           | 141  | 54   | 207  | 380  | 22   | 120  |
| Number of Lanes     | 1    | 1    | 1    | 1    | 1    | 1    |

| Approach                   | EB  | WB   | NB  |
|----------------------------|-----|------|-----|
| Opposing Approach          | WB  | EB   |     |
| Opposing Lanes             | 2   | 2    | 0   |
| Conflicting Approach Left  |     | NB   | EB  |
| Conflicting Lanes Left     | 0   | 2    | 2   |
| Conflicting Approach Right | NB  |      | WB  |
| Conflicting Lanes Right    | 2   | 0    | 2   |
| HCM Control Delay          | 9.4 | 12.9 | 9.7 |
| HCM LOS                    | A   | B    | A   |

| Lane                   | NBLn1 | NBLn2 | EBLn1 | EBLn2 | WBLn1 | WBLn2 |
|------------------------|-------|-------|-------|-------|-------|-------|
| Vol Left, %            | 100%  | 0%    | 0%    | 0%    | 100%  | 0%    |
| Vol Thru, %            | 0%    | 0%    | 100%  | 0%    | 0%    | 100%  |
| Vol Right, %           | 0%    | 100%  | 0%    | 100%  | 0%    | 0%    |
| Sign Control           | Stop  | Stop  | Stop  | Stop  | Stop  | Stop  |
| Traffic Vol by Lane    | 20    | 110   | 130   | 50    | 190   | 350   |
| LT Vol                 | 20    | 0     | 0     | 0     | 190   | 0     |
| Through Vol            | 0     | 0     | 130   | 0     | 0     | 350   |
| RT Vol                 | 0     | 110   | 0     | 50    | 0     | 0     |
| Lane Flow Rate         | 22    | 120   | 141   | 54    | 207   | 380   |
| Geometry Grp           | 7     | 7     | 7     | 7     | 7     | 7     |
| Degree of Util (X)     | 0.041 | 0.186 | 0.217 | 0.073 | 0.322 | 0.541 |
| Departure Headway (Hd) | 6.806 | 5.595 | 5.539 | 4.833 | 5.618 | 5.115 |
| Convergence, Y/N       | Yes   | Yes   | Yes   | Yes   | Yes   | Yes   |
| Cap                    | 523   | 636   | 643   | 734   | 636   | 700   |
| Service Time           | 4.584 | 3.372 | 3.318 | 2.611 | 3.38  | 2.877 |
| HCM Lane V/C Ratio     | 0.042 | 0.189 | 0.219 | 0.074 | 0.325 | 0.543 |
| HCM Control Delay      | 9.9   | 9.7   | 9.9   | 8     | 11.1  | 13.8  |
| HCM Lane LOS           | A     | A     | A     | A     | B     | B     |
| HCM 95th-tile Q        | 0.1   | 0.7   | 0.8   | 0.2   | 1.4   | 3.3   |

| Intersection                |       |       |       |       |
|-----------------------------|-------|-------|-------|-------|
| Intersection Delay, s/veh   | 13.9  |       |       |       |
| Intersection LOS            | B     |       |       |       |
| Approach                    | EB    | WB    | NB    | SB    |
| Entry Lanes                 | 1     | 1     | 1     | 1     |
| Conflicting Circle Lanes    | 1     | 1     | 1     | 1     |
| Adj Approach Flow, veh/h    | 147   | 197   | 36    | 777   |
| Demand Flow Rate, veh/h     | 151   | 207   | 36    | 785   |
| Vehicles Circulating, veh/h | 424   | 113   | 538   | 90    |
| Vehicles Exiting, veh/h     | 451   | 461   | 37    | 230   |
| Follow-Up Headway, s        | 3.186 | 3.186 | 3.186 | 3.186 |
| Ped Vol Crossing Leg, #/h   | 0     | 0     | 0     | 0     |
| Ped Cap Adj                 | 1.000 | 1.000 | 1.000 | 1.000 |
| Approach Delay, s/veh       | 7.3   | 5.7   | 6.0   | 17.5  |
| Approach LOS                | A     | A     | A     | C     |
| Lane                        | Left  | Left  | Left  | Left  |
| Designated Moves            | LTR   | LTR   | LTR   | LTR   |
| Assumed Moves               | LTR   | LTR   | LTR   | LTR   |
| RT Channelized              |       |       |       |       |
| Lane Util                   | 1.000 | 1.000 | 1.000 | 1.000 |
| Critical Headway, s         | 5.193 | 5.193 | 5.193 | 5.193 |
| Entry Flow, veh/h           | 151   | 207   | 36    | 785   |
| Cap Entry Lane, veh/h       | 739   | 1009  | 660   | 1033  |
| Entry HV Adj Factor         | 0.970 | 0.951 | 1.000 | 0.990 |
| Flow Entry, veh/h           | 147   | 197   | 36    | 777   |
| Cap Entry, veh/h            | 718   | 960   | 660   | 1022  |
| V/C Ratio                   | 0.204 | 0.205 | 0.055 | 0.760 |
| Control Delay, s/veh        | 7.3   | 5.7   | 6.0   | 17.5  |
| LOS                         | A     | A     | A     | C     |
| 95th %tile Queue, veh       | 1     | 1     | 0     | 8     |



HCM 2010 Signalized Intersection Summary  
 19: 2nd Avenue & Inter-Garrison Road

Cumulative, AM  
 06/11/2019



| Movement                     | WBL  | WBR  | NBT  | NBR  | SBL  | SBT  |      |      |
|------------------------------|------|------|------|------|------|------|------|------|
| Lane Configurations          |      |      |      |      |      |      |      |      |
| Traffic Volume (veh/h)       | 60   | 30   | 640  | 60   | 20   | 1390 |      |      |
| Future Volume (veh/h)        | 60   | 30   | 640  | 60   | 20   | 1390 |      |      |
| Number                       | 1    | 16   | 8    | 18   | 7    | 4    |      |      |
| Initial Q (Qb), veh          | 0    | 0    | 0    | 0    | 0    | 0    |      |      |
| Ped-Bike Adj(A_pbT)          | 1.00 | 1.00 |      | 1.00 | 1.00 |      |      |      |
| Parking Bus, Adj             | 1.00 | 1.00 | 1.00 | 1.00 | 1.00 | 1.00 |      |      |
| Adj Sat Flow, veh/h/ln       | 1900 | 1900 | 1881 | 1900 | 1881 | 1881 |      |      |
| Adj Flow Rate, veh/h         | 65   | 8    | 688  | 57   | 22   | 1495 |      |      |
| Adj No. of Lanes             | 1    | 1    | 2    | 0    | 1    | 2    |      |      |
| Peak Hour Factor             | 0.93 | 0.93 | 0.93 | 0.93 | 0.93 | 0.93 |      |      |
| Percent Heavy Veh, %         | 0    | 0    | 1    | 1    | 1    | 1    |      |      |
| Cap, veh/h                   | 239  | 214  | 1822 | 151  | 48   | 2318 |      |      |
| Arrive On Green              | 0.13 | 0.13 | 0.55 | 0.55 | 0.03 | 0.65 |      |      |
| Sat Flow, veh/h              | 1810 | 1615 | 3437 | 277  | 1792 | 3668 |      |      |
| Grp Volume(v), veh/h         | 65   | 8    | 368  | 377  | 22   | 1495 |      |      |
| Grp Sat Flow(s),veh/h/ln     | 1810 | 1615 | 1787 | 1832 | 1792 | 1787 |      |      |
| Q Serve(g_s), s              | 1.5  | 0.2  | 5.4  | 5.4  | 0.6  | 11.5 |      |      |
| Cycle Q Clear(g_c), s        | 1.5  | 0.2  | 5.4  | 5.4  | 0.6  | 11.5 |      |      |
| Prop In Lane                 | 1.00 | 1.00 |      | 0.15 | 1.00 |      |      |      |
| Lane Grp Cap(c), veh/h       | 239  | 214  | 974  | 999  | 48   | 2318 |      |      |
| V/C Ratio(X)                 | 0.27 | 0.04 | 0.38 | 0.38 | 0.46 | 0.65 |      |      |
| Avail Cap(c_a), veh/h        | 1389 | 1239 | 1567 | 1607 | 452  | 4310 |      |      |
| HCM Platoon Ratio            | 1.00 | 1.00 | 1.00 | 1.00 | 1.00 | 1.00 |      |      |
| Upstream Filter(I)           | 1.00 | 1.00 | 1.00 | 1.00 | 1.00 | 1.00 |      |      |
| Uniform Delay (d), s/veh     | 17.8 | 17.3 | 5.9  | 5.9  | 21.9 | 4.8  |      |      |
| Incr Delay (d2), s/veh       | 0.6  | 0.1  | 0.2  | 0.2  | 6.8  | 0.3  |      |      |
| Initial Q Delay(d3),s/veh    | 0.0  | 0.0  | 0.0  | 0.0  | 0.0  | 0.0  |      |      |
| %ile BackOfQ(50%),veh/ln     | 0.8  | 0.2  | 2.6  | 2.7  | 0.4  | 5.5  |      |      |
| LnGrp Delay(d),s/veh         | 18.4 | 17.3 | 6.2  | 6.2  | 28.6 | 5.1  |      |      |
| LnGrp LOS                    | B    | B    | A    | A    | C    | A    |      |      |
| Approach Vol, veh/h          | 73   |      | 745  |      |      | 1517 |      |      |
| Approach Delay, s/veh        | 18.3 |      | 6.2  |      |      | 5.5  |      |      |
| Approach LOS                 | B    |      | A    |      |      | A    |      |      |
| Timer                        | 1    | 2    | 3    | 4    | 5    | 6    | 7    | 8    |
| Assigned Phs                 |      |      |      | 4    |      | 6    | 7    | 8    |
| Phs Duration (G+Y+Rc), s     |      |      |      | 34.6 |      | 11.0 | 4.7  | 29.9 |
| Change Period (Y+Rc), s      |      |      |      | 5.0  |      | 5.0  | 3.5  | 5.0  |
| Max Green Setting (Gmax), s  |      |      |      | 55.0 |      | 35.0 | 11.5 | 40.0 |
| Max Q Clear Time (g_c+I1), s |      |      |      | 13.5 |      | 3.5  | 2.6  | 7.4  |
| Green Ext Time (p_c), s      |      |      |      | 16.0 |      | 0.2  | 0.0  | 5.0  |
| <b>Intersection Summary</b>  |      |      |      |      |      |      |      |      |
| HCM 2010 Ctrl Delay          |      |      | 6.1  |      |      |      |      |      |
| HCM 2010 LOS                 |      |      | A    |      |      |      |      |      |

| Intersection              |      |  |  |  |  |  |  |  |  |  |  |  |
|---------------------------|------|--|--|--|--|--|--|--|--|--|--|--|
| Intersection Delay, s/veh | 11.3 |  |  |  |  |  |  |  |  |  |  |  |
| Intersection LOS          | B    |  |  |  |  |  |  |  |  |  |  |  |























| Movement            | EBL  | EBT  | EBR  | WBL  | WBT  | WBR  | NBL  | NBT  | NBR  | SBL  | SBT  | SBR  |
|---------------------|------|------|------|------|------|------|------|------|------|------|------|------|
| Lane Configurations |      | ↕    |      |      | ↕    |      |      | ↕    |      |      | ↕    |      |
| Traffic Vol, veh/h  | 10   | 30   | 10   | 120  | 50   | 20   | 20   | 140  | 140  | 20   | 140  | 10   |
| Future Vol, veh/h   | 10   | 30   | 10   | 120  | 50   | 20   | 20   | 140  | 140  | 20   | 140  | 10   |
| Peak Hour Factor    | 0.85 | 0.85 | 0.85 | 0.85 | 0.85 | 0.85 | 0.85 | 0.85 | 0.85 | 0.85 | 0.85 | 0.85 |
| Heavy Vehicles, %   | 6    | 6    | 6    | 2    | 2    | 2    | 4    | 4    | 4    | 0    | 0    | 0    |
| Mvmt Flow           | 12   | 35   | 12   | 141  | 59   | 24   | 24   | 165  | 165  | 24   | 165  | 12   |
| Number of Lanes     | 0    | 1    | 0    | 0    | 1    | 0    | 0    | 1    | 0    | 0    | 1    | 0    |

| Approach                   | EB  | WB   | NB   | SB   |
|----------------------------|-----|------|------|------|
| Opposing Approach          | WB  | EB   | SB   | NB   |
| Opposing Lanes             | 1   | 1    | 1    | 1    |
| Conflicting Approach Left  | SB  | NB   | EB   | WB   |
| Conflicting Lanes Left     | 1   | 1    | 1    | 1    |
| Conflicting Approach Right | NB  | SB   | WB   | EB   |
| Conflicting Lanes Right    | 1   | 1    | 1    | 1    |
| HCM Control Delay          | 9.3 | 11.3 | 12.1 | 10.3 |
| HCM LOS                    | A   | B    | B    | B    |

| Lane                   | NBLn1 | EBLn1 | WBLn1 | SBLn1 |
|------------------------|-------|-------|-------|-------|
| Vol Left, %            | 7%    | 20%   | 63%   | 12%   |
| Vol Thru, %            | 47%   | 60%   | 26%   | 82%   |
| Vol Right, %           | 47%   | 20%   | 11%   | 6%    |
| Sign Control           | Stop  | Stop  | Stop  | Stop  |
| Traffic Vol by Lane    | 300   | 50    | 190   | 170   |
| LT Vol                 | 20    | 10    | 120   | 20    |
| Through Vol            | 140   | 30    | 50    | 140   |
| RT Vol                 | 140   | 10    | 20    | 10    |
| Lane Flow Rate         | 353   | 59    | 224   | 200   |
| Geometry Grp           | 1     | 1     | 1     | 1     |
| Degree of Util (X)     | 0.473 | 0.093 | 0.34  | 0.288 |
| Departure Headway (Hd) | 4.829 | 5.718 | 5.483 | 5.182 |
| Convergence, Y/N       | Yes   | Yes   | Yes   | Yes   |
| Cap                    | 752   | 626   | 655   | 694   |
| Service Time           | 2.829 | 3.76  | 3.517 | 3.213 |
| HCM Lane V/C Ratio     | 0.469 | 0.094 | 0.342 | 0.288 |
| HCM Control Delay      | 12.1  | 9.3   | 11.3  | 10.3  |
| HCM Lane LOS           | B     | A     | B     | B     |
| HCM 95th-tile Q        | 2.6   | 0.3   | 1.5   | 1.2   |

HCM 2010 Signalized Intersection Summary  
 21: 7th Avenue/8th Street & Inter-Garrison Road

Cumulative, AM  
 07/12/2019

|                              |  |  |  |  |  |  |   |  |  |  |  |  |
|------------------------------|---|---|---|---|---|---|---|---|---|---|---|---|
| Movement                     | EBL   | EBT   | EBR   | WBL   | WBT   | WBR   | NBL   | NBT   | NBR   | SBL   | SBT   | SBR   |
| Lane Configurations          |  |  |   |  |  |   |  |  |  |  |  |  |
| Traffic Volume (veh/h)       | 10  | 130   | 30  | 140   | 270   | 30  | 50  | 100   | 130   | 110   | 200   | 10  |
| Future Volume (veh/h)        | 10  | 130   | 30  | 140   | 270   | 30  | 50  | 100   | 130   | 110   | 200   | 10  |
| Number                       | 5   | 2   | 12  | 1   | 6   | 16  | 3   | 8   | 18  | 7   | 4   | 14  |
| Initial Q (Qb), veh          | 0   | 0   | 0   | 0   | 0   | 0   | 0   | 0   | 0   | 0   | 0   | 0   |
| Ped-Bike Adj(A_pbT)          | 1.00  |   | 0.99  | 1.00  |   | 1.00  | 1.00  |   | 1.00  | 1.00  |   | 1.00  |
| Parking Bus, Adj             | 1.00  | 1.00  | 1.00  | 1.00  | 1.00  | 1.00  | 1.00  | 1.00  | 1.00  | 1.00  | 1.00  | 1.00  |
| Adj Sat Flow, veh/h/ln       | 1759  | 1759  | 1900  | 1845  | 1845  | 1900  | 1597  | 1597  | 1597  | 1776  | 1776  | 1900  |
| Adj Flow Rate, veh/h         | 12  | 160   | 28  | 173   | 333   | 0   | 62  | 123   | 127   | 136   | 247   | 5   |
| Adj No. of Lanes             | 1   | 1   | 0   | 1   | 1   | 0   | 1   | 1   | 1   | 1   | 1   | 0   |
| Peak Hour Factor             | 0.81  | 0.81  | 0.81  | 0.81  | 0.81  | 0.81  | 0.81  | 0.81  | 0.81  | 0.81  | 0.81  | 0.81  |
| Percent Heavy Veh, %         | 8   | 8   | 8   | 3   | 3   | 3   | 19  | 19  | 19  | 7   | 7   | 7   |
| Cap, veh/h                   | 21  | 357   | 62  | 230   | 671   | 0   | 108   | 252   | 214   | 213   | 369   | 7   |
| Arrive On Green              | 0.01  | 0.24  | 0.24  | 0.13  | 0.36  | 0.00  | 0.07  | 0.16  | 0.16  | 0.13  | 0.21  | 0.21  |
| Sat Flow, veh/h              | 1675  | 1457  | 255   | 1757  | 1845  | 0   | 1521  | 1597  | 1357  | 1691  | 1734  | 35  |
| Grp Volume(v), veh/h         | 12  | 0   | 188   | 173   | 333   | 0   | 62  | 123   | 127   | 136   | 0   | 252   |
| Grp Sat Flow(s),veh/h/ln     | 1675  | 0   | 1712  | 1757  | 1845  | 0   | 1521  | 1597  | 1357  | 1691  | 0   | 1770  |
| Q Serve(g_s), s              | 0.3   | 0.0   | 4.1   | 4.2   | 6.2   | 0.0   | 1.7   | 3.1   | 3.8   | 3.4   | 0.0   | 5.8   |
| Cycle Q Clear(g_c), s        | 0.3   | 0.0   | 4.1   | 4.2   | 6.2   | 0.0   | 1.7   | 3.1   | 3.8   | 3.4   | 0.0   | 5.8   |
| Prop In Lane                 | 1.00  |   | 0.15  | 1.00  |   | 0.00  | 1.00  |   | 1.00  | 1.00  |   | 0.02  |
| Lane Grp Cap(c), veh/h       | 21  | 0   | 419   | 230   | 671   | 0   | 108   | 252   | 214   | 213   | 0   | 376   |
| V/C Ratio(X)                 | 0.58  | 0.00  | 0.45  | 0.75  | 0.50  | 0.00  | 0.57  | 0.49  | 0.59  | 0.64  | 0.00  | 0.67  |
| Avail Cap(c_a), veh/h        | 156   | 0   | 1309  | 829   | 2110  | 0   | 811   | 1159  | 985   | 710   | 0   | 1084  |
| HCM Platoon Ratio            | 1.00  | 1.00  | 1.00  | 1.00  | 1.00  | 1.00  | 1.00  | 1.00  | 1.00  | 1.00  | 1.00  | 1.00  |
| Upstream Filter(I)           | 1.00  | 0.00  | 1.00  | 1.00  | 1.00  | 0.00  | 1.00  | 1.00  | 1.00  | 1.00  | 0.00  | 1.00  |
| Uniform Delay (d), s/veh     | 21.6  | 0.0   | 14.1  | 18.5  | 10.9  | 0.0   | 19.8  | 16.9  | 17.3  | 18.3  | 0.0   | 15.9  |
| Incr Delay (d2), s/veh       | 22.8  | 0.0   | 0.8   | 4.9   | 0.6   | 0.0   | 4.7   | 1.5   | 2.6   | 3.2   | 0.0   | 2.1   |
| Initial Q Delay(d3),s/veh    | 0.0   | 0.0   | 0.0   | 0.0   | 0.0   | 0.0   | 0.0   | 0.0   | 0.0   | 0.0   | 0.0   | 0.0   |
| %ile BackOfQ(50%),veh/ln     | 0.3   | 0.0   | 2.0   | 2.3   | 3.3   | 0.0   | 0.9   | 1.5   | 1.6   | 1.7   | 0.0   | 3.0   |
| LnGrp Delay(d),s/veh         | 44.5  | 0.0   | 14.9  | 23.3  | 11.5  | 0.0   | 24.6  | 18.4  | 19.9  | 21.5  | 0.0   | 18.0  |
| LnGrp LOS                    | D   |   | B   | C   | B   |   | C   | B   | B   | C   |   | B   |
| Approach Vol, veh/h          |   | 200   |   |   | 506   |   |   | 312   |   |   | 388   |   |
| Approach Delay, s/veh        |   | 16.6  |   |   | 15.5  |   |   | 20.2  |   |   | 19.2  |   |
| Approach LOS                 |   | B   |   |   | B   |   |   | C   |   |   | B   |   |
| Timer                        | 1   | 2   | 3   | 4   | 5   | 6   | 7   | 8   |   |   |   |   |
| Assigned Phs                 | 1   | 2   | 3   | 4   | 5   | 6   | 7   | 8   |   |   |   |   |
| Phs Duration (G+Y+Rc), s     | 9.3   | 15.8  | 5.6   | 13.4  | 4.0   | 21.0  | 8.1   | 10.9  |   |   |   |   |
| Change Period (Y+Rc), s      | 3.5   | 5.0   | 3.5   | 4.0   | 3.5   | 5.0   | 3.5   | 4.0   |   |   |   |   |
| Max Green Setting (Gmax), s  | 20.8  | 33.7  | 22.5  | 27.0  | 4.1   | 50.4  | 17.5  | 32.0  |   |   |   |   |
| Max Q Clear Time (g_c+I1), s | 6.2   | 6.1   | 3.7   | 7.8   | 2.3   | 8.2   | 5.4   | 5.8   |   |   |   |   |
| Green Ext Time (p_c), s      | 0.4   | 1.0   | 0.1   | 1.3   | 0.0   | 2.2   | 0.2   | 1.1   |   |   |   |   |
| <b>Intersection Summary</b>  |   |   |   |   |   |   |   |   |   |   |   |   |
| HCM 2010 Ctrl Delay          |   |   | 17.7  |   |   |   |   |   |   |   |   |   |
| HCM 2010 LOS                 |   |   | B   |   |   |   |   |   |   |   |   |   |

| Intersection                    |       |       |       |
|---------------------------------|-------|-------|-------|
| Intersection Delay, s/veh 107.6 |       |       |       |
| Intersection LOS F              |       |       |       |
| Approach                        | EB    | WB    | NB    |
| Entry Lanes                     | 1     | 1     | 1     |
| Conflicting Circle Lanes        | 1     | 1     | 1     |
| Adj Approach Flow, veh/h        | 425   | 1276  | 437   |
| Demand Flow Rate, veh/h         | 531   | 1289  | 450   |
| Vehicles Circulating, veh/h     | 860   | 95    | 345   |
| Vehicles Exiting, veh/h         | 524   | 700   | 1046  |
| Follow-Up Headway, s            | 3.186 | 3.186 | 3.186 |
| Ped Vol Crossing Leg, #/h       | 0     | 0     | 0     |
| Ped Cap Adj                     | 1.000 | 1.000 | 1.000 |
| Approach Delay, s/veh           | 112.2 | 138.4 | 13.2  |
| Approach LOS                    | F     | F     | B     |
| Lane                            | Left  | Left  | Left  |
| Designated Moves                | TR    | LT    | LR    |
| Assumed Moves                   | TR    | LT    | LR    |
| RT Channelized                  |       |       |       |
| Lane Util                       | 1.000 | 1.000 | 1.000 |
| Critical Headway, s             | 5.193 | 5.193 | 5.193 |
| Entry Flow, veh/h               | 531   | 1289  | 450   |
| Cap Entry Lane, veh/h           | 478   | 1028  | 800   |
| Entry HV Adj Factor             | 0.800 | 0.990 | 0.971 |
| Flow Entry, veh/h               | 425   | 1276  | 437   |
| Cap Entry, veh/h                | 383   | 1017  | 777   |
| V/C Ratio                       | 1.111 | 1.254 | 0.562 |
| Control Delay, s/veh            | 112.2 | 138.4 | 13.2  |
| LOS                             | F     | F     | B     |
| 95th %tile Queue, veh           | 16    | 43    | 4     |

HCM 2010 Signalized Intersection Summary  
 23: Inter-Garrison Road & Abrams Drive

Cumulative, AM  
 06/11/2019

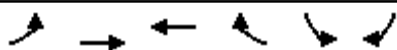

| Movement                     | EBL  | EBT  | WBT  | WBR  | SBL  | SBR  |   |   |
|------------------------------|------|------|------|------|------|------|---|---|
| Lane Configurations          |      |      |      |      |      |      |   |   |
| Traffic Volume (veh/h)       | 250  | 300  | 680  | 10   | 40   | 430  |   |   |
| Future Volume (veh/h)        | 250  | 300  | 680  | 10   | 40   | 430  |   |   |
| Number                       | 5    | 2    | 6    | 16   | 7    | 14   |   |   |
| Initial Q (Qb), veh          | 0    | 0    | 0    | 0    | 0    | 0    |   |   |
| Ped-Bike Adj(A_pbT)          | 1.00 |      |      | 1.00 | 1.00 | 1.00 |   |   |
| Parking Bus, Adj             | 1.00 | 1.00 | 1.00 | 1.00 | 1.00 | 1.00 |   |   |
| Adj Sat Flow, veh/h/ln       | 1759 | 1759 | 1881 | 1881 | 1881 | 1881 |   |   |
| Adj Flow Rate, veh/h         | 294  | 353  | 800  | 6    | 47   | 288  |   |   |
| Adj No. of Lanes             | 1    | 1    | 1    | 1    | 2    | 1    |   |   |
| Peak Hour Factor             | 0.85 | 0.85 | 0.85 | 0.85 | 0.85 | 0.85 |   |   |
| Percent Heavy Veh, %         | 8    | 8    | 1    | 1    | 1    | 1    |   |   |
| Cap, veh/h                   | 284  | 1179 | 844  | 718  | 711  | 327  |   |   |
| Arrive On Green              | 0.17 | 0.67 | 0.45 | 0.45 | 0.20 | 0.20 |   |   |
| Sat Flow, veh/h              | 1675 | 1759 | 1881 | 1599 | 3476 | 1599 |   |   |
| Grp Volume(v), veh/h         | 294  | 353  | 800  | 6    | 47   | 288  |   |   |
| Grp Sat Flow(s),veh/h/ln     | 1675 | 1759 | 1881 | 1599 | 1738 | 1599 |   |   |
| Q Serve(g_s), s              | 11.5 | 5.6  | 27.7 | 0.1  | 0.7  | 11.9 |   |   |
| Cycle Q Clear(g_c), s        | 11.5 | 5.6  | 27.7 | 0.1  | 0.7  | 11.9 |   |   |
| Prop In Lane                 | 1.00 |      |      | 1.00 | 1.00 | 1.00 |   |   |
| Lane Grp Cap(c), veh/h       | 284  | 1179 | 844  | 718  | 711  | 327  |   |   |
| V/C Ratio(X)                 | 1.04 | 0.30 | 0.95 | 0.01 | 0.07 | 0.88 |   |   |
| Avail Cap(c_a), veh/h        | 284  | 1556 | 1248 | 1061 | 1614 | 742  |   |   |
| HCM Platoon Ratio            | 1.00 | 1.00 | 1.00 | 1.00 | 1.00 | 1.00 |   |   |
| Upstream Filter(I)           | 1.00 | 1.00 | 1.00 | 1.00 | 1.00 | 1.00 |   |   |
| Uniform Delay (d), s/veh     | 28.2 | 4.6  | 17.9 | 10.3 | 21.7 | 26.2 |   |   |
| Incr Delay (d2), s/veh       | 62.8 | 0.1  | 9.3  | 0.0  | 0.0  | 3.0  |   |   |
| Initial Q Delay(d3),s/veh    | 0.0  | 0.0  | 0.0  | 0.0  | 0.0  | 0.0  |   |   |
| %ile BackOfQ(50%),veh/lt     | 0.2  | 2.7  | 16.4 | 0.1  | 0.4  | 10.0 |   |   |
| LnGrp Delay(d),s/veh         | 91.0 | 4.7  | 27.3 | 10.3 | 21.8 | 29.2 |   |   |
| LnGrp LOS                    | F    | A    | C    | B    | C    | C    |   |   |
| Approach Vol, veh/h          |      | 647  | 806  |      | 335  |      |   |   |
| Approach Delay, s/veh        |      | 43.9 | 27.1 |      | 28.2 |      |   |   |
| Approach LOS                 |      | D    | C    |      | C    |      |   |   |
| Timer                        | 1    | 2    | 3    | 4    | 5    | 6    | 7 | 8 |
| Assigned Phs                 |      | 2    |      | 4    | 5    | 6    |   |   |
| Phs Duration (G+Y+Rc), s     |      | 50.5 |      | 17.4 | 15.0 | 35.5 |   |   |
| Change Period (Y+Rc), s      |      | 5.0  |      | 3.5  | 3.5  | 5.0  |   |   |
| Max Green Setting (Gmax), s  |      | 60.0 |      | 31.5 | 11.5 | 45.0 |   |   |
| Max Q Clear Time (g_c+I1), s |      | 7.6  |      | 13.9 | 13.5 | 29.7 |   |   |
| Green Ext Time (p_c), s      |      | 0.3  |      | 0.1  | 0.0  | 0.8  |   |   |
| <b>Intersection Summary</b>  |      |      |      |      |      |      |   |   |
| HCM 2010 Ctrl Delay          |      |      | 33.4 |      |      |      |   |   |
| HCM 2010 LOS                 |      |      | C    |      |      |      |   |   |

| Intersection              |      |
|---------------------------|------|
| Intersection Delay, s/veh | 21.1 |
| Intersection LOS          | C    |

| Movement            | EBL  | EBT  | WBT  | WBR  | SBL  | SBR  |
|---------------------|------|------|------|------|------|------|
| Lane Configurations | ↘    | ↑    | ↑↑   | ↗    | ↘    | ↗    |
| Traffic Vol, veh/h  | 60   | 290  | 550  | 10   | 60   | 120  |
| Future Vol, veh/h   | 60   | 290  | 550  | 10   | 60   | 120  |
| Peak Hour Factor    | 0.79 | 0.79 | 0.79 | 0.79 | 0.79 | 0.79 |
| Heavy Vehicles, %   | 5    | 5    | 1    | 1    | 3    | 3    |
| Mvmt Flow           | 76   | 367  | 696  | 13   | 76   | 152  |
| Number of Lanes     | 1    | 1    | 2    | 1    | 1    | 1    |

| Approach                   | EB   | WB   | SB   |
|----------------------------|------|------|------|
| Opposing Approach          | WB   | EB   |      |
| Opposing Lanes             | 3    | 2    | 0    |
| Conflicting Approach Left  | SB   |      | WB   |
| Conflicting Lanes Left     | 2    | 0    | 3    |
| Conflicting Approach Right |      | SB   | EB   |
| Conflicting Lanes Right    | 0    | 2    | 2    |
| HCM Control Delay          | 24.9 | 21.2 | 13.2 |
| HCM LOS                    | C    | C    | B    |

| Lane                   | EBLn1 | EBLn2 | WBLn1 | WBLn2 | WBLn3 | SBLn1 | SBLn2 |
|------------------------|-------|-------|-------|-------|-------|-------|-------|
| Vol Left, %            | 100%  | 0%    | 0%    | 0%    | 0%    | 100%  | 0%    |
| Vol Thru, %            | 0%    | 100%  | 100%  | 100%  | 0%    | 0%    | 0%    |
| Vol Right, %           | 0%    | 0%    | 0%    | 0%    | 100%  | 0%    | 100%  |
| Sign Control           | Stop  | Stop  | Stop  | Stop  | Stop  | Stop  | Stop  |
| Traffic Vol by Lane    | 60    | 290   | 275   | 275   | 10    | 60    | 120   |
| LT Vol                 | 60    | 0     | 0     | 0     | 0     | 60    | 0     |
| Through Vol            | 0     | 290   | 275   | 275   | 0     | 0     | 0     |
| RT Vol                 | 0     | 0     | 0     | 0     | 10    | 0     | 120   |
| Lane Flow Rate         | 76    | 367   | 348   | 348   | 13    | 76    | 152   |
| Geometry Grp           | 8     | 8     | 8     | 8     | 8     | 8     | 8     |
| Degree of Util (X)     | 0.163 | 0.736 | 0.656 | 0.656 | 0.015 | 0.18  | 0.308 |
| Departure Headway (Hd) | 7.737 | 7.213 | 6.787 | 6.787 | 4.33  | 8.521 | 7.299 |
| Convergence, Y/N       | Yes   | Yes   | Yes   | Yes   | Yes   | Yes   | Yes   |
| Cap                    | 465   | 503   | 536   | 536   | 831   | 422   | 492   |
| Service Time           | 5.461 | 4.952 | 4.489 | 4.489 | 2.032 | 6.265 | 5.042 |
| HCM Lane V/C Ratio     | 0.163 | 0.73  | 0.649 | 0.649 | 0.016 | 0.18  | 0.309 |
| HCM Control Delay      | 12    | 27.6  | 21.5  | 21.5  | 7.1   | 13.1  | 13.3  |
| HCM Lane LOS           | B     | D     | C     | C     | A     | B     | B     |
| HCM 95th-tile Q        | 0.6   | 6.1   | 4.7   | 4.7   | 0     | 0.6   | 1.3   |

|                           |      |  |  |  |  |  |
|---------------------------|------|--|--|--|--|--|
| <b>Intersection</b>       |      |  |  |  |  |  |
| Intersection Delay, s/veh | 39.9 |  |  |  |  |  |
| Intersection LOS          | E    |  |  |  |  |  |

| Movement            | EBL  | EBT  | WBT  | WBR  | SBL  | SBR  |
|---------------------|------|------|------|------|------|------|
| Lane Configurations |      |      |      |      |      |      |
| Traffic Vol, veh/h  | 270  | 80   | 170  | 210  | 110  | 430  |
| Future Vol, veh/h   | 270  | 80   | 170  | 210  | 110  | 430  |
| Peak Hour Factor    | 0.82 | 0.82 | 0.82 | 0.82 | 0.82 | 0.82 |
| Heavy Vehicles, %   | 5    | 5    | 1    | 1    | 0    | 0    |
| Mvmt Flow           | 329  | 98   | 207  | 256  | 134  | 524  |
| Number of Lanes     | 1    | 1    | 1    | 0    | 1    | 1    |

| Approach                   | EB   | WB   | SB   |
|----------------------------|------|------|------|
| Opposing Approach          | WB   | EB   |      |
| Opposing Lanes             | 1    | 2    | 0    |
| Conflicting Approach Left  | SB   |      | WB   |
| Conflicting Lanes Left     | 2    | 0    | 1    |
| Conflicting Approach Right |      | SB   | EB   |
| Conflicting Lanes Right    | 0    | 2    | 2    |
| HCM Control Delay          | 27.1 | 42.4 | 46.5 |
| HCM LOS                    | D    | E    | E    |

| Lane                   | EBLn1 | EBLn2 | WBLn1 | SBLn1 | SBLn2 |
|------------------------|-------|-------|-------|-------|-------|
| Vol Left, %            | 100%  | 0%    | 0%    | 100%  | 0%    |
| Vol Thru, %            | 0%    | 100%  | 45%   | 0%    | 0%    |
| Vol Right, %           | 0%    | 0%    | 55%   | 0%    | 100%  |
| Sign Control           | Stop  | Stop  | Stop  | Stop  | Stop  |
| Traffic Vol by Lane    | 270   | 80    | 380   | 110   | 430   |
| LT Vol                 | 270   | 0     | 0     | 110   | 0     |
| Through Vol            | 0     | 80    | 170   | 0     | 0     |
| RT Vol                 | 0     | 0     | 210   | 0     | 430   |
| Lane Flow Rate         | 329   | 98    | 463   | 134   | 524   |
| Geometry Grp           | 7     | 7     | 4     | 7     | 7     |
| Degree of Util (X)     | 0.746 | 0.207 | 0.884 | 0.292 | 0.961 |
| Departure Headway (Hd) | 8.157 | 7.641 | 6.866 | 7.829 | 6.599 |
| Convergence, Y/N       | Yes   | Yes   | Yes   | Yes   | Yes   |
| Cap                    | 445   | 469   | 528   | 460   | 551   |
| Service Time           | 5.91  | 5.394 | 4.909 | 5.568 | 4.338 |
| HCM Lane V/C Ratio     | 0.739 | 0.209 | 0.877 | 0.291 | 0.951 |
| HCM Control Delay      | 31.4  | 12.4  | 42.4  | 13.8  | 54.9  |
| HCM Lane LOS           | D     | B     | E     | B     | F     |
| HCM 95th-tile Q        | 6.1   | 0.8   | 9.9   | 1.2   | 12.7  |

HCM 2010 Signalized Intersection Summary  
 26: East Garrison Road & Reservation Road

Cumulative, AM  
 06/11/2019



| Movement                     | EBL  | EBT  | EBR  | WBL  | WBT  | WBR  | NBL  | NBT  | NBR  | SBL | SBT | SBR |
|------------------------------|------|------|------|------|------|------|------|------|------|-----|-----|-----|
| Lane Configurations          | ↖    | ↗    |      | ↖    | ↗    |      | ↖    |      | ↗    |     |     |     |
| Traffic Volume (veh/h)       | 0    | 420  | 120  | 160  | 850  | 0    | 200  | 0    | 270  | 0   | 0   | 0   |
| Future Volume (veh/h)        | 0    | 420  | 120  | 160  | 850  | 0    | 200  | 0    | 270  | 0   | 0   | 0   |
| Number                       | 5    | 2    | 12   | 1    | 6    | 16   | 3    | 8    | 18   |     |     |     |
| Initial Q (Qb), veh          | 0    | 0    | 0    | 0    | 0    | 0    | 0    | 0    | 0    |     |     |     |
| Ped-Bike Adj(A_pbT)          | 1.00 |      | 1.00 | 1.00 |      | 1.00 | 1.00 |      | 1.00 |     |     |     |
| Parking Bus, Adj             | 1.00 | 1.00 | 1.00 | 1.00 | 1.00 | 1.00 | 1.00 | 1.00 | 1.00 |     |     |     |
| Adj Sat Flow, veh/h/ln       | 1827 | 1827 | 1900 | 1863 | 1863 | 0    | 1881 | 0    | 1881 |     |     |     |
| Adj Flow Rate, veh/h         | 0    | 472  | 133  | 180  | 955  | 0    | 225  | 0    | 231  |     |     |     |
| Adj No. of Lanes             | 1    | 2    | 0    | 1    | 2    | 0    | 1    | 0    | 1    |     |     |     |
| Peak Hour Factor             | 0.89 | 0.89 | 0.89 | 0.89 | 0.89 | 0.89 | 0.89 | 0.89 | 0.89 |     |     |     |
| Percent Heavy Veh, %         | 4    | 4    | 4    | 2    | 2    | 0    | 1    | 0    | 1    |     |     |     |
| Cap, veh/h                   | 4    | 947  | 265  | 229  | 2013 | 0    | 339  | 0    | 303  |     |     |     |
| Arrive On Green              | 0.00 | 0.35 | 0.35 | 0.13 | 0.57 | 0.00 | 0.19 | 0.00 | 0.19 |     |     |     |
| Sat Flow, veh/h              | 1740 | 2680 | 750  | 1774 | 3632 | 0    | 1792 | 0    | 1599 |     |     |     |
| Grp Volume(v), veh/h         | 0    | 305  | 300  | 180  | 955  | 0    | 225  | 0    | 231  |     |     |     |
| Grp Sat Flow(s),veh/h/ln     | 1740 | 1736 | 1695 | 1774 | 1770 | 0    | 1792 | 0    | 1599 |     |     |     |
| Q Serve(g_s), s              | 0.0  | 5.7  | 5.8  | 4.1  | 6.7  | 0.0  | 4.9  | 0.0  | 5.7  |     |     |     |
| Cycle Q Clear(g_c), s        | 0.0  | 5.7  | 5.8  | 4.1  | 6.7  | 0.0  | 4.9  | 0.0  | 5.7  |     |     |     |
| Prop In Lane                 | 1.00 |      | 0.44 | 1.00 |      | 0.00 | 1.00 |      | 1.00 |     |     |     |
| Lane Grp Cap(c), veh/h       | 4    | 613  | 599  | 229  | 2013 | 0    | 339  | 0    | 303  |     |     |     |
| V/C Ratio(X)                 | 0.00 | 0.50 | 0.50 | 0.79 | 0.47 | 0.00 | 0.66 | 0.00 | 0.76 |     |     |     |
| Avail Cap(c_a), veh/h        | 833  | 2494 | 2435 | 850  | 5086 | 0    | 1159 | 0    | 1034 |     |     |     |
| HCM Platoon Ratio            | 1.00 | 1.00 | 1.00 | 1.00 | 1.00 | 1.00 | 1.00 | 1.00 | 1.00 |     |     |     |
| Upstream Filter(I)           | 0.00 | 1.00 | 1.00 | 1.00 | 1.00 | 0.00 | 1.00 | 0.00 | 1.00 |     |     |     |
| Uniform Delay (d), s/veh     | 0.0  | 10.6 | 10.6 | 17.6 | 5.3  | 0.0  | 15.7 | 0.0  | 16.0 |     |     |     |
| Incr Delay (d2), s/veh       | 0.0  | 1.2  | 1.2  | 2.3  | 0.2  | 0.0  | 0.8  | 0.0  | 1.5  |     |     |     |
| Initial Q Delay(d3),s/veh    | 0.0  | 0.0  | 0.0  | 0.0  | 0.0  | 0.0  | 0.0  | 0.0  | 0.0  |     |     |     |
| %ile BackOfQ(50%),veh/ln     | 0.0  | 2.9  | 2.9  | 2.1  | 3.2  | 0.0  | 2.5  | 0.0  | 2.6  |     |     |     |
| LnGrp Delay(d),s/veh         | 0.0  | 11.7 | 11.8 | 19.9 | 5.5  | 0.0  | 16.5 | 0.0  | 17.6 |     |     |     |
| LnGrp LOS                    |      | B    | B    | B    | A    |      | B    |      | B    |     |     |     |
| Approach Vol, veh/h          |      | 605  |      |      | 1135 |      |      | 456  |      |     |     |     |
| Approach Delay, s/veh        |      | 11.8 |      |      | 7.8  |      |      | 17.0 |      |     |     |     |
| Approach LOS                 |      | B    |      |      | A    |      |      | B    |      |     |     |     |
| Timer                        | 1    | 2    | 3    | 4    | 5    | 6    | 7    | 8    |      |     |     |     |
| Assigned Phs                 | 1    | 2    |      |      | 5    | 6    |      | 8    |      |     |     |     |
| Phs Duration (G+Y+Rc), s     | 9.0  | 20.2 |      |      | 0.0  | 29.1 |      | 12.6 |      |     |     |     |
| Change Period (Y+Rc), s      | 3.6  | 5.4  |      |      | 3.5  | 5.4  |      | 4.7  |      |     |     |     |
| Max Green Setting (Gmax), s  | 20   | 60.0 |      |      | 20.0 | 60.0 |      | 27.0 |      |     |     |     |
| Max Q Clear Time (g_c+10), s | 10   | 7.8  |      |      | 0.0  | 8.7  |      | 7.7  |      |     |     |     |
| Green Ext Time (p_c), s      | 0.0  | 6.9  |      |      | 0.0  | 9.1  |      | 0.2  |      |     |     |     |
| <b>Intersection Summary</b>  |      |      |      |      |      |      |      |      |      |     |     |     |
| HCM 2010 Ctrl Delay          |      |      |      | 10.8 |      |      |      |      |      |     |     |     |
| HCM 2010 LOS                 |      |      |      | B    |      |      |      |      |      |     |     |     |
| <b>Notes</b>                 |      |      |      |      |      |      |      |      |      |     |     |     |



HCM 2010 Signalized Intersection Summary  
 27: Reservation Road & Watkins Gate Road

Cumulative, AM  
 06/11/2019



| Movement                     | EBL  | EBR  | NBL  | NBT  | SBT  | SBR  |   |      |
|------------------------------|------|------|------|------|------|------|---|------|
| Lane Configurations          |      |      |      |      |      |      |   |      |
| Traffic Volume (veh/h)       | 10   | 260  | 170  | 1240 | 800  | 60   |   |      |
| Future Volume (veh/h)        | 10   | 260  | 170  | 1240 | 800  | 60   |   |      |
| Number                       | 5    | 12   | 3    | 8    | 4    | 14   |   |      |
| Initial Q (Qb), veh          | 0    | 0    | 0    | 0    | 0    | 0    |   |      |
| Ped-Bike Adj(A_pbT)          | 1.00 | 1.00 | 1.00 |      |      | 1.00 |   |      |
| Parking Bus, Adj             | 1.00 | 1.00 | 1.00 | 1.00 | 1.00 | 1.00 |   |      |
| Adj Sat Flow, veh/h/ln       | 1863 | 1863 | 1863 | 1863 | 1863 | 1900 |   |      |
| Adj Flow Rate, veh/h         | 11   | 55   | 185  | 1348 | 870  | 58   |   |      |
| Adj No. of Lanes             | 1    | 1    | 1    | 2    | 2    | 0    |   |      |
| Peak Hour Factor             | 0.92 | 0.92 | 0.92 | 0.92 | 0.92 | 0.92 |   |      |
| Percent Heavy Veh, %         | 2    | 2    | 2    | 2    | 2    | 2    |   |      |
| Cap, veh/h                   | 107  | 96   | 233  | 2389 | 1557 | 104  |   |      |
| Arrive On Green              | 0.06 | 0.06 | 0.13 | 0.68 | 0.46 | 0.46 |   |      |
| Sat Flow, veh/h              | 1774 | 1583 | 1774 | 3632 | 3461 | 225  |   |      |
| Grp Volume(v), veh/h         | 11   | 55   | 185  | 1348 | 457  | 471  |   |      |
| Grp Sat Flow(s),veh/h/ln     | 1774 | 1583 | 1774 | 1770 | 1770 | 1823 |   |      |
| Q Serve(g_s), s              | 0.3  | 1.7  | 5.0  | 9.8  | 9.2  | 9.2  |   |      |
| Cycle Q Clear(g_c), s        | 0.3  | 1.7  | 5.0  | 9.8  | 9.2  | 9.2  |   |      |
| Prop In Lane                 | 1.00 | 1.00 | 1.00 |      |      | 0.12 |   |      |
| Lane Grp Cap(c), veh/h       | 107  | 96   | 233  | 2389 | 818  | 843  |   |      |
| V/C Ratio(X)                 | 0.10 | 0.57 | 0.79 | 0.56 | 0.56 | 0.56 |   |      |
| Avail Cap(c_a), veh/h        | 668  | 596  | 650  | 4934 | 1675 | 1725 |   |      |
| HCM Platoon Ratio            | 1.00 | 1.00 | 1.00 | 1.00 | 1.00 | 1.00 |   |      |
| Upstream Filter(I)           | 1.00 | 1.00 | 1.00 | 1.00 | 1.00 | 1.00 |   |      |
| Uniform Delay (d), s/veh     | 21.8 | 22.5 | 20.7 | 4.2  | 9.6  | 9.6  |   |      |
| Incr Delay (d2), s/veh       | 0.2  | 2.0  | 2.3  | 0.3  | 1.0  | 0.9  |   |      |
| Initial Q Delay(d3),s/veh    | 0.0  | 0.0  | 0.0  | 0.0  | 0.0  | 0.0  |   |      |
| %ile BackOfQ(50%),veh/ln     | 0.1  | 0.8  | 2.6  | 4.8  | 4.7  | 4.8  |   |      |
| LnGrp Delay(d),s/veh         | 22.0 | 24.5 | 23.0 | 4.5  | 10.5 | 10.5 |   |      |
| LnGrp LOS                    | C    | C    | C    | A    | B    | B    |   |      |
| Approach Vol, veh/h          | 66   |      |      | 1533 | 928  |      |   |      |
| Approach Delay, s/veh        | 24.1 |      |      | 6.8  | 10.5 |      |   |      |
| Approach LOS                 | C    |      |      | A    | B    |      |   |      |
| Timer                        | 1    | 2    | 3    | 4    | 5    | 6    | 7 | 8    |
| Assigned Phs                 |      | 2    | 3    | 4    |      |      |   | 8    |
| Phs Duration (G+Y+Rc), s     |      | 9.5  | 10.5 | 29.2 |      |      |   | 39.7 |
| Change Period (Y+Rc), s      |      | 6.5  | 4.0  | 6.5  |      |      |   | 6.5  |
| Max Green Setting (Gmax), s  |      | 18.5 | 18.0 | 46.5 |      |      |   | 68.5 |
| Max Q Clear Time (g_c+I1), s |      | 3.7  | 7.0  | 11.2 |      |      |   | 11.8 |
| Green Ext Time (p_c), s      |      | 0.0  | 0.0  | 9.8  |      |      |   | 21.3 |
| <b>Intersection Summary</b>  |      |      |      |      |      |      |   |      |
| HCM 2010 Ctrl Delay          |      |      | 8.6  |      |      |      |   |      |
| HCM 2010 LOS                 |      |      | A    |      |      |      |   |      |

HCM 2010 Signalized Intersection Summary  
28: Davis Road & Reservation Road

Cumulative, AM  
06/11/2019



| Movement                     | EBL   | EBT   | EBR  | WBL  | WBT   | WBR  | NBL  | NBT  | NBR  | SBL  | SBT  | SBR  |
|------------------------------|-------|-------|------|------|-------|------|------|------|------|------|------|------|
| Lane Configurations          |       |       |      |      |       |      |      |      |      |      |      |      |
| Traffic Volume (veh/h)       | 460   | 300   | 10   | 10   | 560   | 90   | 10   | 10   | 10   | 160  | 10   | 520  |
| Future Volume (veh/h)        | 460   | 300   | 10   | 10   | 560   | 90   | 10   | 10   | 10   | 160  | 10   | 520  |
| Number                       | 5     | 2     | 12   | 1    | 6     | 16   | 3    | 8    | 18   | 7    | 4    | 14   |
| Initial Q (Qb), veh          | 0     | 0     | 0    | 0    | 0     | 0    | 0    | 0    | 0    | 0    | 0    | 0    |
| Ped-Bike Adj(A_pbT)          | 1.00  |       | 1.00 | 1.00 |       | 1.00 | 1.00 |      | 1.00 | 1.00 |      | 1.00 |
| Parking Bus, Adj             | 1.00  | 1.00  | 1.00 | 1.00 | 1.00  | 1.00 | 1.00 | 1.00 | 1.00 | 1.00 | 1.00 | 1.00 |
| Adj Sat Flow, veh/h/ln       | 1863  | 1863  | 1900 | 1863 | 1863  | 1900 | 1900 | 1900 | 1900 | 1900 | 1845 | 1845 |
| Adj Flow Rate, veh/h         | 535   | 349   | 12   | 12   | 651   | 105  | 12   | 12   | 9    | 186  | 12   | 363  |
| Adj No. of Lanes             | 1     | 2     | 0    | 1    | 1     | 0    | 0    | 1    | 0    | 0    | 1    | 1    |
| Peak Hour Factor             | 0.86  | 0.86  | 0.86 | 0.86 | 0.86  | 0.86 | 0.86 | 0.86 | 0.86 | 0.86 | 0.86 | 0.86 |
| Percent Heavy Veh, %         | 2     | 2     | 2    | 2    | 2     | 2    | 0    | 0    | 0    | 3    | 3    | 3    |
| Cap, veh/h                   | 387   | 2252  | 77   | 18   | 684   | 110  | 17   | 17   | 13   | 334  | 22   | 645  |
| Arrive On Green              | 0.22  | 0.65  | 0.64 | 0.01 | 0.44  | 0.43 | 0.03 | 0.03 | 0.03 | 0.20 | 0.20 | 0.19 |
| Sat Flow, veh/h              | 1774  | 3491  | 120  | 1774 | 1566  | 253  | 648  | 648  | 486  | 1655 | 107  | 1568 |
| Grp Volume(v), veh/h         | 535   | 176   | 185  | 12   | 0     | 756  | 33   | 0    | 0    | 198  | 0    | 363  |
| Grp Sat Flow(s),veh/h/ln     | 1774  | 1770  | 1842 | 1774 | 0     | 1818 | 1782 | 0    | 0    | 1762 | 0    | 1568 |
| Q Serve(g_s), s              | 29.8  | 5.4   | 5.4  | 0.9  | 0.0   | 54.7 | 2.5  | 0.0  | 0.0  | 13.8 | 0.0  | 24.2 |
| Cycle Q Clear(g_c), s        | 29.8  | 5.4   | 5.4  | 0.9  | 0.0   | 54.7 | 2.5  | 0.0  | 0.0  | 13.8 | 0.0  | 24.2 |
| Prop In Lane                 | 1.00  |       | 0.07 | 1.00 |       | 0.14 | 0.36 |      | 0.27 | 0.94 |      | 1.00 |
| Lane Grp Cap(c), veh/h       | 387   | 1142  | 1188 | 18   | 0     | 794  | 47   | 0    | 0    | 355  | 0    | 645  |
| V/C Ratio(X)                 | 1.38  | 0.15  | 0.16 | 0.68 | 0.00  | 0.95 | 0.71 | 0.00 | 0.00 | 0.56 | 0.00 | 0.56 |
| Avail Cap(c_a), veh/h        | 387   | 1142  | 1188 | 389  | 0     | 813  | 392  | 0    | 0    | 400  | 0    | 685  |
| HCM Platoon Ratio            | 1.00  | 1.00  | 1.00 | 1.00 | 1.00  | 1.00 | 1.00 | 1.00 | 1.00 | 1.00 | 1.00 | 1.00 |
| Upstream Filter(I)           | 1.00  | 1.00  | 1.00 | 1.00 | 0.00  | 1.00 | 1.00 | 0.00 | 0.00 | 1.00 | 0.00 | 1.00 |
| Uniform Delay (d), s/veh     | 53.3  | 9.5   | 9.6  | 67.3 | 0.0   | 37.1 | 65.9 | 0.0  | 0.0  | 49.0 | 0.0  | 30.8 |
| Incr Delay (d2), s/veh       | 186.9 | 0.1   | 0.1  | 15.5 | 0.0   | 20.8 | 7.1  | 0.0  | 0.0  | 0.5  | 0.0  | 0.5  |
| Initial Q Delay(d3),s/veh    | 0.0   | 0.0   | 0.0  | 0.0  | 0.0   | 0.0  | 0.0  | 0.0  | 0.0  | 0.0  | 0.0  | 0.0  |
| %ile BackOfQ(50%),veh/ln     | 4.6   | 2.6   | 2.8  | 0.5  | 0.0   | 31.9 | 1.3  | 0.0  | 0.0  | 6.8  | 0.0  | 10.5 |
| LnGrp Delay(d),s/veh         | 240.3 | 9.6   | 9.7  | 82.8 | 0.0   | 57.9 | 73.1 | 0.0  | 0.0  | 49.5 | 0.0  | 31.3 |
| LnGrp LOS                    | F     | A     | A    | F    |       | E    | E    |      |      | D    |      | C    |
| Approach Vol, veh/h          |       | 896   |      |      | 768   |      |      | 33   |      |      | 561  |      |
| Approach Delay, s/veh        |       | 147.4 |      |      | 58.3  |      |      | 73.1 |      |      | 37.7 |      |
| Approach LOS                 |       | F     |      |      | E     |      |      | E    |      |      | D    |      |
| Timer                        | 1     | 2     | 3    | 4    | 5     | 6    | 7    | 8    |      |      |      |      |
| Assigned Phs                 | 1     | 2     |      | 4    | 5     | 6    |      | 8    |      |      |      |      |
| Phs Duration (G+Y+Rc), s     | 5.4   | 92.0  |      | 31.5 | 33.8  | 63.6 |      | 7.6  |      |      |      |      |
| Change Period (Y+Rc), s      | 3.9   | 5.0   |      | 5.0  | * 3.8 | 5.0  |      | 4.0  |      |      |      |      |
| Max Green Setting (Gmax), s  | 30    | 60.0  |      | 30.0 | * 30  | 60.0 |      | 30.0 |      |      |      |      |
| Max Q Clear Time (g_c+12), s | 12.5  | 7.4   |      | 26.2 | 31.8  | 56.7 |      | 4.5  |      |      |      |      |
| Green Ext Time (p_c), s      | 0.0   | 3.2   |      | 0.3  | 0.0   | 1.9  |      | 0.0  |      |      |      |      |
| <b>Intersection Summary</b>  |       |       |      |      |       |      |      |      |      |      |      |      |
| HCM 2010 Ctrl Delay          |       |       |      | 88.8 |       |      |      |      |      |      |      |      |
| HCM 2010 LOS                 |       |       |      | F    |       |      |      |      |      |      |      |      |
| <b>Notes</b>                 |       |       |      |      |       |      |      |      |      |      |      |      |

HCM 2010 Signalized Intersection Summary  
 29: 2nd Avenue & Divarty Street

Cumulative, AM  
 06/11/2019



| Movement                     | EBL  | EBT  | EBR  | WBL  | WBT  | WBR  | NBL  | NBT  | NBR  | SBL  | SBT  | SBR  |
|------------------------------|------|------|------|------|------|------|------|------|------|------|------|------|
| Lane Configurations          |      | ↕    |      |      | ↕    | ↕    | ↕    | ↕↔   |      | ↕    | ↕↔   |      |
| Traffic Volume (veh/h)       | 80   | 10   | 40   | 40   | 20   | 20   | 130  | 610  | 80   | 20   | 1180 | 250  |
| Future Volume (veh/h)        | 80   | 10   | 40   | 40   | 20   | 20   | 130  | 610  | 80   | 20   | 1180 | 250  |
| Number                       | 5    | 2    | 12   | 1    | 6    | 16   | 3    | 8    | 18   | 7    | 4    | 14   |
| Initial Q (Qb), veh          | 0    | 0    | 0    | 0    | 0    | 0    | 0    | 0    | 0    | 0    | 0    | 0    |
| Ped-Bike Adj(A_pbT)          | 1.00 |      | 1.00 | 1.00 |      | 1.00 | 1.00 |      | 1.00 | 1.00 |      | 1.00 |
| Parking Bus, Adj             | 1.00 | 1.00 | 1.00 | 1.00 | 1.00 | 1.00 | 1.00 | 1.00 | 1.00 | 1.00 | 1.00 | 1.00 |
| Adj Sat Flow, veh/h/ln       | 1900 | 1667 | 1900 | 1900 | 1900 | 1900 | 1863 | 1863 | 1900 | 1881 | 1881 | 1900 |
| Adj Flow Rate, veh/h         | 88   | 11   | 44   | 44   | 22   | 22   | 143  | 670  | 88   | 22   | 1297 | 275  |
| Adj No. of Lanes             | 0    | 1    | 0    | 0    | 1    | 1    | 1    | 2    | 0    | 1    | 2    | 0    |
| Peak Hour Factor             | 0.91 | 0.91 | 0.91 | 0.91 | 0.91 | 0.91 | 0.91 | 0.91 | 0.91 | 0.91 | 0.91 | 0.91 |
| Percent Heavy Veh, %         | 14   | 14   | 14   | 0    | 0    | 0    | 2    | 2    | 2    | 1    | 1    | 1    |
| Cap, veh/h                   | 190  | 32   | 59   | 239  | 100  | 256  | 182  | 1927 | 253  | 45   | 1574 | 329  |
| Arrive On Green              | 0.17 | 0.16 | 0.16 | 0.17 | 0.16 | 0.16 | 0.10 | 0.61 | 0.61 | 0.03 | 0.53 | 0.53 |
| Sat Flow, veh/h              | 644  | 199  | 375  | 933  | 631  | 1612 | 1774 | 3146 | 413  | 1792 | 2943 | 616  |
| Grp Volume(v), veh/h         | 143  | 0    | 0    | 66   | 0    | 22   | 143  | 377  | 381  | 22   | 781  | 791  |
| Grp Sat Flow(s),veh/h/ln     | 1218 | 0    | 0    | 1564 | 0    | 1612 | 1774 | 1770 | 1789 | 1792 | 1787 | 1771 |
| Q Serve(g_s), s              | 5.4  | 0.0  | 0.0  | 0.0  | 0.0  | 0.8  | 5.2  | 6.9  | 7.0  | 0.8  | 23.9 | 24.9 |
| Cycle Q Clear(g_c), s        | 7.6  | 0.0  | 0.0  | 2.2  | 0.0  | 0.8  | 5.2  | 6.9  | 7.0  | 0.8  | 23.9 | 24.9 |
| Prop In Lane                 | 0.62 |      | 0.31 | 0.67 |      | 1.00 | 1.00 |      | 0.23 | 1.00 |      | 0.35 |
| Lane Grp Cap(c), veh/h       | 299  | 0    | 0    | 362  | 0    | 256  | 182  | 1084 | 1096 | 45   | 956  | 947  |
| V/C Ratio(X)                 | 0.48 | 0.00 | 0.00 | 0.18 | 0.00 | 0.09 | 0.78 | 0.35 | 0.35 | 0.49 | 0.82 | 0.84 |
| Avail Cap(c_a), veh/h        | 777  | 0    | 0    | 919  | 0    | 850  | 308  | 1084 | 1096 | 311  | 1078 | 1068 |
| HCM Platoon Ratio            | 1.00 | 1.00 | 1.00 | 1.00 | 1.00 | 1.00 | 1.00 | 1.00 | 1.00 | 1.00 | 1.00 | 1.00 |
| Upstream Filter(I)           | 1.00 | 0.00 | 0.00 | 1.00 | 0.00 | 1.00 | 1.00 | 1.00 | 1.00 | 1.00 | 1.00 | 1.00 |
| Uniform Delay (d), s/veh     | 26.5 | 0.0  | 0.0  | 24.1 | 0.0  | 23.8 | 29.0 | 6.3  | 6.3  | 31.9 | 12.7 | 13.0 |
| Incr Delay (d2), s/veh       | 1.2  | 0.0  | 0.0  | 0.2  | 0.0  | 0.1  | 7.2  | 0.2  | 0.2  | 8.0  | 4.5  | 5.3  |
| Initial Q Delay(d3),s/veh    | 0.0  | 0.0  | 0.0  | 0.0  | 0.0  | 0.0  | 0.0  | 0.0  | 0.0  | 0.0  | 0.0  | 0.0  |
| %ile BackOfQ(50%),veh/ln     | 2.5  | 0.0  | 0.0  | 1.1  | 0.0  | 0.4  | 2.9  | 3.4  | 3.4  | 0.5  | 12.9 | 13.5 |
| LnGrp Delay(d),s/veh         | 27.7 | 0.0  | 0.0  | 24.3 | 0.0  | 23.9 | 36.3 | 6.5  | 6.5  | 39.9 | 17.3 | 18.3 |
| LnGrp LOS                    | C    |      |      | C    |      | C    | D    | A    | A    | D    | B    | B    |
| Approach Vol, veh/h          |      | 143  |      |      | 88   |      |      | 901  |      |      | 1594 |      |
| Approach Delay, s/veh        |      | 27.7 |      |      | 24.2 |      |      | 11.2 |      |      | 18.1 |      |
| Approach LOS                 |      | C    |      |      | C    |      |      | B    |      |      | B    |      |
| Timer                        | 1    | 2    | 3    | 4    | 5    | 6    | 7    | 8    |      |      |      |      |
| Assigned Phs                 |      | 2    | 3    | 4    |      | 6    | 7    | 8    |      |      |      |      |
| Phs Duration (G+Y+Rc), s     |      | 15.5 | 10.3 | 40.5 |      | 15.5 | 5.2  | 45.6 |      |      |      |      |
| Change Period (Y+Rc), s      |      | 5.0  | 3.5  | 5.0  |      | 5.0  | 3.5  | 5.0  |      |      |      |      |
| Max Green Setting (Gmax), s  |      | 35.0 | 11.5 | 40.0 |      | 35.0 | 11.5 | 40.0 |      |      |      |      |
| Max Q Clear Time (g_c+I1), s |      | 9.6  | 7.2  | 26.9 |      | 4.2  | 2.8  | 9.0  |      |      |      |      |
| Green Ext Time (p_c), s      |      | 0.8  | 0.1  | 8.6  |      | 0.4  | 0.0  | 5.1  |      |      |      |      |
| <b>Intersection Summary</b>  |      |      |      |      |      |      |      |      |      |      |      |      |
| HCM 2010 Ctrl Delay          |      |      |      | 16.5 |      |      |      |      |      |      |      |      |
| HCM 2010 LOS                 |      |      |      | B    |      |      |      |      |      |      |      |      |

| Intersection              |      |  |  |  |  |  |  |  |  |  |  |  |
|---------------------------|------|--|--|--|--|--|--|--|--|--|--|--|
| Intersection Delay, s/veh | 11.6 |  |  |  |  |  |  |  |  |  |  |  |
| Intersection LOS          | B    |  |  |  |  |  |  |  |  |  |  |  |

| Movement            | EBL  | EBT  | EBR  | WBL  | WBT  | WBR  | NBL  | NBT  | NBR  | SBL  | SBT  | SBR  |
|---------------------|------|------|------|------|------|------|------|------|------|------|------|------|
| Lane Configurations |      | ↕    |      |      | ↕    |      | ↕    | ↕    |      | ↕    | ↕    |      |
| Traffic Vol, veh/h  | 10   | 10   | 20   | 60   | 10   | 10   | 20   | 280  | 40   | 10   | 240  | 20   |
| Future Vol, veh/h   | 10   | 10   | 20   | 60   | 10   | 10   | 20   | 280  | 40   | 10   | 240  | 20   |
| Peak Hour Factor    | 0.91 | 0.91 | 0.91 | 0.91 | 0.91 | 0.91 | 0.91 | 0.91 | 0.91 | 0.91 | 0.91 | 0.91 |
| Heavy Vehicles, %   | 0    | 0    | 0    | 1    | 1    | 1    | 2    | 2    | 2    | 1    | 1    | 1    |
| Mvmt Flow           | 11   | 11   | 22   | 66   | 11   | 11   | 22   | 308  | 44   | 11   | 264  | 22   |
| Number of Lanes     | 0    | 1    | 0    | 0    | 1    | 0    | 1    | 1    | 0    | 1    | 1    | 0    |

| Approach                   | EB  | WB  | NB   | SB   |
|----------------------------|-----|-----|------|------|
| Opposing Approach          | WB  | EB  | SB   | NB   |
| Opposing Lanes             | 1   | 1   | 2    | 2    |
| Conflicting Approach Left  | SB  | NB  | EB   | WB   |
| Conflicting Lanes Left     | 2   | 2   | 1    | 1    |
| Conflicting Approach Right | NB  | SB  | WB   | EB   |
| Conflicting Lanes Right    | 2   | 2   | 1    | 1    |
| HCM Control Delay          | 8.9 | 9.7 | 12.6 | 11.4 |
| HCM LOS                    | A   | A   | B    | B    |

| Lane                   | NBLn1 | NBLn2 | EBLn1 | WBLn1 | SBLn1 | SBLn2 |
|------------------------|-------|-------|-------|-------|-------|-------|
| Vol Left, %            | 100%  | 0%    | 25%   | 75%   | 100%  | 0%    |
| Vol Thru, %            | 0%    | 88%   | 25%   | 12%   | 0%    | 92%   |
| Vol Right, %           | 0%    | 12%   | 50%   | 12%   | 0%    | 8%    |
| Sign Control           | Stop  | Stop  | Stop  | Stop  | Stop  | Stop  |
| Traffic Vol by Lane    | 20    | 320   | 40    | 80    | 10    | 260   |
| LT Vol                 | 20    | 0     | 10    | 60    | 10    | 0     |
| Through Vol            | 0     | 280   | 10    | 10    | 0     | 240   |
| RT Vol                 | 0     | 40    | 20    | 10    | 0     | 20    |
| Lane Flow Rate         | 22    | 352   | 44    | 88    | 11    | 286   |
| Geometry Grp           | 7     | 7     | 2     | 2     | 7     | 7     |
| Degree of Util (X)     | 0.035 | 0.496 | 0.066 | 0.138 | 0.017 | 0.41  |
| Departure Headway (Hd) | 5.669 | 5.078 | 5.406 | 5.658 | 5.722 | 5.164 |
| Convergence, Y/N       | Yes   | Yes   | Yes   | Yes   | Yes   | Yes   |
| Cap                    | 629   | 707   | 655   | 629   | 622   | 694   |
| Service Time           | 3.429 | 2.837 | 3.502 | 3.742 | 3.486 | 2.927 |
| HCM Lane V/C Ratio     | 0.035 | 0.498 | 0.067 | 0.14  | 0.018 | 0.412 |
| HCM Control Delay      | 8.6   | 12.8  | 8.9   | 9.7   | 8.6   | 11.5  |
| HCM Lane LOS           | A     | B     | A     | A     | A     | B     |
| HCM 95th-tile Q        | 0.1   | 2.8   | 0.2   | 0.5   | 0.1   | 2     |

HCM 2010 Signalized Intersection Summary  
31: 1st Avenue & Lightfighter Drive

Cumulative, AM  
06/11/2019



| Movement                     | EBL  | EBT  | EBR  | WBL  | WBT  | WBR  | NBL  | NBT  | NBR  | SBL  | SBT  | SBR  |
|------------------------------|------|------|------|------|------|------|------|------|------|------|------|------|
| Lane Configurations          |      | ↑↑   | ↑    | ↑    | ↑↑   |      | ↑    |      | ↑    | ↑    | ↑    | ↑    |
| Traffic Volume (veh/h)       | 0    | 1120 | 130  | 20   | 1030 | 0    | 160  | 0    | 20   | 120  | 30   | 100  |
| Future Volume (veh/h)        | 0    | 1120 | 130  | 20   | 1030 | 0    | 160  | 0    | 20   | 120  | 30   | 100  |
| Number                       | 7    | 4    | 14   | 3    | 8    | 18   | 5    | 2    | 12   | 1    | 6    | 16   |
| Initial Q (Qb), veh          | 0    | 0    | 0    | 0    | 0    | 0    | 0    | 0    | 0    | 0    | 0    | 0    |
| Ped-Bike Adj(A_pbT)          | 1.00 |      | 1.00 | 1.00 |      | 1.00 | 1.00 |      | 1.00 | 1.00 |      | 1.00 |
| Parking Bus, Adj             | 1.00 | 1.00 | 1.00 | 1.00 | 1.00 | 1.00 | 1.00 | 1.00 | 1.00 | 1.00 | 1.00 | 1.00 |
| Adj Sat Flow, veh/h/ln       | 0    | 1863 | 1863 | 1863 | 1863 | 0    | 1863 | 0    | 1863 | 1792 | 1792 | 1792 |
| Adj Flow Rate, veh/h         | 0    | 1333 | 0    | 24   | 1226 | 0    | 190  | 0    | 10   | 143  | 36   | 100  |
| Adj No. of Lanes             | 0    | 2    | 1    | 1    | 2    | 0    | 1    | 0    | 1    | 1    | 1    | 1    |
| Peak Hour Factor             | 0.84 | 0.84 | 0.84 | 0.84 | 0.84 | 0.84 | 0.84 | 0.84 | 0.84 | 0.84 | 0.84 | 0.84 |
| Percent Heavy Veh, %         | 0    | 2    | 2    | 2    | 2    | 0    | 2    | 0    | 2    | 6    | 6    | 6    |
| Cap, veh/h                   | 0    | 2159 | 966  | 27   | 2456 | 0    | 0    | 0    | 0    | 214  | 225  | 191  |
| Arrive On Green              | 0.00 | 0.61 | 0.00 | 0.02 | 0.69 | 0.00 | 0.00 | 0.00 | 0.00 | 0.13 | 0.13 | 0.13 |
| Sat Flow, veh/h              | 0    | 3632 | 1583 | 1774 | 3632 | 0    | 0    | 0    | 0    | 1707 | 1792 | 1524 |
| Grp Volume(v), veh/h         | 0    | 1333 | 0    | 24   | 1226 | 0    | 0    | 0    | 0    | 143  | 36   | 100  |
| Grp Sat Flow(s),veh/h/ln     | 0    | 1770 | 1583 | 1774 | 1770 | 0    | 0    | 0    | 0    | 1707 | 1792 | 1524 |
| Q Serve(g_s), s              | 0.0  | 12.0 | 0.0  | 0.7  | 8.3  | 0.0  | 0.0  | 0.0  | 0.0  | 4.1  | 0.9  | 3.1  |
| Cycle Q Clear(g_c), s        | 0.0  | 12.0 | 0.0  | 0.7  | 8.3  | 0.0  | 0.0  | 0.0  | 0.0  | 4.1  | 0.9  | 3.1  |
| Prop In Lane                 | 0.00 |      | 1.00 | 1.00 |      | 0.00 |      |      |      | 1.00 |      | 1.00 |
| Lane Grp Cap(c), veh/h       | 0    | 2159 | 966  | 27   | 2456 | 0    | 0    | 0    | 0    | 214  | 225  | 191  |
| V/C Ratio(X)                 | 0.00 | 0.62 | 0.00 | 0.89 | 0.50 | 0.00 | 0.00 | 0.00 | 0.00 | 0.67 | 0.16 | 0.52 |
| Avail Cap(c_a), veh/h        | 0    | 3128 | 1399 | 697  | 3128 | 0    | 0    | 0    | 0    | 838  | 880  | 748  |
| HCM Platoon Ratio            | 1.00 | 1.00 | 1.00 | 1.00 | 1.00 | 1.00 | 1.00 | 1.00 | 1.00 | 1.00 | 1.00 | 1.00 |
| Upstream Filter(I)           | 0.00 | 1.00 | 0.00 | 1.00 | 1.00 | 0.00 | 0.00 | 0.00 | 0.00 | 1.00 | 1.00 | 1.00 |
| Uniform Delay (d), s/veh     | 0.0  | 6.2  | 0.0  | 25.0 | 3.6  | 0.0  | 0.0  | 0.0  | 0.0  | 21.3 | 19.9 | 20.8 |
| Incr Delay (d2), s/veh       | 0.0  | 0.4  | 0.0  | 27.2 | 0.2  | 0.0  | 0.0  | 0.0  | 0.0  | 1.3  | 0.1  | 0.8  |
| Initial Q Delay(d3),s/veh    | 0.0  | 0.0  | 0.0  | 0.0  | 0.0  | 0.0  | 0.0  | 0.0  | 0.0  | 0.0  | 0.0  | 0.0  |
| %ile BackOfQ(50%),veh/ln     | 0.0  | 5.9  | 0.0  | 0.5  | 4.0  | 0.0  | 0.0  | 0.0  | 0.0  | 2.0  | 0.5  | 1.3  |
| LnGrp Delay(d),s/veh         | 0.0  | 6.6  | 0.0  | 52.2 | 3.9  | 0.0  | 0.0  | 0.0  | 0.0  | 22.6 | 20.0 | 21.7 |
| LnGrp LOS                    |      | A    |      | D    | A    |      |      |      |      | C    | B    | C    |
| Approach Vol, veh/h          |      | 1333 |      |      | 1250 |      |      |      |      |      | 279  |      |
| Approach Delay, s/veh        |      | 6.6  |      |      | 4.8  |      |      |      |      |      | 21.9 |      |
| Approach LOS                 |      | A    |      |      | A    |      |      |      |      |      | C    |      |
| Timer                        | 1    | 2    | 3    | 4    | 5    | 6    | 7    | 8    |      |      |      |      |
| Assigned Phs                 |      |      | 3    | 4    |      | 6    |      | 8    |      |      |      |      |
| Phs Duration (G+Y+Rc), s     |      |      | 4.3  | 35.7 |      | 11.0 |      | 39.9 |      |      |      |      |
| Change Period (Y+Rc), s      |      |      | 3.5  | 4.6  |      | 4.6  |      | 4.6  |      |      |      |      |
| Max Green Setting (Gmax), s  |      |      | 20.0 | 45.0 |      | 25.0 |      | 45.0 |      |      |      |      |
| Max Q Clear Time (g_c+I1), s |      |      | 2.7  | 14.0 |      | 6.1  |      | 10.3 |      |      |      |      |
| Green Ext Time (p_c), s      |      |      | 0.0  | 17.1 |      | 0.4  |      | 15.2 |      |      |      |      |
| <b>Intersection Summary</b>  |      |      |      |      |      |      |      |      |      |      |      |      |
| HCM 2010 Ctrl Delay          |      |      | 7.3  |      |      |      |      |      |      |      |      |      |
| HCM 2010 LOS                 |      |      | A    |      |      |      |      |      |      |      |      |      |

HCM 2010 Signalized Intersection Summary  
32: 2nd Avenue & Lightfighter Drive

Cumulative, AM  
06/11/2019



| Movement                    | EBL   | EBT   | EBR  | WBL  | WBT  | WBR  | NBL  | NBT  | NBR  | SBL  | SBT  | SBR  |
|-----------------------------|-------|-------|------|------|------|------|------|------|------|------|------|------|
| Lane Configurations         |       |       |      |      |      |      |      |      |      |      |      |      |
| Traffic Volume (veh/h)      | 340   | 910   | 10   | 40   | 600  | 180  | 20   | 20   | 50   | 350  | 10   | 490  |
| Future Volume (veh/h)       | 340   | 910   | 10   | 40   | 600  | 180  | 20   | 20   | 50   | 350  | 10   | 490  |
| Number                      | 5     | 2     | 12   | 1    | 6    | 16   | 3    | 8    | 18   | 7    | 4    | 14   |
| Initial Q (Qb), veh         | 0     | 0     | 0    | 0    | 0    | 0    | 0    | 0    | 0    | 0    | 0    | 0    |
| Ped-Bike Adj(A_pbT)         | 1.00  |       | 1.00 | 1.00 |      | 1.00 | 1.00 |      | 1.00 | 1.00 |      | 1.00 |
| Parking Bus, Adj            | 1.00  | 1.00  | 1.00 | 1.00 | 1.00 | 1.00 | 1.00 | 1.00 | 1.00 | 1.00 | 1.00 | 1.00 |
| Adj Sat Flow, veh/h/ln      | 1863  | 1863  | 1900 | 1827 | 1827 | 1900 | 1900 | 1900 | 1900 | 1881 | 1881 | 1881 |
| Adj Flow Rate, veh/h        | 378   | 1011  | 11   | 44   | 667  | 191  | 22   | 22   | 55   | 389  | 11   | 268  |
| Adj No. of Lanes            | 1     | 2     | 0    | 1    | 2    | 0    | 0    | 1    | 0    | 1    | 1    | 1    |
| Peak Hour Factor            | 0.90  | 0.90  | 0.90 | 0.90 | 0.90 | 0.90 | 0.90 | 0.90 | 0.90 | 0.90 | 0.90 | 0.90 |
| Percent Heavy Veh, %        | 2     | 2     | 2    | 4    | 4    | 4    | 0    | 0    | 0    | 1    | 1    | 1    |
| Cap, veh/h                  | 220   | 1908  | 21   | 56   | 1173 | 336  | 124  | 131  | 264  | 489  | 572  | 486  |
| Arrive On Green             | 0.12  | 0.53  | 0.53 | 0.03 | 0.44 | 0.44 | 0.31 | 0.30 | 0.30 | 0.30 | 0.30 | 0.30 |
| Sat Flow, veh/h             | 1774  | 3586  | 39   | 1740 | 2665 | 763  | 262  | 432  | 868  | 1330 | 1881 | 1599 |
| Grp Volume(v), veh/h        | 378   | 499   | 523  | 44   | 434  | 424  | 99   | 0    | 0    | 389  | 11   | 268  |
| Grp Sat Flow(s),veh/h/ln    | 1774  | 1770  | 1856 | 1740 | 1736 | 1692 | 1563 | 0    | 0    | 1330 | 1881 | 1599 |
| Q Serve(g_s), s             | 12.4  | 18.4  | 18.4 | 2.5  | 18.7 | 18.7 | 0.0  | 0.0  | 0.0  | 23.2 | 0.4  | 14.0 |
| Cycle Q Clear(g_c), s       | 12.4  | 18.4  | 18.4 | 2.5  | 18.7 | 18.7 | 4.2  | 0.0  | 0.0  | 27.4 | 0.4  | 14.0 |
| Prop In Lane                | 1.00  |       | 0.02 | 1.00 |      | 0.45 | 0.22 |      | 0.56 | 1.00 |      | 1.00 |
| Lane Grp Cap(c), veh/h      | 220   | 942   | 987  | 56   | 764  | 745  | 529  | 0    | 0    | 489  | 572  | 486  |
| V/C Ratio(X)                | 1.72  | 0.53  | 0.53 | 0.79 | 0.57 | 0.57 | 0.19 | 0.00 | 0.00 | 0.79 | 0.02 | 0.55 |
| Avail Cap(c_a), veh/h       | 220   | 942   | 987  | 216  | 764  | 745  | 680  | 0    | 0    | 622  | 760  | 646  |
| HCM Platoon Ratio           | 1.00  | 1.00  | 1.00 | 1.00 | 1.00 | 1.00 | 1.00 | 1.00 | 1.00 | 1.00 | 1.00 | 1.00 |
| Upstream Filter(I)          | 0.62  | 0.62  | 0.62 | 0.09 | 0.09 | 0.09 | 1.00 | 0.00 | 0.00 | 0.39 | 0.39 | 0.39 |
| Uniform Delay (d), s/veh    | 43.8  | 15.2  | 15.2 | 48.1 | 20.9 | 20.9 | 25.6 | 0.0  | 0.0  | 33.4 | 24.4 | 29.1 |
| Incr Delay (d2), s/veh      | 335.0 | 1.3   | 1.3  | 0.9  | 0.3  | 0.3  | 0.1  | 0.0  | 0.0  | 1.7  | 0.0  | 0.1  |
| Initial Q Delay(d3),s/veh   | 0.0   | 0.0   | 0.0  | 0.0  | 0.0  | 0.0  | 0.0  | 0.0  | 0.0  | 0.0  | 0.0  | 0.0  |
| %ile BackOfQ(50%),veh/ln    | 26.5  | 9.2   | 9.6  | 1.2  | 9.0  | 8.8  | 2.0  | 0.0  | 0.0  | 10.6 | 0.2  | 6.2  |
| LnGrp Delay(d),s/veh        | 378.8 | 16.6  | 16.5 | 49.0 | 21.2 | 21.2 | 25.7 | 0.0  | 0.0  | 35.1 | 24.4 | 29.2 |
| LnGrp LOS                   | F     | B     | B    | D    | C    | C    | C    |      |      | D    | C    | C    |
| Approach Vol, veh/h         |       | 1400  |      |      | 902  |      |      | 99   |      |      | 668  |      |
| Approach Delay, s/veh       |       | 114.4 |      |      | 22.6 |      |      | 25.7 |      |      | 32.5 |      |
| Approach LOS                |       | F     |      |      | C    |      |      | C    |      |      | C    |      |
| Timer                       | 1     | 2     | 3    | 4    | 5    | 6    | 7    | 8    |      |      |      |      |
| Assigned Phs                | 1     | 2     |      | 4    | 5    | 6    |      | 8    |      |      |      |      |
| Phs Duration (G+Y+Rc), s    | 7.2   | 57.8  |      | 35.0 | 16.4 | 48.6 |      | 35.0 |      |      |      |      |
| Change Period (Y+Rc), s     | 4.0   | 4.6   |      | 4.6  | 4.0  | 4.6  |      | 4.6  |      |      |      |      |
| Max Green Setting (Gmax), s | 2.4   | 34.0  |      | 40.4 | 12.4 | 24.4 |      | 40.4 |      |      |      |      |
| Max Q Clear Time (g_c+1), s | 14.5  | 20.4  |      | 29.4 | 14.4 | 20.7 |      | 6.2  |      |      |      |      |
| Green Ext Time (p_c), s     | 0.0   | 3.5   |      | 1.0  | 0.0  | 1.3  |      | 0.4  |      |      |      |      |
| <b>Intersection Summary</b> |       |       |      |      |      |      |      |      |      |      |      |      |
| HCM 2010 Ctrl Delay         |       |       | 66.7 |      |      |      |      |      |      |      |      |      |
| HCM 2010 LOS                |       |       | E    |      |      |      |      |      |      |      |      |      |

HCM 2010 Signalized Intersection Summary  
 33: General Jim Moore Boulevard & Lightfighter Drive

Cumulative, AM  
 06/11/2019



| Movement                    | EBL  | EBT  | EBR  | WBL  | WBT  | WBR  | NBL  | NBT  | NBR  | SBL  | SBT  | SBR  |
|-----------------------------|------|------|------|------|------|------|------|------|------|------|------|------|
| Lane Configurations         |      |      |      |      |      |      |      |      |      |      |      |      |
| Traffic Volume (veh/h)      | 70   | 280  | 760  | 20   | 200  | 60   | 620  | 150  | 10   | 30   | 150  | 70   |
| Future Volume (veh/h)       | 70   | 280  | 760  | 20   | 200  | 60   | 620  | 150  | 10   | 30   | 150  | 70   |
| Number                      | 3    | 8    | 18   | 7    | 4    | 14   | 1    | 6    | 16   | 5    | 2    | 12   |
| Initial Q (Qb), veh         | 0    | 0    | 0    | 0    | 0    | 0    | 0    | 0    | 0    | 0    | 0    | 0    |
| Ped-Bike Adj(A_pbT)         | 1.00 |      | 1.00 | 1.00 |      | 1.00 | 1.00 |      | 1.00 | 1.00 |      | 1.00 |
| Parking Bus, Adj            | 1.00 | 1.00 | 1.00 | 1.00 | 1.00 | 1.00 | 1.00 | 1.00 | 1.00 | 1.00 | 1.00 | 1.00 |
| Adj Sat Flow, veh/h/ln      | 1863 | 1863 | 1863 | 1792 | 1792 | 1900 | 1881 | 1881 | 1900 | 1863 | 1863 | 1900 |
| Adj Flow Rate, veh/h        | 79   | 315  | 0    | 22   | 225  | 65   | 697  | 169  | 10   | 34   | 169  | 79   |
| Adj No. of Lanes            | 1    | 1    | 1    | 1    | 1    | 0    | 2    | 1    | 0    | 1    | 2    | 0    |
| Peak Hour Factor            | 0.89 | 0.89 | 0.89 | 0.89 | 0.89 | 0.89 | 0.89 | 0.89 | 0.89 | 0.89 | 0.89 | 0.89 |
| Percent Heavy Veh, %        | 2    | 2    | 2    | 6    | 6    | 6    | 1    | 1    | 1    | 2    | 2    | 2    |
| Cap, veh/h                  | 102  | 508  | 432  | 36   | 316  | 91   | 691  | 559  | 33   | 53   | 354  | 159  |
| Arrive On Green             | 0.06 | 0.27 | 0.00 | 0.02 | 0.24 | 0.24 | 0.20 | 0.32 | 0.32 | 0.03 | 0.15 | 0.15 |
| Sat Flow, veh/h             | 1774 | 1863 | 1583 | 1707 | 1336 | 386  | 3476 | 1759 | 104  | 1774 | 2376 | 1063 |
| Grp Volume(v), veh/h        | 79   | 315  | 0    | 22   | 0    | 290  | 697  | 0    | 179  | 34   | 124  | 124  |
| Grp Sat Flow(s),veh/h/ln    | 1774 | 1863 | 1583 | 1707 | 0    | 1722 | 1738 | 0    | 1863 | 1774 | 1770 | 1670 |
| Q Serve(g_s), s             | 2.2  | 7.4  | 0.0  | 0.6  | 0.0  | 7.8  | 10.0 | 0.0  | 3.6  | 1.0  | 3.2  | 3.4  |
| Cycle Q Clear(g_c), s       | 2.2  | 7.4  | 0.0  | 0.6  | 0.0  | 7.8  | 10.0 | 0.0  | 3.6  | 1.0  | 3.2  | 3.4  |
| Prop In Lane                | 1.00 |      | 1.00 | 1.00 |      | 0.22 | 1.00 |      | 0.06 | 1.00 |      | 0.64 |
| Lane Grp Cap(c), veh/h      | 102  | 508  | 432  | 36   | 0    | 407  | 691  | 0    | 592  | 53   | 264  | 249  |
| V/C Ratio(X)                | 0.77 | 0.62 | 0.00 | 0.61 | 0.00 | 0.71 | 1.01 | 0.00 | 0.30 | 0.64 | 0.47 | 0.50 |
| Avail Cap(c_a), veh/h       | 706  | 1112 | 945  | 679  | 0    | 1028 | 691  | 0    | 1112 | 529  | 1056 | 997  |
| HCM Platoon Ratio           | 1.00 | 1.00 | 1.00 | 1.00 | 1.00 | 1.00 | 1.00 | 1.00 | 1.00 | 1.00 | 1.00 | 1.00 |
| Upstream Filter(l)          | 1.00 | 1.00 | 0.00 | 1.00 | 0.00 | 1.00 | 1.00 | 0.00 | 1.00 | 1.00 | 1.00 | 1.00 |
| Uniform Delay (d), s/veh    | 23.4 | 16.0 | 0.0  | 24.4 | 0.0  | 17.6 | 20.1 | 0.0  | 12.9 | 24.1 | 19.6 | 19.7 |
| Incr Delay (d2), s/veh      | 11.5 | 1.5  | 0.0  | 6.1  | 0.0  | 2.8  | 36.2 | 0.0  | 0.6  | 4.6  | 1.6  | 1.9  |
| Initial Q Delay(d3),s/veh   | 0.0  | 0.0  | 0.0  | 0.0  | 0.0  | 0.0  | 0.0  | 0.0  | 0.0  | 0.0  | 0.0  | 0.0  |
| %ile BackOfQ(50%),veh/ln    | 1.4  | 4.0  | 0.0  | 0.4  | 0.0  | 3.9  | 8.2  | 0.0  | 1.9  | 0.5  | 1.7  | 1.7  |
| LnGrp Delay(d),s/veh        | 34.9 | 17.5 | 0.0  | 30.5 | 0.0  | 20.4 | 56.4 | 0.0  | 13.5 | 28.7 | 21.1 | 21.5 |
| LnGrp LOS                   | C    | B    |      | C    |      | C    | F    |      | B    | C    | C    | C    |
| Approach Vol, veh/h         |      | 394  |      |      | 312  |      |      | 876  |      |      | 282  |      |
| Approach Delay, s/veh       |      | 21.0 |      |      | 21.2 |      |      | 47.6 |      |      | 22.2 |      |
| Approach LOS                |      | C    |      |      | C    |      |      | D    |      |      | C    |      |
| Timer                       | 1    | 2    | 3    | 4    | 5    | 6    | 7    | 8    |      |      |      |      |
| Assigned Phs                | 1    | 2    | 3    | 4    | 5    | 6    | 7    | 8    |      |      |      |      |
| Phs Duration (G+Y+Rc), s    | 4.5  | 12.0 | 7.4  | 16.4 | 6.0  | 20.5 | 5.6  | 18.2 |      |      |      |      |
| Change Period (Y+Rc), s     | 4.5  | 4.5  | 4.5  | 4.5  | 4.5  | 4.5  | 4.5  | 4.5  |      |      |      |      |
| Max Green Setting (Gmax), s | 30.0 | 30.0 | 20.0 | 30.0 | 15.0 | 30.0 | 20.0 | 30.0 |      |      |      |      |
| Max Q Clear Time (g_c+1), s | 5.4  | 4.2  | 9.8  | 3.0  | 5.6  | 2.6  | 9.4  |      |      |      |      |      |
| Green Ext Time (p_c), s     | 0.0  | 1.6  | 0.1  | 2.1  | 0.0  | 1.8  | 0.0  | 2.0  |      |      |      |      |
| <b>Intersection Summary</b> |      |      |      |      |      |      |      |      |      |      |      |      |
| HCM 2010 Ctrl Delay         |      |      | 33.7 |      |      |      |      |      |      |      |      |      |
| HCM 2010 LOS                |      |      | C    |      |      |      |      |      |      |      |      |      |

**Intersection**

Intersection Delay, s/veh 14.6

Intersection LOS B

| Movement            | WBL  | WBR  | NBT  | NBR  | SBL  | SBT  |
|---------------------|------|------|------|------|------|------|
| Lane Configurations |      |      |      |      |      |      |
| Traffic Vol, veh/h  | 70   | 240  | 50   | 20   | 270  | 50   |
| Future Vol, veh/h   | 70   | 240  | 50   | 20   | 270  | 50   |
| Peak Hour Factor    | 0.77 | 0.77 | 0.77 | 0.77 | 0.77 | 0.77 |
| Heavy Vehicles, %   | 4    | 4    | 3    | 3    | 2    | 2    |
| Mvmt Flow           | 91   | 312  | 65   | 26   | 351  | 65   |
| Number of Lanes     | 1    | 0    | 1    | 0    | 0    | 1    |

| Approach                   | WB   | NB  | SB   |
|----------------------------|------|-----|------|
| Opposing Approach          |      | SB  | NB   |
| Opposing Lanes             | 0    | 1   | 1    |
| Conflicting Approach Left  | NB   |     | WB   |
| Conflicting Lanes Left     | 1    | 0   | 1    |
| Conflicting Approach Right | SB   | WB  |      |
| Conflicting Lanes Right    | 1    | 1   | 0    |
| HCM Control Delay          | 13.9 | 9.4 | 16.5 |
| HCM LOS                    | B    | A   | C    |

| Lane                   | NBLn1 | WBLn1 | SBLn1 |
|------------------------|-------|-------|-------|
| Vol Left, %            | 0%    | 23%   | 84%   |
| Vol Thru, %            | 71%   | 0%    | 16%   |
| Vol Right, %           | 29%   | 77%   | 0%    |
| Sign Control           | Stop  | Stop  | Stop  |
| Traffic Vol by Lane    | 70    | 310   | 320   |
| LT Vol                 | 0     | 70    | 270   |
| Through Vol            | 50    | 0     | 50    |
| RT Vol                 | 20    | 240   | 0     |
| Lane Flow Rate         | 91    | 403   | 416   |
| Geometry Grp           | 1     | 1     | 1     |
| Degree of Util (X)     | 0.138 | 0.554 | 0.614 |
| Departure Headway (Hd) | 5.484 | 4.955 | 5.316 |
| Convergence, Y/N       | Yes   | Yes   | Yes   |
| Cap                    | 653   | 733   | 682   |
| Service Time           | 3.526 | 2.955 | 3.345 |
| HCM Lane V/C Ratio     | 0.139 | 0.55  | 0.61  |
| HCM Control Delay      | 9.4   | 13.9  | 16.5  |
| HCM Lane LOS           | A     | B     | C     |
| HCM 95th-tile Q        | 0.5   | 3.4   | 4.2   |



| Intersection             |      |      |      |      |      |      |
|--------------------------|------|------|------|------|------|------|
| Int Delay, s/veh         | 1.5  |      |      |      |      |      |
| Movement                 | EBT  | EBR  | WBL  | WBT  | NBL  | NBR  |
| Lane Configurations      |      |      |      |      |      |      |
| Traffic Vol, veh/h       | 260  | 30   | 20   | 280  | 30   | 30   |
| Future Vol, veh/h        | 260  | 30   | 20   | 280  | 30   | 30   |
| Conflicting Peds, #/hr   | 0    | 0    | 0    | 0    | 0    | 0    |
| Sign Control             | Free | Free | Free | Free | Stop | Stop |
| RT Channelized           | -    | None | -    | None | -    | None |
| Storage Length           | -    | -    | -    | -    | 0    | -    |
| Veh in Median Storage, # | 0    | -    | -    | 0    | 0    | -    |
| Grade, %                 | 0    | -    | -    | 0    | 0    | -    |
| Peak Hour Factor         | 78   | 78   | 78   | 78   | 78   | 78   |
| Heavy Vehicles, %        | 5    | 5    | 4    | 4    | 0    | 0    |
| Mvmt Flow                | 333  | 38   | 26   | 359  | 38   | 38   |

| Major/Minor          | Major1 | Major2 | Minor1 | Minor2 |
|----------------------|--------|--------|--------|--------|
| Conflicting Flow All | 0      | 0      | 371    | 0      |
| Stage 1              | -      | -      | -      | 352    |
| Stage 2              | -      | -      | -      | 411    |
| Critical Hdwy        | -      | -      | 4.14   | -      |
| Critical Hdwy Stg 1  | -      | -      | -      | 5.4    |
| Critical Hdwy Stg 2  | -      | -      | -      | 5.4    |
| Follow-up Hdwy       | -      | -      | 2.236  | -      |
| Pot Cap-1 Maneuver   | -      | -      | 1177   | -      |
| Stage 1              | -      | -      | -      | 716    |
| Stage 2              | -      | -      | -      | 674    |
| Platoon blocked, %   | -      | -      | -      | -      |
| Mov Cap-1 Maneuver   | -      | -      | 1177   | -      |
| Mov Cap-2 Maneuver   | -      | -      | -      | 365    |
| Stage 1              | -      | -      | -      | 696    |
| Stage 2              | -      | -      | -      | 674    |

| Approach             | EB | WB  | NB   |
|----------------------|----|-----|------|
| HCM Control Delay, s | 0  | 0.5 | 13.9 |
| HCM LOS              |    |     | B    |

| Minor Lane/Major Mvmt | NBLn1 | EBT | EBR | WBL   | WBT |
|-----------------------|-------|-----|-----|-------|-----|
| Capacity (veh/h)      | 479   | -   | -   | 1177  | -   |
| HCM Lane V/C Ratio    | 0.161 | -   | -   | 0.022 | -   |
| HCM Control Delay (s) | 13.9  | -   | -   | 8.1   | 0   |
| HCM Lane LOS          | B     | -   | -   | A     | A   |
| HCM 95th %tile Q(veh) | 0.6   | -   | -   | 0.1   | -   |

| Intersection              |      |
|---------------------------|------|
| Intersection Delay, s/veh | 13.1 |
| Intersection LOS          | B    |

| Movement            | EBL  | EBT  | EBR  | WBL  | WBT  | WBR  | NBL  | NBT  | NBR  | SBL  | SBT  | SBR  |
|---------------------|------|------|------|------|------|------|------|------|------|------|------|------|
| Lane Configurations |      | ↕    |      |      | ↕    |      |      | ↕    |      |      | ↕    |      |
| Traffic Vol, veh/h  | 10   | 250  | 30   | 10   | 220  | 10   | 50   | 70   | 20   | 10   | 50   | 30   |
| Future Vol, veh/h   | 10   | 250  | 30   | 10   | 220  | 10   | 50   | 70   | 20   | 10   | 50   | 30   |
| Peak Hour Factor    | 0.79 | 0.79 | 0.79 | 0.79 | 0.79 | 0.79 | 0.79 | 0.79 | 0.79 | 0.79 | 0.79 | 0.79 |
| Heavy Vehicles, %   | 6    | 6    | 6    | 4    | 4    | 4    | 20   | 20   | 20   | 2    | 2    | 2    |
| Mvmt Flow           | 13   | 316  | 38   | 13   | 278  | 13   | 63   | 89   | 25   | 13   | 63   | 38   |
| Number of Lanes     | 0    | 1    | 0    | 0    | 1    | 0    | 0    | 1    | 0    | 0    | 1    | 0    |

| Approach                   | EB   | WB | NB   | SB   |
|----------------------------|------|----|------|------|
| Opposing Approach          | WB   | EB | SB   | NB   |
| Opposing Lanes             | 1    | 1  | 1    | 1    |
| Conflicting Approach Left  | SB   | NB | EB   | WB   |
| Conflicting Lanes Left     | 1    | 1  | 1    | 1    |
| Conflicting Approach Right | NB   | SB | WB   | EB   |
| Conflicting Lanes Right    | 1    | 1  | 1    | 1    |
| HCM Control Delay          | 14.6 | 13 | 12.1 | 10.4 |
| HCM LOS                    | B    | B  | B    | B    |

| Lane                   | NBLn1 | EBLn1 | WBLn1 | SBLn1 |
|------------------------|-------|-------|-------|-------|
| Vol Left, %            | 36%   | 3%    | 4%    | 11%   |
| Vol Thru, %            | 50%   | 86%   | 92%   | 56%   |
| Vol Right, %           | 14%   | 10%   | 4%    | 33%   |
| Sign Control           | Stop  | Stop  | Stop  | Stop  |
| Traffic Vol by Lane    | 140   | 290   | 240   | 90    |
| LT Vol                 | 50    | 10    | 10    | 10    |
| Through Vol            | 70    | 250   | 220   | 50    |
| RT Vol                 | 20    | 30    | 10    | 30    |
| Lane Flow Rate         | 177   | 367   | 304   | 114   |
| Geometry Grp           | 1     | 1     | 1     | 1     |
| Degree of Util (X)     | 0.308 | 0.544 | 0.458 | 0.188 |
| Departure Headway (Hd) | 6.247 | 5.336 | 5.432 | 5.942 |
| Convergence, Y/N       | Yes   | Yes   | Yes   | Yes   |
| Cap                    | 574   | 675   | 662   | 600   |
| Service Time           | 4.308 | 3.386 | 3.485 | 4.01  |
| HCM Lane V/C Ratio     | 0.308 | 0.544 | 0.459 | 0.19  |
| HCM Control Delay      | 12.1  | 14.6  | 13    | 10.4  |
| HCM Lane LOS           | B     | B     | B     | B     |
| HCM 95th-tile Q        | 1.3   | 3.3   | 2.4   | 0.7   |

| Intersection             |      |      |      |      |      |      |      |      |      |      |      |      |
|--------------------------|------|------|------|------|------|------|------|------|------|------|------|------|
| Int Delay, s/veh         | 18.3 |      |      |      |      |      |      |      |      |      |      |      |
| Movement                 | EBL  | EBT  | EBR  | WBL  | WBT  | WBR  | NBL  | NBT  | NBR  | SBL  | SBT  | SBR  |
| Lane Configurations      |      | ↕    |      |      | ↕    |      |      | ↕    |      |      | ↕    |      |
| Traffic Vol, veh/h       | 80   | 110  | 90   | 10   | 100  | 20   | 50   | 100  | 20   | 10   | 170  | 80   |
| Future Vol, veh/h        | 80   | 110  | 90   | 10   | 100  | 20   | 50   | 100  | 20   | 10   | 170  | 80   |
| Conflicting Peds, #/hr   | 0    | 0    | 0    | 0    | 0    | 0    | 0    | 0    | 1    | 1    | 0    | 0    |
| Sign Control             | Stop | Stop | Stop | Stop | Stop | Stop | Free | Free | Free | Free | Free | Free |
| RT Channelized           | -    | -    | None | -    | -    | None | -    | -    | None | -    | -    | None |
| Storage Length           | -    | -    | -    | -    | -    | -    | -    | -    | -    | -    | -    | -    |
| Veh in Median Storage, # | -    | 0    | -    | -    | 0    | -    | -    | 0    | -    | -    | 0    | -    |
| Grade, %                 | -    | 0    | -    | -    | 0    | -    | -    | 0    | -    | -    | 0    | -    |
| Peak Hour Factor         | 82   | 82   | 82   | 82   | 82   | 82   | 82   | 82   | 82   | 82   | 82   | 82   |
| Heavy Vehicles, %        | 12   | 12   | 12   | 0    | 0    | 0    | 10   | 10   | 10   | 10   | 10   | 10   |
| Mvmt Flow                | 98   | 134  | 110  | 12   | 122  | 24   | 61   | 122  | 24   | 12   | 207  | 98   |

| Major/Minor          | Minor2 |       | Minor1 |     | Major1 |     | Major2 |   |   |      |   |   |
|----------------------|--------|-------|--------|-----|--------|-----|--------|---|---|------|---|---|
| Conflicting Flow All | 609    | 549   | 256    | 659 | 586    | 135 | 305    | 0 | 0 | 147  | 0 | 0 |
| Stage 1              | 280    | 280   | -      | 257 | 257    | -   | -      | - | - | -    | - | - |
| Stage 2              | 329    | 269   | -      | 402 | 329    | -   | -      | - | - | -    | - | - |
| Critical Hdwy        | 7.22   | 6.62  | 6.32   | 7.1 | 6.5    | 6.2 | 4.2    | - | - | 4.2  | - | - |
| Critical Hdwy Stg 1  | 6.22   | 5.62  | -      | 6.1 | 5.5    | -   | -      | - | - | -    | - | - |
| Critical Hdwy Stg 2  | 6.22   | 5.62  | -      | 6.1 | 5.5    | -   | -      | - | - | -    | - | - |
| Follow-up Hdwy       | 3.608  | 4.108 | 3.408  | 3.5 | 4      | 3.3 | 2.29   | - | - | 2.29 | - | - |
| Pot Cap-1 Maneuver   | 393    | 430   | 759    | 380 | 425    | 919 | 1212   | - | - | 1387 | - | - |
| Stage 1              | 705    | 661   | -      | 752 | 699    | -   | -      | - | - | -    | - | - |
| Stage 2              | 663    | 669   | -      | 629 | 650    | -   | -      | - | - | -    | - | - |
| Platoon blocked, %   |        |       |        |     |        |     |        | - | - | -    | - | - |
| Mov Cap-1 Maneuver   | 278    | 402   | 759    | 230 | 397    | 918 | 1212   | - | - | 1386 | - | - |
| Mov Cap-2 Maneuver   | 278    | 402   | -      | 230 | 397    | -   | -      | - | - | -    | - | - |
| Stage 1              | 666    | 654   | -      | 710 | 660    | -   | -      | - | - | -    | - | - |
| Stage 2              | 497    | 632   | -      | 423 | 643    | -   | -      | - | - | -    | - | - |

| Approach             | EB   |  | WB   |  | NB  |  | SB  |  |
|----------------------|------|--|------|--|-----|--|-----|--|
| HCM Control Delay, s | 44.1 |  | 19.2 |  | 2.4 |  | 0.3 |  |
| HCM LOS              | E    |  | C    |  |     |  |     |  |

| Minor Lane/Major Mvmt | NBL  | NBT | NBR | EBLn1 | WBLn1 | SBL   | SBT | SBR |
|-----------------------|------|-----|-----|-------|-------|-------|-----|-----|
| Capacity (veh/h)      | 1212 | -   | -   | 412   | 410   | 1386  | -   | -   |
| HCM Lane V/C Ratio    | 0.05 | -   | -   | 0.829 | 0.387 | 0.009 | -   | -   |
| HCM Control Delay (s) | 8.1  | 0   | -   | 44.1  | 19.2  | 7.6   | 0   | -   |
| HCM Lane LOS          | A    | A   | -   | E     | C     | A     | A   | -   |
| HCM 95th %tile Q(veh) | 0.2  | -   | -   | 7.7   | 1.8   | 0     | -   | -   |

| Intersection             |      |      |      |      |      |      |
|--------------------------|------|------|------|------|------|------|
| Int Delay, s/veh         | 3.9  |      |      |      |      |      |
| Movement                 | EBL  | EBR  | NBL  | NBT  | SBT  | SBR  |
| Lane Configurations      | T    |      |      | T    |      |      |
| Traffic Vol, veh/h       | 130  | 10   | 10   | 230  | 420  | 130  |
| Future Vol, veh/h        | 130  | 10   | 10   | 230  | 420  | 130  |
| Conflicting Peds, #/hr   | 0    | 0    | 0    | 0    | 0    | 0    |
| Sign Control             | Stop | Stop | Free | Free | Free | Free |
| RT Channelized           | -    | None | -    | None | -    | None |
| Storage Length           | 0    | -    | -    | -    | -    | -    |
| Veh in Median Storage, # | 0    | -    | -    | 0    | 0    | -    |
| Grade, %                 | 0    | -    | -    | 0    | 0    | -    |
| Peak Hour Factor         | 89   | 89   | 89   | 89   | 89   | 89   |
| Heavy Vehicles, %        | 13   | 13   | 2    | 2    | 0    | 0    |
| Mvmt Flow                | 146  | 11   | 11   | 258  | 472  | 146  |























| Major/Minor          | Minor2 | Major1 |       | Major2 |   |
|----------------------|--------|--------|-------|--------|---|
| Conflicting Flow All | 825    | 545    | 618   | 0      | 0 |
| Stage 1              | 545    | -      | -     | -      | - |
| Stage 2              | 280    | -      | -     | -      | - |
| Critical Hdwy        | 6.53   | 6.33   | 4.12  | -      | - |
| Critical Hdwy Stg 1  | 5.53   | -      | -     | -      | - |
| Critical Hdwy Stg 2  | 5.53   | -      | -     | -      | - |
| Follow-up Hdwy       | 3.617  | 3.417  | 2.218 | -      | - |
| Pot Cap-1 Maneuver   | 328    | 518    | 962   | -      | - |
| Stage 1              | 560    | -      | -     | -      | - |
| Stage 2              | 743    | -      | -     | -      | - |
| Platoon blocked, %   |        |        |       | -      | - |
| Mov Cap-1 Maneuver   | 324    | 518    | 962   | -      | - |
| Mov Cap-2 Maneuver   | 324    | -      | -     | -      | - |
| Stage 1              | 553    | -      | -     | -      | - |
| Stage 2              | 743    | -      | -     | -      | - |

| Approach             | EB   | NB  | SB |
|----------------------|------|-----|----|
| HCM Control Delay, s | 25.1 | 0.4 | 0  |
| HCM LOS              | D    |     |    |

| Minor Lane/Major Mvmt | NBL   | NBT | EBLn1 | SBT | SBR |
|-----------------------|-------|-----|-------|-----|-----|
| Capacity (veh/h)      | 962   | -   | 333   | -   | -   |
| HCM Lane V/C Ratio    | 0.012 | -   | 0.472 | -   | -   |
| HCM Control Delay (s) | 8.8   | 0   | 25.1  | -   | -   |
| HCM Lane LOS          | A     | A   | D     | -   | -   |
| HCM 95th %tile Q(veh) | 0     | -   | 2.4   | -   | -   |

HCM 2010 Signalized Intersection Summary  
 39: General Jim Moore Boulevard & Gigling Road

Cumulative, AM  
 06/11/2019

|                              |  |  |  |  |  |  |  |  |  |  |  |  |
|------------------------------|---|---|---|---|---|---|--|---|---|---|---|---|
| Movement                     | EBL   | EBT   | EBR   | WBL   | WBT   | WBR   | NBL  | NBT   | NBR   | SBL   | SBT   | SBR   |
| Lane Configurations          |  |  |   |  |  |  |  |  |  |  |  |  |
| Traffic Volume (veh/h)       | 30  | 100   | 80  | 420   | 40  | 260   | 50   | 460   | 200   | 230   | 710   | 50  |
| Future Volume (veh/h)        | 30  | 100   | 80  | 420   | 40  | 260   | 50   | 460   | 200   | 230   | 710   | 50  |
| Number                       | 3   | 8   | 18  | 7   | 4   | 14  | 1  | 6   | 16  | 5   | 2   | 12  |
| Initial Q (Qb), veh          | 0   | 0   | 0   | 0   | 0   | 0   | 0  | 0   | 0   | 0   | 0   | 0   |
| Ped-Bike Adj(A_pbT)          | 1.00  |   | 1.00  | 1.00  |   | 1.00  | 1.00   |   | 1.00  | 1.00  |   | 1.00  |
| Parking Bus, Adj             | 1.00  | 1.00  | 1.00  | 1.00  | 1.00  | 1.00  | 1.00   | 1.00  | 1.00  | 1.00  | 1.00  | 1.00  |
| Adj Sat Flow, veh/h/ln       | 1810  | 1810  | 1900  | 1863  | 1863  | 1863  | 1881   | 1881  | 1881  | 1863  | 1863  | 1863  |
| Adj Flow Rate, veh/h         | 34  | 115   | 60  | 483   | 46  | 0   | 57   | 529   | 0   | 264   | 816   | 0   |
| Adj No. of Lanes             | 1   | 2   | 0   | 1   | 2   | 1   | 1  | 2   | 1   | 1   | 2   | 1   |
| Peak Hour Factor             | 0.87  | 0.87  | 0.87  | 0.87  | 0.87  | 0.87  | 0.87   | 0.87  | 0.87  | 0.87  | 0.87  | 0.87  |
| Percent Heavy Veh, %         | 5   | 5   | 5   | 2   | 2   | 2   | 1  | 1   | 1   | 2   | 2   | 2   |
| Cap, veh/h                   | 60  | 195   | 96  | 521   | 1226  | 549   | 87   | 646   | 289   | 307   | 1082  | 484   |
| Arrive On Green              | 0.03  | 0.09  | 0.09  | 0.29  | 0.35  | 0.00  | 0.05   | 0.18  | 0.00  | 0.17  | 0.31  | 0.00  |
| Sat Flow, veh/h              | 1723  | 2232  | 1098  | 1774  | 3539  | 1583  | 1792   | 3574  | 1599  | 1774  | 3539  | 1583  |
| Grp Volume(v), veh/h         | 34  | 87  | 88  | 483   | 46  | 0   | 57   | 529   | 0   | 264   | 816   | 0   |
| Grp Sat Flow(s),veh/h/ln     | 1723  | 1719  | 1611  | 1774  | 1770  | 1583  | 1792   | 1787  | 1599  | 1774  | 1770  | 1583  |
| Q Serve(g_s), s              | 1.3   | 3.3   | 3.6   | 18.0  | 0.6   | 0.0   | 2.1  | 9.7   | 0.0   | 9.8   | 14.2  | 0.0   |
| Cycle Q Clear(g_c), s        | 1.3   | 3.3   | 3.6   | 18.0  | 0.6   | 0.0   | 2.1  | 9.7   | 0.0   | 9.8   | 14.2  | 0.0   |
| Prop In Lane                 | 1.00  |   | 0.68  | 1.00  |   | 1.00  | 1.00   |   | 1.00  | 1.00  |   | 1.00  |
| Lane Grp Cap(c), veh/h       | 60  | 150   | 141   | 521   | 1226  | 549   | 87   | 646   | 289   | 307   | 1082  | 484   |
| V/C Ratio(X)                 | 0.57  | 0.58  | 0.62  | 0.93  | 0.04  | 0.00  | 0.66   | 0.82  | 0.00  | 0.86  | 0.75  | 0.00  |
| Avail Cap(c_a), veh/h        | 266   | 783   | 734   | 535   | 2133  | 954   | 145  | 1314  | 588   | 404   | 1821  | 815   |
| HCM Platoon Ratio            | 1.00  | 1.00  | 1.00  | 1.00  | 1.00  | 1.00  | 1.00   | 1.00  | 1.00  | 1.00  | 1.00  | 1.00  |
| Upstream Filter(I)           | 1.00  | 1.00  | 1.00  | 1.00  | 1.00  | 0.00  | 1.00   | 1.00  | 0.00  | 1.00  | 1.00  | 0.00  |
| Uniform Delay (d), s/veh     | 32.3  | 29.8  | 30.0  | 23.3  | 14.7  | 0.0   | 31.8   | 26.8  | 0.0   | 27.3  | 21.3  | 0.0   |
| Incr Delay (d2), s/veh       | 3.1   | 1.3   | 1.7   | 21.7  | 0.0   | 0.0   | 3.1  | 1.0   | 0.0   | 11.0  | 0.4   | 0.0   |
| Initial Q Delay(d3),s/veh    | 0.0   | 0.0   | 0.0   | 0.0   | 0.0   | 0.0   | 0.0  | 0.0   | 0.0   | 0.0   | 0.0   | 0.0   |
| %ile BackOfQ(50%),veh/ln     | 0.7   | 1.6   | 1.7   | 11.9  | 0.3   | 0.0   | 1.1  | 4.9   | 0.0   | 5.7   | 7.0   | 0.0   |
| LnGrp Delay(d),s/veh         | 35.4  | 31.1  | 31.6  | 45.0  | 14.7  | 0.0   | 34.9   | 27.8  | 0.0   | 38.3  | 21.7  | 0.0   |
| LnGrp LOS                    | D   | C   | C   | D   | B   |   | C  | C   |   | D   | C   |   |
| Approach Vol, veh/h          |   | 209   |   |   | 529   |   |  | 586   |   |   | 1080  |   |
| Approach Delay, s/veh        |   | 32.0  |   |   | 42.3  |   |  | 28.5  |   |   | 25.8  |   |
| Approach LOS                 |   | C   |   |   | D   |   |  | C   |   |   | C   |   |
| Timer                        | 1   | 2   | 3   | 4   | 5   | 6   | 7  | 8   |   |   |   |   |
| Assigned Phs                 | 1   | 2   | 3   | 4   | 5   | 6   | 7  | 8   |   |   |   |   |
| Phs Duration (G+Y+Rc), s     | 7.8   | 25.3  | 6.9   | 28.1  | 16.3  | 16.8  | 24.5   | 10.5  |   |   |   |   |
| Change Period (Y+Rc), s      | 4.5   | 4.5   | 4.5   | 4.5   | 4.5   | 4.5   | 4.5  | 4.5   |   |   |   |   |
| Max Green Setting (Gmax), s  | 5.5   | 35.0  | 10.5  | 41.0  | 15.5  | 25.0  | 20.5   | 31.0  |   |   |   |   |
| Max Q Clear Time (g_c+I1), s | 4.1   | 16.2  | 3.3   | 2.6   | 11.8  | 11.7  | 20.0   | 5.6   |   |   |   |   |
| Green Ext Time (p_c), s      | 0.0   | 1.1   | 0.0   | 0.1   | 0.0   | 0.6   | 0.0  | 0.2   |   |   |   |   |
| <b>Intersection Summary</b>  |   |   |   |   |   |   |  |   |   |   |   |   |
| HCM 2010 Ctrl Delay          |   |   | 30.6  |   |   |   |  |   |   |   |   |   |
| HCM 2010 LOS                 |   |   | C   |   |   |   |  |   |   |   |   |   |
| <b>Notes</b>                 |   |   |   |   |   |   |  |   |   |   |   |   |

HCM 2010 Signalized Intersection Summary  
40: Malmedy Road & Gigling Road

Cumulative, AM  
06/11/2019



| Movement                     | EBL  | EBT  | EBR  | WBL  | WBT  | WBR  | NBL  | NBT  | NBR  | SBL  | SBT  | SBR  |
|------------------------------|------|------|------|------|------|------|------|------|------|------|------|------|
| Lane Configurations          |      | ↔↑   |      |      | ↔↑   |      |      | ↔    |      |      | ↔    |      |
| Traffic Volume (veh/h)       | 20   | 420  | 30   | 50   | 610  | 10   | 20   | 30   | 30   | 10   | 60   | 70   |
| Future Volume (veh/h)        | 20   | 420  | 30   | 50   | 610  | 10   | 20   | 30   | 30   | 10   | 60   | 70   |
| Number                       | 7    | 4    | 14   | 3    | 8    | 18   | 5    | 2    | 12   | 1    | 6    | 16   |
| Initial Q (Qb), veh          | 0    | 0    | 0    | 0    | 0    | 0    | 0    | 0    | 0    | 0    | 0    | 0    |
| Ped-Bike Adj(A_pbT)          | 1.00 |      | 1.00 | 1.00 |      | 1.00 | 1.00 |      | 1.00 | 1.00 |      | 1.00 |
| Parking Bus, Adj             | 1.00 | 1.00 | 1.00 | 1.00 | 1.00 | 1.00 | 1.00 | 1.00 | 1.00 | 1.00 | 1.00 | 1.00 |
| Adj Sat Flow, veh/h/ln       | 1900 | 1845 | 1900 | 1900 | 1845 | 1900 | 1900 | 1863 | 1900 | 1900 | 1827 | 1900 |
| Adj Flow Rate, veh/h         | 23   | 477  | 34   | 57   | 693  | 11   | 23   | 34   | 34   | 11   | 68   | 80   |
| Adj No. of Lanes             | 0    | 2    | 0    | 0    | 2    | 0    | 0    | 1    | 0    | 0    | 1    | 0    |
| Peak Hour Factor             | 0.88 | 0.88 | 0.88 | 0.88 | 0.88 | 0.88 | 0.88 | 0.88 | 0.88 | 0.88 | 0.88 | 0.88 |
| Percent Heavy Veh, %         | 3    | 3    | 3    | 3    | 3    | 3    | 2    | 2    | 2    | 4    | 4    | 4    |
| Cap, veh/h                   | 224  | 1029 | 74   | 264  | 1070 | 17   | 295  | 140  | 119  | 216  | 143  | 159  |
| Arrive On Green              | 0.34 | 0.34 | 0.34 | 0.34 | 0.34 | 0.34 | 0.19 | 0.19 | 0.19 | 0.19 | 0.19 | 0.19 |
| Sat Flow, veh/h              | 61   | 3042 | 218  | 143  | 3163 | 50   | 309  | 731  | 620  | 77   | 743  | 830  |
| Grp Volume(v), veh/h         | 279  | 0    | 255  | 393  | 0    | 368  | 91   | 0    | 0    | 159  | 0    | 0    |
| Grp Sat Flow(s),veh/h/ln     | 1681 | 0    | 1640 | 1686 | 0    | 1670 | 1661 | 0    | 0    | 1650 | 0    | 0    |
| Q Serve(g_s), s              | 0.1  | 0.0  | 2.3  | 1.2  | 0.0  | 3.6  | 0.0  | 0.0  | 0.0  | 0.4  | 0.0  | 0.0  |
| Cycle Q Clear(g_c), s        | 3.6  | 0.0  | 2.3  | 3.6  | 0.0  | 3.6  | 0.9  | 0.0  | 0.0  | 1.6  | 0.0  | 0.0  |
| Prop In Lane                 | 0.08 |      | 0.13 | 0.14 |      | 0.03 | 0.25 |      | 0.37 | 0.07 |      | 0.50 |
| Lane Grp Cap(c), veh/h       | 772  | 0    | 555  | 786  | 0    | 565  | 554  | 0    | 0    | 518  | 0    | 0    |
| V/C Ratio(X)                 | 0.36 | 0.00 | 0.46 | 0.50 | 0.00 | 0.65 | 0.16 | 0.00 | 0.00 | 0.31 | 0.00 | 0.00 |
| Avail Cap(c_a), veh/h        | 4539 | 0    | 4322 | 4438 | 0    | 4401 | 2737 | 0    | 0    | 2808 | 0    | 0    |
| HCM Platoon Ratio            | 1.00 | 1.00 | 1.00 | 1.00 | 1.00 | 1.00 | 1.00 | 1.00 | 1.00 | 1.00 | 1.00 | 1.00 |
| Upstream Filter(I)           | 1.00 | 0.00 | 1.00 | 1.00 | 0.00 | 1.00 | 1.00 | 0.00 | 0.00 | 1.00 | 0.00 | 0.00 |
| Uniform Delay (d), s/veh     | 4.9  | 0.0  | 5.0  | 5.4  | 0.0  | 5.4  | 6.6  | 0.0  | 0.0  | 6.9  | 0.0  | 0.0  |
| Incr Delay (d2), s/veh       | 0.1  | 0.0  | 0.2  | 0.2  | 0.0  | 0.5  | 0.1  | 0.0  | 0.0  | 0.1  | 0.0  | 0.0  |
| Initial Q Delay(d3),s/veh    | 0.0  | 0.0  | 0.0  | 0.0  | 0.0  | 0.0  | 0.0  | 0.0  | 0.0  | 0.0  | 0.0  | 0.0  |
| %ile BackOfQ(50%),veh/ln     | 1.1  | 0.0  | 1.0  | 1.8  | 0.0  | 1.7  | 0.4  | 0.0  | 0.0  | 0.8  | 0.0  | 0.0  |
| LnGrp Delay(d),s/veh         | 5.0  | 0.0  | 5.2  | 5.5  | 0.0  | 5.9  | 6.6  | 0.0  | 0.0  | 7.0  | 0.0  | 0.0  |
| LnGrp LOS                    | A    |      | A    | A    |      | A    | A    |      |      | A    |      |      |
| Approach Vol, veh/h          |      | 534  |      |      | 761  |      |      | 91   |      |      | 159  |      |
| Approach Delay, s/veh        |      | 5.1  |      |      | 5.7  |      |      | 6.6  |      |      | 7.0  |      |
| Approach LOS                 |      | A    |      |      | A    |      |      | A    |      |      | A    |      |
| Timer                        | 1    | 2    | 3    | 4    | 5    | 6    | 7    | 8    |      |      |      |      |
| Assigned Phs                 |      | 2    |      | 4    |      | 6    |      | 8    |      |      |      |      |
| Phs Duration (G+Y+Rc), s     |      | 8.2  |      | 11.0 |      | 8.2  |      | 11.0 |      |      |      |      |
| Change Period (Y+Rc), s      |      | 4.5  |      | 4.5  |      | 4.5  |      | 4.5  |      |      |      |      |
| Max Green Setting (Gmax), s  |      | 30.5 |      | 50.5 |      | 30.5 |      | 50.5 |      |      |      |      |
| Max Q Clear Time (g_c+I1), s |      | 2.9  |      | 5.6  |      | 3.6  |      | 5.6  |      |      |      |      |
| Green Ext Time (p_c), s      |      | 0.1  |      | 0.5  |      | 0.2  |      | 0.8  |      |      |      |      |
| <b>Intersection Summary</b>  |      |      |      |      |      |      |      |      |      |      |      |      |
| HCM 2010 Ctrl Delay          |      |      |      | 5.7  |      |      |      |      |      |      |      |      |
| HCM 2010 LOS                 |      |      |      | A    |      |      |      |      |      |      |      |      |

HCM 2010 Signalized Intersection Summary  
 41: Parker Flatts Cut Off Road & Gigling Road

Cumulative, AM  
 06/11/2019



| Movement                     | EBL  | EBT  | EBR  | WBL  | WBT  | WBR  | NBL  | NBT  | NBR  | SBL  | SBT  | SBR  |
|------------------------------|------|------|------|------|------|------|------|------|------|------|------|------|
| Lane Configurations          |      | ↔↑   |      |      | ↔↑   |      |      | ↔    | ↔    |      | ↔    |      |
| Traffic Volume (veh/h)       | 10   | 370  | 80   | 110  | 610  | 10   | 40   | 10   | 50   | 10   | 30   | 10   |
| Future Volume (veh/h)        | 10   | 370  | 80   | 110  | 610  | 10   | 40   | 10   | 50   | 10   | 30   | 10   |
| Number                       | 7    | 4    | 14   | 3    | 8    | 18   | 5    | 2    | 12   | 1    | 6    | 16   |
| Initial Q (Qb), veh          | 0    | 0    | 0    | 0    | 0    | 0    | 0    | 0    | 0    | 0    | 0    | 0    |
| Ped-Bike Adj(A_pbT)          | 1.00 |      | 1.00 | 1.00 |      | 1.00 | 1.00 |      | 1.00 | 1.00 |      | 1.00 |
| Parking Bus, Adj             | 1.00 | 1.00 | 1.00 | 1.00 | 1.00 | 1.00 | 1.00 | 1.00 | 1.00 | 1.00 | 1.00 | 1.00 |
| Adj Sat Flow, veh/h/ln       | 1900 | 1845 | 1900 | 1900 | 1863 | 1900 | 1900 | 1863 | 1863 | 1900 | 1900 | 1900 |
| Adj Flow Rate, veh/h         | 12   | 440  | 95   | 131  | 726  | 12   | 48   | 12   | 60   | 12   | 36   | 12   |
| Adj No. of Lanes             | 0    | 2    | 0    | 0    | 2    | 0    | 0    | 1    | 1    | 0    | 1    | 0    |
| Peak Hour Factor             | 0.84 | 0.84 | 0.84 | 0.84 | 0.84 | 0.84 | 0.84 | 0.84 | 0.84 | 0.84 | 0.84 | 0.84 |
| Percent Heavy Veh, %         | 3    | 3    | 3    | 2    | 2    | 2    | 2    | 2    | 2    | 0    | 0    | 0    |
| Cap, veh/h                   | 195  | 1105 | 235  | 350  | 1112 | 19   | 489  | 66   | 249  | 254  | 176  | 54   |
| Arrive On Green              | 0.40 | 0.40 | 0.40 | 0.40 | 0.40 | 0.40 | 0.16 | 0.16 | 0.16 | 0.16 | 0.16 | 0.16 |
| Sat Flow, veh/h              | 26   | 2764 | 588  | 297  | 2782 | 46   | 1081 | 420  | 1583 | 263  | 1122 | 346  |
| Grp Volume(v), veh/h         | 292  | 0    | 255  | 433  | 0    | 436  | 60   | 0    | 60   | 60   | 0    | 0    |
| Grp Sat Flow(s),veh/h/ln     | 1803 | 0    | 1575 | 1439 | 0    | 1687 | 1502 | 0    | 1583 | 1731 | 0    | 0    |
| Q Serve(g_s), s              | 0.0  | 0.0  | 2.4  | 2.7  | 0.0  | 4.2  | 0.0  | 0.0  | 0.7  | 0.0  | 0.0  | 0.0  |
| Cycle Q Clear(g_c), s        | 2.3  | 0.0  | 2.4  | 5.1  | 0.0  | 4.2  | 0.6  | 0.0  | 0.7  | 0.6  | 0.0  | 0.0  |
| Prop In Lane                 | 0.04 |      | 0.37 | 0.30 |      | 0.03 | 0.80 |      | 1.00 | 0.20 |      | 0.20 |
| Lane Grp Cap(c), veh/h       | 905  | 0    | 630  | 806  | 0    | 674  | 555  | 0    | 249  | 485  | 0    | 0    |
| V/C Ratio(X)                 | 0.32 | 0.00 | 0.40 | 0.54 | 0.00 | 0.65 | 0.11 | 0.00 | 0.24 | 0.12 | 0.00 | 0.00 |
| Avail Cap(c_a), veh/h        | 4944 | 0    | 4304 | 4030 | 0    | 4610 | 2126 | 0    | 1988 | 2353 | 0    | 0    |
| HCM Platoon Ratio            | 1.00 | 1.00 | 1.00 | 1.00 | 1.00 | 1.00 | 1.00 | 1.00 | 1.00 | 1.00 | 1.00 | 1.00 |
| Upstream Filter(I)           | 1.00 | 0.00 | 1.00 | 1.00 | 0.00 | 1.00 | 1.00 | 0.00 | 1.00 | 1.00 | 0.00 | 0.00 |
| Uniform Delay (d), s/veh     | 4.3  | 0.0  | 4.4  | 5.0  | 0.0  | 4.9  | 7.5  | 0.0  | 7.5  | 7.5  | 0.0  | 0.0  |
| Incr Delay (d2), s/veh       | 0.1  | 0.0  | 0.2  | 0.2  | 0.0  | 0.4  | 0.0  | 0.0  | 0.2  | 0.0  | 0.0  | 0.0  |
| Initial Q Delay(d3),s/veh    | 0.0  | 0.0  | 0.0  | 0.0  | 0.0  | 0.0  | 0.0  | 0.0  | 0.0  | 0.0  | 0.0  | 0.0  |
| %ile BackOfQ(50%),veh/ln     | 1.2  | 0.0  | 1.0  | 2.0  | 0.0  | 2.0  | 0.3  | 0.0  | 0.3  | 0.3  | 0.0  | 0.0  |
| LnGrp Delay(d),s/veh         | 4.4  | 0.0  | 4.5  | 5.2  | 0.0  | 5.3  | 7.5  | 0.0  | 7.7  | 7.5  | 0.0  | 0.0  |
| LnGrp LOS                    | A    |      | A    | A    |      | A    | A    |      | A    | A    |      |      |
| Approach Vol, veh/h          |      | 547  |      |      | 869  |      |      | 120  |      |      | 60   |      |
| Approach Delay, s/veh        |      | 4.5  |      |      | 5.3  |      |      | 7.6  |      |      | 7.5  |      |
| Approach LOS                 |      | A    |      |      | A    |      |      | A    |      |      | A    |      |
| Timer                        | 1    | 2    | 3    | 4    | 5    | 6    | 7    | 8    |      |      |      |      |
| Assigned Phs                 |      | 2    |      | 4    |      | 6    |      | 8    |      |      |      |      |
| Phs Duration (G+Y+Rc), s     |      | 7.7  |      | 12.6 |      | 7.7  |      | 12.6 |      |      |      |      |
| Change Period (Y+Rc), s      |      | 4.5  |      | 4.5  |      | 4.5  |      | 4.5  |      |      |      |      |
| Max Green Setting (Gmax), s  |      | 25.5 |      | 55.5 |      | 25.5 |      | 55.5 |      |      |      |      |
| Max Q Clear Time (g_c+I1), s |      | 2.7  |      | 4.4  |      | 2.6  |      | 7.1  |      |      |      |      |
| Green Ext Time (p_c), s      |      | 0.0  |      | 0.5  |      | 0.0  |      | 1.0  |      |      |      |      |
| <b>Intersection Summary</b>  |      |      |      |      |      |      |      |      |      |      |      |      |
| HCM 2010 Ctrl Delay          |      |      |      | 5.3  |      |      |      |      |      |      |      |      |
| HCM 2010 LOS                 |      |      |      | A    |      |      |      |      |      |      |      |      |

HCM 2010 Signalized Intersection Summary  
42: 6th Avenue & Gigling Road

Cumulative, AM  
06/11/2019



| Movement                     | EBL  | EBT  | EBR  | WBL  | WBT  | WBR  | NBL  | NBT  | NBR  | SBL  | SBT  | SBR  |
|------------------------------|------|------|------|------|------|------|------|------|------|------|------|------|
| Lane Configurations          |      | ↔    |      |      | ↔    |      |      | ↔    | ↔    |      | ↔    |      |
| Traffic Volume (veh/h)       | 90   | 340  | 10   | 30   | 610  | 10   | 10   | 10   | 10   | 10   | 10   | 120  |
| Future Volume (veh/h)        | 90   | 340  | 10   | 30   | 610  | 10   | 10   | 10   | 10   | 10   | 10   | 120  |
| Number                       | 7    | 4    | 14   | 3    | 8    | 18   | 5    | 2    | 12   | 1    | 6    | 16   |
| Initial Q (Qb), veh          | 0    | 0    | 0    | 0    | 0    | 0    | 0    | 0    | 0    | 0    | 0    | 0    |
| Ped-Bike Adj(A_pbT)          | 1.00 |      | 1.00 | 1.00 |      | 1.00 | 1.00 |      | 1.00 | 1.00 |      | 1.00 |
| Parking Bus, Adj             | 1.00 | 1.00 | 1.00 | 1.00 | 1.00 | 1.00 | 1.00 | 1.00 | 1.00 | 1.00 | 1.00 | 1.00 |
| Adj Sat Flow, veh/h/ln       | 1900 | 1845 | 1900 | 1900 | 1863 | 1900 | 1900 | 1429 | 1429 | 1900 | 1863 | 1900 |
| Adj Flow Rate, veh/h         | 101  | 382  | 11   | 34   | 685  | 11   | 11   | 11   | 0    | 11   | 11   | 135  |
| Adj No. of Lanes             | 0    | 2    | 0    | 0    | 2    | 0    | 0    | 1    | 1    | 0    | 1    | 0    |
| Peak Hour Factor             | 0.89 | 0.89 | 0.89 | 0.89 | 0.89 | 0.89 | 0.89 | 0.89 | 0.89 | 0.89 | 0.89 | 0.89 |
| Percent Heavy Veh, %         | 3    | 3    | 3    | 2    | 2    | 2    | 33   | 33   | 33   | 2    | 2    | 2    |
| Cap, veh/h                   | 354  | 846  | 26   | 237  | 1163 | 19   | 364  | 144  | 209  | 220  | 24   | 236  |
| Arrive On Green              | 0.35 | 0.35 | 0.35 | 0.35 | 0.35 | 0.35 | 0.17 | 0.17 | 0.00 | 0.17 | 0.17 | 0.17 |
| Sat Flow, veh/h              | 240  | 2430 | 74   | 82   | 3341 | 53   | 445  | 837  | 1214 | 83   | 140  | 1367 |
| Grp Volume(v), veh/h         | 247  | 0    | 247  | 382  | 0    | 348  | 22   | 0    | 0    | 157  | 0    | 0    |
| Grp Sat Flow(s),veh/h/ln1078 | 0    | 1666 | 1790 | 0    | 1686 | 1281 | 0    | 1214 | 1590 | 0    | 0    | 0    |
| Q Serve(g_s), s              | 0.7  | 0.0  | 2.1  | 0.1  | 0.0  | 3.2  | 0.0  | 0.0  | 0.0  | 0.9  | 0.0  | 0.0  |
| Cycle Q Clear(g_c), s        | 3.8  | 0.0  | 2.1  | 3.2  | 0.0  | 3.2  | 0.2  | 0.0  | 0.0  | 1.7  | 0.0  | 0.0  |
| Prop In Lane                 | 0.41 |      | 0.04 | 0.09 |      | 0.03 | 0.50 |      | 1.00 | 0.07 |      | 0.86 |
| Lane Grp Cap(c), veh/h       | 646  | 0    | 580  | 832  | 0    | 587  | 509  | 0    | 209  | 479  | 0    | 0    |
| V/C Ratio(X)                 | 0.38 | 0.00 | 0.43 | 0.46 | 0.00 | 0.59 | 0.04 | 0.00 | 0.00 | 0.33 | 0.00 | 0.00 |
| Avail Cap(c_a), veh/h        | 3326 | 0    | 4482 | 4877 | 0    | 4537 | 2163 | 0    | 1974 | 2778 | 0    | 0    |
| HCM Platoon Ratio            | 1.00 | 1.00 | 1.00 | 1.00 | 1.00 | 1.00 | 1.00 | 1.00 | 1.00 | 1.00 | 1.00 | 1.00 |
| Upstream Filter(I)           | 1.00 | 0.00 | 1.00 | 1.00 | 0.00 | 1.00 | 1.00 | 0.00 | 0.00 | 1.00 | 0.00 | 0.00 |
| Uniform Delay (d), s/veh     | 4.8  | 0.0  | 4.7  | 5.0  | 0.0  | 5.0  | 6.5  | 0.0  | 0.0  | 7.1  | 0.0  | 0.0  |
| Incr Delay (d2), s/veh       | 0.1  | 0.0  | 0.2  | 0.1  | 0.0  | 0.4  | 0.0  | 0.0  | 0.0  | 0.1  | 0.0  | 0.0  |
| Initial Q Delay(d3),s/veh    | 0.0  | 0.0  | 0.0  | 0.0  | 0.0  | 0.0  | 0.0  | 0.0  | 0.0  | 0.0  | 0.0  | 0.0  |
| %ile BackOfQ(50%),veh/ln1.1  | 0.0  | 1.0  | 1.6  | 0.0  | 1.5  | 0.1  | 0.0  | 0.0  | 0.0  | 0.8  | 0.0  | 0.0  |
| LnGrp Delay(d),s/veh         | 4.9  | 0.0  | 4.9  | 5.2  | 0.0  | 5.4  | 6.5  | 0.0  | 0.0  | 7.3  | 0.0  | 0.0  |
| LnGrp LOS                    | A    |      | A    | A    |      | A    | A    |      |      | A    |      |      |
| Approach Vol, veh/h          |      | 494  |      |      | 730  |      |      | 22   |      |      | 157  |      |
| Approach Delay, s/veh        |      | 4.9  |      |      | 5.3  |      |      | 6.5  |      |      | 7.3  |      |
| Approach LOS                 |      | A    |      |      | A    |      |      | A    |      |      | A    |      |
| Timer                        | 1    | 2    | 3    | 4    | 5    | 6    | 7    | 8    |      |      |      |      |
| Assigned Phs                 |      | 2    |      | 4    |      | 6    |      | 8    |      |      |      |      |
| Phs Duration (G+Y+Rc), s     |      | 7.7  |      | 11.0 |      | 7.7  |      | 11.0 |      |      |      |      |
| Change Period (Y+Rc), s      |      | 4.5  |      | 4.5  |      | 4.5  |      | 4.5  |      |      |      |      |
| Max Green Setting (Gmax), s  |      | 30.5 |      | 50.5 |      | 30.5 |      | 50.5 |      |      |      |      |
| Max Q Clear Time (g_c+I1), s |      | 2.2  |      | 5.8  |      | 3.7  |      | 5.2  |      |      |      |      |
| Green Ext Time (p_c), s      |      | 0.0  |      | 0.7  |      | 0.2  |      | 0.7  |      |      |      |      |
| <b>Intersection Summary</b>  |      |      |      |      |      |      |      |      |      |      |      |      |
| HCM 2010 Ctrl Delay          |      |      |      | 5.4  |      |      |      |      |      |      |      |      |
| HCM 2010 LOS                 |      |      |      | A    |      |      |      |      |      |      |      |      |



HCM 2010 Signalized Intersection Summary  
43: Gigling Road & 7th Avenue

Cumulative, AM  
06/11/2019

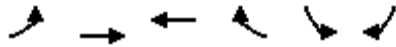

| Movement                     | EBL  | EBT  | WBT  | WBR  | SBL  | SBR  |   |      |
|------------------------------|------|------|------|------|------|------|---|------|
| Lane Configurations          |      | ↑↑   | ↑↑   |      | ↑↑   |      |   |      |
| Traffic Volume (veh/h)       | 130  | 230  | 420  | 10   | 10   | 230  |   |      |
| Future Volume (veh/h)        | 130  | 230  | 420  | 10   | 10   | 230  |   |      |
| Number                       | 7    | 4    | 8    | 18   | 1    | 16   |   |      |
| Initial Q (Qb), veh          | 0    | 0    | 0    | 0    | 0    | 0    |   |      |
| Ped-Bike Adj(A_pbT)          | 1.00 |      |      | 1.00 | 1.00 | 1.00 |   |      |
| Parking Bus, Adj             | 1.00 | 1.00 | 1.00 | 1.00 | 1.00 | 1.00 |   |      |
| Adj Sat Flow, veh/h/ln       | 1900 | 1845 | 1900 | 1900 | 1759 | 1900 |   |      |
| Adj Flow Rate, veh/h         | 151  | 267  | 488  | 12   | 12   | 267  |   |      |
| Adj No. of Lanes             | 0    | 2    | 2    | 0    | 0    | 0    |   |      |
| Peak Hour Factor             | 0.86 | 0.86 | 0.86 | 0.86 | 0.86 | 0.86 |   |      |
| Percent Heavy Veh, %         | 3    | 3    | 0    | 0    | 0    | 0    |   |      |
| Cap, veh/h                   | 462  | 700  | 1203 | 30   | 14   | 318  |   |      |
| Arrive On Green              | 0.33 | 0.33 | 0.33 | 0.33 | 0.22 | 0.22 |   |      |
| Sat Flow, veh/h              | 493  | 2178 | 3696 | 88   | 64   | 1433 |   |      |
| Grp Volume(v), veh/h         | 225  | 193  | 244  | 256  | 280  | 0    |   |      |
| Grp Sat Flow(s),veh/h/ln     | 993  | 1595 | 1805 | 1884 | 1503 | 0    |   |      |
| Q Serve(g_s), s              | 2.1  | 1.9  | 2.1  | 2.1  | 3.6  | 0.0  |   |      |
| Cycle Q Clear(g_c), s        | 4.2  | 1.9  | 2.1  | 2.1  | 3.6  | 0.0  |   |      |
| Prop In Lane                 | 0.67 |      |      | 0.05 | 0.04 | 0.95 |   |      |
| Lane Grp Cap(c), veh/h       | 629  | 533  | 603  | 630  | 334  | 0    |   |      |
| V/C Ratio(X)                 | 0.36 | 0.36 | 0.41 | 0.41 | 0.84 | 0.00 |   |      |
| Avail Cap(c_a), veh/h        | 3194 | 4365 | 4941 | 5158 | 1890 | 0    |   |      |
| HCM Platoon Ratio            | 1.00 | 1.00 | 1.00 | 1.00 | 1.00 | 1.00 |   |      |
| Upstream Filter(I)           | 1.00 | 1.00 | 1.00 | 1.00 | 1.00 | 0.00 |   |      |
| Uniform Delay (d), s/veh     | 5.8  | 5.1  | 5.2  | 5.2  | 7.5  | 0.0  |   |      |
| Incr Delay (d2), s/veh       | 0.1  | 0.2  | 0.2  | 0.2  | 2.2  | 0.0  |   |      |
| Initial Q Delay(d3),s/veh    | 0.0  | 0.0  | 0.0  | 0.0  | 0.0  | 0.0  |   |      |
| %ile BackOfQ(50%),veh/ln     | 1.1  | 0.8  | 1.0  | 1.1  | 1.7  | 0.0  |   |      |
| LnGrp Delay(d),s/veh         | 5.9  | 5.3  | 5.4  | 5.4  | 9.7  | 0.0  |   |      |
| LnGrp LOS                    | A    | A    | A    | A    | A    |      |   |      |
| Approach Vol, veh/h          |      | 418  | 500  |      | 280  |      |   |      |
| Approach Delay, s/veh        |      | 5.6  | 5.4  |      | 9.7  |      |   |      |
| Approach LOS                 |      | A    | A    |      | A    |      |   |      |
| Timer                        | 1    | 2    | 3    | 4    | 5    | 6    | 7 | 8    |
| Assigned Phs                 |      |      |      | 4    |      | 6    |   | 8    |
| Phs Duration (G+Y+Rc), s     |      |      |      | 11.3 |      | 9.0  |   | 11.3 |
| Change Period (Y+Rc), s      |      |      |      | 4.5  |      | 4.5  |   | 4.5  |
| Max Green Setting (Gmax), s  |      |      |      | 55.5 |      | 25.5 |   | 55.5 |
| Max Q Clear Time (g_c+I1), s |      |      |      | 6.2  |      | 5.6  |   | 4.1  |
| Green Ext Time (p_c), s      |      |      |      | 0.6  |      | 0.1  |   | 0.4  |
| <b>Intersection Summary</b>  |      |      |      |      |      |      |   |      |
| HCM 2010 Ctrl Delay          |      |      |      | 6.5  |      |      |   |      |
| HCM 2010 LOS                 |      |      |      | A    |      |      |   |      |
| <b>Notes</b>                 |      |      |      |      |      |      |   |      |

HCM 2010 Signalized Intersection Summary  
44: 8th Avenue & Gigling Road

Cumulative, AM  
06/11/2019



| Movement                     | EBL  | EBT  | EBR  | WBL  | WBT  | WBR  | NBL  | NBT  | NBR  | SBL  | SBT  | SBR  |
|------------------------------|------|------|------|------|------|------|------|------|------|------|------|------|
| Lane Configurations          |      | ↔↔   |      |      | ↔↔   |      |      | ↔    |      |      | ↔    |      |
| Traffic Volume (veh/h)       | 230  | 10   | 10   | 10   | 10   | 10   | 10   | 10   | 10   | 10   | 10   | 420  |
| Future Volume (veh/h)        | 230  | 10   | 10   | 10   | 10   | 10   | 10   | 10   | 10   | 10   | 10   | 420  |
| Number                       | 7    | 4    | 14   | 3    | 8    | 18   | 5    | 2    | 12   | 1    | 6    | 16   |
| Initial Q (Qb), veh          | 0    | 0    | 0    | 0    | 0    | 0    | 0    | 0    | 0    | 0    | 0    | 0    |
| Ped-Bike Adj(A_pbT)          | 1.00 |      | 1.00 | 1.00 |      | 1.00 | 1.00 |      | 1.00 | 1.00 |      | 1.00 |
| Parking Bus, Adj             | 1.00 | 1.00 | 1.00 | 1.00 | 1.00 | 1.00 | 1.00 | 1.00 | 1.00 | 1.00 | 1.00 | 1.00 |
| Adj Sat Flow, veh/h/ln       | 1900 | 1863 | 1900 | 1900 | 1863 | 1900 | 1900 | 1900 | 1900 | 1900 | 1900 | 1900 |
| Adj Flow Rate, veh/h         | 271  | 12   | 12   | 12   | 12   | 12   | 12   | 12   | 12   | 12   | 12   | 494  |
| Adj No. of Lanes             | 0    | 2    | 0    | 0    | 2    | 0    | 0    | 1    | 0    | 0    | 1    | 0    |
| Peak Hour Factor             | 0.85 | 0.85 | 0.85 | 0.85 | 0.85 | 0.85 | 0.85 | 0.85 | 0.85 | 0.85 | 0.85 | 0.85 |
| Percent Heavy Veh, %         | 2    | 2    | 2    | 2    | 2    | 2    | 0    | 0    | 0    | 0    | 0    | 0    |
| Cap, veh/h                   | 627  | 198  | 198  | 401  | 311  | 302  | 329  | 302  | 220  | 152  | 24   | 601  |
| Arrive On Green              | 0.25 | 0.25 | 0.25 | 0.25 | 0.25 | 0.25 | 0.39 | 0.39 | 0.39 | 0.39 | 0.39 | 0.39 |
| Sat Flow, veh/h              | 1340 | 779  | 779  | 693  | 1225 | 1188 | 356  | 779  | 567  | 14   | 61   | 1547 |
| Grp Volume(v), veh/h         | 271  | 0    | 24   | 21   | 0    | 15   | 36   | 0    | 0    | 518  | 0    | 0    |
| Grp Sat Flow(s),veh/h/ln     | 1340 | 0    | 1558 | 1621 | 0    | 1485 | 1702 | 0    | 0    | 1622 | 0    | 0    |
| Q Serve(g_s), s              | 4.6  | 0.0  | 0.3  | 0.0  | 0.0  | 0.2  | 0.0  | 0.0  | 0.0  | 1.1  | 0.0  | 0.0  |
| Cycle Q Clear(g_c), s        | 4.8  | 0.0  | 0.3  | 0.2  | 0.0  | 0.2  | 0.3  | 0.0  | 0.0  | 7.2  | 0.0  | 0.0  |
| Prop In Lane                 | 1.00 |      | 0.50 | 0.57 |      | 0.80 | 0.33 |      | 0.33 | 0.02 |      | 0.95 |
| Lane Grp Cap(c), veh/h       | 627  | 0    | 395  | 637  | 0    | 377  | 852  | 0    | 0    | 776  | 0    | 0    |
| V/C Ratio(X)                 | 0.43 | 0.00 | 0.06 | 0.03 | 0.00 | 0.04 | 0.04 | 0.00 | 0.00 | 0.67 | 0.00 | 0.00 |
| Avail Cap(c_a), veh/h        | 2226 | 0    | 2199 | 2435 | 0    | 2097 | 2749 | 0    | 0    | 3072 | 0    | 0    |
| HCM Platoon Ratio            | 1.00 | 1.00 | 1.00 | 1.00 | 1.00 | 1.00 | 1.00 | 1.00 | 1.00 | 1.00 | 1.00 | 1.00 |
| Upstream Filter(I)           | 1.00 | 0.00 | 1.00 | 1.00 | 0.00 | 1.00 | 1.00 | 0.00 | 0.00 | 1.00 | 0.00 | 0.00 |
| Uniform Delay (d), s/veh     | 8.9  | 0.0  | 7.1  | 7.1  | 0.0  | 7.1  | 4.8  | 0.0  | 0.0  | 6.9  | 0.0  | 0.0  |
| Incr Delay (d2), s/veh       | 0.2  | 0.0  | 0.0  | 0.0  | 0.0  | 0.0  | 0.0  | 0.0  | 0.0  | 0.4  | 0.0  | 0.0  |
| Initial Q Delay(d3),s/veh    | 0.0  | 0.0  | 0.0  | 0.0  | 0.0  | 0.0  | 0.0  | 0.0  | 0.0  | 0.0  | 0.0  | 0.0  |
| %ile BackOfQ(50%),veh/ln     | 1.8  | 0.0  | 0.1  | 0.1  | 0.0  | 0.1  | 0.2  | 0.0  | 0.0  | 3.2  | 0.0  | 0.0  |
| LnGrp Delay(d),s/veh         | 9.1  | 0.0  | 7.1  | 7.1  | 0.0  | 7.1  | 4.8  | 0.0  | 0.0  | 7.3  | 0.0  | 0.0  |
| LnGrp LOS                    | A    |      | A    | A    |      | A    | A    |      |      | A    |      |      |
| Approach Vol, veh/h          |      | 295  |      |      | 36   |      |      | 36   |      |      | 518  |      |
| Approach Delay, s/veh        |      | 8.9  |      |      | 7.1  |      |      | 4.8  |      |      | 7.3  |      |
| Approach LOS                 |      | A    |      |      | A    |      |      | A    |      |      | A    |      |
| Timer                        | 1    | 2    | 3    | 4    | 5    | 6    | 7    | 8    |      |      |      |      |
| Assigned Phs                 |      | 2    |      | 4    |      | 6    |      | 8    |      |      |      |      |
| Phs Duration (G+Y+Rc), s     |      | 14.3 |      | 10.9 |      | 14.3 |      | 10.9 |      |      |      |      |
| Change Period (Y+Rc), s      |      | 4.5  |      | 4.5  |      | 4.5  |      | 4.5  |      |      |      |      |
| Max Green Setting (Gmax), s  |      | 45.5 |      | 35.5 |      | 45.5 |      | 35.5 |      |      |      |      |
| Max Q Clear Time (g_c+I1), s |      | 2.3  |      | 6.8  |      | 9.2  |      | 2.2  |      |      |      |      |
| Green Ext Time (p_c), s      |      | 0.0  |      | 0.3  |      | 0.8  |      | 0.0  |      |      |      |      |
| <b>Intersection Summary</b>  |      |      |      |      |      |      |      |      |      |      |      |      |
| HCM 2010 Ctrl Delay          |      |      |      | 7.7  |      |      |      |      |      |      |      |      |
| HCM 2010 LOS                 |      |      |      | A    |      |      |      |      |      |      |      |      |

HCM 2010 Signalized Intersection Summary  
 46: General Jim Moore Boulevard & Normandy Road

Cumulative, AM  
 06/11/2019



| Movement                      | EBL  | EBT  | EBR  | WBL  | WBT  | WBR  | NBL   | NBT  | NBR  | SBL  | SBT  | SBR  |
|-------------------------------|------|------|------|------|------|------|-------|------|------|------|------|------|
| Lane Configurations           |      | ↕    |      |      | ↕    |      | ↕     | ↕↕   |      | ↕    | ↕↕   | ↕    |
| Traffic Volume (veh/h)        | 90   | 80   | 150  | 150  | 70   | 40   | 200   | 460  | 110  | 80   | 810  | 250  |
| Future Volume (veh/h)         | 90   | 80   | 150  | 150  | 70   | 40   | 200   | 460  | 110  | 80   | 810  | 250  |
| Number                        | 3    | 8    | 18   | 7    | 4    | 14   | 1     | 6    | 16   | 5    | 2    | 12   |
| Initial Q (Qb), veh           | 0    | 0    | 0    | 0    | 0    | 0    | 0     | 0    | 0    | 0    | 0    | 0    |
| Ped-Bike Adj(A_pbT)           | 0.99 |      | 0.98 | 0.99 |      | 0.98 | 1.00  |      | 0.99 | 1.00 |      | 0.99 |
| Parking Bus, Adj              | 1.00 | 1.00 | 1.00 | 1.00 | 1.00 | 1.00 | 1.00  | 1.00 | 1.00 | 1.00 | 1.00 | 1.00 |
| Adj Sat Flow, veh/h/ln        | 1900 | 1881 | 1900 | 1900 | 1863 | 1900 | 1881  | 1881 | 1900 | 1863 | 1863 | 1863 |
| Adj Flow Rate, veh/h          | 115  | 103  | 163  | 192  | 90   | 47   | 256   | 590  | 114  | 103  | 1038 | 252  |
| Adj No. of Lanes              | 0    | 1    | 0    | 0    | 1    | 0    | 1     | 2    | 0    | 1    | 2    | 1    |
| Peak Hour Factor              | 0.78 | 0.78 | 0.78 | 0.78 | 0.78 | 0.78 | 0.78  | 0.78 | 0.78 | 0.78 | 0.78 | 0.78 |
| Percent Heavy Veh, %          | 1    | 1    | 1    | 2    | 2    | 2    | 1     | 1    | 1    | 2    | 2    | 2    |
| Cap, veh/h                    | 212  | 188  | 248  | 321  | 143  | 64   | 206   | 714  | 138  | 351  | 1141 | 505  |
| Arrive On Green               | 0.38 | 0.37 | 0.37 | 0.38 | 0.37 | 0.37 | 0.12  | 0.24 | 0.24 | 0.20 | 0.32 | 0.32 |
| Sat Flow, veh/h               | 392  | 509  | 674  | 647  | 388  | 173  | 1792  | 2982 | 575  | 1774 | 3539 | 1566 |
| Grp Volume(v), veh/h          | 381  | 0    | 0    | 329  | 0    | 0    | 256   | 353  | 351  | 103  | 1038 | 252  |
| Grp Sat Flow(s),veh/h/ln      | 1575 | 0    | 0    | 1208 | 0    | 0    | 1792  | 1787 | 1770 | 1774 | 1770 | 1566 |
| Q Serve(g_s), s               | 0.0  | 0.0  | 0.0  | 3.7  | 0.0  | 0.0  | 8.0   | 13.0 | 13.1 | 3.4  | 19.6 | 9.0  |
| Cycle Q Clear(g_c), s         | 13.4 | 0.0  | 0.0  | 17.2 | 0.0  | 0.0  | 8.0   | 13.0 | 13.1 | 3.4  | 19.6 | 9.0  |
| Prop In Lane                  | 0.30 |      | 0.43 | 0.58 |      | 0.14 | 1.00  |      | 0.32 | 1.00 |      | 1.00 |
| Lane Grp Cap(c), veh/h        | 659  | 0    | 0    | 536  | 0    | 0    | 206   | 428  | 423  | 351  | 1141 | 505  |
| V/C Ratio(X)                  | 0.58 | 0.00 | 0.00 | 0.61 | 0.00 | 0.00 | 1.24  | 0.83 | 0.83 | 0.29 | 0.91 | 0.50 |
| Avail Cap(c_a), veh/h         | 820  | 0    | 0    | 673  | 0    | 0    | 206   | 655  | 649  | 351  | 1298 | 574  |
| HCM Platoon Ratio             | 1.00 | 1.00 | 1.00 | 1.00 | 1.00 | 1.00 | 1.00  | 1.00 | 1.00 | 1.00 | 1.00 | 1.00 |
| Upstream Filter(I)            | 1.00 | 0.00 | 0.00 | 1.00 | 0.00 | 0.00 | 1.00  | 1.00 | 1.00 | 1.00 | 1.00 | 1.00 |
| Uniform Delay (d), s/veh      | 17.9 | 0.0  | 0.0  | 19.1 | 0.0  | 0.0  | 30.8  | 25.1 | 25.1 | 23.7 | 22.6 | 19.0 |
| Incr Delay (d2), s/veh        | 0.3  | 0.0  | 0.0  | 0.4  | 0.0  | 0.0  | 143.0 | 2.9  | 3.1  | 0.2  | 8.3  | 0.3  |
| Initial Q Delay(d3),s/veh     | 0.0  | 0.0  | 0.0  | 0.0  | 0.0  | 0.0  | 0.0   | 0.0  | 0.0  | 0.0  | 0.0  | 0.0  |
| %ile BackOfQ(50%),veh/ln      | 5.9  | 0.0  | 0.0  | 5.5  | 0.0  | 0.0  | 12.1  | 6.7  | 6.7  | 1.7  | 10.8 | 4.0  |
| LnGrp Delay(d),s/veh          | 18.2 | 0.0  | 0.0  | 19.5 | 0.0  | 0.0  | 173.8 | 28.0 | 28.2 | 23.9 | 30.9 | 19.3 |
| LnGrp LOS                     | B    |      |      | B    |      |      | F     | C    | C    | C    | C    | B    |
| Approach Vol, veh/h           |      | 381  |      |      | 329  |      |       | 960  |      |      | 1393 |      |
| Approach Delay, s/veh         |      | 18.2 |      |      | 19.5 |      |       | 66.9 |      |      | 28.3 |      |
| Approach LOS                  |      | B    |      |      | B    |      |       | E    |      |      | C    |      |
| Timer                         | 1    | 2    | 3    | 4    | 5    | 6    | 7     | 8    |      |      |      |      |
| Assigned Phs                  | 1    | 2    |      | 4    | 5    | 6    |       | 8    |      |      |      |      |
| Phs Duration (G+Y+Rc), s      | 26.9 | 26.9 |      | 30.1 | 18.3 | 21.1 |       | 30.1 |      |      |      |      |
| Change Period (Y+Rc), s       | 4.5  | 4.5  |      | 4.5  | 4.5  | 4.5  |       | 4.5  |      |      |      |      |
| Max Green Setting (Gmax), s   | 25.5 | 25.5 |      | 33.0 | 8.0  | 25.5 |       | 33.0 |      |      |      |      |
| Max Q Clear Time (g_c+110), s | 21.6 | 21.6 |      | 19.2 | 5.4  | 15.1 |       | 15.4 |      |      |      |      |
| Green Ext Time (p_c), s       | 0.0  | 0.9  |      | 0.5  | 0.0  | 0.6  |       | 0.6  |      |      |      |      |
| <b>Intersection Summary</b>   |      |      |      |      |      |      |       |      |      |      |      |      |
| HCM 2010 Ctrl Delay           |      |      |      | 38.2 |      |      |       |      |      |      |      |      |
| HCM 2010 LOS                  |      |      |      | D    |      |      |       |      |      |      |      |      |

**Intersection**

Intersection Delay, s/veh 13.7

Intersection LOS F

| Movement            | EBL  | EBR  | NBL  | NBT  | SBT  | SBR  |
|---------------------|------|------|------|------|------|------|
| Lane Configurations |      |      |      |      |      |      |
| Traffic Vol, veh/h  | 90   | 430  | 230  | 390  | 960  | 80   |
| Future Vol, veh/h   | 90   | 430  | 230  | 390  | 960  | 80   |
| Peak Hour Factor    | 0.90 | 0.90 | 0.90 | 0.90 | 0.90 | 0.90 |
| Heavy Vehicles, %   | 1    | 1    | 1    | 1    | 2    | 2    |
| Mvmt Flow           | 100  | 478  | 256  | 433  | 1067 | 89   |
| Number of Lanes     | 1    | 1    | 1    | 2    | 2    | 1    |

| Approach                   | EB    | NB   | SB    |
|----------------------------|-------|------|-------|
| Opposing Approach          |       | SB   | NB    |
| Opposing Lanes             | 0     | 3    | 3     |
| Conflicting Approach Left  | SB    |      |       |
| Conflicting Lanes Left     | 3     | 2    | 0     |
| Conflicting Approach Right | NB    |      | EB    |
| Conflicting Lanes Right    | 3     | 0    | 2     |
| HCM Control Delay          | 118.8 | 25.8 | 163.6 |
| HCM LOS                    | F     | D    | F     |

| Lane                   | NBLn1 | NBLn2  | NBLn3 | EBLn1  | EBLn2 | SBLn1 | SBLn2 | SBLn3 |
|------------------------|-------|--------|-------|--------|-------|-------|-------|-------|
| Vol Left, %            | 100%  | 0%     | 0%    | 100%   | 0%    | 0%    | 0%    | 0%    |
| Vol Thru, %            | 0%    | 100%   | 100%  | 0%     | 0%    | 100%  | 100%  | 0%    |
| Vol Right, %           | 0%    | 0%     | 0%    | 0%     | 100%  | 0%    | 0%    | 100%  |
| Sign Control           | Stop  | Stop   | Stop  | Stop   | Stop  | Stop  | Stop  | Stop  |
| Traffic Vol by Lane    | 230   | 195    | 195   | 90     | 430   | 480   | 480   | 80    |
| LT Vol                 | 230   | 0      | 0     | 90     | 0     | 0     | 0     | 0     |
| Through Vol            | 0     | 195    | 195   | 0      | 0     | 480   | 480   | 0     |
| RT Vol                 | 0     | 0      | 0     | 0      | 430   | 0     | 0     | 80    |
| Lane Flow Rate         | 256   | 217    | 217   | 100    | 478   | 533   | 533   | 89    |
| Geometry Grp           | 8     | 8      | 8     | 8      | 8     | 8     | 8     | 8     |
| Degree of Util (X)     | 0.684 | 0.55   | 0.447 | 0.283  | 1.192 | 1.291 | 1.291 | 0.155 |
| Departure Headway (Hd) | 10.7  | 10.176 | 8.377 | 10.969 | 9.751 | 9.397 | 9.397 | 6.847 |
| Convergence, Y/N       | Yes   | Yes    | Yes   | Yes    | Yes   | Yes   | Yes   | Yes   |
| Cap                    | 340   | 358    | 433   | 330    | 377   | 389   | 389   | 527   |
| Service Time           | 8.4   | 7.876  | 6.077 | 8.669  | 7.451 | 7.097 | 7.097 | 4.547 |
| HCM Lane V/C Ratio     | 0.753 | 0.606  | 0.501 | 0.303  | 1.268 | 1.37  | 1.37  | 0.169 |
| HCM Control Delay      | 33.7  | 24.6   | 17.7  | 17.9   | 139.9 | 176.3 | 176.3 | 10.8  |
| HCM Lane LOS           | D     | C      | C     | C      | F     | F     | F     | B     |
| HCM 95th-tile Q        | 4.8   | 3.2    | 2.3   | 1.1    | 18    | 22.3  | 22.3  | 0.5   |

HCM 2010 Signalized Intersection Summary  
 48: Fremont Boulevard/Hwy 1 SB Off-Ramp/ NB On-Ramp & Monterey Road

Cumulative, AM  
 06/11/2019



| Movement                     | EBL  | EBT  | EBR  | WBL   | WBT  | WBR   | NBL  | NBT  | NBR  | SBL  | SBT   | SBR  |
|------------------------------|------|------|------|-------|------|-------|------|------|------|------|-------|------|
| Lane Configurations          |      |      |      |       |      |       |      |      |      |      |       |      |
| Traffic Volume (veh/h)       | 80   | 100  | 150  | 120   | 220  | 30    | 230  | 670  | 140  | 60   | 990   | 120  |
| Future Volume (veh/h)        | 80   | 100  | 150  | 120   | 220  | 30    | 230  | 670  | 140  | 60   | 990   | 120  |
| Number                       | 7    | 4    | 14   | 3     | 8    | 18    | 5    | 2    | 12   | 1    | 6     | 16   |
| Initial Q (Qb), veh          | 0    | 0    | 0    | 0     | 0    | 0     | 0    | 0    | 0    | 0    | 0     | 0    |
| Ped-Bike Adj(A_pbT)          | 1.00 |      | 0.95 | 1.00  |      | 0.97  | 1.00 |      | 0.99 | 1.00 |       | 0.98 |
| Parking Bus, Adj             | 1.00 | 1.00 | 1.00 | 1.00  | 1.00 | 1.00  | 1.00 | 1.00 | 1.00 | 1.00 | 1.00  | 1.00 |
| Adj Sat Flow, veh/h/ln       | 1845 | 1845 | 1845 | 1900  | 1881 | 1900  | 1827 | 1827 | 1900 | 1827 | 1827  | 1827 |
| Adj Flow Rate, veh/h         | 88   | 110  | 76   | 132   | 242  | 31    | 253  | 736  | 139  | 66   | 1088  | 65   |
| Adj No. of Lanes             | 1    | 1    | 1    | 0     | 1    | 0     | 1    | 2    | 0    | 1    | 2     | 1    |
| Peak Hour Factor             | 0.91 | 0.91 | 0.91 | 0.91  | 0.91 | 0.91  | 0.91 | 0.91 | 0.91 | 0.91 | 0.91  | 0.91 |
| Percent Heavy Veh, %         | 3    | 3    | 3    | 1     | 1    | 1     | 4    | 4    | 4    | 4    | 4     | 4    |
| Cap, veh/h                   | 202  | 212  | 172  | 133   | 244  | 31    | 425  | 1332 | 252  | 84   | 880   | 388  |
| Arrive On Green              | 0.12 | 0.12 | 0.12 | 0.23  | 0.22 | 0.22  | 0.24 | 0.46 | 0.46 | 0.05 | 0.25  | 0.25 |
| Sat Flow, veh/h              | 1757 | 1845 | 1494 | 594   | 1088 | 139   | 1740 | 2907 | 549  | 1740 | 3471  | 1529 |
| Grp Volume(v), veh/h         | 88   | 110  | 76   | 405   | 0    | 0     | 253  | 439  | 436  | 66   | 1088  | 65   |
| Grp Sat Flow(s),veh/h/ln     | 1757 | 1845 | 1494 | 1822  | 0    | 0     | 1740 | 1736 | 1721 | 1740 | 1736  | 1529 |
| Q Serve(g_s), s              | 5.8  | 7.0  | 5.9  | 27.7  | 0.0  | 0.0   | 16.1 | 22.9 | 23.0 | 4.7  | 31.7  | 4.1  |
| Cycle Q Clear(g_c), s        | 5.8  | 7.0  | 5.9  | 27.7  | 0.0  | 0.0   | 16.1 | 22.9 | 23.0 | 4.7  | 31.7  | 4.1  |
| Prop In Lane                 | 1.00 |      | 1.00 | 0.33  |      | 0.08  | 1.00 |      | 0.32 | 1.00 |       | 1.00 |
| Lane Grp Cap(c), veh/h       | 202  | 212  | 172  | 408   | 0    | 0     | 425  | 795  | 788  | 84   | 880   | 388  |
| V/C Ratio(X)                 | 0.44 | 0.52 | 0.44 | 0.99  | 0.00 | 0.00  | 0.60 | 0.55 | 0.55 | 0.78 | 1.24  | 0.17 |
| Avail Cap(c_a), veh/h        | 436  | 457  | 371  | 408   | 0    | 0     | 425  | 795  | 788  | 209  | 880   | 388  |
| HCM Platoon Ratio            | 1.00 | 1.00 | 1.00 | 1.00  | 1.00 | 1.00  | 1.00 | 1.00 | 1.00 | 1.00 | 1.00  | 1.00 |
| Upstream Filter(I)           | 0.76 | 0.76 | 0.76 | 1.00  | 0.00 | 0.00  | 1.00 | 1.00 | 1.00 | 1.00 | 1.00  | 1.00 |
| Uniform Delay (d), s/veh     | 51.5 | 52.1 | 51.6 | 48.2  | 0.0  | 0.0   | 41.8 | 24.6 | 24.6 | 58.8 | 46.7  | 36.4 |
| Incr Delay (d2), s/veh       | 1.1  | 1.5  | 1.4  | 42.5  | 0.0  | 0.0   | 1.6  | 2.8  | 2.8  | 5.9  | 116.0 | 0.9  |
| Initial Q Delay(d3),s/veh    | 0.0  | 0.0  | 0.0  | 0.0   | 0.0  | 0.0   | 0.0  | 0.0  | 0.0  | 0.0  | 0.0   | 0.0  |
| %ile BackOfQ(50%),veh/ln     | 2.9  | 3.7  | 2.5  | 18.8  | 0.0  | 0.0   | 7.9  | 11.6 | 11.5 | 2.4  | 29.3  | 1.9  |
| LnGrp Delay(d),s/veh         | 52.7 | 53.5 | 52.9 | 90.7  | 0.0  | 0.0   | 43.4 | 27.3 | 27.4 | 64.7 | 162.6 | 37.3 |
| LnGrp LOS                    | D    | D    | D    | F     |      |       | D    | C    | C    | E    | F     | D    |
| Approach Vol, veh/h          |      | 274  |      |       | 405  |       |      | 1128 |      |      | 1219  |      |
| Approach Delay, s/veh        |      | 53.1 |      |       | 90.7 |       |      | 30.9 |      |      | 150.7 |      |
| Approach LOS                 |      | D    |      |       | F    |       |      | C    |      |      | F     |      |
| Timer                        | 1    | 2    | 3    | 4     | 5    | 6     | 7    | 8    |      |      |       |      |
| Assigned Phs                 | 1    | 2    |      | 4     | 5    | 6     |      | 8    |      |      |       |      |
| Phs Duration (G+Y+Rc), s     | 30.2 | 62.6 |      | 19.1  | 35.8 | 37.0  |      | 33.1 |      |      |       |      |
| Change Period (Y+Rc), s      | 4.2  | 5.3  |      | * 4.7 | 5.3  | * 5.3 |      | 5.1  |      |      |       |      |
| Max Green Setting (Gmax), s  | 15   | 31.7 |      | * 31  | 15.0 | * 32  |      | 28.0 |      |      |       |      |
| Max Q Clear Time (g_c+10), s | 15   | 25.0 |      | 9.0   | 18.1 | 33.7  |      | 29.7 |      |      |       |      |
| Green Ext Time (p_c), s      | 0.0  | 2.6  |      | 1.1   | 0.0  | 0.0   |      | 0.0  |      |      |       |      |
| <b>Intersection Summary</b>  |      |      |      |       |      |       |      |      |      |      |       |      |
| HCM 2010 Ctrl Delay          |      |      |      | 89.2  |      |       |      |      |      |      |       |      |
| HCM 2010 LOS                 |      |      |      | F     |      |       |      |      |      |      |       |      |
| <b>Notes</b>                 |      |      |      |       |      |       |      |      |      |      |       |      |

HCM 2010 Signalized Intersection Summary  
 49: Highway 1 SB On-Ramp & Highway 1 NB Off-Ramp/Monterey Road

Cumulative, AM  
 06/11/2019



| Movement                     | EBL  | EBT  | EBR  | WBL   | WBT  | WBR   | NBL  | NBT   | NBR  | SBL  | SBT  | SBR  |
|------------------------------|------|------|------|-------|------|-------|------|-------|------|------|------|------|
| Lane Configurations          |      | ↕↕   | ↗    | ↖     |      | ↗     |      | ↕     | ↗    |      | ↕    |      |
| Traffic Volume (veh/h)       | 10   | 200  | 100  | 240   | 0    | 380   | 0    | 50    | 120  | 10   | 10   | 0    |
| Future Volume (veh/h)        | 10   | 200  | 100  | 240   | 0    | 380   | 0    | 50    | 120  | 10   | 10   | 0    |
| Number                       | 1    | 6    | 16   | 5     | 2    | 12    | 7    | 4     | 14   | 3    | 8    | 18   |
| Initial Q (Qb), veh          | 0    | 0    | 0    | 0     | 0    | 0     | 0    | 0     | 0    | 0    | 0    | 0    |
| Ped-Bike Adj(A_pbT)          | 1.00 |      | 1.00 | 1.00  |      | 1.00  | 1.00 |       | 1.00 | 1.00 |      | 1.00 |
| Parking Bus, Adj             | 1.00 | 1.00 | 1.00 | 1.00  | 1.00 | 1.00  | 1.00 | 1.00  | 1.00 | 1.00 | 1.00 | 1.00 |
| Adj Sat Flow, veh/h/ln       | 1900 | 1845 | 1845 | 1863  | 0    | 1863  | 0    | 1845  | 1845 | 1900 | 1900 | 0    |
| Adj Flow Rate, veh/h         | 10   | 206  | 9    | 247   | 0    | 253   | 0    | 52    | 21   | 10   | 10   | 0    |
| Adj No. of Lanes             | 0    | 2    | 1    | 1     | 0    | 1     | 0    | 1     | 1    | 0    | 1    | 0    |
| Peak Hour Factor             | 0.97 | 0.97 | 0.97 | 0.97  | 0.97 | 0.97  | 0.97 | 0.97  | 0.97 | 0.97 | 0.97 | 0.97 |
| Percent Heavy Veh, %         | 3    | 3    | 3    | 2     | 0    | 2     | 0    | 3     | 3    | 0    | 0    | 0    |
| Cap, veh/h                   | 136  | 2942 | 1343 | 0     | 0    | 0     | 0    | 122   | 104  | 75   | 60   | 0    |
| Arrive On Green              | 0.87 | 0.86 | 0.86 | 0.00  | 0.00 | 0.00  | 0.00 | 0.07  | 0.07 | 0.07 | 0.07 | 0.00 |
| Sat Flow, veh/h              | 159  | 3430 | 1566 |       | 0    |       | 0    | 1845  | 1568 | 474  | 898  | 0    |
| Grp Volume(v), veh/h         | 116  | 100  | 9    |       | 0.0  |       | 0    | 52    | 21   | 20   | 0    | 0    |
| Grp Sat Flow(s),veh/h/ln     | 1837 | 1752 | 1566 |       |      |       | 0    | 1845  | 1568 | 1372 | 0    | 0    |
| Q Serve(g_s), s              | 1.2  | 1.1  | 0.1  |       |      |       | 0.0  | 3.4   | 1.6  | 0.0  | 0.0  | 0.0  |
| Cycle Q Clear(g_c), s        | 1.2  | 1.1  | 0.1  |       |      |       | 0.0  | 3.4   | 1.6  | 3.4  | 0.0  | 0.0  |
| Prop In Lane                 | 0.09 |      | 1.00 |       |      |       | 0.00 |       | 1.00 | 0.50 |      | 0.00 |
| Lane Grp Cap(c), veh/h       | 1575 | 1503 | 1343 |       |      |       | 0    | 122   | 104  | 136  | 0    | 0    |
| V/C Ratio(X)                 | 0.07 | 0.07 | 0.01 |       |      |       | 0.00 | 0.43  | 0.20 | 0.15 | 0.00 | 0.00 |
| Avail Cap(c_a), veh/h        | 1575 | 1503 | 1343 |       |      |       | 0    | 148   | 125  | 158  | 0    | 0    |
| HCM Platoon Ratio            | 1.00 | 1.00 | 1.00 |       |      |       | 1.00 | 1.00  | 1.00 | 1.00 | 1.00 | 1.00 |
| Upstream Filter(I)           | 1.00 | 1.00 | 1.00 |       |      |       | 0.00 | 1.00  | 1.00 | 1.00 | 0.00 | 0.00 |
| Uniform Delay (d), s/veh     | 1.3  | 1.3  | 1.3  |       |      |       | 0.0  | 56.1  | 55.2 | 55.0 | 0.0  | 0.0  |
| Incr Delay (d2), s/veh       | 0.0  | 0.0  | 0.0  |       |      |       | 0.0  | 0.9   | 0.4  | 0.2  | 0.0  | 0.0  |
| Initial Q Delay(d3),s/veh    | 0.0  | 0.0  | 0.0  |       |      |       | 0.0  | 0.0   | 0.0  | 0.0  | 0.0  | 0.0  |
| %ile BackOfQ(50%),veh/ln     | 0.6  | 0.5  | 0.0  |       |      |       | 0.0  | 1.8   | 0.7  | 0.7  | 0.0  | 0.0  |
| LnGrp Delay(d),s/veh         | 1.3  | 1.3  | 1.3  |       |      |       | 0.0  | 56.9  | 55.6 | 55.2 | 0.0  | 0.0  |
| LnGrp LOS                    | A    | A    | A    |       |      |       |      | E     | E    | E    |      |      |
| Approach Vol, veh/h          |      | 225  |      |       |      |       |      | 73    |      |      | 20   |      |
| Approach Delay, s/veh        |      | 1.3  |      |       |      |       |      | 56.5  |      |      | 55.2 |      |
| Approach LOS                 |      | A    |      |       |      |       |      | E     |      |      | E    |      |
| Timer                        | 1    | 2    | 3    | 4     | 5    | 6     | 7    | 8     |      |      |      |      |
| Assigned Phs                 |      |      |      | 4     |      | 6     |      | 8     |      |      |      |      |
| Phs Duration (G+Y+Rc), s     |      |      |      | 12.5  |      | 112.5 |      | 12.5  |      |      |      |      |
| Change Period (Y+Rc), s      |      |      |      | * 4.2 |      | 5.3   |      | * 4.2 |      |      |      |      |
| Max Green Setting (Gmax), s  |      |      |      | * 10  |      | 21.0  |      | * 10  |      |      |      |      |
| Max Q Clear Time (g_c+I1), s |      |      |      | 5.4   |      | 3.2   |      | 5.4   |      |      |      |      |
| Green Ext Time (p_c), s      |      |      |      | 0.1   |      | 0.7   |      | 0.0   |      |      |      |      |
| <b>Intersection Summary</b>  |      |      |      |       |      |       |      |       |      |      |      |      |
| HCM 2010 Ctrl Delay          |      |      | 17.4 |       |      |       |      |       |      |      |      |      |
| HCM 2010 LOS                 |      |      | B    |       |      |       |      |       |      |      |      |      |
| <b>Notes</b>                 |      |      |      |       |      |       |      |       |      |      |      |      |

HCM 2010 Signalized Intersection Summary  
 50: Reservation Road & SR 68 WB On Ramp/SR 68 WB Off Ramp

Cumulative, AM  
 06/11/2019



| Movement                    | EBL  | EBT  | EBR | WBL  | WBT  | WBR  | NBL  | NBT  | NBR  | SBL  | SBT  | SBR  |
|-----------------------------|------|------|-----|------|------|------|------|------|------|------|------|------|
| Lane Configurations         |      |      |     |      | ↕    | ↕    | ↕    | ↕    |      |      | ↕    |      |
| Traffic Volume (veh/h)      | 0    | 0    | 0   | 260  | 10   | 310  | 120  | 390  | 0    | 0    | 350  | 140  |
| Future Volume (veh/h)       | 0    | 0    | 0   | 260  | 10   | 310  | 120  | 390  | 0    | 0    | 350  | 140  |
| Number                      |      |      |     | 7    | 4    | 14   | 1    | 6    | 16   | 5    | 2    | 12   |
| Initial Q (Qb), veh         |      |      |     | 0    | 0    | 0    | 0    | 0    | 0    | 0    | 0    | 0    |
| Ped-Bike Adj(A_pbT)         |      |      |     | 1.00 |      | 1.00 | 1.00 |      | 1.00 | 1.00 |      | 1.00 |
| Parking Bus, Adj            |      |      |     | 1.00 | 1.00 | 1.00 | 1.00 | 1.00 | 1.00 | 1.00 | 1.00 | 1.00 |
| Adj Sat Flow, veh/h/ln      |      |      |     | 1900 | 1827 | 1827 | 1863 | 1863 | 0    | 0    | 1827 | 1900 |
| Adj Flow Rate, veh/h        |      |      |     | 274  | 11   | 74   | 126  | 411  | 0    | 0    | 368  | 138  |
| Adj No. of Lanes            |      |      |     | 0    | 1    | 1    | 1    | 1    | 0    | 0    | 1    | 0    |
| Peak Hour Factor            |      |      |     | 0.95 | 0.95 | 0.95 | 0.95 | 0.95 | 0.95 | 0.95 | 0.95 | 0.95 |
| Percent Heavy Veh, %        |      |      |     | 4    | 4    | 4    | 2    | 2    | 0    | 0    | 4    | 4    |
| Cap, veh/h                  |      |      |     | 384  | 15   | 356  | 208  | 1022 | 0    | 0    | 456  | 171  |
| Arrive On Green             |      |      |     | 0.25 | 0.23 | 0.23 | 0.12 | 0.55 | 0.00 | 0.00 | 0.36 | 0.36 |
| Sat Flow, veh/h             |      |      |     | 1676 | 67   | 1553 | 1774 | 1863 | 0    | 0    | 1268 | 475  |
| Grp Volume(v), veh/h        |      |      |     | 285  | 0    | 74   | 126  | 411  | 0    | 0    | 0    | 506  |
| Grp Sat Flow(s),veh/h/ln    |      |      |     | 1743 | 0    | 1553 | 1774 | 1863 | 0    | 0    | 0    | 1743 |
| Q Serve(g_s), s             |      |      |     | 7.3  | 0.0  | 1.9  | 3.3  | 6.3  | 0.0  | 0.0  | 0.0  | 12.8 |
| Cycle Q Clear(g_c), s       |      |      |     | 7.3  | 0.0  | 1.9  | 3.3  | 6.3  | 0.0  | 0.0  | 0.0  | 12.8 |
| Prop In Lane                |      |      |     | 0.96 |      | 1.00 | 1.00 |      | 0.00 | 0.00 |      | 0.27 |
| Lane Grp Cap(c), veh/h      |      |      |     | 400  | 0    | 356  | 208  | 1022 | 0    | 0    | 0    | 628  |
| V/C Ratio(X)                |      |      |     | 0.71 | 0.00 | 0.21 | 0.61 | 0.40 | 0.00 | 0.00 | 0.00 | 0.81 |
| Avail Cap(c_a), veh/h       |      |      |     | 1422 | 0    | 1267 | 941  | 1443 | 0    | 0    | 0    | 1351 |
| HCM Platoon Ratio           |      |      |     | 1.00 | 1.00 | 1.00 | 1.00 | 1.00 | 1.00 | 1.00 | 1.00 | 1.00 |
| Upstream Filter(I)          |      |      |     | 1.00 | 0.00 | 1.00 | 1.00 | 1.00 | 0.00 | 0.00 | 0.00 | 1.00 |
| Uniform Delay (d), s/veh    |      |      |     | 17.0 | 0.0  | 15.3 | 20.6 | 6.4  | 0.0  | 0.0  | 0.0  | 14.1 |
| Incr Delay (d2), s/veh      |      |      |     | 2.4  | 0.0  | 0.3  | 1.1  | 0.3  | 0.0  | 0.0  | 0.0  | 2.5  |
| Initial Q Delay(d3),s/veh   |      |      |     | 0.0  | 0.0  | 0.0  | 0.0  | 0.0  | 0.0  | 0.0  | 0.0  | 0.0  |
| %ile BackOfQ(50%),veh/ln    |      |      |     | 3.7  | 0.0  | 0.8  | 1.7  | 3.3  | 0.0  | 0.0  | 0.0  | 6.5  |
| LnGrp Delay(d),s/veh        |      |      |     | 19.4 | 0.0  | 15.6 | 21.6 | 6.7  | 0.0  | 0.0  | 0.0  | 16.7 |
| LnGrp LOS                   |      |      |     | B    |      | B    | C    | A    |      |      |      | B    |
| Approach Vol, veh/h         |      |      |     |      | 359  |      |      | 537  |      |      | 506  |      |
| Approach Delay, s/veh       |      |      |     |      | 18.6 |      |      | 10.2 |      |      | 16.7 |      |
| Approach LOS                |      |      |     |      | B    |      |      | B    |      |      | B    |      |
| Timer                       | 1    | 2    | 3   | 4    | 5    | 6    | 7    | 8    |      |      |      |      |
| Assigned Phs                | 1    | 2    |     | 4    |      | 6    |      |      |      |      |      |      |
| Phs Duration (G+Y+Rc), s    | 9.2  | 23.7 |     | 16.1 |      | 32.9 |      |      |      |      |      |      |
| Change Period (Y+Rc), s     | 3.5  | 6.0  |     | 4.9  |      | 6.0  |      |      |      |      |      |      |
| Max Green Setting (Gmax), s | 26.0 | 38.0 |     | 40.0 |      | 38.0 |      |      |      |      |      |      |
| Max Q Clear Time (g_c+1), s | 15.3 | 14.8 |     | 9.3  |      | 8.3  |      |      |      |      |      |      |
| Green Ext Time (p_c), s     | 0.1  | 2.8  |     | 2.0  |      | 2.2  |      |      |      |      |      |      |
| <b>Intersection Summary</b> |      |      |     |      |      |      |      |      |      |      |      |      |
| HCM 2010 Ctrl Delay         |      |      |     | 14.7 |      |      |      |      |      |      |      |      |
| HCM 2010 LOS                |      |      |     | B    |      |      |      |      |      |      |      |      |

HCM 2010 Signalized Intersection Summary  
 51: River Road/Reservation Road & SR 68 Off Ramp/SR 68 EB On Ramp

Cumulative, AM  
 06/11/2019





















| Movement                     | EBL  | EBT  | EBR  | WBL | WBT  | WBR  | NBL  | NBT  | NBR  | SBL  | SBT  | SBR  |
|------------------------------|------|------|------|-----|------|------|------|------|------|------|------|------|
| Lane Configurations          |      | ↕    | ↗    |     |      |      |      | ↑    | ↗    | ↖    | ↑    |      |
| Traffic Volume (veh/h)       | 120  | 10   | 110  | 0   | 0    | 0    | 0    | 380  | 660  | 230  | 370  | 0    |
| Future Volume (veh/h)        | 120  | 10   | 110  | 0   | 0    | 0    | 0    | 380  | 660  | 230  | 370  | 0    |
| Number                       | 3    | 8    | 18   |     |      |      | 1    | 6    | 16   | 5    | 2    | 12   |
| Initial Q (Qb), veh          | 0    | 0    | 0    |     |      |      | 0    | 0    | 0    | 0    | 0    | 0    |
| Ped-Bike Adj(A_pbT)          | 1.00 |      | 1.00 |     |      |      | 1.00 |      | 1.00 | 1.00 |      | 1.00 |
| Parking Bus, Adj             | 1.00 | 1.00 | 1.00 |     |      |      | 1.00 | 1.00 | 1.00 | 1.00 | 1.00 | 1.00 |
| Adj Sat Flow, veh/h/ln       | 1900 | 1881 | 1881 |     |      |      | 0    | 1881 | 1881 | 1827 | 1827 | 0    |
| Adj Flow Rate, veh/h         | 130  | 11   | 19   |     |      |      | 0    | 413  | 388  | 250  | 402  | 0    |
| Adj No. of Lanes             | 0    | 1    | 1    |     |      |      | 0    | 1    | 1    | 1    | 1    | 0    |
| Peak Hour Factor             | 0.92 | 0.92 | 0.92 |     |      |      | 0.92 | 0.92 | 0.92 | 0.92 | 0.92 | 0.92 |
| Percent Heavy Veh, %         | 1    | 1    | 1    |     |      |      | 0    | 1    | 1    | 4    | 4    | 0    |
| Cap, veh/h                   | 189  | 16   | 183  |     |      |      | 0    | 648  | 551  | 327  | 1136 | 0    |
| Arrive On Green              | 0.14 | 0.11 | 0.11 |     |      |      | 0.00 | 0.34 | 0.34 | 0.19 | 0.62 | 0.00 |
| Sat Flow, veh/h              | 1658 | 140  | 1599 |     |      |      | 0    | 1881 | 1599 | 1740 | 1827 | 0    |
| Grp Volume(v), veh/h         | 141  | 0    | 19   |     |      |      | 0    | 413  | 388  | 250  | 402  | 0    |
| Grp Sat Flow(s),veh/h/ln     | 1798 | 0    | 1599 |     |      |      | 0    | 1881 | 1599 | 1740 | 1827 | 0    |
| Q Serve(g_s), s              | 3.1  | 0.0  | 0.4  |     |      |      | 0.0  | 7.6  | 8.7  | 5.6  | 4.4  | 0.0  |
| Cycle Q Clear(g_c), s        | 3.1  | 0.0  | 0.4  |     |      |      | 0.0  | 7.6  | 8.7  | 5.6  | 4.4  | 0.0  |
| Prop In Lane                 | 0.92 |      | 1.00 |     |      |      | 0.00 |      | 1.00 | 1.00 |      | 0.00 |
| Lane Grp Cap(c), veh/h       | 205  | 0    | 183  |     |      |      | 0    | 648  | 551  | 327  | 1136 | 0    |
| V/C Ratio(X)                 | 0.69 | 0.00 | 0.10 |     |      |      | 0.00 | 0.64 | 0.70 | 0.77 | 0.35 | 0.00 |
| Avail Cap(c_a), veh/h        | 1741 | 0    | 1548 |     |      |      | 0    | 1685 | 1432 | 1011 | 1636 | 0    |
| HCM Platoon Ratio            | 1.00 | 1.00 | 1.00 |     |      |      | 1.00 | 1.00 | 1.00 | 1.00 | 1.00 | 1.00 |
| Upstream Filter(I)           | 1.00 | 0.00 | 1.00 |     |      |      | 0.00 | 1.00 | 1.00 | 1.00 | 1.00 | 0.00 |
| Uniform Delay (d), s/veh     | 17.2 | 0.0  | 16.4 |     |      |      | 0.0  | 11.4 | 11.7 | 15.9 | 3.8  | 0.0  |
| Incr Delay (d2), s/veh       | 1.5  | 0.0  | 0.1  |     |      |      | 0.0  | 1.0  | 1.7  | 3.7  | 0.2  | 0.0  |
| Initial Q Delay(d3),s/veh    | 0.0  | 0.0  | 0.0  |     |      |      | 0.0  | 0.0  | 0.0  | 0.0  | 0.0  | 0.0  |
| %ile BackOfQ(50%),veh/ln     | 1.6  | 0.0  | 0.2  |     |      |      | 0.0  | 4.1  | 4.0  | 3.0  | 2.2  | 0.0  |
| LnGrp Delay(d),s/veh         | 18.7 | 0.0  | 16.5 |     |      |      | 0.0  | 12.4 | 13.4 | 19.7 | 4.0  | 0.0  |
| LnGrp LOS                    | B    |      | B    |     |      |      |      | B    | B    | B    | A    |      |
| Approach Vol, veh/h          |      | 160  |      |     |      |      |      | 801  |      |      | 652  |      |
| Approach Delay, s/veh        |      | 18.4 |      |     |      |      |      | 12.9 |      |      | 10.0 |      |
| Approach LOS                 |      | B    |      |     |      |      |      | B    |      |      | A    |      |
| Timer                        | 1    | 2    | 3    | 4   | 5    | 6    | 7    | 8    |      |      |      |      |
| Assigned Phs                 |      | 2    |      |     | 5    | 6    |      | 8    |      |      |      |      |
| Phs Duration (G+Y+Rc), s     |      | 31.7 |      |     | 11.5 | 20.2 |      | 9.6  |      |      |      |      |
| Change Period (Y+Rc), s      |      | 6.0  |      |     | 3.7  | 6.0  |      | 4.9  |      |      |      |      |
| Max Green Setting (Gmax), s  |      | 37.0 |      |     | 24.0 | 37.0 |      | 40.0 |      |      |      |      |
| Max Q Clear Time (g_c+I1), s |      | 6.4  |      |     | 7.6  | 10.7 |      | 5.1  |      |      |      |      |
| Green Ext Time (p_c), s      |      | 2.2  |      |     | 0.6  | 3.6  |      | 0.5  |      |      |      |      |
| <b>Intersection Summary</b>  |      |      |      |     |      |      |      |      |      |      |      |      |
| HCM 2010 Ctrl Delay          |      |      | 12.3 |     |      |      |      |      |      |      |      |      |
| HCM 2010 LOS                 |      |      | B    |     |      |      |      |      |      |      |      |      |



HCM 2010 Signalized Intersection Summary  
1: Del Monte Boulevard & Reindollar Avenue

Cumulative, PM  
06/11/2019

|                              |  |  |  |  |  |  |   |  |  |  |  |  |
|------------------------------|---|---|---|---|---|---|---|---|---|---|---|---|
| Movement                     | EBL   | EBT   | EBR   | WBL   | WBT   | WBR   | NBL   | NBT   | NBR   | SBL   | SBT   | SBR   |
| Lane Configurations          |   |   |   |  |  |   |  |  |  |  |  |   |
| Traffic Volume (veh/h)       | 0   | 0   | 0   | 190   | 0   | 450   | 10  | 1320  | 340   | 400   | 830   | 0   |
| Future Volume (veh/h)        | 0   | 0   | 0   | 190   | 0   | 450   | 10  | 1320  | 340   | 400   | 830   | 0   |
| Number                       |   |   |   | 3   | 8   | 18  | 1   | 6   | 16  | 5   | 2   | 12  |
| Initial Q (Qb), veh          |   |   |   | 0   | 0   | 0   | 0   | 0   | 0   | 0   | 0   | 0   |
| Ped-Bike Adj(A_pbT)          |   |   |   | 1.00  |   | 0.99  | 1.00  |   | 1.00  | 1.00  |   | 1.00  |
| Parking Bus, Adj             |   |   |   | 1.00  | 1.00  | 1.00  | 1.00  | 1.00  | 1.00  | 1.00  | 1.00  | 1.00  |
| Adj Sat Flow, veh/h/ln       |   |   |   | 1881  | 1881  | 1900  | 1881  | 1881  | 1881  | 1881  | 1881  | 0   |
| Adj Flow Rate, veh/h         |   |   |   | 198   | 0   | 397   | 10  | 1375  | 271   | 417   | 865   | 0   |
| Adj No. of Lanes             |   |   |   | 1   | 1   | 0   | 1   | 2   | 1   | 1   | 2   | 0   |
| Peak Hour Factor             |   |   |   | 0.96  | 0.96  | 0.96  | 0.96  | 0.96  | 0.96  | 0.96  | 0.96  | 0.96  |
| Percent Heavy Veh, %         |   |   |   | 1   | 1   | 1   | 1   | 1   | 1   | 1   | 1   | 0   |
| Cap, veh/h                   |   |   |   | 501   | 0   | 444   | 22  | 1145  | 512   | 458   | 2015  | 0   |
| Arrive On Green              |   |   |   | 0.28  | 0.00  | 0.28  | 0.01  | 0.32  | 0.32  | 0.26  | 0.56  | 0.00  |
| Sat Flow, veh/h              |   |   |   | 1792  | 0   | 1585  | 1792  | 3574  | 1599  | 1792  | 3668  | 0   |
| Grp Volume(v), veh/h         |   |   |   | 198   | 0   | 397   | 10  | 1375  | 271   | 417   | 865   | 0   |
| Grp Sat Flow(s),veh/h/ln     |   |   |   | 1792  | 0   | 1585  | 1792  | 1787  | 1599  | 1792  | 1787  | 0   |
| Q Serve(g_s), s              |   |   |   | 8.4   | 0.0   | 22.5  | 0.5   | 30.0  | 13.0  | 21.1  | 13.0  | 0.0   |
| Cycle Q Clear(g_c), s        |   |   |   | 8.4   | 0.0   | 22.5  | 0.5   | 30.0  | 13.0  | 21.1  | 13.0  | 0.0   |
| Prop In Lane                 |   |   |   | 1.00  |   | 1.00  | 1.00  |   | 1.00  | 1.00  |   | 0.00  |
| Lane Grp Cap(c), veh/h       |   |   |   | 501   | 0   | 444   | 22  | 1145  | 512   | 458   | 2015  | 0   |
| V/C Ratio(X)                 |   |   |   | 0.39  | 0.00  | 0.89  | 0.46  | 1.20  | 0.53  | 0.91  | 0.43  | 0.00  |
| Avail Cap(c_a), veh/h        |   |   |   | 574   | 0   | 508   | 574   | 1145  | 512   | 574   | 2015  | 0   |
| HCM Platoon Ratio            |   |   |   | 1.00  | 1.00  | 1.00  | 1.00  | 1.00  | 1.00  | 1.00  | 1.00  | 1.00  |
| Upstream Filter(I)           |   |   |   | 1.00  | 0.00  | 1.00  | 1.00  | 1.00  | 1.00  | 1.00  | 1.00  | 0.00  |
| Uniform Delay (d), s/veh     |   |   |   | 27.3  | 0.0   | 32.4  | 45.9  | 31.8  | 26.0  | 33.8  | 11.8  | 0.0   |
| Incr Delay (d2), s/veh       |   |   |   | 0.5   | 0.0   | 16.8  | 14.1  | 99.0  | 1.0   | 16.2  | 0.1   | 0.0   |
| Initial Q Delay(d3),s/veh    |   |   |   | 0.0   | 0.0   | 0.0   | 0.0   | 0.0   | 0.0   | 0.0   | 0.0   | 0.0   |
| %ile BackOfQ(50%),veh/ln     |   |   |   | 4.2   | 0.0   | 11.9  | 0.3   | 30.4  | 5.9   | 12.5  | 6.4   | 0.0   |
| LnGrp Delay(d),s/veh         |   |   |   | 27.8  | 0.0   | 49.2  | 60.0  | 130.8   | 27.1  | 50.0  | 11.9  | 0.0   |
| LnGrp LOS                    |   |   |   | C   |   | D   | E   | F   | C   | D   | B   |   |
| Approach Vol, veh/h          |   |   |   |   | 595   |   |   | 1656  |   |   | 1282  |   |
| Approach Delay, s/veh        |   |   |   |   | 42.1  |   |   | 113.4   |   |   | 24.3  |   |
| Approach LOS                 |   |   |   |   | D   |   |   | F   |   |   | C   |   |
| Timer                        | 1   | 2   | 3   | 4   | 5   | 6   | 7   | 8   |   |   |   |   |
| Assigned Phs                 | 1   | 2   |   |   | 5   | 6   |   | 8   |   |   |   |   |
| Phs Duration (G+Y+Rc), s     | 4.6   | 57.8  |   |   | 27.5  | 35.0  |   | 31.2  |   |   |   |   |
| Change Period (Y+Rc), s      | 3.5   | 5.0   |   |   | 3.5   | 5.0   |   | 5.0   |   |   |   |   |
| Max Green Setting (Gmax), s  | 30.0  | 30.0  |   |   | 30.0  | 30.0  |   | 30.0  |   |   |   |   |
| Max Q Clear Time (g_c+I1), s | 2.5   | 15.0  |   |   | 23.1  | 32.0  |   | 24.5  |   |   |   |   |
| Green Ext Time (p_c), s      | 0.0   | 5.4   |   |   | 0.8   | 0.0   |   | 1.7   |   |   |   |   |
| <b>Intersection Summary</b>  |   |   |   |   |   |   |   |   |   |   |   |   |
| HCM 2010 Ctrl Delay          |   |   |   | 69.1  |   |   |   |   |   |   |   |   |
| HCM 2010 LOS                 |   |   |   | E   |   |   |   |   |   |   |   |   |
| <b>Notes</b>                 |   |   |   |   |   |   |   |   |   |   |   |   |

HCM 2010 Signalized Intersection Summary  
2: 2nd Avenue & Patton Parkway

Cumulative, PM  
06/11/2019



| Movement                     | EBL  | EBT  | EBR  | WBL  | WBT  | WBR  | NBL  | NBT  | NBR  | SBL  | SBT  | SBR  |
|------------------------------|------|------|------|------|------|------|------|------|------|------|------|------|
| Lane Configurations          |      |      |      |      |      |      |      |      |      |      |      |      |
| Traffic Volume (veh/h)       | 50   | 50   | 60   | 90   | 80   | 80   | 70   | 240  | 90   | 80   | 200  | 50   |
| Future Volume (veh/h)        | 50   | 50   | 60   | 90   | 80   | 80   | 70   | 240  | 90   | 80   | 200  | 50   |
| Number                       | 7    | 4    | 14   | 3    | 8    | 18   | 5    | 2    | 12   | 1    | 6    | 16   |
| Initial Q (Qb), veh          | 0    | 0    | 0    | 0    | 0    | 0    | 0    | 0    | 0    | 0    | 0    | 0    |
| Ped-Bike Adj(A_pbT)          | 1.00 |      | 1.00 | 1.00 |      | 1.00 | 1.00 |      | 1.00 | 1.00 |      | 1.00 |
| Parking Bus, Adj             | 1.00 | 1.00 | 1.00 | 1.00 | 1.00 | 1.00 | 1.00 | 1.00 | 1.00 | 1.00 | 1.00 | 1.00 |
| Adj Sat Flow, veh/h/ln       | 1863 | 1863 | 1900 | 1863 | 1863 | 1900 | 1863 | 1863 | 1900 | 1863 | 1863 | 1900 |
| Adj Flow Rate, veh/h         | 54   | 54   | 65   | 98   | 87   | 87   | 76   | 261  | 98   | 87   | 217  | 54   |
| Adj No. of Lanes             | 1    | 1    | 0    | 1    | 1    | 0    | 1    | 1    | 0    | 1    | 1    | 0    |
| Peak Hour Factor             | 0.92 | 0.92 | 0.92 | 0.92 | 0.92 | 0.92 | 0.92 | 0.92 | 0.92 | 0.92 | 0.92 | 0.92 |
| Percent Heavy Veh, %         | 2    | 2    | 2    | 2    | 2    | 2    | 2    | 2    | 2    | 2    | 2    | 2    |
| Cap, veh/h                   | 96   | 163  | 196  | 137  | 201  | 201  | 119  | 356  | 134  | 128  | 405  | 101  |
| Arrive On Green              | 0.05 | 0.21 | 0.21 | 0.08 | 0.23 | 0.23 | 0.07 | 0.28 | 0.28 | 0.07 | 0.28 | 0.28 |
| Sat Flow, veh/h              | 1774 | 771  | 928  | 1774 | 856  | 856  | 1774 | 1292 | 485  | 1774 | 1441 | 359  |
| Grp Volume(v), veh/h         | 54   | 0    | 119  | 98   | 0    | 174  | 76   | 0    | 359  | 87   | 0    | 271  |
| Grp Sat Flow(s),veh/h/ln     | 1774 | 0    | 1699 | 1774 | 0    | 1712 | 1774 | 0    | 1777 | 1774 | 0    | 1799 |
| Q Serve(g_s), s              | 1.4  | 0.0  | 2.8  | 2.5  | 0.0  | 4.0  | 2.0  | 0.0  | 8.6  | 2.2  | 0.0  | 6.0  |
| Cycle Q Clear(g_c), s        | 1.4  | 0.0  | 2.8  | 2.5  | 0.0  | 4.0  | 2.0  | 0.0  | 8.6  | 2.2  | 0.0  | 6.0  |
| Prop In Lane                 | 1.00 |      | 0.55 | 1.00 |      | 0.50 | 1.00 |      | 0.27 | 1.00 |      | 0.20 |
| Lane Grp Cap(c), veh/h       | 96   | 0    | 359  | 137  | 0    | 402  | 119  | 0    | 490  | 128  | 0    | 505  |
| V/C Ratio(X)                 | 0.56 | 0.00 | 0.33 | 0.72 | 0.00 | 0.43 | 0.64 | 0.00 | 0.73 | 0.68 | 0.00 | 0.54 |
| Avail Cap(c_a), veh/h        | 228  | 0    | 1290 | 228  | 0    | 1300 | 228  | 0    | 1349 | 228  | 0    | 1366 |
| HCM Platoon Ratio            | 1.00 | 1.00 | 1.00 | 1.00 | 1.00 | 1.00 | 1.00 | 1.00 | 1.00 | 1.00 | 1.00 | 1.00 |
| Upstream Filter(I)           | 1.00 | 0.00 | 1.00 | 1.00 | 0.00 | 1.00 | 1.00 | 0.00 | 1.00 | 1.00 | 0.00 | 1.00 |
| Uniform Delay (d), s/veh     | 21.6 | 0.0  | 15.6 | 21.1 | 0.0  | 15.2 | 21.3 | 0.0  | 15.4 | 21.2 | 0.0  | 14.2 |
| Incr Delay (d2), s/veh       | 5.1  | 0.0  | 0.5  | 6.9  | 0.0  | 0.7  | 5.6  | 0.0  | 2.1  | 6.1  | 0.0  | 0.9  |
| Initial Q Delay(d3),s/veh    | 0.0  | 0.0  | 0.0  | 0.0  | 0.0  | 0.0  | 0.0  | 0.0  | 0.0  | 0.0  | 0.0  | 0.0  |
| %ile BackOfQ(50%),veh/ln     | 0.8  | 0.0  | 1.3  | 1.5  | 0.0  | 2.0  | 1.1  | 0.0  | 4.5  | 1.3  | 0.0  | 3.1  |
| LnGrp Delay(d),s/veh         | 26.7 | 0.0  | 16.2 | 27.9 | 0.0  | 16.0 | 26.8 | 0.0  | 17.5 | 27.3 | 0.0  | 15.1 |
| LnGrp LOS                    | C    |      | B    | C    |      | B    | C    |      | B    | C    |      | B    |
| Approach Vol, veh/h          |      | 173  |      |      | 272  |      |      | 435  |      |      | 358  |      |
| Approach Delay, s/veh        |      | 19.5 |      |      | 20.3 |      |      | 19.1 |      |      | 18.1 |      |
| Approach LOS                 |      | B    |      |      | C    |      |      | B    |      |      | B    |      |
| Timer                        | 1    | 2    | 3    | 4    | 5    | 6    | 7    | 8    |      |      |      |      |
| Assigned Phs                 | 1    | 2    | 3    | 4    | 5    | 6    | 7    | 8    |      |      |      |      |
| Phs Duration (G+Y+Rc), s     | 7.4  | 17.4 | 7.6  | 14.4 | 7.1  | 17.6 | 6.5  | 15.5 |      |      |      |      |
| Change Period (Y+Rc), s      | 4.0  | 4.5  | 4.0  | 4.5  | 4.0  | 4.5  | 4.0  | 4.5  |      |      |      |      |
| Max Green Setting (Gmax), s  | 35.5 | 35.5 | 6.0  | 35.5 | 6.0  | 35.5 | 6.0  | 35.5 |      |      |      |      |
| Max Q Clear Time (g_c+14), s | 10.6 | 10.6 | 4.5  | 4.8  | 4.0  | 8.0  | 3.4  | 6.0  |      |      |      |      |
| Green Ext Time (p_c), s      | 0.0  | 2.3  | 0.0  | 0.7  | 0.0  | 1.7  | 0.0  | 1.1  |      |      |      |      |
| <b>Intersection Summary</b>  |      |      |      |      |      |      |      |      |      |      |      |      |
| HCM 2010 Ctrl Delay          |      |      |      | 19.1 |      |      |      |      |      |      |      |      |
| HCM 2010 LOS                 |      |      |      | B    |      |      |      |      |      |      |      |      |

HCM 2010 Signalized Intersection Summary  
 3: SR 1 SB On-Ramp/SR 1 SB Off-Ramp & Imjin Parkway

Cumulative, PM  
 06/11/2019



| Movement                     | EBL | EBT | EBR | WBL   | WBT   | WBR  | NBL | NBT | NBR | SBL  | SBT  | SBR  |
|------------------------------|-----|-----|-----|-------|-------|------|-----|-----|-----|------|------|------|
| Lane Configurations          |     |     |     |       | ↕     |      |     |     |     |      | ↕    |      |
| Traffic Volume (veh/h)       | 0   | 0   | 0   | 1260  | 0     | 0    | 0   | 0   | 0   | 580  | 10   | 0    |
| Future Volume (veh/h)        | 0   | 0   | 0   | 1260  | 0     | 0    | 0   | 0   | 0   | 580  | 10   | 0    |
| Number                       |     |     |     | 1     | 6     | 16   |     |     |     | 7    | 4    | 14   |
| Initial Q (Qb), veh          |     |     |     | 0     | 0     | 0    |     |     |     | 0    | 0    | 0    |
| Ped-Bike Adj(A_pbT)          |     |     |     | 1.00  |       | 1.00 |     |     |     | 1.00 |      | 1.00 |
| Parking Bus, Adj             |     |     |     | 1.00  | 1.00  | 1.00 |     |     |     | 1.00 | 1.00 | 1.00 |
| Adj Sat Flow, veh/h/ln       |     |     |     | 1900  | 1881  | 0    |     |     |     | 1900 | 1863 | 0    |
| Adj Flow Rate, veh/h         |     |     |     | 1385  | 0     | 0    |     |     |     | 637  | 11   | 0    |
| Adj No. of Lanes             |     |     |     | 0     | 1     | 0    |     |     |     | 0    | 1    | 0    |
| Peak Hour Factor             |     |     |     | 0.91  | 0.91  | 0.91 |     |     |     | 0.91 | 0.91 | 0.91 |
| Percent Heavy Veh, %         |     |     |     | 1     | 1     | 0    |     |     |     | 2    | 2    | 0    |
| Cap, veh/h                   |     |     |     | 1020  | 0     | 0    |     |     |     | 655  | 11   | 0    |
| Arrive On Green              |     |     |     | 0.57  | 0.00  | 0.00 |     |     |     | 0.38 | 0.38 | 0.00 |
| Sat Flow, veh/h              |     |     |     | 1792  | 0     | 0    |     |     |     | 1745 | 30   | 0    |
| Grp Volume(v), veh/h         |     |     |     | 1385  | 0     | 0    |     |     |     | 648  | 0    | 0    |
| Grp Sat Flow(s),veh/h/ln     |     |     |     | 1792  | 0     | 0    |     |     |     | 1775 | 0    | 0    |
| Q Serve(g_s), s              |     |     |     | 90.0  | 0.0   | 0.0  |     |     |     | 56.8 | 0.0  | 0.0  |
| Cycle Q Clear(g_c), s        |     |     |     | 90.0  | 0.0   | 0.0  |     |     |     | 56.8 | 0.0  | 0.0  |
| Prop In Lane                 |     |     |     | 1.00  |       | 0.00 |     |     |     | 0.98 |      | 0.00 |
| Lane Grp Cap(c), veh/h       |     |     |     | 1020  | 0     | 0    |     |     |     | 666  | 0    | 0    |
| V/C Ratio(X)                 |     |     |     | 1.36  | 0.00  | 0.00 |     |     |     | 0.97 | 0.00 | 0.00 |
| Avail Cap(c_a), veh/h        |     |     |     | 1020  | 0     | 0    |     |     |     | 674  | 0    | 0    |
| HCM Platoon Ratio            |     |     |     | 1.00  | 1.00  | 1.00 |     |     |     | 1.00 | 1.00 | 1.00 |
| Upstream Filter(I)           |     |     |     | 1.00  | 0.00  | 0.00 |     |     |     | 1.00 | 0.00 | 0.00 |
| Uniform Delay (d), s/veh     |     |     |     | 33.9  | 0.0   | 0.0  |     |     |     | 48.4 | 0.0  | 0.0  |
| Incr Delay (d2), s/veh       |     |     |     | 167.6 | 0.0   | 0.0  |     |     |     | 27.8 | 0.0  | 0.0  |
| Initial Q Delay(d3),s/veh    |     |     |     | 0.0   | 0.0   | 0.0  |     |     |     | 0.0  | 0.0  | 0.0  |
| %ile BackOfQ(50%),veh/ln     |     |     |     | 91.7  | 0.0   | 0.0  |     |     |     | 33.0 | 0.0  | 0.0  |
| LnGrp Delay(d),s/veh         |     |     |     | 201.5 | 0.0   | 0.0  |     |     |     | 76.2 | 0.0  | 0.0  |
| LnGrp LOS                    |     |     |     | F     |       |      |     |     |     | E    |      |      |
| Approach Vol, veh/h          |     |     |     |       | 1385  |      |     |     |     |      | 648  |      |
| Approach Delay, s/veh        |     |     |     |       | 201.5 |      |     |     |     |      | 76.2 |      |
| Approach LOS                 |     |     |     |       | F     |      |     |     |     |      | E    |      |
| Timer                        | 1   | 2   | 3   | 4     | 5     | 6    | 7   | 8   |     |      |      |      |
| Assigned Phs                 |     |     |     | 4     |       | 6    |     |     |     |      |      |      |
| Phs Duration (G+Y+Rc), s     |     |     |     | 63.7  |       | 94.4 |     |     |     |      |      |      |
| Change Period (Y+Rc), s      |     |     |     | 4.4   |       | 4.4  |     |     |     |      |      |      |
| Max Green Setting (Gmax), s  |     |     |     | 60.0  |       | 90.0 |     |     |     |      |      |      |
| Max Q Clear Time (g_c+I1), s |     |     |     | 58.8  |       | 92.0 |     |     |     |      |      |      |
| Green Ext Time (p_c), s      |     |     |     | 0.5   |       | 0.0  |     |     |     |      |      |      |
| <b>Intersection Summary</b>  |     |     |     |       |       |      |     |     |     |      |      |      |
| HCM 2010 Ctrl Delay          |     |     |     | 161.5 |       |      |     |     |     |      |      |      |
| HCM 2010 LOS                 |     |     |     | F     |       |      |     |     |     |      |      |      |

| Intersection             |      |      |      |      |      |      |      |      |      |      |       |      |
|--------------------------|------|------|------|------|------|------|------|------|------|------|-------|------|
| Int Delay, s/veh         | 0.9  |      |      |      |      |      |      |      |      |      |       |      |
| Movement                 | EBL  | EBT  | EBR  | WBL  | WBT  | WBR  | NBL  | NBT  | NBR  | SBL  | SBT   | SBR  |
| Lane Configurations      |      | ↔    |      |      | ↑    | ↗    |      | ↖    | ↗    |      |       |      |
| Traffic Vol, veh/h       | 10   | 570  | 0    | 0    | 1250 | 840  | 10   | 10   | 1570 | 0    | 0     | 0    |
| Future Vol, veh/h        | 10   | 570  | 0    | 0    | 1250 | 840  | 10   | 10   | 1570 | 0    | 0     | 0    |
| Conflicting Peds, #/hr   | 0    | 0    | 1    | 1    | 0    | 0    | 0    | 0    | 0    | 0    | 0     | 0    |
| Sign Control             | Free | Free | Free | Free | Free | Free | Stop | Stop | Stop | Stop | Stop  | Stop |
| RT Channelized           | -    | -    | None | -    | -    | Free | -    | -    | Free | -    | -     | None |
| Storage Length           | -    | -    | -    | -    | -    | 0    | -    | -    | 800  | -    | -     | -    |
| Veh in Median Storage, # | -    | 0    | -    | -    | 0    | -    | -    | 0    | -    | -    | 16965 | -    |
| Grade, %                 | -    | 0    | -    | -    | 0    | -    | -    | 0    | -    | -    | 0     | -    |
| Peak Hour Factor         | 95   | 95   | 95   | 95   | 95   | 95   | 95   | 95   | 95   | 95   | 95    | 95   |
| Heavy Vehicles, %        | 2    | 2    | 2    | 1    | 1    | 1    | 1    | 1    | 1    | 2    | 2     | 2    |
| Mvmt Flow                | 11   | 600  | 0    | 0    | 1316 | 884  | 11   | 11   | 1653 | 0    | 0     | 0    |























| Major/Minor          | Major1 | Major2 | Minor1 |
|----------------------|--------|--------|--------|
| Conflicting Flow All | 1316   | 0      | -      |
| Stage 1              | -      | -      | -      |
| Stage 2              | -      | -      | -      |
| Critical Hdwy        | 4.12   | -      | -      |
| Critical Hdwy Stg 1  | -      | -      | -      |
| Critical Hdwy Stg 2  | -      | -      | -      |
| Follow-up Hdwy       | 2.218  | -      | -      |
| Pot Cap-1 Maneuver   | 525    | -      | 0      |
| Stage 1              | -      | -      | 0      |
| Stage 2              | -      | -      | 0      |
| Platoon blocked, %   | -      | -      | -      |
| Mov Cap-1 Maneuver   | 525    | -      | -      |
| Mov Cap-2 Maneuver   | -      | -      | -      |
| Stage 1              | -      | -      | -      |
| Stage 2              | -      | -      | -      |

| Approach             | EB  | WB | NB   |
|----------------------|-----|----|------|
| HCM Control Delay, s | 0.2 | 0  | 77.2 |
| HCM LOS              |     |    | F    |

| Minor Lane/Major Mvmt | NBLn1 | NBLn2 | EBL  | EBT | WBT |
|-----------------------|-------|-------|------|-----|-----|
| Capacity (veh/h)      | 70    | -     | 525  | -   | -   |
| HCM Lane V/C Ratio    | 0.301 | -     | 0.02 | -   | -   |
| HCM Control Delay (s) | 77.2  | 0     | 12   | 0   | -   |
| HCM Lane LOS          | F     | A     | B    | A   | -   |
| HCM 95th %tile Q(veh) | 1.1   | -     | 0.1  | -   | -   |

HCM 2010 Signalized Intersection Summary  
5: 2nd Avenue & Imjin Parkway

Cumulative, PM  
06/11/2019

|                              |  |  |  |  |  |  |  |  |  |  |  |  |
|------------------------------|---|---|---|---|---|---|--|---|---|---|---|---|
| Movement                     | EBL   | EBT   | EBR   | WBL   | WBT   | WBR   | NBL  | NBT   | NBR   | SBL   | SBT   | SBR   |
| Lane Configurations          |  |  |  |  |  |   |  |  |  |  |  |  |
| Traffic Volume (veh/h)       | 140   | 1340  | 670   | 340   | 1140  | 140   | 800  | 110   | 490   | 90  | 90  | 150   |
| Future Volume (veh/h)        | 140   | 1340  | 670   | 340   | 1140  | 140   | 800  | 110   | 490   | 90  | 90  | 150   |
| Number                       | 5   | 2   | 12  | 1   | 6   | 16  | 3  | 8   | 18  | 7   | 4   | 14  |
| Initial Q (Qb), veh          | 0   | 0   | 0   | 0   | 0   | 0   | 0  | 0   | 0   | 0   | 0   | 0   |
| Ped-Bike Adj(A_pbT)          | 1.00  |   | 1.00  | 1.00  |   | 0.99  | 1.00   |   | 0.99  | 1.00  |   | 0.98  |
| Parking Bus, Adj             | 1.00  | 1.00  | 1.00  | 1.00  | 1.00  | 1.00  | 1.00   | 1.00  | 1.00  | 1.00  | 1.00  | 1.00  |
| Adj Sat Flow, veh/h/ln       | 1881  | 1881  | 1881  | 1881  | 1881  | 1900  | 1900   | 1900  | 1900  | 1900  | 1900  | 1900  |
| Adj Flow Rate, veh/h         | 146   | 1396  | 498   | 354   | 1188  | 146   | 833  | 115   | 276   | 94  | 94  | 125   |
| Adj No. of Lanes             | 1   | 2   | 1   | 2   | 2   | 0   | 2  | 1   | 1   | 1   | 2   | 0   |
| Peak Hour Factor             | 0.96  | 0.96  | 0.96  | 0.96  | 0.96  | 0.96  | 0.96   | 0.96  | 0.96  | 0.96  | 0.96  | 0.96  |
| Percent Heavy Veh, %         | 1   | 1   | 1   | 1   | 1   | 1   | 0  | 0   | 0   | 0   | 0   | 0   |
| Cap, veh/h                   | 183   | 1209  | 538   | 426   | 1148  | 141   | 792  | 502   | 423   | 133   | 202   | 177   |
| Arrive On Green              | 0.10  | 0.34  | 0.34  | 0.12  | 0.36  | 0.36  | 0.23   | 0.26  | 0.26  | 0.07  | 0.11  | 0.11  |
| Sat Flow, veh/h              | 1792  | 3574  | 1592  | 3476  | 3203  | 393   | 3510   | 1900  | 1602  | 1810  | 1805  | 1585  |
| Grp Volume(v), veh/h         | 146   | 1396  | 498   | 354   | 661   | 673   | 833  | 115   | 276   | 94  | 94  | 125   |
| Grp Sat Flow(s),veh/h/ln     | 1792  | 1787  | 1592  | 1738  | 1787  | 1809  | 1755   | 1900  | 1602  | 1810  | 1805  | 1585  |
| Q Serve(g_s), s              | 7.1   | 30.0  | 26.7  | 8.8   | 31.8  | 31.8  | 20.0   | 4.2   | 13.6  | 4.5   | 4.3   | 6.7   |
| Cycle Q Clear(g_c), s        | 7.1   | 30.0  | 26.7  | 8.8   | 31.8  | 31.8  | 20.0   | 4.2   | 13.6  | 4.5   | 4.3   | 6.7   |
| Prop In Lane                 | 1.00  |   | 1.00  | 1.00  |   | 0.22  | 1.00   |   | 1.00  | 1.00  |   | 1.00  |
| Lane Grp Cap(c), veh/h       | 183   | 1209  | 538   | 426   | 640   | 648   | 792  | 502   | 423   | 133   | 202   | 177   |
| V/C Ratio(X)                 | 0.80  | 1.15  | 0.92  | 0.83  | 1.03  | 1.04  | 1.05   | 0.23  | 0.65  | 0.71  | 0.47  | 0.70  |
| Avail Cap(c_a), veh/h        | 303   | 1209  | 538   | 588   | 640   | 648   | 792  | 502   | 423   | 204   | 427   | 375   |
| HCM Platoon Ratio            | 1.00  | 1.00  | 1.00  | 1.00  | 1.00  | 1.00  | 1.00   | 1.00  | 1.00  | 1.00  | 1.00  | 1.00  |
| Upstream Filter(I)           | 1.00  | 1.00  | 1.00  | 1.00  | 1.00  | 1.00  | 1.00   | 1.00  | 1.00  | 1.00  | 1.00  | 1.00  |
| Uniform Delay (d), s/veh     | 38.9  | 29.3  | 28.3  | 38.0  | 28.5  | 28.5  | 34.3   | 25.6  | 29.0  | 40.2  | 36.9  | 38.0  |
| Incr Delay (d2), s/veh       | 3.0   | 79.4  | 21.6  | 5.2   | 44.2  | 45.6  | 46.6   | 0.1   | 2.8   | 2.6   | 0.6   | 1.9   |
| Initial Q Delay(d3),s/veh    | 0.0   | 0.0   | 0.0   | 0.0   | 0.0   | 0.0   | 0.0  | 0.0   | 0.0   | 0.0   | 0.0   | 0.0   |
| %ile BackOfQ(50%),veh/ln     | 3.6   | 27.9  | 15.0  | 4.5   | 23.3  | 23.9  | 14.7   | 2.2   | 6.3   | 2.3   | 2.2   | 3.0   |
| LnGrp Delay(d),s/veh         | 41.9  | 108.7   | 49.9  | 43.3  | 72.6  | 74.0  | 81.0   | 25.7  | 31.8  | 42.7  | 37.5  | 39.9  |
| LnGrp LOS                    | D   | F   | D   | D   | F   | F   | F  | C   | C   | D   | D   | D   |
| Approach Vol, veh/h          |   | 2040  |   |   | 1688  |   |  | 1224  |   |   | 313   |   |
| Approach Delay, s/veh        |   | 89.6  |   |   | 67.0  |   |  | 64.7  |   |   | 40.0  |   |
| Approach LOS                 |   | F   |   |   | E   |   |  | E   |   |   | D   |   |
| Timer                        | 1   | 2   | 3   | 4   | 5   | 6   | 7  | 8   |   |   |   |   |
| Assigned Phs                 | 1   | 2   | 3   | 4   | 5   | 6   | 7  | 8   |   |   |   |   |
| Phs Duration (G+Y+Rc), s     | 15.4  | 35.3  | 23.5  | 14.5  | 13.6  | 37.1  | 10.0   | 28.0  |   |   |   |   |
| Change Period (Y+Rc), s      | 4.5   | 5.3   | 3.5   | 4.6   | 4.5   | 5.3   | 3.5  | 4.6   |   |   |   |   |
| Max Green Setting (Gmax), s  | 15.0  | 30.0  | 20.0  | 21.0  | 15.0  | 30.0  | 10.0   | 21.0  |   |   |   |   |
| Max Q Clear Time (g_c+I1), s | 10.8  | 32.0  | 22.0  | 8.7   | 9.1   | 33.8  | 6.5  | 15.6  |   |   |   |   |
| Green Ext Time (p_c), s      | 0.0   | 0.0   | 0.0   | 0.2   | 0.0   | 0.0   | 0.0  | 0.1   |   |   |   |   |
| <b>Intersection Summary</b>  |   |   |   |   |   |   |  |   |   |   |   |   |
| HCM 2010 Ctrl Delay          |   |   | 73.6  |   |   |   |  |   |   |   |   |   |
| HCM 2010 LOS                 |   |   | E   |   |   |   |  |   |   |   |   |   |

HCM 2010 Signalized Intersection Summary  
6: 3rd Avenue & Imjin Parkway

Cumulative, PM  
06/11/2019



| Movement                    | EBL  | EBT  | EBR  | WBL  | WBT  | WBR  | NBL  | NBT  | NBR  | SBL  | SBT  | SBR  |
|-----------------------------|------|------|------|------|------|------|------|------|------|------|------|------|
| Lane Configurations         |      |      |      |      |      |      |      |      |      |      |      |      |
| Traffic Volume (veh/h)      | 50   | 1740 | 170  | 90   | 1240 | 20   | 220  | 10   | 150  | 10   | 10   | 50   |
| Future Volume (veh/h)       | 50   | 1740 | 170  | 90   | 1240 | 20   | 220  | 10   | 150  | 10   | 10   | 50   |
| Number                      | 5    | 2    | 12   | 1    | 6    | 16   | 3    | 8    | 18   | 7    | 4    | 14   |
| Initial Q (Qb), veh         | 0    | 0    | 0    | 0    | 0    | 0    | 0    | 0    | 0    | 0    | 0    | 0    |
| Ped-Bike Adj(A_pbT)         | 1.00 |      | 0.98 | 1.00 |      | 1.00 | 1.00 |      | 1.00 | 1.00 |      | 1.00 |
| Parking Bus, Adj            | 1.00 | 1.00 | 1.00 | 1.00 | 1.00 | 1.00 | 1.00 | 1.00 | 1.00 | 1.00 | 1.00 | 1.00 |
| Adj Sat Flow, veh/h/ln      | 1881 | 1881 | 1900 | 1881 | 1881 | 1900 | 1900 | 1900 | 1900 | 1900 | 1900 | 1900 |
| Adj Flow Rate, veh/h        | 51   | 1776 | 165  | 92   | 1265 | 19   | 224  | 10   | 41   | 10   | 10   | 10   |
| Adj No. of Lanes            | 1    | 2    | 0    | 1    | 2    | 0    | 1    | 1    | 0    | 1    | 1    | 0    |
| Peak Hour Factor            | 0.98 | 0.98 | 0.98 | 0.98 | 0.98 | 0.98 | 0.98 | 0.98 | 0.98 | 0.98 | 0.98 | 0.98 |
| Percent Heavy Veh, %        | 1    | 1    | 1    | 1    | 1    | 1    | 0    | 0    | 0    | 0    | 0    | 0    |
| Cap, veh/h                  | 107  | 1718 | 157  | 118  | 1897 | 28   | 382  | 65   | 265  | 353  | 173  | 173  |
| Arrive On Green             | 0.06 | 0.52 | 0.52 | 0.07 | 0.53 | 0.53 | 0.20 | 0.20 | 0.20 | 0.20 | 0.20 | 0.20 |
| Sat Flow, veh/h             | 1792 | 3305 | 302  | 1792 | 3605 | 54   | 1412 | 326  | 1336 | 1373 | 872  | 872  |
| Grp Volume(v), veh/h        | 51   | 946  | 995  | 92   | 627  | 657  | 224  | 0    | 51   | 10   | 0    | 20   |
| Grp Sat Flow(s),veh/h/ln    | 1792 | 1787 | 1820 | 1792 | 1787 | 1872 | 1412 | 0    | 1662 | 1373 | 0    | 1745 |
| Q Serve(g_s), s             | 1.7  | 32.5 | 32.5 | 3.2  | 16.0 | 16.0 | 9.6  | 0.0  | 1.6  | 0.4  | 0.0  | 0.6  |
| Cycle Q Clear(g_c), s       | 1.7  | 32.5 | 32.5 | 3.2  | 16.0 | 16.0 | 10.1 | 0.0  | 1.6  | 2.0  | 0.0  | 0.6  |
| Prop In Lane                | 1.00 |      | 0.17 | 1.00 |      | 0.03 | 1.00 |      | 0.80 | 1.00 |      | 0.50 |
| Lane Grp Cap(c), veh/h      | 107  | 929  | 946  | 118  | 940  | 985  | 382  | 0    | 330  | 353  | 0    | 346  |
| V/C Ratio(X)                | 0.48 | 1.02 | 1.05 | 0.78 | 0.67 | 0.67 | 0.59 | 0.00 | 0.15 | 0.03 | 0.00 | 0.06 |
| Avail Cap(c_a), veh/h       | 330  | 929  | 946  | 330  | 940  | 985  | 723  | 0    | 731  | 684  | 0    | 767  |
| HCM Platoon Ratio           | 1.00 | 1.00 | 1.00 | 1.00 | 1.00 | 1.00 | 1.00 | 1.00 | 1.00 | 1.00 | 1.00 | 1.00 |
| Upstream Filter(I)          | 1.00 | 1.00 | 1.00 | 1.00 | 1.00 | 1.00 | 1.00 | 0.00 | 1.00 | 1.00 | 0.00 | 1.00 |
| Uniform Delay (d), s/veh    | 28.5 | 15.0 | 15.0 | 28.7 | 10.8 | 10.8 | 24.4 | 0.0  | 20.7 | 21.5 | 0.0  | 20.3 |
| Incr Delay (d2), s/veh      | 1.2  | 34.1 | 44.0 | 4.1  | 1.5  | 1.4  | 0.5  | 0.0  | 0.1  | 0.0  | 0.0  | 0.0  |
| Initial Q Delay(d3),s/veh   | 0.0  | 0.0  | 0.0  | 0.0  | 0.0  | 0.0  | 0.0  | 0.0  | 0.0  | 0.0  | 0.0  | 0.0  |
| %ile BackOfQ(50%),veh/ln    | 0.9  | 24.6 | 27.6 | 1.7  | 8.2  | 8.6  | 3.8  | 0.0  | 0.7  | 0.1  | 0.0  | 0.3  |
| LnGrp Delay(d),s/veh        | 29.7 | 49.2 | 59.0 | 32.9 | 12.3 | 12.2 | 25.0 | 0.0  | 20.8 | 21.6 | 0.0  | 20.4 |
| LnGrp LOS                   | C    | F    | F    | C    | B    | B    | C    |      | C    | C    |      | C    |
| Approach Vol, veh/h         |      | 1992 |      |      | 1376 |      |      | 275  |      |      | 30   |      |
| Approach Delay, s/veh       |      | 53.6 |      |      | 13.6 |      |      | 24.2 |      |      | 20.8 |      |
| Approach LOS                |      | D    |      |      | B    |      |      | C    |      |      | C    |      |
| Timer                       | 1    | 2    | 3    | 4    | 5    | 6    | 7    | 8    |      |      |      |      |
| Assigned Phs                | 1    | 2    |      | 4    | 5    | 6    |      | 8    |      |      |      |      |
| Phs Duration (G+Y+Rc), s    | 7.6  | 38.0 |      | 16.9 | 7.2  | 38.4 |      | 16.9 |      |      |      |      |
| Change Period (Y+Rc), s     | 3.5  | 5.5  |      | 4.5  | 3.5  | 5.5  |      | 4.5  |      |      |      |      |
| Max Green Setting (Gmax), s | 1.5  | 32.5 |      | 27.5 | 11.5 | 32.5 |      | 27.5 |      |      |      |      |
| Max Q Clear Time (g_c+1), s | 1.5  | 34.5 |      | 4.0  | 3.7  | 18.0 |      | 12.1 |      |      |      |      |
| Green Ext Time (p_c), s     | 0.0  | 0.0  |      | 0.0  | 0.0  | 0.9  |      | 0.1  |      |      |      |      |
| <b>Intersection Summary</b> |      |      |      |      |      |      |      |      |      |      |      |      |
| HCM 2010 Ctrl Delay         |      |      |      | 36.1 |      |      |      |      |      |      |      |      |
| HCM 2010 LOS                |      |      |      | D    |      |      |      |      |      |      |      |      |

HCM 2010 Signalized Intersection Summary  
7: 4th Avenue & Imjin Parkway

Cumulative, PM  
06/11/2019



| Movement                    | EBL  | EBT  | EBR  | WBL  | WBT  | WBR  | NBL  | NBT  | NBR  | SBL  | SBT  | SBR  |
|-----------------------------|------|------|------|------|------|------|------|------|------|------|------|------|
| Lane Configurations         |      |      |      |      |      |      |      |      |      |      |      |      |
| Traffic Volume (veh/h)      | 10   | 1900 | 10   | 10   | 1320 | 10   | 20   | 10   | 10   | 10   | 10   | 10   |
| Future Volume (veh/h)       | 10   | 1900 | 10   | 10   | 1320 | 10   | 20   | 10   | 10   | 10   | 10   | 10   |
| Number                      | 5    | 2    | 12   | 1    | 6    | 16   | 3    | 8    | 18   | 7    | 4    | 14   |
| Initial Q (Qb), veh         | 0    | 0    | 0    | 0    | 0    | 0    | 0    | 0    | 0    | 0    | 0    | 0    |
| Ped-Bike Adj(A_pbT)         | 1.00 |      | 1.00 | 1.00 |      | 0.98 | 1.00 |      | 1.00 | 1.00 |      | 1.00 |
| Parking Bus, Adj            | 1.00 | 1.00 | 1.00 | 1.00 | 1.00 | 1.00 | 1.00 | 1.00 | 1.00 | 1.00 | 1.00 | 1.00 |
| Adj Sat Flow, veh/h/ln      | 1881 | 1881 | 1900 | 1881 | 1881 | 1900 | 1900 | 1900 | 1900 | 1900 | 1900 | 1900 |
| Adj Flow Rate, veh/h        | 10   | 1959 | 10   | 10   | 1361 | 10   | 21   | 10   | 8    | 10   | 10   | 10   |
| Adj No. of Lanes            | 1    | 2    | 0    | 1    | 2    | 0    | 0    | 1    | 0    | 0    | 1    | 0    |
| Peak Hour Factor            | 0.97 | 0.97 | 0.97 | 0.97 | 0.97 | 0.97 | 0.97 | 0.97 | 0.97 | 0.97 | 0.97 | 0.97 |
| Percent Heavy Veh, %        | 1    | 1    | 1    | 1    | 1    | 1    | 0    | 0    | 0    | 0    | 0    | 0    |
| Cap, veh/h                  | 14   | 2122 | 11   | 14   | 2116 | 16   | 194  | 23   | 18   | 157  | 31   | 31   |
| Arrive On Green             | 0.01 | 0.58 | 0.58 | 0.01 | 0.58 | 0.58 | 0.07 | 0.05 | 0.05 | 0.07 | 0.05 | 0.05 |
| Sat Flow, veh/h             | 1792 | 3646 | 19   | 1792 | 3636 | 27   | 874  | 416  | 333  | 566  | 566  | 566  |
| Grp Volume(v), veh/h        | 10   | 959  | 1010 | 10   | 669  | 702  | 39   | 0    | 0    | 30   | 0    | 0    |
| Grp Sat Flow(s),veh/h/ln    | 1792 | 1787 | 1878 | 1792 | 1787 | 1876 | 1623 | 0    | 0    | 1698 | 0    | 0    |
| Q Serve(g_s), s             | 0.2  | 18.4 | 18.5 | 0.2  | 9.5  | 9.5  | 0.2  | 0.0  | 0.0  | 0.0  | 0.0  | 0.0  |
| Cycle Q Clear(g_c), s       | 0.2  | 18.4 | 18.5 | 0.2  | 9.5  | 9.5  | 0.8  | 0.0  | 0.0  | 0.6  | 0.0  | 0.0  |
| Prop In Lane                | 1.00 |      | 0.01 | 1.00 |      | 0.01 | 0.54 |      | 0.21 | 0.33 |      | 0.33 |
| Lane Grp Cap(c), veh/h      | 14   | 1040 | 1093 | 14   | 1040 | 1092 | 256  | 0    | 0    | 241  | 0    | 0    |
| V/C Ratio(X)                | 0.71 | 0.92 | 0.92 | 0.71 | 0.64 | 0.64 | 0.15 | 0.00 | 0.00 | 0.12 | 0.00 | 0.00 |
| Avail Cap(c_a), veh/h       | 543  | 1530 | 1608 | 543  | 1530 | 1606 | 1298 | 0    | 0    | 1327 | 0    | 0    |
| HCM Platoon Ratio           | 1.00 | 1.00 | 1.00 | 1.00 | 1.00 | 1.00 | 1.00 | 1.00 | 1.00 | 1.00 | 1.00 | 1.00 |
| Upstream Filter(I)          | 1.00 | 1.00 | 1.00 | 1.00 | 1.00 | 1.00 | 1.00 | 0.00 | 0.00 | 1.00 | 0.00 | 0.00 |
| Uniform Delay (d), s/veh    | 18.8 | 7.2  | 7.2  | 18.8 | 5.3  | 5.3  | 17.2 | 0.0  | 0.0  | 17.2 | 0.0  | 0.0  |
| Incr Delay (d2), s/veh      | 21.0 | 5.6  | 5.4  | 21.0 | 0.2  | 0.2  | 0.1  | 0.0  | 0.0  | 0.1  | 0.0  | 0.0  |
| Initial Q Delay(d3),s/veh   | 0.0  | 0.0  | 0.0  | 0.0  | 0.0  | 0.0  | 0.0  | 0.0  | 0.0  | 0.0  | 0.0  | 0.0  |
| %ile BackOfQ(50%),veh/ln    | 0.2  | 10.4 | 10.9 | 0.2  | 4.5  | 4.8  | 0.4  | 0.0  | 0.0  | 0.3  | 0.0  | 0.0  |
| LnGrp Delay(d),s/veh        | 39.8 | 12.7 | 12.6 | 39.8 | 5.5  | 5.5  | 17.3 | 0.0  | 0.0  | 17.2 | 0.0  | 0.0  |
| LnGrp LOS                   | D    | B    | B    | D    | A    | A    | B    |      |      | B    |      |      |
| Approach Vol, veh/h         |      | 1979 |      |      | 1381 |      |      | 39   |      |      | 30   |      |
| Approach Delay, s/veh       |      | 12.8 |      |      | 5.8  |      |      | 17.3 |      |      | 17.2 |      |
| Approach LOS                |      | B    |      |      | A    |      |      | B    |      |      | B    |      |
| Timer                       | 1    | 2    | 3    | 4    | 5    | 6    | 7    | 8    |      |      |      |      |
| Assigned Phs                | 1    | 2    |      | 4    | 5    | 6    |      | 8    |      |      |      |      |
| Phs Duration (G+Y+Rc), s    | 3.8  | 27.6 |      | 6.6  | 3.8  | 27.6 |      | 6.6  |      |      |      |      |
| Change Period (Y+Rc), s     | 3.5  | 5.5  |      | 4.5  | 3.5  | 5.5  |      | 4.5  |      |      |      |      |
| Max Green Setting (Gmax), s | 1.5  | 32.5 |      | 27.5 | 11.5 | 32.5 |      | 27.5 |      |      |      |      |
| Max Q Clear Time (g_c+1), s | 12.2 | 20.5 |      | 2.6  | 2.2  | 11.5 |      | 2.8  |      |      |      |      |
| Green Ext Time (p_c), s     | 0.0  | 1.6  |      | 0.0  | 0.0  | 1.0  |      | 0.0  |      |      |      |      |
| <b>Intersection Summary</b> |      |      |      |      |      |      |      |      |      |      |      |      |
| HCM 2010 Ctrl Delay         |      |      |      | 10.1 |      |      |      |      |      |      |      |      |
| HCM 2010 LOS                |      |      |      | B    |      |      |      |      |      |      |      |      |

HCM 2010 Signalized Intersection Summary  
 8: 5th Avenue/California Avenue & Imjin Parkway

Cumulative, PM  
 06/11/2019



| Movement                      | EBL  | EBT  | EBR  | WBL  | WBT  | WBR  | NBL  | NBT  | NBR  | SBL  | SBT  | SBR  |
|-------------------------------|------|------|------|------|------|------|------|------|------|------|------|------|
| Lane Configurations           |      |      |      |      |      |      |      |      |      |      |      |      |
| Traffic Volume (veh/h)        | 280  | 1570 | 10   | 10   | 1080 | 90   | 20   | 40   | 10   | 50   | 30   | 230  |
| Future Volume (veh/h)         | 280  | 1570 | 10   | 10   | 1080 | 90   | 20   | 40   | 10   | 50   | 30   | 230  |
| Number                        | 5    | 2    | 12   | 1    | 6    | 16   | 3    | 8    | 18   | 7    | 4    | 14   |
| Initial Q (Qb), veh           | 0    | 0    | 0    | 0    | 0    | 0    | 0    | 0    | 0    | 0    | 0    | 0    |
| Ped-Bike Adj(A_pbT)           | 1.00 |      | 1.00 | 1.00 |      | 1.00 | 1.00 |      | 1.00 | 1.00 |      | 0.98 |
| Parking Bus, Adj              | 1.00 | 1.00 | 1.00 | 1.00 | 1.00 | 1.00 | 1.00 | 1.00 | 1.00 | 1.00 | 1.00 | 1.00 |
| Adj Sat Flow, veh/h/ln        | 1881 | 1881 | 1900 | 1881 | 1881 | 1900 | 1900 | 1900 | 1900 | 1900 | 1881 | 1900 |
| Adj Flow Rate, veh/h          | 289  | 1619 | 10   | 10   | 1113 | 87   | 21   | 41   | 7    | 52   | 31   | 68   |
| Adj No. of Lanes              | 1    | 2    | 0    | 1    | 2    | 0    | 0    | 1    | 0    | 0    | 1    | 0    |
| Peak Hour Factor              | 0.97 | 0.97 | 0.97 | 0.97 | 0.97 | 0.97 | 0.97 | 0.97 | 0.97 | 0.97 | 0.97 | 0.97 |
| Percent Heavy Veh, %          | 1    | 1    | 1    | 1    | 1    | 1    | 0    | 0    | 0    | 1    | 1    | 1    |
| Cap, veh/h                    | 350  | 2047 | 13   | 14   | 1259 | 98   | 152  | 161  | 24   | 167  | 55   | 93   |
| Arrive On Green               | 0.20 | 0.56 | 0.56 | 0.01 | 0.37 | 0.37 | 0.14 | 0.13 | 0.13 | 0.14 | 0.13 | 0.13 |
| Sat Flow, veh/h               | 1792 | 3642 | 22   | 1792 | 3358 | 262  | 364  | 1238 | 181  | 454  | 423  | 718  |
| Grp Volume(v), veh/h          | 289  | 794  | 835  | 10   | 592  | 608  | 69   | 0    | 0    | 151  | 0    | 0    |
| Grp Sat Flow(s),veh/h/ln      | 1792 | 1787 | 1877 | 1792 | 1787 | 1834 | 1783 | 0    | 0    | 1595 | 0    | 0    |
| Q Serve(g_s), s               | 6.9  | 15.6 | 15.7 | 0.2  | 13.8 | 13.9 | 0.0  | 0.0  | 0.0  | 2.4  | 0.0  | 0.0  |
| Cycle Q Clear(g_c), s         | 6.9  | 15.6 | 15.7 | 0.2  | 13.8 | 13.9 | 1.5  | 0.0  | 0.0  | 3.9  | 0.0  | 0.0  |
| Prop In Lane                  | 1.00 |      | 0.01 | 1.00 |      | 0.14 | 0.30 |      | 0.10 | 0.34 |      | 0.45 |
| Lane Grp Cap(c), veh/h        | 350  | 1005 | 1055 | 14   | 670  | 687  | 361  | 0    | 0    | 337  | 0    | 0    |
| V/C Ratio(X)                  | 0.83 | 0.79 | 0.79 | 0.71 | 0.88 | 0.88 | 0.19 | 0.00 | 0.00 | 0.45 | 0.00 | 0.00 |
| Avail Cap(c_a), veh/h         | 601  | 1200 | 1260 | 601  | 1200 | 1231 | 884  | 0    | 0    | 827  | 0    | 0    |
| HCM Platoon Ratio             | 1.00 | 1.00 | 1.00 | 1.00 | 1.00 | 1.00 | 1.00 | 1.00 | 1.00 | 1.00 | 1.00 | 1.00 |
| Upstream Filter(I)            | 1.00 | 1.00 | 1.00 | 1.00 | 1.00 | 1.00 | 1.00 | 0.00 | 0.00 | 1.00 | 0.00 | 0.00 |
| Uniform Delay (d), s/veh      | 17.3 | 7.7  | 7.7  | 22.1 | 13.1 | 13.1 | 17.5 | 0.0  | 0.0  | 18.5 | 0.0  | 0.0  |
| Incr Delay (d2), s/veh        | 1.9  | 2.5  | 2.4  | 21.7 | 1.6  | 1.6  | 0.1  | 0.0  | 0.0  | 0.3  | 0.0  | 0.0  |
| Initial Q Delay(d3),s/veh     | 0.0  | 0.0  | 0.0  | 0.0  | 0.0  | 0.0  | 0.0  | 0.0  | 0.0  | 0.0  | 0.0  | 0.0  |
| %ile BackOfQ(50%),veh/ln      | 3.6  | 8.2  | 8.6  | 0.2  | 7.0  | 7.2  | 0.8  | 0.0  | 0.0  | 1.8  | 0.0  | 0.0  |
| LnGrp Delay(d),s/veh          | 19.2 | 10.2 | 10.1 | 43.8 | 14.6 | 14.6 | 17.6 | 0.0  | 0.0  | 18.8 | 0.0  | 0.0  |
| LnGrp LOS                     | B    | B    | B    | D    | B    | B    | B    |      |      | B    |      |      |
| Approach Vol, veh/h           |      | 1918 |      |      | 1210 |      |      | 69   |      |      | 151  |      |
| Approach Delay, s/veh         |      | 11.5 |      |      | 14.9 |      |      | 17.6 |      |      | 18.8 |      |
| Approach LOS                  |      | B    |      |      | B    |      |      | B    |      |      | B    |      |
| Timer                         | 1    | 2    | 3    | 4    | 5    | 6    | 7    | 8    |      |      |      |      |
| Assigned Phs                  | 1    | 2    |      | 4    | 5    | 6    |      | 8    |      |      |      |      |
| Phs Duration (G+Y+Rc), s      | 3.9  | 30.4 |      | 10.4 | 12.2 | 22.0 |      | 10.4 |      |      |      |      |
| Change Period (Y+Rc), s       | 3.5  | 5.3  |      | 4.6  | 3.5  | 5.3  |      | 4.6  |      |      |      |      |
| Max Green Setting (Gmax), s   | 15.0 | 30.0 |      | 20.0 | 15.0 | 30.0 |      | 20.0 |      |      |      |      |
| Max Q Clear Time (g_c+1/2), s | 12.2 | 17.7 |      | 5.9  | 8.9  | 15.9 |      | 3.5  |      |      |      |      |
| Green Ext Time (p_c), s       | 0.0  | 1.2  |      | 0.1  | 0.0  | 0.9  |      | 0.0  |      |      |      |      |
| <b>Intersection Summary</b>   |      |      |      |      |      |      |      |      |      |      |      |      |
| HCM 2010 Ctrl Delay           |      |      |      | 13.2 |      |      |      |      |      |      |      |      |
| HCM 2010 LOS                  |      |      |      | B    |      |      |      |      |      |      |      |      |



| Intersection             |      |      |      |      |      |      |
|--------------------------|------|------|------|------|------|------|
| Int Delay, s/veh         | 0.6  |      |      |      |      |      |
| Movement                 | EBL  | EBR  | NBL  | NBT  | SBT  | SBR  |
| Lane Configurations      | W    |      | W    | ↑    | ↑    |      |
| Traffic Vol, veh/h       | 10   | 10   | 20   | 380  | 240  | 10   |
| Future Vol, veh/h        | 10   | 10   | 20   | 380  | 240  | 10   |
| Conflicting Peds, #/hr   | 0    | 0    | 0    | 0    | 0    | 0    |
| Sign Control             | Stop | Stop | Free | Free | Free | Free |
| RT Channelized           | -    | None | -    | None | -    | None |
| Storage Length           | 0    | -    | 155  | -    | -    | -    |
| Veh in Median Storage, # | 0    | -    | -    | 0    | 0    | -    |
| Grade, %                 | 0    | -    | -    | 0    | 0    | -    |
| Peak Hour Factor         | 92   | 92   | 92   | 92   | 92   | 92   |
| Heavy Vehicles, %        | 2    | 2    | 2    | 2    | 2    | 2    |
| Mvmt Flow                | 11   | 11   | 22   | 413  | 261  | 11   |















| Major/Minor          | Minor2 | Major1 | Major2 |   |   |   |
|----------------------|--------|--------|--------|---|---|---|
| Conflicting Flow All | 724    | 267    | 272    | 0 | - | 0 |
| Stage 1              | 267    | -      | -      | - | - | - |
| Stage 2              | 457    | -      | -      | - | - | - |
| Critical Hdwy        | 6.42   | 6.22   | 4.12   | - | - | - |
| Critical Hdwy Stg 1  | 5.42   | -      | -      | - | - | - |
| Critical Hdwy Stg 2  | 5.42   | -      | -      | - | - | - |
| Follow-up Hdwy       | 3.518  | 3.318  | 2.218  | - | - | - |
| Pot Cap-1 Maneuver   | 393    | 772    | 1291   | - | - | - |
| Stage 1              | 778    | -      | -      | - | - | - |
| Stage 2              | 638    | -      | -      | - | - | - |
| Platoon blocked, %   |        |        |        | - | - | - |
| Mov Cap-1 Maneuver   | 386    | 772    | 1291   | - | - | - |
| Mov Cap-2 Maneuver   | 386    | -      | -      | - | - | - |
| Stage 1              | 765    | -      | -      | - | - | - |
| Stage 2              | 638    | -      | -      | - | - | - |

| Approach             | EB   | NB  | SB |
|----------------------|------|-----|----|
| HCM Control Delay, s | 12.3 | 0.4 | 0  |
| HCM LOS              | B    |     |    |

| Minor Lane/Major Mvmt | NBL   | NBT | EBLn1 | SBT | SBR |
|-----------------------|-------|-----|-------|-----|-----|
| Capacity (veh/h)      | 1291  | -   | 515   | -   | -   |
| HCM Lane V/C Ratio    | 0.017 | -   | 0.042 | -   | -   |
| HCM Control Delay (s) | 7.8   | -   | 12.3  | -   | -   |
| HCM Lane LOS          | A     | -   | B     | -   | -   |
| HCM 95th %tile Q(veh) | 0.1   | -   | 0.1   | -   | -   |

HCM 2010 Signalized Intersection Summary  
 10: Imjin Road & Imjin Parkway

Cumulative, PM  
 06/11/2019

|                              |    |  |  |    |    |  |   |      |
|------------------------------|---|---|---|---|---|---|---|------|
| Movement                     | EBT   | EBR   | WBL   | WBT   | NBL   | NBR   |   |      |
| Lane Configurations          |   |   |  |   |    |  |   |      |
| Traffic Volume (veh/h)       | 1540  | 80  | 170   | 960   | 180   | 430   |   |      |
| Future Volume (veh/h)        | 1540  | 80  | 170   | 960   | 180   | 430   |   |      |
| Number                       | 2   | 12  | 1   | 6   | 3   | 18  |   |      |
| Initial Q (Qb), veh          | 0   | 0   | 0   | 0   | 0   | 0   |   |      |
| Ped-Bike Adj(A_pbT)          |   | 1.00  | 1.00  |   | 1.00  | 1.00  |   |      |
| Parking Bus, Adj             | 1.00  | 1.00  | 1.00  | 1.00  | 1.00  | 1.00  |   |      |
| Adj Sat Flow, veh/h/ln       | 1881  | 1900  | 1881  | 1881  | 1881  | 1881  |   |      |
| Adj Flow Rate, veh/h         | 1621  | 81  | 179   | 1011  | 189   | 387   |   |      |
| Adj No. of Lanes             | 2   | 0   | 1   | 2   | 1   | 2   |   |      |
| Peak Hour Factor             | 0.95  | 0.95  | 0.95  | 0.95  | 0.95  | 0.95  |   |      |
| Percent Heavy Veh, %         | 1   | 1   | 1   | 1   | 1   | 1   |   |      |
| Cap, veh/h                   | 1689  | 84  | 222   | 2494  | 270   | 483   |   |      |
| Arrive On Green              | 0.49  | 0.49  | 0.12  | 0.70  | 0.15  | 0.15  |   |      |
| Sat Flow, veh/h              | 3560  | 172   | 1792  | 3668  | 1792  | 3198  |   |      |
| Grp Volume(v), veh/h         | 832   | 870   | 179   | 1011  | 189   | 387   |   |      |
| Grp Sat Flow(s),veh/h/ln     | 1787  | 1851  | 1792  | 1787  | 1792  | 1599  |   |      |
| Q Serve(g_s), s              | 27.5  | 27.9  | 6.0   | 7.3   | 6.2   | 7.2   |   |      |
| Cycle Q Clear(g_c), s        | 27.5  | 27.9  | 6.0   | 7.3   | 6.2   | 7.2   |   |      |
| Prop In Lane                 |   | 0.09  | 1.00  |   | 1.00  | 1.00  |   |      |
| Lane Grp Cap(c), veh/h       | 871   | 902   | 222   | 2494  | 270   | 483   |   |      |
| V/C Ratio(X)                 | 0.96  | 0.96  | 0.80  | 0.41  | 0.70  | 0.80  |   |      |
| Avail Cap(c_a), veh/h        | 872   | 903   | 583   | 2494  | 641   | 1144  |   |      |
| HCM Platoon Ratio            | 1.00  | 1.00  | 1.00  | 1.00  | 1.00  | 1.00  |   |      |
| Upstream Filter(I)           | 1.00  | 1.00  | 1.00  | 1.00  | 1.00  | 1.00  |   |      |
| Uniform Delay (d), s/veh     | 15.1  | 15.2  | 26.2  | 3.9   | 24.8  | 25.2  |   |      |
| Incr Delay (d2), s/veh       | 20.2  | 21.5  | 2.6   | 0.0   | 1.2   | 1.2   |   |      |
| Initial Q Delay(d3),s/veh    | 0.0   | 0.0   | 0.0   | 0.0   | 0.0   | 0.0   |   |      |
| %ile BackOfQ(50%),veh/ln     | 18.3  | 19.4  | 3.1   | 3.5   | 3.1   | 3.3   |   |      |
| LnGrp Delay(d),s/veh         | 35.3  | 36.7  | 28.8  | 4.0   | 26.0  | 26.4  |   |      |
| LnGrp LOS                    | D   | D   | C   | A   | C   | C   |   |      |
| Approach Vol, veh/h          | 1702  |   |   | 1190  | 576   |   |   |      |
| Approach Delay, s/veh        | 36.0  |   |   | 7.7   | 26.3  |   |   |      |
| Approach LOS                 | D   |   |   | A   | C   |   |   |      |
| Timer                        | 1   | 2   | 3   | 4   | 5   | 6   | 7 | 8    |
| Assigned Phs                 | 1   | 2   |   |   |   | 6   |   | 8    |
| Phs Duration (G+Y+Rc), s     | 12.9  | 35.3  |   |   |   | 48.2  |   | 13.3 |
| Change Period (Y+Rc), s      | 5.3   | * 5.3   |   |   |   | 5.3   |   | 4.0  |
| Max Green Setting (Gmax), s  | 20.0  | * 30  |   |   |   | 30.0  |   | 22.0 |
| Max Q Clear Time (g_c+I1), s | 8.0   | 29.9  |   |   |   | 9.3   |   | 9.2  |
| Green Ext Time (p_c), s      | 0.0   | 0.0   |   |   |   | 1.1   |   | 0.1  |
| <b>Intersection Summary</b>  |   |   |   |   |   |   |   |      |
| HCM 2010 Ctrl Delay          |   |   | 24.7  |   |   |   |   |      |
| HCM 2010 LOS                 |   |   | C   |   |   |   |   |      |
| <b>Notes</b>                 |   |   |   |   |   |   |   |      |

HCM 2010 Signalized Intersection Summary  
 11: Abrams Drive & Imjin Parkway

Cumulative, PM  
 06/11/2019



| Movement                     | EBL  | EBT  | EBR  | WBL  | WBT  | WBR  | NBL  | NBT  | NBR  | SBL  | SBT  | SBR  |
|------------------------------|------|------|------|------|------|------|------|------|------|------|------|------|
| Lane Configurations          | ↔    | ↗    |      | ↔    | ↗    |      | ↔    | ↑    | ↗    | ↔    | ↑    | ↗    |
| Traffic Volume (veh/h)       | 130  | 1570 | 180  | 170  | 920  | 120  | 160  | 30   | 210  | 60   | 20   | 120  |
| Future Volume (veh/h)        | 130  | 1570 | 180  | 170  | 920  | 120  | 160  | 30   | 210  | 60   | 20   | 120  |
| Number                       | 5    | 2    | 12   | 1    | 6    | 16   | 3    | 8    | 18   | 7    | 4    | 14   |
| Initial Q (Qb), veh          | 0    | 0    | 0    | 0    | 0    | 0    | 0    | 0    | 0    | 0    | 0    | 0    |
| Ped-Bike Adj(A_pbT)          | 1.00 |      | 1.00 | 1.00 |      | 1.00 | 1.00 |      | 1.00 | 1.00 |      | 1.00 |
| Parking Bus, Adj             | 1.00 | 1.00 | 1.00 | 1.00 | 1.00 | 1.00 | 1.00 | 1.00 | 1.00 | 1.00 | 1.00 | 1.00 |
| Adj Sat Flow, veh/h/ln       | 1881 | 1881 | 1900 | 1881 | 1881 | 1900 | 1881 | 1881 | 1881 | 1863 | 1863 | 1863 |
| Adj Flow Rate, veh/h         | 140  | 1688 | 145  | 183  | 989  | 109  | 172  | 32   | 0    | 65   | 22   | 0    |
| Adj No. of Lanes             | 2    | 2    | 0    | 2    | 2    | 0    | 1    | 1    | 1    | 1    | 1    | 1    |
| Peak Hour Factor             | 0.93 | 0.93 | 0.93 | 0.93 | 0.93 | 0.93 | 0.93 | 0.93 | 0.93 | 0.93 | 0.93 | 0.93 |
| Percent Heavy Veh, %         | 1    | 1    | 1    | 1    | 1    | 1    | 1    | 1    | 1    | 2    | 2    | 2    |
| Cap, veh/h                   | 278  | 1932 | 164  | 270  | 1852 | 204  | 312  | 302  | 256  | 302  | 299  | 254  |
| Arrive On Green              | 0.08 | 0.58 | 0.56 | 0.08 | 0.57 | 0.55 | 0.16 | 0.16 | 0.00 | 0.16 | 0.16 | 0.00 |
| Sat Flow, veh/h              | 3476 | 3335 | 283  | 3476 | 3247 | 358  | 1395 | 1881 | 1599 | 1369 | 1863 | 1583 |
| Grp Volume(v), veh/h         | 140  | 896  | 937  | 183  | 544  | 554  | 172  | 32   | 0    | 65   | 22   | 0    |
| Grp Sat Flow(s),veh/h/ln     | 1738 | 1787 | 1831 | 1738 | 1787 | 1818 | 1395 | 1881 | 1599 | 1369 | 1863 | 1583 |
| Q Serve(g_s), s              | 2.7  | 29.6 | 31.0 | 3.6  | 13.2 | 13.3 | 8.4  | 1.0  | 0.0  | 3.0  | 0.7  | 0.0  |
| Cycle Q Clear(g_c), s        | 2.7  | 29.6 | 31.0 | 3.6  | 13.2 | 13.3 | 9.1  | 1.0  | 0.0  | 4.0  | 0.7  | 0.0  |
| Prop In Lane                 | 1.00 |      | 0.15 | 1.00 |      | 0.20 | 1.00 |      | 1.00 | 1.00 |      | 1.00 |
| Lane Grp Cap(c), veh/h       | 278  | 1036 | 1061 | 270  | 1019 | 1037 | 312  | 302  | 256  | 302  | 299  | 254  |
| V/C Ratio(X)                 | 0.50 | 0.86 | 0.88 | 0.68 | 0.53 | 0.53 | 0.55 | 0.11 | 0.00 | 0.22 | 0.07 | 0.00 |
| Avail Cap(c_a), veh/h        | 991  | 1274 | 1305 | 991  | 1274 | 1296 | 685  | 804  | 684  | 668  | 797  | 677  |
| HCM Platoon Ratio            | 1.00 | 1.00 | 1.00 | 1.00 | 1.00 | 1.00 | 1.00 | 1.00 | 1.00 | 1.00 | 1.00 | 1.00 |
| Upstream Filter(I)           | 1.00 | 1.00 | 1.00 | 1.00 | 1.00 | 1.00 | 1.00 | 1.00 | 0.00 | 1.00 | 1.00 | 0.00 |
| Uniform Delay (d), s/veh     | 30.9 | 12.4 | 12.8 | 31.5 | 9.3  | 9.4  | 28.9 | 25.2 | 0.0  | 26.9 | 25.0 | 0.0  |
| Incr Delay (d2), s/veh       | 0.5  | 4.7  | 5.6  | 1.1  | 0.2  | 0.2  | 0.6  | 0.1  | 0.0  | 0.1  | 0.0  | 0.0  |
| Initial Q Delay(d3),s/veh    | 0.0  | 0.0  | 0.0  | 0.0  | 0.0  | 0.0  | 0.0  | 0.0  | 0.0  | 0.0  | 0.0  | 0.0  |
| %ile BackOfQ(50%),veh/ln     | 1.3  | 15.8 | 17.0 | 1.8  | 6.4  | 6.7  | 3.2  | 0.5  | 0.0  | 1.1  | 0.4  | 0.0  |
| LnGrp Delay(d),s/veh         | 31.5 | 17.1 | 18.4 | 32.6 | 9.5  | 9.6  | 29.5 | 25.2 | 0.0  | 27.0 | 25.1 | 0.0  |
| LnGrp LOS                    | C    | B    | B    | C    | A    | A    | C    | C    |      | C    | C    |      |
| Approach Vol, veh/h          |      | 1973 |      |      | 1281 |      |      | 204  |      |      | 87   |      |
| Approach Delay, s/veh        |      | 18.7 |      |      | 12.8 |      |      | 28.8 |      |      | 26.5 |      |
| Approach LOS                 |      | B    |      |      | B    |      |      | C    |      |      | C    |      |
| Timer                        | 1    | 2    | 3    | 4    | 5    | 6    | 7    | 8    |      |      |      |      |
| Assigned Phs                 | 1    | 2    |      | 4    | 5    | 6    |      | 8    |      |      |      |      |
| Phs Duration (G+Y+Rc), s     | 9.0  | 46.0 |      | 15.2 | 9.6  | 45.3 |      | 15.2 |      |      |      |      |
| Change Period (Y+Rc), s      | 3.5  | 5.3  |      | 4.0  | 4.0  | 5.3  |      | 4.0  |      |      |      |      |
| Max Green Setting (Gmax), s  | 20.0 | 50.0 |      | 30.0 | 20.0 | 50.0 |      | 30.0 |      |      |      |      |
| Max Q Clear Time (g_c+15), s | 15.6 | 33.0 |      | 6.0  | 4.7  | 15.3 |      | 11.1 |      |      |      |      |
| Green Ext Time (p_c), s      | 0.0  | 1.6  |      | 0.0  | 0.0  | 0.8  |      | 0.0  |      |      |      |      |
| <b>Intersection Summary</b>  |      |      |      |      |      |      |      |      |      |      |      |      |
| HCM 2010 Ctrl Delay          |      |      |      | 17.4 |      |      |      |      |      |      |      |      |
| HCM 2010 LOS                 |      |      |      | B    |      |      |      |      |      |      |      |      |













HCM 2010 Signalized Intersection Summary  
 12: Reservation Road & Imjin Parkway

Cumulative, PM  
 06/11/2019



| Movement                    | EBL  | EBT   | EBR   | WBL  | WBT  | WBR   | NBL   | NBT   | NBR  | SBL  | SBT  | SBR  |
|-----------------------------|------|-------|-------|------|------|-------|-------|-------|------|------|------|------|
| Lane Configurations         | ↖↗   | ↑     | ↖↗    | ↖    | ↑    | ↖     | ↖↗    | ↑↑    | ↖    | ↖↗   | ↑↑   | ↖    |
| Traffic Volume (veh/h)      | 120  | 20    | 1670  | 10   | 40   | 30    | 970   | 640   | 10   | 20   | 950  | 200  |
| Future Volume (veh/h)       | 120  | 20    | 1670  | 10   | 40   | 30    | 970   | 640   | 10   | 20   | 950  | 200  |
| Number                      | 3    | 8     | 18    | 7    | 4    | 14    | 1     | 6     | 16   | 5    | 2    | 12   |
| Initial Q (Qb), veh         | 0    | 0     | 0     | 0    | 0    | 0     | 0     | 0     | 0    | 0    | 0    | 0    |
| Ped-Bike Adj(A_pbT)         | 1.00 |       | 1.00  | 1.00 |      | 0.99  | 1.00  |       | 1.00 | 1.00 |      | 1.00 |
| Parking Bus, Adj            | 1.00 | 1.00  | 1.00  | 1.00 | 1.00 | 1.00  | 1.00  | 1.00  | 1.00 | 1.00 | 1.00 | 1.00 |
| Adj Sat Flow, veh/h/ln      | 1881 | 1881  | 1881  | 1827 | 1827 | 1827  | 1881  | 1881  | 1881 | 1881 | 1881 | 1881 |
| Adj Flow Rate, veh/h        | 135  | 22    | 1475  | 11   | 45   | 12    | 1090  | 719   | 10   | 22   | 1067 | 91   |
| Adj No. of Lanes            | 2    | 1     | 2     | 1    | 1    | 1     | 2     | 2     | 1    | 2    | 2    | 1    |
| Peak Hour Factor            | 0.89 | 0.89  | 0.89  | 0.89 | 0.89 | 0.89  | 0.89  | 0.89  | 0.89 | 0.89 | 0.89 | 0.89 |
| Percent Heavy Veh, %        | 1    | 1     | 1     | 4    | 4    | 4     | 1     | 1     | 1    | 1    | 1    | 1    |
| Cap, veh/h                  | 799  | 433   | 1292  | 75   | 79   | 66    | 799   | 2052  | 918  | 55   | 1287 | 576  |
| Arrive On Green             | 0.23 | 0.23  | 0.23  | 0.04 | 0.04 | 0.04  | 0.23  | 0.57  | 0.57 | 0.02 | 0.36 | 0.36 |
| Sat Flow, veh/h             | 3476 | 1881  | 2802  | 1740 | 1827 | 1531  | 3476  | 3574  | 1599 | 3476 | 3574 | 1599 |
| Grp Volume(v), veh/h        | 135  | 22    | 1475  | 11   | 45   | 12    | 1090  | 719   | 10   | 22   | 1067 | 91   |
| Grp Sat Flow(s),veh/h/ln    | 1738 | 1881  | 1401  | 1740 | 1827 | 1531  | 1738  | 1787  | 1599 | 1738 | 1787 | 1599 |
| Q Serve(g_s), s             | 4.7  | 1.4   | 35.0  | 0.9  | 3.7  | 1.1   | 35.0  | 16.3  | 0.4  | 1.0  | 41.4 | 5.9  |
| Cycle Q Clear(g_c), s       | 4.7  | 1.4   | 35.0  | 0.9  | 3.7  | 1.1   | 35.0  | 16.3  | 0.4  | 1.0  | 41.4 | 5.9  |
| Prop In Lane                | 1.00 |       | 1.00  | 1.00 |      | 1.00  | 1.00  |       | 1.00 | 1.00 |      | 1.00 |
| Lane Grp Cap(c), veh/h      | 799  | 433   | 1292  | 75   | 79   | 66    | 799   | 2052  | 918  | 55   | 1287 | 576  |
| V/C Ratio(X)                | 0.17 | 0.05  | 1.14  | 0.15 | 0.57 | 0.18  | 1.36  | 0.35  | 0.01 | 0.40 | 0.83 | 0.16 |
| Avail Cap(c_a), veh/h       | 799  | 433   | 1292  | 354  | 372  | 312   | 799   | 2052  | 918  | 457  | 1409 | 630  |
| HCM Platoon Ratio           | 1.00 | 1.00  | 1.00  | 1.00 | 1.00 | 1.00  | 1.00  | 1.00  | 1.00 | 1.00 | 1.00 | 1.00 |
| Upstream Filter(I)          | 1.00 | 1.00  | 1.00  | 1.00 | 1.00 | 1.00  | 1.00  | 1.00  | 1.00 | 1.00 | 1.00 | 1.00 |
| Uniform Delay (d), s/veh    | 46.9 | 45.6  | 41.1  | 70.1 | 71.4 | 70.2  | 58.6  | 17.3  | 13.9 | 74.2 | 44.4 | 33.0 |
| Incr Delay (d2), s/veh      | 0.0  | 0.0   | 73.6  | 0.3  | 2.4  | 0.5   | 171.6 | 0.3   | 0.0  | 1.7  | 5.1  | 0.3  |
| Initial Q Delay(d3),s/veh   | 0.0  | 0.0   | 0.0   | 0.0  | 0.0  | 0.0   | 0.0   | 0.0   | 0.0  | 0.0  | 0.0  | 0.0  |
| %ile BackOfQ(50%),veh/ln    | 2.3  | 0.7   | 40.3  | 0.5  | 1.9  | 0.5   | 35.8  | 8.1   | 0.2  | 0.5  | 21.4 | 2.7  |
| LnGrp Delay(d),s/veh        | 47.0 | 45.7  | 114.7 | 70.4 | 73.8 | 70.7  | 230.2 | 17.6  | 13.9 | 75.9 | 49.5 | 33.4 |
| LnGrp LOS                   | D    | D     | F     | E    | E    | E     | F     | B     | B    | E    | D    | C    |
| Approach Vol, veh/h         |      | 1632  |       |      | 68   |       |       | 1819  |      |      | 1180 |      |
| Approach Delay, s/veh       |      | 108.2 |       |      | 72.7 |       |       | 145.0 |      |      | 48.8 |      |
| Approach LOS                |      | F     |       |      | E    |       |       | F     |      |      | D    |      |
| Timer                       | 1    | 2     | 3     | 4    | 5    | 6     | 7     | 8     |      |      |      |      |
| Assigned Phs                | 1    | 2     |       | 4    | 5    | 6     |       | 8     |      |      |      |      |
| Phs Duration (G+Y+Rc), s    | 39.1 | 61.0  |       | 11.6 | 6.5  | 93.6  |       | 40.5  |      |      |      |      |
| Change Period (Y+Rc), s     | 4.1  | * 6.2 |       | 5.0  | 4.1  | * 6.2 |       | 5.5   |      |      |      |      |
| Max Green Setting (Gmax), s | 35.0 | * 60  |       | 31.0 | 20.0 | * 50  |       | 35.0  |      |      |      |      |
| Max Q Clear Time (g_c+Q), s | 37.0 | 43.4  |       | 5.7  | 3.0  | 18.3  |       | 37.0  |      |      |      |      |
| Green Ext Time (p_c), s     | 0.0  | 11.4  |       | 0.2  | 0.0  | 10.8  |       | 0.0   |      |      |      |      |
| <b>Intersection Summary</b> |      |       |       |      |      |       |       |       |      |      |      |      |
| HCM 2010 Ctrl Delay         |      |       | 107.0 |      |      |       |       |       |      |      |      |      |
| HCM 2010 LOS                |      |       | F     |      |      |       |       |       |      |      |      |      |
| <b>Notes</b>                |      |       |       |      |      |       |       |       |      |      |      |      |

HCM 2010 Signalized Intersection Summary  
 13: Reservation Road & Blanco Road

|                              |  |  |  |  |  |  |   |   |
|------------------------------|---|---|---|---|---|---|---|---|
| Movement                     | EBL   | EBT   | WBT   | WBR   | SBL   | SBR   |   |   |
| Lane Configurations          |  |  |  |  |  |  |   |   |
| Traffic Volume (veh/h)       | 1110  | 1440  | 490   | 50  | 40  | 1140  |   |   |
| Future Volume (veh/h)        | 1110  | 1440  | 490   | 50  | 40  | 1140  |   |   |
| Number                       | 5   | 2   | 6   | 16  | 7   | 14  |   |   |
| Initial Q (Qb), veh          | 0   | 0   | 0   | 0   | 0   | 0   |   |   |
| Ped-Bike Adj(A_pbT)          | 1.00  |   |   | 1.00  | 1.00  | 1.00  |   |   |
| Parking Bus, Adj             | 1.00  | 1.00  | 1.00  | 1.00  | 1.00  | 1.00  |   |   |
| Adj Sat Flow, veh/h/ln       | 1881  | 1881  | 1863  | 1863  | 1863  | 1863  |   |   |
| Adj Flow Rate, veh/h         | 1181  | 1532  | 521   | 29  | 43  | 0   |   |   |
| Adj No. of Lanes             | 2   | 2   | 1   | 1   | 2   | 2   |   |   |
| Peak Hour Factor             | 0.94  | 0.94  | 0.94  | 0.94  | 0.94  | 0.94  |   |   |
| Percent Heavy Veh, %         | 1   | 1   | 2   | 2   | 2   | 2   |   |   |
| Cap, veh/h                   | 1292  | 2869  | 624   | 530   | 119   | 96  |   |   |
| Arrive On Green              | 0.37  | 0.80  | 0.33  | 0.33  | 0.03  | 0.00  |   |   |
| Sat Flow, veh/h              | 3476  | 3668  | 1863  | 1583  | 3442  | 2787  |   |   |
| Grp Volume(v), veh/h         | 1181  | 1532  | 521   | 29  | 43  | 0   |   |   |
| Grp Sat Flow(s),veh/h/ln     | 1738  | 1787  | 1863  | 1583  | 1721  | 1393  |   |   |
| Q Serve(g_s), s              | 18.5  | 8.5   | 14.8  | 0.7   | 0.7   | 0.0   |   |   |
| Cycle Q Clear(g_c), s        | 18.5  | 8.5   | 14.8  | 0.7   | 0.7   | 0.0   |   |   |
| Prop In Lane                 | 1.00  |   |   | 1.00  | 1.00  | 1.00  |   |   |
| Lane Grp Cap(c), veh/h       | 1292  | 2869  | 624   | 530   | 119   | 96  |   |   |
| V/C Ratio(X)                 | 0.91  | 0.53  | 0.84  | 0.05  | 0.36  | 0.00  |   |   |
| Avail Cap(c_a), veh/h        | 2431  | 3751  | 1955  | 1661  | 1625  | 1316  |   |   |
| HCM Platoon Ratio            | 1.00  | 1.00  | 1.00  | 1.00  | 1.00  | 1.00  |   |   |
| Upstream Filter(I)           | 1.00  | 1.00  | 1.00  | 1.00  | 1.00  | 0.00  |   |   |
| Uniform Delay (d), s/veh     | 17.1  | 1.9   | 17.6  | 12.9  | 27.0  | 0.0   |   |   |
| Incr Delay (d2), s/veh       | 1.2   | 0.1   | 2.3   | 0.0   | 0.7   | 0.0   |   |   |
| Initial Q Delay(d3),s/veh    | 0.0   | 0.0   | 0.0   | 0.0   | 0.0   | 0.0   |   |   |
| %ile BackOfQ(50%),veh/ln     | 9.1   | 4.1   | 7.9   | 0.3   | 0.3   | 0.0   |   |   |
| LnGrp Delay(d),s/veh         | 18.2  | 2.1   | 19.8  | 12.9  | 27.7  | 0.0   |   |   |
| LnGrp LOS                    | B   | A   | B   | B   | C   |   |   |   |
| Approach Vol, veh/h          |   | 2713  | 550   |   | 43  |   |   |   |
| Approach Delay, s/veh        |   | 9.1   | 19.5  |   | 27.7  |   |   |   |
| Approach LOS                 |   | A   | B   |   | C   |   |   |   |
| Timer                        | 1   | 2   | 3   | 4   | 5   | 6   | 7 | 8 |
| Assigned Phs                 |   | 2   |   | 4   | 5   | 6   |   |   |
| Phs Duration (G+Y+Rc), s     |   | 51.7  |   | 5.5   | 26.8  | 24.9  |   |   |
| Change Period (Y+Rc), s      |   | 5.8   |   | 3.5   | 5.5   | 5.8   |   |   |
| Max Green Setting (Gmax), s  |   | 60.0  |   | 27.0  | 40.0  | 60.0  |   |   |
| Max Q Clear Time (g_c+I1), s |   | 10.5  |   | 2.7   | 20.5  | 16.8  |   |   |
| Green Ext Time (p_c), s      |   | 11.2  |   | 0.0   | 0.8   | 2.4   |   |   |
| <b>Intersection Summary</b>  |   |   |   |   |   |   |   |   |
| HCM 2010 Ctrl Delay          |   |   | 11.1  |   |   |   |   |   |
| HCM 2010 LOS                 |   |   | B   |   |   |   |   |   |

HCM 2010 Signalized Intersection Summary  
 14: Reservation Road & Inter-Garrison Road

Cumulative, PM  
 06/11/2019



| Movement                       | EBL  | EBR  | NBL  | NBT  | SBT  | SBR  |   |      |
|--------------------------------|------|------|------|------|------|------|---|------|
| Lane Configurations            |      |      |      |      |      |      |   |      |
| Traffic Volume (veh/h)         | 110  | 320  | 220  | 440  | 1300 | 270  |   |      |
| Future Volume (veh/h)          | 110  | 320  | 220  | 440  | 1300 | 270  |   |      |
| Number                         | 3    | 18   | 1    | 6    | 2    | 12   |   |      |
| Initial Q (Qb), veh            | 0    | 0    | 0    | 0    | 0    | 0    |   |      |
| Ped-Bike Adj(A_pbT)            | 1.00 | 1.00 | 1.00 |      |      | 1.00 |   |      |
| Parking Bus, Adj               | 1.00 | 1.00 | 1.00 | 1.00 | 1.00 | 1.00 |   |      |
| Adj Sat Flow, veh/h/ln         | 1881 | 1881 | 1845 | 1845 | 1881 | 1900 |   |      |
| Adj Flow Rate, veh/h           | 134  | 235  | 268  | 537  | 1585 | 320  |   |      |
| Adj No. of Lanes               | 1    | 1    | 1    | 2    | 2    | 0    |   |      |
| Peak Hour Factor               | 0.82 | 0.82 | 0.82 | 0.82 | 0.82 | 0.82 |   |      |
| Percent Heavy Veh, %           | 1    | 1    | 3    | 3    | 1    | 1    |   |      |
| Cap, veh/h                     | 260  | 502  | 296  | 2649 | 1624 | 318  |   |      |
| Arrive On Green                | 0.15 | 0.15 | 0.17 | 0.76 | 0.54 | 0.54 |   |      |
| Sat Flow, veh/h                | 1792 | 1599 | 1757 | 3597 | 3076 | 584  |   |      |
| Grp Volume(v), veh/h           | 134  | 235  | 268  | 537  | 930  | 975  |   |      |
| Grp Sat Flow(s),veh/h/ln       | 1792 | 1599 | 1757 | 1752 | 1787 | 1778 |   |      |
| Q Serve(g_s), s                | 7.6  | 13.0 | 16.5 | 4.9  | 54.5 | 60.0 |   |      |
| Cycle Q Clear(g_c), s          | 7.6  | 13.0 | 16.5 | 4.9  | 54.5 | 60.0 |   |      |
| Prop In Lane                   | 1.00 | 1.00 | 1.00 |      |      | 0.33 |   |      |
| Lane Grp Cap(c), veh/h         | 260  | 502  | 296  | 2649 | 973  | 969  |   |      |
| V/C Ratio(X)                   | 0.51 | 0.47 | 0.91 | 0.20 | 0.96 | 1.01 |   |      |
| Avail Cap(c_a), veh/h          | 439  | 661  | 319  | 2649 | 973  | 969  |   |      |
| HCM Platoon Ratio              | 1.00 | 1.00 | 1.00 | 1.00 | 1.00 | 1.00 |   |      |
| Upstream Filter(I)             | 1.00 | 1.00 | 1.00 | 1.00 | 1.00 | 1.00 |   |      |
| Uniform Delay (d), s/veh       | 43.5 | 30.4 | 44.9 | 3.9  | 23.8 | 25.1 |   |      |
| Incr Delay (d2), s/veh         | 1.6  | 0.7  | 25.7 | 0.1  | 19.2 | 30.5 |   |      |
| Initial Q Delay(d3),s/veh      | 0.0  | 0.0  | 0.0  | 0.0  | 0.0  | 0.0  |   |      |
| %ile BackOfQ(50%),veh/ln       | 3.9  | 5.8  | 10.2 | 2.3  | 31.8 | 37.5 |   |      |
| LnGrp Delay(d),s/veh           | 45.1 | 31.1 | 70.7 | 3.9  | 43.0 | 55.5 |   |      |
| LnGrp LOS                      | D    | C    | E    | A    | D    | F    |   |      |
| Approach Vol, veh/h            | 369  |      |      | 805  | 1905 |      |   |      |
| Approach Delay, s/veh          | 36.2 |      |      | 26.2 | 49.4 |      |   |      |
| Approach LOS                   | D    |      |      | C    | D    |      |   |      |
| Timer                          | 1    | 2    | 3    | 4    | 5    | 6    | 7 | 8    |
| Assigned Phs                   | 1    | 2    |      |      |      | 6    |   | 8    |
| Phs Duration (G+Y+Rc), s       | 33.2 | 66.4 |      |      |      | 89.6 |   | 20.5 |
| Change Period (Y+Rc), s        | 4.7  | 6.4  |      |      |      | 6.4  |   | 4.5  |
| Max Green Setting (Gmax), s    | 26   | 60.0 |      |      |      | 60.0 |   | 27.0 |
| Max Q Clear Time (g_c+11.5), s | 11.5 | 62.0 |      |      |      | 6.9  |   | 15.0 |
| Green Ext Time (p_c), s        | 0.1  | 0.0  |      |      |      | 6.5  |   | 1.0  |
| <b>Intersection Summary</b>    |      |      |      |      |      |      |   |      |
| HCM 2010 Ctrl Delay            |      |      | 41.8 |      |      |      |   |      |
| HCM 2010 LOS                   |      |      | D    |      |      |      |   |      |
| <b>Notes</b>                   |      |      |      |      |      |      |   |      |

HCM 2010 Signalized Intersection Summary  
 15: 2nd Avenue & 9th Street

Cumulative, PM  
 06/11/2019



| Movement                     | EBL  | EBT  | EBR  | WBL  | WBT  | WBR  | NBL  | NBT  | NBR  | SBL  | SBT  | SBR  |
|------------------------------|------|------|------|------|------|------|------|------|------|------|------|------|
| Lane Configurations          |      | ↕    | ↗    |      | ↕    |      | ↕    | ↕↔   |      | ↕    | ↕↔   |      |
| Traffic Volume (veh/h)       | 10   | 10   | 30   | 40   | 10   | 20   | 20   | 640  | 50   | 40   | 540  | 10   |
| Future Volume (veh/h)        | 10   | 10   | 30   | 40   | 10   | 20   | 20   | 640  | 50   | 40   | 540  | 10   |
| Number                       | 5    | 2    | 12   | 1    | 6    | 16   | 3    | 8    | 18   | 7    | 4    | 14   |
| Initial Q (Qb), veh          | 0    | 0    | 0    | 0    | 0    | 0    | 0    | 0    | 0    | 0    | 0    | 0    |
| Ped-Bike Adj(A_pbT)          | 1.00 |      | 0.99 | 1.00 |      | 1.00 | 1.00 |      | 0.97 | 1.00 |      | 1.00 |
| Parking Bus, Adj             | 1.00 | 1.00 | 1.00 | 1.00 | 1.00 | 1.00 | 1.00 | 1.00 | 1.00 | 1.00 | 1.00 | 1.00 |
| Adj Sat Flow, veh/h/ln       | 1900 | 1900 | 1900 | 1900 | 1900 | 1900 | 1881 | 1881 | 1900 | 1827 | 1827 | 1900 |
| Adj Flow Rate, veh/h         | 11   | 11   | 23   | 44   | 11   | 3    | 22   | 703  | 51   | 44   | 593  | -1   |
| Adj No. of Lanes             | 0    | 1    | 1    | 0    | 1    | 0    | 1    | 2    | 0    | 1    | 2    | 0    |
| Peak Hour Factor             | 0.91 | 0.91 | 0.91 | 0.91 | 0.91 | 0.91 | 0.91 | 0.91 | 0.91 | 0.91 | 0.91 | 0.91 |
| Percent Heavy Veh, %         | 0    | 0    | 0    | 0    | 0    | 0    | 1    | 1    | 1    | 4    | 4    | 4    |
| Cap, veh/h                   | 273  | 207  | 306  | 379  | 78   | 15   | 49   | 1254 | 91   | 87   | 1369 | 0    |
| Arrive On Green              | 0.22 | 0.19 | 0.19 | 0.22 | 0.19 | 0.19 | 0.03 | 0.37 | 0.37 | 0.05 | 0.39 | 0.00 |
| Sat Flow, veh/h              | 616  | 1074 | 1591 | 1029 | 404  | 78   | 1792 | 3371 | 244  | 1740 | 3563 | 0    |
| Grp Volume(v), veh/h         | 22   | 0    | 23   | 58   | 0    | 0    | 22   | 372  | 382  | 44   | 592  | 0    |
| Grp Sat Flow(s),veh/h/ln     | 1689 | 0    | 1591 | 1511 | 0    | 0    | 1792 | 1787 | 1828 | 1740 | 1736 | 0    |
| Q Serve(g_s), s              | 0.0  | 0.0  | 0.4  | 0.3  | 0.0  | 0.0  | 0.4  | 5.8  | 5.8  | 0.9  | 4.4  | 0.0  |
| Cycle Q Clear(g_c), s        | 0.3  | 0.0  | 0.4  | 0.9  | 0.0  | 0.0  | 0.4  | 5.8  | 5.8  | 0.9  | 4.4  | 0.0  |
| Prop In Lane                 | 0.50 |      | 1.00 | 0.76 |      | 0.05 | 1.00 |      | 0.13 | 1.00 |      | 0.00 |
| Lane Grp Cap(c), veh/h       | 528  | 0    | 306  | 515  | 0    | 0    | 49   | 665  | 680  | 87   | 1369 | 0    |
| V/C Ratio(X)                 | 0.04 | 0.00 | 0.08 | 0.11 | 0.00 | 0.00 | 0.45 | 0.56 | 0.56 | 0.51 | 0.43 | 0.00 |
| Avail Cap(c_a), veh/h        | 1838 | 0    | 1591 | 1709 | 0    | 0    | 589  | 2043 | 2090 | 572  | 3968 | 0    |
| HCM Platoon Ratio            | 1.00 | 1.00 | 1.00 | 1.00 | 1.00 | 1.00 | 1.00 | 1.00 | 1.00 | 1.00 | 1.00 | 1.00 |
| Upstream Filter(I)           | 1.00 | 0.00 | 1.00 | 1.00 | 0.00 | 0.00 | 1.00 | 1.00 | 1.00 | 1.00 | 1.00 | 0.00 |
| Uniform Delay (d), s/veh     | 11.3 | 0.0  | 11.6 | 11.5 | 0.0  | 0.0  | 16.8 | 8.7  | 8.7  | 16.2 | 7.7  | 0.0  |
| Incr Delay (d2), s/veh       | 0.0  | 0.0  | 0.1  | 0.1  | 0.0  | 0.0  | 6.2  | 0.7  | 0.7  | 4.6  | 0.2  | 0.0  |
| Initial Q Delay(d3),s/veh    | 0.0  | 0.0  | 0.0  | 0.0  | 0.0  | 0.0  | 0.0  | 0.0  | 0.0  | 0.0  | 0.0  | 0.0  |
| %ile BackOfQ(50%),veh/ln     | 0.2  | 0.0  | 0.2  | 0.5  | 0.0  | 0.0  | 0.3  | 2.9  | 3.0  | 0.5  | 2.1  | 0.0  |
| LnGrp Delay(d),s/veh         | 11.4 | 0.0  | 11.7 | 11.6 | 0.0  | 0.0  | 23.0 | 9.5  | 9.4  | 20.8 | 8.0  | 0.0  |
| LnGrp LOS                    | B    |      | B    | B    |      |      | C    | A    | A    | C    | A    |      |
| Approach Vol, veh/h          |      | 45   |      |      | 58   |      |      | 776  |      |      | 636  |      |
| Approach Delay, s/veh        |      | 11.5 |      |      | 11.6 |      |      | 9.8  |      |      | 8.8  |      |
| Approach LOS                 |      | B    |      |      | B    |      |      | A    |      |      | A    |      |
| Timer                        | 1    | 2    | 3    | 4    | 5    | 6    | 7    | 8    |      |      |      |      |
| Assigned Phs                 |      | 2    | 3    | 4    |      | 6    | 7    | 8    |      |      |      |      |
| Phs Duration (G+Y+Rc), s     |      | 11.7 | 4.5  | 18.8 |      | 11.7 | 5.2  | 18.0 |      |      |      |      |
| Change Period (Y+Rc), s      |      | 5.0  | 3.5  | 5.0  |      | 5.0  | 3.5  | 5.0  |      |      |      |      |
| Max Green Setting (Gmax), s  |      | 35.0 | 11.5 | 40.0 |      | 35.0 | 11.5 | 40.0 |      |      |      |      |
| Max Q Clear Time (g_c+I1), s |      | 2.4  | 2.4  | 6.4  |      | 2.9  | 2.9  | 7.8  |      |      |      |      |
| Green Ext Time (p_c), s      |      | 0.1  | 0.0  | 4.3  |      | 0.3  | 0.0  | 5.1  |      |      |      |      |
| <b>Intersection Summary</b>  |      |      |      |      |      |      |      |      |      |      |      |      |
| HCM 2010 Ctrl Delay          |      |      | 9.5  |      |      |      |      |      |      |      |      |      |
| HCM 2010 LOS                 |      |      | A    |      |      |      |      |      |      |      |      |      |

HCM 2010 Signalized Intersection Summary  
 16: 2nd Avenue & 8th Street

Cumulative, PM  
 06/11/2019



| Movement                     | WBL  | WBR  | NBT  | NBR  | SBL  | SBT  |      |      |
|------------------------------|------|------|------|------|------|------|------|------|
| Lane Configurations          |      |      |      |      |      |      |      |      |
| Traffic Volume (veh/h)       | 130  | 40   | 580  | 260  | 30   | 560  |      |      |
| Future Volume (veh/h)        | 130  | 40   | 580  | 260  | 30   | 560  |      |      |
| Number                       | 1    | 16   | 8    | 18   | 7    | 4    |      |      |
| Initial Q (Qb), veh          | 0    | 0    | 0    | 0    | 0    | 0    |      |      |
| Ped-Bike Adj(A_pbT)          | 1.00 | 1.00 |      | 0.97 | 1.00 |      |      |      |
| Parking Bus, Adj             | 1.00 | 1.00 | 1.00 | 1.00 | 1.00 | 1.00 |      |      |
| Adj Sat Flow, veh/h/ln       | 1900 | 1900 | 1881 | 1900 | 1827 | 1827 |      |      |
| Adj Flow Rate, veh/h         | 138  | 9    | 617  | 246  | 32   | 596  |      |      |
| Adj No. of Lanes             | 1    | 1    | 2    | 0    | 1    | 2    |      |      |
| Peak Hour Factor             | 0.94 | 0.94 | 0.94 | 0.94 | 0.94 | 0.94 |      |      |
| Percent Heavy Veh, %         | 0    | 0    | 1    | 1    | 4    | 4    |      |      |
| Cap, veh/h                   | 202  | 180  | 1102 | 439  | 67   | 2042 |      |      |
| Arrive On Green              | 0.11 | 0.11 | 0.44 | 0.44 | 0.04 | 0.59 |      |      |
| Sat Flow, veh/h              | 1810 | 1615 | 2571 | 987  | 1740 | 3563 |      |      |
| Grp Volume(v), veh/h         | 138  | 9    | 445  | 418  | 32   | 596  |      |      |
| Grp Sat Flow(s),veh/h/ln     | 1810 | 1615 | 1787 | 1677 | 1740 | 1736 |      |      |
| Q Serve(g_s), s              | 2.4  | 0.2  | 6.1  | 6.1  | 0.6  | 2.8  |      |      |
| Cycle Q Clear(g_c), s        | 2.4  | 0.2  | 6.1  | 6.1  | 0.6  | 2.8  |      |      |
| Prop In Lane                 | 1.00 | 1.00 |      | 0.59 | 1.00 |      |      |      |
| Lane Grp Cap(c), veh/h       | 202  | 180  | 795  | 746  | 67   | 2042 |      |      |
| V/C Ratio(X)                 | 0.68 | 0.05 | 0.56 | 0.56 | 0.48 | 0.29 |      |      |
| Avail Cap(c_a), veh/h        | 1629 | 1454 | 2414 | 2265 | 601  | 6251 |      |      |
| HCM Platoon Ratio            | 1.00 | 1.00 | 1.00 | 1.00 | 1.00 | 1.00 |      |      |
| Upstream Filter(I)           | 1.00 | 1.00 | 1.00 | 1.00 | 1.00 | 1.00 |      |      |
| Uniform Delay (d), s/veh     | 14.2 | 13.2 | 6.8  | 6.8  | 15.7 | 3.4  |      |      |
| Incr Delay (d2), s/veh       | 4.0  | 0.1  | 0.6  | 0.7  | 5.2  | 0.1  |      |      |
| Initial Q Delay(d3),s/veh    | 0.0  | 0.0  | 0.0  | 0.0  | 0.0  | 0.0  |      |      |
| %ile BackOfQ(50%),veh/ln     | 1.4  | 0.2  | 3.1  | 2.9  | 0.4  | 1.3  |      |      |
| LnGrp Delay(d),s/veh         | 18.3 | 13.3 | 7.5  | 7.5  | 20.9 | 3.5  |      |      |
| LnGrp LOS                    | B    | B    | A    | A    | C    | A    |      |      |
| Approach Vol, veh/h          | 147  |      | 863  |      |      | 628  |      |      |
| Approach Delay, s/veh        | 18.0 |      | 7.5  |      |      | 4.4  |      |      |
| Approach LOS                 | B    |      | A    |      |      | A    |      |      |
| Timer                        | 1    | 2    | 3    | 4    | 5    | 6    | 7    | 8    |
| Assigned Phs                 |      |      |      | 4    |      | 6    | 7    | 8    |
| Phs Duration (G+Y+Rc), s     |      |      |      | 24.6 |      | 8.7  | 4.8  | 19.8 |
| Change Period (Y+Rc), s      |      |      |      | 5.0  |      | 5.0  | 3.5  | 5.0  |
| Max Green Setting (Gmax), s  |      |      |      | 60.0 |      | 30.0 | 11.5 | 45.0 |
| Max Q Clear Time (g_c+I1), s |      |      |      | 4.8  |      | 4.4  | 2.6  | 8.1  |
| Green Ext Time (p_c), s      |      |      |      | 4.5  |      | 0.4  | 0.0  | 6.4  |
| <b>Intersection Summary</b>  |      |      |      |      |      |      |      |      |
| HCM 2010 Ctrl Delay          |      |      | 7.2  |      |      |      |      |      |
| HCM 2010 LOS                 |      |      | A    |      |      |      |      |      |



| Intersection              |      |
|---------------------------|------|
| Intersection Delay, s/veh | 10.2 |
| Intersection LOS          | B    |

| Movement            | EBT  | EBR  | WBL  | WBT  | NBL  | NBR  |
|---------------------|------|------|------|------|------|------|
| Lane Configurations | ↑    | ↑    | ↑    | ↑    | ↑    | ↑    |
| Traffic Vol, veh/h  | 270  | 30   | 80   | 130  | 30   | 110  |
| Future Vol, veh/h   | 270  | 30   | 80   | 130  | 30   | 110  |
| Peak Hour Factor    | 0.92 | 0.92 | 0.92 | 0.92 | 0.92 | 0.92 |
| Heavy Vehicles, %   | 2    | 2    | 2    | 2    | 2    | 2    |
| Mvmt Flow           | 293  | 33   | 87   | 141  | 33   | 120  |
| Number of Lanes     | 1    | 1    | 1    | 1    | 1    | 1    |

| Approach                   | EB   | WB  | NB  |
|----------------------------|------|-----|-----|
| Opposing Approach          | WB   | EB  |     |
| Opposing Lanes             | 2    | 2   | 0   |
| Conflicting Approach Left  |      | NB  | EB  |
| Conflicting Lanes Left     | 0    | 2   | 2   |
| Conflicting Approach Right | NB   |     | WB  |
| Conflicting Lanes Right    | 2    | 0   | 2   |
| HCM Control Delay          | 11.3 | 9.4 | 9.1 |
| HCM LOS                    | B    | A   | A   |

| Lane                   | NBLn1 | NBLn2 | EBLn1 | EBLn2 | WBLn1 | WBLn2 |
|------------------------|-------|-------|-------|-------|-------|-------|
| Vol Left, %            | 100%  | 0%    | 0%    | 0%    | 100%  | 0%    |
| Vol Thru, %            | 0%    | 0%    | 100%  | 0%    | 0%    | 100%  |
| Vol Right, %           | 0%    | 100%  | 0%    | 100%  | 0%    | 0%    |
| Sign Control           | Stop  | Stop  | Stop  | Stop  | Stop  | Stop  |
| Traffic Vol by Lane    | 30    | 110   | 270   | 30    | 80    | 130   |
| LT Vol                 | 30    | 0     | 0     | 0     | 80    | 0     |
| Through Vol            | 0     | 0     | 270   | 0     | 0     | 130   |
| RT Vol                 | 0     | 110   | 0     | 30    | 0     | 0     |
| Lane Flow Rate         | 33    | 120   | 293   | 33    | 87    | 141   |
| Geometry Grp           | 7     | 7     | 7     | 7     | 7     | 7     |
| Degree of Util (X)     | 0.058 | 0.171 | 0.421 | 0.04  | 0.139 | 0.206 |
| Departure Headway (Hd) | 6.371 | 5.162 | 5.169 | 4.465 | 5.745 | 5.242 |
| Convergence, Y/N       | Yes   | Yes   | Yes   | Yes   | Yes   | Yes   |
| Cap                    | 560   | 691   | 696   | 798   | 622   | 682   |
| Service Time           | 4.132 | 2.923 | 2.919 | 2.214 | 3.499 | 2.995 |
| HCM Lane V/C Ratio     | 0.059 | 0.174 | 0.421 | 0.041 | 0.14  | 0.207 |
| HCM Control Delay      | 9.5   | 9     | 11.7  | 7.4   | 9.4   | 9.4   |
| HCM Lane LOS           | A     | A     | B     | A     | A     | A     |
| HCM 95th-tile Q        | 0.2   | 0.6   | 2.1   | 0.1   | 0.5   | 0.8   |

| Intersection                |       |       |       |       |
|-----------------------------|-------|-------|-------|-------|
| Intersection Delay, s/veh   | 7.7   |       |       |       |
| Intersection LOS            | A     |       |       |       |
| Approach                    | EB    | WB    | NB    | SB    |
| Entry Lanes                 | 1     | 1     | 1     | 1     |
| Conflicting Circle Lanes    | 1     | 1     | 1     | 1     |
| Adj Approach Flow, veh/h    | 361   | 283   | 66    | 284   |
| Demand Flow Rate, veh/h     | 372   | 285   | 66    | 289   |
| Vehicles Circulating, veh/h | 162   | 350   | 474   | 74    |
| Vehicles Exiting, veh/h     | 201   | 190   | 60    | 561   |
| Follow-Up Headway, s        | 3.186 | 3.186 | 3.186 | 3.186 |
| Ped Vol Crossing Leg, #/h   | 0     | 0     | 0     | 0     |
| Ped Cap Adj                 | 1.000 | 1.000 | 1.000 | 1.000 |
| Approach Delay, s/veh       | 8.2   | 8.9   | 6.1   | 6.2   |
| Approach LOS                | A     | A     | A     | A     |
| Lane                        | Left  | Left  | Left  | Left  |
| Designated Moves            | LTR   | LTR   | LTR   | LTR   |
| Assumed Moves               | LTR   | LTR   | LTR   | LTR   |
| RT Channelized              |       |       |       |       |
| Lane Util                   | 1.000 | 1.000 | 1.000 | 1.000 |
| Critical Headway, s         | 5.193 | 5.193 | 5.193 | 5.193 |
| Entry Flow, veh/h           | 372   | 285   | 66    | 289   |
| Cap Entry Lane, veh/h       | 961   | 796   | 703   | 1049  |
| Entry HV Adj Factor         | 0.970 | 0.992 | 1.000 | 0.981 |
| Flow Entry, veh/h           | 361   | 283   | 66    | 284   |
| Cap Entry, veh/h            | 932   | 790   | 703   | 1030  |
| V/C Ratio                   | 0.387 | 0.358 | 0.094 | 0.275 |
| Control Delay, s/veh        | 8.2   | 8.9   | 6.1   | 6.2   |
| LOS                         | A     | A     | A     | A     |
| 95th %tile Queue, veh       | 2     | 2     | 0     | 1     |

HCM 2010 Signalized Intersection Summary  
 19: 2nd Avenue & Inter-Garrison Road

Cumulative, PM  
 06/11/2019



| Movement                     | WBL  | WBR  | NBT  | NBR  | SBL  | SBT  |      |      |
|------------------------------|------|------|------|------|------|------|------|------|
| Lane Configurations          |      |      |      |      |      |      |      |      |
| Traffic Volume (veh/h)       | 60   | 30   | 820  | 60   | 30   | 670  |      |      |
| Future Volume (veh/h)        | 60   | 30   | 820  | 60   | 30   | 670  |      |      |
| Number                       | 1    | 16   | 8    | 18   | 7    | 4    |      |      |
| Initial Q (Qb), veh          | 0    | 0    | 0    | 0    | 0    | 0    |      |      |
| Ped-Bike Adj(A_pbT)          | 1.00 | 1.00 |      | 1.00 | 1.00 |      |      |      |
| Parking Bus, Adj             | 1.00 | 1.00 | 1.00 | 1.00 | 1.00 | 1.00 |      |      |
| Adj Sat Flow, veh/h/ln       | 1900 | 1900 | 1881 | 1900 | 1863 | 1863 |      |      |
| Adj Flow Rate, veh/h         | 62   | 7    | 845  | 54   | 31   | 691  |      |      |
| Adj No. of Lanes             | 1    | 1    | 2    | 0    | 1    | 2    |      |      |
| Peak Hour Factor             | 0.97 | 0.97 | 0.97 | 0.97 | 0.97 | 0.97 |      |      |
| Percent Heavy Veh, %         | 0    | 0    | 1    | 1    | 2    | 2    |      |      |
| Cap, veh/h                   | 254  | 227  | 1467 | 94   | 66   | 2013 |      |      |
| Arrive On Green              | 0.14 | 0.14 | 0.43 | 0.43 | 0.04 | 0.57 |      |      |
| Sat Flow, veh/h              | 1810 | 1615 | 3506 | 218  | 1774 | 3632 |      |      |
| Grp Volume(v), veh/h         | 62   | 7    | 443  | 456  | 31   | 691  |      |      |
| Grp Sat Flow(s),veh/h/ln     | 1810 | 1615 | 1787 | 1843 | 1774 | 1770 |      |      |
| Q Serve(g_s), s              | 1.0  | 0.1  | 6.5  | 6.5  | 0.6  | 3.6  |      |      |
| Cycle Q Clear(g_c), s        | 1.0  | 0.1  | 6.5  | 6.5  | 0.6  | 3.6  |      |      |
| Prop In Lane                 | 1.00 | 1.00 |      | 0.12 | 1.00 |      |      |      |
| Lane Grp Cap(c), veh/h       | 254  | 227  | 768  | 792  | 66   | 2013 |      |      |
| V/C Ratio(X)                 | 0.24 | 0.03 | 0.58 | 0.58 | 0.47 | 0.34 |      |      |
| Avail Cap(c_a), veh/h        | 1841 | 1643 | 2078 | 2143 | 593  | 5659 |      |      |
| HCM Platoon Ratio            | 1.00 | 1.00 | 1.00 | 1.00 | 1.00 | 1.00 |      |      |
| Upstream Filter(I)           | 1.00 | 1.00 | 1.00 | 1.00 | 1.00 | 1.00 |      |      |
| Uniform Delay (d), s/veh     | 13.2 | 12.8 | 7.4  | 7.4  | 16.2 | 4.0  |      |      |
| Incr Delay (d2), s/veh       | 0.5  | 0.1  | 0.7  | 0.7  | 5.1  | 0.1  |      |      |
| Initial Q Delay(d3),s/veh    | 0.0  | 0.0  | 0.0  | 0.0  | 0.0  | 0.0  |      |      |
| %ile BackOfQ(50%),veh/ln     | 0.6  | 0.1  | 3.2  | 3.3  | 0.4  | 1.8  |      |      |
| LnGrp Delay(d),s/veh         | 13.7 | 12.8 | 8.1  | 8.1  | 21.3 | 4.1  |      |      |
| LnGrp LOS                    | B    | B    | A    | A    | C    | A    |      |      |
| Approach Vol, veh/h          | 69   |      | 899  |      |      | 722  |      |      |
| Approach Delay, s/veh        | 13.6 |      | 8.1  |      |      | 4.8  |      |      |
| Approach LOS                 | B    |      | A    |      |      | A    |      |      |
| Timer                        | 1    | 2    | 3    | 4    | 5    | 6    | 7    | 8    |
| Assigned Phs                 |      |      |      | 4    |      | 6    | 7    | 8    |
| Phs Duration (G+Y+Rc), s     |      |      |      | 24.6 |      | 9.8  | 4.8  | 19.8 |
| Change Period (Y+Rc), s      |      |      |      | 5.0  |      | 5.0  | 3.5  | 5.0  |
| Max Green Setting (Gmax), s  |      |      |      | 55.0 |      | 35.0 | 11.5 | 40.0 |
| Max Q Clear Time (g_c+I1), s |      |      |      | 5.6  |      | 3.0  | 2.6  | 8.5  |
| Green Ext Time (p_c), s      |      |      |      | 5.4  |      | 0.2  | 0.0  | 6.3  |
| <b>Intersection Summary</b>  |      |      |      |      |      |      |      |      |
| HCM 2010 Ctrl Delay          |      |      | 6.9  |      |      |      |      |      |
| HCM 2010 LOS                 |      |      | A    |      |      |      |      |      |

| Intersection              |      |  |  |  |  |  |  |  |  |  |  |  |
|---------------------------|------|--|--|--|--|--|--|--|--|--|--|--|
| Intersection Delay, s/veh | 10.5 |  |  |  |  |  |  |  |  |  |  |  |
| Intersection LOS          | B    |  |  |  |  |  |  |  |  |  |  |  |























| Movement            | EBL  | EBT  | EBR  | WBL  | WBT  | WBR  | NBL  | NBT  | NBR  | SBL  | SBT  | SBR  |
|---------------------|------|------|------|------|------|------|------|------|------|------|------|------|
| Lane Configurations |      | ↕    |      |      | ↕    |      |      | ↕    |      |      | ↕    |      |
| Traffic Vol, veh/h  | 10   | 40   | 30   | 170  | 30   | 10   | 20   | 60   | 170  | 20   | 70   | 10   |
| Future Vol, veh/h   | 10   | 40   | 30   | 170  | 30   | 10   | 20   | 60   | 170  | 20   | 70   | 10   |
| Peak Hour Factor    | 0.82 | 0.82 | 0.82 | 0.82 | 0.82 | 0.82 | 0.82 | 0.82 | 0.82 | 0.82 | 0.82 | 0.82 |
| Heavy Vehicles, %   | 1    | 1    | 1    | 1    | 1    | 1    | 3    | 3    | 3    | 0    | 0    | 0    |
| Mvmt Flow           | 12   | 49   | 37   | 207  | 37   | 12   | 24   | 73   | 207  | 24   | 85   | 12   |
| Number of Lanes     | 0    | 1    | 0    | 0    | 1    | 0    | 0    | 1    | 0    | 0    | 1    | 0    |

| Approach                   | EB  | WB   | NB   | SB  |
|----------------------------|-----|------|------|-----|
| Opposing Approach          | WB  | EB   | SB   | NB  |
| Opposing Lanes             | 1   | 1    | 1    | 1   |
| Conflicting Approach Left  | SB  | NB   | EB   | WB  |
| Conflicting Lanes Left     | 1   | 1    | 1    | 1   |
| Conflicting Approach Right | NB  | SB   | WB   | EB  |
| Conflicting Lanes Right    | 1   | 1    | 1    | 1   |
| HCM Control Delay          | 9.1 | 11.4 | 10.7 | 9.4 |
| HCM LOS                    | A   | B    | B    | A   |

| Lane                   | NBLn1 | EBLn1 | WBLn1 | SBLn1 |
|------------------------|-------|-------|-------|-------|
| Vol Left, %            | 8%    | 12%   | 81%   | 20%   |
| Vol Thru, %            | 24%   | 50%   | 14%   | 70%   |
| Vol Right, %           | 68%   | 38%   | 5%    | 10%   |
| Sign Control           | Stop  | Stop  | Stop  | Stop  |
| Traffic Vol by Lane    | 250   | 80    | 210   | 100   |
| LT Vol                 | 20    | 10    | 170   | 20    |
| Through Vol            | 60    | 40    | 30    | 70    |
| RT Vol                 | 170   | 30    | 10    | 10    |
| Lane Flow Rate         | 305   | 98    | 256   | 122   |
| Geometry Grp           | 1     | 1     | 1     | 1     |
| Degree of Util (X)     | 0.392 | 0.141 | 0.376 | 0.178 |
| Departure Headway (Hd) | 4.729 | 5.2   | 5.283 | 5.269 |
| Convergence, Y/N       | Yes   | Yes   | Yes   | Yes   |
| Cap                    | 765   | 692   | 686   | 682   |
| Service Time           | 2.729 | 3.215 | 3.283 | 3.291 |
| HCM Lane V/C Ratio     | 0.399 | 0.142 | 0.373 | 0.179 |
| HCM Control Delay      | 10.7  | 9.1   | 11.4  | 9.4   |
| HCM Lane LOS           | B     | A     | B     | A     |
| HCM 95th-tile Q        | 1.9   | 0.5   | 1.8   | 0.6   |

HCM 2010 Signalized Intersection Summary  
 21: 7th Avenue/8th Street & Inter-Garrison Road

Cumulative, PM  
 07/12/2019

|                              |  |  |  |  |  |  |  |  |  |  |  |  |
|------------------------------|---|---|---|---|---|---|---|---|---|---|---|---|
| Movement                     | EBL   | EBT   | EBR   | WBL   | WBT   | WBR   | NBL   | NBT   | NBR   | SBL   | SBT   | SBR   |
| Lane Configurations          |  |  |   |  |  |  |  |  |  |  |  |  |
| Traffic Volume (veh/h)       | 10  | 260   | 70  | 130   | 170   | 30  | 50  | 180   | 240   | 80  | 60  | 10  |
| Future Volume (veh/h)        | 10  | 260   | 70  | 130   | 170   | 30  | 50  | 180   | 240   | 80  | 60  | 10  |
| Number                       | 5   | 2   | 12  | 1   | 6   | 16  | 3   | 8   | 18  | 7   | 4   | 14  |
| Initial Q (Qb), veh          | 0   | 0   | 0   | 0   | 0   | 0   | 0   | 0   | 0   | 0   | 0   | 0   |
| Ped-Bike Adj(A_pbT)          | 1.00  |   | 0.99  | 1.00  |   | 0.99  | 1.00  |   | 0.98  | 1.00  |   | 1.00  |
| Parking Bus, Adj             | 1.00  | 1.00  | 1.00  | 1.00  | 1.00  | 1.00  | 1.00  | 1.00  | 1.00  | 1.00  | 1.00  | 1.00  |
| Adj Sat Flow, veh/h/ln       | 1881  | 1881  | 1900  | 1827  | 1827  | 1827  | 1810  | 1810  | 1810  | 1900  | 1900  | 1900  |
| Adj Flow Rate, veh/h         | 11  | 280   | 69  | 140   | 183   | 17  | 54  | 194   | 186   | 86  | 65  | 2   |
| Adj No. of Lanes             | 1   | 1   | 0   | 1   | 1   | 1   | 1   | 1   | 1   | 1   | 1   | 0   |
| Peak Hour Factor             | 0.93  | 0.93  | 0.93  | 0.93  | 0.93  | 0.93  | 0.93  | 0.93  | 0.93  | 0.93  | 0.93  | 0.93  |
| Percent Heavy Veh, %         | 1   | 1   | 1   | 4   | 4   | 4   | 5   | 5   | 5   | 0   | 0   | 0   |
| Cap, veh/h                   | 20  | 412   | 102   | 179   | 684   | 578   | 114   | 354   | 294   | 152   | 392   | 12  |
| Arrive On Green              | 0.01  | 0.28  | 0.28  | 0.10  | 0.37  | 0.37  | 0.07  | 0.20  | 0.20  | 0.08  | 0.21  | 0.21  |
| Sat Flow, veh/h              | 1792  | 1456  | 359   | 1740  | 1827  | 1545  | 1723  | 1810  | 1501  | 1810  | 1833  | 56  |
| Grp Volume(v), veh/h         | 11  | 0   | 349   | 140   | 183   | 17  | 54  | 194   | 186   | 86  | 0   | 67  |
| Grp Sat Flow(s),veh/h/ln     | 1792  | 0   | 1815  | 1740  | 1827  | 1545  | 1723  | 1810  | 1501  | 1810  | 0   | 1890  |
| Q Serve(g_s), s              | 0.3   | 0.0   | 7.7   | 3.5   | 3.1   | 0.3   | 1.4   | 4.3   | 5.1   | 2.0   | 0.0   | 1.3   |
| Cycle Q Clear(g_c), s        | 0.3   | 0.0   | 7.7   | 3.5   | 3.1   | 0.3   | 1.4   | 4.3   | 5.1   | 2.0   | 0.0   | 1.3   |
| Prop In Lane                 | 1.00  |   | 0.20  | 1.00  |   | 1.00  | 1.00  |   | 1.00  | 1.00  |   | 0.03  |
| Lane Grp Cap(c), veh/h       | 20  | 0   | 514   | 179   | 684   | 578   | 114   | 354   | 294   | 152   | 0   | 404   |
| V/C Ratio(X)                 | 0.54  | 0.00  | 0.68  | 0.78  | 0.27  | 0.03  | 0.48  | 0.55  | 0.63  | 0.57  | 0.00  | 0.17  |
| Avail Cap(c_a), veh/h        | 160   | 0   | 1295  | 291   | 1446  | 1222  | 903   | 887   | 736   | 948   | 0   | 927   |
| HCM Platoon Ratio            | 1.00  | 1.00  | 1.00  | 1.00  | 1.00  | 1.00  | 1.00  | 1.00  | 1.00  | 1.00  | 1.00  | 1.00  |
| Upstream Filter(I)           | 1.00  | 0.00  | 1.00  | 1.00  | 1.00  | 1.00  | 1.00  | 1.00  | 1.00  | 1.00  | 0.00  | 1.00  |
| Uniform Delay (d), s/veh     | 22.1  | 0.0   | 14.3  | 19.6  | 9.8   | 8.9   | 20.2  | 16.3  | 16.6  | 19.8  | 0.0   | 14.4  |
| Incr Delay (d2), s/veh       | 20.1  | 0.0   | 1.6   | 7.3   | 0.2   | 0.0   | 3.1   | 1.3   | 2.3   | 3.3   | 0.0   | 0.2   |
| Initial Q Delay(d3),s/veh    | 0.0   | 0.0   | 0.0   | 0.0   | 0.0   | 0.0   | 0.0   | 0.0   | 0.0   | 0.0   | 0.0   | 0.0   |
| %ile BackOfQ(50%),veh/ln     | 0.2   | 0.0   | 4.0   | 2.0   | 1.6   | 0.1   | 0.7   | 2.3   | 2.3   | 1.2   | 0.0   | 0.7   |
| LnGrp Delay(d),s/veh         | 42.2  | 0.0   | 15.9  | 26.9  | 10.0  | 8.9   | 23.3  | 17.6  | 18.8  | 23.0  | 0.0   | 14.6  |
| LnGrp LOS                    | D   |   | B   | C   | A   | A   | C   | B   | B   | C   |   | B   |
| Approach Vol, veh/h          |   | 360   |   |   | 340   |   |   | 434   |   |   | 153   |   |
| Approach Delay, s/veh        |   | 16.7  |   |   | 16.9  |   |   | 18.8  |   |   | 19.3  |   |
| Approach LOS                 |   | B   |   |   | B   |   |   | B   |   |   | B   |   |
| Timer                        | 1   | 2   | 3   | 4   | 5   | 6   | 7   | 8   |   |   |   |   |
| Assigned Phs                 | 1   | 2   | 3   | 4   | 5   | 6   | 7   | 8   |   |   |   |   |
| Phs Duration (G+Y+Rc), s     | 8.1   | 17.7  | 5.5   | 13.6  | 4.0   | 21.8  | 6.3   | 12.8  |   |   |   |   |
| Change Period (Y+Rc), s      | 3.5   | 5.0   | 3.5   | 4.0   | 3.5   | 5.0   | 3.5   | 4.0   |   |   |   |   |
| Max Green Setting (Gmax), s  | 7.5   | 32.0  | 22.5  | 22.0  | 4.0   | 35.5  | 22.5  | 22.0  |   |   |   |   |
| Max Q Clear Time (g_c+I1), s | 5.5   | 9.7   | 3.4   | 3.3   | 2.3   | 5.1   | 4.0   | 7.1   |   |   |   |   |
| Green Ext Time (p_c), s      | 0.1   | 2.0   | 0.1   | 0.2   | 0.0   | 1.1   | 0.2   | 1.5   |   |   |   |   |
| <b>Intersection Summary</b>  |   |   |   |   |   |   |   |   |   |   |   |   |
| HCM 2010 Ctrl Delay          |   |   | 17.8  |   |   |   |   |   |   |   |   |   |
| HCM 2010 LOS                 |   |   | B   |   |   |   |   |   |   |   |   |   |

| Intersection                   |       |       |       |
|--------------------------------|-------|-------|-------|
| Intersection Delay, s/veh 28.5 |       |       |       |
| Intersection LOS D             |       |       |       |
| Approach                       | EB    | WB    | NB    |
| Entry Lanes                    | 1     | 1     | 1     |
| Conflicting Circle Lanes       | 1     | 1     | 1     |
| Adj Approach Flow, veh/h       | 598   | 680   | 660   |
| Demand Flow Rate, veh/h        | 609   | 694   | 660   |
| Vehicles Circulating, veh/h    | 410   | 62    | 483   |
| Vehicles Exiting, veh/h        | 346   | 1081  | 536   |
| Follow-Up Headway, s           | 3.186 | 3.186 | 3.186 |
| Ped Vol Crossing Leg, #/h      | 0     | 0     | 0     |
| Ped Cap Adj                    | 1.000 | 1.000 | 1.000 |
| Approach Delay, s/veh          | 26.5  | 13.0  | 46.3  |
| Approach LOS                   | D     | B     | E     |
| Lane                           | Left  | Left  | Left  |
| Designated Moves               | TR    | LT    | LR    |
| Assumed Moves                  | TR    | LT    | LR    |
| RT Channelized                 |       |       |       |
| Lane Util                      | 1.000 | 1.000 | 1.000 |
| Critical Headway, s            | 5.193 | 5.193 | 5.193 |
| Entry Flow, veh/h              | 609   | 694   | 660   |
| Cap Entry Lane, veh/h          | 750   | 1062  | 697   |
| Entry HV Adj Factor            | 0.981 | 0.980 | 1.000 |
| Flow Entry, veh/h              | 598   | 680   | 660   |
| Cap Entry, veh/h               | 736   | 1041  | 697   |
| V/C Ratio                      | 0.812 | 0.653 | 0.947 |
| Control Delay, s/veh           | 26.5  | 13.0  | 46.3  |
| LOS                            | D     | B     | E     |
| 95th %tile Queue, veh          | 9     | 5     | 14    |

HCM 2010 Signalized Intersection Summary  
 23: Inter-Garrison Road & Abrams Drive

Cumulative, PM  
 06/11/2019

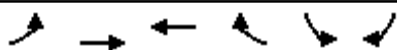

| Movement                     | EBL  | EBT  | WBT  | WBR  | SBL  | SBR  |   |   |
|------------------------------|------|------|------|------|------|------|---|---|
| Lane Configurations          |      |      |      |      |      |      |   |   |
| Traffic Volume (veh/h)       | 520  | 520  | 260  | 30   | 20   | 410  |   |   |
| Future Volume (veh/h)        | 520  | 520  | 260  | 30   | 20   | 410  |   |   |
| Number                       | 5    | 2    | 6    | 16   | 7    | 14   |   |   |
| Initial Q (Qb), veh          | 0    | 0    | 0    | 0    | 0    | 0    |   |   |
| Ped-Bike Adj(A_pbT)          | 1.00 |      |      | 0.98 | 1.00 | 1.00 |   |   |
| Parking Bus, Adj             | 1.00 | 1.00 | 1.00 | 1.00 | 1.00 | 1.00 |   |   |
| Adj Sat Flow, veh/h/ln       | 1863 | 1863 | 1792 | 1792 | 1827 | 1827 |   |   |
| Adj Flow Rate, veh/h         | 547  | 547  | 274  | 6    | 21   | 209  |   |   |
| Adj No. of Lanes             | 1    | 1    | 1    | 1    | 2    | 1    |   |   |
| Peak Hour Factor             | 0.95 | 0.95 | 0.95 | 0.95 | 0.95 | 0.95 |   |   |
| Percent Heavy Veh, %         | 2    | 2    | 6    | 6    | 4    | 4    |   |   |
| Cap, veh/h                   | 508  | 1158 | 446  | 371  | 562  | 259  |   |   |
| Arrive On Green              | 0.29 | 0.62 | 0.25 | 0.25 | 0.17 | 0.17 |   |   |
| Sat Flow, veh/h              | 1774 | 1863 | 1792 | 1491 | 3375 | 1553 |   |   |
| Grp Volume(v), veh/h         | 547  | 547  | 274  | 6    | 21   | 209  |   |   |
| Grp Sat Flow(s),veh/h/ln     | 1774 | 1863 | 1792 | 1491 | 1688 | 1553 |   |   |
| Q Serve(g_s), s              | 11.5 | 6.3  | 5.4  | 0.1  | 0.2  | 5.2  |   |   |
| Cycle Q Clear(g_c), s        | 11.5 | 6.3  | 5.4  | 0.1  | 0.2  | 5.2  |   |   |
| Prop In Lane                 | 1.00 |      |      | 1.00 | 1.00 | 1.00 |   |   |
| Lane Grp Cap(c), veh/h       | 508  | 1158 | 446  | 371  | 562  | 259  |   |   |
| V/C Ratio(X)                 | 1.08 | 0.47 | 0.61 | 0.02 | 0.04 | 0.81 |   |   |
| Avail Cap(c_a), veh/h        | 508  | 2780 | 2007 | 1669 | 2645 | 1217 |   |   |
| HCM Platoon Ratio            | 1.00 | 1.00 | 1.00 | 1.00 | 1.00 | 1.00 |   |   |
| Upstream Filter(I)           | 1.00 | 1.00 | 1.00 | 1.00 | 1.00 | 1.00 |   |   |
| Uniform Delay (d), s/veh     | 14.3 | 4.1  | 13.4 | 11.4 | 14.0 | 16.1 |   |   |
| Incr Delay (d2), s/veh       | 62.5 | 0.1  | 0.5  | 0.0  | 0.0  | 2.3  |   |   |
| Initial Q Delay(d3),s/veh    | 0.0  | 0.0  | 0.0  | 0.0  | 0.0  | 0.0  |   |   |
| %ile BackOfQ(50%),veh/ln     | 4.3  | 3.2  | 2.7  | 0.1  | 0.1  | 4.4  |   |   |
| LnGrp Delay(d),s/veh         | 76.9 | 4.2  | 13.9 | 11.4 | 14.1 | 18.4 |   |   |
| LnGrp LOS                    | F    | A    | B    | B    | B    | B    |   |   |
| Approach Vol, veh/h          |      | 1094 | 280  |      | 230  |      |   |   |
| Approach Delay, s/veh        |      | 40.5 | 13.8 |      | 18.0 |      |   |   |
| Approach LOS                 |      | D    | B    |      | B    |      |   |   |
| Timer                        | 1    | 2    | 3    | 4    | 5    | 6    | 7 | 8 |
| Assigned Phs                 |      | 2    |      | 4    | 5    | 6    |   |   |
| Phs Duration (G+Y+Rc), s     |      | 30.0 |      | 10.2 | 15.0 | 15.0 |   |   |
| Change Period (Y+Rc), s      |      | 5.0  |      | 3.5  | 3.5  | 5.0  |   |   |
| Max Green Setting (Gmax), s  |      | 60.0 |      | 31.5 | 11.5 | 45.0 |   |   |
| Max Q Clear Time (g_c+I1), s |      | 8.3  |      | 7.2  | 13.5 | 7.4  |   |   |
| Green Ext Time (p_c), s      |      | 0.5  |      | 0.0  | 0.0  | 0.2  |   |   |
| <b>Intersection Summary</b>  |      |      |      |      |      |      |   |   |
| HCM 2010 Ctrl Delay          |      |      | 32.6 |      |      |      |   |   |
| HCM 2010 LOS                 |      |      | C    |      |      |      |   |   |
| <b>Notes</b>                 |      |      |      |      |      |      |   |   |

| Intersection              |      |
|---------------------------|------|
| Intersection Delay, s/veh | 19.8 |
| Intersection LOS          | C    |

| Movement            | EBL  | EBT  | WBT  | WBR  | SBL  | SBR  |
|---------------------|------|------|------|------|------|------|
| Lane Configurations |      |      |      |      |      |      |
| Traffic Vol, veh/h  | 110  | 460  | 220  | 50   | 30   | 40   |
| Future Vol, veh/h   | 110  | 460  | 220  | 50   | 30   | 40   |
| Peak Hour Factor    | 0.86 | 0.86 | 0.86 | 0.86 | 0.86 | 0.86 |
| Heavy Vehicles, %   | 1    | 1    | 5    | 5    | 17   | 17   |
| Mvmt Flow           | 128  | 535  | 256  | 58   | 35   | 47   |
| Number of Lanes     | 1    | 1    | 2    | 1    | 1    | 1    |

| Approach                   | EB   | WB   | SB   |
|----------------------------|------|------|------|
| Opposing Approach          | WB   | EB   |      |
| Opposing Lanes             | 3    | 2    | 0    |
| Conflicting Approach Left  | SB   |      | WB   |
| Conflicting Lanes Left     | 2    | 0    | 3    |
| Conflicting Approach Right |      | SB   | EB   |
| Conflicting Lanes Right    | 0    | 2    | 2    |
| HCM Control Delay          | 25.6 | 10.1 | 10.6 |
| HCM LOS                    | D    | B    | B    |

| Lane                   | EBLn1 | EBLn2 | WBLn1 | WBLn2 | WBLn3 | SBLn1 | SBLn2 |
|------------------------|-------|-------|-------|-------|-------|-------|-------|
| Vol Left, %            | 100%  | 0%    | 0%    | 0%    | 0%    | 100%  | 0%    |
| Vol Thru, %            | 0%    | 100%  | 100%  | 100%  | 0%    | 0%    | 0%    |
| Vol Right, %           | 0%    | 0%    | 0%    | 0%    | 100%  | 0%    | 100%  |
| Sign Control           | Stop  | Stop  | Stop  | Stop  | Stop  | Stop  | Stop  |
| Traffic Vol by Lane    | 110   | 460   | 110   | 110   | 50    | 30    | 40    |
| LT Vol                 | 110   | 0     | 0     | 0     | 0     | 30    | 0     |
| Through Vol            | 0     | 460   | 110   | 110   | 0     | 0     | 0     |
| RT Vol                 | 0     | 0     | 0     | 0     | 50    | 0     | 40    |
| Lane Flow Rate         | 128   | 535   | 128   | 128   | 58    | 35    | 47    |
| Geometry Grp           | 8     | 8     | 8     | 8     | 8     | 8     | 8     |
| Degree of Util (X)     | 0.215 | 0.826 | 0.226 | 0.226 | 0.062 | 0.077 | 0.087 |
| Departure Headway (Hd) | 6.062 | 5.56  | 6.357 | 6.357 | 3.849 | 7.934 | 6.723 |
| Convergence, Y/N       | Yes   | Yes   | Yes   | Yes   | Yes   | Yes   | Yes   |
| Cap                    | 593   | 653   | 565   | 565   | 928   | 452   | 533   |
| Service Time           | 3.786 | 3.283 | 4.09  | 4.09  | 1.582 | 5.68  | 4.468 |
| HCM Lane V/C Ratio     | 0.216 | 0.819 | 0.227 | 0.227 | 0.063 | 0.077 | 0.088 |
| HCM Control Delay      | 10.4  | 29.2  | 10.9  | 10.9  | 6.8   | 11.3  | 10.1  |
| HCM Lane LOS           | B     | D     | B     | B     | A     | B     | B     |
| HCM 95th-tile Q        | 0.8   | 8.8   | 0.9   | 0.9   | 0.2   | 0.2   | 0.3   |



|                           |      |
|---------------------------|------|
| <b>Intersection</b>       |      |
| Intersection Delay, s/veh | 17.3 |
| Intersection LOS          | C    |

| Movement            | EBL  | EBT  | WBT  | WBR  | SBL  | SBR  |
|---------------------|------|------|------|------|------|------|
| Lane Configurations |      |      |      |      |      |      |
| Traffic Vol, veh/h  | 350  | 140  | 100  | 130  | 190  | 110  |
| Future Vol, veh/h   | 350  | 140  | 100  | 130  | 190  | 110  |
| Peak Hour Factor    | 0.87 | 0.87 | 0.87 | 0.87 | 0.87 | 0.87 |
| Heavy Vehicles, %   | 1    | 1    | 6    | 6    | 3    | 3    |
| Mvmt Flow           | 402  | 161  | 115  | 149  | 218  | 126  |
| Number of Lanes     | 1    | 1    | 1    | 0    | 1    | 1    |

| Approach                   | EB   | WB   | SB   |
|----------------------------|------|------|------|
| Opposing Approach          | WB   | EB   |      |
| Opposing Lanes             | 1    | 2    | 0    |
| Conflicting Approach Left  | SB   |      | WB   |
| Conflicting Lanes Left     | 2    | 0    | 1    |
| Conflicting Approach Right |      | SB   | EB   |
| Conflicting Lanes Right    | 0    | 2    | 2    |
| HCM Control Delay          | 21.1 | 13.7 | 13.9 |
| HCM LOS                    | C    | B    | B    |

| Lane                   | EBLn1 | EBLn2 | WBLn1 | SBLn1 | SBLn2 |
|------------------------|-------|-------|-------|-------|-------|
| Vol Left, %            | 100%  | 0%    | 0%    | 100%  | 0%    |
| Vol Thru, %            | 0%    | 100%  | 43%   | 0%    | 0%    |
| Vol Right, %           | 0%    | 0%    | 57%   | 0%    | 100%  |
| Sign Control           | Stop  | Stop  | Stop  | Stop  | Stop  |
| Traffic Vol by Lane    | 350   | 140   | 230   | 190   | 110   |
| LT Vol                 | 350   | 0     | 0     | 190   | 0     |
| Through Vol            | 0     | 140   | 100   | 0     | 0     |
| RT Vol                 | 0     | 0     | 130   | 0     | 110   |
| Lane Flow Rate         | 402   | 161   | 264   | 218   | 126   |
| Geometry Grp           | 7     | 7     | 4     | 7     | 7     |
| Degree of Util (X)     | 0.732 | 0.27  | 0.44  | 0.443 | 0.214 |
| Departure Headway (Hd) | 6.553 | 6.046 | 5.988 | 7.299 | 6.079 |
| Convergence, Y/N       | Yes   | Yes   | Yes   | Yes   | Yes   |
| Cap                    | 551   | 594   | 600   | 494   | 589   |
| Service Time           | 4.299 | 3.792 | 4.037 | 5.052 | 3.831 |
| HCM Lane V/C Ratio     | 0.73  | 0.271 | 0.44  | 0.441 | 0.214 |
| HCM Control Delay      | 25.2  | 11    | 13.7  | 15.8  | 10.5  |
| HCM Lane LOS           | D     | B     | B     | C     | B     |
| HCM 95th-tile Q        | 6.1   | 1.1   | 2.2   | 2.2   | 0.8   |

HCM 2010 Signalized Intersection Summary  
 26: East Garrison Road & Reservation Road

Cumulative, PM  
 06/11/2019



| Movement                      | EBL  | EBT  | EBR  | WBL  | WBT  | WBR  | NBL  | NBT  | NBR  | SBL | SBT | SBR |
|-------------------------------|------|------|------|------|------|------|------|------|------|-----|-----|-----|
| Lane Configurations           | ↖    | ↗    |      | ↖    | ↗    |      | ↖    |      | ↗    |     |     |     |
| Traffic Volume (veh/h)        | 0    | 1350 | 190  | 240  | 500  | 0    | 150  | 0    | 150  | 0   | 0   | 0   |
| Future Volume (veh/h)         | 0    | 1350 | 190  | 240  | 500  | 0    | 150  | 0    | 150  | 0   | 0   | 0   |
| Number                        | 5    | 2    | 12   | 1    | 6    | 16   | 3    | 8    | 18   |     |     |     |
| Initial Q (Qb), veh           | 0    | 0    | 0    | 0    | 0    | 0    | 0    | 0    | 0    |     |     |     |
| Ped-Bike Adj(A_pbT)           | 1.00 |      | 1.00 | 1.00 |      | 1.00 | 1.00 |      | 1.00 |     |     |     |
| Parking Bus, Adj              | 1.00 | 1.00 | 1.00 | 1.00 | 1.00 | 1.00 | 1.00 | 1.00 | 1.00 |     |     |     |
| Adj Sat Flow, veh/h/ln        | 1863 | 1863 | 1900 | 1881 | 1881 | 0    | 1845 | 0    | 1845 |     |     |     |
| Adj Flow Rate, veh/h          | 0    | 1392 | 194  | 247  | 515  | 0    | 155  | 0    | 126  |     |     |     |
| Adj No. of Lanes              | 1    | 2    | 0    | 1    | 2    | 0    | 1    | 0    | 1    |     |     |     |
| Peak Hour Factor              | 0.97 | 0.97 | 0.97 | 0.97 | 0.97 | 0.97 | 0.97 | 0.97 | 0.97 |     |     |     |
| Percent Heavy Veh, %          | 2    | 2    | 2    | 1    | 1    | 0    | 3    | 0    | 3    |     |     |     |
| Cap, veh/h                    | 2    | 1814 | 250  | 282  | 2780 | 0    | 193  | 0    | 172  |     |     |     |
| Arrive On Green               | 0.00 | 0.58 | 0.58 | 0.16 | 0.78 | 0.00 | 0.11 | 0.00 | 0.11 |     |     |     |
| Sat Flow, veh/h               | 1774 | 3125 | 431  | 1792 | 3668 | 0    | 1757 | 0    | 1568 |     |     |     |
| Grp Volume(v), veh/h          | 0    | 783  | 803  | 247  | 515  | 0    | 155  | 0    | 126  |     |     |     |
| Grp Sat Flow(s),veh/h/ln      | 1774 | 1770 | 1787 | 1792 | 1787 | 0    | 1757 | 0    | 1568 |     |     |     |
| Q Serve(g_s), s               | 0.0  | 29.9 | 30.8 | 12.1 | 3.4  | 0.0  | 7.7  | 0.0  | 7.0  |     |     |     |
| Cycle Q Clear(g_c), s         | 0.0  | 29.9 | 30.8 | 12.1 | 3.4  | 0.0  | 7.7  | 0.0  | 7.0  |     |     |     |
| Prop In Lane                  | 1.00 |      | 0.24 | 1.00 |      | 0.00 | 1.00 |      | 1.00 |     |     |     |
| Lane Grp Cap(c), veh/h        | 2    | 1027 | 1037 | 282  | 2780 | 0    | 193  | 0    | 172  |     |     |     |
| V/C Ratio(X)                  | 0.00 | 0.76 | 0.77 | 0.88 | 0.19 | 0.00 | 0.80 | 0.00 | 0.73 |     |     |     |
| Avail Cap(c_a), veh/h         | 395  | 1182 | 1193 | 399  | 2780 | 0    | 528  | 0    | 471  |     |     |     |
| HCM Platoon Ratio             | 1.00 | 1.00 | 1.00 | 1.00 | 1.00 | 1.00 | 1.00 | 1.00 | 1.00 |     |     |     |
| Upstream Filter(I)            | 0.00 | 1.00 | 1.00 | 1.00 | 1.00 | 0.00 | 1.00 | 0.00 | 1.00 |     |     |     |
| Uniform Delay (d), s/veh      | 0.0  | 14.2 | 14.4 | 37.0 | 2.6  | 0.0  | 39.0 | 0.0  | 38.7 |     |     |     |
| Incr Delay (d2), s/veh        | 0.0  | 3.2  | 3.5  | 11.3 | 0.0  | 0.0  | 3.0  | 0.0  | 2.2  |     |     |     |
| Initial Q Delay(d3),s/veh     | 0.0  | 0.0  | 0.0  | 0.0  | 0.0  | 0.0  | 0.0  | 0.0  | 0.0  |     |     |     |
| %ile BackOfQ(50%),veh/ln      | 0.0  | 15.3 | 16.0 | 6.9  | 1.7  | 0.0  | 3.9  | 0.0  | 3.1  |     |     |     |
| LnGrp Delay(d),s/veh          | 0.0  | 17.4 | 17.9 | 48.3 | 2.6  | 0.0  | 42.0 | 0.0  | 41.0 |     |     |     |
| LnGrp LOS                     |      | B    | B    | D    | A    |      | D    |      | D    |     |     |     |
| Approach Vol, veh/h           |      | 1586 |      |      | 762  |      |      | 281  |      |     |     |     |
| Approach Delay, s/veh         |      | 17.7 |      |      | 17.4 |      |      | 41.5 |      |     |     |     |
| Approach LOS                  |      | B    |      |      | B    |      |      | D    |      |     |     |     |
| Timer                         | 1    | 2    | 3    | 4    | 5    | 6    | 7    | 8    |      |     |     |     |
| Assigned Phs                  | 1    | 2    |      |      | 5    | 6    |      | 8    |      |     |     |     |
| Phs Duration (G+Y+Rc), s      | 7.7  | 57.6 |      |      | 0.0  | 75.3 |      | 14.6 |      |     |     |     |
| Change Period (Y+Rc), s       | 3.6  | 5.4  |      |      | 3.5  | 5.4  |      | 4.7  |      |     |     |     |
| Max Green Setting (Gmax), s   | 20   | 60.0 |      |      | 20.0 | 60.0 |      | 27.0 |      |     |     |     |
| Max Q Clear Time (g_c+1/4), s | 11.4 | 32.8 |      |      | 0.0  | 5.4  |      | 9.7  |      |     |     |     |
| Green Ext Time (p_c), s       | 0.0  | 19.4 |      |      | 0.0  | 4.1  |      | 0.1  |      |     |     |     |
| <b>Intersection Summary</b>   |      |      |      |      |      |      |      |      |      |     |     |     |
| HCM 2010 Ctrl Delay           |      |      |      | 20.1 |      |      |      |      |      |     |     |     |
| HCM 2010 LOS                  |      |      |      | C    |      |      |      |      |      |     |     |     |
| <b>Notes</b>                  |      |      |      |      |      |      |      |      |      |     |     |     |

HCM 2010 Signalized Intersection Summary  
 27: Reservation Road & Watkins Gate Road

Cumulative, PM  
 06/11/2019



| Movement                     | EBL  | EBR  | NBL   | NBT  | SBT  | SBR  |   |       |
|------------------------------|------|------|-------|------|------|------|---|-------|
| Lane Configurations          |      |      |       |      |      |      |   |       |
| Traffic Volume (veh/h)       | 10   | 230  | 220   | 930  | 1960 | 60   |   |       |
| Future Volume (veh/h)        | 10   | 230  | 220   | 930  | 1960 | 60   |   |       |
| Number                       | 5    | 12   | 3     | 8    | 4    | 14   |   |       |
| Initial Q (Qb), veh          | 0    | 0    | 0     | 0    | 0    | 0    |   |       |
| Ped-Bike Adj(A_pbT)          | 1.00 | 1.00 | 1.00  |      |      | 1.00 |   |       |
| Parking Bus, Adj             | 1.00 | 1.00 | 1.00  | 1.00 | 1.00 | 1.00 |   |       |
| Adj Sat Flow, veh/h/ln       | 1863 | 1863 | 1881  | 1881 | 1863 | 1900 |   |       |
| Adj Flow Rate, veh/h         | 11   | 43   | 239   | 1011 | 2130 | 62   |   |       |
| Adj No. of Lanes             | 1    | 1    | 1     | 2    | 2    | 0    |   |       |
| Peak Hour Factor             | 0.92 | 0.92 | 0.92  | 0.92 | 0.92 | 0.92 |   |       |
| Percent Heavy Veh, %         | 2    | 2    | 1     | 1    | 2    | 2    |   |       |
| Cap, veh/h                   | 65   | 58   | 247   | 3088 | 2443 | 71   |   |       |
| Arrive On Green              | 0.04 | 0.04 | 0.14  | 0.86 | 0.70 | 0.70 |   |       |
| Sat Flow, veh/h              | 1774 | 1583 | 1792  | 3668 | 3606 | 102  |   |       |
| Grp Volume(v), veh/h         | 11   | 43   | 239   | 1011 | 1068 | 1124 |   |       |
| Grp Sat Flow(s),veh/h/ln     | 1774 | 1583 | 1792  | 1787 | 1770 | 1845 |   |       |
| Q Serve(g_s), s              | 0.8  | 3.5  | 17.3  | 7.0  | 60.5 | 62.0 |   |       |
| Cycle Q Clear(g_c), s        | 0.8  | 3.5  | 17.3  | 7.0  | 60.5 | 62.0 |   |       |
| Prop In Lane                 | 1.00 | 1.00 | 1.00  |      |      | 0.06 |   |       |
| Lane Grp Cap(c), veh/h       | 65   | 58   | 247   | 3088 | 1231 | 1283 |   |       |
| V/C Ratio(X)                 | 0.17 | 0.75 | 0.97  | 0.33 | 0.87 | 0.88 |   |       |
| Avail Cap(c_a), veh/h        | 279  | 249  | 247   | 3189 | 1281 | 1335 |   |       |
| HCM Platoon Ratio            | 1.00 | 1.00 | 1.00  | 1.00 | 1.00 | 1.00 |   |       |
| Upstream Filter(I)           | 1.00 | 1.00 | 1.00  | 1.00 | 1.00 | 1.00 |   |       |
| Uniform Delay (d), s/veh     | 61.0 | 62.3 | 56.0  | 1.7  | 15.3 | 15.5 |   |       |
| Incr Delay (d2), s/veh       | 0.5  | 6.9  | 47.8  | 0.1  | 6.7  | 7.0  |   |       |
| Initial Q Delay(d3),s/veh    | 0.0  | 0.0  | 0.0   | 0.0  | 0.0  | 0.0  |   |       |
| %ile BackOfQ(50%),veh/ln     | 0.4  | 1.6  | 11.8  | 3.4  | 31.4 | 33.7 |   |       |
| LnGrp Delay(d),s/veh         | 61.5 | 69.2 | 103.8 | 1.8  | 22.0 | 22.5 |   |       |
| LnGrp LOS                    | E    | E    | F     | A    | C    | C    |   |       |
| Approach Vol, veh/h          | 54   |      |       | 1250 | 2192 |      |   |       |
| Approach Delay, s/veh        | 67.7 |      |       | 21.3 | 22.2 |      |   |       |
| Approach LOS                 | E    |      |       | C    | C    |      |   |       |
| Timer                        | 1    | 2    | 3     | 4    | 5    | 6    | 7 | 8     |
| Assigned Phs                 |      | 2    | 3     | 4    |      |      |   | 8     |
| Phs Duration (G+Y+Rc), s     |      | 11.3 | 22.0  | 97.3 |      |      |   | 119.3 |
| Change Period (Y+Rc), s      |      | 6.5  | 4.0   | 6.5  |      |      |   | 6.5   |
| Max Green Setting (Gmax), s  |      | 20.5 | 18.0  | 94.5 |      |      |   | 116.5 |
| Max Q Clear Time (g_c+11), s |      | 5.5  | 19.3  | 64.0 |      |      |   | 9.0   |
| Green Ext Time (p_c), s      |      | 0.0  | 0.0   | 26.8 |      |      |   | 14.0  |
| <b>Intersection Summary</b>  |      |      |       |      |      |      |   |       |
| HCM 2010 Ctrl Delay          |      |      | 22.6  |      |      |      |   |       |
| HCM 2010 LOS                 |      |      | C     |      |      |      |   |       |

HCM 2010 Signalized Intersection Summary  
28: Davis Road & Reservation Road

Cumulative, PM  
06/11/2019



| Movement                      | EBL   | EBT   | EBR  | WBL   | WBT   | WBR  | NBL  | NBT  | NBR  | SBL  | SBT  | SBR  |
|-------------------------------|-------|-------|------|-------|-------|------|------|------|------|------|------|------|
| Lane Configurations           |       |       |      |       |       |      |      |      |      |      |      |      |
| Traffic Volume (veh/h)        | 1120  | 500   | 10   | 10    | 350   | 110  | 10   | 10   | 10   | 130  | 10   | 480  |
| Future Volume (veh/h)         | 1120  | 500   | 10   | 10    | 350   | 110  | 10   | 10   | 10   | 130  | 10   | 480  |
| Number                        | 5     | 2     | 12   | 1     | 6     | 16   | 3    | 8    | 18   | 7    | 4    | 14   |
| Initial Q (Qb), veh           | 0     | 0     | 0    | 0     | 0     | 0    | 0    | 0    | 0    | 0    | 0    | 0    |
| Ped-Bike Adj(A_pbT)           | 1.00  |       | 1.00 | 1.00  |       | 1.00 | 1.00 |      | 1.00 | 1.00 |      | 1.00 |
| Parking Bus, Adj              | 1.00  | 1.00  | 1.00 | 1.00  | 1.00  | 1.00 | 1.00 | 1.00 | 1.00 | 1.00 | 1.00 | 1.00 |
| Adj Sat Flow, veh/h/ln        | 1863  | 1863  | 1900 | 1827  | 1835  | 1900 | 1900 | 1900 | 1900 | 1900 | 1881 | 1881 |
| Adj Flow Rate, veh/h          | 1191  | 532   | 11   | 11    | 372   | 117  | 11   | 11   | 9    | 138  | 11   | 376  |
| Adj No. of Lanes              | 1     | 2     | 0    | 1     | 1     | 0    | 0    | 1    | 0    | 0    | 1    | 1    |
| Peak Hour Factor              | 0.94  | 0.94  | 0.94 | 0.94  | 0.94  | 0.94 | 0.94 | 0.94 | 0.94 | 0.94 | 0.94 | 0.94 |
| Percent Heavy Veh, %          | 2     | 2     | 2    | 4     | 4     | 4    | 0    | 0    | 0    | 1    | 1    | 1    |
| Cap, veh/h                    | 511   | 2123  | 44   | 17    | 444   | 140  | 18   | 18   | 15   | 317  | 25   | 728  |
| Arrive On Green               | 0.29  | 0.60  | 0.60 | 0.01  | 0.33  | 0.32 | 0.03 | 0.03 | 0.03 | 0.20 | 0.19 | 0.18 |
| Sat Flow, veh/h               | 1774  | 3546  | 73   | 1740  | 1340  | 421  | 631  | 631  | 516  | 1665 | 133  | 1599 |
| Grp Volume(v), veh/h          | 1191  | 265   | 278  | 11    | 0     | 489  | 31   | 0    | 0    | 149  | 0    | 376  |
| Grp Sat Flow(s),veh/h/ln      | 1774  | 1770  | 1850 | 1740  | 0     | 1761 | 1777 | 0    | 0    | 1798 | 0    | 1599 |
| Q Serve(g_s), s               | 30.0  | 7.4   | 7.4  | 0.7   | 0.0   | 26.8 | 1.8  | 0.0  | 0.0  | 7.6  | 0.0  | 17.4 |
| Cycle Q Clear(g_c), s         | 30.0  | 7.4   | 7.4  | 0.7   | 0.0   | 26.8 | 1.8  | 0.0  | 0.0  | 7.6  | 0.0  | 17.4 |
| Prop In Lane                  | 1.00  |       | 0.04 | 1.00  |       | 0.24 | 0.35 |      | 0.29 | 0.93 |      | 1.00 |
| Lane Grp Cap(c), veh/h        | 511   | 1060  | 1108 | 17    | 0     | 584  | 51   | 0    | 0    | 342  | 0    | 728  |
| V/C Ratio(X)                  | 2.33  | 0.25  | 0.25 | 0.66  | 0.00  | 0.84 | 0.61 | 0.00 | 0.00 | 0.44 | 0.00 | 0.52 |
| Avail Cap(c_a), veh/h         | 511   | 1060  | 1108 | 500   | 0     | 1032 | 512  | 0    | 0    | 518  | 0    | 884  |
| HCM Platoon Ratio             | 1.00  | 1.00  | 1.00 | 1.00  | 1.00  | 1.00 | 1.00 | 1.00 | 1.00 | 1.00 | 1.00 | 1.00 |
| Upstream Filter(I)            | 1.00  | 1.00  | 1.00 | 1.00  | 0.00  | 1.00 | 1.00 | 0.00 | 0.00 | 1.00 | 0.00 | 1.00 |
| Uniform Delay (d), s/veh      | 37.1  | 9.9   | 9.9  | 51.4  | 0.0   | 32.3 | 50.0 | 0.0  | 0.0  | 36.8 | 0.0  | 20.2 |
| Incr Delay (d2), s/veh        | 604.8 | 0.2   | 0.2  | 15.6  | 0.0   | 5.1  | 4.4  | 0.0  | 0.0  | 0.3  | 0.0  | 0.2  |
| Initial Q Delay(d3),s/veh     | 0.0   | 0.0   | 0.0  | 0.0   | 0.0   | 0.0  | 0.0  | 0.0  | 0.0  | 0.0  | 0.0  | 0.0  |
| %ile BackOfQ(50%),veh/ln      | 0.5   | 3.6   | 3.8  | 0.4   | 0.0   | 13.7 | 0.9  | 0.0  | 0.0  | 3.8  | 0.0  | 7.7  |
| LnGrp Delay(d),s/veh          | 641.9 | 10.1  | 10.0 | 67.1  | 0.0   | 37.4 | 54.4 | 0.0  | 0.0  | 37.1 | 0.0  | 20.4 |
| LnGrp LOS                     | F     | B     | B    | E     |       | D    | D    |      |      | D    |      | C    |
| Approach Vol, veh/h           |       | 1734  |      |       | 500   |      |      | 31   |      |      | 525  |      |
| Approach Delay, s/veh         |       | 444.0 |      |       | 38.0  |      |      | 54.4 |      |      | 25.1 |      |
| Approach LOS                  |       | F     |      |       | D     |      |      | D    |      |      | C    |      |
| Timer                         | 1     | 2     | 3    | 4     | 5     | 6    | 7    | 8    |      |      |      |      |
| Assigned Phs                  | 1     | 2     |      | 4     | 5     | 6    |      | 8    |      |      |      |      |
| Phs Duration (G+Y+Rc), s      | 5.0   | 67.4  |      | 24.8  | 33.8  | 38.5 |      | 7.0  |      |      |      |      |
| Change Period (Y+Rc), s       | 3.9   | 5.0   |      | 5.0   | * 3.8 | 5.0  |      | 4.0  |      |      |      |      |
| Max Green Setting (Gmax), s   | 30    | 60.0  |      | 30.0  | * 30  | 60.0 |      | 30.0 |      |      |      |      |
| Max Q Clear Time (g_c+1/2), s | 12.5  | 9.4   |      | 19.4  | 32.0  | 28.8 |      | 3.8  |      |      |      |      |
| Green Ext Time (p_c), s       | 0.0   | 5.1   |      | 0.4   | 0.0   | 4.8  |      | 0.0  |      |      |      |      |
| <b>Intersection Summary</b>   |       |       |      |       |       |      |      |      |      |      |      |      |
| HCM 2010 Ctrl Delay           |       |       |      | 288.1 |       |      |      |      |      |      |      |      |
| HCM 2010 LOS                  |       |       |      | F     |       |      |      |      |      |      |      |      |
| <b>Notes</b>                  |       |       |      |       |       |      |      |      |      |      |      |      |

HCM 2010 Signalized Intersection Summary  
29: 2nd Avenue & Divarty Street

Cumulative, PM  
06/11/2019



| Movement                     | EBL  | EBT  | EBR  | WBL  | WBT  | WBR  | NBL  | NBT  | NBR  | SBL  | SBT  | SBR  |
|------------------------------|------|------|------|------|------|------|------|------|------|------|------|------|
| Lane Configurations          |      | ↕    |      |      | ↕    | ↕    | ↕    | ↕↔   |      | ↕    | ↕↔   |      |
| Traffic Volume (veh/h)       | 200  | 10   | 80   | 80   | 10   | 20   | 40   | 670  | 60   | 20   | 620  | 100  |
| Future Volume (veh/h)        | 200  | 10   | 80   | 80   | 10   | 20   | 40   | 670  | 60   | 20   | 620  | 100  |
| Number                       | 5    | 2    | 12   | 1    | 6    | 16   | 3    | 8    | 18   | 7    | 4    | 14   |
| Initial Q (Qb), veh          | 0    | 0    | 0    | 0    | 0    | 0    | 0    | 0    | 0    | 0    | 0    | 0    |
| Ped-Bike Adj(A_pbT)          | 1.00 |      | 1.00 | 1.00 |      | 1.00 | 1.00 |      | 0.99 | 1.00 |      | 0.99 |
| Parking Bus, Adj             | 1.00 | 1.00 | 1.00 | 1.00 | 1.00 | 1.00 | 1.00 | 1.00 | 1.00 | 1.00 | 1.00 | 1.00 |
| Adj Sat Flow, veh/h/ln       | 1900 | 1900 | 1900 | 1900 | 1900 | 1900 | 1900 | 1900 | 1900 | 1881 | 1881 | 1900 |
| Adj Flow Rate, veh/h         | 213  | 11   | 85   | 85   | 11   | 21   | 43   | 713  | 64   | 21   | 660  | 106  |
| Adj No. of Lanes             | 0    | 1    | 0    | 0    | 1    | 1    | 1    | 2    | 0    | 1    | 2    | 0    |
| Peak Hour Factor             | 0.94 | 0.94 | 0.94 | 0.94 | 0.94 | 0.94 | 0.94 | 0.94 | 0.94 | 0.94 | 0.94 | 0.94 |
| Percent Heavy Veh, %         | 0    | 0    | 0    | 0    | 0    | 0    | 0    | 0    | 0    | 1    | 1    | 1    |
| Cap, veh/h                   | 405  | 37   | 117  | 531  | 59   | 501  | 84   | 1214 | 109  | 46   | 1054 | 169  |
| Arrive On Green              | 0.33 | 0.31 | 0.31 | 0.33 | 0.31 | 0.31 | 0.05 | 0.36 | 0.36 | 0.03 | 0.34 | 0.34 |
| Sat Flow, veh/h              | 867  | 119  | 374  | 1219 | 190  | 1607 | 1810 | 3350 | 300  | 1792 | 3083 | 495  |
| Grp Volume(v), veh/h         | 309  | 0    | 0    | 96   | 0    | 21   | 43   | 384  | 393  | 21   | 382  | 384  |
| Grp Sat Flow(s),veh/h/ln     | 1361 | 0    | 0    | 1409 | 0    | 1607 | 1810 | 1805 | 1845 | 1792 | 1787 | 1790 |
| Q Serve(g_s), s              | 7.3  | 0.0  | 0.0  | 0.0  | 0.0  | 0.4  | 1.0  | 7.7  | 7.8  | 0.5  | 8.0  | 8.1  |
| Cycle Q Clear(g_c), s        | 9.4  | 0.0  | 0.0  | 2.1  | 0.0  | 0.4  | 1.0  | 7.7  | 7.8  | 0.5  | 8.0  | 8.1  |
| Prop In Lane                 | 0.69 |      | 0.28 | 0.89 |      | 1.00 | 1.00 |      | 0.16 | 1.00 |      | 0.28 |
| Lane Grp Cap(c), veh/h       | 590  | 0    | 0    | 621  | 0    | 501  | 84   | 654  | 669  | 46   | 611  | 612  |
| V/C Ratio(X)                 | 0.52 | 0.00 | 0.00 | 0.15 | 0.00 | 0.04 | 0.51 | 0.59 | 0.59 | 0.46 | 0.63 | 0.63 |
| Avail Cap(c_a), veh/h        | 1272 | 0    | 0    | 1259 | 0    | 1252 | 463  | 1606 | 1642 | 458  | 1392 | 1394 |
| HCM Platoon Ratio            | 1.00 | 1.00 | 1.00 | 1.00 | 1.00 | 1.00 | 1.00 | 1.00 | 1.00 | 1.00 | 1.00 | 1.00 |
| Upstream Filter(I)           | 1.00 | 0.00 | 0.00 | 1.00 | 0.00 | 1.00 | 1.00 | 1.00 | 1.00 | 1.00 | 1.00 | 1.00 |
| Uniform Delay (d), s/veh     | 13.9 | 0.0  | 0.0  | 11.0 | 0.0  | 10.8 | 20.9 | 11.6 | 11.6 | 21.6 | 12.4 | 12.4 |
| Incr Delay (d2), s/veh       | 0.7  | 0.0  | 0.0  | 0.1  | 0.0  | 0.0  | 4.8  | 0.8  | 0.8  | 6.9  | 1.1  | 1.1  |
| Initial Q Delay(d3),s/veh    | 0.0  | 0.0  | 0.0  | 0.0  | 0.0  | 0.0  | 0.0  | 0.0  | 0.0  | 0.0  | 0.0  | 0.0  |
| %ile BackOfQ(50%),veh/ln     | 3.3  | 0.0  | 0.0  | 0.8  | 0.0  | 0.2  | 0.6  | 4.0  | 4.1  | 0.3  | 4.1  | 4.1  |
| LnGrp Delay(d),s/veh         | 14.6 | 0.0  | 0.0  | 11.1 | 0.0  | 10.8 | 25.8 | 12.4 | 12.4 | 28.5 | 13.4 | 13.5 |
| LnGrp LOS                    | B    |      |      | B    |      | B    | C    | B    | B    | C    | B    | B    |
| Approach Vol, veh/h          |      | 309  |      |      | 117  |      |      | 820  |      |      | 787  |      |
| Approach Delay, s/veh        |      | 14.6 |      |      | 11.1 |      |      | 13.1 |      |      | 13.8 |      |
| Approach LOS                 |      | B    |      |      | B    |      |      | B    |      |      | B    |      |
| Timer                        | 1    | 2    | 3    | 4    | 5    | 6    | 7    | 8    |      |      |      |      |
| Assigned Phs                 |      | 2    | 3    | 4    |      | 6    | 7    | 8    |      |      |      |      |
| Phs Duration (G+Y+Rc), s     |      | 19.0 | 5.6  | 20.4 |      | 19.0 | 4.7  | 21.3 |      |      |      |      |
| Change Period (Y+Rc), s      |      | 5.0  | 3.5  | 5.0  |      | 5.0  | 3.5  | 5.0  |      |      |      |      |
| Max Green Setting (Gmax), s  |      | 35.0 | 11.5 | 35.0 |      | 35.0 | 11.5 | 40.0 |      |      |      |      |
| Max Q Clear Time (g_c+I1), s |      | 11.4 | 3.0  | 10.1 |      | 4.1  | 2.5  | 9.8  |      |      |      |      |
| Green Ext Time (p_c), s      |      | 1.8  | 0.0  | 5.0  |      | 0.6  | 0.0  | 5.2  |      |      |      |      |
| <b>Intersection Summary</b>  |      |      |      |      |      |      |      |      |      |      |      |      |
| HCM 2010 Ctrl Delay          |      |      |      | 13.5 |      |      |      |      |      |      |      |      |
| HCM 2010 LOS                 |      |      |      | B    |      |      |      |      |      |      |      |      |

| Intersection              |      |  |  |  |  |  |  |  |  |  |  |  |
|---------------------------|------|--|--|--|--|--|--|--|--|--|--|--|
| Intersection Delay, s/veh | 11.9 |  |  |  |  |  |  |  |  |  |  |  |
| Intersection LOS          | B    |  |  |  |  |  |  |  |  |  |  |  |

| Movement            | EBL  | EBT  | EBR  | WBL  | WBT  | WBR  | NBL  | NBT  | NBR  | SBL  | SBT  | SBR  |
|---------------------|------|------|------|------|------|------|------|------|------|------|------|------|
| Lane Configurations |      | ↕    |      |      | ↕    |      | ↕    | ↕    |      | ↕    | ↕    |      |
| Traffic Vol, veh/h  | 20   | 10   | 30   | 40   | 10   | 10   | 20   | 240  | 70   | 10   | 240  | 20   |
| Future Vol, veh/h   | 20   | 10   | 30   | 40   | 10   | 10   | 20   | 240  | 70   | 10   | 240  | 20   |
| Peak Hour Factor    | 0.85 | 0.85 | 0.85 | 0.85 | 0.85 | 0.85 | 0.85 | 0.85 | 0.85 | 0.85 | 0.85 | 0.85 |
| Heavy Vehicles, %   | 0    | 0    | 0    | 1    | 1    | 1    | 0    | 0    | 0    | 1    | 1    | 1    |
| Mvmt Flow           | 24   | 12   | 35   | 47   | 12   | 12   | 24   | 282  | 82   | 12   | 282  | 24   |
| Number of Lanes     | 0    | 1    | 0    | 0    | 1    | 0    | 1    | 1    | 0    | 1    | 1    | 0    |

| Approach                   | EB  | WB  | NB   | SB |
|----------------------------|-----|-----|------|----|
| Opposing Approach          | WB  | EB  | SB   | NB |
| Opposing Lanes             | 1   | 1   | 2    | 2  |
| Conflicting Approach Left  | SB  | NB  | EB   | WB |
| Conflicting Lanes Left     | 2   | 2   | 1    | 1  |
| Conflicting Approach Right | NB  | SB  | WB   | EB |
| Conflicting Lanes Right    | 2   | 2   | 1    | 1  |
| HCM Control Delay          | 9.2 | 9.6 | 12.7 | 12 |
| HCM LOS                    | A   | A   | B    | B  |

| Lane                   | NBLn1 | NBLn2 | EBLn1 | WBLn1 | SBLn1 | SBLn2 |
|------------------------|-------|-------|-------|-------|-------|-------|
| Vol Left, %            | 100%  | 0%    | 33%   | 67%   | 100%  | 0%    |
| Vol Thru, %            | 0%    | 77%   | 17%   | 17%   | 0%    | 92%   |
| Vol Right, %           | 0%    | 23%   | 50%   | 17%   | 0%    | 8%    |
| Sign Control           | Stop  | Stop  | Stop  | Stop  | Stop  | Stop  |
| Traffic Vol by Lane    | 20    | 310   | 60    | 60    | 10    | 260   |
| LT Vol                 | 20    | 0     | 20    | 40    | 10    | 0     |
| Through Vol            | 0     | 240   | 10    | 10    | 0     | 240   |
| RT Vol                 | 0     | 70    | 30    | 10    | 0     | 20    |
| Lane Flow Rate         | 24    | 365   | 71    | 71    | 12    | 306   |
| Geometry Grp           | 7     | 7     | 2     | 2     | 7     | 7     |
| Degree of Util (X)     | 0.037 | 0.509 | 0.109 | 0.114 | 0.019 | 0.442 |
| Departure Headway (Hd) | 5.683 | 5.02  | 5.562 | 5.839 | 5.758 | 5.199 |
| Convergence, Y/N       | Yes   | Yes   | Yes   | Yes   | Yes   | Yes   |
| Cap                    | 625   | 711   | 648   | 617   | 617   | 685   |
| Service Time           | 3.46  | 2.797 | 3.562 | 3.842 | 3.54  | 2.981 |
| HCM Lane V/C Ratio     | 0.038 | 0.513 | 0.11  | 0.115 | 0.019 | 0.447 |
| HCM Control Delay      | 8.7   | 13    | 9.2   | 9.6   | 8.7   | 12.1  |
| HCM Lane LOS           | A     | B     | A     | A     | A     | B     |
| HCM 95th-tile Q        | 0.1   | 2.9   | 0.4   | 0.4   | 0.1   | 2.3   |

HCM 2010 Signalized Intersection Summary  
31: 1st Avenue & Lightfighter Drive

Cumulative, PM  
06/11/2019



| Movement                     | EBL  | EBT  | EBR  | WBL  | WBT  | WBR  | NBL  | NBT  | NBR  | SBL  | SBT  | SBR  |
|------------------------------|------|------|------|------|------|------|------|------|------|------|------|------|
| Lane Configurations          |      | ↑↑   | ↑    | ↑    | ↑↑   |      | ↑    |      | ↑    | ↑    | ↑    | ↑    |
| Traffic Volume (veh/h)       | 0    | 730  | 110  | 20   | 1340 | 0    | 200  | 0    | 30   | 60   | 50   | 80   |
| Future Volume (veh/h)        | 0    | 730  | 110  | 20   | 1340 | 0    | 200  | 0    | 30   | 60   | 50   | 80   |
| Number                       | 7    | 4    | 14   | 3    | 8    | 18   | 5    | 2    | 12   | 1    | 6    | 16   |
| Initial Q (Qb), veh          | 0    | 0    | 0    | 0    | 0    | 0    | 0    | 0    | 0    | 0    | 0    | 0    |
| Ped-Bike Adj(A_pbT)          | 1.00 |      | 1.00 | 1.00 |      | 1.00 | 1.00 |      | 1.00 | 1.00 |      | 1.00 |
| Parking Bus, Adj             | 1.00 | 1.00 | 1.00 | 1.00 | 1.00 | 1.00 | 1.00 | 1.00 | 1.00 | 1.00 | 1.00 | 1.00 |
| Adj Sat Flow, veh/h/ln       | 0    | 1881 | 1881 | 1881 | 1881 | 0    | 1881 | 0    | 1881 | 1810 | 1810 | 1810 |
| Adj Flow Rate, veh/h         | 0    | 768  | 0    | 21   | 1411 | 0    | 211  | 0    | 14   | 63   | 53   | 64   |
| Adj No. of Lanes             | 0    | 2    | 1    | 1    | 2    | 0    | 1    | 0    | 1    | 1    | 1    | 1    |
| Peak Hour Factor             | 0.95 | 0.95 | 0.95 | 0.95 | 0.95 | 0.95 | 0.95 | 0.95 | 0.95 | 0.95 | 0.95 | 0.95 |
| Percent Heavy Veh, %         | 0    | 1    | 1    | 1    | 1    | 0    | 1    | 0    | 1    | 5    | 5    | 5    |
| Cap, veh/h                   | 0    | 2129 | 952  | 23   | 2478 | 0    | 0    | 0    | 0    | 144  | 152  | 129  |
| Arrive On Green              | 0.00 | 0.60 | 0.00 | 0.01 | 0.69 | 0.00 | 0.00 | 0.00 | 0.00 | 0.08 | 0.08 | 0.08 |
| Sat Flow, veh/h              | 0    | 3668 | 1599 | 1792 | 3668 | 0    |      | 0    |      | 1723 | 1810 | 1538 |
| Grp Volume(v), veh/h         | 0    | 768  | 0    | 21   | 1411 | 0    |      | 0.0  |      | 63   | 53   | 64   |
| Grp Sat Flow(s),veh/h/ln     | 0    | 1787 | 1599 | 1792 | 1787 | 0    |      |      |      | 1723 | 1810 | 1538 |
| Q Serve(g_s), s              | 0.0  | 4.6  | 0.0  | 0.5  | 8.3  | 0.0  |      |      |      | 1.4  | 1.1  | 1.6  |
| Cycle Q Clear(g_c), s        | 0.0  | 4.6  | 0.0  | 0.5  | 8.3  | 0.0  |      |      |      | 1.4  | 1.1  | 1.6  |
| Prop In Lane                 | 0.00 |      | 1.00 | 1.00 |      | 0.00 |      |      |      | 1.00 |      | 1.00 |
| Lane Grp Cap(c), veh/h       | 0    | 2129 | 952  | 23   | 2478 | 0    |      |      |      | 144  | 152  | 129  |
| V/C Ratio(X)                 | 0.00 | 0.36 | 0.00 | 0.91 | 0.57 | 0.00 |      |      |      | 0.44 | 0.35 | 0.50 |
| Avail Cap(c_a), veh/h        | 0    | 3897 | 1744 | 868  | 3897 | 0    |      |      |      | 1044 | 1096 | 932  |
| HCM Platoon Ratio            | 1.00 | 1.00 | 1.00 | 1.00 | 1.00 | 1.00 |      |      |      | 1.00 | 1.00 | 1.00 |
| Upstream Filter(I)           | 0.00 | 1.00 | 0.00 | 1.00 | 1.00 | 0.00 |      |      |      | 1.00 | 1.00 | 1.00 |
| Uniform Delay (d), s/veh     | 0.0  | 4.3  | 0.0  | 20.3 | 3.2  | 0.0  |      |      |      | 18.0 | 17.8 | 18.1 |
| Incr Delay (d2), s/veh       | 0.0  | 0.1  | 0.0  | 33.7 | 0.3  | 0.0  |      |      |      | 0.8  | 0.5  | 1.1  |
| Initial Q Delay(d3),s/veh    | 0.0  | 0.0  | 0.0  | 0.0  | 0.0  | 0.0  |      |      |      | 0.0  | 0.0  | 0.0  |
| %ile BackOfQ(50%),veh/lr0.0  | 0.0  | 2.2  | 0.0  | 0.5  | 4.0  | 0.0  |      |      |      | 0.7  | 0.6  | 0.7  |
| LnGrp Delay(d),s/veh         | 0.0  | 4.4  | 0.0  | 54.0 | 3.5  | 0.0  |      |      |      | 18.7 | 18.4 | 19.2 |
| LnGrp LOS                    |      | A    |      | D    | A    |      |      |      |      | B    | B    | B    |
| Approach Vol, veh/h          |      | 768  |      |      | 1432 |      |      |      |      |      | 180  |      |
| Approach Delay, s/veh        |      | 4.4  |      |      | 4.2  |      |      |      |      |      | 18.8 |      |
| Approach LOS                 |      | A    |      |      | A    |      |      |      |      |      | B    |      |
| Timer                        | 1    | 2    | 3    | 4    | 5    | 6    | 7    | 8    |      |      |      |      |
| Assigned Phs                 |      |      | 3    | 4    |      | 6    |      | 8    |      |      |      |      |
| Phs Duration (G+Y+Rc), s     |      |      | 4.0  | 29.2 |      | 8.1  |      | 33.2 |      |      |      |      |
| Change Period (Y+Rc), s      |      |      | 3.5  | 4.6  |      | 4.6  |      | 4.6  |      |      |      |      |
| Max Green Setting (Gmax), s  |      |      | 20.0 | 45.0 |      | 25.0 |      | 45.0 |      |      |      |      |
| Max Q Clear Time (g_c+I1), s |      |      | 2.5  | 6.6  |      | 3.6  |      | 10.3 |      |      |      |      |
| Green Ext Time (p_c), s      |      |      | 0.0  | 9.1  |      | 0.3  |      | 18.4 |      |      |      |      |
| <b>Intersection Summary</b>  |      |      |      |      |      |      |      |      |      |      |      |      |
| HCM 2010 Ctrl Delay          |      |      | 5.4  |      |      |      |      |      |      |      |      |      |
| HCM 2010 LOS                 |      |      | A    |      |      |      |      |      |      |      |      |      |

HCM 2010 Signalized Intersection Summary  
 32: 2nd Avenue & Lightfighter Drive

Cumulative, PM  
 06/11/2019



| Movement                     | EBL   | EBT  | EBR  | WBL  | WBT  | WBR  | NBL  | NBT  | NBR  | SBL  | SBT  | SBR  |
|------------------------------|-------|------|------|------|------|------|------|------|------|------|------|------|
| Lane Configurations          |       |      |      |      |      |      |      |      |      |      |      |      |
| Traffic Volume (veh/h)       | 290   | 530  | 10   | 80   | 1070 | 220  | 20   | 20   | 50   | 230  | 30   | 330  |
| Future Volume (veh/h)        | 290   | 530  | 10   | 80   | 1070 | 220  | 20   | 20   | 50   | 230  | 30   | 330  |
| Number                       | 5     | 2    | 12   | 1    | 6    | 16   | 3    | 8    | 18   | 7    | 4    | 14   |
| Initial Q (Qb), veh          | 0     | 0    | 0    | 0    | 0    | 0    | 0    | 0    | 0    | 0    | 0    | 0    |
| Ped-Bike Adj(A_pbT)          | 1.00  |      | 1.00 | 1.00 |      | 1.00 | 1.00 |      | 0.99 | 1.00 |      | 0.99 |
| Parking Bus, Adj             | 1.00  | 1.00 | 1.00 | 1.00 | 1.00 | 1.00 | 1.00 | 1.00 | 1.00 | 1.00 | 1.00 | 1.00 |
| Adj Sat Flow, veh/h/ln       | 1881  | 1881 | 1900 | 1881 | 1881 | 1900 | 1900 | 1900 | 1900 | 1845 | 1845 | 1845 |
| Adj Flow Rate, veh/h         | 305   | 558  | 11   | 84   | 1126 | 227  | 21   | 21   | 47   | 242  | 32   | 244  |
| Adj No. of Lanes             | 1     | 2    | 0    | 1    | 2    | 0    | 0    | 1    | 0    | 1    | 1    | 1    |
| Peak Hour Factor             | 0.95  | 0.95 | 0.95 | 0.95 | 0.95 | 0.95 | 0.95 | 0.95 | 0.95 | 0.95 | 0.95 | 0.95 |
| Percent Heavy Veh, %         | 1     | 1    | 1    | 1    | 1    | 1    | 0    | 0    | 0    | 3    | 3    | 3    |
| Cap, veh/h                   | 222   | 2170 | 43   | 108  | 1606 | 322  | 96   | 99   | 168  | 349  | 374  | 316  |
| Arrive On Green              | 0.12  | 0.61 | 0.61 | 0.06 | 0.54 | 0.54 | 0.21 | 0.20 | 0.20 | 0.20 | 0.20 | 0.20 |
| Sat Flow, veh/h              | 1792  | 3585 | 71   | 1792 | 2967 | 595  | 252  | 490  | 830  | 1308 | 1845 | 1559 |
| Grp Volume(v), veh/h         | 305   | 278  | 291  | 84   | 676  | 677  | 89   | 0    | 0    | 242  | 32   | 244  |
| Grp Sat Flow(s),veh/h/ln     | 1792  | 1787 | 1869 | 1792 | 1787 | 1775 | 1571 | 0    | 0    | 1308 | 1845 | 1559 |
| Q Serve(g_s), s              | 12.4  | 7.3  | 7.3  | 4.6  | 27.9 | 28.3 | 0.0  | 0.0  | 0.0  | 12.7 | 1.4  | 14.8 |
| Cycle Q Clear(g_c), s        | 12.4  | 7.3  | 7.3  | 4.6  | 27.9 | 28.3 | 4.3  | 0.0  | 0.0  | 17.0 | 1.4  | 14.8 |
| Prop In Lane                 | 1.00  |      | 0.04 | 1.00 |      | 0.34 | 0.24 |      | 0.53 | 1.00 |      | 1.00 |
| Lane Grp Cap(c), veh/h       | 222   | 1082 | 1131 | 108  | 967  | 961  | 372  | 0    | 0    | 349  | 374  | 316  |
| V/C Ratio(X)                 | 1.37  | 0.26 | 0.26 | 0.78 | 0.70 | 0.70 | 0.24 | 0.00 | 0.00 | 0.69 | 0.09 | 0.77 |
| Avail Cap(c_a), veh/h        | 222   | 1082 | 1131 | 222  | 967  | 961  | 675  | 0    | 0    | 612  | 745  | 630  |
| HCM Platoon Ratio            | 1.00  | 1.00 | 1.00 | 1.00 | 1.00 | 1.00 | 1.00 | 1.00 | 1.00 | 1.00 | 1.00 | 1.00 |
| Upstream Filter(I)           | 0.91  | 0.91 | 0.91 | 0.20 | 0.20 | 0.20 | 1.00 | 0.00 | 0.00 | 0.77 | 0.77 | 0.77 |
| Uniform Delay (d), s/veh     | 43.8  | 9.2  | 9.2  | 46.4 | 16.9 | 17.0 | 33.4 | 0.0  | 0.0  | 38.3 | 32.3 | 37.7 |
| Incr Delay (d2), s/veh       | 191.6 | 0.5  | 0.5  | 1.0  | 0.9  | 0.9  | 0.1  | 0.0  | 0.0  | 0.7  | 0.0  | 1.2  |
| Initial Q Delay(d3),s/veh    | 0.0   | 0.0  | 0.0  | 0.0  | 0.0  | 0.0  | 0.0  | 0.0  | 0.0  | 0.0  | 0.0  | 0.0  |
| %ile BackOfQ(50%),veh/ln     | 7.9   | 3.7  | 3.9  | 2.3  | 13.9 | 14.0 | 2.1  | 0.0  | 0.0  | 6.5  | 0.7  | 6.5  |
| LnGrp Delay(d),s/veh         | 235.4 | 9.8  | 9.7  | 47.3 | 17.8 | 17.9 | 33.6 | 0.0  | 0.0  | 39.0 | 32.4 | 38.9 |
| LnGrp LOS                    | F     | A    | A    | D    | B    | B    | C    |      |      | D    | C    | D    |
| Approach Vol, veh/h          |       | 874  |      |      | 1437 |      |      | 89   |      |      | 518  |      |
| Approach Delay, s/veh        |       | 88.5 |      |      | 19.6 |      |      | 33.6 |      |      | 38.5 |      |
| Approach LOS                 |       | F    |      |      | B    |      |      | C    |      |      | D    |      |
| Timer                        | 1     | 2    | 3    | 4    | 5    | 6    | 7    | 8    |      |      |      |      |
| Assigned Phs                 | 1     | 2    |      | 4    | 5    | 6    |      | 8    |      |      |      |      |
| Phs Duration (G+Y+Rc), s     | 40.0  | 65.1 |      | 24.9 | 16.4 | 58.7 |      | 24.9 |      |      |      |      |
| Change Period (Y+Rc), s      | 4.0   | 4.6  |      | 4.6  | 4.0  | 4.6  |      | 4.6  |      |      |      |      |
| Max Green Setting (Gmax), s  | 40.0  | 34.0 |      | 40.4 | 12.4 | 24.4 |      | 40.4 |      |      |      |      |
| Max Q Clear Time (g_c+10), s | 10.0  | 9.3  |      | 19.0 | 14.4 | 30.3 |      | 6.3  |      |      |      |      |
| Green Ext Time (p_c), s      | 0.0   | 2.0  |      | 0.9  | 0.0  | 0.0  |      | 0.3  |      |      |      |      |
| <b>Intersection Summary</b>  |       |      |      |      |      |      |      |      |      |      |      |      |
| HCM 2010 Ctrl Delay          |       |      |      | 44.0 |      |      |      |      |      |      |      |      |
| HCM 2010 LOS                 |       |      |      | D    |      |      |      |      |      |      |      |      |



HCM 2010 Signalized Intersection Summary  
 33: General Jim Moore Boulevard & Lightfighter Drive

Cumulative, PM  
 06/11/2019



| Movement                      | EBL  | EBT  | EBR  | WBL  | WBT  | WBR  | NBL  | NBT  | NBR  | SBL  | SBT  | SBR  |
|-------------------------------|------|------|------|------|------|------|------|------|------|------|------|------|
| Lane Configurations           |      |      |      |      |      |      |      |      |      |      |      |      |
| Traffic Volume (veh/h)        | 80   | 270  | 600  | 40   | 270  | 50   | 600  | 170  | 20   | 60   | 180  | 40   |
| Future Volume (veh/h)         | 80   | 270  | 600  | 40   | 270  | 50   | 600  | 170  | 20   | 60   | 180  | 40   |
| Number                        | 3    | 8    | 18   | 7    | 4    | 14   | 1    | 6    | 16   | 5    | 2    | 12   |
| Initial Q (Qb), veh           | 0    | 0    | 0    | 0    | 0    | 0    | 0    | 0    | 0    | 0    | 0    | 0    |
| Ped-Bike Adj(A_pbT)           | 1.00 |      | 1.00 | 1.00 |      | 1.00 | 1.00 |      | 1.00 | 1.00 |      | 1.00 |
| Parking Bus, Adj              | 1.00 | 1.00 | 1.00 | 1.00 | 1.00 | 1.00 | 1.00 | 1.00 | 1.00 | 1.00 | 1.00 | 1.00 |
| Adj Sat Flow, veh/h/ln        | 1881 | 1881 | 1881 | 1900 | 1900 | 1900 | 1881 | 1881 | 1900 | 1900 | 1900 | 1900 |
| Adj Flow Rate, veh/h          | 83   | 281  | 0    | 42   | 281  | 51   | 625  | 177  | 19   | 62   | 188  | -70  |
| Adj No. of Lanes              | 1    | 1    | 1    | 1    | 1    | 0    | 2    | 1    | 0    | 1    | 2    | 0    |
| Peak Hour Factor              | 0.96 | 0.96 | 0.96 | 0.96 | 0.96 | 0.96 | 0.96 | 0.96 | 0.96 | 0.96 | 0.96 | 0.96 |
| Percent Heavy Veh, %          | 1    | 1    | 1    | 0    | 0    | 0    | 1    | 1    | 1    | 0    | 0    | 0    |
| Cap, veh/h                    | 108  | 522  | 444  | 64   | 396  | 72   | 702  | 462  | 50   | 84   | 438  | 0    |
| Arrive On Green               | 0.06 | 0.28 | 0.00 | 0.04 | 0.25 | 0.25 | 0.20 | 0.28 | 0.28 | 0.05 | 0.12 | 0.00 |
| Sat Flow, veh/h               | 1792 | 1881 | 1599 | 1810 | 1566 | 284  | 3476 | 1670 | 179  | 1810 | 3705 | 0    |
| Grp Volume(v), veh/h          | 83   | 281  | 0    | 42   | 0    | 332  | 625  | 0    | 196  | 62   | 118  | 0    |
| Grp Sat Flow(s),veh/h/ln      | 1792 | 1881 | 1599 | 1810 | 0    | 1850 | 1738 | 0    | 1850 | 1810 | 1805 | 0    |
| Q Serve(g_s), s               | 2.3  | 6.3  | 0.0  | 1.1  | 0.0  | 8.1  | 8.7  | 0.0  | 4.2  | 1.7  | 1.5  | 0.0  |
| Cycle Q Clear(g_c), s         | 2.3  | 6.3  | 0.0  | 1.1  | 0.0  | 8.1  | 8.7  | 0.0  | 4.2  | 1.7  | 1.5  | 0.0  |
| Prop In Lane                  | 1.00 |      | 1.00 | 1.00 |      | 0.15 | 1.00 |      | 0.10 | 1.00 |      | 0.00 |
| Lane Grp Cap(c), veh/h        | 108  | 522  | 444  | 64   | 0    | 467  | 702  | 0    | 512  | 84   | 438  | 0    |
| V/C Ratio(X)                  | 0.77 | 0.54 | 0.00 | 0.65 | 0.00 | 0.71 | 0.89 | 0.00 | 0.38 | 0.74 | 0.27 | 0.00 |
| Avail Cap(c_a), veh/h         | 724  | 1140 | 969  | 731  | 0    | 1121 | 702  | 0    | 1121 | 548  | 2188 | 0    |
| HCM Platoon Ratio             | 1.00 | 1.00 | 1.00 | 1.00 | 1.00 | 1.00 | 1.00 | 1.00 | 1.00 | 1.00 | 1.00 | 1.00 |
| Upstream Filter(I)            | 1.00 | 1.00 | 0.00 | 1.00 | 0.00 | 1.00 | 1.00 | 0.00 | 1.00 | 1.00 | 1.00 | 0.00 |
| Uniform Delay (d), s/veh      | 22.9 | 15.2 | 0.0  | 23.6 | 0.0  | 16.8 | 19.2 | 0.0  | 14.5 | 23.3 | 19.8 | 0.0  |
| Incr Delay (d2), s/veh        | 10.6 | 1.0  | 0.0  | 4.1  | 0.0  | 2.4  | 13.3 | 0.0  | 1.0  | 4.7  | 0.4  | 0.0  |
| Initial Q Delay(d3),s/veh     | 0.0  | 0.0  | 0.0  | 0.0  | 0.0  | 0.0  | 0.0  | 0.0  | 0.0  | 0.0  | 0.0  | 0.0  |
| %ile BackOfQ(50%),veh/ln      | 1.4  | 3.4  | 0.0  | 0.6  | 0.0  | 4.4  | 5.5  | 0.0  | 2.3  | 0.9  | 0.8  | 0.0  |
| LnGrp Delay(d),s/veh          | 33.5 | 16.2 | 0.0  | 27.7 | 0.0  | 19.3 | 32.6 | 0.0  | 15.5 | 28.0 | 20.2 | 0.0  |
| LnGrp LOS                     | C    | B    |      | C    |      | B    | C    |      | B    | C    | C    |      |
| Approach Vol, veh/h           |      | 364  |      |      | 374  |      |      | 821  |      |      | 180  |      |
| Approach Delay, s/veh         |      | 20.2 |      |      | 20.2 |      |      | 28.5 |      |      | 22.9 |      |
| Approach LOS                  |      | C    |      |      | C    |      |      | C    |      |      | C    |      |
| Timer                         | 1    | 2    | 3    | 4    | 5    | 6    | 7    | 8    |      |      |      |      |
| Assigned Phs                  | 1    | 2    | 3    | 4    | 5    | 6    | 7    | 8    |      |      |      |      |
| Phs Duration (G+Y+Rc), s      | 4.5  | 10.5 | 7.5  | 17.0 | 6.8  | 18.2 | 6.3  | 18.2 |      |      |      |      |
| Change Period (Y+Rc), s       | 4.5  | 4.5  | 4.5  | 4.5  | 4.5  | 4.5  | 4.5  | 4.5  |      |      |      |      |
| Max Green Setting (Gmax), s   | 30.0 | 30.0 | 20.0 | 30.0 | 15.0 | 30.0 | 20.0 | 30.0 |      |      |      |      |
| Max Q Clear Time (g_c+110), s | 3.5  | 4.3  | 10.1 | 3.7  | 6.2  | 3.1  | 8.3  |      |      |      |      |      |
| Green Ext Time (p_c), s       | 0.0  | 0.8  | 0.1  | 2.4  | 0.0  | 2.0  | 0.0  | 1.8  |      |      |      |      |
| <b>Intersection Summary</b>   |      |      |      |      |      |      |      |      |      |      |      |      |
| HCM 2010 Ctrl Delay           |      |      |      | 24.4 |      |      |      |      |      |      |      |      |
| HCM 2010 LOS                  |      |      |      | C    |      |      |      |      |      |      |      |      |

| Intersection              |    |
|---------------------------|----|
| Intersection Delay, s/veh | 13 |
| Intersection LOS          | B  |

| Movement            | WBL  | WBR  | NBT  | NBR  | SBL  | SBT  |
|---------------------|------|------|------|------|------|------|
| Lane Configurations |      |      |      |      |      |      |
| Traffic Vol, veh/h  | 30   | 290  | 60   | 50   | 300  | 50   |
| Future Vol, veh/h   | 30   | 290  | 60   | 50   | 300  | 50   |
| Peak Hour Factor    | 0.88 | 0.88 | 0.88 | 0.88 | 0.88 | 0.88 |
| Heavy Vehicles, %   | 0    | 0    | 2    | 2    | 1    | 1    |
| Mvmt Flow           | 34   | 330  | 68   | 57   | 341  | 57   |
| Number of Lanes     | 1    | 0    | 1    | 0    | 0    | 1    |

| Approach                   | WB | NB  | SB |
|----------------------------|----|-----|----|
| Opposing Approach          |    | SB  | NB |
| Opposing Lanes             | 0  | 1   | 1  |
| Conflicting Approach Left  | NB |     | WB |
| Conflicting Lanes Left     | 1  | 0   | 1  |
| Conflicting Approach Right | SB | WB  |    |
| Conflicting Lanes Right    | 1  | 1   | 0  |
| HCM Control Delay          | 12 | 9.3 | 15 |
| HCM LOS                    | B  | A   | B  |

| Lane                   | NBLn1 | WBLn1 | SBLn1 |
|------------------------|-------|-------|-------|
| Vol Left, %            | 0%    | 9%    | 86%   |
| Vol Thru, %            | 55%   | 0%    | 14%   |
| Vol Right, %           | 45%   | 91%   | 0%    |
| Sign Control           | Stop  | Stop  | Stop  |
| Traffic Vol by Lane    | 110   | 320   | 350   |
| LT Vol                 | 0     | 30    | 300   |
| Through Vol            | 60    | 0     | 50    |
| RT Vol                 | 50    | 290   | 0     |
| Lane Flow Rate         | 125   | 364   | 398   |
| Geometry Grp           | 1     | 1     | 1     |
| Degree of Util (X)     | 0.18  | 0.472 | 0.575 |
| Departure Headway (Hd) | 5.172 | 4.773 | 5.208 |
| Convergence, Y/N       | Yes   | Yes   | Yes   |
| Cap                    | 696   | 760   | 696   |
| Service Time           | 3.183 | 2.773 | 3.208 |
| HCM Lane V/C Ratio     | 0.18  | 0.479 | 0.572 |
| HCM Control Delay      | 9.3   | 12    | 15    |
| HCM Lane LOS           | A     | B     | B     |
| HCM 95th-tile Q        | 0.7   | 2.6   | 3.7   |

| Intersection             |      |      |      |      |      |      |
|--------------------------|------|------|------|------|------|------|
| Int Delay, s/veh         | 1.8  |      |      |      |      |      |
| Movement                 | EBT  | EBR  | WBL  | WBT  | NBL  | NBR  |
| Lane Configurations      |      |      |      |      |      |      |
| Traffic Vol, veh/h       | 300  | 50   | 30   | 280  | 40   | 30   |
| Future Vol, veh/h        | 300  | 50   | 30   | 280  | 40   | 30   |
| Conflicting Peds, #/hr   | 0    | 0    | 0    | 0    | 0    | 0    |
| Sign Control             | Free | Free | Free | Free | Stop | Stop |
| RT Channelized           | -    | None | -    | None | -    | None |
| Storage Length           | -    | -    | -    | -    | 0    | -    |
| Veh in Median Storage, # | 0    | -    | -    | 0    | 0    | -    |
| Grade, %                 | 0    | -    | -    | 0    | 0    | -    |
| Peak Hour Factor         | 85   | 85   | 85   | 85   | 85   | 85   |
| Heavy Vehicles, %        | 0    | 0    | 0    | 0    | 0    | 0    |
| Mvmt Flow                | 353  | 59   | 35   | 329  | 47   | 35   |

| Major/Minor          | Major1 | Major2 | Minor1 | Minor2 | Minor3 |
|----------------------|--------|--------|--------|--------|--------|
| Conflicting Flow All | 0      | 0      | 412    | 0      | 782    |
| Stage 1              | -      | -      | -      | -      | 383    |
| Stage 2              | -      | -      | -      | -      | 399    |
| Critical Hdwy        | -      | -      | 4.1    | -      | 6.4    |
| Critical Hdwy Stg 1  | -      | -      | -      | -      | 5.4    |
| Critical Hdwy Stg 2  | -      | -      | -      | -      | 5.4    |
| Follow-up Hdwy       | -      | -      | 2.2    | -      | 3.5    |
| Pot Cap-1 Maneuver   | -      | -      | 1158   | -      | 366    |
| Stage 1              | -      | -      | -      | -      | 694    |
| Stage 2              | -      | -      | -      | -      | 682    |
| Platoon blocked, %   | -      | -      | -      | -      | -      |
| Mov Cap-1 Maneuver   | -      | -      | 1158   | -      | 352    |
| Mov Cap-2 Maneuver   | -      | -      | -      | -      | 352    |
| Stage 1              | -      | -      | -      | -      | 668    |
| Stage 2              | -      | -      | -      | -      | 682    |

| Approach             | EB | WB  | NB |
|----------------------|----|-----|----|
| HCM Control Delay, s | 0  | 0.8 | 15 |
| HCM LOS              |    |     | C  |

| Minor Lane/Major Mvmt | NBLn1 | EBT | EBR | WBL  | WBT |
|-----------------------|-------|-----|-----|------|-----|
| Capacity (veh/h)      | 442   | -   | -   | 1158 | -   |
| HCM Lane V/C Ratio    | 0.186 | -   | -   | 0.03 | -   |
| HCM Control Delay (s) | 15    | -   | -   | 8.2  | 0   |
| HCM Lane LOS          | C     | -   | -   | A    | A   |
| HCM 95th %tile Q(veh) | 0.7   | -   | -   | 0.1  | -   |

| Intersection              |      |
|---------------------------|------|
| Intersection Delay, s/veh | 14.2 |
| Intersection LOS          | B    |

| Movement            | EBL  | EBT  | EBR  | WBL  | WBT  | WBR  | NBL  | NBT  | NBR  | SBL  | SBT  | SBR  |
|---------------------|------|------|------|------|------|------|------|------|------|------|------|------|
| Lane Configurations |      | ↕    |      |      | ↕    |      |      | ↕    |      |      | ↕    |      |
| Traffic Vol, veh/h  | 10   | 270  | 60   | 30   | 240  | 10   | 50   | 60   | 20   | 10   | 80   | 20   |
| Future Vol, veh/h   | 10   | 270  | 60   | 30   | 240  | 10   | 50   | 60   | 20   | 10   | 80   | 20   |
| Peak Hour Factor    | 0.82 | 0.82 | 0.82 | 0.82 | 0.82 | 0.82 | 0.82 | 0.82 | 0.82 | 0.82 | 0.82 | 0.82 |
| Heavy Vehicles, %   | 0    | 0    | 0    | 0    | 0    | 0    | 2    | 2    | 2    | 0    | 0    | 0    |
| Mvmt Flow           | 12   | 329  | 73   | 37   | 293  | 12   | 61   | 73   | 24   | 12   | 98   | 24   |
| Number of Lanes     | 0    | 1    | 0    | 0    | 1    | 0    | 0    | 1    | 0    | 0    | 1    | 0    |

| Approach                   | EB   | WB   | NB   | SB   |
|----------------------------|------|------|------|------|
| Opposing Approach          | WB   | EB   | SB   | NB   |
| Opposing Lanes             | 1    | 1    | 1    | 1    |
| Conflicting Approach Left  | SB   | NB   | EB   | WB   |
| Conflicting Lanes Left     | 1    | 1    | 1    | 1    |
| Conflicting Approach Right | NB   | SB   | WB   | EB   |
| Conflicting Lanes Right    | 1    | 1    | 1    | 1    |
| HCM Control Delay          | 16.1 | 14.3 | 11.6 | 11.1 |
| HCM LOS                    | C    | B    | B    | B    |

| Lane                   | NBLn1 | EBLn1 | WBLn1 | SBLn1 |
|------------------------|-------|-------|-------|-------|
| Vol Left, %            | 38%   | 3%    | 11%   | 9%    |
| Vol Thru, %            | 46%   | 79%   | 86%   | 73%   |
| Vol Right, %           | 15%   | 18%   | 4%    | 18%   |
| Sign Control           | Stop  | Stop  | Stop  | Stop  |
| Traffic Vol by Lane    | 130   | 340   | 280   | 110   |
| LT Vol                 | 50    | 10    | 30    | 10    |
| Through Vol            | 60    | 270   | 240   | 80    |
| RT Vol                 | 20    | 60    | 10    | 20    |
| Lane Flow Rate         | 159   | 415   | 341   | 134   |
| Geometry Grp           | 1     | 1     | 1     | 1     |
| Degree of Util (X)     | 0.273 | 0.605 | 0.517 | 0.229 |
| Departure Headway (Hd) | 6.195 | 5.255 | 5.451 | 6.151 |
| Convergence, Y/N       | Yes   | Yes   | Yes   | Yes   |
| Cap                    | 575   | 684   | 659   | 580   |
| Service Time           | 4.274 | 3.314 | 3.513 | 4.233 |
| HCM Lane V/C Ratio     | 0.277 | 0.607 | 0.517 | 0.231 |
| HCM Control Delay      | 11.6  | 16.1  | 14.3  | 11.1  |
| HCM Lane LOS           | B     | C     | B     | B     |
| HCM 95th-tile Q        | 1.1   | 4.1   | 3     | 0.9   |

| Intersection             |      |      |      |      |      |      |      |      |      |      |      |      |
|--------------------------|------|------|------|------|------|------|------|------|------|------|------|------|
| Int Delay, s/veh         | 97.6 |      |      |      |      |      |      |      |      |      |      |      |
| Movement                 | EBL  | EBT  | EBR  | WBL  | WBT  | WBR  | NBL  | NBT  | NBR  | SBL  | SBT  | SBR  |
| Lane Configurations      |      | ↕    |      |      | ↕    |      |      | ↕    |      |      | ↕    |      |
| Traffic Vol, veh/h       | 90   | 150  | 50   | 30   | 130  | 10   | 90   | 160  | 20   | 10   | 100  | 50   |
| Future Vol, veh/h        | 90   | 150  | 50   | 30   | 130  | 10   | 90   | 160  | 20   | 10   | 100  | 50   |
| Conflicting Peds, #/hr   | 0    | 0    | 0    | 0    | 0    | 0    | 0    | 0    | 0    | 0    | 0    | 0    |
| Sign Control             | Stop | Stop | Stop | Stop | Stop | Stop | Free | Free | Free | Free | Free | Free |
| RT Channelized           | -    | -    | None | -    | -    | None | -    | -    | None | -    | -    | None |
| Storage Length           | -    | -    | -    | -    | -    | -    | -    | -    | -    | -    | -    | -    |
| Veh in Median Storage, # | -    | 0    | -    | -    | 0    | -    | -    | 0    | -    | -    | 0    | -    |
| Grade, %                 | -    | 0    | -    | -    | 0    | -    | -    | 0    | -    | -    | 0    | -    |
| Peak Hour Factor         | 74   | 74   | 74   | 74   | 74   | 74   | 74   | 74   | 74   | 74   | 74   | 74   |
| Heavy Vehicles, %        | 3    | 3    | 3    | 2    | 2    | 2    | 3    | 3    | 3    | 8    | 8    | 8    |
| Mvmt Flow                | 122  | 203  | 68   | 41   | 176  | 14   | 122  | 216  | 27   | 14   | 135  | 68   |

| Major/Minor          | Minor2 |       | Minor1 |       | Major1 |       | Major2 |   |   |       |   |   |
|----------------------|--------|-------|--------|-------|--------|-------|--------|---|---|-------|---|---|
| Conflicting Flow All | 766    | 684   | 169    | 807   | 705    | 230   | 203    | 0 | 0 | 243   | 0 | 0 |
| Stage 1              | 197    | 197   | -      | 474   | 474    | -     | -      | - | - | -     | - | - |
| Stage 2              | 569    | 487   | -      | 333   | 231    | -     | -      | - | - | -     | - | - |
| Critical Hdwy        | 7.13   | 6.53  | 6.23   | 7.12  | 6.52   | 6.22  | 4.13   | - | - | 4.18  | - | - |
| Critical Hdwy Stg 1  | 6.13   | 5.53  | -      | 6.12  | 5.52   | -     | -      | - | - | -     | - | - |
| Critical Hdwy Stg 2  | 6.13   | 5.53  | -      | 6.12  | 5.52   | -     | -      | - | - | -     | - | - |
| Follow-up Hdwy       | 3.527  | 4.027 | 3.327  | 3.518 | 4.018  | 3.318 | 2.227  | - | - | 2.272 | - | - |
| Pot Cap-1 Maneuver   | 318    | 370   | 872    | 300   | 361    | 809   | 1363   | - | - | 1289  | - | - |
| Stage 1              | 803    | 736   | -      | 571   | 558    | -     | -      | - | - | -     | - | - |
| Stage 2              | 505    | 549   | -      | 681   | 713    | -     | -      | - | - | -     | - | - |
| Platoon blocked, %   |        |       |        |       |        |       |        | - | - | -     | - | - |
| Mov Cap-1 Maneuver   | 162    | 327   | 872    | 129   | 319    | 809   | 1363   | - | - | 1289  | - | - |
| Mov Cap-2 Maneuver   | 162    | 327   | -      | 129   | 319    | -     | -      | - | - | -     | - | - |
| Stage 1              | 719    | 727   | -      | 512   | 500    | -     | -      | - | - | -     | - | - |
| Stage 2              | 289    | 492   | -      | 448   | 704    | -     | -      | - | - | -     | - | - |

| Approach             | EB    |  | WB   |  | NB  |  | SB  |  |
|----------------------|-------|--|------|--|-----|--|-----|--|
| HCM Control Delay, s | 255.5 |  | 70.5 |  | 2.6 |  | 0.5 |  |
| HCM LOS              | F     |  | F    |  |     |  |     |  |

| Minor Lane/Major Mvmt | NBL   | NBT | NBR | EBLn1WBLn1 | SBL  | SBT  | SBR |
|-----------------------|-------|-----|-----|------------|------|------|-----|
| Capacity (veh/h)      | 1363  | -   | -   | 271        | 261  | 1289 | -   |
| HCM Lane V/C Ratio    | 0.089 | -   | -   | 1.446      | 0.88 | 0.01 | -   |
| HCM Control Delay (s) | 7.9   | 0   | -   | 255.5      | 70.5 | 7.8  | 0   |
| HCM Lane LOS          | A     | A   | -   | F          | F    | A    | A   |
| HCM 95th %tile Q(veh) | 0.3   | -   | -   | 21.8       | 7.5  | 0    | -   |

| Intersection             |      |      |      |      |      |      |
|--------------------------|------|------|------|------|------|------|
| Int Delay, s/veh         | 5.1  |      |      |      |      |      |
| Movement                 | EBL  | EBR  | NBL  | NBT  | SBT  | SBR  |
| Lane Configurations      | T    |      |      | T    |      | T    |
| Traffic Vol, veh/h       | 170  | 10   | 10   | 370  | 220  | 160  |
| Future Vol, veh/h        | 170  | 10   | 10   | 370  | 220  | 160  |
| Conflicting Peds, #/hr   | 0    | 0    | 0    | 0    | 0    | 0    |
| Sign Control             | Stop | Stop | Free | Free | Free | Free |
| RT Channelized           | -    | None | -    | None | -    | None |
| Storage Length           | 0    | -    | -    | -    | -    | -    |
| Veh in Median Storage, # | 0    | -    | -    | 0    | 0    | -    |
| Grade, %                 | 0    | -    | -    | 0    | 0    | -    |
| Peak Hour Factor         | 88   | 88   | 88   | 88   | 88   | 88   |
| Heavy Vehicles, %        | 0    | 0    | 2    | 2    | 1    | 1    |
| Mvmt Flow                | 193  | 11   | 11   | 420  | 250  | 182  |























| Major/Minor          | Minor2 | Major1 |       | Major2 |   |
|----------------------|--------|--------|-------|--------|---|
| Conflicting Flow All | 783    | 341    | 432   | 0      | 0 |
| Stage 1              | 341    | -      | -     | -      | - |
| Stage 2              | 442    | -      | -     | -      | - |
| Critical Hdwy        | 6.4    | 6.2    | 4.12  | -      | - |
| Critical Hdwy Stg 1  | 5.4    | -      | -     | -      | - |
| Critical Hdwy Stg 2  | 5.4    | -      | -     | -      | - |
| Follow-up Hdwy       | 3.5    | 3.3    | 2.218 | -      | - |
| Pot Cap-1 Maneuver   | 365    | 706    | 1128  | -      | - |
| Stage 1              | 725    | -      | -     | -      | - |
| Stage 2              | 652    | -      | -     | -      | - |
| Platoon blocked, %   |        |        |       | -      | - |
| Mov Cap-1 Maneuver   | 360    | 706    | 1128  | -      | - |
| Mov Cap-2 Maneuver   | 360    | -      | -     | -      | - |
| Stage 1              | 716    | -      | -     | -      | - |
| Stage 2              | 652    | -      | -     | -      | - |

| Approach             | EB   | NB  | SB |
|----------------------|------|-----|----|
| HCM Control Delay, s | 26.1 | 0.2 | 0  |
| HCM LOS              | D    |     |    |

| Minor Lane/Major Mvmt | NBL  | NBT | EBLn1 | SBT | SBR |
|-----------------------|------|-----|-------|-----|-----|
| Capacity (veh/h)      | 1128 | -   | 370   | -   | -   |
| HCM Lane V/C Ratio    | 0.01 | -   | 0.553 | -   | -   |
| HCM Control Delay (s) | 8.2  | 0   | 26.1  | -   | -   |
| HCM Lane LOS          | A    | A   | D     | -   | -   |
| HCM 95th %tile Q(veh) | 0    | -   | 3.2   | -   | -   |

HCM 2010 Signalized Intersection Summary  
 39: General Jim Moore Boulevard & Gigling Road

Cumulative, PM  
 06/11/2019

|                              |  |  |  |  |  |  |   |  |  |  |  |  |
|------------------------------|---|---|---|---|---|---|---|---|---|---|---|---|
| Movement                     | EBL   | EBT   | EBR   | WBL   | WBT   | WBR   | NBL   | NBT   | NBR   | SBL   | SBT   | SBR   |
| Lane Configurations          |  |  |   |  |  |  |  |  |  |  |  |  |
| Traffic Volume (veh/h)       | 20  | 20  | 30  | 170   | 50  | 320   | 60  | 430   | 320   | 310   | 430   | 50  |
| Future Volume (veh/h)        | 20  | 20  | 30  | 170   | 50  | 320   | 60  | 430   | 320   | 310   | 430   | 50  |
| Number                       | 3   | 8   | 18  | 7   | 4   | 14  | 1   | 6   | 16  | 5   | 2   | 12  |
| Initial Q (Qb), veh          | 0   | 0   | 0   | 0   | 0   | 0   | 0   | 0   | 0   | 0   | 0   | 0   |
| Ped-Bike Adj(A_pbT)          | 1.00  |   | 0.99  | 1.00  |   | 1.00  | 1.00  |   | 1.00  | 1.00  |   | 1.00  |
| Parking Bus, Adj             | 1.00  | 1.00  | 1.00  | 1.00  | 1.00  | 1.00  | 1.00  | 1.00  | 1.00  | 1.00  | 1.00  | 1.00  |
| Adj Sat Flow, veh/h/ln       | 1776  | 1776  | 1900  | 1881  | 1881  | 1881  | 1863  | 1863  | 1863  | 1863  | 1863  | 1863  |
| Adj Flow Rate, veh/h         | 22  | 22  | 3   | 191   | 56  | 0   | 67  | 483   | 0   | 348   | 483   | 0   |
| Adj No. of Lanes             | 1   | 2   | 0   | 1   | 2   | 1   | 1   | 2   | 1   | 1   | 2   | 1   |
| Peak Hour Factor             | 0.89  | 0.89  | 0.89  | 0.89  | 0.89  | 0.89  | 0.89  | 0.89  | 0.89  | 0.89  | 0.89  | 0.89  |
| Percent Heavy Veh, %         | 7   | 7   | 7   | 1   | 1   | 1   | 2   | 2   | 2   | 2   | 2   | 2   |
| Cap, veh/h                   | 45  | 265   | 35  | 241   | 702   | 314   | 109   | 670   | 300   | 384   | 1220  | 546   |
| Arrive On Green              | 0.03  | 0.09  | 0.09  | 0.13  | 0.20  | 0.00  | 0.06  | 0.19  | 0.00  | 0.22  | 0.34  | 0.00  |
| Sat Flow, veh/h              | 1691  | 2991  | 399   | 1792  | 3574  | 1599  | 1774  | 3539  | 1583  | 1774  | 3539  | 1583  |
| Grp Volume(v), veh/h         | 22  | 12  | 13  | 191   | 56  | 0   | 67  | 483   | 0   | 348   | 483   | 0   |
| Grp Sat Flow(s),veh/h/ln     | 1691  | 1687  | 1703  | 1792  | 1787  | 1599  | 1774  | 1770  | 1583  | 1774  | 1770  | 1583  |
| Q Serve(g_s), s              | 0.6   | 0.3   | 0.3   | 5.0   | 0.6   | 0.0   | 1.8   | 6.2   | 0.0   | 9.3   | 5.0   | 0.0   |
| Cycle Q Clear(g_c), s        | 0.6   | 0.3   | 0.3   | 5.0   | 0.6   | 0.0   | 1.8   | 6.2   | 0.0   | 9.3   | 5.0   | 0.0   |
| Prop In Lane                 | 1.00  |   | 0.23  | 1.00  |   | 1.00  | 1.00  |   | 1.00  | 1.00  |   | 1.00  |
| Lane Grp Cap(c), veh/h       | 45  | 150   | 151   | 241   | 702   | 314   | 109   | 670   | 300   | 384   | 1220  | 546   |
| V/C Ratio(X)                 | 0.49  | 0.08  | 0.08  | 0.79  | 0.08  | 0.00  | 0.62  | 0.72  | 0.00  | 0.91  | 0.40  | 0.00  |
| Avail Cap(c_a), veh/h        | 715   | 1061  | 1071  | 757   | 2248  | 1006  | 384   | 1861  | 833   | 384   | 1861  | 833   |
| HCM Platoon Ratio            | 1.00  | 1.00  | 1.00  | 1.00  | 1.00  | 1.00  | 1.00  | 1.00  | 1.00  | 1.00  | 1.00  | 1.00  |
| Upstream Filter(I)           | 1.00  | 1.00  | 1.00  | 1.00  | 1.00  | 0.00  | 1.00  | 1.00  | 0.00  | 1.00  | 1.00  | 0.00  |
| Uniform Delay (d), s/veh     | 23.3  | 20.3  | 20.3  | 20.3  | 15.9  | 0.0   | 22.2  | 18.5  | 0.0   | 18.5  | 12.1  | 0.0   |
| Incr Delay (d2), s/veh       | 3.1   | 0.1   | 0.1   | 2.3   | 0.0   | 0.0   | 2.1   | 0.6   | 0.0   | 23.9  | 0.1   | 0.0   |
| Initial Q Delay(d3),s/veh    | 0.0   | 0.0   | 0.0   | 0.0   | 0.0   | 0.0   | 0.0   | 0.0   | 0.0   | 0.0   | 0.0   | 0.0   |
| %ile BackOfQ(50%),veh/ln     | 0.3   | 0.2   | 0.2   | 2.6   | 0.3   | 0.0   | 0.9   | 3.1   | 0.0   | 7.1   | 2.4   | 0.0   |
| LnGrp Delay(d),s/veh         | 26.4  | 20.4  | 20.4  | 22.6  | 15.9  | 0.0   | 24.3  | 19.0  | 0.0   | 42.4  | 12.1  | 0.0   |
| LnGrp LOS                    | C   | C   | C   | C   | B   |   | C   | B   |   | D   | B   |   |
| Approach Vol, veh/h          |   | 47  |   |   | 247   |   |   | 550   |   |   | 831   |   |
| Approach Delay, s/veh        |   | 23.2  |   |   | 21.1  |   |   | 19.6  |   |   | 24.8  |   |
| Approach LOS                 |   | C   |   |   | C   |   |   | B   |   |   | C   |   |
| Timer                        | 1   | 2   | 3   | 4   | 5   | 6   | 7   | 8   |   |   |   |   |
| Assigned Phs                 | 1   | 2   | 3   | 4   | 5   | 6   | 7   | 8   |   |   |   |   |
| Phs Duration (G+Y+Rc), s     | 7.5   | 21.2  | 5.8   | 14.0  | 15.0  | 13.7  | 11.0  | 8.8   |   |   |   |   |
| Change Period (Y+Rc), s      | 4.5   | 4.5   | 4.5   | 4.5   | 4.5   | 4.5   | 4.5   | 4.5   |   |   |   |   |
| Max Green Setting (Gmax), s  | 10.5  | 25.5  | 20.5  | 30.5  | 10.5  | 25.5  | 20.5  | 30.5  |   |   |   |   |
| Max Q Clear Time (g_c+I1), s | 3.8   | 7.0   | 2.6   | 2.6   | 11.3  | 8.2   | 7.0   | 2.3   |   |   |   |   |
| Green Ext Time (p_c), s      | 0.0   | 0.6   | 0.0   | 0.1   | 0.0   | 0.6   | 0.0   | 0.0   |   |   |   |   |
| <b>Intersection Summary</b>  |   |   |   |   |   |   |   |   |   |   |   |   |
| HCM 2010 Ctrl Delay          |   |   |   | 22.5  |   |   |   |   |   |   |   |   |
| HCM 2010 LOS                 |   |   |   | C   |   |   |   |   |   |   |   |   |
| <b>Notes</b>                 |   |   |   |   |   |   |   |   |   |   |   |   |

HCM 2010 Signalized Intersection Summary  
40: Malmedy Road & Gigling Road

Cumulative, PM  
06/11/2019



| Movement                     | EBL  | EBT  | EBR  | WBL  | WBT  | WBR  | NBL  | NBT  | NBR  | SBL  | SBT  | SBR  |
|------------------------------|------|------|------|------|------|------|------|------|------|------|------|------|
| Lane Configurations          |      | ↔    |      |      | ↔    |      |      | ↔    |      |      | ↔    |      |
| Traffic Volume (veh/h)       | 50   | 600  | 10   | 30   | 490  | 10   | 30   | 60   | 50   | 10   | 40   | 20   |
| Future Volume (veh/h)        | 50   | 600  | 10   | 30   | 490  | 10   | 30   | 60   | 50   | 10   | 40   | 20   |
| Number                       | 7    | 4    | 14   | 3    | 8    | 18   | 5    | 2    | 12   | 1    | 6    | 16   |
| Initial Q (Qb), veh          | 0    | 0    | 0    | 0    | 0    | 0    | 0    | 0    | 0    | 0    | 0    | 0    |
| Ped-Bike Adj(A_pbT)          | 1.00 |      | 1.00 | 1.00 |      | 1.00 | 1.00 |      | 1.00 | 1.00 |      | 1.00 |
| Parking Bus, Adj             | 1.00 | 1.00 | 1.00 | 1.00 | 1.00 | 1.00 | 1.00 | 1.00 | 1.00 | 1.00 | 1.00 | 1.00 |
| Adj Sat Flow, veh/h/ln       | 1900 | 1863 | 1900 | 1900 | 1881 | 1900 | 1900 | 1900 | 1900 | 1900 | 1810 | 1900 |
| Adj Flow Rate, veh/h         | 55   | 659  | 11   | 33   | 538  | 11   | 33   | 66   | 55   | 11   | 44   | 22   |
| Adj No. of Lanes             | 0    | 2    | 0    | 0    | 2    | 0    | 0    | 1    | 0    | 0    | 1    | 0    |
| Peak Hour Factor             | 0.91 | 0.91 | 0.91 | 0.91 | 0.91 | 0.91 | 0.91 | 0.91 | 0.91 | 0.91 | 0.91 | 0.91 |
| Percent Heavy Veh, %         | 2    | 2    | 2    | 1    | 1    | 1    | 0    | 0    | 0    | 5    | 5    | 5    |
| Cap, veh/h                   | 267  | 1058 | 18   | 241  | 1069 | 22   | 287  | 147  | 112  | 250  | 192  | 89   |
| Arrive On Green              | 0.33 | 0.33 | 0.33 | 0.33 | 0.33 | 0.33 | 0.19 | 0.19 | 0.19 | 0.19 | 0.19 | 0.19 |
| Sat Flow, veh/h              | 141  | 3160 | 53   | 85   | 3192 | 66   | 291  | 791  | 601  | 166  | 1029 | 478  |
| Grp Volume(v), veh/h         | 374  | 0    | 351  | 300  | 0    | 282  | 154  | 0    | 0    | 77   | 0    | 0    |
| Grp Sat Flow(s),veh/h/ln     | 1669 | 0    | 1686 | 1644 | 0    | 1700 | 1683 | 0    | 0    | 1673 | 0    | 0    |
| Q Serve(g_s), s              | 0.9  | 0.0  | 3.3  | 0.1  | 0.0  | 2.5  | 0.8  | 0.0  | 0.0  | 0.0  | 0.0  | 0.0  |
| Cycle Q Clear(g_c), s        | 3.4  | 0.0  | 3.3  | 3.4  | 0.0  | 2.5  | 1.5  | 0.0  | 0.0  | 0.7  | 0.0  | 0.0  |
| Prop In Lane                 | 0.15 |      | 0.03 | 0.11 |      | 0.04 | 0.21 |      | 0.36 | 0.14 |      | 0.29 |
| Lane Grp Cap(c), veh/h       | 779  | 0    | 565  | 763  | 0    | 569  | 546  | 0    | 0    | 531  | 0    | 0    |
| V/C Ratio(X)                 | 0.48 | 0.00 | 0.62 | 0.39 | 0.00 | 0.49 | 0.28 | 0.00 | 0.00 | 0.15 | 0.00 | 0.00 |
| Avail Cap(c_a), veh/h        | 4510 | 0    | 4527 | 4582 | 0    | 4566 | 2921 | 0    | 0    | 2855 | 0    | 0    |
| HCM Platoon Ratio            | 1.00 | 1.00 | 1.00 | 1.00 | 1.00 | 1.00 | 1.00 | 1.00 | 1.00 | 1.00 | 1.00 | 1.00 |
| Upstream Filter(I)           | 1.00 | 0.00 | 1.00 | 1.00 | 0.00 | 1.00 | 1.00 | 0.00 | 0.00 | 1.00 | 0.00 | 0.00 |
| Uniform Delay (d), s/veh     | 5.2  | 0.0  | 5.3  | 5.0  | 0.0  | 5.0  | 6.8  | 0.0  | 0.0  | 6.5  | 0.0  | 0.0  |
| Incr Delay (d2), s/veh       | 0.2  | 0.0  | 0.4  | 0.1  | 0.0  | 0.2  | 0.1  | 0.0  | 0.0  | 0.0  | 0.0  | 0.0  |
| Initial Q Delay(d3),s/veh    | 0.0  | 0.0  | 0.0  | 0.0  | 0.0  | 0.0  | 0.0  | 0.0  | 0.0  | 0.0  | 0.0  | 0.0  |
| %ile BackOfQ(50%),veh/ln     | 1.6  | 0.0  | 1.5  | 1.2  | 0.0  | 1.1  | 0.7  | 0.0  | 0.0  | 0.3  | 0.0  | 0.0  |
| LnGrp Delay(d),s/veh         | 5.4  | 0.0  | 5.7  | 5.1  | 0.0  | 5.2  | 6.9  | 0.0  | 0.0  | 6.6  | 0.0  | 0.0  |
| LnGrp LOS                    | A    |      | A    | A    |      | A    | A    |      |      | A    |      |      |
| Approach Vol, veh/h          |      | 725  |      |      | 582  |      |      | 154  |      |      | 77   |      |
| Approach Delay, s/veh        |      | 5.5  |      |      | 5.2  |      |      | 6.9  |      |      | 6.6  |      |
| Approach LOS                 |      | A    |      |      | A    |      |      | A    |      |      | A    |      |
| Timer                        | 1    | 2    | 3    | 4    | 5    | 6    | 7    | 8    |      |      |      |      |
| Assigned Phs                 |      | 2    |      | 4    |      | 6    |      | 8    |      |      |      |      |
| Phs Duration (G+Y+Rc), s     |      | 8.0  |      | 10.8 |      | 8.0  |      | 10.8 |      |      |      |      |
| Change Period (Y+Rc), s      |      | 4.5  |      | 4.5  |      | 4.5  |      | 4.5  |      |      |      |      |
| Max Green Setting (Gmax), s  |      | 30.5 |      | 50.5 |      | 30.5 |      | 50.5 |      |      |      |      |
| Max Q Clear Time (g_c+I1), s |      | 3.5  |      | 5.4  |      | 2.7  |      | 5.4  |      |      |      |      |
| Green Ext Time (p_c), s      |      | 0.2  |      | 0.7  |      | 0.1  |      | 0.6  |      |      |      |      |
| <b>Intersection Summary</b>  |      |      |      |      |      |      |      |      |      |      |      |      |
| HCM 2010 Ctrl Delay          |      |      |      | 5.6  |      |      |      |      |      |      |      |      |
| HCM 2010 LOS                 |      |      |      | A    |      |      |      |      |      |      |      |      |



HCM 2010 Signalized Intersection Summary  
 41: Parker Flatts Cut Off Road & Gigling Road

Cumulative, PM  
 06/11/2019



| Movement                     | EBL  | EBT  | EBR  | WBL  | WBT  | WBR  | NBL  | NBT  | NBR  | SBL  | SBT  | SBR  |
|------------------------------|------|------|------|------|------|------|------|------|------|------|------|------|
| Lane Configurations          |      | ↔    |      |      | ↔    |      |      | ↔    | ↔    |      | ↔    |      |
| Traffic Volume (veh/h)       | 10   | 620  | 30   | 50   | 440  | 20   | 90   | 20   | 100  | 20   | 20   | 10   |
| Future Volume (veh/h)        | 10   | 620  | 30   | 50   | 440  | 20   | 90   | 20   | 100  | 20   | 20   | 10   |
| Number                       | 7    | 4    | 14   | 3    | 8    | 18   | 5    | 2    | 12   | 1    | 6    | 16   |
| Initial Q (Qb), veh          | 0    | 0    | 0    | 0    | 0    | 0    | 0    | 0    | 0    | 0    | 0    | 0    |
| Ped-Bike Adj(A_pbT)          | 1.00 |      | 1.00 | 1.00 |      | 1.00 | 1.00 |      | 1.00 | 1.00 |      | 1.00 |
| Parking Bus, Adj             | 1.00 | 1.00 | 1.00 | 1.00 | 1.00 | 1.00 | 1.00 | 1.00 | 1.00 | 1.00 | 1.00 | 1.00 |
| Adj Sat Flow, veh/h/ln       | 1900 | 1863 | 1900 | 1900 | 1881 | 1900 | 1900 | 1900 | 1900 | 1900 | 1900 | 1900 |
| Adj Flow Rate, veh/h         | 11   | 697  | 34   | 56   | 494  | 22   | 101  | 22   | 112  | 22   | 22   | 11   |
| Adj No. of Lanes             | 0    | 2    | 0    | 0    | 2    | 0    | 0    | 1    | 1    | 0    | 1    | 0    |
| Peak Hour Factor             | 0.89 | 0.89 | 0.89 | 0.89 | 0.89 | 0.89 | 0.89 | 0.89 | 0.89 | 0.89 | 0.89 | 0.89 |
| Percent Heavy Veh, %         | 2    | 2    | 2    | 1    | 1    | 1    | 0    | 0    | 0    | 0    | 0    | 0    |
| Cap, veh/h                   | 194  | 1110 | 54   | 261  | 941  | 44   | 566  | 85   | 341  | 343  | 188  | 69   |
| Arrive On Green              | 0.33 | 0.33 | 0.33 | 0.33 | 0.33 | 0.33 | 0.21 | 0.21 | 0.21 | 0.21 | 0.21 | 0.21 |
| Sat Flow, veh/h              | 21   | 3323 | 161  | 130  | 2818 | 131  | 1112 | 400  | 1611 | 420  | 888  | 327  |
| Grp Volume(v), veh/h         | 391  | 0    | 351  | 289  | 0    | 283  | 123  | 0    | 112  | 55   | 0    | 0    |
| Grp Sat Flow(s),veh/h/ln     | 1839 | 0    | 1666 | 1392 | 0    | 1688 | 1512 | 0    | 1611 | 1634 | 0    | 0    |
| Q Serve(g_s), s              | 0.0  | 0.0  | 3.5  | 0.3  | 0.0  | 2.7  | 0.8  | 0.0  | 1.2  | 0.0  | 0.0  | 0.0  |
| Cycle Q Clear(g_c), s        | 3.5  | 0.0  | 3.5  | 3.8  | 0.0  | 2.7  | 1.3  | 0.0  | 1.2  | 0.5  | 0.0  | 0.0  |
| Prop In Lane                 | 0.03 |      | 0.10 | 0.19 |      | 0.08 | 0.82 |      | 1.00 | 0.40 |      | 0.20 |
| Lane Grp Cap(c), veh/h       | 801  | 0    | 556  | 682  | 0    | 564  | 651  | 0    | 341  | 600  | 0    | 0    |
| V/C Ratio(X)                 | 0.49 | 0.00 | 0.63 | 0.42 | 0.00 | 0.50 | 0.19 | 0.00 | 0.33 | 0.09 | 0.00 | 0.00 |
| Avail Cap(c_a), veh/h        | 4804 | 0    | 4248 | 3874 | 0    | 4305 | 2596 | 0    | 2482 | 2648 | 0    | 0    |
| HCM Platoon Ratio            | 1.00 | 1.00 | 1.00 | 1.00 | 1.00 | 1.00 | 1.00 | 1.00 | 1.00 | 1.00 | 1.00 | 1.00 |
| Upstream Filter(I)           | 1.00 | 0.00 | 1.00 | 1.00 | 0.00 | 1.00 | 1.00 | 0.00 | 1.00 | 1.00 | 0.00 | 0.00 |
| Uniform Delay (d), s/veh     | 5.6  | 0.0  | 5.6  | 5.2  | 0.0  | 5.3  | 6.6  | 0.0  | 6.6  | 6.3  | 0.0  | 0.0  |
| Incr Delay (d2), s/veh       | 0.2  | 0.0  | 0.4  | 0.2  | 0.0  | 0.3  | 0.1  | 0.0  | 0.2  | 0.0  | 0.0  | 0.0  |
| Initial Q Delay(d3),s/veh    | 0.0  | 0.0  | 0.0  | 0.0  | 0.0  | 0.0  | 0.0  | 0.0  | 0.0  | 0.0  | 0.0  | 0.0  |
| %ile BackOfQ(50%),veh/ln     | 1.8  | 0.0  | 1.6  | 1.2  | 0.0  | 1.2  | 0.6  | 0.0  | 0.5  | 0.2  | 0.0  | 0.0  |
| LnGrp Delay(d),s/veh         | 5.7  | 0.0  | 6.0  | 5.4  | 0.0  | 5.5  | 6.7  | 0.0  | 6.8  | 6.4  | 0.0  | 0.0  |
| LnGrp LOS                    | A    |      | A    | A    |      | A    | A    |      | A    | A    |      |      |
| Approach Vol, veh/h          |      | 742  |      |      | 572  |      |      | 235  |      |      | 55   |      |
| Approach Delay, s/veh        |      | 5.9  |      |      | 5.5  |      |      | 6.7  |      |      | 6.4  |      |
| Approach LOS                 |      | A    |      |      | A    |      |      | A    |      |      | A    |      |
| Timer                        | 1    | 2    | 3    | 4    | 5    | 6    | 7    | 8    |      |      |      |      |
| Assigned Phs                 |      | 2    |      | 4    |      | 6    |      | 8    |      |      |      |      |
| Phs Duration (G+Y+Rc), s     |      | 8.7  |      | 11.1 |      | 8.7  |      | 11.1 |      |      |      |      |
| Change Period (Y+Rc), s      |      | 4.5  |      | 4.5  |      | 4.5  |      | 4.5  |      |      |      |      |
| Max Green Setting (Gmax), s  |      | 30.5 |      | 50.5 |      | 30.5 |      | 50.5 |      |      |      |      |
| Max Q Clear Time (g_c+I1), s |      | 3.3  |      | 5.5  |      | 2.5  |      | 5.8  |      |      |      |      |
| Green Ext Time (p_c), s      |      | 0.1  |      | 0.7  |      | 0.0  |      | 0.7  |      |      |      |      |
| <b>Intersection Summary</b>  |      |      |      |      |      |      |      |      |      |      |      |      |
| HCM 2010 Ctrl Delay          |      |      |      | 5.9  |      |      |      |      |      |      |      |      |
| HCM 2010 LOS                 |      |      |      | A    |      |      |      |      |      |      |      |      |

HCM 2010 Signalized Intersection Summary  
42: 6th Avenue & Gigling Road

Cumulative, PM  
06/11/2019



| Movement                     | EBL  | EBT  | EBR  | WBL  | WBT  | WBR  | NBL  | NBT  | NBR  | SBL  | SBT  | SBR  |
|------------------------------|------|------|------|------|------|------|------|------|------|------|------|------|
| Lane Configurations          |      | ↔    |      |      | ↔    |      |      | ↕    | ↕    |      | ↕    |      |
| Traffic Volume (veh/h)       | 140  | 590  | 10   | 10   | 370  | 10   | 10   | 10   | 20   | 10   | 10   | 140  |
| Future Volume (veh/h)        | 140  | 590  | 10   | 10   | 370  | 10   | 10   | 10   | 20   | 10   | 10   | 140  |
| Number                       | 7    | 4    | 14   | 3    | 8    | 18   | 5    | 2    | 12   | 1    | 6    | 16   |
| Initial Q (Qb), veh          | 0    | 0    | 0    | 0    | 0    | 0    | 0    | 0    | 0    | 0    | 0    | 0    |
| Ped-Bike Adj(A_pbT)          | 1.00 |      | 1.00 | 1.00 |      | 1.00 | 1.00 |      | 1.00 | 1.00 |      | 1.00 |
| Parking Bus, Adj             | 1.00 | 1.00 | 1.00 | 1.00 | 1.00 | 1.00 | 1.00 | 1.00 | 1.00 | 1.00 | 1.00 | 1.00 |
| Adj Sat Flow, veh/h/ln       | 1900 | 1881 | 1900 | 1900 | 1863 | 1900 | 1900 | 1900 | 1900 | 1900 | 1900 | 1900 |
| Adj Flow Rate, veh/h         | 147  | 621  | 11   | 11   | 389  | 11   | 11   | 11   | 0    | 11   | 11   | 147  |
| Adj No. of Lanes             | 0    | 2    | 0    | 0    | 2    | 0    | 0    | 1    | 1    | 0    | 1    | 0    |
| Peak Hour Factor             | 0.95 | 0.95 | 0.95 | 0.95 | 0.95 | 0.95 | 0.95 | 0.95 | 0.95 | 0.95 | 0.95 | 0.95 |
| Percent Heavy Veh, %         | 1    | 1    | 1    | 2    | 2    | 2    | 0    | 0    | 0    | 0    | 0    | 0    |
| Cap, veh/h                   | 402  | 1008 | 18   | 205  | 1251 | 35   | 374  | 193  | 275  | 208  | 23   | 240  |
| Arrive On Green              | 0.37 | 0.37 | 0.37 | 0.37 | 0.37 | 0.37 | 0.17 | 0.17 | 0.00 | 0.17 | 0.17 | 0.17 |
| Sat Flow, veh/h              | 407  | 2714 | 49   | 34   | 3366 | 94   | 582  | 1134 | 1615 | 77   | 134  | 1412 |
| Grp Volume(v), veh/h         | 396  | 0    | 383  | 216  | 0    | 195  | 22   | 0    | 0    | 169  | 0    | 0    |
| Grp Sat Flow(s),veh/h/ln     | 1467 | 0    | 1703 | 1816 | 0    | 1678 | 1715 | 0    | 1615 | 1623 | 0    | 0    |
| Q Serve(g_s), s              | 2.8  | 0.0  | 3.6  | 0.0  | 0.0  | 1.6  | 0.0  | 0.0  | 0.0  | 1.0  | 0.0  | 0.0  |
| Cycle Q Clear(g_c), s        | 4.4  | 0.0  | 3.6  | 1.6  | 0.0  | 1.6  | 0.2  | 0.0  | 0.0  | 1.9  | 0.0  | 0.0  |
| Prop In Lane                 | 0.37 |      | 0.03 | 0.05 |      | 0.06 | 0.50 |      | 1.00 | 0.07 |      | 0.87 |
| Lane Grp Cap(c), veh/h       | 796  | 0    | 633  | 868  | 0    | 624  | 567  | 0    | 275  | 471  | 0    | 0    |
| V/C Ratio(X)                 | 0.50 | 0.00 | 0.60 | 0.25 | 0.00 | 0.31 | 0.04 | 0.00 | 0.00 | 0.36 | 0.00 | 0.00 |
| Avail Cap(c_a), veh/h        | 3900 | 0    | 4381 | 4702 | 0    | 4317 | 2649 | 0    | 2509 | 2705 | 0    | 0    |
| HCM Platoon Ratio            | 1.00 | 1.00 | 1.00 | 1.00 | 1.00 | 1.00 | 1.00 | 1.00 | 1.00 | 1.00 | 1.00 | 1.00 |
| Upstream Filter(I)           | 1.00 | 0.00 | 1.00 | 1.00 | 0.00 | 1.00 | 1.00 | 0.00 | 0.00 | 1.00 | 0.00 | 0.00 |
| Uniform Delay (d), s/veh     | 5.2  | 0.0  | 5.0  | 4.4  | 0.0  | 4.4  | 6.8  | 0.0  | 0.0  | 7.5  | 0.0  | 0.0  |
| Incr Delay (d2), s/veh       | 0.2  | 0.0  | 0.3  | 0.1  | 0.0  | 0.1  | 0.0  | 0.0  | 0.0  | 0.2  | 0.0  | 0.0  |
| Initial Q Delay(d3),s/veh    | 0.0  | 0.0  | 0.0  | 0.0  | 0.0  | 0.0  | 0.0  | 0.0  | 0.0  | 0.0  | 0.0  | 0.0  |
| %ile BackOfQ(50%),veh/ln     | 1.8  | 0.0  | 1.7  | 0.8  | 0.0  | 0.7  | 0.1  | 0.0  | 0.0  | 0.9  | 0.0  | 0.0  |
| LnGrp Delay(d),s/veh         | 5.3  | 0.0  | 5.3  | 4.4  | 0.0  | 4.5  | 6.9  | 0.0  | 0.0  | 7.7  | 0.0  | 0.0  |
| LnGrp LOS                    | A    |      | A    | A    |      | A    | A    |      |      | A    |      |      |
| Approach Vol, veh/h          |      | 779  |      |      | 411  |      |      | 22   |      |      | 169  |      |
| Approach Delay, s/veh        |      | 5.3  |      |      | 4.5  |      |      | 6.9  |      |      | 7.7  |      |
| Approach LOS                 |      | A    |      |      | A    |      |      | A    |      |      | A    |      |
| Timer                        | 1    | 2    | 3    | 4    | 5    | 6    | 7    | 8    |      |      |      |      |
| Assigned Phs                 |      | 2    |      | 4    |      | 6    |      | 8    |      |      |      |      |
| Phs Duration (G+Y+Rc), s     |      | 7.8  |      | 11.8 |      | 7.8  |      | 11.8 |      |      |      |      |
| Change Period (Y+Rc), s      |      | 4.5  |      | 4.5  |      | 4.5  |      | 4.5  |      |      |      |      |
| Max Green Setting (Gmax), s  |      | 30.5 |      | 50.5 |      | 30.5 |      | 50.5 |      |      |      |      |
| Max Q Clear Time (g_c+I1), s |      | 2.2  |      | 6.4  |      | 3.9  |      | 3.6  |      |      |      |      |
| Green Ext Time (p_c), s      |      | 0.0  |      | 0.9  |      | 0.2  |      | 0.4  |      |      |      |      |
| <b>Intersection Summary</b>  |      |      |      |      |      |      |      |      |      |      |      |      |
| HCM 2010 Ctrl Delay          |      |      |      | 5.4  |      |      |      |      |      |      |      |      |
| HCM 2010 LOS                 |      |      |      | A    |      |      |      |      |      |      |      |      |

HCM 2010 Signalized Intersection Summary  
43: Gigling Road & 7th Avenue

Cumulative, PM  
06/11/2019

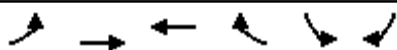

| Movement                     | EBL  | EBT  | WBT  | WBR  | SBL  | SBR  |   |      |
|------------------------------|------|------|------|------|------|------|---|------|
| Lane Configurations          |      | ↑↑   | ↑↑   |      | ↑↑   |      |   |      |
| Traffic Volume (veh/h)       | 250  | 370  | 230  | 10   | 10   | 160  |   |      |
| Future Volume (veh/h)        | 250  | 370  | 230  | 10   | 10   | 160  |   |      |
| Number                       | 7    | 4    | 8    | 18   | 1    | 16   |   |      |
| Initial Q (Qb), veh          | 0    | 0    | 0    | 0    | 0    | 0    |   |      |
| Ped-Bike Adj(A_pbT)          | 1.00 |      |      | 1.00 | 1.00 | 1.00 |   |      |
| Parking Bus, Adj             | 1.00 | 1.00 | 1.00 | 1.00 | 1.00 | 1.00 |   |      |
| Adj Sat Flow, veh/h/ln       | 1900 | 1863 | 1881 | 1900 | 1827 | 1900 |   |      |
| Adj Flow Rate, veh/h         | 260  | 385  | 240  | 10   | 10   | 167  |   |      |
| Adj No. of Lanes             | 0    | 2    | 2    | 0    | 0    | 0    |   |      |
| Peak Hour Factor             | 0.96 | 0.96 | 0.96 | 0.96 | 0.96 | 0.96 |   |      |
| Percent Heavy Veh, %         | 2    | 2    | 1    | 1    | 0    | 0    |   |      |
| Cap, veh/h                   | 633  | 781  | 1359 | 56   | 14   | 234  |   |      |
| Arrive On Green              | 0.39 | 0.39 | 0.39 | 0.39 | 0.16 | 0.16 |   |      |
| Sat Flow, veh/h              | 820  | 2095 | 3592 | 145  | 88   | 1465 |   |      |
| Grp Volume(v), veh/h         | 351  | 294  | 122  | 128  | 178  | 0    |   |      |
| Grp Sat Flow(s),veh/h/ln     | 1220 | 1610 | 1787 | 1856 | 1562 | 0    |   |      |
| Q Serve(g_s), s              | 4.1  | 2.7  | 0.9  | 0.9  | 2.2  | 0.0  |   |      |
| Cycle Q Clear(g_c), s        | 5.0  | 2.7  | 0.9  | 0.9  | 2.2  | 0.0  |   |      |
| Prop In Lane                 | 0.74 |      |      | 0.08 | 0.06 | 0.94 |   |      |
| Lane Grp Cap(c), veh/h       | 788  | 626  | 694  | 721  | 250  | 0    |   |      |
| V/C Ratio(X)                 | 0.45 | 0.47 | 0.18 | 0.18 | 0.71 | 0.00 |   |      |
| Avail Cap(c_a), veh/h        | 3794 | 4485 | 4977 | 5168 | 1999 | 0    |   |      |
| HCM Platoon Ratio            | 1.00 | 1.00 | 1.00 | 1.00 | 1.00 | 1.00 |   |      |
| Upstream Filter(I)           | 1.00 | 1.00 | 1.00 | 1.00 | 1.00 | 0.00 |   |      |
| Uniform Delay (d), s/veh     | 5.3  | 4.6  | 4.0  | 4.0  | 7.9  | 0.0  |   |      |
| Incr Delay (d2), s/veh       | 0.1  | 0.2  | 0.0  | 0.0  | 1.4  | 0.0  |   |      |
| Initial Q Delay(d3),s/veh    | 0.0  | 0.0  | 0.0  | 0.0  | 0.0  | 0.0  |   |      |
| %ile BackOfQ(50%),veh/ln     | 1.6  | 1.2  | 0.4  | 0.5  | 1.0  | 0.0  |   |      |
| LnGrp Delay(d),s/veh         | 5.5  | 4.8  | 4.0  | 4.0  | 9.4  | 0.0  |   |      |
| LnGrp LOS                    | A    | A    | A    | A    | A    |      |   |      |
| Approach Vol, veh/h          |      | 645  | 250  |      | 178  |      |   |      |
| Approach Delay, s/veh        |      | 5.1  | 4.0  |      | 9.4  |      |   |      |
| Approach LOS                 |      | A    | A    |      | A    |      |   |      |
| Timer                        | 1    | 2    | 3    | 4    | 5    | 6    | 7 | 8    |
| Assigned Phs                 |      |      |      | 4    |      | 6    |   | 8    |
| Phs Duration (G+Y+Rc), s     |      |      |      | 12.2 |      | 7.7  |   | 12.2 |
| Change Period (Y+Rc), s      |      |      |      | 4.5  |      | 4.5  |   | 4.5  |
| Max Green Setting (Gmax), s  |      |      |      | 55.5 |      | 25.5 |   | 55.5 |
| Max Q Clear Time (g_c+I1), s |      |      |      | 7.0  |      | 4.2  |   | 2.9  |
| Green Ext Time (p_c), s      |      |      |      | 0.8  |      | 0.0  |   | 0.2  |
| <b>Intersection Summary</b>  |      |      |      |      |      |      |   |      |
| HCM 2010 Ctrl Delay          |      |      |      | 5.6  |      |      |   |      |
| HCM 2010 LOS                 |      |      |      | A    |      |      |   |      |
| <b>Notes</b>                 |      |      |      |      |      |      |   |      |

HCM 2010 Signalized Intersection Summary  
44: 8th Avenue & Gigling Road

Cumulative, PM  
06/11/2019



| Movement                     | EBL  | EBT  | EBR  | WBL  | WBT  | WBR  | NBL  | NBT  | NBR  | SBL  | SBT  | SBR  |
|------------------------------|------|------|------|------|------|------|------|------|------|------|------|------|
| Lane Configurations          |      | ↔    |      |      | ↔    |      |      | ↔    |      |      | ↔    |      |
| Traffic Volume (veh/h)       | 370  | 10   | 10   | 10   | 10   | 10   | 10   | 10   | 10   | 10   | 10   | 220  |
| Future Volume (veh/h)        | 370  | 10   | 10   | 10   | 10   | 10   | 10   | 10   | 10   | 10   | 10   | 220  |
| Number                       | 7    | 4    | 14   | 3    | 8    | 18   | 5    | 2    | 12   | 1    | 6    | 16   |
| Initial Q (Qb), veh          | 0    | 0    | 0    | 0    | 0    | 0    | 0    | 0    | 0    | 0    | 0    | 0    |
| Ped-Bike Adj(A_pbT)          | 1.00 |      | 1.00 | 1.00 |      | 1.00 | 1.00 |      | 1.00 | 1.00 |      | 1.00 |
| Parking Bus, Adj             | 1.00 | 1.00 | 1.00 | 1.00 | 1.00 | 1.00 | 1.00 | 1.00 | 1.00 | 1.00 | 1.00 | 1.00 |
| Adj Sat Flow, veh/h/ln       | 1900 | 1863 | 1900 | 1900 | 1863 | 1900 | 1900 | 1900 | 1900 | 1900 | 1881 | 1900 |
| Adj Flow Rate, veh/h         | 407  | 11   | 11   | 11   | 11   | 11   | 11   | 11   | 11   | 11   | 11   | 242  |
| Adj No. of Lanes             | 0    | 2    | 0    | 0    | 2    | 0    | 0    | 1    | 0    | 0    | 1    | 0    |
| Peak Hour Factor             | 0.91 | 0.91 | 0.91 | 0.91 | 0.91 | 0.91 | 0.91 | 0.91 | 0.91 | 0.91 | 0.91 | 0.91 |
| Percent Heavy Veh, %         | 2    | 2    | 2    | 2    | 2    | 2    | 0    | 0    | 0    | 1    | 1    | 1    |
| Cap, veh/h                   | 831  | 287  | 287  | 536  | 437  | 428  | 289  | 182  | 125  | 180  | 21   | 321  |
| Arrive On Green              | 0.37 | 0.37 | 0.37 | 0.37 | 0.37 | 0.37 | 0.22 | 0.22 | 0.22 | 0.22 | 0.22 | 0.22 |
| Sat Flow, veh/h              | 1356 | 777  | 777  | 743  | 1184 | 1159 | 315  | 834  | 574  | 38   | 96   | 1474 |
| Grp Volume(v), veh/h         | 407  | 0    | 22   | 19   | 0    | 14   | 33   | 0    | 0    | 264  | 0    | 0    |
| Grp Sat Flow(s),veh/h/ln     | 1356 | 0    | 1554 | 1602 | 0    | 1485 | 1723 | 0    | 0    | 1608 | 0    | 0    |
| Q Serve(g_s), s              | 5.8  | 0.0  | 0.2  | 0.0  | 0.0  | 0.1  | 0.0  | 0.0  | 0.0  | 1.3  | 0.0  | 0.0  |
| Cycle Q Clear(g_c), s        | 5.9  | 0.0  | 0.2  | 0.1  | 0.0  | 0.1  | 0.3  | 0.0  | 0.0  | 3.3  | 0.0  | 0.0  |
| Prop In Lane                 | 1.00 |      | 0.50 | 0.58 |      | 0.78 | 0.33 |      | 0.33 | 0.04 |      | 0.92 |
| Lane Grp Cap(c), veh/h       | 831  | 0    | 573  | 852  | 0    | 548  | 596  | 0    | 0    | 523  | 0    | 0    |
| V/C Ratio(X)                 | 0.49 | 0.00 | 0.04 | 0.02 | 0.00 | 0.03 | 0.06 | 0.00 | 0.00 | 0.51 | 0.00 | 0.00 |
| Avail Cap(c_a), veh/h        | 3203 | 0    | 3247 | 3513 | 0    | 3102 | 2694 | 0    | 0    | 2781 | 0    | 0    |
| HCM Platoon Ratio            | 1.00 | 1.00 | 1.00 | 1.00 | 1.00 | 1.00 | 1.00 | 1.00 | 1.00 | 1.00 | 1.00 | 1.00 |
| Upstream Filter(I)           | 1.00 | 0.00 | 1.00 | 1.00 | 0.00 | 1.00 | 1.00 | 0.00 | 0.00 | 1.00 | 0.00 | 0.00 |
| Uniform Delay (d), s/veh     | 6.3  | 0.0  | 4.4  | 4.4  | 0.0  | 4.4  | 6.8  | 0.0  | 0.0  | 8.0  | 0.0  | 0.0  |
| Incr Delay (d2), s/veh       | 0.2  | 0.0  | 0.0  | 0.0  | 0.0  | 0.0  | 0.0  | 0.0  | 0.0  | 0.3  | 0.0  | 0.0  |
| Initial Q Delay(d3),s/veh    | 0.0  | 0.0  | 0.0  | 0.0  | 0.0  | 0.0  | 0.0  | 0.0  | 0.0  | 0.0  | 0.0  | 0.0  |
| %ile BackOfQ(50%),veh/ln     | 2.2  | 0.0  | 0.1  | 0.1  | 0.0  | 0.1  | 0.2  | 0.0  | 0.0  | 1.5  | 0.0  | 0.0  |
| LnGrp Delay(d),s/veh         | 6.4  | 0.0  | 4.4  | 4.4  | 0.0  | 4.4  | 6.8  | 0.0  | 0.0  | 8.2  | 0.0  | 0.0  |
| LnGrp LOS                    | A    |      | A    | A    |      | A    | A    |      |      | A    |      |      |
| Approach Vol, veh/h          |      | 429  |      |      | 33   |      |      | 33   |      |      | 264  |      |
| Approach Delay, s/veh        |      | 6.3  |      |      | 4.4  |      |      | 6.8  |      |      | 8.2  |      |
| Approach LOS                 |      | A    |      |      | A    |      |      | A    |      |      | A    |      |
| Timer                        | 1    | 2    | 3    | 4    | 5    | 6    | 7    | 8    |      |      |      |      |
| Assigned Phs                 |      | 2    |      | 4    |      | 6    |      | 8    |      |      |      |      |
| Phs Duration (G+Y+Rc), s     |      | 9.2  |      | 12.5 |      | 9.2  |      | 12.5 |      |      |      |      |
| Change Period (Y+Rc), s      |      | 4.5  |      | 4.5  |      | 4.5  |      | 4.5  |      |      |      |      |
| Max Green Setting (Gmax), s  |      | 35.5 |      | 45.5 |      | 35.5 |      | 45.5 |      |      |      |      |
| Max Q Clear Time (g_c+I1), s |      | 2.3  |      | 7.9  |      | 5.3  |      | 2.1  |      |      |      |      |
| Green Ext Time (p_c), s      |      | 0.0  |      | 0.4  |      | 0.4  |      | 0.0  |      |      |      |      |
| <b>Intersection Summary</b>  |      |      |      |      |      |      |      |      |      |      |      |      |
| HCM 2010 Ctrl Delay          |      |      |      | 6.9  |      |      |      |      |      |      |      |      |
| HCM 2010 LOS                 |      |      |      | A    |      |      |      |      |      |      |      |      |

HCM 2010 Signalized Intersection Summary  
 46: General Jim Moore Boulevard & Normandy Road

Cumulative, PM  
 06/11/2019



| Movement                    | EBL  | EBT  | EBR  | WBL  | WBT  | WBR  | NBL  | NBT  | NBR  | SBL  | SBT  | SBR  |
|-----------------------------|------|------|------|------|------|------|------|------|------|------|------|------|
| Lane Configurations         |      | ↕    |      |      | ↕    |      | ↕    | ↕↕   |      | ↕    | ↕↕   | ↕    |
| Traffic Volume (veh/h)      | 150  | 30   | 100  | 50   | 30   | 10   | 90   | 830  | 70   | 30   | 530  | 80   |
| Future Volume (veh/h)       | 150  | 30   | 100  | 50   | 30   | 10   | 90   | 830  | 70   | 30   | 530  | 80   |
| Number                      | 3    | 8    | 18   | 7    | 4    | 14   | 1    | 6    | 16   | 5    | 2    | 12   |
| Initial Q (Qb), veh         | 0    | 0    | 0    | 0    | 0    | 0    | 0    | 0    | 0    | 0    | 0    | 0    |
| Ped-Bike Adj(A_pbT)         | 1.00 |      | 1.00 | 1.00 |      | 1.00 | 1.00 |      | 1.00 | 1.00 |      | 1.00 |
| Parking Bus, Adj            | 1.00 | 1.00 | 1.00 | 1.00 | 1.00 | 1.00 | 1.00 | 1.00 | 1.00 | 1.00 | 1.00 | 1.00 |
| Adj Sat Flow, veh/h/ln      | 1900 | 1863 | 1900 | 1900 | 1881 | 1900 | 1881 | 1881 | 1900 | 1900 | 1900 | 1900 |
| Adj Flow Rate, veh/h        | 163  | 33   | 84   | 54   | 33   | 8    | 98   | 902  | 53   | 33   | 576  | 28   |
| Adj No. of Lanes            | 0    | 1    | 0    | 0    | 1    | 0    | 1    | 2    | 0    | 1    | 2    | 1    |
| Peak Hour Factor            | 0.92 | 0.92 | 0.92 | 0.92 | 0.92 | 0.92 | 0.92 | 0.92 | 0.92 | 0.92 | 0.92 | 0.92 |
| Percent Heavy Veh, %        | 2    | 2    | 2    | 1    | 1    | 1    | 1    | 1    | 1    | 0    | 0    | 0    |
| Cap, veh/h                  | 358  | 57   | 105  | 347  | 179  | 33   | 247  | 1126 | 66   | 71   | 829  | 370  |
| Arrive On Green             | 0.25 | 0.23 | 0.23 | 0.25 | 0.23 | 0.23 | 0.14 | 0.33 | 0.33 | 0.04 | 0.23 | 0.23 |
| Sat Flow, veh/h             | 818  | 245  | 456  | 777  | 777  | 143  | 1792 | 3431 | 202  | 1810 | 3610 | 1611 |
| Grp Volume(v), veh/h        | 280  | 0    | 0    | 95   | 0    | 0    | 98   | 470  | 485  | 33   | 576  | 28   |
| Grp Sat Flow(s),veh/h/ln    | 1519 | 0    | 0    | 1697 | 0    | 0    | 1792 | 1787 | 1845 | 1810 | 1805 | 1611 |
| Q Serve(g_s), s             | 4.3  | 0.0  | 0.0  | 0.0  | 0.0  | 0.0  | 1.7  | 8.1  | 8.1  | 0.6  | 4.9  | 0.5  |
| Cycle Q Clear(g_c), s       | 5.6  | 0.0  | 0.0  | 1.4  | 0.0  | 0.0  | 1.7  | 8.1  | 8.1  | 0.6  | 4.9  | 0.5  |
| Prop In Lane                | 0.58 |      | 0.30 | 0.57 |      | 0.08 | 1.00 |      | 0.11 | 1.00 |      | 1.00 |
| Lane Grp Cap(c), veh/h      | 543  | 0    | 0    | 585  | 0    | 0    | 247  | 587  | 606  | 71   | 829  | 370  |
| V/C Ratio(X)                | 0.52 | 0.00 | 0.00 | 0.16 | 0.00 | 0.00 | 0.40 | 0.80 | 0.80 | 0.46 | 0.69 | 0.08 |
| Avail Cap(c_a), veh/h       | 1642 | 0    | 0    | 1686 | 0    | 0    | 426  | 1355 | 1399 | 430  | 2737 | 1222 |
| HCM Platoon Ratio           | 1.00 | 1.00 | 1.00 | 1.00 | 1.00 | 1.00 | 1.00 | 1.00 | 1.00 | 1.00 | 1.00 | 1.00 |
| Upstream Filter(I)          | 1.00 | 0.00 | 0.00 | 1.00 | 0.00 | 0.00 | 1.00 | 1.00 | 1.00 | 1.00 | 1.00 | 1.00 |
| Uniform Delay (d), s/veh    | 11.9 | 0.0  | 0.0  | 10.4 | 0.0  | 0.0  | 13.2 | 10.3 | 10.3 | 15.8 | 11.9 | 10.2 |
| Incr Delay (d2), s/veh      | 0.3  | 0.0  | 0.0  | 0.0  | 0.0  | 0.0  | 0.4  | 1.0  | 0.9  | 1.7  | 0.4  | 0.0  |
| Initial Q Delay(d3),s/veh   | 0.0  | 0.0  | 0.0  | 0.0  | 0.0  | 0.0  | 0.0  | 0.0  | 0.0  | 0.0  | 0.0  | 0.0  |
| %ile BackOfQ(50%),veh/ln    | 2.3  | 0.0  | 0.0  | 0.7  | 0.0  | 0.0  | 0.8  | 4.1  | 4.2  | 0.3  | 2.4  | 0.2  |
| LnGrp Delay(d),s/veh        | 12.2 | 0.0  | 0.0  | 10.4 | 0.0  | 0.0  | 13.6 | 11.3 | 11.2 | 17.5 | 12.3 | 10.2 |
| LnGrp LOS                   | B    |      |      | B    |      |      | B    | B    | B    | B    | B    | B    |
| Approach Vol, veh/h         |      | 280  |      |      | 95   |      |      | 1053 |      |      | 637  |      |
| Approach Delay, s/veh       |      | 12.2 |      |      | 10.4 |      |      | 11.5 |      |      | 12.4 |      |
| Approach LOS                |      | B    |      |      | B    |      |      | B    |      |      | B    |      |
| Timer                       | 1    | 2    | 3    | 4    | 5    | 6    | 7    | 8    |      |      |      |      |
| Assigned Phs                | 1    | 2    |      | 4    | 5    | 6    |      | 8    |      |      |      |      |
| Phs Duration (G+Y+Rc), s    | 9.1  | 12.2 |      | 12.3 | 5.8  | 15.5 |      | 12.3 |      |      |      |      |
| Change Period (Y+Rc), s     | 4.5  | 4.5  |      | 4.5  | 4.5  | 4.5  |      | 4.5  |      |      |      |      |
| Max Green Setting (Gmax), s | 25.5 | 25.5 |      | 33.0 | 8.0  | 25.5 |      | 33.0 |      |      |      |      |
| Max Q Clear Time (g_c+1), s | 6.9  | 6.9  |      | 3.4  | 2.6  | 10.1 |      | 7.6  |      |      |      |      |
| Green Ext Time (p_c), s     | 0.0  | 0.7  |      | 0.1  | 0.0  | 0.9  |      | 0.4  |      |      |      |      |
| <b>Intersection Summary</b> |      |      |      |      |      |      |      |      |      |      |      |      |
| HCM 2010 Ctrl Delay         |      |      |      | 11.8 |      |      |      |      |      |      |      |      |
| HCM 2010 LOS                |      |      |      | B    |      |      |      |      |      |      |      |      |

| Intersection              |      |
|---------------------------|------|
| Intersection Delay, s/veh | 30.4 |
| Intersection LOS          | D    |

| Movement            | EBL  | EBR  | NBL  | NBT  | SBT  | SBR  |
|---------------------|------|------|------|------|------|------|
| Lane Configurations |      |      |      |      |      |      |
| Traffic Vol, veh/h  | 60   | 100  | 150  | 950  | 410  | 50   |
| Future Vol, veh/h   | 60   | 100  | 150  | 950  | 410  | 50   |
| Peak Hour Factor    | 0.89 | 0.89 | 0.89 | 0.89 | 0.89 | 0.89 |
| Heavy Vehicles, %   | 1    | 1    | 1    | 1    | 1    | 1    |
| Mvmt Flow           | 67   | 112  | 169  | 1067 | 461  | 56   |
| Number of Lanes     | 1    | 1    | 1    | 2    | 2    | 1    |

| Approach                   | EB   | NB   | SB   |
|----------------------------|------|------|------|
| Opposing Approach          |      | SB   | NB   |
| Opposing Lanes             | 0    | 3    | 3    |
| Conflicting Approach Left  | SB   |      |      |
| Conflicting Lanes Left     | 3    | 2    | 0    |
| Conflicting Approach Right | NB   |      | EB   |
| Conflicting Lanes Right    | 3    | 0    | 2    |
| HCM Control Delay          | 13.8 | 38.6 | 16.6 |
| HCM LOS                    | B    | E    | C    |

| Lane                   | NBLn1 | NBLn2 | NBLn3 | EBLn1 | EBLn2 | SBLn1 | SBLn2 | SBLn3 |
|------------------------|-------|-------|-------|-------|-------|-------|-------|-------|
| Vol Left, %            | 100%  | 0%    | 0%    | 100%  | 0%    | 0%    | 0%    | 0%    |
| Vol Thru, %            | 0%    | 100%  | 100%  | 0%    | 0%    | 100%  | 100%  | 0%    |
| Vol Right, %           | 0%    | 0%    | 0%    | 0%    | 100%  | 0%    | 0%    | 100%  |
| Sign Control           | Stop  | Stop  | Stop  | Stop  | Stop  | Stop  | Stop  | Stop  |
| Traffic Vol by Lane    | 150   | 475   | 475   | 60    | 100   | 205   | 205   | 50    |
| LT Vol                 | 150   | 0     | 0     | 60    | 0     | 0     | 0     | 0     |
| Through Vol            | 0     | 475   | 475   | 0     | 0     | 205   | 205   | 0     |
| RT Vol                 | 0     | 0     | 0     | 0     | 100   | 0     | 0     | 50    |
| Lane Flow Rate         | 169   | 534   | 534   | 67    | 112   | 230   | 230   | 56    |
| Geometry Grp           | 8     | 8     | 8     | 8     | 8     | 8     | 8     | 8     |
| Degree of Util (X)     | 0.339 | 0.999 | 0.741 | 0.174 | 0.253 | 0.491 | 0.491 | 0.081 |
| Departure Headway (Hd) | 7.246 | 6.739 | 4.997 | 9.307 | 8.092 | 7.674 | 7.674 | 5.217 |
| Convergence, Y/N       | Yes   | Yes   | Yes   | Yes   | Yes   | Yes   | Yes   | Yes   |
| Cap                    | 497   | 539   | 726   | 385   | 443   | 470   | 470   | 685   |
| Service Time           | 4.982 | 4.475 | 2.732 | 7.069 | 5.854 | 5.423 | 5.423 | 2.965 |
| HCM Lane V/C Ratio     | 0.34  | 0.991 | 0.736 | 0.174 | 0.253 | 0.489 | 0.489 | 0.082 |
| HCM Control Delay      | 13.7  | 64.4  | 20.7  | 14    | 13.6  | 17.6  | 17.6  | 8.4   |
| HCM Lane LOS           | B     | F     | C     | B     | B     | C     | C     | A     |
| HCM 95th-tile Q        | 1.5   | 14.1  | 6.7   | 0.6   | 1     | 2.7   | 2.7   | 0.3   |



| Movement                      | EBL  | EBT  | EBR  | WBL   | WBT  | WBR   | NBL  | NBT  | NBR  | SBL  | SBT  | SBR  |
|-------------------------------|------|------|------|-------|------|-------|------|------|------|------|------|------|
| Lane Configurations           |      |      |      |       |      |       |      |      |      |      |      |      |
| Traffic Volume (veh/h)        | 220  | 170  | 80   | 90    | 100  | 70    | 110  | 1180 | 230  | 100  | 680  | 220  |
| Future Volume (veh/h)         | 220  | 170  | 80   | 90    | 100  | 70    | 110  | 1180 | 230  | 100  | 680  | 220  |
| Number                        | 7    | 4    | 14   | 3     | 8    | 18    | 5    | 2    | 12   | 1    | 6    | 16   |
| Initial Q (Qb), veh           | 0    | 0    | 0    | 0     | 0    | 0     | 0    | 0    | 0    | 0    | 0    | 0    |
| Ped-Bike Adj(A_pbT)           | 1.00 |      | 0.98 | 1.00  |      | 0.99  | 1.00 |      | 0.99 | 1.00 |      | 0.99 |
| Parking Bus, Adj              | 1.00 | 1.00 | 1.00 | 1.00  | 1.00 | 1.00  | 1.00 | 1.00 | 1.00 | 1.00 | 1.00 | 1.00 |
| Adj Sat Flow, veh/h/ln        | 1881 | 1881 | 1881 | 1900  | 1900 | 1900  | 1881 | 1881 | 1900 | 1863 | 1863 | 1863 |
| Adj Flow Rate, veh/h          | 201  | 211  | 35   | 93    | 103  | 66    | 113  | 1216 | 225  | 103  | 701  | 155  |
| Adj No. of Lanes              | 1    | 1    | 1    | 0     | 1    | 0     | 1    | 2    | 0    | 1    | 2    | 1    |
| Peak Hour Factor              | 0.97 | 0.97 | 0.97 | 0.97  | 0.97 | 0.97  | 0.97 | 0.97 | 0.97 | 0.97 | 0.97 | 0.97 |
| Percent Heavy Veh, %          | 1    | 1    | 1    | 0     | 0    | 0     | 1    | 1    | 1    | 2    | 2    | 2    |
| Cap, veh/h                    | 265  | 279  | 232  | 105   | 117  | 75    | 596  | 1385 | 254  | 127  | 671  | 297  |
| Arrive On Green               | 0.15 | 0.15 | 0.15 | 0.17  | 0.17 | 0.17  | 0.33 | 0.46 | 0.46 | 0.07 | 0.19 | 0.19 |
| Sat Flow, veh/h               | 1792 | 1881 | 1565 | 634   | 702  | 450   | 1792 | 3013 | 553  | 1774 | 3539 | 1568 |
| Grp Volume(v), veh/h          | 201  | 211  | 35   | 262   | 0    | 0     | 113  | 718  | 723  | 103  | 701  | 155  |
| Grp Sat Flow(s),veh/h/ln      | 1792 | 1881 | 1565 | 1785  | 0    | 0     | 1792 | 1787 | 1779 | 1774 | 1770 | 1568 |
| Q Serve(g_s), s               | 13.5 | 13.5 | 2.4  | 17.9  | 0.0  | 0.0   | 5.6  | 45.3 | 46.3 | 7.2  | 23.7 | 11.1 |
| Cycle Q Clear(g_c), s         | 13.5 | 13.5 | 2.4  | 17.9  | 0.0  | 0.0   | 5.6  | 45.3 | 46.3 | 7.2  | 23.7 | 11.1 |
| Prop In Lane                  | 1.00 |      | 1.00 | 0.35  |      | 0.25  | 1.00 |      | 0.31 | 1.00 |      | 1.00 |
| Lane Grp Cap(c), veh/h        | 265  | 279  | 232  | 297   | 0    | 0     | 596  | 821  | 818  | 127  | 671  | 297  |
| V/C Ratio(X)                  | 0.76 | 0.76 | 0.15 | 0.88  | 0.00 | 0.00  | 0.19 | 0.87 | 0.88 | 0.81 | 1.04 | 0.52 |
| Avail Cap(c_a), veh/h         | 573  | 602  | 501  | 357   | 0    | 0     | 596  | 821  | 818  | 241  | 671  | 297  |
| HCM Platoon Ratio             | 1.00 | 1.00 | 1.00 | 1.00  | 1.00 | 1.00  | 1.00 | 1.00 | 1.00 | 1.00 | 1.00 | 1.00 |
| Upstream Filter(I)            | 0.69 | 0.69 | 0.69 | 1.00  | 0.00 | 0.00  | 1.00 | 1.00 | 1.00 | 1.00 | 1.00 | 1.00 |
| Uniform Delay (d), s/veh      | 51.1 | 51.1 | 46.4 | 50.7  | 0.0  | 0.0   | 29.7 | 30.5 | 30.8 | 57.2 | 50.7 | 45.5 |
| Incr Delay (d2), s/veh        | 3.1  | 2.9  | 0.2  | 20.8  | 0.0  | 0.0   | 0.1  | 12.4 | 13.4 | 4.6  | 47.0 | 6.4  |
| Initial Q Delay(d3),s/veh     | 0.0  | 0.0  | 0.0  | 0.0   | 0.0  | 0.0   | 0.0  | 0.0  | 0.0  | 0.0  | 0.0  | 0.0  |
| %ile BackOfQ(50%),veh/ln      | 6.9  | 7.2  | 1.1  | 10.6  | 0.0  | 0.0   | 2.8  | 25.2 | 25.8 | 3.7  | 15.9 | 5.4  |
| LnGrp Delay(d),s/veh          | 54.1 | 54.0 | 46.6 | 71.5  | 0.0  | 0.0   | 29.7 | 42.9 | 44.2 | 61.8 | 97.6 | 51.9 |
| LnGrp LOS                     | D    | D    | D    | E     |      |       | C    | D    | D    | E    | F    | D    |
| Approach Vol, veh/h           |      | 447  |      |       | 262  |       |      | 1554 |      |      | 959  |      |
| Approach Delay, s/veh         |      | 53.5 |      |       | 71.5 |       |      | 42.5 |      |      | 86.4 |      |
| Approach LOS                  |      | D    |      |       | E    |       |      | D    |      |      | F    |      |
| Timer                         | 1    | 2    | 3    | 4     | 5    | 6     | 7    | 8    |      |      |      |      |
| Assigned Phs                  | 1    | 2    |      | 4     | 5    | 6     |      | 8    |      |      |      |      |
| Phs Duration (G+Y+Rc), s      | 3.2  | 62.8 |      | 23.2  | 46.9 | 29.0  |      | 25.9 |      |      |      |      |
| Change Period (Y+Rc), s       | 4.2  | 5.3  |      | * 4.7 | 5.3  | * 5.3 |      | 5.1  |      |      |      |      |
| Max Green Setting (Gmax), s   | 13   | 23.7 |      | * 40  | 17.0 | * 24  |      | 25.0 |      |      |      |      |
| Max Q Clear Time (g_c+119), s | 19.2 | 48.3 |      | 15.5  | 7.6  | 25.7  |      | 19.9 |      |      |      |      |
| Green Ext Time (p_c), s       | 0.1  | 0.0  |      | 1.9   | 0.1  | 0.0   |      | 0.8  |      |      |      |      |
| <b>Intersection Summary</b>   |      |      |      |       |      |       |      |      |      |      |      |      |
| HCM 2010 Ctrl Delay           |      |      |      | 59.5  |      |       |      |      |      |      |      |      |
| HCM 2010 LOS                  |      |      |      | E     |      |       |      |      |      |      |      |      |
| <b>Notes</b>                  |      |      |      |       |      |       |      |      |      |      |      |      |

HCM 2010 Signalized Intersection Summary  
 49: Highway 1 SB On-Ramp & Highway 1 NB Off-Ramp/Monterey Road

Cumulative, PM  
 06/11/2019



| Movement                     | EBL  | EBT  | EBR  | WBL   | WBT  | WBR   | NBL  | NBT   | NBR  | SBL  | SBT  | SBR  |
|------------------------------|------|------|------|-------|------|-------|------|-------|------|------|------|------|
| Lane Configurations          |      | ↔↔   | ↗    | ↖     |      | ↗     |      | ↕     | ↗    |      | ↖    |      |
| Traffic Volume (veh/h)       | 10   | 160  | 120  | 280   | 0    | 130   | 0    | 120   | 300  | 10   | 10   | 0    |
| Future Volume (veh/h)        | 10   | 160  | 120  | 280   | 0    | 130   | 0    | 120   | 300  | 10   | 10   | 0    |
| Number                       | 1    | 6    | 16   | 5     | 2    | 12    | 7    | 4     | 14   | 3    | 8    | 18   |
| Initial Q (Qb), veh          | 0    | 0    | 0    | 0     | 0    | 0     | 0    | 0     | 0    | 0    | 0    | 0    |
| Ped-Bike Adj(A_pbT)          | 1.00 |      | 1.00 | 1.00  |      | 1.00  | 1.00 |       | 1.00 | 1.00 |      | 1.00 |
| Parking Bus, Adj             | 1.00 | 1.00 | 1.00 | 1.00  | 1.00 | 1.00  | 1.00 | 1.00  | 1.00 | 1.00 | 1.00 | 1.00 |
| Adj Sat Flow, veh/h/ln       | 1900 | 1863 | 1863 | 1900  | 0    | 1900  | 0    | 1881  | 1881 | 1900 | 1900 | 0    |
| Adj Flow Rate, veh/h         | 11   | 176  | 14   | 308   | 0    | 69    | 0    | 132   | 51   | 11   | 11   | 0    |
| Adj No. of Lanes             | 0    | 2    | 1    | 1     | 0    | 1     | 0    | 1     | 1    | 0    | 1    | 0    |
| Peak Hour Factor             | 0.91 | 0.91 | 0.91 | 0.91  | 0.91 | 0.91  | 0.91 | 0.91  | 0.91 | 0.91 | 0.91 | 0.91 |
| Percent Heavy Veh, %         | 2    | 2    | 2    | 0     | 0    | 0     | 0    | 1     | 1    | 0    | 0    | 0    |
| Cap, veh/h                   | 170  | 2861 | 1323 | 0     | 0    | 0     | 0    | 164   | 139  | 58   | 44   | 0    |
| Arrive On Green              | 0.85 | 0.84 | 0.84 | 0.00  | 0.00 | 0.00  | 0.00 | 0.09  | 0.09 | 0.09 | 0.09 | 0.00 |
| Sat Flow, veh/h              | 203  | 3419 | 1580 |       |      | 0     | 0    | 1881  | 1599 | 166  | 501  | 0    |
| Grp Volume(v), veh/h         | 100  | 87   | 14   |       | 0.0  |       | 0    | 132   | 51   | 22   | 0    | 0    |
| Grp Sat Flow(s),veh/h/ln     | 1853 | 1770 | 1580 |       |      |       | 0    | 1881  | 1599 | 667  | 0    | 0    |
| Q Serve(g_s), s              | 1.2  | 1.1  | 0.2  |       |      |       | 0.0  | 8.6   | 3.8  | 0.1  | 0.0  | 0.0  |
| Cycle Q Clear(g_c), s        | 1.2  | 1.1  | 0.2  |       |      |       | 0.0  | 8.6   | 3.8  | 8.7  | 0.0  | 0.0  |
| Prop In Lane                 | 0.11 |      | 1.00 |       |      |       | 0.00 |       | 1.00 | 0.50 |      | 0.00 |
| Lane Grp Cap(c), veh/h       | 1551 | 1481 | 1323 |       |      |       | 0    | 164   | 139  | 102  | 0    | 0    |
| V/C Ratio(X)                 | 0.06 | 0.06 | 0.01 |       |      |       | 0.00 | 0.81  | 0.37 | 0.22 | 0.00 | 0.00 |
| Avail Cap(c_a), veh/h        | 1551 | 1481 | 1323 |       |      |       | 0    | 271   | 230  | 127  | 0    | 0    |
| HCM Platoon Ratio            | 1.00 | 1.00 | 1.00 |       |      |       | 1.00 | 1.00  | 1.00 | 1.00 | 1.00 | 1.00 |
| Upstream Filter(I)           | 1.00 | 1.00 | 1.00 |       |      |       | 0.00 | 1.00  | 1.00 | 1.00 | 0.00 | 0.00 |
| Uniform Delay (d), s/veh     | 1.7  | 1.7  | 1.7  |       |      |       | 0.0  | 56.0  | 53.8 | 52.8 | 0.0  | 0.0  |
| Incr Delay (d2), s/veh       | 0.0  | 0.0  | 0.0  |       |      |       | 0.0  | 3.5   | 0.6  | 0.4  | 0.0  | 0.0  |
| Initial Q Delay(d3),s/veh    | 0.0  | 0.0  | 0.0  |       |      |       | 0.0  | 0.0   | 0.0  | 0.0  | 0.0  | 0.0  |
| %ile BackOfQ(50%),veh/ln     | 0.6  | 0.5  | 0.1  |       |      |       | 0.0  | 4.6   | 1.7  | 0.7  | 0.0  | 0.0  |
| LnGrp Delay(d),s/veh         | 1.8  | 1.8  | 1.7  |       |      |       | 0.0  | 59.5  | 54.4 | 53.2 | 0.0  | 0.0  |
| LnGrp LOS                    | A    | A    | A    |       |      |       |      | E     | D    | D    |      |      |
| Approach Vol, veh/h          |      | 201  |      |       |      |       |      | 183   |      |      | 22   |      |
| Approach Delay, s/veh        |      | 1.7  |      |       |      |       |      | 58.1  |      |      | 53.2 |      |
| Approach LOS                 |      | A    |      |       |      |       |      | E     |      |      | D    |      |
| Timer                        | 1    | 2    | 3    | 4     | 5    | 6     | 7    | 8     |      |      |      |      |
| Assigned Phs                 |      |      |      | 4     |      | 6     |      | 8     |      |      |      |      |
| Phs Duration (G+Y+Rc), s     |      |      |      | 15.1  |      | 109.9 |      | 15.1  |      |      |      |      |
| Change Period (Y+Rc), s      |      |      |      | * 4.2 |      | 5.3   |      | * 4.2 |      |      |      |      |
| Max Green Setting (Gmax), s  |      |      |      | * 18  |      | 21.0  |      | * 13  |      |      |      |      |
| Max Q Clear Time (g_c+I1), s |      |      |      | 10.6  |      | 3.2   |      | 10.7  |      |      |      |      |
| Green Ext Time (p_c), s      |      |      |      | 0.3   |      | 0.6   |      | 0.0   |      |      |      |      |
| <b>Intersection Summary</b>  |      |      |      |       |      |       |      |       |      |      |      |      |
| HCM 2010 Ctrl Delay          |      |      | 29.9 |       |      |       |      |       |      |      |      |      |
| HCM 2010 LOS                 |      |      | C    |       |      |       |      |       |      |      |      |      |
| <b>Notes</b>                 |      |      |      |       |      |       |      |       |      |      |      |      |



HCM 2010 Signalized Intersection Summary  
 50: Reservation Road & SR 68 WB On Ramp/SR 68 WB Off Ramp

Cumulative, PM  
 06/11/2019



| Movement                       | EBL | EBT  | EBR | WBL  | WBT  | WBR  | NBL  | NBT  | NBR  | SBL  | SBT  | SBR  |
|--------------------------------|-----|------|-----|------|------|------|------|------|------|------|------|------|
| Lane Configurations            |     |      |     |      | ↕    | ↕    | ↕    | ↕    |      |      | ↕    |      |
| Traffic Volume (veh/h)         | 0   | 0    | 0   | 410  | 10   | 250  | 140  | 250  | 0    | 0    | 510  | 180  |
| Future Volume (veh/h)          | 0   | 0    | 0   | 410  | 10   | 250  | 140  | 250  | 0    | 0    | 510  | 180  |
| Number                         |     |      |     | 7    | 4    | 14   | 1    | 6    | 16   | 5    | 2    | 12   |
| Initial Q (Qb), veh            |     |      |     | 0    | 0    | 0    | 0    | 0    | 0    | 0    | 0    | 0    |
| Ped-Bike Adj(A_pbT)            |     |      |     | 1.00 |      | 1.00 | 1.00 |      | 1.00 | 1.00 |      | 1.00 |
| Parking Bus, Adj               |     |      |     | 1.00 | 1.00 | 1.00 | 1.00 | 1.00 | 1.00 | 1.00 | 1.00 | 1.00 |
| Adj Sat Flow, veh/h/ln         |     |      |     | 1900 | 1863 | 1863 | 1845 | 1845 | 0    | 0    | 1827 | 1900 |
| Adj Flow Rate, veh/h           |     |      |     | 436  | 11   | 84   | 149  | 266  | 0    | 0    | 543  | 181  |
| Adj No. of Lanes               |     |      |     | 0    | 1    | 1    | 1    | 1    | 0    | 0    | 1    | 0    |
| Peak Hour Factor               |     |      |     | 0.94 | 0.94 | 0.94 | 0.94 | 0.94 | 0.94 | 0.94 | 0.94 | 0.94 |
| Percent Heavy Veh, %           |     |      |     | 2    | 2    | 2    | 3    | 3    | 0    | 0    | 4    | 4    |
| Cap, veh/h                     |     |      |     | 485  | 12   | 442  | 185  | 1092 | 0    | 0    | 585  | 195  |
| Arrive On Green                |     |      |     | 0.29 | 0.28 | 0.28 | 0.03 | 0.20 | 0.00 | 0.00 | 0.45 | 0.45 |
| Sat Flow, veh/h                |     |      |     | 1732 | 44   | 1581 | 1757 | 1845 | 0    | 0    | 1312 | 437  |
| Grp Volume(v), veh/h           |     |      |     | 447  | 0    | 84   | 149  | 266  | 0    | 0    | 0    | 724  |
| Grp Sat Flow(s),veh/h/ln       |     |      |     | 1776 | 0    | 1581 | 1757 | 1845 | 0    | 0    | 0    | 1750 |
| Q Serve(g_s), s                |     |      |     | 20.5 | 0.0  | 3.4  | 7.2  | 10.4 | 0.0  | 0.0  | 0.0  | 33.3 |
| Cycle Q Clear(g_c), s          |     |      |     | 20.5 | 0.0  | 3.4  | 7.2  | 10.4 | 0.0  | 0.0  | 0.0  | 33.3 |
| Prop In Lane                   |     |      |     | 0.98 |      | 1.00 | 1.00 |      | 0.00 | 0.00 |      | 0.25 |
| Lane Grp Cap(c), veh/h         |     |      |     | 497  | 0    | 442  | 185  | 1092 | 0    | 0    | 0    | 780  |
| V/C Ratio(X)                   |     |      |     | 0.90 | 0.00 | 0.19 | 0.81 | 0.24 | 0.00 | 0.00 | 0.00 | 0.93 |
| Avail Cap(c_a), veh/h          |     |      |     | 564  | 0    | 502  | 248  | 1092 | 0    | 0    | 0    | 780  |
| HCM Platoon Ratio              |     |      |     | 1.00 | 1.00 | 1.00 | 0.33 | 0.33 | 1.00 | 1.00 | 1.00 | 1.00 |
| Upstream Filter(I)             |     |      |     | 1.00 | 0.00 | 1.00 | 0.95 | 0.95 | 0.00 | 0.00 | 0.00 | 1.00 |
| Uniform Delay (d), s/veh       |     |      |     | 29.0 | 0.0  | 23.3 | 40.2 | 18.1 | 0.0  | 0.0  | 0.0  | 22.3 |
| Incr Delay (d2), s/veh         |     |      |     | 16.1 | 0.0  | 0.2  | 9.3  | 0.5  | 0.0  | 0.0  | 0.0  | 18.9 |
| Initial Q Delay(d3),s/veh      |     |      |     | 0.0  | 0.0  | 0.0  | 0.0  | 0.0  | 0.0  | 0.0  | 0.0  | 0.0  |
| %ile BackOfQ(50%),veh/ln       |     |      |     | 12.3 | 0.0  | 1.5  | 4.0  | 5.5  | 0.0  | 0.0  | 0.0  | 20.0 |
| LnGrp Delay(d),s/veh           |     |      |     | 45.1 | 0.0  | 23.5 | 49.5 | 18.6 | 0.0  | 0.0  | 0.0  | 41.2 |
| LnGrp LOS                      |     |      |     | D    |      | C    | D    | B    |      |      |      | D    |
| Approach Vol, veh/h            |     |      |     |      | 531  |      |      | 415  |      |      | 724  |      |
| Approach Delay, s/veh          |     |      |     |      | 41.7 |      |      | 29.7 |      |      | 41.2 |      |
| Approach LOS                   |     |      |     |      | D    |      |      | C    |      |      | D    |      |
| Timer                          | 1   | 2    | 3   | 4    | 5    | 6    | 7    | 8    |      |      |      |      |
| Assigned Phs                   | 1   | 2    |     | 4    |      | 6    |      |      |      |      |      |      |
| Phs Duration (G+Y+Rc), s       | 2.4 | 43.9 |     | 28.7 |      | 56.3 |      |      |      |      |      |      |
| Change Period (Y+Rc), s        | 3.5 | 6.0  |     | 4.9  |      | 6.0  |      |      |      |      |      |      |
| Max Green Setting (Gmax), s    | 2.0 | 31.6 |     | 27.0 |      | 47.1 |      |      |      |      |      |      |
| Max Q Clear Time (g_c+19.2), s | 1.0 | 35.3 |     | 22.5 |      | 12.4 |      |      |      |      |      |      |
| Green Ext Time (p_c), s        | 0.0 | 0.0  |     | 1.3  |      | 1.3  |      |      |      |      |      |      |
| <b>Intersection Summary</b>    |     |      |     |      |      |      |      |      |      |      |      |      |
| HCM 2010 Ctrl Delay            |     |      |     | 38.5 |      |      |      |      |      |      |      |      |
| HCM 2010 LOS                   |     |      |     | D    |      |      |      |      |      |      |      |      |

HCM 2010 Signalized Intersection Summary  
 51: River Road/Reservation Road & SR 68 Off Ramp/SR 68 EB On Ramp





















Cumulative, PM  
 06/11/2019



| Movement                     | EBL  | EBT  | EBR  | WBL | WBT  | WBR  | NBL  | NBT  | NBR  | SBL  | SBT  | SBR  |
|------------------------------|------|------|------|-----|------|------|------|------|------|------|------|------|
| Lane Configurations          |      | ↕    | ↗    |     |      |      |      | ↑    | ↗    | ↖    | ↑    |      |
| Traffic Volume (veh/h)       | 110  | 10   | 190  | 0   | 0    | 0    | 0    | 300  | 320  | 250  | 670  | 0    |
| Future Volume (veh/h)        | 110  | 10   | 190  | 0   | 0    | 0    | 0    | 300  | 320  | 250  | 670  | 0    |
| Number                       | 3    | 8    | 18   |     |      |      | 1    | 6    | 16   | 5    | 2    | 12   |
| Initial Q (Qb), veh          | 0    | 0    | 0    |     |      |      | 0    | 0    | 0    | 0    | 0    | 0    |
| Ped-Bike Adj(A_pbT)          | 1.00 |      | 1.00 |     |      |      | 1.00 |      | 1.00 | 1.00 |      | 1.00 |
| Parking Bus, Adj             | 1.00 | 1.00 | 1.00 |     |      |      | 1.00 | 1.00 | 1.00 | 1.00 | 1.00 | 1.00 |
| Adj Sat Flow, veh/h/ln       | 1900 | 1863 | 1863 |     |      |      | 0    | 1845 | 1845 | 1827 | 1827 | 0    |
| Adj Flow Rate, veh/h         | 117  | 11   | 23   |     |      |      | 0    | 319  | 201  | 266  | 713  | 0    |
| Adj No. of Lanes             | 0    | 1    | 1    |     |      |      | 0    | 1    | 1    | 1    | 1    | 0    |
| Peak Hour Factor             | 0.94 | 0.94 | 0.94 |     |      |      | 0.94 | 0.94 | 0.94 | 0.94 | 0.94 | 0.94 |
| Percent Heavy Veh, %         | 2    | 2    | 2    |     |      |      | 0    | 3    | 3    | 4    | 4    | 0    |
| Cap, veh/h                   | 159  | 15   | 154  |     |      |      | 0    | 1033 | 878  | 297  | 1415 | 0    |
| Arrive On Green              | 0.11 | 0.10 | 0.10 |     |      |      | 0.00 | 0.56 | 0.56 | 0.34 | 1.00 | 0.00 |
| Sat Flow, veh/h              | 1628 | 153  | 1583 |     |      |      | 0    | 1845 | 1568 | 1740 | 1827 | 0    |
| Grp Volume(v), veh/h         | 128  | 0    | 23   |     |      |      | 0    | 319  | 201  | 266  | 713  | 0    |
| Grp Sat Flow(s),veh/h/ln     | 1781 | 0    | 1583 |     |      |      | 0    | 1845 | 1568 | 1740 | 1827 | 0    |
| Q Serve(g_s), s              | 5.9  | 0.0  | 1.1  |     |      |      | 0.0  | 7.8  | 5.5  | 12.3 | 0.0  | 0.0  |
| Cycle Q Clear(g_c), s        | 5.9  | 0.0  | 1.1  |     |      |      | 0.0  | 7.8  | 5.5  | 12.3 | 0.0  | 0.0  |
| Prop In Lane                 | 0.91 |      | 1.00 |     |      |      | 0.00 |      | 1.00 | 1.00 |      | 0.00 |
| Lane Grp Cap(c), veh/h       | 174  | 0    | 154  |     |      |      | 0    | 1033 | 878  | 297  | 1415 | 0    |
| V/C Ratio(X)                 | 0.74 | 0.00 | 0.15 |     |      |      | 0.00 | 0.31 | 0.23 | 0.90 | 0.50 | 0.00 |
| Avail Cap(c_a), veh/h        | 524  | 0    | 466  |     |      |      | 0    | 1033 | 878  | 348  | 1415 | 0    |
| HCM Platoon Ratio            | 1.00 | 1.00 | 1.00 |     |      |      | 1.00 | 1.00 | 1.00 | 2.00 | 2.00 | 1.00 |
| Upstream Filter(I)           | 1.00 | 0.00 | 1.00 |     |      |      | 0.00 | 1.00 | 1.00 | 0.13 | 0.13 | 0.00 |
| Uniform Delay (d), s/veh     | 36.9 | 0.0  | 35.1 |     |      |      | 0.0  | 9.9  | 9.4  | 27.3 | 0.0  | 0.0  |
| Incr Delay (d2), s/veh       | 6.0  | 0.0  | 0.4  |     |      |      | 0.0  | 0.8  | 0.6  | 4.1  | 0.2  | 0.0  |
| Initial Q Delay(d3),s/veh    | 0.0  | 0.0  | 0.0  |     |      |      | 0.0  | 0.0  | 0.0  | 0.0  | 0.0  | 0.0  |
| %ile BackOfQ(50%),veh/ln     | 3.2  | 0.0  | 0.5  |     |      |      | 0.0  | 4.2  | 2.5  | 6.2  | 0.1  | 0.0  |
| LnGrp Delay(d),s/veh         | 42.9 | 0.0  | 35.6 |     |      |      | 0.0  | 10.7 | 10.0 | 31.4 | 0.2  | 0.0  |
| LnGrp LOS                    | D    |      | D    |     |      |      |      | B    | B    | C    | A    |      |
| Approach Vol, veh/h          |      | 151  |      |     |      |      |      | 520  |      |      | 979  |      |
| Approach Delay, s/veh        |      | 41.7 |      |     |      |      |      | 10.5 |      |      | 8.6  |      |
| Approach LOS                 |      | D    |      |     |      |      |      | B    |      |      | A    |      |
| Timer                        | 1    | 2    | 3    | 4   | 5    | 6    | 7    | 8    |      |      |      |      |
| Assigned Phs                 |      | 2    |      |     | 5    | 6    |      | 8    |      |      |      |      |
| Phs Duration (G+Y+Rc), s     |      | 71.8 |      |     | 18.2 | 53.6 |      | 13.2 |      |      |      |      |
| Change Period (Y+Rc), s      |      | 6.0  |      |     | 3.7  | 6.0  |      | 4.9  |      |      |      |      |
| Max Green Setting (Gmax), s  |      | 43.1 |      |     | 17.0 | 28.4 |      | 25.0 |      |      |      |      |
| Max Q Clear Time (g_c+I1), s |      | 2.0  |      |     | 14.3 | 9.8  |      | 7.9  |      |      |      |      |
| Green Ext Time (p_c), s      |      | 4.9  |      |     | 0.2  | 2.1  |      | 0.6  |      |      |      |      |
| <b>Intersection Summary</b>  |      |      |      |     |      |      |      |      |      |      |      |      |
| HCM 2010 Ctrl Delay          |      |      | 12.2 |     |      |      |      |      |      |      |      |      |
| HCM 2010 LOS                 |      |      | B    |     |      |      |      |      |      |      |      |      |

HCM 2010 Signalized Intersection Summary  
1: Del Monte Boulevard & Reindollar Avenue

Cumulative with Project, AM  
06/11/2019

|                              |  |  |  |  |  |  |   |  |  |  |  |  |
|------------------------------|---|---|---|---|---|---|---|---|---|---|---|---|
| Movement                     | EBL   | EBT   | EBR   | WBL   | WBT   | WBR   | NBL   | NBT   | NBR   | SBL   | SBT   | SBR   |
| Lane Configurations          |   |   |   |  |  |   |  |  |  |  |  |  |
| Traffic Volume (veh/h)       | 0   | 0   | 0   | 450   | 0   | 420   | 10  | 650   | 120   | 410   | 1170  | 0   |
| Future Volume (veh/h)        | 0   | 0   | 0   | 450   | 0   | 420   | 10  | 650   | 120   | 410   | 1170  | 0   |
| Number                       |   |   |   | 3   | 8   | 18  | 1   | 6   | 16  | 5   | 2   | 12  |
| Initial Q (Qb), veh          |   |   |   | 0   | 0   | 0   | 0   | 0   | 0   | 0   | 0   | 0   |
| Ped-Bike Adj(A_pbT)          |   |   |   | 1.00  |   | 0.99  | 1.00  |   | 1.00  | 1.00  |   | 1.00  |
| Parking Bus, Adj             |   |   |   | 1.00  | 1.00  | 1.00  | 1.00  | 1.00  | 1.00  | 1.00  | 1.00  | 1.00  |
| Adj Sat Flow, veh/h/ln       |   |   |   | 1900  | 1900  | 1900  | 1863  | 1863  | 1863  | 1845  | 1845  | 0   |
| Adj Flow Rate, veh/h         |   |   |   | 468   | 54  | 429   | 11  | 730   | 68  | 461   | 1315  | 0   |
| Adj No. of Lanes             |   |   |   | 1   | 1   | 0   | 1   | 2   | 1   | 1   | 2   | 0   |
| Peak Hour Factor             |   |   |   | 0.89  | 0.89  | 0.89  | 0.89  | 0.89  | 0.89  | 0.89  | 0.89  | 0.89  |
| Percent Heavy Veh, %         |   |   |   | 0   | 0   | 0   | 2   | 2   | 2   | 3   | 3   | 0   |
| Cap, veh/h                   |   |   |   | 573   | 58  | 459   | 24  | 900   | 401   | 498   | 1839  | 0   |
| Arrive On Green              |   |   |   | 0.32  | 0.32  | 0.32  | 0.01  | 0.25  | 0.25  | 0.28  | 0.52  | 0.00  |
| Sat Flow, veh/h              |   |   |   | 1810  | 183   | 1451  | 1774  | 3539  | 1577  | 1757  | 3597  | 0   |
| Grp Volume(v), veh/h         |   |   |   | 468   | 0   | 483   | 11  | 730   | 68  | 461   | 1315  | 0   |
| Grp Sat Flow(s),veh/h/ln     |   |   |   | 1810  | 0   | 1634  | 1774  | 1770  | 1577  | 1757  | 1752  | 0   |
| Q Serve(g_s), s              |   |   |   | 22.1  | 0.0   | 26.6  | 0.6   | 18.0  | 3.1   | 23.6  | 26.5  | 0.0   |
| Cycle Q Clear(g_c), s        |   |   |   | 22.1  | 0.0   | 26.6  | 0.6   | 18.0  | 3.1   | 23.6  | 26.5  | 0.0   |
| Prop In Lane                 |   |   |   | 1.00  |   | 0.89  | 1.00  |   | 1.00  | 1.00  |   | 0.00  |
| Lane Grp Cap(c), veh/h       |   |   |   | 573   | 0   | 517   | 24  | 900   | 401   | 498   | 1839  | 0   |
| V/C Ratio(X)                 |   |   |   | 0.82  | 0.00  | 0.93  | 0.47  | 0.81  | 0.17  | 0.92  | 0.72  | 0.00  |
| Avail Cap(c_a), veh/h        |   |   |   | 585   | 0   | 529   | 574   | 1145  | 510   | 568   | 1839  | 0   |
| HCM Platoon Ratio            |   |   |   | 1.00  | 1.00  | 1.00  | 1.00  | 1.00  | 1.00  | 1.00  | 1.00  | 1.00  |
| Upstream Filter(I)           |   |   |   | 1.00  | 0.00  | 1.00  | 1.00  | 1.00  | 1.00  | 1.00  | 1.00  | 0.00  |
| Uniform Delay (d), s/veh     |   |   |   | 29.2  | 0.0   | 30.8  | 45.4  | 32.5  | 27.0  | 32.3  | 16.8  | 0.0   |
| Incr Delay (d2), s/veh       |   |   |   | 8.7   | 0.0   | 23.7  | 13.6  | 3.6   | 0.2   | 19.8  | 1.3   | 0.0   |
| Initial Q Delay(d3),s/veh    |   |   |   | 0.0   | 0.0   | 0.0   | 0.0   | 0.0   | 0.0   | 0.0   | 0.0   | 0.0   |
| %ile BackOfQ(50%),veh/ln     |   |   |   | 12.4  | 0.0   | 15.3  | 0.4   | 9.2   | 1.4   | 14.1  | 12.9  | 0.0   |
| LnGrp Delay(d),s/veh         |   |   |   | 37.9  | 0.0   | 54.4  | 59.0  | 36.1  | 27.2  | 52.0  | 18.1  | 0.0   |
| LnGrp LOS                    |   |   |   | D   |   | D   | E   | D   | C   | D   | B   |   |
| Approach Vol, veh/h          |   |   |   |   | 951   |   |   | 809   |   |   | 1776  |   |
| Approach Delay, s/veh        |   |   |   |   | 46.3  |   |   | 35.6  |   |   | 26.9  |   |
| Approach LOS                 |   |   |   |   | D   |   |   | D   |   |   | C   |   |
| Timer                        | 1   | 2   | 3   | 4   | 5   | 6   | 7   | 8   |   |   |   |   |
| Assigned Phs                 | 1   | 2   |   |   | 5   | 6   |   | 8   |   |   |   |   |
| Phs Duration (G+Y+Rc), s     | 4.7   | 53.7  |   |   | 29.8  | 28.6  |   | 34.4  |   |   |   |   |
| Change Period (Y+Rc), s      | 3.5   | 5.0   |   |   | 3.5   | 5.0   |   | 5.0   |   |   |   |   |
| Max Green Setting (Gmax), s  | 30.0  | 30.0  |   |   | 30.0  | 30.0  |   | 30.0  |   |   |   |   |
| Max Q Clear Time (g_c+I1), s | 2.6   | 28.5  |   |   | 25.6  | 20.0  |   | 28.6  |   |   |   |   |
| Green Ext Time (p_c), s      | 0.0   | 1.2   |   |   | 0.7   | 3.6   |   | 0.8   |   |   |   |   |
| <b>Intersection Summary</b>  |   |   |   |   |   |   |   |   |   |   |   |   |
| HCM 2010 Ctrl Delay          |   |   |   | 34.1  |   |   |   |   |   |   |   |   |
| HCM 2010 LOS                 |   |   |   | C   |   |   |   |   |   |   |   |   |
| <b>Notes</b>                 |   |   |   |   |   |   |   |   |   |   |   |   |

HCM 2010 Signalized Intersection Summary  
2: 2nd Avenue & Patton Parkway

Cumulative with Project, AM  
06/11/2019



| Movement                     | EBL  | EBT  | EBR  | WBL  | WBT  | WBR  | NBL  | NBT  | NBR  | SBL  | SBT  | SBR  |
|------------------------------|------|------|------|------|------|------|------|------|------|------|------|------|
| Lane Configurations          | ↖    | ↗    |      | ↖    | ↗    |      | ↖    | ↗    |      | ↖    | ↗    |      |
| Traffic Volume (veh/h)       | 50   | 90   | 60   | 30   | 90   | 100  | 70   | 220  | 100  | 90   | 200  | 50   |
| Future Volume (veh/h)        | 50   | 90   | 60   | 30   | 90   | 100  | 70   | 220  | 100  | 90   | 200  | 50   |
| Number                       | 7    | 4    | 14   | 3    | 8    | 18   | 5    | 2    | 12   | 1    | 6    | 16   |
| Initial Q (Qb), veh          | 0    | 0    | 0    | 0    | 0    | 0    | 0    | 0    | 0    | 0    | 0    | 0    |
| Ped-Bike Adj(A_pbT)          | 1.00 |      | 1.00 | 1.00 |      | 1.00 | 1.00 |      | 1.00 | 1.00 |      | 1.00 |
| Parking Bus, Adj             | 1.00 | 1.00 | 1.00 | 1.00 | 1.00 | 1.00 | 1.00 | 1.00 | 1.00 | 1.00 | 1.00 | 1.00 |
| Adj Sat Flow, veh/h/ln       | 1863 | 1863 | 1900 | 1863 | 1863 | 1900 | 1863 | 1863 | 1900 | 1863 | 1863 | 1900 |
| Adj Flow Rate, veh/h         | 54   | 98   | 65   | 33   | 98   | 109  | 76   | 239  | 109  | 98   | 217  | 54   |
| Adj No. of Lanes             | 1    | 1    | 0    | 1    | 1    | 0    | 1    | 1    | 0    | 1    | 1    | 0    |
| Peak Hour Factor             | 0.92 | 0.92 | 0.92 | 0.92 | 0.92 | 0.92 | 0.92 | 0.92 | 0.92 | 0.92 | 0.92 | 0.92 |
| Percent Heavy Veh, %         | 2    | 2    | 2    | 2    | 2    | 2    | 2    | 2    | 2    | 2    | 2    | 2    |
| Cap, veh/h                   | 97   | 247  | 164  | 67   | 177  | 197  | 121  | 330  | 151  | 139  | 407  | 101  |
| Arrive On Green              | 0.05 | 0.24 | 0.24 | 0.04 | 0.22 | 0.22 | 0.07 | 0.27 | 0.27 | 0.08 | 0.28 | 0.28 |
| Sat Flow, veh/h              | 1774 | 1046 | 694  | 1774 | 807  | 897  | 1774 | 1212 | 553  | 1774 | 1441 | 359  |
| Grp Volume(v), veh/h         | 54   | 0    | 163  | 33   | 0    | 207  | 76   | 0    | 348  | 98   | 0    | 271  |
| Grp Sat Flow(s),veh/h/ln     | 1774 | 0    | 1740 | 1774 | 0    | 1704 | 1774 | 0    | 1765 | 1774 | 0    | 1799 |
| Q Serve(g_s), s              | 1.3  | 0.0  | 3.6  | 0.8  | 0.0  | 4.9  | 1.9  | 0.0  | 8.1  | 2.4  | 0.0  | 5.8  |
| Cycle Q Clear(g_c), s        | 1.3  | 0.0  | 3.6  | 0.8  | 0.0  | 4.9  | 1.9  | 0.0  | 8.1  | 2.4  | 0.0  | 5.8  |
| Prop In Lane                 | 1.00 |      | 0.40 | 1.00 |      | 0.53 | 1.00 |      | 0.31 | 1.00 |      | 0.20 |
| Lane Grp Cap(c), veh/h       | 97   | 0    | 411  | 67   | 0    | 374  | 121  | 0    | 481  | 139  | 0    | 509  |
| V/C Ratio(X)                 | 0.56 | 0.00 | 0.40 | 0.50 | 0.00 | 0.55 | 0.63 | 0.00 | 0.72 | 0.71 | 0.00 | 0.53 |
| Avail Cap(c_a), veh/h        | 235  | 0    | 1364 | 235  | 0    | 1336 | 235  | 0    | 1384 | 235  | 0    | 1411 |
| HCM Platoon Ratio            | 1.00 | 1.00 | 1.00 | 1.00 | 1.00 | 1.00 | 1.00 | 1.00 | 1.00 | 1.00 | 1.00 | 1.00 |
| Upstream Filter(I)           | 1.00 | 0.00 | 1.00 | 1.00 | 0.00 | 1.00 | 1.00 | 0.00 | 1.00 | 1.00 | 0.00 | 1.00 |
| Uniform Delay (d), s/veh     | 20.9 | 0.0  | 14.6 | 21.4 | 0.0  | 15.7 | 20.5 | 0.0  | 14.9 | 20.4 | 0.0  | 13.7 |
| Incr Delay (d2), s/veh       | 5.0  | 0.0  | 0.6  | 5.6  | 0.0  | 1.3  | 5.3  | 0.0  | 2.1  | 6.4  | 0.0  | 0.9  |
| Initial Q Delay(d3),s/veh    | 0.0  | 0.0  | 0.0  | 0.0  | 0.0  | 0.0  | 0.0  | 0.0  | 0.0  | 0.0  | 0.0  | 0.0  |
| %ile BackOfQ(50%),veh/ln     | 0.8  | 0.0  | 1.8  | 0.5  | 0.0  | 2.4  | 1.1  | 0.0  | 4.1  | 1.4  | 0.0  | 3.0  |
| LnGrp Delay(d),s/veh         | 25.9 | 0.0  | 15.2 | 27.0 | 0.0  | 17.0 | 25.9 | 0.0  | 17.0 | 26.8 | 0.0  | 14.6 |
| LnGrp LOS                    | C    |      | B    | C    |      | B    | C    |      | B    | C    |      | B    |
| Approach Vol, veh/h          |      | 217  |      |      | 240  |      |      | 424  |      |      | 369  |      |
| Approach Delay, s/veh        |      | 17.8 |      |      | 18.4 |      |      | 18.6 |      |      | 17.8 |      |
| Approach LOS                 |      | B    |      |      | B    |      |      | B    |      |      | B    |      |
| Timer                        | 1    | 2    | 3    | 4    | 5    | 6    | 7    | 8    |      |      |      |      |
| Assigned Phs                 | 1    | 2    | 3    | 4    | 5    | 6    | 7    | 8    |      |      |      |      |
| Phs Duration (G+Y+Rc), s     | 7.5  | 16.8 | 5.7  | 15.2 | 7.1  | 17.3 | 6.5  | 14.4 |      |      |      |      |
| Change Period (Y+Rc), s      | 4.0  | 4.5  | 4.0  | 4.5  | 4.0  | 4.5  | 4.0  | 4.5  |      |      |      |      |
| Max Green Setting (Gmax), s  | 6.0  | 35.5 | 6.0  | 35.5 | 6.0  | 35.5 | 6.0  | 35.5 |      |      |      |      |
| Max Q Clear Time (g_c+14), s | 14.4 | 10.1 | 2.8  | 5.6  | 3.9  | 7.8  | 3.3  | 6.9  |      |      |      |      |
| Green Ext Time (p_c), s      | 0.0  | 2.2  | 0.0  | 1.0  | 0.0  | 1.7  | 0.0  | 1.3  |      |      |      |      |
| <b>Intersection Summary</b>  |      |      |      |      |      |      |      |      |      |      |      |      |
| HCM 2010 Ctrl Delay          |      |      | 18.2 |      |      |      |      |      |      |      |      |      |
| HCM 2010 LOS                 |      |      | B    |      |      |      |      |      |      |      |      |      |

HCM 2010 Signalized Intersection Summary  
 3: SR 1 SB On-Ramp/SR 1 SB Off-Ramp & Imjin Parkway

Cumulative with Project, AM  
 06/11/2019



| Movement                     | EBL | EBT | EBR | WBL   | WBT   | WBR  | NBL | NBT | NBR | SBL   | SBT   | SBR  |
|------------------------------|-----|-----|-----|-------|-------|------|-----|-----|-----|-------|-------|------|
| Lane Configurations          |     |     |     |       | ↕     |      |     |     |     |       | ↕     |      |
| Traffic Volume (veh/h)       | 0   | 0   | 0   | 1180  | 0     | 0    | 0   | 0   | 0   | 980   | 10    | 0    |
| Future Volume (veh/h)        | 0   | 0   | 0   | 1180  | 0     | 0    | 0   | 0   | 0   | 980   | 10    | 0    |
| Number                       |     |     |     | 1     | 6     | 16   |     |     |     | 7     | 4     | 14   |
| Initial Q (Qb), veh          |     |     |     | 0     | 0     | 0    |     |     |     | 0     | 0     | 0    |
| Ped-Bike Adj(A_pbT)          |     |     |     | 1.00  |       | 1.00 |     |     |     | 1.00  |       | 1.00 |
| Parking Bus, Adj             |     |     |     | 1.00  | 1.00  | 1.00 |     |     |     | 1.00  | 1.00  | 1.00 |
| Adj Sat Flow, veh/h/ln       |     |     |     | 1900  | 1845  | 0    |     |     |     | 1900  | 1845  | 0    |
| Adj Flow Rate, veh/h         |     |     |     | 1297  | 0     | 0    |     |     |     | 1077  | 11    | 0    |
| Adj No. of Lanes             |     |     |     | 0     | 1     | 0    |     |     |     | 0     | 1     | 0    |
| Peak Hour Factor             |     |     |     | 0.91  | 0.91  | 0.91 |     |     |     | 0.91  | 0.91  | 0.91 |
| Percent Heavy Veh, %         |     |     |     | 3     | 3     | 0    |     |     |     | 3     | 3     | 0    |
| Cap, veh/h                   |     |     |     | 996   | 0     | 0    |     |     |     | 657   | 7     | 0    |
| Arrive On Green              |     |     |     | 0.57  | 0.00  | 0.00 |     |     |     | 0.38  | 0.38  | 0.00 |
| Sat Flow, veh/h              |     |     |     | 1757  | 0     | 0    |     |     |     | 1740  | 18    | 0    |
| Grp Volume(v), veh/h         |     |     |     | 1297  | 0     | 0    |     |     |     | 1088  | 0     | 0    |
| Grp Sat Flow(s),veh/h/ln     |     |     |     | 1757  | 0     | 0    |     |     |     | 1758  | 0     | 0    |
| Q Serve(g_s), s              |     |     |     | 90.0  | 0.0   | 0.0  |     |     |     | 60.0  | 0.0   | 0.0  |
| Cycle Q Clear(g_c), s        |     |     |     | 90.0  | 0.0   | 0.0  |     |     |     | 60.0  | 0.0   | 0.0  |
| Prop In Lane                 |     |     |     | 1.00  |       | 0.00 |     |     |     | 0.99  |       | 0.00 |
| Lane Grp Cap(c), veh/h       |     |     |     | 996   | 0     | 0    |     |     |     | 664   | 0     | 0    |
| V/C Ratio(X)                 |     |     |     | 1.30  | 0.00  | 0.00 |     |     |     | 1.64  | 0.00  | 0.00 |
| Avail Cap(c_a), veh/h        |     |     |     | 996   | 0     | 0    |     |     |     | 664   | 0     | 0    |
| HCM Platoon Ratio            |     |     |     | 1.00  | 1.00  | 1.00 |     |     |     | 1.00  | 1.00  | 1.00 |
| Upstream Filter(I)           |     |     |     | 1.00  | 0.00  | 0.00 |     |     |     | 1.00  | 0.00  | 0.00 |
| Uniform Delay (d), s/veh     |     |     |     | 34.4  | 0.0   | 0.0  |     |     |     | 49.4  | 0.0   | 0.0  |
| Incr Delay (d2), s/veh       |     |     |     | 143.6 | 0.0   | 0.0  |     |     |     | 294.0 | 0.0   | 0.0  |
| Initial Q Delay(d3),s/veh    |     |     |     | 0.0   | 0.0   | 0.0  |     |     |     | 0.0   | 0.0   | 0.0  |
| %ile BackOfQ(50%),veh/ln     |     |     |     | 83.1  | 0.0   | 0.0  |     |     |     | 83.2  | 0.0   | 0.0  |
| LnGrp Delay(d),s/veh         |     |     |     | 178.0 | 0.0   | 0.0  |     |     |     | 343.4 | 0.0   | 0.0  |
| LnGrp LOS                    |     |     |     | F     |       |      |     |     |     | F     |       |      |
| Approach Vol, veh/h          |     |     |     |       | 1297  |      |     |     |     |       | 1088  |      |
| Approach Delay, s/veh        |     |     |     |       | 178.0 |      |     |     |     |       | 343.4 |      |
| Approach LOS                 |     |     |     |       | F     |      |     |     |     |       | F     |      |
| Timer                        | 1   | 2   | 3   | 4     | 5     | 6    | 7   | 8   |     |       |       |      |
| Assigned Phs                 |     |     |     | 4     |       | 6    |     |     |     |       |       |      |
| Phs Duration (G+Y+Rc), s     |     |     |     | 64.4  |       | 94.4 |     |     |     |       |       |      |
| Change Period (Y+Rc), s      |     |     |     | 4.4   |       | 4.4  |     |     |     |       |       |      |
| Max Green Setting (Gmax), s  |     |     |     | 60.0  |       | 90.0 |     |     |     |       |       |      |
| Max Q Clear Time (g_c+I1), s |     |     |     | 62.0  |       | 92.0 |     |     |     |       |       |      |
| Green Ext Time (p_c), s      |     |     |     | 0.0   |       | 0.0  |     |     |     |       |       |      |
| <b>Intersection Summary</b>  |     |     |     |       |       |      |     |     |     |       |       |      |
| HCM 2010 Ctrl Delay          |     |     |     | 253.4 |       |      |     |     |     |       |       |      |
| HCM 2010 LOS                 |     |     |     | F     |       |      |     |     |     |       |       |      |

| Intersection             |      |      |      |      |      |      |      |      |      |      |       |      |
|--------------------------|------|------|------|------|------|------|------|------|------|------|-------|------|
| Int Delay, s/veh         | 1.3  |      |      |      |      |      |      |      |      |      |       |      |
| Movement                 | EBL  | EBT  | EBR  | WBL  | WBT  | WBR  | NBL  | NBT  | NBR  | SBL  | SBT   | SBR  |
| Lane Configurations      |      | ↔    |      |      | ↑    | ↗    |      | ↖    | ↗    |      |       |      |
| Traffic Vol, veh/h       | 10   | 990  | 0    | 0    | 1140 | 440  | 10   | 10   | 1060 | 0    | 0     | 0    |
| Future Vol, veh/h        | 10   | 990  | 0    | 0    | 1140 | 440  | 10   | 10   | 1060 | 0    | 0     | 0    |
| Conflicting Peds, #/hr   | 0    | 0    | 3    | 3    | 0    | 0    | 0    | 0    | 0    | 0    | 0     | 0    |
| Sign Control             | Free | Free | Free | Free | Free | Free | Stop | Stop | Stop | Stop | Stop  | Stop |
| RT Channelized           | -    | -    | None | -    | -    | Free | -    | -    | Free | -    | -     | None |
| Storage Length           | -    | -    | -    | -    | -    | 0    | -    | -    | 800  | -    | -     | -    |
| Veh in Median Storage, # | -    | 0    | -    | -    | 0    | -    | -    | 0    | -    | -    | 16965 | -    |
| Grade, %                 | -    | 0    | -    | -    | 0    | -    | -    | 0    | -    | -    | 0     | -    |
| Peak Hour Factor         | 97   | 97   | 97   | 97   | 97   | 97   | 97   | 97   | 97   | 97   | 97    | 97   |
| Heavy Vehicles, %        | 3    | 3    | 3    | 3    | 3    | 3    | 2    | 2    | 2    | 2    | 2     | 2    |
| Mvmt Flow                | 10   | 1021 | 0    | 0    | 1175 | 454  | 10   | 10   | 1093 | 0    | 0     | 0    |























| Major/Minor          | Major1 | Major2 | Minor1 |
|----------------------|--------|--------|--------|
| Conflicting Flow All | 1175   | 0      | -      |
| Stage 1              | -      | -      | -      |
| Stage 2              | -      | -      | -      |
| Critical Hdwy        | 4.13   | -      | -      |
| Critical Hdwy Stg 1  | -      | -      | -      |
| Critical Hdwy Stg 2  | -      | -      | -      |
| Follow-up Hdwy       | 2.227  | -      | -      |
| Pot Cap-1 Maneuver   | 591    | 0      | 0      |
| Stage 1              | -      | 0      | 0      |
| Stage 2              | -      | 0      | 0      |
| Platoon blocked, %   | -      | -      | -      |
| Mov Cap-1 Maneuver   | 591    | -      | -      |
| Mov Cap-2 Maneuver   | -      | -      | -      |
| Stage 1              | -      | -      | -      |
| Stage 2              | -      | -      | -      |

| Approach             | EB  | WB | NB    |
|----------------------|-----|----|-------|
| HCM Control Delay, s | 0.1 | 0  | 135.7 |
| HCM LOS              |     |    | F     |

| Minor Lane/Major Mvmt | NBLn1 | NBLn2 | EBL   | EBT | WBT |
|-----------------------|-------|-------|-------|-----|-----|
| Capacity (veh/h)      | 46    | -     | 591   | -   | -   |
| HCM Lane V/C Ratio    | 0.448 | -     | 0.017 | -   | -   |
| HCM Control Delay (s) | 135.7 | 0     | 11.2  | 0   | -   |
| HCM Lane LOS          | F     | A     | B     | A   | -   |
| HCM 95th %tile Q(veh) | 1.6   | -     | 0.1   | -   | -   |

HCM 2010 Signalized Intersection Summary  
 5: 2nd Avenue & Imjin Parkway

Cumulative with Project, AM  
 06/11/2019

|                              |  |  |  |  |  |  |  |  |  |  |  |  |
|------------------------------|---|---|---|---|---|---|--|---|---|---|---|---|
| Movement                     | EBL   | EBT   | EBR   | WBL   | WBT   | WBR   | NBL  | NBT   | NBR   | SBL   | SBT   | SBR   |
| Lane Configurations          |  |  |  |  |  |   |  |  |  |  |  |  |
| Traffic Volume (veh/h)       | 180   | 1160  | 880   | 520   | 1010  | 120   | 370  | 90  | 200   | 50  | 100   | 210   |
| Future Volume (veh/h)        | 180   | 1160  | 880   | 520   | 1010  | 120   | 370  | 90  | 200   | 50  | 100   | 210   |
| Number                       | 5   | 2   | 12  | 1   | 6   | 16  | 3  | 8   | 18  | 7   | 4   | 14  |
| Initial Q (Qb), veh          | 0   | 0   | 0   | 0   | 0   | 0   | 0  | 0   | 0   | 0   | 0   | 0   |
| Ped-Bike Adj(A_pbT)          | 1.00  |   | 1.00  | 1.00  |   | 1.00  | 1.00   |   | 1.00  | 1.00  |   | 1.00  |
| Parking Bus, Adj             | 1.00  | 1.00  | 1.00  | 1.00  | 1.00  | 1.00  | 1.00   | 1.00  | 1.00  | 1.00  | 1.00  | 1.00  |
| Adj Sat Flow, veh/h/ln       | 1863  | 1863  | 1863  | 1863  | 1863  | 1900  | 1810   | 1810  | 1810  | 1900  | 1900  | 1900  |
| Adj Flow Rate, veh/h         | 184   | 1184  | 679   | 531   | 1031  | 122   | 378  | 92  | 82  | 51  | 102   | 209   |
| Adj No. of Lanes             | 1   | 2   | 1   | 2   | 2   | 0   | 2  | 1   | 1   | 1   | 2   | 0   |
| Peak Hour Factor             | 0.98  | 0.98  | 0.98  | 0.98  | 0.98  | 0.98  | 0.98   | 0.98  | 0.98  | 0.98  | 0.98  | 0.98  |
| Percent Heavy Veh, %         | 2   | 2   | 2   | 2   | 2   | 2   | 5  | 5   | 5   | 0   | 0   | 0   |
| Cap, veh/h                   | 220   | 1204  | 539   | 585   | 1231  | 146   | 447  | 428   | 363   | 91  | 276   | 247   |
| Arrive On Green              | 0.12  | 0.34  | 0.34  | 0.17  | 0.39  | 0.39  | 0.13   | 0.24  | 0.24  | 0.05  | 0.15  | 0.15  |
| Sat Flow, veh/h              | 1774  | 3539  | 1583  | 3442  | 3189  | 377   | 3343   | 1810  | 1536  | 1810  | 1805  | 1612  |
| Grp Volume(v), veh/h         | 184   | 1184  | 679   | 531   | 572   | 581   | 378  | 92  | 82  | 51  | 102   | 209   |
| Grp Sat Flow(s),veh/h/ln     | 1774  | 1770  | 1583  | 1721  | 1770  | 1796  | 1672   | 1810  | 1536  | 1810  | 1805  | 1612  |
| Q Serve(g_s), s              | 8.9   | 29.2  | 30.0  | 13.3  | 25.8  | 25.9  | 9.7  | 3.6   | 3.8   | 2.4   | 4.5   | 11.1  |
| Cycle Q Clear(g_c), s        | 8.9   | 29.2  | 30.0  | 13.3  | 25.8  | 25.9  | 9.7  | 3.6   | 3.8   | 2.4   | 4.5   | 11.1  |
| Prop In Lane                 | 1.00  |   | 1.00  | 1.00  |   | 0.21  | 1.00   |   | 1.00  | 1.00  |   | 1.00  |
| Lane Grp Cap(c), veh/h       | 220   | 1204  | 539   | 585   | 683   | 694   | 447  | 428   | 363   | 91  | 276   | 247   |
| V/C Ratio(X)                 | 0.83  | 0.98  | 1.26  | 0.91  | 0.84  | 0.84  | 0.85   | 0.22  | 0.23  | 0.56  | 0.37  | 0.85  |
| Avail Cap(c_a), veh/h        | 302   | 1204  | 539   | 585   | 683   | 694   | 758  | 431   | 366   | 205   | 430   | 384   |
| HCM Platoon Ratio            | 1.00  | 1.00  | 1.00  | 1.00  | 1.00  | 1.00  | 1.00   | 1.00  | 1.00  | 1.00  | 1.00  | 1.00  |
| Upstream Filter(I)           | 1.00  | 1.00  | 1.00  | 1.00  | 1.00  | 1.00  | 1.00   | 1.00  | 1.00  | 1.00  | 1.00  | 1.00  |
| Uniform Delay (d), s/veh     | 37.7  | 28.8  | 29.1  | 35.9  | 24.5  | 24.6  | 37.3   | 27.1  | 27.2  | 40.9  | 33.5  | 36.3  |
| Incr Delay (d2), s/veh       | 10.2  | 21.8  | 131.6   | 17.5  | 8.5   | 8.4   | 1.7  | 0.1   | 0.1   | 2.0   | 0.3   | 6.0   |
| Initial Q Delay(d3),s/veh    | 0.0   | 0.0   | 0.0   | 0.0   | 0.0   | 0.0   | 0.0  | 0.0   | 0.0   | 0.0   | 0.0   | 0.0   |
| %ile BackOfQ(50%),veh/ln     | 5.0   | 17.8  | 32.7  | 7.8   | 14.2  | 14.4  | 4.6  | 1.8   | 1.6   | 1.3   | 2.3   | 5.3   |
| LnGrp Delay(d),s/veh         | 47.9  | 50.7  | 160.7   | 53.4  | 33.0  | 33.0  | 39.0   | 27.2  | 27.3  | 42.9  | 33.8  | 42.4  |
| LnGrp LOS                    | D   | D   | F   | D   | C   | C   | D  | C   | C   | D   | C   | D   |
| Approach Vol, veh/h          |   | 2047  |   |   | 1684  |   |  | 552   |   |   | 362   |   |
| Approach Delay, s/veh        |   | 86.9  |   |   | 39.4  |   |  | 35.3  |   |   | 40.1  |   |
| Approach LOS                 |   | F   |   |   | D   |   |  | D   |   |   | D   |   |
| Timer                        | 1   | 2   | 3   | 4   | 5   | 6   | 7  | 8   |   |   |   |   |
| Assigned Phs                 | 1   | 2   | 3   | 4   | 5   | 6   | 7  | 8   |   |   |   |   |
| Phs Duration (G+Y+Rc), s     | 19.5  | 35.3  | 15.3  | 18.1  | 15.5  | 39.3  | 7.9  | 25.4  |   |   |   |   |
| Change Period (Y+Rc), s      | 4.5   | 5.3   | 3.5   | 4.6   | 4.5   | 5.3   | 3.5  | 4.6   |   |   |   |   |
| Max Green Setting (Gmax), s  | 15.0  | 30.0  | 20.0  | 21.0  | 15.0  | 30.0  | 10.0   | 21.0  |   |   |   |   |
| Max Q Clear Time (g_c+I1), s | 15.3  | 32.0  | 11.7  | 13.1  | 10.9  | 27.9  | 4.4  | 5.8   |   |   |   |   |
| Green Ext Time (p_c), s      | 0.0   | 0.0   | 0.1   | 0.3   | 0.0   | 0.5   | 0.0  | 0.1   |   |   |   |   |
| <b>Intersection Summary</b>  |   |   |   |   |   |   |  |   |   |   |   |   |
| HCM 2010 Ctrl Delay          |   |   | 59.9  |   |   |   |  |   |   |   |   |   |
| HCM 2010 LOS                 |   |   | E   |   |   |   |  |   |   |   |   |   |

HCM 2010 Signalized Intersection Summary  
6: 3rd Avenue & Imjin Parkway

Cumulative with Project, AM  
06/11/2019



| Movement                       | EBL  | EBT  | EBR  | WBL  | WBT  | WBR  | NBL  | NBT  | NBR  | SBL  | SBT  | SBR  |
|--------------------------------|------|------|------|------|------|------|------|------|------|------|------|------|
| Lane Configurations            | ↖    | ↗    |      | ↖    | ↗    |      | ↖    | ↗    |      | ↖    | ↗    |      |
| Traffic Volume (veh/h)         | 50   | 1010 | 220  | 350  | 1510 | 30   | 130  | 10   | 70   | 10   | 10   | 30   |
| Future Volume (veh/h)          | 50   | 1010 | 220  | 350  | 1510 | 30   | 130  | 10   | 70   | 10   | 10   | 30   |
| Number                         | 5    | 2    | 12   | 1    | 6    | 16   | 3    | 8    | 18   | 7    | 4    | 14   |
| Initial Q (Qb), veh            | 0    | 0    | 0    | 0    | 0    | 0    | 0    | 0    | 0    | 0    | 0    | 0    |
| Ped-Bike Adj(A_pbT)            | 1.00 |      | 1.00 | 1.00 |      | 1.00 | 1.00 |      | 1.00 | 1.00 |      | 1.00 |
| Parking Bus, Adj               | 1.00 | 1.00 | 1.00 | 1.00 | 1.00 | 1.00 | 1.00 | 1.00 | 1.00 | 1.00 | 1.00 | 1.00 |
| Adj Sat Flow, veh/h/ln         | 1863 | 1863 | 1900 | 1863 | 1863 | 1900 | 1810 | 1810 | 1900 | 1863 | 1863 | 1900 |
| Adj Flow Rate, veh/h           | 52   | 1052 | 200  | 365  | 1573 | 30   | 135  | 10   | 19   | 10   | 10   | -4   |
| Adj No. of Lanes               | 1    | 2    | 0    | 1    | 2    | 0    | 1    | 1    | 0    | 1    | 1    | 0    |
| Peak Hour Factor               | 0.96 | 0.96 | 0.96 | 0.96 | 0.96 | 0.96 | 0.96 | 0.96 | 0.96 | 0.96 | 0.96 | 0.96 |
| Percent Heavy Veh, %           | 2    | 2    | 2    | 2    | 2    | 2    | 5    | 5    | 5    | 2    | 2    | 2    |
| Cap, veh/h                     | 64   | 1178 | 223  | 380  | 2042 | 39   | 318  | 77   | 146  | 302  | 257  | 0    |
| Arrive On Green                | 0.04 | 0.40 | 0.40 | 0.21 | 0.57 | 0.57 | 0.14 | 0.14 | 0.14 | 0.14 | 0.14 | 0.00 |
| Sat Flow, veh/h                | 1774 | 2969 | 563  | 1774 | 3553 | 68   | 1358 | 558  | 1059 | 1370 | 1863 | 0    |
| Grp Volume(v), veh/h           | 52   | 626  | 626  | 365  | 782  | 821  | 135  | 0    | 29   | 10   | 6    | 0    |
| Grp Sat Flow(s),veh/h/ln       | 1774 | 1770 | 1763 | 1774 | 1770 | 1851 | 1358 | 0    | 1617 | 1370 | 1863 | 0    |
| Q Serve(g_s), s                | 1.6  | 17.7 | 17.9 | 10.9 | 18.1 | 18.2 | 5.1  | 0.0  | 0.8  | 0.3  | 0.1  | 0.0  |
| Cycle Q Clear(g_c), s          | 1.6  | 17.7 | 17.9 | 10.9 | 18.1 | 18.2 | 5.3  | 0.0  | 0.8  | 1.2  | 0.1  | 0.0  |
| Prop In Lane                   | 1.00 |      | 0.32 | 1.00 |      | 0.04 | 1.00 |      | 0.66 | 1.00 |      | 0.00 |
| Lane Grp Cap(c), veh/h         | 64   | 702  | 699  | 380  | 1017 | 1064 | 318  | 0    | 223  | 302  | 257  | 0    |
| V/C Ratio(X)                   | 0.82 | 0.89 | 0.90 | 0.96 | 0.77 | 0.77 | 0.42 | 0.00 | 0.13 | 0.03 | 0.02 | 0.00 |
| Avail Cap(c_a), veh/h          | 380  | 1070 | 1066 | 380  | 1070 | 1120 | 825  | 0    | 828  | 814  | 953  | 0    |
| HCM Platoon Ratio              | 1.00 | 1.00 | 1.00 | 1.00 | 1.00 | 1.00 | 1.00 | 1.00 | 1.00 | 1.00 | 1.00 | 1.00 |
| Upstream Filter(I)             | 1.00 | 1.00 | 1.00 | 1.00 | 1.00 | 1.00 | 1.00 | 0.00 | 1.00 | 1.00 | 1.00 | 0.00 |
| Uniform Delay (d), s/veh       | 25.7 | 15.1 | 15.2 | 20.9 | 8.7  | 8.7  | 22.3 | 0.0  | 20.3 | 20.8 | 20.0 | 0.0  |
| Incr Delay (d2), s/veh         | 9.1  | 4.6  | 4.8  | 35.8 | 2.9  | 2.8  | 0.3  | 0.0  | 0.1  | 0.0  | 0.0  | 0.0  |
| Initial Q Delay(d3),s/veh      | 0.0  | 0.0  | 0.0  | 0.0  | 0.0  | 0.0  | 0.0  | 0.0  | 0.0  | 0.0  | 0.0  | 0.0  |
| %ile BackOfQ(50%),veh/ln       | 0.9  | 9.4  | 9.5  | 9.0  | 9.5  | 10.0 | 1.9  | 0.0  | 0.4  | 0.1  | 0.1  | 0.0  |
| LnGrp Delay(d),s/veh           | 34.9 | 19.7 | 20.0 | 56.7 | 11.6 | 11.6 | 22.6 | 0.0  | 20.4 | 20.9 | 20.0 | 0.0  |
| LnGrp LOS                      | C    | B    | B    | E    | B    | B    | C    |      | C    | C    | C    |      |
| Approach Vol, veh/h            |      | 1304 |      |      | 1968 |      |      | 164  |      |      | 16   |      |
| Approach Delay, s/veh          |      | 20.4 |      |      | 19.9 |      |      | 22.2 |      |      | 20.6 |      |
| Approach LOS                   |      | C    |      |      | B    |      |      | C    |      |      | C    |      |
| Timer                          | 1    | 2    | 3    | 4    | 5    | 6    | 7    | 8    |      |      |      |      |
| Assigned Phs                   | 1    | 2    |      | 4    | 5    | 6    |      | 8    |      |      |      |      |
| Phs Duration (G+Y+Rc), s       | 5.0  | 26.8 |      | 11.9 | 5.4  | 36.4 |      | 11.9 |      |      |      |      |
| Change Period (Y+Rc), s        | 3.5  | 5.5  |      | 4.5  | 3.5  | 5.5  |      | 4.5  |      |      |      |      |
| Max Green Setting (Gmax), s    | 11.5 | 32.5 |      | 27.5 | 11.5 | 32.5 |      | 27.5 |      |      |      |      |
| Max Q Clear Time (g_c+11.2), s | 11.2 | 19.9 |      | 3.2  | 3.6  | 20.2 |      | 7.3  |      |      |      |      |
| Green Ext Time (p_c), s        | 0.0  | 1.4  |      | 0.0  | 0.0  | 1.2  |      | 0.0  |      |      |      |      |
| <b>Intersection Summary</b>    |      |      |      |      |      |      |      |      |      |      |      |      |
| HCM 2010 Ctrl Delay            |      |      |      | 20.2 |      |      |      |      |      |      |      |      |
| HCM 2010 LOS                   |      |      |      | C    |      |      |      |      |      |      |      |      |



HCM 2010 Signalized Intersection Summary  
7: 4th Avenue & Imjin Parkway

Cumulative with Project, AM  
06/11/2019



| Movement                    | EBL  | EBT  | EBR  | WBL  | WBT  | WBR  | NBL  | NBT  | NBR  | SBL  | SBT  | SBR  |
|-----------------------------|------|------|------|------|------|------|------|------|------|------|------|------|
| Lane Configurations         |      |      |      |      |      |      |      |      |      |      |      |      |
| Traffic Volume (veh/h)      | 10   | 1110 | 20   | 10   | 1820 | 10   | 10   | 10   | 10   | 10   | 10   | 10   |
| Future Volume (veh/h)       | 10   | 1110 | 20   | 10   | 1820 | 10   | 10   | 10   | 10   | 10   | 10   | 10   |
| Number                      | 5    | 2    | 12   | 1    | 6    | 16   | 3    | 8    | 18   | 7    | 4    | 14   |
| Initial Q (Qb), veh         | 0    | 0    | 0    | 0    | 0    | 0    | 0    | 0    | 0    | 0    | 0    | 0    |
| Ped-Bike Adj(A_pbT)         | 1.00 |      | 1.00 | 1.00 |      | 1.00 | 1.00 |      | 1.00 | 1.00 |      | 1.00 |
| Parking Bus, Adj            | 1.00 | 1.00 | 1.00 | 1.00 | 1.00 | 1.00 | 1.00 | 1.00 | 1.00 | 1.00 | 1.00 | 1.00 |
| Adj Sat Flow, veh/h/ln      | 1863 | 1863 | 1900 | 1863 | 1863 | 1900 | 1900 | 1267 | 1900 | 1900 | 1900 | 1900 |
| Adj Flow Rate, veh/h        | 10   | 1156 | 20   | 10   | 1896 | 9    | 10   | 10   | 9    | 10   | 10   | 10   |
| Adj No. of Lanes            | 1    | 2    | 0    | 1    | 2    | 0    | 0    | 1    | 0    | 0    | 1    | 0    |
| Peak Hour Factor            | 0.96 | 0.96 | 0.96 | 0.96 | 0.96 | 0.96 | 0.96 | 0.96 | 0.96 | 0.96 | 0.96 | 0.96 |
| Percent Heavy Veh, %        | 2    | 2    | 2    | 2    | 2    | 2    | 50   | 50   | 50   | 0    | 0    | 0    |
| Cap, veh/h                  | 14   | 2036 | 35   | 14   | 2066 | 10   | 152  | 19   | 17   | 160  | 29   | 29   |
| Arrive On Green             | 0.01 | 0.57 | 0.57 | 0.01 | 0.57 | 0.57 | 0.05 | 0.05 | 0.05 | 0.05 | 0.05 | 0.05 |
| Sat Flow, veh/h             | 1774 | 3560 | 62   | 1774 | 3612 | 17   | 390  | 390  | 351  | 580  | 580  | 580  |
| Grp Volume(v), veh/h        | 10   | 575  | 601  | 10   | 928  | 977  | 29   | 0    | 0    | 30   | 0    | 0    |
| Grp Sat Flow(s),veh/h/ln    | 1774 | 1770 | 1852 | 1774 | 1770 | 1860 | 1132 | 0    | 0    | 1740 | 0    | 0    |
| Q Serve(g_s), s             | 0.2  | 7.5  | 7.5  | 0.2  | 17.2 | 17.2 | 0.3  | 0.0  | 0.0  | 0.0  | 0.0  | 0.0  |
| Cycle Q Clear(g_c), s       | 0.2  | 7.5  | 7.5  | 0.2  | 17.2 | 17.2 | 0.9  | 0.0  | 0.0  | 0.6  | 0.0  | 0.0  |
| Prop In Lane                | 1.00 |      | 0.03 | 1.00 |      | 0.01 | 0.34 |      | 0.31 | 0.33 |      | 0.33 |
| Lane Grp Cap(c), veh/h      | 14   | 1012 | 1059 | 14   | 1012 | 1064 | 189  | 0    | 0    | 218  | 0    | 0    |
| V/C Ratio(X)                | 0.71 | 0.57 | 0.57 | 0.71 | 0.92 | 0.92 | 0.15 | 0.00 | 0.00 | 0.14 | 0.00 | 0.00 |
| Avail Cap(c_a), veh/h       | 560  | 1580 | 1653 | 560  | 1580 | 1660 | 951  | 0    | 0    | 1361 | 0    | 0    |
| HCM Platoon Ratio           | 1.00 | 1.00 | 1.00 | 1.00 | 1.00 | 1.00 | 1.00 | 1.00 | 1.00 | 1.00 | 1.00 | 1.00 |
| Upstream Filter(I)          | 1.00 | 1.00 | 1.00 | 1.00 | 1.00 | 1.00 | 1.00 | 0.00 | 0.00 | 1.00 | 0.00 | 0.00 |
| Uniform Delay (d), s/veh    | 18.0 | 4.9  | 4.9  | 18.0 | 7.0  | 7.0  | 16.8 | 0.0  | 0.0  | 16.7 | 0.0  | 0.0  |
| Incr Delay (d2), s/veh      | 21.6 | 0.2  | 0.2  | 21.6 | 4.3  | 4.2  | 0.1  | 0.0  | 0.0  | 0.1  | 0.0  | 0.0  |
| Initial Q Delay(d3),s/veh   | 0.0  | 0.0  | 0.0  | 0.0  | 0.0  | 0.0  | 0.0  | 0.0  | 0.0  | 0.0  | 0.0  | 0.0  |
| %ile BackOfQ(50%),veh/ln    | 0.2  | 3.6  | 3.7  | 0.2  | 9.2  | 9.6  | 0.3  | 0.0  | 0.0  | 0.3  | 0.0  | 0.0  |
| LnGrp Delay(d),s/veh        | 39.6 | 5.1  | 5.1  | 39.6 | 11.3 | 11.2 | 17.0 | 0.0  | 0.0  | 16.8 | 0.0  | 0.0  |
| LnGrp LOS                   | D    | A    | A    | D    | B    | B    | B    |      |      | B    |      |      |
| Approach Vol, veh/h         |      | 1186 |      |      | 1915 |      |      | 29   |      |      | 30   |      |
| Approach Delay, s/veh       |      | 5.4  |      |      | 11.4 |      |      | 17.0 |      |      | 16.8 |      |
| Approach LOS                |      | A    |      |      | B    |      |      | B    |      |      | B    |      |
| Timer                       | 1    | 2    | 3    | 4    | 5    | 6    | 7    | 8    |      |      |      |      |
| Assigned Phs                | 1    | 2    |      | 4    | 5    | 6    |      | 8    |      |      |      |      |
| Phs Duration (G+Y+Rc), s    | 3.8  | 26.3 |      | 6.3  | 3.8  | 26.3 |      | 6.3  |      |      |      |      |
| Change Period (Y+Rc), s     | 3.5  | 5.5  |      | 4.5  | 3.5  | 5.5  |      | 4.5  |      |      |      |      |
| Max Green Setting (Gmax), s | 1.5  | 32.5 |      | 27.5 | 11.5 | 32.5 |      | 27.5 |      |      |      |      |
| Max Q Clear Time (g_c+1), s | 12.2 | 9.5  |      | 2.6  | 2.2  | 19.2 |      | 2.9  |      |      |      |      |
| Green Ext Time (p_c), s     | 0.0  | 0.8  |      | 0.0  | 0.0  | 1.6  |      | 0.0  |      |      |      |      |
| <b>Intersection Summary</b> |      |      |      |      |      |      |      |      |      |      |      |      |
| HCM 2010 Ctrl Delay         |      |      |      | 9.2  |      |      |      |      |      |      |      |      |
| HCM 2010 LOS                |      |      |      | A    |      |      |      |      |      |      |      |      |

HCM 2010 Signalized Intersection Summary  
 8: 5th Avenue/California Avenue & Imjin Parkway

Cumulative with Project, AM  
 06/11/2019



| Movement                    | EBL  | EBT  | EBR  | WBL  | WBT  | WBR  | NBL  | NBT  | NBR  | SBL   | SBT   | SBR  |
|-----------------------------|------|------|------|------|------|------|------|------|------|-------|-------|------|
| Lane Configurations         |      |      |      |      |      |      |      |      |      |       |       |      |
| Traffic Volume (veh/h)      | 140  | 1020 | 20   | 10   | 1200 | 80   | 20   | 20   | 10   | 100   | 130   | 490  |
| Future Volume (veh/h)       | 140  | 1020 | 20   | 10   | 1200 | 80   | 20   | 20   | 10   | 100   | 130   | 490  |
| Number                      | 5    | 2    | 12   | 1    | 6    | 16   | 3    | 8    | 18   | 7     | 4     | 14   |
| Initial Q (Qb), veh         | 0    | 0    | 0    | 0    | 0    | 0    | 0    | 0    | 0    | 0     | 0     | 0    |
| Ped-Bike Adj(A_pbT)         | 1.00 |      | 0.98 | 1.00 |      | 1.00 | 1.00 |      | 0.99 | 1.00  |       | 1.00 |
| Parking Bus, Adj            | 1.00 | 1.00 | 1.00 | 1.00 | 1.00 | 1.00 | 1.00 | 1.00 | 1.00 | 1.00  | 1.00  | 1.00 |
| Adj Sat Flow, veh/h/ln      | 1881 | 1881 | 1900 | 1863 | 1863 | 1900 | 1900 | 1624 | 1900 | 1900  | 1881  | 1900 |
| Adj Flow Rate, veh/h        | 147  | 1074 | 19   | 11   | 1263 | 78   | 21   | 21   | 10   | 105   | 137   | 442  |
| Adj No. of Lanes            | 1    | 2    | 0    | 1    | 2    | 0    | 0    | 1    | 0    | 0     | 1     | 0    |
| Peak Hour Factor            | 0.95 | 0.95 | 0.95 | 0.95 | 0.95 | 0.95 | 0.95 | 0.95 | 0.95 | 0.95  | 0.95  | 0.95 |
| Percent Heavy Veh, %        | 1    | 1    | 1    | 2    | 2    | 2    | 17   | 17   | 17   | 1     | 1     | 1    |
| Cap, veh/h                  | 185  | 1773 | 31   | 15   | 1350 | 83   | 157  | 137  | 52   | 123   | 110   | 312  |
| Arrive On Green             | 0.10 | 0.49 | 0.49 | 0.01 | 0.40 | 0.40 | 0.30 | 0.30 | 0.30 | 0.30  | 0.30  | 0.30 |
| Sat Flow, veh/h             | 1792 | 3592 | 64   | 1774 | 3387 | 209  | 275  | 461  | 175  | 205   | 368   | 1047 |
| Grp Volume(v), veh/h        | 147  | 534  | 559  | 11   | 659  | 682  | 52   | 0    | 0    | 684   | 0     | 0    |
| Grp Sat Flow(s),veh/h/ln    | 1792 | 1787 | 1868 | 1774 | 1770 | 1826 | 911  | 0    | 0    | 1620  | 0     | 0    |
| Q Serve(g_s), s             | 5.4  | 14.5 | 14.5 | 0.4  | 23.9 | 24.0 | 0.0  | 0.0  | 0.0  | 16.6  | 0.0   | 0.0  |
| Cycle Q Clear(g_c), s       | 5.4  | 14.5 | 14.5 | 0.4  | 23.9 | 24.0 | 1.6  | 0.0  | 0.0  | 20.0  | 0.0   | 0.0  |
| Prop In Lane                | 1.00 |      | 0.03 | 1.00 |      | 0.11 | 0.40 |      | 0.19 | 0.15  |       | 0.65 |
| Lane Grp Cap(c), veh/h      | 185  | 882  | 922  | 15   | 706  | 728  | 347  | 0    | 0    | 545   | 0     | 0    |
| V/C Ratio(X)                | 0.80 | 0.61 | 0.61 | 0.75 | 0.93 | 0.94 | 0.15 | 0.00 | 0.00 | 1.25  | 0.00  | 0.00 |
| Avail Cap(c_a), veh/h       | 401  | 882  | 922  | 397  | 792  | 817  | 347  | 0    | 0    | 545   | 0     | 0    |
| HCM Platoon Ratio           | 1.00 | 1.00 | 1.00 | 1.00 | 1.00 | 1.00 | 1.00 | 1.00 | 1.00 | 1.00  | 1.00  | 1.00 |
| Upstream Filter(I)          | 1.00 | 1.00 | 1.00 | 1.00 | 1.00 | 1.00 | 1.00 | 0.00 | 0.00 | 1.00  | 0.00  | 0.00 |
| Uniform Delay (d), s/veh    | 29.4 | 12.3 | 12.3 | 33.2 | 19.3 | 19.3 | 17.1 | 0.0  | 0.0  | 24.6  | 0.0   | 0.0  |
| Incr Delay (d2), s/veh      | 2.9  | 0.9  | 0.8  | 24.0 | 16.2 | 16.2 | 0.1  | 0.0  | 0.0  | 129.0 | 0.0   | 0.0  |
| Initial Q Delay(d3),s/veh   | 0.0  | 0.0  | 0.0  | 0.0  | 0.0  | 0.0  | 0.0  | 0.0  | 0.0  | 0.0   | 0.0   | 0.0  |
| %ile BackOfQ(50%),veh/ln    | 2.8  | 7.3  | 7.7  | 0.3  | 14.7 | 15.2 | 0.7  | 0.0  | 0.0  | 29.5  | 0.0   | 0.0  |
| LnGrp Delay(d),s/veh        | 32.3 | 13.1 | 13.1 | 57.2 | 35.5 | 35.6 | 17.2 | 0.0  | 0.0  | 153.6 | 0.0   | 0.0  |
| LnGrp LOS                   | C    | B    | B    | E    | D    | D    | B    |      |      | F     |       |      |
| Approach Vol, veh/h         |      | 1240 |      |      | 1352 |      |      | 52   |      |       | 684   |      |
| Approach Delay, s/veh       |      | 15.4 |      |      | 35.7 |      |      | 17.2 |      |       | 153.6 |      |
| Approach LOS                |      | B    |      |      | D    |      |      | B    |      |       | F     |      |
| Timer                       | 1    | 2    | 3    | 4    | 5    | 6    | 7    | 8    |      |       |       |      |
| Assigned Phs                | 1    | 2    |      | 4    | 5    | 6    |      | 8    |      |       |       |      |
| Phs Duration (G+Y+Rc), s    | 4.1  | 38.4 |      | 24.6 | 10.4 | 32.0 |      | 24.6 |      |       |       |      |
| Change Period (Y+Rc), s     | 3.5  | 5.3  |      | 4.6  | 3.5  | 5.3  |      | 4.6  |      |       |       |      |
| Max Green Setting (Gmax), s | 5.0  | 30.0 |      | 20.0 | 15.0 | 30.0 |      | 20.0 |      |       |       |      |
| Max Q Clear Time (g_c+1), s | 12.4 | 16.5 |      | 22.0 | 7.4  | 26.0 |      | 3.6  |      |       |       |      |
| Green Ext Time (p_c), s     | 0.0  | 0.8  |      | 0.0  | 0.0  | 0.7  |      | 0.1  |      |       |       |      |
| <b>Intersection Summary</b> |      |      |      |      |      |      |      |      |      |       |       |      |
| HCM 2010 Ctrl Delay         |      |      |      | 52.1 |      |      |      |      |      |       |       |      |
| HCM 2010 LOS                |      |      |      | D    |      |      |      |      |      |       |       |      |

| Intersection             |      |      |      |      |      |      |
|--------------------------|------|------|------|------|------|------|
| Int Delay, s/veh         | 1.4  |      |      |      |      |      |
| Movement                 | EBL  | EBR  | NBL  | NBT  | SBT  | SBR  |
| Lane Configurations      |      |      |      |      |      |      |
| Traffic Vol, veh/h       | 30   | 30   | 30   | 220  | 620  | 80   |
| Future Vol, veh/h        | 30   | 30   | 30   | 220  | 620  | 80   |
| Conflicting Peds, #/hr   | 0    | 0    | 0    | 0    | 0    | 0    |
| Sign Control             | Stop | Stop | Free | Free | Free | Free |
| RT Channelized           | -    | None | -    | None | -    | None |
| Storage Length           | 0    | -    | 155  | -    | -    | -    |
| Veh in Median Storage, # | 0    | -    | -    | 0    | 0    | -    |
| Grade, %                 | 0    | -    | -    | 0    | 0    | -    |
| Peak Hour Factor         | 92   | 92   | 92   | 92   | 92   | 92   |
| Heavy Vehicles, %        | 2    | 2    | 2    | 2    | 2    | 2    |
| Mvmt Flow                | 33   | 33   | 33   | 239  | 674  | 87   |











| Major/Minor          | Minor2 | Major1 | Major2 |   |   |   |
|----------------------|--------|--------|--------|---|---|---|
| Conflicting Flow All | 1023   | 718    | 761    | 0 | - | 0 |
| Stage 1              | 718    | -      | -      | - | - | - |
| Stage 2              | 305    | -      | -      | - | - | - |
| Critical Hdwy        | 6.42   | 6.22   | 4.12   | - | - | - |
| Critical Hdwy Stg 1  | 5.42   | -      | -      | - | - | - |
| Critical Hdwy Stg 2  | 5.42   | -      | -      | - | - | - |
| Follow-up Hdwy       | 3.518  | 3.318  | 2.218  | - | - | - |
| Pot Cap-1 Maneuver   | 261    | 429    | 851    | - | - | - |
| Stage 1              | 483    | -      | -      | - | - | - |
| Stage 2              | 748    | -      | -      | - | - | - |
| Platoon blocked, %   |        |        |        | - | - | - |
| Mov Cap-1 Maneuver   | 251    | 429    | 851    | - | - | - |
| Mov Cap-2 Maneuver   | 251    | -      | -      | - | - | - |
| Stage 1              | 464    | -      | -      | - | - | - |
| Stage 2              | 748    | -      | -      | - | - | - |

| Approach             | EB   | NB  | SB |
|----------------------|------|-----|----|
| HCM Control Delay, s | 19.3 | 1.1 | 0  |
| HCM LOS              | C    |     |    |

| Minor Lane/Major Mvmt | NBL   | NBT | EBLn1 | SBT | SBR |
|-----------------------|-------|-----|-------|-----|-----|
| Capacity (veh/h)      | 851   | -   | 317   | -   | -   |
| HCM Lane V/C Ratio    | 0.038 | -   | 0.206 | -   | -   |
| HCM Control Delay (s) | 9.4   | -   | 19.3  | -   | -   |
| HCM Lane LOS          | A     | -   | C     | -   | -   |
| HCM 95th %tile Q(veh) | 0.1   | -   | 0.8   | -   | -   |

HCM 2010 Signalized Intersection Summary  
 10: Imjin Road & Imjin Parkway

Cumulative with Project, AM  
 06/11/2019

|                              |  |  |  |  |  |  |   |      |
|------------------------------|---|---|---|---|---|---|---|------|
| Movement                     | EBT   | EBR   | WBL   | WBT   | NBL   | NBR   |   |      |
| Lane Configurations          |  |   |  |  |  |  |   |      |
| Traffic Volume (veh/h)       | 900   | 250   | 550   | 1170  | 100   | 160   |   |      |
| Future Volume (veh/h)        | 900   | 250   | 550   | 1170  | 100   | 160   |   |      |
| Number                       | 2   | 12  | 1   | 6   | 3   | 18  |   |      |
| Initial Q (Qb), veh          | 0   | 0   | 0   | 0   | 0   | 0   |   |      |
| Ped-Bike Adj(A_pbT)          |   | 1.00  | 1.00  |   | 1.00  | 1.00  |   |      |
| Parking Bus, Adj             | 1.00  | 1.00  | 1.00  | 1.00  | 1.00  | 1.00  |   |      |
| Adj Sat Flow, veh/h/ln       | 1863  | 1900  | 1845  | 1845  | 1810  | 1810  |   |      |
| Adj Flow Rate, veh/h         | 947   | 250   | 579   | 1232  | 91  | 183   |   |      |
| Adj No. of Lanes             | 2   | 0   | 1   | 2   | 1   | 2   |   |      |
| Peak Hour Factor             | 0.95  | 0.95  | 0.95  | 0.95  | 0.95  | 0.95  |   |      |
| Percent Heavy Veh, %         | 2   | 2   | 3   | 3   | 5   | 5   |   |      |
| Cap, veh/h                   | 1030  | 271   | 548   | 2685  | 153   | 273   |   |      |
| Arrive On Green              | 0.37  | 0.37  | 0.31  | 0.77  | 0.09  | 0.09  |   |      |
| Sat Flow, veh/h              | 2866  | 730   | 1757  | 3597  | 1723  | 3076  |   |      |
| Grp Volume(v), veh/h         | 604   | 593   | 579   | 1232  | 91  | 183   |   |      |
| Grp Sat Flow(s),veh/h/ln     | 1770  | 1734  | 1757  | 1752  | 1723  | 1538  |   |      |
| Q Serve(g_s), s              | 20.9  | 21.0  | 20.0  | 8.1   | 3.3   | 3.7   |   |      |
| Cycle Q Clear(g_c), s        | 20.9  | 21.0  | 20.0  | 8.1   | 3.3   | 3.7   |   |      |
| Prop In Lane                 |   | 0.42  | 1.00  |   | 1.00  | 1.00  |   |      |
| Lane Grp Cap(c), veh/h       | 657   | 644   | 548   | 2685  | 153   | 273   |   |      |
| V/C Ratio(X)                 | 0.92  | 0.92  | 1.06  | 0.46  | 0.59  | 0.67  |   |      |
| Avail Cap(c_a), veh/h        | 828   | 812   | 548   | 2685  | 592   | 1056  |   |      |
| HCM Platoon Ratio            | 1.00  | 1.00  | 1.00  | 1.00  | 1.00  | 1.00  |   |      |
| Upstream Filter(I)           | 1.00  | 1.00  | 1.00  | 1.00  | 1.00  | 1.00  |   |      |
| Uniform Delay (d), s/veh     | 19.2  | 19.3  | 22.0  | 2.7   | 28.1  | 28.3  |   |      |
| Incr Delay (d2), s/veh       | 11.7  | 12.4  | 54.1  | 0.0   | 1.4   | 1.1   |   |      |
| Initial Q Delay(d3),s/veh    | 0.0   | 0.0   | 0.0   | 0.0   | 0.0   | 0.0   |   |      |
| %ile BackOfQ(50%),veh/ln     | 12.2  | 12.1  | 17.8  | 3.8   | 1.6   | 1.6   |   |      |
| LnGrp Delay(d),s/veh         | 30.9  | 31.6  | 76.1  | 2.8   | 29.5  | 29.3  |   |      |
| LnGrp LOS                    | C   | C   | F   | A   | C   | C   |   |      |
| Approach Vol, veh/h          | 1197  |   |   | 1811  | 274   |   |   |      |
| Approach Delay, s/veh        | 31.3  |   |   | 26.2  | 29.4  |   |   |      |
| Approach LOS                 | C   |   |   | C   | C   |   |   |      |
| Timer                        | 1   | 2   | 3   | 4   | 5   | 6   | 7 | 8    |
| Assigned Phs                 | 1   | 2   |   |   |   | 6   |   | 8    |
| Phs Duration (G+Y+Rc), s     | 25.3  | 29.1  |   |   |   | 54.4  |   | 9.7  |
| Change Period (Y+Rc), s      | 5.3   | * 5.3   |   |   |   | 5.3   |   | 4.0  |
| Max Green Setting (Gmax), s  | 20.0  | * 30  |   |   |   | 30.0  |   | 22.0 |
| Max Q Clear Time (g_c+I1), s | 22.0  | 23.0  |   |   |   | 10.1  |   | 5.7  |
| Green Ext Time (p_c), s      | 0.0   | 0.8   |   |   |   | 1.5   |   | 0.0  |
| <b>Intersection Summary</b>  |   |   |   |   |   |   |   |      |
| HCM 2010 Ctrl Delay          |   |   | 28.3  |   |   |   |   |      |
| HCM 2010 LOS                 |   |   | C   |   |   |   |   |      |
| <b>Notes</b>                 |   |   |   |   |   |   |   |      |

HCM 2010 Signalized Intersection Summary  
 11: Abrams Drive & Imjin Parkway

Cumulative with Project, AM  
 06/11/2019



| Movement                     | EBL  | EBT  | EBR  | WBL  | WBT  | WBR  | NBL  | NBT  | NBR  | SBL  | SBT  | SBR  |
|------------------------------|------|------|------|------|------|------|------|------|------|------|------|------|
| Lane Configurations          | ↔    | ↗    |      | ↔    | ↗    |      | ↔    | ↑    | ↗    | ↔    | ↑    | ↗    |
| Traffic Volume (veh/h)       | 50   | 840  | 80   | 90   | 1250 | 70   | 320  | 30   | 90   | 90   | 50   | 250  |
| Future Volume (veh/h)        | 50   | 840  | 80   | 90   | 1250 | 70   | 320  | 30   | 90   | 90   | 50   | 250  |
| Number                       | 5    | 2    | 12   | 1    | 6    | 16   | 3    | 8    | 18   | 7    | 4    | 14   |
| Initial Q (Qb), veh          | 0    | 0    | 0    | 0    | 0    | 0    | 0    | 0    | 0    | 0    | 0    | 0    |
| Ped-Bike Adj(A_pbT)          | 1.00 |      | 1.00 | 1.00 |      | 1.00 | 1.00 |      | 1.00 | 1.00 |      | 1.00 |
| Parking Bus, Adj             | 1.00 | 1.00 | 1.00 | 1.00 | 1.00 | 1.00 | 1.00 | 1.00 | 1.00 | 1.00 | 1.00 | 1.00 |
| Adj Sat Flow, veh/h/ln       | 1881 | 1881 | 1900 | 1863 | 1863 | 1900 | 1845 | 1845 | 1845 | 1863 | 1863 | 1863 |
| Adj Flow Rate, veh/h         | 54   | 903  | 74   | 97   | 1344 | 70   | 344  | 32   | 0    | 97   | 54   | 0    |
| Adj No. of Lanes             | 2    | 2    | 0    | 2    | 2    | 0    | 1    | 1    | 1    | 1    | 1    | 1    |
| Peak Hour Factor             | 0.93 | 0.93 | 0.93 | 0.93 | 0.93 | 0.93 | 0.93 | 0.93 | 0.93 | 0.93 | 0.93 | 0.93 |
| Percent Heavy Veh, %         | 1    | 1    | 1    | 2    | 2    | 2    | 3    | 3    | 3    | 2    | 2    | 2    |
| Cap, veh/h                   | 180  | 1670 | 137  | 160  | 1670 | 87   | 457  | 550  | 468  | 479  | 555  | 472  |
| Arrive On Green              | 0.05 | 0.50 | 0.50 | 0.05 | 0.49 | 0.49 | 0.30 | 0.30 | 0.00 | 0.30 | 0.30 | 0.00 |
| Sat Flow, veh/h              | 3476 | 3346 | 274  | 3442 | 3423 | 178  | 1330 | 1845 | 1568 | 1370 | 1863 | 1583 |
| Grp Volume(v), veh/h         | 54   | 482  | 495  | 97   | 694  | 720  | 344  | 32   | 0    | 97   | 54   | 0    |
| Grp Sat Flow(s),veh/h/ln     | 1738 | 1787 | 1833 | 1721 | 1770 | 1831 | 1330 | 1845 | 1568 | 1370 | 1863 | 1583 |
| Q Serve(g_s), s              | 1.2  | 15.2 | 15.2 | 2.3  | 27.1 | 27.2 | 20.7 | 1.0  | 0.0  | 4.5  | 1.7  | 0.0  |
| Cycle Q Clear(g_c), s        | 1.2  | 15.2 | 15.2 | 2.3  | 27.1 | 27.2 | 22.4 | 1.0  | 0.0  | 5.5  | 1.7  | 0.0  |
| Prop In Lane                 | 1.00 |      | 0.15 | 1.00 |      | 0.10 | 1.00 |      | 1.00 | 1.00 |      | 1.00 |
| Lane Grp Cap(c), veh/h       | 180  | 892  | 915  | 160  | 863  | 893  | 457  | 550  | 468  | 479  | 555  | 472  |
| V/C Ratio(X)                 | 0.30 | 0.54 | 0.54 | 0.61 | 0.80 | 0.81 | 0.75 | 0.06 | 0.00 | 0.20 | 0.10 | 0.00 |
| Avail Cap(c_a), veh/h        | 848  | 1090 | 1117 | 839  | 1079 | 1117 | 547  | 675  | 574  | 572  | 682  | 579  |
| HCM Platoon Ratio            | 1.00 | 1.00 | 1.00 | 1.00 | 1.00 | 1.00 | 1.00 | 1.00 | 1.00 | 1.00 | 1.00 | 1.00 |
| Upstream Filter(I)           | 1.00 | 1.00 | 1.00 | 1.00 | 1.00 | 1.00 | 1.00 | 1.00 | 0.00 | 1.00 | 1.00 | 0.00 |
| Uniform Delay (d), s/veh     | 37.4 | 14.1 | 14.1 | 38.4 | 17.7 | 17.7 | 28.9 | 20.5 | 0.0  | 22.5 | 20.8 | 0.0  |
| Incr Delay (d2), s/veh       | 0.3  | 0.2  | 0.2  | 1.4  | 2.8  | 2.8  | 3.7  | 0.0  | 0.0  | 0.1  | 0.0  | 0.0  |
| Initial Q Delay(d3),s/veh    | 0.0  | 0.0  | 0.0  | 0.0  | 0.0  | 0.0  | 0.0  | 0.0  | 0.0  | 0.0  | 0.0  | 0.0  |
| %ile BackOfQ(50%),veh/ln     | 0.6  | 7.4  | 7.6  | 1.1  | 13.8 | 14.3 | 8.0  | 0.5  | 0.0  | 1.7  | 0.9  | 0.0  |
| LnGrp Delay(d),s/veh         | 37.8 | 14.3 | 14.3 | 39.7 | 20.5 | 20.5 | 32.6 | 20.6 | 0.0  | 22.6 | 20.8 | 0.0  |
| LnGrp LOS                    | D    | B    | B    | D    | C    | C    | C    | C    |      | C    | C    |      |
| Approach Vol, veh/h          |      | 1031 |      |      | 1511 |      |      | 376  |      |      | 151  |      |
| Approach Delay, s/veh        |      | 15.5 |      |      | 21.8 |      |      | 31.6 |      |      | 22.0 |      |
| Approach LOS                 |      | B    |      |      | C    |      |      | C    |      |      | C    |      |
| Timer                        | 1    | 2    | 3    | 4    | 5    | 6    | 7    | 8    |      |      |      |      |
| Assigned Phs                 | 1    | 2    |      | 4    | 5    | 6    |      | 8    |      |      |      |      |
| Phs Duration (G+Y+Rc), s     | 7.3  | 46.2 |      | 28.5 | 8.2  | 45.3 |      | 28.5 |      |      |      |      |
| Change Period (Y+Rc), s      | 3.5  | 5.3  |      | 4.0  | 4.0  | 5.3  |      | 4.0  |      |      |      |      |
| Max Green Setting (Gmax), s  | 20.0 | 50.0 |      | 30.0 | 20.0 | 50.0 |      | 30.0 |      |      |      |      |
| Max Q Clear Time (g_c+14), s | 14.3 | 17.2 |      | 7.5  | 3.2  | 29.2 |      | 24.4 |      |      |      |      |
| Green Ext Time (p_c), s      | 0.0  | 0.7  |      | 0.0  | 0.0  | 1.1  |      | 0.1  |      |      |      |      |
| <b>Intersection Summary</b>  |      |      |      |      |      |      |      |      |      |      |      |      |
| HCM 2010 Ctrl Delay          |      |      | 20.9 |      |      |      |      |      |      |      |      |      |
| HCM 2010 LOS                 |      |      | C    |      |      |      |      |      |      |      |      |      |

HCM 2010 Signalized Intersection Summary  
 12: Reservation Road & Imjin Parkway

Cumulative with Project, AM  
 06/11/2019



| Movement                    | EBL  | EBT   | EBR  | WBL  | WBT  | WBR   | NBL  | NBT  | NBR  | SBL  | SBT  | SBR  |
|-----------------------------|------|-------|------|------|------|-------|------|------|------|------|------|------|
| Lane Configurations         |      |       |      |      |      |       |      |      |      |      |      |      |
| Traffic Volume (veh/h)      | 180  | 50    | 810  | 10   | 20   | 30    | 1220 | 890  | 20   | 60   | 590  | 90   |
| Future Volume (veh/h)       | 180  | 50    | 810  | 10   | 20   | 30    | 1220 | 890  | 20   | 60   | 590  | 90   |
| Number                      | 3    | 8     | 18   | 7    | 4    | 14    | 1    | 6    | 16   | 5    | 2    | 12   |
| Initial Q (Qb), veh         | 0    | 0     | 0    | 0    | 0    | 0     | 0    | 0    | 0    | 0    | 0    | 0    |
| Ped-Bike Adj(A_pbT)         | 1.00 |       | 1.00 | 1.00 |      | 0.99  | 1.00 |      | 1.00 | 1.00 |      | 0.98 |
| Parking Bus, Adj            | 1.00 | 1.00  | 1.00 | 1.00 | 1.00 | 1.00  | 1.00 | 1.00 | 1.00 | 1.00 | 1.00 | 1.00 |
| Adj Sat Flow, veh/h/ln      | 1863 | 1863  | 1863 | 1638 | 1638 | 1638  | 1863 | 1863 | 1863 | 1863 | 1863 | 1863 |
| Adj Flow Rate, veh/h        | 194  | 54    | 457  | 11   | 22   | 19    | 1312 | 957  | 16   | 65   | 634  | 34   |
| Adj No. of Lanes            | 2    | 1     | 2    | 1    | 1    | 1     | 2    | 2    | 1    | 2    | 2    | 1    |
| Peak Hour Factor            | 0.93 | 0.93  | 0.93 | 0.93 | 0.93 | 0.93  | 0.93 | 0.93 | 0.93 | 0.93 | 0.93 | 0.93 |
| Percent Heavy Veh, %        | 2    | 2     | 2    | 16   | 16   | 16    | 2    | 2    | 2    | 2    | 2    | 2    |
| Cap, veh/h                  | 479  | 259   | 1343 | 53   | 56   | 47    | 1182 | 2087 | 932  | 114  | 988  | 435  |
| Arrive On Green             | 0.14 | 0.14  | 0.14 | 0.03 | 0.03 | 0.03  | 0.34 | 0.59 | 0.59 | 0.03 | 0.28 | 0.28 |
| Sat Flow, veh/h             | 3442 | 1863  | 2777 | 1560 | 1638 | 1382  | 3442 | 3539 | 1581 | 3442 | 3539 | 1558 |
| Grp Volume(v), veh/h        | 194  | 54    | 457  | 11   | 22   | 19    | 1312 | 957  | 16   | 65   | 634  | 34   |
| Grp Sat Flow(s),veh/h/ln    | 1721 | 1863  | 1388 | 1560 | 1638 | 1382  | 1721 | 1770 | 1581 | 1721 | 1770 | 1558 |
| Q Serve(g_s), s             | 5.2  | 2.6   | 10.4 | 0.7  | 1.3  | 1.4   | 35.0 | 15.5 | 0.4  | 1.9  | 16.0 | 1.6  |
| Cycle Q Clear(g_c), s       | 5.2  | 2.6   | 10.4 | 0.7  | 1.3  | 1.4   | 35.0 | 15.5 | 0.4  | 1.9  | 16.0 | 1.6  |
| Prop In Lane                | 1.00 |       | 1.00 | 1.00 |      | 1.00  | 1.00 |      | 1.00 | 1.00 |      | 1.00 |
| Lane Grp Cap(c), veh/h      | 479  | 259   | 1343 | 53   | 56   | 47    | 1182 | 2087 | 932  | 114  | 988  | 435  |
| V/C Ratio(X)                | 0.41 | 0.21  | 0.34 | 0.21 | 0.39 | 0.40  | 1.11 | 0.46 | 0.02 | 0.57 | 0.64 | 0.08 |
| Avail Cap(c_a), veh/h       | 1182 | 640   | 1911 | 475  | 498  | 420   | 1182 | 2087 | 932  | 675  | 2084 | 917  |
| HCM Platoon Ratio           | 1.00 | 1.00  | 1.00 | 1.00 | 1.00 | 1.00  | 1.00 | 1.00 | 1.00 | 1.00 | 1.00 | 1.00 |
| Upstream Filter(I)          | 1.00 | 1.00  | 1.00 | 1.00 | 1.00 | 1.00  | 1.00 | 1.00 | 1.00 | 1.00 | 1.00 | 1.00 |
| Uniform Delay (d), s/veh    | 40.0 | 38.9  | 16.3 | 47.9 | 48.2 | 48.2  | 33.5 | 11.8 | 8.7  | 48.6 | 32.2 | 27.1 |
| Incr Delay (d2), s/veh      | 0.2  | 0.1   | 0.1  | 0.7  | 1.7  | 2.0   | 61.8 | 0.4  | 0.0  | 1.7  | 1.9  | 0.2  |
| Initial Q Delay(d3),s/veh   | 0.0  | 0.0   | 0.0  | 0.0  | 0.0  | 0.0   | 0.0  | 0.0  | 0.0  | 0.0  | 0.0  | 0.0  |
| %ile BackOfQ(50%),veh/ln    | 2.5  | 1.4   | 4.0  | 0.3  | 0.6  | 0.6   | 26.7 | 7.7  | 0.2  | 0.9  | 8.1  | 0.7  |
| LnGrp Delay(d),s/veh        | 40.2 | 39.0  | 16.4 | 48.6 | 49.8 | 50.2  | 95.2 | 12.2 | 8.7  | 50.2 | 34.2 | 27.3 |
| LnGrp LOS                   | D    | D     | B    | D    | D    | D     | F    | B    | A    | D    | C    | C    |
| Approach Vol, veh/h         |      | 705   |      |      | 52   |       |      | 2285 |      |      | 733  |      |
| Approach Delay, s/veh       |      | 24.7  |      |      | 49.7 |       |      | 59.9 |      |      | 35.3 |      |
| Approach LOS                |      | C     |      |      | D    |       |      | E    |      |      | D    |      |
| Timer                       | 1    | 2     | 3    | 4    | 5    | 6     | 7    | 8    |      |      |      |      |
| Assigned Phs                | 1    | 2     |      | 4    | 5    | 6     |      | 8    |      |      |      |      |
| Phs Duration (G+Y+Rc), s    | 39.1 | 34.7  |      | 8.5  | 7.5  | 66.3  |      | 19.7 |      |      |      |      |
| Change Period (Y+Rc), s     | 4.1  | * 6.2 |      | 5.0  | 4.1  | * 6.2 |      | 5.5  |      |      |      |      |
| Max Green Setting (Gmax), s | 35.0 | * 60  |      | 31.0 | 20.0 | * 50  |      | 35.0 |      |      |      |      |
| Max Q Clear Time (g_c+Q), s | 37.0 | 18.0  |      | 3.4  | 3.9  | 17.5  |      | 12.4 |      |      |      |      |
| Green Ext Time (p_c), s     | 0.0  | 10.4  |      | 0.1  | 0.0  | 15.3  |      | 1.5  |      |      |      |      |
| <b>Intersection Summary</b> |      |       |      |      |      |       |      |      |      |      |      |      |
| HCM 2010 Ctrl Delay         |      |       | 48.4 |      |      |       |      |      |      |      |      |      |
| HCM 2010 LOS                |      |       | D    |      |      |       |      |      |      |      |      |      |
| <b>Notes</b>                |      |       |      |      |      |       |      |      |      |      |      |      |

HCM 2010 Signalized Intersection Summary  
 13: Reservation Road & Blanco Road

Cumulative with Project, AM  
 06/11/2019

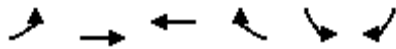

| Movement                     | EBL  | EBT  | WBT  | WBR  | SBL  | SBR  |   |   |
|------------------------------|------|------|------|------|------|------|---|---|
| Lane Configurations          |      |      |      |      |      |      |   |   |
| Traffic Volume (veh/h)       | 1060 | 380  | 720  | 40   | 40   | 1410 |   |   |
| Future Volume (veh/h)        | 1060 | 380  | 720  | 40   | 40   | 1410 |   |   |
| Number                       | 5    | 2    | 6    | 16   | 7    | 14   |   |   |
| Initial Q (Qb), veh          | 0    | 0    | 0    | 0    | 0    | 0    |   |   |
| Ped-Bike Adj(A_pbT)          | 1.00 |      |      | 1.00 | 1.00 | 1.00 |   |   |
| Parking Bus, Adj             | 1.00 | 1.00 | 1.00 | 1.00 | 1.00 | 1.00 |   |   |
| Adj Sat Flow, veh/h/ln       | 1863 | 1863 | 1845 | 1845 | 1845 | 1845 |   |   |
| Adj Flow Rate, veh/h         | 1140 | 409  | 774  | 24   | 43   | 0    |   |   |
| Adj No. of Lanes             | 2    | 2    | 1    | 1    | 2    | 2    |   |   |
| Peak Hour Factor             | 0.93 | 0.93 | 0.93 | 0.93 | 0.93 | 0.93 |   |   |
| Percent Heavy Veh, %         | 2    | 2    | 3    | 3    | 3    | 3    |   |   |
| Cap, veh/h                   | 1208 | 3074 | 843  | 716  | 99   | 80   |   |   |
| Arrive On Green              | 0.35 | 0.87 | 0.46 | 0.46 | 0.03 | 0.00 |   |   |
| Sat Flow, veh/h              | 3442 | 3632 | 1845 | 1568 | 3408 | 2760 |   |   |
| Grp Volume(v), veh/h         | 1140 | 409  | 774  | 24   | 43   | 0    |   |   |
| Grp Sat Flow(s),veh/h/ln     | 1721 | 1770 | 1845 | 1568 | 1704 | 1380 |   |   |
| Q Serve(g_s), s              | 29.2 | 1.6  | 35.7 | 0.8  | 1.1  | 0.0  |   |   |
| Cycle Q Clear(g_c), s        | 29.2 | 1.6  | 35.7 | 0.8  | 1.1  | 0.0  |   |   |
| Prop In Lane                 | 1.00 |      |      | 1.00 | 1.00 | 1.00 |   |   |
| Lane Grp Cap(c), veh/h       | 1208 | 3074 | 843  | 716  | 99   | 80   |   |   |
| V/C Ratio(X)                 | 0.94 | 0.13 | 0.92 | 0.03 | 0.43 | 0.00 |   |   |
| Avail Cap(c_a), veh/h        | 1516 | 3074 | 1219 | 1036 | 1013 | 821  |   |   |
| HCM Platoon Ratio            | 1.00 | 1.00 | 1.00 | 1.00 | 1.00 | 1.00 |   |   |
| Upstream Filter(I)           | 1.00 | 1.00 | 1.00 | 1.00 | 1.00 | 0.00 |   |   |
| Uniform Delay (d), s/veh     | 28.6 | 0.9  | 23.1 | 13.6 | 43.3 | 0.0  |   |   |
| Incr Delay (d2), s/veh       | 9.8  | 0.0  | 7.7  | 0.0  | 1.1  | 0.0  |   |   |
| Initial Q Delay(d3),s/veh    | 0.0  | 0.0  | 0.0  | 0.0  | 0.0  | 0.0  |   |   |
| %ile BackOfQ(50%),veh/lt     | 5.4  | 0.7  | 19.9 | 0.3  | 0.5  | 0.0  |   |   |
| LnGrp Delay(d),s/veh         | 38.4 | 0.9  | 30.8 | 13.6 | 44.4 | 0.0  |   |   |
| LnGrp LOS                    | D    | A    | C    | B    | D    |      |   |   |
| Approach Vol, veh/h          |      | 1549 | 798  |      | 43   |      |   |   |
| Approach Delay, s/veh        |      | 28.5 | 30.3 |      | 44.4 |      |   |   |
| Approach LOS                 |      | C    | C    |      | D    |      |   |   |
| Timer                        | 1    | 2    | 3    | 4    | 5    | 6    | 7 | 8 |
| Assigned Phs                 |      | 2    |      | 4    | 5    | 6    |   |   |
| Phs Duration (G+Y+Rc), s     |      | 84.6 |      | 6.1  | 37.4 | 47.3 |   |   |
| Change Period (Y+Rc), s      |      | 5.8  |      | 3.5  | 5.5  | 5.8  |   |   |
| Max Green Setting (Gmax), s  |      | 60.0 |      | 27.0 | 40.0 | 60.0 |   |   |
| Max Q Clear Time (g_c+I1), s |      | 3.6  |      | 3.1  | 31.2 | 37.7 |   |   |
| Green Ext Time (p_c), s      |      | 1.9  |      | 0.0  | 0.7  | 3.8  |   |   |
| <b>Intersection Summary</b>  |      |      |      |      |      |      |   |   |
| HCM 2010 Ctrl Delay          |      |      | 29.4 |      |      |      |   |   |
| HCM 2010 LOS                 |      |      | C    |      |      |      |   |   |

HCM 2010 Signalized Intersection Summary  
 14: Reservation Road & Inter-Garrison Road

Cumulative with Project, AM  
 06/11/2019



| Movement                     | EBL  | EBR  | NBL   | NBT  | SBT  | SBR  |   |      |
|------------------------------|------|------|-------|------|------|------|---|------|
| Lane Configurations          |      |      |       |      |      |      |   |      |
| Traffic Volume (veh/h)       | 190  | 370  | 600   | 600  | 310  | 190  |   |      |
| Future Volume (veh/h)        | 190  | 370  | 600   | 600  | 310  | 190  |   |      |
| Number                       | 3    | 18   | 1     | 6    | 2    | 12   |   |      |
| Initial Q (Qb), veh          | 0    | 0    | 0     | 0    | 0    | 0    |   |      |
| Ped-Bike Adj(A_pbT)          | 1.00 | 1.00 | 1.00  |      |      | 1.00 |   |      |
| Parking Bus, Adj             | 1.00 | 1.00 | 1.00  | 1.00 | 1.00 | 1.00 |   |      |
| Adj Sat Flow, veh/h/ln       | 1845 | 1845 | 1863  | 1863 | 1845 | 1900 |   |      |
| Adj Flow Rate, veh/h         | 202  | 355  | 638   | 638  | 330  | 186  |   |      |
| Adj No. of Lanes             | 1    | 1    | 1     | 2    | 2    | 0    |   |      |
| Peak Hour Factor             | 0.94 | 0.94 | 0.94  | 0.94 | 0.94 | 0.94 |   |      |
| Percent Heavy Veh, %         | 3    | 3    | 2     | 2    | 3    | 3    |   |      |
| Cap, veh/h                   | 354  | 795  | 542   | 2236 | 555  | 307  |   |      |
| Arrive On Green              | 0.20 | 0.20 | 0.31  | 0.63 | 0.25 | 0.25 |   |      |
| Sat Flow, veh/h              | 1757 | 1568 | 1774  | 3632 | 2273 | 1204 |   |      |
| Grp Volume(v), veh/h         | 202  | 355  | 638   | 638  | 264  | 252  |   |      |
| Grp Sat Flow(s),veh/h/ln     | 1757 | 1568 | 1774  | 1770 | 1752 | 1632 |   |      |
| Q Serve(g_s), s              | 6.8  | 9.4  | 20.0  | 5.3  | 8.7  | 8.9  |   |      |
| Cycle Q Clear(g_c), s        | 6.8  | 9.4  | 20.0  | 5.3  | 8.7  | 8.9  |   |      |
| Prop In Lane                 | 1.00 | 1.00 | 1.00  |      |      | 0.74 |   |      |
| Lane Grp Cap(c), veh/h       | 354  | 795  | 542   | 2236 | 446  | 416  |   |      |
| V/C Ratio(X)                 | 0.57 | 0.45 | 1.18  | 0.29 | 0.59 | 0.61 |   |      |
| Avail Cap(c_a), veh/h        | 724  | 1126 | 542   | 3243 | 1606 | 1496 |   |      |
| HCM Platoon Ratio            | 1.00 | 1.00 | 1.00  | 1.00 | 1.00 | 1.00 |   |      |
| Upstream Filter(I)           | 1.00 | 1.00 | 1.00  | 1.00 | 1.00 | 1.00 |   |      |
| Uniform Delay (d), s/veh     | 23.6 | 10.3 | 22.7  | 5.4  | 21.4 | 21.5 |   |      |
| Incr Delay (d2), s/veh       | 1.4  | 0.4  | 97.8  | 0.1  | 2.3  | 2.7  |   |      |
| Initial Q Delay(d3),s/veh    | 0.0  | 0.0  | 0.0   | 0.0  | 0.0  | 0.0  |   |      |
| %ile BackOfQ(50%),veh/ln     | 3.4  | 4.2  | 24.4  | 2.6  | 4.5  | 4.3  |   |      |
| LnGrp Delay(d),s/veh         | 25.0 | 10.7 | 120.5 | 5.5  | 23.7 | 24.2 |   |      |
| LnGrp LOS                    | C    | B    | F     | A    | C    | C    |   |      |
| Approach Vol, veh/h          | 557  |      |       | 1276 | 516  |      |   |      |
| Approach Delay, s/veh        | 15.9 |      |       | 63.0 | 23.9 |      |   |      |
| Approach LOS                 | B    |      |       | E    | C    |      |   |      |
| Timer                        | 1    | 2    | 3     | 4    | 5    | 6    | 7 | 8    |
| Assigned Phs                 | 1    | 2    |       |      |      | 6    |   | 8    |
| Phs Duration (G+Y+Rc), s     | 24.7 | 23.1 |       |      |      | 47.8 |   | 17.7 |
| Change Period (Y+Rc), s      | 4.7  | 6.4  |       |      |      | 6.4  |   | 4.5  |
| Max Green Setting (Gmax), s  | 26   | 60.0 |       |      |      | 60.0 |   | 27.0 |
| Max Q Clear Time (g_c+Yc), s | 22.6 | 10.9 |       |      |      | 7.3  |   | 11.4 |
| Green Ext Time (p_c), s      | 0.0  | 5.8  |       |      |      | 8.0  |   | 1.8  |
| <b>Intersection Summary</b>  |      |      |       |      |      |      |   |      |
| HCM 2010 Ctrl Delay          |      |      | 43.3  |      |      |      |   |      |
| HCM 2010 LOS                 |      |      | D     |      |      |      |   |      |
| <b>Notes</b>                 |      |      |       |      |      |      |   |      |



HCM 2010 Signalized Intersection Summary  
 15: 2nd Avenue & 9th Street

Cumulative with Project, AM  
 06/11/2019



| Movement                     | EBL  | EBT    | EBR   | WBL  | WBT  | WBR  | NBL  | NBT  | NBR  | SBL  | SBT  | SBR  |
|------------------------------|------|--------|-------|------|------|------|------|------|------|------|------|------|
| Lane Configurations          |      | ↕      | ↗     |      | ↕    |      | ↖    | ↕    |      | ↖    | ↕    |      |
| Traffic Volume (veh/h)       | 10   | 10     | 10    | 260  | 10   | 20   | 20   | 390  | 30   | 40   | 920  | 10   |
| Future Volume (veh/h)        | 10   | 10     | 10    | 260  | 10   | 20   | 20   | 390  | 30   | 40   | 920  | 10   |
| Number                       | 5    | 2      | 12    | 1    | 6    | 16   | 3    | 8    | 18   | 7    | 4    | 14   |
| Initial Q (Qb), veh          | 0    | 0      | 0     | 0    | 0    | 0    | 0    | 0    | 0    | 0    | 0    | 0    |
| Ped-Bike Adj(A_pbT)          | 0.99 |        | 1.00  | 0.99 |      | 0.99 | 1.00 |      | 0.99 | 1.00 |      | 0.99 |
| Parking Bus, Adj             | 1.00 | 1.00   | 1.00  | 1.00 | 1.00 | 1.00 | 1.00 | 1.00 | 1.00 | 1.00 | 1.00 | 1.00 |
| Adj Sat Flow, veh/h/ln       | 1900 | 1881   | 1881  | 1900 | 1900 | 1900 | 1881 | 1881 | 1900 | 1863 | 1863 | 1900 |
| Adj Flow Rate, veh/h         | 11   | 11     | -24   | 277  | 11   | 20   | 21   | 415  | 27   | 43   | 979  | 4    |
| Adj No. of Lanes             | 0    | 1      | 1     | 0    | 1    | 0    | 1    | 2    | 0    | 1    | 2    | 0    |
| Peak Hour Factor             | 0.94 | 0.94   | 0.94  | 0.94 | 0.94 | 0.94 | 0.94 | 0.94 | 0.94 | 0.94 | 0.94 | 0.94 |
| Percent Heavy Veh, %         | 1    | 1      | 1     | 0    | 0    | 0    | 1    | 1    | 1    | 2    | 2    | 2    |
| Cap, veh/h                   | 318  | 283    | 450   | 513  | 15   | 27   | 46   | 1337 | 87   | 81   | 1491 | 6    |
| Arrive On Green              | 0.28 | 0.28   | 0.00  | 0.28 | 0.28 | 0.28 | 0.03 | 0.39 | 0.39 | 0.05 | 0.41 | 0.41 |
| Sat Flow, veh/h              | 731  | 1006   | 1599  | 1318 | 52   | 95   | 1792 | 3406 | 221  | 1774 | 3615 | 15   |
| Grp Volume(v), veh/h         | 22   | 0      | -24   | 308  | 0    | 0    | 21   | 217  | 225  | 43   | 479  | 504  |
| Grp Sat Flow(s),veh/h/ln1737 | 0    | 1599   | 1466  | 0    | 0    | 1792 | 1787 | 1840 | 1774 | 1770 | 1860 |      |
| Q Serve(g_s), s              | 0.0  | 0.0    | 0.0   | 8.7  | 0.0  | 0.0  | 0.6  | 4.0  | 4.1  | 1.1  | 10.5 | 10.5 |
| Cycle Q Clear(g_c), s        | 0.4  | 0.0    | 0.0   | 9.2  | 0.0  | 0.0  | 0.6  | 4.0  | 4.1  | 1.1  | 10.5 | 10.5 |
| Prop In Lane                 | 0.50 |        | 1.00  | 0.90 |      | 0.06 | 1.00 |      | 0.12 | 1.00 |      | 0.01 |
| Lane Grp Cap(c), veh/h       | 601  | 0      | 450   | 555  | 0    | 0    | 46   | 701  | 722  | 81   | 730  | 767  |
| V/C Ratio(X)                 | 0.04 | 0.00   | -0.05 | 0.56 | 0.00 | 0.00 | 0.46 | 0.31 | 0.31 | 0.53 | 0.66 | 0.66 |
| Avail Cap(c_a), veh/h        | 1146 | 0      | 998   | 1053 | 0    | 0    | 429  | 1673 | 1723 | 424  | 1657 | 1741 |
| HCM Platoon Ratio            | 1.00 | 1.00   | 1.00  | 1.00 | 1.00 | 1.00 | 1.00 | 1.00 | 1.00 | 1.00 | 1.00 | 1.00 |
| Upstream Filter(I)           | 1.00 | 0.00   | 0.00  | 1.00 | 0.00 | 0.00 | 1.00 | 1.00 | 1.00 | 1.00 | 1.00 | 1.00 |
| Uniform Delay (d), s/veh     | 12.6 | 0.0    | 0.0   | 15.7 | 0.0  | 0.0  | 23.1 | 10.1 | 10.1 | 22.4 | 11.4 | 11.4 |
| Incr Delay (d2), s/veh       | 0.0  | 0.0    | 0.0   | 0.9  | 0.0  | 0.0  | 7.1  | 0.2  | 0.2  | 5.4  | 1.0  | 1.0  |
| Initial Q Delay(d3),s/veh    | 0.0  | 0.0    | 0.0   | 0.0  | 0.0  | 0.0  | 0.0  | 0.0  | 0.0  | 0.0  | 0.0  | 0.0  |
| %ile BackOfQ(50%),veh/ln0.2  | 0.0  | 0.0    | 3.8   | 0.0  | 0.0  | 0.4  | 2.0  | 2.1  | 0.7  | 5.3  | 5.5  |      |
| LnGrp Delay(d),s/veh         | 12.6 | 0.0    | 0.0   | 16.5 | 0.0  | 0.0  | 30.2 | 10.3 | 10.4 | 27.8 | 12.4 | 12.3 |
| LnGrp LOS                    | B    |        |       | B    |      |      | C    | B    | B    | C    | B    | B    |
| Approach Vol, veh/h          |      | -2     |       |      | 308  |      |      | 463  |      |      | 1026 |      |
| Approach Delay, s/veh        |      | -138.5 |       |      | 16.5 |      |      | 11.2 |      |      | 13.0 |      |
| Approach LOS                 |      | A      |       |      | B    |      |      | B    |      |      | B    |      |
| Timer                        | 1    | 2      | 3     | 4    | 5    | 6    | 7    | 8    |      |      |      |      |
| Assigned Phs                 |      | 2      | 3     | 4    |      | 6    | 7    | 8    |      |      |      |      |
| Phs Duration (G+Y+Rc), s     |      | 18.5   | 4.7   | 24.8 |      | 18.5 | 5.7  | 23.9 |      |      |      |      |
| Change Period (Y+Rc), s      |      | 5.0    | 3.5   | 5.0  |      | 5.0  | 3.5  | 5.0  |      |      |      |      |
| Max Green Setting (Gmax), s  |      | 30.0   | 11.5  | 45.0 |      | 30.0 | 11.5 | 45.0 |      |      |      |      |
| Max Q Clear Time (g_c+I1), s |      | 2.4    | 2.6   | 12.5 |      | 11.2 | 3.1  | 6.1  |      |      |      |      |
| Green Ext Time (p_c), s      |      | 0.1    | 0.0   | 7.1  |      | 1.6  | 0.0  | 2.7  |      |      |      |      |
| <b>Intersection Summary</b>  |      |        |       |      |      |      |      |      |      |      |      |      |
| HCM 2010 Ctrl Delay          |      |        |       | 13.3 |      |      |      |      |      |      |      |      |
| HCM 2010 LOS                 |      |        |       | B    |      |      |      |      |      |      |      |      |

HCM 2010 Signalized Intersection Summary  
 16: 2nd Avenue & 8th Street

Cumulative with Project, AM  
 06/11/2019



| Movement                     | WBL  | WBR  | NBT  | NBR  | SBL  | SBT  |      |      |
|------------------------------|------|------|------|------|------|------|------|------|
| Lane Configurations          |      |      |      |      |      |      |      |      |
| Traffic Volume (veh/h)       | 380  | 40   | 510  | 160  | 80   | 1070 |      |      |
| Future Volume (veh/h)        | 380  | 40   | 510  | 160  | 80   | 1070 |      |      |
| Number                       | 1    | 16   | 8    | 18   | 7    | 4    |      |      |
| Initial Q (Qb), veh          | 0    | 0    | 0    | 0    | 0    | 0    |      |      |
| Ped-Bike Adj(A_pbT)          | 1.00 | 1.00 |      | 1.00 | 1.00 |      |      |      |
| Parking Bus, Adj             | 1.00 | 1.00 | 1.00 | 1.00 | 1.00 | 1.00 |      |      |
| Adj Sat Flow, veh/h/ln       | 1583 | 1583 | 1863 | 1900 | 1881 | 1881 |      |      |
| Adj Flow Rate, veh/h         | 400  | 26   | 537  | 152  | 84   | 1126 |      |      |
| Adj No. of Lanes             | 1    | 1    | 2    | 0    | 1    | 2    |      |      |
| Peak Hour Factor             | 0.95 | 0.95 | 0.95 | 0.95 | 0.95 | 0.95 |      |      |
| Percent Heavy Veh, %         | 20   | 20   | 2    | 2    | 1    | 1    |      |      |
| Cap, veh/h                   | 471  | 420  | 948  | 267  | 124  | 1740 |      |      |
| Arrive On Green              | 0.31 | 0.31 | 0.35 | 0.35 | 0.07 | 0.49 |      |      |
| Sat Flow, veh/h              | 1508 | 1346 | 2821 | 769  | 1792 | 3668 |      |      |
| Grp Volume(v), veh/h         | 400  | 26   | 348  | 341  | 84   | 1126 |      |      |
| Grp Sat Flow(s),veh/h/ln     | 1508 | 1346 | 1770 | 1727 | 1792 | 1787 |      |      |
| Q Serve(g_s), s              | 12.4 | 0.7  | 7.9  | 8.0  | 2.3  | 11.8 |      |      |
| Cycle Q Clear(g_c), s        | 12.4 | 0.7  | 7.9  | 8.0  | 2.3  | 11.8 |      |      |
| Prop In Lane                 | 1.00 | 1.00 |      | 0.45 | 1.00 |      |      |      |
| Lane Grp Cap(c), veh/h       | 471  | 420  | 615  | 600  | 124  | 1740 |      |      |
| V/C Ratio(X)                 | 0.85 | 0.06 | 0.57 | 0.57 | 0.68 | 0.65 |      |      |
| Avail Cap(c_a), veh/h        | 908  | 811  | 1599 | 1560 | 414  | 4306 |      |      |
| HCM Platoon Ratio            | 1.00 | 1.00 | 1.00 | 1.00 | 1.00 | 1.00 |      |      |
| Upstream Filter(I)           | 1.00 | 1.00 | 1.00 | 1.00 | 1.00 | 1.00 |      |      |
| Uniform Delay (d), s/veh     | 16.0 | 12.0 | 13.2 | 13.2 | 22.6 | 9.6  |      |      |
| Incr Delay (d2), s/veh       | 4.4  | 0.1  | 0.8  | 0.8  | 6.4  | 0.4  |      |      |
| Initial Q Delay(d3),s/veh    | 0.0  | 0.0  | 0.0  | 0.0  | 0.0  | 0.0  |      |      |
| %ile BackOfQ(50%),veh/ln     | 6.7  | 0.6  | 4.0  | 3.9  | 1.3  | 5.7  |      |      |
| LnGrp Delay(d),s/veh         | 20.4 | 12.1 | 14.0 | 14.1 | 29.0 | 10.0 |      |      |
| LnGrp LOS                    | C    | B    | B    | B    | C    | A    |      |      |
| Approach Vol, veh/h          | 426  |      | 689  |      |      | 1210 |      |      |
| Approach Delay, s/veh        | 19.9 |      | 14.0 |      |      | 11.3 |      |      |
| Approach LOS                 | B    |      | B    |      |      | B    |      |      |
| Timer                        | 1    | 2    | 3    | 4    | 5    | 6    | 7    | 8    |
| Assigned Phs                 |      |      |      | 4    |      | 6    | 7    | 8    |
| Phs Duration (G+Y+Rc), s     |      |      |      | 29.2 |      | 20.6 | 6.9  | 22.3 |
| Change Period (Y+Rc), s      |      |      |      | 5.0  |      | 5.0  | 3.5  | 5.0  |
| Max Green Setting (Gmax), s  |      |      |      | 60.0 |      | 30.0 | 11.5 | 45.0 |
| Max Q Clear Time (g_c+I1), s |      |      |      | 13.8 |      | 14.4 | 4.3  | 10.0 |
| Green Ext Time (p_c), s      |      |      |      | 10.5 |      | 1.2  | 0.1  | 4.7  |
| <b>Intersection Summary</b>  |      |      |      |      |      |      |      |      |
| HCM 2010 Ctrl Delay          |      |      | 13.7 |      |      |      |      |      |
| HCM 2010 LOS                 |      |      | B    |      |      |      |      |      |

| Intersection              |      |
|---------------------------|------|
| Intersection Delay, s/veh | 14.9 |
| Intersection LOS          | B    |

| Movement            | EBT  | EBR  | WBL  | WBT  | NBL  | NBR  |
|---------------------|------|------|------|------|------|------|
| Lane Configurations | ↑    | ↑    | ↑    | ↑    | ↑    | ↑    |
| Traffic Vol, veh/h  | 160  | 80   | 270  | 390  | 40   | 180  |
| Future Vol, veh/h   | 160  | 80   | 270  | 390  | 40   | 180  |
| Peak Hour Factor    | 0.92 | 0.92 | 0.92 | 0.92 | 0.92 | 0.92 |
| Heavy Vehicles, %   | 2    | 2    | 2    | 2    | 2    | 2    |
| Mvmt Flow           | 174  | 87   | 293  | 424  | 43   | 196  |
| Number of Lanes     | 1    | 1    | 1    | 1    | 1    | 1    |

| Approach                   | EB   | WB   | NB   |
|----------------------------|------|------|------|
| Opposing Approach          | WB   | EB   |      |
| Opposing Lanes             | 2    | 2    | 0    |
| Conflicting Approach Left  |      | NB   | EB   |
| Conflicting Lanes Left     | 0    | 2    | 2    |
| Conflicting Approach Right | NB   |      | WB   |
| Conflicting Lanes Right    | 2    | 0    | 2    |
| HCM Control Delay          | 10.8 | 17.4 | 11.8 |
| HCM LOS                    | B    | C    | B    |

| Lane                   | NBLn1 | NBLn2 | EBLn1 | EBLn2 | WBLn1 | WBLn2 |
|------------------------|-------|-------|-------|-------|-------|-------|
| Vol Left, %            | 100%  | 0%    | 0%    | 0%    | 100%  | 0%    |
| Vol Thru, %            | 0%    | 0%    | 100%  | 0%    | 0%    | 100%  |
| Vol Right, %           | 0%    | 100%  | 0%    | 100%  | 0%    | 0%    |
| Sign Control           | Stop  | Stop  | Stop  | Stop  | Stop  | Stop  |
| Traffic Vol by Lane    | 40    | 180   | 160   | 80    | 270   | 390   |
| LT Vol                 | 40    | 0     | 0     | 0     | 270   | 0     |
| Through Vol            | 0     | 0     | 160   | 0     | 0     | 390   |
| RT Vol                 | 0     | 180   | 0     | 80    | 0     | 0     |
| Lane Flow Rate         | 43    | 196   | 174   | 87    | 293   | 424   |
| Geometry Grp           | 7     | 7     | 7     | 7     | 7     | 7     |
| Degree of Util (X)     | 0.089 | 0.334 | 0.302 | 0.134 | 0.502 | 0.666 |
| Departure Headway (Hd) | 7.363 | 6.147 | 6.244 | 5.533 | 6.162 | 5.656 |
| Convergence, Y/N       | Yes   | Yes   | Yes   | Yes   | Yes   | Yes   |
| Cap                    | 487   | 585   | 576   | 647   | 587   | 640   |
| Service Time           | 5.107 | 3.89  | 3.987 | 3.276 | 3.892 | 3.387 |
| HCM Lane V/C Ratio     | 0.088 | 0.335 | 0.302 | 0.134 | 0.499 | 0.662 |
| HCM Control Delay      | 10.8  | 12    | 11.7  | 9.1   | 15    | 19    |
| HCM Lane LOS           | B     | B     | B     | A     | B     | C     |
| HCM 95th-tile Q        | 0.3   | 1.5   | 1.3   | 0.5   | 2.8   | 5     |

| Intersection                   |       |       |       |       |
|--------------------------------|-------|-------|-------|-------|
| Intersection Delay, s/veh 25.7 |       |       |       |       |
| Intersection LOS D             |       |       |       |       |
| Approach                       | EB    | WB    | NB    | SB    |
| Entry Lanes                    | 1     | 1     | 1     | 1     |
| Conflicting Circle Lanes       | 1     | 1     | 1     | 1     |
| Adj Approach Flow, veh/h       | 197   | 333   | 49    | 901   |
| Demand Flow Rate, veh/h        | 203   | 350   | 49    | 910   |
| Vehicles Circulating, veh/h    | 549   | 126   | 715   | 154   |
| Vehicles Exiting, veh/h        | 515   | 638   | 37    | 322   |
| Follow-Up Headway, s           | 3.186 | 3.186 | 3.186 | 3.186 |
| Ped Vol Crossing Leg, #/h      | 0     | 0     | 0     | 0     |
| Ped Cap Adj                    | 1.000 | 1.000 | 1.000 | 1.000 |
| Approach Delay, s/veh          | 9.8   | 7.6   | 7.6   | 36.9  |
| Approach LOS                   | A     | A     | A     | E     |
| Lane                           | Left  | Left  | Left  | Left  |
| Designated Moves               | LTR   | LTR   | LTR   | LTR   |
| Assumed Moves                  | LTR   | LTR   | LTR   | LTR   |
| RT Channelized                 |       |       |       |       |
| Lane Util                      | 1.000 | 1.000 | 1.000 | 1.000 |
| Critical Headway, s            | 5.193 | 5.193 | 5.193 | 5.193 |
| Entry Flow, veh/h              | 203   | 350   | 49    | 910   |
| Cap Entry Lane, veh/h          | 653   | 996   | 553   | 969   |
| Entry HV Adj Factor            | 0.971 | 0.951 | 1.000 | 0.990 |
| Flow Entry, veh/h              | 197   | 333   | 49    | 901   |
| Cap Entry, veh/h               | 633   | 947   | 553   | 959   |
| V/C Ratio                      | 0.311 | 0.351 | 0.089 | 0.939 |
| Control Delay, s/veh           | 9.8   | 7.6   | 7.6   | 36.9  |
| LOS                            | A     | A     | A     | E     |
| 95th %tile Queue, veh          | 1     | 2     | 0     | 15    |

HCM 2010 Signalized Intersection Summary  
 19: 2nd Avenue & Inter-Garrison Road

Cumulative with Project, AM  
 06/11/2019



| Movement                     | WBL  | WBR  | NBT  | NBR  | SBL  | SBT  |      |      |
|------------------------------|------|------|------|------|------|------|------|------|
| Lane Configurations          |      |      |      |      |      |      |      |      |
| Traffic Volume (veh/h)       | 40   | 30   | 680  | 60   | 30   | 1440 |      |      |
| Future Volume (veh/h)        | 40   | 30   | 680  | 60   | 30   | 1440 |      |      |
| Number                       | 1    | 16   | 8    | 18   | 7    | 4    |      |      |
| Initial Q (Qb), veh          | 0    | 0    | 0    | 0    | 0    | 0    |      |      |
| Ped-Bike Adj(A_pbT)          | 1.00 | 1.00 |      | 1.00 | 1.00 |      |      |      |
| Parking Bus, Adj             | 1.00 | 1.00 | 1.00 | 1.00 | 1.00 | 1.00 |      |      |
| Adj Sat Flow, veh/h/ln       | 1900 | 1900 | 1881 | 1900 | 1881 | 1881 |      |      |
| Adj Flow Rate, veh/h         | 43   | 8    | 731  | 57   | 32   | 1548 |      |      |
| Adj No. of Lanes             | 1    | 1    | 2    | 0    | 1    | 2    |      |      |
| Peak Hour Factor             | 0.93 | 0.93 | 0.93 | 0.93 | 0.93 | 0.93 |      |      |
| Percent Heavy Veh, %         | 0    | 0    | 1    | 1    | 1    | 1    |      |      |
| Cap, veh/h                   | 190  | 169  | 1876 | 146  | 66   | 2405 |      |      |
| Arrive On Green              | 0.10 | 0.10 | 0.56 | 0.56 | 0.04 | 0.67 |      |      |
| Sat Flow, veh/h              | 1810 | 1615 | 3454 | 262  | 1792 | 3668 |      |      |
| Grp Volume(v), veh/h         | 43   | 8    | 389  | 399  | 32   | 1548 |      |      |
| Grp Sat Flow(s),veh/h/ln     | 1810 | 1615 | 1787 | 1835 | 1792 | 1787 |      |      |
| Q Serve(g_s), s              | 1.0  | 0.2  | 5.5  | 5.5  | 0.8  | 11.2 |      |      |
| Cycle Q Clear(g_c), s        | 1.0  | 0.2  | 5.5  | 5.5  | 0.8  | 11.2 |      |      |
| Prop In Lane                 | 1.00 | 1.00 |      | 0.14 | 1.00 |      |      |      |
| Lane Grp Cap(c), veh/h       | 190  | 169  | 998  | 1025 | 66   | 2405 |      |      |
| V/C Ratio(X)                 | 0.23 | 0.05 | 0.39 | 0.39 | 0.49 | 0.64 |      |      |
| Avail Cap(c_a), veh/h        | 1408 | 1257 | 1590 | 1632 | 458  | 4371 |      |      |
| HCM Platoon Ratio            | 1.00 | 1.00 | 1.00 | 1.00 | 1.00 | 1.00 |      |      |
| Upstream Filter(I)           | 1.00 | 1.00 | 1.00 | 1.00 | 1.00 | 1.00 |      |      |
| Uniform Delay (d), s/veh     | 18.5 | 18.1 | 5.6  | 5.6  | 21.2 | 4.2  |      |      |
| Incr Delay (d2), s/veh       | 0.6  | 0.1  | 0.2  | 0.2  | 5.5  | 0.3  |      |      |
| Initial Q Delay(d3),s/veh    | 0.0  | 0.0  | 0.0  | 0.0  | 0.0  | 0.0  |      |      |
| %ile BackOfQ(50%),veh/ln     | 0.5  | 0.2  | 2.8  | 2.8  | 0.5  | 5.5  |      |      |
| LnGrp Delay(d),s/veh         | 19.1 | 18.2 | 5.9  | 5.8  | 26.8 | 4.5  |      |      |
| LnGrp LOS                    | B    | B    | A    | A    | C    | A    |      |      |
| Approach Vol, veh/h          | 51   |      | 788  |      |      | 1580 |      |      |
| Approach Delay, s/veh        | 18.9 |      | 5.8  |      |      | 5.0  |      |      |
| Approach LOS                 | B    |      | A    |      |      | A    |      |      |
| Timer                        | 1    | 2    | 3    | 4    | 5    | 6    | 7    | 8    |
| Assigned Phs                 |      |      |      | 4    |      | 6    | 7    | 8    |
| Phs Duration (G+Y+Rc), s     |      |      |      | 35.3 |      | 9.7  | 5.1  | 30.1 |
| Change Period (Y+Rc), s      |      |      |      | 5.0  |      | 5.0  | 3.5  | 5.0  |
| Max Green Setting (Gmax), s  |      |      |      | 55.0 |      | 35.0 | 11.5 | 40.0 |
| Max Q Clear Time (g_c+I1), s |      |      |      | 13.2 |      | 3.0  | 2.8  | 7.5  |
| Green Ext Time (p_c), s      |      |      |      | 17.0 |      | 0.1  | 0.0  | 5.4  |
| <b>Intersection Summary</b>  |      |      |      |      |      |      |      |      |
| HCM 2010 Ctrl Delay          |      |      | 5.6  |      |      |      |      |      |
| HCM 2010 LOS                 |      |      | A    |      |      |      |      |      |

|                                |  |  |  |  |  |  |  |  |  |  |  |  |
|--------------------------------|--|--|--|--|--|--|--|--|--|--|--|--|
| <b>Intersection</b>            |  |  |  |  |  |  |  |  |  |  |  |  |
| Intersection Delay, s/veh 10.5 |  |  |  |  |  |  |  |  |  |  |  |  |
| Intersection LOS B             |  |  |  |  |  |  |  |  |  |  |  |  |























| Movement            | EBL  | EBT  | EBR  | WBL  | WBT  | WBR  | NBL  | NBT  | NBR  | SBL  | SBT  | SBR  |
|---------------------|------|------|------|------|------|------|------|------|------|------|------|------|
| Lane Configurations |      | ↕    |      |      | ↕    |      |      | ↕    |      |      | ↕    |      |
| Traffic Vol, veh/h  | 10   | 20   | 10   | 70   | 20   | 30   | 20   | 180  | 100  | 30   | 160  | 10   |
| Future Vol, veh/h   | 10   | 20   | 10   | 70   | 20   | 30   | 20   | 180  | 100  | 30   | 160  | 10   |
| Peak Hour Factor    | 0.85 | 0.85 | 0.85 | 0.85 | 0.85 | 0.85 | 0.85 | 0.85 | 0.85 | 0.85 | 0.85 | 0.85 |
| Heavy Vehicles, %   | 6    | 6    | 6    | 2    | 2    | 2    | 4    | 4    | 4    | 0    | 0    | 0    |
| Mvmt Flow           | 12   | 24   | 12   | 82   | 24   | 35   | 24   | 212  | 118  | 35   | 188  | 12   |
| Number of Lanes     | 0    | 1    | 0    | 0    | 1    | 0    | 0    | 1    | 0    | 0    | 1    | 0    |

| Approach                   | EB | WB  | NB   | SB   |
|----------------------------|----|-----|------|------|
| Opposing Approach          | WB | EB  | SB   | NB   |
| Opposing Lanes             | 1  | 1   | 1    | 1    |
| Conflicting Approach Left  | SB | NB  | EB   | WB   |
| Conflicting Lanes Left     | 1  | 1   | 1    | 1    |
| Conflicting Approach Right | NB | SB  | WB   | EB   |
| Conflicting Lanes Right    | 1  | 1   | 1    | 1    |
| HCM Control Delay          | 9  | 9.8 | 11.3 | 10.1 |
| HCM LOS                    | A  | A   | B    | B    |

| Lane                   | NBLn1 | EBLn1 | WBLn1 | SBLn1 |
|------------------------|-------|-------|-------|-------|
| Vol Left, %            | 7%    | 25%   | 58%   | 15%   |
| Vol Thru, %            | 60%   | 50%   | 17%   | 80%   |
| Vol Right, %           | 33%   | 25%   | 25%   | 5%    |
| Sign Control           | Stop  | Stop  | Stop  | Stop  |
| Traffic Vol by Lane    | 300   | 40    | 120   | 200   |
| LT Vol                 | 20    | 10    | 70    | 30    |
| Through Vol            | 180   | 20    | 20    | 160   |
| RT Vol                 | 100   | 10    | 30    | 10    |
| Lane Flow Rate         | 353   | 47    | 141   | 235   |
| Geometry Grp           | 1     | 1     | 1     | 1     |
| Degree of Util (X)     | 0.447 | 0.073 | 0.208 | 0.314 |
| Departure Headway (Hd) | 4.562 | 5.567 | 5.302 | 4.802 |
| Convergence, Y/N       | Yes   | Yes   | Yes   | Yes   |
| Cap                    | 784   | 648   | 671   | 741   |
| Service Time           | 2.625 | 3.567 | 3.39  | 2.874 |
| HCM Lane V/C Ratio     | 0.45  | 0.073 | 0.21  | 0.317 |
| HCM Control Delay      | 11.3  | 9     | 9.8   | 10.1  |
| HCM Lane LOS           | B     | A     | A     | B     |
| HCM 95th-tile Q        | 2.3   | 0.2   | 0.8   | 1.3   |

HCM 2010 Signalized Intersection Summary  
 21: 7th Avenue/8th Street & Inter-Garrison Road

Cumulative with Project, AM  
 07/12/2019

|                              |  |  |  |  |  |  |   |  |  |  |  |  |
|------------------------------|---|---|---|---|---|---|---|---|---|---|---|---|
| Movement                     | EBL   | EBT   | EBR   | WBL   | WBT   | WBR   | NBL   | NBT   | NBR   | SBL   | SBT   | SBR   |
| Lane Configurations          |  |  |   |  |  |   |  |  |  |  |  |  |
| Traffic Volume (veh/h)       | 10  | 90  | 50  | 350   | 230   | 40  | 80  | 170   | 150   | 240   | 150   | 10  |
| Future Volume (veh/h)        | 10  | 90  | 50  | 350   | 230   | 40  | 80  | 170   | 150   | 240   | 150   | 10  |
| Number                       | 5   | 2   | 12  | 1   | 6   | 16  | 3   | 8   | 18  | 7   | 4   | 14  |
| Initial Q (Qb), veh          | 0   | 0   | 0   | 0   | 0   | 0   | 0   | 0   | 0   | 0   | 0   | 0   |
| Ped-Bike Adj(A_pbT)          | 1.00  |   | 0.99  | 1.00  |   | 1.00  | 1.00  |   | 1.00  | 1.00  |   | 1.00  |
| Parking Bus, Adj             | 1.00  | 1.00  | 1.00  | 1.00  | 1.00  | 1.00  | 1.00  | 1.00  | 1.00  | 1.00  | 1.00  | 1.00  |
| Adj Sat Flow, veh/h/ln       | 1759  | 1759  | 1900  | 1845  | 1845  | 1900  | 1597  | 1597  | 1597  | 1776  | 1776  | 1900  |
| Adj Flow Rate, veh/h         | 12  | 111   | 53  | 432   | 284   | 0   | 99  | 210   | 152   | 296   | 185   | 5   |
| Adj No. of Lanes             | 1   | 1   | 0   | 1   | 1   | 0   | 1   | 1   | 1   | 1   | 1   | 0   |
| Peak Hour Factor             | 0.81  | 0.81  | 0.81  | 0.81  | 0.81  | 0.81  | 0.81  | 0.81  | 0.81  | 0.81  | 0.81  | 0.81  |
| Percent Heavy Veh, %         | 8   | 8   | 8   | 3   | 3   | 3   | 19  | 19  | 19  | 7   | 7   | 7   |
| Cap, veh/h                   | 20  | 167   | 80  | 483   | 759   | 0   | 123   | 269   | 228   | 340   | 497   | 13  |
| Arrive On Green              | 0.01  | 0.15  | 0.15  | 0.28  | 0.41  | 0.00  | 0.08  | 0.17  | 0.17  | 0.20  | 0.29  | 0.29  |
| Sat Flow, veh/h              | 1675  | 1122  | 536   | 1757  | 1845  | 0   | 1521  | 1597  | 1357  | 1691  | 1721  | 47  |
| Grp Volume(v), veh/h         | 12  | 0   | 164   | 432   | 284   | 0   | 99  | 210   | 152   | 296   | 0   | 190   |
| Grp Sat Flow(s),veh/h/ln     | 1675  | 0   | 1658  | 1757  | 1845  | 0   | 1521  | 1597  | 1357  | 1691  | 0   | 1767  |
| Q Serve(g_s), s              | 0.6   | 0.0   | 7.2   | 18.2  | 8.3   | 0.0   | 4.9   | 9.7   | 8.1   | 13.1  | 0.0   | 6.6   |
| Cycle Q Clear(g_c), s        | 0.6   | 0.0   | 7.2   | 18.2  | 8.3   | 0.0   | 4.9   | 9.7   | 8.1   | 13.1  | 0.0   | 6.6   |
| Prop In Lane                 | 1.00  |   | 0.32  | 1.00  |   | 0.00  | 1.00  |   | 1.00  | 1.00  |   | 0.03  |
| Lane Grp Cap(c), veh/h       | 20  | 0   | 246   | 483   | 759   | 0   | 123   | 269   | 228   | 340   | 0   | 510   |
| V/C Ratio(X)                 | 0.61  | 0.00  | 0.67  | 0.89  | 0.37  | 0.00  | 0.81  | 0.78  | 0.67  | 0.87  | 0.00  | 0.37  |
| Avail Cap(c_a), veh/h        | 87  | 0   | 688   | 663   | 1365  | 0   | 302   | 455   | 387   | 458   | 0   | 632   |
| HCM Platoon Ratio            | 1.00  | 1.00  | 1.00  | 1.00  | 1.00  | 1.00  | 1.00  | 1.00  | 1.00  | 1.00  | 1.00  | 1.00  |
| Upstream Filter(I)           | 1.00  | 0.00  | 1.00  | 1.00  | 1.00  | 0.00  | 1.00  | 1.00  | 1.00  | 1.00  | 0.00  | 1.00  |
| Uniform Delay (d), s/veh     | 38.0  | 0.0   | 31.0  | 26.9  | 15.8  | 0.0   | 34.9  | 30.7  | 30.1  | 29.9  | 0.0   | 21.9  |
| Incr Delay (d2), s/veh       | 26.7  | 0.0   | 3.1   | 11.5  | 0.3   | 0.0   | 11.7  | 4.9   | 3.3   | 13.0  | 0.0   | 0.5   |
| Initial Q Delay(d3),s/veh    | 0.0   | 0.0   | 0.0   | 0.0   | 0.0   | 0.0   | 0.0   | 0.0   | 0.0   | 0.0   | 0.0   | 0.0   |
| %ile BackOfQ(50%),veh/ln     | 0.4   | 0.0   | 3.5   | 10.3  | 4.2   | 0.0   | 2.5   | 4.6   | 3.2   | 7.3   | 0.0   | 3.3   |
| LnGrp Delay(d),s/veh         | 64.7  | 0.0   | 34.1  | 38.4  | 16.1  | 0.0   | 46.6  | 35.7  | 33.4  | 42.9  | 0.0   | 22.3  |
| LnGrp LOS                    | E   |   | C   | D   | B   |   | D   | D   | C   | D   |   | C   |
| Approach Vol, veh/h          |   | 176   |   |   | 716   |   |   | 461   |   |   | 486   |   |
| Approach Delay, s/veh        |   | 36.2  |   |   | 29.6  |   |   | 37.3  |   |   | 34.8  |   |
| Approach LOS                 |   | D   |   |   | C   |   |   | D   |   |   | C   |   |
| Timer                        | 1   | 2   | 3   | 4   | 5   | 6   | 7   | 8   |   |   |   |   |
| Assigned Phs                 | 1   | 2   | 3   | 4   | 5   | 6   | 7   | 8   |   |   |   |   |
| Phs Duration (G+Y+Rc), s     | 24.7  | 16.5  | 9.7   | 26.3  | 4.4   | 36.8  | 19.0  | 17.0  |   |   |   |   |
| Change Period (Y+Rc), s      | 3.5   | 5.0   | 3.5   | 4.0   | 3.5   | 5.0   | 3.5   | 4.0   |   |   |   |   |
| Max Green Setting (Gmax), s  | 29.1  | 32.0  | 15.3  | 27.6  | 4.0   | 57.1  | 20.9  | 22.0  |   |   |   |   |
| Max Q Clear Time (g_c+I1), s | 20.2  | 9.2   | 6.9   | 8.6   | 2.6   | 10.3  | 15.1  | 11.7  |   |   |   |   |
| Green Ext Time (p_c), s      | 1.0   | 0.8   | 0.1   | 0.9   | 0.0   | 1.9   | 0.5   | 1.3   |   |   |   |   |
| <b>Intersection Summary</b>  |   |   |   |   |   |   |   |   |   |   |   |   |
| HCM 2010 Ctrl Delay          |   |   | 33.5  |   |   |   |   |   |   |   |   |   |
| HCM 2010 LOS                 |   |   | C   |   |   |   |   |   |   |   |   |   |

| Intersection                |       |       |       |
|-----------------------------|-------|-------|-------|
| Intersection Delay, s/veh   | 185.7 |       |       |
| Intersection LOS            | F     |       |       |
| Approach                    | EB    | WB    | NB    |
| Entry Lanes                 | 1     | 1     | 1     |
| Conflicting Circle Lanes    | 1     | 1     | 1     |
| Adj Approach Flow, veh/h    | 563   | 1517  | 528   |
| Demand Flow Rate, veh/h     | 704   | 1533  | 544   |
| Vehicles Circulating, veh/h | 871   | 59    | 345   |
| Vehicles Exiting, veh/h     | 721   | 830   | 1230  |
| Follow-Up Headway, s        | 3.186 | 3.186 | 3.186 |
| Ped Vol Crossing Leg, #/h   | 0     | 0     | 0     |
| Ped Cap Adj                 | 1.000 | 1.000 | 1.000 |
| Approach Delay, s/veh       | 260.3 | 216.7 | 17.3  |
| Approach LOS                | F     | F     | C     |
| Lane                        | Left  | Left  | Left  |
| Designated Moves            | TR    | LT    | LR    |
| Assumed Moves               | TR    | LT    | LR    |
| RT Channelized              |       |       |       |
| Lane Util                   | 1.000 | 1.000 | 1.000 |
| Critical Headway, s         | 5.193 | 5.193 | 5.193 |
| Entry Flow, veh/h           | 704   | 1533  | 544   |
| Cap Entry Lane, veh/h       | 473   | 1065  | 800   |
| Entry HV Adj Factor         | 0.800 | 0.990 | 0.971 |
| Flow Entry, veh/h           | 563   | 1517  | 528   |
| Cap Entry, veh/h            | 378   | 1054  | 777   |
| V/C Ratio                   | 1.489 | 1.439 | 0.680 |
| Control Delay, s/veh        | 260.3 | 216.7 | 17.3  |
| LOS                         | F     | F     | C     |
| 95th %tile Queue, veh       | 30    | 66    | 5     |



HCM 2010 Signalized Intersection Summary  
 23: Inter-Garrison Road & Abrams Drive

Cumulative with Project, AM  
 06/11/2019

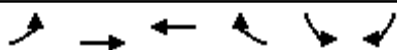

| Movement                     | EBL   | EBT   | WBT  | WBR  | SBL  | SBR  |   |   |
|------------------------------|-------|-------|------|------|------|------|---|---|
| Lane Configurations          |       |       |      |      |      |      |   |   |
| Traffic Volume (veh/h)       | 260   | 390   | 820  | 10   | 40   | 500  |   |   |
| Future Volume (veh/h)        | 260   | 390   | 820  | 10   | 40   | 500  |   |   |
| Number                       | 5     | 2     | 6    | 16   | 7    | 14   |   |   |
| Initial Q (Qb), veh          | 0     | 0     | 0    | 0    | 0    | 0    |   |   |
| Ped-Bike Adj(A_pbT)          | 1.00  |       |      | 1.00 | 1.00 | 1.00 |   |   |
| Parking Bus, Adj             | 1.00  | 1.00  | 1.00 | 1.00 | 1.00 | 1.00 |   |   |
| Adj Sat Flow, veh/h/ln       | 1759  | 1759  | 1881 | 1881 | 1881 | 1881 |   |   |
| Adj Flow Rate, veh/h         | 306   | 459   | 965  | 6    | 47   | 370  |   |   |
| Adj No. of Lanes             | 1     | 1     | 1    | 1    | 2    | 1    |   |   |
| Peak Hour Factor             | 0.85  | 0.85  | 0.85 | 0.85 | 0.85 | 0.85 |   |   |
| Percent Heavy Veh, %         | 8     | 8     | 1    | 1    | 1    | 1    |   |   |
| Cap, veh/h                   | 211   | 1157  | 928  | 789  | 865  | 398  |   |   |
| Arrive On Green              | 0.13  | 0.66  | 0.49 | 0.49 | 0.25 | 0.25 |   |   |
| Sat Flow, veh/h              | 1675  | 1759  | 1881 | 1599 | 3476 | 1599 |   |   |
| Grp Volume(v), veh/h         | 306   | 459   | 965  | 6    | 47   | 370  |   |   |
| Grp Sat Flow(s),veh/h/ln     | 1675  | 1759  | 1881 | 1599 | 1738 | 1599 |   |   |
| Q Serve(g_s), s              | 11.5  | 11.0  | 45.0 | 0.2  | 0.9  | 20.6 |   |   |
| Cycle Q Clear(g_c), s        | 11.5  | 11.0  | 45.0 | 0.2  | 0.9  | 20.6 |   |   |
| Prop In Lane                 | 1.00  |       |      | 1.00 | 1.00 | 1.00 |   |   |
| Lane Grp Cap(c), veh/h       | 211   | 1157  | 928  | 789  | 865  | 398  |   |   |
| V/C Ratio(X)                 | 1.45  | 0.40  | 1.04 | 0.01 | 0.05 | 0.93 |   |   |
| Avail Cap(c_a), veh/h        | 211   | 1157  | 928  | 789  | 1201 | 552  |   |   |
| HCM Platoon Ratio            | 1.00  | 1.00  | 1.00 | 1.00 | 1.00 | 1.00 |   |   |
| Upstream Filter(I)           | 1.00  | 1.00  | 1.00 | 1.00 | 1.00 | 1.00 |   |   |
| Uniform Delay (d), s/veh     | 39.8  | 7.2   | 23.1 | 11.7 | 26.1 | 33.5 |   |   |
| Incr Delay (d2), s/veh       | 226.3 | 0.1   | 40.3 | 0.0  | 0.0  | 15.7 |   |   |
| Initial Q Delay(d3),s/veh    | 0.0   | 0.0   | 0.0  | 0.0  | 0.0  | 0.0  |   |   |
| %ile BackOfQ(50%),veh/lt     | 8.6   | 5.3   | 33.6 | 0.1  | 0.5  | 18.1 |   |   |
| LnGrp Delay(d),s/veh         | 266.1 | 7.3   | 63.4 | 11.7 | 26.1 | 49.2 |   |   |
| LnGrp LOS                    | F     | A     | F    | B    | C    | D    |   |   |
| Approach Vol, veh/h          |       | 765   | 971  |      | 417  |      |   |   |
| Approach Delay, s/veh        |       | 110.8 | 63.1 |      | 46.6 |      |   |   |
| Approach LOS                 |       | F     | E    |      | D    |      |   |   |
| Timer                        | 1     | 2     | 3    | 4    | 5    | 6    | 7 | 8 |
| Assigned Phs                 |       | 2     |      | 4    | 5    | 6    |   |   |
| Phs Duration (G+Y+Rc), s     |       | 65.0  |      | 26.2 | 15.0 | 50.0 |   |   |
| Change Period (Y+Rc), s      |       | 5.0   |      | 3.5  | 3.5  | 5.0  |   |   |
| Max Green Setting (Gmax), s  |       | 60.0  |      | 31.5 | 11.5 | 45.0 |   |   |
| Max Q Clear Time (g_c+I1), s |       | 13.0  |      | 22.6 | 13.5 | 47.0 |   |   |
| Green Ext Time (p_c), s      |       | 0.4   |      | 0.1  | 0.0  | 0.0  |   |   |
| <b>Intersection Summary</b>  |       |       |      |      |      |      |   |   |
| HCM 2010 Ctrl Delay          |       |       | 76.9 |      |      |      |   |   |
| HCM 2010 LOS                 |       |       | E    |      |      |      |   |   |

| Intersection              |      |
|---------------------------|------|
| Intersection Delay, s/veh | 49.4 |
| Intersection LOS          | E    |

| Movement            | EBL  | EBT  | WBT  | WBR  | SBL  | SBR  |
|---------------------|------|------|------|------|------|------|
| Lane Configurations |      |      |      |      |      |      |
| Traffic Vol, veh/h  | 70   | 380  | 660  | 10   | 70   | 160  |
| Future Vol, veh/h   | 70   | 380  | 660  | 10   | 70   | 160  |
| Peak Hour Factor    | 0.79 | 0.79 | 0.79 | 0.79 | 0.79 | 0.79 |
| Heavy Vehicles, %   | 5    | 5    | 1    | 1    | 3    | 3    |
| Mvmt Flow           | 89   | 481  | 835  | 13   | 89   | 203  |
| Number of Lanes     | 1    | 1    | 2    | 1    | 1    | 1    |

| Approach                   | EB   | WB   | SB   |
|----------------------------|------|------|------|
| Opposing Approach          | WB   | EB   |      |
| Opposing Lanes             | 3    | 2    | 0    |
| Conflicting Approach Left  | SB   |      | WB   |
| Conflicting Lanes Left     | 2    | 0    | 3    |
| Conflicting Approach Right |      | SB   | EB   |
| Conflicting Lanes Right    | 0    | 2    | 2    |
| HCM Control Delay          | 77.7 | 41.6 | 16.7 |
| HCM LOS                    | F    | E    | C    |

| Lane                   | EBLn1 | EBLn2 | WBLn1 | WBLn2 | WBLn3 | SBLn1 | SBLn2 |
|------------------------|-------|-------|-------|-------|-------|-------|-------|
| Vol Left, %            | 100%  | 0%    | 0%    | 0%    | 0%    | 100%  | 0%    |
| Vol Thru, %            | 0%    | 100%  | 100%  | 100%  | 0%    | 0%    | 0%    |
| Vol Right, %           | 0%    | 0%    | 0%    | 0%    | 100%  | 0%    | 100%  |
| Sign Control           | Stop  | Stop  | Stop  | Stop  | Stop  | Stop  | Stop  |
| Traffic Vol by Lane    | 70    | 380   | 330   | 330   | 10    | 70    | 160   |
| LT Vol                 | 70    | 0     | 0     | 0     | 0     | 70    | 0     |
| Through Vol            | 0     | 380   | 330   | 330   | 0     | 0     | 0     |
| RT Vol                 | 0     | 0     | 0     | 0     | 10    | 0     | 160   |
| Lane Flow Rate         | 89    | 481   | 418   | 418   | 13    | 89    | 203   |
| Geometry Grp           | 8     | 8     | 8     | 8     | 8     | 8     | 8     |
| Degree of Util (X)     | 0.209 | 1.067 | 0.863 | 0.863 | 0.017 | 0.228 | 0.451 |
| Departure Headway (Hd) | 8.5   | 7.987 | 7.638 | 7.638 | 5.162 | 9.48  | 8.245 |
| Convergence, Y/N       | Yes   | Yes   | Yes   | Yes   | Yes   | Yes   | Yes   |
| Cap                    | 424   | 457   | 476   | 476   | 698   | 381   | 439   |
| Service Time           | 6.2   | 5.687 | 5.338 | 5.338 | 2.862 | 7.18  | 5.945 |
| HCM Lane V/C Ratio     | 0.21  | 1.053 | 0.878 | 0.878 | 0.019 | 0.234 | 0.462 |
| HCM Control Delay      | 13.4  | 89.5  | 42.1  | 42.1  | 8     | 15    | 17.5  |
| HCM Lane LOS           | B     | F     | E     | E     | A     | B     | C     |
| HCM 95th-tile Q        | 0.8   | 15.4  | 9     | 9     | 0.1   | 0.9   | 2.3   |

| Intersection              |      |
|---------------------------|------|
| Intersection Delay, s/veh | 80.7 |
| Intersection LOS          | F    |

| Movement            | EBL  | EBT  | WBT  | WBR  | SBL  | SBR  |
|---------------------|------|------|------|------|------|------|
| Lane Configurations |      |      |      |      |      |      |
| Traffic Vol, veh/h  | 370  | 80   | 170  | 210  | 110  | 510  |
| Future Vol, veh/h   | 370  | 80   | 170  | 210  | 110  | 510  |
| Peak Hour Factor    | 0.82 | 0.82 | 0.82 | 0.82 | 0.82 | 0.82 |
| Heavy Vehicles, %   | 5    | 5    | 1    | 1    | 0    | 0    |
| Mvmt Flow           | 451  | 98   | 207  | 256  | 134  | 622  |
| Number of Lanes     | 1    | 1    | 1    | 0    | 1    | 1    |

| Approach                   | EB   | WB   | SB    |
|----------------------------|------|------|-------|
| Opposing Approach          | WB   | EB   |       |
| Opposing Lanes             | 1    | 2    | 0     |
| Conflicting Approach Left  | SB   |      | WB    |
| Conflicting Lanes Left     | 2    | 0    | 1     |
| Conflicting Approach Right |      | SB   | EB    |
| Conflicting Lanes Right    | 0    | 2    | 2     |
| HCM Control Delay          | 67.3 | 49.6 | 109.5 |
| HCM LOS                    | F    | E    | F     |

| Lane                   | EBLn1 | EBLn2 | WBLn1 | SBLn1 | SBLn2 |
|------------------------|-------|-------|-------|-------|-------|
| Vol Left, %            | 100%  | 0%    | 0%    | 100%  | 0%    |
| Vol Thru, %            | 0%    | 100%  | 45%   | 0%    | 0%    |
| Vol Right, %           | 0%    | 0%    | 55%   | 0%    | 100%  |
| Sign Control           | Stop  | Stop  | Stop  | Stop  | Stop  |
| Traffic Vol by Lane    | 370   | 80    | 380   | 110   | 510   |
| LT Vol                 | 370   | 0     | 0     | 110   | 0     |
| Through Vol            | 0     | 80    | 170   | 0     | 0     |
| RT Vol                 | 0     | 0     | 210   | 0     | 510   |
| Lane Flow Rate         | 451   | 98    | 463   | 134   | 622   |
| Geometry Grp           | 7     | 7     | 4     | 7     | 7     |
| Degree of Util (X)     | 1.019 | 0.207 | 0.91  | 0.3   | 1.198 |
| Departure Headway (Hd) | 8.701 | 8.183 | 7.589 | 8.216 | 6.932 |
| Convergence, Y/N       | Yes   | Yes   | Yes   | Yes   | Yes   |
| Cap                    | 420   | 441   | 482   | 440   | 522   |
| Service Time           | 6.401 | 5.883 | 5.589 | 5.916 | 4.68  |
| HCM Lane V/C Ratio     | 1.074 | 0.222 | 0.961 | 0.305 | 1.192 |
| HCM Control Delay      | 79    | 13    | 49.6  | 14.4  | 130   |
| HCM Lane LOS           | F     | B     | E     | B     | F     |
| HCM 95th-tile Q        | 13.1  | 0.8   | 10.3  | 1.2   | 22.9  |

HCM 2010 Signalized Intersection Summary  
 26: East Garrison Road & Reservation Road

Cumulative with Project, AM  
 06/11/2019



| Movement                    | EBL  | EBT  | EBR  | WBL  | WBT  | WBR  | NBL  | NBT  | NBR  | SBL | SBT | SBR |
|-----------------------------|------|------|------|------|------|------|------|------|------|-----|-----|-----|
| Lane Configurations         |      |      |      |      |      |      |      |      |      |     |     |     |
| Traffic Volume (veh/h)      | 0    | 520  | 120  | 160  | 970  | 0    | 200  | 0    | 270  | 0   | 0   | 0   |
| Future Volume (veh/h)       | 0    | 520  | 120  | 160  | 970  | 0    | 200  | 0    | 270  | 0   | 0   | 0   |
| Number                      | 5    | 2    | 12   | 1    | 6    | 16   | 3    | 8    | 18   |     |     |     |
| Initial Q (Qb), veh         | 0    | 0    | 0    | 0    | 0    | 0    | 0    | 0    | 0    |     |     |     |
| Ped-Bike Adj(A_pbT)         | 1.00 |      | 1.00 | 1.00 |      | 1.00 | 1.00 |      | 1.00 |     |     |     |
| Parking Bus, Adj            | 1.00 | 1.00 | 1.00 | 1.00 | 1.00 | 1.00 | 1.00 | 1.00 | 1.00 |     |     |     |
| Adj Sat Flow, veh/h/ln      | 1827 | 1827 | 1900 | 1863 | 1863 | 0    | 1881 | 0    | 1881 |     |     |     |
| Adj Flow Rate, veh/h        | 0    | 584  | 133  | 180  | 1090 | 0    | 225  | 0    | 231  |     |     |     |
| Adj No. of Lanes            | 1    | 2    | 0    | 1    | 2    | 0    | 1    | 0    | 1    |     |     |     |
| Peak Hour Factor            | 0.89 | 0.89 | 0.89 | 0.89 | 0.89 | 0.89 | 0.89 | 0.89 | 0.89 |     |     |     |
| Percent Heavy Veh, %        | 4    | 4    | 4    | 2    | 2    | 0    | 1    | 0    | 1    |     |     |     |
| Cap, veh/h                  | 4    | 1096 | 249  | 228  | 2111 | 0    | 332  | 0    | 296  |     |     |     |
| Arrive On Green             | 0.00 | 0.39 | 0.39 | 0.13 | 0.60 | 0.00 | 0.19 | 0.00 | 0.19 |     |     |     |
| Sat Flow, veh/h             | 1740 | 2811 | 639  | 1774 | 3632 | 0    | 1792 | 0    | 1599 |     |     |     |
| Grp Volume(v), veh/h        | 0    | 360  | 357  | 180  | 1090 | 0    | 225  | 0    | 231  |     |     |     |
| Grp Sat Flow(s),veh/h/ln    | 1740 | 1736 | 1714 | 1774 | 1770 | 0    | 1792 | 0    | 1599 |     |     |     |
| Q Serve(g_s), s             | 0.0  | 7.4  | 7.4  | 4.5  | 8.3  | 0.0  | 5.4  | 0.0  | 6.4  |     |     |     |
| Cycle Q Clear(g_c), s       | 0.0  | 7.4  | 7.4  | 4.5  | 8.3  | 0.0  | 5.4  | 0.0  | 6.4  |     |     |     |
| Prop In Lane                | 1.00 |      | 0.37 | 1.00 |      | 0.00 | 1.00 |      | 1.00 |     |     |     |
| Lane Grp Cap(c), veh/h      | 4    | 677  | 668  | 228  | 2111 | 0    | 332  | 0    | 296  |     |     |     |
| V/C Ratio(X)                | 0.00 | 0.53 | 0.53 | 0.79 | 0.52 | 0.00 | 0.68 | 0.00 | 0.78 |     |     |     |
| Avail Cap(c_a), veh/h       | 753  | 2252 | 2225 | 767  | 4593 | 0    | 1046 | 0    | 934  |     |     |     |
| HCM Platoon Ratio           | 1.00 | 1.00 | 1.00 | 1.00 | 1.00 | 1.00 | 1.00 | 1.00 | 1.00 |     |     |     |
| Upstream Filter(I)          | 0.00 | 1.00 | 1.00 | 1.00 | 1.00 | 0.00 | 1.00 | 0.00 | 1.00 |     |     |     |
| Uniform Delay (d), s/veh    | 0.0  | 10.9 | 10.9 | 19.5 | 5.4  | 0.0  | 17.6 | 0.0  | 17.9 |     |     |     |
| Incr Delay (d2), s/veh      | 0.0  | 1.2  | 1.2  | 2.3  | 0.2  | 0.0  | 0.9  | 0.0  | 1.7  |     |     |     |
| Initial Q Delay(d3),s/veh   | 0.0  | 0.0  | 0.0  | 0.0  | 0.0  | 0.0  | 0.0  | 0.0  | 0.0  |     |     |     |
| %ile BackOfQ(50%),veh/ln    | 0.0  | 3.7  | 3.7  | 2.3  | 4.0  | 0.0  | 2.7  | 0.0  | 2.9  |     |     |     |
| LnGrp Delay(d),s/veh        | 0.0  | 12.1 | 12.1 | 21.8 | 5.7  | 0.0  | 18.5 | 0.0  | 19.6 |     |     |     |
| LnGrp LOS                   |      | B    | B    | C    | A    |      | B    |      | B    |     |     |     |
| Approach Vol, veh/h         |      | 717  |      |      | 1270 |      |      | 456  |      |     |     |     |
| Approach Delay, s/veh       |      | 12.1 |      |      | 8.0  |      |      | 19.1 |      |     |     |     |
| Approach LOS                |      | B    |      |      | A    |      |      | B    |      |     |     |     |
| Timer                       | 1    | 2    | 3    | 4    | 5    | 6    | 7    | 8    |      |     |     |     |
| Assigned Phs                | 1    | 2    |      |      | 5    | 6    |      | 8    |      |     |     |     |
| Phs Duration (G+Y+Rc), s    | 9.5  | 23.4 |      |      | 0.0  | 33.0 |      | 13.3 |      |     |     |     |
| Change Period (Y+Rc), s     | 3.6  | 5.4  |      |      | 3.5  | 5.4  |      | 4.7  |      |     |     |     |
| Max Green Setting (Gmax)    | 20   | 60.0 |      |      | 20.0 | 60.0 |      | 27.0 |      |     |     |     |
| Max Q Clear Time (g_c+10)   | 5    | 9.4  |      |      | 0.0  | 10.3 |      | 8.4  |      |     |     |     |
| Green Ext Time (p_c), s     | 0.0  | 8.6  |      |      | 0.0  | 11.1 |      | 0.2  |      |     |     |     |
| <b>Intersection Summary</b> |      |      |      |      |      |      |      |      |      |     |     |     |
| HCM 2010 Ctrl Delay         |      |      |      | 11.3 |      |      |      |      |      |     |     |     |
| HCM 2010 LOS                |      |      |      | B    |      |      |      |      |      |     |     |     |
| <b>Notes</b>                |      |      |      |      |      |      |      |      |      |     |     |     |

HCM 2010 Signalized Intersection Summary  
 27: Reservation Road & Watkins Gate Road

Cumulative with Project, AM  
 06/11/2019



| Movement                     | EBL  | EBR  | NBL  | NBT  | SBT  | SBR  |   |      |
|------------------------------|------|------|------|------|------|------|---|------|
| Lane Configurations          |      |      |      |      |      |      |   |      |
| Traffic Volume (veh/h)       | 10   | 260  | 170  | 1370 | 890  | 60   |   |      |
| Future Volume (veh/h)        | 10   | 260  | 170  | 1370 | 890  | 60   |   |      |
| Number                       | 5    | 12   | 3    | 8    | 4    | 14   |   |      |
| Initial Q (Qb), veh          | 0    | 0    | 0    | 0    | 0    | 0    |   |      |
| Ped-Bike Adj(A_pbT)          | 1.00 | 1.00 | 1.00 |      |      | 1.00 |   |      |
| Parking Bus, Adj             | 1.00 | 1.00 | 1.00 | 1.00 | 1.00 | 1.00 |   |      |
| Adj Sat Flow, veh/h/ln       | 1863 | 1863 | 1863 | 1863 | 1863 | 1900 |   |      |
| Adj Flow Rate, veh/h         | 11   | 55   | 185  | 1489 | 967  | 58   |   |      |
| Adj No. of Lanes             | 1    | 1    | 1    | 2    | 2    | 0    |   |      |
| Peak Hour Factor             | 0.92 | 0.92 | 0.92 | 0.92 | 0.92 | 0.92 |   |      |
| Percent Heavy Veh, %         | 2    | 2    | 2    | 2    | 2    | 2    |   |      |
| Cap, veh/h                   | 103  | 92   | 231  | 2495 | 1702 | 102  |   |      |
| Arrive On Green              | 0.06 | 0.06 | 0.13 | 0.70 | 0.50 | 0.50 |   |      |
| Sat Flow, veh/h              | 1774 | 1583 | 1774 | 3632 | 3486 | 204  |   |      |
| Grp Volume(v), veh/h         | 11   | 55   | 185  | 1489 | 504  | 521  |   |      |
| Grp Sat Flow(s),veh/h/ln     | 1774 | 1583 | 1774 | 1770 | 1770 | 1827 |   |      |
| Q Serve(g_s), s              | 0.3  | 1.9  | 5.5  | 11.7 | 10.9 | 10.9 |   |      |
| Cycle Q Clear(g_c), s        | 0.3  | 1.9  | 5.5  | 11.7 | 10.9 | 10.9 |   |      |
| Prop In Lane                 | 1.00 | 1.00 | 1.00 |      |      | 0.11 |   |      |
| Lane Grp Cap(c), veh/h       | 103  | 92   | 231  | 2495 | 888  | 916  |   |      |
| V/C Ratio(X)                 | 0.11 | 0.60 | 0.80 | 0.60 | 0.57 | 0.57 |   |      |
| Avail Cap(c_a), veh/h        | 599  | 535  | 583  | 4425 | 1502 | 1550 |   |      |
| HCM Platoon Ratio            | 1.00 | 1.00 | 1.00 | 1.00 | 1.00 | 1.00 |   |      |
| Upstream Filter(I)           | 1.00 | 1.00 | 1.00 | 1.00 | 1.00 | 1.00 |   |      |
| Uniform Delay (d), s/veh     | 24.5 | 25.2 | 23.1 | 4.1  | 9.5  | 9.5  |   |      |
| Incr Delay (d2), s/veh       | 0.2  | 2.3  | 2.4  | 0.4  | 0.9  | 0.9  |   |      |
| Initial Q Delay(d3),s/veh    | 0.0  | 0.0  | 0.0  | 0.0  | 0.0  | 0.0  |   |      |
| %ile BackOfQ(50%),veh/ln     | 0.2  | 0.9  | 2.9  | 5.7  | 5.4  | 5.6  |   |      |
| LnGrp Delay(d),s/veh         | 24.6 | 27.5 | 25.6 | 4.5  | 10.4 | 10.4 |   |      |
| LnGrp LOS                    | C    | C    | C    | A    | B    | B    |   |      |
| Approach Vol, veh/h          | 66   |      |      | 1674 | 1025 |      |   |      |
| Approach Delay, s/veh        | 27.0 |      |      | 6.8  | 10.4 |      |   |      |
| Approach LOS                 | C    |      |      | A    | B    |      |   |      |
| Timer                        | 1    | 2    | 3    | 4    | 5    | 6    | 7 | 8    |
| Assigned Phs                 |      | 2    | 3    | 4    |      |      |   | 8    |
| Phs Duration (G+Y+Rc), s     |      | 9.7  | 11.1 | 34.0 |      |      |   | 45.1 |
| Change Period (Y+Rc), s      |      | 6.5  | 4.0  | 6.5  |      |      |   | 6.5  |
| Max Green Setting (Gmax), s  |      | 18.5 | 18.0 | 46.5 |      |      |   | 68.5 |
| Max Q Clear Time (g_c+I1), s |      | 3.9  | 7.5  | 12.9 |      |      |   | 13.7 |
| Green Ext Time (p_c), s      |      | 0.0  | 0.0  | 11.0 |      |      |   | 24.9 |
| <b>Intersection Summary</b>  |      |      |      |      |      |      |   |      |
| HCM 2010 Ctrl Delay          |      |      | 8.6  |      |      |      |   |      |
| HCM 2010 LOS                 |      |      | A    |      |      |      |   |      |

HCM 2010 Signalized Intersection Summary  
 28: Davis Road & Reservation Road

Cumulative with Project, AM  
 06/11/2019



| Movement                     | EBL   | EBT   | EBR   | WBL  | WBT   | WBR  | NBL  | NBT  | NBR  | SBL  | SBT  | SBR  |
|------------------------------|-------|-------|-------|------|-------|------|------|------|------|------|------|------|
| Lane Configurations          |       |       |       |      |       |      |      |      |      |      |      |      |
| Traffic Volume (veh/h)       | 550   | 310   | 10    | 10   | 560   | 90   | 10   | 10   | 10   | 150  | 10   | 640  |
| Future Volume (veh/h)        | 550   | 310   | 10    | 10   | 560   | 90   | 10   | 10   | 10   | 150  | 10   | 640  |
| Number                       | 5     | 2     | 12    | 1    | 6     | 16   | 3    | 8    | 18   | 7    | 4    | 14   |
| Initial Q (Qb), veh          | 0     | 0     | 0     | 0    | 0     | 0    | 0    | 0    | 0    | 0    | 0    | 0    |
| Ped-Bike Adj(A_pbT)          | 1.00  |       | 1.00  | 1.00 |       | 1.00 | 1.00 |      | 1.00 | 1.00 |      | 1.00 |
| Parking Bus, Adj             | 1.00  | 1.00  | 1.00  | 1.00 | 1.00  | 1.00 | 1.00 | 1.00 | 1.00 | 1.00 | 1.00 | 1.00 |
| Adj Sat Flow, veh/h/ln       | 1863  | 1863  | 1900  | 1863 | 1863  | 1900 | 1900 | 1900 | 1900 | 1900 | 1845 | 1845 |
| Adj Flow Rate, veh/h         | 640   | 360   | 12    | 12   | 651   | 105  | 12   | 12   | 9    | 174  | 12   | 502  |
| Adj No. of Lanes             | 1     | 2     | 0     | 1    | 1     | 0    | 0    | 1    | 0    | 0    | 1    | 1    |
| Peak Hour Factor             | 0.86  | 0.86  | 0.86  | 0.86 | 0.86  | 0.86 | 0.86 | 0.86 | 0.86 | 0.86 | 0.86 | 0.86 |
| Percent Heavy Veh, %         | 2     | 2     | 2     | 2    | 2     | 2    | 0    | 0    | 0    | 3    | 3    | 3    |
| Cap, veh/h                   | 376   | 2185  | 73    | 19   | 664   | 107  | 17   | 17   | 12   | 350  | 24   | 665  |
| Arrive On Green              | 0.21  | 0.62  | 0.62  | 0.01 | 0.42  | 0.42 | 0.03 | 0.03 | 0.03 | 0.21 | 0.21 | 0.21 |
| Sat Flow, veh/h              | 1774  | 3496  | 116   | 1774 | 1566  | 253  | 648  | 648  | 486  | 1649 | 114  | 1568 |
| Grp Volume(v), veh/h         | 640   | 182   | 190   | 12   | 0     | 756  | 33   | 0    | 0    | 186  | 0    | 502  |
| Grp Sat Flow(s),veh/h/ln     | 1774  | 1770  | 1842  | 1774 | 0     | 1818 | 1782 | 0    | 0    | 1762 | 0    | 1568 |
| Q Serve(g_s), s              | 30.0  | 6.1   | 6.1   | 1.0  | 0.0   | 58.0 | 2.6  | 0.0  | 0.0  | 13.1 | 0.0  | 30.0 |
| Cycle Q Clear(g_c), s        | 30.0  | 6.1   | 6.1   | 1.0  | 0.0   | 58.0 | 2.6  | 0.0  | 0.0  | 13.1 | 0.0  | 30.0 |
| Prop In Lane                 | 1.00  |       | 0.06  | 1.00 |       | 0.14 | 0.36 |      | 0.27 | 0.94 |      | 1.00 |
| Lane Grp Cap(c), veh/h       | 376   | 1106  | 1151  | 19   | 0     | 771  | 46   | 0    | 0    | 374  | 0    | 665  |
| V/C Ratio(X)                 | 1.70  | 0.16  | 0.17  | 0.64 | 0.00  | 0.98 | 0.72 | 0.00 | 0.00 | 0.50 | 0.00 | 0.75 |
| Avail Cap(c_a), veh/h        | 376   | 1106  | 1151  | 376  | 0     | 771  | 378  | 0    | 0    | 374  | 0    | 665  |
| HCM Platoon Ratio            | 1.00  | 1.00  | 1.00  | 1.00 | 1.00  | 1.00 | 1.00 | 1.00 | 1.00 | 1.00 | 1.00 | 1.00 |
| Upstream Filter(I)           | 1.00  | 1.00  | 1.00  | 1.00 | 0.00  | 1.00 | 1.00 | 0.00 | 0.00 | 1.00 | 0.00 | 1.00 |
| Uniform Delay (d), s/veh     | 55.7  | 11.1  | 11.1  | 69.7 | 0.0   | 40.1 | 68.4 | 0.0  | 0.0  | 49.1 | 0.0  | 34.5 |
| Incr Delay (d2), s/veh       | 326.5 | 0.1   | 0.1   | 12.4 | 0.0   | 27.5 | 7.7  | 0.0  | 0.0  | 0.4  | 0.0  | 4.4  |
| Initial Q Delay(d3),s/veh    | 0.0   | 0.0   | 0.0   | 0.0  | 0.0   | 0.0  | 0.0  | 0.0  | 0.0  | 0.0  | 0.0  | 0.0  |
| %ile BackOfQ(50%),veh/#      | 8.8   | 3.0   | 3.1   | 0.5  | 0.0   | 34.9 | 1.4  | 0.0  | 0.0  | 6.4  | 0.0  | 17.3 |
| LnGrp Delay(d),s/veh         | 382.2 | 11.2  | 11.2  | 82.1 | 0.0   | 67.7 | 76.1 | 0.0  | 0.0  | 49.5 | 0.0  | 38.9 |
| LnGrp LOS                    | F     | B     | B     | F    |       | E    | E    |      |      | D    |      | D    |
| Approach Vol, veh/h          |       | 1012  |       |      | 768   |      |      | 33   |      |      | 688  |      |
| Approach Delay, s/veh        |       | 245.8 |       |      | 67.9  |      |      | 76.1 |      |      | 41.7 |      |
| Approach LOS                 |       | F     |       |      | E     |      |      | E    |      |      | D    |      |
| Timer                        | 1     | 2     | 3     | 4    | 5     | 6    | 7    | 8    |      |      |      |      |
| Assigned Phs                 | 1     | 2     |       | 4    | 5     | 6    |      | 8    |      |      |      |      |
| Phs Duration (G+Y+Rc), s     | 5.4   | 93.4  |       | 35.0 | 33.8  | 65.0 |      | 7.6  |      |      |      |      |
| Change Period (Y+Rc), s      | 3.9   | 5.0   |       | 5.0  | * 3.8 | 5.0  |      | 4.0  |      |      |      |      |
| Max Green Setting (Gmax), s  | 30    | 60.0  |       | 30.0 | * 30  | 60.0 |      | 30.0 |      |      |      |      |
| Max Q Clear Time (g_c+13), s | 3.0   | 8.1   |       | 32.0 | 32.0  | 60.0 |      | 4.6  |      |      |      |      |
| Green Ext Time (p_c), s      | 0.0   | 3.3   |       | 0.0  | 0.0   | 0.0  |      | 0.0  |      |      |      |      |
| <b>Intersection Summary</b>  |       |       |       |      |       |      |      |      |      |      |      |      |
| HCM 2010 Ctrl Delay          |       |       | 132.8 |      |       |      |      |      |      |      |      |      |
| HCM 2010 LOS                 |       |       | F     |      |       |      |      |      |      |      |      |      |
| <b>Notes</b>                 |       |       |       |      |       |      |      |      |      |      |      |      |

HCM 2010 Signalized Intersection Summary  
 29: 2nd Avenue & Divarty Street

Cumulative with Project, AM  
 06/11/2019



| Movement                     | EBL  | EBT  | EBR  | WBL  | WBT  | WBR  | NBL  | NBT  | NBR  | SBL  | SBT  | SBR  |
|------------------------------|------|------|------|------|------|------|------|------|------|------|------|------|
| Lane Configurations          |      | ↕    |      |      | ↕    | ↕    | ↕    | ↕↔   |      | ↕    | ↕↔   |      |
| Traffic Volume (veh/h)       | 80   | 10   | 40   | 70   | 20   | 20   | 130  | 640  | 130  | 20   | 1200 | 250  |
| Future Volume (veh/h)        | 80   | 10   | 40   | 70   | 20   | 20   | 130  | 640  | 130  | 20   | 1200 | 250  |
| Number                       | 5    | 2    | 12   | 1    | 6    | 16   | 3    | 8    | 18   | 7    | 4    | 14   |
| Initial Q (Qb), veh          | 0    | 0    | 0    | 0    | 0    | 0    | 0    | 0    | 0    | 0    | 0    | 0    |
| Ped-Bike Adj(A_pbT)          | 1.00 |      | 1.00 | 1.00 |      | 1.00 | 1.00 |      | 1.00 | 1.00 |      | 1.00 |
| Parking Bus, Adj             | 1.00 | 1.00 | 1.00 | 1.00 | 1.00 | 1.00 | 1.00 | 1.00 | 1.00 | 1.00 | 1.00 | 1.00 |
| Adj Sat Flow, veh/h/ln       | 1900 | 1667 | 1900 | 1900 | 1900 | 1900 | 1863 | 1863 | 1900 | 1881 | 1881 | 1900 |
| Adj Flow Rate, veh/h         | 88   | 11   | 44   | 77   | 22   | 22   | 143  | 703  | 143  | 22   | 1319 | 275  |
| Adj No. of Lanes             | 0    | 1    | 0    | 0    | 1    | 1    | 1    | 2    | 0    | 1    | 2    | 0    |
| Peak Hour Factor             | 0.91 | 0.91 | 0.91 | 0.91 | 0.91 | 0.91 | 0.91 | 0.91 | 0.91 | 0.91 | 0.91 | 0.91 |
| Percent Heavy Veh, %         | 14   | 14   | 14   | 0    | 0    | 0    | 2    | 2    | 2    | 1    | 1    | 1    |
| Cap, veh/h                   | 182  | 32   | 59   | 282  | 70   | 300  | 181  | 1756 | 357  | 44   | 1542 | 317  |
| Arrive On Green              | 0.19 | 0.19 | 0.19 | 0.19 | 0.19 | 0.19 | 0.10 | 0.60 | 0.60 | 0.02 | 0.52 | 0.52 |
| Sat Flow, veh/h              | 540  | 171  | 316  | 1033 | 377  | 1612 | 1774 | 2930 | 596  | 1792 | 2953 | 607  |
| Grp Volume(v), veh/h         | 143  | 0    | 0    | 99   | 0    | 22   | 143  | 424  | 422  | 22   | 791  | 803  |
| Grp Sat Flow(s),veh/h/ln     | 1026 | 0    | 0    | 1410 | 0    | 1612 | 1774 | 1770 | 1756 | 1792 | 1787 | 1773 |
| Q Serve(g_s), s              | 6.0  | 0.0  | 0.0  | 0.0  | 0.0  | 0.8  | 5.6  | 9.0  | 9.0  | 0.9  | 27.0 | 28.2 |
| Cycle Q Clear(g_c), s        | 10.3 | 0.0  | 0.0  | 4.3  | 0.0  | 0.8  | 5.6  | 9.0  | 9.0  | 0.9  | 27.0 | 28.2 |
| Prop In Lane                 | 0.62 |      | 0.31 | 0.78 |      | 1.00 | 1.00 |      | 0.34 | 1.00 |      | 0.34 |
| Lane Grp Cap(c), veh/h       | 273  | 0    | 0    | 352  | 0    | 300  | 181  | 1061 | 1053 | 44   | 933  | 926  |
| V/C Ratio(X)                 | 0.52 | 0.00 | 0.00 | 0.28 | 0.00 | 0.07 | 0.79 | 0.40 | 0.40 | 0.50 | 0.85 | 0.87 |
| Avail Cap(c_a), veh/h        | 670  | 0    | 0    | 799  | 0    | 794  | 287  | 1061 | 1053 | 290  | 1005 | 997  |
| HCM Platoon Ratio            | 1.00 | 1.00 | 1.00 | 1.00 | 1.00 | 1.00 | 1.00 | 1.00 | 1.00 | 1.00 | 1.00 | 1.00 |
| Upstream Filter(I)           | 1.00 | 0.00 | 0.00 | 1.00 | 0.00 | 1.00 | 1.00 | 1.00 | 1.00 | 1.00 | 1.00 | 1.00 |
| Uniform Delay (d), s/veh     | 28.5 | 0.0  | 0.0  | 25.2 | 0.0  | 23.9 | 31.2 | 7.5  | 7.5  | 34.2 | 14.6 | 14.8 |
| Incr Delay (d2), s/veh       | 1.6  | 0.0  | 0.0  | 0.4  | 0.0  | 0.1  | 7.5  | 0.2  | 0.2  | 8.3  | 6.5  | 7.8  |
| Initial Q Delay(d3),s/veh    | 0.0  | 0.0  | 0.0  | 0.0  | 0.0  | 0.0  | 0.0  | 0.0  | 0.0  | 0.0  | 0.0  | 0.0  |
| %ile BackOfQ(50%),veh/ln     | 2.8  | 0.0  | 0.0  | 1.7  | 0.0  | 0.4  | 3.1  | 4.4  | 4.4  | 0.5  | 14.9 | 15.6 |
| LnGrp Delay(d),s/veh         | 30.1 | 0.0  | 0.0  | 25.6 | 0.0  | 24.0 | 38.7 | 7.8  | 7.8  | 42.5 | 21.1 | 22.7 |
| LnGrp LOS                    | C    |      |      | C    |      | C    | D    | A    | A    | D    | C    | C    |
| Approach Vol, veh/h          |      | 143  |      |      | 121  |      |      | 989  |      |      | 1616 |      |
| Approach Delay, s/veh        |      | 30.1 |      |      | 25.3 |      |      | 12.2 |      |      | 22.2 |      |
| Approach LOS                 |      | C    |      |      | C    |      |      | B    |      |      | C    |      |
| Timer                        | 1    | 2    | 3    | 4    | 5    | 6    | 7    | 8    |      |      |      |      |
| Assigned Phs                 |      | 2    | 3    | 4    |      | 6    | 7    | 8    |      |      |      |      |
| Phs Duration (G+Y+Rc), s     |      | 18.2 | 10.8 | 42.1 |      | 18.2 | 5.3  | 47.6 |      |      |      |      |
| Change Period (Y+Rc), s      |      | 5.0  | 3.5  | 5.0  |      | 5.0  | 3.5  | 5.0  |      |      |      |      |
| Max Green Setting (Gmax), s  |      | 35.0 | 11.5 | 40.0 |      | 35.0 | 11.5 | 40.0 |      |      |      |      |
| Max Q Clear Time (g_c+I1), s |      | 12.3 | 7.6  | 30.2 |      | 6.3  | 2.9  | 11.0 |      |      |      |      |
| Green Ext Time (p_c), s      |      | 0.7  | 0.1  | 7.0  |      | 0.6  | 0.0  | 5.8  |      |      |      |      |
| <b>Intersection Summary</b>  |      |      |      |      |      |      |      |      |      |      |      |      |
| HCM 2010 Ctrl Delay          |      |      |      | 19.3 |      |      |      |      |      |      |      |      |
| HCM 2010 LOS                 |      |      |      | B    |      |      |      |      |      |      |      |      |

| Intersection              |      |  |  |  |  |  |  |  |  |  |  |  |
|---------------------------|------|--|--|--|--|--|--|--|--|--|--|--|
| Intersection Delay, s/veh | 10.2 |  |  |  |  |  |  |  |  |  |  |  |
| Intersection LOS          | B    |  |  |  |  |  |  |  |  |  |  |  |

| Movement            | EBL  | EBT  | EBR  | WBL  | WBT  | WBR  | NBL  | NBT  | NBR  | SBL  | SBT  | SBR  |
|---------------------|------|------|------|------|------|------|------|------|------|------|------|------|
| Lane Configurations |      | ↕    |      |      | ↕    |      | ↕    | ↕    |      | ↕    | ↕    |      |
| Traffic Vol, veh/h  | 10   | 10   | 20   | 10   | 10   | 20   | 30   | 260  | 10   | 20   | 200  | 20   |
| Future Vol, veh/h   | 10   | 10   | 20   | 10   | 10   | 20   | 30   | 260  | 10   | 20   | 200  | 20   |
| Peak Hour Factor    | 0.91 | 0.91 | 0.91 | 0.91 | 0.91 | 0.91 | 0.91 | 0.91 | 0.91 | 0.91 | 0.91 | 0.91 |
| Heavy Vehicles, %   | 0    | 0    | 0    | 1    | 1    | 1    | 2    | 2    | 2    | 1    | 1    | 1    |
| Mvmt Flow           | 11   | 11   | 22   | 11   | 11   | 22   | 33   | 286  | 11   | 22   | 220  | 22   |
| Number of Lanes     | 0    | 1    | 0    | 0    | 1    | 0    | 1    | 1    | 0    | 1    | 1    | 0    |

| Approach                   | EB  | WB  | NB   | SB   |
|----------------------------|-----|-----|------|------|
| Opposing Approach          | WB  | EB  | SB   | NB   |
| Opposing Lanes             | 1   | 1   | 2    | 2    |
| Conflicting Approach Left  | SB  | NB  | EB   | WB   |
| Conflicting Lanes Left     | 2   | 2   | 1    | 1    |
| Conflicting Approach Right | NB  | SB  | WB   | EB   |
| Conflicting Lanes Right    | 2   | 2   | 1    | 1    |
| HCM Control Delay          | 8.5 | 8.5 | 10.8 | 10.1 |
| HCM LOS                    | A   | A   | B    | B    |

| Lane                   | NBLn1 | NBLn2 | EBLn1 | WBLn1 | SBLn1 | SBLn2 |
|------------------------|-------|-------|-------|-------|-------|-------|
| Vol Left, %            | 100%  | 0%    | 25%   | 25%   | 100%  | 0%    |
| Vol Thru, %            | 0%    | 96%   | 25%   | 25%   | 0%    | 91%   |
| Vol Right, %           | 0%    | 4%    | 50%   | 50%   | 0%    | 9%    |
| Sign Control           | Stop  | Stop  | Stop  | Stop  | Stop  | Stop  |
| Traffic Vol by Lane    | 30    | 270   | 40    | 40    | 20    | 220   |
| LT Vol                 | 30    | 0     | 10    | 10    | 20    | 0     |
| Through Vol            | 0     | 260   | 10    | 10    | 0     | 200   |
| RT Vol                 | 0     | 10    | 20    | 20    | 0     | 20    |
| Lane Flow Rate         | 33    | 297   | 44    | 44    | 22    | 242   |
| Geometry Grp           | 7     | 7     | 2     | 2     | 7     | 7     |
| Degree of Util (X)     | 0.05  | 0.408 | 0.062 | 0.063 | 0.034 | 0.333 |
| Departure Headway (Hd) | 5.481 | 4.953 | 5.103 | 5.121 | 5.524 | 4.958 |
| Convergence, Y/N       | Yes   | Yes   | Yes   | Yes   | Yes   | Yes   |
| Cap                    | 653   | 727   | 699   | 697   | 648   | 725   |
| Service Time           | 3.214 | 2.685 | 3.153 | 3.169 | 3.258 | 2.691 |
| HCM Lane V/C Ratio     | 0.051 | 0.409 | 0.063 | 0.063 | 0.034 | 0.334 |
| HCM Control Delay      | 8.5   | 11.1  | 8.5   | 8.5   | 8.5   | 10.2  |
| HCM Lane LOS           | A     | B     | A     | A     | A     | B     |
| HCM 95th-tile Q        | 0.2   | 2     | 0.2   | 0.2   | 0.1   | 1.5   |



HCM 2010 Signalized Intersection Summary  
 31: 1st Avenue & Lightfighter Drive

Cumulative with Project, AM  
 06/11/2019



| Movement                     | EBL  | EBT  | EBR  | WBL  | WBT  | WBR  | NBL  | NBT  | NBR  | SBL  | SBT  | SBR  |
|------------------------------|------|------|------|------|------|------|------|------|------|------|------|------|
| Lane Configurations          |      | ↑↑   | ↑    | ↑    | ↑↑   |      | ↑    |      | ↑    | ↑    | ↑    | ↑    |
| Traffic Volume (veh/h)       | 0    | 1250 | 130  | 20   | 1150 | 0    | 160  | 0    | 20   | 120  | 30   | 100  |
| Future Volume (veh/h)        | 0    | 1250 | 130  | 20   | 1150 | 0    | 160  | 0    | 20   | 120  | 30   | 100  |
| Number                       | 7    | 4    | 14   | 3    | 8    | 18   | 5    | 2    | 12   | 1    | 6    | 16   |
| Initial Q (Qb), veh          | 0    | 0    | 0    | 0    | 0    | 0    | 0    | 0    | 0    | 0    | 0    | 0    |
| Ped-Bike Adj(A_pbT)          | 1.00 |      | 1.00 | 1.00 |      | 1.00 | 1.00 |      | 1.00 | 1.00 |      | 1.00 |
| Parking Bus, Adj             | 1.00 | 1.00 | 1.00 | 1.00 | 1.00 | 1.00 | 1.00 | 1.00 | 1.00 | 1.00 | 1.00 | 1.00 |
| Adj Sat Flow, veh/h/ln       | 0    | 1863 | 1863 | 1863 | 1863 | 0    | 1863 | 0    | 1863 | 1792 | 1792 | 1792 |
| Adj Flow Rate, veh/h         | 0    | 1488 | 0    | 24   | 1369 | 0    | 190  | 0    | 10   | 143  | 36   | 100  |
| Adj No. of Lanes             | 0    | 2    | 1    | 1    | 2    | 0    | 1    | 0    | 1    | 1    | 1    | 1    |
| Peak Hour Factor             | 0.84 | 0.84 | 0.84 | 0.84 | 0.84 | 0.84 | 0.84 | 0.84 | 0.84 | 0.84 | 0.84 | 0.84 |
| Percent Heavy Veh, %         | 0    | 2    | 2    | 2    | 2    | 0    | 2    | 0    | 2    | 6    | 6    | 6    |
| Cap, veh/h                   | 0    | 2238 | 1001 | 27   | 2517 | 0    | 0    | 0    | 0    | 209  | 220  | 187  |
| Arrive On Green              | 0.00 | 0.63 | 0.00 | 0.02 | 0.71 | 0.00 | 0.00 | 0.00 | 0.00 | 0.12 | 0.12 | 0.12 |
| Sat Flow, veh/h              | 0    | 3632 | 1583 | 1774 | 3632 | 0    |      | 0    |      | 1707 | 1792 | 1524 |
| Grp Volume(v), veh/h         | 0    | 1488 | 0    | 24   | 1369 | 0    |      | 0.0  |      | 143  | 36   | 100  |
| Grp Sat Flow(s),veh/h/ln     | 0    | 1770 | 1583 | 1774 | 1770 | 0    |      |      |      | 1707 | 1792 | 1524 |
| Q Serve(g_s), s              | 0.0  | 14.7 | 0.0  | 0.7  | 10.1 | 0.0  |      |      |      | 4.4  | 1.0  | 3.4  |
| Cycle Q Clear(g_c), s        | 0.0  | 14.7 | 0.0  | 0.7  | 10.1 | 0.0  |      |      |      | 4.4  | 1.0  | 3.4  |
| Prop In Lane                 | 0.00 |      | 1.00 | 1.00 |      | 0.00 |      |      |      | 1.00 |      | 1.00 |
| Lane Grp Cap(c), veh/h       | 0    | 2238 | 1001 | 27   | 2517 | 0    |      |      |      | 209  | 220  | 187  |
| V/C Ratio(X)                 | 0.00 | 0.66 | 0.00 | 0.88 | 0.54 | 0.00 |      |      |      | 0.68 | 0.16 | 0.54 |
| Avail Cap(c_a), veh/h        | 0    | 2880 | 1288 | 642  | 2880 | 0    |      |      |      | 772  | 810  | 689  |
| HCM Platoon Ratio            | 1.00 | 1.00 | 1.00 | 1.00 | 1.00 | 1.00 |      |      |      | 1.00 | 1.00 | 1.00 |
| Upstream Filter(I)           | 0.00 | 1.00 | 0.00 | 1.00 | 1.00 | 0.00 |      |      |      | 1.00 | 1.00 | 1.00 |
| Uniform Delay (d), s/veh     | 0.0  | 6.4  | 0.0  | 27.2 | 3.8  | 0.0  |      |      |      | 23.2 | 21.7 | 22.8 |
| Incr Delay (d2), s/veh       | 0.0  | 0.5  | 0.0  | 26.1 | 0.3  | 0.0  |      |      |      | 1.5  | 0.1  | 0.9  |
| Initial Q Delay(d3),s/veh    | 0.0  | 0.0  | 0.0  | 0.0  | 0.0  | 0.0  |      |      |      | 0.0  | 0.0  | 0.0  |
| %ile BackOfQ(50%),veh/lr     | 0.0  | 7.2  | 0.0  | 0.6  | 4.8  | 0.0  |      |      |      | 2.2  | 0.5  | 1.5  |
| LnGrp Delay(d),s/veh         | 0.0  | 7.0  | 0.0  | 53.3 | 4.0  | 0.0  |      |      |      | 24.7 | 21.9 | 23.7 |
| LnGrp LOS                    |      | A    |      | D    | A    |      |      |      |      | C    | C    | C    |
| Approach Vol, veh/h          |      | 1488 |      |      | 1393 |      |      |      |      |      | 279  |      |
| Approach Delay, s/veh        |      | 7.0  |      |      | 4.9  |      |      |      |      |      | 24.0 |      |
| Approach LOS                 |      | A    |      |      | A    |      |      |      |      |      | C    |      |
| Timer                        | 1    | 2    | 3    | 4    | 5    | 6    | 7    | 8    |      |      |      |      |
| Assigned Phs                 |      |      | 3    | 4    |      | 6    |      | 8    |      |      |      |      |
| Phs Duration (G+Y+Rc), s     |      |      | 4.4  | 39.6 |      | 11.4 |      | 43.9 |      |      |      |      |
| Change Period (Y+Rc), s      |      |      | 3.5  | 4.6  |      | 4.6  |      | 4.6  |      |      |      |      |
| Max Green Setting (Gmax), s  |      |      | 20.0 | 45.0 |      | 25.0 |      | 45.0 |      |      |      |      |
| Max Q Clear Time (g_c+I1), s |      |      | 2.7  | 16.7 |      | 6.4  |      | 12.1 |      |      |      |      |
| Green Ext Time (p_c), s      |      |      | 0.0  | 18.2 |      | 0.4  |      | 17.2 |      |      |      |      |
| <b>Intersection Summary</b>  |      |      |      |      |      |      |      |      |      |      |      |      |
| HCM 2010 Ctrl Delay          |      |      | 7.5  |      |      |      |      |      |      |      |      |      |
| HCM 2010 LOS                 |      |      | A    |      |      |      |      |      |      |      |      |      |

HCM 2010 Signalized Intersection Summary  
 32: 2nd Avenue & Lightfighter Drive

Cumulative with Project, AM  
 06/11/2019



| Movement                    | EBL   | EBT   | EBR  | WBL  | WBT  | WBR  | NBL  | NBT  | NBR  | SBL  | SBT  | SBR  |
|-----------------------------|-------|-------|------|------|------|------|------|------|------|------|------|------|
| Lane Configurations         |       |       |      |      |      |      |      |      |      |      |      |      |
| Traffic Volume (veh/h)      | 340   | 1040  | 10   | 40   | 710  | 180  | 20   | 20   | 50   | 370  | 10   | 490  |
| Future Volume (veh/h)       | 340   | 1040  | 10   | 40   | 710  | 180  | 20   | 20   | 50   | 370  | 10   | 490  |
| Number                      | 5     | 2     | 12   | 1    | 6    | 16   | 3    | 8    | 18   | 7    | 4    | 14   |
| Initial Q (Qb), veh         | 0     | 0     | 0    | 0    | 0    | 0    | 0    | 0    | 0    | 0    | 0    | 0    |
| Ped-Bike Adj(A_pbT)         | 1.00  |       | 1.00 | 1.00 |      | 1.00 | 1.00 |      | 1.00 | 1.00 |      | 1.00 |
| Parking Bus, Adj            | 1.00  | 1.00  | 1.00 | 1.00 | 1.00 | 1.00 | 1.00 | 1.00 | 1.00 | 1.00 | 1.00 | 1.00 |
| Adj Sat Flow, veh/h/ln      | 1863  | 1863  | 1900 | 1827 | 1827 | 1900 | 1900 | 1900 | 1900 | 1881 | 1881 | 1881 |
| Adj Flow Rate, veh/h        | 378   | 1156  | 11   | 44   | 789  | 191  | 22   | 22   | 55   | 411  | 11   | 268  |
| Adj No. of Lanes            | 1     | 2     | 0    | 1    | 2    | 0    | 0    | 1    | 0    | 1    | 1    | 1    |
| Peak Hour Factor            | 0.90  | 0.90  | 0.90 | 0.90 | 0.90 | 0.90 | 0.90 | 0.90 | 0.90 | 0.90 | 0.90 | 0.90 |
| Percent Heavy Veh, %        | 2     | 2     | 2    | 4    | 4    | 4    | 0    | 0    | 0    | 1    | 1    | 1    |
| Cap, veh/h                  | 220   | 1856  | 18   | 56   | 1178 | 285  | 128  | 137  | 277  | 511  | 601  | 511  |
| Arrive On Green             | 0.12  | 0.52  | 0.52 | 0.03 | 0.42 | 0.42 | 0.32 | 0.32 | 0.32 | 0.32 | 0.32 | 0.32 |
| Sat Flow, veh/h             | 1774  | 3592  | 34   | 1740 | 2773 | 671  | 264  | 430  | 868  | 1330 | 1881 | 1599 |
| Grp Volume(v), veh/h        | 378   | 569   | 598  | 44   | 494  | 486  | 99   | 0    | 0    | 411  | 11   | 268  |
| Grp Sat Flow(s),veh/h/ln    | 1774  | 1770  | 1857 | 1740 | 1736 | 1708 | 1562 | 0    | 0    | 1330 | 1881 | 1599 |
| Q Serve(g_s), s             | 12.4  | 22.9  | 22.9 | 2.5  | 22.9 | 22.9 | 0.0  | 0.0  | 0.0  | 24.8 | 0.4  | 13.7 |
| Cycle Q Clear(g_c), s       | 12.4  | 22.9  | 22.9 | 2.5  | 22.9 | 22.9 | 4.1  | 0.0  | 0.0  | 28.9 | 0.4  | 13.7 |
| Prop In Lane                | 1.00  |       | 0.02 | 1.00 |      | 0.39 | 0.22 |      | 0.56 | 1.00 |      | 1.00 |
| Lane Grp Cap(c), veh/h      | 220   | 915   | 960  | 56   | 737  | 726  | 543  | 0    | 0    | 511  | 601  | 511  |
| V/C Ratio(X)                | 1.72  | 0.62  | 0.62 | 0.79 | 0.67 | 0.67 | 0.18 | 0.00 | 0.00 | 0.80 | 0.02 | 0.52 |
| Avail Cap(c_a), veh/h       | 220   | 915   | 960  | 216  | 737  | 726  | 671  | 0    | 0    | 623  | 760  | 646  |
| HCM Platoon Ratio           | 1.00  | 1.00  | 1.00 | 1.00 | 1.00 | 1.00 | 1.00 | 1.00 | 1.00 | 1.00 | 1.00 | 1.00 |
| Upstream Filter(I)          | 0.50  | 0.50  | 0.50 | 0.09 | 0.09 | 0.09 | 1.00 | 0.00 | 0.00 | 0.36 | 0.36 | 0.36 |
| Uniform Delay (d), s/veh    | 43.8  | 17.2  | 17.2 | 48.1 | 23.1 | 23.1 | 24.6 | 0.0  | 0.0  | 32.6 | 23.3 | 27.8 |
| Incr Delay (d2), s/veh      | 332.8 | 1.6   | 1.5  | 0.9  | 0.4  | 0.5  | 0.1  | 0.0  | 0.0  | 1.9  | 0.0  | 0.1  |
| Initial Q Delay(d3),s/veh   | 0.0   | 0.0   | 0.0  | 0.0  | 0.0  | 0.0  | 0.0  | 0.0  | 0.0  | 0.0  | 0.0  | 0.0  |
| %ile BackOfQ(50%),veh/ln    | 26.4  | 11.5  | 12.0 | 1.2  | 11.1 | 10.9 | 2.0  | 0.0  | 0.0  | 11.2 | 0.2  | 6.1  |
| LnGrp Delay(d),s/veh        | 376.6 | 18.8  | 18.7 | 49.0 | 23.6 | 23.6 | 24.6 | 0.0  | 0.0  | 34.5 | 23.3 | 27.9 |
| LnGrp LOS                   | F     | B     | B    | D    | C    | C    | C    |      |      | C    | C    | C    |
| Approach Vol, veh/h         |       | 1545  |      |      | 1024 |      |      | 99   |      |      | 690  |      |
| Approach Delay, s/veh       |       | 106.3 |      |      | 24.7 |      |      | 24.6 |      |      | 31.8 |      |
| Approach LOS                |       | F     |      |      | C    |      |      | C    |      |      | C    |      |
| Timer                       | 1     | 2     | 3    | 4    | 5    | 6    | 7    | 8    |      |      |      |      |
| Assigned Phs                | 1     | 2     |      | 4    | 5    | 6    |      | 8    |      |      |      |      |
| Phs Duration (G+Y+Rc), s    | 7.2   | 56.3  |      | 36.5 | 16.4 | 47.1 |      | 36.5 |      |      |      |      |
| Change Period (Y+Rc), s     | 4.0   | 4.6   |      | 4.6  | 4.0  | 4.6  |      | 4.6  |      |      |      |      |
| Max Green Setting (Gmax), s | 2.4   | 34.0  |      | 40.4 | 12.4 | 24.4 |      | 40.4 |      |      |      |      |
| Max Q Clear Time (g_c+1), s | 14.5  | 24.9  |      | 30.9 | 14.4 | 24.9 |      | 6.1  |      |      |      |      |
| Green Ext Time (p_c), s     | 0.0   | 3.3   |      | 1.0  | 0.0  | 0.0  |      | 0.4  |      |      |      |      |
| <b>Intersection Summary</b> |       |       |      |      |      |      |      |      |      |      |      |      |
| HCM 2010 Ctrl Delay         |       |       |      | 63.7 |      |      |      |      |      |      |      |      |
| HCM 2010 LOS                |       |       |      | E    |      |      |      |      |      |      |      |      |

HCM 2010 Signalized Intersection Summary  
 33: General Jim Moore Boulevard & Lightfighter Drive

Cumulative with Project, AM  
 06/11/2019



| Movement                    | EBL  | EBT  | EBR  | WBL  | WBT  | WBR  | NBL   | NBT   | NBR  | SBL  | SBT  | SBR  |
|-----------------------------|------|------|------|------|------|------|-------|-------|------|------|------|------|
| Lane Configurations         |      |      |      |      |      |      |       |       |      |      |      |      |
| Traffic Volume (veh/h)      | 50   | 280  | 880  | 20   | 170  | 70   | 810   | 70    | 10   | 40   | 50   | 20   |
| Future Volume (veh/h)       | 50   | 280  | 880  | 20   | 170  | 70   | 810   | 70    | 10   | 40   | 50   | 20   |
| Number                      | 3    | 8    | 18   | 7    | 4    | 14   | 1     | 6     | 16   | 5    | 2    | 12   |
| Initial Q (Qb), veh         | 0    | 0    | 0    | 0    | 0    | 0    | 0     | 0     | 0    | 0    | 0    | 0    |
| Ped-Bike Adj(A_pbT)         | 1.00 |      | 1.00 | 1.00 |      | 1.00 | 1.00  |       | 1.00 | 1.00 |      | 1.00 |
| Parking Bus, Adj            | 1.00 | 1.00 | 1.00 | 1.00 | 1.00 | 1.00 | 1.00  | 1.00  | 1.00 | 1.00 | 1.00 | 1.00 |
| Adj Sat Flow, veh/h/ln      | 1863 | 1863 | 1863 | 1792 | 1792 | 1900 | 1881  | 1881  | 1900 | 1863 | 1863 | 1900 |
| Adj Flow Rate, veh/h        | 56   | 315  | 0    | 22   | 191  | 77   | 910   | 79    | 10   | 45   | 56   | 22   |
| Adj No. of Lanes            | 1    | 1    | 1    | 1    | 1    | 0    | 2     | 1     | 0    | 1    | 2    | 0    |
| Peak Hour Factor            | 0.89 | 0.89 | 0.89 | 0.89 | 0.89 | 0.89 | 0.89  | 0.89  | 0.89 | 0.89 | 0.89 | 0.89 |
| Percent Heavy Veh, %        | 2    | 2    | 2    | 6    | 6    | 6    | 1     | 1     | 1    | 2    | 2    | 2    |
| Cap, veh/h                  | 78   | 467  | 397  | 36   | 277  | 111  | 735   | 507   | 64   | 67   | 343  | 127  |
| Arrive On Green             | 0.04 | 0.25 | 0.00 | 0.02 | 0.23 | 0.23 | 0.21  | 0.31  | 0.31 | 0.04 | 0.14 | 0.14 |
| Sat Flow, veh/h             | 1774 | 1863 | 1583 | 1707 | 1214 | 489  | 3476  | 1637  | 207  | 1774 | 2524 | 938  |
| Grp Volume(v), veh/h        | 56   | 315  | 0    | 22   | 0    | 268  | 910   | 0     | 89   | 45   | 38   | 40   |
| Grp Sat Flow(s),veh/h/ln    | 1774 | 1863 | 1583 | 1707 | 0    | 1704 | 1738  | 0     | 1844 | 1774 | 1770 | 1692 |
| Q Serve(g_s), s             | 1.5  | 7.2  | 0.0  | 0.6  | 0.0  | 6.8  | 10.0  | 0.0   | 1.7  | 1.2  | 0.9  | 1.0  |
| Cycle Q Clear(g_c), s       | 1.5  | 7.2  | 0.0  | 0.6  | 0.0  | 6.8  | 10.0  | 0.0   | 1.7  | 1.2  | 0.9  | 1.0  |
| Prop In Lane                | 1.00 |      | 1.00 | 1.00 |      | 0.29 | 1.00  |       | 0.11 | 1.00 |      | 0.55 |
| Lane Grp Cap(c), veh/h      | 78   | 467  | 397  | 36   | 0    | 388  | 735   | 0     | 571  | 67   | 240  | 230  |
| V/C Ratio(X)                | 0.72 | 0.67 | 0.00 | 0.61 | 0.00 | 0.69 | 1.24  | 0.00  | 0.16 | 0.67 | 0.16 | 0.17 |
| Avail Cap(c_a), veh/h       | 751  | 1182 | 1005 | 722  | 0    | 1081 | 735   | 0     | 1170 | 563  | 1123 | 1074 |
| HCM Platoon Ratio           | 1.00 | 1.00 | 1.00 | 1.00 | 1.00 | 1.00 | 1.00  | 1.00  | 1.00 | 1.00 | 1.00 | 1.00 |
| Upstream Filter(l)          | 1.00 | 1.00 | 0.00 | 1.00 | 0.00 | 1.00 | 1.00  | 0.00  | 1.00 | 1.00 | 1.00 | 1.00 |
| Uniform Delay (d), s/veh    | 22.3 | 16.0 | 0.0  | 22.9 | 0.0  | 16.7 | 18.6  | 0.0   | 11.8 | 22.5 | 18.0 | 18.1 |
| Incr Delay (d2), s/veh      | 11.5 | 2.1  | 0.0  | 5.9  | 0.0  | 2.7  | 118.5 | 0.0   | 0.3  | 4.3  | 0.4  | 0.4  |
| Initial Q Delay(d3),s/veh   | 0.0  | 0.0  | 0.0  | 0.0  | 0.0  | 0.0  | 0.0   | 0.0   | 0.0  | 0.0  | 0.0  | 0.0  |
| %ile BackOfQ(50%),veh/ln    | 1.0  | 3.9  | 0.0  | 0.3  | 0.0  | 3.5  | 16.8  | 0.0   | 0.9  | 0.7  | 0.5  | 0.5  |
| LnGrp Delay(d),s/veh        | 33.8 | 18.0 | 0.0  | 28.9 | 0.0  | 19.4 | 137.1 | 0.0   | 12.1 | 26.7 | 18.4 | 18.5 |
| LnGrp LOS                   | C    | B    |      | C    |      | B    | F     |       | B    | C    | B    | B    |
| Approach Vol, veh/h         |      | 371  |      |      | 290  |      |       | 999   |      |      | 123  |      |
| Approach Delay, s/veh       |      | 20.4 |      |      | 20.1 |      |       | 126.0 |      |      | 21.5 |      |
| Approach LOS                |      | C    |      |      | C    |      |       | F     |      |      | C    |      |
| Timer                       | 1    | 2    | 3    | 4    | 5    | 6    | 7     | 8     |      |      |      |      |
| Assigned Phs                | 1    | 2    | 3    | 4    | 5    | 6    | 7     | 8     |      |      |      |      |
| Phs Duration (G+Y+Rc), s    | 4.5  | 10.9 | 6.6  | 15.3 | 6.3  | 19.1 | 5.5   | 16.3  |      |      |      |      |
| Change Period (Y+Rc), s     | 4.5  | 4.5  | 4.5  | 4.5  | 4.5  | 4.5  | 4.5   | 4.5   |      |      |      |      |
| Max Green Setting (Gmax), s | 30.0 | 30.0 | 20.0 | 30.0 | 15.0 | 30.0 | 20.0  | 30.0  |      |      |      |      |
| Max Q Clear Time (g_c+1), s | 3.0  | 3.5  | 8.8  | 3.2  | 3.7  | 2.6  | 9.2   |       |      |      |      |      |
| Green Ext Time (p_c), s     | 0.0  | 0.4  | 0.1  | 2.0  | 0.0  | 0.8  | 0.0   | 2.0   |      |      |      |      |
| <b>Intersection Summary</b> |      |      |      |      |      |      |       |       |      |      |      |      |
| HCM 2010 Ctrl Delay         |      |      |      | 79.6 |      |      |       |       |      |      |      |      |
| HCM 2010 LOS                |      |      |      | E    |      |      |       |       |      |      |      |      |

**Intersection**

Intersection Delay, s/veh 13.1  
 Intersection LOS B

| Movement            | WBL  | WBR  | NBT  | NBR  | SBL  | SBT  |
|---------------------|------|------|------|------|------|------|
| Lane Configurations |      |      |      |      |      |      |
| Traffic Vol, veh/h  | 30   | 200  | 60   | 10   | 270  | 70   |
| Future Vol, veh/h   | 30   | 200  | 60   | 10   | 270  | 70   |
| Peak Hour Factor    | 0.77 | 0.77 | 0.77 | 0.77 | 0.77 | 0.77 |
| Heavy Vehicles, %   | 4    | 4    | 3    | 3    | 2    | 2    |
| Mvmt Flow           | 39   | 260  | 78   | 13   | 351  | 91   |
| Number of Lanes     | 1    | 0    | 1    | 0    | 0    | 1    |

| Approach                      | WB | NB  | SB   |
|-------------------------------|----|-----|------|
| Opposing Approach             |    | SB  | NB   |
| Opposing Lanes                | 0  | 1   | 1    |
| Conflicting Approach Left NB  |    |     | WB   |
| Conflicting Lanes Left        | 1  | 0   | 1    |
| Conflicting Approach Right SB |    | WB  |      |
| Conflicting Lanes Right       | 1  | 1   | 0    |
| HCM Control Delay             | 11 | 9.1 | 15.4 |
| HCM LOS                       | B  | A   | C    |

| Lane                   | NBLn1 | WBLn1 | SBLn1 |
|------------------------|-------|-------|-------|
| Vol Left, %            | 0%    | 13%   | 79%   |
| Vol Thru, %            | 86%   | 0%    | 21%   |
| Vol Right, %           | 14%   | 87%   | 0%    |
| Sign Control           | Stop  | Stop  | Stop  |
| Traffic Vol by Lane    | 70    | 230   | 340   |
| LT Vol                 | 0     | 30    | 270   |
| Through Vol            | 60    | 0     | 70    |
| RT Vol                 | 10    | 200   | 0     |
| Lane Flow Rate         | 91    | 299   | 442   |
| Geometry Grp           | 1     | 1     | 1     |
| Degree of Util (X)     | 0.133 | 0.397 | 0.605 |
| Departure Headway (Hd) | 5.254 | 4.78  | 4.929 |
| Convergence, Y/N       | Yes   | Yes   | Yes   |
| Cap                    | 686   | 747   | 724   |
| Service Time           | 3.254 | 2.854 | 3.011 |
| HCM Lane V/C Ratio     | 0.133 | 0.4   | 0.61  |
| HCM Control Delay      | 9.1   | 11    | 15.4  |
| HCM Lane LOS           | A     | B     | C     |
| HCM 95th-tile Q        | 0.5   | 1.9   | 4.1   |

| Intersection             |      |      |      |      |      |      |
|--------------------------|------|------|------|------|------|------|
| Int Delay, s/veh         | 1.7  |      |      |      |      |      |
| Movement                 | EBT  | EBR  | WBL  | WBT  | NBL  | NBR  |
| Lane Configurations      |      |      |      |      |      |      |
| Traffic Vol, veh/h       | 250  | 30   | 20   | 200  | 30   | 30   |
| Future Vol, veh/h        | 250  | 30   | 20   | 200  | 30   | 30   |
| Conflicting Peds, #/hr   | 0    | 0    | 0    | 0    | 0    | 0    |
| Sign Control             | Free | Free | Free | Free | Stop | Stop |
| RT Channelized           | -    | None | -    | None | -    | None |
| Storage Length           | -    | -    | -    | -    | 0    | -    |
| Veh in Median Storage, # | 0    | -    | -    | 0    | 0    | -    |
| Grade, %                 | 0    | -    | -    | 0    | 0    | -    |
| Peak Hour Factor         | 78   | 78   | 78   | 78   | 78   | 78   |
| Heavy Vehicles, %        | 5    | 5    | 4    | 4    | 0    | 0    |
| Mvmt Flow                | 321  | 38   | 26   | 256  | 38   | 38   |

| Major/Minor          | Major1 | Major2 | Minor1 | Minor2 | Minor3 |
|----------------------|--------|--------|--------|--------|--------|
| Conflicting Flow All | 0      | 0      | 359    | 0      | 648    |
| Stage 1              | -      | -      | -      | -      | 340    |
| Stage 2              | -      | -      | -      | -      | 308    |
| Critical Hdwy        | -      | -      | 4.14   | -      | 6.4    |
| Critical Hdwy Stg 1  | -      | -      | -      | -      | 5.4    |
| Critical Hdwy Stg 2  | -      | -      | -      | -      | 5.4    |
| Follow-up Hdwy       | -      | -      | 2.236  | -      | 3.5    |
| Pot Cap-1 Maneuver   | -      | -      | 1189   | -      | 438    |
| Stage 1              | -      | -      | -      | -      | 725    |
| Stage 2              | -      | -      | -      | -      | 750    |
| Platoon blocked, %   | -      | -      | -      | -      | -      |
| Mov Cap-1 Maneuver   | -      | -      | 1189   | -      | 427    |
| Mov Cap-2 Maneuver   | -      | -      | -      | -      | 427    |
| Stage 1              | -      | -      | -      | -      | 707    |
| Stage 2              | -      | -      | -      | -      | 750    |

| Approach             | EB | WB  | NB   |
|----------------------|----|-----|------|
| HCM Control Delay, s | 0  | 0.7 | 12.9 |
| HCM LOS              |    |     | B    |

| Minor Lane/Major Mvmt | NBLn1 | EBT | EBR | WBL   | WBT |
|-----------------------|-------|-----|-----|-------|-----|
| Capacity (veh/h)      | 532   | -   | -   | 1189  | -   |
| HCM Lane V/C Ratio    | 0.145 | -   | -   | 0.022 | -   |
| HCM Control Delay (s) | 12.9  | -   | -   | 8.1   | 0   |
| HCM Lane LOS          | B     | -   | -   | A     | A   |
| HCM 95th %tile Q(veh) | 0.5   | -   | -   | 0.1   | -   |

| Intersection              |      |
|---------------------------|------|
| Intersection Delay, s/veh | 15.9 |
| Intersection LOS          | C    |

| Movement            | EBL  | EBT  | EBR  | WBL  | WBT  | WBR  | NBL  | NBT  | NBR  | SBL  | SBT  | SBR  |
|---------------------|------|------|------|------|------|------|------|------|------|------|------|------|
| Lane Configurations |      | ↕    |      |      | ↕    |      |      | ↕    |      |      | ↕    |      |
| Traffic Vol, veh/h  | 10   | 230  | 30   | 10   | 140  | 10   | 50   | 170  | 20   | 10   | 140  | 40   |
| Future Vol, veh/h   | 10   | 230  | 30   | 10   | 140  | 10   | 50   | 170  | 20   | 10   | 140  | 40   |
| Peak Hour Factor    | 0.79 | 0.79 | 0.79 | 0.79 | 0.79 | 0.79 | 0.79 | 0.79 | 0.79 | 0.79 | 0.79 | 0.79 |
| Heavy Vehicles, %   | 6    | 6    | 6    | 4    | 4    | 4    | 20   | 20   | 20   | 2    | 2    | 2    |
| Mvmt Flow           | 13   | 291  | 38   | 13   | 177  | 13   | 63   | 215  | 25   | 13   | 177  | 51   |
| Number of Lanes     | 0    | 1    | 0    | 0    | 1    | 0    | 0    | 1    | 0    | 0    | 1    | 0    |

| Approach                   | EB   | WB   | NB   | SB   |
|----------------------------|------|------|------|------|
| Opposing Approach          | WB   | EB   | SB   | NB   |
| Opposing Lanes             | 1    | 1    | 1    | 1    |
| Conflicting Approach Left  | SB   | NB   | EB   | WB   |
| Conflicting Lanes Left     | 1    | 1    | 1    | 1    |
| Conflicting Approach Right | NB   | SB   | WB   | EB   |
| Conflicting Lanes Right    | 1    | 1    | 1    | 1    |
| HCM Control Delay          | 17.7 | 13.3 | 17.3 | 13.8 |
| HCM LOS                    | C    | B    | C    | B    |

| Lane                   | NBLn1 | EBLn1 | WBLn1 | SBLn1 |
|------------------------|-------|-------|-------|-------|
| Vol Left, %            | 21%   | 4%    | 6%    | 5%    |
| Vol Thru, %            | 71%   | 85%   | 88%   | 74%   |
| Vol Right, %           | 8%    | 11%   | 6%    | 21%   |
| Sign Control           | Stop  | Stop  | Stop  | Stop  |
| Traffic Vol by Lane    | 240   | 270   | 160   | 190   |
| LT Vol                 | 50    | 10    | 10    | 10    |
| Through Vol            | 170   | 230   | 140   | 140   |
| RT Vol                 | 20    | 30    | 10    | 40    |
| Lane Flow Rate         | 304   | 342   | 203   | 241   |
| Geometry Grp           | 1     | 1     | 1     | 1     |
| Degree of Util (X)     | 0.55  | 0.586 | 0.365 | 0.419 |
| Departure Headway (Hd) | 6.514 | 6.174 | 6.492 | 6.275 |
| Convergence, Y/N       | Yes   | Yes   | Yes   | Yes   |
| Cap                    | 553   | 584   | 553   | 572   |
| Service Time           | 4.564 | 4.223 | 4.549 | 4.332 |
| HCM Lane V/C Ratio     | 0.55  | 0.586 | 0.367 | 0.421 |
| HCM Control Delay      | 17.3  | 17.7  | 13.3  | 13.8  |
| HCM Lane LOS           | C     | C     | B     | B     |
| HCM 95th-tile Q        | 3.3   | 3.8   | 1.7   | 2.1   |

| Intersection             |      |      |      |      |      |      |      |      |      |      |      |      |
|--------------------------|------|------|------|------|------|------|------|------|------|------|------|------|
| Int Delay, s/veh         | 10.4 |      |      |      |      |      |      |      |      |      |      |      |
| Movement                 | EBL  | EBT  | EBR  | WBL  | WBT  | WBR  | NBL  | NBT  | NBR  | SBL  | SBT  | SBR  |
| Lane Configurations      |      | ↕    |      |      | ↕    |      |      | ↕    |      |      | ↕    |      |
| Traffic Vol, veh/h       | 80   | 80   | 90   | 10   | 90   | 20   | 50   | 140  | 20   | 0    | 0    | 0    |
| Future Vol, veh/h        | 80   | 80   | 90   | 10   | 90   | 20   | 50   | 140  | 20   | 0    | 0    | 0    |
| Conflicting Peds, #/hr   | 0    | 0    | 0    | 0    | 0    | 0    | 0    | 0    | 1    | 1    | 0    | 0    |
| Sign Control             | Stop | Stop | Stop | Stop | Stop | Stop | Free | Free | Free | Free | Free | Free |
| RT Channelized           | -    | -    | None | -    | -    | None | -    | -    | None | -    | -    | None |
| Storage Length           | -    | -    | -    | -    | -    | -    | -    | -    | -    | -    | -    | -    |
| Veh in Median Storage, # | -    | 0    | -    | -    | 0    | -    | -    | 0    | -    | -    | 0    | -    |
| Grade, %                 | -    | 0    | -    | -    | 0    | -    | -    | 0    | -    | -    | 0    | -    |
| Peak Hour Factor         | 82   | 82   | 82   | 82   | 82   | 82   | 82   | 82   | 82   | 82   | 82   | 82   |
| Heavy Vehicles, %        | 12   | 12   | 12   | 0    | 0    | 0    | 10   | 10   | 10   | 10   | 10   | 10   |
| Mvmt Flow                | 98   | 98   | 110  | 12   | 110  | 24   | 61   | 171  | 24   | 0    | 0    | 0    |

| Major/Minor          | Minor2 |       | Minor1 |     | Major1 |     |      | Major2 |   |      |   |   |
|----------------------|--------|-------|--------|-----|--------|-----|------|--------|---|------|---|---|
| Conflicting Flow All | 373    | 319   | 1      | 411 | 307    | 184 | 1    | 0      | 0 | 196  | 0 | 0 |
| Stage 1              | 1      | 1     | -      | 306 | 306    | -   | -    | -      | - | -    | - | - |
| Stage 2              | 372    | 318   | -      | 105 | 1      | -   | -    | -      | - | -    | - | - |
| Critical Hdwy        | 7.22   | 6.62  | 6.32   | 7.1 | 6.5    | 6.2 | 4.2  | -      | - | 4.2  | - | - |
| Critical Hdwy Stg 1  | 6.22   | 5.62  | -      | 6.1 | 5.5    | -   | -    | -      | - | -    | - | - |
| Critical Hdwy Stg 2  | 6.22   | 5.62  | -      | 6.1 | 5.5    | -   | -    | -      | - | -    | - | - |
| Follow-up Hdwy       | 3.608  | 4.108 | 3.408  | 3.5 | 4      | 3.3 | 2.29 | -      | - | 2.29 | - | - |
| Pot Cap-1 Maneuver   | 566    | 582   | 1055   | 555 | 610    | 864 | 1571 | -      | - | 1330 | - | - |
| Stage 1              | 997    | 875   | -      | 708 | 665    | -   | -    | -      | - | -    | - | - |
| Stage 2              | 629    | 636   | -      | 906 | 899    | -   | -    | -      | - | -    | - | - |
| Platoon blocked, %   |        |       |        |     |        |     |      | -      | - | -    | - | - |
| Mov Cap-1 Maneuver   | 455    | 556   | 1055   | 416 | 583    | 863 | 1571 | -      | - | 1329 | - | - |
| Mov Cap-2 Maneuver   | 455    | 556   | -      | 416 | 583    | -   | -    | -      | - | -    | - | - |
| Stage 1              | 953    | 875   | -      | 676 | 635    | -   | -    | -      | - | -    | - | - |
| Stage 2              | 483    | 607   | -      | 721 | 899    | -   | -    | -      | - | -    | - | - |

| Approach             | EB   |  | WB |  | NB  |  | SB |  |
|----------------------|------|--|----|--|-----|--|----|--|
| HCM Control Delay, s | 16.4 |  | 13 |  | 1.8 |  | 0  |  |
| HCM LOS              | C    |  | B  |  |     |  |    |  |

| Minor Lane/Major Mvmt | NBL   | NBT | NBR | EBLn1WBLn1 | SBL   | SBT  | SBR |
|-----------------------|-------|-----|-----|------------|-------|------|-----|
| Capacity (veh/h)      | 1571  | -   | -   | 617        | 595   | 1329 | -   |
| HCM Lane V/C Ratio    | 0.039 | -   | -   | 0.494      | 0.246 | -    | -   |
| HCM Control Delay (s) | 7.4   | 0   | -   | 16.4       | 13    | 0    | -   |
| HCM Lane LOS          | A     | A   | -   | C          | B     | A    | -   |
| HCM 95th %tile Q(veh) | 0.1   | -   | -   | 2.7        | 1     | 0    | -   |

| Intersection             |      |      |      |      |      |      |
|--------------------------|------|------|------|------|------|------|
| Int Delay, s/veh         | 6.3  |      |      |      |      |      |
| Movement                 | EBL  | EBR  | NBL  | NBT  | SBT  | SBR  |
| Lane Configurations      | T    |      |      | T    |      | T    |
| Traffic Vol, veh/h       | 110  | 10   | 10   | 260  | 780  | 120  |
| Future Vol, veh/h        | 110  | 10   | 10   | 260  | 780  | 120  |
| Conflicting Peds, #/hr   | 0    | 0    | 0    | 0    | 0    | 0    |
| Sign Control             | Stop | Stop | Free | Free | Free | Free |
| RT Channelized           | -    | None | -    | None | -    | None |
| Storage Length           | 0    | -    | -    | -    | -    | -    |
| Veh in Median Storage, # | 0    | -    | -    | 0    | 0    | -    |
| Grade, %                 | 0    | -    | -    | 0    | 0    | -    |
| Peak Hour Factor         | 89   | 89   | 89   | 89   | 89   | 89   |
| Heavy Vehicles, %        | 13   | 13   | 2    | 2    | 0    | 0    |
| Mvmt Flow                | 124  | 11   | 11   | 292  | 876  | 135  |

| Major/Minor          | Minor2 | Major1 |       | Major2 |   |
|----------------------|--------|--------|-------|--------|---|
| Conflicting Flow All | 1258   | 944    | 1011  | 0      | 0 |
| Stage 1              | 944    | -      | -     | -      | - |
| Stage 2              | 314    | -      | -     | -      | - |
| Critical Hdwy        | 6.53   | 6.33   | 4.12  | -      | - |
| Critical Hdwy Stg 1  | 5.53   | -      | -     | -      | - |
| Critical Hdwy Stg 2  | 5.53   | -      | -     | -      | - |
| Follow-up Hdwy       | 3.617  | 3.417  | 2.218 | -      | - |
| Pot Cap-1 Maneuver   | 179    | 303    | 686   | -      | - |
| Stage 1              | 361    | -      | -     | -      | - |
| Stage 2              | 716    | -      | -     | -      | - |
| Platoon blocked, %   |        |        |       | -      | - |
| Mov Cap-1 Maneuver   | 176    | 303    | 686   | -      | - |
| Mov Cap-2 Maneuver   | 176    | -      | -     | -      | - |
| Stage 1              | 354    | -      | -     | -      | - |
| Stage 2              | 716    | -      | -     | -      | - |



























| Approach             | EB   | NB  | SB |
|----------------------|------|-----|----|
| HCM Control Delay, s | 66.4 | 0.4 | 0  |
| HCM LOS              | F    |     |    |

| Minor Lane/Major Mvmt | NBL   | NBT | EBLn1 | SBT | SBR |
|-----------------------|-------|-----|-------|-----|-----|
| Capacity (veh/h)      | 686   | -   | 182   | -   | -   |
| HCM Lane V/C Ratio    | 0.016 | -   | 0.741 | -   | -   |
| HCM Control Delay (s) | 10.3  | 0   | 66.4  | -   | -   |
| HCM Lane LOS          | B     | A   | F     | -   | -   |
| HCM 95th %tile Q(veh) | 0.1   | -   | 4.8   | -   | -   |



HCM 2010 Signalized Intersection Summary  
 39: General Jim Moore Boulevard & Gigling Road

Cumulative with Project, AM  
 06/11/2019

|                              |  |    |  |  |    |  |   |    |  |  |    |  |
|------------------------------|---|---|---|---|---|---|---|---|---|---|---|---|
| Movement                     | EBL   | EBT   | EBR   | WBL   | WBT   | WBR   | NBL   | NBT   | NBR   | SBL   | SBT   | SBR   |
| Lane Configurations          |  |   |   |  |   |  |  |   |  |  |   |  |
| Traffic Volume (veh/h)       | 30  | 100   | 80  | 510   | 40  | 410   | 50  | 410   | 280   | 310   | 650   | 50  |
| Future Volume (veh/h)        | 30  | 100   | 80  | 510   | 40  | 410   | 50  | 410   | 280   | 310   | 650   | 50  |
| Number                       | 3   | 8   | 18  | 7   | 4   | 14  | 1   | 6   | 16  | 5   | 2   | 12  |
| Initial Q (Qb), veh          | 0   | 0   | 0   | 0   | 0   | 0   | 0   | 0   | 0   | 0   | 0   | 0   |
| Ped-Bike Adj(A_pbT)          | 1.00  |   | 1.00  | 1.00  |   | 1.00  | 1.00  |   | 1.00  | 1.00  |   | 1.00  |
| Parking Bus, Adj             | 1.00  | 1.00  | 1.00  | 1.00  | 1.00  | 1.00  | 1.00  | 1.00  | 1.00  | 1.00  | 1.00  | 1.00  |
| Adj Sat Flow, veh/h/ln       | 1810  | 1810  | 1900  | 1863  | 1863  | 1863  | 1881  | 1881  | 1881  | 1863  | 1863  | 1863  |
| Adj Flow Rate, veh/h         | 34  | 115   | 60  | 586   | 46  | 0   | 57  | 471   | 0   | 356   | 747   | 0   |
| Adj No. of Lanes             | 1   | 2   | 0   | 1   | 2   | 1   | 1   | 2   | 1   | 1   | 2   | 1   |
| Peak Hour Factor             | 0.87  | 0.87  | 0.87  | 0.87  | 0.87  | 0.87  | 0.87  | 0.87  | 0.87  | 0.87  | 0.87  | 0.87  |
| Percent Heavy Veh, %         | 5   | 5   | 5   | 2   | 2   | 2   | 1   | 1   | 1   | 2   | 2   | 2   |
| Cap, veh/h                   | 59  | 192   | 94  | 506   | 1193  | 534   | 85  | 581   | 260   | 383   | 1171  | 524   |
| Arrive On Green              | 0.03  | 0.09  | 0.09  | 0.29  | 0.34  | 0.00  | 0.05  | 0.16  | 0.00  | 0.22  | 0.33  | 0.00  |
| Sat Flow, veh/h              | 1723  | 2232  | 1098  | 1774  | 3539  | 1583  | 1792  | 3574  | 1599  | 1774  | 3539  | 1583  |
| Grp Volume(v), veh/h         | 34  | 87  | 88  | 586   | 46  | 0   | 57  | 471   | 0   | 356   | 747   | 0   |
| Grp Sat Flow(s),veh/h/ln     | 1723  | 1719  | 1611  | 1774  | 1770  | 1583  | 1792  | 1787  | 1599  | 1774  | 1770  | 1583  |
| Q Serve(g_s), s              | 1.4   | 3.5   | 3.8   | 20.5  | 0.6   | 0.0   | 2.2   | 9.1   | 0.0   | 14.2  | 12.9  | 0.0   |
| Cycle Q Clear(g_c), s        | 1.4   | 3.5   | 3.8   | 20.5  | 0.6   | 0.0   | 2.2   | 9.1   | 0.0   | 14.2  | 12.9  | 0.0   |
| Prop In Lane                 | 1.00  |   | 0.68  | 1.00  |   | 1.00  | 1.00  |   | 1.00  | 1.00  |   | 1.00  |
| Lane Grp Cap(c), veh/h       | 59  | 148   | 139   | 506   | 1193  | 534   | 85  | 581   | 260   | 383   | 1171  | 524   |
| V/C Ratio(X)                 | 0.58  | 0.59  | 0.64  | 1.16  | 0.04  | 0.00  | 0.67  | 0.81  | 0.00  | 0.93  | 0.64  | 0.00  |
| Avail Cap(c_a), veh/h        | 252   | 742   | 695   | 506   | 2019  | 903   | 137   | 1243  | 556   | 383   | 1724  | 771   |
| HCM Platoon Ratio            | 1.00  | 1.00  | 1.00  | 1.00  | 1.00  | 1.00  | 1.00  | 1.00  | 1.00  | 1.00  | 1.00  | 1.00  |
| Upstream Filter(I)           | 1.00  | 1.00  | 1.00  | 1.00  | 1.00  | 0.00  | 1.00  | 1.00  | 0.00  | 1.00  | 1.00  | 0.00  |
| Uniform Delay (d), s/veh     | 34.2  | 31.6  | 31.8  | 25.7  | 16.0  | 0.0   | 33.7  | 29.0  | 0.0   | 27.7  | 20.4  | 0.0   |
| Incr Delay (d2), s/veh       | 3.2   | 1.4   | 1.8   | 91.4  | 0.0   | 0.0   | 3.4   | 1.0   | 0.0   | 28.6  | 0.2   | 0.0   |
| Initial Q Delay(d3),s/veh    | 0.0   | 0.0   | 0.0   | 0.0   | 0.0   | 0.0   | 0.0   | 0.0   | 0.0   | 0.0   | 0.0   | 0.0   |
| %ile BackOfQ(50%),veh/ln     | 0.7   | 1.7   | 1.8   | 22.7  | 0.3   | 0.0   | 1.2   | 4.6   | 0.0   | 10.0  | 6.3   | 0.0   |
| LnGrp Delay(d),s/veh         | 37.4  | 33.0  | 33.5  | 117.1   | 16.0  | 0.0   | 37.1  | 30.1  | 0.0   | 56.3  | 20.6  | 0.0   |
| LnGrp LOS                    | D   | C   | C   | F   | B   |   | D   | C   |   | E   | C   |   |
| Approach Vol, veh/h          |   | 209   |   |   | 632   |   |   | 528   |   |   | 1103  |   |
| Approach Delay, s/veh        |   | 33.9  |   |   | 109.7   |   |   | 30.8  |   |   | 32.1  |   |
| Approach LOS                 |   | C   |   |   | F   |   |   | C   |   |   | C   |   |
| Timer                        | 1   | 2   | 3   | 4   | 5   | 6   | 7   | 8   |   |   |   |   |
| Assigned Phs                 | 1   | 2   | 3   | 4   | 5   | 6   | 7   | 8   |   |   |   |   |
| Phs Duration (G+Y+Rc), s     | 7.9   | 28.3  | 7.0   | 28.7  | 20.0  | 16.2  | 25.0  | 10.7  |   |   |   |   |
| Change Period (Y+Rc), s      | 4.5   | 4.5   | 4.5   | 4.5   | 4.5   | 4.5   | 4.5   | 4.5   |   |   |   |   |
| Max Green Setting (Gmax), s  | 5.5   | 35.0  | 10.5  | 41.0  | 15.5  | 25.0  | 20.5  | 31.0  |   |   |   |   |
| Max Q Clear Time (g_c+I1), s | 4.2   | 14.9  | 3.4   | 2.6   | 16.2  | 11.1  | 22.5  | 5.8   |   |   |   |   |
| Green Ext Time (p_c), s      | 0.0   | 1.0   | 0.0   | 0.1   | 0.0   | 0.5   | 0.0   | 0.2   |   |   |   |   |
| <b>Intersection Summary</b>  |   |   |   |   |   |   |   |   |   |   |   |   |
| HCM 2010 Ctrl Delay          |   |   | 51.8  |   |   |   |   |   |   |   |   |   |
| HCM 2010 LOS                 |   |   | D   |   |   |   |   |   |   |   |   |   |
| <b>Notes</b>                 |   |   |   |   |   |   |   |   |   |   |   |   |

HCM 2010 Signalized Intersection Summary  
40: Malmedy Road & Gigling Road

Cumulative with Project, AM  
06/11/2019



| Movement                     | EBL  | EBT  | EBR  | WBL  | WBT  | WBR  | NBL  | NBT  | NBR  | SBL  | SBT  | SBR  |
|------------------------------|------|------|------|------|------|------|------|------|------|------|------|------|
| Lane Configurations          |      | ↕↕   |      |      | ↕↕   |      |      | ↕    |      |      | ↕    |      |
| Traffic Volume (veh/h)       | 10   | 590  | 30   | 50   | 900  | 20   | 20   | 30   | 30   | 20   | 60   | 30   |
| Future Volume (veh/h)        | 10   | 590  | 30   | 50   | 900  | 20   | 20   | 30   | 30   | 20   | 60   | 30   |
| Number                       | 7    | 4    | 14   | 3    | 8    | 18   | 5    | 2    | 12   | 1    | 6    | 16   |
| Initial Q (Qb), veh          | 0    | 0    | 0    | 0    | 0    | 0    | 0    | 0    | 0    | 0    | 0    | 0    |
| Ped-Bike Adj(A_pbT)          | 1.00 |      | 1.00 | 1.00 |      | 1.00 | 1.00 |      | 1.00 | 1.00 |      | 1.00 |
| Parking Bus, Adj             | 1.00 | 1.00 | 1.00 | 1.00 | 1.00 | 1.00 | 1.00 | 1.00 | 1.00 | 1.00 | 1.00 | 1.00 |
| Adj Sat Flow, veh/h/ln       | 1900 | 1845 | 1900 | 1900 | 1845 | 1900 | 1900 | 1863 | 1900 | 1900 | 1827 | 1900 |
| Adj Flow Rate, veh/h         | 11   | 670  | 34   | 57   | 1023 | 23   | 23   | 34   | 34   | 23   | 68   | 34   |
| Adj No. of Lanes             | 0    | 2    | 0    | 0    | 2    | 0    | 0    | 1    | 0    | 0    | 1    | 0    |
| Peak Hour Factor             | 0.88 | 0.88 | 0.88 | 0.88 | 0.88 | 0.88 | 0.88 | 0.88 | 0.88 | 0.88 | 0.88 | 0.88 |
| Percent Heavy Veh, %         | 3    | 3    | 3    | 3    | 3    | 3    | 2    | 2    | 2    | 4    | 4    | 4    |
| Cap, veh/h                   | 176  | 1385 | 70   | 218  | 1362 | 30   | 258  | 121  | 103  | 233  | 163  | 75   |
| Arrive On Green              | 0.42 | 0.42 | 0.42 | 0.42 | 0.42 | 0.42 | 0.17 | 0.17 | 0.17 | 0.17 | 0.17 | 0.17 |
| Sat Flow, veh/h              | 17   | 3271 | 165  | 89   | 3215 | 71   | 317  | 723  | 620  | 231  | 979  | 452  |
| Grp Volume(v), veh/h         | 375  | 0    | 340  | 566  | 0    | 537  | 91   | 0    | 0    | 125  | 0    | 0    |
| Grp Sat Flow(s),veh/h/ln     | 1803 | 0    | 1649 | 1709 | 0    | 1666 | 1661 | 0    | 0    | 1662 | 0    | 0    |
| Q Serve(g_s), s              | 0.0  | 0.0  | 3.3  | 1.8  | 0.0  | 6.0  | 0.0  | 0.0  | 0.0  | 0.4  | 0.0  | 0.0  |
| Cycle Q Clear(g_c), s        | 3.2  | 0.0  | 3.3  | 5.9  | 0.0  | 6.0  | 1.0  | 0.0  | 0.0  | 1.4  | 0.0  | 0.0  |
| Prop In Lane                 | 0.03 |      | 0.10 | 0.10 |      | 0.04 | 0.25 |      | 0.37 | 0.18 |      | 0.27 |
| Lane Grp Cap(c), veh/h       | 932  | 0    | 699  | 904  | 0    | 706  | 482  | 0    | 0    | 471  | 0    | 0    |
| V/C Ratio(X)                 | 0.40 | 0.00 | 0.49 | 0.63 | 0.00 | 0.76 | 0.19 | 0.00 | 0.00 | 0.27 | 0.00 | 0.00 |
| Avail Cap(c_a), veh/h        | 4158 | 0    | 3792 | 3905 | 0    | 3830 | 2413 | 0    | 0    | 2460 | 0    | 0    |
| HCM Platoon Ratio            | 1.00 | 1.00 | 1.00 | 1.00 | 1.00 | 1.00 | 1.00 | 1.00 | 1.00 | 1.00 | 1.00 | 1.00 |
| Upstream Filter(I)           | 1.00 | 0.00 | 1.00 | 1.00 | 0.00 | 1.00 | 1.00 | 0.00 | 0.00 | 1.00 | 0.00 | 0.00 |
| Uniform Delay (d), s/veh     | 4.6  | 0.0  | 4.6  | 5.3  | 0.0  | 5.4  | 8.0  | 0.0  | 0.0  | 8.2  | 0.0  | 0.0  |
| Incr Delay (d2), s/veh       | 0.1  | 0.0  | 0.2  | 0.3  | 0.0  | 0.6  | 0.1  | 0.0  | 0.0  | 0.1  | 0.0  | 0.0  |
| Initial Q Delay(d3),s/veh    | 0.0  | 0.0  | 0.0  | 0.0  | 0.0  | 0.0  | 0.0  | 0.0  | 0.0  | 0.0  | 0.0  | 0.0  |
| %ile BackOfQ(50%),veh/ln     | 1.6  | 0.0  | 1.5  | 2.9  | 0.0  | 2.8  | 0.5  | 0.0  | 0.0  | 0.7  | 0.0  | 0.0  |
| LnGrp Delay(d),s/veh         | 4.7  | 0.0  | 4.8  | 5.6  | 0.0  | 6.0  | 8.1  | 0.0  | 0.0  | 8.3  | 0.0  | 0.0  |
| LnGrp LOS                    | A    |      | A    | A    |      | A    | A    |      |      | A    |      |      |
| Approach Vol, veh/h          |      | 715  |      |      | 1103 |      |      | 91   |      |      | 125  |      |
| Approach Delay, s/veh        |      | 4.7  |      |      | 5.8  |      |      | 8.1  |      |      | 8.3  |      |
| Approach LOS                 |      | A    |      |      | A    |      |      | A    |      |      | A    |      |
| Timer                        | 1    | 2    | 3    | 4    | 5    | 6    | 7    | 8    |      |      |      |      |
| Assigned Phs                 |      | 2    |      | 4    |      | 6    |      | 8    |      |      |      |      |
| Phs Duration (G+Y+Rc), s     |      | 8.2  |      | 13.8 |      | 8.2  |      | 13.8 |      |      |      |      |
| Change Period (Y+Rc), s      |      | 4.5  |      | 4.5  |      | 4.5  |      | 4.5  |      |      |      |      |
| Max Green Setting (Gmax), s  |      | 30.5 |      | 50.5 |      | 30.5 |      | 50.5 |      |      |      |      |
| Max Q Clear Time (g_c+I1), s |      | 3.0  |      | 5.3  |      | 3.4  |      | 8.0  |      |      |      |      |
| Green Ext Time (p_c), s      |      | 0.1  |      | 0.7  |      | 0.1  |      | 1.2  |      |      |      |      |
| <b>Intersection Summary</b>  |      |      |      |      |      |      |      |      |      |      |      |      |
| HCM 2010 Ctrl Delay          |      |      |      | 5.7  |      |      |      |      |      |      |      |      |
| HCM 2010 LOS                 |      |      |      | A    |      |      |      |      |      |      |      |      |

HCM 2010 Signalized Intersection Summary  
 41: Parker Flatts Cut Off Road & Gigling Road

Cumulative with Project, AM  
 06/11/2019



| Movement                     | EBL  | EBT  | EBR  | WBL  | WBT  | WBR  | NBL  | NBT  | NBR  | SBL  | SBT  | SBR  |
|------------------------------|------|------|------|------|------|------|------|------|------|------|------|------|
| Lane Configurations          |      | ↕↕   |      |      | ↕↕   |      |      | ↕    | ↕    |      | ↕↕   |      |
| Traffic Volume (veh/h)       | 10   | 560  | 80   | 110  | 910  | 10   | 40   | 10   | 50   | 10   | 30   | 10   |
| Future Volume (veh/h)        | 10   | 560  | 80   | 110  | 910  | 10   | 40   | 10   | 50   | 10   | 30   | 10   |
| Number                       | 7    | 4    | 14   | 3    | 8    | 18   | 5    | 2    | 12   | 1    | 6    | 16   |
| Initial Q (Qb), veh          | 0    | 0    | 0    | 0    | 0    | 0    | 0    | 0    | 0    | 0    | 0    | 0    |
| Ped-Bike Adj(A_pbT)          | 1.00 |      | 1.00 | 1.00 |      | 1.00 | 1.00 |      | 1.00 | 1.00 |      | 1.00 |
| Parking Bus, Adj             | 1.00 | 1.00 | 1.00 | 1.00 | 1.00 | 1.00 | 1.00 | 1.00 | 1.00 | 1.00 | 1.00 | 1.00 |
| Adj Sat Flow, veh/h/ln       | 1900 | 1845 | 1900 | 1900 | 1863 | 1900 | 1900 | 1863 | 1863 | 1900 | 1900 | 1900 |
| Adj Flow Rate, veh/h         | 12   | 667  | 95   | 131  | 1083 | 12   | 48   | 12   | 60   | 12   | 36   | 12   |
| Adj No. of Lanes             | 0    | 2    | 0    | 0    | 2    | 0    | 0    | 1    | 1    | 0    | 1    | 0    |
| Peak Hour Factor             | 0.84 | 0.84 | 0.84 | 0.84 | 0.84 | 0.84 | 0.84 | 0.84 | 0.84 | 0.84 | 0.84 | 0.84 |
| Percent Heavy Veh, %         | 3    | 3    | 3    | 2    | 2    | 2    | 2    | 2    | 2    | 0    | 0    | 0    |
| Cap, veh/h                   | 159  | 1449 | 204  | 281  | 1417 | 16   | 417  | 67   | 229  | 213  | 165  | 50   |
| Arrive On Green              | 0.49 | 0.49 | 0.49 | 0.49 | 0.49 | 0.49 | 0.14 | 0.14 | 0.14 | 0.14 | 0.14 | 0.14 |
| Sat Flow, veh/h              | 15   | 2975 | 419  | 208  | 2909 | 32   | 1049 | 461  | 1583 | 248  | 1142 | 347  |
| Grp Volume(v), veh/h         | 410  | 0    | 364  | 596  | 0    | 630  | 60   | 0    | 60   | 60   | 0    | 0    |
| Grp Sat Flow(s),veh/h/ln     | 1805 | 0    | 1605 | 1460 | 0    | 1689 | 1510 | 0    | 1583 | 1737 | 0    | 0    |
| Q Serve(g_s), s              | 0.0  | 0.0  | 3.7  | 4.6  | 0.0  | 7.4  | 0.0  | 0.0  | 0.8  | 0.0  | 0.0  | 0.0  |
| Cycle Q Clear(g_c), s        | 3.6  | 0.0  | 3.7  | 8.2  | 0.0  | 7.4  | 0.7  | 0.0  | 0.8  | 0.7  | 0.0  | 0.0  |
| Prop In Lane                 | 0.03 |      | 0.26 | 0.22 |      | 0.02 | 0.80 |      | 1.00 | 0.20 |      | 0.20 |
| Lane Grp Cap(c), veh/h       | 1031 | 0    | 782  | 891  | 0    | 823  | 483  | 0    | 229  | 428  | 0    | 0    |
| V/C Ratio(X)                 | 0.40 | 0.00 | 0.47 | 0.67 | 0.00 | 0.77 | 0.12 | 0.00 | 0.26 | 0.14 | 0.00 | 0.00 |
| Avail Cap(c_a), veh/h        | 4088 | 0    | 3646 | 3329 | 0    | 3839 | 1770 | 0    | 1653 | 1958 | 0    | 0    |
| HCM Platoon Ratio            | 1.00 | 1.00 | 1.00 | 1.00 | 1.00 | 1.00 | 1.00 | 1.00 | 1.00 | 1.00 | 1.00 | 1.00 |
| Upstream Filter(I)           | 1.00 | 0.00 | 1.00 | 1.00 | 0.00 | 1.00 | 1.00 | 0.00 | 1.00 | 1.00 | 0.00 | 0.00 |
| Uniform Delay (d), s/veh     | 4.1  | 0.0  | 4.2  | 5.1  | 0.0  | 5.1  | 9.2  | 0.0  | 9.3  | 9.2  | 0.0  | 0.0  |
| Incr Delay (d2), s/veh       | 0.1  | 0.0  | 0.2  | 0.3  | 0.0  | 0.6  | 0.0  | 0.0  | 0.2  | 0.1  | 0.0  | 0.0  |
| Initial Q Delay(d3),s/veh    | 0.0  | 0.0  | 0.0  | 0.0  | 0.0  | 0.0  | 0.0  | 0.0  | 0.0  | 0.0  | 0.0  | 0.0  |
| %ile BackOfQ(50%),veh/ln     | 1.7  | 0.0  | 1.5  | 3.2  | 0.0  | 3.5  | 0.4  | 0.0  | 0.4  | 0.4  | 0.0  | 0.0  |
| LnGrp Delay(d),s/veh         | 4.2  | 0.0  | 4.3  | 5.4  | 0.0  | 5.7  | 9.3  | 0.0  | 9.5  | 9.3  | 0.0  | 0.0  |
| LnGrp LOS                    | A    |      | A    | A    |      | A    | A    |      | A    | A    |      |      |
| Approach Vol, veh/h          |      | 774  |      |      | 1226 |      |      | 120  |      |      | 60   |      |
| Approach Delay, s/veh        |      | 4.3  |      |      | 5.5  |      |      | 9.4  |      |      | 9.3  |      |
| Approach LOS                 |      | A    |      |      | A    |      |      | A    |      |      | A    |      |
| Timer                        | 1    | 2    | 3    | 4    | 5    | 6    | 7    | 8    |      |      |      |      |
| Assigned Phs                 |      | 2    |      | 4    |      | 6    |      | 8    |      |      |      |      |
| Phs Duration (G+Y+Rc), s     |      | 8.0  |      | 16.4 |      | 8.0  |      | 16.4 |      |      |      |      |
| Change Period (Y+Rc), s      |      | 4.5  |      | 4.5  |      | 4.5  |      | 4.5  |      |      |      |      |
| Max Green Setting (Gmax), s  |      | 25.5 |      | 55.5 |      | 25.5 |      | 55.5 |      |      |      |      |
| Max Q Clear Time (g_c+I1), s |      | 2.8  |      | 5.7  |      | 2.7  |      | 10.2 |      |      |      |      |
| Green Ext Time (p_c), s      |      | 0.0  |      | 0.8  |      | 0.0  |      | 1.7  |      |      |      |      |
| <b>Intersection Summary</b>  |      |      |      |      |      |      |      |      |      |      |      |      |
| HCM 2010 Ctrl Delay          |      |      |      | 5.4  |      |      |      |      |      |      |      |      |
| HCM 2010 LOS                 |      |      |      | A    |      |      |      |      |      |      |      |      |

HCM 2010 Signalized Intersection Summary  
42: 6th Avenue & Gigling Road

Cumulative with Project, AM  
06/11/2019



| Movement                     | EBL  | EBT  | EBR  | WBL  | WBT  | WBR  | NBL  | NBT  | NBR  | SBL  | SBT  | SBR  |
|------------------------------|------|------|------|------|------|------|------|------|------|------|------|------|
| Lane Configurations          |      | ↔    |      |      | ↔    |      |      | ↔    | ↔    |      | ↔    |      |
| Traffic Volume (veh/h)       | 200  | 420  | 10   | 30   | 820  | 10   | 10   | 10   | 10   | 10   | 10   | 210  |
| Future Volume (veh/h)        | 200  | 420  | 10   | 30   | 820  | 10   | 10   | 10   | 10   | 10   | 10   | 210  |
| Number                       | 7    | 4    | 14   | 3    | 8    | 18   | 5    | 2    | 12   | 1    | 6    | 16   |
| Initial Q (Qb), veh          | 0    | 0    | 0    | 0    | 0    | 0    | 0    | 0    | 0    | 0    | 0    | 0    |
| Ped-Bike Adj(A_pbT)          | 1.00 |      | 1.00 | 1.00 |      | 1.00 | 1.00 |      | 1.00 | 1.00 |      | 1.00 |
| Parking Bus, Adj             | 1.00 | 1.00 | 1.00 | 1.00 | 1.00 | 1.00 | 1.00 | 1.00 | 1.00 | 1.00 | 1.00 | 1.00 |
| Adj Sat Flow, veh/h/ln       | 1900 | 1845 | 1900 | 1900 | 1863 | 1900 | 1900 | 1429 | 1429 | 1900 | 1863 | 1900 |
| Adj Flow Rate, veh/h         | 225  | 472  | 11   | 34   | 921  | 11   | 11   | 11   | 0    | 11   | 11   | 236  |
| Adj No. of Lanes             | 0    | 2    | 0    | 0    | 2    | 0    | 0    | 1    | 1    | 0    | 1    | 0    |
| Peak Hour Factor             | 0.89 | 0.89 | 0.89 | 0.89 | 0.89 | 0.89 | 0.89 | 0.89 | 0.89 | 0.89 | 0.89 | 0.89 |
| Percent Heavy Veh, %         | 3    | 3    | 3    | 2    | 2    | 2    | 33   | 33   | 33   | 2    | 2    | 2    |
| Cap, veh/h                   | 403  | 992  | 23   | 119  | 1997 | 23   | 220  | 159  | 252  | 92   | 22   | 302  |
| Arrive On Green              | 0.59 | 0.59 | 0.59 | 0.59 | 0.59 | 0.59 | 0.21 | 0.21 | 0.00 | 0.21 | 0.21 | 0.21 |
| Sat Flow, veh/h              | 420  | 1690 | 40   | 53   | 3401 | 40   | 465  | 766  | 1214 | 29   | 106  | 1455 |
| Grp Volume(v), veh/h         | 248  | 0    | 460  | 501  | 0    | 465  | 22   | 0    | 0    | 258  | 0    | 0    |
| Grp Sat Flow(s),veh/h/ln     | 478  | 0    | 1672 | 1807 | 0    | 1688 | 1231 | 0    | 1214 | 1591 | 0    | 0    |
| Q Serve(g_s), s              | 15.2 | 0.0  | 6.9  | 0.0  | 0.0  | 6.9  | 0.0  | 0.0  | 0.0  | 1.6  | 0.0  | 0.0  |
| Cycle Q Clear(g_c), s        | 22.0 | 0.0  | 6.9  | 6.7  | 0.0  | 6.9  | 0.5  | 0.0  | 0.0  | 6.7  | 0.0  | 0.0  |
| Prop In Lane                 | 0.91 |      | 0.02 | 0.07 |      | 0.02 | 0.50 |      | 1.00 | 0.04 |      | 0.91 |
| Lane Grp Cap(c), veh/h       | 437  | 0    | 981  | 1148 | 0    | 991  | 379  | 0    | 252  | 416  | 0    | 0    |
| V/C Ratio(X)                 | 0.57 | 0.00 | 0.47 | 0.44 | 0.00 | 0.47 | 0.06 | 0.00 | 0.00 | 0.62 | 0.00 | 0.00 |
| Avail Cap(c_a), veh/h        | 794  | 0    | 1924 | 2129 | 0    | 1943 | 904  | 0    | 844  | 1186 | 0    | 0    |
| HCM Platoon Ratio            | 1.00 | 1.00 | 1.00 | 1.00 | 1.00 | 1.00 | 1.00 | 1.00 | 1.00 | 1.00 | 1.00 | 1.00 |
| Upstream Filter(I)           | 1.00 | 0.00 | 1.00 | 1.00 | 0.00 | 1.00 | 1.00 | 0.00 | 0.00 | 1.00 | 0.00 | 0.00 |
| Uniform Delay (d), s/veh     | 10.9 | 0.0  | 5.2  | 5.1  | 0.0  | 5.2  | 14.0 | 0.0  | 0.0  | 16.4 | 0.0  | 0.0  |
| Incr Delay (d2), s/veh       | 0.4  | 0.0  | 0.1  | 0.1  | 0.0  | 0.1  | 0.0  | 0.0  | 0.0  | 0.6  | 0.0  | 0.0  |
| Initial Q Delay(d3),s/veh    | 0.0  | 0.0  | 0.0  | 0.0  | 0.0  | 0.0  | 0.0  | 0.0  | 0.0  | 0.0  | 0.0  | 0.0  |
| %ile BackOfQ(50%),veh/ln     | 2.7  | 0.0  | 3.1  | 3.4  | 0.0  | 3.1  | 0.2  | 0.0  | 0.0  | 3.0  | 0.0  | 0.0  |
| LnGrp Delay(d),s/veh         | 11.4 | 0.0  | 5.3  | 5.2  | 0.0  | 5.3  | 14.0 | 0.0  | 0.0  | 17.0 | 0.0  | 0.0  |
| LnGrp LOS                    | B    |      | A    | A    |      | A    | B    |      |      | B    |      |      |
| Approach Vol, veh/h          |      | 708  |      |      | 966  |      |      | 22   |      |      | 258  |      |
| Approach Delay, s/veh        |      | 7.4  |      |      | 5.2  |      |      | 14.0 |      |      | 17.0 |      |
| Approach LOS                 |      | A    |      |      | A    |      |      | B    |      |      | B    |      |
| Timer                        | 1    | 2    | 3    | 4    | 5    | 6    | 7    | 8    |      |      |      |      |
| Assigned Phs                 |      | 2    |      | 4    |      | 6    |      | 8    |      |      |      |      |
| Phs Duration (G+Y+Rc), s     |      | 13.6 |      | 30.3 |      | 13.6 |      | 30.3 |      |      |      |      |
| Change Period (Y+Rc), s      |      | 4.5  |      | 4.5  |      | 4.5  |      | 4.5  |      |      |      |      |
| Max Green Setting (Gmax), s  |      | 30.5 |      | 50.5 |      | 30.5 |      | 50.5 |      |      |      |      |
| Max Q Clear Time (g_c+I1), s |      | 2.5  |      | 24.0 |      | 8.7  |      | 8.9  |      |      |      |      |
| Green Ext Time (p_c), s      |      | 0.0  |      | 1.7  |      | 0.4  |      | 1.0  |      |      |      |      |
| <b>Intersection Summary</b>  |      |      |      |      |      |      |      |      |      |      |      |      |
| HCM 2010 Ctrl Delay          |      |      |      | 7.7  |      |      |      |      |      |      |      |      |
| HCM 2010 LOS                 |      |      |      | A    |      |      |      |      |      |      |      |      |

HCM 2010 Signalized Intersection Summary  
43: Gigling Road & 7th Avenue

Cumulative with Project, AM  
06/11/2019

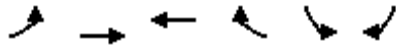

| Movement                     | EBL  | EBT  | WBT  | WBR  | SBL  | SBR  |   |      |
|------------------------------|------|------|------|------|------|------|---|------|
| Lane Configurations          |      | ↑↑   | ↑↑   |      | ↘    |      |   |      |
| Traffic Volume (veh/h)       | 180  | 260  | 780  | 10   | 10   | 70   |   |      |
| Future Volume (veh/h)        | 180  | 260  | 780  | 10   | 10   | 70   |   |      |
| Number                       | 7    | 4    | 8    | 18   | 1    | 16   |   |      |
| Initial Q (Qb), veh          | 0    | 0    | 0    | 0    | 0    | 0    |   |      |
| Ped-Bike Adj(A_pbT)          | 1.00 |      |      | 1.00 | 1.00 | 1.00 |   |      |
| Parking Bus, Adj             | 1.00 | 1.00 | 1.00 | 1.00 | 1.00 | 1.00 |   |      |
| Adj Sat Flow, veh/h/ln       | 1900 | 1845 | 1900 | 1900 | 1759 | 1900 |   |      |
| Adj Flow Rate, veh/h         | 209  | 302  | 907  | 12   | 12   | 81   |   |      |
| Adj No. of Lanes             | 0    | 2    | 2    | 0    | 0    | 0    |   |      |
| Peak Hour Factor             | 0.86 | 0.86 | 0.86 | 0.86 | 0.86 | 0.86 |   |      |
| Percent Heavy Veh, %         | 3    | 3    | 0    | 0    | 0    | 0    |   |      |
| Cap, veh/h                   | 522  | 918  | 2086 | 28   | 18   | 123  |   |      |
| Arrive On Green              | 0.57 | 0.57 | 0.57 | 0.57 | 0.09 | 0.09 |   |      |
| Sat Flow, veh/h              | 449  | 1690 | 3743 | 48   | 194  | 1309 |   |      |
| Grp Volume(v), veh/h         | 212  | 299  | 449  | 470  | 94   | 0    |   |      |
| Grp Sat Flow(s),veh/h/ln     | 460  | 1595 | 1805 | 1891 | 1519 | 0    |   |      |
| Q Serve(g_s), s              | 8.1  | 2.7  | 3.8  | 3.8  | 1.6  | 0.0  |   |      |
| Cycle Q Clear(g_c), s        | 11.9 | 2.7  | 3.8  | 3.8  | 1.6  | 0.0  |   |      |
| Prop In Lane                 | 0.98 |      |      | 0.03 | 0.13 | 0.86 |   |      |
| Lane Grp Cap(c), veh/h       | 528  | 912  | 1032 | 1081 | 142  | 0    |   |      |
| V/C Ratio(X)                 | 0.40 | 0.33 | 0.43 | 0.43 | 0.66 | 0.00 |   |      |
| Avail Cap(c_a), veh/h        | 1432 | 3289 | 3723 | 3901 | 1439 | 0    |   |      |
| HCM Platoon Ratio            | 1.00 | 1.00 | 1.00 | 1.00 | 1.00 | 1.00 |   |      |
| Upstream Filter(I)           | 1.00 | 1.00 | 1.00 | 1.00 | 1.00 | 0.00 |   |      |
| Uniform Delay (d), s/veh     | 6.6  | 3.0  | 3.3  | 3.3  | 11.8 | 0.0  |   |      |
| Incr Delay (d2), s/veh       | 0.2  | 0.1  | 0.1  | 0.1  | 1.9  | 0.0  |   |      |
| Initial Q Delay(d3),s/veh    | 0.0  | 0.0  | 0.0  | 0.0  | 0.0  | 0.0  |   |      |
| %ile BackOfQ(50%),veh/ln     | 1.4  | 1.2  | 1.9  | 2.0  | 0.7  | 0.0  |   |      |
| LnGrp Delay(d),s/veh         | 6.8  | 3.1  | 3.4  | 3.4  | 13.7 | 0.0  |   |      |
| LnGrp LOS                    | A    | A    | A    | A    | B    |      |   |      |
| Approach Vol, veh/h          |      | 511  | 919  |      | 94   |      |   |      |
| Approach Delay, s/veh        |      | 4.6  | 3.4  |      | 13.7 |      |   |      |
| Approach LOS                 |      | A    | A    |      | B    |      |   |      |
| Timer                        | 1    | 2    | 3    | 4    | 5    | 6    | 7 | 8    |
| Assigned Phs                 |      |      |      | 4    |      | 6    |   | 8    |
| Phs Duration (G+Y+Rc), s     |      |      |      | 19.9 |      | 7.0  |   | 19.9 |
| Change Period (Y+Rc), s      |      |      |      | 4.5  |      | 4.5  |   | 4.5  |
| Max Green Setting (Gmax), s  |      |      |      | 55.5 |      | 25.5 |   | 55.5 |
| Max Q Clear Time (g_c+I1), s |      |      |      | 13.9 |      | 3.6  |   | 5.8  |
| Green Ext Time (p_c), s      |      |      |      | 1.5  |      | 0.0  |   | 0.8  |
| <b>Intersection Summary</b>  |      |      |      |      |      |      |   |      |
| HCM 2010 Ctrl Delay          |      |      | 4.4  |      |      |      |   |      |
| HCM 2010 LOS                 |      |      | A    |      |      |      |   |      |
| <b>Notes</b>                 |      |      |      |      |      |      |   |      |

HCM 2010 Signalized Intersection Summary  
44: 8th Avenue & Gigling Road

Cumulative with Project, AM  
06/11/2019



| Movement                     | EBL  | EBT  | EBR  | WBL  | WBT  | WBR  | NBL  | NBT  | NBR  | SBL  | SBT  | SBR  |
|------------------------------|------|------|------|------|------|------|------|------|------|------|------|------|
| Lane Configurations          |      | ↔↑   |      |      | ↔↑   |      |      | ↔↑   |      |      | ↔↑   |      |
| Traffic Volume (veh/h)       | 260  | 10   | 10   | 10   | 10   | 10   | 10   | 10   | 10   | 10   | 10   | 780  |
| Future Volume (veh/h)        | 260  | 10   | 10   | 10   | 10   | 10   | 10   | 10   | 10   | 10   | 10   | 780  |
| Number                       | 7    | 4    | 14   | 3    | 8    | 18   | 5    | 2    | 12   | 1    | 6    | 16   |
| Initial Q (Qb), veh          | 0    | 0    | 0    | 0    | 0    | 0    | 0    | 0    | 0    | 0    | 0    | 0    |
| Ped-Bike Adj(A_pbT)          | 1.00 |      | 1.00 | 1.00 |      | 1.00 | 1.00 |      | 1.00 | 1.00 |      | 1.00 |
| Parking Bus, Adj             | 1.00 | 1.00 | 1.00 | 1.00 | 1.00 | 1.00 | 1.00 | 1.00 | 1.00 | 1.00 | 1.00 | 1.00 |
| Adj Sat Flow, veh/h/ln       | 1900 | 1863 | 1900 | 1900 | 1863 | 1900 | 1900 | 1900 | 1900 | 1900 | 1900 | 1900 |
| Adj Flow Rate, veh/h         | 306  | 12   | 12   | 12   | 12   | 12   | 12   | 12   | 12   | 12   | 12   | 918  |
| Adj No. of Lanes             | 0    | 2    | 0    | 0    | 2    | 0    | 0    | 1    | 0    | 0    | 1    | 0    |
| Peak Hour Factor             | 0.85 | 0.85 | 0.85 | 0.85 | 0.85 | 0.85 | 0.85 | 0.85 | 0.85 | 0.85 | 0.85 | 0.85 |
| Percent Heavy Veh, %         | 2    | 2    | 2    | 2    | 2    | 2    | 0    | 0    | 0    | 0    | 0    | 0    |
| Cap, veh/h                   | 456  | 200  | 200  | 311  | 281  | 285  | 183  | 183  | 146  | 61   | 21   | 952  |
| Arrive On Green              | 0.26 | 0.26 | 0.26 | 0.26 | 0.26 | 0.26 | 0.60 | 0.60 | 0.60 | 0.60 | 0.60 | 0.60 |
| Sat Flow, veh/h              | 1338 | 779  | 779  | 860  | 1093 | 1109 | 180  | 303  | 241  | 7    | 34   | 1578 |
| Grp Volume(v), veh/h         | 306  | 0    | 24   | 20   | 0    | 16   | 36   | 0    | 0    | 942  | 0    | 0    |
| Grp Sat Flow(s),veh/h/ln     | 1338 | 0    | 1558 | 1563 | 0    | 1499 | 724  | 0    | 0    | 1619 | 0    | 0    |
| Q Serve(g_s), s              | 13.8 | 0.0  | 0.7  | 0.0  | 0.0  | 0.5  | 0.0  | 0.0  | 0.0  | 9.5  | 0.0  | 0.0  |
| Cycle Q Clear(g_c), s        | 14.3 | 0.0  | 0.7  | 0.5  | 0.0  | 0.5  | 0.5  | 0.0  | 0.0  | 35.6 | 0.0  | 0.0  |
| Prop In Lane                 | 1.00 |      | 0.50 | 0.61 |      | 0.74 | 0.33 |      | 0.33 | 0.01 |      | 0.97 |
| Lane Grp Cap(c), veh/h       | 456  | 0    | 400  | 491  | 0    | 385  | 511  | 0    | 0    | 1034 | 0    | 0    |
| V/C Ratio(X)                 | 0.67 | 0.00 | 0.06 | 0.04 | 0.00 | 0.04 | 0.07 | 0.00 | 0.00 | 0.91 | 0.00 | 0.00 |
| Avail Cap(c_a), veh/h        | 861  | 0    | 857  | 943  | 0    | 825  | 621  | 0    | 0    | 1198 | 0    | 0    |
| HCM Platoon Ratio            | 1.00 | 1.00 | 1.00 | 1.00 | 1.00 | 1.00 | 1.00 | 1.00 | 1.00 | 1.00 | 1.00 | 1.00 |
| Upstream Filter(I)           | 1.00 | 0.00 | 1.00 | 1.00 | 0.00 | 1.00 | 1.00 | 0.00 | 0.00 | 1.00 | 0.00 | 0.00 |
| Uniform Delay (d), s/veh     | 23.4 | 0.0  | 18.1 | 18.0 | 0.0  | 18.0 | 5.2  | 0.0  | 0.0  | 12.1 | 0.0  | 0.0  |
| Incr Delay (d2), s/veh       | 0.6  | 0.0  | 0.0  | 0.0  | 0.0  | 0.0  | 0.0  | 0.0  | 0.0  | 8.9  | 0.0  | 0.0  |
| Initial Q Delay(d3),s/veh    | 0.0  | 0.0  | 0.0  | 0.0  | 0.0  | 0.0  | 0.0  | 0.0  | 0.0  | 0.0  | 0.0  | 0.0  |
| %ile BackOfQ(50%),veh/ln     | 5.4  | 0.0  | 0.3  | 0.3  | 0.0  | 0.2  | 0.3  | 0.0  | 0.0  | 18.0 | 0.0  | 0.0  |
| LnGrp Delay(d),s/veh         | 24.0 | 0.0  | 18.1 | 18.0 | 0.0  | 18.0 | 5.2  | 0.0  | 0.0  | 21.0 | 0.0  | 0.0  |
| LnGrp LOS                    | C    |      | B    | B    |      | B    | A    |      |      | C    |      |      |
| Approach Vol, veh/h          |      | 330  |      |      | 36   |      |      | 36   |      |      | 942  |      |
| Approach Delay, s/veh        |      | 23.6 |      |      | 18.0 |      |      | 5.2  |      |      | 21.0 |      |
| Approach LOS                 |      | C    |      |      | B    |      |      | A    |      |      | C    |      |
| Timer                        | 1    | 2    | 3    | 4    | 5    | 6    | 7    | 8    |      |      |      |      |
| Assigned Phs                 |      | 2    |      | 4    |      | 6    |      | 8    |      |      |      |      |
| Phs Duration (G+Y+Rc), s     |      | 43.4 |      | 21.1 |      | 43.4 |      | 21.1 |      |      |      |      |
| Change Period (Y+Rc), s      |      | 4.5  |      | 4.5  |      | 4.5  |      | 4.5  |      |      |      |      |
| Max Green Setting (Gmax), s  |      | 45.5 |      | 35.5 |      | 45.5 |      | 35.5 |      |      |      |      |
| Max Q Clear Time (g_c+I1), s |      | 2.5  |      | 16.3 |      | 37.6 |      | 2.5  |      |      |      |      |
| Green Ext Time (p_c), s      |      | 0.1  |      | 0.3  |      | 1.4  |      | 0.0  |      |      |      |      |
| <b>Intersection Summary</b>  |      |      |      |      |      |      |      |      |      |      |      |      |
| HCM 2010 Ctrl Delay          |      |      |      | 21.1 |      |      |      |      |      |      |      |      |
| HCM 2010 LOS                 |      |      |      | C    |      |      |      |      |      |      |      |      |

HCM 2010 Signalized Intersection Summary  
 46: General Jim Moore Boulevard & Normandy Road

Cumulative with Project, AM  
 06/11/2019



| Movement                      | EBL  | EBT  | EBR  | WBL  | WBT  | WBR  | NBL   | NBT  | NBR  | SBL  | SBT  | SBR  |
|-------------------------------|------|------|------|------|------|------|-------|------|------|------|------|------|
| Lane Configurations           |      | ↕    |      |      | ↕    |      | ↕     | ↕↕   |      | ↕    | ↕↕   | ↕    |
| Traffic Volume (veh/h)        | 90   | 80   | 150  | 150  | 70   | 40   | 200   | 490  | 110  | 80   | 840  | 250  |
| Future Volume (veh/h)         | 90   | 80   | 150  | 150  | 70   | 40   | 200   | 490  | 110  | 80   | 840  | 250  |
| Number                        | 3    | 8    | 18   | 7    | 4    | 14   | 1     | 6    | 16   | 5    | 2    | 12   |
| Initial Q (Qb), veh           | 0    | 0    | 0    | 0    | 0    | 0    | 0     | 0    | 0    | 0    | 0    | 0    |
| Ped-Bike Adj(A_pbT)           | 0.99 |      | 0.98 | 0.99 |      | 0.98 | 1.00  |      | 0.99 | 1.00 |      | 0.99 |
| Parking Bus, Adj              | 1.00 | 1.00 | 1.00 | 1.00 | 1.00 | 1.00 | 1.00  | 1.00 | 1.00 | 1.00 | 1.00 | 1.00 |
| Adj Sat Flow, veh/h/ln        | 1900 | 1881 | 1900 | 1900 | 1863 | 1900 | 1881  | 1881 | 1900 | 1863 | 1863 | 1863 |
| Adj Flow Rate, veh/h          | 115  | 103  | 163  | 192  | 90   | 47   | 256   | 628  | 114  | 103  | 1077 | 252  |
| Adj No. of Lanes              | 0    | 1    | 0    | 0    | 1    | 0    | 1     | 2    | 0    | 1    | 2    | 1    |
| Peak Hour Factor              | 0.78 | 0.78 | 0.78 | 0.78 | 0.78 | 0.78 | 0.78  | 0.78 | 0.78 | 0.78 | 0.78 | 0.78 |
| Percent Heavy Veh, %          | 1    | 1    | 1    | 2    | 2    | 2    | 1     | 1    | 1    | 2    | 2    | 2    |
| Cap, veh/h                    | 210  | 187  | 248  | 315  | 141  | 63   | 201   | 745  | 135  | 348  | 1170 | 518  |
| Arrive On Green               | 0.37 | 0.37 | 0.37 | 0.37 | 0.37 | 0.37 | 0.11  | 0.25 | 0.25 | 0.20 | 0.33 | 0.33 |
| Sat Flow, veh/h               | 391  | 509  | 673  | 640  | 384  | 171  | 1792  | 3016 | 546  | 1774 | 3539 | 1567 |
| Grp Volume(v), veh/h          | 381  | 0    | 0    | 329  | 0    | 0    | 256   | 372  | 370  | 103  | 1077 | 252  |
| Grp Sat Flow(s),veh/h/ln      | 1573 | 0    | 0    | 1195 | 0    | 0    | 1792  | 1787 | 1776 | 1774 | 1770 | 1567 |
| Q Serve(g_s), s               | 0.0  | 0.0  | 0.0  | 4.1  | 0.0  | 0.0  | 8.0   | 14.1 | 14.1 | 3.5  | 20.9 | 9.1  |
| Cycle Q Clear(g_c), s         | 13.9 | 0.0  | 0.0  | 18.1 | 0.0  | 0.0  | 8.0   | 14.1 | 14.1 | 3.5  | 20.9 | 9.1  |
| Prop In Lane                  | 0.30 |      | 0.43 | 0.58 |      | 0.14 | 1.00  |      | 0.31 | 1.00 |      | 1.00 |
| Lane Grp Cap(c), veh/h        | 644  | 0    | 0    | 520  | 0    | 0    | 201   | 441  | 438  | 348  | 1170 | 518  |
| V/C Ratio(X)                  | 0.59 | 0.00 | 0.00 | 0.63 | 0.00 | 0.00 | 1.27  | 0.84 | 0.84 | 0.30 | 0.92 | 0.49 |
| Avail Cap(c_a), veh/h         | 789  | 0    | 0    | 643  | 0    | 0    | 201   | 639  | 635  | 348  | 1266 | 561  |
| HCM Platoon Ratio             | 1.00 | 1.00 | 1.00 | 1.00 | 1.00 | 1.00 | 1.00  | 1.00 | 1.00 | 1.00 | 1.00 | 1.00 |
| Upstream Filter(I)            | 1.00 | 0.00 | 0.00 | 1.00 | 0.00 | 0.00 | 1.00  | 1.00 | 1.00 | 1.00 | 1.00 | 1.00 |
| Uniform Delay (d), s/veh      | 18.5 | 0.0  | 0.0  | 19.9 | 0.0  | 0.0  | 31.6  | 25.5 | 25.5 | 24.5 | 23.0 | 19.0 |
| Incr Delay (d2), s/veh        | 0.3  | 0.0  | 0.0  | 0.6  | 0.0  | 0.0  | 155.7 | 4.7  | 4.9  | 0.2  | 10.1 | 0.3  |
| Initial Q Delay(d3),s/veh     | 0.0  | 0.0  | 0.0  | 0.0  | 0.0  | 0.0  | 0.0   | 0.0  | 0.0  | 0.0  | 0.0  | 0.0  |
| %ile BackOfQ(50%),veh/ln      | 6.2  | 0.0  | 0.0  | 5.8  | 0.0  | 0.0  | 12.6  | 7.5  | 7.5  | 1.7  | 11.8 | 4.0  |
| LnGrp Delay(d),s/veh          | 18.8 | 0.0  | 0.0  | 20.5 | 0.0  | 0.0  | 187.4 | 30.2 | 30.4 | 24.6 | 33.0 | 19.3 |
| LnGrp LOS                     | B    |      |      | C    |      |      | F     | C    | C    | C    | C    | B    |
| Approach Vol, veh/h           |      | 381  |      |      | 329  |      |       | 998  |      |      | 1432 |      |
| Approach Delay, s/veh         |      | 18.8 |      |      | 20.5 |      |       | 70.6 |      |      | 30.0 |      |
| Approach LOS                  |      | B    |      |      | C    |      |       | E    |      |      | C    |      |
| Timer                         | 1    | 2    | 3    | 4    | 5    | 6    | 7     | 8    |      |      |      |      |
| Assigned Phs                  | 1    | 2    |      | 4    | 5    | 6    |       | 8    |      |      |      |      |
| Phs Duration (G+Y+Rc), s      | 2.5  | 28.1 |      | 30.7 | 18.5 | 22.1 |       | 30.7 |      |      |      |      |
| Change Period (Y+Rc), s       | 4.5  | 4.5  |      | 4.5  | 4.5  | 4.5  |       | 4.5  |      |      |      |      |
| Max Green Setting (Gmax), s   | 30.0 | 25.5 |      | 33.0 | 8.0  | 25.5 |       | 33.0 |      |      |      |      |
| Max Q Clear Time (g_c+110), s | 11.0 | 22.9 |      | 20.1 | 5.5  | 16.1 |       | 15.9 |      |      |      |      |
| Green Ext Time (p_c), s       | 0.0  | 0.7  |      | 0.5  | 0.0  | 0.6  |       | 0.6  |      |      |      |      |
| <b>Intersection Summary</b>   |      |      |      |      |      |      |       |      |      |      |      |      |
| HCM 2010 Ctrl Delay           |      |      | 40.6 |      |      |      |       |      |      |      |      |      |
| HCM 2010 LOS                  |      |      | D    |      |      |      |       |      |      |      |      |      |

|                           |      |
|---------------------------|------|
| <b>Intersection</b>       |      |
| Intersection Delay, s/veh | 22.3 |
| Intersection LOS          | F    |

| Movement            | EBL  | EBR  | NBL  | NBT  | SBT  | SBR  |
|---------------------|------|------|------|------|------|------|
| Lane Configurations |      |      |      |      |      |      |
| Traffic Vol, veh/h  | 90   | 430  | 230  | 420  | 980  | 80   |
| Future Vol, veh/h   | 90   | 430  | 230  | 420  | 980  | 80   |
| Peak Hour Factor    | 0.90 | 0.90 | 0.90 | 0.90 | 0.90 | 0.90 |
| Heavy Vehicles, %   | 1    | 1    | 1    | 1    | 2    | 2    |
| Mvmt Flow           | 100  | 478  | 256  | 467  | 1089 | 89   |
| Number of Lanes     | 1    | 1    | 1    | 2    | 2    | 1    |

| Approach                   | EB    | NB   | SB    |
|----------------------------|-------|------|-------|
| Opposing Approach          |       | SB   | NB    |
| Opposing Lanes             | 0     | 3    | 3     |
| Conflicting Approach Left  | SB    |      |       |
| Conflicting Lanes Left     | 3     | 2    | 0     |
| Conflicting Approach Right | NB    |      | EB    |
| Conflicting Lanes Right    | 3     | 0    | 2     |
| HCM Control Delay          | 125.2 | 26.7 | 179.4 |
| HCM LOS                    | F     | D    | F     |

| Lane                   | NBLn1  | NBLn2  | NBLn3 | EBLn1  | EBLn2 | SBLn1 | SBLn2 | SBLn3 |
|------------------------|--------|--------|-------|--------|-------|-------|-------|-------|
| Vol Left, %            | 100%   | 0%     | 0%    | 100%   | 0%    | 0%    | 0%    | 0%    |
| Vol Thru, %            | 0%     | 100%   | 100%  | 0%     | 0%    | 100%  | 100%  | 0%    |
| Vol Right, %           | 0%     | 0%     | 0%    | 0%     | 100%  | 0%    | 0%    | 100%  |
| Sign Control           | Stop   | Stop   | Stop  | Stop   | Stop  | Stop  | Stop  | Stop  |
| Traffic Vol by Lane    | 230    | 210    | 210   | 90     | 430   | 490   | 490   | 80    |
| LT Vol                 | 230    | 0      | 0     | 90     | 0     | 0     | 0     | 0     |
| Through Vol            | 0      | 210    | 210   | 0      | 0     | 490   | 490   | 0     |
| RT Vol                 | 0      | 0      | 0     | 0      | 430   | 0     | 0     | 80    |
| Lane Flow Rate         | 256    | 233    | 233   | 100    | 478   | 544   | 544   | 89    |
| Geometry Grp           | 8      | 8      | 8     | 8      | 8     | 8     | 8     | 8     |
| Degree of Util (X)     | 0.684  | 0.592  | 0.481 | 0.286  | 1.21  | 1.332 | 1.332 | 0.158 |
| Departure Headway (Hd) | 10.797 | 10.273 | 8.473 | 11.218 | 10    | 9.52  | 9.52  | 6.968 |
| Convergence, Y/N       | Yes    | Yes    | Yes   | Yes    | Yes   | Yes   | Yes   | Yes   |
| Cap                    | 337    | 355    | 429   | 322    | 368   | 387   | 387   | 518   |
| Service Time           | 8.497  | 7.973  | 6.173 | 8.918  | 7.7   | 7.22  | 7.22  | 4.668 |
| HCM Lane V/C Ratio     | 0.76   | 0.656  | 0.543 | 0.311  | 1.299 | 1.406 | 1.406 | 0.172 |
| HCM Control Delay      | 33.9   | 26.8   | 18.8  | 18.4   | 147.6 | 193.2 | 193.2 | 11    |
| HCM Lane LOS           | D      | D      | C     | C      | F     | F     | F     | B     |
| HCM 95th-tile Q        | 4.8    | 3.6    | 2.5   | 1.2    | 18.4  | 23.7  | 23.7  | 0.6   |





| Movement                     | EBL  | EBT  | EBR  | WBL   | WBT  | WBR   | NBL  | NBT  | NBR  | SBL  | SBT   | SBR  |
|------------------------------|------|------|------|-------|------|-------|------|------|------|------|-------|------|
| Lane Configurations          |      |      |      |       |      |       |      |      |      |      |       |      |
| Traffic Volume (veh/h)       | 80   | 100  | 140  | 120   | 210  | 30    | 230  | 680  | 140  | 60   | 1010  | 120  |
| Future Volume (veh/h)        | 80   | 100  | 140  | 120   | 210  | 30    | 230  | 680  | 140  | 60   | 1010  | 120  |
| Number                       | 7    | 4    | 14   | 3     | 8    | 18    | 5    | 2    | 12   | 1    | 6     | 16   |
| Initial Q (Qb), veh          | 0    | 0    | 0    | 0     | 0    | 0     | 0    | 0    | 0    | 0    | 0     | 0    |
| Ped-Bike Adj(A_pbT)          | 1.00 |      | 0.95 | 1.00  |      | 0.97  | 1.00 |      | 0.99 | 1.00 |       | 0.98 |
| Parking Bus, Adj             | 1.00 | 1.00 | 1.00 | 1.00  | 1.00 | 1.00  | 1.00 | 1.00 | 1.00 | 1.00 | 1.00  | 1.00 |
| Adj Sat Flow, veh/h/ln       | 1845 | 1845 | 1845 | 1900  | 1881 | 1900  | 1827 | 1827 | 1900 | 1827 | 1827  | 1827 |
| Adj Flow Rate, veh/h         | 88   | 110  | 65   | 132   | 231  | 31    | 253  | 747  | 139  | 66   | 1110  | 65   |
| Adj No. of Lanes             | 1    | 1    | 1    | 0     | 1    | 0     | 1    | 2    | 0    | 1    | 2     | 1    |
| Peak Hour Factor             | 0.91 | 0.91 | 0.91 | 0.91  | 0.91 | 0.91  | 0.91 | 0.91 | 0.91 | 0.91 | 0.91  | 0.91 |
| Percent Heavy Veh, %         | 3    | 3    | 3    | 1     | 1    | 1     | 4    | 4    | 4    | 4    | 4     | 4    |
| Cap, veh/h                   | 202  | 212  | 172  | 137   | 239  | 32    | 425  | 1337 | 249  | 84   | 880   | 388  |
| Arrive On Green              | 0.11 | 0.11 | 0.11 | 0.22  | 0.22 | 0.22  | 0.24 | 0.46 | 0.46 | 0.05 | 0.25  | 0.25 |
| Sat Flow, veh/h              | 1757 | 1845 | 1494 | 610   | 1067 | 143   | 1740 | 2915 | 542  | 1740 | 3471  | 1529 |
| Grp Volume(v), veh/h         | 88   | 110  | 65   | 394   | 0    | 0     | 253  | 445  | 441  | 66   | 1110  | 65   |
| Grp Sat Flow(s),veh/h/ln     | 1757 | 1845 | 1494 | 1820  | 0    | 0     | 1740 | 1736 | 1722 | 1740 | 1736  | 1529 |
| Q Serve(g_s), s              | 5.8  | 7.0  | 5.0  | 26.8  | 0.0  | 0.0   | 16.1 | 23.3 | 23.3 | 4.7  | 31.7  | 4.1  |
| Cycle Q Clear(g_c), s        | 5.8  | 7.0  | 5.0  | 26.8  | 0.0  | 0.0   | 16.1 | 23.3 | 23.3 | 4.7  | 31.7  | 4.1  |
| Prop In Lane                 | 1.00 |      | 1.00 | 0.34  |      | 0.08  | 1.00 |      | 0.31 | 1.00 |       | 1.00 |
| Lane Grp Cap(c), veh/h       | 202  | 212  | 172  | 408   | 0    | 0     | 425  | 796  | 789  | 84   | 880   | 388  |
| V/C Ratio(X)                 | 0.44 | 0.52 | 0.38 | 0.97  | 0.00 | 0.00  | 0.59 | 0.56 | 0.56 | 0.78 | 1.26  | 0.17 |
| Avail Cap(c_a), veh/h        | 436  | 457  | 371  | 408   | 0    | 0     | 425  | 796  | 789  | 209  | 880   | 388  |
| HCM Platoon Ratio            | 1.00 | 1.00 | 1.00 | 1.00  | 1.00 | 1.00  | 1.00 | 1.00 | 1.00 | 1.00 | 1.00  | 1.00 |
| Upstream Filter(I)           | 0.76 | 0.76 | 0.76 | 1.00  | 0.00 | 0.00  | 1.00 | 1.00 | 1.00 | 1.00 | 1.00  | 1.00 |
| Uniform Delay (d), s/veh     | 51.6 | 52.1 | 51.2 | 48.0  | 0.0  | 0.0   | 41.8 | 24.6 | 24.6 | 58.8 | 46.7  | 36.4 |
| Incr Delay (d2), s/veh       | 1.1  | 1.5  | 1.1  | 35.9  | 0.0  | 0.0   | 1.6  | 2.8  | 2.8  | 5.9  | 126.6 | 0.9  |
| Initial Q Delay(d3),s/veh    | 0.0  | 0.0  | 0.0  | 0.0   | 0.0  | 0.0   | 0.0  | 0.0  | 0.0  | 0.0  | 0.0   | 0.0  |
| %ile BackOfQ(50%),veh/ln     | 2.9  | 3.7  | 2.1  | 17.5  | 0.0  | 0.0   | 7.9  | 11.7 | 11.7 | 2.4  | 30.6  | 1.9  |
| LnGrp Delay(d),s/veh         | 52.7 | 53.6 | 52.3 | 83.9  | 0.0  | 0.0   | 43.3 | 27.5 | 27.5 | 64.7 | 173.2 | 37.3 |
| LnGrp LOS                    | D    | D    | D    | F     |      |       | D    | C    | C    | E    | F     | D    |
| Approach Vol, veh/h          |      | 263  |      |       | 394  |       |      | 1139 |      |      | 1241  |      |
| Approach Delay, s/veh        |      | 53.0 |      |       | 83.9 |       |      | 31.0 |      |      | 160.4 |      |
| Approach LOS                 |      | D    |      |       | F    |       |      | C    |      |      | F     |      |
| Timer                        | 1    | 2    | 3    | 4     | 5    | 6     | 7    | 8    |      |      |       |      |
| Assigned Phs                 | 1    | 2    |      | 4     | 5    | 6     |      | 8    |      |      |       |      |
| Phs Duration (G+Y+Rc), s     | 40.2 | 62.6 |      | 19.0  | 35.9 | 37.0  |      | 33.1 |      |      |       |      |
| Change Period (Y+Rc), s      | 4.2  | 5.3  |      | * 4.7 | 5.3  | * 5.3 |      | 5.1  |      |      |       |      |
| Max Green Setting (Gmax), s  | 15   | 31.7 |      | * 31  | 15.0 | * 32  |      | 28.0 |      |      |       |      |
| Max Q Clear Time (g_c+10), s | 15   | 25.3 |      | 9.0   | 18.1 | 33.7  |      | 28.8 |      |      |       |      |
| Green Ext Time (p_c), s      | 0.0  | 2.5  |      | 1.0   | 0.0  | 0.0   |      | 0.0  |      |      |       |      |
| <b>Intersection Summary</b>  |      |      |      |       |      |       |      |      |      |      |       |      |
| HCM 2010 Ctrl Delay          |      |      |      | 92.6  |      |       |      |      |      |      |       |      |
| HCM 2010 LOS                 |      |      |      | F     |      |       |      |      |      |      |       |      |
| <b>Notes</b>                 |      |      |      |       |      |       |      |      |      |      |       |      |

HCM 2010 Signalized Intersection Summary  
 49: Highway 1 SB On-Ramp & Highway 1 NB Off-Ramp/Monterey Road

Cumulative with Project, AM  
 06/11/2019



| Movement                     | EBL  | EBT  | EBR  | WBL   | WBT  | WBR   | NBL  | NBT   | NBR  | SBL  | SBT  | SBR  |
|------------------------------|------|------|------|-------|------|-------|------|-------|------|------|------|------|
| Lane Configurations          |      | ↕↕   | ↗    | ↖     |      | ↗     |      | ↕     | ↗    |      | ↕    |      |
| Traffic Volume (veh/h)       | 10   | 200  | 100  | 240   | 0    | 380   | 0    | 50    | 120  | 10   | 10   | 0    |
| Future Volume (veh/h)        | 10   | 200  | 100  | 240   | 0    | 380   | 0    | 50    | 120  | 10   | 10   | 0    |
| Number                       | 1    | 6    | 16   | 5     | 2    | 12    | 7    | 4     | 14   | 3    | 8    | 18   |
| Initial Q (Qb), veh          | 0    | 0    | 0    | 0     | 0    | 0     | 0    | 0     | 0    | 0    | 0    | 0    |
| Ped-Bike Adj(A_pbT)          | 1.00 |      | 1.00 | 1.00  |      | 1.00  | 1.00 |       | 1.00 | 1.00 |      | 1.00 |
| Parking Bus, Adj             | 1.00 | 1.00 | 1.00 | 1.00  | 1.00 | 1.00  | 1.00 | 1.00  | 1.00 | 1.00 | 1.00 | 1.00 |
| Adj Sat Flow, veh/h/ln       | 1900 | 1845 | 1845 | 1863  | 0    | 1863  | 0    | 1845  | 1845 | 1900 | 1900 | 0    |
| Adj Flow Rate, veh/h         | 10   | 206  | 9    | 247   | 0    | 253   | 0    | 52    | 21   | 10   | 10   | 0    |
| Adj No. of Lanes             | 0    | 2    | 1    | 1     | 0    | 1     | 0    | 1     | 1    | 0    | 1    | 0    |
| Peak Hour Factor             | 0.97 | 0.97 | 0.97 | 0.97  | 0.97 | 0.97  | 0.97 | 0.97  | 0.97 | 0.97 | 0.97 | 0.97 |
| Percent Heavy Veh, %         | 3    | 3    | 3    | 2     | 0    | 2     | 0    | 3     | 3    | 0    | 0    | 0    |
| Cap, veh/h                   | 136  | 2942 | 1343 | 0     | 0    | 0     | 0    | 122   | 104  | 74   | 60   | 0    |
| Arrive On Green              | 0.86 | 0.86 | 0.86 | 0.00  | 0.00 | 0.00  | 0.00 | 0.07  | 0.07 | 0.07 | 0.07 | 0.00 |
| Sat Flow, veh/h              | 159  | 3430 | 1566 |       |      |       | 0    | 1845  | 1568 | 466  | 899  | 0    |
| Grp Volume(v), veh/h         | 116  | 100  | 9    |       | 0.0  |       | 0    | 52    | 21   | 20   | 0    | 0    |
| Grp Sat Flow(s),veh/h/ln     | 1837 | 1752 | 1566 |       |      |       | 0    | 1845  | 1568 | 1365 | 0    | 0    |
| Q Serve(g_s), s              | 1.2  | 1.1  | 0.1  |       |      |       | 0.0  | 3.4   | 1.6  | 0.0  | 0.0  | 0.0  |
| Cycle Q Clear(g_c), s        | 1.2  | 1.1  | 0.1  |       |      |       | 0.0  | 3.4   | 1.6  | 3.4  | 0.0  | 0.0  |
| Prop In Lane                 | 0.09 |      | 1.00 |       |      |       | 0.00 |       | 1.00 | 0.50 |      | 0.00 |
| Lane Grp Cap(c), veh/h       | 1575 | 1503 | 1343 |       |      |       | 0    | 122   | 104  | 134  | 0    | 0    |
| V/C Ratio(X)                 | 0.07 | 0.07 | 0.01 |       |      |       | 0.00 | 0.43  | 0.20 | 0.15 | 0.00 | 0.00 |
| Avail Cap(c_a), veh/h        | 1575 | 1503 | 1343 |       |      |       | 0    | 148   | 125  | 155  | 0    | 0    |
| HCM Platoon Ratio            | 1.00 | 1.00 | 1.00 |       |      |       | 1.00 | 1.00  | 1.00 | 1.00 | 1.00 | 1.00 |
| Upstream Filter(I)           | 1.00 | 1.00 | 1.00 |       |      |       | 0.00 | 1.00  | 1.00 | 1.00 | 0.00 | 0.00 |
| Uniform Delay (d), s/veh     | 1.4  | 1.3  | 1.3  |       |      |       | 0.0  | 56.1  | 55.2 | 55.1 | 0.0  | 0.0  |
| Incr Delay (d2), s/veh       | 0.0  | 0.0  | 0.0  |       |      |       | 0.0  | 0.9   | 0.4  | 0.2  | 0.0  | 0.0  |
| Initial Q Delay(d3),s/veh    | 0.0  | 0.0  | 0.0  |       |      |       | 0.0  | 0.0   | 0.0  | 0.0  | 0.0  | 0.0  |
| %ile BackOfQ(50%),veh/ln     | 0.6  | 0.5  | 0.0  |       |      |       | 0.0  | 1.8   | 0.7  | 0.7  | 0.0  | 0.0  |
| LnGrp Delay(d),s/veh         | 1.4  | 1.3  | 1.3  |       |      |       | 0.0  | 56.9  | 55.6 | 55.3 | 0.0  | 0.0  |
| LnGrp LOS                    | A    | A    | A    |       |      |       |      | E     | E    | E    |      |      |
| Approach Vol, veh/h          |      | 225  |      |       |      |       |      | 73    |      |      | 20   |      |
| Approach Delay, s/veh        |      | 1.4  |      |       |      |       |      | 56.5  |      |      | 55.3 |      |
| Approach LOS                 |      | A    |      |       |      |       |      | E     |      |      | E    |      |
| Timer                        | 1    | 2    | 3    | 4     | 5    | 6     | 7    | 8     |      |      |      |      |
| Assigned Phs                 |      |      |      | 4     |      | 6     |      | 8     |      |      |      |      |
| Phs Duration (G+Y+Rc), s     |      |      |      | 12.5  |      | 112.5 |      | 12.5  |      |      |      |      |
| Change Period (Y+Rc), s      |      |      |      | * 4.2 |      | 5.3   |      | * 4.2 |      |      |      |      |
| Max Green Setting (Gmax), s  |      |      |      | * 10  |      | 21.0  |      | * 10  |      |      |      |      |
| Max Q Clear Time (g_c+I1), s |      |      |      | 5.4   |      | 3.2   |      | 5.4   |      |      |      |      |
| Green Ext Time (p_c), s      |      |      |      | 0.1   |      | 0.7   |      | 0.0   |      |      |      |      |
| <b>Intersection Summary</b>  |      |      |      |       |      |       |      |       |      |      |      |      |
| HCM 2010 Ctrl Delay          |      |      | 17.4 |       |      |       |      |       |      |      |      |      |
| HCM 2010 LOS                 |      |      | B    |       |      |       |      |       |      |      |      |      |
| <b>Notes</b>                 |      |      |      |       |      |       |      |       |      |      |      |      |

HCM 2010 Signalized Intersection Summary  
 50: Reservation Road & SR 68 WB On Ramp/SR 68 WB Off Ramp

Cumulative with Project, AM  
 06/11/2019



| Movement                    | EBL  | EBT  | EBR | WBL  | WBT  | WBR  | NBL  | NBT  | NBR  | SBL  | SBT  | SBR  |
|-----------------------------|------|------|-----|------|------|------|------|------|------|------|------|------|
| Lane Configurations         |      |      |     |      | ↕    | ↕    | ↕    | ↕    |      |      | ↕    |      |
| Traffic Volume (veh/h)      | 0    | 0    | 0   | 260  | 10   | 310  | 120  | 400  | 0    | 0    | 350  | 130  |
| Future Volume (veh/h)       | 0    | 0    | 0   | 260  | 10   | 310  | 120  | 400  | 0    | 0    | 350  | 130  |
| Number                      |      |      |     | 7    | 4    | 14   | 1    | 6    | 16   | 5    | 2    | 12   |
| Initial Q (Qb), veh         |      |      |     | 0    | 0    | 0    | 0    | 0    | 0    | 0    | 0    | 0    |
| Ped-Bike Adj(A_pbT)         |      |      |     | 1.00 |      | 1.00 | 1.00 |      | 1.00 | 1.00 |      | 1.00 |
| Parking Bus, Adj            |      |      |     | 1.00 | 1.00 | 1.00 | 1.00 | 1.00 | 1.00 | 1.00 | 1.00 | 1.00 |
| Adj Sat Flow, veh/h/ln      |      |      |     | 1900 | 1827 | 1827 | 1863 | 1863 | 0    | 0    | 1827 | 1900 |
| Adj Flow Rate, veh/h        |      |      |     | 274  | 11   | 74   | 126  | 421  | 0    | 0    | 368  | 128  |
| Adj No. of Lanes            |      |      |     | 0    | 1    | 1    | 1    | 1    | 0    | 0    | 1    | 0    |
| Peak Hour Factor            |      |      |     | 0.95 | 0.95 | 0.95 | 0.95 | 0.95 | 0.95 | 0.95 | 0.95 | 0.95 |
| Percent Heavy Veh, %        |      |      |     | 4    | 4    | 4    | 2    | 2    | 0    | 0    | 4    | 4    |
| Cap, veh/h                  |      |      |     | 387  | 16   | 359  | 209  | 1014 | 0    | 0    | 459  | 160  |
| Arrive On Green             |      |      |     | 0.23 | 0.23 | 0.23 | 0.12 | 0.54 | 0.00 | 0.00 | 0.35 | 0.35 |
| Sat Flow, veh/h             |      |      |     | 1676 | 67   | 1553 | 1774 | 1863 | 0    | 0    | 1296 | 451  |
| Grp Volume(v), veh/h        |      |      |     | 285  | 0    | 74   | 126  | 421  | 0    | 0    | 0    | 496  |
| Grp Sat Flow(s),veh/h/ln    |      |      |     | 1743 | 0    | 1553 | 1774 | 1863 | 0    | 0    | 0    | 1747 |
| Q Serve(g_s), s             |      |      |     | 7.3  | 0.0  | 1.9  | 3.3  | 6.5  | 0.0  | 0.0  | 0.0  | 12.4 |
| Cycle Q Clear(g_c), s       |      |      |     | 7.3  | 0.0  | 1.9  | 3.3  | 6.5  | 0.0  | 0.0  | 0.0  | 12.4 |
| Prop In Lane                |      |      |     | 0.96 |      | 1.00 | 1.00 |      | 0.00 | 0.00 |      | 0.26 |
| Lane Grp Cap(c), veh/h      |      |      |     | 403  | 0    | 359  | 209  | 1014 | 0    | 0    | 0    | 619  |
| V/C Ratio(X)                |      |      |     | 0.71 | 0.00 | 0.21 | 0.60 | 0.42 | 0.00 | 0.00 | 0.00 | 0.80 |
| Avail Cap(c_a), veh/h       |      |      |     | 1438 | 0    | 1281 | 952  | 1460 | 0    | 0    | 0    | 1370 |
| HCM Platoon Ratio           |      |      |     | 1.00 | 1.00 | 1.00 | 1.00 | 1.00 | 1.00 | 1.00 | 1.00 | 1.00 |
| Upstream Filter(I)          |      |      |     | 1.00 | 0.00 | 1.00 | 1.00 | 1.00 | 0.00 | 0.00 | 0.00 | 1.00 |
| Uniform Delay (d), s/veh    |      |      |     | 17.1 | 0.0  | 15.1 | 20.3 | 6.5  | 0.0  | 0.0  | 0.0  | 14.1 |
| Incr Delay (d2), s/veh      |      |      |     | 2.3  | 0.0  | 0.3  | 1.0  | 0.3  | 0.0  | 0.0  | 0.0  | 2.5  |
| Initial Q Delay(d3),s/veh   |      |      |     | 0.0  | 0.0  | 0.0  | 0.0  | 0.0  | 0.0  | 0.0  | 0.0  | 0.0  |
| %ile BackOfQ(50%),veh/ln    |      |      |     | 3.7  | 0.0  | 0.8  | 1.6  | 3.4  | 0.0  | 0.0  | 0.0  | 6.3  |
| LnGrp Delay(d),s/veh        |      |      |     | 19.4 | 0.0  | 15.3 | 21.3 | 6.8  | 0.0  | 0.0  | 0.0  | 16.6 |
| LnGrp LOS                   |      |      |     | B    |      | B    | C    | A    |      |      |      | B    |
| Approach Vol, veh/h         |      |      |     |      | 359  |      |      | 547  |      |      | 496  |      |
| Approach Delay, s/veh       |      |      |     |      | 18.6 |      |      | 10.1 |      |      | 16.6 |      |
| Approach LOS                |      |      |     |      | B    |      |      | B    |      |      | B    |      |
| Timer                       | 1    | 2    | 3   | 4    | 5    | 6    | 7    | 8    |      |      |      |      |
| Assigned Phs                | 1    | 2    |     | 4    |      | 6    |      |      |      |      |      |      |
| Phs Duration (G+Y+Rc), s    | 9.2  | 23.2 |     | 16.1 |      | 32.4 |      |      |      |      |      |      |
| Change Period (Y+Rc), s     | 3.5  | 6.0  |     | 4.9  |      | 6.0  |      |      |      |      |      |      |
| Max Green Setting (Gmax)    | 26.0 | 38.0 |     | 40.0 |      | 38.0 |      |      |      |      |      |      |
| Max Q Clear Time (g_c+1)    | 15.3 | 14.4 |     | 9.3  |      | 8.5  |      |      |      |      |      |      |
| Green Ext Time (p_c), s     | 0.1  | 2.8  |     | 2.0  |      | 2.2  |      |      |      |      |      |      |
| <b>Intersection Summary</b> |      |      |     |      |      |      |      |      |      |      |      |      |
| HCM 2010 Ctrl Delay         |      |      |     | 14.6 |      |      |      |      |      |      |      |      |
| HCM 2010 LOS                |      |      |     | B    |      |      |      |      |      |      |      |      |



| Movement                     | EBL  | EBT  | EBR  | WBL | WBT  | WBR  | NBL  | NBT  | NBR  | SBL  | SBT  | SBR  |
|------------------------------|------|------|------|-----|------|------|------|------|------|------|------|------|
| Lane Configurations          |      | ↕    | ↗    |     |      |      |      | ↑    | ↗    | ↘    | ↑    |      |
| Traffic Volume (veh/h)       | 130  | 10   | 110  | 0   | 0    | 0    | 0    | 390  | 660  | 230  | 370  | 0    |
| Future Volume (veh/h)        | 130  | 10   | 110  | 0   | 0    | 0    | 0    | 390  | 660  | 230  | 370  | 0    |
| Number                       | 3    | 8    | 18   |     |      |      | 1    | 6    | 16   | 5    | 2    | 12   |
| Initial Q (Qb), veh          | 0    | 0    | 0    |     |      |      | 0    | 0    | 0    | 0    | 0    | 0    |
| Ped-Bike Adj(A_pbT)          | 1.00 |      | 1.00 |     |      |      | 1.00 |      | 1.00 | 1.00 |      | 1.00 |
| Parking Bus, Adj             | 1.00 | 1.00 | 1.00 |     |      |      | 1.00 | 1.00 | 1.00 | 1.00 | 1.00 | 1.00 |
| Adj Sat Flow, veh/h/ln       | 1900 | 1881 | 1881 |     |      |      | 0    | 1881 | 1881 | 1827 | 1827 | 0    |
| Adj Flow Rate, veh/h         | 141  | 11   | 19   |     |      |      | 0    | 424  | 388  | 250  | 402  | 0    |
| Adj No. of Lanes             | 0    | 1    | 1    |     |      |      | 0    | 1    | 1    | 1    | 1    | 0    |
| Peak Hour Factor             | 0.92 | 0.92 | 0.92 |     |      |      | 0.92 | 0.92 | 0.92 | 0.92 | 0.92 | 0.92 |
| Percent Heavy Veh, %         | 1    | 1    | 1    |     |      |      | 0    | 1    | 1    | 4    | 4    | 0    |
| Cap, veh/h                   | 205  | 16   | 196  |     |      |      | 0    | 647  | 550  | 326  | 1130 | 0    |
| Arrive On Green              | 0.12 | 0.12 | 0.12 |     |      |      | 0.00 | 0.34 | 0.34 | 0.19 | 0.62 | 0.00 |
| Sat Flow, veh/h              | 1668 | 130  | 1599 |     |      |      | 0    | 1881 | 1599 | 1740 | 1827 | 0    |
| Grp Volume(v), veh/h         | 152  | 0    | 19   |     |      |      | 0    | 424  | 388  | 250  | 402  | 0    |
| Grp Sat Flow(s),veh/h/ln     | 1798 | 0    | 1599 |     |      |      | 0    | 1881 | 1599 | 1740 | 1827 | 0    |
| Q Serve(g_s), s              | 3.4  | 0.0  | 0.4  |     |      |      | 0.0  | 8.1  | 8.9  | 5.8  | 4.5  | 0.0  |
| Cycle Q Clear(g_c), s        | 3.4  | 0.0  | 0.4  |     |      |      | 0.0  | 8.1  | 8.9  | 5.8  | 4.5  | 0.0  |
| Prop In Lane                 | 0.93 |      | 1.00 |     |      |      | 0.00 |      | 1.00 | 1.00 |      | 0.00 |
| Lane Grp Cap(c), veh/h       | 221  | 0    | 196  |     |      |      | 0    | 647  | 550  | 326  | 1130 | 0    |
| V/C Ratio(X)                 | 0.69 | 0.00 | 0.10 |     |      |      | 0.00 | 0.66 | 0.71 | 0.77 | 0.36 | 0.00 |
| Avail Cap(c_a), veh/h        | 1705 | 0    | 1517 |     |      |      | 0    | 1650 | 1403 | 990  | 1603 | 0    |
| HCM Platoon Ratio            | 1.00 | 1.00 | 1.00 |     |      |      | 1.00 | 1.00 | 1.00 | 1.00 | 1.00 | 1.00 |
| Upstream Filter(I)           | 1.00 | 0.00 | 1.00 |     |      |      | 0.00 | 1.00 | 1.00 | 1.00 | 1.00 | 0.00 |
| Uniform Delay (d), s/veh     | 17.7 | 0.0  | 16.4 |     |      |      | 0.0  | 11.7 | 12.0 | 16.3 | 3.9  | 0.0  |
| Incr Delay (d2), s/veh       | 1.4  | 0.0  | 0.1  |     |      |      | 0.0  | 1.1  | 1.7  | 3.8  | 0.2  | 0.0  |
| Initial Q Delay(d3),s/veh    | 0.0  | 0.0  | 0.0  |     |      |      | 0.0  | 0.0  | 0.0  | 0.0  | 0.0  | 0.0  |
| %ile BackOfQ(50%),veh/ln     | 1.8  | 0.0  | 0.2  |     |      |      | 0.0  | 4.3  | 4.1  | 3.1  | 2.3  | 0.0  |
| LnGrp Delay(d),s/veh         | 19.2 | 0.0  | 16.5 |     |      |      | 0.0  | 12.9 | 13.7 | 20.1 | 4.1  | 0.0  |
| LnGrp LOS                    | B    |      | B    |     |      |      |      | B    | B    | C    | A    |      |
| Approach Vol, veh/h          |      | 171  |      |     |      |      |      | 812  |      |      | 652  |      |
| Approach Delay, s/veh        |      | 18.9 |      |     |      |      |      | 13.2 |      |      | 10.2 |      |
| Approach LOS                 |      | B    |      |     |      |      |      | B    |      |      | B    |      |
| Timer                        | 1    | 2    | 3    | 4   | 5    | 6    | 7    | 8    |      |      |      |      |
| Assigned Phs                 |      | 2    |      |     | 5    | 6    |      | 8    |      |      |      |      |
| Phs Duration (G+Y+Rc), s     |      | 32.1 |      |     | 11.6 | 20.5 |      | 10.1 |      |      |      |      |
| Change Period (Y+Rc), s      |      | 6.0  |      |     | 3.7  | 6.0  |      | 4.9  |      |      |      |      |
| Max Green Setting (Gmax), s  |      | 37.0 |      |     | 24.0 | 37.0 |      | 40.0 |      |      |      |      |
| Max Q Clear Time (g_c+I1), s |      | 6.5  |      |     | 7.8  | 10.9 |      | 5.4  |      |      |      |      |
| Green Ext Time (p_c), s      |      | 2.2  |      |     | 0.6  | 3.6  |      | 0.6  |      |      |      |      |
| <b>Intersection Summary</b>  |      |      |      |     |      |      |      |      |      |      |      |      |
| HCM 2010 Ctrl Delay          |      |      | 12.6 |     |      |      |      |      |      |      |      |      |
| HCM 2010 LOS                 |      |      | B    |     |      |      |      |      |      |      |      |      |

HCM 2010 Signalized Intersection Summary  
 1: Del Monte Boulevard & Reindollar Avenue

Cumulative with Project, PM  
 06/11/2019

| Movement                     | EBL  | EBT  | EBR | WBL  | WBT  | WBR  | NBL  | NBT   | NBR  | SBL  | SBT  | SBR  |
|------------------------------|------|------|-----|------|------|------|------|-------|------|------|------|------|
| Lane Configurations          |      |      |     |      |      |      |      |       |      |      |      |      |
| Traffic Volume (veh/h)       | 0    | 0    | 0   | 190  | 0    | 450  | 10   | 1330  | 340  | 400  | 850  | 0    |
| Future Volume (veh/h)        | 0    | 0    | 0   | 190  | 0    | 450  | 10   | 1330  | 340  | 400  | 850  | 0    |
| Number                       |      |      |     | 3    | 8    | 18   | 1    | 6     | 16   | 5    | 2    | 12   |
| Initial Q (Qb), veh          |      |      |     | 0    | 0    | 0    | 0    | 0     | 0    | 0    | 0    | 0    |
| Ped-Bike Adj(A_pbT)          |      |      |     | 1.00 |      | 0.99 | 1.00 |       | 1.00 | 1.00 |      | 1.00 |
| Parking Bus, Adj             |      |      |     | 1.00 | 1.00 | 1.00 | 1.00 | 1.00  | 1.00 | 1.00 | 1.00 | 1.00 |
| Adj Sat Flow, veh/h/ln       |      |      |     | 1881 | 1881 | 1900 | 1881 | 1881  | 1881 | 1881 | 1881 | 0    |
| Adj Flow Rate, veh/h         |      |      |     | 198  | 0    | 397  | 10   | 1385  | 271  | 417  | 885  | 0    |
| Adj No. of Lanes             |      |      |     | 1    | 1    | 0    | 1    | 2     | 1    | 1    | 2    | 0    |
| Peak Hour Factor             |      |      |     | 0.96 | 0.96 | 0.96 | 0.96 | 0.96  | 0.96 | 0.96 | 0.96 | 0.96 |
| Percent Heavy Veh, %         |      |      |     | 1    | 1    | 1    | 1    | 1     | 1    | 1    | 1    | 0    |
| Cap, veh/h                   |      |      |     | 501  | 0    | 444  | 22   | 1145  | 512  | 458  | 2015 | 0    |
| Arrive On Green              |      |      |     | 0.28 | 0.00 | 0.28 | 0.01 | 0.32  | 0.32 | 0.26 | 0.56 | 0.00 |
| Sat Flow, veh/h              |      |      |     | 1792 | 0    | 1585 | 1792 | 3574  | 1599 | 1792 | 3668 | 0    |
| Grp Volume(v), veh/h         |      |      |     | 198  | 0    | 397  | 10   | 1385  | 271  | 417  | 885  | 0    |
| Grp Sat Flow(s),veh/h/ln     |      |      |     | 1792 | 0    | 1585 | 1792 | 1787  | 1599 | 1792 | 1787 | 0    |
| Q Serve(g_s), s              |      |      |     | 8.4  | 0.0  | 22.5 | 0.5  | 30.0  | 13.0 | 21.1 | 13.4 | 0.0  |
| Cycle Q Clear(g_c), s        |      |      |     | 8.4  | 0.0  | 22.5 | 0.5  | 30.0  | 13.0 | 21.1 | 13.4 | 0.0  |
| Prop In Lane                 |      |      |     | 1.00 |      | 1.00 | 1.00 |       | 1.00 | 1.00 |      | 0.00 |
| Lane Grp Cap(c), veh/h       |      |      |     | 501  | 0    | 444  | 22   | 1145  | 512  | 458  | 2015 | 0    |
| V/C Ratio(X)                 |      |      |     | 0.39 | 0.00 | 0.89 | 0.46 | 1.21  | 0.53 | 0.91 | 0.44 | 0.00 |
| Avail Cap(c_a), veh/h        |      |      |     | 574  | 0    | 508  | 574  | 1145  | 512  | 574  | 2015 | 0    |
| HCM Platoon Ratio            |      |      |     | 1.00 | 1.00 | 1.00 | 1.00 | 1.00  | 1.00 | 1.00 | 1.00 | 1.00 |
| Upstream Filter(l)           |      |      |     | 1.00 | 0.00 | 1.00 | 1.00 | 1.00  | 1.00 | 1.00 | 1.00 | 0.00 |
| Uniform Delay (d), s/veh     |      |      |     | 27.3 | 0.0  | 32.4 | 45.9 | 31.8  | 26.0 | 33.8 | 11.8 | 0.0  |
| Incr Delay (d2), s/veh       |      |      |     | 0.5  | 0.0  | 16.8 | 14.1 | 102.7 | 1.0  | 16.2 | 0.2  | 0.0  |
| Initial Q Delay(d3),s/veh    |      |      |     | 0.0  | 0.0  | 0.0  | 0.0  | 0.0   | 0.0  | 0.0  | 0.0  | 0.0  |
| %ile BackOfQ(50%),veh/ln     |      |      |     | 4.2  | 0.0  | 11.9 | 0.3  | 31.0  | 5.9  | 12.5 | 6.7  | 0.0  |
| LnGrp Delay(d),s/veh         |      |      |     | 27.8 | 0.0  | 49.2 | 60.0 | 134.5 | 27.1 | 50.0 | 12.0 | 0.0  |
| LnGrp LOS                    |      |      |     | C    |      | D    | E    | F     | C    | D    | B    |      |
| Approach Vol, veh/h          |      |      |     |      | 595  |      |      | 1666  |      |      | 1302 |      |
| Approach Delay, s/veh        |      |      |     |      | 42.1 |      |      | 116.6 |      |      | 24.2 |      |
| Approach LOS                 |      |      |     |      | D    |      |      | F     |      |      | C    |      |
| Timer                        | 1    | 2    | 3   | 4    | 5    | 6    | 7    | 8     |      |      |      |      |
| Assigned Phs                 | 1    | 2    |     |      | 5    | 6    |      | 8     |      |      |      |      |
| Phs Duration (G+Y+Rc), s     | 4.6  | 57.8 |     |      | 27.5 | 35.0 |      | 31.2  |      |      |      |      |
| Change Period (Y+Rc), s      | 3.5  | 5.0  |     |      | 3.5  | 5.0  |      | 5.0   |      |      |      |      |
| Max Green Setting (Gmax), s  | 30.0 | 30.0 |     |      | 30.0 | 30.0 |      | 30.0  |      |      |      |      |
| Max Q Clear Time (g_c+I1), s | 2.5  | 15.4 |     |      | 23.1 | 32.0 |      | 24.5  |      |      |      |      |
| Green Ext Time (p_c), s      | 0.0  | 5.4  |     |      | 0.8  | 0.0  |      | 1.7   |      |      |      |      |
| <b>Intersection Summary</b>  |      |      |     |      |      |      |      |       |      |      |      |      |
| HCM 2010 Ctrl Delay          |      |      |     | 70.4 |      |      |      |       |      |      |      |      |
| HCM 2010 LOS                 |      |      |     | E    |      |      |      |       |      |      |      |      |
| <b>Notes</b>                 |      |      |     |      |      |      |      |       |      |      |      |      |

HCM 2010 Signalized Intersection Summary  
 2: 2nd Avenue & Patton Parkway

Cumulative with Project, PM  
 06/11/2019



| Movement                     | EBL  | EBT  | EBR  | WBL  | WBT  | WBR  | NBL  | NBT  | NBR  | SBL  | SBT  | SBR  |
|------------------------------|------|------|------|------|------|------|------|------|------|------|------|------|
| Lane Configurations          |      |      |      |      |      |      |      |      |      |      |      |      |
| Traffic Volume (veh/h)       | 50   | 50   | 60   | 90   | 80   | 80   | 70   | 240  | 90   | 80   | 200  | 50   |
| Future Volume (veh/h)        | 50   | 50   | 60   | 90   | 80   | 80   | 70   | 240  | 90   | 80   | 200  | 50   |
| Number                       | 7    | 4    | 14   | 3    | 8    | 18   | 5    | 2    | 12   | 1    | 6    | 16   |
| Initial Q (Qb), veh          | 0    | 0    | 0    | 0    | 0    | 0    | 0    | 0    | 0    | 0    | 0    | 0    |
| Ped-Bike Adj(A_pbT)          | 1.00 |      | 1.00 | 1.00 |      | 1.00 | 1.00 |      | 1.00 | 1.00 |      | 1.00 |
| Parking Bus, Adj             | 1.00 | 1.00 | 1.00 | 1.00 | 1.00 | 1.00 | 1.00 | 1.00 | 1.00 | 1.00 | 1.00 | 1.00 |
| Adj Sat Flow, veh/h/ln       | 1863 | 1863 | 1900 | 1863 | 1863 | 1900 | 1863 | 1863 | 1900 | 1863 | 1863 | 1900 |
| Adj Flow Rate, veh/h         | 54   | 54   | 65   | 98   | 87   | 87   | 76   | 261  | 98   | 87   | 217  | 54   |
| Adj No. of Lanes             | 1    | 1    | 0    | 1    | 1    | 0    | 1    | 1    | 0    | 1    | 1    | 0    |
| Peak Hour Factor             | 0.92 | 0.92 | 0.92 | 0.92 | 0.92 | 0.92 | 0.92 | 0.92 | 0.92 | 0.92 | 0.92 | 0.92 |
| Percent Heavy Veh, %         | 2    | 2    | 2    | 2    | 2    | 2    | 2    | 2    | 2    | 2    | 2    | 2    |
| Cap, veh/h                   | 96   | 163  | 196  | 137  | 201  | 201  | 119  | 356  | 134  | 128  | 405  | 101  |
| Arrive On Green              | 0.05 | 0.21 | 0.21 | 0.08 | 0.23 | 0.23 | 0.07 | 0.28 | 0.28 | 0.07 | 0.28 | 0.28 |
| Sat Flow, veh/h              | 1774 | 771  | 928  | 1774 | 856  | 856  | 1774 | 1292 | 485  | 1774 | 1441 | 359  |
| Grp Volume(v), veh/h         | 54   | 0    | 119  | 98   | 0    | 174  | 76   | 0    | 359  | 87   | 0    | 271  |
| Grp Sat Flow(s),veh/h/ln     | 1774 | 0    | 1699 | 1774 | 0    | 1712 | 1774 | 0    | 1777 | 1774 | 0    | 1799 |
| Q Serve(g_s), s              | 1.4  | 0.0  | 2.8  | 2.5  | 0.0  | 4.0  | 2.0  | 0.0  | 8.6  | 2.2  | 0.0  | 6.0  |
| Cycle Q Clear(g_c), s        | 1.4  | 0.0  | 2.8  | 2.5  | 0.0  | 4.0  | 2.0  | 0.0  | 8.6  | 2.2  | 0.0  | 6.0  |
| Prop In Lane                 | 1.00 |      | 0.55 | 1.00 |      | 0.50 | 1.00 |      | 0.27 | 1.00 |      | 0.20 |
| Lane Grp Cap(c), veh/h       | 96   | 0    | 359  | 137  | 0    | 402  | 119  | 0    | 490  | 128  | 0    | 505  |
| V/C Ratio(X)                 | 0.56 | 0.00 | 0.33 | 0.72 | 0.00 | 0.43 | 0.64 | 0.00 | 0.73 | 0.68 | 0.00 | 0.54 |
| Avail Cap(c_a), veh/h        | 228  | 0    | 1290 | 228  | 0    | 1300 | 228  | 0    | 1349 | 228  | 0    | 1366 |
| HCM Platoon Ratio            | 1.00 | 1.00 | 1.00 | 1.00 | 1.00 | 1.00 | 1.00 | 1.00 | 1.00 | 1.00 | 1.00 | 1.00 |
| Upstream Filter(I)           | 1.00 | 0.00 | 1.00 | 1.00 | 0.00 | 1.00 | 1.00 | 0.00 | 1.00 | 1.00 | 0.00 | 1.00 |
| Uniform Delay (d), s/veh     | 21.6 | 0.0  | 15.6 | 21.1 | 0.0  | 15.2 | 21.3 | 0.0  | 15.4 | 21.2 | 0.0  | 14.2 |
| Incr Delay (d2), s/veh       | 5.1  | 0.0  | 0.5  | 6.9  | 0.0  | 0.7  | 5.6  | 0.0  | 2.1  | 6.1  | 0.0  | 0.9  |
| Initial Q Delay(d3),s/veh    | 0.0  | 0.0  | 0.0  | 0.0  | 0.0  | 0.0  | 0.0  | 0.0  | 0.0  | 0.0  | 0.0  | 0.0  |
| %ile BackOfQ(50%),veh/ln     | 0.8  | 0.0  | 1.3  | 1.5  | 0.0  | 2.0  | 1.1  | 0.0  | 4.5  | 1.3  | 0.0  | 3.1  |
| LnGrp Delay(d),s/veh         | 26.7 | 0.0  | 16.2 | 27.9 | 0.0  | 16.0 | 26.8 | 0.0  | 17.5 | 27.3 | 0.0  | 15.1 |
| LnGrp LOS                    | C    |      | B    | C    |      | B    | C    |      | B    | C    |      | B    |
| Approach Vol, veh/h          |      | 173  |      |      | 272  |      |      | 435  |      |      | 358  |      |
| Approach Delay, s/veh        |      | 19.5 |      |      | 20.3 |      |      | 19.1 |      |      | 18.1 |      |
| Approach LOS                 |      | B    |      |      | C    |      |      | B    |      |      | B    |      |
| Timer                        | 1    | 2    | 3    | 4    | 5    | 6    | 7    | 8    |      |      |      |      |
| Assigned Phs                 | 1    | 2    | 3    | 4    | 5    | 6    | 7    | 8    |      |      |      |      |
| Phs Duration (G+Y+Rc), s     | 7.4  | 17.4 | 7.6  | 14.4 | 7.1  | 17.6 | 6.5  | 15.5 |      |      |      |      |
| Change Period (Y+Rc), s      | 4.0  | 4.5  | 4.0  | 4.5  | 4.0  | 4.5  | 4.0  | 4.5  |      |      |      |      |
| Max Green Setting (Gmax), s  | 35.5 | 35.5 | 6.0  | 35.5 | 6.0  | 35.5 | 6.0  | 35.5 |      |      |      |      |
| Max Q Clear Time (g_c+14), s | 10.6 | 10.6 | 4.5  | 4.8  | 4.0  | 8.0  | 3.4  | 6.0  |      |      |      |      |
| Green Ext Time (p_c), s      | 0.0  | 2.3  | 0.0  | 0.7  | 0.0  | 1.7  | 0.0  | 1.1  |      |      |      |      |
| <b>Intersection Summary</b>  |      |      |      |      |      |      |      |      |      |      |      |      |
| HCM 2010 Ctrl Delay          |      |      | 19.1 |      |      |      |      |      |      |      |      |      |
| HCM 2010 LOS                 |      |      | B    |      |      |      |      |      |      |      |      |      |

HCM 2010 Signalized Intersection Summary  
 3: SR 1 SB On-Ramp/SR 1 SB Off-Ramp & Imjin Parkway

Cumulative with Project, PM  
 06/11/2019



| Movement                     | EBL | EBT | EBR | WBL   | WBT   | WBR  | NBL | NBT | NBR | SBL   | SBT   | SBR  |
|------------------------------|-----|-----|-----|-------|-------|------|-----|-----|-----|-------|-------|------|
| Lane Configurations          |     |     |     |       | ↕     |      |     |     |     |       | ↕     |      |
| Traffic Volume (veh/h)       | 0   | 0   | 0   | 1240  | 0     | 0    | 0   | 0   | 0   | 660   | 10    | 0    |
| Future Volume (veh/h)        | 0   | 0   | 0   | 1240  | 0     | 0    | 0   | 0   | 0   | 660   | 10    | 0    |
| Number                       |     |     |     | 1     | 6     | 16   |     |     |     | 7     | 4     | 14   |
| Initial Q (Qb), veh          |     |     |     | 0     | 0     | 0    |     |     |     | 0     | 0     | 0    |
| Ped-Bike Adj(A_pbT)          |     |     |     | 1.00  |       | 1.00 |     |     |     | 1.00  |       | 1.00 |
| Parking Bus, Adj             |     |     |     | 1.00  | 1.00  | 1.00 |     |     |     | 1.00  | 1.00  | 1.00 |
| Adj Sat Flow, veh/h/ln       |     |     |     | 1900  | 1881  | 0    |     |     |     | 1900  | 1863  | 0    |
| Adj Flow Rate, veh/h         |     |     |     | 1363  | 0     | 0    |     |     |     | 725   | 11    | 0    |
| Adj No. of Lanes             |     |     |     | 0     | 1     | 0    |     |     |     | 0     | 1     | 0    |
| Peak Hour Factor             |     |     |     | 0.91  | 0.91  | 0.91 |     |     |     | 0.91  | 0.91  | 0.91 |
| Percent Heavy Veh, %         |     |     |     | 1     | 1     | 0    |     |     |     | 2     | 2     | 0    |
| Cap, veh/h                   |     |     |     | 1015  | 0     | 0    |     |     |     | 661   | 10    | 0    |
| Arrive On Green              |     |     |     | 0.57  | 0.00  | 0.00 |     |     |     | 0.38  | 0.38  | 0.00 |
| Sat Flow, veh/h              |     |     |     | 1792  | 0     | 0    |     |     |     | 1749  | 27    | 0    |
| Grp Volume(v), veh/h         |     |     |     | 1363  | 0     | 0    |     |     |     | 736   | 0     | 0    |
| Grp Sat Flow(s),veh/h/ln     |     |     |     | 1792  | 0     | 0    |     |     |     | 1775  | 0     | 0    |
| Q Serve(g_s), s              |     |     |     | 90.0  | 0.0   | 0.0  |     |     |     | 60.0  | 0.0   | 0.0  |
| Cycle Q Clear(g_c), s        |     |     |     | 90.0  | 0.0   | 0.0  |     |     |     | 60.0  | 0.0   | 0.0  |
| Prop In Lane                 |     |     |     | 1.00  |       | 0.00 |     |     |     | 0.99  |       | 0.00 |
| Lane Grp Cap(c), veh/h       |     |     |     | 1015  | 0     | 0    |     |     |     | 671   | 0     | 0    |
| V/C Ratio(X)                 |     |     |     | 1.34  | 0.00  | 0.00 |     |     |     | 1.10  | 0.00  | 0.00 |
| Avail Cap(c_a), veh/h        |     |     |     | 1015  | 0     | 0    |     |     |     | 671   | 0     | 0    |
| HCM Platoon Ratio            |     |     |     | 1.00  | 1.00  | 1.00 |     |     |     | 1.00  | 1.00  | 1.00 |
| Upstream Filter(I)           |     |     |     | 1.00  | 0.00  | 0.00 |     |     |     | 1.00  | 0.00  | 0.00 |
| Uniform Delay (d), s/veh     |     |     |     | 34.4  | 0.0   | 0.0  |     |     |     | 49.4  | 0.0   | 0.0  |
| Incr Delay (d2), s/veh       |     |     |     | 160.7 | 0.0   | 0.0  |     |     |     | 64.4  | 0.0   | 0.0  |
| Initial Q Delay(d3),s/veh    |     |     |     | 0.0   | 0.0   | 0.0  |     |     |     | 0.0   | 0.0   | 0.0  |
| %ile BackOfQ(50%),veh/ln     |     |     |     | 89.6  | 0.0   | 0.0  |     |     |     | 41.2  | 0.0   | 0.0  |
| LnGrp Delay(d),s/veh         |     |     |     | 195.1 | 0.0   | 0.0  |     |     |     | 113.8 | 0.0   | 0.0  |
| LnGrp LOS                    |     |     |     | F     |       |      |     |     |     | F     |       |      |
| Approach Vol, veh/h          |     |     |     |       | 1363  |      |     |     |     |       | 736   |      |
| Approach Delay, s/veh        |     |     |     |       | 195.1 |      |     |     |     |       | 113.8 |      |
| Approach LOS                 |     |     |     |       | F     |      |     |     |     |       | F     |      |
| Timer                        | 1   | 2   | 3   | 4     | 5     | 6    | 7   | 8   |     |       |       |      |
| Assigned Phs                 |     |     |     | 4     |       | 6    |     |     |     |       |       |      |
| Phs Duration (G+Y+Rc), s     |     |     |     | 64.4  |       | 94.4 |     |     |     |       |       |      |
| Change Period (Y+Rc), s      |     |     |     | 4.4   |       | 4.4  |     |     |     |       |       |      |
| Max Green Setting (Gmax), s  |     |     |     | 60.0  |       | 90.0 |     |     |     |       |       |      |
| Max Q Clear Time (g_c+I1), s |     |     |     | 62.0  |       | 92.0 |     |     |     |       |       |      |
| Green Ext Time (p_c), s      |     |     |     | 0.0   |       | 0.0  |     |     |     |       |       |      |
| <b>Intersection Summary</b>  |     |     |     |       |       |      |     |     |     |       |       |      |
| HCM 2010 Ctrl Delay          |     |     |     | 166.6 |       |      |     |     |     |       |       |      |
| HCM 2010 LOS                 |     |     |     | F     |       |      |     |     |     |       |       |      |

| Intersection             |      |      |      |      |      |      |      |      |      |      |       |      |
|--------------------------|------|------|------|------|------|------|------|------|------|------|-------|------|
| Int Delay, s/veh         | 1    |      |      |      |      |      |      |      |      |      |       |      |
| Movement                 | EBL  | EBT  | EBR  | WBL  | WBT  | WBR  | NBL  | NBT  | NBR  | SBL  | SBT   | SBR  |
| Lane Configurations      |      | ↕    |      |      | ↑    | ↗    |      | ↕    | ↗    |      |       |      |
| Traffic Vol, veh/h       | 10   | 650  | 0    | 0    | 1220 | 920  | 10   | 10   | 1560 | 0    | 0     | 0    |
| Future Vol, veh/h        | 10   | 650  | 0    | 0    | 1220 | 920  | 10   | 10   | 1560 | 0    | 0     | 0    |
| Conflicting Peds, #/hr   | 0    | 0    | 1    | 1    | 0    | 0    | 0    | 0    | 0    | 0    | 0     | 0    |
| Sign Control             | Free | Free | Free | Free | Free | Free | Stop | Stop | Stop | Stop | Stop  | Stop |
| RT Channelized           | -    | -    | None | -    | -    | Free | -    | -    | Free | -    | -     | None |
| Storage Length           | -    | -    | -    | -    | -    | 0    | -    | -    | 800  | -    | -     | -    |
| Veh in Median Storage, # | -    | 0    | -    | -    | 0    | -    | -    | 0    | -    | -    | 16965 | -    |
| Grade, %                 | -    | 0    | -    | -    | 0    | -    | -    | 0    | -    | -    | 0     | -    |
| Peak Hour Factor         | 95   | 95   | 95   | 95   | 95   | 95   | 95   | 95   | 95   | 95   | 95    | 95   |
| Heavy Vehicles, %        | 2    | 2    | 2    | 1    | 1    | 1    | 1    | 1    | 1    | 2    | 2     | 2    |
| Mvmt Flow                | 11   | 684  | 0    | 0    | 1284 | 968  | 11   | 11   | 1642 | 0    | 0     | 0    |

| Major/Minor          | Major1 | Major2 | Minor1 |
|----------------------|--------|--------|--------|
| Conflicting Flow All | 1284   | 0      | -      |
| Stage 1              | -      | -      | -      |
| Stage 2              | -      | -      | -      |
| Critical Hdwy        | 4.12   | -      | -      |
| Critical Hdwy Stg 1  | -      | -      | -      |
| Critical Hdwy Stg 2  | -      | -      | -      |
| Follow-up Hdwy       | 2.218  | -      | -      |
| Pot Cap-1 Maneuver   | 540    | 0      | 0      |
| Stage 1              | -      | 0      | 0      |
| Stage 2              | -      | 0      | 0      |
| Platoon blocked, %   | -      | -      | -      |
| Mov Cap-1 Maneuver   | 540    | -      | -      |
| Mov Cap-2 Maneuver   | -      | -      | -      |
| Stage 1              | -      | -      | -      |
| Stage 2              | -      | -      | -      |























| Approach             | EB  | WB | NB   |
|----------------------|-----|----|------|
| HCM Control Delay, s | 0.2 | 0  | 84.9 |
| HCM LOS              |     |    | F    |

| Minor Lane/Major Mvmt | NBLn1 | NBLn2 | EBL   | EBT | WBT |
|-----------------------|-------|-------|-------|-----|-----|
| Capacity (veh/h)      | 65    | -     | 540   | -   | -   |
| HCM Lane V/C Ratio    | 0.324 | -     | 0.019 | -   | -   |
| HCM Control Delay (s) | 84.9  | 0     | 11.8  | 0   | -   |
| HCM Lane LOS          | F     | A     | B     | A   | -   |
| HCM 95th %tile Q(veh) | 1.2   | -     | 0.1   | -   | -   |



HCM 2010 Signalized Intersection Summary  
5: 2nd Avenue & Imjin Parkway

Cumulative with Project, PM  
06/11/2019

|                              |  |  |  |  |  |  |  |  |  |  |  |  |
|------------------------------|---|---|---|---|---|---|--|---|---|---|---|---|
| Movement                     | EBL   | EBT   | EBR   | WBL   | WBT   | WBR   | NBL  | NBT   | NBR   | SBL   | SBT   | SBR   |
| Lane Configurations          |  |  |  |  |  |   |  |  |  |  |  |  |
| Traffic Volume (veh/h)       | 140   | 1370  | 710   | 330   | 1160  | 140   | 830  | 110   | 540   | 90  | 100   | 150   |
| Future Volume (veh/h)        | 140   | 1370  | 710   | 330   | 1160  | 140   | 830  | 110   | 540   | 90  | 100   | 150   |
| Number                       | 5   | 2   | 12  | 1   | 6   | 16  | 3  | 8   | 18  | 7   | 4   | 14  |
| Initial Q (Qb), veh          | 0   | 0   | 0   | 0   | 0   | 0   | 0  | 0   | 0   | 0   | 0   | 0   |
| Ped-Bike Adj(A_pbT)          | 1.00  |   | 1.00  | 1.00  |   | 0.99  | 1.00   |   | 0.99  | 1.00  |   | 0.98  |
| Parking Bus, Adj             | 1.00  | 1.00  | 1.00  | 1.00  | 1.00  | 1.00  | 1.00   | 1.00  | 1.00  | 1.00  | 1.00  | 1.00  |
| Adj Sat Flow, veh/h/ln       | 1881  | 1881  | 1881  | 1881  | 1881  | 1900  | 1900   | 1900  | 1900  | 1900  | 1900  | 1900  |
| Adj Flow Rate, veh/h         | 146   | 1427  | 540   | 344   | 1208  | 146   | 865  | 115   | 328   | 94  | 104   | 125   |
| Adj No. of Lanes             | 1   | 2   | 1   | 2   | 2   | 0   | 2  | 1   | 1   | 1   | 2   | 0   |
| Peak Hour Factor             | 0.96  | 0.96  | 0.96  | 0.96  | 0.96  | 0.96  | 0.96   | 0.96  | 0.96  | 0.96  | 0.96  | 0.96  |
| Percent Heavy Veh, %         | 1   | 1   | 1   | 1   | 1   | 1   | 0  | 0   | 0   | 0   | 0   | 0   |
| Cap, veh/h                   | 184   | 1213  | 540   | 416   | 1145  | 138   | 794  | 503   | 425   | 133   | 203   | 178   |
| Arrive On Green              | 0.10  | 0.34  | 0.34  | 0.12  | 0.36  | 0.36  | 0.23   | 0.26  | 0.26  | 0.07  | 0.11  | 0.11  |
| Sat Flow, veh/h              | 1792  | 3574  | 1592  | 3476  | 3210  | 387   | 3510   | 1900  | 1602  | 1810  | 1805  | 1585  |
| Grp Volume(v), veh/h         | 146   | 1427  | 540   | 344   | 671   | 683   | 865  | 115   | 328   | 94  | 104   | 125   |
| Grp Sat Flow(s),veh/h/ln     | 1792  | 1787  | 1592  | 1738  | 1787  | 1810  | 1755   | 1900  | 1602  | 1810  | 1805  | 1585  |
| Q Serve(g_s), s              | 7.0   | 30.0  | 30.0  | 8.5   | 31.5  | 31.5  | 20.0   | 4.2   | 16.7  | 4.5   | 4.8   | 6.7   |
| Cycle Q Clear(g_c), s        | 7.0   | 30.0  | 30.0  | 8.5   | 31.5  | 31.5  | 20.0   | 4.2   | 16.7  | 4.5   | 4.8   | 6.7   |
| Prop In Lane                 | 1.00  |   | 1.00  | 1.00  |   | 0.21  | 1.00   |   | 1.00  | 1.00  |   | 1.00  |
| Lane Grp Cap(c), veh/h       | 184   | 1213  | 540   | 416   | 637   | 645   | 794  | 503   | 425   | 133   | 203   | 178   |
| V/C Ratio(X)                 | 0.80  | 1.18  | 1.00  | 0.83  | 1.05  | 1.06  | 1.09   | 0.23  | 0.77  | 0.71  | 0.51  | 0.70  |
| Avail Cap(c_a), veh/h        | 304   | 1213  | 540   | 590   | 637   | 645   | 794  | 503   | 425   | 205   | 429   | 376   |
| HCM Platoon Ratio            | 1.00  | 1.00  | 1.00  | 1.00  | 1.00  | 1.00  | 1.00   | 1.00  | 1.00  | 1.00  | 1.00  | 1.00  |
| Upstream Filter(I)           | 1.00  | 1.00  | 1.00  | 1.00  | 1.00  | 1.00  | 1.00   | 1.00  | 1.00  | 1.00  | 1.00  | 1.00  |
| Uniform Delay (d), s/veh     | 38.8  | 29.2  | 29.2  | 38.0  | 28.4  | 28.4  | 34.2   | 25.4  | 30.0  | 40.0  | 37.0  | 37.8  |
| Incr Delay (d2), s/veh       | 3.0   | 88.3  | 38.6  | 4.5   | 50.2  | 52.0  | 59.0   | 0.1   | 7.8   | 2.6   | 0.7   | 1.9   |
| Initial Q Delay(d3),s/veh    | 0.0   | 0.0   | 0.0   | 0.0   | 0.0   | 0.0   | 0.0  | 0.0   | 0.0   | 0.0   | 0.0   | 0.0   |
| %ile BackOfQ(50%),veh/ln     | 3.6   | 29.5  | 18.9  | 4.4   | 24.3  | 24.9  | 16.1   | 2.2   | 8.3   | 2.3   | 2.4   | 3.0   |
| LnGrp Delay(d),s/veh         | 41.7  | 117.5   | 67.8  | 42.6  | 78.7  | 80.4  | 93.2   | 25.5  | 37.8  | 42.6  | 37.7  | 39.7  |
| LnGrp LOS                    | D   | F   | E   | D   | F   | F   | F  | C   | D   | D   | D   | D   |
| Approach Vol, veh/h          |   | 2113  |   |   | 1698  |   |  | 1308  |   |   | 323   |   |
| Approach Delay, s/veh        |   | 99.6  |   |   | 72.1  |   |  | 73.3  |   |   | 39.9  |   |
| Approach LOS                 |   | F   |   |   | E   |   |  | E   |   |   | D   |   |
| Timer                        | 1   | 2   | 3   | 4   | 5   | 6   | 7  | 8   |   |   |   |   |
| Assigned Phs                 | 1   | 2   | 3   | 4   | 5   | 6   | 7  | 8   |   |   |   |   |
| Phs Duration (G+Y+Rc), s     | 15.1  | 35.3  | 23.5  | 14.5  | 13.6  | 36.8  | 10.0   | 28.0  |   |   |   |   |
| Change Period (Y+Rc), s      | 4.5   | 5.3   | 3.5   | 4.6   | 4.5   | 5.3   | 3.5  | 4.6   |   |   |   |   |
| Max Green Setting (Gmax), s  | 15.0  | 30.0  | 20.0  | 21.0  | 15.0  | 30.0  | 10.0   | 21.0  |   |   |   |   |
| Max Q Clear Time (g_c+I1), s | 10.5  | 32.0  | 22.0  | 8.7   | 9.0   | 33.5  | 6.5  | 18.7  |   |   |   |   |
| Green Ext Time (p_c), s      | 0.0   | 0.0   | 0.0   | 0.2   | 0.0   | 0.0   | 0.0  | 0.0   |   |   |   |   |
| <b>Intersection Summary</b>  |   |   |   |   |   |   |  |   |   |   |   |   |
| HCM 2010 Ctrl Delay          |   |   | 81.2  |   |   |   |  |   |   |   |   |   |
| HCM 2010 LOS                 |   |   | F   |   |   |   |  |   |   |   |   |   |

HCM 2010 Signalized Intersection Summary  
6: 3rd Avenue & Imjin Parkway

Cumulative with Project, PM  
06/11/2019



| Movement                    | EBL  | EBT  | EBR  | WBL  | WBT  | WBR  | NBL  | NBT  | NBR  | SBL  | SBT  | SBR  |
|-----------------------------|------|------|------|------|------|------|------|------|------|------|------|------|
| Lane Configurations         |      |      |      |      |      |      |      |      |      |      |      |      |
| Traffic Volume (veh/h)      | 50   | 1830 | 160  | 100  | 1260 | 20   | 220  | 10   | 150  | 10   | 10   | 50   |
| Future Volume (veh/h)       | 50   | 1830 | 160  | 100  | 1260 | 20   | 220  | 10   | 150  | 10   | 10   | 50   |
| Number                      | 5    | 2    | 12   | 1    | 6    | 16   | 3    | 8    | 18   | 7    | 4    | 14   |
| Initial Q (Qb), veh         | 0    | 0    | 0    | 0    | 0    | 0    | 0    | 0    | 0    | 0    | 0    | 0    |
| Ped-Bike Adj(A_pbT)         | 1.00 |      | 0.98 | 1.00 |      | 1.00 | 1.00 |      | 1.00 | 1.00 |      | 1.00 |
| Parking Bus, Adj            | 1.00 | 1.00 | 1.00 | 1.00 | 1.00 | 1.00 | 1.00 | 1.00 | 1.00 | 1.00 | 1.00 | 1.00 |
| Adj Sat Flow, veh/h/ln      | 1881 | 1881 | 1900 | 1881 | 1881 | 1900 | 1900 | 1900 | 1900 | 1900 | 1900 | 1900 |
| Adj Flow Rate, veh/h        | 51   | 1867 | 155  | 102  | 1286 | 19   | 224  | 10   | 41   | 10   | 10   | 10   |
| Adj No. of Lanes            | 1    | 2    | 0    | 1    | 2    | 0    | 1    | 1    | 0    | 1    | 1    | 0    |
| Peak Hour Factor            | 0.98 | 0.98 | 0.98 | 0.98 | 0.98 | 0.98 | 0.98 | 0.98 | 0.98 | 0.98 | 0.98 | 0.98 |
| Percent Heavy Veh, %        | 1    | 1    | 1    | 1    | 1    | 1    | 0    | 0    | 0    | 0    | 0    | 0    |
| Cap, veh/h                  | 106  | 1720 | 141  | 131  | 1906 | 28   | 381  | 65   | 265  | 351  | 173  | 173  |
| Arrive On Green             | 0.06 | 0.51 | 0.51 | 0.07 | 0.53 | 0.53 | 0.20 | 0.20 | 0.20 | 0.20 | 0.20 | 0.20 |
| Sat Flow, veh/h             | 1792 | 3340 | 273  | 1792 | 3606 | 53   | 1412 | 326  | 1336 | 1373 | 872  | 872  |
| Grp Volume(v), veh/h        | 51   | 985  | 1037 | 102  | 637  | 668  | 224  | 0    | 51   | 10   | 0    | 20   |
| Grp Sat Flow(s),veh/h/ln    | 1792 | 1787 | 1826 | 1792 | 1787 | 1872 | 1412 | 0    | 1662 | 1373 | 0    | 1745 |
| Q Serve(g_s), s             | 1.7  | 32.5 | 32.5 | 3.5  | 16.5 | 16.5 | 9.7  | 0.0  | 1.6  | 0.4  | 0.0  | 0.6  |
| Cycle Q Clear(g_c), s       | 1.7  | 32.5 | 32.5 | 3.5  | 16.5 | 16.5 | 10.2 | 0.0  | 1.6  | 2.0  | 0.0  | 0.6  |
| Prop In Lane                | 1.00 |      | 0.15 | 1.00 |      | 0.03 | 1.00 |      | 0.80 | 1.00 |      | 0.50 |
| Lane Grp Cap(c), veh/h      | 106  | 920  | 940  | 131  | 945  | 990  | 381  | 0    | 329  | 351  | 0    | 346  |
| V/C Ratio(X)                | 0.48 | 1.07 | 1.10 | 0.78 | 0.67 | 0.67 | 0.59 | 0.00 | 0.15 | 0.03 | 0.00 | 0.06 |
| Avail Cap(c_a), veh/h       | 326  | 920  | 940  | 326  | 945  | 990  | 716  | 0    | 724  | 678  | 0    | 760  |
| HCM Platoon Ratio           | 1.00 | 1.00 | 1.00 | 1.00 | 1.00 | 1.00 | 1.00 | 1.00 | 1.00 | 1.00 | 1.00 | 1.00 |
| Upstream Filter(I)          | 1.00 | 1.00 | 1.00 | 1.00 | 1.00 | 1.00 | 1.00 | 0.00 | 1.00 | 1.00 | 0.00 | 1.00 |
| Uniform Delay (d), s/veh    | 28.7 | 15.3 | 15.3 | 28.7 | 10.9 | 10.9 | 24.7 | 0.0  | 20.9 | 21.8 | 0.0  | 20.5 |
| Incr Delay (d2), s/veh      | 1.2  | 50.4 | 61.8 | 3.7  | 1.6  | 1.5  | 0.5  | 0.0  | 0.1  | 0.0  | 0.0  | 0.0  |
| Initial Q Delay(d3),s/veh   | 0.0  | 0.0  | 0.0  | 0.0  | 0.0  | 0.0  | 0.0  | 0.0  | 0.0  | 0.0  | 0.0  | 0.0  |
| %ile BackOfQ(50%),veh/ln    | 0.9  | 28.7 | 32.3 | 1.9  | 8.4  | 8.8  | 3.8  | 0.0  | 0.7  | 0.1  | 0.0  | 0.3  |
| LnGrp Delay(d),s/veh        | 30.0 | 65.7 | 77.1 | 32.5 | 12.5 | 12.4 | 25.2 | 0.0  | 21.0 | 21.8 | 0.0  | 20.6 |
| LnGrp LOS                   | C    | F    | F    | C    | B    | B    | C    |      | C    | C    |      | C    |
| Approach Vol, veh/h         |      | 2073 |      |      | 1407 |      |      | 275  |      |      | 30   |      |
| Approach Delay, s/veh       |      | 70.5 |      |      | 13.9 |      |      | 24.4 |      |      | 21.0 |      |
| Approach LOS                |      | E    |      |      | B    |      |      | C    |      |      | C    |      |
| Timer                       | 1    | 2    | 3    | 4    | 5    | 6    | 7    | 8    |      |      |      |      |
| Assigned Phs                | 1    | 2    |      | 4    | 5    | 6    |      | 8    |      |      |      |      |
| Phs Duration (G+Y+Rc), s    | 8.1  | 38.0 |      | 17.0 | 7.2  | 38.9 |      | 17.0 |      |      |      |      |
| Change Period (Y+Rc), s     | 3.5  | 5.5  |      | 4.5  | 3.5  | 5.5  |      | 4.5  |      |      |      |      |
| Max Green Setting (Gmax), s | 1.5  | 32.5 |      | 27.5 | 11.5 | 32.5 |      | 27.5 |      |      |      |      |
| Max Q Clear Time (g_c+1), s | 1.5  | 34.5 |      | 4.0  | 3.7  | 18.5 |      | 12.2 |      |      |      |      |
| Green Ext Time (p_c), s     | 0.0  | 0.0  |      | 0.0  | 0.0  | 0.9  |      | 0.1  |      |      |      |      |
| <b>Intersection Summary</b> |      |      |      |      |      |      |      |      |      |      |      |      |
| HCM 2010 Ctrl Delay         |      |      |      | 45.7 |      |      |      |      |      |      |      |      |
| HCM 2010 LOS                |      |      |      | D    |      |      |      |      |      |      |      |      |

HCM 2010 Signalized Intersection Summary  
7: 4th Avenue & Imjin Parkway

Cumulative with Project, PM  
06/11/2019



| Movement                       | EBL  | EBT  | EBR  | WBL  | WBT  | WBR  | NBL  | NBT  | NBR  | SBL  | SBT  | SBR  |
|--------------------------------|------|------|------|------|------|------|------|------|------|------|------|------|
| Lane Configurations            |      |      |      |      |      |      |      |      |      |      |      |      |
| Traffic Volume (veh/h)         | 10   | 2000 | 10   | 10   | 1340 | 10   | 20   | 10   | 10   | 10   | 10   | 10   |
| Future Volume (veh/h)          | 10   | 2000 | 10   | 10   | 1340 | 10   | 20   | 10   | 10   | 10   | 10   | 10   |
| Number                         | 5    | 2    | 12   | 1    | 6    | 16   | 3    | 8    | 18   | 7    | 4    | 14   |
| Initial Q (Qb), veh            | 0    | 0    | 0    | 0    | 0    | 0    | 0    | 0    | 0    | 0    | 0    | 0    |
| Ped-Bike Adj(A_pbT)            | 1.00 |      | 1.00 | 1.00 |      | 0.98 | 1.00 |      | 1.00 | 1.00 |      | 1.00 |
| Parking Bus, Adj               | 1.00 | 1.00 | 1.00 | 1.00 | 1.00 | 1.00 | 1.00 | 1.00 | 1.00 | 1.00 | 1.00 | 1.00 |
| Adj Sat Flow, veh/h/ln         | 1881 | 1881 | 1900 | 1881 | 1881 | 1900 | 1900 | 1900 | 1900 | 1900 | 1900 | 1900 |
| Adj Flow Rate, veh/h           | 10   | 2062 | 10   | 10   | 1381 | 10   | 21   | 10   | 8    | 10   | 10   | 10   |
| Adj No. of Lanes               | 1    | 2    | 0    | 1    | 2    | 0    | 0    | 1    | 0    | 0    | 1    | 0    |
| Peak Hour Factor               | 0.97 | 0.97 | 0.97 | 0.97 | 0.97 | 0.97 | 0.97 | 0.97 | 0.97 | 0.97 | 0.97 | 0.97 |
| Percent Heavy Veh, %           | 1    | 1    | 1    | 1    | 1    | 1    | 0    | 0    | 0    | 0    | 0    | 0    |
| Cap, veh/h                     | 14   | 2208 | 11   | 14   | 2202 | 16   | 184  | 22   | 18   | 149  | 31   | 31   |
| Arrive On Green                | 0.01 | 0.61 | 0.61 | 0.01 | 0.61 | 0.61 | 0.05 | 0.05 | 0.05 | 0.05 | 0.05 | 0.05 |
| Sat Flow, veh/h                | 1792 | 3647 | 18   | 1792 | 3637 | 26   | 884  | 421  | 337  | 573  | 573  | 573  |
| Grp Volume(v), veh/h           | 10   | 1009 | 1063 | 10   | 678  | 713  | 39   | 0    | 0    | 30   | 0    | 0    |
| Grp Sat Flow(s),veh/h/ln       | 1792 | 1787 | 1878 | 1792 | 1787 | 1876 | 1641 | 0    | 0    | 1720 | 0    | 0    |
| Q Serve(g_s), s                | 0.2  | 20.7 | 20.8 | 0.2  | 9.8  | 9.8  | 0.2  | 0.0  | 0.0  | 0.0  | 0.0  | 0.0  |
| Cycle Q Clear(g_c), s          | 0.2  | 20.7 | 20.8 | 0.2  | 9.8  | 9.8  | 0.9  | 0.0  | 0.0  | 0.6  | 0.0  | 0.0  |
| Prop In Lane                   | 1.00 |      | 0.01 | 1.00 |      | 0.01 | 0.54 |      | 0.21 | 0.33 |      | 0.33 |
| Lane Grp Cap(c), veh/h         | 14   | 1082 | 1137 | 14   | 1082 | 1136 | 224  | 0    | 0    | 210  | 0    | 0    |
| V/C Ratio(X)                   | 0.71 | 0.93 | 0.93 | 0.71 | 0.63 | 0.63 | 0.17 | 0.00 | 0.00 | 0.14 | 0.00 | 0.00 |
| Avail Cap(c_a), veh/h          | 509  | 1434 | 1507 | 509  | 1434 | 1505 | 1198 | 0    | 0    | 1224 | 0    | 0    |
| HCM Platoon Ratio              | 1.00 | 1.00 | 1.00 | 1.00 | 1.00 | 1.00 | 1.00 | 1.00 | 1.00 | 1.00 | 1.00 | 1.00 |
| Upstream Filter(I)             | 1.00 | 1.00 | 1.00 | 1.00 | 1.00 | 1.00 | 1.00 | 0.00 | 0.00 | 1.00 | 0.00 | 0.00 |
| Uniform Delay (d), s/veh       | 20.0 | 7.2  | 7.3  | 20.0 | 5.1  | 5.1  | 18.5 | 0.0  | 0.0  | 18.4 | 0.0  | 0.0  |
| Incr Delay (d2), s/veh         | 21.3 | 8.3  | 8.1  | 21.3 | 0.2  | 0.2  | 0.1  | 0.0  | 0.0  | 0.1  | 0.0  | 0.0  |
| Initial Q Delay(d3),s/veh      | 0.0  | 0.0  | 0.0  | 0.0  | 0.0  | 0.0  | 0.0  | 0.0  | 0.0  | 0.0  | 0.0  | 0.0  |
| %ile BackOfQ(50%),veh/ln       | 0.2  | 12.3 | 12.9 | 0.2  | 4.8  | 5.0  | 0.4  | 0.0  | 0.0  | 0.3  | 0.0  | 0.0  |
| LnGrp Delay(d),s/veh           | 41.3 | 15.5 | 15.4 | 41.3 | 5.3  | 5.3  | 18.7 | 0.0  | 0.0  | 18.6 | 0.0  | 0.0  |
| LnGrp LOS                      | D    | B    | B    | D    | A    | A    | B    |      |      | B    |      |      |
| Approach Vol, veh/h            |      | 2082 |      |      | 1401 |      |      | 39   |      |      | 30   |      |
| Approach Delay, s/veh          |      | 15.6 |      |      | 5.6  |      |      | 18.7 |      |      | 18.6 |      |
| Approach LOS                   |      | B    |      |      | A    |      |      | B    |      |      | B    |      |
| Timer                          | 1    | 2    | 3    | 4    | 5    | 6    | 7    | 8    |      |      |      |      |
| Assigned Phs                   | 1    | 2    |      | 4    | 5    | 6    |      | 8    |      |      |      |      |
| Phs Duration (G+Y+Rc), s       | 3.8  | 30.0 |      | 6.7  | 3.8  | 30.0 |      | 6.7  |      |      |      |      |
| Change Period (Y+Rc), s        | 3.5  | 5.5  |      | 4.5  | 3.5  | 5.5  |      | 4.5  |      |      |      |      |
| Max Green Setting (Gmax), s    | 1.5  | 32.5 |      | 27.5 | 11.5 | 32.5 |      | 27.5 |      |      |      |      |
| Max Q Clear Time (g_c+12.2), s | 1.5  | 22.8 |      | 2.6  | 2.2  | 11.8 |      | 2.9  |      |      |      |      |
| Green Ext Time (p_c), s        | 0.0  | 1.7  |      | 0.0  | 0.0  | 1.0  |      | 0.0  |      |      |      |      |
| <b>Intersection Summary</b>    |      |      |      |      |      |      |      |      |      |      |      |      |
| HCM 2010 Ctrl Delay            |      |      |      | 11.7 |      |      |      |      |      |      |      |      |
| HCM 2010 LOS                   |      |      |      | B    |      |      |      |      |      |      |      |      |

HCM 2010 Signalized Intersection Summary  
 8: 5th Avenue/California Avenue & Imjin Parkway

Cumulative with Project, PM  
 06/11/2019



| Movement                      | EBL  | EBT  | EBR  | WBL  | WBT  | WBR  | NBL  | NBT  | NBR  | SBL  | SBT  | SBR  |
|-------------------------------|------|------|------|------|------|------|------|------|------|------|------|------|
| Lane Configurations           |      |      |      |      |      |      |      |      |      |      |      |      |
| Traffic Volume (veh/h)        | 280  | 1670 | 10   | 10   | 1100 | 110  | 20   | 50   | 10   | 70   | 30   | 230  |
| Future Volume (veh/h)         | 280  | 1670 | 10   | 10   | 1100 | 110  | 20   | 50   | 10   | 70   | 30   | 230  |
| Number                        | 5    | 2    | 12   | 1    | 6    | 16   | 3    | 8    | 18   | 7    | 4    | 14   |
| Initial Q (Qb), veh           | 0    | 0    | 0    | 0    | 0    | 0    | 0    | 0    | 0    | 0    | 0    | 0    |
| Ped-Bike Adj(A_pbT)           | 1.00 |      | 1.00 | 1.00 |      | 1.00 | 1.00 |      | 1.00 | 1.00 |      | 0.98 |
| Parking Bus, Adj              | 1.00 | 1.00 | 1.00 | 1.00 | 1.00 | 1.00 | 1.00 | 1.00 | 1.00 | 1.00 | 1.00 | 1.00 |
| Adj Sat Flow, veh/h/ln        | 1881 | 1881 | 1900 | 1881 | 1881 | 1900 | 1900 | 1900 | 1900 | 1900 | 1881 | 1900 |
| Adj Flow Rate, veh/h          | 289  | 1722 | 10   | 10   | 1134 | 107  | 21   | 52   | 7    | 72   | 31   | 68   |
| Adj No. of Lanes              | 1    | 2    | 0    | 1    | 2    | 0    | 0    | 1    | 0    | 0    | 1    | 0    |
| Peak Hour Factor              | 0.97 | 0.97 | 0.97 | 0.97 | 0.97 | 0.97 | 0.97 | 0.97 | 0.97 | 0.97 | 0.97 | 0.97 |
| Percent Heavy Veh, %          | 1    | 1    | 1    | 1    | 1    | 1    | 0    | 0    | 0    | 1    | 1    | 1    |
| Cap, veh/h                    | 347  | 2075 | 12   | 14   | 1267 | 119  | 136  | 197  | 23   | 187  | 56   | 91   |
| Arrive On Green               | 0.19 | 0.57 | 0.57 | 0.01 | 0.38 | 0.38 | 0.14 | 0.14 | 0.14 | 0.14 | 0.14 | 0.14 |
| Sat Flow, veh/h               | 1792 | 3643 | 21   | 1792 | 3301 | 311  | 285  | 1371 | 159  | 563  | 393  | 631  |
| Grp Volume(v), veh/h          | 289  | 844  | 888  | 10   | 613  | 628  | 80   | 0    | 0    | 171  | 0    | 0    |
| Grp Sat Flow(s),veh/h/ln      | 1792 | 1787 | 1877 | 1792 | 1787 | 1825 | 1815 | 0    | 0    | 1586 | 0    | 0    |
| Q Serve(g_s), s               | 7.5  | 18.5 | 18.6 | 0.3  | 15.5 | 15.5 | 0.0  | 0.0  | 0.0  | 3.0  | 0.0  | 0.0  |
| Cycle Q Clear(g_c), s         | 7.5  | 18.5 | 18.6 | 0.3  | 15.5 | 15.5 | 1.8  | 0.0  | 0.0  | 4.9  | 0.0  | 0.0  |
| Prop In Lane                  | 1.00 |      | 0.01 | 1.00 |      | 0.17 | 0.26 |      | 0.09 | 0.42 |      | 0.40 |
| Lane Grp Cap(c), veh/h        | 347  | 1018 | 1069 | 14   | 686  | 700  | 356  | 0    | 0    | 335  | 0    | 0    |
| V/C Ratio(X)                  | 0.83 | 0.83 | 0.83 | 0.72 | 0.89 | 0.90 | 0.22 | 0.00 | 0.00 | 0.51 | 0.00 | 0.00 |
| Avail Cap(c_a), veh/h         | 559  | 1116 | 1172 | 559  | 1116 | 1140 | 813  | 0    | 0    | 747  | 0    | 0    |
| HCM Platoon Ratio             | 1.00 | 1.00 | 1.00 | 1.00 | 1.00 | 1.00 | 1.00 | 1.00 | 1.00 | 1.00 | 1.00 | 1.00 |
| Upstream Filter(I)            | 1.00 | 1.00 | 1.00 | 1.00 | 1.00 | 1.00 | 1.00 | 0.00 | 0.00 | 1.00 | 0.00 | 0.00 |
| Uniform Delay (d), s/veh      | 18.6 | 8.4  | 8.4  | 23.8 | 13.9 | 13.9 | 18.4 | 0.0  | 0.0  | 19.6 | 0.0  | 0.0  |
| Incr Delay (d2), s/veh        | 2.8  | 4.5  | 4.3  | 22.1 | 3.5  | 3.6  | 0.1  | 0.0  | 0.0  | 0.4  | 0.0  | 0.0  |
| Initial Q Delay(d3),s/veh     | 0.0  | 0.0  | 0.0  | 0.0  | 0.0  | 0.0  | 0.0  | 0.0  | 0.0  | 0.0  | 0.0  | 0.0  |
| %ile BackOfQ(50%),veh/ln      | 4.0  | 10.2 | 10.7 | 0.2  | 8.2  | 8.4  | 0.9  | 0.0  | 0.0  | 2.2  | 0.0  | 0.0  |
| LnGrp Delay(d),s/veh          | 21.4 | 12.9 | 12.8 | 45.9 | 17.4 | 17.5 | 18.5 | 0.0  | 0.0  | 20.0 | 0.0  | 0.0  |
| LnGrp LOS                     | C    | B    | B    | D    | B    | B    | B    |      |      | C    |      |      |
| Approach Vol, veh/h           |      | 2021 |      |      | 1251 |      |      | 80   |      |      | 171  |      |
| Approach Delay, s/veh         |      | 14.1 |      |      | 17.7 |      |      | 18.5 |      |      | 20.0 |      |
| Approach LOS                  |      | B    |      |      | B    |      |      | B    |      |      | C    |      |
| Timer                         | 1    | 2    | 3    | 4    | 5    | 6    | 7    | 8    |      |      |      |      |
| Assigned Phs                  | 1    | 2    |      | 4    | 5    | 6    |      | 8    |      |      |      |      |
| Phs Duration (G+Y+Rc), s      | 3.9  | 32.7 |      | 11.5 | 12.8 | 23.7 |      | 11.5 |      |      |      |      |
| Change Period (Y+Rc), s       | 3.5  | 5.3  |      | 4.6  | 3.5  | 5.3  |      | 4.6  |      |      |      |      |
| Max Green Setting (Gmax), s   | 5.0  | 30.0 |      | 20.0 | 15.0 | 30.0 |      | 20.0 |      |      |      |      |
| Max Q Clear Time (g_c+1/3), s | 12.3 | 20.6 |      | 6.9  | 9.5  | 17.5 |      | 3.8  |      |      |      |      |
| Green Ext Time (p_c), s       | 0.0  | 1.3  |      | 0.1  | 0.0  | 0.9  |      | 0.1  |      |      |      |      |
| <b>Intersection Summary</b>   |      |      |      |      |      |      |      |      |      |      |      |      |
| HCM 2010 Ctrl Delay           |      |      |      | 15.7 |      |      |      |      |      |      |      |      |
| HCM 2010 LOS                  |      |      |      | B    |      |      |      |      |      |      |      |      |

| Intersection             |      |      |      |      |      |      |
|--------------------------|------|------|------|------|------|------|
| Int Delay, s/veh         | 0.6  |      |      |      |      |      |
| Movement                 | EBL  | EBR  | NBL  | NBT  | SBT  | SBR  |
| Lane Configurations      | ↔    |      | ↔    | ↑    | ↑    |      |
| Traffic Vol, veh/h       | 10   | 10   | 20   | 400  | 260  | 10   |
| Future Vol, veh/h        | 10   | 10   | 20   | 400  | 260  | 10   |
| Conflicting Peds, #/hr   | 0    | 0    | 0    | 0    | 0    | 0    |
| Sign Control             | Stop | Stop | Free | Free | Free | Free |
| RT Channelized           | -    | None | -    | None | -    | None |
| Storage Length           | 0    | -    | 155  | -    | -    | -    |
| Veh in Median Storage, # | 0    | -    | -    | 0    | 0    | -    |
| Grade, %                 | 0    | -    | -    | 0    | 0    | -    |
| Peak Hour Factor         | 92   | 92   | 92   | 92   | 92   | 92   |
| Heavy Vehicles, %        | 2    | 2    | 2    | 2    | 2    | 2    |
| Mvmt Flow                | 11   | 11   | 22   | 435  | 283  | 11   |

| Major/Minor          | Minor2 | Major1 |       | Major2 |   |
|----------------------|--------|--------|-------|--------|---|
| Conflicting Flow All | 768    | 289    | 294   | 0      | 0 |
| Stage 1              | 289    | -      | -     | -      | - |
| Stage 2              | 479    | -      | -     | -      | - |
| Critical Hdwy        | 6.42   | 6.22   | 4.12  | -      | - |
| Critical Hdwy Stg 1  | 5.42   | -      | -     | -      | - |
| Critical Hdwy Stg 2  | 5.42   | -      | -     | -      | - |
| Follow-up Hdwy       | 3.518  | 3.318  | 2.218 | -      | - |
| Pot Cap-1 Maneuver   | 370    | 750    | 1268  | -      | - |
| Stage 1              | 760    | -      | -     | -      | - |
| Stage 2              | 623    | -      | -     | -      | - |
| Platoon blocked, %   |        |        |       | -      | - |
| Mov Cap-1 Maneuver   | 364    | 750    | 1268  | -      | - |
| Mov Cap-2 Maneuver   | 364    | -      | -     | -      | - |
| Stage 1              | 747    | -      | -     | -      | - |
| Stage 2              | 623    | -      | -     | -      | - |

| Approach             | EB   | NB  | SB |
|----------------------|------|-----|----|
| HCM Control Delay, s | 12.7 | 0.4 | 0  |
| HCM LOS              | B    |     |    |

| Minor Lane/Major Mvmt | NBL   | NBT | EBLn1 | SBT | SBR |
|-----------------------|-------|-----|-------|-----|-----|
| Capacity (veh/h)      | 1268  | -   | 490   | -   | -   |
| HCM Lane V/C Ratio    | 0.017 | -   | 0.044 | -   | -   |
| HCM Control Delay (s) | 7.9   | -   | 12.7  | -   | -   |
| HCM Lane LOS          | A     | -   | B     | -   | -   |
| HCM 95th %tile Q(veh) | 0.1   | -   | 0.1   | -   | -   |

HCM 2010 Signalized Intersection Summary  
 10: Imjin Road & Imjin Parkway

Cumulative with Project, PM  
 06/11/2019

|                              | →     | ↘     | ↙    | ←    | ↖    | ↗    |   |      |
|------------------------------|-------|-------|------|------|------|------|---|------|
| Movement                     | EBT   | EBR   | WBL  | WBT  | NBL  | NBR  |   |      |
| Lane Configurations          | ↑↑    |       | ↖    | ↑↑   | ↖↖   | ↗    |   |      |
| Traffic Volume (veh/h)       | 1590  | 150   | 260  | 920  | 250  | 520  |   |      |
| Future Volume (veh/h)        | 1590  | 150   | 260  | 920  | 250  | 520  |   |      |
| Number                       | 2     | 12    | 1    | 6    | 3    | 18   |   |      |
| Initial Q (Qb), veh          | 0     | 0     | 0    | 0    | 0    | 0    |   |      |
| Ped-Bike Adj(A_pbT)          |       | 1.00  | 1.00 |      | 1.00 | 1.00 |   |      |
| Parking Bus, Adj             | 1.00  | 1.00  | 1.00 | 1.00 | 1.00 | 1.00 |   |      |
| Adj Sat Flow, veh/h/ln       | 1881  | 1900  | 1881 | 1881 | 1881 | 1881 |   |      |
| Adj Flow Rate, veh/h         | 1674  | 155   | 274  | 968  | 248  | 497  |   |      |
| Adj No. of Lanes             | 2     | 0     | 1    | 2    | 1    | 2    |   |      |
| Peak Hour Factor             | 0.95  | 0.95  | 0.95 | 0.95 | 0.95 | 0.95 |   |      |
| Percent Heavy Veh, %         | 1     | 1     | 1    | 1    | 1    | 1    |   |      |
| Cap, veh/h                   | 1429  | 131   | 317  | 2448 | 325  | 579  |   |      |
| Arrive On Green              | 0.43  | 0.43  | 0.18 | 0.69 | 0.18 | 0.18 |   |      |
| Sat Flow, veh/h              | 3406  | 303   | 1792 | 3668 | 1792 | 3198 |   |      |
| Grp Volume(v), veh/h         | 894   | 935   | 274  | 968  | 248  | 497  |   |      |
| Grp Sat Flow(s),veh/h/ln     | 1787  | 1828  | 1792 | 1787 | 1792 | 1599 |   |      |
| Q Serve(g_s), s              | 30.0  | 30.0  | 10.3 | 8.1  | 9.1  | 10.5 |   |      |
| Cycle Q Clear(g_c), s        | 30.0  | 30.0  | 10.3 | 8.1  | 9.1  | 10.5 |   |      |
| Prop In Lane                 |       | 0.17  | 1.00 |      | 1.00 | 1.00 |   |      |
| Lane Grp Cap(c), veh/h       | 771   | 789   | 317  | 2448 | 325  | 579  |   |      |
| V/C Ratio(X)                 | 1.16  | 1.19  | 0.86 | 0.40 | 0.76 | 0.86 |   |      |
| Avail Cap(c_a), veh/h        | 771   | 789   | 516  | 2448 | 567  | 1012 |   |      |
| HCM Platoon Ratio            | 1.00  | 1.00  | 1.00 | 1.00 | 1.00 | 1.00 |   |      |
| Upstream Filter(I)           | 1.00  | 1.00  | 1.00 | 1.00 | 1.00 | 1.00 |   |      |
| Uniform Delay (d), s/veh     | 19.8  | 19.8  | 27.8 | 4.7  | 27.0 | 27.6 |   |      |
| Incr Delay (d2), s/veh       | 85.8  | 96.0  | 4.6  | 0.0  | 1.4  | 1.5  |   |      |
| Initial Q Delay(d3),s/veh    | 0.0   | 0.0   | 0.0  | 0.0  | 0.0  | 0.0  |   |      |
| %ile BackOfQ(50%),veh/ln     | 32.9  | 35.9  | 5.5  | 3.9  | 4.6  | 4.7  |   |      |
| LnGrp Delay(d),s/veh         | 105.5 | 115.7 | 32.4 | 4.8  | 28.5 | 29.1 |   |      |
| LnGrp LOS                    | F     | F     | C    | A    | C    | C    |   |      |
| Approach Vol, veh/h          | 1829  |       |      | 1242 | 745  |      |   |      |
| Approach Delay, s/veh        | 110.7 |       |      | 10.9 | 28.9 |      |   |      |
| Approach LOS                 | F     |       |      | B    | C    |      |   |      |
| Timer                        | 1     | 2     | 3    | 4    | 5    | 6    | 7 | 8    |
| Assigned Phs                 | 1     | 2     |      |      |      | 6    |   | 8    |
| Phs Duration (G+Y+Rc), s     | 17.6  | 35.3  |      |      |      | 52.9 |   | 16.6 |
| Change Period (Y+Rc), s      | 5.3   | * 5.3 |      |      |      | 5.3  |   | 4.0  |
| Max Green Setting (Gmax), s  | 20.0  | * 30  |      |      |      | 30.0 |   | 22.0 |
| Max Q Clear Time (g_c+I1), s | 12.3  | 32.0  |      |      |      | 10.1 |   | 12.5 |
| Green Ext Time (p_c), s      | 0.0   | 0.0   |      |      |      | 1.1  |   | 0.1  |
| <b>Intersection Summary</b>  |       |       |      |      |      |      |   |      |
| HCM 2010 Ctrl Delay          |       |       | 62.2 |      |      |      |   |      |
| HCM 2010 LOS                 |       |       | E    |      |      |      |   |      |
| <b>Notes</b>                 |       |       |      |      |      |      |   |      |

HCM 2010 Signalized Intersection Summary  
 11: Abrams Drive & Imjin Parkway

Cumulative with Project, PM  
 06/11/2019



| Movement                     | EBL  | EBT  | EBR  | WBL  | WBT  | WBR  | NBL  | NBT  | NBR  | SBL  | SBT  | SBR  |
|------------------------------|------|------|------|------|------|------|------|------|------|------|------|------|
| Lane Configurations          | ↔    | ↗    |      | ↔    | ↗    |      | ↔    | ↑    | ↗    | ↔    | ↑    | ↗    |
| Traffic Volume (veh/h)       | 130  | 1630 | 250  | 180  | 950  | 120  | 180  | 30   | 190  | 60   | 20   | 130  |
| Future Volume (veh/h)        | 130  | 1630 | 250  | 180  | 950  | 120  | 180  | 30   | 190  | 60   | 20   | 130  |
| Number                       | 5    | 2    | 12   | 1    | 6    | 16   | 3    | 8    | 18   | 7    | 4    | 14   |
| Initial Q (Qb), veh          | 0    | 0    | 0    | 0    | 0    | 0    | 0    | 0    | 0    | 0    | 0    | 0    |
| Ped-Bike Adj(A_pbT)          | 1.00 |      | 1.00 | 1.00 |      | 1.00 | 1.00 |      | 1.00 | 1.00 |      | 1.00 |
| Parking Bus, Adj             | 1.00 | 1.00 | 1.00 | 1.00 | 1.00 | 1.00 | 1.00 | 1.00 | 1.00 | 1.00 | 1.00 | 1.00 |
| Adj Sat Flow, veh/h/ln       | 1881 | 1881 | 1900 | 1881 | 1881 | 1900 | 1881 | 1881 | 1881 | 1863 | 1863 | 1863 |
| Adj Flow Rate, veh/h         | 140  | 1753 | 220  | 194  | 1022 | 109  | 194  | 32   | 0    | 65   | 22   | 0    |
| Adj No. of Lanes             | 2    | 2    | 0    | 2    | 2    | 0    | 1    | 1    | 1    | 1    | 1    | 1    |
| Peak Hour Factor             | 0.93 | 0.93 | 0.93 | 0.93 | 0.93 | 0.93 | 0.93 | 0.93 | 0.93 | 0.93 | 0.93 | 0.93 |
| Percent Heavy Veh, %         | 1    | 1    | 1    | 1    | 1    | 1    | 1    | 1    | 1    | 2    | 2    | 2    |
| Cap, veh/h                   | 260  | 1856 | 228  | 277  | 1882 | 201  | 323  | 326  | 277  | 312  | 323  | 274  |
| Arrive On Green              | 0.07 | 0.58 | 0.58 | 0.08 | 0.58 | 0.58 | 0.17 | 0.17 | 0.00 | 0.17 | 0.17 | 0.00 |
| Sat Flow, veh/h              | 3476 | 3205 | 394  | 3476 | 3260 | 347  | 1395 | 1881 | 1599 | 1369 | 1863 | 1583 |
| Grp Volume(v), veh/h         | 140  | 961  | 1012 | 194  | 560  | 571  | 194  | 32   | 0    | 65   | 22   | 0    |
| Grp Sat Flow(s),veh/h/ln     | 1738 | 1787 | 1812 | 1738 | 1787 | 1820 | 1395 | 1881 | 1599 | 1369 | 1863 | 1583 |
| Q Serve(g_s), s              | 3.0  | 37.3 | 40.6 | 4.1  | 14.7 | 14.7 | 10.3 | 1.1  | 0.0  | 3.2  | 0.8  | 0.0  |
| Cycle Q Clear(g_c), s        | 3.0  | 37.3 | 40.6 | 4.1  | 14.7 | 14.7 | 11.0 | 1.1  | 0.0  | 4.3  | 0.8  | 0.0  |
| Prop In Lane                 | 1.00 |      | 0.22 | 1.00 |      | 0.19 | 1.00 |      | 1.00 | 1.00 |      | 1.00 |
| Lane Grp Cap(c), veh/h       | 260  | 1035 | 1049 | 277  | 1032 | 1051 | 323  | 326  | 277  | 312  | 323  | 274  |
| V/C Ratio(X)                 | 0.54 | 0.93 | 0.96 | 0.70 | 0.54 | 0.54 | 0.60 | 0.10 | 0.00 | 0.21 | 0.07 | 0.00 |
| Avail Cap(c_a), veh/h        | 913  | 1173 | 1189 | 913  | 1173 | 1194 | 630  | 741  | 630  | 614  | 734  | 624  |
| HCM Platoon Ratio            | 1.00 | 1.00 | 1.00 | 1.00 | 1.00 | 1.00 | 1.00 | 1.00 | 1.00 | 1.00 | 1.00 | 1.00 |
| Upstream Filter(I)           | 1.00 | 1.00 | 1.00 | 1.00 | 1.00 | 1.00 | 1.00 | 1.00 | 0.00 | 1.00 | 1.00 | 0.00 |
| Uniform Delay (d), s/veh     | 34.0 | 14.6 | 15.3 | 34.2 | 9.9  | 9.9  | 31.0 | 26.5 | 0.0  | 28.3 | 26.3 | 0.0  |
| Incr Delay (d2), s/veh       | 0.6  | 11.2 | 16.6 | 1.2  | 0.2  | 0.2  | 0.7  | 0.0  | 0.0  | 0.1  | 0.0  | 0.0  |
| Initial Q Delay(d3),s/veh    | 0.0  | 0.0  | 0.0  | 0.0  | 0.0  | 0.0  | 0.0  | 0.0  | 0.0  | 0.0  | 0.0  | 0.0  |
| %ile BackOfQ(50%),veh/ln     | 1.4  | 21.4 | 24.8 | 2.0  | 7.2  | 7.3  | 4.0  | 0.6  | 0.0  | 1.2  | 0.4  | 0.0  |
| LnGrp Delay(d),s/veh         | 34.6 | 25.8 | 31.9 | 35.4 | 10.1 | 10.1 | 31.6 | 26.5 | 0.0  | 28.4 | 26.4 | 0.0  |
| LnGrp LOS                    | C    | C    | C    | D    | B    | B    | C    | C    |      | C    | C    |      |
| Approach Vol, veh/h          |      | 2113 |      |      | 1325 |      |      | 226  |      |      | 87   |      |
| Approach Delay, s/veh        |      | 29.3 |      |      | 13.8 |      |      | 30.9 |      |      | 27.9 |      |
| Approach LOS                 |      | C    |      |      | B    |      |      | C    |      |      | C    |      |
| Timer                        | 1    | 2    | 3    | 4    | 5    | 6    | 7    | 8    |      |      |      |      |
| Assigned Phs                 | 1    | 2    |      | 4    | 5    | 6    |      | 8    |      |      |      |      |
| Phs Duration (G+Y+Rc), s     | 9.6  | 49.4 |      | 17.2 | 9.7  | 49.3 |      | 17.2 |      |      |      |      |
| Change Period (Y+Rc), s      | 3.5  | 5.3  |      | 4.0  | 4.0  | 5.3  |      | 4.0  |      |      |      |      |
| Max Green Setting (Gmax), s  | 20.0 | 50.0 |      | 30.0 | 20.0 | 50.0 |      | 30.0 |      |      |      |      |
| Max Q Clear Time (g_c+10), s | 10.0 | 42.6 |      | 6.3  | 5.0  | 16.7 |      | 13.0 |      |      |      |      |
| Green Ext Time (p_c), s      | 0.0  | 1.6  |      | 0.0  | 0.0  | 0.8  |      | 0.0  |      |      |      |      |
| <b>Intersection Summary</b>  |      |      |      |      |      |      |      |      |      |      |      |      |
| HCM 2010 Ctrl Delay          |      |      |      | 23.9 |      |      |      |      |      |      |      |      |
| HCM 2010 LOS                 |      |      |      | C    |      |      |      |      |      |      |      |      |

HCM 2010 Signalized Intersection Summary  
 12: Reservation Road & Imjin Parkway













Cumulative with Project, PM  
 06/11/2019



| Movement                    | EBL  | EBT   | EBR   | WBL  | WBT  | WBR   | NBL   | NBT   | NBR  | SBL  | SBT  | SBR  |
|-----------------------------|------|-------|-------|------|------|-------|-------|-------|------|------|------|------|
| Lane Configurations         |      |       |       |      |      |       |       |       |      |      |      |      |
| Traffic Volume (veh/h)      | 110  | 20    | 1730  | 10   | 40   | 30    | 1000  | 630   | 10   | 20   | 950  | 200  |
| Future Volume (veh/h)       | 110  | 20    | 1730  | 10   | 40   | 30    | 1000  | 630   | 10   | 20   | 950  | 200  |
| Number                      | 3    | 8     | 18    | 7    | 4    | 14    | 1     | 6     | 16   | 5    | 2    | 12   |
| Initial Q (Qb), veh         | 0    | 0     | 0     | 0    | 0    | 0     | 0     | 0     | 0    | 0    | 0    | 0    |
| Ped-Bike Adj(A_pbT)         | 1.00 |       | 1.00  | 1.00 |      | 0.99  | 1.00  |       | 1.00 | 1.00 |      | 1.00 |
| Parking Bus, Adj            | 1.00 | 1.00  | 1.00  | 1.00 | 1.00 | 1.00  | 1.00  | 1.00  | 1.00 | 1.00 | 1.00 | 1.00 |
| Adj Sat Flow, veh/h/ln      | 1881 | 1881  | 1881  | 1827 | 1827 | 1827  | 1881  | 1881  | 1881 | 1881 | 1881 | 1881 |
| Adj Flow Rate, veh/h        | 124  | 22    | 1543  | 11   | 45   | 12    | 1124  | 708   | 10   | 22   | 1067 | 91   |
| Adj No. of Lanes            | 2    | 1     | 2     | 1    | 1    | 1     | 2     | 2     | 1    | 2    | 2    | 1    |
| Peak Hour Factor            | 0.89 | 0.89  | 0.89  | 0.89 | 0.89 | 0.89  | 0.89  | 0.89  | 0.89 | 0.89 | 0.89 | 0.89 |
| Percent Heavy Veh, %        | 1    | 1     | 1     | 4    | 4    | 4     | 1     | 1     | 1    | 1    | 1    | 1    |
| Cap, veh/h                  | 799  | 433   | 1292  | 75   | 79   | 66    | 799   | 2052  | 918  | 55   | 1287 | 576  |
| Arrive On Green             | 0.23 | 0.23  | 0.23  | 0.04 | 0.04 | 0.04  | 0.23  | 0.57  | 0.57 | 0.02 | 0.36 | 0.36 |
| Sat Flow, veh/h             | 3476 | 1881  | 2802  | 1740 | 1827 | 1531  | 3476  | 3574  | 1599 | 3476 | 3574 | 1599 |
| Grp Volume(v), veh/h        | 124  | 22    | 1543  | 11   | 45   | 12    | 1124  | 708   | 10   | 22   | 1067 | 91   |
| Grp Sat Flow(s),veh/h/ln    | 1738 | 1881  | 1401  | 1740 | 1827 | 1531  | 1738  | 1787  | 1599 | 1738 | 1787 | 1599 |
| Q Serve(g_s), s             | 4.3  | 1.4   | 35.0  | 0.9  | 3.7  | 1.1   | 35.0  | 16.0  | 0.4  | 1.0  | 41.4 | 5.9  |
| Cycle Q Clear(g_c), s       | 4.3  | 1.4   | 35.0  | 0.9  | 3.7  | 1.1   | 35.0  | 16.0  | 0.4  | 1.0  | 41.4 | 5.9  |
| Prop In Lane                | 1.00 |       | 1.00  | 1.00 |      | 1.00  | 1.00  |       | 1.00 | 1.00 |      | 1.00 |
| Lane Grp Cap(c), veh/h      | 799  | 433   | 1292  | 75   | 79   | 66    | 799   | 2052  | 918  | 55   | 1287 | 576  |
| V/C Ratio(X)                | 0.16 | 0.05  | 1.19  | 0.15 | 0.57 | 0.18  | 1.41  | 0.34  | 0.01 | 0.40 | 0.83 | 0.16 |
| Avail Cap(c_a), veh/h       | 799  | 433   | 1292  | 354  | 372  | 312   | 799   | 2052  | 918  | 457  | 1409 | 630  |
| HCM Platoon Ratio           | 1.00 | 1.00  | 1.00  | 1.00 | 1.00 | 1.00  | 1.00  | 1.00  | 1.00 | 1.00 | 1.00 | 1.00 |
| Upstream Filter(I)          | 1.00 | 1.00  | 1.00  | 1.00 | 1.00 | 1.00  | 1.00  | 1.00  | 1.00 | 1.00 | 1.00 | 1.00 |
| Uniform Delay (d), s/veh    | 46.8 | 45.6  | 41.1  | 70.1 | 71.4 | 70.2  | 58.6  | 17.2  | 13.9 | 74.2 | 44.4 | 33.0 |
| Incr Delay (d2), s/veh      | 0.0  | 0.0   | 95.4  | 0.3  | 2.4  | 0.5   | 190.2 | 0.3   | 0.0  | 1.7  | 5.1  | 0.3  |
| Initial Q Delay(d3),s/veh   | 0.0  | 0.0   | 0.0   | 0.0  | 0.0  | 0.0   | 0.0   | 0.0   | 0.0  | 0.0  | 0.0  | 0.0  |
| %ile BackOfQ(50%),veh/ln    | 2.1  | 0.7   | 44.2  | 0.5  | 1.9  | 0.5   | 37.9  | 7.9   | 0.2  | 0.5  | 21.4 | 2.7  |
| LnGrp Delay(d),s/veh        | 46.8 | 45.7  | 136.5 | 70.4 | 73.8 | 70.7  | 248.8 | 17.5  | 13.9 | 75.9 | 49.5 | 33.4 |
| LnGrp LOS                   | D    | D     | F     | E    | E    | E     | F     | B     | B    | E    | D    | C    |
| Approach Vol, veh/h         |      | 1689  |       |      | 68   |       |       | 1842  |      |      | 1180 |      |
| Approach Delay, s/veh       |      | 128.8 |       |      | 72.7 |       |       | 158.6 |      |      | 48.8 |      |
| Approach LOS                |      | F     |       |      | E    |       |       | F     |      |      | D    |      |
| Timer                       | 1    | 2     | 3     | 4    | 5    | 6     | 7     | 8     |      |      |      |      |
| Assigned Phs                | 1    | 2     |       | 4    | 5    | 6     |       | 8     |      |      |      |      |
| Phs Duration (G+Y+Rc), s    | 39.1 | 61.0  |       | 11.6 | 6.5  | 93.6  |       | 40.5  |      |      |      |      |
| Change Period (Y+Rc), s     | 4.1  | * 6.2 |       | 5.0  | 4.1  | * 6.2 |       | 5.5   |      |      |      |      |
| Max Green Setting (Gmax), s | 35.0 | * 60  |       | 31.0 | 20.0 | * 50  |       | 35.0  |      |      |      |      |
| Max Q Clear Time (g_c+Q), s | 37.0 | 43.4  |       | 5.7  | 3.0  | 18.0  |       | 37.0  |      |      |      |      |
| Green Ext Time (p_c), s     | 0.0  | 11.4  |       | 0.2  | 0.0  | 10.6  |       | 0.0   |      |      |      |      |
| <b>Intersection Summary</b> |      |       |       |      |      |       |       |       |      |      |      |      |
| HCM 2010 Ctrl Delay         |      |       | 119.7 |      |      |       |       |       |      |      |      |      |
| HCM 2010 LOS                |      |       | F     |      |      |       |       |       |      |      |      |      |
| <b>Notes</b>                |      |       |       |      |      |       |       |       |      |      |      |      |



HCM 2010 Signalized Intersection Summary  
13: Reservation Road & Blanco Road

|                              |  |  |  |  |  |  |   |   |
|------------------------------|---|---|---|---|---|---|---|---|
| Movement                     | EBL   | EBT   | WBT   | WBR   | SBL   | SBR   |   |   |
| Lane Configurations          |  |  |  |  |  |  |   |   |
| Traffic Volume (veh/h)       | 1130  | 1490  | 490   | 50  | 40  | 1160  |   |   |
| Future Volume (veh/h)        | 1130  | 1490  | 490   | 50  | 40  | 1160  |   |   |
| Number                       | 5   | 2   | 6   | 16  | 7   | 14  |   |   |
| Initial Q (Qb), veh          | 0   | 0   | 0   | 0   | 0   | 0   |   |   |
| Ped-Bike Adj(A_pbT)          | 1.00  |   |   | 1.00  | 1.00  | 1.00  |   |   |
| Parking Bus, Adj             | 1.00  | 1.00  | 1.00  | 1.00  | 1.00  | 1.00  |   |   |
| Adj Sat Flow, veh/h/ln       | 1881  | 1881  | 1863  | 1863  | 1863  | 1863  |   |   |
| Adj Flow Rate, veh/h         | 1202  | 1585  | 521   | 29  | 43  | 0   |   |   |
| Adj No. of Lanes             | 2   | 2   | 1   | 1   | 2   | 2   |   |   |
| Peak Hour Factor             | 0.94  | 0.94  | 0.94  | 0.94  | 0.94  | 0.94  |   |   |
| Percent Heavy Veh, %         | 1   | 1   | 2   | 2   | 2   | 2   |   |   |
| Cap, veh/h                   | 1311  | 2879  | 622   | 529   | 119   | 96  |   |   |
| Arrive On Green              | 0.38  | 0.81  | 0.33  | 0.33  | 0.03  | 0.00  |   |   |
| Sat Flow, veh/h              | 3476  | 3668  | 1863  | 1583  | 3442  | 2787  |   |   |
| Grp Volume(v), veh/h         | 1202  | 1585  | 521   | 29  | 43  | 0   |   |   |
| Grp Sat Flow(s),veh/h/ln     | 1738  | 1787  | 1863  | 1583  | 1721  | 1393  |   |   |
| Q Serve(g_s), s              | 19.1  | 9.0   | 15.0  | 0.7   | 0.7   | 0.0   |   |   |
| Cycle Q Clear(g_c), s        | 19.1  | 9.0   | 15.0  | 0.7   | 0.7   | 0.0   |   |   |
| Prop In Lane                 | 1.00  |   |   | 1.00  | 1.00  | 1.00  |   |   |
| Lane Grp Cap(c), veh/h       | 1311  | 2879  | 622   | 529   | 119   | 96  |   |   |
| V/C Ratio(X)                 | 0.92  | 0.55  | 0.84  | 0.05  | 0.36  | 0.00  |   |   |
| Avail Cap(c_a), veh/h        | 2391  | 3688  | 1922  | 1634  | 1598  | 1294  |   |   |
| HCM Platoon Ratio            | 1.00  | 1.00  | 1.00  | 1.00  | 1.00  | 1.00  |   |   |
| Upstream Filter(I)           | 1.00  | 1.00  | 1.00  | 1.00  | 1.00  | 0.00  |   |   |
| Uniform Delay (d), s/veh     | 17.2  | 2.0   | 17.9  | 13.1  | 27.4  | 0.0   |   |   |
| Incr Delay (d2), s/veh       | 1.2   | 0.1   | 2.3   | 0.0   | 0.7   | 0.0   |   |   |
| Initial Q Delay(d3),s/veh    | 0.0   | 0.0   | 0.0   | 0.0   | 0.0   | 0.0   |   |   |
| %ile BackOfQ(50%),veh/ln     | 9.2   | 4.2   | 8.1   | 0.3   | 0.3   | 0.0   |   |   |
| LnGrp Delay(d),s/veh         | 18.5  | 2.1   | 20.2  | 13.2  | 28.1  | 0.0   |   |   |
| LnGrp LOS                    | B   | A   | C   | B   | C   |   |   |   |
| Approach Vol, veh/h          |   | 2787  | 550   |   | 43  |   |   |   |
| Approach Delay, s/veh        |   | 9.2   | 19.9  |   | 28.1  |   |   |   |
| Approach LOS                 |   | A   | B   |   | C   |   |   |   |
| Timer                        | 1   | 2   | 3   | 4   | 5   | 6   | 7 | 8 |
| Assigned Phs                 |   | 2   |   | 4   | 5   | 6   |   |   |
| Phs Duration (G+Y+Rc), s     |   | 52.6  |   | 5.5   | 27.4  | 25.2  |   |   |
| Change Period (Y+Rc), s      |   | 5.8   |   | 3.5   | 5.5   | 5.8   |   |   |
| Max Green Setting (Gmax), s  |   | 60.0  |   | 27.0  | 40.0  | 60.0  |   |   |
| Max Q Clear Time (g_c+I1), s |   | 11.0  |   | 2.7   | 21.1  | 17.0  |   |   |
| Green Ext Time (p_c), s      |   | 11.9  |   | 0.0   | 0.8   | 2.4   |   |   |
| <b>Intersection Summary</b>  |   |   |   |   |   |   |   |   |
| HCM 2010 Ctrl Delay          |   |   | 11.1  |   |   |   |   |   |
| HCM 2010 LOS                 |   |   | B   |   |   |   |   |   |

HCM 2010 Signalized Intersection Summary  
 14: Reservation Road & Inter-Garrison Road

Cumulative with Project, PM  
 06/11/2019



| Movement                     | EBL  | EBR  | NBL   | NBT  | SBT  | SBR   |   |      |
|------------------------------|------|------|-------|------|------|-------|---|------|
| Lane Configurations          |      |      |       |      |      |       |   |      |
| Traffic Volume (veh/h)       | 110  | 430  | 290   | 450  | 1350 | 270   |   |      |
| Future Volume (veh/h)        | 110  | 430  | 290   | 450  | 1350 | 270   |   |      |
| Number                       | 3    | 18   | 1     | 6    | 2    | 12    |   |      |
| Initial Q (Qb), veh          | 0    | 0    | 0     | 0    | 0    | 0     |   |      |
| Ped-Bike Adj(A_pbT)          | 1.00 | 1.00 | 1.00  |      |      | 1.00  |   |      |
| Parking Bus, Adj             | 1.00 | 1.00 | 1.00  | 1.00 | 1.00 | 1.00  |   |      |
| Adj Sat Flow, veh/h/ln       | 1881 | 1881 | 1845  | 1845 | 1881 | 1900  |   |      |
| Adj Flow Rate, veh/h         | 134  | 369  | 354   | 549  | 1646 | 320   |   |      |
| Adj No. of Lanes             | 1    | 1    | 1     | 2    | 2    | 0     |   |      |
| Peak Hour Factor             | 0.82 | 0.82 | 0.82  | 0.82 | 0.82 | 0.82  |   |      |
| Percent Heavy Veh, %         | 1    | 1    | 3     | 3    | 1    | 1     |   |      |
| Cap, veh/h                   | 373  | 598  | 291   | 2458 | 1492 | 281   |   |      |
| Arrive On Green              | 0.21 | 0.21 | 0.17  | 0.70 | 0.50 | 0.50  |   |      |
| Sat Flow, veh/h              | 1792 | 1599 | 1757  | 3597 | 3097 | 565   |   |      |
| Grp Volume(v), veh/h         | 134  | 369  | 354   | 549  | 958  | 1008  |   |      |
| Grp Sat Flow(s),veh/h/ln     | 1792 | 1599 | 1757  | 1752 | 1787 | 1781  |   |      |
| Q Serve(g_s), s              | 7.7  | 22.7 | 20.0  | 6.7  | 60.0 | 60.0  |   |      |
| Cycle Q Clear(g_c), s        | 7.7  | 22.7 | 20.0  | 6.7  | 60.0 | 60.0  |   |      |
| Prop In Lane                 | 1.00 | 1.00 | 1.00  |      |      | 0.32  |   |      |
| Lane Grp Cap(c), veh/h       | 373  | 598  | 291   | 2458 | 888  | 885   |   |      |
| V/C Ratio(X)                 | 0.36 | 0.62 | 1.22  | 0.22 | 1.08 | 1.14  |   |      |
| Avail Cap(c_a), veh/h        | 401  | 622  | 291   | 2458 | 888  | 885   |   |      |
| HCM Platoon Ratio            | 1.00 | 1.00 | 1.00  | 1.00 | 1.00 | 1.00  |   |      |
| Upstream Filter(I)           | 1.00 | 1.00 | 1.00  | 1.00 | 1.00 | 1.00  |   |      |
| Uniform Delay (d), s/veh     | 40.9 | 30.8 | 50.4  | 6.4  | 30.4 | 30.4  |   |      |
| Incr Delay (d2), s/veh       | 0.6  | 1.7  | 124.7 | 0.1  | 53.7 | 76.3  |   |      |
| Initial Q Delay(d3),s/veh    | 0.0  | 0.0  | 0.0   | 0.0  | 0.0  | 0.0   |   |      |
| %ile BackOfQ(50%),veh/ln     | 3.9  | 10.3 | 19.7  | 3.2  | 42.6 | 48.0  |   |      |
| LnGrp Delay(d),s/veh         | 41.5 | 32.5 | 175.0 | 6.5  | 84.1 | 106.6 |   |      |
| LnGrp LOS                    | D    | C    | F     | A    | F    | F     |   |      |
| Approach Vol, veh/h          | 503  |      |       | 903  | 1966 |       |   |      |
| Approach Delay, s/veh        | 34.9 |      |       | 72.6 | 95.7 |       |   |      |
| Approach LOS                 | C    |      |       | E    | F    |       |   |      |
| Timer                        | 1    | 2    | 3     | 4    | 5    | 6     | 7 | 8    |
| Assigned Phs                 | 1    | 2    |       |      |      | 6     |   | 8    |
| Phs Duration (G+Y+Rc), s     | 24.7 | 66.4 |       |      |      | 91.1  |   | 29.7 |
| Change Period (Y+Rc), s      | 4.7  | 6.4  |       |      |      | 6.4   |   | 4.5  |
| Max Green Setting (Gmax), s  | 26   | 60.0 |       |      |      | 60.0  |   | 27.0 |
| Max Q Clear Time (g_c+Yc), s | 22.6 | 62.0 |       |      |      | 8.7   |   | 24.7 |
| Green Ext Time (p_c), s      | 0.0  | 0.0  |       |      |      | 6.7   |   | 0.5  |
| <b>Intersection Summary</b>  |      |      |       |      |      |       |   |      |
| HCM 2010 Ctrl Delay          |      |      | 80.4  |      |      |       |   |      |
| HCM 2010 LOS                 |      |      | F     |      |      |       |   |      |
| <b>Notes</b>                 |      |      |       |      |      |       |   |      |

HCM 2010 Signalized Intersection Summary  
 15: 2nd Avenue & 9th Street

Cumulative with Project, PM  
 06/11/2019



| Movement                     | EBL  | EBT  | EBR  | WBL  | WBT  | WBR  | NBL  | NBT  | NBR  | SBL  | SBT  | SBR  |
|------------------------------|------|------|------|------|------|------|------|------|------|------|------|------|
| Lane Configurations          |      | ↔    | ↔    |      | ↔    |      | ↔    | ↕    |      | ↔    | ↕    |      |
| Traffic Volume (veh/h)       | 10   | 10   | 30   | 40   | 10   | 20   | 20   | 760  | 50   | 40   | 620  | 10   |
| Future Volume (veh/h)        | 10   | 10   | 30   | 40   | 10   | 20   | 20   | 760  | 50   | 40   | 620  | 10   |
| Number                       | 5    | 2    | 12   | 1    | 6    | 16   | 3    | 8    | 18   | 7    | 4    | 14   |
| Initial Q (Qb), veh          | 0    | 0    | 0    | 0    | 0    | 0    | 0    | 0    | 0    | 0    | 0    | 0    |
| Ped-Bike Adj(A_pbT)          | 1.00 |      | 0.98 | 1.00 |      | 1.00 | 1.00 |      | 0.97 | 1.00 |      | 1.00 |
| Parking Bus, Adj             | 1.00 | 1.00 | 1.00 | 1.00 | 1.00 | 1.00 | 1.00 | 1.00 | 1.00 | 1.00 | 1.00 | 1.00 |
| Adj Sat Flow, veh/h/ln       | 1900 | 1900 | 1900 | 1900 | 1900 | 1900 | 1881 | 1881 | 1900 | 1827 | 1827 | 1900 |
| Adj Flow Rate, veh/h         | 11   | 11   | 23   | 44   | 11   | 3    | 22   | 835  | 51   | 44   | 681  | -1   |
| Adj No. of Lanes             | 0    | 1    | 1    | 0    | 1    | 0    | 1    | 2    | 0    | 1    | 2    | 0    |
| Peak Hour Factor             | 0.91 | 0.91 | 0.91 | 0.91 | 0.91 | 0.91 | 0.91 | 0.91 | 0.91 | 0.91 | 0.91 | 0.91 |
| Percent Heavy Veh, %         | 0    | 0    | 0    | 0    | 0    | 0    | 1    | 1    | 1    | 4    | 4    | 4    |
| Cap, veh/h                   | 255  | 204  | 296  | 357  | 77   | 15   | 49   | 1393 | 85   | 85   | 1491 | 0    |
| Arrive On Green              | 0.19 | 0.19 | 0.19 | 0.19 | 0.19 | 0.19 | 0.03 | 0.41 | 0.41 | 0.05 | 0.43 | 0.00 |
| Sat Flow, veh/h              | 601  | 1093 | 1591 | 1020 | 415  | 78   | 1792 | 3415 | 209  | 1740 | 3563 | 0    |
| Grp Volume(v), veh/h         | 22   | 0    | 23   | 58   | 0    | 0    | 22   | 437  | 449  | 44   | 680  | 0    |
| Grp Sat Flow(s),veh/h/ln     | 1694 | 0    | 1591 | 1514 | 0    | 0    | 1792 | 1787 | 1836 | 1740 | 1736 | 0    |
| Q Serve(g_s), s              | 0.0  | 0.0  | 0.5  | 0.4  | 0.0  | 0.0  | 0.5  | 7.2  | 7.2  | 0.9  | 5.3  | 0.0  |
| Cycle Q Clear(g_c), s        | 0.4  | 0.0  | 0.5  | 1.1  | 0.0  | 0.0  | 0.5  | 7.2  | 7.2  | 0.9  | 5.3  | 0.0  |
| Prop In Lane                 | 0.50 |      | 1.00 | 0.76 |      | 0.05 | 1.00 |      | 0.11 | 1.00 |      | 0.00 |
| Lane Grp Cap(c), veh/h       | 458  | 0    | 296  | 449  | 0    | 0    | 49   | 729  | 749  | 85   | 1491 | 0    |
| V/C Ratio(X)                 | 0.05 | 0.00 | 0.08 | 0.13 | 0.00 | 0.00 | 0.45 | 0.60 | 0.60 | 0.52 | 0.46 | 0.00 |
| Avail Cap(c_a), veh/h        | 1657 | 0    | 1472 | 1541 | 0    | 0    | 545  | 1890 | 1942 | 529  | 3670 | 0    |
| HCM Platoon Ratio            | 1.00 | 1.00 | 1.00 | 1.00 | 1.00 | 1.00 | 1.00 | 1.00 | 1.00 | 1.00 | 1.00 | 1.00 |
| Upstream Filter(I)           | 1.00 | 0.00 | 1.00 | 1.00 | 0.00 | 0.00 | 1.00 | 1.00 | 1.00 | 1.00 | 1.00 | 0.00 |
| Uniform Delay (d), s/veh     | 12.7 | 0.0  | 12.7 | 12.9 | 0.0  | 0.0  | 18.1 | 8.8  | 8.8  | 17.6 | 7.7  | 0.0  |
| Incr Delay (d2), s/veh       | 0.0  | 0.0  | 0.1  | 0.1  | 0.0  | 0.0  | 6.4  | 0.8  | 0.8  | 4.8  | 0.2  | 0.0  |
| Initial Q Delay(d3),s/veh    | 0.0  | 0.0  | 0.0  | 0.0  | 0.0  | 0.0  | 0.0  | 0.0  | 0.0  | 0.0  | 0.0  | 0.0  |
| %ile BackOfQ(50%),veh/ln     | 0.2  | 0.0  | 0.2  | 0.5  | 0.0  | 0.0  | 0.3  | 3.7  | 3.8  | 0.6  | 2.5  | 0.0  |
| LnGrp Delay(d),s/veh         | 12.7 | 0.0  | 12.8 | 13.1 | 0.0  | 0.0  | 24.5 | 9.6  | 9.5  | 22.3 | 7.9  | 0.0  |
| LnGrp LOS                    | B    |      | B    | B    |      |      | C    | A    | A    | C    | A    |      |
| Approach Vol, veh/h          |      | 45   |      |      | 58   |      |      | 908  |      |      | 724  |      |
| Approach Delay, s/veh        |      | 12.8 |      |      | 13.1 |      |      | 9.9  |      |      | 8.7  |      |
| Approach LOS                 |      | B    |      |      | B    |      |      | A    |      |      | A    |      |
| Timer                        | 1    | 2    | 3    | 4    | 5    | 6    | 7    | 8    |      |      |      |      |
| Assigned Phs                 |      | 2    | 3    | 4    |      | 6    | 7    | 8    |      |      |      |      |
| Phs Duration (G+Y+Rc), s     |      | 12.0 | 4.5  | 21.3 |      | 12.0 | 5.4  | 20.4 |      |      |      |      |
| Change Period (Y+Rc), s      |      | 5.0  | 3.5  | 5.0  |      | 5.0  | 3.5  | 5.0  |      |      |      |      |
| Max Green Setting (Gmax), s  |      | 35.0 | 11.5 | 40.0 |      | 35.0 | 11.5 | 40.0 |      |      |      |      |
| Max Q Clear Time (g_c+I1), s |      | 2.5  | 2.5  | 7.3  |      | 3.1  | 2.9  | 9.2  |      |      |      |      |
| Green Ext Time (p_c), s      |      | 0.1  | 0.0  | 5.1  |      | 0.3  | 0.0  | 6.2  |      |      |      |      |
| <b>Intersection Summary</b>  |      |      |      |      |      |      |      |      |      |      |      |      |
| HCM 2010 Ctrl Delay          |      |      | 9.6  |      |      |      |      |      |      |      |      |      |
| HCM 2010 LOS                 |      |      | A    |      |      |      |      |      |      |      |      |      |

HCM 2010 Signalized Intersection Summary  
 16: 2nd Avenue & 8th Street

Cumulative with Project, PM  
 06/11/2019



| Movement                     | WBL  | WBR  | NBT  | NBR  | SBL  | SBT  |      |      |
|------------------------------|------|------|------|------|------|------|------|------|
| Lane Configurations          |      |      |      |      |      |      |      |      |
| Traffic Volume (veh/h)       | 130  | 80   | 600  | 270  | 70   | 570  |      |      |
| Future Volume (veh/h)        | 130  | 80   | 600  | 270  | 70   | 570  |      |      |
| Number                       | 1    | 16   | 8    | 18   | 7    | 4    |      |      |
| Initial Q (Qb), veh          | 0    | 0    | 0    | 0    | 0    | 0    |      |      |
| Ped-Bike Adj(A_pbT)          | 1.00 | 1.00 |      | 0.97 | 1.00 |      |      |      |
| Parking Bus, Adj             | 1.00 | 1.00 | 1.00 | 1.00 | 1.00 | 1.00 |      |      |
| Adj Sat Flow, veh/h/ln       | 1900 | 1900 | 1881 | 1900 | 1827 | 1827 |      |      |
| Adj Flow Rate, veh/h         | 138  | 51   | 638  | 256  | 74   | 606  |      |      |
| Adj No. of Lanes             | 1    | 1    | 2    | 0    | 1    | 2    |      |      |
| Peak Hour Factor             | 0.94 | 0.94 | 0.94 | 0.94 | 0.94 | 0.94 |      |      |
| Percent Heavy Veh, %         | 0    | 0    | 1    | 1    | 4    | 4    |      |      |
| Cap, veh/h                   | 218  | 195  | 1085 | 435  | 126  | 2106 |      |      |
| Arrive On Green              | 0.12 | 0.12 | 0.44 | 0.44 | 0.07 | 0.61 |      |      |
| Sat Flow, veh/h              | 1810 | 1615 | 2566 | 991  | 1740 | 3563 |      |      |
| Grp Volume(v), veh/h         | 138  | 51   | 461  | 433  | 74   | 606  |      |      |
| Grp Sat Flow(s),veh/h/ln     | 1810 | 1615 | 1787 | 1676 | 1740 | 1736 |      |      |
| Q Serve(g_s), s              | 2.7  | 1.1  | 7.2  | 7.2  | 1.5  | 3.1  |      |      |
| Cycle Q Clear(g_c), s        | 2.7  | 1.1  | 7.2  | 7.2  | 1.5  | 3.1  |      |      |
| Prop In Lane                 | 1.00 | 1.00 |      | 0.59 | 1.00 |      |      |      |
| Lane Grp Cap(c), veh/h       | 218  | 195  | 785  | 736  | 126  | 2106 |      |      |
| V/C Ratio(X)                 | 0.63 | 0.26 | 0.59 | 0.59 | 0.59 | 0.29 |      |      |
| Avail Cap(c_a), veh/h        | 1480 | 1321 | 2193 | 2057 | 546  | 5680 |      |      |
| HCM Platoon Ratio            | 1.00 | 1.00 | 1.00 | 1.00 | 1.00 | 1.00 |      |      |
| Upstream Filter(I)           | 1.00 | 1.00 | 1.00 | 1.00 | 1.00 | 1.00 |      |      |
| Uniform Delay (d), s/veh     | 15.3 | 14.6 | 7.8  | 7.8  | 16.5 | 3.4  |      |      |
| Incr Delay (d2), s/veh       | 3.0  | 0.7  | 0.7  | 0.8  | 4.3  | 0.1  |      |      |
| Initial Q Delay(d3),s/veh    | 0.0  | 0.0  | 0.0  | 0.0  | 0.0  | 0.0  |      |      |
| %ile BackOfQ(50%),veh/ln     | 1.5  | 1.0  | 3.6  | 3.4  | 0.9  | 1.5  |      |      |
| LnGrp Delay(d),s/veh         | 18.4 | 15.3 | 8.5  | 8.5  | 20.8 | 3.5  |      |      |
| LnGrp LOS                    | B    | B    | A    | A    | C    | A    |      |      |
| Approach Vol, veh/h          | 189  |      | 894  |      |      | 680  |      |      |
| Approach Delay, s/veh        | 17.5 |      | 8.5  |      |      | 5.4  |      |      |
| Approach LOS                 | B    |      | A    |      |      | A    |      |      |
| Timer                        | 1    | 2    | 3    | 4    | 5    | 6    | 7    | 8    |
| Assigned Phs                 |      |      |      | 4    |      | 6    | 7    | 8    |
| Phs Duration (G+Y+Rc), s     |      |      |      | 27.2 |      | 9.4  | 6.1  | 21.1 |
| Change Period (Y+Rc), s      |      |      |      | 5.0  |      | 5.0  | 3.5  | 5.0  |
| Max Green Setting (Gmax), s  |      |      |      | 60.0 |      | 30.0 | 11.5 | 45.0 |
| Max Q Clear Time (g_c+I1), s |      |      |      | 5.1  |      | 4.7  | 3.5  | 9.2  |
| Green Ext Time (p_c), s      |      |      |      | 4.6  |      | 0.5  | 0.1  | 6.7  |
| <b>Intersection Summary</b>  |      |      |      |      |      |      |      |      |
| HCM 2010 Ctrl Delay          |      |      | 8.3  |      |      |      |      |      |
| HCM 2010 LOS                 |      |      | A    |      |      |      |      |      |

| Intersection              |      |
|---------------------------|------|
| Intersection Delay, s/veh | 12.3 |
| Intersection LOS          | B    |

| Movement            | EBT  | EBR  | WBL  | WBT  | NBL  | NBR  |
|---------------------|------|------|------|------|------|------|
| Lane Configurations | ↑    | ↑    | ↑    | ↑    | ↑    | ↑    |
| Traffic Vol, veh/h  | 270  | 70   | 180  | 130  | 80   | 220  |
| Future Vol, veh/h   | 270  | 70   | 180  | 130  | 80   | 220  |
| Peak Hour Factor    | 0.92 | 0.92 | 0.92 | 0.92 | 0.92 | 0.92 |
| Heavy Vehicles, %   | 2    | 2    | 2    | 2    | 2    | 2    |
| Mvmt Flow           | 293  | 76   | 196  | 141  | 87   | 239  |
| Number of Lanes     | 1    | 1    | 1    | 1    | 1    | 1    |

| Approach                   | EB   | WB   | NB   |
|----------------------------|------|------|------|
| Opposing Approach          | WB   | EB   |      |
| Opposing Lanes             | 2    | 2    | 0    |
| Conflicting Approach Left  |      | NB   | EB   |
| Conflicting Lanes Left     | 0    | 2    | 2    |
| Conflicting Approach Right | NB   |      | WB   |
| Conflicting Lanes Right    | 2    | 0    | 2    |
| HCM Control Delay          | 13.2 | 11.9 | 11.7 |
| HCM LOS                    | B    | B    | B    |

| Lane                   | NBLn1 | NBLn2 | EBLn1 | EBLn2 | WBLn1 | WBLn2 |
|------------------------|-------|-------|-------|-------|-------|-------|
| Vol Left, %            | 100%  | 0%    | 0%    | 0%    | 100%  | 0%    |
| Vol Thru, %            | 0%    | 0%    | 100%  | 0%    | 0%    | 100%  |
| Vol Right, %           | 0%    | 100%  | 0%    | 100%  | 0%    | 0%    |
| Sign Control           | Stop  | Stop  | Stop  | Stop  | Stop  | Stop  |
| Traffic Vol by Lane    | 80    | 220   | 270   | 70    | 180   | 130   |
| LT Vol                 | 80    | 0     | 0     | 0     | 180   | 0     |
| Through Vol            | 0     | 0     | 270   | 0     | 0     | 130   |
| RT Vol                 | 0     | 220   | 0     | 70    | 0     | 0     |
| Lane Flow Rate         | 87    | 239   | 293   | 76    | 196   | 141   |
| Geometry Grp           | 7     | 7     | 7     | 7     | 7     | 7     |
| Degree of Util (X)     | 0.167 | 0.379 | 0.489 | 0.112 | 0.354 | 0.236 |
| Departure Headway (Hd) | 6.917 | 5.703 | 5.998 | 5.288 | 6.517 | 6.01  |
| Convergence, Y/N       | Yes   | Yes   | Yes   | Yes   | Yes   | Yes   |
| Cap                    | 518   | 631   | 602   | 677   | 552   | 598   |
| Service Time           | 4.658 | 3.443 | 3.736 | 3.025 | 4.255 | 3.748 |
| HCM Lane V/C Ratio     | 0.168 | 0.379 | 0.487 | 0.112 | 0.355 | 0.236 |
| HCM Control Delay      | 11    | 11.9  | 14.4  | 8.7   | 12.8  | 10.6  |
| HCM Lane LOS           | B     | B     | B     | A     | B     | B     |
| HCM 95th-tile Q        | 0.6   | 1.8   | 2.7   | 0.4   | 1.6   | 0.9   |

| Intersection                |       |       |       |       |
|-----------------------------|-------|-------|-------|-------|
| Intersection Delay, s/veh   | 10.4  |       |       |       |
| Intersection LOS            | B     |       |       |       |
| Approach                    | EB    | WB    | NB    | SB    |
| Entry Lanes                 | 1     | 1     | 1     | 1     |
| Conflicting Circle Lanes    | 1     | 1     | 1     | 1     |
| Adj Approach Flow, veh/h    | 418   | 429   | 66    | 374   |
| Demand Flow Rate, veh/h     | 431   | 433   | 66    | 381   |
| Vehicles Circulating, veh/h | 257   | 361   | 621   | 111   |
| Vehicles Exiting, veh/h     | 235   | 326   | 67    | 683   |
| Follow-Up Headway, s        | 3.186 | 3.186 | 3.186 | 3.186 |
| Ped Vol Crossing Leg, #/h   | 0     | 0     | 0     | 0     |
| Ped Cap Adj                 | 1.000 | 1.000 | 1.000 | 1.000 |
| Approach Delay, s/veh       | 10.8  | 12.8  | 7.2   | 7.7   |
| Approach LOS                | B     | B     | A     | A     |
| Lane                        | Left  | Left  | Left  | Left  |
| Designated Moves            | LTR   | LTR   | LTR   | LTR   |
| Assumed Moves               | LTR   | LTR   | LTR   | LTR   |
| RT Channelized              |       |       |       |       |
| Lane Util                   | 1.000 | 1.000 | 1.000 | 1.000 |
| Critical Headway, s         | 5.193 | 5.193 | 5.193 | 5.193 |
| Entry Flow, veh/h           | 431   | 433   | 66    | 381   |
| Cap Entry Lane, veh/h       | 874   | 788   | 607   | 1011  |
| Entry HV Adj Factor         | 0.971 | 0.992 | 1.000 | 0.980 |
| Flow Entry, veh/h           | 418   | 429   | 66    | 374   |
| Cap Entry, veh/h            | 848   | 781   | 607   | 992   |
| V/C Ratio                   | 0.493 | 0.550 | 0.109 | 0.377 |
| Control Delay, s/veh        | 10.8  | 12.8  | 7.2   | 7.7   |
| LOS                         | B     | B     | A     | A     |
| 95th %tile Queue, veh       | 3     | 3     | 0     | 2     |

HCM 2010 Signalized Intersection Summary  
 19: 2nd Avenue & Inter-Garrison Road

Cumulative with Project, PM  
 06/11/2019



| Movement                     | WBL  | WBR  | NBT  | NBR  | SBL  | SBT  |      |      |
|------------------------------|------|------|------|------|------|------|------|------|
| Lane Configurations          |      |      |      |      |      |      |      |      |
| Traffic Volume (veh/h)       | 70   | 30   | 840  | 60   | 40   | 690  |      |      |
| Future Volume (veh/h)        | 70   | 30   | 840  | 60   | 40   | 690  |      |      |
| Number                       | 1    | 16   | 8    | 18   | 7    | 4    |      |      |
| Initial Q (Qb), veh          | 0    | 0    | 0    | 0    | 0    | 0    |      |      |
| Ped-Bike Adj(A_pbT)          | 1.00 | 1.00 |      | 1.00 | 1.00 |      |      |      |
| Parking Bus, Adj             | 1.00 | 1.00 | 1.00 | 1.00 | 1.00 | 1.00 |      |      |
| Adj Sat Flow, veh/h/ln       | 1900 | 1900 | 1881 | 1900 | 1863 | 1863 |      |      |
| Adj Flow Rate, veh/h         | 72   | 7    | 866  | 54   | 41   | 711  |      |      |
| Adj No. of Lanes             | 1    | 1    | 2    | 0    | 1    | 2    |      |      |
| Peak Hour Factor             | 0.97 | 0.97 | 0.97 | 0.97 | 0.97 | 0.97 |      |      |
| Percent Heavy Veh, %         | 0    | 0    | 1    | 1    | 2    | 2    |      |      |
| Cap, veh/h                   | 274  | 245  | 1466 | 91   | 83   | 2025 |      |      |
| Arrive On Green              | 0.15 | 0.15 | 0.43 | 0.43 | 0.05 | 0.57 |      |      |
| Sat Flow, veh/h              | 1810 | 1615 | 3512 | 213  | 1774 | 3632 |      |      |
| Grp Volume(v), veh/h         | 72   | 7    | 453  | 467  | 41   | 711  |      |      |
| Grp Sat Flow(s),veh/h/ln     | 1810 | 1615 | 1787 | 1844 | 1774 | 1770 |      |      |
| Q Serve(g_s), s              | 1.3  | 0.1  | 7.0  | 7.0  | 0.8  | 3.9  |      |      |
| Cycle Q Clear(g_c), s        | 1.3  | 0.1  | 7.0  | 7.0  | 0.8  | 3.9  |      |      |
| Prop In Lane                 | 1.00 | 1.00 |      | 0.12 | 1.00 |      |      |      |
| Lane Grp Cap(c), veh/h       | 274  | 245  | 766  | 791  | 83   | 2025 |      |      |
| V/C Ratio(X)                 | 0.26 | 0.03 | 0.59 | 0.59 | 0.50 | 0.35 |      |      |
| Avail Cap(c_a), veh/h        | 1750 | 1562 | 1975 | 2038 | 564  | 5379 |      |      |
| HCM Platoon Ratio            | 1.00 | 1.00 | 1.00 | 1.00 | 1.00 | 1.00 |      |      |
| Upstream Filter(I)           | 1.00 | 1.00 | 1.00 | 1.00 | 1.00 | 1.00 |      |      |
| Uniform Delay (d), s/veh     | 13.6 | 13.1 | 7.9  | 7.9  | 16.8 | 4.1  |      |      |
| Incr Delay (d2), s/veh       | 0.5  | 0.0  | 0.7  | 0.7  | 4.5  | 0.1  |      |      |
| Initial Q Delay(d3),s/veh    | 0.0  | 0.0  | 0.0  | 0.0  | 0.0  | 0.0  |      |      |
| %ile BackOfQ(50%),veh/ln     | 0.7  | 0.1  | 3.6  | 3.7  | 0.5  | 1.9  |      |      |
| LnGrp Delay(d),s/veh         | 14.1 | 13.1 | 8.6  | 8.6  | 21.4 | 4.2  |      |      |
| LnGrp LOS                    | B    | B    | A    | A    | C    | A    |      |      |
| Approach Vol, veh/h          | 79   |      | 920  |      |      | 752  |      |      |
| Approach Delay, s/veh        | 14.0 |      | 8.6  |      |      | 5.2  |      |      |
| Approach LOS                 | B    |      | A    |      |      | A    |      |      |
| Timer                        | 1    | 2    | 3    | 4    | 5    | 6    | 7    | 8    |
| Assigned Phs                 |      |      |      | 4    |      | 6    | 7    | 8    |
| Phs Duration (G+Y+Rc), s     |      |      |      | 25.7 |      | 10.5 | 5.2  | 20.5 |
| Change Period (Y+Rc), s      |      |      |      | 5.0  |      | 5.0  | 3.5  | 5.0  |
| Max Green Setting (Gmax), s  |      |      |      | 55.0 |      | 35.0 | 11.5 | 40.0 |
| Max Q Clear Time (g_c+I1), s |      |      |      | 5.9  |      | 3.3  | 2.8  | 9.0  |
| Green Ext Time (p_c), s      |      |      |      | 5.6  |      | 0.2  | 0.0  | 6.5  |
| <b>Intersection Summary</b>  |      |      |      |      |      |      |      |      |
| HCM 2010 Ctrl Delay          |      |      | 7.4  |      |      |      |      |      |
| HCM 2010 LOS                 |      |      | A    |      |      |      |      |      |

|                           |     |  |  |  |  |  |  |  |  |  |  |  |
|---------------------------|-----|--|--|--|--|--|--|--|--|--|--|--|
| <b>Intersection</b>       |     |  |  |  |  |  |  |  |  |  |  |  |
| Intersection Delay, s/veh | 9.5 |  |  |  |  |  |  |  |  |  |  |  |
| Intersection LOS          | A   |  |  |  |  |  |  |  |  |  |  |  |

| Movement            | EBL  | EBT  | EBR  | WBL  | WBT  | WBR  | NBL  | NBT  | NBR  | SBL  | SBT  | SBR  |
|---------------------|------|------|------|------|------|------|------|------|------|------|------|------|
| Lane Configurations |      | ↕    |      |      | ↕    |      |      | ↕    |      |      | ↕    |      |
| Traffic Vol, veh/h  | 10   | 20   | 30   | 120  | 30   | 20   | 20   | 80   | 100  | 20   | 90   | 10   |
| Future Vol, veh/h   | 10   | 20   | 30   | 120  | 30   | 20   | 20   | 80   | 100  | 20   | 90   | 10   |
| Peak Hour Factor    | 0.82 | 0.82 | 0.82 | 0.82 | 0.82 | 0.82 | 0.82 | 0.82 | 0.82 | 0.82 | 0.82 | 0.82 |
| Heavy Vehicles, %   | 1    | 1    | 1    | 1    | 1    | 1    | 3    | 3    | 3    | 0    | 0    | 0    |
| Mvmt Flow           | 12   | 24   | 37   | 146  | 37   | 24   | 24   | 98   | 122  | 24   | 110  | 12   |
| Number of Lanes     | 0    | 1    | 0    | 0    | 1    | 0    | 0    | 1    | 0    | 0    | 1    | 0    |























| Approach                   | EB  | WB   | NB  | SB  |
|----------------------------|-----|------|-----|-----|
| Opposing Approach          | WB  | EB   | SB  | NB  |
| Opposing Lanes             | 1   | 1    | 1   | 1   |
| Conflicting Approach Left  | SB  | NB   | EB  | WB  |
| Conflicting Lanes Left     | 1   | 1    | 1   | 1   |
| Conflicting Approach Right | NB  | SB   | WB  | EB  |
| Conflicting Lanes Right    | 1   | 1    | 1   | 1   |
| HCM Control Delay          | 8.4 | 10.1 | 9.6 | 9.1 |
| HCM LOS                    | A   | B    | A   | A   |

| Lane                   | NBLn1 | EBLn1 | WBLn1 | SBLn1 |
|------------------------|-------|-------|-------|-------|
| Vol Left, %            | 10%   | 17%   | 71%   | 17%   |
| Vol Thru, %            | 40%   | 33%   | 18%   | 75%   |
| Vol Right, %           | 50%   | 50%   | 12%   | 8%    |
| Sign Control           | Stop  | Stop  | Stop  | Stop  |
| Traffic Vol by Lane    | 200   | 60    | 170   | 120   |
| LT Vol                 | 20    | 10    | 120   | 20    |
| Through Vol            | 80    | 20    | 30    | 90    |
| RT Vol                 | 100   | 30    | 20    | 10    |
| Lane Flow Rate         | 244   | 73    | 207   | 146   |
| Geometry Grp           | 1     | 1     | 1     | 1     |
| Degree of Util (X)     | 0.308 | 0.098 | 0.287 | 0.198 |
| Departure Headway (Hd) | 4.552 | 4.838 | 4.982 | 4.871 |
| Convergence, Y/N       | Yes   | Yes   | Yes   | Yes   |
| Cap                    | 785   | 733   | 717   | 732   |
| Service Time           | 2.608 | 2.916 | 3.047 | 2.935 |
| HCM Lane V/C Ratio     | 0.311 | 0.1   | 0.289 | 0.199 |
| HCM Control Delay      | 9.6   | 8.4   | 10.1  | 9.1   |
| HCM Lane LOS           | A     | A     | B     | A     |
| HCM 95th-tile Q        | 1.3   | 0.3   | 1.2   | 0.7   |



HCM 2010 Signalized Intersection Summary  
 21: 7th Avenue/8th Street & Inter-Garrison Road

Cumulative with Project, PM  
 07/12/2019

|                              |  |  |  |  |  |  |  |  |  |  |  |  |
|------------------------------|---|---|---|---|---|---|--|---|---|---|---|---|
| Movement                     | EBL   | EBT   | EBR   | WBL   | WBT   | WBR   | NBL  | NBT   | NBR   | SBL   | SBT   | SBR   |
| Lane Configurations          |  |  |   |  |  |   |  |  |  |  |  |  |
| Traffic Volume (veh/h)       | 10  | 250   | 80  | 250   | 170   | 50  | 60   | 250   | 400   | 130   | 90  | 10  |
| Future Volume (veh/h)        | 10  | 250   | 80  | 250   | 170   | 50  | 60   | 250   | 400   | 130   | 90  | 10  |
| Number                       | 5   | 2   | 12  | 1   | 6   | 16  | 3  | 8   | 18  | 7   | 4   | 14  |
| Initial Q (Qb), veh          | 0   | 0   | 0   | 0   | 0   | 0   | 0  | 0   | 0   | 0   | 0   | 0   |
| Ped-Bike Adj(A_pbT)          | 1.00  |   | 0.99  | 1.00  |   | 1.00  | 1.00   |   | 0.98  | 1.00  |   | 1.00  |
| Parking Bus, Adj             | 1.00  | 1.00  | 1.00  | 1.00  | 1.00  | 1.00  | 1.00   | 1.00  | 1.00  | 1.00  | 1.00  | 1.00  |
| Adj Sat Flow, veh/h/ln       | 1881  | 1881  | 1900  | 1827  | 1827  | 1900  | 1810   | 1810  | 1810  | 1900  | 1900  | 1900  |
| Adj Flow Rate, veh/h         | 11  | 269   | 80  | 269   | 183   | 39  | 65   | 269   | 358   | 140   | 97  | 2   |
| Adj No. of Lanes             | 1   | 1   | 0   | 1   | 1   | 0   | 1  | 1   | 1   | 1   | 1   | 0   |
| Peak Hour Factor             | 0.93  | 0.93  | 0.93  | 0.93  | 0.93  | 0.93  | 0.93   | 0.93  | 0.93  | 0.93  | 0.93  | 0.93  |
| Percent Heavy Veh, %         | 1   | 1   | 1   | 4   | 4   | 4   | 5  | 5   | 5   | 0   | 0   | 0   |
| Cap, veh/h                   | 20  | 335   | 100   | 314   | 599   | 128   | 83   | 488   | 405   | 176   | 592   | 12  |
| Arrive On Green              | 0.01  | 0.24  | 0.24  | 0.18  | 0.41  | 0.41  | 0.05   | 0.27  | 0.27  | 0.10  | 0.32  | 0.32  |
| Sat Flow, veh/h              | 1792  | 1391  | 414   | 1740  | 1459  | 311   | 1723   | 1810  | 1502  | 1810  | 1855  | 38  |
| Grp Volume(v), veh/h         | 11  | 0   | 349   | 269   | 0   | 222   | 65   | 269   | 358   | 140   | 0   | 99  |
| Grp Sat Flow(s),veh/h/ln     | 1792  | 0   | 1804  | 1740  | 0   | 1770  | 1723   | 1810  | 1502  | 1810  | 0   | 1893  |
| Q Serve(g_s), s              | 0.5   | 0.0   | 13.8  | 11.3  | 0.0   | 6.4   | 2.8  | 9.7   | 17.3  | 5.7   | 0.0   | 2.8   |
| Cycle Q Clear(g_c), s        | 0.5   | 0.0   | 13.8  | 11.3  | 0.0   | 6.4   | 2.8  | 9.7   | 17.3  | 5.7   | 0.0   | 2.8   |
| Prop In Lane                 | 1.00  |   | 0.23  | 1.00  |   | 0.18  | 1.00   |   | 1.00  | 1.00  |   | 0.02  |
| Lane Grp Cap(c), veh/h       | 20  | 0   | 435   | 314   | 0   | 727   | 83   | 488   | 405   | 176   | 0   | 604   |
| V/C Ratio(X)                 | 0.56  | 0.00  | 0.80  | 0.86  | 0.00  | 0.31  | 0.79   | 0.55  | 0.88  | 0.79  | 0.00  | 0.16  |
| Avail Cap(c_a), veh/h        | 95  | 0   | 786   | 425   | 0   | 1110  | 216  | 550   | 456   | 227   | 0   | 604   |
| HCM Platoon Ratio            | 1.00  | 1.00  | 1.00  | 1.00  | 1.00  | 1.00  | 1.00   | 1.00  | 1.00  | 1.00  | 1.00  | 1.00  |
| Upstream Filter(I)           | 1.00  | 0.00  | 1.00  | 1.00  | 0.00  | 1.00  | 1.00   | 1.00  | 1.00  | 1.00  | 0.00  | 1.00  |
| Uniform Delay (d), s/veh     | 37.3  | 0.0   | 27.0  | 30.1  | 0.0   | 15.0  | 35.7   | 23.7  | 26.5  | 33.4  | 0.0   | 18.5  |
| Incr Delay (d2), s/veh       | 22.9  | 0.0   | 3.5   | 12.2  | 0.0   | 0.2   | 15.1   | 1.0   | 16.9  | 13.7  | 0.0   | 0.1   |
| Initial Q Delay(d3),s/veh    | 0.0   | 0.0   | 0.0   | 0.0   | 0.0   | 0.0   | 0.0  | 0.0   | 0.0   | 0.0   | 0.0   | 0.0   |
| %ile BackOfQ(50%),veh/ln     | 0.4   | 0.0   | 7.3   | 6.5   | 0.0   | 3.1   | 1.7  | 4.9   | 9.0   | 3.5   | 0.0   | 1.5   |
| LnGrp Delay(d),s/veh         | 60.2  | 0.0   | 30.5  | 42.3  | 0.0   | 15.3  | 50.7   | 24.7  | 43.4  | 47.1  | 0.0   | 18.6  |
| LnGrp LOS                    | E   |   | C   | D   |   | B   | D  | C   | D   | D   |   | B   |
| Approach Vol, veh/h          |   | 360   |   |   | 491   |   |  | 692   |   |   | 239   |   |
| Approach Delay, s/veh        |   | 31.4  |   |   | 30.1  |   |  | 36.8  |   |   | 35.3  |   |
| Approach LOS                 |   | C   |   |   | C   |   |  | D   |   |   | D   |   |
| Timer                        | 1   | 2   | 3   | 4   | 5   | 6   | 7  | 8   |   |   |   |   |
| Assigned Phs                 | 1   | 2   | 3   | 4   | 5   | 6   | 7  | 8   |   |   |   |   |
| Phs Duration (G+Y+Rc), s     | 17.2  | 23.3  | 7.1   | 28.2  | 4.3   | 36.1  | 10.9   | 24.4  |   |   |   |   |
| Change Period (Y+Rc), s      | 3.5   | 5.0   | 3.5   | 4.0   | 3.5   | 5.0   | 3.5  | 4.0   |   |   |   |   |
| Max Green Setting (Gmax), s  | 18.5  | 33.0  | 9.5   | 23.0  | 4.0   | 47.5  | 9.5  | 23.0  |   |   |   |   |
| Max Q Clear Time (g_c+I1), s | 13.3  | 15.8  | 4.8   | 4.8   | 2.5   | 8.4   | 7.7  | 19.3  |   |   |   |   |
| Green Ext Time (p_c), s      | 0.4   | 1.9   | 0.0   | 0.4   | 0.0   | 1.4   | 0.1  | 1.1   |   |   |   |   |
| <b>Intersection Summary</b>  |   |   |   |   |   |   |  |   |   |   |   |   |
| HCM 2010 Ctrl Delay          |   |   | 33.7  |   |   |   |  |   |   |   |   |   |
| HCM 2010 LOS                 |   |   | C   |   |   |   |  |   |   |   |   |   |

| Intersection                |       |       |       |
|-----------------------------|-------|-------|-------|
| Intersection Delay, s/veh   | 114.3 |       |       |
| Intersection LOS            | F     |       |       |
| Approach                    | EB    | WB    | NB    |
| Entry Lanes                 | 1     | 1     | 1     |
| Conflicting Circle Lanes    | 1     | 1     | 1     |
| Adj Approach Flow, veh/h    | 804   | 866   | 825   |
| Demand Flow Rate, veh/h     | 820   | 883   | 825   |
| Vehicles Circulating, veh/h | 452   | 52    | 673   |
| Vehicles Exiting, veh/h     | 483   | 1446  | 599   |
| Follow-Up Headway, s        | 3.186 | 3.186 | 3.186 |
| Ped Vol Crossing Leg, #/h   | 0     | 0     | 0     |
| Ped Cap Adj                 | 1.000 | 1.000 | 1.000 |
| Approach Delay, s/veh       | 101.9 | 21.1  | 224.1 |
| Approach LOS                | F     | C     | F     |
| Lane                        | Left  | Left  | Left  |
| Designated Moves            | TR    | LT    | LR    |
| Assumed Moves               | TR    | LT    | LR    |
| RT Channelized              |       |       |       |
| Lane Util                   | 1.000 | 1.000 | 1.000 |
| Critical Headway, s         | 5.193 | 5.193 | 5.193 |
| Entry Flow, veh/h           | 820   | 883   | 825   |
| Cap Entry Lane, veh/h       | 719   | 1073  | 576   |
| Entry HV Adj Factor         | 0.980 | 0.980 | 1.000 |
| Flow Entry, veh/h           | 804   | 866   | 825   |
| Cap Entry, veh/h            | 705   | 1051  | 576   |
| V/C Ratio                   | 1.140 | 0.823 | 1.431 |
| Control Delay, s/veh        | 101.9 | 21.1  | 224.1 |
| LOS                         | F     | C     | F     |
| 95th %tile Queue, veh       | 25    | 10    | 39    |

HCM 2010 Signalized Intersection Summary  
 23: Inter-Garrison Road & Abrams Drive

Cumulative with Project, PM  
 06/11/2019

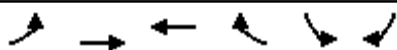

| Movement                     | EBL   | EBT   | WBT  | WBR  | SBL  | SBR  |   |   |
|------------------------------|-------|-------|------|------|------|------|---|---|
| Lane Configurations          |       |       |      |      |      |      |   |   |
| Traffic Volume (veh/h)       | 630   | 760   | 420  | 30   | 20   | 420  |   |   |
| Future Volume (veh/h)        | 630   | 760   | 420  | 30   | 20   | 420  |   |   |
| Number                       | 5     | 2     | 6    | 16   | 7    | 14   |   |   |
| Initial Q (Qb), veh          | 0     | 0     | 0    | 0    | 0    | 0    |   |   |
| Ped-Bike Adj(A_pbT)          | 1.00  |       |      | 0.98 | 1.00 | 1.00 |   |   |
| Parking Bus, Adj             | 1.00  | 1.00  | 1.00 | 1.00 | 1.00 | 1.00 |   |   |
| Adj Sat Flow, veh/h/ln       | 1863  | 1863  | 1792 | 1792 | 1827 | 1827 |   |   |
| Adj Flow Rate, veh/h         | 663   | 800   | 442  | 6    | 21   | 219  |   |   |
| Adj No. of Lanes             | 1     | 1     | 1    | 1    | 2    | 1    |   |   |
| Peak Hour Factor             | 0.95  | 0.95  | 0.95 | 0.95 | 0.95 | 0.95 |   |   |
| Percent Heavy Veh, %         | 2     | 2     | 6    | 6    | 4    | 4    |   |   |
| Cap, veh/h                   | 468   | 1178  | 516  | 430  | 583  | 268  |   |   |
| Arrive On Green              | 0.26  | 0.63  | 0.29 | 0.29 | 0.17 | 0.17 |   |   |
| Sat Flow, veh/h              | 1774  | 1863  | 1792 | 1491 | 3375 | 1553 |   |   |
| Grp Volume(v), veh/h         | 663   | 800   | 442  | 6    | 21   | 219  |   |   |
| Grp Sat Flow(s),veh/h/ln     | 1774  | 1863  | 1792 | 1491 | 1688 | 1553 |   |   |
| Q Serve(g_s), s              | 11.5  | 12.1  | 10.2 | 0.1  | 0.2  | 5.9  |   |   |
| Cycle Q Clear(g_c), s        | 11.5  | 12.1  | 10.2 | 0.1  | 0.2  | 5.9  |   |   |
| Prop In Lane                 | 1.00  |       |      | 1.00 | 1.00 | 1.00 |   |   |
| Lane Grp Cap(c), veh/h       | 468   | 1178  | 516  | 430  | 583  | 268  |   |   |
| V/C Ratio(X)                 | 1.42  | 0.68  | 0.86 | 0.01 | 0.04 | 0.82 |   |   |
| Avail Cap(c_a), veh/h        | 468   | 2564  | 1850 | 1539 | 2439 | 1122 |   |   |
| HCM Platoon Ratio            | 1.00  | 1.00  | 1.00 | 1.00 | 1.00 | 1.00 |   |   |
| Upstream Filter(I)           | 1.00  | 1.00  | 1.00 | 1.00 | 1.00 | 1.00 |   |   |
| Uniform Delay (d), s/veh     | 16.0  | 5.2   | 14.7 | 11.1 | 15.0 | 17.4 |   |   |
| Incr Delay (d2), s/veh       | 199.7 | 0.3   | 1.6  | 0.0  | 0.0  | 2.3  |   |   |
| Initial Q Delay(d3),s/veh    | 0.0   | 0.0   | 0.0  | 0.0  | 0.0  | 0.0  |   |   |
| %ile BackOfQ(50%),veh/ln     | 1.4   | 6.1   | 5.1  | 0.1  | 0.1  | 5.0  |   |   |
| LnGrp Delay(d),s/veh         | 215.8 | 5.4   | 16.3 | 11.1 | 15.0 | 19.7 |   |   |
| LnGrp LOS                    | F     | A     | B    | B    | B    | B    |   |   |
| Approach Vol, veh/h          |       | 1463  | 448  |      | 240  |      |   |   |
| Approach Delay, s/veh        |       | 100.8 | 16.2 |      | 19.3 |      |   |   |
| Approach LOS                 |       | F     | B    |      | B    |      |   |   |
| Timer                        | 1     | 2     | 3    | 4    | 5    | 6    | 7 | 8 |
| Assigned Phs                 |       | 2     |      | 4    | 5    | 6    |   |   |
| Phs Duration (G+Y+Rc), s     |       | 32.6  |      | 11.0 | 15.0 | 17.6 |   |   |
| Change Period (Y+Rc), s      |       | 5.0   |      | 3.5  | 3.5  | 5.0  |   |   |
| Max Green Setting (Gmax), s  |       | 60.0  |      | 31.5 | 11.5 | 45.0 |   |   |
| Max Q Clear Time (g_c+I1), s |       | 14.1  |      | 7.9  | 13.5 | 12.2 |   |   |
| Green Ext Time (p_c), s      |       | 0.8   |      | 0.0  | 0.0  | 0.4  |   |   |
| <b>Intersection Summary</b>  |       |       |      |      |      |      |   |   |
| HCM 2010 Ctrl Delay          |       |       | 74.1 |      |      |      |   |   |
| HCM 2010 LOS                 |       |       | E    |      |      |      |   |   |
| <b>Notes</b>                 |       |       |      |      |      |      |   |   |

**Intersection**

Intersection Delay, s/veh 67.1

Intersection LOS F

| Movement            | EBL  | EBT  | WBT  | WBR  | SBL  | SBR  |
|---------------------|------|------|------|------|------|------|
| Lane Configurations |      |      |      |      |      |      |
| Traffic Vol, veh/h  | 200  | 610  | 350  | 50   | 20   | 70   |
| Future Vol, veh/h   | 200  | 610  | 350  | 50   | 20   | 70   |
| Peak Hour Factor    | 0.86 | 0.86 | 0.86 | 0.86 | 0.86 | 0.86 |
| Heavy Vehicles, %   | 1    | 1    | 5    | 5    | 17   | 17   |
| Mvmt Flow           | 233  | 709  | 407  | 58   | 23   | 81   |
| Number of Lanes     | 1    | 1    | 2    | 1    | 1    | 1    |

| Approach                   | EB   | WB   | SB   |
|----------------------------|------|------|------|
| Opposing Approach          | WB   | EB   |      |
| Opposing Lanes             | 3    | 2    | 0    |
| Conflicting Approach Left  | SB   |      | WB   |
| Conflicting Lanes Left     | 2    | 0    | 3    |
| Conflicting Approach Right |      | SB   | EB   |
| Conflicting Lanes Right    | 0    | 2    | 2    |
| HCM Control Delay          | 99.6 | 13.5 | 12.2 |
| HCM LOS                    | F    | B    | B    |

| Lane                   | EBLn1 | EBLn2 | WBLn1 | WBLn2 | WBLn3 | SBLn1 | SBLn2 |
|------------------------|-------|-------|-------|-------|-------|-------|-------|
| Vol Left, %            | 100%  | 0%    | 0%    | 0%    | 0%    | 100%  | 0%    |
| Vol Thru, %            | 0%    | 100%  | 100%  | 100%  | 0%    | 0%    | 0%    |
| Vol Right, %           | 0%    | 0%    | 0%    | 0%    | 100%  | 0%    | 100%  |
| Sign Control           | Stop  | Stop  | Stop  | Stop  | Stop  | Stop  | Stop  |
| Traffic Vol by Lane    | 200   | 610   | 175   | 175   | 50    | 20    | 70    |
| LT Vol                 | 200   | 0     | 0     | 0     | 0     | 20    | 0     |
| Through Vol            | 0     | 610   | 175   | 175   | 0     | 0     | 0     |
| RT Vol                 | 0     | 0     | 0     | 0     | 50    | 0     | 70    |
| Lane Flow Rate         | 233   | 709   | 203   | 203   | 58    | 23    | 81    |
| Geometry Grp           | 8     | 8     | 8     | 8     | 8     | 8     | 8     |
| Degree of Util (X)     | 0.427 | 1.202 | 0.388 | 0.388 | 0.071 | 0.056 | 0.17  |
| Departure Headway (Hd) | 6.607 | 6.103 | 7.165 | 7.165 | 4.647 | 9.124 | 7.899 |
| Convergence, Y/N       | Yes   | Yes   | Yes   | Yes   | Yes   | Yes   | Yes   |
| Cap                    | 547   | 596   | 505   | 505   | 776   | 395   | 457   |
| Service Time           | 4.334 | 3.83  | 4.865 | 4.865 | 2.347 | 6.824 | 5.599 |
| HCM Lane V/C Ratio     | 0.426 | 1.19  | 0.402 | 0.402 | 0.075 | 0.058 | 0.177 |
| HCM Control Delay      | 14.2  | 127.6 | 14.3  | 14.3  | 7.7   | 12.4  | 12.2  |
| HCM Lane LOS           | B     | F     | B     | B     | A     | B     | B     |
| HCM 95th-tile Q        | 2.1   | 25.3  | 1.8   | 1.8   | 0.2   | 0.2   | 0.6   |

| Intersection              |      |
|---------------------------|------|
| Intersection Delay, s/veh | 34.5 |
| Intersection LOS          | D    |

| Movement            | EBL  | EBT  | WBT  | WBR  | SBL  | SBR  |
|---------------------|------|------|------|------|------|------|
| Lane Configurations |      |      |      |      |      |      |
| Traffic Vol, veh/h  | 460  | 150  | 100  | 130  | 190  | 180  |
| Future Vol, veh/h   | 460  | 150  | 100  | 130  | 190  | 180  |
| Peak Hour Factor    | 0.87 | 0.87 | 0.87 | 0.87 | 0.87 | 0.87 |
| Heavy Vehicles, %   | 1    | 1    | 6    | 6    | 3    | 3    |
| Mvmt Flow           | 529  | 172  | 115  | 149  | 218  | 207  |
| Number of Lanes     | 1    | 1    | 1    | 0    | 1    | 1    |

| Approach                   | EB   | WB   | SB   |
|----------------------------|------|------|------|
| Opposing Approach          | WB   | EB   |      |
| Opposing Lanes             | 1    | 2    | 0    |
| Conflicting Approach Left  | SB   |      | WB   |
| Conflicting Lanes Left     | 2    | 0    | 1    |
| Conflicting Approach Right |      | SB   | EB   |
| Conflicting Lanes Right    | 0    | 2    | 2    |
| HCM Control Delay          | 53.4 | 15.2 | 15.2 |
| HCM LOS                    | F    | C    | C    |

| Lane                   | EBLn1 | EBLn2 | WBLn1 | SBLn1 | SBLn2 |
|------------------------|-------|-------|-------|-------|-------|
| Vol Left, %            | 100%  | 0%    | 0%    | 100%  | 0%    |
| Vol Thru, %            | 0%    | 100%  | 43%   | 0%    | 0%    |
| Vol Right, %           | 0%    | 0%    | 57%   | 0%    | 100%  |
| Sign Control           | Stop  | Stop  | Stop  | Stop  | Stop  |
| Traffic Vol by Lane    | 460   | 150   | 230   | 190   | 180   |
| LT Vol                 | 460   | 0     | 0     | 190   | 0     |
| Through Vol            | 0     | 150   | 100   | 0     | 0     |
| RT Vol                 | 0     | 0     | 130   | 0     | 180   |
| Lane Flow Rate         | 529   | 172   | 264   | 218   | 207   |
| Geometry Grp           | 7     | 7     | 4     | 7     | 7     |
| Degree of Util (X)     | 1.006 | 0.304 | 0.473 | 0.468 | 0.373 |
| Departure Headway (Hd) | 6.849 | 6.341 | 6.438 | 7.707 | 6.482 |
| Convergence, Y/N       | Yes   | Yes   | Yes   | Yes   | Yes   |
| Cap                    | 529   | 566   | 558   | 465   | 552   |
| Service Time           | 4.613 | 4.104 | 4.507 | 5.481 | 4.256 |
| HCM Lane V/C Ratio     | 1     | 0.304 | 0.473 | 0.469 | 0.375 |
| HCM Control Delay      | 66.9  | 11.9  | 15.2  | 17.1  | 13.1  |
| HCM Lane LOS           | F     | B     | C     | C     | B     |
| HCM 95th-tile Q        | 14.2  | 1.3   | 2.5   | 2.4   | 1.7   |

HCM 2010 Signalized Intersection Summary  
 26: East Garrison Road & Reservation Road

Cumulative with Project, PM  
 06/11/2019



| Movement                      | EBL  | EBT  | EBR  | WBL  | WBT  | WBR  | NBL  | NBT  | NBR  | SBL | SBT | SBR |
|-------------------------------|------|------|------|------|------|------|------|------|------|-----|-----|-----|
| Lane Configurations           |      |      |      |      |      |      |      |      |      |     |     |     |
| Traffic Volume (veh/h)        | 0    | 1500 | 190  | 240  | 570  | 0    | 150  | 0    | 150  | 0   | 0   | 0   |
| Future Volume (veh/h)         | 0    | 1500 | 190  | 240  | 570  | 0    | 150  | 0    | 150  | 0   | 0   | 0   |
| Number                        | 5    | 2    | 12   | 1    | 6    | 16   | 3    | 8    | 18   |     |     |     |
| Initial Q (Qb), veh           | 0    | 0    | 0    | 0    | 0    | 0    | 0    | 0    | 0    |     |     |     |
| Ped-Bike Adj(A_pbT)           | 1.00 |      | 1.00 | 1.00 |      | 1.00 | 1.00 |      | 1.00 |     |     |     |
| Parking Bus, Adj              | 1.00 | 1.00 | 1.00 | 1.00 | 1.00 | 1.00 | 1.00 | 1.00 | 1.00 |     |     |     |
| Adj Sat Flow, veh/h/ln        | 1863 | 1863 | 1900 | 1881 | 1881 | 0    | 1845 | 0    | 1845 |     |     |     |
| Adj Flow Rate, veh/h          | 0    | 1546 | 194  | 247  | 588  | 0    | 155  | 0    | 126  |     |     |     |
| Adj No. of Lanes              | 1    | 2    | 0    | 1    | 2    | 0    | 1    | 0    | 1    |     |     |     |
| Peak Hour Factor              | 0.97 | 0.97 | 0.97 | 0.97 | 0.97 | 0.97 | 0.97 | 0.97 | 0.97 |     |     |     |
| Percent Heavy Veh, %          | 2    | 2    | 2    | 1    | 1    | 0    | 3    | 0    | 3    |     |     |     |
| Cap, veh/h                    | 2    | 1876 | 232  | 280  | 2808 | 0    | 191  | 0    | 170  |     |     |     |
| Arrive On Green               | 0.00 | 0.59 | 0.59 | 0.16 | 0.79 | 0.00 | 0.11 | 0.00 | 0.11 |     |     |     |
| Sat Flow, veh/h               | 1774 | 3170 | 393  | 1792 | 3668 | 0    | 1757 | 0    | 1568 |     |     |     |
| Grp Volume(v), veh/h          | 0    | 854  | 886  | 247  | 588  | 0    | 155  | 0    | 126  |     |     |     |
| Grp Sat Flow(s),veh/h/ln      | 1774 | 1770 | 1793 | 1792 | 1787 | 0    | 1757 | 0    | 1568 |     |     |     |
| Q Serve(g_s), s               | 0.0  | 36.3 | 38.0 | 12.9 | 4.0  | 0.0  | 8.2  | 0.0  | 7.4  |     |     |     |
| Cycle Q Clear(g_c), s         | 0.0  | 36.3 | 38.0 | 12.9 | 4.0  | 0.0  | 8.2  | 0.0  | 7.4  |     |     |     |
| Prop In Lane                  | 1.00 |      | 0.22 | 1.00 |      | 0.00 | 1.00 |      | 1.00 |     |     |     |
| Lane Grp Cap(c), veh/h        | 2    | 1047 | 1061 | 280  | 2808 | 0    | 191  | 0    | 170  |     |     |     |
| V/C Ratio(X)                  | 0.00 | 0.82 | 0.84 | 0.88 | 0.21 | 0.00 | 0.81 | 0.00 | 0.74 |     |     |     |
| Avail Cap(c_a), veh/h         | 372  | 1113 | 1128 | 376  | 2808 | 0    | 497  | 0    | 444  |     |     |     |
| HCM Platoon Ratio             | 1.00 | 1.00 | 1.00 | 1.00 | 1.00 | 1.00 | 1.00 | 1.00 | 1.00 |     |     |     |
| Upstream Filter(I)            | 0.00 | 1.00 | 1.00 | 1.00 | 1.00 | 0.00 | 1.00 | 0.00 | 1.00 |     |     |     |
| Uniform Delay (d), s/veh      | 0.0  | 15.4 | 15.7 | 39.4 | 2.6  | 0.0  | 41.6 | 0.0  | 41.2 |     |     |     |
| Incr Delay (d2), s/veh        | 0.0  | 5.2  | 5.9  | 14.1 | 0.0  | 0.0  | 3.2  | 0.0  | 2.4  |     |     |     |
| Initial Q Delay(d3),s/veh     | 0.0  | 0.0  | 0.0  | 0.0  | 0.0  | 0.0  | 0.0  | 0.0  | 0.0  |     |     |     |
| %ile BackOfQ(50%),veh/ln      | 0.0  | 19.1 | 20.4 | 7.5  | 2.0  | 0.0  | 4.2  | 0.0  | 3.3  |     |     |     |
| LnGrp Delay(d),s/veh          | 0.0  | 20.5 | 21.6 | 53.5 | 2.7  | 0.0  | 44.7 | 0.0  | 43.6 |     |     |     |
| LnGrp LOS                     |      | C    | C    | D    | A    |      | D    |      | D    |     |     |     |
| Approach Vol, veh/h           |      | 1740 |      |      | 835  |      |      | 281  |      |     |     |     |
| Approach Delay, s/veh         |      | 21.1 |      |      | 17.7 |      |      | 44.2 |      |     |     |     |
| Approach LOS                  |      | C    |      |      | B    |      |      | D    |      |     |     |     |
| Timer                         | 1    | 2    | 3    | 4    | 5    | 6    | 7    | 8    |      |     |     |     |
| Assigned Phs                  | 1    | 2    |      |      | 5    | 6    |      | 8    |      |     |     |     |
| Phs Duration (G+Y+Rc), s      | 8.5  | 61.8 |      |      | 0.0  | 80.3 |      | 15.1 |      |     |     |     |
| Change Period (Y+Rc), s       | 3.6  | 5.4  |      |      | 3.5  | 5.4  |      | 4.7  |      |     |     |     |
| Max Green Setting (Gmax), s   | 20   | 60.0 |      |      | 20.0 | 60.0 |      | 27.0 |      |     |     |     |
| Max Q Clear Time (g_c+1/4), s | 11.4 | 40.0 |      |      | 0.0  | 6.0  |      | 10.2 |      |     |     |     |
| Green Ext Time (p_c), s       | 0.0  | 16.4 |      |      | 0.0  | 4.8  |      | 0.1  |      |     |     |     |
| <b>Intersection Summary</b>   |      |      |      |      |      |      |      |      |      |     |     |     |
| HCM 2010 Ctrl Delay           |      |      |      | 22.4 |      |      |      |      |      |     |     |     |
| HCM 2010 LOS                  |      |      |      | C    |      |      |      |      |      |     |     |     |
| <b>Notes</b>                  |      |      |      |      |      |      |      |      |      |     |     |     |

HCM 2010 Signalized Intersection Summary  
 27: Reservation Road & Watkins Gate Road

Cumulative with Project, PM  
 06/11/2019



| Movement                     | EBL  | EBR  | NBL  | NBT   | SBT  | SBR  |   |       |
|------------------------------|------|------|------|-------|------|------|---|-------|
| Lane Configurations          |      |      |      |       |      |      |   |       |
| Traffic Volume (veh/h)       | 10   | 230  | 210  | 1000  | 2110 | 60   |   |       |
| Future Volume (veh/h)        | 10   | 230  | 210  | 1000  | 2110 | 60   |   |       |
| Number                       | 5    | 12   | 3    | 8     | 4    | 14   |   |       |
| Initial Q (Qb), veh          | 0    | 0    | 0    | 0     | 0    | 0    |   |       |
| Ped-Bike Adj(A_pbT)          | 1.00 | 1.00 | 1.00 |       |      | 1.00 |   |       |
| Parking Bus, Adj             | 1.00 | 1.00 | 1.00 | 1.00  | 1.00 | 1.00 |   |       |
| Adj Sat Flow, veh/h/ln       | 1863 | 1863 | 1881 | 1881  | 1863 | 1900 |   |       |
| Adj Flow Rate, veh/h         | 11   | 43   | 228  | 1087  | 2293 | 62   |   |       |
| Adj No. of Lanes             | 1    | 1    | 1    | 2     | 2    | 0    |   |       |
| Peak Hour Factor             | 0.92 | 0.92 | 0.92 | 0.92  | 0.92 | 0.92 |   |       |
| Percent Heavy Veh, %         | 2    | 2    | 1    | 1     | 2    | 2    |   |       |
| Cap, veh/h                   | 64   | 58   | 242  | 3096  | 2470 | 66   |   |       |
| Arrive On Green              | 0.04 | 0.04 | 0.13 | 0.87  | 0.70 | 0.70 |   |       |
| Sat Flow, veh/h              | 1774 | 1583 | 1792 | 3668  | 3614 | 95   |   |       |
| Grp Volume(v), veh/h         | 11   | 43   | 228  | 1087  | 1147 | 1208 |   |       |
| Grp Sat Flow(s),veh/h/ln     | 1774 | 1583 | 1792 | 1787  | 1770 | 1846 |   |       |
| Q Serve(g_s), s              | 0.8  | 3.6  | 16.8 | 7.8   | 73.5 | 75.4 |   |       |
| Cycle Q Clear(g_c), s        | 0.8  | 3.6  | 16.8 | 7.8   | 73.5 | 75.4 |   |       |
| Prop In Lane                 | 1.00 | 1.00 | 1.00 |       |      | 0.05 |   |       |
| Lane Grp Cap(c), veh/h       | 64   | 58   | 242  | 3096  | 1241 | 1295 |   |       |
| V/C Ratio(X)                 | 0.17 | 0.75 | 0.94 | 0.35  | 0.92 | 0.93 |   |       |
| Avail Cap(c_a), veh/h        | 272  | 243  | 242  | 3119  | 1253 | 1307 |   |       |
| HCM Platoon Ratio            | 1.00 | 1.00 | 1.00 | 1.00  | 1.00 | 1.00 |   |       |
| Upstream Filter(I)           | 1.00 | 1.00 | 1.00 | 1.00  | 1.00 | 1.00 |   |       |
| Uniform Delay (d), s/veh     | 62.4 | 63.7 | 57.3 | 1.7   | 16.9 | 17.2 |   |       |
| Incr Delay (d2), s/veh       | 0.5  | 7.0  | 42.1 | 0.1   | 11.7 | 12.3 |   |       |
| Initial Q Delay(d3),s/veh    | 0.0  | 0.0  | 0.0  | 0.0   | 0.0  | 0.0  |   |       |
| %ile BackOfQ(50%),veh/ln     | 0.4  | 1.7  | 11.2 | 3.8   | 39.4 | 42.3 |   |       |
| LnGrp Delay(d),s/veh         | 62.8 | 70.7 | 99.4 | 1.8   | 28.6 | 29.5 |   |       |
| LnGrp LOS                    | E    | E    | F    | A     | C    | C    |   |       |
| Approach Vol, veh/h          | 54   |      |      | 1315  | 2355 |      |   |       |
| Approach Delay, s/veh        | 69.1 |      |      | 18.7  | 29.1 |      |   |       |
| Approach LOS                 | E    |      |      | B     | C    |      |   |       |
| Timer                        | 1    | 2    | 3    | 4     | 5    | 6    | 7 | 8     |
| Assigned Phs                 |      | 2    | 3    | 4     |      |      |   | 8     |
| Phs Duration (G+Y+Rc), s     |      | 11.4 | 22.0 | 100.2 |      |      |   | 122.2 |
| Change Period (Y+Rc), s      |      | 6.5  | 4.0  | 6.5   |      |      |   | 6.5   |
| Max Green Setting (Gmax), s  |      | 20.5 | 18.0 | 94.5  |      |      |   | 116.5 |
| Max Q Clear Time (g_c+I1), s |      | 5.6  | 18.8 | 77.4  |      |      |   | 9.8   |
| Green Ext Time (p_c), s      |      | 0.0  | 0.0  | 16.3  |      |      |   | 15.9  |
| <b>Intersection Summary</b>  |      |      |      |       |      |      |   |       |
| HCM 2010 Ctrl Delay          |      |      | 26.0 |       |      |      |   |       |
| HCM 2010 LOS                 |      |      | C    |       |      |      |   |       |

HCM 2010 Signalized Intersection Summary  
28: Davis Road & Reservation Road

Cumulative with Project, PM  
06/11/2019



| Movement                      | EBL   | EBT   | EBR  | WBL   | WBT   | WBR  | NBL  | NBT  | NBR  | SBL  | SBT  | SBR  |
|-------------------------------|-------|-------|------|-------|-------|------|------|------|------|------|------|------|
| Lane Configurations           |       |       |      |       |       |      |      |      |      |      |      |      |
| Traffic Volume (veh/h)        | 1260  | 500   | 10   | 10    | 360   | 100  | 10   | 10   | 10   | 120  | 10   | 540  |
| Future Volume (veh/h)         | 1260  | 500   | 10   | 10    | 360   | 100  | 10   | 10   | 10   | 120  | 10   | 540  |
| Number                        | 5     | 2     | 12   | 1     | 6     | 16   | 3    | 8    | 18   | 7    | 4    | 14   |
| Initial Q (Qb), veh           | 0     | 0     | 0    | 0     | 0     | 0    | 0    | 0    | 0    | 0    | 0    | 0    |
| Ped-Bike Adj(A_pbT)           | 1.00  |       | 1.00 | 1.00  |       | 1.00 | 1.00 |      | 1.00 | 1.00 |      | 1.00 |
| Parking Bus, Adj              | 1.00  | 1.00  | 1.00 | 1.00  | 1.00  | 1.00 | 1.00 | 1.00 | 1.00 | 1.00 | 1.00 | 1.00 |
| Adj Sat Flow, veh/h/ln        | 1863  | 1863  | 1900 | 1827  | 1835  | 1900 | 1900 | 1900 | 1900 | 1900 | 1881 | 1881 |
| Adj Flow Rate, veh/h          | 1340  | 532   | 11   | 11    | 383   | 106  | 11   | 11   | 9    | 128  | 11   | 439  |
| Adj No. of Lanes              | 1     | 2     | 0    | 1     | 1     | 0    | 0    | 1    | 0    | 0    | 1    | 1    |
| Peak Hour Factor              | 0.94  | 0.94  | 0.94 | 0.94  | 0.94  | 0.94 | 0.94 | 0.94 | 0.94 | 0.94 | 0.94 | 0.94 |
| Percent Heavy Veh, %          | 2     | 2     | 2    | 4     | 4     | 4    | 0    | 0    | 0    | 1    | 1    | 1    |
| Cap, veh/h                    | 486   | 2069  | 43   | 18    | 444   | 123  | 18   | 18   | 14   | 356  | 31   | 782  |
| Arrive On Green               | 0.27  | 0.58  | 0.58 | 0.01  | 0.32  | 0.32 | 0.03 | 0.03 | 0.03 | 0.22 | 0.22 | 0.22 |
| Sat Flow, veh/h               | 1774  | 3546  | 73   | 1740  | 1384  | 383  | 631  | 631  | 516  | 1656 | 142  | 1599 |
| Grp Volume(v), veh/h          | 1340  | 265   | 278  | 11    | 0     | 489  | 31   | 0    | 0    | 139  | 0    | 439  |
| Grp Sat Flow(s),veh/h/ln      | 1774  | 1770  | 1850 | 1740  | 0     | 1767 | 1777 | 0    | 0    | 1798 | 0    | 1599 |
| Q Serve(g_s), s               | 30.0  | 8.1   | 8.1  | 0.7   | 0.0   | 28.5 | 1.9  | 0.0  | 0.0  | 7.2  | 0.0  | 21.2 |
| Cycle Q Clear(g_c), s         | 30.0  | 8.1   | 8.1  | 0.7   | 0.0   | 28.5 | 1.9  | 0.0  | 0.0  | 7.2  | 0.0  | 21.2 |
| Prop In Lane                  | 1.00  |       | 0.04 | 1.00  |       | 0.22 | 0.35 |      | 0.29 | 0.92 |      | 1.00 |
| Lane Grp Cap(c), veh/h        | 486   | 1032  | 1079 | 18    | 0     | 567  | 50   | 0    | 0    | 387  | 0    | 782  |
| V/C Ratio(X)                  | 2.76  | 0.26  | 0.26 | 0.61  | 0.00  | 0.86 | 0.63 | 0.00 | 0.00 | 0.36 | 0.00 | 0.56 |
| Avail Cap(c_a), veh/h         | 486   | 1032  | 1079 | 476   | 0     | 967  | 487  | 0    | 0    | 492  | 0    | 875  |
| HCM Platoon Ratio             | 1.00  | 1.00  | 1.00 | 1.00  | 1.00  | 1.00 | 1.00 | 1.00 | 1.00 | 1.00 | 1.00 | 1.00 |
| Upstream Filter(I)            | 1.00  | 1.00  | 1.00 | 1.00  | 0.00  | 1.00 | 1.00 | 0.00 | 0.00 | 1.00 | 0.00 | 1.00 |
| Uniform Delay (d), s/veh      | 39.8  | 11.2  | 11.2 | 54.0  | 0.0   | 34.9 | 52.7 | 0.0  | 0.0  | 36.6 | 0.0  | 19.7 |
| Incr Delay (d2), s/veh        | 797.5 | 0.2   | 0.2  | 11.6  | 0.0   | 6.3  | 4.7  | 0.0  | 0.0  | 0.2  | 0.0  | 0.2  |
| Initial Q Delay(d3),s/veh     | 0.0   | 0.0   | 0.0  | 0.0   | 0.0   | 0.0  | 0.0  | 0.0  | 0.0  | 0.0  | 0.0  | 0.0  |
| %ile BackOfQ(50%),veh/ln      | 22.1  | 4.0   | 4.1  | 0.4   | 0.0   | 14.8 | 1.0  | 0.0  | 0.0  | 3.6  | 0.0  | 9.3  |
| LnGrp Delay(d),s/veh          | 837.3 | 11.4  | 11.4 | 65.6  | 0.0   | 41.2 | 57.4 | 0.0  | 0.0  | 36.8 | 0.0  | 20.0 |
| LnGrp LOS                     | F     | B     | B    | E     |       | D    | E    |      |      | D    |      | B    |
| Approach Vol, veh/h           |       | 1883  |      |       | 500   |      |      | 31   |      |      | 578  |      |
| Approach Delay, s/veh         |       | 599.1 |      |       | 41.8  |      |      | 57.4 |      |      | 24.0 |      |
| Approach LOS                  |       | F     |      |       | D     |      |      | E    |      |      | C    |      |
| Timer                         | 1     | 2     | 3    | 4     | 5     | 6    | 7    | 8    |      |      |      |      |
| Assigned Phs                  | 1     | 2     |      | 4     | 5     | 6    |      | 8    |      |      |      |      |
| Phs Duration (G+Y+Rc), s      | 5.0   | 68.9  |      | 28.6  | 33.8  | 40.2 |      | 7.1  |      |      |      |      |
| Change Period (Y+Rc), s       | 3.9   | 5.0   |      | 5.0   | * 3.8 | 5.0  |      | 4.0  |      |      |      |      |
| Max Green Setting (Gmax), s   | 30    | 60.0  |      | 30.0  | * 30  | 60.0 |      | 30.0 |      |      |      |      |
| Max Q Clear Time (g_c+1/2), s | 11.2  | 10.1  |      | 23.2  | 32.0  | 30.5 |      | 3.9  |      |      |      |      |
| Green Ext Time (p_c), s       | 0.0   | 5.1   |      | 0.4   | 0.0   | 4.7  |      | 0.0  |      |      |      |      |
| <b>Intersection Summary</b>   |       |       |      |       |       |      |      |      |      |      |      |      |
| HCM 2010 Ctrl Delay           |       |       |      | 389.3 |       |      |      |      |      |      |      |      |
| HCM 2010 LOS                  |       |       |      | F     |       |      |      |      |      |      |      |      |
| <b>Notes</b>                  |       |       |      |       |       |      |      |      |      |      |      |      |



HCM 2010 Signalized Intersection Summary  
 29: 2nd Avenue & Divarty Street

Cumulative with Project, PM  
 06/11/2019



| Movement                     | EBL  | EBT  | EBR  | WBL  | WBT  | WBR  | NBL  | NBT  | NBR  | SBL  | SBT  | SBR  |
|------------------------------|------|------|------|------|------|------|------|------|------|------|------|------|
| Lane Configurations          |      | ↕    |      |      | ↕    | ↕    | ↕    | ↕↔   |      | ↕    | ↕↔   |      |
| Traffic Volume (veh/h)       | 200  | 10   | 80   | 140  | 10   | 30   | 40   | 660  | 110  | 30   | 630  | 100  |
| Future Volume (veh/h)        | 200  | 10   | 80   | 140  | 10   | 30   | 40   | 660  | 110  | 30   | 630  | 100  |
| Number                       | 5    | 2    | 12   | 1    | 6    | 16   | 3    | 8    | 18   | 7    | 4    | 14   |
| Initial Q (Qb), veh          | 0    | 0    | 0    | 0    | 0    | 0    | 0    | 0    | 0    | 0    | 0    | 0    |
| Ped-Bike Adj(A_pbT)          | 1.00 |      | 1.00 | 1.00 |      | 1.00 | 1.00 |      | 0.99 | 1.00 |      | 0.99 |
| Parking Bus, Adj             | 1.00 | 1.00 | 1.00 | 1.00 | 1.00 | 1.00 | 1.00 | 1.00 | 1.00 | 1.00 | 1.00 | 1.00 |
| Adj Sat Flow, veh/h/ln       | 1900 | 1900 | 1900 | 1900 | 1900 | 1900 | 1900 | 1900 | 1900 | 1881 | 1881 | 1900 |
| Adj Flow Rate, veh/h         | 213  | 11   | 85   | 149  | 11   | 32   | 43   | 702  | 117  | 32   | 670  | 106  |
| Adj No. of Lanes             | 0    | 1    | 0    | 0    | 1    | 1    | 1    | 2    | 0    | 1    | 2    | 0    |
| Peak Hour Factor             | 0.94 | 0.94 | 0.94 | 0.94 | 0.94 | 0.94 | 0.94 | 0.94 | 0.94 | 0.94 | 0.94 | 0.94 |
| Percent Heavy Veh, %         | 0    | 0    | 0    | 0    | 0    | 0    | 0    | 0    | 0    | 1    | 1    | 1    |
| Cap, veh/h                   | 382  | 37   | 113  | 572  | 38   | 558  | 81   | 1076 | 179  | 64   | 1046 | 165  |
| Arrive On Green              | 0.35 | 0.35 | 0.35 | 0.35 | 0.35 | 0.35 | 0.04 | 0.35 | 0.35 | 0.04 | 0.34 | 0.34 |
| Sat Flow, veh/h              | 752  | 107  | 326  | 1249 | 108  | 1608 | 1810 | 3095 | 515  | 1792 | 3090 | 488  |
| Grp Volume(v), veh/h         | 309  | 0    | 0    | 160  | 0    | 32   | 43   | 409  | 410  | 32   | 387  | 389  |
| Grp Sat Flow(s),veh/h/ln     | 1185 | 0    | 0    | 1358 | 0    | 1608 | 1810 | 1805 | 1806 | 1792 | 1787 | 1792 |
| Q Serve(g_s), s              | 8.6  | 0.0  | 0.0  | 0.0  | 0.0  | 0.7  | 1.2  | 9.6  | 9.6  | 0.9  | 9.2  | 9.2  |
| Cycle Q Clear(g_c), s        | 12.9 | 0.0  | 0.0  | 4.3  | 0.0  | 0.7  | 1.2  | 9.6  | 9.6  | 0.9  | 9.2  | 9.2  |
| Prop In Lane                 | 0.69 |      | 0.28 | 0.93 |      | 1.00 | 1.00 |      | 0.29 | 1.00 |      | 0.27 |
| Lane Grp Cap(c), veh/h       | 532  | 0    | 0    | 610  | 0    | 558  | 81   | 628  | 628  | 64   | 605  | 607  |
| V/C Ratio(X)                 | 0.58 | 0.00 | 0.00 | 0.26 | 0.00 | 0.06 | 0.53 | 0.65 | 0.65 | 0.50 | 0.64 | 0.64 |
| Avail Cap(c_a), veh/h        | 1044 | 0    | 0    | 1084 | 0    | 1124 | 416  | 1442 | 1443 | 412  | 1250 | 1253 |
| HCM Platoon Ratio            | 1.00 | 1.00 | 1.00 | 1.00 | 1.00 | 1.00 | 1.00 | 1.00 | 1.00 | 1.00 | 1.00 | 1.00 |
| Upstream Filter(I)           | 1.00 | 0.00 | 0.00 | 1.00 | 0.00 | 1.00 | 1.00 | 1.00 | 1.00 | 1.00 | 1.00 | 1.00 |
| Uniform Delay (d), s/veh     | 16.0 | 0.0  | 0.0  | 12.1 | 0.0  | 10.9 | 23.4 | 13.8 | 13.8 | 23.7 | 14.0 | 14.0 |
| Incr Delay (d2), s/veh       | 1.0  | 0.0  | 0.0  | 0.2  | 0.0  | 0.0  | 5.2  | 1.2  | 1.2  | 5.8  | 1.1  | 1.1  |
| Initial Q Delay(d3),s/veh    | 0.0  | 0.0  | 0.0  | 0.0  | 0.0  | 0.0  | 0.0  | 0.0  | 0.0  | 0.0  | 0.0  | 0.0  |
| %ile BackOfQ(50%),veh/ln     | 4.0  | 0.0  | 0.0  | 1.6  | 0.0  | 0.3  | 0.7  | 4.9  | 5.0  | 0.5  | 4.7  | 4.7  |
| LnGrp Delay(d),s/veh         | 17.0 | 0.0  | 0.0  | 12.3 | 0.0  | 10.9 | 28.6 | 14.9 | 14.9 | 29.5 | 15.1 | 15.1 |
| LnGrp LOS                    | B    |      |      | B    |      | B    | C    | B    | B    | C    | B    | B    |
| Approach Vol, veh/h          |      | 309  |      |      | 192  |      |      | 862  |      |      | 808  |      |
| Approach Delay, s/veh        |      | 17.0 |      |      | 12.1 |      |      | 15.6 |      |      | 15.7 |      |
| Approach LOS                 |      | B    |      |      | B    |      |      | B    |      |      | B    |      |
| Timer                        | 1    | 2    | 3    | 4    | 5    | 6    | 7    | 8    |      |      |      |      |
| Assigned Phs                 |      | 2    | 3    | 4    |      | 6    | 7    | 8    |      |      |      |      |
| Phs Duration (G+Y+Rc), s     |      | 22.4 | 5.8  | 21.9 |      | 22.4 | 5.3  | 22.4 |      |      |      |      |
| Change Period (Y+Rc), s      |      | 5.0  | 3.5  | 5.0  |      | 5.0  | 3.5  | 5.0  |      |      |      |      |
| Max Green Setting (Gmax), s  |      | 35.0 | 11.5 | 35.0 |      | 35.0 | 11.5 | 40.0 |      |      |      |      |
| Max Q Clear Time (g_c+I1), s |      | 14.9 | 3.2  | 11.2 |      | 6.3  | 2.9  | 11.6 |      |      |      |      |
| Green Ext Time (p_c), s      |      | 1.8  | 0.0  | 5.0  |      | 1.0  | 0.0  | 5.5  |      |      |      |      |
| <b>Intersection Summary</b>  |      |      |      |      |      |      |      |      |      |      |      |      |
| HCM 2010 Ctrl Delay          |      |      |      | 15.5 |      |      |      |      |      |      |      |      |
| HCM 2010 LOS                 |      |      |      | B    |      |      |      |      |      |      |      |      |

| Intersection              |    |
|---------------------------|----|
| Intersection Delay, s/veh | 10 |
| Intersection LOS          | A  |

| Movement            | EBL  | EBT  | EBR  | WBL  | WBT  | WBR  | NBL  | NBT  | NBR  | SBL  | SBT  | SBR  |
|---------------------|------|------|------|------|------|------|------|------|------|------|------|------|
| Lane Configurations |      | ↕    |      |      | ↕    |      | ↕    | ↕    |      | ↕    | ↕    |      |
| Traffic Vol, veh/h  | 20   | 10   | 40   | 10   | 10   | 10   | 30   | 180  | 10   | 10   | 220  | 20   |
| Future Vol, veh/h   | 20   | 10   | 40   | 10   | 10   | 10   | 30   | 180  | 10   | 10   | 220  | 20   |
| Peak Hour Factor    | 0.85 | 0.85 | 0.85 | 0.85 | 0.85 | 0.85 | 0.85 | 0.85 | 0.85 | 0.85 | 0.85 | 0.85 |
| Heavy Vehicles, %   | 0    | 0    | 0    | 1    | 1    | 1    | 0    | 0    | 0    | 1    | 1    | 1    |
| Mvmt Flow           | 24   | 12   | 47   | 12   | 12   | 12   | 35   | 212  | 12   | 12   | 259  | 24   |
| Number of Lanes     | 0    | 1    | 0    | 0    | 1    | 0    | 1    | 1    | 0    | 1    | 1    | 0    |

| Approach                   | EB  | WB  | NB  | SB   |
|----------------------------|-----|-----|-----|------|
| Opposing Approach          | WB  | EB  | SB  | NB   |
| Opposing Lanes             | 1   | 1   | 2   | 2    |
| Conflicting Approach Left  | SB  | NB  | EB  | WB   |
| Conflicting Lanes Left     | 2   | 2   | 1   | 1    |
| Conflicting Approach Right | NB  | SB  | WB  | EB   |
| Conflicting Lanes Right    | 2   | 2   | 1   | 1    |
| HCM Control Delay          | 8.7 | 8.6 | 9.8 | 10.8 |
| HCM LOS                    | A   | A   | A   | B    |

| Lane                   | NBLn1 | NBLn2 | EBLn1 | WBLn1 | SBLn1 | SBLn2 |
|------------------------|-------|-------|-------|-------|-------|-------|
| Vol Left, %            | 100%  | 0%    | 29%   | 33%   | 100%  | 0%    |
| Vol Thru, %            | 0%    | 95%   | 14%   | 33%   | 0%    | 92%   |
| Vol Right, %           | 0%    | 5%    | 57%   | 33%   | 0%    | 8%    |
| Sign Control           | Stop  | Stop  | Stop  | Stop  | Stop  | Stop  |
| Traffic Vol by Lane    | 30    | 190   | 70    | 30    | 10    | 240   |
| LT Vol                 | 30    | 0     | 20    | 10    | 10    | 0     |
| Through Vol            | 0     | 180   | 10    | 10    | 0     | 220   |
| RT Vol                 | 0     | 10    | 40    | 10    | 0     | 20    |
| Lane Flow Rate         | 35    | 224   | 82    | 35    | 12    | 282   |
| Geometry Grp           | 7     | 7     | 2     | 2     | 7     | 7     |
| Degree of Util (X)     | 0.054 | 0.311 | 0.114 | 0.051 | 0.018 | 0.391 |
| Departure Headway (Hd) | 5.554 | 5.014 | 4.978 | 5.223 | 5.548 | 4.986 |
| Convergence, Y/N       | Yes   | Yes   | Yes   | Yes   | Yes   | Yes   |
| Cap                    | 644   | 715   | 717   | 682   | 645   | 720   |
| Service Time           | 3.295 | 2.754 | 3.027 | 3.28  | 3.287 | 2.725 |
| HCM Lane V/C Ratio     | 0.054 | 0.313 | 0.114 | 0.051 | 0.019 | 0.392 |
| HCM Control Delay      | 8.6   | 10    | 8.7   | 8.6   | 8.4   | 10.9  |
| HCM Lane LOS           | A     | A     | A     | A     | A     | B     |
| HCM 95th-tile Q        | 0.2   | 1.3   | 0.4   | 0.2   | 0.1   | 1.9   |

HCM 2010 Signalized Intersection Summary  
 31: 1st Avenue & Lightfighter Drive

Cumulative with Project, PM  
 06/11/2019



| Movement                     | EBL  | EBT  | EBR  | WBL  | WBT  | WBR  | NBL  | NBT  | NBR  | SBL  | SBT  | SBR  |
|------------------------------|------|------|------|------|------|------|------|------|------|------|------|------|
| Lane Configurations          |      | ↑↑   | ↑    | ↑    | ↑↑   |      | ↑    |      | ↑    | ↑    | ↑    | ↑    |
| Traffic Volume (veh/h)       | 0    | 860  | 110  | 20   | 1500 | 0    | 200  | 0    | 30   | 60   | 50   | 80   |
| Future Volume (veh/h)        | 0    | 860  | 110  | 20   | 1500 | 0    | 200  | 0    | 30   | 60   | 50   | 80   |
| Number                       | 7    | 4    | 14   | 3    | 8    | 18   | 5    | 2    | 12   | 1    | 6    | 16   |
| Initial Q (Qb), veh          | 0    | 0    | 0    | 0    | 0    | 0    | 0    | 0    | 0    | 0    | 0    | 0    |
| Ped-Bike Adj(A_pbT)          | 1.00 |      | 1.00 | 1.00 |      | 1.00 | 1.00 |      | 1.00 | 1.00 |      | 1.00 |
| Parking Bus, Adj             | 1.00 | 1.00 | 1.00 | 1.00 | 1.00 | 1.00 | 1.00 | 1.00 | 1.00 | 1.00 | 1.00 | 1.00 |
| Adj Sat Flow, veh/h/ln       | 0    | 1881 | 1881 | 1881 | 1881 | 0    | 1881 | 0    | 1881 | 1810 | 1810 | 1810 |
| Adj Flow Rate, veh/h         | 0    | 905  | 0    | 21   | 1579 | 0    | 211  | 0    | 14   | 63   | 53   | 64   |
| Adj No. of Lanes             | 0    | 2    | 1    | 1    | 2    | 0    | 1    | 0    | 1    | 1    | 1    | 1    |
| Peak Hour Factor             | 0.95 | 0.95 | 0.95 | 0.95 | 0.95 | 0.95 | 0.95 | 0.95 | 0.95 | 0.95 | 0.95 | 0.95 |
| Percent Heavy Veh, %         | 0    | 1    | 1    | 1    | 1    | 0    | 1    | 0    | 1    | 5    | 5    | 5    |
| Cap, veh/h                   | 0    | 2239 | 1002 | 23   | 2561 | 0    | 0    | 0    | 0    | 140  | 147  | 125  |
| Arrive On Green              | 0.00 | 0.63 | 0.00 | 0.01 | 0.72 | 0.00 | 0.00 | 0.00 | 0.00 | 0.08 | 0.08 | 0.08 |
| Sat Flow, veh/h              | 0    | 3668 | 1599 | 1792 | 3668 | 0    |      | 0    |      | 1723 | 1810 | 1538 |
| Grp Volume(v), veh/h         | 0    | 905  | 0    | 21   | 1579 | 0    |      | 0.0  |      | 63   | 53   | 64   |
| Grp Sat Flow(s),veh/h/ln     | 0    | 1787 | 1599 | 1792 | 1787 | 0    |      |      |      | 1723 | 1810 | 1538 |
| Q Serve(g_s), s              | 0.0  | 5.8  | 0.0  | 0.5  | 10.2 | 0.0  |      |      |      | 1.6  | 1.3  | 1.8  |
| Cycle Q Clear(g_c), s        | 0.0  | 5.8  | 0.0  | 0.5  | 10.2 | 0.0  |      |      |      | 1.6  | 1.3  | 1.8  |
| Prop In Lane                 | 0.00 |      | 1.00 | 1.00 |      | 0.00 |      |      |      | 1.00 |      | 1.00 |
| Lane Grp Cap(c), veh/h       | 0    | 2239 | 1002 | 23   | 2561 | 0    |      |      |      | 140  | 147  | 125  |
| V/C Ratio(X)                 | 0.00 | 0.40 | 0.00 | 0.90 | 0.62 | 0.00 |      |      |      | 0.45 | 0.36 | 0.51 |
| Avail Cap(c_a), veh/h        | 0    | 3533 | 1580 | 787  | 3533 | 0    |      |      |      | 946  | 994  | 845  |
| HCM Platoon Ratio            | 1.00 | 1.00 | 1.00 | 1.00 | 1.00 | 1.00 |      |      |      | 1.00 | 1.00 | 1.00 |
| Upstream Filter(I)           | 0.00 | 1.00 | 0.00 | 1.00 | 1.00 | 0.00 |      |      |      | 1.00 | 1.00 | 1.00 |
| Uniform Delay (d), s/veh     | 0.0  | 4.3  | 0.0  | 22.4 | 3.3  | 0.0  |      |      |      | 19.9 | 19.8 | 20.0 |
| Incr Delay (d2), s/veh       | 0.0  | 0.2  | 0.0  | 32.4 | 0.3  | 0.0  |      |      |      | 0.8  | 0.5  | 1.2  |
| Initial Q Delay(d3),s/veh    | 0.0  | 0.0  | 0.0  | 0.0  | 0.0  | 0.0  |      |      |      | 0.0  | 0.0  | 0.0  |
| %ile BackOfQ(50%),veh/ln     | 0.0  | 2.8  | 0.0  | 0.5  | 4.9  | 0.0  |      |      |      | 0.8  | 0.7  | 0.8  |
| LnGrp Delay(d),s/veh         | 0.0  | 4.4  | 0.0  | 54.8 | 3.6  | 0.0  |      |      |      | 20.8 | 20.3 | 21.2 |
| LnGrp LOS                    |      | A    |      | D    | A    |      |      |      |      | C    | C    | C    |
| Approach Vol, veh/h          |      | 905  |      |      | 1600 |      |      |      |      |      | 180  |      |
| Approach Delay, s/veh        |      | 4.4  |      |      | 4.3  |      |      |      |      |      | 20.8 |      |
| Approach LOS                 |      | A    |      |      | A    |      |      |      |      |      | C    |      |
| Timer                        | 1    | 2    | 3    | 4    | 5    | 6    | 7    | 8    |      |      |      |      |
| Assigned Phs                 |      |      | 3    | 4    |      | 6    |      | 8    |      |      |      |      |
| Phs Duration (G+Y+Rc), s     |      |      | 4.1  | 33.1 |      | 8.3  |      | 37.2 |      |      |      |      |
| Change Period (Y+Rc), s      |      |      | 3.5  | 4.6  |      | 4.6  |      | 4.6  |      |      |      |      |
| Max Green Setting (Gmax), s  |      |      | 20.0 | 45.0 |      | 25.0 |      | 45.0 |      |      |      |      |
| Max Q Clear Time (g_c+I1), s |      |      | 2.5  | 7.8  |      | 3.8  |      | 12.2 |      |      |      |      |
| Green Ext Time (p_c), s      |      |      | 0.0  | 11.2 |      | 0.3  |      | 20.4 |      |      |      |      |
| <b>Intersection Summary</b>  |      |      |      |      |      |      |      |      |      |      |      |      |
| HCM 2010 Ctrl Delay          |      |      | 5.4  |      |      |      |      |      |      |      |      |      |
| HCM 2010 LOS                 |      |      | A    |      |      |      |      |      |      |      |      |      |

HCM 2010 Signalized Intersection Summary  
 32: 2nd Avenue & Lightfighter Drive

Cumulative with Project, PM  
 06/11/2019



| Movement                     | EBL   | EBT  | EBR  | WBL  | WBT  | WBR  | NBL  | NBT  | NBR  | SBL  | SBT  | SBR  |
|------------------------------|-------|------|------|------|------|------|------|------|------|------|------|------|
| Lane Configurations          |       |      |      |      |      |      |      |      |      |      |      |      |
| Traffic Volume (veh/h)       | 290   | 660  | 10   | 80   | 1230 | 220  | 20   | 20   | 50   | 230  | 30   | 330  |
| Future Volume (veh/h)        | 290   | 660  | 10   | 80   | 1230 | 220  | 20   | 20   | 50   | 230  | 30   | 330  |
| Number                       | 5     | 2    | 12   | 1    | 6    | 16   | 3    | 8    | 18   | 7    | 4    | 14   |
| Initial Q (Qb), veh          | 0     | 0    | 0    | 0    | 0    | 0    | 0    | 0    | 0    | 0    | 0    | 0    |
| Ped-Bike Adj(A_pbT)          | 1.00  |      | 1.00 | 1.00 |      | 1.00 | 1.00 |      | 0.99 | 1.00 |      | 0.99 |
| Parking Bus, Adj             | 1.00  | 1.00 | 1.00 | 1.00 | 1.00 | 1.00 | 1.00 | 1.00 | 1.00 | 1.00 | 1.00 | 1.00 |
| Adj Sat Flow, veh/h/ln       | 1881  | 1881 | 1900 | 1881 | 1881 | 1900 | 1900 | 1900 | 1900 | 1845 | 1845 | 1845 |
| Adj Flow Rate, veh/h         | 305   | 695  | 11   | 84   | 1295 | 227  | 21   | 21   | 47   | 242  | 32   | 244  |
| Adj No. of Lanes             | 1     | 2    | 0    | 1    | 2    | 0    | 0    | 1    | 0    | 1    | 1    | 1    |
| Peak Hour Factor             | 0.95  | 0.95 | 0.95 | 0.95 | 0.95 | 0.95 | 0.95 | 0.95 | 0.95 | 0.95 | 0.95 | 0.95 |
| Percent Heavy Veh, %         | 1     | 1    | 1    | 1    | 1    | 1    | 0    | 0    | 0    | 3    | 3    | 3    |
| Cap, veh/h                   | 222   | 2179 | 34   | 108  | 1648 | 286  | 95   | 100  | 168  | 349  | 374  | 316  |
| Arrive On Green              | 0.12  | 0.61 | 0.61 | 0.06 | 0.54 | 0.54 | 0.20 | 0.20 | 0.20 | 0.20 | 0.20 | 0.20 |
| Sat Flow, veh/h              | 1792  | 3601 | 57   | 1792 | 3045 | 529  | 249  | 493  | 831  | 1308 | 1845 | 1559 |
| Grp Volume(v), veh/h         | 305   | 345  | 361  | 84   | 755  | 767  | 89   | 0    | 0    | 242  | 32   | 244  |
| Grp Sat Flow(s),veh/h/ln     | 1792  | 1787 | 1871 | 1792 | 1787 | 1787 | 1573 | 0    | 0    | 1308 | 1845 | 1559 |
| Q Serve(g_s), s              | 12.4  | 9.4  | 9.4  | 4.6  | 33.6 | 34.5 | 0.0  | 0.0  | 0.0  | 12.7 | 1.4  | 14.8 |
| Cycle Q Clear(g_c), s        | 12.4  | 9.4  | 9.4  | 4.6  | 33.6 | 34.5 | 4.3  | 0.0  | 0.0  | 17.0 | 1.4  | 14.8 |
| Prop In Lane                 | 1.00  |      | 0.03 | 1.00 |      | 0.30 | 0.24 |      | 0.53 | 1.00 |      | 1.00 |
| Lane Grp Cap(c), veh/h       | 222   | 1081 | 1132 | 108  | 967  | 967  | 364  | 0    | 0    | 349  | 374  | 316  |
| V/C Ratio(X)                 | 1.37  | 0.32 | 0.32 | 0.78 | 0.78 | 0.79 | 0.24 | 0.00 | 0.00 | 0.69 | 0.09 | 0.77 |
| Avail Cap(c_a), veh/h        | 222   | 1081 | 1132 | 222  | 967  | 967  | 666  | 0    | 0    | 612  | 745  | 630  |
| HCM Platoon Ratio            | 1.00  | 1.00 | 1.00 | 1.00 | 1.00 | 1.00 | 1.00 | 1.00 | 1.00 | 1.00 | 1.00 | 1.00 |
| Upstream Filter(I)           | 0.88  | 0.88 | 0.88 | 0.24 | 0.24 | 0.24 | 1.00 | 0.00 | 0.00 | 0.77 | 0.77 | 0.77 |
| Uniform Delay (d), s/veh     | 43.8  | 9.7  | 9.7  | 46.4 | 18.2 | 18.4 | 33.5 | 0.0  | 0.0  | 38.3 | 32.3 | 37.7 |
| Incr Delay (d2), s/veh       | 190.8 | 0.7  | 0.7  | 1.1  | 1.6  | 1.7  | 0.1  | 0.0  | 0.0  | 0.7  | 0.0  | 1.2  |
| Initial Q Delay(d3),s/veh    | 0.0   | 0.0  | 0.0  | 0.0  | 0.0  | 0.0  | 0.0  | 0.0  | 0.0  | 0.0  | 0.0  | 0.0  |
| %ile BackOfQ(50%),veh/ln     | 7.9   | 4.8  | 5.0  | 2.3  | 16.8 | 17.3 | 2.1  | 0.0  | 0.0  | 6.5  | 0.7  | 6.5  |
| LnGrp Delay(d),s/veh         | 234.6 | 10.3 | 10.3 | 47.5 | 19.8 | 20.1 | 33.6 | 0.0  | 0.0  | 39.0 | 32.4 | 38.8 |
| LnGrp LOS                    | F     | B    | B    | D    | B    | C    | C    |      |      | D    | C    | D    |
| Approach Vol, veh/h          |       | 1011 |      |      | 1606 |      |      | 89   |      |      | 518  |      |
| Approach Delay, s/veh        |       | 78.0 |      |      | 21.4 |      |      | 33.6 |      |      | 38.5 |      |
| Approach LOS                 |       | E    |      |      | C    |      |      | C    |      |      | D    |      |
| Timer                        | 1     | 2    | 3    | 4    | 5    | 6    | 7    | 8    |      |      |      |      |
| Assigned Phs                 | 1     | 2    |      | 4    | 5    | 6    |      | 8    |      |      |      |      |
| Phs Duration (G+Y+Rc), s     | 40.0  | 65.1 |      | 24.9 | 16.4 | 58.7 |      | 24.9 |      |      |      |      |
| Change Period (Y+Rc), s      | 4.0   | 4.6  |      | 4.6  | 4.0  | 4.6  |      | 4.6  |      |      |      |      |
| Max Green Setting (Gmax), s  | 40.0  | 34.0 |      | 40.4 | 12.4 | 24.4 |      | 40.4 |      |      |      |      |
| Max Q Clear Time (g_c+10), s | 10.0  | 11.4 |      | 19.0 | 14.4 | 36.5 |      | 6.3  |      |      |      |      |
| Green Ext Time (p_c), s      | 0.0   | 2.5  |      | 0.9  | 0.0  | 0.0  |      | 0.3  |      |      |      |      |
| <b>Intersection Summary</b>  |       |      |      |      |      |      |      |      |      |      |      |      |
| HCM 2010 Ctrl Delay          |       |      |      | 42.2 |      |      |      |      |      |      |      |      |
| HCM 2010 LOS                 |       |      |      | D    |      |      |      |      |      |      |      |      |

HCM 2010 Signalized Intersection Summary  
 33: General Jim Moore Boulevard & Lightfighter Drive



Cumulative with Project, PM  
 06/11/2019



| Movement                     | EBL  | EBT  | EBR  | WBL  | WBT  | WBR  | NBL  | NBT  | NBR  | SBL  | SBT  | SBR  |
|------------------------------|------|------|------|------|------|------|------|------|------|------|------|------|
| Lane Configurations          |      |      |      |      |      |      |      |      |      |      |      |      |
| Traffic Volume (veh/h)       | 50   | 280  | 690  | 40   | 250  | 50   | 670  | 70   | 20   | 60   | 100  | 40   |
| Future Volume (veh/h)        | 50   | 280  | 690  | 40   | 250  | 50   | 670  | 70   | 20   | 60   | 100  | 40   |
| Number                       | 3    | 8    | 18   | 7    | 4    | 14   | 1    | 6    | 16   | 5    | 2    | 12   |
| Initial Q (Qb), veh          | 0    | 0    | 0    | 0    | 0    | 0    | 0    | 0    | 0    | 0    | 0    | 0    |
| Ped-Bike Adj(A_pbT)          | 1.00 |      | 1.00 | 1.00 |      | 1.00 | 1.00 |      | 1.00 | 1.00 |      | 1.00 |
| Parking Bus, Adj             | 1.00 | 1.00 | 1.00 | 1.00 | 1.00 | 1.00 | 1.00 | 1.00 | 1.00 | 1.00 | 1.00 | 1.00 |
| Adj Sat Flow, veh/h/ln       | 1881 | 1881 | 1881 | 1900 | 1900 | 1900 | 1881 | 1881 | 1900 | 1900 | 1900 | 1900 |
| Adj Flow Rate, veh/h         | 52   | 292  | 0    | 42   | 260  | 51   | 698  | 73   | 19   | 62   | 104  | -70  |
| Adj No. of Lanes             | 1    | 1    | 1    | 1    | 1    | 0    | 2    | 1    | 0    | 1    | 2    | 0    |
| Peak Hour Factor             | 0.96 | 0.96 | 0.96 | 0.96 | 0.96 | 0.96 | 0.96 | 0.96 | 0.96 | 0.96 | 0.96 | 0.96 |
| Percent Heavy Veh, %         | 1    | 1    | 1    | 0    | 0    | 0    | 1    | 1    | 1    | 0    | 0    | 0    |
| Cap, veh/h                   | 75   | 468  | 398  | 65   | 375  | 74   | 731  | 417  | 109  | 85   | 456  | 0    |
| Arrive On Green              | 0.04 | 0.25 | 0.00 | 0.04 | 0.24 | 0.24 | 0.21 | 0.29 | 0.29 | 0.05 | 0.13 | 0.00 |
| Sat Flow, veh/h              | 1792 | 1881 | 1599 | 1810 | 1544 | 303  | 3476 | 1440 | 375  | 1810 | 3705 | 0    |
| Grp Volume(v), veh/h         | 52   | 292  | 0    | 42   | 0    | 311  | 698  | 0    | 92   | 62   | 34   | 0    |
| Grp Sat Flow(s),veh/h/ln     | 1792 | 1881 | 1599 | 1810 | 0    | 1847 | 1738 | 0    | 1815 | 1810 | 1805 | 0    |
| Q Serve(g_s), s              | 1.4  | 6.6  | 0.0  | 1.1  | 0.0  | 7.3  | 9.4  | 0.0  | 1.8  | 1.6  | 0.4  | 0.0  |
| Cycle Q Clear(g_c), s        | 1.4  | 6.6  | 0.0  | 1.1  | 0.0  | 7.3  | 9.4  | 0.0  | 1.8  | 1.6  | 0.4  | 0.0  |
| Prop In Lane                 | 1.00 |      | 1.00 | 1.00 |      | 0.16 | 1.00 |      | 0.21 | 1.00 |      | 0.00 |
| Lane Grp Cap(c), veh/h       | 75   | 468  | 398  | 65   | 0    | 449  | 731  | 0    | 525  | 85   | 456  | 0    |
| V/C Ratio(X)                 | 0.69 | 0.62 | 0.00 | 0.65 | 0.00 | 0.69 | 0.95 | 0.00 | 0.18 | 0.73 | 0.07 | 0.00 |
| Avail Cap(c_a), veh/h        | 754  | 1187 | 1009 | 761  | 0    | 1165 | 731  | 0    | 1145 | 571  | 2278 | 0    |
| HCM Platoon Ratio            | 1.00 | 1.00 | 1.00 | 1.00 | 1.00 | 1.00 | 1.00 | 1.00 | 1.00 | 1.00 | 1.00 | 1.00 |
| Upstream Filter(I)           | 1.00 | 1.00 | 0.00 | 1.00 | 0.00 | 1.00 | 1.00 | 0.00 | 1.00 | 1.00 | 1.00 | 0.00 |
| Uniform Delay (d), s/veh     | 22.5 | 15.9 | 0.0  | 22.6 | 0.0  | 16.4 | 18.5 | 0.0  | 12.6 | 22.4 | 18.3 | 0.0  |
| Incr Delay (d2), s/veh       | 10.9 | 1.6  | 0.0  | 4.0  | 0.0  | 2.3  | 22.7 | 0.0  | 0.3  | 4.4  | 0.1  | 0.0  |
| Initial Q Delay(d3),s/veh    | 0.0  | 0.0  | 0.0  | 0.0  | 0.0  | 0.0  | 0.0  | 0.0  | 0.0  | 0.0  | 0.0  | 0.0  |
| %ile BackOfQ(50%),veh/ln     | 0.9  | 3.6  | 0.0  | 0.6  | 0.0  | 4.0  | 6.8  | 0.0  | 0.9  | 0.9  | 0.2  | 0.0  |
| LnGrp Delay(d),s/veh         | 33.4 | 17.5 | 0.0  | 26.6 | 0.0  | 18.7 | 41.3 | 0.0  | 13.0 | 26.7 | 18.4 | 0.0  |
| LnGrp LOS                    | C    | B    |      | C    |      | B    | D    |      | B    | C    | B    |      |
| Approach Vol, veh/h          |      | 344  |      |      | 353  |      |      | 790  |      |      | 96   |      |
| Approach Delay, s/veh        |      | 19.9 |      |      | 19.6 |      |      | 38.0 |      |      | 23.8 |      |
| Approach LOS                 |      | B    |      |      | B    |      |      | D    |      |      | C    |      |
| Timer                        | 1    | 2    | 3    | 4    | 5    | 6    | 7    | 8    |      |      |      |      |
| Assigned Phs                 | 1    | 2    | 3    | 4    | 5    | 6    | 7    | 8    |      |      |      |      |
| Phs Duration (G+Y+Rc), s     | 4.5  | 10.5 | 6.5  | 16.1 | 6.7  | 18.3 | 6.2  | 16.3 |      |      |      |      |
| Change Period (Y+Rc), s      | 4.5  | 4.5  | 4.5  | 4.5  | 4.5  | 4.5  | 4.5  | 4.5  |      |      |      |      |
| Max Green Setting (Gmax), s  | 30.0 | 30.0 | 20.0 | 30.0 | 15.0 | 30.0 | 20.0 | 30.0 |      |      |      |      |
| Max Q Clear Time (g_c+I1), s | 4.5  | 2.4  | 3.4  | 9.3  | 3.6  | 3.8  | 3.1  | 8.6  |      |      |      |      |
| Green Ext Time (p_c), s      | 0.0  | 0.1  | 0.1  | 2.3  | 0.0  | 0.8  | 0.0  | 1.8  |      |      |      |      |
| <b>Intersection Summary</b>  |      |      |      |      |      |      |      |      |      |      |      |      |
| HCM 2010 Ctrl Delay          |      |      |      | 29.1 |      |      |      |      |      |      |      |      |
| HCM 2010 LOS                 |      |      |      | C    |      |      |      |      |      |      |      |      |

**Intersection**

Intersection Delay, s/veh 12.1  
 Intersection LOS B

| Movement            | WBL   | WBR  | NBT   | NBR  | SBL  | SBT   |
|---------------------|---|------|---|------|------|---|
| Lane Configurations |  |      |  |      |      |  |
| Traffic Vol, veh/h  | 10  | 250  | 90  | 20   | 270  | 90  |
| Future Vol, veh/h   | 10  | 250  | 90  | 20   | 270  | 90  |
| Peak Hour Factor    | 0.88  | 0.88 | 0.88  | 0.88 | 0.88 | 0.88  |
| Heavy Vehicles, %   | 0   | 0    | 2   | 2    | 1    | 1   |
| Mvmt Flow           | 11  | 284  | 102   | 23   | 307  | 102   |
| Number of Lanes     | 1   | 0    | 1   | 0    | 0    | 1   |

| Approach                      | WB   | NB  | SB   |
|-------------------------------|------|-----|------|
| Opposing Approach             |      | SB  | NB   |
| Opposing Lanes                | 0    | 1   | 1    |
| Conflicting Approach Left NB  |      |     | WB   |
| Conflicting Lanes Left        | 1    | 0   | 1    |
| Conflicting Approach Right SB |      | WB  |      |
| Conflicting Lanes Right       | 1    | 1   | 0    |
| HCM Control Delay             | 10.5 | 9.2 | 14.1 |
| HCM LOS                       | B    | A   | B    |

| Lane                   | NBLn1 | WBLn1 | SBLn1 |
|------------------------|-------|-------|-------|
| Vol Left, %            | 0%    | 4%    | 75%   |
| Vol Thru, %            | 82%   | 0%    | 25%   |
| Vol Right, %           | 18%   | 96%   | 0%    |
| Sign Control           | Stop  | Stop  | Stop  |
| Traffic Vol by Lane    | 110   | 260   | 360   |
| LT Vol                 | 0     | 10    | 270   |
| Through Vol            | 90    | 0     | 90    |
| RT Vol                 | 20    | 250   | 0     |
| Lane Flow Rate         | 125   | 295   | 409   |
| Geometry Grp           | 1     | 1     | 1     |
| Degree of Util (X)     | 0.175 | 0.38  | 0.558 |
| Departure Headway (Hd) | 5.031 | 4.625 | 4.913 |
| Convergence, Y/N       | Yes   | Yes   | Yes   |
| Cap                    | 704   | 771   | 728   |
| Service Time           | 3.128 | 2.689 | 2.992 |
| HCM Lane V/C Ratio     | 0.178 | 0.383 | 0.562 |
| HCM Control Delay      | 9.2   | 10.5  | 14.1  |
| HCM Lane LOS           | A     | B     | B     |
| HCM 95th-tile Q        | 0.6   | 1.8   | 3.5   |

| Intersection             |      |      |      |      |      |      |
|--------------------------|------|------|------|------|------|------|
| Int Delay, s/veh         | 1.9  |      |      |      |      |      |
| Movement                 | EBT  | EBR  | WBL  | WBT  | NBL  | NBR  |
| Lane Configurations      |      |      |      |      |      |      |
| Traffic Vol, veh/h       | 250  | 50   | 30   | 220  | 40   | 30   |
| Future Vol, veh/h        | 250  | 50   | 30   | 220  | 40   | 30   |
| Conflicting Peds, #/hr   | 0    | 0    | 0    | 0    | 0    | 0    |
| Sign Control             | Free | Free | Free | Free | Stop | Stop |
| RT Channelized           | -    | None | -    | None | -    | None |
| Storage Length           | -    | -    | -    | -    | 0    | -    |
| Veh in Median Storage, # | 0    | -    | -    | 0    | 0    | -    |
| Grade, %                 | 0    | -    | -    | 0    | 0    | -    |
| Peak Hour Factor         | 85   | 85   | 85   | 85   | 85   | 85   |
| Heavy Vehicles, %        | 0    | 0    | 0    | 0    | 0    | 0    |
| Mvmt Flow                | 294  | 59   | 35   | 259  | 47   | 35   |

| Major/Minor          | Major1 | Major2 | Minor1 | Minor2 | Minor3 |
|----------------------|--------|--------|--------|--------|--------|
| Conflicting Flow All | 0      | 0      | 353    | 0      | 653    |
| Stage 1              | -      | -      | -      | -      | 324    |
| Stage 2              | -      | -      | -      | -      | 329    |
| Critical Hdwy        | -      | -      | 4.1    | -      | 6.4    |
| Critical Hdwy Stg 1  | -      | -      | -      | -      | 5.4    |
| Critical Hdwy Stg 2  | -      | -      | -      | -      | 5.4    |
| Follow-up Hdwy       | -      | -      | 2.2    | -      | 3.5    |
| Pot Cap-1 Maneuver   | -      | -      | 1217   | -      | 435    |
| Stage 1              | -      | -      | -      | -      | 738    |
| Stage 2              | -      | -      | -      | -      | 734    |
| Platoon blocked, %   | -      | -      | -      | -      | -      |
| Mov Cap-1 Maneuver   | -      | -      | 1217   | -      | 420    |
| Mov Cap-2 Maneuver   | -      | -      | -      | -      | 420    |
| Stage 1              | -      | -      | -      | -      | 713    |
| Stage 2              | -      | -      | -      | -      | 734    |

| Approach             | EB | WB | NB   |
|----------------------|----|----|------|
| HCM Control Delay, s | 0  | 1  | 13.4 |
| HCM LOS              |    |    | B    |

| Minor Lane/Major Mvmt | NBLn1 | EBT | EBR | WBL   | WBT |
|-----------------------|-------|-----|-----|-------|-----|
| Capacity (veh/h)      | 512   | -   | -   | 1217  | -   |
| HCM Lane V/C Ratio    | 0.161 | -   | -   | 0.029 | -   |
| HCM Control Delay (s) | 13.4  | -   | -   | 8     | 0   |
| HCM Lane LOS          | B     | -   | -   | A     | A   |
| HCM 95th %tile Q(veh) | 0.6   | -   | -   | 0.1   | -   |

| Intersection              |    |
|---------------------------|----|
| Intersection Delay, s/veh | 22 |
| Intersection LOS          | C  |

| Movement            | EBL  | EBT  | EBR  | WBL  | WBT  | WBR  | NBL  | NBT  | NBR  | SBL  | SBT  | SBR  |
|---------------------|------|------|------|------|------|------|------|------|------|------|------|------|
| Lane Configurations |      | ↕    |      |      | ↕    |      |      | ↕    |      |      | ↕    |      |
| Traffic Vol, veh/h  | 10   | 200  | 60   | 30   | 180  | 10   | 50   | 230  | 20   | 10   | 220  | 30   |
| Future Vol, veh/h   | 10   | 200  | 60   | 30   | 180  | 10   | 50   | 230  | 20   | 10   | 220  | 30   |
| Peak Hour Factor    | 0.82 | 0.82 | 0.82 | 0.82 | 0.82 | 0.82 | 0.82 | 0.82 | 0.82 | 0.82 | 0.82 | 0.82 |
| Heavy Vehicles, %   | 0    | 0    | 0    | 0    | 0    | 0    | 2    | 2    | 2    | 0    | 0    | 0    |
| Mvmt Flow           | 12   | 244  | 73   | 37   | 220  | 12   | 61   | 280  | 24   | 12   | 268  | 37   |
| Number of Lanes     | 0    | 1    | 0    | 0    | 1    | 0    | 0    | 1    | 0    | 0    | 1    | 0    |

| Approach                   | EB   | WB   | NB   | SB |
|----------------------------|------|------|------|----|
| Opposing Approach          | WB   | EB   | SB   | NB |
| Opposing Lanes             | 1    | 1    | 1    | 1  |
| Conflicting Approach Left  | SB   | NB   | EB   | WB |
| Conflicting Lanes Left     | 1    | 1    | 1    | 1  |
| Conflicting Approach Right | NB   | SB   | WB   | EB |
| Conflicting Lanes Right    | 1    | 1    | 1    | 1  |
| HCM Control Delay          | 21.8 | 18.8 | 25.5 | 21 |
| HCM LOS                    | C    | C    | D    | C  |

| Lane                   | NBLn1 | EBLn1 | WBLn1 | SBLn1 |
|------------------------|-------|-------|-------|-------|
| Vol Left, %            | 17%   | 4%    | 14%   | 4%    |
| Vol Thru, %            | 77%   | 74%   | 82%   | 85%   |
| Vol Right, %           | 7%    | 22%   | 5%    | 12%   |
| Sign Control           | Stop  | Stop  | Stop  | Stop  |
| Traffic Vol by Lane    | 300   | 270   | 220   | 260   |
| LT Vol                 | 50    | 10    | 30    | 10    |
| Through Vol            | 230   | 200   | 180   | 220   |
| RT Vol                 | 20    | 60    | 10    | 30    |
| Lane Flow Rate         | 366   | 329   | 268   | 317   |
| Geometry Grp           | 1     | 1     | 1     | 1     |
| Degree of Util (X)     | 0.71  | 0.64  | 0.544 | 0.62  |
| Departure Headway (Hd) | 6.982 | 6.999 | 7.301 | 7.038 |
| Convergence, Y/N       | Yes   | Yes   | Yes   | Yes   |
| Cap                    | 516   | 514   | 491   | 510   |
| Service Time           | 5.052 | 5.071 | 5.377 | 5.112 |
| HCM Lane V/C Ratio     | 0.709 | 0.64  | 0.546 | 0.622 |
| HCM Control Delay      | 25.5  | 21.8  | 18.8  | 21    |
| HCM Lane LOS           | D     | C     | C     | C     |
| HCM 95th-tile Q        | 5.6   | 4.5   | 3.2   | 4.2   |



| Intersection             |      |      |      |      |      |      |      |      |      |      |      |      |
|--------------------------|------|------|------|------|------|------|------|------|------|------|------|------|
| Int Delay, s/veh         | 18.5 |      |      |      |      |      |      |      |      |      |      |      |
| Movement                 | EBL  | EBT  | EBR  | WBL  | WBT  | WBR  | NBL  | NBT  | NBR  | SBL  | SBT  | SBR  |
| Lane Configurations      |      | ↕    |      |      | ↕    |      |      | ↕    |      |      | ↕    |      |
| Traffic Vol, veh/h       | 70   | 110  | 50   | 30   | 90   | 10   | 90   | 210  | 20   | 0    | 0    | 0    |
| Future Vol, veh/h        | 70   | 110  | 50   | 30   | 90   | 10   | 90   | 210  | 20   | 0    | 0    | 0    |
| Conflicting Peds, #/hr   | 0    | 0    | 0    | 0    | 0    | 0    | 0    | 0    | 0    | 0    | 0    | 0    |
| Sign Control             | Stop | Stop | Stop | Stop | Stop | Stop | Free | Free | Free | Free | Free | Free |
| RT Channelized           | -    | -    | None | -    | -    | None | -    | -    | None | -    | -    | None |
| Storage Length           | -    | -    | -    | -    | -    | -    | -    | -    | -    | -    | -    | -    |
| Veh in Median Storage, # | -    | 0    | -    | -    | 0    | -    | -    | 0    | -    | -    | 0    | -    |
| Grade, %                 | -    | 0    | -    | -    | 0    | -    | -    | 0    | -    | -    | 0    | -    |
| Peak Hour Factor         | 74   | 74   | 74   | 74   | 74   | 74   | 74   | 74   | 74   | 74   | 74   | 74   |
| Heavy Vehicles, %        | 3    | 3    | 3    | 2    | 2    | 2    | 3    | 3    | 3    | 8    | 8    | 8    |
| Mvmt Flow                | 95   | 149  | 68   | 41   | 122  | 14   | 122  | 284  | 27   | 0    | 0    | 0    |

| Major/Minor          | Minor2 |       | Minor1 |       | Major1 |       |       | Major2 |   |       |   |   |
|----------------------|--------|-------|--------|-------|--------|-------|-------|--------|---|-------|---|---|
| Conflicting Flow All | 611    | 556   | 1      | 652   | 543    | 298   | 1     | 0      | 0 | 311   | 0 | 0 |
| Stage 1              | 1      | 1     | -      | 542   | 542    | -     | -     | -      | - | -     | - | - |
| Stage 2              | 610    | 555   | -      | 110   | 1      | -     | -     | -      | - | -     | - | - |
| Critical Hdwy        | 7.13   | 6.53  | 6.23   | 7.12  | 6.52   | 6.22  | 4.13  | -      | - | 4.18  | - | - |
| Critical Hdwy Stg 1  | 6.13   | 5.53  | -      | 6.12  | 5.52   | -     | -     | -      | - | -     | - | - |
| Critical Hdwy Stg 2  | 6.13   | 5.53  | -      | 6.12  | 5.52   | -     | -     | -      | - | -     | - | - |
| Follow-up Hdwy       | 3.527  | 4.027 | 3.327  | 3.518 | 4.018  | 3.318 | 2.227 | -      | - | 2.272 | - | - |
| Pot Cap-1 Maneuver   | 404    | 438   | 1081   | 381   | 447    | 741   | 1615  | -      | - | 1216  | - | - |
| Stage 1              | 1019   | 893   | -      | 525   | 520    | -     | -     | -      | - | -     | - | - |
| Stage 2              | 480    | 512   | -      | 895   | 895    | -     | -     | -      | - | -     | - | - |
| Platoon blocked, %   |        |       |        |       |        |       |       | -      | - | -     | - | - |
| Mov Cap-1 Maneuver   | 284    | 398   | 1081   | 237   | 406    | 741   | 1615  | -      | - | 1216  | - | - |
| Mov Cap-2 Maneuver   | 284    | 398   | -      | 237   | 406    | -     | -     | -      | - | -     | - | - |
| Stage 1              | 925    | 893   | -      | 477   | 472    | -     | -     | -      | - | -     | - | - |
| Stage 2              | 318    | 465   | -      | 699   | 895    | -     | -     | -      | - | -     | - | - |

| Approach             | EB |  | WB   |  | NB  |  | SB |  |
|----------------------|----|--|------|--|-----|--|----|--|
| HCM Control Delay, s | 38 |  | 24.3 |  | 2.1 |  | 0  |  |
| HCM LOS              | E  |  | C    |  |     |  |    |  |

| Minor Lane/Major Mvmt | NBL   | NBT | NBR | EBLn1WBLn1 | SBL   | SBT  | SBR |
|-----------------------|-------|-----|-----|------------|-------|------|-----|
| Capacity (veh/h)      | 1615  | -   | -   | 404        | 359   | 1216 | -   |
| HCM Lane V/C Ratio    | 0.075 | -   | -   | 0.769      | 0.489 | -    | -   |
| HCM Control Delay (s) | 7.4   | 0   | -   | 38         | 24.3  | 0    | -   |
| HCM Lane LOS          | A     | A   | -   | E          | C     | A    | -   |
| HCM 95th %tile Q(veh) | 0.2   | -   | -   | 6.4        | 2.6   | 0    | -   |

| Intersection             |      |      |      |      |      |      |
|--------------------------|------|------|------|------|------|------|
| Int Delay, s/veh         | 4.7  |      |      |      |      |      |
| Movement                 | EBL  | EBR  | NBL  | NBT  | SBT  | SBR  |
| Lane Configurations      | T    |      | T    |      | T    |      |
| Traffic Vol, veh/h       | 130  | 10   | 10   | 450  | 380  | 120  |
| Future Vol, veh/h        | 130  | 10   | 10   | 450  | 380  | 120  |
| Conflicting Peds, #/hr   | 0    | 0    | 0    | 0    | 0    | 0    |
| Sign Control             | Stop | Stop | Free | Free | Free | Free |
| RT Channelized           | -    | None | -    | None | -    | None |
| Storage Length           | 0    | -    | -    | -    | -    | -    |
| Veh in Median Storage, # | 0    | -    | -    | 0    | 0    | -    |
| Grade, %                 | 0    | -    | -    | 0    | 0    | -    |
| Peak Hour Factor         | 88   | 88   | 88   | 88   | 88   | 88   |
| Heavy Vehicles, %        | 0    | 0    | 2    | 2    | 1    | 1    |
| Mvmt Flow                | 148  | 11   | 11   | 511  | 432  | 136  |























| Major/Minor          | Minor2 | Major1 |       | Major2 |   |
|----------------------|--------|--------|-------|--------|---|
| Conflicting Flow All | 1033   | 500    | 568   | 0      | 0 |
| Stage 1              | 500    | -      | -     | -      | - |
| Stage 2              | 533    | -      | -     | -      | - |
| Critical Hdwy        | 6.4    | 6.2    | 4.12  | -      | - |
| Critical Hdwy Stg 1  | 5.4    | -      | -     | -      | - |
| Critical Hdwy Stg 2  | 5.4    | -      | -     | -      | - |
| Follow-up Hdwy       | 3.5    | 3.3    | 2.218 | -      | - |
| Pot Cap-1 Maneuver   | 260    | 575    | 1004  | -      | - |
| Stage 1              | 613    | -      | -     | -      | - |
| Stage 2              | 593    | -      | -     | -      | - |
| Platoon blocked, %   |        |        |       | -      | - |
| Mov Cap-1 Maneuver   | 256    | 575    | 1004  | -      | - |
| Mov Cap-2 Maneuver   | 256    | -      | -     | -      | - |
| Stage 1              | 604    | -      | -     | -      | - |
| Stage 2              | 593    | -      | -     | -      | - |

| Approach             | EB   | NB  | SB |
|----------------------|------|-----|----|
| HCM Control Delay, s | 36.6 | 0.2 | 0  |
| HCM LOS              | E    |     |    |

| Minor Lane/Major Mvmt | NBL   | NBT | EBLn1 | SBT | SBR |
|-----------------------|-------|-----|-------|-----|-----|
| Capacity (veh/h)      | 1004  | -   | 267   | -   | -   |
| HCM Lane V/C Ratio    | 0.011 | -   | 0.596 | -   | -   |
| HCM Control Delay (s) | 8.6   | 0   | 36.6  | -   | -   |
| HCM Lane LOS          | A     | A   | E     | -   | -   |
| HCM 95th %tile Q(veh) | 0     | -   | 3.5   | -   | -   |

HCM 2010 Signalized Intersection Summary  
 39: General Jim Moore Boulevard & Gigling Road

Cumulative with Project, PM  
 06/11/2019

|                              |  |  |  |  |  |  |  |  |  |  |  |  |
|------------------------------|---|---|---|---|---|---|--|---|---|---|---|---|
| Movement                     | EBL   | EBT   | EBR   | WBL   | WBT   | WBR   | NBL  | NBT   | NBR   | SBL   | SBT   | SBR   |
| Lane Configurations          |  |  |   |  |  |  |  |  |  |  |  |  |
| Traffic Volume (veh/h)       | 20  | 20  | 30  | 290   | 50  | 380   | 60   | 340   | 460   | 400   | 350   | 50  |
| Future Volume (veh/h)        | 20  | 20  | 30  | 290   | 50  | 380   | 60   | 340   | 460   | 400   | 350   | 50  |
| Number                       | 3   | 8   | 18  | 7   | 4   | 14  | 1  | 6   | 16  | 5   | 2   | 12  |
| Initial Q (Qb), veh          | 0   | 0   | 0   | 0   | 0   | 0   | 0  | 0   | 0   | 0   | 0   | 0   |
| Ped-Bike Adj(A_pbT)          | 1.00  |   | 0.99  | 1.00  |   | 1.00  | 1.00   |   | 1.00  | 1.00  |   | 1.00  |
| Parking Bus, Adj             | 1.00  | 1.00  | 1.00  | 1.00  | 1.00  | 1.00  | 1.00   | 1.00  | 1.00  | 1.00  | 1.00  | 1.00  |
| Adj Sat Flow, veh/h/ln       | 1776  | 1776  | 1900  | 1881  | 1881  | 1881  | 1863   | 1863  | 1863  | 1863  | 1863  | 1863  |
| Adj Flow Rate, veh/h         | 22  | 22  | 3   | 326   | 56  | 0   | 67   | 382   | 0   | 449   | 393   | 0   |
| Adj No. of Lanes             | 1   | 2   | 0   | 1   | 2   | 1   | 1  | 2   | 1   | 1   | 2   | 1   |
| Peak Hour Factor             | 0.89  | 0.89  | 0.89  | 0.89  | 0.89  | 0.89  | 0.89   | 0.89  | 0.89  | 0.89  | 0.89  | 0.89  |
| Percent Heavy Veh, %         | 7   | 7   | 7   | 1   | 1   | 1   | 2  | 2   | 2   | 2   | 2   | 2   |
| Cap, veh/h                   | 44  | 255   | 34  | 381   | 972   | 435   | 105  | 557   | 249   | 356   | 1057  | 473   |
| Arrive On Green              | 0.03  | 0.09  | 0.09  | 0.21  | 0.27  | 0.00  | 0.06   | 0.16  | 0.00  | 0.20  | 0.30  | 0.00  |
| Sat Flow, veh/h              | 1691  | 2991  | 399   | 1792  | 3574  | 1599  | 1774   | 3539  | 1583  | 1774  | 3539  | 1583  |
| Grp Volume(v), veh/h         | 22  | 12  | 13  | 326   | 56  | 0   | 67   | 382   | 0   | 449   | 393   | 0   |
| Grp Sat Flow(s),veh/h/ln     | 1691  | 1687  | 1702  | 1792  | 1787  | 1599  | 1774   | 1770  | 1583  | 1774  | 1770  | 1583  |
| Q Serve(g_s), s              | 0.7   | 0.3   | 0.4   | 9.2   | 0.6   | 0.0   | 1.9  | 5.3   | 0.0   | 10.5  | 4.6   | 0.0   |
| Cycle Q Clear(g_c), s        | 0.7   | 0.3   | 0.4   | 9.2   | 0.6   | 0.0   | 1.9  | 5.3   | 0.0   | 10.5  | 4.6   | 0.0   |
| Prop In Lane                 | 1.00  |   | 0.23  | 1.00  |   | 1.00  | 1.00   |   | 1.00  | 1.00  |   | 1.00  |
| Lane Grp Cap(c), veh/h       | 44  | 144   | 145   | 381   | 972   | 435   | 105  | 557   | 249   | 356   | 1057  | 473   |
| V/C Ratio(X)                 | 0.50  | 0.08  | 0.09  | 0.86  | 0.06  | 0.00  | 0.64   | 0.69  | 0.00  | 1.26  | 0.37  | 0.00  |
| Avail Cap(c_a), veh/h        | 662   | 983   | 992   | 702   | 2083  | 932   | 356  | 1724  | 771   | 356   | 1724  | 771   |
| HCM Platoon Ratio            | 1.00  | 1.00  | 1.00  | 1.00  | 1.00  | 1.00  | 1.00   | 1.00  | 1.00  | 1.00  | 1.00  | 1.00  |
| Upstream Filter(I)           | 1.00  | 1.00  | 1.00  | 1.00  | 1.00  | 0.00  | 1.00   | 1.00  | 0.00  | 1.00  | 1.00  | 0.00  |
| Uniform Delay (d), s/veh     | 25.1  | 22.0  | 22.1  | 19.8  | 14.1  | 0.0   | 24.1   | 20.8  | 0.0   | 20.9  | 14.5  | 0.0   |
| Incr Delay (d2), s/veh       | 3.2   | 0.1   | 0.1   | 2.2   | 0.0   | 0.0   | 2.3  | 0.6   | 0.0   | 138.4   | 0.1   | 0.0   |
| Initial Q Delay(d3),s/veh    | 0.0   | 0.0   | 0.0   | 0.0   | 0.0   | 0.0   | 0.0  | 0.0   | 0.0   | 0.0   | 0.0   | 0.0   |
| %ile BackOfQ(50%),veh/ln     | 0.4   | 0.2   | 0.2   | 4.8   | 0.3   | 0.0   | 1.0  | 2.6   | 0.0   | 18.7  | 2.2   | 0.0   |
| LnGrp Delay(d),s/veh         | 28.3  | 22.1  | 22.2  | 22.0  | 14.1  | 0.0   | 26.4   | 21.4  | 0.0   | 159.4   | 14.6  | 0.0   |
| LnGrp LOS                    | C   | C   | C   | C   | B   |   | C  | C   |   | F   | B   |   |
| Approach Vol, veh/h          |   | 47  |   |   | 382   |   |  | 449   |   |   | 842   |   |
| Approach Delay, s/veh        |   | 25.0  |   |   | 20.8  |   |  | 22.1  |   |   | 91.8  |   |
| Approach LOS                 |   | C   |   |   | C   |   |  | C   |   |   | F   |   |
| Timer                        | 1   | 2   | 3   | 4   | 5   | 6   | 7  | 8   |   |   |   |   |
| Assigned Phs                 | 1   | 2   | 3   | 4   | 5   | 6   | 7  | 8   |   |   |   |   |
| Phs Duration (G+Y+Rc), s     | 7.6   | 20.1  | 5.9   | 18.7  | 15.0  | 12.7  | 15.6   | 9.0   |   |   |   |   |
| Change Period (Y+Rc), s      | 4.5   | 4.5   | 4.5   | 4.5   | 4.5   | 4.5   | 4.5  | 4.5   |   |   |   |   |
| Max Green Setting (Gmax), s  | 10.5  | 25.5  | 20.5  | 30.5  | 10.5  | 25.5  | 20.5   | 30.5  |   |   |   |   |
| Max Q Clear Time (g_c+I1), s | 3.9   | 6.6   | 2.7   | 2.6   | 12.5  | 7.3   | 11.2   | 2.4   |   |   |   |   |
| Green Ext Time (p_c), s      | 0.0   | 0.5   | 0.0   | 0.1   | 0.0   | 0.5   | 0.1  | 0.0   |   |   |   |   |
| <b>Intersection Summary</b>  |   |   |   |   |   |   |  |   |   |   |   |   |
| HCM 2010 Ctrl Delay          |   |   |   | 56.0  |   |   |  |   |   |   |   |   |
| HCM 2010 LOS                 |   |   |   | E   |   |   |  |   |   |   |   |   |
| <b>Notes</b>                 |   |   |   |   |   |   |  |   |   |   |   |   |

HCM 2010 Signalized Intersection Summary  
40: Malmedy Road & Gigling Road

Cumulative with Project, PM  
06/11/2019



| Movement                     | EBL  | EBT  | EBR  | WBL  | WBT  | WBR  | NBL  | NBT  | NBR  | SBL  | SBT  | SBR  |
|------------------------------|------|------|------|------|------|------|------|------|------|------|------|------|
| Lane Configurations          |      | ↔    |      |      | ↔    |      |      | ↔    |      |      | ↔    |      |
| Traffic Volume (veh/h)       | 20   | 850  | 10   | 30   | 680  | 40   | 30   | 60   | 50   | 40   | 40   | 10   |
| Future Volume (veh/h)        | 20   | 850  | 10   | 30   | 680  | 40   | 30   | 60   | 50   | 40   | 40   | 10   |
| Number                       | 7    | 4    | 14   | 3    | 8    | 18   | 5    | 2    | 12   | 1    | 6    | 16   |
| Initial Q (Qb), veh          | 0    | 0    | 0    | 0    | 0    | 0    | 0    | 0    | 0    | 0    | 0    | 0    |
| Ped-Bike Adj(A_pbT)          | 1.00 |      | 1.00 | 1.00 |      | 1.00 | 1.00 |      | 1.00 | 1.00 |      | 1.00 |
| Parking Bus, Adj             | 1.00 | 1.00 | 1.00 | 1.00 | 1.00 | 1.00 | 1.00 | 1.00 | 1.00 | 1.00 | 1.00 | 1.00 |
| Adj Sat Flow, veh/h/ln       | 1900 | 1863 | 1900 | 1900 | 1881 | 1900 | 1900 | 1900 | 1900 | 1900 | 1810 | 1900 |
| Adj Flow Rate, veh/h         | 22   | 934  | 11   | 33   | 747  | 44   | 33   | 66   | 55   | 44   | 44   | 11   |
| Adj No. of Lanes             | 0    | 2    | 0    | 0    | 2    | 0    | 0    | 1    | 0    | 0    | 1    | 0    |
| Peak Hour Factor             | 0.91 | 0.91 | 0.91 | 0.91 | 0.91 | 0.91 | 0.91 | 0.91 | 0.91 | 0.91 | 0.91 | 0.91 |
| Percent Heavy Veh, %         | 2    | 2    | 2    | 1    | 1    | 1    | 0    | 0    | 0    | 5    | 5    | 5    |
| Cap, veh/h                   | 192  | 1326 | 15   | 204  | 1186 | 72   | 260  | 149  | 111  | 353  | 156  | 33   |
| Arrive On Green              | 0.39 | 0.39 | 0.39 | 0.39 | 0.39 | 0.39 | 0.18 | 0.18 | 0.18 | 0.18 | 0.18 | 0.18 |
| Sat Flow, veh/h              | 33   | 3422 | 40   | 50   | 3060 | 185  | 280  | 811  | 606  | 573  | 850  | 178  |
| Grp Volume(v), veh/h         | 503  | 0    | 464  | 425  | 0    | 399  | 154  | 0    | 0    | 99   | 0    | 0    |
| Grp Sat Flow(s),veh/h/ln     | 1806 | 0    | 1688 | 1617 | 0    | 1679 | 1696 | 0    | 0    | 1601 | 0    | 0    |
| Q Serve(g_s), s              | 0.1  | 0.0  | 4.9  | 0.2  | 0.0  | 4.0  | 0.6  | 0.0  | 0.0  | 0.0  | 0.0  | 0.0  |
| Cycle Q Clear(g_c), s        | 4.8  | 0.0  | 4.9  | 5.1  | 0.0  | 4.0  | 1.7  | 0.0  | 0.0  | 1.0  | 0.0  | 0.0  |
| Prop In Lane                 | 0.04 |      | 0.02 | 0.08 |      | 0.11 | 0.21 |      | 0.36 | 0.44 |      | 0.11 |
| Lane Grp Cap(c), veh/h       | 879  | 0    | 654  | 811  | 0    | 650  | 520  | 0    | 0    | 542  | 0    | 0    |
| V/C Ratio(X)                 | 0.57 | 0.00 | 0.71 | 0.52 | 0.00 | 0.61 | 0.30 | 0.00 | 0.00 | 0.18 | 0.00 | 0.00 |
| Avail Cap(c_a), veh/h        | 4375 | 0    | 4062 | 4065 | 0    | 4040 | 2625 | 0    | 0    | 2411 | 0    | 0    |
| HCM Platoon Ratio            | 1.00 | 1.00 | 1.00 | 1.00 | 1.00 | 1.00 | 1.00 | 1.00 | 1.00 | 1.00 | 1.00 | 1.00 |
| Upstream Filter(I)           | 1.00 | 0.00 | 1.00 | 1.00 | 0.00 | 1.00 | 1.00 | 0.00 | 0.00 | 1.00 | 0.00 | 0.00 |
| Uniform Delay (d), s/veh     | 5.4  | 0.0  | 5.4  | 5.1  | 0.0  | 5.2  | 7.7  | 0.0  | 0.0  | 7.4  | 0.0  | 0.0  |
| Incr Delay (d2), s/veh       | 0.2  | 0.0  | 0.5  | 0.2  | 0.0  | 0.4  | 0.1  | 0.0  | 0.0  | 0.1  | 0.0  | 0.0  |
| Initial Q Delay(d3),s/veh    | 0.0  | 0.0  | 0.0  | 0.0  | 0.0  | 0.0  | 0.0  | 0.0  | 0.0  | 0.0  | 0.0  | 0.0  |
| %ile BackOfQ(50%),veh/ln     | 2.4  | 0.0  | 2.3  | 1.9  | 0.0  | 1.8  | 0.8  | 0.0  | 0.0  | 0.5  | 0.0  | 0.0  |
| LnGrp Delay(d),s/veh         | 5.6  | 0.0  | 6.0  | 5.3  | 0.0  | 5.5  | 7.8  | 0.0  | 0.0  | 7.5  | 0.0  | 0.0  |
| LnGrp LOS                    | A    |      | A    | A    |      | A    | A    |      |      | A    |      |      |
| Approach Vol, veh/h          |      | 967  |      |      | 824  |      |      | 154  |      |      | 99   |      |
| Approach Delay, s/veh        |      | 5.8  |      |      | 5.4  |      |      | 7.8  |      |      | 7.5  |      |
| Approach LOS                 |      | A    |      |      | A    |      |      | A    |      |      | A    |      |
| Timer                        | 1    | 2    | 3    | 4    | 5    | 6    | 7    | 8    |      |      |      |      |
| Assigned Phs                 |      | 2    |      | 4    |      | 6    |      | 8    |      |      |      |      |
| Phs Duration (G+Y+Rc), s     |      | 8.4  |      | 12.6 |      | 8.4  |      | 12.6 |      |      |      |      |
| Change Period (Y+Rc), s      |      | 4.5  |      | 4.5  |      | 4.5  |      | 4.5  |      |      |      |      |
| Max Green Setting (Gmax), s  |      | 30.5 |      | 50.5 |      | 30.5 |      | 50.5 |      |      |      |      |
| Max Q Clear Time (g_c+I1), s |      | 3.7  |      | 6.9  |      | 3.0  |      | 7.1  |      |      |      |      |
| Green Ext Time (p_c), s      |      | 0.2  |      | 1.0  |      | 0.1  |      | 0.9  |      |      |      |      |
| <b>Intersection Summary</b>  |      |      |      |      |      |      |      |      |      |      |      |      |
| HCM 2010 Ctrl Delay          |      |      |      | 5.9  |      |      |      |      |      |      |      |      |
| HCM 2010 LOS                 |      |      |      | A    |      |      |      |      |      |      |      |      |

HCM 2010 Signalized Intersection Summary  
 41: Parker Flatts Cut Off Road & Gigling Road

Cumulative with Project, PM  
 06/11/2019



| Movement                     | EBL  | EBT  | EBR  | WBL  | WBT  | WBR  | NBL  | NBT  | NBR  | SBL  | SBT  | SBR  |
|------------------------------|------|------|------|------|------|------|------|------|------|------|------|------|
| Lane Configurations          |      | ↔    |      |      | ↔    |      |      | ↔    | ↔    |      | ↔    |      |
| Traffic Volume (veh/h)       | 10   | 910  | 30   | 50   | 650  | 20   | 90   | 20   | 100  | 20   | 20   | 10   |
| Future Volume (veh/h)        | 10   | 910  | 30   | 50   | 650  | 20   | 90   | 20   | 100  | 20   | 20   | 10   |
| Number                       | 7    | 4    | 14   | 3    | 8    | 18   | 5    | 2    | 12   | 1    | 6    | 16   |
| Initial Q (Qb), veh          | 0    | 0    | 0    | 0    | 0    | 0    | 0    | 0    | 0    | 0    | 0    | 0    |
| Ped-Bike Adj(A_pbT)          | 1.00 |      | 1.00 | 1.00 |      | 1.00 | 1.00 |      | 1.00 | 1.00 |      | 1.00 |
| Parking Bus, Adj             | 1.00 | 1.00 | 1.00 | 1.00 | 1.00 | 1.00 | 1.00 | 1.00 | 1.00 | 1.00 | 1.00 | 1.00 |
| Adj Sat Flow, veh/h/ln       | 1900 | 1863 | 1900 | 1900 | 1881 | 1900 | 1900 | 1900 | 1900 | 1900 | 1900 | 1900 |
| Adj Flow Rate, veh/h         | 11   | 1022 | 34   | 56   | 730  | 22   | 101  | 22   | 112  | 22   | 22   | 11   |
| Adj No. of Lanes             | 0    | 2    | 0    | 0    | 2    | 0    | 0    | 1    | 1    | 0    | 1    | 0    |
| Peak Hour Factor             | 0.89 | 0.89 | 0.89 | 0.89 | 0.89 | 0.89 | 0.89 | 0.89 | 0.89 | 0.89 | 0.89 | 0.89 |
| Percent Heavy Veh, %         | 2    | 2    | 2    | 1    | 1    | 1    | 0    | 0    | 0    | 0    | 0    | 0    |
| Cap, veh/h                   | 164  | 1416 | 47   | 210  | 1217 | 38   | 506  | 76   | 311  | 298  | 173  | 63   |
| Arrive On Green              | 0.42 | 0.42 | 0.42 | 0.42 | 0.42 | 0.42 | 0.19 | 0.19 | 0.19 | 0.19 | 0.19 | 0.19 |
| Sat Flow, veh/h              | 12   | 3394 | 112  | 77   | 2918 | 92   | 1151 | 393  | 1611 | 414  | 896  | 327  |
| Grp Volume(v), veh/h         | 560  | 0    | 507  | 401  | 0    | 407  | 123  | 0    | 112  | 55   | 0    | 0    |
| Grp Sat Flow(s),veh/h/ln     | 1844 | 0    | 1675 | 1391 | 0    | 1695 | 1544 | 0    | 1611 | 1637 | 0    | 0    |
| Q Serve(g_s), s              | 0.0  | 0.0  | 5.8  | 0.6  | 0.0  | 4.2  | 0.5  | 0.0  | 1.4  | 0.0  | 0.0  | 0.0  |
| Cycle Q Clear(g_c), s        | 5.8  | 0.0  | 5.8  | 6.5  | 0.0  | 4.2  | 1.4  | 0.0  | 1.4  | 0.6  | 0.0  | 0.0  |
| Prop In Lane                 | 0.02 |      | 0.07 | 0.14 |      | 0.05 | 0.82 |      | 1.00 | 0.40 |      | 0.20 |
| Lane Grp Cap(c), veh/h       | 928  | 0    | 699  | 758  | 0    | 707  | 582  | 0    | 311  | 534  | 0    | 0    |
| V/C Ratio(X)                 | 0.60 | 0.00 | 0.73 | 0.53 | 0.00 | 0.58 | 0.21 | 0.00 | 0.36 | 0.10 | 0.00 | 0.00 |
| Avail Cap(c_a), veh/h        | 4123 | 0    | 3664 | 3226 | 0    | 3709 | 2234 | 0    | 2128 | 2273 | 0    | 0    |
| HCM Platoon Ratio            | 1.00 | 1.00 | 1.00 | 1.00 | 1.00 | 1.00 | 1.00 | 1.00 | 1.00 | 1.00 | 1.00 | 1.00 |
| Upstream Filter(I)           | 1.00 | 0.00 | 1.00 | 1.00 | 0.00 | 1.00 | 1.00 | 0.00 | 1.00 | 1.00 | 0.00 | 0.00 |
| Uniform Delay (d), s/veh     | 5.6  | 0.0  | 5.6  | 5.1  | 0.0  | 5.2  | 8.1  | 0.0  | 8.1  | 7.8  | 0.0  | 0.0  |
| Incr Delay (d2), s/veh       | 0.2  | 0.0  | 0.5  | 0.2  | 0.0  | 0.3  | 0.1  | 0.0  | 0.3  | 0.0  | 0.0  | 0.0  |
| Initial Q Delay(d3),s/veh    | 0.0  | 0.0  | 0.0  | 0.0  | 0.0  | 0.0  | 0.0  | 0.0  | 0.0  | 0.0  | 0.0  | 0.0  |
| %ile BackOfQ(50%),veh/ln     | 2.9  | 0.0  | 2.6  | 1.8  | 0.0  | 2.0  | 0.7  | 0.0  | 0.6  | 0.3  | 0.0  | 0.0  |
| LnGrp Delay(d),s/veh         | 5.8  | 0.0  | 6.2  | 5.3  | 0.0  | 5.4  | 8.1  | 0.0  | 8.3  | 7.8  | 0.0  | 0.0  |
| LnGrp LOS                    | A    |      | A    | A    |      | A    | A    |      | A    | A    |      |      |
| Approach Vol, veh/h          |      | 1067 |      |      | 808  |      |      | 235  |      |      | 55   |      |
| Approach Delay, s/veh        |      | 6.0  |      |      | 5.4  |      |      | 8.2  |      |      | 7.8  |      |
| Approach LOS                 |      | A    |      |      | A    |      |      | A    |      |      | A    |      |
| Timer                        | 1    | 2    | 3    | 4    | 5    | 6    | 7    | 8    |      |      |      |      |
| Assigned Phs                 |      | 2    |      | 4    |      | 6    |      | 8    |      |      |      |      |
| Phs Duration (G+Y+Rc), s     |      | 9.0  |      | 14.1 |      | 9.0  |      | 14.1 |      |      |      |      |
| Change Period (Y+Rc), s      |      | 4.5  |      | 4.5  |      | 4.5  |      | 4.5  |      |      |      |      |
| Max Green Setting (Gmax), s  |      | 30.5 |      | 50.5 |      | 30.5 |      | 50.5 |      |      |      |      |
| Max Q Clear Time (g_c+I1), s |      | 3.4  |      | 7.8  |      | 2.6  |      | 8.5  |      |      |      |      |
| Green Ext Time (p_c), s      |      | 0.1  |      | 1.1  |      | 0.0  |      | 1.0  |      |      |      |      |
| <b>Intersection Summary</b>  |      |      |      |      |      |      |      |      |      |      |      |      |
| HCM 2010 Ctrl Delay          |      |      |      | 6.0  |      |      |      |      |      |      |      |      |
| HCM 2010 LOS                 |      |      |      | A    |      |      |      |      |      |      |      |      |

HCM 2010 Signalized Intersection Summary  
42: 6th Avenue & Gigling Road

Cumulative with Project, PM  
06/11/2019



| Movement                     | EBL  | EBT  | EBR  | WBL  | WBT  | WBR  | NBL  | NBT  | NBR  | SBL  | SBT  | SBR  |
|------------------------------|------|------|------|------|------|------|------|------|------|------|------|------|
| Lane Configurations          |      | ↔    |      |      | ↔    |      |      | ↔    | ↔    |      | ↔    |      |
| Traffic Volume (veh/h)       | 310  | 710  | 10   | 10   | 440  | 10   | 10   | 10   | 20   | 10   | 10   | 280  |
| Future Volume (veh/h)        | 310  | 710  | 10   | 10   | 440  | 10   | 10   | 10   | 20   | 10   | 10   | 280  |
| Number                       | 7    | 4    | 14   | 3    | 8    | 18   | 5    | 2    | 12   | 1    | 6    | 16   |
| Initial Q (Qb), veh          | 0    | 0    | 0    | 0    | 0    | 0    | 0    | 0    | 0    | 0    | 0    | 0    |
| Ped-Bike Adj(A_pbT)          | 1.00 |      | 1.00 | 1.00 |      | 1.00 | 1.00 |      | 1.00 | 1.00 |      | 1.00 |
| Parking Bus, Adj             | 1.00 | 1.00 | 1.00 | 1.00 | 1.00 | 1.00 | 1.00 | 1.00 | 1.00 | 1.00 | 1.00 | 1.00 |
| Adj Sat Flow, veh/h/ln       | 1900 | 1881 | 1900 | 1900 | 1863 | 1900 | 1900 | 1900 | 1900 | 1900 | 1900 | 1900 |
| Adj Flow Rate, veh/h         | 326  | 747  | 11   | 11   | 463  | 11   | 11   | 11   | 0    | 11   | 11   | 295  |
| Adj No. of Lanes             | 0    | 2    | 0    | 0    | 2    | 0    | 0    | 1    | 1    | 0    | 1    | 0    |
| Peak Hour Factor             | 0.95 | 0.95 | 0.95 | 0.95 | 0.95 | 0.95 | 0.95 | 0.95 | 0.95 | 0.95 | 0.95 | 0.95 |
| Percent Heavy Veh, %         | 1    | 1    | 1    | 2    | 2    | 2    | 0    | 0    | 0    | 0    | 0    | 0    |
| Cap, veh/h                   | 503  | 1073 | 16   | 102  | 1839 | 43   | 274  | 232  | 391  | 96   | 22   | 366  |
| Arrive On Green              | 0.54 | 0.54 | 0.54 | 0.54 | 0.54 | 0.54 | 0.24 | 0.24 | 0.00 | 0.24 | 0.24 | 0.24 |
| Sat Flow, veh/h              | 657  | 1990 | 31   | 20   | 3410 | 80   | 588  | 958  | 1615 | 23   | 90   | 1511 |
| Grp Volume(v), veh/h         | 469  | 0    | 615  | 253  | 0    | 232  | 22   | 0    | 0    | 317  | 0    | 0    |
| Grp Sat Flow(s),veh/h/ln     | 971  | 0    | 1706 | 1829 | 0    | 1681 | 1546 | 0    | 1615 | 1624 | 0    | 0    |
| Q Serve(g_s), s              | 15.6 | 0.0  | 10.7 | 0.0  | 0.0  | 3.0  | 0.0  | 0.0  | 0.0  | 1.7  | 0.0  | 0.0  |
| Cycle Q Clear(g_c), s        | 18.6 | 0.0  | 10.7 | 3.0  | 0.0  | 3.0  | 0.4  | 0.0  | 0.0  | 7.6  | 0.0  | 0.0  |
| Prop In Lane                 | 0.70 |      | 0.02 | 0.04 |      | 0.05 | 0.50 |      | 1.00 | 0.03 |      | 0.93 |
| Lane Grp Cap(c), veh/h       | 672  | 0    | 920  | 1078 | 0    | 907  | 505  | 0    | 391  | 483  | 0    | 0    |
| V/C Ratio(X)                 | 0.70 | 0.00 | 0.67 | 0.24 | 0.00 | 0.26 | 0.04 | 0.00 | 0.00 | 0.66 | 0.00 | 0.00 |
| Avail Cap(c_a), veh/h        | 1424 | 0    | 2093 | 2273 | 0    | 2062 | 1196 | 0    | 1196 | 1289 | 0    | 0    |
| HCM Platoon Ratio            | 1.00 | 1.00 | 1.00 | 1.00 | 1.00 | 1.00 | 1.00 | 1.00 | 1.00 | 1.00 | 1.00 | 1.00 |
| Upstream Filter(I)           | 1.00 | 0.00 | 1.00 | 1.00 | 0.00 | 1.00 | 1.00 | 0.00 | 0.00 | 1.00 | 0.00 | 0.00 |
| Uniform Delay (d), s/veh     | 9.7  | 0.0  | 6.8  | 5.1  | 0.0  | 5.1  | 12.0 | 0.0  | 0.0  | 14.7 | 0.0  | 0.0  |
| Incr Delay (d2), s/veh       | 0.5  | 0.0  | 0.3  | 0.0  | 0.0  | 0.1  | 0.0  | 0.0  | 0.0  | 0.6  | 0.0  | 0.0  |
| Initial Q Delay(d3),s/veh    | 0.0  | 0.0  | 0.0  | 0.0  | 0.0  | 0.0  | 0.0  | 0.0  | 0.0  | 0.0  | 0.0  | 0.0  |
| %ile BackOfQ(50%),veh/ln#    | 4.8  | 0.0  | 5.0  | 1.5  | 0.0  | 1.4  | 0.2  | 0.0  | 0.0  | 3.4  | 0.0  | 0.0  |
| LnGrp Delay(d),s/veh         | 10.2 | 0.0  | 7.1  | 5.1  | 0.0  | 5.1  | 12.0 | 0.0  | 0.0  | 15.2 | 0.0  | 0.0  |
| LnGrp LOS                    | B    |      | A    | A    |      | A    | B    |      |      | B    |      |      |
| Approach Vol, veh/h          |      | 1084 |      |      | 485  |      |      | 22   |      |      | 317  |      |
| Approach Delay, s/veh        |      | 8.5  |      |      | 5.1  |      |      | 12.0 |      |      | 15.2 |      |
| Approach LOS                 |      | A    |      |      | A    |      |      | B    |      |      | B    |      |
| Timer                        | 1    | 2    | 3    | 4    | 5    | 6    | 7    | 8    |      |      |      |      |
| Assigned Phs                 |      | 2    |      | 4    |      | 6    |      | 8    |      |      |      |      |
| Phs Duration (G+Y+Rc), s     |      | 14.5 |      | 26.7 |      | 14.5 |      | 26.7 |      |      |      |      |
| Change Period (Y+Rc), s      |      | 4.5  |      | 4.5  |      | 4.5  |      | 4.5  |      |      |      |      |
| Max Green Setting (Gmax), s  |      | 30.5 |      | 50.5 |      | 30.5 |      | 50.5 |      |      |      |      |
| Max Q Clear Time (g_c+I1), s |      | 2.4  |      | 20.6 |      | 9.6  |      | 5.0  |      |      |      |      |
| Green Ext Time (p_c), s      |      | 0.0  |      | 1.6  |      | 0.5  |      | 0.4  |      |      |      |      |
| <b>Intersection Summary</b>  |      |      |      |      |      |      |      |      |      |      |      |      |
| HCM 2010 Ctrl Delay          |      |      |      | 8.8  |      |      |      |      |      |      |      |      |
| HCM 2010 LOS                 |      |      |      | A    |      |      |      |      |      |      |      |      |

HCM 2010 Signalized Intersection Summary  
43: Gigling Road & 7th Avenue

Cumulative with Project, PM  
06/11/2019

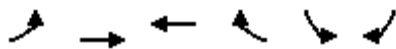

| Movement                     | EBL  | EBT  | WBT  | WBR  | SBL  | SBR  |   |      |
|------------------------------|------|------|------|------|------|------|---|------|
| Lane Configurations          |      | ↑↑   | ↑↑   |      | ↑↑   |      |   |      |
| Traffic Volume (veh/h)       | 290  | 450  | 390  | 10   | 10   | 70   |   |      |
| Future Volume (veh/h)        | 290  | 450  | 390  | 10   | 10   | 70   |   |      |
| Number                       | 7    | 4    | 8    | 18   | 1    | 16   |   |      |
| Initial Q (Qb), veh          | 0    | 0    | 0    | 0    | 0    | 0    |   |      |
| Ped-Bike Adj(A_pbT)          | 1.00 |      |      | 1.00 | 1.00 | 1.00 |   |      |
| Parking Bus, Adj             | 1.00 | 1.00 | 1.00 | 1.00 | 1.00 | 1.00 |   |      |
| Adj Sat Flow, veh/h/ln       | 1900 | 1863 | 1881 | 1900 | 1827 | 1900 |   |      |
| Adj Flow Rate, veh/h         | 302  | 469  | 406  | 10   | 10   | 73   |   |      |
| Adj No. of Lanes             | 0    | 2    | 2    | 0    | 0    | 0    |   |      |
| Peak Hour Factor             | 0.96 | 0.96 | 0.96 | 0.96 | 0.96 | 0.96 |   |      |
| Percent Heavy Veh, %         | 2    | 2    | 1    | 1    | 0    | 0    |   |      |
| Cap, veh/h                   | 648  | 915  | 1693 | 42   | 18   | 130  |   |      |
| Arrive On Green              | 0.47 | 0.47 | 0.47 | 0.47 | 0.10 | 0.10 |   |      |
| Sat Flow, veh/h              | 721  | 2012 | 3659 | 88   | 187  | 1368 |   |      |
| Grp Volume(v), veh/h         | 389  | 382  | 203  | 213  | 84   | 0    |   |      |
| Grp Sat Flow(s),veh/h/ln     | 1037 | 1610 | 1787 | 1866 | 1574 | 0    |   |      |
| Q Serve(g_s), s              | 5.4  | 3.4  | 1.4  | 1.4  | 1.1  | 0.0  |   |      |
| Cycle Q Clear(g_c), s        | 6.8  | 3.4  | 1.4  | 1.4  | 1.1  | 0.0  |   |      |
| Prop In Lane                 | 0.78 |      |      | 0.05 | 0.12 | 0.87 |   |      |
| Lane Grp Cap(c), veh/h       | 798  | 765  | 849  | 886  | 150  | 0    |   |      |
| V/C Ratio(X)                 | 0.49 | 0.50 | 0.24 | 0.24 | 0.56 | 0.00 |   |      |
| Avail Cap(c_a), veh/h        | 3156 | 4270 | 4739 | 4947 | 1918 | 0    |   |      |
| HCM Platoon Ratio            | 1.00 | 1.00 | 1.00 | 1.00 | 1.00 | 1.00 |   |      |
| Upstream Filter(I)           | 1.00 | 1.00 | 1.00 | 1.00 | 1.00 | 0.00 |   |      |
| Uniform Delay (d), s/veh     | 4.8  | 3.8  | 3.3  | 3.3  | 9.1  | 0.0  |   |      |
| Incr Delay (d2), s/veh       | 0.2  | 0.2  | 0.1  | 0.1  | 1.2  | 0.0  |   |      |
| Initial Q Delay(d3),s/veh    | 0.0  | 0.0  | 0.0  | 0.0  | 0.0  | 0.0  |   |      |
| %ile BackOfQ(50%),veh/ln     | 1.9  | 1.5  | 0.7  | 0.7  | 0.5  | 0.0  |   |      |
| LnGrp Delay(d),s/veh         | 4.9  | 4.0  | 3.3  | 3.3  | 10.3 | 0.0  |   |      |
| LnGrp LOS                    | A    | A    | A    | A    | B    |      |   |      |
| Approach Vol, veh/h          |      | 771  | 416  |      | 84   |      |   |      |
| Approach Delay, s/veh        |      | 4.5  | 3.3  |      | 10.3 |      |   |      |
| Approach LOS                 |      | A    | A    |      | B    |      |   |      |
| Timer                        | 1    | 2    | 3    | 4    | 5    | 6    | 7 | 8    |
| Assigned Phs                 |      |      |      | 4    |      | 6    |   | 8    |
| Phs Duration (G+Y+Rc), s     |      |      |      | 14.4 |      | 6.5  |   | 14.4 |
| Change Period (Y+Rc), s      |      |      |      | 4.5  |      | 4.5  |   | 4.5  |
| Max Green Setting (Gmax), s  |      |      |      | 55.5 |      | 25.5 |   | 55.5 |
| Max Q Clear Time (g_c+I1), s |      |      |      | 8.8  |      | 3.1  |   | 3.4  |
| Green Ext Time (p_c), s      |      |      |      | 1.1  |      | 0.0  |   | 0.4  |
| <b>Intersection Summary</b>  |      |      |      |      |      |      |   |      |
| HCM 2010 Ctrl Delay          |      |      |      | 4.5  |      |      |   |      |
| HCM 2010 LOS                 |      |      |      | A    |      |      |   |      |
| <b>Notes</b>                 |      |      |      |      |      |      |   |      |

HCM 2010 Signalized Intersection Summary  
44: 8th Avenue & Gigling Road

Cumulative with Project, PM  
06/11/2019



| Movement                     | EBL  | EBT  | EBR  | WBL  | WBT  | WBR  | NBL  | NBT  | NBR  | SBL  | SBT  | SBR  |
|------------------------------|------|------|------|------|------|------|------|------|------|------|------|------|
| Lane Configurations          |      | ↔    |      |      | ↔    |      |      | ↔    |      |      | ↔    |      |
| Traffic Volume (veh/h)       | 450  | 10   | 10   | 10   | 10   | 10   | 10   | 10   | 10   | 10   | 10   | 380  |
| Future Volume (veh/h)        | 450  | 10   | 10   | 10   | 10   | 10   | 10   | 10   | 10   | 10   | 10   | 380  |
| Number                       | 7    | 4    | 14   | 3    | 8    | 18   | 5    | 2    | 12   | 1    | 6    | 16   |
| Initial Q (Qb), veh          | 0    | 0    | 0    | 0    | 0    | 0    | 0    | 0    | 0    | 0    | 0    | 0    |
| Ped-Bike Adj(A_pbT)          | 1.00 |      | 1.00 | 1.00 |      | 1.00 | 1.00 |      | 1.00 | 1.00 |      | 1.00 |
| Parking Bus, Adj             | 1.00 | 1.00 | 1.00 | 1.00 | 1.00 | 1.00 | 1.00 | 1.00 | 1.00 | 1.00 | 1.00 | 1.00 |
| Adj Sat Flow, veh/h/ln       | 1900 | 1863 | 1900 | 1900 | 1863 | 1900 | 1900 | 1900 | 1900 | 1900 | 1881 | 1900 |
| Adj Flow Rate, veh/h         | 495  | 11   | 11   | 11   | 11   | 11   | 11   | 11   | 11   | 11   | 11   | 418  |
| Adj No. of Lanes             | 0    | 2    | 0    | 0    | 2    | 0    | 0    | 1    | 0    | 0    | 1    | 0    |
| Peak Hour Factor             | 0.91 | 0.91 | 0.91 | 0.91 | 0.91 | 0.91 | 0.91 | 0.91 | 0.91 | 0.91 | 0.91 | 0.91 |
| Percent Heavy Veh, %         | 2    | 2    | 2    | 2    | 2    | 2    | 0    | 0    | 0    | 1    | 1    | 1    |
| Cap, veh/h                   | 770  | 320  | 320  | 514  | 456  | 460  | 256  | 241  | 179  | 112  | 21   | 498  |
| Arrive On Green              | 0.41 | 0.41 | 0.41 | 0.41 | 0.41 | 0.41 | 0.33 | 0.33 | 0.33 | 0.33 | 0.33 | 0.33 |
| Sat Flow, veh/h              | 1360 | 777  | 777  | 840  | 1107 | 1115 | 357  | 739  | 548  | 15   | 66   | 1526 |
| Grp Volume(v), veh/h         | 495  | 0    | 22   | 18   | 0    | 15   | 33   | 0    | 0    | 440  | 0    | 0    |
| Grp Sat Flow(s),veh/h/ln     | 1360 | 0    | 1555 | 1568 | 0    | 1493 | 1644 | 0    | 0    | 1607 | 0    | 0    |
| Q Serve(g_s), s              | 11.4 | 0.0  | 0.3  | 0.0  | 0.0  | 0.2  | 0.0  | 0.0  | 0.0  | 1.6  | 0.0  | 0.0  |
| Cycle Q Clear(g_c), s        | 11.6 | 0.0  | 0.3  | 0.2  | 0.0  | 0.2  | 0.4  | 0.0  | 0.0  | 8.7  | 0.0  | 0.0  |
| Prop In Lane                 | 1.00 |      | 0.50 | 0.60 |      | 0.75 | 0.33 |      | 0.33 | 0.02 |      | 0.95 |
| Lane Grp Cap(c), veh/h       | 770  | 0    | 641  | 814  | 0    | 616  | 676  | 0    | 0    | 632  | 0    | 0    |
| V/C Ratio(X)                 | 0.64 | 0.00 | 0.03 | 0.02 | 0.00 | 0.02 | 0.05 | 0.00 | 0.00 | 0.70 | 0.00 | 0.00 |
| Avail Cap(c_a), veh/h        | 2024 | 0    | 2055 | 2213 | 0    | 1974 | 1650 | 0    | 0    | 1759 | 0    | 0    |
| HCM Platoon Ratio            | 1.00 | 1.00 | 1.00 | 1.00 | 1.00 | 1.00 | 1.00 | 1.00 | 1.00 | 1.00 | 1.00 | 1.00 |
| Upstream Filter(I)           | 1.00 | 0.00 | 1.00 | 1.00 | 0.00 | 1.00 | 1.00 | 0.00 | 0.00 | 1.00 | 0.00 | 0.00 |
| Uniform Delay (d), s/veh     | 9.5  | 0.0  | 6.0  | 6.0  | 0.0  | 6.0  | 8.0  | 0.0  | 0.0  | 10.7 | 0.0  | 0.0  |
| Incr Delay (d2), s/veh       | 0.3  | 0.0  | 0.0  | 0.0  | 0.0  | 0.0  | 0.0  | 0.0  | 0.0  | 0.5  | 0.0  | 0.0  |
| Initial Q Delay(d3),s/veh    | 0.0  | 0.0  | 0.0  | 0.0  | 0.0  | 0.0  | 0.0  | 0.0  | 0.0  | 0.0  | 0.0  | 0.0  |
| %ile BackOfQ(50%),veh/ln     | 4.3  | 0.0  | 0.1  | 0.1  | 0.0  | 0.1  | 0.2  | 0.0  | 0.0  | 3.9  | 0.0  | 0.0  |
| LnGrp Delay(d),s/veh         | 9.8  | 0.0  | 6.0  | 6.0  | 0.0  | 6.0  | 8.0  | 0.0  | 0.0  | 11.3 | 0.0  | 0.0  |
| LnGrp LOS                    | A    |      | A    | A    |      | A    | A    |      |      | B    |      |      |
| Approach Vol, veh/h          |      | 517  |      |      | 33   |      |      | 33   |      |      | 440  |      |
| Approach Delay, s/veh        |      | 9.6  |      |      | 6.0  |      |      | 8.0  |      |      | 11.3 |      |
| Approach LOS                 |      | A    |      |      | A    |      |      | A    |      |      | B    |      |
| Timer                        | 1    | 2    | 3    | 4    | 5    | 6    | 7    | 8    |      |      |      |      |
| Assigned Phs                 |      | 2    |      | 4    |      | 6    |      | 8    |      |      |      |      |
| Phs Duration (G+Y+Rc), s     |      | 15.7 |      | 18.7 |      | 15.7 |      | 18.7 |      |      |      |      |
| Change Period (Y+Rc), s      |      | 4.5  |      | 4.5  |      | 4.5  |      | 4.5  |      |      |      |      |
| Max Green Setting (Gmax), s  |      | 35.5 |      | 45.5 |      | 35.5 |      | 45.5 |      |      |      |      |
| Max Q Clear Time (g_c+I1), s |      | 2.4  |      | 13.6 |      | 10.7 |      | 2.2  |      |      |      |      |
| Green Ext Time (p_c), s      |      | 0.0  |      | 0.5  |      | 0.6  |      | 0.0  |      |      |      |      |
| <b>Intersection Summary</b>  |      |      |      |      |      |      |      |      |      |      |      |      |
| HCM 2010 Ctrl Delay          |      |      |      | 10.2 |      |      |      |      |      |      |      |      |
| HCM 2010 LOS                 |      |      |      | B    |      |      |      |      |      |      |      |      |



HCM 2010 Signalized Intersection Summary  
 46: General Jim Moore Boulevard & Normandy Road

Cumulative with Project, PM  
 06/11/2019



| Movement                    | EBL  | EBT  | EBR  | WBL  | WBT  | WBR  | NBL  | NBT  | NBR  | SBL  | SBT  | SBR  |
|-----------------------------|------|------|------|------|------|------|------|------|------|------|------|------|
| Lane Configurations         |      | ↕    |      |      | ↕    |      | ↕    | ↕↕   |      | ↕    | ↕↕   | ↕    |
| Traffic Volume (veh/h)      | 150  | 30   | 100  | 50   | 30   | 10   | 90   | 860  | 70   | 30   | 570  | 80   |
| Future Volume (veh/h)       | 150  | 30   | 100  | 50   | 30   | 10   | 90   | 860  | 70   | 30   | 570  | 80   |
| Number                      | 3    | 8    | 18   | 7    | 4    | 14   | 1    | 6    | 16   | 5    | 2    | 12   |
| Initial Q (Qb), veh         | 0    | 0    | 0    | 0    | 0    | 0    | 0    | 0    | 0    | 0    | 0    | 0    |
| Ped-Bike Adj(A_pbT)         | 1.00 |      | 1.00 | 1.00 |      | 1.00 | 1.00 |      | 1.00 | 1.00 |      | 1.00 |
| Parking Bus, Adj            | 1.00 | 1.00 | 1.00 | 1.00 | 1.00 | 1.00 | 1.00 | 1.00 | 1.00 | 1.00 | 1.00 | 1.00 |
| Adj Sat Flow, veh/h/ln      | 1900 | 1863 | 1900 | 1900 | 1881 | 1900 | 1881 | 1881 | 1900 | 1900 | 1900 | 1900 |
| Adj Flow Rate, veh/h        | 163  | 33   | 84   | 54   | 33   | 8    | 98   | 935  | 53   | 33   | 620  | 28   |
| Adj No. of Lanes            | 0    | 1    | 0    | 0    | 1    | 0    | 1    | 2    | 0    | 1    | 2    | 1    |
| Peak Hour Factor            | 0.92 | 0.92 | 0.92 | 0.92 | 0.92 | 0.92 | 0.92 | 0.92 | 0.92 | 0.92 | 0.92 | 0.92 |
| Percent Heavy Veh, %        | 2    | 2    | 2    | 1    | 1    | 1    | 1    | 1    | 1    | 0    | 0    | 0    |
| Cap, veh/h                  | 355  | 59   | 106  | 343  | 182  | 33   | 241  | 1154 | 65   | 71   | 869  | 388  |
| Arrive On Green             | 0.23 | 0.23 | 0.23 | 0.23 | 0.23 | 0.23 | 0.13 | 0.34 | 0.34 | 0.04 | 0.24 | 0.24 |
| Sat Flow, veh/h             | 814  | 252  | 457  | 771  | 782  | 143  | 1792 | 3439 | 195  | 1810 | 3610 | 1612 |
| Grp Volume(v), veh/h        | 280  | 0    | 0    | 95   | 0    | 0    | 98   | 486  | 502  | 33   | 620  | 28   |
| Grp Sat Flow(s),veh/h/ln    | 1523 | 0    | 0    | 1696 | 0    | 0    | 1792 | 1787 | 1846 | 1810 | 1805 | 1612 |
| Q Serve(g_s), s             | 4.4  | 0.0  | 0.0  | 0.0  | 0.0  | 0.0  | 1.7  | 8.5  | 8.5  | 0.6  | 5.4  | 0.5  |
| Cycle Q Clear(g_c), s       | 5.8  | 0.0  | 0.0  | 1.4  | 0.0  | 0.0  | 1.7  | 8.5  | 8.5  | 0.6  | 5.4  | 0.5  |
| Prop In Lane                | 0.58 |      | 0.30 | 0.57 |      | 0.08 | 1.00 |      | 0.11 | 1.00 |      | 1.00 |
| Lane Grp Cap(c), veh/h      | 519  | 0    | 0    | 558  | 0    | 0    | 241  | 600  | 620  | 71   | 869  | 388  |
| V/C Ratio(X)                | 0.54 | 0.00 | 0.00 | 0.17 | 0.00 | 0.00 | 0.41 | 0.81 | 0.81 | 0.46 | 0.71 | 0.07 |
| Avail Cap(c_a), veh/h       | 1585 | 0    | 0    | 1625 | 0    | 0    | 417  | 1325 | 1369 | 421  | 2677 | 1195 |
| HCM Platoon Ratio           | 1.00 | 1.00 | 1.00 | 1.00 | 1.00 | 1.00 | 1.00 | 1.00 | 1.00 | 1.00 | 1.00 | 1.00 |
| Upstream Filter(I)          | 1.00 | 0.00 | 0.00 | 1.00 | 0.00 | 0.00 | 1.00 | 1.00 | 1.00 | 1.00 | 1.00 | 1.00 |
| Uniform Delay (d), s/veh    | 12.3 | 0.0  | 0.0  | 10.7 | 0.0  | 0.0  | 13.6 | 10.4 | 10.4 | 16.2 | 12.0 | 10.1 |
| Incr Delay (d2), s/veh      | 0.3  | 0.0  | 0.0  | 0.1  | 0.0  | 0.0  | 0.4  | 1.0  | 1.0  | 1.7  | 0.4  | 0.0  |
| Initial Q Delay(d3),s/veh   | 0.0  | 0.0  | 0.0  | 0.0  | 0.0  | 0.0  | 0.0  | 0.0  | 0.0  | 0.0  | 0.0  | 0.0  |
| %ile BackOfQ(50%),veh/ln    | 2.5  | 0.0  | 0.0  | 0.7  | 0.0  | 0.0  | 0.9  | 4.4  | 4.5  | 0.3  | 2.7  | 0.2  |
| LnGrp Delay(d),s/veh        | 12.6 | 0.0  | 0.0  | 10.7 | 0.0  | 0.0  | 14.0 | 11.4 | 11.4 | 17.9 | 12.4 | 10.1 |
| LnGrp LOS                   | B    |      |      | B    |      |      | B    | B    | B    | B    | B    | B    |
| Approach Vol, veh/h         |      | 280  |      |      | 95   |      |      | 1086 |      |      | 681  |      |
| Approach Delay, s/veh       |      | 12.6 |      |      | 10.7 |      |      | 11.7 |      |      | 12.6 |      |
| Approach LOS                |      | B    |      |      | B    |      |      | B    |      |      | B    |      |
| Timer                       | 1    | 2    | 3    | 4    | 5    | 6    | 7    | 8    |      |      |      |      |
| Assigned Phs                | 1    | 2    |      | 4    | 5    | 6    |      | 8    |      |      |      |      |
| Phs Duration (G+Y+Rc), s    | 9.1  | 12.8 |      | 12.5 | 5.9  | 16.0 |      | 12.5 |      |      |      |      |
| Change Period (Y+Rc), s     | 4.5  | 4.5  |      | 4.5  | 4.5  | 4.5  |      | 4.5  |      |      |      |      |
| Max Green Setting (Gmax), s | 25.5 | 25.5 |      | 33.0 | 8.0  | 25.5 |      | 33.0 |      |      |      |      |
| Max Q Clear Time (g_c+1), s | 7.4  | 7.4  |      | 3.4  | 2.6  | 10.5 |      | 7.8  |      |      |      |      |
| Green Ext Time (p_c), s     | 0.0  | 0.8  |      | 0.1  | 0.0  | 0.9  |      | 0.4  |      |      |      |      |
| <b>Intersection Summary</b> |      |      |      |      |      |      |      |      |      |      |      |      |
| HCM 2010 Ctrl Delay         |      |      |      | 12.0 |      |      |      |      |      |      |      |      |
| HCM 2010 LOS                |      |      |      | B    |      |      |      |      |      |      |      |      |

| Intersection              |      |
|---------------------------|------|
| Intersection Delay, s/veh | 35.2 |
| Intersection LOS          | E    |

| Movement            | EBL  | EBR  | NBL  | NBT  | SBT  | SBR  |
|---------------------|------|------|------|------|------|------|
| Lane Configurations |      |      |      |      |      |      |
| Traffic Vol, veh/h  | 60   | 100  | 150  | 980  | 440  | 50   |
| Future Vol, veh/h   | 60   | 100  | 150  | 980  | 440  | 50   |
| Peak Hour Factor    | 0.89 | 0.89 | 0.89 | 0.89 | 0.89 | 0.89 |
| Heavy Vehicles, %   | 1    | 1    | 1    | 1    | 1    | 1    |
| Mvmt Flow           | 67   | 112  | 169  | 1101 | 494  | 56   |
| Number of Lanes     | 1    | 1    | 1    | 2    | 2    | 1    |

| Approach                   | EB   | NB   | SB   |
|----------------------------|------|------|------|
| Opposing Approach          |      | SB   | NB   |
| Opposing Lanes             | 0    | 3    | 3    |
| Conflicting Approach Left  | SB   |      |      |
| Conflicting Lanes Left     | 3    | 2    | 0    |
| Conflicting Approach Right |      | NB   | EB   |
| Conflicting Lanes Right    | 3    | 0    | 2    |
| HCM Control Delay          | 14.1 | 45.8 | 17.7 |
| HCM LOS                    | B    | E    | C    |

| Lane                   | NBLn1 | NBLn2 | NBLn3 | EBLn1 | EBLn2 | SBLn1 | SBLn2 | SBLn3 |
|------------------------|-------|-------|-------|-------|-------|-------|-------|-------|
| Vol Left, %            | 100%  | 0%    | 0%    | 100%  | 0%    | 0%    | 0%    | 0%    |
| Vol Thru, %            | 0%    | 100%  | 100%  | 0%    | 0%    | 100%  | 100%  | 0%    |
| Vol Right, %           | 0%    | 0%    | 0%    | 0%    | 100%  | 0%    | 0%    | 100%  |
| Sign Control           | Stop  | Stop  | Stop  | Stop  | Stop  | Stop  | Stop  | Stop  |
| Traffic Vol by Lane    | 150   | 490   | 490   | 60    | 100   | 220   | 220   | 50    |
| LT Vol                 | 150   | 0     | 0     | 60    | 0     | 0     | 0     | 0     |
| Through Vol            | 0     | 490   | 490   | 0     | 0     | 220   | 220   | 0     |
| RT Vol                 | 0     | 0     | 0     | 0     | 100   | 0     | 0     | 50    |
| Lane Flow Rate         | 169   | 551   | 551   | 67    | 112   | 247   | 247   | 56    |
| Geometry Grp           | 8     | 8     | 8     | 8     | 8     | 8     | 8     | 8     |
| Degree of Util (X)     | 0.344 | 1.047 | 0.781 | 0.175 | 0.257 | 0.524 | 0.524 | 0.081 |
| Departure Headway (Hd) | 7.356 | 6.849 | 5.106 | 9.561 | 8.345 | 7.809 | 7.809 | 5.351 |
| Convergence, Y/N       | Yes   | Yes   | Yes   | Yes   | Yes   | Yes   | Yes   | Yes   |
| Cap                    | 492   | 534   | 710   | 378   | 433   | 465   | 465   | 674   |
| Service Time           | 5.064 | 4.557 | 2.814 | 7.261 | 6.045 | 5.509 | 5.509 | 3.051 |
| HCM Lane V/C Ratio     | 0.343 | 1.032 | 0.776 | 0.177 | 0.259 | 0.531 | 0.531 | 0.083 |
| HCM Control Delay      | 13.9  | 77.9  | 23.5  | 14.3  | 13.9  | 18.8  | 18.8  | 8.5   |
| HCM Lane LOS           | B     | F     | C     | B     | B     | C     | C     | A     |
| HCM 95th-tile Q        | 1.5   | 16    | 7.7   | 0.6   | 1     | 3     | 3     | 0.3   |

HCM 2010 Signalized Intersection Summary

Cumulative with Project, PM

48: Fremont Boulevard/Hwy 1 SB Off-Ramp/ NB On-Ramp & Monterey Road

06/11/2019



| Movement                     | EBL  | EBT  | EBR  | WBL   | WBT  | WBR   | NBL  | NBT  | NBR  | SBL  | SBT   | SBR  |
|------------------------------|------|------|------|-------|------|-------|------|------|------|------|-------|------|
| Lane Configurations          |      |      |      |       |      |       |      |      |      |      |       |      |
| Traffic Volume (veh/h)       | 230  | 170  | 70   | 90    | 100  | 70    | 110  | 1200 | 230  | 100  | 690   | 220  |
| Future Volume (veh/h)        | 230  | 170  | 70   | 90    | 100  | 70    | 110  | 1200 | 230  | 100  | 690   | 220  |
| Number                       | 7    | 4    | 14   | 3     | 8    | 18    | 5    | 2    | 12   | 1    | 6     | 16   |
| Initial Q (Qb), veh          | 0    | 0    | 0    | 0     | 0    | 0     | 0    | 0    | 0    | 0    | 0     | 0    |
| Ped-Bike Adj(A_pbT)          | 1.00 |      | 0.98 | 1.00  |      | 0.99  | 1.00 |      | 0.99 | 1.00 |       | 0.99 |
| Parking Bus, Adj             | 1.00 | 1.00 | 1.00 | 1.00  | 1.00 | 1.00  | 1.00 | 1.00 | 1.00 | 1.00 | 1.00  | 1.00 |
| Adj Sat Flow, veh/h/ln       | 1881 | 1881 | 1881 | 1900  | 1900 | 1900  | 1881 | 1881 | 1900 | 1863 | 1863  | 1863 |
| Adj Flow Rate, veh/h         | 206  | 218  | 25   | 93    | 103  | 66    | 113  | 1237 | 225  | 103  | 711   | 155  |
| Adj No. of Lanes             | 1    | 1    | 1    | 0     | 1    | 0     | 1    | 2    | 0    | 1    | 2     | 1    |
| Peak Hour Factor             | 0.97 | 0.97 | 0.97 | 0.97  | 0.97 | 0.97  | 0.97 | 0.97 | 0.97 | 0.97 | 0.97  | 0.97 |
| Percent Heavy Veh, %         | 1    | 1    | 1    | 0     | 0    | 0     | 1    | 1    | 1    | 2    | 2     | 2    |
| Cap, veh/h                   | 272  | 285  | 237  | 105   | 117  | 75    | 590  | 1379 | 249  | 127  | 671   | 297  |
| Arrive On Green              | 0.15 | 0.15 | 0.15 | 0.17  | 0.17 | 0.17  | 0.33 | 0.46 | 0.46 | 0.07 | 0.19  | 0.19 |
| Sat Flow, veh/h              | 1792 | 1881 | 1565 | 634   | 702  | 450   | 1792 | 3022 | 545  | 1774 | 3539  | 1568 |
| Grp Volume(v), veh/h         | 206  | 218  | 25   | 262   | 0    | 0     | 113  | 727  | 735  | 103  | 711   | 155  |
| Grp Sat Flow(s),veh/h/ln     | 1792 | 1881 | 1565 | 1785  | 0    | 0     | 1792 | 1787 | 1781 | 1774 | 1770  | 1568 |
| Q Serve(g_s), s              | 13.8 | 13.9 | 1.7  | 17.9  | 0.0  | 0.0   | 5.6  | 46.7 | 47.7 | 7.2  | 23.7  | 11.1 |
| Cycle Q Clear(g_c), s        | 13.8 | 13.9 | 1.7  | 17.9  | 0.0  | 0.0   | 5.6  | 46.7 | 47.7 | 7.2  | 23.7  | 11.1 |
| Prop In Lane                 | 1.00 |      | 1.00 | 0.35  |      | 0.25  | 1.00 |      | 0.31 | 1.00 |       | 1.00 |
| Lane Grp Cap(c), veh/h       | 272  | 285  | 237  | 297   | 0    | 0     | 590  | 815  | 812  | 127  | 671   | 297  |
| V/C Ratio(X)                 | 0.76 | 0.76 | 0.11 | 0.88  | 0.00 | 0.00  | 0.19 | 0.89 | 0.90 | 0.81 | 1.06  | 0.52 |
| Avail Cap(c_a), veh/h        | 573  | 602  | 501  | 357   | 0    | 0     | 590  | 815  | 812  | 241  | 671   | 297  |
| HCM Platoon Ratio            | 1.00 | 1.00 | 1.00 | 1.00  | 1.00 | 1.00  | 1.00 | 1.00 | 1.00 | 1.00 | 1.00  | 1.00 |
| Upstream Filter(I)           | 0.69 | 0.69 | 0.69 | 1.00  | 0.00 | 0.00  | 1.00 | 1.00 | 1.00 | 1.00 | 1.00  | 1.00 |
| Uniform Delay (d), s/veh     | 50.8 | 50.9 | 45.7 | 50.9  | 0.0  | 0.0   | 30.0 | 31.2 | 31.5 | 57.2 | 50.7  | 45.5 |
| Incr Delay (d2), s/veh       | 3.0  | 3.0  | 0.1  | 20.8  | 0.0  | 0.0   | 0.1  | 14.2 | 15.4 | 4.6  | 51.6  | 6.4  |
| Initial Q Delay(d3),s/veh    | 0.0  | 0.0  | 0.0  | 0.0   | 0.0  | 0.0   | 0.0  | 0.0  | 0.0  | 0.0  | 0.0   | 0.0  |
| %ile BackOfQ(50%),veh/ln     | 7.0  | 7.4  | 0.8  | 10.6  | 0.0  | 0.0   | 2.8  | 26.0 | 27.0 | 3.7  | 16.4  | 5.4  |
| LnGrp Delay(d),s/veh         | 53.9 | 53.9 | 45.9 | 71.7  | 0.0  | 0.0   | 30.1 | 45.3 | 46.9 | 61.8 | 102.2 | 51.9 |
| LnGrp LOS                    | D    | D    | D    | E     |      |       | C    | D    | D    | E    | F     | D    |
| Approach Vol, veh/h          |      | 449  |      |       | 262  |       |      | 1575 |      |      | 969   |      |
| Approach Delay, s/veh        |      | 53.4 |      |       | 71.7 |       |      | 45.0 |      |      | 89.9  |      |
| Approach LOS                 |      | D    |      |       | E    |       |      | D    |      |      | F     |      |
| Timer                        | 1    | 2    | 3    | 4     | 5    | 6     | 7    | 8    |      |      |       |      |
| Assigned Phs                 | 1    | 2    |      | 4     | 5    | 6     |      | 8    |      |      |       |      |
| Phs Duration (G+Y+Rc), s     | 3.2  | 62.3 |      | 23.6  | 46.5 | 29.0  |      | 25.9 |      |      |       |      |
| Change Period (Y+Rc), s      | 4.2  | 5.3  |      | * 4.7 | 5.3  | * 5.3 |      | 5.1  |      |      |       |      |
| Max Green Setting (Gmax), s  | 13   | 23.7 |      | * 40  | 17.0 | * 24  |      | 25.0 |      |      |       |      |
| Max Q Clear Time (g_c+19), s | 19.2 | 49.7 |      | 15.9  | 7.6  | 25.7  |      | 19.9 |      |      |       |      |
| Green Ext Time (p_c), s      | 0.1  | 0.0  |      | 1.9   | 0.1  | 0.0   |      | 0.8  |      |      |       |      |
| <b>Intersection Summary</b>  |      |      |      |       |      |       |      |      |      |      |       |      |
| HCM 2010 Ctrl Delay          |      |      |      | 61.7  |      |       |      |      |      |      |       |      |
| HCM 2010 LOS                 |      |      |      | E     |      |       |      |      |      |      |       |      |
| <b>Notes</b>                 |      |      |      |       |      |       |      |      |      |      |       |      |

HCM 2010 Signalized Intersection Summary  
 49: Highway 1 SB On-Ramp & Highway 1 NB Off-Ramp/Monterey Road

Cumulative with Project, PM  
 06/11/2019



| Movement                     | EBL  | EBT  | EBR  | WBL   | WBT  | WBR   | NBL  | NBT   | NBR  | SBL  | SBT  | SBR  |
|------------------------------|------|------|------|-------|------|-------|------|-------|------|------|------|------|
| Lane Configurations          |      | ↕↕   | ↗    | ↖     |      | ↗     |      | ↕     | ↗    |      | ↕    |      |
| Traffic Volume (veh/h)       | 10   | 150  | 120  | 280   | 0    | 130   | 0    | 120   | 300  | 10   | 10   | 0    |
| Future Volume (veh/h)        | 10   | 150  | 120  | 280   | 0    | 130   | 0    | 120   | 300  | 10   | 10   | 0    |
| Number                       | 1    | 6    | 16   | 5     | 2    | 12    | 7    | 4     | 14   | 3    | 8    | 18   |
| Initial Q (Qb), veh          | 0    | 0    | 0    | 0     | 0    | 0     | 0    | 0     | 0    | 0    | 0    | 0    |
| Ped-Bike Adj(A_pbT)          | 1.00 |      | 1.00 | 1.00  |      | 1.00  | 1.00 |       | 1.00 | 1.00 |      | 1.00 |
| Parking Bus, Adj             | 1.00 | 1.00 | 1.00 | 1.00  | 1.00 | 1.00  | 1.00 | 1.00  | 1.00 | 1.00 | 1.00 | 1.00 |
| Adj Sat Flow, veh/h/ln       | 1900 | 1863 | 1863 | 1900  | 0    | 1900  | 0    | 1881  | 1881 | 1900 | 1900 | 0    |
| Adj Flow Rate, veh/h         | 11   | 165  | 14   | 308   | 0    | 69    | 0    | 132   | 51   | 11   | 11   | 0    |
| Adj No. of Lanes             | 0    | 2    | 1    | 1     | 0    | 1     | 0    | 1     | 1    | 0    | 1    | 0    |
| Peak Hour Factor             | 0.91 | 0.91 | 0.91 | 0.91  | 0.91 | 0.91  | 0.91 | 0.91  | 0.91 | 0.91 | 0.91 | 0.91 |
| Percent Heavy Veh, %         | 2    | 2    | 2    | 0     | 0    | 0     | 0    | 1     | 1    | 0    | 0    | 0    |
| Cap, veh/h                   | 181  | 2850 | 1323 | 0     | 0    | 0     | 0    | 164   | 139  | 57   | 43   | 0    |
| Arrive On Green              | 0.84 | 0.84 | 0.84 | 0.00  | 0.00 | 0.00  | 0.00 | 0.09  | 0.09 | 0.09 | 0.09 | 0.00 |
| Sat Flow, veh/h              | 216  | 3406 | 1580 |       |      |       | 0    | 1881  | 1599 | 155  | 496  | 0    |
| Grp Volume(v), veh/h         | 94   | 82   | 14   |       | 0.0  |       | 0    | 132   | 51   | 22   | 0    | 0    |
| Grp Sat Flow(s),veh/h/ln     | 182  | 1770 | 1580 |       |      |       | 0    | 1881  | 1599 | 651  | 0    | 0    |
| Q Serve(g_s), s              | 1.1  | 1.0  | 0.2  |       |      |       | 0.0  | 8.6   | 3.8  | 0.1  | 0.0  | 0.0  |
| Cycle Q Clear(g_c), s        | 1.1  | 1.0  | 0.2  |       |      |       | 0.0  | 8.6   | 3.8  | 8.7  | 0.0  | 0.0  |
| Prop In Lane                 | 0.12 |      | 1.00 |       |      |       | 0.00 |       | 1.00 | 0.50 |      | 0.00 |
| Lane Grp Cap(c), veh/h       | 1550 | 1481 | 1323 |       |      |       | 0    | 164   | 139  | 100  | 0    | 0    |
| V/C Ratio(X)                 | 0.06 | 0.06 | 0.01 |       |      |       | 0.00 | 0.81  | 0.37 | 0.22 | 0.00 | 0.00 |
| Avail Cap(c_a), veh/h        | 1550 | 1481 | 1323 |       |      |       | 0    | 271   | 230  | 125  | 0    | 0    |
| HCM Platoon Ratio            | 1.00 | 1.00 | 1.00 |       |      |       | 1.00 | 1.00  | 1.00 | 1.00 | 1.00 | 1.00 |
| Upstream Filter(I)           | 1.00 | 1.00 | 1.00 |       |      |       | 0.00 | 1.00  | 1.00 | 1.00 | 0.00 | 0.00 |
| Uniform Delay (d), s/veh     | 1.8  | 1.7  | 1.7  |       |      |       | 0.0  | 56.0  | 53.8 | 52.9 | 0.0  | 0.0  |
| Incr Delay (d2), s/veh       | 0.0  | 0.0  | 0.0  |       |      |       | 0.0  | 3.5   | 0.6  | 0.4  | 0.0  | 0.0  |
| Initial Q Delay(d3),s/veh    | 0.0  | 0.0  | 0.0  |       |      |       | 0.0  | 0.0   | 0.0  | 0.0  | 0.0  | 0.0  |
| %ile BackOfQ(50%),veh/ln     | 0.6  | 0.5  | 0.1  |       |      |       | 0.0  | 4.6   | 1.7  | 0.7  | 0.0  | 0.0  |
| LnGrp Delay(d),s/veh         | 1.8  | 1.7  | 1.7  |       |      |       | 0.0  | 59.5  | 54.4 | 53.3 | 0.0  | 0.0  |
| LnGrp LOS                    | A    | A    | A    |       |      |       |      | E     | D    | D    |      |      |
| Approach Vol, veh/h          |      | 190  |      |       |      |       |      | 183   |      |      | 22   |      |
| Approach Delay, s/veh        |      | 1.7  |      |       |      |       |      | 58.1  |      |      | 53.3 |      |
| Approach LOS                 |      | A    |      |       |      |       |      | E     |      |      | D    |      |
| Timer                        | 1    | 2    | 3    | 4     | 5    | 6     | 7    | 8     |      |      |      |      |
| Assigned Phs                 |      |      |      | 4     |      | 6     |      | 8     |      |      |      |      |
| Phs Duration (G+Y+Rc), s     |      |      |      | 15.1  |      | 109.9 |      | 15.1  |      |      |      |      |
| Change Period (Y+Rc), s      |      |      |      | * 4.2 |      | 5.3   |      | * 4.2 |      |      |      |      |
| Max Green Setting (Gmax), s  |      |      |      | * 18  |      | 21.0  |      | * 13  |      |      |      |      |
| Max Q Clear Time (g_c+I1), s |      |      |      | 10.6  |      | 3.1   |      | 10.7  |      |      |      |      |
| Green Ext Time (p_c), s      |      |      |      | 0.3   |      | 0.6   |      | 0.0   |      |      |      |      |
| <b>Intersection Summary</b>  |      |      |      |       |      |       |      |       |      |      |      |      |
| HCM 2010 Ctrl Delay          |      |      | 30.7 |       |      |       |      |       |      |      |      |      |
| HCM 2010 LOS                 |      |      | C    |       |      |       |      |       |      |      |      |      |
| <b>Notes</b>                 |      |      |      |       |      |       |      |       |      |      |      |      |

HCM 2010 Signalized Intersection Summary  
 50: Reservation Road & SR 68 WB On Ramp/SR 68 WB Off Ramp

Cumulative with Project, PM  
 06/11/2019























| Movement                       | EBL  | EBT  | EBR | WBL  | WBT  | WBR  | NBL  | NBT  | NBR  | SBL  | SBT  | SBR  |
|--------------------------------|------|------|-----|------|------|------|------|------|------|------|------|------|
| Lane Configurations            |      |      |     |      | ↕    | ↕    | ↕    | ↑    |      |      | ↕    |      |
| Traffic Volume (veh/h)         | 0    | 0    | 0   | 410  | 10   | 250  | 140  | 250  | 0    | 0    | 520  | 180  |
| Future Volume (veh/h)          | 0    | 0    | 0   | 410  | 10   | 250  | 140  | 250  | 0    | 0    | 520  | 180  |
| Number                         |      |      |     | 7    | 4    | 14   | 1    | 6    | 16   | 5    | 2    | 12   |
| Initial Q (Qb), veh            |      |      |     | 0    | 0    | 0    | 0    | 0    | 0    | 0    | 0    | 0    |
| Ped-Bike Adj(A_pbT)            |      |      |     | 1.00 |      | 1.00 | 1.00 |      | 1.00 | 1.00 |      | 1.00 |
| Parking Bus, Adj               |      |      |     | 1.00 | 1.00 | 1.00 | 1.00 | 1.00 | 1.00 | 1.00 | 1.00 | 1.00 |
| Adj Sat Flow, veh/h/ln         |      |      |     | 1900 | 1863 | 1863 | 1845 | 1845 | 0    | 0    | 1827 | 1900 |
| Adj Flow Rate, veh/h           |      |      |     | 436  | 11   | 84   | 149  | 266  | 0    | 0    | 553  | 181  |
| Adj No. of Lanes               |      |      |     | 0    | 1    | 1    | 1    | 1    | 0    | 0    | 1    | 0    |
| Peak Hour Factor               |      |      |     | 0.94 | 0.94 | 0.94 | 0.94 | 0.94 | 0.94 | 0.94 | 0.94 | 0.94 |
| Percent Heavy Veh, %           |      |      |     | 2    | 2    | 2    | 3    | 3    | 0    | 0    | 4    | 4    |
| Cap, veh/h                     |      |      |     | 485  | 12   | 443  | 185  | 1091 | 0    | 0    | 587  | 192  |
| Arrive On Green                |      |      |     | 0.28 | 0.28 | 0.28 | 0.03 | 0.20 | 0.00 | 0.00 | 0.45 | 0.45 |
| Sat Flow, veh/h                |      |      |     | 1732 | 44   | 1581 | 1757 | 1845 | 0    | 0    | 1319 | 432  |
| Grp Volume(v), veh/h           |      |      |     | 447  | 0    | 84   | 149  | 266  | 0    | 0    | 0    | 734  |
| Grp Sat Flow(s),veh/h/ln       |      |      |     | 1776 | 0    | 1581 | 1757 | 1845 | 0    | 0    | 0    | 1751 |
| Q Serve(g_s), s                |      |      |     | 20.6 | 0.0  | 3.4  | 7.2  | 10.4 | 0.0  | 0.0  | 0.0  | 34.0 |
| Cycle Q Clear(g_c), s          |      |      |     | 20.6 | 0.0  | 3.4  | 7.2  | 10.4 | 0.0  | 0.0  | 0.0  | 34.0 |
| Prop In Lane                   |      |      |     | 0.98 |      | 1.00 | 1.00 |      | 0.00 | 0.00 |      | 0.25 |
| Lane Grp Cap(c), veh/h         |      |      |     | 498  | 0    | 443  | 185  | 1091 | 0    | 0    | 0    | 780  |
| V/C Ratio(X)                   |      |      |     | 0.90 | 0.00 | 0.19 | 0.81 | 0.24 | 0.00 | 0.00 | 0.00 | 0.94 |
| Avail Cap(c_a), veh/h          |      |      |     | 564  | 0    | 502  | 248  | 1091 | 0    | 0    | 0    | 780  |
| HCM Platoon Ratio              |      |      |     | 1.00 | 1.00 | 1.00 | 0.33 | 0.33 | 1.00 | 1.00 | 1.00 | 1.00 |
| Upstream Filter(I)             |      |      |     | 1.00 | 0.00 | 1.00 | 0.95 | 0.95 | 0.00 | 0.00 | 0.00 | 1.00 |
| Uniform Delay (d), s/veh       |      |      |     | 29.4 | 0.0  | 23.3 | 40.2 | 18.1 | 0.0  | 0.0  | 0.0  | 22.5 |
| Incr Delay (d2), s/veh         |      |      |     | 15.9 | 0.0  | 0.2  | 9.3  | 0.5  | 0.0  | 0.0  | 0.0  | 20.8 |
| Initial Q Delay(d3),s/veh      |      |      |     | 0.0  | 0.0  | 0.0  | 0.0  | 0.0  | 0.0  | 0.0  | 0.0  | 0.0  |
| %ile BackOfQ(50%),veh/ln       |      |      |     | 12.3 | 0.0  | 1.5  | 4.0  | 5.5  | 0.0  | 0.0  | 0.0  | 20.8 |
| LnGrp Delay(d),s/veh           |      |      |     | 45.4 | 0.0  | 23.5 | 49.5 | 18.6 | 0.0  | 0.0  | 0.0  | 43.3 |
| LnGrp LOS                      |      |      |     | D    |      | C    | D    | B    |      |      |      | D    |
| Approach Vol, veh/h            |      |      |     |      | 531  |      |      | 415  |      |      | 734  |      |
| Approach Delay, s/veh          |      |      |     |      | 41.9 |      |      | 29.7 |      |      | 43.3 |      |
| Approach LOS                   |      |      |     |      | D    |      |      | C    |      |      | D    |      |
| Timer                          | 1    | 2    | 3   | 4    | 5    | 6    | 7    | 8    |      |      |      |      |
| Assigned Phs                   | 1    | 2    |     | 4    |      | 6    |      |      |      |      |      |      |
| Phs Duration (G+Y+Rc), s       | 2.4  | 43.8 |     | 28.7 |      | 56.3 |      |      |      |      |      |      |
| Change Period (Y+Rc), s        | 3.5  | 6.0  |     | 4.9  |      | 6.0  |      |      |      |      |      |      |
| Max Green Setting (Gmax), s    | 2.0  | 31.6 |     | 27.0 |      | 47.1 |      |      |      |      |      |      |
| Max Q Clear Time (g_c+19.2), s | 19.2 | 36.0 |     | 22.6 |      | 12.4 |      |      |      |      |      |      |
| Green Ext Time (p_c), s        | 0.0  | 0.0  |     | 1.2  |      | 1.3  |      |      |      |      |      |      |
| <b>Intersection Summary</b>    |      |      |     |      |      |      |      |      |      |      |      |      |
| HCM 2010 Ctrl Delay            |      |      |     | 39.5 |      |      |      |      |      |      |      |      |
| HCM 2010 LOS                   |      |      |     | D    |      |      |      |      |      |      |      |      |



| Movement                     | EBL  | EBT  | EBR  | WBL | WBT  | WBR  | NBL  | NBT  | NBR  | SBL  | SBT  | SBR  |
|------------------------------|------|------|------|-----|------|------|------|------|------|------|------|------|
| Lane Configurations          |      | ↕    | ↗    |     |      |      |      | ↑    | ↗    | ↘    | ↑    |      |
| Traffic Volume (veh/h)       | 110  | 10   | 190  | 0   | 0    | 0    | 0    | 300  | 320  | 260  | 670  | 0    |
| Future Volume (veh/h)        | 110  | 10   | 190  | 0   | 0    | 0    | 0    | 300  | 320  | 260  | 670  | 0    |
| Number                       | 3    | 8    | 18   |     |      |      | 1    | 6    | 16   | 5    | 2    | 12   |
| Initial Q (Qb), veh          | 0    | 0    | 0    |     |      |      | 0    | 0    | 0    | 0    | 0    | 0    |
| Ped-Bike Adj(A_pbT)          | 1.00 |      | 1.00 |     |      |      | 1.00 |      | 1.00 | 1.00 |      | 1.00 |
| Parking Bus, Adj             | 1.00 | 1.00 | 1.00 |     |      |      | 1.00 | 1.00 | 1.00 | 1.00 | 1.00 | 1.00 |
| Adj Sat Flow, veh/h/ln       | 1900 | 1863 | 1863 |     |      |      | 0    | 1845 | 1845 | 1827 | 1827 | 0    |
| Adj Flow Rate, veh/h         | 117  | 11   | 23   |     |      |      | 0    | 319  | 201  | 277  | 713  | 0    |
| Adj No. of Lanes             | 0    | 1    | 1    |     |      |      | 0    | 1    | 1    | 1    | 1    | 0    |
| Peak Hour Factor             | 0.94 | 0.94 | 0.94 |     |      |      | 0.94 | 0.94 | 0.94 | 0.94 | 0.94 | 0.94 |
| Percent Heavy Veh, %         | 2    | 2    | 2    |     |      |      | 0    | 3    | 3    | 4    | 4    | 0    |
| Cap, veh/h                   | 159  | 15   | 155  |     |      |      | 0    | 1022 | 869  | 307  | 1414 | 0    |
| Arrive On Green              | 0.10 | 0.10 | 0.10 |     |      |      | 0.00 | 0.55 | 0.55 | 0.35 | 1.00 | 0.00 |
| Sat Flow, veh/h              | 1628 | 153  | 1583 |     |      |      | 0    | 1845 | 1568 | 1740 | 1827 | 0    |
| Grp Volume(v), veh/h         | 128  | 0    | 23   |     |      |      | 0    | 319  | 201  | 277  | 713  | 0    |
| Grp Sat Flow(s),veh/h/ln     | 1781 | 0    | 1583 |     |      |      | 0    | 1845 | 1568 | 1740 | 1827 | 0    |
| Q Serve(g_s), s              | 5.9  | 0.0  | 1.1  |     |      |      | 0.0  | 7.9  | 5.6  | 12.8 | 0.0  | 0.0  |
| Cycle Q Clear(g_c), s        | 5.9  | 0.0  | 1.1  |     |      |      | 0.0  | 7.9  | 5.6  | 12.8 | 0.0  | 0.0  |
| Prop In Lane                 | 0.91 |      | 1.00 |     |      |      | 0.00 |      | 1.00 | 1.00 |      | 0.00 |
| Lane Grp Cap(c), veh/h       | 174  | 0    | 155  |     |      |      | 0    | 1022 | 869  | 307  | 1414 | 0    |
| V/C Ratio(X)                 | 0.74 | 0.00 | 0.15 |     |      |      | 0.00 | 0.31 | 0.23 | 0.90 | 0.50 | 0.00 |
| Avail Cap(c_a), veh/h        | 524  | 0    | 466  |     |      |      | 0    | 1022 | 869  | 348  | 1414 | 0    |
| HCM Platoon Ratio            | 1.00 | 1.00 | 1.00 |     |      |      | 1.00 | 1.00 | 1.00 | 2.00 | 2.00 | 1.00 |
| Upstream Filter(I)           | 1.00 | 0.00 | 1.00 |     |      |      | 0.00 | 1.00 | 1.00 | 0.10 | 0.10 | 0.00 |
| Uniform Delay (d), s/veh     | 37.3 | 0.0  | 35.1 |     |      |      | 0.0  | 10.2 | 9.7  | 26.8 | 0.0  | 0.0  |
| Incr Delay (d2), s/veh       | 5.9  | 0.0  | 0.4  |     |      |      | 0.0  | 0.8  | 0.6  | 3.4  | 0.1  | 0.0  |
| Initial Q Delay(d3),s/veh    | 0.0  | 0.0  | 0.0  |     |      |      | 0.0  | 0.0  | 0.0  | 0.0  | 0.0  | 0.0  |
| %ile BackOfQ(50%),veh/ln     | 3.2  | 0.0  | 0.5  |     |      |      | 0.0  | 4.2  | 2.6  | 6.4  | 0.1  | 0.0  |
| LnGrp Delay(d),s/veh         | 43.2 | 0.0  | 35.5 |     |      |      | 0.0  | 11.0 | 10.3 | 30.2 | 0.1  | 0.0  |
| LnGrp LOS                    | D    |      | D    |     |      |      |      | B    | B    | C    | A    |      |
| Approach Vol, veh/h          |      | 151  |      |     |      |      |      | 520  |      |      | 990  |      |
| Approach Delay, s/veh        |      | 42.0 |      |     |      |      |      | 10.7 |      |      | 8.5  |      |
| Approach LOS                 |      | D    |      |     |      |      |      | B    |      |      | A    |      |
| Timer                        | 1    | 2    | 3    | 4   | 5    | 6    | 7    | 8    |      |      |      |      |
| Assigned Phs                 |      | 2    |      |     | 5    | 6    |      | 8    |      |      |      |      |
| Phs Duration (G+Y+Rc), s     |      | 71.8 |      |     | 18.7 | 53.1 |      | 13.2 |      |      |      |      |
| Change Period (Y+Rc), s      |      | 6.0  |      |     | 3.7  | 6.0  |      | 4.9  |      |      |      |      |
| Max Green Setting (Gmax), s  |      | 43.1 |      |     | 17.0 | 28.4 |      | 25.0 |      |      |      |      |
| Max Q Clear Time (g_c+I1), s |      | 2.0  |      |     | 14.8 | 9.9  |      | 7.9  |      |      |      |      |
| Green Ext Time (p_c), s      |      | 4.9  |      |     | 0.2  | 2.1  |      | 0.6  |      |      |      |      |
| <b>Intersection Summary</b>  |      |      |      |     |      |      |      |      |      |      |      |      |
| HCM 2010 Ctrl Delay          |      |      | 12.3 |     |      |      |      |      |      |      |      |      |
| HCM 2010 LOS                 |      |      | B    |     |      |      |      |      |      |      |      |      |

HCM 2010 Signalized Intersection Summary  
 1: Del Monte Boulevard & Reindollar Avenue

Cumulative with Eastside Parkway, AM  
 06/11/2019

|                              |  |  |  |  |  |  |   |  |  |  |  |  |
|------------------------------|---|---|---|---|---|---|---|---|---|---|---|---|
| Movement                     | EBL   | EBT   | EBR   | WBL   | WBT   | WBR   | NBL   | NBT   | NBR   | SBL   | SBT   | SBR   |
| Lane Configurations          |   |   |   |  |  |   |  |  |  |  |  |  |
| Traffic Volume (veh/h)       | 0   | 0   | 0   | 450   | 0   | 420   | 10  | 640   | 120   | 410   | 1170  | 0   |
| Future Volume (veh/h)        | 0   | 0   | 0   | 450   | 0   | 420   | 10  | 640   | 120   | 410   | 1170  | 0   |
| Number                       |   |   |   | 3   | 8   | 18  | 1   | 6   | 16  | 5   | 2   | 12  |
| Initial Q (Qb), veh          |   |   |   | 0   | 0   | 0   | 0   | 0   | 0   | 0   | 0   | 0   |
| Ped-Bike Adj(A_pbT)          |   |   |   | 1.00  |   | 0.99  | 1.00  |   | 1.00  | 1.00  |   | 1.00  |
| Parking Bus, Adj             |   |   |   | 1.00  | 1.00  | 1.00  | 1.00  | 1.00  | 1.00  | 1.00  | 1.00  | 1.00  |
| Adj Sat Flow, veh/h/ln       |   |   |   | 1900  | 1900  | 1900  | 1863  | 1863  | 1863  | 1845  | 1845  | 0   |
| Adj Flow Rate, veh/h         |   |   |   | 468   | 54  | 429   | 11  | 719   | 68  | 461   | 1315  | 0   |
| Adj No. of Lanes             |   |   |   | 1   | 1   | 0   | 1   | 2   | 1   | 1   | 2   | 0   |
| Peak Hour Factor             |   |   |   | 0.89  | 0.89  | 0.89  | 0.89  | 0.89  | 0.89  | 0.89  | 0.89  | 0.89  |
| Percent Heavy Veh, %         |   |   |   | 0   | 0   | 0   | 2   | 2   | 2   | 3   | 3   | 0   |
| Cap, veh/h                   |   |   |   | 575   | 58  | 461   | 24  | 892   | 397   | 499   | 1832  | 0   |
| Arrive On Green              |   |   |   | 0.32  | 0.32  | 0.32  | 0.01  | 0.25  | 0.25  | 0.28  | 0.52  | 0.00  |
| Sat Flow, veh/h              |   |   |   | 1810  | 183   | 1451  | 1774  | 3539  | 1577  | 1757  | 3597  | 0   |
| Grp Volume(v), veh/h         |   |   |   | 468   | 0   | 483   | 11  | 719   | 68  | 461   | 1315  | 0   |
| Grp Sat Flow(s),veh/h/ln     |   |   |   | 1810  | 0   | 1634  | 1774  | 1770  | 1577  | 1757  | 1752  | 0   |
| Q Serve(g_s), s              |   |   |   | 21.9  | 0.0   | 26.4  | 0.6   | 17.6  | 3.1   | 23.5  | 26.4  | 0.0   |
| Cycle Q Clear(g_c), s        |   |   |   | 21.9  | 0.0   | 26.4  | 0.6   | 17.6  | 3.1   | 23.5  | 26.4  | 0.0   |
| Prop In Lane                 |   |   |   | 1.00  |   | 0.89  | 1.00  |   | 1.00  | 1.00  |   | 0.00  |
| Lane Grp Cap(c), veh/h       |   |   |   | 575   | 0   | 519   | 24  | 892   | 397   | 499   | 1832  | 0   |
| V/C Ratio(X)                 |   |   |   | 0.81  | 0.00  | 0.93  | 0.47  | 0.81  | 0.17  | 0.92  | 0.72  | 0.00  |
| Avail Cap(c_a), veh/h        |   |   |   | 589   | 0   | 532   | 578   | 1153  | 514   | 572   | 1832  | 0   |
| HCM Platoon Ratio            |   |   |   | 1.00  | 1.00  | 1.00  | 1.00  | 1.00  | 1.00  | 1.00  | 1.00  | 1.00  |
| Upstream Filter(I)           |   |   |   | 1.00  | 0.00  | 1.00  | 1.00  | 1.00  | 1.00  | 1.00  | 1.00  | 0.00  |
| Uniform Delay (d), s/veh     |   |   |   | 28.9  | 0.0   | 30.5  | 45.1  | 32.3  | 26.9  | 32.0  | 16.8  | 0.0   |
| Incr Delay (d2), s/veh       |   |   |   | 8.5   | 0.0   | 23.0  | 13.6  | 3.3   | 0.2   | 19.4  | 1.4   | 0.0   |
| Initial Q Delay(d3),s/veh    |   |   |   | 0.0   | 0.0   | 0.0   | 0.0   | 0.0   | 0.0   | 0.0   | 0.0   | 0.0   |
| %ile BackOfQ(50%),veh/ln     |   |   |   | 12.3  | 0.0   | 15.1  | 0.4   | 9.0   | 1.4   | 14.1  | 13.0  | 0.0   |
| LnGrp Delay(d),s/veh         |   |   |   | 37.4  | 0.0   | 53.4  | 58.7  | 35.7  | 27.1  | 51.5  | 18.2  | 0.0   |
| LnGrp LOS                    |   |   |   | D   |   | D   | E   | D   | C   | D   | B   |   |
| Approach Vol, veh/h          |   |   |   |   | 951   |   |   | 798   |   |   | 1776  |   |
| Approach Delay, s/veh        |   |   |   |   | 45.5  |   |   | 35.3  |   |   | 26.8  |   |
| Approach LOS                 |   |   |   |   | D   |   |   | D   |   |   | C   |   |
| Timer                        | 1   | 2   | 3   | 4   | 5   | 6   | 7   | 8   |   |   |   |   |
| Assigned Phs                 | 1   | 2   |   |   | 5   | 6   |   | 8   |   |   |   |   |
| Phs Duration (G+Y+Rc), s     | 4.7   | 53.1  |   |   | 29.7  | 28.2  |   | 34.2  |   |   |   |   |
| Change Period (Y+Rc), s      | 3.5   | 5.0   |   |   | 3.5   | 5.0   |   | 5.0   |   |   |   |   |
| Max Green Setting (Gmax), s  | 30.0  | 30.0  |   |   | 30.0  | 30.0  |   | 30.0  |   |   |   |   |
| Max Q Clear Time (g_c+I1), s | 2.6   | 28.4  |   |   | 25.5  | 19.6  |   | 28.4  |   |   |   |   |
| Green Ext Time (p_c), s      | 0.0   | 1.2   |   |   | 0.7   | 3.6   |   | 0.9   |   |   |   |   |
| <b>Intersection Summary</b>  |   |   |   |   |   |   |   |   |   |   |   |   |
| HCM 2010 Ctrl Delay          |   |   |   | 33.8  |   |   |   |   |   |   |   |   |
| HCM 2010 LOS                 |   |   |   | C   |   |   |   |   |   |   |   |   |
| <b>Notes</b>                 |   |   |   |   |   |   |   |   |   |   |   |   |

HCM 2010 Signalized Intersection Summary  
2: 2nd Avenue & Patton Parkway

Cumulative with Eastside Parkway, AM  
06/11/2019



| Movement                     | EBL  | EBT  | EBR  | WBL  | WBT  | WBR  | NBL  | NBT  | NBR  | SBL  | SBT  | SBR  |
|------------------------------|------|------|------|------|------|------|------|------|------|------|------|------|
| Lane Configurations          |      |      |      |      |      |      |      |      |      |      |      |      |
| Traffic Volume (veh/h)       | 50   | 90   | 60   | 30   | 90   | 100  | 70   | 220  | 100  | 90   | 200  | 50   |
| Future Volume (veh/h)        | 50   | 90   | 60   | 30   | 90   | 100  | 70   | 220  | 100  | 90   | 200  | 50   |
| Number                       | 7    | 4    | 14   | 3    | 8    | 18   | 5    | 2    | 12   | 1    | 6    | 16   |
| Initial Q (Qb), veh          | 0    | 0    | 0    | 0    | 0    | 0    | 0    | 0    | 0    | 0    | 0    | 0    |
| Ped-Bike Adj(A_pbT)          | 1.00 |      | 1.00 | 1.00 |      | 1.00 | 1.00 |      | 1.00 | 1.00 |      | 1.00 |
| Parking Bus, Adj             | 1.00 | 1.00 | 1.00 | 1.00 | 1.00 | 1.00 | 1.00 | 1.00 | 1.00 | 1.00 | 1.00 | 1.00 |
| Adj Sat Flow, veh/h/ln       | 1863 | 1863 | 1900 | 1863 | 1863 | 1900 | 1863 | 1863 | 1900 | 1863 | 1863 | 1900 |
| Adj Flow Rate, veh/h         | 54   | 98   | 65   | 33   | 98   | 109  | 76   | 239  | 109  | 98   | 217  | 54   |
| Adj No. of Lanes             | 1    | 1    | 0    | 1    | 1    | 0    | 1    | 1    | 0    | 1    | 1    | 0    |
| Peak Hour Factor             | 0.92 | 0.92 | 0.92 | 0.92 | 0.92 | 0.92 | 0.92 | 0.92 | 0.92 | 0.92 | 0.92 | 0.92 |
| Percent Heavy Veh, %         | 2    | 2    | 2    | 2    | 2    | 2    | 2    | 2    | 2    | 2    | 2    | 2    |
| Cap, veh/h                   | 97   | 247  | 164  | 67   | 177  | 197  | 121  | 330  | 151  | 139  | 407  | 101  |
| Arrive On Green              | 0.05 | 0.24 | 0.24 | 0.04 | 0.22 | 0.22 | 0.07 | 0.27 | 0.27 | 0.08 | 0.28 | 0.28 |
| Sat Flow, veh/h              | 1774 | 1046 | 694  | 1774 | 807  | 897  | 1774 | 1212 | 553  | 1774 | 1441 | 359  |
| Grp Volume(v), veh/h         | 54   | 0    | 163  | 33   | 0    | 207  | 76   | 0    | 348  | 98   | 0    | 271  |
| Grp Sat Flow(s),veh/h/ln     | 1774 | 0    | 1740 | 1774 | 0    | 1704 | 1774 | 0    | 1765 | 1774 | 0    | 1799 |
| Q Serve(g_s), s              | 1.3  | 0.0  | 3.6  | 0.8  | 0.0  | 4.9  | 1.9  | 0.0  | 8.1  | 2.4  | 0.0  | 5.8  |
| Cycle Q Clear(g_c), s        | 1.3  | 0.0  | 3.6  | 0.8  | 0.0  | 4.9  | 1.9  | 0.0  | 8.1  | 2.4  | 0.0  | 5.8  |
| Prop In Lane                 | 1.00 |      | 0.40 | 1.00 |      | 0.53 | 1.00 |      | 0.31 | 1.00 |      | 0.20 |
| Lane Grp Cap(c), veh/h       | 97   | 0    | 411  | 67   | 0    | 374  | 121  | 0    | 481  | 139  | 0    | 509  |
| V/C Ratio(X)                 | 0.56 | 0.00 | 0.40 | 0.50 | 0.00 | 0.55 | 0.63 | 0.00 | 0.72 | 0.71 | 0.00 | 0.53 |
| Avail Cap(c_a), veh/h        | 235  | 0    | 1364 | 235  | 0    | 1336 | 235  | 0    | 1384 | 235  | 0    | 1411 |
| HCM Platoon Ratio            | 1.00 | 1.00 | 1.00 | 1.00 | 1.00 | 1.00 | 1.00 | 1.00 | 1.00 | 1.00 | 1.00 | 1.00 |
| Upstream Filter(l)           | 1.00 | 0.00 | 1.00 | 1.00 | 0.00 | 1.00 | 1.00 | 0.00 | 1.00 | 1.00 | 0.00 | 1.00 |
| Uniform Delay (d), s/veh     | 20.9 | 0.0  | 14.6 | 21.4 | 0.0  | 15.7 | 20.5 | 0.0  | 14.9 | 20.4 | 0.0  | 13.7 |
| Incr Delay (d2), s/veh       | 5.0  | 0.0  | 0.6  | 5.6  | 0.0  | 1.3  | 5.3  | 0.0  | 2.1  | 6.4  | 0.0  | 0.9  |
| Initial Q Delay(d3),s/veh    | 0.0  | 0.0  | 0.0  | 0.0  | 0.0  | 0.0  | 0.0  | 0.0  | 0.0  | 0.0  | 0.0  | 0.0  |
| %ile BackOfQ(50%),veh/ln     | 0.8  | 0.0  | 1.8  | 0.5  | 0.0  | 2.4  | 1.1  | 0.0  | 4.1  | 1.4  | 0.0  | 3.0  |
| LnGrp Delay(d),s/veh         | 25.9 | 0.0  | 15.2 | 27.0 | 0.0  | 17.0 | 25.9 | 0.0  | 17.0 | 26.8 | 0.0  | 14.6 |
| LnGrp LOS                    | C    |      | B    | C    |      | B    | C    |      | B    | C    |      | B    |
| Approach Vol, veh/h          |      | 217  |      |      | 240  |      |      | 424  |      |      | 369  |      |
| Approach Delay, s/veh        |      | 17.8 |      |      | 18.4 |      |      | 18.6 |      |      | 17.8 |      |
| Approach LOS                 |      | B    |      |      | B    |      |      | B    |      |      | B    |      |
| Timer                        | 1    | 2    | 3    | 4    | 5    | 6    | 7    | 8    |      |      |      |      |
| Assigned Phs                 | 1    | 2    | 3    | 4    | 5    | 6    | 7    | 8    |      |      |      |      |
| Phs Duration (G+Y+Rc), s     | 7.5  | 16.8 | 5.7  | 15.2 | 7.1  | 17.3 | 6.5  | 14.4 |      |      |      |      |
| Change Period (Y+Rc), s      | 4.0  | 4.5  | 4.0  | 4.5  | 4.0  | 4.5  | 4.0  | 4.5  |      |      |      |      |
| Max Green Setting (Gmax), s  | 6.0  | 35.5 | 6.0  | 35.5 | 6.0  | 35.5 | 6.0  | 35.5 |      |      |      |      |
| Max Q Clear Time (g_c+14), s | 14.4 | 10.1 | 2.8  | 5.6  | 3.9  | 7.8  | 3.3  | 6.9  |      |      |      |      |
| Green Ext Time (p_c), s      | 0.0  | 2.2  | 0.0  | 1.0  | 0.0  | 1.7  | 0.0  | 1.3  |      |      |      |      |
| <b>Intersection Summary</b>  |      |      |      |      |      |      |      |      |      |      |      |      |
| HCM 2010 Ctrl Delay          |      |      |      | 18.2 |      |      |      |      |      |      |      |      |
| HCM 2010 LOS                 |      |      |      | B    |      |      |      |      |      |      |      |      |



HCM 2010 Signalized Intersection Summary  
 3: SR 1 SB On-Ramp/SR 1 SB Off-Ramp & Imjin Parkway

Cumulative with Eastside Parkway, AM  
 06/11/2019



| Movement                     | EBL | EBT | EBR | WBL   | WBT   | WBR  | NBL | NBT | NBR | SBL   | SBT   | SBR  |
|------------------------------|-----|-----|-----|-------|-------|------|-----|-----|-----|-------|-------|------|
| Lane Configurations          |     |     |     |       | ↕     |      |     |     |     |       | ↕     |      |
| Traffic Volume (veh/h)       | 0   | 0   | 0   | 1040  | 0     | 0    | 0   | 0   | 0   | 920   | 10    | 0    |
| Future Volume (veh/h)        | 0   | 0   | 0   | 1040  | 0     | 0    | 0   | 0   | 0   | 920   | 10    | 0    |
| Number                       |     |     |     | 1     | 6     | 16   |     |     |     | 7     | 4     | 14   |
| Initial Q (Qb), veh          |     |     |     | 0     | 0     | 0    |     |     |     | 0     | 0     | 0    |
| Ped-Bike Adj(A_pbT)          |     |     |     | 1.00  |       | 1.00 |     |     |     | 1.00  |       | 1.00 |
| Parking Bus, Adj             |     |     |     | 1.00  | 1.00  | 1.00 |     |     |     | 1.00  | 1.00  | 1.00 |
| Adj Sat Flow, veh/h/ln       |     |     |     | 1900  | 1845  | 0    |     |     |     | 1900  | 1845  | 0    |
| Adj Flow Rate, veh/h         |     |     |     | 1143  | 0     | 0    |     |     |     | 1011  | 11    | 0    |
| Adj No. of Lanes             |     |     |     | 0     | 1     | 0    |     |     |     | 0     | 1     | 0    |
| Peak Hour Factor             |     |     |     | 0.91  | 0.91  | 0.91 |     |     |     | 0.91  | 0.91  | 0.91 |
| Percent Heavy Veh, %         |     |     |     | 3     | 3     | 0    |     |     |     | 3     | 3     | 0    |
| Cap, veh/h                   |     |     |     | 996   | 0     | 0    |     |     |     | 657   | 7     | 0    |
| Arrive On Green              |     |     |     | 0.57  | 0.00  | 0.00 |     |     |     | 0.38  | 0.38  | 0.00 |
| Sat Flow, veh/h              |     |     |     | 1757  | 0     | 0    |     |     |     | 1739  | 19    | 0    |
| Grp Volume(v), veh/h         |     |     |     | 1143  | 0     | 0    |     |     |     | 1022  | 0     | 0    |
| Grp Sat Flow(s),veh/h/ln     |     |     |     | 1757  | 0     | 0    |     |     |     | 1758  | 0     | 0    |
| Q Serve(g_s), s              |     |     |     | 90.0  | 0.0   | 0.0  |     |     |     | 60.0  | 0.0   | 0.0  |
| Cycle Q Clear(g_c), s        |     |     |     | 90.0  | 0.0   | 0.0  |     |     |     | 60.0  | 0.0   | 0.0  |
| Prop In Lane                 |     |     |     | 1.00  |       | 0.00 |     |     |     | 0.99  |       | 0.00 |
| Lane Grp Cap(c), veh/h       |     |     |     | 996   | 0     | 0    |     |     |     | 664   | 0     | 0    |
| V/C Ratio(X)                 |     |     |     | 1.15  | 0.00  | 0.00 |     |     |     | 1.54  | 0.00  | 0.00 |
| Avail Cap(c_a), veh/h        |     |     |     | 996   | 0     | 0    |     |     |     | 664   | 0     | 0    |
| HCM Platoon Ratio            |     |     |     | 1.00  | 1.00  | 1.00 |     |     |     | 1.00  | 1.00  | 1.00 |
| Upstream Filter(I)           |     |     |     | 1.00  | 0.00  | 0.00 |     |     |     | 1.00  | 0.00  | 0.00 |
| Uniform Delay (d), s/veh     |     |     |     | 34.4  | 0.0   | 0.0  |     |     |     | 49.4  | 0.0   | 0.0  |
| Incr Delay (d2), s/veh       |     |     |     | 78.5  | 0.0   | 0.0  |     |     |     | 250.0 | 0.0   | 0.0  |
| Initial Q Delay(d3),s/veh    |     |     |     | 0.0   | 0.0   | 0.0  |     |     |     | 0.0   | 0.0   | 0.0  |
| %ile BackOfQ(50%),veh/ln     |     |     |     | 65.1  | 0.0   | 0.0  |     |     |     | 75.1  | 0.0   | 0.0  |
| LnGrp Delay(d),s/veh         |     |     |     | 112.9 | 0.0   | 0.0  |     |     |     | 299.4 | 0.0   | 0.0  |
| LnGrp LOS                    |     |     |     | F     |       |      |     |     |     | F     |       |      |
| Approach Vol, veh/h          |     |     |     |       | 1143  |      |     |     |     |       | 1022  |      |
| Approach Delay, s/veh        |     |     |     |       | 112.9 |      |     |     |     |       | 299.4 |      |
| Approach LOS                 |     |     |     |       | F     |      |     |     |     |       | F     |      |
| Timer                        | 1   | 2   | 3   | 4     | 5     | 6    | 7   | 8   |     |       |       |      |
| Assigned Phs                 |     |     |     | 4     |       | 6    |     |     |     |       |       |      |
| Phs Duration (G+Y+Rc), s     |     |     |     | 64.4  |       | 94.4 |     |     |     |       |       |      |
| Change Period (Y+Rc), s      |     |     |     | 4.4   |       | 4.4  |     |     |     |       |       |      |
| Max Green Setting (Gmax), s  |     |     |     | 60.0  |       | 90.0 |     |     |     |       |       |      |
| Max Q Clear Time (g_c+I1), s |     |     |     | 62.0  |       | 92.0 |     |     |     |       |       |      |
| Green Ext Time (p_c), s      |     |     |     | 0.0   |       | 0.0  |     |     |     |       |       |      |
| <b>Intersection Summary</b>  |     |     |     |       |       |      |     |     |     |       |       |      |
| HCM 2010 Ctrl Delay          |     |     |     | 200.9 |       |      |     |     |     |       |       |      |
| HCM 2010 LOS                 |     |     |     | F     |       |      |     |     |     |       |       |      |

| Intersection             |      |      |      |      |      |      |      |      |      |      |       |      |
|--------------------------|------|------|------|------|------|------|------|------|------|------|-------|------|
| Int Delay, s/veh         | 0.9  |      |      |      |      |      |      |      |      |      |       |      |
| Movement                 | EBL  | EBT  | EBR  | WBL  | WBT  | WBR  | NBL  | NBT  | NBR  | SBL  | SBT   | SBR  |
| Lane Configurations      |      | ↕    |      |      | ↑    | ↗    |      | ↕    | ↗    |      |       |      |
| Traffic Vol, veh/h       | 10   | 930  | 0    | 0    | 1000 | 410  | 10   | 10   | 950  | 0    | 0     | 0    |
| Future Vol, veh/h        | 10   | 930  | 0    | 0    | 1000 | 410  | 10   | 10   | 950  | 0    | 0     | 0    |
| Conflicting Peds, #/hr   | 0    | 0    | 3    | 3    | 0    | 0    | 0    | 0    | 0    | 0    | 0     | 0    |
| Sign Control             | Free | Free | Free | Free | Free | Free | Stop | Stop | Stop | Stop | Stop  | Stop |
| RT Channelized           | -    | -    | None | -    | -    | Free | -    | -    | Free | -    | -     | None |
| Storage Length           | -    | -    | -    | -    | -    | 0    | -    | -    | 800  | -    | -     | -    |
| Veh in Median Storage, # | -    | 0    | -    | -    | 0    | -    | -    | 0    | -    | -    | 16965 | -    |
| Grade, %                 | -    | 0    | -    | -    | 0    | -    | -    | 0    | -    | -    | 0     | -    |
| Peak Hour Factor         | 97   | 97   | 97   | 97   | 97   | 97   | 97   | 97   | 97   | 97   | 97    | 97   |
| Heavy Vehicles, %        | 3    | 3    | 3    | 3    | 3    | 3    | 2    | 2    | 2    | 2    | 2     | 2    |
| Mvmt Flow                | 10   | 959  | 0    | 0    | 1031 | 423  | 10   | 10   | 979  | 0    | 0     | 0    |























| Major/Minor          | Major1 | Major2 | Minor1 |
|----------------------|--------|--------|--------|
| Conflicting Flow All | 1031   | 0      | -      |
| Stage 1              | -      | -      | -      |
| Stage 2              | -      | -      | -      |
| Critical Hdwy        | 4.13   | -      | -      |
| Critical Hdwy Stg 1  | -      | -      | -      |
| Critical Hdwy Stg 2  | -      | -      | -      |
| Follow-up Hdwy       | 2.227  | -      | -      |
| Pot Cap-1 Maneuver   | 670    | 0      | 0      |
| Stage 1              | -      | 0      | 0      |
| Stage 2              | -      | 0      | 0      |
| Platoon blocked, %   | -      | -      | -      |
| Mov Cap-1 Maneuver   | 670    | -      | -      |
| Mov Cap-2 Maneuver   | -      | -      | -      |
| Stage 1              | -      | -      | -      |
| Stage 2              | -      | -      | -      |

| Approach             | EB  | WB | NB   |
|----------------------|-----|----|------|
| HCM Control Delay, s | 0.1 | 0  | 87.8 |
| HCM LOS              |     |    | F    |

| Minor Lane/Major Mvmt | NBLn1 | NBLn2 | EBL   | EBT | WBT |
|-----------------------|-------|-------|-------|-----|-----|
| Capacity (veh/h)      | 63    | -     | 670   | -   | -   |
| HCM Lane V/C Ratio    | 0.327 | -     | 0.015 | -   | -   |
| HCM Control Delay (s) | 87.8  | 0     | 10.5  | 0   | -   |
| HCM Lane LOS          | F     | A     | B     | A   | -   |
| HCM 95th %tile Q(veh) | 1.2   | -     | 0     | -   | -   |

HCM 2010 Signalized Intersection Summary  
5: 2nd Avenue & Imjin Parkway

Cumulative with Eastside Parkway, AM  
06/11/2019

|                              |  |  |  |  |  |  |  |  |  |  |  |  |
|------------------------------|---|---|---|---|---|---|--|---|---|---|---|---|
| Movement                     | EBL   | EBT   | EBR   | WBL   | WBT   | WBR   | NBL  | NBT   | NBR   | SBL   | SBT   | SBR   |
| Lane Configurations          |  |  |  |  |  |   |  |  |  |  |  |  |
| Traffic Volume (veh/h)       | 180   | 970   | 890   | 470   | 830   | 120   | 390  | 90  | 200   | 50  | 100   | 210   |
| Future Volume (veh/h)        | 180   | 970   | 890   | 470   | 830   | 120   | 390  | 90  | 200   | 50  | 100   | 210   |
| Number                       | 5   | 2   | 12  | 1   | 6   | 16  | 3  | 8   | 18  | 7   | 4   | 14  |
| Initial Q (Qb), veh          | 0   | 0   | 0   | 0   | 0   | 0   | 0  | 0   | 0   | 0   | 0   | 0   |
| Ped-Bike Adj(A_pbT)          | 1.00  |   | 1.00  | 1.00  |   | 1.00  | 1.00   |   | 1.00  | 1.00  |   | 1.00  |
| Parking Bus, Adj             | 1.00  | 1.00  | 1.00  | 1.00  | 1.00  | 1.00  | 1.00   | 1.00  | 1.00  | 1.00  | 1.00  | 1.00  |
| Adj Sat Flow, veh/h/ln       | 1863  | 1863  | 1863  | 1863  | 1863  | 1900  | 1810   | 1810  | 1810  | 1900  | 1900  | 1900  |
| Adj Flow Rate, veh/h         | 184   | 990   | 689   | 480   | 847   | 122   | 398  | 92  | 82  | 51  | 102   | 209   |
| Adj No. of Lanes             | 1   | 2   | 1   | 2   | 2   | 0   | 2  | 1   | 1   | 1   | 2   | 0   |
| Peak Hour Factor             | 0.98  | 0.98  | 0.98  | 0.98  | 0.98  | 0.98  | 0.98   | 0.98  | 0.98  | 0.98  | 0.98  | 0.98  |
| Percent Heavy Veh, %         | 2   | 2   | 2   | 2   | 2   | 2   | 5  | 5   | 5   | 0   | 0   | 0   |
| Cap, veh/h                   | 221   | 1214  | 543   | 549   | 1174  | 169   | 467  | 439   | 372   | 91  | 276   | 247   |
| Arrive On Green              | 0.12  | 0.34  | 0.34  | 0.16  | 0.38  | 0.38  | 0.14   | 0.24  | 0.24  | 0.05  | 0.15  | 0.15  |
| Sat Flow, veh/h              | 1774  | 3539  | 1583  | 3442  | 3106  | 447   | 3343   | 1810  | 1536  | 1810  | 1805  | 1612  |
| Grp Volume(v), veh/h         | 184   | 990   | 689   | 480   | 483   | 486   | 398  | 92  | 82  | 51  | 102   | 209   |
| Grp Sat Flow(s),veh/h/ln     | 1774  | 1770  | 1583  | 1721  | 1770  | 1784  | 1672   | 1810  | 1536  | 1810  | 1805  | 1612  |
| Q Serve(g_s), s              | 8.9   | 22.3  | 30.0  | 11.9  | 20.4  | 20.4  | 10.2   | 3.5   | 3.7   | 2.4   | 4.4   | 11.0  |
| Cycle Q Clear(g_c), s        | 8.9   | 22.3  | 30.0  | 11.9  | 20.4  | 20.4  | 10.2   | 3.5   | 3.7   | 2.4   | 4.4   | 11.0  |
| Prop In Lane                 | 1.00  |   | 1.00  | 1.00  |   | 0.25  | 1.00   |   | 1.00  | 1.00  |   | 1.00  |
| Lane Grp Cap(c), veh/h       | 221   | 1214  | 543   | 549   | 669   | 674   | 467  | 439   | 372   | 91  | 276   | 247   |
| V/C Ratio(X)                 | 0.83  | 0.82  | 1.27  | 0.88  | 0.72  | 0.72  | 0.85   | 0.21  | 0.22  | 0.56  | 0.37  | 0.85  |
| Avail Cap(c_a), veh/h        | 304   | 1214  | 543   | 590   | 669   | 674   | 765  | 439   | 372   | 207   | 433   | 387   |
| HCM Platoon Ratio            | 1.00  | 1.00  | 1.00  | 1.00  | 1.00  | 1.00  | 1.00   | 1.00  | 1.00  | 1.00  | 1.00  | 1.00  |
| Upstream Filter(I)           | 1.00  | 1.00  | 1.00  | 1.00  | 1.00  | 1.00  | 1.00   | 1.00  | 1.00  | 1.00  | 1.00  | 1.00  |
| Uniform Delay (d), s/veh     | 37.4  | 26.2  | 28.7  | 35.9  | 23.3  | 23.3  | 36.7   | 26.4  | 26.5  | 40.6  | 33.2  | 36.0  |
| Incr Delay (d2), s/veh       | 9.8   | 4.1   | 134.8   | 12.4  | 3.3   | 3.3   | 2.5  | 0.1   | 0.1   | 2.0   | 0.3   | 5.7   |
| Initial Q Delay(d3),s/veh    | 0.0   | 0.0   | 0.0   | 0.0   | 0.0   | 0.0   | 0.0  | 0.0   | 0.0   | 0.0   | 0.0   | 0.0   |
| %ile BackOfQ(50%),veh/ln     | 4.9   | 11.6  | 33.4  | 6.6   | 10.5  | 10.6  | 4.9  | 1.8   | 1.6   | 1.3   | 2.2   | 5.3   |
| LnGrp Delay(d),s/veh         | 47.2  | 30.3  | 163.6   | 48.3  | 26.6  | 26.5  | 39.2   | 26.5  | 26.6  | 42.5  | 33.5  | 41.7  |
| LnGrp LOS                    | D   | C   | F   | D   | C   | C   | D  | C   | C   | D   | C   | D   |
| Approach Vol, veh/h          |   | 1863  |   |   | 1449  |   |  | 572   |   |   | 362   |   |
| Approach Delay, s/veh        |   | 81.3  |   |   | 33.7  |   |  | 35.4  |   |   | 39.5  |   |
| Approach LOS                 |   | F   |   |   | C   |   |  | D   |   |   | D   |   |
| Timer                        | 1   | 2   | 3   | 4   | 5   | 6   | 7  | 8   |   |   |   |   |
| Assigned Phs                 | 1   | 2   | 3   | 4   | 5   | 6   | 7  | 8   |   |   |   |   |
| Phs Duration (G+Y+Rc), s     | 18.4  | 35.3  | 15.7  | 18.0  | 15.4  | 38.4  | 7.9  | 25.8  |   |   |   |   |
| Change Period (Y+Rc), s      | 4.5   | 5.3   | 3.5   | 4.6   | 4.5   | 5.3   | 3.5  | 4.6   |   |   |   |   |
| Max Green Setting (Gmax), s  | 15.0  | 30.0  | 20.0  | 21.0  | 15.0  | 30.0  | 10.0   | 21.0  |   |   |   |   |
| Max Q Clear Time (g_c+I1), s | 13.9  | 32.0  | 12.2  | 13.0  | 10.9  | 22.4  | 4.4  | 5.7   |   |   |   |   |
| Green Ext Time (p_c), s      | 0.0   | 0.0   | 0.1   | 0.3   | 0.0   | 0.9   | 0.0  | 0.1   |   |   |   |   |
| <b>Intersection Summary</b>  |   |   |   |   |   |   |  |   |   |   |   |   |
| HCM 2010 Ctrl Delay          |   |   | 55.3  |   |   |   |  |   |   |   |   |   |
| HCM 2010 LOS                 |   |   | E   |   |   |   |  |   |   |   |   |   |

HCM 2010 Signalized Intersection Summary  
6: 3rd Avenue & Imjin Parkway

Cumulative with Eastside Parkway, AM  
06/11/2019



| Movement                     | EBL  | EBT  | EBR  | WBL  | WBT  | WBR  | NBL  | NBT  | NBR  | SBL  | SBT  | SBR  |
|------------------------------|------|------|------|------|------|------|------|------|------|------|------|------|
| Lane Configurations          | ↖    | ↗    |      | ↖    | ↗    |      | ↖    | ↗    |      | ↖    | ↗    |      |
| Traffic Volume (veh/h)       | 50   | 820  | 230  | 340  | 1240 | 30   | 130  | 10   | 60   | 10   | 10   | 40   |
| Future Volume (veh/h)        | 50   | 820  | 230  | 340  | 1240 | 30   | 130  | 10   | 60   | 10   | 10   | 40   |
| Number                       | 5    | 2    | 12   | 1    | 6    | 16   | 3    | 8    | 18   | 7    | 4    | 14   |
| Initial Q (Qb), veh          | 0    | 0    | 0    | 0    | 0    | 0    | 0    | 0    | 0    | 0    | 0    | 0    |
| Ped-Bike Adj(A_pbT)          | 1.00 |      | 1.00 | 1.00 |      | 1.00 | 1.00 |      | 1.00 | 1.00 |      | 1.00 |
| Parking Bus, Adj             | 1.00 | 1.00 | 1.00 | 1.00 | 1.00 | 1.00 | 1.00 | 1.00 | 1.00 | 1.00 | 1.00 | 1.00 |
| Adj Sat Flow, veh/h/ln       | 1863 | 1863 | 1900 | 1863 | 1863 | 1900 | 1810 | 1810 | 1900 | 1863 | 1863 | 1900 |
| Adj Flow Rate, veh/h         | 52   | 854  | 211  | 354  | 1292 | 30   | 135  | 10   | 8    | 10   | 10   | 7    |
| Adj No. of Lanes             | 1    | 2    | 0    | 1    | 2    | 0    | 1    | 1    | 0    | 1    | 1    | 0    |
| Peak Hour Factor             | 0.96 | 0.96 | 0.96 | 0.96 | 0.96 | 0.96 | 0.96 | 0.96 | 0.96 | 0.96 | 0.96 | 0.96 |
| Percent Heavy Veh, %         | 2    | 2    | 2    | 2    | 2    | 2    | 5    | 5    | 5    | 2    | 2    | 2    |
| Cap, veh/h                   | 63   | 983  | 243  | 409  | 1926 | 45   | 330  | 135  | 108  | 334  | 148  | 104  |
| Arrive On Green              | 0.04 | 0.35 | 0.35 | 0.23 | 0.54 | 0.54 | 0.15 | 0.15 | 0.15 | 0.15 | 0.15 | 0.15 |
| Sat Flow, veh/h              | 1774 | 2814 | 695  | 1774 | 3536 | 82   | 1345 | 930  | 744  | 1384 | 1020 | 714  |
| Grp Volume(v), veh/h         | 52   | 537  | 528  | 354  | 646  | 676  | 135  | 0    | 18   | 10   | 0    | 17   |
| Grp Sat Flow(s),veh/h/ln     | 1774 | 1770 | 1739 | 1774 | 1770 | 1848 | 1345 | 0    | 1675 | 1384 | 0    | 1733 |
| Q Serve(g_s), s              | 1.4  | 13.9 | 13.9 | 9.4  | 12.9 | 12.9 | 4.7  | 0.0  | 0.5  | 0.3  | 0.0  | 0.4  |
| Cycle Q Clear(g_c), s        | 1.4  | 13.9 | 13.9 | 9.4  | 12.9 | 12.9 | 5.1  | 0.0  | 0.5  | 0.8  | 0.0  | 0.4  |
| Prop In Lane                 | 1.00 |      | 0.40 | 1.00 |      | 0.04 | 1.00 |      | 0.44 | 1.00 |      | 0.41 |
| Lane Grp Cap(c), veh/h       | 63   | 618  | 608  | 409  | 964  | 1007 | 330  | 0    | 243  | 334  | 0    | 251  |
| V/C Ratio(X)                 | 0.82 | 0.87 | 0.87 | 0.87 | 0.67 | 0.67 | 0.41 | 0.00 | 0.07 | 0.03 | 0.00 | 0.07 |
| Avail Cap(c_a), veh/h        | 415  | 1171 | 1150 | 415  | 1171 | 1223 | 888  | 0    | 937  | 908  | 0    | 970  |
| HCM Platoon Ratio            | 1.00 | 1.00 | 1.00 | 1.00 | 1.00 | 1.00 | 1.00 | 1.00 | 1.00 | 1.00 | 1.00 | 1.00 |
| Upstream Filter(I)           | 1.00 | 1.00 | 1.00 | 1.00 | 1.00 | 1.00 | 1.00 | 0.00 | 1.00 | 1.00 | 0.00 | 1.00 |
| Uniform Delay (d), s/veh     | 23.5 | 14.9 | 14.9 | 18.2 | 8.0  | 8.0  | 20.4 | 0.0  | 18.1 | 18.5 | 0.0  | 18.1 |
| Incr Delay (d2), s/veh       | 9.6  | 1.5  | 1.5  | 16.2 | 0.7  | 0.6  | 0.3  | 0.0  | 0.0  | 0.0  | 0.0  | 0.0  |
| Initial Q Delay(d3),s/veh    | 0.0  | 0.0  | 0.0  | 0.0  | 0.0  | 0.0  | 0.0  | 0.0  | 0.0  | 0.0  | 0.0  | 0.0  |
| %ile BackOfQ(50%),veh/ln     | 0.9  | 7.0  | 6.9  | 6.4  | 6.3  | 6.6  | 1.8  | 0.0  | 0.2  | 0.1  | 0.0  | 0.2  |
| LnGrp Delay(d),s/veh         | 33.1 | 16.4 | 16.5 | 34.4 | 8.7  | 8.7  | 20.7 | 0.0  | 18.2 | 18.5 | 0.0  | 18.2 |
| LnGrp LOS                    | C    | B    | B    | C    | A    | A    | C    |      | B    | B    |      | B    |
| Approach Vol, veh/h          |      | 1117 |      |      | 1676 |      |      | 153  |      |      | 27   |      |
| Approach Delay, s/veh        |      | 17.2 |      |      | 14.1 |      |      | 20.4 |      |      | 18.3 |      |
| Approach LOS                 |      | B    |      |      | B    |      |      | C    |      |      | B    |      |
| Timer                        | 1    | 2    | 3    | 4    | 5    | 6    | 7    | 8    |      |      |      |      |
| Assigned Phs                 | 1    | 2    |      | 4    | 5    | 6    |      | 8    |      |      |      |      |
| Phs Duration (G+Y+Rc), s     | 4.8  | 22.7 |      | 11.6 | 5.2  | 32.3 |      | 11.6 |      |      |      |      |
| Change Period (Y+Rc), s      | 3.5  | 5.5  |      | 4.5  | 3.5  | 5.5  |      | 4.5  |      |      |      |      |
| Max Green Setting (Gmax), s  | 1.5  | 32.5 |      | 27.5 | 11.5 | 32.5 |      | 27.5 |      |      |      |      |
| Max Q Clear Time (g_c+I1), s | 1.4  | 15.9 |      | 2.8  | 3.4  | 14.9 |      | 7.1  |      |      |      |      |
| Green Ext Time (p_c), s      | 0.0  | 1.2  |      | 0.0  | 0.0  | 1.0  |      | 0.0  |      |      |      |      |
| <b>Intersection Summary</b>  |      |      |      |      |      |      |      |      |      |      |      |      |
| HCM 2010 Ctrl Delay          |      |      |      | 15.6 |      |      |      |      |      |      |      |      |
| HCM 2010 LOS                 |      |      |      | B    |      |      |      |      |      |      |      |      |

HCM 2010 Signalized Intersection Summary  
7: 4th Avenue & Imjin Parkway

Cumulative with Eastside Parkway, AM  
06/11/2019



| Movement                    | EBL  | EBT  | EBR  | WBL  | WBT  | WBR  | NBL  | NBT  | NBR  | SBL  | SBT  | SBR  |
|-----------------------------|------|------|------|------|------|------|------|------|------|------|------|------|
| Lane Configurations         |      |      |      |      |      |      |      |      |      |      |      |      |
| Traffic Volume (veh/h)      | 10   | 910  | 20   | 10   | 1530 | 10   | 10   | 10   | 10   | 10   | 10   | 10   |
| Future Volume (veh/h)       | 10   | 910  | 20   | 10   | 1530 | 10   | 10   | 10   | 10   | 10   | 10   | 10   |
| Number                      | 5    | 2    | 12   | 1    | 6    | 16   | 3    | 8    | 18   | 7    | 4    | 14   |
| Initial Q (Qb), veh         | 0    | 0    | 0    | 0    | 0    | 0    | 0    | 0    | 0    | 0    | 0    | 0    |
| Ped-Bike Adj(A_pbT)         | 1.00 |      | 1.00 | 1.00 |      | 1.00 | 1.00 |      | 1.00 | 1.00 |      | 1.00 |
| Parking Bus, Adj            | 1.00 | 1.00 | 1.00 | 1.00 | 1.00 | 1.00 | 1.00 | 1.00 | 1.00 | 1.00 | 1.00 | 1.00 |
| Adj Sat Flow, veh/h/ln      | 1863 | 1863 | 1900 | 1863 | 1863 | 1900 | 1900 | 1267 | 1900 | 1900 | 1900 | 1900 |
| Adj Flow Rate, veh/h        | 10   | 948  | 20   | 10   | 1594 | 9    | 10   | 10   | 9    | 10   | 10   | 10   |
| Adj No. of Lanes            | 1    | 2    | 0    | 1    | 2    | 0    | 0    | 1    | 0    | 0    | 1    | 0    |
| Peak Hour Factor            | 0.96 | 0.96 | 0.96 | 0.96 | 0.96 | 0.96 | 0.96 | 0.96 | 0.96 | 0.96 | 0.96 | 0.96 |
| Percent Heavy Veh, %        | 2    | 2    | 2    | 2    | 2    | 2    | 50   | 50   | 50   | 0    | 0    | 0    |
| Cap, veh/h                  | 14   | 1776 | 37   | 14   | 1809 | 10   | 178  | 20   | 18   | 186  | 30   | 30   |
| Arrive On Green             | 0.01 | 0.50 | 0.50 | 0.01 | 0.50 | 0.50 | 0.05 | 0.05 | 0.05 | 0.05 | 0.05 | 0.05 |
| Sat Flow, veh/h             | 1774 | 3544 | 75   | 1774 | 3608 | 20   | 389  | 389  | 351  | 578  | 578  | 578  |
| Grp Volume(v), veh/h        | 10   | 473  | 495  | 10   | 781  | 822  | 29   | 0    | 0    | 30   | 0    | 0    |
| Grp Sat Flow(s),veh/h/ln    | 1774 | 1770 | 1849 | 1774 | 1770 | 1859 | 1129 | 0    | 0    | 1735 | 0    | 0    |
| Q Serve(g_s), s             | 0.2  | 5.6  | 5.6  | 0.2  | 12.1 | 12.1 | 0.3  | 0.0  | 0.0  | 0.0  | 0.0  | 0.0  |
| Cycle Q Clear(g_c), s       | 0.2  | 5.6  | 5.6  | 0.2  | 12.1 | 12.1 | 0.7  | 0.0  | 0.0  | 0.5  | 0.0  | 0.0  |
| Prop In Lane                | 1.00 |      | 0.04 | 1.00 |      | 0.01 | 0.34 |      | 0.31 | 0.33 |      | 0.33 |
| Lane Grp Cap(c), veh/h      | 14   | 887  | 927  | 14   | 887  | 932  | 216  | 0    | 0    | 246  | 0    | 0    |
| V/C Ratio(X)                | 0.71 | 0.53 | 0.53 | 0.71 | 0.88 | 0.88 | 0.13 | 0.00 | 0.00 | 0.12 | 0.00 | 0.00 |
| Avail Cap(c_a), veh/h       | 664  | 1871 | 1956 | 664  | 1871 | 1966 | 1126 | 0    | 0    | 1612 | 0    | 0    |
| HCM Platoon Ratio           | 1.00 | 1.00 | 1.00 | 1.00 | 1.00 | 1.00 | 1.00 | 1.00 | 1.00 | 1.00 | 1.00 | 1.00 |
| Upstream Filter(I)          | 1.00 | 1.00 | 1.00 | 1.00 | 1.00 | 1.00 | 1.00 | 0.00 | 0.00 | 1.00 | 0.00 | 0.00 |
| Uniform Delay (d), s/veh    | 15.2 | 5.2  | 5.2  | 15.2 | 6.8  | 6.8  | 14.2 | 0.0  | 0.0  | 14.0 | 0.0  | 0.0  |
| Incr Delay (d2), s/veh      | 21.0 | 0.2  | 0.2  | 21.0 | 1.2  | 1.1  | 0.1  | 0.0  | 0.0  | 0.1  | 0.0  | 0.0  |
| Initial Q Delay(d3),s/veh   | 0.0  | 0.0  | 0.0  | 0.0  | 0.0  | 0.0  | 0.0  | 0.0  | 0.0  | 0.0  | 0.0  | 0.0  |
| %ile BackOfQ(50%),veh/ln    | 0.2  | 2.7  | 2.8  | 0.2  | 5.9  | 6.2  | 0.2  | 0.0  | 0.0  | 0.2  | 0.0  | 0.0  |
| LnGrp Delay(d),s/veh        | 36.2 | 5.4  | 5.4  | 36.2 | 8.0  | 8.0  | 14.3 | 0.0  | 0.0  | 14.1 | 0.0  | 0.0  |
| LnGrp LOS                   | D    | A    | A    | D    | A    | A    | B    |      |      | B    |      |      |
| Approach Vol, veh/h         |      | 978  |      |      | 1613 |      |      | 29   |      |      | 30   |      |
| Approach Delay, s/veh       |      | 5.7  |      |      | 8.2  |      |      | 14.3 |      |      | 14.1 |      |
| Approach LOS                |      | A    |      |      | A    |      |      | B    |      |      | B    |      |
| Timer                       | 1    | 2    | 3    | 4    | 5    | 6    | 7    | 8    |      |      |      |      |
| Assigned Phs                | 1    | 2    |      | 4    | 5    | 6    |      | 8    |      |      |      |      |
| Phs Duration (G+Y+Rc), s    | 3.7  | 20.9 |      | 6.1  | 3.7  | 20.9 |      | 6.1  |      |      |      |      |
| Change Period (Y+Rc), s     | 3.5  | 5.5  |      | 4.5  | 3.5  | 5.5  |      | 4.5  |      |      |      |      |
| Max Green Setting (Gmax), s | 1.5  | 32.5 |      | 27.5 | 11.5 | 32.5 |      | 27.5 |      |      |      |      |
| Max Q Clear Time (g_c+1), s | 12.2 | 7.6  |      | 2.5  | 2.2  | 14.1 |      | 2.7  |      |      |      |      |
| Green Ext Time (p_c), s     | 0.0  | 0.7  |      | 0.0  | 0.0  | 1.3  |      | 0.0  |      |      |      |      |
| <b>Intersection Summary</b> |      |      |      |      |      |      |      |      |      |      |      |      |
| HCM 2010 Ctrl Delay         |      |      |      | 7.4  |      |      |      |      |      |      |      |      |
| HCM 2010 LOS                |      |      |      | A    |      |      |      |      |      |      |      |      |

HCM 2010 Signalized Intersection Summary  
 8: 5th Avenue/California Avenue & Imjin Parkway

Cumulative with Eastside Parkway, AM  
 06/11/2019



| Movement                    | EBL  | EBT  | EBR  | WBL  | WBT  | WBR  | NBL  | NBT  | NBR  | SBL  | SBT  | SBR  |
|-----------------------------|------|------|------|------|------|------|------|------|------|------|------|------|
| Lane Configurations         |      |      |      |      |      |      |      |      |      |      |      |      |
| Traffic Volume (veh/h)      | 140  | 790  | 20   | 10   | 960  | 70   | 20   | 20   | 10   | 80   | 150  | 460  |
| Future Volume (veh/h)       | 140  | 790  | 20   | 10   | 960  | 70   | 20   | 20   | 10   | 80   | 150  | 460  |
| Number                      | 5    | 2    | 12   | 1    | 6    | 16   | 3    | 8    | 18   | 7    | 4    | 14   |
| Initial Q (Qb), veh         | 0    | 0    | 0    | 0    | 0    | 0    | 0    | 0    | 0    | 0    | 0    | 0    |
| Ped-Bike Adj(A_pbT)         | 1.00 |      | 0.98 | 1.00 |      | 1.00 | 1.00 |      | 0.99 | 1.00 |      | 1.00 |
| Parking Bus, Adj            | 1.00 | 1.00 | 1.00 | 1.00 | 1.00 | 1.00 | 1.00 | 1.00 | 1.00 | 1.00 | 1.00 | 1.00 |
| Adj Sat Flow, veh/h/ln      | 1881 | 1881 | 1900 | 1863 | 1863 | 1900 | 1900 | 1624 | 1900 | 1900 | 1881 | 1900 |
| Adj Flow Rate, veh/h        | 147  | 832  | 19   | 11   | 1011 | 68   | 21   | 21   | 10   | 84   | 158  | 410  |
| Adj No. of Lanes            | 1    | 2    | 0    | 1    | 2    | 0    | 0    | 1    | 0    | 0    | 1    | 0    |
| Peak Hour Factor            | 0.95 | 0.95 | 0.95 | 0.95 | 0.95 | 0.95 | 0.95 | 0.95 | 0.95 | 0.95 | 0.95 | 0.95 |
| Percent Heavy Veh, %        | 1    | 1    | 1    | 2    | 2    | 2    | 17   | 17   | 17   | 1    | 1    | 1    |
| Cap, veh/h                  | 186  | 1530 | 35   | 15   | 1120 | 75   | 175  | 152  | 58   | 122  | 152  | 348  |
| Arrive On Green             | 0.10 | 0.43 | 0.43 | 0.01 | 0.33 | 0.33 | 0.34 | 0.34 | 0.34 | 0.34 | 0.34 | 0.34 |
| Sat Flow, veh/h             | 1792 | 3570 | 82   | 1774 | 3366 | 226  | 266  | 452  | 171  | 157  | 452  | 1032 |
| Grp Volume(v), veh/h        | 147  | 416  | 435  | 11   | 531  | 548  | 52   | 0    | 0    | 652  | 0    | 0    |
| Grp Sat Flow(s),veh/h/ln    | 1792 | 1787 | 1865 | 1774 | 1770 | 1823 | 889  | 0    | 0    | 1640 | 0    | 0    |
| Q Serve(g_s), s             | 4.8  | 10.3 | 10.3 | 0.4  | 17.0 | 17.0 | 0.0  | 0.0  | 0.0  | 15.0 | 0.0  | 0.0  |
| Cycle Q Clear(g_c), s       | 4.8  | 10.3 | 10.3 | 0.4  | 17.0 | 17.0 | 1.4  | 0.0  | 0.0  | 20.0 | 0.0  | 0.0  |
| Prop In Lane                | 1.00 |      | 0.04 | 1.00 |      | 0.12 | 0.40 |      | 0.19 | 0.13 |      | 0.63 |
| Lane Grp Cap(c), veh/h      | 186  | 766  | 799  | 15   | 589  | 607  | 385  | 0    | 0    | 622  | 0    | 0    |
| V/C Ratio(X)                | 0.79 | 0.54 | 0.54 | 0.74 | 0.90 | 0.90 | 0.14 | 0.00 | 0.00 | 1.05 | 0.00 | 0.00 |
| Avail Cap(c_a), veh/h       | 453  | 904  | 943  | 449  | 895  | 922  | 385  | 0    | 0    | 622  | 0    | 0    |
| HCM Platoon Ratio           | 1.00 | 1.00 | 1.00 | 1.00 | 1.00 | 1.00 | 1.00 | 1.00 | 1.00 | 1.00 | 1.00 | 1.00 |
| Upstream Filter(I)          | 1.00 | 1.00 | 1.00 | 1.00 | 1.00 | 1.00 | 1.00 | 0.00 | 0.00 | 1.00 | 0.00 | 0.00 |
| Uniform Delay (d), s/veh    | 25.9 | 12.6 | 12.6 | 29.3 | 18.9 | 18.9 | 13.5 | 0.0  | 0.0  | 20.7 | 0.0  | 0.0  |
| Incr Delay (d2), s/veh      | 2.8  | 0.2  | 0.2  | 23.0 | 6.2  | 6.1  | 0.1  | 0.0  | 0.0  | 49.5 | 0.0  | 0.0  |
| Initial Q Delay(d3),s/veh   | 0.0  | 0.0  | 0.0  | 0.0  | 0.0  | 0.0  | 0.0  | 0.0  | 0.0  | 0.0  | 0.0  | 0.0  |
| %ile BackOfQ(50%),veh/ln    | 2.5  | 5.0  | 5.2  | 0.3  | 9.3  | 9.5  | 0.6  | 0.0  | 0.0  | 18.6 | 0.0  | 0.0  |
| LnGrp Delay(d),s/veh        | 28.7 | 12.9 | 12.8 | 52.3 | 25.1 | 25.0 | 13.5 | 0.0  | 0.0  | 70.2 | 0.0  | 0.0  |
| LnGrp LOS                   | C    | B    | B    | D    | C    | C    | B    |      |      | F    |      |      |
| Approach Vol, veh/h         |      | 998  |      |      | 1090 |      |      | 52   |      |      | 652  |      |
| Approach Delay, s/veh       |      | 15.2 |      |      | 25.3 |      |      | 13.5 |      |      | 70.2 |      |
| Approach LOS                |      | B    |      |      | C    |      |      | B    |      |      | E    |      |
| Timer                       | 1    | 2    | 3    | 4    | 5    | 6    | 7    | 8    |      |      |      |      |
| Assigned Phs                | 1    | 2    |      | 4    | 5    | 6    |      | 8    |      |      |      |      |
| Phs Duration (G+Y+Rc), s    | 4.0  | 30.7 |      | 24.6 | 9.7  | 25.0 |      | 24.6 |      |      |      |      |
| Change Period (Y+Rc), s     | 3.5  | 5.3  |      | 4.6  | 3.5  | 5.3  |      | 4.6  |      |      |      |      |
| Max Green Setting (Gmax), s | 5.0  | 30.0 |      | 20.0 | 15.0 | 30.0 |      | 20.0 |      |      |      |      |
| Max Q Clear Time (g_c+1), s | 12.4 | 12.3 |      | 22.0 | 6.8  | 19.0 |      | 3.4  |      |      |      |      |
| Green Ext Time (p_c), s     | 0.0  | 0.6  |      | 0.0  | 0.0  | 0.8  |      | 0.1  |      |      |      |      |
| <b>Intersection Summary</b> |      |      |      |      |      |      |      |      |      |      |      |      |
| HCM 2010 Ctrl Delay         |      |      |      | 32.0 |      |      |      |      |      |      |      |      |
| HCM 2010 LOS                |      |      |      | C    |      |      |      |      |      |      |      |      |

| Intersection             |      |      |      |      |      |      |
|--------------------------|------|------|------|------|------|------|
| Int Delay, s/veh         | 1.4  |      |      |      |      |      |
| Movement                 | EBL  | EBR  | NBL  | NBT  | SBT  | SBR  |
| Lane Configurations      | Y    |      | Y    | ↑    | ↑    |      |
| Traffic Vol, veh/h       | 30   | 30   | 30   | 210  | 610  | 80   |
| Future Vol, veh/h        | 30   | 30   | 30   | 210  | 610  | 80   |
| Conflicting Peds, #/hr   | 0    | 0    | 0    | 0    | 0    | 0    |
| Sign Control             | Stop | Stop | Free | Free | Free | Free |
| RT Channelized           | -    | None | -    | None | -    | None |
| Storage Length           | 0    | -    | 155  | -    | -    | -    |
| Veh in Median Storage, # | 0    | -    | -    | 0    | 0    | -    |
| Grade, %                 | 0    | -    | -    | 0    | 0    | -    |
| Peak Hour Factor         | 92   | 92   | 92   | 92   | 92   | 92   |
| Heavy Vehicles, %        | 2    | 2    | 2    | 2    | 2    | 2    |
| Mvmt Flow                | 33   | 33   | 33   | 228  | 663  | 87   |

| Major/Minor          | Minor2 | Major1 | Major2 |   |   |   |
|----------------------|--------|--------|--------|---|---|---|
| Conflicting Flow All | 1001   | 707    | 750    | 0 | - | 0 |
| Stage 1              | 707    | -      | -      | - | - | - |
| Stage 2              | 294    | -      | -      | - | - | - |
| Critical Hdwy        | 6.42   | 6.22   | 4.12   | - | - | - |
| Critical Hdwy Stg 1  | 5.42   | -      | -      | - | - | - |
| Critical Hdwy Stg 2  | 5.42   | -      | -      | - | - | - |
| Follow-up Hdwy       | 3.518  | 3.318  | 2.218  | - | - | - |
| Pot Cap-1 Maneuver   | 269    | 435    | 859    | - | - | - |
| Stage 1              | 489    | -      | -      | - | - | - |
| Stage 2              | 756    | -      | -      | - | - | - |
| Platoon blocked, %   |        |        |        | - | - | - |
| Mov Cap-1 Maneuver   | 259    | 435    | 859    | - | - | - |
| Mov Cap-2 Maneuver   | 259    | -      | -      | - | - | - |
| Stage 1              | 470    | -      | -      | - | - | - |
| Stage 2              | 756    | -      | -      | - | - | - |

| Approach             | EB   | NB  | SB |
|----------------------|------|-----|----|
| HCM Control Delay, s | 18.8 | 1.2 | 0  |
| HCM LOS              | C    |     |    |

| Minor Lane/Major Mvmt | NBL   | NBT | EBLn1 | SBT | SBR |
|-----------------------|-------|-----|-------|-----|-----|
| Capacity (veh/h)      | 859   | -   | 325   | -   | -   |
| HCM Lane V/C Ratio    | 0.038 | -   | 0.201 | -   | -   |
| HCM Control Delay (s) | 9.4   | -   | 18.8  | -   | -   |
| HCM Lane LOS          | A     | -   | C     | -   | -   |
| HCM 95th %tile Q(veh) | 0.1   | -   | 0.7   | -   | -   |

HCM 2010 Signalized Intersection Summary  
 10: Imjin Road & Imjin Parkway

Cumulative with Eastside Parkway, AM  
 06/11/2019

|                              | →    | ↘     | ↙    | ←    | ↖    | ↗    |   |      |
|------------------------------|------|-------|------|------|------|------|---|------|
| Movement                     | EBT  | EBR   | WBL  | WBT  | NBL  | NBR  |   |      |
| Lane Configurations          | ↑↑   |       | ↘    | ↑↑   | ↘↘   | ↗    |   |      |
| Traffic Volume (veh/h)       | 750  | 150   | 310  | 1000 | 30   | 20   |   |      |
| Future Volume (veh/h)        | 750  | 150   | 310  | 1000 | 30   | 20   |   |      |
| Number                       | 2    | 12    | 1    | 6    | 3    | 18   |   |      |
| Initial Q (Qb), veh          | 0    | 0     | 0    | 0    | 0    | 0    |   |      |
| Ped-Bike Adj(A_pbT)          |      | 1.00  | 1.00 |      | 1.00 | 1.00 |   |      |
| Parking Bus, Adj             | 1.00 | 1.00  | 1.00 | 1.00 | 1.00 | 1.00 |   |      |
| Adj Sat Flow, veh/h/ln       | 1863 | 1900  | 1845 | 1845 | 1810 | 1810 |   |      |
| Adj Flow Rate, veh/h         | 789  | 145   | 326  | 1053 | 35   | 18   |   |      |
| Adj No. of Lanes             | 2    | 0     | 1    | 2    | 2    | 1    |   |      |
| Peak Hour Factor             | 0.95 | 0.95  | 0.95 | 0.95 | 0.95 | 0.95 |   |      |
| Percent Heavy Veh, %         | 2    | 2     | 3    | 3    | 5    | 5    |   |      |
| Cap, veh/h                   | 959  | 176   | 397  | 2449 | 119  | 53   |   |      |
| Arrive On Green              | 0.32 | 0.32  | 0.23 | 0.70 | 0.03 | 0.03 |   |      |
| Sat Flow, veh/h              | 3080 | 549   | 1757 | 3597 | 3447 | 1538 |   |      |
| Grp Volume(v), veh/h         | 467  | 467   | 326  | 1053 | 35   | 18   |   |      |
| Grp Sat Flow(s),veh/h/ln     | 1770 | 1766  | 1757 | 1752 | 1723 | 1538 |   |      |
| Q Serve(g_s), s              | 8.5  | 8.5   | 6.2  | 4.5  | 0.3  | 0.4  |   |      |
| Cycle Q Clear(g_c), s        | 8.5  | 8.5   | 6.2  | 4.5  | 0.3  | 0.4  |   |      |
| Prop In Lane                 |      | 0.31  | 1.00 |      | 1.00 | 1.00 |   |      |
| Lane Grp Cap(c), veh/h       | 568  | 567   | 397  | 2449 | 119  | 53   |   |      |
| V/C Ratio(X)                 | 0.82 | 0.82  | 0.82 | 0.43 | 0.29 | 0.34 |   |      |
| Avail Cap(c_a), veh/h        | 1523 | 1520  | 1008 | 3016 | 2175 | 971  |   |      |
| HCM Platoon Ratio            | 1.00 | 1.00  | 1.00 | 1.00 | 1.00 | 1.00 |   |      |
| Upstream Filter(I)           | 1.00 | 1.00  | 1.00 | 1.00 | 1.00 | 1.00 |   |      |
| Uniform Delay (d), s/veh     | 10.9 | 10.9  | 12.8 | 2.3  | 16.4 | 16.4 |   |      |
| Incr Delay (d2), s/veh       | 1.2  | 1.2   | 1.6  | 0.0  | 0.5  | 1.4  |   |      |
| Initial Q Delay(d3),s/veh    | 0.0  | 0.0   | 0.0  | 0.0  | 0.0  | 0.0  |   |      |
| %ile BackOfQ(50%),veh/ln     | 4.2  | 4.2   | 3.1  | 2.1  | 0.2  | 0.2  |   |      |
| LnGrp Delay(d),s/veh         | 12.1 | 12.1  | 14.5 | 2.3  | 16.9 | 17.8 |   |      |
| LnGrp LOS                    | B    | B     | B    | A    | B    | B    |   |      |
| Approach Vol, veh/h          | 934  |       |      | 1379 | 53   |      |   |      |
| Approach Delay, s/veh        | 12.1 |       |      | 5.2  | 17.2 |      |   |      |
| Approach LOS                 | B    |       |      | A    | B    |      |   |      |
| Timer                        | 1    | 2     | 3    | 4    | 5    | 6    | 7 | 8    |
| Assigned Phs                 | 1    | 2     |      |      |      | 6    |   | 8    |
| Phs Duration (G+Y+Rc), s     | 13.2 | 16.5  |      |      |      | 29.7 |   | 5.2  |
| Change Period (Y+Rc), s      | 5.3  | * 5.3 |      |      |      | 5.3  |   | 4.0  |
| Max Green Setting (Gmax), s  | 20.0 | * 30  |      |      |      | 30.0 |   | 22.0 |
| Max Q Clear Time (g_c+I1), s | 8.2  | 10.5  |      |      |      | 6.5  |   | 2.4  |
| Green Ext Time (p_c), s      | 0.1  | 0.7   |      |      |      | 1.2  |   | 0.0  |
| <b>Intersection Summary</b>  |      |       |      |      |      |      |   |      |
| HCM 2010 Ctrl Delay          |      |       | 8.2  |      |      |      |   |      |
| HCM 2010 LOS                 |      |       | A    |      |      |      |   |      |
| <b>Notes</b>                 |      |       |      |      |      |      |   |      |



HCM 2010 Signalized Intersection Summary  
 11: Abrams Drive & Imjin Parkway

Cumulative with Eastside Parkway, AM  
 06/11/2019



| Movement                     | EBL  | EBT  | EBR  | WBL  | WBT  | WBR  | NBL  | NBT  | NBR  | SBL  | SBT  | SBR  |
|------------------------------|------|------|------|------|------|------|------|------|------|------|------|------|
| Lane Configurations          | ↔    | ↑    |      | ↔    | ↑    |      | ↔    | ↑    | ↔    | ↔    | ↑    | ↔    |
| Traffic Volume (veh/h)       | 50   | 590  | 50   | 80   | 960  | 70   | 170  | 30   | 160  | 90   | 50   | 250  |
| Future Volume (veh/h)        | 50   | 590  | 50   | 80   | 960  | 70   | 170  | 30   | 160  | 90   | 50   | 250  |
| Number                       | 5    | 2    | 12   | 1    | 6    | 16   | 3    | 8    | 18   | 7    | 4    | 14   |
| Initial Q (Qb), veh          | 0    | 0    | 0    | 0    | 0    | 0    | 0    | 0    | 0    | 0    | 0    | 0    |
| Ped-Bike Adj(A_pbT)          | 1.00 |      | 1.00 | 1.00 |      | 1.00 | 1.00 |      | 1.00 | 1.00 |      | 1.00 |
| Parking Bus, Adj             | 1.00 | 1.00 | 1.00 | 1.00 | 1.00 | 1.00 | 1.00 | 1.00 | 1.00 | 1.00 | 1.00 | 1.00 |
| Adj Sat Flow, veh/h/ln       | 1881 | 1881 | 1900 | 1863 | 1863 | 1900 | 1845 | 1845 | 1845 | 1863 | 1863 | 1863 |
| Adj Flow Rate, veh/h         | 54   | 634  | 42   | 86   | 1032 | 70   | 183  | 32   | 0    | 97   | 54   | 0    |
| Adj No. of Lanes             | 2    | 2    | 0    | 2    | 2    | 0    | 1    | 1    | 1    | 1    | 1    | 1    |
| Peak Hour Factor             | 0.93 | 0.93 | 0.93 | 0.93 | 0.93 | 0.93 | 0.93 | 0.93 | 0.93 | 0.93 | 0.93 | 0.93 |
| Percent Heavy Veh, %         | 1    | 1    | 1    | 2    | 2    | 2    | 3    | 3    | 3    | 2    | 2    | 2    |
| Cap, veh/h                   | 193  | 1998 | 132  | 149  | 1909 | 129  | 320  | 347  | 295  | 340  | 351  | 298  |
| Arrive On Green              | 0.06 | 0.59 | 0.59 | 0.04 | 0.57 | 0.57 | 0.19 | 0.19 | 0.00 | 0.19 | 0.19 | 0.00 |
| Sat Flow, veh/h              | 3476 | 3403 | 225  | 3442 | 3364 | 228  | 1330 | 1845 | 1568 | 1370 | 1863 | 1583 |
| Grp Volume(v), veh/h         | 54   | 333  | 343  | 86   | 543  | 559  | 183  | 32   | 0    | 97   | 54   | 0    |
| Grp Sat Flow(s),veh/h/ln     | 1738 | 1787 | 1841 | 1721 | 1770 | 1822 | 1330 | 1845 | 1568 | 1370 | 1863 | 1583 |
| Q Serve(g_s), s              | 1.1  | 6.7  | 6.7  | 1.7  | 13.5 | 13.5 | 9.4  | 1.0  | 0.0  | 4.4  | 1.7  | 0.0  |
| Cycle Q Clear(g_c), s        | 1.1  | 6.7  | 6.7  | 1.7  | 13.5 | 13.5 | 11.1 | 1.0  | 0.0  | 5.4  | 1.7  | 0.0  |
| Prop In Lane                 | 1.00 |      | 0.12 | 1.00 |      | 0.13 | 1.00 |      | 1.00 | 1.00 |      | 1.00 |
| Lane Grp Cap(c), veh/h       | 193  | 1049 | 1081 | 149  | 1004 | 1034 | 320  | 347  | 295  | 340  | 351  | 298  |
| V/C Ratio(X)                 | 0.28 | 0.32 | 0.32 | 0.58 | 0.54 | 0.54 | 0.57 | 0.09 | 0.00 | 0.29 | 0.15 | 0.00 |
| Avail Cap(c_a), veh/h        | 986  | 1268 | 1306 | 977  | 1255 | 1293 | 636  | 785  | 667  | 665  | 793  | 674  |
| HCM Platoon Ratio            | 1.00 | 1.00 | 1.00 | 1.00 | 1.00 | 1.00 | 1.00 | 1.00 | 1.00 | 1.00 | 1.00 | 1.00 |
| Upstream Filter(I)           | 1.00 | 1.00 | 1.00 | 1.00 | 1.00 | 1.00 | 1.00 | 1.00 | 0.00 | 1.00 | 1.00 | 0.00 |
| Uniform Delay (d), s/veh     | 31.9 | 7.4  | 7.4  | 33.1 | 9.5  | 9.5  | 28.6 | 23.6 | 0.0  | 25.9 | 23.9 | 0.0  |
| Incr Delay (d2), s/veh       | 0.3  | 0.1  | 0.1  | 1.3  | 0.2  | 0.2  | 0.6  | 0.0  | 0.0  | 0.2  | 0.1  | 0.0  |
| Initial Q Delay(d3),s/veh    | 0.0  | 0.0  | 0.0  | 0.0  | 0.0  | 0.0  | 0.0  | 0.0  | 0.0  | 0.0  | 0.0  | 0.0  |
| %ile BackOfQ(50%),veh/ln     | 0.5  | 3.3  | 3.4  | 0.9  | 6.5  | 6.7  | 3.5  | 0.5  | 0.0  | 1.7  | 0.9  | 0.0  |
| LnGrp Delay(d),s/veh         | 32.2 | 7.4  | 7.4  | 34.4 | 9.7  | 9.7  | 29.2 | 23.7 | 0.0  | 26.1 | 24.0 | 0.0  |
| LnGrp LOS                    | C    | A    | A    | C    | A    | A    | C    | C    |      | C    | C    |      |
| Approach Vol, veh/h          |      | 730  |      |      | 1188 |      |      | 215  |      |      | 151  |      |
| Approach Delay, s/veh        |      | 9.3  |      |      | 11.5 |      |      | 28.3 |      |      | 25.3 |      |
| Approach LOS                 |      | A    |      |      | B    |      |      | C    |      |      | C    |      |
| Timer                        | 1    | 2    | 3    | 4    | 5    | 6    | 7    | 8    |      |      |      |      |
| Assigned Phs                 | 1    | 2    |      | 4    | 5    | 6    |      | 8    |      |      |      |      |
| Phs Duration (G+Y+Rc), s     | 6.5  | 46.7 |      | 17.3 | 7.9  | 45.3 |      | 17.3 |      |      |      |      |
| Change Period (Y+Rc), s      | 3.5  | 5.3  |      | 4.0  | 4.0  | 5.3  |      | 4.0  |      |      |      |      |
| Max Green Setting (Gmax), s  | 20.0 | 50.0 |      | 30.0 | 20.0 | 50.0 |      | 30.0 |      |      |      |      |
| Max Q Clear Time (g_c+13), s | 13.5 | 8.7  |      | 7.4  | 3.1  | 15.5 |      | 13.1 |      |      |      |      |
| Green Ext Time (p_c), s      | 0.0  | 0.5  |      | 0.0  | 0.0  | 0.8  |      | 0.0  |      |      |      |      |
| <b>Intersection Summary</b>  |      |      |      |      |      |      |      |      |      |      |      |      |
| HCM 2010 Ctrl Delay          |      |      | 13.3 |      |      |      |      |      |      |      |      |      |
| HCM 2010 LOS                 |      |      | B    |      |      |      |      |      |      |      |      |      |

HCM 2010 Signalized Intersection Summary  
 12: Reservation Road & Imjin Parkway

Cumulative with Eastside Parkway, AM  
 06/11/2019



| Movement                     | EBL  | EBT   | EBR  | WBL  | WBT  | WBR   | NBL  | NBT  | NBR  | SBL  | SBT  | SBR  |
|------------------------------|------|-------|------|------|------|-------|------|------|------|------|------|------|
| Lane Configurations          |      |       |      |      |      |       |      |      |      |      |      |      |
| Traffic Volume (veh/h)       | 170  | 50    | 670  | 10   | 20   | 30    | 940  | 880  | 20   | 60   | 590  | 90   |
| Future Volume (veh/h)        | 170  | 50    | 670  | 10   | 20   | 30    | 940  | 880  | 20   | 60   | 590  | 90   |
| Number                       | 3    | 8     | 18   | 7    | 4    | 14    | 1    | 6    | 16   | 5    | 2    | 12   |
| Initial Q (Qb), veh          | 0    | 0     | 0    | 0    | 0    | 0     | 0    | 0    | 0    | 0    | 0    | 0    |
| Ped-Bike Adj(A_pbT)          | 1.00 |       | 1.00 | 1.00 |      | 0.99  | 1.00 |      | 1.00 | 1.00 |      | 0.98 |
| Parking Bus, Adj             | 1.00 | 1.00  | 1.00 | 1.00 | 1.00 | 1.00  | 1.00 | 1.00 | 1.00 | 1.00 | 1.00 | 1.00 |
| Adj Sat Flow, veh/h/ln       | 1863 | 1863  | 1863 | 1638 | 1638 | 1638  | 1863 | 1863 | 1863 | 1863 | 1863 | 1863 |
| Adj Flow Rate, veh/h         | 183  | 54    | 306  | 11   | 22   | 19    | 1011 | 946  | 16   | 65   | 634  | 34   |
| Adj No. of Lanes             | 2    | 1     | 2    | 1    | 1    | 1     | 2    | 2    | 1    | 2    | 2    | 1    |
| Peak Hour Factor             | 0.93 | 0.93  | 0.93 | 0.93 | 0.93 | 0.93  | 0.93 | 0.93 | 0.93 | 0.93 | 0.93 | 0.93 |
| Percent Heavy Veh, %         | 2    | 2     | 2    | 16   | 16   | 16    | 2    | 2    | 2    | 2    | 2    | 2    |
| Cap, veh/h                   | 379  | 205   | 1192 | 57   | 60   | 51    | 1096 | 2050 | 916  | 125  | 1052 | 463  |
| Arrive On Green              | 0.11 | 0.11  | 0.11 | 0.04 | 0.04 | 0.04  | 0.32 | 0.58 | 0.58 | 0.04 | 0.30 | 0.30 |
| Sat Flow, veh/h              | 3442 | 1863  | 2774 | 1560 | 1638 | 1383  | 3442 | 3539 | 1581 | 3442 | 3539 | 1558 |
| Grp Volume(v), veh/h         | 183  | 54    | 306  | 11   | 22   | 19    | 1011 | 946  | 16   | 65   | 634  | 34   |
| Grp Sat Flow(s),veh/h/ln     | 1721 | 1863  | 1387 | 1560 | 1638 | 1383  | 1721 | 1770 | 1581 | 1721 | 1770 | 1558 |
| Q Serve(g_s), s              | 4.4  | 2.3   | 6.2  | 0.6  | 1.1  | 1.2   | 24.8 | 13.4 | 0.4  | 1.6  | 13.4 | 1.4  |
| Cycle Q Clear(g_c), s        | 4.4  | 2.3   | 6.2  | 0.6  | 1.1  | 1.2   | 24.8 | 13.4 | 0.4  | 1.6  | 13.4 | 1.4  |
| Prop In Lane                 | 1.00 |       | 1.00 | 1.00 |      | 1.00  | 1.00 |      | 1.00 | 1.00 |      | 1.00 |
| Lane Grp Cap(c), veh/h       | 379  | 205   | 1192 | 57   | 60   | 51    | 1096 | 2050 | 916  | 125  | 1052 | 463  |
| V/C Ratio(X)                 | 0.48 | 0.26  | 0.26 | 0.19 | 0.37 | 0.37  | 0.92 | 0.46 | 0.02 | 0.52 | 0.60 | 0.07 |
| Avail Cap(c_a), veh/h        | 1377 | 745   | 1997 | 553  | 580  | 490   | 1377 | 2050 | 916  | 787  | 2427 | 1069 |
| HCM Platoon Ratio            | 1.00 | 1.00  | 1.00 | 1.00 | 1.00 | 1.00  | 1.00 | 1.00 | 1.00 | 1.00 | 1.00 | 1.00 |
| Upstream Filter(I)           | 1.00 | 1.00  | 1.00 | 1.00 | 1.00 | 1.00  | 1.00 | 1.00 | 1.00 | 1.00 | 1.00 | 1.00 |
| Uniform Delay (d), s/veh     | 36.6 | 35.7  | 16.1 | 40.9 | 41.1 | 41.2  | 28.8 | 10.6 | 7.8  | 41.4 | 26.3 | 22.1 |
| Incr Delay (d2), s/veh       | 0.4  | 0.3   | 0.0  | 0.6  | 1.4  | 1.7   | 8.1  | 0.4  | 0.0  | 1.2  | 1.5  | 0.2  |
| Initial Q Delay(d3),s/veh    | 0.0  | 0.0   | 0.0  | 0.0  | 0.0  | 0.0   | 0.0  | 0.0  | 0.0  | 0.0  | 0.0  | 0.0  |
| %ile BackOfQ(50%),veh/ln     | 2.1  | 1.2   | 2.4  | 0.3  | 0.5  | 0.5   | 13.0 | 6.6  | 0.2  | 0.8  | 6.7  | 0.6  |
| LnGrp Delay(d),s/veh         | 37.0 | 35.9  | 16.1 | 41.5 | 42.5 | 42.8  | 36.9 | 11.0 | 7.8  | 42.7 | 27.9 | 22.3 |
| LnGrp LOS                    | D    | D     | B    | D    | D    | D     | D    | B    | A    | D    | C    | C    |
| Approach Vol, veh/h          |      | 543   |      |      | 52   |       |      | 1973 |      |      | 733  |      |
| Approach Delay, s/veh        |      | 25.1  |      |      | 42.4 |       |      | 24.3 |      |      | 28.9 |      |
| Approach LOS                 |      | C     |      |      | D    |       |      | C    |      |      | C    |      |
| Timer                        | 1    | 2     | 3    | 4    | 5    | 6     | 7    | 8    |      |      |      |      |
| Assigned Phs                 | 1    | 2     |      | 4    | 5    | 6     |      | 8    |      |      |      |      |
| Phs Duration (G+Y+Rc), s     | 32.0 |       |      | 8.2  | 7.3  | 56.9  |      | 15.1 |      |      |      |      |
| Change Period (Y+Rc), s      | 4.1  | * 6.2 |      | 5.0  | 4.1  | * 6.2 |      | 5.5  |      |      |      |      |
| Max Green Setting (Gmax), s  | 35.0 | * 60  |      | 31.0 | 20.0 | * 50  |      | 35.0 |      |      |      |      |
| Max Q Clear Time (g_c+Tb), s | 26.8 | 15.4  |      | 3.2  | 3.6  | 15.4  |      | 8.2  |      |      |      |      |
| Green Ext Time (p_c), s      | 1.0  | 10.6  |      | 0.1  | 0.0  | 15.5  |      | 1.1  |      |      |      |      |
| <b>Intersection Summary</b>  |      |       |      |      |      |       |      |      |      |      |      |      |
| HCM 2010 Ctrl Delay          |      |       | 25.7 |      |      |       |      |      |      |      |      |      |
| HCM 2010 LOS                 |      |       | C    |      |      |       |      |      |      |      |      |      |
| <b>Notes</b>                 |      |       |      |      |      |       |      |      |      |      |      |      |

HCM 2010 Signalized Intersection Summary  
 13: Reservation Road & Blanco Road

Cumulative with Eastside Parkway, AM  
 06/11/2019

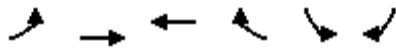

| Movement                     | EBL  | EBT  | WBT  | WBR  | SBL  | SBR  |   |   |
|------------------------------|------|------|------|------|------|------|---|---|
| Lane Configurations          | ↖↗   | ↑↑   | ↑    | ↑    | ↖↗   | ↖↗   |   |   |
| Traffic Volume (veh/h)       | 1000 | 300  | 500  | 40   | 40   | 1340 |   |   |
| Future Volume (veh/h)        | 1000 | 300  | 500  | 40   | 40   | 1340 |   |   |
| Number                       | 5    | 2    | 6    | 16   | 7    | 14   |   |   |
| Initial Q (Qb), veh          | 0    | 0    | 0    | 0    | 0    | 0    |   |   |
| Ped-Bike Adj(A_pbT)          | 1.00 |      |      | 1.00 | 1.00 | 1.00 |   |   |
| Parking Bus, Adj             | 1.00 | 1.00 | 1.00 | 1.00 | 1.00 | 1.00 |   |   |
| Adj Sat Flow, veh/h/ln       | 1863 | 1863 | 1845 | 1845 | 1845 | 1845 |   |   |
| Adj Flow Rate, veh/h         | 1075 | 323  | 538  | 24   | 43   | 0    |   |   |
| Adj No. of Lanes             | 2    | 2    | 1    | 1    | 2    | 2    |   |   |
| Peak Hour Factor             | 0.93 | 0.93 | 0.93 | 0.93 | 0.93 | 0.93 |   |   |
| Percent Heavy Veh, %         | 2    | 2    | 3    | 3    | 3    | 3    |   |   |
| Cap, veh/h                   | 1191 | 2816 | 644  | 548  | 119  | 97   |   |   |
| Arrive On Green              | 0.35 | 0.80 | 0.35 | 0.35 | 0.04 | 0.00 |   |   |
| Sat Flow, veh/h              | 3442 | 3632 | 1845 | 1568 | 3408 | 2760 |   |   |
| Grp Volume(v), veh/h         | 1075 | 323  | 538  | 24   | 43   | 0    |   |   |
| Grp Sat Flow(s),veh/h/ln     | 1721 | 1770 | 1845 | 1568 | 1704 | 1380 |   |   |
| Q Serve(g_s), s              | 16.3 | 1.1  | 14.7 | 0.6  | 0.7  | 0.0  |   |   |
| Cycle Q Clear(g_c), s        | 16.3 | 1.1  | 14.7 | 0.6  | 0.7  | 0.0  |   |   |
| Prop In Lane                 | 1.00 |      |      | 1.00 | 1.00 | 1.00 |   |   |
| Lane Grp Cap(c), veh/h       | 1191 | 2816 | 644  | 548  | 119  | 97   |   |   |
| V/C Ratio(X)                 | 0.90 | 0.11 | 0.83 | 0.04 | 0.36 | 0.00 |   |   |
| Avail Cap(c_a), veh/h        | 2508 | 3869 | 2016 | 1714 | 1676 | 1357 |   |   |
| HCM Platoon Ratio            | 1.00 | 1.00 | 1.00 | 1.00 | 1.00 | 1.00 |   |   |
| Upstream Filter(I)           | 1.00 | 1.00 | 1.00 | 1.00 | 1.00 | 0.00 |   |   |
| Uniform Delay (d), s/veh     | 17.1 | 1.3  | 16.4 | 11.8 | 25.9 | 0.0  |   |   |
| Incr Delay (d2), s/veh       | 1.1  | 0.0  | 2.2  | 0.0  | 0.7  | 0.0  |   |   |
| Initial Q Delay(d3),s/veh    | 0.0  | 0.0  | 0.0  | 0.0  | 0.0  | 0.0  |   |   |
| %ile BackOfQ(50%),veh/ln     | 7.8  | 0.5  | 7.9  | 0.2  | 0.3  | 0.0  |   |   |
| LnGrp Delay(d),s/veh         | 18.2 | 1.3  | 18.6 | 11.8 | 26.6 | 0.0  |   |   |
| LnGrp LOS                    | B    | A    | B    | B    | C    |      |   |   |
| Approach Vol, veh/h          |      | 1398 | 562  |      | 43   |      |   |   |
| Approach Delay, s/veh        |      | 14.3 | 18.3 |      | 26.6 |      |   |   |
| Approach LOS                 |      | B    | B    |      | C    |      |   |   |
| Timer                        | 1    | 2    | 3    | 4    | 5    | 6    | 7 | 8 |
| Assigned Phs                 |      | 2    |      | 4    | 5    | 6    |   |   |
| Phs Duration (G+Y+Rc), s     |      | 49.5 |      | 5.4  | 24.5 | 25.0 |   |   |
| Change Period (Y+Rc), s      |      | 5.8  |      | 3.5  | 5.5  | 5.8  |   |   |
| Max Green Setting (Gmax), s  |      | 60.0 |      | 27.0 | 40.0 | 60.0 |   |   |
| Max Q Clear Time (g_c+I1), s |      | 3.1  |      | 2.7  | 18.3 | 16.7 |   |   |
| Green Ext Time (p_c), s      |      | 1.5  |      | 0.0  | 0.7  | 2.5  |   |   |
| <b>Intersection Summary</b>  |      |      |      |      |      |      |   |   |
| HCM 2010 Ctrl Delay          |      |      | 15.7 |      |      |      |   |   |
| HCM 2010 LOS                 |      |      | B    |      |      |      |   |   |

HCM 2010 Signalized Intersection Summary  
 14: Reservation Road & Inter-Garrison Road

Cumulative with Eastside Parkway, AM  
 06/11/2019



| Movement                     | EBL  | EBR  | NBL   | NBT   | SBT  | SBR  |   |      |
|------------------------------|------|------|-------|-------|------|------|---|------|
| Lane Configurations          |      |      |       |       |      |      |   |      |
| Traffic Volume (veh/h)       | 110  | 500  | 790   | 460   | 260  | 160  |   |      |
| Future Volume (veh/h)        | 110  | 500  | 790   | 460   | 260  | 160  |   |      |
| Number                       | 3    | 18   | 1     | 6     | 2    | 12   |   |      |
| Initial Q (Qb), veh          | 0    | 0    | 0     | 0     | 0    | 0    |   |      |
| Ped-Bike Adj(A_pbT)          | 1.00 | 1.00 | 1.00  |       |      | 1.00 |   |      |
| Parking Bus, Adj             | 1.00 | 1.00 | 1.00  | 1.00  | 1.00 | 1.00 |   |      |
| Adj Sat Flow, veh/h/ln       | 1845 | 1845 | 1863  | 1863  | 1845 | 1900 |   |      |
| Adj Flow Rate, veh/h         | 117  | 493  | 840   | 489   | 277  | 154  |   |      |
| Adj No. of Lanes             | 1    | 1    | 1     | 2     | 2    | 0    |   |      |
| Peak Hour Factor             | 0.94 | 0.94 | 0.94  | 0.94  | 0.94 | 0.94 |   |      |
| Percent Heavy Veh, %         | 3    | 3    | 2     | 2     | 3    | 3    |   |      |
| Cap, veh/h                   | 458  | 870  | 523   | 2049  | 473  | 255  |   |      |
| Arrive On Green              | 0.26 | 0.26 | 0.29  | 0.58  | 0.21 | 0.21 |   |      |
| Sat Flow, veh/h              | 1757 | 1568 | 1774  | 3632  | 2291 | 1188 |   |      |
| Grp Volume(v), veh/h         | 117  | 493  | 840   | 489   | 219  | 212  |   |      |
| Grp Sat Flow(s),veh/h/ln     | 1757 | 1568 | 1774  | 1770  | 1752 | 1635 |   |      |
| Q Serve(g_s), s              | 3.6  | 13.8 | 20.0  | 4.6   | 7.6  | 7.9  |   |      |
| Cycle Q Clear(g_c), s        | 3.6  | 13.8 | 20.0  | 4.6   | 7.6  | 7.9  |   |      |
| Prop In Lane                 | 1.00 | 1.00 | 1.00  |       |      | 0.73 |   |      |
| Lane Grp Cap(c), veh/h       | 458  | 870  | 523   | 2049  | 377  | 351  |   |      |
| V/C Ratio(X)                 | 0.26 | 0.57 | 1.61  | 0.24  | 0.58 | 0.60 |   |      |
| Avail Cap(c_a), veh/h        | 699  | 1086 | 523   | 3129  | 1549 | 1446 |   |      |
| HCM Platoon Ratio            | 1.00 | 1.00 | 1.00  | 1.00  | 1.00 | 1.00 |   |      |
| Upstream Filter(I)           | 1.00 | 1.00 | 1.00  | 1.00  | 1.00 | 1.00 |   |      |
| Uniform Delay (d), s/veh     | 19.9 | 9.8  | 23.9  | 7.0   | 23.9 | 24.0 |   |      |
| Incr Delay (d2), s/veh       | 0.3  | 0.6  | 281.8 | 0.1   | 2.6  | 3.1  |   |      |
| Initial Q Delay(d3),s/veh    | 0.0  | 0.0  | 0.0   | 0.0   | 0.0  | 0.0  |   |      |
| %ile BackOfQ(50%),veh/ln     | 1.8  | 6.1  | 50.7  | 2.3   | 3.9  | 3.9  |   |      |
| LnGrp Delay(d),s/veh         | 20.2 | 10.4 | 305.7 | 7.1   | 26.5 | 27.1 |   |      |
| LnGrp LOS                    | C    | B    | F     | A     | C    | C    |   |      |
| Approach Vol, veh/h          | 610  |      |       | 1329  | 431  |      |   |      |
| Approach Delay, s/veh        | 12.3 |      |       | 195.8 | 26.8 |      |   |      |
| Approach LOS                 | B    |      |       | F     | C    |      |   |      |
| Timer                        | 1    | 2    | 3     | 4     | 5    | 6    | 7 | 8    |
| Assigned Phs                 | 1    | 2    |       |       |      | 6    |   | 8    |
| Phs Duration (G+Y+Rc), s     | 24.7 | 21.0 |       |       |      | 45.7 |   | 22.2 |
| Change Period (Y+Rc), s      | 4.7  | 6.4  |       |       |      | 6.4  |   | 4.5  |
| Max Green Setting (Gmax), s  | 26   | 60.0 |       |       |      | 60.0 |   | 27.0 |
| Max Q Clear Time (g_c+Yc), s | 22.5 | 9.9  |       |       |      | 6.6  |   | 15.8 |
| Green Ext Time (p_c), s      | 0.0  | 4.7  |       |       |      | 5.8  |   | 1.8  |
| <b>Intersection Summary</b>  |      |      |       |       |      |      |   |      |
| HCM 2010 Ctrl Delay          |      |      | 117.8 |       |      |      |   |      |
| HCM 2010 LOS                 |      |      | F     |       |      |      |   |      |
| <b>Notes</b>                 |      |      |       |       |      |      |   |      |

HCM 2010 Signalized Intersection Summary  
 15: 2nd Avenue & 9th Street

Cumulative with Eastside Parkway, AM  
 06/11/2019



| Movement                     | EBL  | EBT    | EBR   | WBL  | WBT  | WBR  | NBL  | NBT  | NBR  | SBL  | SBT  | SBR  |
|------------------------------|------|--------|-------|------|------|------|------|------|------|------|------|------|
| Lane Configurations          |      | ↕      | ↗     |      | ↕    |      | ↖    | ↕    |      | ↖    | ↕    |      |
| Traffic Volume (veh/h)       | 10   | 10     | 10    | 260  | 10   | 20   | 20   | 360  | 30   | 40   | 850  | 10   |
| Future Volume (veh/h)        | 10   | 10     | 10    | 260  | 10   | 20   | 20   | 360  | 30   | 40   | 850  | 10   |
| Number                       | 5    | 2      | 12    | 1    | 6    | 16   | 3    | 8    | 18   | 7    | 4    | 14   |
| Initial Q (Qb), veh          | 0    | 0      | 0     | 0    | 0    | 0    | 0    | 0    | 0    | 0    | 0    | 0    |
| Ped-Bike Adj(A_pbT)          | 0.99 |        | 1.00  | 0.99 |      | 0.99 | 1.00 |      | 0.99 | 1.00 |      | 0.99 |
| Parking Bus, Adj             | 1.00 | 1.00   | 1.00  | 1.00 | 1.00 | 1.00 | 1.00 | 1.00 | 1.00 | 1.00 | 1.00 | 1.00 |
| Adj Sat Flow, veh/h/ln       | 1900 | 1881   | 1881  | 1900 | 1900 | 1900 | 1881 | 1881 | 1900 | 1863 | 1863 | 1900 |
| Adj Flow Rate, veh/h         | 11   | 11     | -24   | 277  | 11   | 20   | 21   | 383  | 27   | 43   | 904  | 4    |
| Adj No. of Lanes             | 0    | 1      | 1     | 0    | 1    | 0    | 1    | 2    | 0    | 1    | 2    | 0    |
| Peak Hour Factor             | 0.94 | 0.94   | 0.94  | 0.94 | 0.94 | 0.94 | 0.94 | 0.94 | 0.94 | 0.94 | 0.94 | 0.94 |
| Percent Heavy Veh, %         | 1    | 1      | 1     | 0    | 0    | 0    | 1    | 1    | 1    | 2    | 2    | 2    |
| Cap, veh/h                   | 325  | 288    | 455   | 525  | 15   | 27   | 46   | 1266 | 89   | 82   | 1425 | 6    |
| Arrive On Green              | 0.28 | 0.28   | 0.00  | 0.28 | 0.28 | 0.28 | 0.03 | 0.37 | 0.37 | 0.05 | 0.39 | 0.39 |
| Sat Flow, veh/h              | 725  | 1012   | 1599  | 1318 | 52   | 95   | 1792 | 3386 | 238  | 1774 | 3613 | 16   |
| Grp Volume(v), veh/h         | 22   | 0      | -24   | 308  | 0    | 0    | 21   | 201  | 209  | 43   | 443  | 465  |
| Grp Sat Flow(s),veh/h/ln1737 | 0    | 1599   | 1466  | 0    | 0    | 1792 | 1787 | 1837 | 1774 | 1770 | 1860 |      |
| Q Serve(g_s), s              | 0.0  | 0.0    | 0.0   | 8.3  | 0.0  | 0.0  | 0.5  | 3.6  | 3.7  | 1.1  | 9.2  | 9.2  |
| Cycle Q Clear(g_c), s        | 0.4  | 0.0    | 0.0   | 8.7  | 0.0  | 0.0  | 0.5  | 3.6  | 3.7  | 1.1  | 9.2  | 9.2  |
| Prop In Lane                 | 0.50 |        | 1.00  | 0.90 |      | 0.06 | 1.00 |      | 0.13 | 1.00 |      | 0.01 |
| Lane Grp Cap(c), veh/h       | 612  | 0      | 455   | 567  | 0    | 0    | 46   | 668  | 687  | 82   | 698  | 733  |
| V/C Ratio(X)                 | 0.04 | 0.00   | -0.05 | 0.54 | 0.00 | 0.00 | 0.46 | 0.30 | 0.30 | 0.53 | 0.63 | 0.63 |
| Avail Cap(c_a), veh/h        | 1205 | 0      | 1051  | 1109 | 0    | 0    | 451  | 1761 | 1811 | 447  | 1744 | 1833 |
| HCM Platoon Ratio            | 1.00 | 1.00   | 1.00  | 1.00 | 1.00 | 1.00 | 1.00 | 1.00 | 1.00 | 1.00 | 1.00 | 1.00 |
| Upstream Filter(I)           | 1.00 | 0.00   | 0.00  | 1.00 | 0.00 | 0.00 | 1.00 | 1.00 | 1.00 | 1.00 | 1.00 | 1.00 |
| Uniform Delay (d), s/veh     | 11.8 | 0.0    | 0.0   | 14.7 | 0.0  | 0.0  | 21.9 | 10.1 | 10.1 | 21.3 | 11.2 | 11.2 |
| Incr Delay (d2), s/veh       | 0.0  | 0.0    | 0.0   | 0.8  | 0.0  | 0.0  | 7.0  | 0.3  | 0.2  | 5.2  | 1.0  | 0.9  |
| Initial Q Delay(d3),s/veh    | 0.0  | 0.0    | 0.0   | 0.0  | 0.0  | 0.0  | 0.0  | 0.0  | 0.0  | 0.0  | 0.0  | 0.0  |
| %ile BackOfQ(50%),veh/ln0.2  | 0.0  | 0.0    | 0.0   | 3.6  | 0.0  | 0.0  | 0.3  | 1.8  | 1.9  | 0.6  | 4.6  | 4.8  |
| LnGrp Delay(d),s/veh         | 11.9 | 0.0    | 0.0   | 15.6 | 0.0  | 0.0  | 28.9 | 10.3 | 10.3 | 26.5 | 12.1 | 12.1 |
| LnGrp LOS                    | B    |        |       | B    |      |      | C    | B    | B    | C    | B    | B    |
| Approach Vol, veh/h          |      | -2     |       |      | 308  |      |      | 431  |      |      | 951  |      |
| Approach Delay, s/veh        |      | -130.4 |       |      | 15.6 |      |      | 11.2 |      |      | 12.8 |      |
| Approach LOS                 |      | A      |       |      | B    |      |      | B    |      |      | B    |      |
| Timer                        | 1    | 2      | 3     | 4    | 5    | 6    | 7    | 8    |      |      |      |      |
| Assigned Phs                 |      | 2      | 3     | 4    |      | 6    | 7    | 8    |      |      |      |      |
| Phs Duration (G+Y+Rc), s     |      | 18.0   | 4.7   | 23.0 |      | 18.0 | 5.6  | 22.1 |      |      |      |      |
| Change Period (Y+Rc), s      |      | 5.0    | 3.5   | 5.0  |      | 5.0  | 3.5  | 5.0  |      |      |      |      |
| Max Green Setting (Gmax), s  |      | 30.0   | 11.5  | 45.0 |      | 30.0 | 11.5 | 45.0 |      |      |      |      |
| Max Q Clear Time (g_c+I1), s |      | 2.4    | 2.5   | 11.2 |      | 10.7 | 3.1  | 5.7  |      |      |      |      |
| Green Ext Time (p_c), s      |      | 0.1    | 0.0   | 6.5  |      | 1.7  | 0.0  | 2.5  |      |      |      |      |
| <b>Intersection Summary</b>  |      |        |       |      |      |      |      |      |      |      |      |      |
| HCM 2010 Ctrl Delay          |      |        |       | 13.1 |      |      |      |      |      |      |      |      |
| HCM 2010 LOS                 |      |        |       | B    |      |      |      |      |      |      |      |      |

HCM 2010 Signalized Intersection Summary  
 16: 2nd Avenue & 8th Street

Cumulative with Eastside Parkway, AM  
 06/11/2019



| Movement                     | WBL  | WBR  | NBT  | NBR  | SBL  | SBT  |      |      |
|------------------------------|------|------|------|------|------|------|------|------|
| Lane Configurations          |      |      |      |      |      |      |      |      |
| Traffic Volume (veh/h)       | 210  | 20   | 480  | 110  | 50   | 910  |      |      |
| Future Volume (veh/h)        | 210  | 20   | 480  | 110  | 50   | 910  |      |      |
| Number                       | 1    | 16   | 8    | 18   | 7    | 4    |      |      |
| Initial Q (Qb), veh          | 0    | 0    | 0    | 0    | 0    | 0    |      |      |
| Ped-Bike Adj(A_pbT)          | 1.00 | 1.00 |      | 1.00 | 1.00 |      |      |      |
| Parking Bus, Adj             | 1.00 | 1.00 | 1.00 | 1.00 | 1.00 | 1.00 |      |      |
| Adj Sat Flow, veh/h/ln       | 1583 | 1583 | 1863 | 1900 | 1881 | 1881 |      |      |
| Adj Flow Rate, veh/h         | 221  | 5    | 505  | 100  | 53   | 958  |      |      |
| Adj No. of Lanes             | 1    | 1    | 2    | 0    | 1    | 2    |      |      |
| Peak Hour Factor             | 0.95 | 0.95 | 0.95 | 0.95 | 0.95 | 0.95 |      |      |
| Percent Heavy Veh, %         | 20   | 20   | 2    | 2    | 1    | 1    |      |      |
| Cap, veh/h                   | 289  | 258  | 988  | 195  | 105  | 1791 |      |      |
| Arrive On Green              | 0.19 | 0.19 | 0.34 | 0.34 | 0.06 | 0.50 |      |      |
| Sat Flow, veh/h              | 1508 | 1346 | 3042 | 581  | 1792 | 3668 |      |      |
| Grp Volume(v), veh/h         | 221  | 5    | 302  | 303  | 53   | 958  |      |      |
| Grp Sat Flow(s),veh/h/ln     | 1508 | 1346 | 1770 | 1760 | 1792 | 1787 |      |      |
| Q Serve(g_s), s              | 4.5  | 0.1  | 4.5  | 4.5  | 0.9  | 5.9  |      |      |
| Cycle Q Clear(g_c), s        | 4.5  | 0.1  | 4.5  | 4.5  | 0.9  | 5.9  |      |      |
| Prop In Lane                 | 1.00 | 1.00 |      | 0.33 | 1.00 |      |      |      |
| Lane Grp Cap(c), veh/h       | 289  | 258  | 593  | 590  | 105  | 1791 |      |      |
| V/C Ratio(X)                 | 0.77 | 0.02 | 0.51 | 0.51 | 0.51 | 0.53 |      |      |
| Avail Cap(c_a), veh/h        | 1391 | 1241 | 2448 | 2435 | 633  | 6593 |      |      |
| HCM Platoon Ratio            | 1.00 | 1.00 | 1.00 | 1.00 | 1.00 | 1.00 |      |      |
| Upstream Filter(I)           | 1.00 | 1.00 | 1.00 | 1.00 | 1.00 | 1.00 |      |      |
| Uniform Delay (d), s/veh     | 12.5 | 10.7 | 8.7  | 8.7  | 14.9 | 5.5  |      |      |
| Incr Delay (d2), s/veh       | 4.2  | 0.0  | 0.7  | 0.7  | 3.7  | 0.2  |      |      |
| Initial Q Delay(d3),s/veh    | 0.0  | 0.0  | 0.0  | 0.0  | 0.0  | 0.0  |      |      |
| %ile BackOfQ(50%),veh/ln     | 2.2  | 0.1  | 2.2  | 2.3  | 0.6  | 2.9  |      |      |
| LnGrp Delay(d),s/veh         | 16.7 | 10.7 | 9.4  | 9.4  | 18.6 | 5.8  |      |      |
| LnGrp LOS                    | B    | B    | A    | A    | B    | A    |      |      |
| Approach Vol, veh/h          | 226  |      | 605  |      |      | 1011 |      |      |
| Approach Delay, s/veh        | 16.6 |      | 9.4  |      |      | 6.5  |      |      |
| Approach LOS                 | B    |      | A    |      |      | A    |      |      |
| Timer                        | 1    | 2    | 3    | 4    | 5    | 6    | 7    | 8    |
| Assigned Phs                 |      |      |      | 4    |      | 6    | 7    | 8    |
| Phs Duration (G+Y+Rc), s     |      |      |      | 21.3 |      | 11.2 | 5.4  | 15.9 |
| Change Period (Y+Rc), s      |      |      |      | 5.0  |      | 5.0  | 3.5  | 5.0  |
| Max Green Setting (Gmax), s  |      |      |      | 60.0 |      | 30.0 | 11.5 | 45.0 |
| Max Q Clear Time (g_c+I1), s |      |      |      | 7.9  |      | 6.5  | 2.9  | 6.5  |
| Green Ext Time (p_c), s      |      |      |      | 8.4  |      | 0.6  | 0.0  | 4.0  |
| <b>Intersection Summary</b>  |      |      |      |      |      |      |      |      |
| HCM 2010 Ctrl Delay          |      |      | 8.6  |      |      |      |      |      |
| HCM 2010 LOS                 |      |      | A    |      |      |      |      |      |

| Intersection              |     |
|---------------------------|-----|
| Intersection Delay, s/veh | 9.7 |
| Intersection LOS          | A   |

| Movement            | EBT  | EBR  | WBL  | WBT  | NBL  | NBR  |
|---------------------|------|------|------|------|------|------|
| Lane Configurations | ↑    | ↑    | ↑    | ↑    | ↑    | ↑    |
| Traffic Vol, veh/h  | 110  | 50   | 170  | 210  | 20   | 100  |
| Future Vol, veh/h   | 110  | 50   | 170  | 210  | 20   | 100  |
| Peak Hour Factor    | 0.92 | 0.92 | 0.92 | 0.92 | 0.92 | 0.92 |
| Heavy Vehicles, %   | 2    | 2    | 2    | 2    | 2    | 2    |
| Mvmt Flow           | 120  | 54   | 185  | 228  | 22   | 109  |
| Number of Lanes     | 1    | 1    | 1    | 1    | 1    | 1    |

| Approach                   | EB  | WB   | NB |
|----------------------------|-----|------|----|
| Opposing Approach          | WB  | EB   |    |
| Opposing Lanes             | 2   | 2    | 0  |
| Conflicting Approach Left  |     | NB   | EB |
| Conflicting Lanes Left     | 0   | 2    | 2  |
| Conflicting Approach Right | NB  |      | WB |
| Conflicting Lanes Right    | 2   | 0    | 2  |
| HCM Control Delay          | 8.7 | 10.3 | 9  |
| HCM LOS                    | A   | B    | A  |

| Lane                   | NBLn1 | NBLn2 | EBLn1 | EBLn2 | WBLn1 | WBLn2 |
|------------------------|-------|-------|-------|-------|-------|-------|
| Vol Left, %            | 100%  | 0%    | 0%    | 0%    | 100%  | 0%    |
| Vol Thru, %            | 0%    | 0%    | 100%  | 0%    | 0%    | 100%  |
| Vol Right, %           | 0%    | 100%  | 0%    | 100%  | 0%    | 0%    |
| Sign Control           | Stop  | Stop  | Stop  | Stop  | Stop  | Stop  |
| Traffic Vol by Lane    | 20    | 100   | 110   | 50    | 170   | 210   |
| LT Vol                 | 20    | 0     | 0     | 0     | 170   | 0     |
| Through Vol            | 0     | 0     | 110   | 0     | 0     | 210   |
| RT Vol                 | 0     | 100   | 0     | 50    | 0     | 0     |
| Lane Flow Rate         | 22    | 109   | 120   | 54    | 185   | 228   |
| Geometry Grp           | 7     | 7     | 7     | 7     | 7     | 7     |
| Degree of Util (X)     | 0.039 | 0.157 | 0.176 | 0.069 | 0.284 | 0.319 |
| Departure Headway (Hd) | 6.406 | 5.198 | 5.294 | 4.589 | 5.538 | 5.036 |
| Convergence, Y/N       | Yes   | Yes   | Yes   | Yes   | Yes   | Yes   |
| Cap                    | 558   | 688   | 676   | 777   | 647   | 712   |
| Service Time           | 4.156 | 2.947 | 3.046 | 2.341 | 3.283 | 2.78  |
| HCM Lane V/C Ratio     | 0.039 | 0.158 | 0.178 | 0.069 | 0.286 | 0.32  |
| HCM Control Delay      | 9.4   | 8.9   | 9.2   | 7.7   | 10.5  | 10.1  |
| HCM Lane LOS           | A     | A     | A     | A     | B     | B     |
| HCM 95th-tile Q        | 0.1   | 0.6   | 0.6   | 0.2   | 1.2   | 1.4   |

| Intersection                |       |       |       |       |
|-----------------------------|-------|-------|-------|-------|
| Intersection Delay, s/veh   | 8.0   |       |       |       |
| Intersection LOS            | A     |       |       |       |
| Approach                    | EB    | WB    | NB    | SB    |
| Entry Lanes                 | 1     | 1     | 1     | 1     |
| Conflicting Circle Lanes    | 1     | 1     | 1     | 1     |
| Adj Approach Flow, veh/h    | 135   | 197   | 49    | 518   |
| Demand Flow Rate, veh/h     | 138   | 207   | 49    | 523   |
| Vehicles Circulating, veh/h | 324   | 113   | 425   | 90    |
| Vehicles Exiting, veh/h     | 289   | 361   | 37    | 230   |
| Follow-Up Headway, s        | 3.186 | 3.186 | 3.186 | 3.186 |
| Ped Vol Crossing Leg, #/h   | 0     | 0     | 0     | 0     |
| Ped Cap Adj                 | 1.000 | 1.000 | 1.000 | 1.000 |
| Approach Delay, s/veh       | 6.3   | 5.7   | 5.6   | 9.6   |
| Approach LOS                | A     | A     | A     | A     |
| Lane                        | Left  | Left  | Left  | Left  |
| Designated Moves            | LTR   | LTR   | LTR   | LTR   |
| Assumed Moves               | LTR   | LTR   | LTR   | LTR   |
| RT Channelized              |       |       |       |       |
| Lane Util                   | 1.000 | 1.000 | 1.000 | 1.000 |
| Critical Headway, s         | 5.193 | 5.193 | 5.193 | 5.193 |
| Entry Flow, veh/h           | 138   | 207   | 49    | 523   |
| Cap Entry Lane, veh/h       | 817   | 1009  | 739   | 1033  |
| Entry HV Adj Factor         | 0.975 | 0.951 | 1.000 | 0.990 |
| Flow Entry, veh/h           | 135   | 197   | 49    | 518   |
| Cap Entry, veh/h            | 797   | 960   | 739   | 1023  |
| V/C Ratio                   | 0.169 | 0.205 | 0.066 | 0.506 |
| Control Delay, s/veh        | 6.3   | 5.7   | 5.6   | 9.6   |
| LOS                         | A     | A     | A     | A     |
| 95th %tile Queue, veh       | 1     | 1     | 0     | 3     |



HCM 2010 Signalized Intersection Summary  
 19: 2nd Avenue & Inter-Garrison Road

Cumulative with Eastside Parkway, AM  
 06/11/2019



| Movement                     | WBL  | WBR  | NBT  | NBR  | SBL  | SBT  |      |      |
|------------------------------|------|------|------|------|------|------|------|------|
| Lane Configurations          |      |      |      |      |      |      |      |      |
| Traffic Volume (veh/h)       | 50   | 30   | 590  | 70   | 20   | 1110 |      |      |
| Future Volume (veh/h)        | 50   | 30   | 590  | 70   | 20   | 1110 |      |      |
| Number                       | 1    | 16   | 8    | 18   | 7    | 4    |      |      |
| Initial Q (Qb), veh          | 0    | 0    | 0    | 0    | 0    | 0    |      |      |
| Ped-Bike Adj(A_pbT)          | 1.00 | 1.00 |      | 1.00 | 1.00 |      |      |      |
| Parking Bus, Adj             | 1.00 | 1.00 | 1.00 | 1.00 | 1.00 | 1.00 |      |      |
| Adj Sat Flow, veh/h/ln       | 1900 | 1900 | 1881 | 1900 | 1881 | 1881 |      |      |
| Adj Flow Rate, veh/h         | 54   | 8    | 634  | 67   | 22   | 1194 |      |      |
| Adj No. of Lanes             | 1    | 1    | 2    | 0    | 1    | 2    |      |      |
| Peak Hour Factor             | 0.93 | 0.93 | 0.93 | 0.93 | 0.93 | 0.93 |      |      |
| Percent Heavy Veh, %         | 0    | 0    | 1    | 1    | 1    | 1    |      |      |
| Cap, veh/h                   | 233  | 208  | 1506 | 159  | 49   | 2102 |      |      |
| Arrive On Green              | 0.13 | 0.13 | 0.46 | 0.46 | 0.03 | 0.59 |      |      |
| Sat Flow, veh/h              | 1810 | 1615 | 3357 | 344  | 1792 | 3668 |      |      |
| Grp Volume(v), veh/h         | 54   | 8    | 347  | 354  | 22   | 1194 |      |      |
| Grp Sat Flow(s),veh/h/ln     | 1810 | 1615 | 1787 | 1820 | 1792 | 1787 |      |      |
| Q Serve(g_s), s              | 0.9  | 0.2  | 4.6  | 4.6  | 0.4  | 7.3  |      |      |
| Cycle Q Clear(g_c), s        | 0.9  | 0.2  | 4.6  | 4.6  | 0.4  | 7.3  |      |      |
| Prop In Lane                 | 1.00 | 1.00 |      | 0.19 | 1.00 |      |      |      |
| Lane Grp Cap(c), veh/h       | 233  | 208  | 825  | 840  | 49   | 2102 |      |      |
| V/C Ratio(X)                 | 0.23 | 0.04 | 0.42 | 0.42 | 0.45 | 0.57 |      |      |
| Avail Cap(c_a), veh/h        | 1792 | 1600 | 2023 | 2061 | 583  | 5563 |      |      |
| HCM Platoon Ratio            | 1.00 | 1.00 | 1.00 | 1.00 | 1.00 | 1.00 |      |      |
| Upstream Filter(l)           | 1.00 | 1.00 | 1.00 | 1.00 | 1.00 | 1.00 |      |      |
| Uniform Delay (d), s/veh     | 13.8 | 13.5 | 6.4  | 6.4  | 16.9 | 4.5  |      |      |
| Incr Delay (d2), s/veh       | 0.5  | 0.1  | 0.3  | 0.3  | 6.2  | 0.2  |      |      |
| Initial Q Delay(d3),s/veh    | 0.0  | 0.0  | 0.0  | 0.0  | 0.0  | 0.0  |      |      |
| %ile BackOfQ(50%),veh/ln     | 0.5  | 0.2  | 2.3  | 2.3  | 0.3  | 3.6  |      |      |
| LnGrp Delay(d),s/veh         | 14.3 | 13.5 | 6.7  | 6.7  | 23.1 | 4.7  |      |      |
| LnGrp LOS                    | B    | B    | A    | A    | C    | A    |      |      |
| Approach Vol, veh/h          | 62   |      | 701  |      |      | 1216 |      |      |
| Approach Delay, s/veh        | 14.2 |      | 6.7  |      |      | 5.1  |      |      |
| Approach LOS                 | B    |      | A    |      |      | A    |      |      |
| Timer                        | 1    | 2    | 3    | 4    | 5    | 6    | 7    | 8    |
| Assigned Phs                 |      |      |      | 4    |      | 6    | 7    | 8    |
| Phs Duration (G+Y+Rc), s     |      |      |      | 25.8 |      | 9.6  | 4.5  | 21.3 |
| Change Period (Y+Rc), s      |      |      |      | 5.0  |      | 5.0  | 3.5  | 5.0  |
| Max Green Setting (Gmax), s  |      |      |      | 55.0 |      | 35.0 | 11.5 | 40.0 |
| Max Q Clear Time (g_c+I1), s |      |      |      | 9.3  |      | 2.9  | 2.4  | 6.6  |
| Green Ext Time (p_c), s      |      |      |      | 11.5 |      | 0.1  | 0.0  | 4.7  |
| <b>Intersection Summary</b>  |      |      |      |      |      |      |      |      |
| HCM 2010 Ctrl Delay          |      |      | 5.9  |      |      |      |      |      |
| HCM 2010 LOS                 |      |      | A    |      |      |      |      |      |

| Intersection                   |  |  |  |  |  |  |  |  |  |  |  |  |
|--------------------------------|--|--|--|--|--|--|--|--|--|--|--|--|
| Intersection Delay, s/veh 10.1 |  |  |  |  |  |  |  |  |  |  |  |  |
| Intersection LOS B             |  |  |  |  |  |  |  |  |  |  |  |  |























| Movement            | EBL  | EBT  | EBR  | WBL  | WBT  | WBR  | NBL  | NBT  | NBR  | SBL  | SBT  | SBR  |
|---------------------|------|------|------|------|------|------|------|------|------|------|------|------|
| Lane Configurations |      | ↕    |      |      | ↕    |      |      | ↕    |      |      | ↕    |      |
| Traffic Vol, veh/h  | 10   | 40   | 10   | 90   | 40   | 20   | 20   | 130  | 120  | 20   | 110  | 10   |
| Future Vol, veh/h   | 10   | 40   | 10   | 90   | 40   | 20   | 20   | 130  | 120  | 20   | 110  | 10   |
| Peak Hour Factor    | 0.85 | 0.85 | 0.85 | 0.85 | 0.85 | 0.85 | 0.85 | 0.85 | 0.85 | 0.85 | 0.85 | 0.85 |
| Heavy Vehicles, %   | 6    | 6    | 6    | 2    | 2    | 2    | 4    | 4    | 4    | 0    | 0    | 0    |
| Mvmt Flow           | 12   | 47   | 12   | 106  | 47   | 24   | 24   | 153  | 141  | 24   | 129  | 12   |
| Number of Lanes     | 0    | 1    | 0    | 0    | 1    | 0    | 0    | 1    | 0    | 0    | 1    | 0    |

| Approach                   | EB | WB | NB   | SB  |
|----------------------------|----|----|------|-----|
| Opposing Approach          | WB | EB | SB   | NB  |
| Opposing Lanes             | 1  | 1  | 1    | 1   |
| Conflicting Approach Left  | SB | NB | EB   | WB  |
| Conflicting Lanes Left     | 1  | 1  | 1    | 1   |
| Conflicting Approach Right | NB | SB | WB   | EB  |
| Conflicting Lanes Right    | 1  | 1  | 1    | 1   |
| HCM Control Delay          | 9  | 10 | 10.7 | 9.4 |
| HCM LOS                    | A  | A  | B    | A   |

| Lane                   | NBLn1 | EBLn1 | WBLn1 | SBLn1 |
|------------------------|-------|-------|-------|-------|
| Vol Left, %            | 7%    | 17%   | 60%   | 14%   |
| Vol Thru, %            | 48%   | 67%   | 27%   | 79%   |
| Vol Right, %           | 44%   | 17%   | 13%   | 7%    |
| Sign Control           | Stop  | Stop  | Stop  | Stop  |
| Traffic Vol by Lane    | 270   | 60    | 150   | 140   |
| LT Vol                 | 20    | 10    | 90    | 20    |
| Through Vol            | 130   | 40    | 40    | 110   |
| RT Vol                 | 120   | 10    | 20    | 10    |
| Lane Flow Rate         | 318   | 71    | 176   | 165   |
| Geometry Grp           | 1     | 1     | 1     | 1     |
| Degree of Util (X)     | 0.403 | 0.104 | 0.254 | 0.224 |
| Departure Headway (Hd) | 4.563 | 5.307 | 5.181 | 4.902 |
| Convergence, Y/N       | Yes   | Yes   | Yes   | Yes   |
| Cap                    | 785   | 667   | 686   | 726   |
| Service Time           | 2.625 | 3.405 | 3.266 | 2.978 |
| HCM Lane V/C Ratio     | 0.405 | 0.106 | 0.257 | 0.227 |
| HCM Control Delay      | 10.7  | 9     | 10    | 9.4   |
| HCM Lane LOS           | B     | A     | A     | A     |
| HCM 95th-tile Q        | 2     | 0.3   | 1     | 0.9   |

HCM 2010 Signalized Intersection Summary  
 21: 7th Avenue/8th Street & Inter-Garrison Road

Cumulative with Eastside Parkway, AM  
 07/12/2019

|                              |  |  |  |  |  |  |   |  |  |  |  |  |
|------------------------------|---|---|---|---|---|---|---|---|---|---|---|---|
| Movement                     | EBL   | EBT   | EBR   | WBL   | WBT   | WBR   | NBL   | NBT   | NBR   | SBL   | SBT   | SBR   |
| Lane Configurations          |  |  |   |  |  |   |  |  |  |  |  |  |
| Traffic Volume (veh/h)       | 10  | 110   | 30  | 80  | 240   | 20  | 50  | 100   | 80  | 130   | 80  | 10  |
| Future Volume (veh/h)        | 10  | 110   | 30  | 80  | 240   | 20  | 50  | 100   | 80  | 130   | 80  | 10  |
| Number                       | 5   | 2   | 12  | 1   | 6   | 16  | 3   | 8   | 18  | 7   | 4   | 14  |
| Initial Q (Qb), veh          | 0   | 0   | 0   | 0   | 0   | 0   | 0   | 0   | 0   | 0   | 0   | 0   |
| Ped-Bike Adj(A_pbT)          | 1.00  |   | 0.99  | 1.00  |   | 1.00  | 1.00  |   | 1.00  | 1.00  |   | 1.00  |
| Parking Bus, Adj             | 1.00  | 1.00  | 1.00  | 1.00  | 1.00  | 1.00  | 1.00  | 1.00  | 1.00  | 1.00  | 1.00  | 1.00  |
| Adj Sat Flow, veh/h/ln       | 1759  | 1759  | 1900  | 1845  | 1845  | 1900  | 1597  | 1597  | 1597  | 1776  | 1776  | 1900  |
| Adj Flow Rate, veh/h         | 12  | 136   | 28  | 99  | 296   | 0   | 62  | 123   | 66  | 160   | 99  | 5   |
| Adj No. of Lanes             | 1   | 1   | 0   | 1   | 1   | 0   | 1   | 1   | 1   | 1   | 1   | 0   |
| Peak Hour Factor             | 0.81  | 0.81  | 0.81  | 0.81  | 0.81  | 0.81  | 0.81  | 0.81  | 0.81  | 0.81  | 0.81  | 0.81  |
| Percent Heavy Veh, %         | 8   | 8   | 8   | 3   | 3   | 3   | 19  | 19  | 19  | 7   | 7   | 7   |
| Cap, veh/h                   | 21  | 377   | 78  | 127   | 602   | 0   | 76  | 220   | 187   | 210   | 356   | 18  |
| Arrive On Green              | 0.01  | 0.27  | 0.27  | 0.07  | 0.33  | 0.00  | 0.05  | 0.14  | 0.14  | 0.12  | 0.21  | 0.21  |
| Sat Flow, veh/h              | 1675  | 1415  | 291   | 1757  | 1845  | 0   | 1521  | 1597  | 1357  | 1691  | 1676  | 85  |
| Grp Volume(v), veh/h         | 12  | 0   | 164   | 99  | 296   | 0   | 62  | 123   | 66  | 160   | 0   | 104   |
| Grp Sat Flow(s),veh/h/ln     | 1675  | 0   | 1706  | 1757  | 1845  | 0   | 1521  | 1597  | 1357  | 1691  | 0   | 1761  |
| Q Serve(g_s), s              | 0.3   | 0.0   | 3.1   | 2.2   | 5.2   | 0.0   | 1.6   | 2.9   | 1.8   | 3.7   | 0.0   | 2.0   |
| Cycle Q Clear(g_c), s        | 0.3   | 0.0   | 3.1   | 2.2   | 5.2   | 0.0   | 1.6   | 2.9   | 1.8   | 3.7   | 0.0   | 2.0   |
| Prop In Lane                 | 1.00  |   | 0.17  | 1.00  |   | 0.00  | 1.00  |   | 1.00  | 1.00  |   | 0.05  |
| Lane Grp Cap(c), veh/h       | 21  | 0   | 455   | 127   | 602   | 0   | 76  | 220   | 187   | 210   | 0   | 374   |
| V/C Ratio(X)                 | 0.57  | 0.00  | 0.36  | 0.78  | 0.49  | 0.00  | 0.82  | 0.56  | 0.35  | 0.76  | 0.00  | 0.28  |
| Avail Cap(c_a), veh/h        | 167   | 0   | 1383  | 535   | 1873  | 0   | 398   | 876   | 745   | 730   | 0   | 1265  |
| HCM Platoon Ratio            | 1.00  | 1.00  | 1.00  | 1.00  | 1.00  | 1.00  | 1.00  | 1.00  | 1.00  | 1.00  | 1.00  | 1.00  |
| Upstream Filter(I)           | 1.00  | 0.00  | 1.00  | 1.00  | 1.00  | 0.00  | 1.00  | 1.00  | 1.00  | 1.00  | 0.00  | 1.00  |
| Uniform Delay (d), s/veh     | 19.7  | 0.0   | 11.9  | 18.3  | 10.8  | 0.0   | 18.9  | 16.1  | 15.7  | 17.0  | 0.0   | 13.2  |
| Incr Delay (d2), s/veh       | 22.4  | 0.0   | 0.5   | 9.8   | 0.6   | 0.0   | 18.9  | 2.2   | 1.1   | 5.7   | 0.0   | 0.4   |
| Initial Q Delay(d3),s/veh    | 0.0   | 0.0   | 0.0   | 0.0   | 0.0   | 0.0   | 0.0   | 0.0   | 0.0   | 0.0   | 0.0   | 0.0   |
| %ile BackOfQ(50%),veh/ln     | 0.3   | 0.0   | 1.5   | 1.4   | 2.7   | 0.0   | 1.1   | 1.4   | 0.7   | 2.0   | 0.0   | 1.0   |
| LnGrp Delay(d),s/veh         | 42.1  | 0.0   | 12.4  | 28.1  | 11.5  | 0.0   | 37.8  | 18.3  | 16.8  | 22.7  | 0.0   | 13.6  |
| LnGrp LOS                    | D   |   | B   | C   | B   |   | D   | B   | B   | C   |   | B   |
| Approach Vol, veh/h          |   | 176   |   |   | 395   |   |   | 251   |   |   | 264   |   |
| Approach Delay, s/veh        |   | 14.4  |   |   | 15.6  |   |   | 22.7  |   |   | 19.1  |   |
| Approach LOS                 |   | B   |   |   | B   |   |   | C   |   |   | B   |   |
| Timer                        | 1   | 2   | 3   | 4   | 5   | 6   | 7   | 8   |   |   |   |   |
| Assigned Phs                 | 1   | 2   | 3   | 4   | 5   | 6   | 7   | 8   |   |   |   |   |
| Phs Duration (G+Y+Rc), s     | 6.4   | 15.7  | 5.5   | 12.5  | 4.0   | 18.1  | 8.5   | 9.5   |   |   |   |   |
| Change Period (Y+Rc), s      | 3.5   | 5.0   | 3.5   | 4.0   | 3.5   | 5.0   | 3.5   | 4.0   |   |   |   |   |
| Max Green Setting (Gmax), s  | 12.2  | 32.5  | 10.5  | 28.8  | 4.0   | 40.7  | 17.3  | 22.0  |   |   |   |   |
| Max Q Clear Time (g_c+I1), s | 4.2   | 5.1   | 3.6   | 4.0   | 2.3   | 7.2   | 5.7   | 4.9   |   |   |   |   |
| Green Ext Time (p_c), s      | 0.1   | 0.9   | 0.1   | 0.5   | 0.0   | 1.9   | 0.3   | 0.8   |   |   |   |   |
| <b>Intersection Summary</b>  |   |   |   |   |   |   |   |   |   |   |   |   |
| HCM 2010 Ctrl Delay          |   |   | 17.9  |   |   |   |   |   |   |   |   |   |
| HCM 2010 LOS                 |   |   | B   |   |   |   |   |   |   |   |   |   |

| Intersection                   |       |       |       |
|--------------------------------|-------|-------|-------|
| Intersection Delay, s/veh 50.5 |       |       |       |
| Intersection LOS F             |       |       |       |
| Approach                       | EB    | WB    | NB    |
| Entry Lanes                    | 1     | 1     | 1     |
| Conflicting Circle Lanes       | 1     | 1     | 1     |
| Adj Approach Flow, veh/h       | 368   | 1080  | 425   |
| Demand Flow Rate, veh/h        | 460   | 1091  | 438   |
| Vehicles Circulating, veh/h    | 778   | 95    | 230   |
| Vehicles Exiting, veh/h        | 408   | 573   | 1008  |
| Follow-Up Headway, s           | 3.186 | 3.186 | 3.186 |
| Ped Vol Crossing Leg, #/h      | 0     | 0     | 0     |
| Ped Cap Adj                    | 1.000 | 1.000 | 1.000 |
| Approach Delay, s/veh          | 51.6  | 65.8  | 10.4  |
| Approach LOS                   | F     | F     | B     |
| Lane                           | Left  | Left  | Left  |
| Designated Moves               | TR    | LT    | LR    |
| Assumed Moves                  | TR    | LT    | LR    |
| RT Channelized                 |       |       |       |
| Lane Util                      | 1.000 | 1.000 | 1.000 |
| Critical Headway, s            | 5.193 | 5.193 | 5.193 |
| Entry Flow, veh/h              | 460   | 1091  | 438   |
| Cap Entry Lane, veh/h          | 519   | 1028  | 898   |
| Entry HV Adj Factor            | 0.800 | 0.990 | 0.970 |
| Flow Entry, veh/h              | 368   | 1080  | 425   |
| Cap Entry, veh/h               | 415   | 1017  | 871   |
| V/C Ratio                      | 0.886 | 1.062 | 0.488 |
| Control Delay, s/veh           | 51.6  | 65.8  | 10.4  |
| LOS                            | F     | F     | B     |
| 95th %tile Queue, veh          | 9     | 24    | 3     |

HCM 2010 Signalized Intersection Summary  
 23: Inter-Garrison Road & Abrams Drive

Cumulative with Eastside Parkway, AM  
 06/11/2019

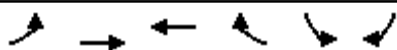

| Movement                     | EBL  | EBT  | WBT  | WBR  | SBL  | SBR  |   |   |
|------------------------------|------|------|------|------|------|------|---|---|
| Lane Configurations          |      |      |      |      |      |      |   |   |
| Traffic Volume (veh/h)       | 160  | 290  | 620  | 70   | 80   | 320  |   |   |
| Future Volume (veh/h)        | 160  | 290  | 620  | 70   | 80   | 320  |   |   |
| Number                       | 5    | 2    | 6    | 16   | 7    | 14   |   |   |
| Initial Q (Qb), veh          | 0    | 0    | 0    | 0    | 0    | 0    |   |   |
| Ped-Bike Adj(A_pbT)          | 1.00 |      |      | 1.00 | 1.00 | 1.00 |   |   |
| Parking Bus, Adj             | 1.00 | 1.00 | 1.00 | 1.00 | 1.00 | 1.00 |   |   |
| Adj Sat Flow, veh/h/ln       | 1759 | 1759 | 1881 | 1881 | 1881 | 1881 |   |   |
| Adj Flow Rate, veh/h         | 188  | 341  | 729  | 76   | 94   | 158  |   |   |
| Adj No. of Lanes             | 1    | 1    | 1    | 1    | 2    | 1    |   |   |
| Peak Hour Factor             | 0.85 | 0.85 | 0.85 | 0.85 | 0.85 | 0.85 |   |   |
| Percent Heavy Veh, %         | 8    | 8    | 1    | 1    | 1    | 1    |   |   |
| Cap, veh/h                   | 234  | 1151 | 806  | 685  | 474  | 218  |   |   |
| Arrive On Green              | 0.14 | 0.65 | 0.43 | 0.43 | 0.14 | 0.14 |   |   |
| Sat Flow, veh/h              | 1675 | 1759 | 1881 | 1599 | 3476 | 1599 |   |   |
| Grp Volume(v), veh/h         | 188  | 341  | 729  | 76   | 94   | 158  |   |   |
| Grp Sat Flow(s),veh/h/ln     | 1675 | 1759 | 1881 | 1599 | 1738 | 1599 |   |   |
| Q Serve(g_s), s              | 4.4  | 3.4  | 14.7 | 1.2  | 1.0  | 3.8  |   |   |
| Cycle Q Clear(g_c), s        | 4.4  | 3.4  | 14.7 | 1.2  | 1.0  | 3.8  |   |   |
| Prop In Lane                 | 1.00 |      |      | 1.00 | 1.00 | 1.00 |   |   |
| Lane Grp Cap(c), veh/h       | 234  | 1151 | 806  | 685  | 474  | 218  |   |   |
| V/C Ratio(X)                 | 0.80 | 0.30 | 0.90 | 0.11 | 0.20 | 0.72 |   |   |
| Avail Cap(c_a), veh/h        | 475  | 2602 | 2087 | 1774 | 2699 | 1242 |   |   |
| HCM Platoon Ratio            | 1.00 | 1.00 | 1.00 | 1.00 | 1.00 | 1.00 |   |   |
| Upstream Filter(I)           | 1.00 | 1.00 | 1.00 | 1.00 | 1.00 | 1.00 |   |   |
| Uniform Delay (d), s/veh     | 16.9 | 3.0  | 10.8 | 7.0  | 15.5 | 16.8 |   |   |
| Incr Delay (d2), s/veh       | 2.5  | 0.1  | 1.6  | 0.0  | 0.1  | 1.7  |   |   |
| Initial Q Delay(d3),s/veh    | 0.0  | 0.0  | 0.0  | 0.0  | 0.0  | 0.0  |   |   |
| %ile BackOfQ(50%),veh/ln     | 2.2  | 1.6  | 7.9  | 0.5  | 0.5  | 3.4  |   |   |
| LnGrp Delay(d),s/veh         | 19.4 | 3.1  | 12.5 | 7.0  | 15.6 | 18.5 |   |   |
| LnGrp LOS                    | B    | A    | B    | A    | B    | B    |   |   |
| Approach Vol, veh/h          |      | 529  | 805  |      | 252  |      |   |   |
| Approach Delay, s/veh        |      | 8.9  | 11.9 |      | 17.4 |      |   |   |
| Approach LOS                 |      | A    | B    |      | B    |      |   |   |
| Timer                        | 1    | 2    | 3    | 4    | 5    | 6    | 7 | 8 |
| Assigned Phs                 |      | 2    |      | 4    | 5    | 6    |   |   |
| Phs Duration (G+Y+Rc), s     |      | 31.5 |      | 9.0  | 9.2  | 22.4 |   |   |
| Change Period (Y+Rc), s      |      | 5.0  |      | 3.5  | 3.5  | 5.0  |   |   |
| Max Green Setting (Gmax), s  |      | 60.0 |      | 31.5 | 11.5 | 45.0 |   |   |
| Max Q Clear Time (g_c+I1), s |      | 5.4  |      | 5.8  | 6.4  | 16.7 |   |   |
| Green Ext Time (p_c), s      |      | 0.3  |      | 0.0  | 0.0  | 0.7  |   |   |
| <b>Intersection Summary</b>  |      |      |      |      |      |      |   |   |
| HCM 2010 Ctrl Delay          |      |      | 11.8 |      |      |      |   |   |
| HCM 2010 LOS                 |      |      | B    |      |      |      |   |   |

HCM 2010 Signalized Intersection Summary  
 24: Inter-Garrison Road & Schoonover Road

Cumulative with Eastside Parkway, AM  
 06/11/2019



| Movement                      | EBL  | EBT  | EBR  | WBL  | WBT  | WBR  | NBL  | NBT  | NBR  | SBL  | SBT  | SBR  |
|-------------------------------|------|------|------|------|------|------|------|------|------|------|------|------|
| Lane Configurations           |      |      |      |      |      |      |      |      |      |      |      |      |
| Traffic Volume (veh/h)        | 60   | 270  | 60   | 560  | 490  | 10   | 60   | 10   | 340  | 40   | 40   | 120  |
| Future Volume (veh/h)         | 60   | 270  | 60   | 560  | 490  | 10   | 60   | 10   | 340  | 40   | 40   | 120  |
| Number                        | 5    | 2    | 12   | 1    | 6    | 16   | 3    | 8    | 18   | 7    | 4    | 14   |
| Initial Q (Qb), veh           | 0    | 0    | 0    | 0    | 0    | 0    | 0    | 0    | 0    | 0    | 0    | 0    |
| Ped-Bike Adj(A_pbT)           | 1.00 |      | 1.00 | 1.00 |      | 1.00 | 1.00 |      | 1.00 | 1.00 |      | 1.00 |
| Parking Bus, Adj              | 1.00 | 1.00 | 1.00 | 1.00 | 1.00 | 1.00 | 1.00 | 1.00 | 1.00 | 1.00 | 1.00 | 1.00 |
| Adj Sat Flow, veh/h/ln        | 1810 | 1819 | 1900 | 1863 | 1881 | 1881 | 1863 | 1863 | 1863 | 1900 | 1854 | 1845 |
| Adj Flow Rate, veh/h          | 76   | 342  | 51   | 709  | 620  | 9    | 76   | 13   | 0    | 51   | 51   | 101  |
| Adj No. of Lanes              | 1    | 2    | 0    | 1    | 2    | 1    | 1    | 1    | 1    | 0    | 1    | 1    |
| Peak Hour Factor              | 0.79 | 0.79 | 0.79 | 0.79 | 0.79 | 0.79 | 0.79 | 0.79 | 0.79 | 0.79 | 0.79 | 0.79 |
| Percent Heavy Veh, %          | 5    | 5    | 5    | 2    | 1    | 1    | 2    | 2    | 2    | 2    | 2    | 3    |
| Cap, veh/h                    | 102  | 420  | 62   | 736  | 1768 | 791  | 185  | 194  | 165  | 109  | 109  | 189  |
| Arrive On Green               | 0.06 | 0.14 | 0.14 | 0.42 | 0.49 | 0.49 | 0.10 | 0.10 | 0.00 | 0.12 | 0.12 | 0.12 |
| Sat Flow, veh/h               | 1723 | 3022 | 447  | 1774 | 3574 | 1599 | 1774 | 1863 | 1583 | 904  | 904  | 1564 |
| Grp Volume(v), veh/h          | 76   | 194  | 199  | 709  | 620  | 9    | 76   | 13   | 0    | 102  | 0    | 101  |
| Grp Sat Flow(s),veh/h/ln      | 1723 | 1728 | 1740 | 1774 | 1787 | 1599 | 1774 | 1863 | 1583 | 1808 | 0    | 1564 |
| Q Serve(g_s), s               | 3.6  | 9.1  | 9.3  | 32.6 | 8.9  | 0.2  | 3.4  | 0.5  | 0.0  | 4.4  | 0.0  | 5.1  |
| Cycle Q Clear(g_c), s         | 3.6  | 9.1  | 9.3  | 32.6 | 8.9  | 0.2  | 3.4  | 0.5  | 0.0  | 4.4  | 0.0  | 5.1  |
| Prop In Lane                  | 1.00 |      | 0.26 | 1.00 |      | 1.00 | 1.00 |      | 1.00 | 0.50 |      | 1.00 |
| Lane Grp Cap(c), veh/h        | 102  | 240  | 242  | 736  | 1768 | 791  | 185  | 194  | 165  | 218  | 0    | 189  |
| V/C Ratio(X)                  | 0.74 | 0.81 | 0.82 | 0.96 | 0.35 | 0.01 | 0.41 | 0.07 | 0.00 | 0.47 | 0.00 | 0.53 |
| Avail Cap(c_a), veh/h         | 319  | 619  | 623  | 1006 | 2645 | 1183 | 572  | 600  | 510  | 583  | 0    | 504  |
| HCM Platoon Ratio             | 1.00 | 1.00 | 1.00 | 1.00 | 1.00 | 1.00 | 1.00 | 1.00 | 1.00 | 1.00 | 1.00 | 1.00 |
| Upstream Filter(I)            | 1.00 | 1.00 | 1.00 | 1.00 | 1.00 | 1.00 | 1.00 | 1.00 | 0.00 | 1.00 | 0.00 | 1.00 |
| Uniform Delay (d), s/veh      | 38.8 | 35.0 | 35.1 | 23.9 | 12.9 | 10.8 | 35.1 | 33.8 | 0.0  | 34.3 | 0.0  | 34.6 |
| Incr Delay (d2), s/veh        | 3.9  | 2.5  | 2.7  | 15.2 | 0.0  | 0.0  | 0.5  | 0.1  | 0.0  | 0.6  | 0.0  | 0.9  |
| Initial Q Delay(d3),s/veh     | 0.0  | 0.0  | 0.0  | 0.0  | 0.0  | 0.0  | 0.0  | 0.0  | 0.0  | 0.0  | 0.0  | 0.0  |
| %ile BackOfQ(50%),veh/ln      | 1.8  | 4.5  | 4.6  | 18.9 | 4.4  | 0.1  | 1.7  | 0.3  | 0.0  | 2.2  | 0.0  | 2.3  |
| LnGrp Delay(d),s/veh          | 42.7 | 37.5 | 37.7 | 39.0 | 13.0 | 10.8 | 35.6 | 33.9 | 0.0  | 34.9 | 0.0  | 35.5 |
| LnGrp LOS                     | D    | D    | D    | D    | B    | B    | D    | C    |      | C    |      | D    |
| Approach Vol, veh/h           |      | 469  |      |      | 1338 |      |      | 89   |      |      | 203  |      |
| Approach Delay, s/veh         |      | 38.4 |      |      | 26.8 |      |      | 35.4 |      |      | 35.2 |      |
| Approach LOS                  |      | D    |      |      | C    |      |      | D    |      |      | D    |      |
| Timer                         | 1    | 2    | 3    | 4    | 5    | 6    | 7    | 8    |      |      |      |      |
| Assigned Phs                  | 1    | 2    |      | 4    | 5    | 6    |      | 8    |      |      |      |      |
| Phs Duration (G+Y+Rc), s      | 38.3 | 16.6 |      | 15.1 | 8.5  | 46.4 |      | 13.7 |      |      |      |      |
| Change Period (Y+Rc), s       | 3.5  | 5.0  |      | 5.0  | 3.5  | 5.0  |      | 5.0  |      |      |      |      |
| Max Green Setting (Gmax), s   | 47.5 | 30.0 |      | 27.0 | 15.5 | 62.0 |      | 27.0 |      |      |      |      |
| Max Q Clear Time (g_c+3.6), s | 34.6 | 11.3 |      | 7.1  | 5.6  | 10.9 |      | 5.4  |      |      |      |      |
| Green Ext Time (p_c), s       | 0.2  | 0.3  |      | 0.1  | 0.0  | 0.8  |      | 0.0  |      |      |      |      |
| <b>Intersection Summary</b>   |      |      |      |      |      |      |      |      |      |      |      |      |
| HCM 2010 Ctrl Delay           |      |      |      | 30.5 |      |      |      |      |      |      |      |      |
| HCM 2010 LOS                  |      |      |      | C    |      |      |      |      |      |      |      |      |

| Intersection              |       |
|---------------------------|-------|
| Intersection Delay, s/veh | 198.7 |
| Intersection LOS          | F     |

| Movement            | EBL  | EBT  | WBT  | WBR  | SBL  | SBR  |
|---------------------|------|------|------|------|------|------|
| Lane Configurations |      |      |      |      |      |      |
| Traffic Vol, veh/h  | 490  | 130  | 310  | 130  | 90   | 700  |
| Future Vol, veh/h   | 490  | 130  | 310  | 130  | 90   | 700  |
| Peak Hour Factor    | 0.82 | 0.82 | 0.82 | 0.82 | 0.82 | 0.82 |
| Heavy Vehicles, %   | 5    | 5    | 1    | 1    | 0    | 0    |
| Mvmt Flow           | 598  | 159  | 378  | 159  | 110  | 854  |
| Number of Lanes     | 1    | 1    | 1    | 0    | 1    | 1    |

| Approach                   | EB    | WB   | SB    |
|----------------------------|-------|------|-------|
| Opposing Approach          | WB    | EB   |       |
| Opposing Lanes             | 1     | 2    | 0     |
| Conflicting Approach Left  | SB    |      | WB    |
| Conflicting Lanes Left     | 2     | 0    | 1     |
| Conflicting Approach Right |       | SB   | EB    |
| Conflicting Lanes Right    | 0     | 2    | 2     |
| HCM Control Delay          | 165.2 | 97.2 | 281.5 |
| HCM LOS                    | F     | F    | F     |

| Lane                   | EBLn1 | EBLn2 | WBLn1 | SBLn1 | SBLn2 |
|------------------------|-------|-------|-------|-------|-------|
| Vol Left, %            | 100%  | 0%    | 0%    | 100%  | 0%    |
| Vol Thru, %            | 0%    | 100%  | 70%   | 0%    | 0%    |
| Vol Right, %           | 0%    | 0%    | 30%   | 0%    | 100%  |
| Sign Control           | Stop  | Stop  | Stop  | Stop  | Stop  |
| Traffic Vol by Lane    | 490   | 130   | 440   | 90    | 700   |
| LT Vol                 | 490   | 0     | 0     | 90    | 0     |
| Through Vol            | 0     | 130   | 310   | 0     | 0     |
| RT Vol                 | 0     | 0     | 130   | 0     | 700   |
| Lane Flow Rate         | 598   | 159   | 537   | 110   | 854   |
| Geometry Grp           | 7     | 7     | 4     | 7     | 7     |
| Degree of Util (X)     | 1.357 | 0.338 | 1.077 | 0.247 | 1.639 |
| Departure Headway (Hd) | 9.865 | 9.341 | 8.921 | 8.734 | 7.488 |
| Convergence, Y/N       | Yes   | Yes   | Yes   | Yes   | Yes   |
| Cap                    | 376   | 388   | 413   | 414   | 495   |
| Service Time           | 7.565 | 7.041 | 6.921 | 6.434 | 5.188 |
| HCM Lane V/C Ratio     | 1.59  | 0.41  | 1.3   | 0.266 | 1.725 |
| HCM Control Delay      | 204.6 | 16.7  | 97.2  | 14.3  | 315.8 |
| HCM Lane LOS           | F     | C     | F     | B     | F     |
| HCM 95th-tile Q        | 24    | 1.5   | 14.9  | 1     | 45    |

HCM 2010 Signalized Intersection Summary  
 26: East Garrison Road & Reservation Road

Cumulative with Eastside Parkway, AM  
 06/11/2019



| Movement                    | EBL  | EBT  | EBR  | WBL  | WBT  | WBR  | NBL  | NBT  | NBR  | SBL | SBT | SBR |
|-----------------------------|------|------|------|------|------|------|------|------|------|-----|-----|-----|
| Lane Configurations         | ↖    | ↗    |      | ↖    | ↗    |      | ↖    |      | ↗    |     |     |     |
| Traffic Volume (veh/h)      | 0    | 620  | 80   | 150  | 1090 | 0    | 130  | 0    | 260  | 0   | 0   | 0   |
| Future Volume (veh/h)       | 0    | 620  | 80   | 150  | 1090 | 0    | 130  | 0    | 260  | 0   | 0   | 0   |
| Number                      | 5    | 2    | 12   | 1    | 6    | 16   | 3    | 8    | 18   |     |     |     |
| Initial Q (Qb), veh         | 0    | 0    | 0    | 0    | 0    | 0    | 0    | 0    | 0    |     |     |     |
| Ped-Bike Adj(A_pbT)         | 1.00 |      | 1.00 | 1.00 |      | 1.00 | 1.00 |      | 1.00 |     |     |     |
| Parking Bus, Adj            | 1.00 | 1.00 | 1.00 | 1.00 | 1.00 | 1.00 | 1.00 | 1.00 | 1.00 |     |     |     |
| Adj Sat Flow, veh/h/ln      | 1827 | 1827 | 1900 | 1863 | 1863 | 0    | 1881 | 0    | 1881 |     |     |     |
| Adj Flow Rate, veh/h        | 0    | 697  | 88   | 169  | 1225 | 0    | 146  | 0    | 220  |     |     |     |
| Adj No. of Lanes            | 1    | 2    | 0    | 1    | 2    | 0    | 1    | 0    | 1    |     |     |     |
| Peak Hour Factor            | 0.89 | 0.89 | 0.89 | 0.89 | 0.89 | 0.89 | 0.89 | 0.89 | 0.89 |     |     |     |
| Percent Heavy Veh, %        | 4    | 4    | 4    | 2    | 2    | 0    | 1    | 0    | 1    |     |     |     |
| Cap, veh/h                  | 4    | 1287 | 162  | 215  | 2164 | 0    | 315  | 0    | 281  |     |     |     |
| Arrive On Green             | 0.00 | 0.41 | 0.41 | 0.12 | 0.61 | 0.00 | 0.18 | 0.00 | 0.18 |     |     |     |
| Sat Flow, veh/h             | 1740 | 3102 | 391  | 1774 | 3632 | 0    | 1792 | 0    | 1599 |     |     |     |
| Grp Volume(v), veh/h        | 0    | 390  | 395  | 169  | 1225 | 0    | 146  | 0    | 220  |     |     |     |
| Grp Sat Flow(s),veh/h/ln    | 1740 | 1736 | 1758 | 1774 | 1770 | 0    | 1792 | 0    | 1599 |     |     |     |
| Q Serve(g_s), s             | 0.0  | 8.1  | 8.1  | 4.4  | 9.8  | 0.0  | 3.5  | 0.0  | 6.2  |     |     |     |
| Cycle Q Clear(g_c), s       | 0.0  | 8.1  | 8.1  | 4.4  | 9.8  | 0.0  | 3.5  | 0.0  | 6.2  |     |     |     |
| Prop In Lane                | 1.00 |      | 0.22 | 1.00 |      | 0.00 | 1.00 |      | 1.00 |     |     |     |
| Lane Grp Cap(c), veh/h      | 4    | 720  | 729  | 215  | 2164 | 0    | 315  | 0    | 281  |     |     |     |
| V/C Ratio(X)                | 0.00 | 0.54 | 0.54 | 0.79 | 0.57 | 0.00 | 0.46 | 0.00 | 0.78 |     |     |     |
| Avail Cap(c_a), veh/h       | 732  | 2191 | 2219 | 746  | 4467 | 0    | 1018 | 0    | 908  |     |     |     |
| HCM Platoon Ratio           | 1.00 | 1.00 | 1.00 | 1.00 | 1.00 | 1.00 | 1.00 | 1.00 | 1.00 |     |     |     |
| Upstream Filter(I)          | 0.00 | 1.00 | 1.00 | 1.00 | 1.00 | 0.00 | 1.00 | 0.00 | 1.00 |     |     |     |
| Uniform Delay (d), s/veh    | 0.0  | 10.5 | 10.5 | 20.3 | 5.5  | 0.0  | 17.6 | 0.0  | 18.7 |     |     |     |
| Incr Delay (d2), s/veh      | 0.0  | 1.2  | 1.2  | 2.4  | 0.3  | 0.0  | 0.4  | 0.0  | 1.8  |     |     |     |
| Initial Q Delay(d3),s/veh   | 0.0  | 0.0  | 0.0  | 0.0  | 0.0  | 0.0  | 0.0  | 0.0  | 0.0  |     |     |     |
| %ile BackOfQ(50%),veh/ln    | 0.0  | 4.0  | 4.1  | 2.3  | 4.7  | 0.0  | 1.7  | 0.0  | 2.9  |     |     |     |
| LnGrp Delay(d),s/veh        | 0.0  | 11.7 | 11.7 | 22.7 | 5.8  | 0.0  | 18.0 | 0.0  | 20.5 |     |     |     |
| LnGrp LOS                   |      | B    | B    | C    | A    |      | B    |      | C    |     |     |     |
| Approach Vol, veh/h         |      | 785  |      |      | 1394 |      |      | 366  |      |     |     |     |
| Approach Delay, s/veh       |      | 11.7 |      |      | 7.8  |      |      | 19.5 |      |     |     |     |
| Approach LOS                |      | B    |      |      | A    |      |      | B    |      |     |     |     |
| Timer                       | 1    | 2    | 3    | 4    | 5    | 6    | 7    | 8    |      |     |     |     |
| Assigned Phs                | 1    | 2    |      |      | 5    | 6    |      | 8    |      |     |     |     |
| Phs Duration (G+Y+Rc), s    | 9.4  | 25.1 |      |      | 0.0  | 34.5 |      | 13.1 |      |     |     |     |
| Change Period (Y+Rc), s     | 3.6  | 5.4  |      |      | 3.5  | 5.4  |      | 4.7  |      |     |     |     |
| Max Green Setting (Gmax)    | 20   | 60.0 |      |      | 20.0 | 60.0 |      | 27.0 |      |     |     |     |
| Max Q Clear Time (g_c+10)   | 4    | 10.1 |      |      | 0.0  | 11.8 |      | 8.2  |      |     |     |     |
| Green Ext Time (p_c), s     | 0.0  | 9.6  |      |      | 0.0  | 13.3 |      | 0.2  |      |     |     |     |
| <b>Intersection Summary</b> |      |      |      |      |      |      |      |      |      |     |     |     |
| HCM 2010 Ctrl Delay         |      |      |      | 10.7 |      |      |      |      |      |     |     |     |
| HCM 2010 LOS                |      |      |      | B    |      |      |      |      |      |     |     |     |
| <b>Notes</b>                |      |      |      |      |      |      |      |      |      |     |     |     |



HCM 2010 Signalized Intersection Summary  
27: Reservation Road & Watkins Gate Road

Cumulative with Eastside Parkway, AM  
06/11/2019



| Movement                     | EBL  | EBR  | NBL  | NBT  | SBT  | SBR  |   |      |
|------------------------------|------|------|------|------|------|------|---|------|
| Lane Configurations          |      |      |      |      |      |      |   |      |
| Traffic Volume (veh/h)       | 10   | 250  | 160  | 1480 | 990  | 60   |   |      |
| Future Volume (veh/h)        | 10   | 250  | 160  | 1480 | 990  | 60   |   |      |
| Number                       | 5    | 12   | 3    | 8    | 4    | 14   |   |      |
| Initial Q (Qb), veh          | 0    | 0    | 0    | 0    | 0    | 0    |   |      |
| Ped-Bike Adj(A_pbT)          | 1.00 | 1.00 | 1.00 |      |      | 1.00 |   |      |
| Parking Bus, Adj             | 1.00 | 1.00 | 1.00 | 1.00 | 1.00 | 1.00 |   |      |
| Adj Sat Flow, veh/h/ln       | 1863 | 1863 | 1863 | 1863 | 1863 | 1900 |   |      |
| Adj Flow Rate, veh/h         | 11   | 44   | 174  | 1609 | 1076 | 58   |   |      |
| Adj No. of Lanes             | 1    | 1    | 1    | 2    | 2    | 0    |   |      |
| Peak Hour Factor             | 0.92 | 0.92 | 0.92 | 0.92 | 0.92 | 0.92 |   |      |
| Percent Heavy Veh, %         | 2    | 2    | 2    | 2    | 2    | 2    |   |      |
| Cap, veh/h                   | 89   | 80   | 217  | 2583 | 1843 | 99   |   |      |
| Arrive On Green              | 0.05 | 0.05 | 0.12 | 0.73 | 0.54 | 0.54 |   |      |
| Sat Flow, veh/h              | 1774 | 1583 | 1774 | 3632 | 3509 | 184  |   |      |
| Grp Volume(v), veh/h         | 11   | 44   | 174  | 1609 | 557  | 577  |   |      |
| Grp Sat Flow(s),veh/h/ln     | 1774 | 1583 | 1774 | 1770 | 1770 | 1830 |   |      |
| Q Serve(g_s), s              | 0.4  | 1.6  | 5.6  | 13.3 | 12.5 | 12.5 |   |      |
| Cycle Q Clear(g_c), s        | 0.4  | 1.6  | 5.6  | 13.3 | 12.5 | 12.5 |   |      |
| Prop In Lane                 | 1.00 | 1.00 | 1.00 |      |      | 0.10 |   |      |
| Lane Grp Cap(c), veh/h       | 89   | 80   | 217  | 2583 | 955  | 988  |   |      |
| V/C Ratio(X)                 | 0.12 | 0.55 | 0.80 | 0.62 | 0.58 | 0.58 |   |      |
| Avail Cap(c_a), veh/h        | 555  | 496  | 540  | 4102 | 1392 | 1440 |   |      |
| HCM Platoon Ratio            | 1.00 | 1.00 | 1.00 | 1.00 | 1.00 | 1.00 |   |      |
| Upstream Filter(I)           | 1.00 | 1.00 | 1.00 | 1.00 | 1.00 | 1.00 |   |      |
| Uniform Delay (d), s/veh     | 26.8 | 27.4 | 25.2 | 4.0  | 9.1  | 9.1  |   |      |
| Incr Delay (d2), s/veh       | 0.2  | 2.2  | 2.6  | 0.4  | 0.9  | 0.9  |   |      |
| Initial Q Delay(d3),s/veh    | 0.0  | 0.0  | 0.0  | 0.0  | 0.0  | 0.0  |   |      |
| %ile BackOfQ(50%),veh/ln     | 0.2  | 0.7  | 2.9  | 6.4  | 6.3  | 6.5  |   |      |
| LnGrp Delay(d),s/veh         | 27.0 | 29.6 | 27.8 | 4.4  | 10.0 | 10.0 |   |      |
| LnGrp LOS                    | C    | C    | C    | A    | B    | B    |   |      |
| Approach Vol, veh/h          | 55   |      |      | 1783 | 1134 |      |   |      |
| Approach Delay, s/veh        | 29.1 |      |      | 6.6  | 10.0 |      |   |      |
| Approach LOS                 | C    |      |      | A    | B    |      |   |      |
| Timer                        | 1    | 2    | 3    | 4    | 5    | 6    | 7 | 8    |
| Assigned Phs                 |      | 2    | 3    | 4    |      |      |   | 8    |
| Phs Duration (G+Y+Rc), s     |      | 9.5  | 11.2 | 38.4 |      |      |   | 49.6 |
| Change Period (Y+Rc), s      |      | 6.5  | 4.0  | 6.5  |      |      |   | 6.5  |
| Max Green Setting (Gmax), s  |      | 18.5 | 18.0 | 46.5 |      |      |   | 68.5 |
| Max Q Clear Time (g_c+I1), s |      | 3.6  | 7.6  | 14.5 |      |      |   | 15.3 |
| Green Ext Time (p_c), s      |      | 0.0  | 0.0  | 12.5 |      |      |   | 27.8 |
| <b>Intersection Summary</b>  |      |      |      |      |      |      |   |      |
| HCM 2010 Ctrl Delay          |      |      | 8.4  |      |      |      |   |      |
| HCM 2010 LOS                 |      |      | A    |      |      |      |   |      |

HCM 2010 Signalized Intersection Summary  
28: Davis Road & Reservation Road

Cumulative with Eastside Parkway, AM  
06/11/2019



| Movement                     | EBL   | EBT   | EBR   | WBL  | WBT   | WBR  | NBL  | NBT  | NBR  | SBL  | SBT  | SBR  |
|------------------------------|-------|-------|-------|------|-------|------|------|------|------|------|------|------|
| Lane Configurations          |       |       |       |      |       |      |      |      |      |      |      |      |
| Traffic Volume (veh/h)       | 650   | 310   | 10    | 10   | 560   | 90   | 10   | 10   | 10   | 150  | 10   | 750  |
| Future Volume (veh/h)        | 650   | 310   | 10    | 10   | 560   | 90   | 10   | 10   | 10   | 150  | 10   | 750  |
| Number                       | 5     | 2     | 12    | 1    | 6     | 16   | 3    | 8    | 18   | 7    | 4    | 14   |
| Initial Q (Qb), veh          | 0     | 0     | 0     | 0    | 0     | 0    | 0    | 0    | 0    | 0    | 0    | 0    |
| Ped-Bike Adj(A_pbT)          | 1.00  |       | 1.00  | 1.00 |       | 1.00 | 1.00 |      | 1.00 | 1.00 |      | 1.00 |
| Parking Bus, Adj             | 1.00  | 1.00  | 1.00  | 1.00 | 1.00  | 1.00 | 1.00 | 1.00 | 1.00 | 1.00 | 1.00 | 1.00 |
| Adj Sat Flow, veh/h/ln       | 1863  | 1863  | 1900  | 1863 | 1863  | 1900 | 1900 | 1900 | 1900 | 1900 | 1845 | 1845 |
| Adj Flow Rate, veh/h         | 756   | 360   | 12    | 12   | 651   | 105  | 12   | 12   | 9    | 174  | 12   | 630  |
| Adj No. of Lanes             | 1     | 2     | 0     | 1    | 1     | 0    | 0    | 1    | 0    | 0    | 1    | 1    |
| Peak Hour Factor             | 0.86  | 0.86  | 0.86  | 0.86 | 0.86  | 0.86 | 0.86 | 0.86 | 0.86 | 0.86 | 0.86 | 0.86 |
| Percent Heavy Veh, %         | 2     | 2     | 2     | 2    | 2     | 2    | 0    | 0    | 0    | 3    | 3    | 3    |
| Cap, veh/h                   | 376   | 2185  | 73    | 19   | 664   | 107  | 17   | 17   | 12   | 350  | 24   | 665  |
| Arrive On Green              | 0.21  | 0.62  | 0.62  | 0.01 | 0.42  | 0.42 | 0.03 | 0.03 | 0.03 | 0.21 | 0.21 | 0.21 |
| Sat Flow, veh/h              | 1774  | 3496  | 116   | 1774 | 1566  | 253  | 648  | 648  | 486  | 1649 | 114  | 1568 |
| Grp Volume(v), veh/h         | 756   | 182   | 190   | 12   | 0     | 756  | 33   | 0    | 0    | 186  | 0    | 630  |
| Grp Sat Flow(s),veh/h/ln     | 1774  | 1770  | 1842  | 1774 | 0     | 1818 | 1782 | 0    | 0    | 1762 | 0    | 1568 |
| Q Serve(g_s), s              | 30.0  | 6.1   | 6.1   | 1.0  | 0.0   | 58.0 | 2.6  | 0.0  | 0.0  | 13.1 | 0.0  | 30.0 |
| Cycle Q Clear(g_c), s        | 30.0  | 6.1   | 6.1   | 1.0  | 0.0   | 58.0 | 2.6  | 0.0  | 0.0  | 13.1 | 0.0  | 30.0 |
| Prop In Lane                 | 1.00  |       | 0.06  | 1.00 |       | 0.14 | 0.36 |      | 0.27 | 0.94 |      | 1.00 |
| Lane Grp Cap(c), veh/h       | 376   | 1106  | 1151  | 19   | 0     | 771  | 46   | 0    | 0    | 374  | 0    | 665  |
| V/C Ratio(X)                 | 2.01  | 0.16  | 0.17  | 0.64 | 0.00  | 0.98 | 0.72 | 0.00 | 0.00 | 0.50 | 0.00 | 0.95 |
| Avail Cap(c_a), veh/h        | 376   | 1106  | 1151  | 376  | 0     | 771  | 378  | 0    | 0    | 374  | 0    | 665  |
| HCM Platoon Ratio            | 1.00  | 1.00  | 1.00  | 1.00 | 1.00  | 1.00 | 1.00 | 1.00 | 1.00 | 1.00 | 1.00 | 1.00 |
| Upstream Filter(I)           | 1.00  | 1.00  | 1.00  | 1.00 | 0.00  | 1.00 | 1.00 | 0.00 | 0.00 | 1.00 | 0.00 | 1.00 |
| Uniform Delay (d), s/veh     | 55.7  | 11.1  | 11.1  | 69.7 | 0.0   | 40.1 | 68.4 | 0.0  | 0.0  | 49.1 | 0.0  | 39.2 |
| Incr Delay (d2), s/veh       | 463.3 | 0.1   | 0.1   | 12.4 | 0.0   | 27.5 | 7.7  | 0.0  | 0.0  | 0.4  | 0.0  | 22.5 |
| Initial Q Delay(d3),s/veh    | 0.0   | 0.0   | 0.0   | 0.0  | 0.0   | 0.0  | 0.0  | 0.0  | 0.0  | 0.0  | 0.0  | 0.0  |
| %ile BackOfQ(50%),veh/ln     | 63.1  | 3.0   | 3.1   | 0.5  | 0.0   | 34.9 | 1.4  | 0.0  | 0.0  | 6.4  | 0.0  | 27.9 |
| LnGrp Delay(d),s/veh         | 519.0 | 11.2  | 11.2  | 82.1 | 0.0   | 67.7 | 76.1 | 0.0  | 0.0  | 49.5 | 0.0  | 61.6 |
| LnGrp LOS                    | F     | B     | B     | F    |       | E    | E    |      |      | D    |      | E    |
| Approach Vol, veh/h          |       | 1128  |       |      | 768   |      |      | 33   |      |      | 816  |      |
| Approach Delay, s/veh        |       | 351.5 |       |      | 67.9  |      |      | 76.1 |      |      | 58.9 |      |
| Approach LOS                 |       | F     |       |      | E     |      |      | E    |      |      | E    |      |
| Timer                        | 1     | 2     | 3     | 4    | 5     | 6    | 7    | 8    |      |      |      |      |
| Assigned Phs                 | 1     | 2     |       | 4    | 5     | 6    |      | 8    |      |      |      |      |
| Phs Duration (G+Y+Rc), s     | 5.4   | 93.4  |       | 35.0 | 33.8  | 65.0 |      | 7.6  |      |      |      |      |
| Change Period (Y+Rc), s      | 3.9   | 5.0   |       | 5.0  | * 3.8 | 5.0  |      | 4.0  |      |      |      |      |
| Max Green Setting (Gmax), s  | 30    | 60.0  |       | 30.0 | * 30  | 60.0 |      | 30.0 |      |      |      |      |
| Max Q Clear Time (g_c+13), s | 13.5  | 8.1   |       | 32.0 | 32.0  | 60.0 |      | 4.6  |      |      |      |      |
| Green Ext Time (p_c), s      | 0.0   | 3.3   |       | 0.0  | 0.0   | 0.0  |      | 0.0  |      |      |      |      |
| <b>Intersection Summary</b>  |       |       |       |      |       |      |      |      |      |      |      |      |
| HCM 2010 Ctrl Delay          |       |       | 181.9 |      |       |      |      |      |      |      |      |      |
| HCM 2010 LOS                 |       |       | F     |      |       |      |      |      |      |      |      |      |
| <b>Notes</b>                 |       |       |       |      |       |      |      |      |      |      |      |      |

HCM 2010 Signalized Intersection Summary  
 29: 2nd Avenue & Divarty Street

Cumulative with Eastside Parkway, AM  
 06/11/2019



| Movement                     | EBL  | EBT  | EBR  | WBL  | WBT  | WBR  | NBL  | NBT  | NBR  | SBL  | SBT  | SBR  |
|------------------------------|------|------|------|------|------|------|------|------|------|------|------|------|
| Lane Configurations          |      | ↕    |      |      | ↕    | ↕    | ↕    | ↕    |      | ↕    | ↕    |      |
| Traffic Volume (veh/h)       | 80   | 10   | 40   | 40   | 20   | 20   | 130  | 560  | 80   | 20   | 890  | 250  |
| Future Volume (veh/h)        | 80   | 10   | 40   | 40   | 20   | 20   | 130  | 560  | 80   | 20   | 890  | 250  |
| Number                       | 5    | 2    | 12   | 1    | 6    | 16   | 3    | 8    | 18   | 7    | 4    | 14   |
| Initial Q (Qb), veh          | 0    | 0    | 0    | 0    | 0    | 0    | 0    | 0    | 0    | 0    | 0    | 0    |
| Ped-Bike Adj(A_pbT)          | 1.00 |      | 1.00 | 1.00 |      | 1.00 | 1.00 |      | 1.00 | 1.00 |      | 1.00 |
| Parking Bus, Adj             | 1.00 | 1.00 | 1.00 | 1.00 | 1.00 | 1.00 | 1.00 | 1.00 | 1.00 | 1.00 | 1.00 | 1.00 |
| Adj Sat Flow, veh/h/ln       | 1900 | 1667 | 1900 | 1900 | 1900 | 1900 | 1863 | 1863 | 1900 | 1881 | 1881 | 1900 |
| Adj Flow Rate, veh/h         | 88   | 11   | 44   | 44   | 22   | 22   | 143  | 615  | 88   | 22   | 978  | 275  |
| Adj No. of Lanes             | 0    | 1    | 0    | 0    | 1    | 1    | 1    | 2    | 0    | 1    | 2    | 0    |
| Peak Hour Factor             | 0.91 | 0.91 | 0.91 | 0.91 | 0.91 | 0.91 | 0.91 | 0.91 | 0.91 | 0.91 | 0.91 | 0.91 |
| Percent Heavy Veh, %         | 14   | 14   | 14   | 0    | 0    | 0    | 2    | 2    | 2    | 1    | 1    | 1    |
| Cap, veh/h                   | 219  | 38   | 69   | 276  | 118  | 285  | 185  | 1739 | 248  | 46   | 1327 | 372  |
| Arrive On Green              | 0.18 | 0.18 | 0.18 | 0.18 | 0.18 | 0.18 | 0.10 | 0.56 | 0.56 | 0.03 | 0.48 | 0.48 |
| Sat Flow, veh/h              | 656  | 217  | 388  | 961  | 669  | 1612 | 1774 | 3109 | 444  | 1792 | 2758 | 772  |
| Grp Volume(v), veh/h         | 143  | 0    | 0    | 66   | 0    | 22   | 143  | 350  | 353  | 22   | 632  | 621  |
| Grp Sat Flow(s),veh/h/ln     | 1262 | 0    | 0    | 1630 | 0    | 1612 | 1774 | 1770 | 1783 | 1792 | 1787 | 1743 |
| Q Serve(g_s), s              | 4.3  | 0.0  | 0.0  | 0.0  | 0.0  | 0.6  | 4.5  | 6.1  | 6.2  | 0.7  | 16.1 | 16.3 |
| Cycle Q Clear(g_c), s        | 6.1  | 0.0  | 0.0  | 1.8  | 0.0  | 0.6  | 4.5  | 6.1  | 6.2  | 0.7  | 16.1 | 16.3 |
| Prop In Lane                 | 0.62 |      | 0.31 | 0.67 |      | 1.00 | 1.00 |      | 0.25 | 1.00 |      | 0.44 |
| Lane Grp Cap(c), veh/h       | 325  | 0    | 0    | 394  | 0    | 285  | 185  | 990  | 998  | 46   | 860  | 839  |
| V/C Ratio(X)                 | 0.44 | 0.00 | 0.00 | 0.17 | 0.00 | 0.08 | 0.77 | 0.35 | 0.35 | 0.48 | 0.74 | 0.74 |
| Avail Cap(c_a), veh/h        | 897  | 0    | 0    | 1059 | 0    | 996  | 360  | 1249 | 1259 | 364  | 1261 | 1230 |
| HCM Platoon Ratio            | 1.00 | 1.00 | 1.00 | 1.00 | 1.00 | 1.00 | 1.00 | 1.00 | 1.00 | 1.00 | 1.00 | 1.00 |
| Upstream Filter(I)           | 1.00 | 0.00 | 0.00 | 1.00 | 0.00 | 1.00 | 1.00 | 1.00 | 1.00 | 1.00 | 1.00 | 1.00 |
| Uniform Delay (d), s/veh     | 21.7 | 0.0  | 0.0  | 19.9 | 0.0  | 19.5 | 24.7 | 6.9  | 6.9  | 27.2 | 11.8 | 11.9 |
| Incr Delay (d2), s/veh       | 0.9  | 0.0  | 0.0  | 0.2  | 0.0  | 0.1  | 6.8  | 0.2  | 0.2  | 7.4  | 1.3  | 1.3  |
| Initial Q Delay(d3),s/veh    | 0.0  | 0.0  | 0.0  | 0.0  | 0.0  | 0.0  | 0.0  | 0.0  | 0.0  | 0.0  | 0.0  | 0.0  |
| %ile BackOfQ(50%),veh/ln     | 2.1  | 0.0  | 0.0  | 0.9  | 0.0  | 0.3  | 2.5  | 3.0  | 3.0  | 0.4  | 8.2  | 8.1  |
| LnGrp Delay(d),s/veh         | 22.7 | 0.0  | 0.0  | 20.1 | 0.0  | 19.6 | 31.5 | 7.1  | 7.1  | 34.6 | 13.1 | 13.2 |
| LnGrp LOS                    | C    |      |      | C    |      | B    | C    | A    | A    | C    | B    | B    |
| Approach Vol, veh/h          |      | 143  |      |      | 88   |      |      | 846  |      |      | 1275 |      |
| Approach Delay, s/veh        |      | 22.7 |      |      | 20.0 |      |      | 11.2 |      |      | 13.5 |      |
| Approach LOS                 |      | C    |      |      | B    |      |      | B    |      |      | B    |      |
| Timer                        | 1    | 2    | 3    | 4    | 5    | 6    | 7    | 8    |      |      |      |      |
| Assigned Phs                 |      | 2    | 3    | 4    |      | 6    | 7    | 8    |      |      |      |      |
| Phs Duration (G+Y+Rc), s     |      | 15.0 | 9.4  | 32.3 |      | 15.0 | 5.0  | 36.7 |      |      |      |      |
| Change Period (Y+Rc), s      |      | 5.0  | 3.5  | 5.0  |      | 5.0  | 3.5  | 5.0  |      |      |      |      |
| Max Green Setting (Gmax), s  |      | 35.0 | 11.5 | 40.0 |      | 35.0 | 11.5 | 40.0 |      |      |      |      |
| Max Q Clear Time (g_c+I1), s |      | 8.1  | 6.5  | 18.3 |      | 3.8  | 2.7  | 8.2  |      |      |      |      |
| Green Ext Time (p_c), s      |      | 0.8  | 0.1  | 9.0  |      | 0.4  | 0.0  | 4.7  |      |      |      |      |
| <b>Intersection Summary</b>  |      |      |      |      |      |      |      |      |      |      |      |      |
| HCM 2010 Ctrl Delay          |      |      |      | 13.5 |      |      |      |      |      |      |      |      |
| HCM 2010 LOS                 |      |      |      | B    |      |      |      |      |      |      |      |      |

| Intersection              |      |  |  |  |  |  |  |  |  |  |  |  |
|---------------------------|------|--|--|--|--|--|--|--|--|--|--|--|
| Intersection Delay, s/veh | 10.1 |  |  |  |  |  |  |  |  |  |  |  |
| Intersection LOS          | B    |  |  |  |  |  |  |  |  |  |  |  |

| Movement            | EBL  | EBT  | EBR  | WBL  | WBT  | WBR  | NBL  | NBT  | NBR  | SBL  | SBT  | SBR  |
|---------------------|------|------|------|------|------|------|------|------|------|------|------|------|
| Lane Configurations |      | ↕    |      |      | ↕    |      | ↕    | ↕    |      | ↕    | ↕    |      |
| Traffic Vol, veh/h  | 10   | 10   | 20   | 40   | 10   | 10   | 30   | 240  | 20   | 10   | 190  | 20   |
| Future Vol, veh/h   | 10   | 10   | 20   | 40   | 10   | 10   | 30   | 240  | 20   | 10   | 190  | 20   |
| Peak Hour Factor    | 0.91 | 0.91 | 0.91 | 0.91 | 0.91 | 0.91 | 0.91 | 0.91 | 0.91 | 0.91 | 0.91 | 0.91 |
| Heavy Vehicles, %   | 0    | 0    | 0    | 1    | 1    | 1    | 2    | 2    | 2    | 1    | 1    | 1    |
| Mvmt Flow           | 11   | 11   | 22   | 44   | 11   | 11   | 33   | 264  | 22   | 11   | 209  | 22   |
| Number of Lanes     | 0    | 1    | 0    | 0    | 1    | 0    | 1    | 1    | 0    | 1    | 1    | 0    |

| Approach                   | EB  | WB | NB   | SB |
|----------------------------|-----|----|------|----|
| Opposing Approach          | WB  | EB | SB   | NB |
| Opposing Lanes             | 1   | 1  | 2    | 2  |
| Conflicting Approach Left  | SB  | NB | EB   | WB |
| Conflicting Lanes Left     | 2   | 2  | 1    | 1  |
| Conflicting Approach Right | NB  | SB | WB   | EB |
| Conflicting Lanes Right    | 2   | 2  | 1    | 1  |
| HCM Control Delay          | 8.5 | 9  | 10.7 | 10 |
| HCM LOS                    | A   | A  | B    | A  |

| Lane                   | NBLn1 | NBLn2 | EBLn1 | WBLn1 | SBLn1 | SBLn2 |
|------------------------|-------|-------|-------|-------|-------|-------|
| Vol Left, %            | 100%  | 0%    | 25%   | 67%   | 100%  | 0%    |
| Vol Thru, %            | 0%    | 92%   | 25%   | 17%   | 0%    | 90%   |
| Vol Right, %           | 0%    | 8%    | 50%   | 17%   | 0%    | 10%   |
| Sign Control           | Stop  | Stop  | Stop  | Stop  | Stop  | Stop  |
| Traffic Vol by Lane    | 30    | 260   | 40    | 60    | 10    | 210   |
| LT Vol                 | 30    | 0     | 10    | 40    | 10    | 0     |
| Through Vol            | 0     | 240   | 10    | 10    | 0     | 190   |
| RT Vol                 | 0     | 20    | 20    | 10    | 0     | 20    |
| Lane Flow Rate         | 33    | 286   | 44    | 66    | 11    | 231   |
| Geometry Grp           | 7     | 7     | 2     | 2     | 7     | 7     |
| Degree of Util (X)     | 0.051 | 0.395 | 0.062 | 0.098 | 0.017 | 0.322 |
| Departure Headway (Hd) | 5.531 | 4.974 | 5.081 | 5.34  | 5.587 | 5.017 |
| Convergence, Y/N       | Yes   | Yes   | Yes   | Yes   | Yes   | Yes   |
| Cap                    | 647   | 723   | 701   | 668   | 640   | 715   |
| Service Time           | 3.271 | 2.714 | 3.141 | 3.397 | 3.329 | 2.759 |
| HCM Lane V/C Ratio     | 0.051 | 0.396 | 0.063 | 0.099 | 0.017 | 0.323 |
| HCM Control Delay      | 8.6   | 10.9  | 8.5   | 9     | 8.4   | 10.1  |
| HCM Lane LOS           | A     | B     | A     | A     | A     | B     |
| HCM 95th-tile Q        | 0.2   | 1.9   | 0.2   | 0.3   | 0.1   | 1.4   |

HCM 2010 Signalized Intersection Summary  
31: 1st Avenue & Lightfighter Drive

Cumulative with Eastside Parkway, AM  
06/11/2019



| Movement                     | EBL  | EBT  | EBR  | WBL  | WBT  | WBR  | NBL  | NBT  | NBR  | SBL  | SBT  | SBR  |
|------------------------------|------|------|------|------|------|------|------|------|------|------|------|------|
| Lane Configurations          |      | ↑↑   | ↑    | ↑    | ↑↑   |      | ↑    |      | ↑    | ↑    | ↑    | ↑    |
| Traffic Volume (veh/h)       | 0    | 1180 | 130  | 20   | 1190 | 0    | 160  | 0    | 20   | 120  | 30   | 100  |
| Future Volume (veh/h)        | 0    | 1180 | 130  | 20   | 1190 | 0    | 160  | 0    | 20   | 120  | 30   | 100  |
| Number                       | 7    | 4    | 14   | 3    | 8    | 18   | 5    | 2    | 12   | 1    | 6    | 16   |
| Initial Q (Qb), veh          | 0    | 0    | 0    | 0    | 0    | 0    | 0    | 0    | 0    | 0    | 0    | 0    |
| Ped-Bike Adj(A_pbT)          | 1.00 |      | 1.00 | 1.00 |      | 1.00 | 1.00 |      | 1.00 | 1.00 |      | 1.00 |
| Parking Bus, Adj             | 1.00 | 1.00 | 1.00 | 1.00 | 1.00 | 1.00 | 1.00 | 1.00 | 1.00 | 1.00 | 1.00 | 1.00 |
| Adj Sat Flow, veh/h/ln       | 0    | 1863 | 1863 | 1863 | 1863 | 0    | 1863 | 0    | 1863 | 1792 | 1792 | 1792 |
| Adj Flow Rate, veh/h         | 0    | 1405 | 0    | 24   | 1417 | 0    | 190  | 0    | 10   | 143  | 36   | 100  |
| Adj No. of Lanes             | 0    | 2    | 1    | 1    | 2    | 0    | 1    | 0    | 1    | 1    | 1    | 1    |
| Peak Hour Factor             | 0.84 | 0.84 | 0.84 | 0.84 | 0.84 | 0.84 | 0.84 | 0.84 | 0.84 | 0.84 | 0.84 | 0.84 |
| Percent Heavy Veh, %         | 0    | 2    | 2    | 2    | 2    | 0    | 2    | 0    | 2    | 6    | 6    | 6    |
| Cap, veh/h                   | 0    | 2198 | 983  | 27   | 2486 | 0    | 0    | 0    | 0    | 212  | 222  | 189  |
| Arrive On Green              | 0.00 | 0.62 | 0.00 | 0.02 | 0.70 | 0.00 | 0.00 | 0.00 | 0.00 | 0.12 | 0.12 | 0.12 |
| Sat Flow, veh/h              | 0    | 3632 | 1583 | 1774 | 3632 | 0    |      | 0    |      | 1707 | 1792 | 1524 |
| Grp Volume(v), veh/h         | 0    | 1405 | 0    | 24   | 1417 | 0    |      | 0.0  |      | 143  | 36   | 100  |
| Grp Sat Flow(s),veh/h/ln     | 0    | 1770 | 1583 | 1774 | 1770 | 0    |      |      |      | 1707 | 1792 | 1524 |
| Q Serve(g_s), s              | 0.0  | 13.2 | 0.0  | 0.7  | 10.5 | 0.0  |      |      |      | 4.2  | 1.0  | 3.3  |
| Cycle Q Clear(g_c), s        | 0.0  | 13.2 | 0.0  | 0.7  | 10.5 | 0.0  |      |      |      | 4.2  | 1.0  | 3.3  |
| Prop In Lane                 | 0.00 |      | 1.00 | 1.00 |      | 0.00 |      |      |      | 1.00 |      | 1.00 |
| Lane Grp Cap(c), veh/h       | 0    | 2198 | 983  | 27   | 2486 | 0    |      |      |      | 212  | 222  | 189  |
| V/C Ratio(X)                 | 0.00 | 0.64 | 0.00 | 0.88 | 0.57 | 0.00 |      |      |      | 0.68 | 0.16 | 0.53 |
| Avail Cap(c_a), veh/h        | 0    | 3004 | 1344 | 669  | 3004 | 0    |      |      |      | 805  | 845  | 718  |
| HCM Platoon Ratio            | 1.00 | 1.00 | 1.00 | 1.00 | 1.00 | 1.00 |      |      |      | 1.00 | 1.00 | 1.00 |
| Upstream Filter(I)           | 0.00 | 1.00 | 0.00 | 1.00 | 1.00 | 0.00 |      |      |      | 1.00 | 1.00 | 1.00 |
| Uniform Delay (d), s/veh     | 0.0  | 6.3  | 0.0  | 26.1 | 3.9  | 0.0  |      |      |      | 22.2 | 20.8 | 21.8 |
| Incr Delay (d2), s/veh       | 0.0  | 0.4  | 0.0  | 26.7 | 0.3  | 0.0  |      |      |      | 1.4  | 0.1  | 0.9  |
| Initial Q Delay(d3),s/veh    | 0.0  | 0.0  | 0.0  | 0.0  | 0.0  | 0.0  |      |      |      | 0.0  | 0.0  | 0.0  |
| %ile BackOfQ(50%),veh/ln     | 0.0  | 6.4  | 0.0  | 0.5  | 5.0  | 0.0  |      |      |      | 2.1  | 0.5  | 1.4  |
| LnGrp Delay(d),s/veh         | 0.0  | 6.8  | 0.0  | 52.7 | 4.2  | 0.0  |      |      |      | 23.6 | 20.9 | 22.6 |
| LnGrp LOS                    |      | A    |      | D    | A    |      |      |      |      | C    | C    | C    |
| Approach Vol, veh/h          |      | 1405 |      |      | 1441 |      |      |      |      |      | 279  |      |
| Approach Delay, s/veh        |      | 6.8  |      |      | 5.0  |      |      |      |      |      | 22.9 |      |
| Approach LOS                 |      | A    |      |      | A    |      |      |      |      |      | C    |      |
| Timer                        | 1    | 2    | 3    | 4    | 5    | 6    | 7    | 8    |      |      |      |      |
| Assigned Phs                 |      |      | 3    | 4    |      | 6    |      | 8    |      |      |      |      |
| Phs Duration (G+Y+Rc), s     |      |      | 4.3  | 37.5 |      | 11.2 |      | 41.8 |      |      |      |      |
| Change Period (Y+Rc), s      |      |      | 3.5  | 4.6  |      | 4.6  |      | 4.6  |      |      |      |      |
| Max Green Setting (Gmax), s  |      |      | 20.0 | 45.0 |      | 25.0 |      | 45.0 |      |      |      |      |
| Max Q Clear Time (g_c+I1), s |      |      | 2.7  | 15.2 |      | 6.2  |      | 12.5 |      |      |      |      |
| Green Ext Time (p_c), s      |      |      | 0.0  | 17.7 |      | 0.4  |      | 17.8 |      |      |      |      |
| <b>Intersection Summary</b>  |      |      |      |      |      |      |      |      |      |      |      |      |
| HCM 2010 Ctrl Delay          |      |      | 7.4  |      |      |      |      |      |      |      |      |      |
| HCM 2010 LOS                 |      |      | A    |      |      |      |      |      |      |      |      |      |

HCM 2010 Signalized Intersection Summary  
 32: 2nd Avenue & Lightfighter Drive

Cumulative with Eastside Parkway, AM  
 06/11/2019



| Movement                    | EBL   | EBT   | EBR  | WBL  | WBT  | WBR  | NBL  | NBT  | NBR  | SBL  | SBT  | SBR  |
|-----------------------------|-------|-------|------|------|------|------|------|------|------|------|------|------|
| Lane Configurations         |       |       |      |      |      |      |      |      |      |      |      |      |
| Traffic Volume (veh/h)      | 340   | 970   | 10   | 40   | 760  | 190  | 20   | 20   | 50   | 350  | 10   | 490  |
| Future Volume (veh/h)       | 340   | 970   | 10   | 40   | 760  | 190  | 20   | 20   | 50   | 350  | 10   | 490  |
| Number                      | 5     | 2     | 12   | 1    | 6    | 16   | 3    | 8    | 18   | 7    | 4    | 14   |
| Initial Q (Qb), veh         | 0     | 0     | 0    | 0    | 0    | 0    | 0    | 0    | 0    | 0    | 0    | 0    |
| Ped-Bike Adj(A_pbT)         | 1.00  |       | 1.00 | 1.00 |      | 1.00 | 1.00 |      | 1.00 | 1.00 |      | 1.00 |
| Parking Bus, Adj            | 1.00  | 1.00  | 1.00 | 1.00 | 1.00 | 1.00 | 1.00 | 1.00 | 1.00 | 1.00 | 1.00 | 1.00 |
| Adj Sat Flow, veh/h/ln      | 1863  | 1863  | 1900 | 1827 | 1827 | 1900 | 1900 | 1900 | 1900 | 1881 | 1881 | 1881 |
| Adj Flow Rate, veh/h        | 378   | 1078  | 11   | 44   | 844  | 202  | 22   | 22   | 55   | 389  | 11   | 268  |
| Adj No. of Lanes            | 1     | 2     | 0    | 1    | 2    | 0    | 0    | 1    | 0    | 1    | 1    | 1    |
| Peak Hour Factor            | 0.90  | 0.90  | 0.90 | 0.90 | 0.90 | 0.90 | 0.90 | 0.90 | 0.90 | 0.90 | 0.90 | 0.90 |
| Percent Heavy Veh, %        | 2     | 2     | 2    | 4    | 4    | 4    | 0    | 0    | 0    | 1    | 1    | 1    |
| Cap, veh/h                  | 220   | 1909  | 19   | 56   | 1223 | 293  | 123  | 132  | 264  | 489  | 572  | 486  |
| Arrive On Green             | 0.12  | 0.53  | 0.53 | 0.03 | 0.44 | 0.44 | 0.30 | 0.30 | 0.30 | 0.30 | 0.30 | 0.30 |
| Sat Flow, veh/h             | 1774  | 3589  | 37   | 1740 | 2780 | 665  | 261  | 434  | 869  | 1330 | 1881 | 1599 |
| Grp Volume(v), veh/h        | 378   | 531   | 558  | 44   | 527  | 519  | 99   | 0    | 0    | 389  | 11   | 268  |
| Grp Sat Flow(s),veh/h/ln    | 1774  | 1770  | 1856 | 1740 | 1736 | 1710 | 1564 | 0    | 0    | 1330 | 1881 | 1599 |
| Q Serve(g_s), s             | 12.4  | 20.1  | 20.1 | 2.5  | 24.4 | 24.4 | 0.0  | 0.0  | 0.0  | 23.2 | 0.4  | 14.0 |
| Cycle Q Clear(g_c), s       | 12.4  | 20.1  | 20.1 | 2.5  | 24.4 | 24.4 | 4.2  | 0.0  | 0.0  | 27.4 | 0.4  | 14.0 |
| Prop In Lane                | 1.00  |       | 0.02 | 1.00 |      | 0.39 | 0.22 |      | 0.56 | 1.00 |      | 1.00 |
| Lane Grp Cap(c), veh/h      | 220   | 941   | 988  | 56   | 763  | 752  | 520  | 0    | 0    | 489  | 572  | 486  |
| V/C Ratio(X)                | 1.72  | 0.56  | 0.56 | 0.79 | 0.69 | 0.69 | 0.19 | 0.00 | 0.00 | 0.79 | 0.02 | 0.55 |
| Avail Cap(c_a), veh/h       | 220   | 941   | 988  | 216  | 763  | 752  | 671  | 0    | 0    | 622  | 760  | 646  |
| HCM Platoon Ratio           | 1.00  | 1.00  | 1.00 | 1.00 | 1.00 | 1.00 | 1.00 | 1.00 | 1.00 | 1.00 | 1.00 | 1.00 |
| Upstream Filter(I)          | 0.57  | 0.57  | 0.57 | 0.09 | 0.09 | 0.09 | 1.00 | 0.00 | 0.00 | 0.57 | 0.57 | 0.57 |
| Uniform Delay (d), s/veh    | 43.8  | 15.7  | 15.7 | 48.1 | 22.5 | 22.5 | 25.7 | 0.0  | 0.0  | 33.4 | 24.4 | 29.1 |
| Incr Delay (d2), s/veh      | 334.0 | 1.4   | 1.3  | 0.9  | 0.5  | 0.5  | 0.1  | 0.0  | 0.0  | 2.5  | 0.0  | 0.2  |
| Initial Q Delay(d3),s/veh   | 0.0   | 0.0   | 0.0  | 0.0  | 0.0  | 0.0  | 0.0  | 0.0  | 0.0  | 0.0  | 0.0  | 0.0  |
| %ile BackOfQ(50%),veh/ln    | 26.5  | 10.1  | 10.6 | 1.2  | 11.8 | 11.6 | 2.0  | 0.0  | 0.0  | 10.7 | 0.2  | 6.2  |
| LnGrp Delay(d),s/veh        | 377.8 | 17.1  | 17.0 | 49.0 | 23.0 | 23.0 | 25.7 | 0.0  | 0.0  | 35.8 | 24.4 | 29.3 |
| LnGrp LOS                   | F     | B     | B    | D    | C    | C    | C    |      |      | D    | C    | C    |
| Approach Vol, veh/h         |       | 1467  |      |      | 1090 |      |      | 99   |      |      | 668  |      |
| Approach Delay, s/veh       |       | 110.0 |      |      | 24.0 |      |      | 25.7 |      |      | 33.0 |      |
| Approach LOS                |       | F     |      |      | C    |      |      | C    |      |      | C    |      |
| Timer                       | 1     | 2     | 3    | 4    | 5    | 6    | 7    | 8    |      |      |      |      |
| Assigned Phs                | 1     | 2     |      | 4    | 5    | 6    |      | 8    |      |      |      |      |
| Phs Duration (G+Y+Rc), s    | 7.2   | 57.8  |      | 35.0 | 16.4 | 48.6 |      | 35.0 |      |      |      |      |
| Change Period (Y+Rc), s     | 4.0   | 4.6   |      | 4.6  | 4.0  | 4.6  |      | 4.6  |      |      |      |      |
| Max Green Setting (Gmax), s | 2.4   | 34.0  |      | 40.4 | 12.4 | 24.4 |      | 40.4 |      |      |      |      |
| Max Q Clear Time (g_c+1), s | 14.5  | 22.1  |      | 29.4 | 14.4 | 26.4 |      | 6.2  |      |      |      |      |
| Green Ext Time (p_c), s     | 0.0   | 3.5   |      | 1.0  | 0.0  | 0.0  |      | 0.4  |      |      |      |      |
| <b>Intersection Summary</b> |       |       |      |      |      |      |      |      |      |      |      |      |
| HCM 2010 Ctrl Delay         |       |       | 63.8 |      |      |      |      |      |      |      |      |      |
| HCM 2010 LOS                |       |       | E    |      |      |      |      |      |      |      |      |      |

HCM 2010 Signalized Intersection Summary  
 33: General Jim Moore Boulevard & Lightfighter Drive

Cumulative with Eastside Parkway, AM  
 06/11/2019



| Movement                    | EBL  | EBT  | EBR  | WBL  | WBT  | WBR  | NBL   | NBT   | NBR  | SBL  | SBT  | SBR  |
|-----------------------------|------|------|------|------|------|------|-------|-------|------|------|------|------|
| Lane Configurations         |      |      |      |      |      |      |       |       |      |      |      |      |
| Traffic Volume (veh/h)      | 80   | 280  | 710  | 20   | 210  | 60   | 760   | 90    | 10   | 30   | 80   | 70   |
| Future Volume (veh/h)       | 80   | 280  | 710  | 20   | 210  | 60   | 760   | 90    | 10   | 30   | 80   | 70   |
| Number                      | 3    | 8    | 18   | 7    | 4    | 14   | 1     | 6     | 16   | 5    | 2    | 12   |
| Initial Q (Qb), veh         | 0    | 0    | 0    | 0    | 0    | 0    | 0     | 0     | 0    | 0    | 0    | 0    |
| Ped-Bike Adj(A_pbT)         | 1.00 |      | 1.00 | 1.00 |      | 1.00 | 1.00  |       | 1.00 | 1.00 |      | 1.00 |
| Parking Bus, Adj            | 1.00 | 1.00 | 1.00 | 1.00 | 1.00 | 1.00 | 1.00  | 1.00  | 1.00 | 1.00 | 1.00 | 1.00 |
| Adj Sat Flow, veh/h/ln      | 1863 | 1863 | 1863 | 1792 | 1792 | 1900 | 1881  | 1881  | 1900 | 1863 | 1863 | 1900 |
| Adj Flow Rate, veh/h        | 90   | 315  | 0    | 22   | 236  | 65   | 854   | 101   | 10   | 34   | 90   | 79   |
| Adj No. of Lanes            | 1    | 1    | 1    | 1    | 1    | 0    | 2     | 1     | 0    | 1    | 2    | 0    |
| Peak Hour Factor            | 0.89 | 0.89 | 0.89 | 0.89 | 0.89 | 0.89 | 0.89  | 0.89  | 0.89 | 0.89 | 0.89 | 0.89 |
| Percent Heavy Veh, %        | 2    | 2    | 2    | 6    | 6    | 6    | 1     | 1     | 1    | 2    | 2    | 2    |
| Cap, veh/h                  | 118  | 538  | 458  | 36   | 330  | 91   | 696   | 504   | 50   | 53   | 242  | 192  |
| Arrive On Green             | 0.07 | 0.29 | 0.00 | 0.02 | 0.24 | 0.24 | 0.20  | 0.30  | 0.30 | 0.03 | 0.13 | 0.13 |
| Sat Flow, veh/h             | 1774 | 1863 | 1583 | 1707 | 1352 | 372  | 3476  | 1685  | 167  | 1774 | 1872 | 1489 |
| Grp Volume(v), veh/h        | 90   | 315  | 0    | 22   | 0    | 301  | 854   | 0     | 111  | 34   | 85   | 84   |
| Grp Sat Flow(s),veh/h/ln    | 1774 | 1863 | 1583 | 1707 | 0    | 1725 | 1738  | 0     | 1851 | 1774 | 1770 | 1592 |
| Q Serve(g_s), s             | 2.5  | 7.2  | 0.0  | 0.6  | 0.0  | 8.0  | 10.0  | 0.0   | 2.2  | 0.9  | 2.2  | 2.4  |
| Cycle Q Clear(g_c), s       | 2.5  | 7.2  | 0.0  | 0.6  | 0.0  | 8.0  | 10.0  | 0.0   | 2.2  | 0.9  | 2.2  | 2.4  |
| Prop In Lane                | 1.00 |      | 1.00 | 1.00 |      | 0.22 | 1.00  |       | 0.09 | 1.00 |      | 0.94 |
| Lane Grp Cap(c), veh/h      | 118  | 538  | 458  | 36   | 0    | 420  | 696   | 0     | 554  | 53   | 228  | 206  |
| V/C Ratio(X)                | 0.76 | 0.59 | 0.00 | 0.61 | 0.00 | 0.72 | 1.23  | 0.00  | 0.20 | 0.64 | 0.37 | 0.41 |
| Avail Cap(c_a), veh/h       | 711  | 1119 | 951  | 684  | 0    | 1036 | 696   | 0     | 1112 | 533  | 1063 | 956  |
| HCM Platoon Ratio           | 1.00 | 1.00 | 1.00 | 1.00 | 1.00 | 1.00 | 1.00  | 1.00  | 1.00 | 1.00 | 1.00 | 1.00 |
| Upstream Filter(I)          | 1.00 | 1.00 | 0.00 | 1.00 | 0.00 | 1.00 | 1.00  | 0.00  | 1.00 | 1.00 | 1.00 | 1.00 |
| Uniform Delay (d), s/veh    | 22.9 | 15.2 | 0.0  | 24.2 | 0.0  | 17.3 | 20.0  | 0.0   | 13.0 | 23.9 | 19.9 | 20.0 |
| Incr Delay (d2), s/veh      | 9.8  | 1.2  | 0.0  | 6.1  | 0.0  | 2.8  | 114.5 | 0.0   | 0.4  | 4.6  | 1.2  | 1.6  |
| Initial Q Delay(d3),s/veh   | 0.0  | 0.0  | 0.0  | 0.0  | 0.0  | 0.0  | 0.0   | 0.0   | 0.0  | 0.0  | 0.0  | 0.0  |
| %ile BackOfQ(50%),veh/ln    | 1.5  | 3.9  | 0.0  | 0.4  | 0.0  | 4.1  | 15.8  | 0.0   | 1.2  | 0.5  | 1.1  | 1.1  |
| LnGrp Delay(d),s/veh        | 32.7 | 16.4 | 0.0  | 30.3 | 0.0  | 20.1 | 134.4 | 0.0   | 13.4 | 28.5 | 21.1 | 21.6 |
| LnGrp LOS                   | C    | B    |      | C    |      | C    | F     |       | B    | C    | C    | C    |
| Approach Vol, veh/h         |      | 405  |      |      | 323  |      |       | 965   |      |      | 203  |      |
| Approach Delay, s/veh       |      | 20.0 |      |      | 20.8 |      |       | 120.5 |      |      | 22.5 |      |
| Approach LOS                |      | C    |      |      | C    |      |       | F     |      |      | C    |      |
| Timer                       | 1    | 2    | 3    | 4    | 5    | 6    | 7     | 8     |      |      |      |      |
| Assigned Phs                | 1    | 2    | 3    | 4    | 5    | 6    | 7     | 8     |      |      |      |      |
| Phs Duration (G+Y+Rc), s    | 4.5  | 10.9 | 7.8  | 16.7 | 6.0  | 19.4 | 5.6   | 18.9  |      |      |      |      |
| Change Period (Y+Rc), s     | 4.5  | 4.5  | 4.5  | 4.5  | 4.5  | 4.5  | 4.5   | 4.5   |      |      |      |      |
| Max Green Setting (Gmax), s | 30.0 | 30.0 | 20.0 | 30.0 | 15.0 | 30.0 | 20.0  | 30.0  |      |      |      |      |
| Max Q Clear Time (g_c+1), s | 4.4  | 4.5  | 10.0 | 2.9  | 4.2  | 2.6  | 9.2   |       |      |      |      |      |
| Green Ext Time (p_c), s     | 0.0  | 1.1  | 0.2  | 2.2  | 0.0  | 1.0  | 0.0   | 2.0   |      |      |      |      |
| <b>Intersection Summary</b> |      |      |      |      |      |      |       |       |      |      |      |      |
| HCM 2010 Ctrl Delay         |      |      |      | 71.6 |      |      |       |       |      |      |      |      |
| HCM 2010 LOS                |      |      |      | E    |      |      |       |       |      |      |      |      |

**Intersection**

Intersection Delay, s/veh 13.1  
 Intersection LOS B

| Movement            | WBL  | WBR  | NBT  | NBR  | SBL  | SBT  |
|---------------------|------|------|------|------|------|------|
| Lane Configurations |      |      |      |      |      |      |
| Traffic Vol, veh/h  | 30   | 240  | 50   | 20   | 270  | 50   |
| Future Vol, veh/h   | 30   | 240  | 50   | 20   | 270  | 50   |
| Peak Hour Factor    | 0.77 | 0.77 | 0.77 | 0.77 | 0.77 | 0.77 |
| Heavy Vehicles, %   | 4    | 4    | 3    | 3    | 2    | 2    |
| Mvmt Flow           | 39   | 312  | 65   | 26   | 351  | 65   |
| Number of Lanes     | 1    | 0    | 1    | 0    | 0    | 1    |

| Approach                      | WB   | NB  | SB   |
|-------------------------------|------|-----|------|
| Opposing Approach             |      | SB  | NB   |
| Opposing Lanes                | 0    | 1   | 1    |
| Conflicting Approach Left NB  |      |     | WB   |
| Conflicting Lanes Left        | 1    | 0   | 1    |
| Conflicting Approach Right SB |      | WB  |      |
| Conflicting Lanes Right       | 1    | 1   | 0    |
| HCM Control Delay             | 11.8 | 9.1 | 15.1 |
| HCM LOS                       | B    | A   | C    |

| Lane                   | NBLn1 | WBLn1 | SBLn1 |
|------------------------|-------|-------|-------|
| Vol Left, %            | 0%    | 11%   | 84%   |
| Vol Thru, %            | 71%   | 0%    | 16%   |
| Vol Right, %           | 29%   | 89%   | 0%    |
| Sign Control           | Stop  | Stop  | Stop  |
| Traffic Vol by Lane    | 70    | 270   | 320   |
| LT Vol                 | 0     | 30    | 270   |
| Through Vol            | 50    | 0     | 50    |
| RT Vol                 | 20    | 240   | 0     |
| Lane Flow Rate         | 91    | 351   | 416   |
| Geometry Grp           | 1     | 1     | 1     |
| Degree of Util (X)     | 0.133 | 0.46  | 0.583 |
| Departure Headway (Hd) | 5.285 | 4.723 | 5.054 |
| Convergence, Y/N       | Yes   | Yes   | Yes   |
| Cap                    | 683   | 757   | 706   |
| Service Time           | 3.285 | 2.797 | 3.149 |
| HCM Lane V/C Ratio     | 0.133 | 0.464 | 0.589 |
| HCM Control Delay      | 9.1   | 11.8  | 15.1  |
| HCM Lane LOS           | A     | B     | C     |
| HCM 95th-tile Q        | 0.5   | 2.4   | 3.8   |



| Intersection             |      |      |      |      |      |      |
|--------------------------|------|------|------|------|------|------|
| Int Delay, s/veh         | 1.6  |      |      |      |      |      |
| Movement                 | EBT  | EBR  | WBL  | WBT  | NBL  | NBR  |
| Lane Configurations      |      |      |      |      |      |      |
| Traffic Vol, veh/h       | 260  | 30   | 20   | 250  | 30   | 30   |
| Future Vol, veh/h        | 260  | 30   | 20   | 250  | 30   | 30   |
| Conflicting Peds, #/hr   | 0    | 0    | 0    | 0    | 0    | 0    |
| Sign Control             | Free | Free | Free | Free | Stop | Stop |
| RT Channelized           | -    | None | -    | None | -    | None |
| Storage Length           | -    | -    | -    | -    | 0    | -    |
| Veh in Median Storage, # | 0    | -    | -    | 0    | 0    | -    |
| Grade, %                 | 0    | -    | -    | 0    | 0    | -    |
| Peak Hour Factor         | 78   | 78   | 78   | 78   | 78   | 78   |
| Heavy Vehicles, %        | 5    | 5    | 4    | 4    | 0    | 0    |
| Mvmt Flow                | 333  | 38   | 26   | 321  | 38   | 38   |

| Major/Minor          | Major1 | Major2 | Minor1 | Minor2 | Minor3 |
|----------------------|--------|--------|--------|--------|--------|
| Conflicting Flow All | 0      | 0      | 371    | 0      | 725    |
| Stage 1              | -      | -      | -      | -      | 352    |
| Stage 2              | -      | -      | -      | -      | 373    |
| Critical Hdwy        | -      | -      | 4.14   | -      | 6.4    |
| Critical Hdwy Stg 1  | -      | -      | -      | -      | 5.4    |
| Critical Hdwy Stg 2  | -      | -      | -      | -      | 5.4    |
| Follow-up Hdwy       | -      | -      | 2.236  | -      | 3.5    |
| Pot Cap-1 Maneuver   | -      | -      | 1177   | -      | 395    |
| Stage 1              | -      | -      | -      | -      | 716    |
| Stage 2              | -      | -      | -      | -      | 701    |
| Platoon blocked, %   | -      | -      | -      | -      | -      |
| Mov Cap-1 Maneuver   | -      | -      | 1177   | -      | 384    |
| Mov Cap-2 Maneuver   | -      | -      | -      | -      | 384    |
| Stage 1              | -      | -      | -      | -      | 697    |
| Stage 2              | -      | -      | -      | -      | 701    |

| Approach             | EB | WB  | NB   |
|----------------------|----|-----|------|
| HCM Control Delay, s | 0  | 0.6 | 13.6 |
| HCM LOS              |    |     | B    |

| Minor Lane/Major Mvmt | NBLn1 | EBT | EBR | WBL   | WBT |
|-----------------------|-------|-----|-----|-------|-----|
| Capacity (veh/h)      | 495   | -   | -   | 1177  | -   |
| HCM Lane V/C Ratio    | 0.155 | -   | -   | 0.022 | -   |
| HCM Control Delay (s) | 13.6  | -   | -   | 8.1   | 0   |
| HCM Lane LOS          | B     | -   | -   | A     | A   |
| HCM 95th %tile Q(veh) | 0.5   | -   | -   | 0.1   | -   |

| Intersection              |      |
|---------------------------|------|
| Intersection Delay, s/veh | 12.7 |
| Intersection LOS          | B    |

| Movement            | EBL  | EBT  | EBR  | WBL  | WBT  | WBR  | NBL  | NBT  | NBR  | SBL  | SBT  | SBR  |
|---------------------|------|------|------|------|------|------|------|------|------|------|------|------|
| Lane Configurations |      | ↕    |      |      | ↕    |      |      | ↕    |      |      | ↕    |      |
| Traffic Vol, veh/h  | 10   | 250  | 30   | 10   | 190  | 10   | 50   | 70   | 20   | 10   | 50   | 30   |
| Future Vol, veh/h   | 10   | 250  | 30   | 10   | 190  | 10   | 50   | 70   | 20   | 10   | 50   | 30   |
| Peak Hour Factor    | 0.79 | 0.79 | 0.79 | 0.79 | 0.79 | 0.79 | 0.79 | 0.79 | 0.79 | 0.79 | 0.79 | 0.79 |
| Heavy Vehicles, %   | 6    | 6    | 6    | 4    | 4    | 4    | 20   | 20   | 20   | 2    | 2    | 2    |
| Mvmt Flow           | 13   | 316  | 38   | 13   | 241  | 13   | 63   | 89   | 25   | 13   | 63   | 38   |
| Number of Lanes     | 0    | 1    | 0    | 0    | 1    | 0    | 0    | 1    | 0    | 0    | 1    | 0    |

| Approach                   | EB   | WB | NB   | SB   |
|----------------------------|------|----|------|------|
| Opposing Approach          | WB   | EB | SB   | NB   |
| Opposing Lanes             | 1    | 1  | 1    | 1    |
| Conflicting Approach Left  | SB   | NB | EB   | WB   |
| Conflicting Lanes Left     | 1    | 1  | 1    | 1    |
| Conflicting Approach Right | NB   | SB | WB   | EB   |
| Conflicting Lanes Right    | 1    | 1  | 1    | 1    |
| HCM Control Delay          | 14.3 | 12 | 11.8 | 10.2 |
| HCM LOS                    | B    | B  | B    | B    |

| Lane                   | NBLn1 | EBLn1 | WBLn1 | SBLn1 |
|------------------------|-------|-------|-------|-------|
| Vol Left, %            | 36%   | 3%    | 5%    | 11%   |
| Vol Thru, %            | 50%   | 86%   | 90%   | 56%   |
| Vol Right, %           | 14%   | 10%   | 5%    | 33%   |
| Sign Control           | Stop  | Stop  | Stop  | Stop  |
| Traffic Vol by Lane    | 140   | 290   | 210   | 90    |
| LT Vol                 | 50    | 10    | 10    | 10    |
| Through Vol            | 70    | 250   | 190   | 50    |
| RT Vol                 | 20    | 30    | 10    | 30    |
| Lane Flow Rate         | 177   | 367   | 266   | 114   |
| Geometry Grp           | 1     | 1     | 1     | 1     |
| Degree of Util (X)     | 0.302 | 0.536 | 0.399 | 0.184 |
| Departure Headway (Hd) | 6.129 | 5.257 | 5.405 | 5.814 |
| Convergence, Y/N       | Yes   | Yes   | Yes   | Yes   |
| Cap                    | 585   | 686   | 665   | 614   |
| Service Time           | 4.183 | 3.3   | 3.452 | 3.875 |
| HCM Lane V/C Ratio     | 0.303 | 0.535 | 0.4   | 0.186 |
| HCM Control Delay      | 11.8  | 14.3  | 12    | 10.2  |
| HCM Lane LOS           | B     | B     | B     | B     |
| HCM 95th-tile Q        | 1.3   | 3.2   | 1.9   | 0.7   |

| Intersection             |      |      |      |      |      |      |      |      |      |      |      |      |
|--------------------------|------|------|------|------|------|------|------|------|------|------|------|------|
| Int Delay, s/veh         | 12   |      |      |      |      |      |      |      |      |      |      |      |
| Movement                 | EBL  | EBT  | EBR  | WBL  | WBT  | WBR  | NBL  | NBT  | NBR  | SBL  | SBT  | SBR  |
| Lane Configurations      |      | ↕    |      |      | ↕    |      |      | ↕    |      |      | ↕    |      |
| Traffic Vol, veh/h       | 70   | 110  | 90   | 10   | 110  | 20   | 50   | 60   | 20   | 10   | 60   | 40   |
| Future Vol, veh/h        | 70   | 110  | 90   | 10   | 110  | 20   | 50   | 60   | 20   | 10   | 60   | 40   |
| Conflicting Peds, #/hr   | 0    | 0    | 0    | 0    | 0    | 0    | 0    | 0    | 1    | 1    | 0    | 0    |
| Sign Control             | Stop | Stop | Stop | Stop | Stop | Stop | Free | Free | Free | Free | Free | Free |
| RT Channelized           | -    | -    | None | -    | -    | None | -    | -    | None | -    | -    | None |
| Storage Length           | -    | -    | -    | -    | -    | -    | -    | -    | -    | -    | -    | -    |
| Veh in Median Storage, # | -    | 0    | -    | -    | 0    | -    | -    | 0    | -    | -    | 0    | -    |
| Grade, %                 | -    | 0    | -    | -    | 0    | -    | -    | 0    | -    | -    | 0    | -    |
| Peak Hour Factor         | 82   | 82   | 82   | 82   | 82   | 82   | 82   | 82   | 82   | 82   | 82   | 82   |
| Heavy Vehicles, %        | 12   | 12   | 12   | 0    | 0    | 0    | 10   | 10   | 10   | 10   | 10   | 10   |
| Mvmt Flow                | 85   | 134  | 110  | 12   | 134  | 24   | 61   | 73   | 24   | 12   | 73   | 49   |

| Major/Minor          | Minor2 |       | Minor1 |     | Major1 |     |      | Major2 |   |      |   |   |
|----------------------|--------|-------|--------|-----|--------|-----|------|--------|---|------|---|---|
| Conflicting Flow All | 408    | 342   | 98     | 452 | 354    | 86  | 122  | 0      | 0 | 98   | 0 | 0 |
| Stage 1              | 122    | 122   | -      | 208 | 208    | -   | -    | -      | - | -    | - | - |
| Stage 2              | 286    | 220   | -      | 244 | 146    | -   | -    | -      | - | -    | - | - |
| Critical Hdwy        | 7.22   | 6.62  | 6.32   | 7.1 | 6.5    | 6.2 | 4.2  | -      | - | 4.2  | - | - |
| Critical Hdwy Stg 1  | 6.22   | 5.62  | -      | 6.1 | 5.5    | -   | -    | -      | - | -    | - | - |
| Critical Hdwy Stg 2  | 6.22   | 5.62  | -      | 6.1 | 5.5    | -   | -    | -      | - | -    | - | - |
| Follow-up Hdwy       | 3.608  | 4.108 | 3.408  | 3.5 | 4      | 3.3 | 2.29 | -      | - | 2.29 | - | - |
| Pot Cap-1 Maneuver   | 536    | 564   | 931    | 521 | 574    | 978 | 1417 | -      | - | 1446 | - | - |
| Stage 1              | 859    | 776   | -      | 799 | 734    | -   | -    | -      | - | -    | - | - |
| Stage 2              | 700    | 703   | -      | 764 | 780    | -   | -    | -      | - | -    | - | - |
| Platoon blocked, %   |        |       |        |     |        |     |      | -      | - | -    | - | - |
| Mov Cap-1 Maneuver   | 406    | 532   | 931    | 355 | 542    | 977 | 1417 | -      | - | 1445 | - | - |
| Mov Cap-2 Maneuver   | 406    | 532   | -      | 355 | 542    | -   | -    | -      | - | -    | - | - |
| Stage 1              | 819    | 769   | -      | 761 | 700    | -   | -    | -      | - | -    | - | - |
| Stage 2              | 526    | 670   | -      | 551 | 773    | -   | -    | -      | - | -    | - | - |

| Approach             | EB   |  | WB   |  | NB  |  | SB  |  |
|----------------------|------|--|------|--|-----|--|-----|--|
| HCM Control Delay, s | 19.8 |  | 14.3 |  | 2.9 |  | 0.7 |  |
| HCM LOS              | C    |  | B    |  |     |  |     |  |

| Minor Lane/Major Mvmt | NBL   | NBT | NBR | EBLn1 | WBLn1 | SBL   | SBT | SBR |
|-----------------------|-------|-----|-----|-------|-------|-------|-----|-----|
| Capacity (veh/h)      | 1417  | -   | -   | 567   | 556   | 1445  | -   | -   |
| HCM Lane V/C Ratio    | 0.043 | -   | -   | 0.581 | 0.307 | 0.008 | -   | -   |
| HCM Control Delay (s) | 7.7   | 0   | -   | 19.8  | 14.3  | 7.5   | 0   | -   |
| HCM Lane LOS          | A     | A   | -   | C     | B     | A     | A   | -   |
| HCM 95th %tile Q(veh) | 0.1   | -   | -   | 3.7   | 1.3   | 0     | -   | -   |

| Intersection             |      |      |      |      |      |      |
|--------------------------|------|------|------|------|------|------|
| Int Delay, s/veh         | 3.7  |      |      |      |      |      |
| Movement                 | EBL  | EBR  | NBL  | NBT  | SBT  | SBR  |
| Lane Configurations      | T    |      | T    |      | T    |      |
| Traffic Vol, veh/h       | 130  | 10   | 10   | 220  | 370  | 130  |
| Future Vol, veh/h        | 130  | 10   | 10   | 220  | 370  | 130  |
| Conflicting Peds, #/hr   | 0    | 0    | 0    | 0    | 0    | 0    |
| Sign Control             | Stop | Stop | Free | Free | Free | Free |
| RT Channelized           | -    | None | -    | None | -    | None |
| Storage Length           | 0    | -    | -    | -    | -    | -    |
| Veh in Median Storage, # | 0    | -    | -    | 0    | 0    | -    |
| Grade, %                 | 0    | -    | -    | 0    | 0    | -    |
| Peak Hour Factor         | 89   | 89   | 89   | 89   | 89   | 89   |
| Heavy Vehicles, %        | 13   | 13   | 2    | 2    | 0    | 0    |
| Mvmt Flow                | 146  | 11   | 11   | 247  | 416  | 146  |























| Major/Minor          | Minor2 | Major1 |       | Major2 |   |
|----------------------|--------|--------|-------|--------|---|
| Conflicting Flow All | 758    | 489    | 562   | 0      | 0 |
| Stage 1              | 489    | -      | -     | -      | - |
| Stage 2              | 269    | -      | -     | -      | - |
| Critical Hdwy        | 6.53   | 6.33   | 4.12  | -      | - |
| Critical Hdwy Stg 1  | 5.53   | -      | -     | -      | - |
| Critical Hdwy Stg 2  | 5.53   | -      | -     | -      | - |
| Follow-up Hdwy       | 3.617  | 3.417  | 2.218 | -      | - |
| Pot Cap-1 Maneuver   | 360    | 557    | 1009  | -      | - |
| Stage 1              | 594    | -      | -     | -      | - |
| Stage 2              | 751    | -      | -     | -      | - |
| Platoon blocked, %   |        |        |       | -      | - |
| Mov Cap-1 Maneuver   | 355    | 557    | 1009  | -      | - |
| Mov Cap-2 Maneuver   | 355    | -      | -     | -      | - |
| Stage 1              | 586    | -      | -     | -      | - |
| Stage 2              | 751    | -      | -     | -      | - |

| Approach             | EB   | NB  | SB |
|----------------------|------|-----|----|
| HCM Control Delay, s | 22.2 | 0.4 | 0  |
| HCM LOS              | C    |     |    |

| Minor Lane/Major Mvmt | NBL   | NBT | EBLn1 | SBT | SBR |
|-----------------------|-------|-----|-------|-----|-----|
| Capacity (veh/h)      | 1009  | -   | 364   | -   | -   |
| HCM Lane V/C Ratio    | 0.011 | -   | 0.432 | -   | -   |
| HCM Control Delay (s) | 8.6   | 0   | 22.2  | -   | -   |
| HCM Lane LOS          | A     | A   | C     | -   | -   |
| HCM 95th %tile Q(veh) | 0     | -   | 2.1   | -   | -   |

HCM 2010 Signalized Intersection Summary  
 39: General Jim Moore Boulevard & Gigling Road

Cumulative with Eastside Parkway, AM  
 06/11/2019

|                              |  |  |  |  |  |  |  |  |  |  |  |  |
|------------------------------|---|---|---|---|---|---|--|---|---|---|---|---|
| Movement                     | EBL   | EBT   | EBR   | WBL   | WBT   | WBR   | NBL  | NBT   | NBR   | SBL   | SBT   | SBR   |
| Lane Configurations          |  |  |   |  |  |  |  |  |  |  |  |  |
| Traffic Volume (veh/h)       | 30  | 100   | 80  | 430   | 40  | 450   | 50   | 350   | 270   | 330   | 480   | 50  |
| Future Volume (veh/h)        | 30  | 100   | 80  | 430   | 40  | 450   | 50   | 350   | 270   | 330   | 480   | 50  |
| Number                       | 3   | 8   | 18  | 7   | 4   | 14  | 1  | 6   | 16  | 5   | 2   | 12  |
| Initial Q (Qb), veh          | 0   | 0   | 0   | 0   | 0   | 0   | 0  | 0   | 0   | 0   | 0   | 0   |
| Ped-Bike Adj(A_pbT)          | 1.00  |   | 1.00  | 1.00  |   | 1.00  | 1.00   |   | 1.00  | 1.00  |   | 1.00  |
| Parking Bus, Adj             | 1.00  | 1.00  | 1.00  | 1.00  | 1.00  | 1.00  | 1.00   | 1.00  | 1.00  | 1.00  | 1.00  | 1.00  |
| Adj Sat Flow, veh/h/ln       | 1810  | 1810  | 1900  | 1863  | 1863  | 1863  | 1881   | 1881  | 1881  | 1863  | 1863  | 1863  |
| Adj Flow Rate, veh/h         | 34  | 115   | 60  | 494   | 46  | 0   | 57   | 402   | 0   | 379   | 552   | 0   |
| Adj No. of Lanes             | 1   | 2   | 0   | 1   | 2   | 1   | 1  | 2   | 1   | 1   | 2   | 1   |
| Peak Hour Factor             | 0.87  | 0.87  | 0.87  | 0.87  | 0.87  | 0.87  | 0.87   | 0.87  | 0.87  | 0.87  | 0.87  | 0.87  |
| Percent Heavy Veh, %         | 5   | 5   | 5   | 2   | 2   | 2   | 1  | 1   | 1   | 2   | 2   | 2   |
| Cap, veh/h                   | 60  | 193   | 95  | 518   | 1219  | 545   | 86   | 514   | 230   | 392   | 1121  | 502   |
| Arrive On Green              | 0.03  | 0.09  | 0.09  | 0.29  | 0.34  | 0.00  | 0.05   | 0.14  | 0.00  | 0.22  | 0.32  | 0.00  |
| Sat Flow, veh/h              | 1723  | 2232  | 1098  | 1774  | 3539  | 1583  | 1792   | 3574  | 1599  | 1774  | 3539  | 1583  |
| Grp Volume(v), veh/h         | 34  | 87  | 88  | 494   | 46  | 0   | 57   | 402   | 0   | 379   | 552   | 0   |
| Grp Sat Flow(s),veh/h/ln     | 1723  | 1719  | 1611  | 1774  | 1770  | 1583  | 1792   | 1787  | 1599  | 1774  | 1770  | 1583  |
| Q Serve(g_s), s              | 1.4   | 3.4   | 3.7   | 19.2  | 0.6   | 0.0   | 2.2  | 7.6   | 0.0   | 14.9  | 8.9   | 0.0   |
| Cycle Q Clear(g_c), s        | 1.4   | 3.4   | 3.7   | 19.2  | 0.6   | 0.0   | 2.2  | 7.6   | 0.0   | 14.9  | 8.9   | 0.0   |
| Prop In Lane                 | 1.00  |   | 0.68  | 1.00  |   | 1.00  | 1.00   |   | 1.00  | 1.00  |   | 1.00  |
| Lane Grp Cap(c), veh/h       | 60  | 149   | 140   | 518   | 1219  | 545   | 86   | 514   | 230   | 392   | 1121  | 502   |
| V/C Ratio(X)                 | 0.57  | 0.58  | 0.63  | 0.95  | 0.04  | 0.00  | 0.67   | 0.78  | 0.00  | 0.97  | 0.49  | 0.00  |
| Avail Cap(c_a), veh/h        | 258   | 760   | 712   | 518   | 2068  | 925   | 140  | 1274  | 570   | 392   | 1766  | 790   |
| HCM Platoon Ratio            | 1.00  | 1.00  | 1.00  | 1.00  | 1.00  | 1.00  | 1.00   | 1.00  | 1.00  | 1.00  | 1.00  | 1.00  |
| Upstream Filter(I)           | 1.00  | 1.00  | 1.00  | 1.00  | 1.00  | 0.00  | 1.00   | 1.00  | 0.00  | 1.00  | 1.00  | 0.00  |
| Uniform Delay (d), s/veh     | 33.4  | 30.8  | 31.0  | 24.4  | 15.3  | 0.0   | 32.9   | 29.0  | 0.0   | 27.1  | 19.4  | 0.0   |
| Incr Delay (d2), s/veh       | 3.2   | 1.3   | 1.7   | 27.8  | 0.0   | 0.0   | 3.3  | 1.0   | 0.0   | 36.5  | 0.1   | 0.0   |
| Initial Q Delay(d3),s/veh    | 0.0   | 0.0   | 0.0   | 0.0   | 0.0   | 0.0   | 0.0  | 0.0   | 0.0   | 0.0   | 0.0   | 0.0   |
| %ile BackOfQ(50%),veh/ln     | 0.7   | 1.7   | 1.7   | 13.3  | 0.3   | 0.0   | 1.2  | 3.8   | 0.0   | 11.2  | 4.3   | 0.0   |
| LnGrp Delay(d),s/veh         | 36.5  | 32.2  | 32.7  | 52.2  | 15.3  | 0.0   | 36.1   | 30.0  | 0.0   | 63.6  | 19.5  | 0.0   |
| LnGrp LOS                    | D   | C   | C   | D   | B   |   | D  | C   |   | E   | B   |   |
| Approach Vol, veh/h          |   | 209   |   |   | 540   |   |  | 459   |   |   | 931   |   |
| Approach Delay, s/veh        |   | 33.1  |   |   | 49.0  |   |  | 30.7  |   |   | 37.5  |   |
| Approach LOS                 |   | C   |   |   | D   |   |  | C   |   |   | D   |   |
| Timer                        | 1   | 2   | 3   | 4   | 5   | 6   | 7  | 8   |   |   |   |   |
| Assigned Phs                 | 1   | 2   | 3   | 4   | 5   | 6   | 7  | 8   |   |   |   |   |
| Phs Duration (G+Y+Rc), s     | 7.9   | 26.7  | 6.9   | 28.7  | 20.0  | 14.6  | 25.0   | 10.6  |   |   |   |   |
| Change Period (Y+Rc), s      | 4.5   | 4.5   | 4.5   | 4.5   | 4.5   | 4.5   | 4.5  | 4.5   |   |   |   |   |
| Max Green Setting (Gmax), s  | 5.5   | 35.0  | 10.5  | 41.0  | 15.5  | 25.0  | 20.5   | 31.0  |   |   |   |   |
| Max Q Clear Time (g_c+I1), s | 4.2   | 10.9  | 3.4   | 2.6   | 16.9  | 9.6   | 21.2   | 5.7   |   |   |   |   |
| Green Ext Time (p_c), s      | 0.0   | 0.7   | 0.0   | 0.1   | 0.0   | 0.5   | 0.0  | 0.2   |   |   |   |   |
| <b>Intersection Summary</b>  |   |   |   |   |   |   |  |   |   |   |   |   |
| HCM 2010 Ctrl Delay          |   |   | 38.5  |   |   |   |  |   |   |   |   |   |
| HCM 2010 LOS                 |   |   | D   |   |   |   |  |   |   |   |   |   |

HCM 2010 Signalized Intersection Summary  
40: Malmedy Road & Gigling Road

Cumulative with Eastside Parkway, AM  
06/11/2019



| Movement                     | EBL  | EBT  | EBR  | WBL  | WBT  | WBR  | NBL  | NBT  | NBR  | SBL  | SBT  | SBR  |
|------------------------------|------|------|------|------|------|------|------|------|------|------|------|------|
| Lane Configurations          |      | ↔↑   |      |      | ↔↑   |      |      | ↔    |      |      | ↔    |      |
| Traffic Volume (veh/h)       | 20   | 610  | 30   | 50   | 850  | 10   | 20   | 30   | 30   | 10   | 60   | 30   |
| Future Volume (veh/h)        | 20   | 610  | 30   | 50   | 850  | 10   | 20   | 30   | 30   | 10   | 60   | 30   |
| Number                       | 7    | 4    | 14   | 3    | 8    | 18   | 5    | 2    | 12   | 1    | 6    | 16   |
| Initial Q (Qb), veh          | 0    | 0    | 0    | 0    | 0    | 0    | 0    | 0    | 0    | 0    | 0    | 0    |
| Ped-Bike Adj(A_pbT)          | 1.00 |      | 1.00 | 1.00 |      | 1.00 | 1.00 |      | 1.00 | 1.00 |      | 1.00 |
| Parking Bus, Adj             | 1.00 | 1.00 | 1.00 | 1.00 | 1.00 | 1.00 | 1.00 | 1.00 | 1.00 | 1.00 | 1.00 | 1.00 |
| Adj Sat Flow, veh/h/ln       | 1900 | 1845 | 1900 | 1900 | 1845 | 1900 | 1900 | 1863 | 1900 | 1900 | 1827 | 1900 |
| Adj Flow Rate, veh/h         | 23   | 693  | 34   | 57   | 966  | 11   | 23   | 34   | 34   | 11   | 68   | 34   |
| Adj No. of Lanes             | 0    | 2    | 0    | 0    | 2    | 0    | 0    | 1    | 0    | 0    | 1    | 0    |
| Peak Hour Factor             | 0.88 | 0.88 | 0.88 | 0.88 | 0.88 | 0.88 | 0.88 | 0.88 | 0.88 | 0.88 | 0.88 | 0.88 |
| Percent Heavy Veh, %         | 3    | 3    | 3    | 3    | 3    | 3    | 2    | 2    | 2    | 4    | 4    | 4    |
| Cap, veh/h                   | 195  | 1279 | 63   | 228  | 1320 | 15   | 267  | 117  | 102  | 206  | 176  | 84   |
| Arrive On Green              | 0.41 | 0.41 | 0.41 | 0.41 | 0.41 | 0.41 | 0.17 | 0.17 | 0.17 | 0.17 | 0.17 | 0.17 |
| Sat Flow, veh/h              | 36   | 3132 | 155  | 96   | 3234 | 36   | 325  | 710  | 618  | 116  | 1065 | 509  |
| Grp Volume(v), veh/h         | 389  | 0    | 361  | 528  | 0    | 506  | 91   | 0    | 0    | 113  | 0    | 0    |
| Grp Sat Flow(s),veh/h/ln     | 1672 | 0    | 1651 | 1694 | 0    | 1672 | 1653 | 0    | 0    | 1690 | 0    | 0    |
| Q Serve(g_s), s              | 0.1  | 0.0  | 3.5  | 1.6  | 0.0  | 5.4  | 0.0  | 0.0  | 0.0  | 0.2  | 0.0  | 0.0  |
| Cycle Q Clear(g_c), s        | 5.6  | 0.0  | 3.5  | 5.3  | 0.0  | 5.4  | 1.0  | 0.0  | 0.0  | 1.2  | 0.0  | 0.0  |
| Prop In Lane                 | 0.06 |      | 0.09 | 0.11 |      | 0.02 | 0.25 |      | 0.37 | 0.10 |      | 0.30 |
| Lane Grp Cap(c), veh/h       | 863  | 0    | 674  | 881  | 0    | 683  | 487  | 0    | 0    | 467  | 0    | 0    |
| V/C Ratio(X)                 | 0.45 | 0.00 | 0.54 | 0.60 | 0.00 | 0.74 | 0.19 | 0.00 | 0.00 | 0.24 | 0.00 | 0.00 |
| Avail Cap(c_a), veh/h        | 4094 | 0    | 3950 | 4010 | 0    | 4001 | 2509 | 0    | 0    | 2607 | 0    | 0    |
| HCM Platoon Ratio            | 1.00 | 1.00 | 1.00 | 1.00 | 1.00 | 1.00 | 1.00 | 1.00 | 1.00 | 1.00 | 1.00 | 1.00 |
| Upstream Filter(I)           | 1.00 | 0.00 | 1.00 | 1.00 | 0.00 | 1.00 | 1.00 | 0.00 | 0.00 | 1.00 | 0.00 | 0.00 |
| Uniform Delay (d), s/veh     | 4.7  | 0.0  | 4.7  | 5.2  | 0.0  | 5.3  | 7.8  | 0.0  | 0.0  | 7.9  | 0.0  | 0.0  |
| Incr Delay (d2), s/veh       | 0.1  | 0.0  | 0.2  | 0.2  | 0.0  | 0.6  | 0.1  | 0.0  | 0.0  | 0.1  | 0.0  | 0.0  |
| Initial Q Delay(d3),s/veh    | 0.0  | 0.0  | 0.0  | 0.0  | 0.0  | 0.0  | 0.0  | 0.0  | 0.0  | 0.0  | 0.0  | 0.0  |
| %ile BackOfQ(50%),veh/ln     | 1.7  | 0.0  | 1.6  | 2.6  | 0.0  | 2.5  | 0.5  | 0.0  | 0.0  | 0.6  | 0.0  | 0.0  |
| LnGrp Delay(d),s/veh         | 4.8  | 0.0  | 5.0  | 5.4  | 0.0  | 5.9  | 7.8  | 0.0  | 0.0  | 8.0  | 0.0  | 0.0  |
| LnGrp LOS                    | A    |      | A    | A    |      | A    | A    |      |      | A    |      |      |
| Approach Vol, veh/h          |      | 750  |      |      | 1034 |      |      | 91   |      |      | 113  |      |
| Approach Delay, s/veh        |      | 4.9  |      |      | 5.7  |      |      | 7.8  |      |      | 8.0  |      |
| Approach LOS                 |      | A    |      |      | A    |      |      | A    |      |      | A    |      |
| Timer                        | 1    | 2    | 3    | 4    | 5    | 6    | 7    | 8    |      |      |      |      |
| Assigned Phs                 |      | 2    |      | 4    |      | 6    |      | 8    |      |      |      |      |
| Phs Duration (G+Y+Rc), s     |      | 8.0  |      | 13.1 |      | 8.0  |      | 13.1 |      |      |      |      |
| Change Period (Y+Rc), s      |      | 4.5  |      | 4.5  |      | 4.5  |      | 4.5  |      |      |      |      |
| Max Green Setting (Gmax), s  |      | 30.5 |      | 50.5 |      | 30.5 |      | 50.5 |      |      |      |      |
| Max Q Clear Time (g_c+I1), s |      | 3.0  |      | 7.6  |      | 3.2  |      | 7.4  |      |      |      |      |
| Green Ext Time (p_c), s      |      | 0.1  |      | 0.8  |      | 0.1  |      | 1.1  |      |      |      |      |
| <b>Intersection Summary</b>  |      |      |      |      |      |      |      |      |      |      |      |      |
| HCM 2010 Ctrl Delay          |      |      |      | 5.6  |      |      |      |      |      |      |      |      |
| HCM 2010 LOS                 |      |      |      | A    |      |      |      |      |      |      |      |      |

HCM 2010 Signalized Intersection Summary  
41: Parker Flatts Cut Off Road & Gigling Road

Cumulative with Eastside Parkway, AM  
06/11/2019



| Movement                     | EBL  | EBT  | EBR  | WBL  | WBT  | WBR  | NBL  | NBT  | NBR  | SBL  | SBT  | SBR  |
|------------------------------|------|------|------|------|------|------|------|------|------|------|------|------|
| Lane Configurations          |      | ↕↕   |      |      | ↕↕   |      |      | ↕    | ↕    |      | ↕↕   |      |
| Traffic Volume (veh/h)       | 10   | 560  | 80   | 110  | 850  | 10   | 40   | 10   | 50   | 10   | 30   | 10   |
| Future Volume (veh/h)        | 10   | 560  | 80   | 110  | 850  | 10   | 40   | 10   | 50   | 10   | 30   | 10   |
| Number                       | 7    | 4    | 14   | 3    | 8    | 18   | 5    | 2    | 12   | 1    | 6    | 16   |
| Initial Q (Qb), veh          | 0    | 0    | 0    | 0    | 0    | 0    | 0    | 0    | 0    | 0    | 0    | 0    |
| Ped-Bike Adj(A_pbT)          | 1.00 |      | 1.00 | 1.00 |      | 1.00 | 1.00 |      | 1.00 | 1.00 |      | 1.00 |
| Parking Bus, Adj             | 1.00 | 1.00 | 1.00 | 1.00 | 1.00 | 1.00 | 1.00 | 1.00 | 1.00 | 1.00 | 1.00 | 1.00 |
| Adj Sat Flow, veh/h/ln       | 1900 | 1845 | 1900 | 1900 | 1863 | 1900 | 1900 | 1863 | 1863 | 1900 | 1900 | 1900 |
| Adj Flow Rate, veh/h         | 12   | 667  | 95   | 131  | 1012 | 12   | 48   | 12   | 60   | 12   | 36   | 12   |
| Adj No. of Lanes             | 0    | 2    | 0    | 0    | 2    | 0    | 0    | 1    | 1    | 0    | 1    | 0    |
| Peak Hour Factor             | 0.84 | 0.84 | 0.84 | 0.84 | 0.84 | 0.84 | 0.84 | 0.84 | 0.84 | 0.84 | 0.84 | 0.84 |
| Percent Heavy Veh, %         | 3    | 3    | 3    | 2    | 2    | 2    | 2    | 2    | 2    | 0    | 0    | 0    |
| Cap, veh/h                   | 163  | 1416 | 200  | 288  | 1362 | 16   | 426  | 67   | 231  | 218  | 167  | 51   |
| Arrive On Green              | 0.48 | 0.48 | 0.48 | 0.48 | 0.48 | 0.48 | 0.15 | 0.15 | 0.15 | 0.15 | 0.15 | 0.15 |
| Sat Flow, veh/h              | 16   | 2976 | 420  | 213  | 2863 | 34   | 1052 | 457  | 1583 | 250  | 1139 | 347  |
| Grp Volume(v), veh/h         | 411  | 0    | 363  | 559  | 0    | 596  | 60   | 0    | 60   | 60   | 0    | 0    |
| Grp Sat Flow(s),veh/h/ln     | 1807 | 0    | 1605 | 1421 | 0    | 1689 | 1509 | 0    | 1583 | 1737 | 0    | 0    |
| Q Serve(g_s), s              | 0.0  | 0.0  | 3.7  | 4.1  | 0.0  | 6.8  | 0.0  | 0.0  | 0.8  | 0.0  | 0.0  | 0.0  |
| Cycle Q Clear(g_c), s        | 3.6  | 0.0  | 3.7  | 7.8  | 0.0  | 6.8  | 0.7  | 0.0  | 0.8  | 0.7  | 0.0  | 0.0  |
| Prop In Lane                 | 0.03 |      | 0.26 | 0.23 |      | 0.02 | 0.80 |      | 1.00 | 0.20 |      | 0.20 |
| Lane Grp Cap(c), veh/h       | 1015 | 0    | 763  | 863  | 0    | 804  | 493  | 0    | 231  | 435  | 0    | 0    |
| V/C Ratio(X)                 | 0.40 | 0.00 | 0.48 | 0.65 | 0.00 | 0.74 | 0.12 | 0.00 | 0.26 | 0.14 | 0.00 | 0.00 |
| Avail Cap(c_a), veh/h        | 4215 | 0    | 3741 | 3353 | 0    | 3938 | 1816 | 0    | 1696 | 2009 | 0    | 0    |
| HCM Platoon Ratio            | 1.00 | 1.00 | 1.00 | 1.00 | 1.00 | 1.00 | 1.00 | 1.00 | 1.00 | 1.00 | 1.00 | 1.00 |
| Upstream Filter(I)           | 1.00 | 0.00 | 1.00 | 1.00 | 0.00 | 1.00 | 1.00 | 0.00 | 1.00 | 1.00 | 0.00 | 0.00 |
| Uniform Delay (d), s/veh     | 4.2  | 0.0  | 4.2  | 5.1  | 0.0  | 5.1  | 9.0  | 0.0  | 9.0  | 9.0  | 0.0  | 0.0  |
| Incr Delay (d2), s/veh       | 0.1  | 0.0  | 0.2  | 0.3  | 0.0  | 0.5  | 0.0  | 0.0  | 0.2  | 0.1  | 0.0  | 0.0  |
| Initial Q Delay(d3),s/veh    | 0.0  | 0.0  | 0.0  | 0.0  | 0.0  | 0.0  | 0.0  | 0.0  | 0.0  | 0.0  | 0.0  | 0.0  |
| %ile BackOfQ(50%),veh/ln     | 1.7  | 0.0  | 1.5  | 3.0  | 0.0  | 3.1  | 0.4  | 0.0  | 0.4  | 0.4  | 0.0  | 0.0  |
| LnGrp Delay(d),s/veh         | 4.3  | 0.0  | 4.4  | 5.4  | 0.0  | 5.6  | 9.0  | 0.0  | 9.2  | 9.0  | 0.0  | 0.0  |
| LnGrp LOS                    | A    |      | A    | A    |      | A    | A    |      | A    | A    |      |      |
| Approach Vol, veh/h          |      | 774  |      |      | 1155 |      |      | 120  |      |      | 60   |      |
| Approach Delay, s/veh        |      | 4.3  |      |      | 5.5  |      |      | 9.1  |      |      | 9.0  |      |
| Approach LOS                 |      | A    |      |      | A    |      |      | A    |      |      | A    |      |
| Timer                        | 1    | 2    | 3    | 4    | 5    | 6    | 7    | 8    |      |      |      |      |
| Assigned Phs                 |      | 2    |      | 4    |      | 6    |      | 8    |      |      |      |      |
| Phs Duration (G+Y+Rc), s     |      | 8.0  |      | 15.8 |      | 8.0  |      | 15.8 |      |      |      |      |
| Change Period (Y+Rc), s      |      | 4.5  |      | 4.5  |      | 4.5  |      | 4.5  |      |      |      |      |
| Max Green Setting (Gmax), s  |      | 25.5 |      | 55.5 |      | 25.5 |      | 55.5 |      |      |      |      |
| Max Q Clear Time (g_c+I1), s |      | 2.8  |      | 5.7  |      | 2.7  |      | 9.8  |      |      |      |      |
| Green Ext Time (p_c), s      |      | 0.0  |      | 0.8  |      | 0.0  |      | 1.6  |      |      |      |      |
| <b>Intersection Summary</b>  |      |      |      |      |      |      |      |      |      |      |      |      |
| HCM 2010 Ctrl Delay          |      |      |      | 5.4  |      |      |      |      |      |      |      |      |
| HCM 2010 LOS                 |      |      |      | A    |      |      |      |      |      |      |      |      |

HCM 2010 Signalized Intersection Summary  
42: 6th Avenue & Gigling Road

Cumulative with Eastside Parkway, AM  
06/11/2019



| Movement                     | EBL  | EBT  | EBR  | WBL  | WBT  | WBR  | NBL  | NBT  | NBR  | SBL  | SBT  | SBR  |
|------------------------------|------|------|------|------|------|------|------|------|------|------|------|------|
| Lane Configurations          |      | ↔    |      |      | ↔    |      |      | ↑    | ↗    |      | ↔    |      |
| Traffic Volume (veh/h)       | 90   | 520  | 10   | 30   | 850  | 10   | 10   | 10   | 10   | 10   | 10   | 120  |
| Future Volume (veh/h)        | 90   | 520  | 10   | 30   | 850  | 10   | 10   | 10   | 10   | 10   | 10   | 120  |
| Number                       | 7    | 4    | 14   | 3    | 8    | 18   | 5    | 2    | 12   | 1    | 6    | 16   |
| Initial Q (Qb), veh          | 0    | 0    | 0    | 0    | 0    | 0    | 0    | 0    | 0    | 0    | 0    | 0    |
| Ped-Bike Adj(A_pbT)          | 1.00 |      | 1.00 | 1.00 |      | 1.00 | 1.00 |      | 1.00 | 1.00 |      | 1.00 |
| Parking Bus, Adj             | 1.00 | 1.00 | 1.00 | 1.00 | 1.00 | 1.00 | 1.00 | 1.00 | 1.00 | 1.00 | 1.00 | 1.00 |
| Adj Sat Flow, veh/h/ln       | 1900 | 1845 | 1900 | 1900 | 1863 | 1900 | 1900 | 1429 | 1429 | 1900 | 1863 | 1900 |
| Adj Flow Rate, veh/h         | 101  | 584  | 11   | 34   | 955  | 11   | 11   | 11   | 0    | 11   | 11   | 135  |
| Adj No. of Lanes             | 0    | 2    | 0    | 0    | 2    | 0    | 0    | 1    | 1    | 0    | 1    | 0    |
| Peak Hour Factor             | 0.89 | 0.89 | 0.89 | 0.89 | 0.89 | 0.89 | 0.89 | 0.89 | 0.89 | 0.89 | 0.89 | 0.89 |
| Percent Heavy Veh, %         | 3    | 3    | 3    | 2    | 2    | 2    | 33   | 33   | 33   | 2    | 2    | 2    |
| Cap, veh/h                   | 282  | 1063 | 21   | 201  | 1416 | 16   | 321  | 142  | 198  | 192  | 23   | 223  |
| Arrive On Green              | 0.42 | 0.42 | 0.42 | 0.42 | 0.42 | 0.42 | 0.16 | 0.16 | 0.00 | 0.16 | 0.16 | 0.16 |
| Sat Flow, veh/h              | 150  | 2546 | 50   | 53   | 3393 | 39   | 423  | 869  | 1214 | 79   | 144  | 1368 |
| Grp Volume(v), veh/h         | 329  | 0    | 367  | 519  | 0    | 481  | 22   | 0    | 0    | 157  | 0    | 0    |
| Grp Sat Flow(s),veh/h/ln     | 1076 | 0    | 1670 | 1796 | 0    | 1688 | 1292 | 0    | 1214 | 1591 | 0    | 0    |
| Q Serve(g_s), s              | 0.9  | 0.0  | 3.5  | 0.1  | 0.0  | 5.0  | 0.0  | 0.0  | 0.0  | 1.0  | 0.0  | 0.0  |
| Cycle Q Clear(g_c), s        | 5.9  | 0.0  | 3.5  | 4.8  | 0.0  | 5.0  | 0.3  | 0.0  | 0.0  | 2.0  | 0.0  | 0.0  |
| Prop In Lane                 | 0.31 |      | 0.03 | 0.07 |      | 0.02 | 0.50 |      | 1.00 | 0.07 |      | 0.86 |
| Lane Grp Cap(c), veh/h       | 668  | 0    | 697  | 928  | 0    | 705  | 462  | 0    | 198  | 439  | 0    | 0    |
| V/C Ratio(X)                 | 0.49 | 0.00 | 0.53 | 0.56 | 0.00 | 0.68 | 0.05 | 0.00 | 0.00 | 0.36 | 0.00 | 0.00 |
| Avail Cap(c_a), veh/h        | 2793 | 0    | 3927 | 4254 | 0    | 3971 | 1894 | 0    | 1725 | 2427 | 0    | 0    |
| HCM Platoon Ratio            | 1.00 | 1.00 | 1.00 | 1.00 | 1.00 | 1.00 | 1.00 | 1.00 | 1.00 | 1.00 | 1.00 | 1.00 |
| Upstream Filter(I)           | 1.00 | 0.00 | 1.00 | 1.00 | 0.00 | 1.00 | 1.00 | 0.00 | 0.00 | 1.00 | 0.00 | 0.00 |
| Uniform Delay (d), s/veh     | 4.6  | 0.0  | 4.7  | 5.1  | 0.0  | 5.1  | 7.6  | 0.0  | 0.0  | 8.3  | 0.0  | 0.0  |
| Incr Delay (d2), s/veh       | 0.2  | 0.0  | 0.2  | 0.2  | 0.0  | 0.4  | 0.0  | 0.0  | 0.0  | 0.2  | 0.0  | 0.0  |
| Initial Q Delay(d3),s/veh    | 0.0  | 0.0  | 0.0  | 0.0  | 0.0  | 0.0  | 0.0  | 0.0  | 0.0  | 0.0  | 0.0  | 0.0  |
| %ile BackOfQ(50%),veh/ln     | 1.4  | 0.0  | 1.6  | 2.5  | 0.0  | 2.4  | 0.1  | 0.0  | 0.0  | 0.9  | 0.0  | 0.0  |
| LnGrp Delay(d),s/veh         | 4.8  | 0.0  | 4.9  | 5.2  | 0.0  | 5.5  | 7.6  | 0.0  | 0.0  | 8.5  | 0.0  | 0.0  |
| LnGrp LOS                    | A    |      | A    | A    |      | A    | A    |      |      | A    |      |      |
| Approach Vol, veh/h          |      | 696  |      |      | 1000 |      |      | 22   |      |      | 157  |      |
| Approach Delay, s/veh        |      | 4.8  |      |      | 5.4  |      |      | 7.6  |      |      | 8.5  |      |
| Approach LOS                 |      | A    |      |      | A    |      |      | A    |      |      | A    |      |
| Timer                        | 1    | 2    | 3    | 4    | 5    | 6    | 7    | 8    |      |      |      |      |
| Assigned Phs                 |      | 2    |      | 4    |      | 6    |      | 8    |      |      |      |      |
| Phs Duration (G+Y+Rc), s     |      | 8.0  |      | 13.5 |      | 8.0  |      | 13.5 |      |      |      |      |
| Change Period (Y+Rc), s      |      | 4.5  |      | 4.5  |      | 4.5  |      | 4.5  |      |      |      |      |
| Max Green Setting (Gmax), s  |      | 30.5 |      | 50.5 |      | 30.5 |      | 50.5 |      |      |      |      |
| Max Q Clear Time (g_c+I1), s |      | 2.3  |      | 7.9  |      | 4.0  |      | 7.0  |      |      |      |      |
| Green Ext Time (p_c), s      |      | 0.0  |      | 1.1  |      | 0.2  |      | 1.0  |      |      |      |      |
| <b>Intersection Summary</b>  |      |      |      |      |      |      |      |      |      |      |      |      |
| HCM 2010 Ctrl Delay          |      |      |      | 5.5  |      |      |      |      |      |      |      |      |
| HCM 2010 LOS                 |      |      |      | A    |      |      |      |      |      |      |      |      |



HCM 2010 Signalized Intersection Summary  
43: Gigling Road & 7th Avenue

Cumulative with Eastside Parkway, AM  
06/11/2019

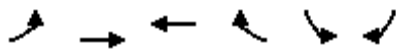

| Movement                     | EBL  | EBT  | WBT  | WBR  | SBL  | SBR  |   |      |
|------------------------------|------|------|------|------|------|------|---|------|
| Lane Configurations          |      | ↑↑   | ↑↑   |      | ↑↑   |      |   |      |
| Traffic Volume (veh/h)       | 100  | 450  | 750  | 10   | 10   | 130  |   |      |
| Future Volume (veh/h)        | 100  | 450  | 750  | 10   | 10   | 130  |   |      |
| Number                       | 7    | 4    | 8    | 18   | 1    | 16   |   |      |
| Initial Q (Qb), veh          | 0    | 0    | 0    | 0    | 0    | 0    |   |      |
| Ped-Bike Adj(A_pbT)          | 1.00 |      |      | 1.00 | 1.00 | 1.00 |   |      |
| Parking Bus, Adj             | 1.00 | 1.00 | 1.00 | 1.00 | 1.00 | 1.00 |   |      |
| Adj Sat Flow, veh/h/ln       | 1900 | 1845 | 1900 | 1900 | 1759 | 1900 |   |      |
| Adj Flow Rate, veh/h         | 116  | 523  | 872  | 12   | 12   | 151  |   |      |
| Adj No. of Lanes             | 0    | 2    | 2    | 0    | 0    | 0    |   |      |
| Peak Hour Factor             | 0.86 | 0.86 | 0.86 | 0.86 | 0.86 | 0.86 |   |      |
| Percent Heavy Veh, %         | 3    | 3    | 0    | 0    | 0    | 0    |   |      |
| Cap, veh/h                   | 331  | 979  | 1455 | 20   | 17   | 208  |   |      |
| Arrive On Green              | 0.40 | 0.40 | 0.40 | 0.40 | 0.15 | 0.15 |   |      |
| Sat Flow, veh/h              | 208  | 2537 | 3741 | 50   | 110  | 1389 |   |      |
| Grp Volume(v), veh/h         | 312  | 327  | 432  | 452  | 164  | 0    |   |      |
| Grp Sat Flow(s),veh/h/ln     | 1067 | 1595 | 1805 | 1891 | 1509 | 0    |   |      |
| Q Serve(g_s), s              | 1.2  | 3.1  | 3.8  | 3.8  | 2.1  | 0.0  |   |      |
| Cycle Q Clear(g_c), s        | 4.9  | 3.1  | 3.8  | 3.8  | 2.1  | 0.0  |   |      |
| Prop In Lane                 | 0.37 |      |      | 0.03 | 0.07 | 0.92 |   |      |
| Lane Grp Cap(c), veh/h       | 673  | 636  | 720  | 755  | 226  | 0    |   |      |
| V/C Ratio(X)                 | 0.46 | 0.51 | 0.60 | 0.60 | 0.73 | 0.00 |   |      |
| Avail Cap(c_a), veh/h        | 3208 | 4438 | 5023 | 5263 | 1929 | 0    |   |      |
| HCM Platoon Ratio            | 1.00 | 1.00 | 1.00 | 1.00 | 1.00 | 1.00 |   |      |
| Upstream Filter(I)           | 1.00 | 1.00 | 1.00 | 1.00 | 1.00 | 0.00 |   |      |
| Uniform Delay (d), s/veh     | 4.6  | 4.5  | 4.7  | 4.7  | 8.1  | 0.0  |   |      |
| Incr Delay (d2), s/veh       | 0.2  | 0.2  | 0.3  | 0.3  | 1.7  | 0.0  |   |      |
| Initial Q Delay(d3),s/veh    | 0.0  | 0.0  | 0.0  | 0.0  | 0.0  | 0.0  |   |      |
| %ile BackOfQ(50%),veh/ln     | 1.4  | 1.3  | 1.9  | 1.9  | 0.9  | 0.0  |   |      |
| LnGrp Delay(d),s/veh         | 4.8  | 4.8  | 5.0  | 5.0  | 9.8  | 0.0  |   |      |
| LnGrp LOS                    | A    | A    | A    | A    | A    |      |   |      |
| Approach Vol, veh/h          |      | 639  | 884  |      | 164  |      |   |      |
| Approach Delay, s/veh        |      | 4.8  | 5.0  |      | 9.8  |      |   |      |
| Approach LOS                 |      | A    | A    |      | A    |      |   |      |
| Timer                        | 1    | 2    | 3    | 4    | 5    | 6    | 7 | 8    |
| Assigned Phs                 |      |      |      | 4    |      | 6    |   | 8    |
| Phs Duration (G+Y+Rc), s     |      |      |      | 12.5 |      | 7.5  |   | 12.5 |
| Change Period (Y+Rc), s      |      |      |      | 4.5  |      | 4.5  |   | 4.5  |
| Max Green Setting (Gmax), s  |      |      |      | 55.5 |      | 25.5 |   | 55.5 |
| Max Q Clear Time (g_c+I1), s |      |      |      | 6.9  |      | 4.1  |   | 5.8  |
| Green Ext Time (p_c), s      |      |      |      | 1.0  |      | 0.0  |   | 0.8  |
| <b>Intersection Summary</b>  |      |      |      |      |      |      |   |      |
| HCM 2010 Ctrl Delay          |      |      | 5.4  |      |      |      |   |      |
| HCM 2010 LOS                 |      |      | A    |      |      |      |   |      |
| <b>Notes</b>                 |      |      |      |      |      |      |   |      |

HCM 2010 Signalized Intersection Summary  
44: 8th Avenue & Gigling Road

Cumulative with Eastside Parkway, AM  
06/11/2019



| Movement                     | EBL  | EBT  | EBR  | WBL  | WBT  | WBR  | NBL  | NBT  | NBR  | SBL  | SBT  | SBR  |
|------------------------------|------|------|------|------|------|------|------|------|------|------|------|------|
| Lane Configurations          |      | ↕↕   |      |      | ↕↕   |      |      | ↕    |      |      | ↕    |      |
| Traffic Volume (veh/h)       | 220  | 240  | 10   | 10   | 400  | 10   | 10   | 10   | 10   | 10   | 10   | 360  |
| Future Volume (veh/h)        | 220  | 240  | 10   | 10   | 400  | 10   | 10   | 10   | 10   | 10   | 10   | 360  |
| Number                       | 7    | 4    | 14   | 3    | 8    | 18   | 5    | 2    | 12   | 1    | 6    | 16   |
| Initial Q (Qb), veh          | 0    | 0    | 0    | 0    | 0    | 0    | 0    | 0    | 0    | 0    | 0    | 0    |
| Ped-Bike Adj(A_pbT)          | 1.00 |      | 1.00 | 1.00 |      | 1.00 | 1.00 |      | 1.00 | 1.00 |      | 1.00 |
| Parking Bus, Adj             | 1.00 | 1.00 | 1.00 | 1.00 | 1.00 | 1.00 | 1.00 | 1.00 | 1.00 | 1.00 | 1.00 | 1.00 |
| Adj Sat Flow, veh/h/ln       | 1900 | 1863 | 1900 | 1900 | 1863 | 1900 | 1900 | 1900 | 1900 | 1900 | 1900 | 1900 |
| Adj Flow Rate, veh/h         | 259  | 282  | 12   | 12   | 471  | 12   | 12   | 12   | 12   | 12   | 12   | 248  |
| Adj No. of Lanes             | 0    | 2    | 0    | 0    | 2    | 0    | 0    | 1    | 0    | 0    | 1    | 0    |
| Peak Hour Factor             | 0.85 | 0.85 | 0.85 | 0.85 | 0.85 | 0.85 | 0.85 | 0.85 | 0.85 | 0.85 | 0.85 | 0.85 |
| Percent Heavy Veh, %         | 2    | 2    | 2    | 2    | 2    | 2    | 0    | 0    | 0    | 0    | 0    | 0    |
| Cap, veh/h                   | 586  | 737  | 32   | 150  | 1537 | 39   | 240  | 188  | 126  | 146  | 24   | 325  |
| Arrive On Green              | 0.45 | 0.45 | 0.45 | 0.45 | 0.45 | 0.45 | 0.22 | 0.22 | 0.22 | 0.22 | 0.22 | 0.22 |
| Sat Flow, veh/h              | 720  | 1636 | 70   | 26   | 3413 | 86   | 293  | 855  | 574  | 36   | 107  | 1482 |
| Grp Volume(v), veh/h         | 265  | 0    | 288  | 260  | 0    | 235  | 36   | 0    | 0    | 272  | 0    | 0    |
| Grp Sat Flow(s),veh/h/ln     | 743  | 0    | 1683 | 1844 | 0    | 1680 | 1722 | 0    | 0    | 1626 | 0    | 0    |
| Q Serve(g_s), s              | 6.9  | 0.0  | 3.1  | 0.0  | 0.0  | 2.4  | 0.0  | 0.0  | 0.0  | 1.3  | 0.0  | 0.0  |
| Cycle Q Clear(g_c), s        | 9.4  | 0.0  | 3.1  | 2.4  | 0.0  | 2.4  | 0.4  | 0.0  | 0.0  | 4.3  | 0.0  | 0.0  |
| Prop In Lane                 | 0.98 |      | 0.04 | 0.05 |      | 0.05 | 0.33 |      | 0.33 | 0.04 |      | 0.91 |
| Lane Grp Cap(c), veh/h       | 596  | 0    | 758  | 969  | 0    | 757  | 554  | 0    | 0    | 495  | 0    | 0    |
| V/C Ratio(X)                 | 0.44 | 0.00 | 0.38 | 0.27 | 0.00 | 0.31 | 0.06 | 0.00 | 0.00 | 0.55 | 0.00 | 0.00 |
| Avail Cap(c_a), veh/h        | 1379 | 0    | 2191 | 2504 | 0    | 2187 | 2701 | 0    | 0    | 2836 | 0    | 0    |
| HCM Platoon Ratio            | 1.00 | 1.00 | 1.00 | 1.00 | 1.00 | 1.00 | 1.00 | 1.00 | 1.00 | 1.00 | 1.00 | 1.00 |
| Upstream Filter(I)           | 1.00 | 0.00 | 1.00 | 1.00 | 0.00 | 1.00 | 1.00 | 0.00 | 0.00 | 1.00 | 0.00 | 0.00 |
| Uniform Delay (d), s/veh     | 7.7  | 0.0  | 5.0  | 4.8  | 0.0  | 4.8  | 8.5  | 0.0  | 0.0  | 10.0 | 0.0  | 0.0  |
| Incr Delay (d2), s/veh       | 0.2  | 0.0  | 0.1  | 0.1  | 0.0  | 0.1  | 0.0  | 0.0  | 0.0  | 0.4  | 0.0  | 0.0  |
| Initial Q Delay(d3),s/veh    | 0.0  | 0.0  | 0.0  | 0.0  | 0.0  | 0.0  | 0.0  | 0.0  | 0.0  | 0.0  | 0.0  | 0.0  |
| %ile BackOfQ(50%),veh/ln     | 1.7  | 0.0  | 1.4  | 1.2  | 0.0  | 1.1  | 0.2  | 0.0  | 0.0  | 1.9  | 0.0  | 0.0  |
| LnGrp Delay(d),s/veh         | 7.9  | 0.0  | 5.1  | 4.8  | 0.0  | 4.9  | 8.5  | 0.0  | 0.0  | 10.3 | 0.0  | 0.0  |
| LnGrp LOS                    | A    |      | A    | A    |      | A    | A    |      |      | B    |      |      |
| Approach Vol, veh/h          |      | 553  |      |      | 495  |      |      | 36   |      |      | 272  |      |
| Approach Delay, s/veh        |      | 6.4  |      |      | 4.9  |      |      | 8.5  |      |      | 10.3 |      |
| Approach LOS                 |      | A    |      |      | A    |      |      | A    |      |      | B    |      |
| Timer                        | 1    | 2    | 3    | 4    | 5    | 6    | 7    | 8    |      |      |      |      |
| Assigned Phs                 |      | 2    |      | 4    |      | 6    |      | 8    |      |      |      |      |
| Phs Duration (G+Y+Rc), s     |      | 10.5 |      | 16.8 |      | 10.5 |      | 16.8 |      |      |      |      |
| Change Period (Y+Rc), s      |      | 4.5  |      | 4.5  |      | 4.5  |      | 4.5  |      |      |      |      |
| Max Green Setting (Gmax), s  |      | 45.5 |      | 35.5 |      | 45.5 |      | 35.5 |      |      |      |      |
| Max Q Clear Time (g_c+I1), s |      | 2.4  |      | 11.4 |      | 6.3  |      | 4.4  |      |      |      |      |
| Green Ext Time (p_c), s      |      | 0.0  |      | 0.9  |      | 0.4  |      | 0.6  |      |      |      |      |
| <b>Intersection Summary</b>  |      |      |      |      |      |      |      |      |      |      |      |      |
| HCM 2010 Ctrl Delay          |      |      |      | 6.7  |      |      |      |      |      |      |      |      |
| HCM 2010 LOS                 |      |      |      | A    |      |      |      |      |      |      |      |      |

HCM 2010 Signalized Intersection Summary  
45: Eastside Parkway & Gigling Road

Cumulative with Eastside Parkway, AM  
06/11/2019



| Movement                      | EBL  | EBT  | EBR  | WBL  | WBT  | WBR  | NBL  | NBT  | NBR  | SBL  | SBT  | SBR  |
|-------------------------------|------|------|------|------|------|------|------|------|------|------|------|------|
| Lane Configurations           |      |      |      |      |      |      |      |      |      |      |      |      |
| Traffic Volume (veh/h)        | 230  | 10   | 10   | 10   | 10   | 10   | 10   | 180  | 10   | 10   | 280  | 390  |
| Future Volume (veh/h)         | 230  | 10   | 10   | 10   | 10   | 10   | 10   | 180  | 10   | 10   | 280  | 390  |
| Number                        | 7    | 4    | 14   | 3    | 8    | 18   | 5    | 2    | 12   | 1    | 6    | 16   |
| Initial Q (Qb), veh           | 0    | 0    | 0    | 0    | 0    | 0    | 0    | 0    | 0    | 0    | 0    | 0    |
| Ped-Bike Adj(A_pbT)           | 1.00 |      | 1.00 | 1.00 |      | 1.00 | 1.00 |      | 1.00 | 1.00 |      | 1.00 |
| Parking Bus, Adj              | 1.00 | 1.00 | 1.00 | 1.00 | 1.00 | 1.00 | 1.00 | 1.00 | 1.00 | 1.00 | 1.00 | 1.00 |
| Adj Sat Flow, veh/h/ln        | 1863 | 1863 | 1900 | 1900 | 1863 | 1900 | 1863 | 1863 | 1900 | 1863 | 1863 | 1863 |
| Adj Flow Rate, veh/h          | 250  | 11   | 11   | 11   | 11   | 11   | 11   | 196  | 11   | 11   | 304  | 299  |
| Adj No. of Lanes              | 1    | 2    | 0    | 0    | 1    | 0    | 1    | 1    | 0    | 1    | 1    | 1    |
| Peak Hour Factor              | 0.92 | 0.92 | 0.92 | 0.92 | 0.92 | 0.92 | 0.92 | 0.92 | 0.92 | 0.92 | 0.92 | 0.92 |
| Percent Heavy Veh, %          | 2    | 2    | 2    | 2    | 2    | 2    | 2    | 2    | 2    | 2    | 2    | 2    |
| Cap, veh/h                    | 322  | 327  | 282  | 23   | 23   | 23   | 26   | 433  | 24   | 26   | 462  | 393  |
| Arrive On Green               | 0.18 | 0.18 | 0.18 | 0.04 | 0.04 | 0.04 | 0.01 | 0.25 | 0.25 | 0.01 | 0.25 | 0.25 |
| Sat Flow, veh/h               | 1774 | 1803 | 1555 | 577  | 577  | 577  | 1774 | 1747 | 98   | 1774 | 1863 | 1583 |
| Grp Volume(v), veh/h          | 250  | 11   | 11   | 33   | 0    | 0    | 11   | 0    | 207  | 11   | 304  | 299  |
| Grp Sat Flow(s),veh/h/ln      | 1774 | 1770 | 1588 | 1732 | 0    | 0    | 1774 | 0    | 1845 | 1774 | 1863 | 1583 |
| Q Serve(g_s), s               | 4.2  | 0.2  | 0.2  | 0.6  | 0.0  | 0.0  | 0.2  | 0.0  | 2.9  | 0.2  | 4.5  | 5.4  |
| Cycle Q Clear(g_c), s         | 4.2  | 0.2  | 0.2  | 0.6  | 0.0  | 0.0  | 0.2  | 0.0  | 2.9  | 0.2  | 4.5  | 5.4  |
| Prop In Lane                  | 1.00 |      | 0.98 | 0.33 |      | 0.33 | 1.00 |      | 0.05 | 1.00 |      | 1.00 |
| Lane Grp Cap(c), veh/h        | 322  | 321  | 288  | 69   | 0    | 0    | 26   | 0    | 458  | 26   | 462  | 393  |
| V/C Ratio(X)                  | 0.78 | 0.03 | 0.04 | 0.48 | 0.00 | 0.00 | 0.43 | 0.00 | 0.45 | 0.43 | 0.66 | 0.76 |
| Avail Cap(c_a), veh/h         | 1373 | 1370 | 1230 | 1033 | 0    | 0    | 315  | 0    | 1548 | 315  | 1562 | 1328 |
| HCM Platoon Ratio             | 1.00 | 1.00 | 1.00 | 1.00 | 1.00 | 1.00 | 1.00 | 1.00 | 1.00 | 1.00 | 1.00 | 1.00 |
| Upstream Filter(I)            | 1.00 | 1.00 | 1.00 | 1.00 | 0.00 | 0.00 | 1.00 | 0.00 | 1.00 | 1.00 | 1.00 | 1.00 |
| Uniform Delay (d), s/veh      | 12.1 | 10.5 | 10.5 | 14.6 | 0.0  | 0.0  | 15.1 | 0.0  | 9.9  | 15.1 | 10.5 | 10.8 |
| Incr Delay (d2), s/veh        | 1.5  | 0.0  | 0.0  | 1.9  | 0.0  | 0.0  | 10.7 | 0.0  | 0.3  | 10.7 | 0.6  | 1.2  |
| Initial Q Delay(d3),s/veh     | 0.0  | 0.0  | 0.0  | 0.0  | 0.0  | 0.0  | 0.0  | 0.0  | 0.0  | 0.0  | 0.0  | 0.0  |
| %ile BackOfQ(50%),veh/ln      | 2.2  | 0.1  | 0.1  | 0.3  | 0.0  | 0.0  | 0.2  | 0.0  | 1.5  | 0.2  | 2.4  | 2.5  |
| LnGrp Delay(d),s/veh          | 13.6 | 10.5 | 10.5 | 16.5 | 0.0  | 0.0  | 25.8 | 0.0  | 10.1 | 25.8 | 11.1 | 12.0 |
| LnGrp LOS                     | B    | B    | B    | B    |      |      | C    |      | B    | C    | B    | B    |
| Approach Vol, veh/h           |      | 272  |      |      | 33   |      |      | 218  |      |      | 614  |      |
| Approach Delay, s/veh         |      | 13.4 |      |      | 16.5 |      |      | 10.9 |      |      | 11.8 |      |
| Approach LOS                  |      | B    |      |      | B    |      |      | B    |      |      | B    |      |
| Timer                         | 1    | 2    | 3    | 4    | 5    | 6    | 7    | 8    |      |      |      |      |
| Assigned Phs                  | 1    | 2    |      | 4    | 5    | 6    |      | 8    |      |      |      |      |
| Phs Duration (G+Y+Rc), s      | 4.5  | 11.7 |      | 9.6  | 4.5  | 11.7 |      | 5.2  |      |      |      |      |
| Change Period (Y+Rc), s       | 4.0  | 4.0  |      | 4.0  | 4.0  | 4.0  |      | 4.0  |      |      |      |      |
| Max Green Setting (Gmax), s   | 5.5  | 26.0 |      | 24.0 | 5.5  | 26.0 |      | 18.5 |      |      |      |      |
| Max Q Clear Time (g_c+1/2), s | 12.2 | 4.9  |      | 6.2  | 2.2  | 7.4  |      | 2.6  |      |      |      |      |
| Green Ext Time (p_c), s       | 0.0  | 0.2  |      | 0.1  | 0.0  | 0.3  |      | 0.0  |      |      |      |      |
| <b>Intersection Summary</b>   |      |      |      |      |      |      |      |      |      |      |      |      |
| HCM 2010 Ctrl Delay           |      |      |      | 12.1 |      |      |      |      |      |      |      |      |
| HCM 2010 LOS                  |      |      |      | B    |      |      |      |      |      |      |      |      |

HCM 2010 Signalized Intersection Summary  
46: General Jim Moore Boulevard & Normandy Road

Cumulative with Eastside Parkway, AM  
06/11/2019



| Movement                      | EBL  | EBT  | EBR  | WBL   | WBT  | WBR  | NBL   | NBT  | NBR  | SBL  | SBT  | SBR  |
|-------------------------------|------|------|------|-------|------|------|-------|------|------|------|------|------|
| Lane Configurations           |      | ↕    |      |       | ↕    |      | ↕     | ↕    |      | ↕    | ↕    | ↕    |
| Traffic Volume (veh/h)        | 90   | 110  | 150  | 370   | 80   | 40   | 200   | 380  | 320  | 80   | 730  | 250  |
| Future Volume (veh/h)         | 90   | 110  | 150  | 370   | 80   | 40   | 200   | 380  | 320  | 80   | 730  | 250  |
| Number                        | 3    | 8    | 18   | 7     | 4    | 14   | 1     | 6    | 16   | 5    | 2    | 12   |
| Initial Q (Qb), veh           | 0    | 0    | 0    | 0     | 0    | 0    | 0     | 0    | 0    | 0    | 0    | 0    |
| Ped-Bike Adj(A_pbT)           | 0.99 |      | 0.98 | 0.99  |      | 0.98 | 1.00  |      | 0.99 | 1.00 |      | 0.99 |
| Parking Bus, Adj              | 1.00 | 1.00 | 1.00 | 1.00  | 1.00 | 1.00 | 1.00  | 1.00 | 1.00 | 1.00 | 1.00 | 1.00 |
| Adj Sat Flow, veh/h/ln        | 1900 | 1881 | 1900 | 1900  | 1863 | 1900 | 1881  | 1881 | 1900 | 1863 | 1863 | 1863 |
| Adj Flow Rate, veh/h          | 115  | 141  | 163  | 474   | 103  | 47   | 256   | 487  | 383  | 103  | 936  | 252  |
| Adj No. of Lanes              | 0    | 1    | 0    | 0     | 1    | 0    | 1     | 2    | 0    | 1    | 2    | 1    |
| Peak Hour Factor              | 0.78 | 0.78 | 0.78 | 0.78  | 0.78 | 0.78 | 0.78  | 0.78 | 0.78 | 0.78 | 0.78 | 0.78 |
| Percent Heavy Veh, %          | 1    | 1    | 1    | 2     | 2    | 2    | 1     | 1    | 1    | 2    | 2    | 2    |
| Cap, veh/h                    | 231  | 283  | 289  | 418   | 73   | 33   | 187   | 539  | 423  | 196  | 1029 | 455  |
| Arrive On Green               | 0.43 | 0.43 | 0.43 | 0.43  | 0.43 | 0.43 | 0.10  | 0.28 | 0.28 | 0.11 | 0.29 | 0.29 |
| Sat Flow, veh/h               | 398  | 658  | 673  | 781   | 170  | 77   | 1792  | 1896 | 1488 | 1774 | 3539 | 1564 |
| Grp Volume(v), veh/h          | 419  | 0    | 0    | 624   | 0    | 0    | 256   | 459  | 411  | 103  | 936  | 252  |
| Grp Sat Flow(s),veh/h/ln      | 1729 | 0    | 0    | 1028  | 0    | 0    | 1792  | 1787 | 1597 | 1774 | 1770 | 1564 |
| Q Serve(g_s), s               | 0.0  | 0.0  | 0.0  | 19.0  | 0.0  | 0.0  | 8.0   | 19.0 | 19.1 | 4.2  | 19.6 | 10.5 |
| Cycle Q Clear(g_c), s         | 14.0 | 0.0  | 0.0  | 33.0  | 0.0  | 0.0  | 8.0   | 19.0 | 19.1 | 4.2  | 19.6 | 10.5 |
| Prop In Lane                  | 0.27 |      | 0.39 | 0.76  |      | 0.08 | 1.00  |      | 0.93 | 1.00 |      | 1.00 |
| Lane Grp Cap(c), veh/h        | 802  | 0    | 0    | 524   | 0    | 0    | 187   | 508  | 454  | 196  | 1029 | 455  |
| V/C Ratio(X)                  | 0.52 | 0.00 | 0.00 | 1.19  | 0.00 | 0.00 | 1.37  | 0.90 | 0.90 | 0.53 | 0.91 | 0.55 |
| Avail Cap(c_a), veh/h         | 802  | 0    | 0    | 524   | 0    | 0    | 187   | 593  | 530  | 196  | 1174 | 519  |
| HCM Platoon Ratio             | 1.00 | 1.00 | 1.00 | 1.00  | 1.00 | 1.00 | 1.00  | 1.00 | 1.00 | 1.00 | 1.00 | 1.00 |
| Upstream Filter(I)            | 1.00 | 0.00 | 0.00 | 1.00  | 0.00 | 0.00 | 1.00  | 1.00 | 1.00 | 1.00 | 1.00 | 1.00 |
| Uniform Delay (d), s/veh      | 16.5 | 0.0  | 0.0  | 25.6  | 0.0  | 0.0  | 34.4  | 26.5 | 26.5 | 32.3 | 26.3 | 23.0 |
| Incr Delay (d2), s/veh        | 0.3  | 0.0  | 0.0  | 103.8 | 0.0  | 0.0  | 197.8 | 14.5 | 16.1 | 1.3  | 9.0  | 0.4  |
| Initial Q Delay(d3),s/veh     | 0.0  | 0.0  | 0.0  | 0.0   | 0.0  | 0.0  | 0.0   | 0.0  | 0.0  | 0.0  | 0.0  | 0.0  |
| %ile BackOfQ(50%),veh/ln      | 6.7  | 0.0  | 0.0  | 26.0  | 0.0  | 0.0  | 14.1  | 11.4 | 10.4 | 2.1  | 10.8 | 4.5  |
| LnGrp Delay(d),s/veh          | 16.8 | 0.0  | 0.0  | 129.4 | 0.0  | 0.0  | 232.2 | 41.0 | 42.6 | 33.6 | 35.3 | 23.4 |
| LnGrp LOS                     | B    |      |      | F     |      |      | F     | D    | D    | C    | D    | C    |
| Approach Vol, veh/h           |      | 419  |      | 624   |      |      | 1126  |      |      | 1291 |      |      |
| Approach Delay, s/veh         |      | 16.8 |      | 129.4 |      |      | 85.0  |      |      | 32.8 |      |      |
| Approach LOS                  |      | B    |      | F     |      |      | F     |      |      | C    |      |      |
| Timer                         | 1    | 2    | 3    | 4     | 5    | 6    | 7     | 8    |      |      |      |      |
| Assigned Phs                  | 1    | 2    |      | 4     | 5    | 6    |       | 8    |      |      |      |      |
| Phs Duration (G+Y+Rc), s      | 2.5  | 26.8 |      | 37.5  | 13.0 | 26.4 |       | 37.5 |      |      |      |      |
| Change Period (Y+Rc), s       | 4.5  | 4.5  |      | 4.5   | 4.5  | 4.5  |       | 4.5  |      |      |      |      |
| Max Green Setting (Gmax), s   | 3.0  | 25.5 |      | 33.0  | 8.0  | 25.5 |       | 33.0 |      |      |      |      |
| Max Q Clear Time (g_c+110), s | 11.0 | 21.6 |      | 35.0  | 6.2  | 21.1 |       | 16.0 |      |      |      |      |
| Green Ext Time (p_c), s       | 0.0  | 0.8  |      | 0.0   | 0.0  | 0.6  |       | 0.6  |      |      |      |      |
| <b>Intersection Summary</b>   |      |      |      |       |      |      |       |      |      |      |      |      |
| HCM 2010 Ctrl Delay           |      |      | 65.3 |       |      |      |       |      |      |      |      |      |
| HCM 2010 LOS                  |      |      | E    |       |      |      |       |      |      |      |      |      |

HCM 2010 Signalized Intersection Summary  
 47: General Jim Moore Boulevard & Coe Avenue

Cumulative with Eastside Parkway, AM  
 06/11/2019



| Movement                     | EBL  | EBT  | EBR  | WBL  | WBT  | WBR  | NBL   | NBT  | NBR  | SBL  | SBT  | SBR  |
|------------------------------|------|------|------|------|------|------|-------|------|------|------|------|------|
| Lane Configurations          |      |      |      |      |      |      |       |      |      |      |      |      |
| Traffic Volume (veh/h)       | 100  | 10   | 430  | 370  | 10   | 10   | 230   | 460  | 250  | 10   | 1040 | 90   |
| Future Volume (veh/h)        | 100  | 10   | 430  | 370  | 10   | 10   | 230   | 460  | 250  | 10   | 1040 | 90   |
| Number                       | 3    | 8    | 18   | 7    | 4    | 14   | 1     | 6    | 16   | 5    | 2    | 12   |
| Initial Q (Qb), veh          | 0    | 0    | 0    | 0    | 0    | 0    | 0     | 0    | 0    | 0    | 0    | 0    |
| Ped-Bike Adj(A_pbT)          | 1.00 |      | 1.00 | 1.00 |      | 1.00 | 1.00  |      | 1.00 | 1.00 |      | 1.00 |
| Parking Bus, Adj             | 1.00 | 1.00 | 1.00 | 1.00 | 1.00 | 1.00 | 1.00  | 1.00 | 1.00 | 1.00 | 1.00 | 1.00 |
| Adj Sat Flow, veh/h/ln       | 1881 | 1863 | 1881 | 1863 | 1863 | 1863 | 1881  | 1881 | 1863 | 1863 | 1863 | 1863 |
| Adj Flow Rate, veh/h         | 111  | 11   | 367  | 411  | 11   | 11   | 256   | 511  | 244  | 11   | 1156 | 39   |
| Adj No. of Lanes             | 1    | 1    | 1    | 1    | 1    | 1    | 1     | 2    | 1    | 1    | 2    | 1    |
| Peak Hour Factor             | 0.90 | 0.90 | 0.90 | 0.90 | 0.90 | 0.90 | 0.90  | 0.90 | 0.90 | 0.90 | 0.90 | 0.90 |
| Percent Heavy Veh, %         | 1    | 2    | 1    | 2    | 2    | 2    | 1     | 1    | 2    | 2    | 2    | 2    |
| Cap, veh/h                   | 625  | 750  | 644  | 466  | 750  | 638  | 257   | 1641 | 727  | 23   | 1163 | 520  |
| Arrive On Green              | 0.40 | 0.40 | 0.40 | 0.40 | 0.40 | 0.40 | 0.14  | 0.46 | 0.46 | 0.01 | 0.33 | 0.33 |
| Sat Flow, veh/h              | 1398 | 1863 | 1598 | 1000 | 1863 | 1583 | 1792  | 3574 | 1583 | 1774 | 3539 | 1583 |
| Grp Volume(v), veh/h         | 111  | 11   | 367  | 411  | 11   | 11   | 256   | 511  | 244  | 11   | 1156 | 39   |
| Grp Sat Flow(s),veh/h/ln     | 1398 | 1863 | 1598 | 1000 | 1863 | 1583 | 1792  | 1787 | 1583 | 1774 | 1770 | 1583 |
| Q Serve(g_s), s              | 5.6  | 0.4  | 19.2 | 43.1 | 0.4  | 0.5  | 15.4  | 9.7  | 10.6 | 0.7  | 35.2 | 1.8  |
| Cycle Q Clear(g_c), s        | 6.0  | 0.4  | 19.2 | 43.5 | 0.4  | 0.5  | 15.4  | 9.7  | 10.6 | 0.7  | 35.2 | 1.8  |
| Prop In Lane                 | 1.00 |      | 1.00 | 1.00 |      | 1.00 | 1.00  |      | 1.00 | 1.00 |      | 1.00 |
| Lane Grp Cap(c), veh/h       | 625  | 750  | 644  | 466  | 750  | 638  | 257   | 1641 | 727  | 23   | 1163 | 520  |
| V/C Ratio(X)                 | 0.18 | 0.01 | 0.57 | 0.88 | 0.01 | 0.02 | 1.00  | 0.31 | 0.34 | 0.48 | 0.99 | 0.07 |
| Avail Cap(c_a), veh/h        | 625  | 750  | 644  | 466  | 750  | 638  | 257   | 1641 | 727  | 90   | 1163 | 520  |
| HCM Platoon Ratio            | 1.00 | 1.00 | 1.00 | 1.00 | 1.00 | 1.00 | 1.00  | 1.00 | 1.00 | 1.00 | 1.00 | 1.00 |
| Upstream Filter(I)           | 1.00 | 1.00 | 1.00 | 1.00 | 1.00 | 1.00 | 1.00  | 1.00 | 1.00 | 1.00 | 1.00 | 1.00 |
| Uniform Delay (d), s/veh     | 21.2 | 19.4 | 25.0 | 33.1 | 19.4 | 19.4 | 46.2  | 18.4 | 18.7 | 52.9 | 36.1 | 24.9 |
| Incr Delay (d2), s/veh       | 0.0  | 0.0  | 0.8  | 17.1 | 0.0  | 0.0  | 54.8  | 0.0  | 0.1  | 5.5  | 24.8 | 0.0  |
| Initial Q Delay(d3),s/veh    | 0.0  | 0.0  | 0.0  | 0.0  | 0.0  | 0.0  | 0.0   | 0.0  | 0.0  | 0.0  | 0.0  | 0.0  |
| %ile BackOfQ(50%),veh/ln     | 2.2  | 0.2  | 8.5  | 14.4 | 0.2  | 0.2  | 11.5  | 4.8  | 4.6  | 0.4  | 21.2 | 0.8  |
| LnGrp Delay(d),s/veh         | 21.2 | 19.4 | 25.8 | 50.1 | 19.4 | 19.4 | 101.0 | 18.5 | 18.8 | 58.5 | 60.9 | 25.0 |
| LnGrp LOS                    | C    | B    | C    | D    | B    | B    | F     | B    | B    | E    | E    | C    |
| Approach Vol, veh/h          |      | 489  |      |      | 433  |      |       | 1011 |      |      | 1206 |      |
| Approach Delay, s/veh        |      | 24.6 |      |      | 48.6 |      |       | 39.4 |      |      | 59.7 |      |
| Approach LOS                 |      | C    |      |      | D    |      |       | D    |      |      | E    |      |
| Timer                        | 1    | 2    | 3    | 4    | 5    | 6    | 7     | 8    |      |      |      |      |
| Assigned Phs                 | 1    | 2    |      | 4    | 5    | 6    |       | 8    |      |      |      |      |
| Phs Duration (G+Y+Rc), s     | 30.0 | 40.0 |      | 48.0 | 5.9  | 54.1 |       | 48.0 |      |      |      |      |
| Change Period (Y+Rc), s      | 4.5  | 4.5  |      | 4.5  | 4.5  | 4.5  |       | 4.5  |      |      |      |      |
| Max Green Setting (Gmax), s  | 55.5 | 35.5 |      | 43.5 | 5.5  | 45.5 |       | 43.5 |      |      |      |      |
| Max Q Clear Time (g_c+I1), s | 11.4 | 37.2 |      | 45.5 | 2.7  | 12.6 |       | 21.2 |      |      |      |      |
| Green Ext Time (p_c), s      | 0.0  | 0.0  |      | 0.0  | 0.0  | 0.5  |       | 0.1  |      |      |      |      |
| <b>Intersection Summary</b>  |      |      |      |      |      |      |       |      |      |      |      |      |
| HCM 2010 Ctrl Delay          |      |      | 46.2 |      |      |      |       |      |      |      |      |      |
| HCM 2010 LOS                 |      |      | D    |      |      |      |       |      |      |      |      |      |



| Movement                       | EBL  | EBT  | EBR  | WBL   | WBT  | WBR   | NBL  | NBT  | NBR  | SBL  | SBT   | SBR  |
|--------------------------------|------|------|------|-------|------|-------|------|------|------|------|-------|------|
| Lane Configurations            |      |      |      |       |      |       |      |      |      |      |       |      |
| Traffic Volume (veh/h)         | 80   | 100  | 140  | 120   | 220  | 30    | 230  | 670  | 140  | 10   | 1000  | 70   |
| Future Volume (veh/h)          | 80   | 100  | 140  | 120   | 220  | 30    | 230  | 670  | 140  | 10   | 1000  | 70   |
| Number                         | 7    | 4    | 14   | 3     | 8    | 18    | 5    | 2    | 12   | 1    | 6     | 16   |
| Initial Q (Qb), veh            | 0    | 0    | 0    | 0     | 0    | 0     | 0    | 0    | 0    | 0    | 0     | 0    |
| Ped-Bike Adj(A_pbT)            | 1.00 |      | 0.95 | 1.00  |      | 0.97  | 1.00 |      | 0.99 | 1.00 |       | 0.98 |
| Parking Bus, Adj               | 1.00 | 1.00 | 1.00 | 1.00  | 1.00 | 1.00  | 1.00 | 1.00 | 1.00 | 1.00 | 1.00  | 1.00 |
| Adj Sat Flow, veh/h/ln         | 1845 | 1845 | 1845 | 1900  | 1881 | 1900  | 1827 | 1827 | 1900 | 1827 | 1827  | 1827 |
| Adj Flow Rate, veh/h           | 88   | 110  | 65   | 132   | 242  | 31    | 253  | 736  | 139  | 11   | 1099  | 10   |
| Adj No. of Lanes               | 1    | 1    | 1    | 0     | 1    | 0     | 1    | 2    | 0    | 1    | 2     | 1    |
| Peak Hour Factor               | 0.91 | 0.91 | 0.91 | 0.91  | 0.91 | 0.91  | 0.91 | 0.91 | 0.91 | 0.91 | 0.91  | 0.91 |
| Percent Heavy Veh, %           | 3    | 3    | 3    | 1     | 1    | 1     | 4    | 4    | 4    | 4    | 4     | 4    |
| Cap, veh/h                     | 202  | 212  | 172  | 133   | 244  | 31    | 425  | 1444 | 273  | 18   | 880   | 388  |
| Arrive On Green                | 0.11 | 0.11 | 0.11 | 0.22  | 0.22 | 0.22  | 0.24 | 0.50 | 0.50 | 0.01 | 0.25  | 0.25 |
| Sat Flow, veh/h                | 1757 | 1845 | 1494 | 594   | 1088 | 139   | 1740 | 2908 | 549  | 1740 | 3471  | 1529 |
| Grp Volume(v), veh/h           | 88   | 110  | 65   | 405   | 0    | 0     | 253  | 439  | 436  | 11   | 1099  | 10   |
| Grp Sat Flow(s),veh/h/ln       | 1757 | 1845 | 1494 | 1822  | 0    | 0     | 1740 | 1736 | 1721 | 1740 | 1736  | 1529 |
| Q Serve(g_s), s                | 5.8  | 7.0  | 5.0  | 27.7  | 0.0  | 0.0   | 16.1 | 21.3 | 21.3 | 0.8  | 31.7  | 0.6  |
| Cycle Q Clear(g_c), s          | 5.8  | 7.0  | 5.0  | 27.7  | 0.0  | 0.0   | 16.1 | 21.3 | 21.3 | 0.8  | 31.7  | 0.6  |
| Prop In Lane                   | 1.00 |      | 1.00 | 0.33  |      | 0.08  | 1.00 |      | 0.32 | 1.00 |       | 1.00 |
| Lane Grp Cap(c), veh/h         | 202  | 212  | 172  | 408   | 0    | 0     | 425  | 862  | 855  | 18   | 880   | 388  |
| V/C Ratio(X)                   | 0.44 | 0.52 | 0.38 | 0.99  | 0.00 | 0.00  | 0.59 | 0.51 | 0.51 | 0.62 | 1.25  | 0.03 |
| Avail Cap(c_a), veh/h          | 436  | 457  | 371  | 408   | 0    | 0     | 425  | 862  | 855  | 209  | 880   | 388  |
| HCM Platoon Ratio              | 1.00 | 1.00 | 1.00 | 1.00  | 1.00 | 1.00  | 1.00 | 1.00 | 1.00 | 1.00 | 1.00  | 1.00 |
| Upstream Filter(I)             | 0.76 | 0.76 | 0.76 | 1.00  | 0.00 | 0.00  | 1.00 | 1.00 | 1.00 | 1.00 | 1.00  | 1.00 |
| Uniform Delay (d), s/veh       | 51.6 | 52.1 | 51.2 | 48.4  | 0.0  | 0.0   | 41.8 | 21.2 | 21.2 | 61.6 | 46.7  | 35.0 |
| Incr Delay (d2), s/veh         | 1.1  | 1.5  | 1.1  | 42.5  | 0.0  | 0.0   | 1.6  | 2.1  | 2.2  | 12.5 | 121.3 | 0.1  |
| Initial Q Delay(d3),s/veh      | 0.0  | 0.0  | 0.0  | 0.0   | 0.0  | 0.0   | 0.0  | 0.0  | 0.0  | 0.0  | 0.0   | 0.0  |
| %ile BackOfQ(50%),veh/ln       | 2.9  | 3.7  | 2.1  | 18.8  | 0.0  | 0.0   | 7.9  | 10.8 | 10.7 | 0.4  | 30.0  | 0.3  |
| LnGrp Delay(d),s/veh           | 52.7 | 53.6 | 52.3 | 90.9  | 0.0  | 0.0   | 43.3 | 23.3 | 23.4 | 74.2 | 167.9 | 35.2 |
| LnGrp LOS                      | D    | D    | D    | F     |      |       | D    | C    | C    | E    | F     | D    |
| Approach Vol, veh/h            |      | 263  |      |       | 405  |       |      | 1128 |      |      | 1120  |      |
| Approach Delay, s/veh          |      | 53.0 |      |       | 90.9 |       |      | 27.8 |      |      | 165.8 |      |
| Approach LOS                   |      | D    |      |       | F    |       |      | C    |      |      | F     |      |
| Timer                          | 1    | 2    | 3    | 4     | 5    | 6     | 7    | 8    |      |      |       |      |
| Assigned Phs                   | 1    | 2    |      | 4     | 5    | 6     |      | 8    |      |      |       |      |
| Phs Duration (G+Y+Rc), s       | 5.5  | 67.4 |      | 19.0  | 35.9 | 37.0  |      | 33.1 |      |      |       |      |
| Change Period (Y+Rc), s        | 4.2  | 5.3  |      | * 4.7 | 5.3  | * 5.3 |      | 5.1  |      |      |       |      |
| Max Green Setting (Gmax), s    | 15   | 31.7 |      | * 31  | 15.0 | * 32  |      | 28.0 |      |      |       |      |
| Max Q Clear Time (g_c+1/2g), s | 12.8 | 23.3 |      | 9.0   | 18.1 | 33.7  |      | 29.7 |      |      |       |      |
| Green Ext Time (p_c), s        | 0.0  | 3.0  |      | 1.0   | 0.0  | 0.0   |      | 0.0  |      |      |       |      |
| <b>Intersection Summary</b>    |      |      |      |       |      |       |      |      |      |      |       |      |
| HCM 2010 Ctrl Delay            |      |      | 91.9 |       |      |       |      |      |      |      |       |      |
| HCM 2010 LOS                   |      |      | F    |       |      |       |      |      |      |      |       |      |
| <b>Notes</b>                   |      |      |      |       |      |       |      |      |      |      |       |      |



| Movement                     | EBL  | EBT  | EBR  | WBL   | WBT  | WBR   | NBL  | NBT   | NBR  | SBL  | SBT  | SBR  |
|------------------------------|------|------|------|-------|------|-------|------|-------|------|------|------|------|
| Lane Configurations          |      | ↕↕   | ↗    | ↖     |      | ↗     |      | ↕     | ↗    |      | ↕    |      |
| Traffic Volume (veh/h)       | 10   | 200  | 100  | 240   | 0    | 380   | 0    | 50    | 120  | 10   | 10   | 0    |
| Future Volume (veh/h)        | 10   | 200  | 100  | 240   | 0    | 380   | 0    | 50    | 120  | 10   | 10   | 0    |
| Number                       | 1    | 6    | 16   | 5     | 2    | 12    | 7    | 4     | 14   | 3    | 8    | 18   |
| Initial Q (Qb), veh          | 0    | 0    | 0    | 0     | 0    | 0     | 0    | 0     | 0    | 0    | 0    | 0    |
| Ped-Bike Adj(A_pbT)          | 1.00 |      | 1.00 | 1.00  |      | 1.00  | 1.00 |       | 1.00 | 1.00 |      | 1.00 |
| Parking Bus, Adj             | 1.00 | 1.00 | 1.00 | 1.00  | 1.00 | 1.00  | 1.00 | 1.00  | 1.00 | 1.00 | 1.00 | 1.00 |
| Adj Sat Flow, veh/h/ln       | 1900 | 1845 | 1845 | 1863  | 0    | 1863  | 0    | 1845  | 1845 | 1900 | 1900 | 0    |
| Adj Flow Rate, veh/h         | 10   | 206  | 9    | 247   | 0    | 253   | 0    | 52    | 21   | 10   | 10   | 0    |
| Adj No. of Lanes             | 0    | 2    | 1    | 1     | 0    | 1     | 0    | 1     | 1    | 0    | 1    | 0    |
| Peak Hour Factor             | 0.97 | 0.97 | 0.97 | 0.97  | 0.97 | 0.97  | 0.97 | 0.97  | 0.97 | 0.97 | 0.97 | 0.97 |
| Percent Heavy Veh, %         | 3    | 3    | 3    | 2     | 0    | 2     | 0    | 3     | 3    | 0    | 0    | 0    |
| Cap, veh/h                   | 136  | 2942 | 1343 | 0     | 0    | 0     | 0    | 122   | 104  | 74   | 60   | 0    |
| Arrive On Green              | 0.86 | 0.86 | 0.86 | 0.00  | 0.00 | 0.00  | 0.00 | 0.07  | 0.07 | 0.07 | 0.07 | 0.00 |
| Sat Flow, veh/h              | 159  | 3430 | 1566 |       |      |       | 0    | 1845  | 1568 | 466  | 899  | 0    |
| Grp Volume(v), veh/h         | 116  | 100  | 9    |       | 0.0  |       | 0    | 52    | 21   | 20   | 0    | 0    |
| Grp Sat Flow(s),veh/h/ln     | 1837 | 1752 | 1566 |       |      |       | 0    | 1845  | 1568 | 1365 | 0    | 0    |
| Q Serve(g_s), s              | 1.2  | 1.1  | 0.1  |       |      |       | 0.0  | 3.4   | 1.6  | 0.0  | 0.0  | 0.0  |
| Cycle Q Clear(g_c), s        | 1.2  | 1.1  | 0.1  |       |      |       | 0.0  | 3.4   | 1.6  | 3.4  | 0.0  | 0.0  |
| Prop In Lane                 | 0.09 |      | 1.00 |       |      |       | 0.00 |       | 1.00 | 0.50 |      | 0.00 |
| Lane Grp Cap(c), veh/h       | 1575 | 1503 | 1343 |       |      |       | 0    | 122   | 104  | 134  | 0    | 0    |
| V/C Ratio(X)                 | 0.07 | 0.07 | 0.01 |       |      |       | 0.00 | 0.43  | 0.20 | 0.15 | 0.00 | 0.00 |
| Avail Cap(c_a), veh/h        | 1575 | 1503 | 1343 |       |      |       | 0    | 148   | 125  | 155  | 0    | 0    |
| HCM Platoon Ratio            | 1.00 | 1.00 | 1.00 |       |      |       | 1.00 | 1.00  | 1.00 | 1.00 | 1.00 | 1.00 |
| Upstream Filter(I)           | 1.00 | 1.00 | 1.00 |       |      |       | 0.00 | 1.00  | 1.00 | 1.00 | 0.00 | 0.00 |
| Uniform Delay (d), s/veh     | 1.4  | 1.3  | 1.3  |       |      |       | 0.0  | 56.1  | 55.2 | 55.1 | 0.0  | 0.0  |
| Incr Delay (d2), s/veh       | 0.0  | 0.0  | 0.0  |       |      |       | 0.0  | 0.9   | 0.4  | 0.2  | 0.0  | 0.0  |
| Initial Q Delay(d3),s/veh    | 0.0  | 0.0  | 0.0  |       |      |       | 0.0  | 0.0   | 0.0  | 0.0  | 0.0  | 0.0  |
| %ile BackOfQ(50%),veh/ln     | 0.6  | 0.5  | 0.0  |       |      |       | 0.0  | 1.8   | 0.7  | 0.7  | 0.0  | 0.0  |
| LnGrp Delay(d),s/veh         | 1.4  | 1.3  | 1.3  |       |      |       | 0.0  | 56.9  | 55.6 | 55.3 | 0.0  | 0.0  |
| LnGrp LOS                    | A    | A    | A    |       |      |       |      | E     | E    | E    |      |      |
| Approach Vol, veh/h          |      | 225  |      |       |      |       |      | 73    |      |      | 20   |      |
| Approach Delay, s/veh        |      | 1.4  |      |       |      |       |      | 56.5  |      |      | 55.3 |      |
| Approach LOS                 |      | A    |      |       |      |       |      | E     |      |      | E    |      |
| Timer                        | 1    | 2    | 3    | 4     | 5    | 6     | 7    | 8     |      |      |      |      |
| Assigned Phs                 |      |      |      | 4     |      | 6     |      | 8     |      |      |      |      |
| Phs Duration (G+Y+Rc), s     |      |      |      | 12.5  |      | 112.5 |      | 12.5  |      |      |      |      |
| Change Period (Y+Rc), s      |      |      |      | * 4.2 |      | 5.3   |      | * 4.2 |      |      |      |      |
| Max Green Setting (Gmax), s  |      |      |      | * 10  |      | 21.0  |      | * 10  |      |      |      |      |
| Max Q Clear Time (g_c+I1), s |      |      |      | 5.4   |      | 3.2   |      | 5.4   |      |      |      |      |
| Green Ext Time (p_c), s      |      |      |      | 0.1   |      | 0.7   |      | 0.0   |      |      |      |      |
| <b>Intersection Summary</b>  |      |      |      |       |      |       |      |       |      |      |      |      |
| HCM 2010 Ctrl Delay          |      |      | 17.4 |       |      |       |      |       |      |      |      |      |
| HCM 2010 LOS                 |      |      | B    |       |      |       |      |       |      |      |      |      |
| <b>Notes</b>                 |      |      |      |       |      |       |      |       |      |      |      |      |

HCM 2010 Signalized Intersection Summary

Cumulative with Eastside Parkway, AM

50: Reservation Road & SR 68 WB On Ramp/SR 68 WB Off Ramp

06/11/2019



| Movement                     | EBL  | EBT  | EBR | WBL  | WBT  | WBR  | NBL  | NBT  | NBR  | SBL  | SBT  | SBR  |
|------------------------------|------|------|-----|------|------|------|------|------|------|------|------|------|
| Lane Configurations          |      |      |     |      | ↕    | ↕    | ↕    | ↑    |      |      | ↕    |      |
| Traffic Volume (veh/h)       | 0    | 0    | 0   | 260  | 10   | 310  | 120  | 400  | 0    | 0    | 350  | 120  |
| Future Volume (veh/h)        | 0    | 0    | 0   | 260  | 10   | 310  | 120  | 400  | 0    | 0    | 350  | 120  |
| Number                       |      |      |     | 7    | 4    | 14   | 1    | 6    | 16   | 5    | 2    | 12   |
| Initial Q (Qb), veh          |      |      |     | 0    | 0    | 0    | 0    | 0    | 0    | 0    | 0    | 0    |
| Ped-Bike Adj(A_pbT)          |      |      |     | 1.00 |      | 1.00 | 1.00 |      | 1.00 | 1.00 |      | 1.00 |
| Parking Bus, Adj             |      |      |     | 1.00 | 1.00 | 1.00 | 1.00 | 1.00 | 1.00 | 1.00 | 1.00 | 1.00 |
| Adj Sat Flow, veh/h/ln       |      |      |     | 1900 | 1827 | 1827 | 1863 | 1863 | 0    | 0    | 1827 | 1900 |
| Adj Flow Rate, veh/h         |      |      |     | 274  | 11   | 74   | 126  | 421  | 0    | 0    | 368  | 117  |
| Adj No. of Lanes             |      |      |     | 0    | 1    | 1    | 1    | 1    | 0    | 0    | 1    | 0    |
| Peak Hour Factor             |      |      |     | 0.95 | 0.95 | 0.95 | 0.95 | 0.95 | 0.95 | 0.95 | 0.95 | 0.95 |
| Percent Heavy Veh, %         |      |      |     | 4    | 4    | 4    | 2    | 2    | 0    | 0    | 4    | 4    |
| Cap, veh/h                   |      |      |     | 389  | 16   | 360  | 211  | 1006 | 0    | 0    | 462  | 147  |
| Arrive On Green              |      |      |     | 0.23 | 0.23 | 0.23 | 0.12 | 0.54 | 0.00 | 0.00 | 0.35 | 0.35 |
| Sat Flow, veh/h              |      |      |     | 1676 | 67   | 1553 | 1774 | 1863 | 0    | 0    | 1330 | 423  |
| Grp Volume(v), veh/h         |      |      |     | 285  | 0    | 74   | 126  | 421  | 0    | 0    | 0    | 485  |
| Grp Sat Flow(s),veh/h/ln     |      |      |     | 1743 | 0    | 1553 | 1774 | 1863 | 0    | 0    | 0    | 1752 |
| Q Serve(g_s), s              |      |      |     | 7.2  | 0.0  | 1.8  | 3.2  | 6.4  | 0.0  | 0.0  | 0.0  | 11.9 |
| Cycle Q Clear(g_c), s        |      |      |     | 7.2  | 0.0  | 1.8  | 3.2  | 6.4  | 0.0  | 0.0  | 0.0  | 11.9 |
| Prop In Lane                 |      |      |     | 0.96 |      | 1.00 | 1.00 |      | 0.00 | 0.00 |      | 0.24 |
| Lane Grp Cap(c), veh/h       |      |      |     | 404  | 0    | 360  | 211  | 1006 | 0    | 0    | 0    | 609  |
| V/C Ratio(X)                 |      |      |     | 0.71 | 0.00 | 0.21 | 0.60 | 0.42 | 0.00 | 0.00 | 0.00 | 0.80 |
| Avail Cap(c_a), veh/h        |      |      |     | 1460 | 0    | 1300 | 966  | 1482 | 0    | 0    | 0    | 1394 |
| HCM Platoon Ratio            |      |      |     | 1.00 | 1.00 | 1.00 | 1.00 | 1.00 | 1.00 | 1.00 | 1.00 | 1.00 |
| Upstream Filter(I)           |      |      |     | 1.00 | 0.00 | 1.00 | 1.00 | 1.00 | 0.00 | 0.00 | 0.00 | 1.00 |
| Uniform Delay (d), s/veh     |      |      |     | 16.8 | 0.0  | 14.8 | 20.0 | 6.5  | 0.0  | 0.0  | 0.0  | 14.1 |
| Incr Delay (d2), s/veh       |      |      |     | 2.3  | 0.0  | 0.3  | 1.0  | 0.3  | 0.0  | 0.0  | 0.0  | 2.4  |
| Initial Q Delay(d3),s/veh    |      |      |     | 0.0  | 0.0  | 0.0  | 0.0  | 0.0  | 0.0  | 0.0  | 0.0  | 0.0  |
| %ile BackOfQ(50%),veh/ln     |      |      |     | 3.7  | 0.0  | 0.8  | 1.6  | 3.4  | 0.0  | 0.0  | 0.0  | 6.1  |
| LnGrp Delay(d),s/veh         |      |      |     | 19.1 | 0.0  | 15.1 | 21.0 | 6.8  | 0.0  | 0.0  | 0.0  | 16.5 |
| LnGrp LOS                    |      |      |     | B    |      | B    | C    | A    |      |      |      | B    |
| Approach Vol, veh/h          |      |      |     |      | 359  |      |      | 547  |      |      | 485  |      |
| Approach Delay, s/veh        |      |      |     |      | 18.3 |      |      | 10.1 |      |      | 16.5 |      |
| Approach LOS                 |      |      |     |      | B    |      |      | B    |      |      | B    |      |
| Timer                        | 1    | 2    | 3   | 4    | 5    | 6    | 7    | 8    |      |      |      |      |
| Assigned Phs                 | 1    | 2    |     | 4    |      | 6    |      |      |      |      |      |      |
| Phs Duration (G+Y+Rc), s     | 9.2  | 22.6 |     | 16.0 |      | 31.8 |      |      |      |      |      |      |
| Change Period (Y+Rc), s      | 3.5  | 6.0  |     | 4.9  |      | 6.0  |      |      |      |      |      |      |
| Max Green Setting (Gmax), s  | 26.0 | 38.0 |     | 40.0 |      | 38.0 |      |      |      |      |      |      |
| Max Q Clear Time (g_c+15), s | 15.2 | 13.9 |     | 9.2  |      | 8.4  |      |      |      |      |      |      |
| Green Ext Time (p_c), s      | 0.1  | 2.7  |     | 2.0  |      | 2.2  |      |      |      |      |      |      |
| <b>Intersection Summary</b>  |      |      |     |      |      |      |      |      |      |      |      |      |
| HCM 2010 Ctrl Delay          |      |      |     | 14.4 |      |      |      |      |      |      |      |      |
| HCM 2010 LOS                 |      |      |     | B    |      |      |      |      |      |      |      |      |























| Movement                     | EBL  | EBT  | EBR  | WBL | WBT  | WBR  | NBL  | NBT  | NBR  | SBL  | SBT  | SBR  |
|------------------------------|------|------|------|-----|------|------|------|------|------|------|------|------|
| Lane Configurations          |      | ↕    | ↗    |     |      |      |      | ↑    | ↗    | ↘    | ↑    |      |
| Traffic Volume (veh/h)       | 120  | 10   | 110  | 0   | 0    | 0    | 0    | 390  | 660  | 230  | 370  | 0    |
| Future Volume (veh/h)        | 120  | 10   | 110  | 0   | 0    | 0    | 0    | 390  | 660  | 230  | 370  | 0    |
| Number                       | 3    | 8    | 18   |     |      |      | 1    | 6    | 16   | 5    | 2    | 12   |
| Initial Q (Qb), veh          | 0    | 0    | 0    |     |      |      | 0    | 0    | 0    | 0    | 0    | 0    |
| Ped-Bike Adj(A_pbT)          | 1.00 |      | 1.00 |     |      |      | 1.00 |      | 1.00 | 1.00 |      | 1.00 |
| Parking Bus, Adj             | 1.00 | 1.00 | 1.00 |     |      |      | 1.00 | 1.00 | 1.00 | 1.00 | 1.00 | 1.00 |
| Adj Sat Flow, veh/h/ln       | 1900 | 1881 | 1881 |     |      |      | 0    | 1881 | 1881 | 1827 | 1827 | 0    |
| Adj Flow Rate, veh/h         | 130  | 11   | 19   |     |      |      | 0    | 424  | 388  | 250  | 402  | 0    |
| Adj No. of Lanes             | 0    | 1    | 1    |     |      |      | 0    | 1    | 1    | 1    | 1    | 0    |
| Peak Hour Factor             | 0.92 | 0.92 | 0.92 |     |      |      | 0.92 | 0.92 | 0.92 | 0.92 | 0.92 | 0.92 |
| Percent Heavy Veh, %         | 1    | 1    | 1    |     |      |      | 0    | 1    | 1    | 4    | 4    | 0    |
| Cap, veh/h                   | 190  | 16   | 183  |     |      |      | 0    | 650  | 553  | 327  | 1137 | 0    |
| Arrive On Green              | 0.11 | 0.11 | 0.11 |     |      |      | 0.00 | 0.35 | 0.35 | 0.19 | 0.62 | 0.00 |
| Sat Flow, veh/h              | 1658 | 140  | 1599 |     |      |      | 0    | 1881 | 1599 | 1740 | 1827 | 0    |
| Grp Volume(v), veh/h         | 141  | 0    | 19   |     |      |      | 0    | 424  | 388  | 250  | 402  | 0    |
| Grp Sat Flow(s),veh/h/ln     | 1798 | 0    | 1599 |     |      |      | 0    | 1881 | 1599 | 1740 | 1827 | 0    |
| Q Serve(g_s), s              | 3.1  | 0.0  | 0.4  |     |      |      | 0.0  | 7.9  | 8.7  | 5.7  | 4.4  | 0.0  |
| Cycle Q Clear(g_c), s        | 3.1  | 0.0  | 0.4  |     |      |      | 0.0  | 7.9  | 8.7  | 5.7  | 4.4  | 0.0  |
| Prop In Lane                 | 0.92 |      | 1.00 |     |      |      | 0.00 |      | 1.00 | 1.00 |      | 0.00 |
| Lane Grp Cap(c), veh/h       | 206  | 0    | 183  |     |      |      | 0    | 650  | 553  | 327  | 1137 | 0    |
| V/C Ratio(X)                 | 0.68 | 0.00 | 0.10 |     |      |      | 0.00 | 0.65 | 0.70 | 0.77 | 0.35 | 0.00 |
| Avail Cap(c_a), veh/h        | 1735 | 0    | 1543 |     |      |      | 0    | 1679 | 1427 | 1007 | 1630 | 0    |
| HCM Platoon Ratio            | 1.00 | 1.00 | 1.00 |     |      |      | 1.00 | 1.00 | 1.00 | 1.00 | 1.00 | 1.00 |
| Upstream Filter(I)           | 1.00 | 0.00 | 1.00 |     |      |      | 0.00 | 1.00 | 1.00 | 1.00 | 1.00 | 0.00 |
| Uniform Delay (d), s/veh     | 17.6 | 0.0  | 16.4 |     |      |      | 0.0  | 11.5 | 11.7 | 16.0 | 3.8  | 0.0  |
| Incr Delay (d2), s/veh       | 1.5  | 0.0  | 0.1  |     |      |      | 0.0  | 1.1  | 1.6  | 3.8  | 0.2  | 0.0  |
| Initial Q Delay(d3),s/veh    | 0.0  | 0.0  | 0.0  |     |      |      | 0.0  | 0.0  | 0.0  | 0.0  | 0.0  | 0.0  |
| %ile BackOfQ(50%),veh/ln     | 1.6  | 0.0  | 0.2  |     |      |      | 0.0  | 4.2  | 4.0  | 3.0  | 2.2  | 0.0  |
| LnGrp Delay(d),s/veh         | 19.1 | 0.0  | 16.5 |     |      |      | 0.0  | 12.6 | 13.4 | 19.7 | 4.0  | 0.0  |
| LnGrp LOS                    | B    |      | B    |     |      |      |      | B    | B    | B    | A    |      |
| Approach Vol, veh/h          |      | 160  |      |     |      |      |      | 812  |      |      | 652  |      |
| Approach Delay, s/veh        |      | 18.8 |      |     |      |      |      | 13.0 |      |      | 10.0 |      |
| Approach LOS                 |      | B    |      |     |      |      |      | B    |      |      | B    |      |
| Timer                        | 1    | 2    | 3    | 4   | 5    | 6    | 7    | 8    |      |      |      |      |
| Assigned Phs                 |      | 2    |      |     | 5    | 6    |      | 8    |      |      |      |      |
| Phs Duration (G+Y+Rc), s     |      | 31.8 |      |     | 11.5 | 20.3 |      | 9.7  |      |      |      |      |
| Change Period (Y+Rc), s      |      | 6.0  |      |     | 3.7  | 6.0  |      | 4.9  |      |      |      |      |
| Max Green Setting (Gmax), s  |      | 37.0 |      |     | 24.0 | 37.0 |      | 40.0 |      |      |      |      |
| Max Q Clear Time (g_c+I1), s |      | 6.4  |      |     | 7.7  | 10.7 |      | 5.1  |      |      |      |      |
| Green Ext Time (p_c), s      |      | 2.2  |      |     | 0.6  | 3.6  |      | 0.5  |      |      |      |      |
| <b>Intersection Summary</b>  |      |      |      |     |      |      |      |      |      |      |      |      |
| HCM 2010 Ctrl Delay          |      |      | 12.4 |     |      |      |      |      |      |      |      |      |
| HCM 2010 LOS                 |      |      | B    |     |      |      |      |      |      |      |      |      |

HCM 2010 Signalized Intersection Summary  
 1: Del Monte Boulevard & Reindollar Avenue

Cumulative with Eastside Parkway, PM  
 06/11/2019

|                              |  |  |  |  |  |  |   |  |  |  |  |  |
|------------------------------|---|---|---|---|---|---|---|---|---|---|---|---|
| Movement                     | EBL   | EBT   | EBR   | WBL   | WBT   | WBR   | NBL   | NBT   | NBR   | SBL   | SBT   | SBR   |
| Lane Configurations          |   |   |   |  |  |   |  |  |  |  |  |   |
| Traffic Volume (veh/h)       | 0   | 0   | 0   | 190   | 0   | 450   | 10  | 1290  | 340   | 400   | 840   | 0   |
| Future Volume (veh/h)        | 0   | 0   | 0   | 190   | 0   | 450   | 10  | 1290  | 340   | 400   | 840   | 0   |
| Number                       |   |   |   | 3   | 8   | 18  | 1   | 6   | 16  | 5   | 2   | 12  |
| Initial Q (Qb), veh          |   |   |   | 0   | 0   | 0   | 0   | 0   | 0   | 0   | 0   | 0   |
| Ped-Bike Adj(A_pbT)          |   |   |   | 1.00  |   | 0.99  | 1.00  |   | 1.00  | 1.00  |   | 1.00  |
| Parking Bus, Adj             |   |   |   | 1.00  | 1.00  | 1.00  | 1.00  | 1.00  | 1.00  | 1.00  | 1.00  | 1.00  |
| Adj Sat Flow, veh/h/ln       |   |   |   | 1881  | 1881  | 1900  | 1881  | 1881  | 1881  | 1881  | 1881  | 0   |
| Adj Flow Rate, veh/h         |   |   |   | 198   | 0   | 397   | 10  | 1344  | 271   | 417   | 875   | 0   |
| Adj No. of Lanes             |   |   |   | 1   | 1   | 0   | 1   | 2   | 1   | 1   | 2   | 0   |
| Peak Hour Factor             |   |   |   | 0.96  | 0.96  | 0.96  | 0.96  | 0.96  | 0.96  | 0.96  | 0.96  | 0.96  |
| Percent Heavy Veh, %         |   |   |   | 1   | 1   | 1   | 1   | 1   | 1   | 1   | 1   | 0   |
| Cap, veh/h                   |   |   |   | 501   | 0   | 444   | 22  | 1145  | 512   | 458   | 2015  | 0   |
| Arrive On Green              |   |   |   | 0.28  | 0.00  | 0.28  | 0.01  | 0.32  | 0.32  | 0.26  | 0.56  | 0.00  |
| Sat Flow, veh/h              |   |   |   | 1792  | 0   | 1585  | 1792  | 3574  | 1599  | 1792  | 3668  | 0   |
| Grp Volume(v), veh/h         |   |   |   | 198   | 0   | 397   | 10  | 1344  | 271   | 417   | 875   | 0   |
| Grp Sat Flow(s),veh/h/ln     |   |   |   | 1792  | 0   | 1585  | 1792  | 1787  | 1599  | 1792  | 1787  | 0   |
| Q Serve(g_s), s              |   |   |   | 8.4   | 0.0   | 22.5  | 0.5   | 30.0  | 13.0  | 21.1  | 13.2  | 0.0   |
| Cycle Q Clear(g_c), s        |   |   |   | 8.4   | 0.0   | 22.5  | 0.5   | 30.0  | 13.0  | 21.1  | 13.2  | 0.0   |
| Prop In Lane                 |   |   |   | 1.00  |   | 1.00  | 1.00  |   | 1.00  | 1.00  |   | 0.00  |
| Lane Grp Cap(c), veh/h       |   |   |   | 501   | 0   | 444   | 22  | 1145  | 512   | 458   | 2015  | 0   |
| V/C Ratio(X)                 |   |   |   | 0.39  | 0.00  | 0.89  | 0.46  | 1.17  | 0.53  | 0.91  | 0.43  | 0.00  |
| Avail Cap(c_a), veh/h        |   |   |   | 574   | 0   | 508   | 574   | 1145  | 512   | 574   | 2015  | 0   |
| HCM Platoon Ratio            |   |   |   | 1.00  | 1.00  | 1.00  | 1.00  | 1.00  | 1.00  | 1.00  | 1.00  | 1.00  |
| Upstream Filter(I)           |   |   |   | 1.00  | 0.00  | 1.00  | 1.00  | 1.00  | 1.00  | 1.00  | 1.00  | 0.00  |
| Uniform Delay (d), s/veh     |   |   |   | 27.3  | 0.0   | 32.4  | 45.9  | 31.8  | 26.0  | 33.8  | 11.8  | 0.0   |
| Incr Delay (d2), s/veh       |   |   |   | 0.5   | 0.0   | 16.8  | 14.1  | 87.7  | 1.0   | 16.2  | 0.1   | 0.0   |
| Initial Q Delay(d3),s/veh    |   |   |   | 0.0   | 0.0   | 0.0   | 0.0   | 0.0   | 0.0   | 0.0   | 0.0   | 0.0   |
| %ile BackOfQ(50%),veh/ln     |   |   |   | 4.2   | 0.0   | 11.9  | 0.3   | 28.6  | 5.9   | 12.5  | 6.5   | 0.0   |
| LnGrp Delay(d),s/veh         |   |   |   | 27.8  | 0.0   | 49.2  | 60.0  | 119.5   | 27.1  | 50.0  | 11.9  | 0.0   |
| LnGrp LOS                    |   |   |   | C   |   | D   | E   | F   | C   | D   | B   |   |
| Approach Vol, veh/h          |   |   |   |   | 595   |   |   | 1625  |   |   | 1292  |   |
| Approach Delay, s/veh        |   |   |   |   | 42.1  |   |   | 103.8   |   |   | 24.2  |   |
| Approach LOS                 |   |   |   |   | D   |   |   | F   |   |   | C   |   |
| Timer                        | 1   | 2   | 3   | 4   | 5   | 6   | 7   | 8   |   |   |   |   |
| Assigned Phs                 | 1   | 2   |   |   | 5   | 6   |   | 8   |   |   |   |   |
| Phs Duration (G+Y+Rc), s     | 4.6   | 57.8  |   |   | 27.5  | 35.0  |   | 31.2  |   |   |   |   |
| Change Period (Y+Rc), s      | 3.5   | 5.0   |   |   | 3.5   | 5.0   |   | 5.0   |   |   |   |   |
| Max Green Setting (Gmax), s  | 30.0  | 30.0  |   |   | 30.0  | 30.0  |   | 30.0  |   |   |   |   |
| Max Q Clear Time (g_c+I1), s | 2.5   | 15.2  |   |   | 23.1  | 32.0  |   | 24.5  |   |   |   |   |
| Green Ext Time (p_c), s      | 0.0   | 5.4   |   |   | 0.8   | 0.0   |   | 1.7   |   |   |   |   |
| <b>Intersection Summary</b>  |   |   |   |   |   |   |   |   |   |   |   |   |
| HCM 2010 Ctrl Delay          |   |   |   | 64.1  |   |   |   |   |   |   |   |   |
| HCM 2010 LOS                 |   |   |   | E   |   |   |   |   |   |   |   |   |
| <b>Notes</b>                 |   |   |   |   |   |   |   |   |   |   |   |   |

HCM 2010 Signalized Intersection Summary  
 2: 2nd Avenue & Patton Parkway

Cumulative with Eastside Parkway, PM  
 06/11/2019



| Movement                     | EBL  | EBT  | EBR  | WBL  | WBT  | WBR  | NBL  | NBT  | NBR  | SBL  | SBT  | SBR  |
|------------------------------|------|------|------|------|------|------|------|------|------|------|------|------|
| Lane Configurations          | ↖    | ↗    |      | ↖    | ↗    |      | ↖    | ↗    |      | ↖    | ↗    |      |
| Traffic Volume (veh/h)       | 50   | 50   | 60   | 90   | 80   | 80   | 70   | 240  | 90   | 80   | 200  | 50   |
| Future Volume (veh/h)        | 50   | 50   | 60   | 90   | 80   | 80   | 70   | 240  | 90   | 80   | 200  | 50   |
| Number                       | 7    | 4    | 14   | 3    | 8    | 18   | 5    | 2    | 12   | 1    | 6    | 16   |
| Initial Q (Qb), veh          | 0    | 0    | 0    | 0    | 0    | 0    | 0    | 0    | 0    | 0    | 0    | 0    |
| Ped-Bike Adj(A_pbT)          | 1.00 |      | 1.00 | 1.00 |      | 1.00 | 1.00 |      | 1.00 | 1.00 |      | 1.00 |
| Parking Bus, Adj             | 1.00 | 1.00 | 1.00 | 1.00 | 1.00 | 1.00 | 1.00 | 1.00 | 1.00 | 1.00 | 1.00 | 1.00 |
| Adj Sat Flow, veh/h/ln       | 1863 | 1863 | 1900 | 1863 | 1863 | 1900 | 1863 | 1863 | 1900 | 1863 | 1863 | 1900 |
| Adj Flow Rate, veh/h         | 54   | 54   | 65   | 98   | 87   | 87   | 76   | 261  | 98   | 87   | 217  | 54   |
| Adj No. of Lanes             | 1    | 1    | 0    | 1    | 1    | 0    | 1    | 1    | 0    | 1    | 1    | 0    |
| Peak Hour Factor             | 0.92 | 0.92 | 0.92 | 0.92 | 0.92 | 0.92 | 0.92 | 0.92 | 0.92 | 0.92 | 0.92 | 0.92 |
| Percent Heavy Veh, %         | 2    | 2    | 2    | 2    | 2    | 2    | 2    | 2    | 2    | 2    | 2    | 2    |
| Cap, veh/h                   | 96   | 163  | 196  | 137  | 201  | 201  | 119  | 356  | 134  | 128  | 405  | 101  |
| Arrive On Green              | 0.05 | 0.21 | 0.21 | 0.08 | 0.23 | 0.23 | 0.07 | 0.28 | 0.28 | 0.07 | 0.28 | 0.28 |
| Sat Flow, veh/h              | 1774 | 771  | 928  | 1774 | 856  | 856  | 1774 | 1292 | 485  | 1774 | 1441 | 359  |
| Grp Volume(v), veh/h         | 54   | 0    | 119  | 98   | 0    | 174  | 76   | 0    | 359  | 87   | 0    | 271  |
| Grp Sat Flow(s),veh/h/ln     | 1774 | 0    | 1699 | 1774 | 0    | 1712 | 1774 | 0    | 1777 | 1774 | 0    | 1799 |
| Q Serve(g_s), s              | 1.4  | 0.0  | 2.8  | 2.5  | 0.0  | 4.0  | 2.0  | 0.0  | 8.6  | 2.2  | 0.0  | 6.0  |
| Cycle Q Clear(g_c), s        | 1.4  | 0.0  | 2.8  | 2.5  | 0.0  | 4.0  | 2.0  | 0.0  | 8.6  | 2.2  | 0.0  | 6.0  |
| Prop In Lane                 | 1.00 |      | 0.55 | 1.00 |      | 0.50 | 1.00 |      | 0.27 | 1.00 |      | 0.20 |
| Lane Grp Cap(c), veh/h       | 96   | 0    | 359  | 137  | 0    | 402  | 119  | 0    | 490  | 128  | 0    | 505  |
| V/C Ratio(X)                 | 0.56 | 0.00 | 0.33 | 0.72 | 0.00 | 0.43 | 0.64 | 0.00 | 0.73 | 0.68 | 0.00 | 0.54 |
| Avail Cap(c_a), veh/h        | 228  | 0    | 1290 | 228  | 0    | 1300 | 228  | 0    | 1349 | 228  | 0    | 1366 |
| HCM Platoon Ratio            | 1.00 | 1.00 | 1.00 | 1.00 | 1.00 | 1.00 | 1.00 | 1.00 | 1.00 | 1.00 | 1.00 | 1.00 |
| Upstream Filter(I)           | 1.00 | 0.00 | 1.00 | 1.00 | 0.00 | 1.00 | 1.00 | 0.00 | 1.00 | 1.00 | 0.00 | 1.00 |
| Uniform Delay (d), s/veh     | 21.6 | 0.0  | 15.6 | 21.1 | 0.0  | 15.2 | 21.3 | 0.0  | 15.4 | 21.2 | 0.0  | 14.2 |
| Incr Delay (d2), s/veh       | 5.1  | 0.0  | 0.5  | 6.9  | 0.0  | 0.7  | 5.6  | 0.0  | 2.1  | 6.1  | 0.0  | 0.9  |
| Initial Q Delay(d3),s/veh    | 0.0  | 0.0  | 0.0  | 0.0  | 0.0  | 0.0  | 0.0  | 0.0  | 0.0  | 0.0  | 0.0  | 0.0  |
| %ile BackOfQ(50%),veh/ln     | 0.8  | 0.0  | 1.3  | 1.5  | 0.0  | 2.0  | 1.1  | 0.0  | 4.5  | 1.3  | 0.0  | 3.1  |
| LnGrp Delay(d),s/veh         | 26.7 | 0.0  | 16.2 | 27.9 | 0.0  | 16.0 | 26.8 | 0.0  | 17.5 | 27.3 | 0.0  | 15.1 |
| LnGrp LOS                    | C    |      | B    | C    |      | B    | C    |      | B    | C    |      | B    |
| Approach Vol, veh/h          |      | 173  |      |      | 272  |      |      | 435  |      |      | 358  |      |
| Approach Delay, s/veh        |      | 19.5 |      |      | 20.3 |      |      | 19.1 |      |      | 18.1 |      |
| Approach LOS                 |      | B    |      |      | C    |      |      | B    |      |      | B    |      |
| Timer                        | 1    | 2    | 3    | 4    | 5    | 6    | 7    | 8    |      |      |      |      |
| Assigned Phs                 | 1    | 2    | 3    | 4    | 5    | 6    | 7    | 8    |      |      |      |      |
| Phs Duration (G+Y+Rc), s     | 7.4  | 17.4 | 7.6  | 14.4 | 7.1  | 17.6 | 6.5  | 15.5 |      |      |      |      |
| Change Period (Y+Rc), s      | 4.0  | 4.5  | 4.0  | 4.5  | 4.0  | 4.5  | 4.0  | 4.5  |      |      |      |      |
| Max Green Setting (Gmax), s  | 35.5 | 35.5 | 6.0  | 35.5 | 6.0  | 35.5 | 6.0  | 35.5 |      |      |      |      |
| Max Q Clear Time (g_c+14), s | 10.6 | 10.6 | 4.5  | 4.8  | 4.0  | 8.0  | 3.4  | 6.0  |      |      |      |      |
| Green Ext Time (p_c), s      | 0.0  | 2.3  | 0.0  | 0.7  | 0.0  | 1.7  | 0.0  | 1.1  |      |      |      |      |
| <b>Intersection Summary</b>  |      |      |      |      |      |      |      |      |      |      |      |      |
| HCM 2010 Ctrl Delay          |      |      |      | 19.1 |      |      |      |      |      |      |      |      |
| HCM 2010 LOS                 |      |      |      | B    |      |      |      |      |      |      |      |      |

HCM 2010 Signalized Intersection Summary  
 3: SR 1 SB On-Ramp/SR 1 SB Off-Ramp & Imjin Parkway

Cumulative with Eastside Parkway, PM  
 06/11/2019



| Movement                     | EBL | EBT | EBR | WBL   | WBT   | WBR  | NBL | NBT | NBR | SBL   | SBT   | SBR  |
|------------------------------|-----|-----|-----|-------|-------|------|-----|-----|-----|-------|-------|------|
| Lane Configurations          |     |     |     |       | ↕     |      |     |     |     |       | ↕     |      |
| Traffic Volume (veh/h)       | 0   | 0   | 0   | 1200  | 0     | 0    | 0   | 0   | 0   | 680   | 10    | 0    |
| Future Volume (veh/h)        | 0   | 0   | 0   | 1200  | 0     | 0    | 0   | 0   | 0   | 680   | 10    | 0    |
| Number                       |     |     |     | 1     | 6     | 16   |     |     |     | 7     | 4     | 14   |
| Initial Q (Qb), veh          |     |     |     | 0     | 0     | 0    |     |     |     | 0     | 0     | 0    |
| Ped-Bike Adj(A_pbT)          |     |     |     | 1.00  |       | 1.00 |     |     |     | 1.00  |       | 1.00 |
| Parking Bus, Adj             |     |     |     | 1.00  | 1.00  | 1.00 |     |     |     | 1.00  | 1.00  | 1.00 |
| Adj Sat Flow, veh/h/ln       |     |     |     | 1900  | 1881  | 0    |     |     |     | 1900  | 1863  | 0    |
| Adj Flow Rate, veh/h         |     |     |     | 1319  | 0     | 0    |     |     |     | 747   | 11    | 0    |
| Adj No. of Lanes             |     |     |     | 0     | 1     | 0    |     |     |     | 0     | 1     | 0    |
| Peak Hour Factor             |     |     |     | 0.91  | 0.91  | 0.91 |     |     |     | 0.91  | 0.91  | 0.91 |
| Percent Heavy Veh, %         |     |     |     | 1     | 1     | 0    |     |     |     | 2     | 2     | 0    |
| Cap, veh/h                   |     |     |     | 1015  | 0     | 0    |     |     |     | 661   | 10    | 0    |
| Arrive On Green              |     |     |     | 0.57  | 0.00  | 0.00 |     |     |     | 0.38  | 0.38  | 0.00 |
| Sat Flow, veh/h              |     |     |     | 1792  | 0     | 0    |     |     |     | 1750  | 26    | 0    |
| Grp Volume(v), veh/h         |     |     |     | 1319  | 0     | 0    |     |     |     | 758   | 0     | 0    |
| Grp Sat Flow(s),veh/h/ln     |     |     |     | 1792  | 0     | 0    |     |     |     | 1775  | 0     | 0    |
| Q Serve(g_s), s              |     |     |     | 90.0  | 0.0   | 0.0  |     |     |     | 60.0  | 0.0   | 0.0  |
| Cycle Q Clear(g_c), s        |     |     |     | 90.0  | 0.0   | 0.0  |     |     |     | 60.0  | 0.0   | 0.0  |
| Prop In Lane                 |     |     |     | 1.00  |       | 0.00 |     |     |     | 0.99  |       | 0.00 |
| Lane Grp Cap(c), veh/h       |     |     |     | 1015  | 0     | 0    |     |     |     | 671   | 0     | 0    |
| V/C Ratio(X)                 |     |     |     | 1.30  | 0.00  | 0.00 |     |     |     | 1.13  | 0.00  | 0.00 |
| Avail Cap(c_a), veh/h        |     |     |     | 1015  | 0     | 0    |     |     |     | 671   | 0     | 0    |
| HCM Platoon Ratio            |     |     |     | 1.00  | 1.00  | 1.00 |     |     |     | 1.00  | 1.00  | 1.00 |
| Upstream Filter(I)           |     |     |     | 1.00  | 0.00  | 0.00 |     |     |     | 1.00  | 0.00  | 0.00 |
| Uniform Delay (d), s/veh     |     |     |     | 34.4  | 0.0   | 0.0  |     |     |     | 49.4  | 0.0   | 0.0  |
| Incr Delay (d2), s/veh       |     |     |     | 141.9 | 0.0   | 0.0  |     |     |     | 76.4  | 0.0   | 0.0  |
| Initial Q Delay(d3),s/veh    |     |     |     | 0.0   | 0.0   | 0.0  |     |     |     | 0.0   | 0.0   | 0.0  |
| %ile BackOfQ(50%),veh/ln     |     |     |     | 84.3  | 0.0   | 0.0  |     |     |     | 43.5  | 0.0   | 0.0  |
| LnGrp Delay(d),s/veh         |     |     |     | 176.3 | 0.0   | 0.0  |     |     |     | 125.8 | 0.0   | 0.0  |
| LnGrp LOS                    |     |     |     | F     |       |      |     |     |     | F     |       |      |
| Approach Vol, veh/h          |     |     |     |       | 1319  |      |     |     |     |       | 758   |      |
| Approach Delay, s/veh        |     |     |     |       | 176.3 |      |     |     |     |       | 125.8 |      |
| Approach LOS                 |     |     |     |       | F     |      |     |     |     |       | F     |      |
| Timer                        | 1   | 2   | 3   | 4     | 5     | 6    | 7   | 8   |     |       |       |      |
| Assigned Phs                 |     |     |     | 4     |       | 6    |     |     |     |       |       |      |
| Phs Duration (G+Y+Rc), s     |     |     |     | 64.4  |       | 94.4 |     |     |     |       |       |      |
| Change Period (Y+Rc), s      |     |     |     | 4.4   |       | 4.4  |     |     |     |       |       |      |
| Max Green Setting (Gmax), s  |     |     |     | 60.0  |       | 90.0 |     |     |     |       |       |      |
| Max Q Clear Time (g_c+I1), s |     |     |     | 62.0  |       | 92.0 |     |     |     |       |       |      |
| Green Ext Time (p_c), s      |     |     |     | 0.0   |       | 0.0  |     |     |     |       |       |      |
| <b>Intersection Summary</b>  |     |     |     |       |       |      |     |     |     |       |       |      |
| HCM 2010 Ctrl Delay          |     |     |     | 157.8 |       |      |     |     |     |       |       |      |
| HCM 2010 LOS                 |     |     |     | F     |       |      |     |     |     |       |       |      |

| Intersection             |      |      |      |      |      |      |      |      |      |      |       |      |
|--------------------------|------|------|------|------|------|------|------|------|------|------|-------|------|
| Int Delay, s/veh         | 0.9  |      |      |      |      |      |      |      |      |      |       |      |
| Movement                 | EBL  | EBT  | EBR  | WBL  | WBT  | WBR  | NBL  | NBT  | NBR  | SBL  | SBT   | SBR  |
| Lane Configurations      |      | ↕    |      |      | ↑    | ↗    |      | ↕    | ↗    |      |       |      |
| Traffic Vol, veh/h       | 10   | 660  | 0    | 0    | 1180 | 840  | 10   | 10   | 1180 | 0    | 0     | 0    |
| Future Vol, veh/h        | 10   | 660  | 0    | 0    | 1180 | 840  | 10   | 10   | 1180 | 0    | 0     | 0    |
| Conflicting Peds, #/hr   | 0    | 0    | 1    | 1    | 0    | 0    | 0    | 0    | 0    | 0    | 0     | 0    |
| Sign Control             | Free | Free | Free | Free | Free | Free | Stop | Stop | Stop | Stop | Stop  | Stop |
| RT Channelized           | -    | -    | None | -    | -    | Free | -    | -    | Free | -    | -     | None |
| Storage Length           | -    | -    | -    | -    | -    | 0    | -    | -    | 800  | -    | -     | -    |
| Veh in Median Storage, # | -    | 0    | -    | -    | 0    | -    | -    | 0    | -    | -    | 16965 | -    |
| Grade, %                 | -    | 0    | -    | -    | 0    | -    | -    | 0    | -    | -    | 0     | -    |
| Peak Hour Factor         | 95   | 95   | 95   | 95   | 95   | 95   | 95   | 95   | 95   | 95   | 95    | 95   |
| Heavy Vehicles, %        | 2    | 2    | 2    | 1    | 1    | 1    | 1    | 1    | 1    | 2    | 2     | 2    |
| Mvmt Flow                | 11   | 695  | 0    | 0    | 1242 | 884  | 11   | 11   | 1242 | 0    | 0     | 0    |























| Major/Minor          | Major1 | Major2 | Minor1 |
|----------------------|--------|--------|--------|
| Conflicting Flow All | 1242   | 0      | -      |
| Stage 1              | -      | -      | -      |
| Stage 2              | -      | -      | -      |
| Critical Hdwy        | 4.12   | -      | -      |
| Critical Hdwy Stg 1  | -      | -      | -      |
| Critical Hdwy Stg 2  | -      | -      | -      |
| Follow-up Hdwy       | 2.218  | -      | -      |
| Pot Cap-1 Maneuver   | 561    | 0      | 0      |
| Stage 1              | -      | 0      | 0      |
| Stage 2              | -      | 0      | 0      |
| Platoon blocked, %   | -      | -      | -      |
| Mov Cap-1 Maneuver   | 561    | -      | -      |
| Mov Cap-2 Maneuver   | -      | -      | -      |
| Stage 1              | -      | -      | -      |
| Stage 2              | -      | -      | -      |

| Approach             | EB  | WB | NB   |
|----------------------|-----|----|------|
| HCM Control Delay, s | 0.2 | 0  | 80.1 |
| HCM LOS              |     |    | F    |

| Minor Lane/Major Mvmt | NBLn1 | NBLn2 | EBL   | EBT | WBT |
|-----------------------|-------|-------|-------|-----|-----|
| Capacity (veh/h)      | 68    | -     | 561   | -   | -   |
| HCM Lane V/C Ratio    | 0.31  | -     | 0.019 | -   | -   |
| HCM Control Delay (s) | 80.1  | 0     | 11.5  | 0   | -   |
| HCM Lane LOS          | F     | A     | B     | A   | -   |
| HCM 95th %tile Q(veh) | 1.1   | -     | 0.1   | -   | -   |

HCM 2010 Signalized Intersection Summary  
5: 2nd Avenue & Imjin Parkway

Cumulative with Eastside Parkway, PM  
06/11/2019

|                              |  |  |  |  |  |  |  |  |  |  |  |  |
|------------------------------|---|---|---|---|---|---|--|---|---|---|---|---|
| Movement                     | EBL   | EBT   | EBR   | WBL   | WBT   | WBR   | NBL  | NBT   | NBR   | SBL   | SBT   | SBR   |
| Lane Configurations          |  |  |  |  |  |   |  |  |  |  |  |   |
| Traffic Volume (veh/h)       | 140   | 990   | 720   | 330   | 1030  | 140   | 840  | 110   | 480   | 90  | 90  | 150   |
| Future Volume (veh/h)        | 140   | 990   | 720   | 330   | 1030  | 140   | 840  | 110   | 480   | 90  | 90  | 150   |
| Number                       | 5   | 2   | 12  | 1   | 6   | 16  | 3  | 8   | 18  | 7   | 4   | 14  |
| Initial Q (Qb), veh          | 0   | 0   | 0   | 0   | 0   | 0   | 0  | 0   | 0   | 0   | 0   | 0   |
| Ped-Bike Adj(A_pbT)          | 1.00  |   | 1.00  | 1.00  |   | 0.99  | 1.00   |   | 0.99  | 1.00  |   | 0.98  |
| Parking Bus, Adj             | 1.00  | 1.00  | 1.00  | 1.00  | 1.00  | 1.00  | 1.00   | 1.00  | 1.00  | 1.00  | 1.00  | 1.00  |
| Adj Sat Flow, veh/h/ln       | 1881  | 1881  | 1881  | 1881  | 1881  | 1900  | 1900   | 1900  | 1900  | 1900  | 1900  | 1900  |
| Adj Flow Rate, veh/h         | 146   | 1031  | 550   | 344   | 1073  | 146   | 875  | 115   | 266   | 94  | 94  | 125   |
| Adj No. of Lanes             | 1   | 2   | 1   | 2   | 2   | 0   | 2  | 1   | 1   | 1   | 2   | 0   |
| Peak Hour Factor             | 0.96  | 0.96  | 0.96  | 0.96  | 0.96  | 0.96  | 0.96   | 0.96  | 0.96  | 0.96  | 0.96  | 0.96  |
| Percent Heavy Veh, %         | 1   | 1   | 1   | 1   | 1   | 1   | 0  | 0   | 0   | 0   | 0   | 0   |
| Cap, veh/h                   | 184   | 1213  | 540   | 416   | 1127  | 153   | 794  | 503   | 424   | 133   | 202   | 178   |
| Arrive On Green              | 0.10  | 0.34  | 0.34  | 0.12  | 0.36  | 0.36  | 0.23   | 0.26  | 0.26  | 0.07  | 0.11  | 0.11  |
| Sat Flow, veh/h              | 1792  | 3574  | 1592  | 3476  | 3160  | 429   | 3510   | 1900  | 1602  | 1810  | 1805  | 1585  |
| Grp Volume(v), veh/h         | 146   | 1031  | 550   | 344   | 606   | 613   | 875  | 115   | 266   | 94  | 94  | 125   |
| Grp Sat Flow(s),veh/h/ln     | 1792  | 1787  | 1592  | 1738  | 1787  | 1802  | 1755   | 1900  | 1602  | 1810  | 1805  | 1585  |
| Q Serve(g_s), s              | 7.0   | 23.7  | 30.0  | 8.5   | 29.2  | 29.3  | 20.0   | 4.2   | 12.9  | 4.5   | 4.3   | 6.7   |
| Cycle Q Clear(g_c), s        | 7.0   | 23.7  | 30.0  | 8.5   | 29.2  | 29.3  | 20.0   | 4.2   | 12.9  | 4.5   | 4.3   | 6.7   |
| Prop In Lane                 | 1.00  |   | 1.00  | 1.00  |   | 0.24  | 1.00   |   | 1.00  | 1.00  |   | 1.00  |
| Lane Grp Cap(c), veh/h       | 184   | 1213  | 540   | 416   | 637   | 643   | 794  | 503   | 424   | 133   | 202   | 178   |
| V/C Ratio(X)                 | 0.80  | 0.85  | 1.02  | 0.83  | 0.95  | 0.95  | 1.10   | 0.23  | 0.63  | 0.71  | 0.46  | 0.70  |
| Avail Cap(c_a), veh/h        | 304   | 1213  | 540   | 590   | 637   | 643   | 794  | 503   | 424   | 205   | 429   | 377   |
| HCM Platoon Ratio            | 1.00  | 1.00  | 1.00  | 1.00  | 1.00  | 1.00  | 1.00   | 1.00  | 1.00  | 1.00  | 1.00  | 1.00  |
| Upstream Filter(I)           | 1.00  | 1.00  | 1.00  | 1.00  | 1.00  | 1.00  | 1.00   | 1.00  | 1.00  | 1.00  | 1.00  | 1.00  |
| Uniform Delay (d), s/veh     | 38.8  | 27.1  | 29.2  | 38.0  | 27.7  | 27.7  | 34.2   | 25.4  | 28.6  | 40.0  | 36.8  | 37.8  |
| Incr Delay (d2), s/veh       | 3.0   | 5.6   | 43.3  | 4.5   | 23.9  | 24.3  | 63.4   | 0.1   | 2.2   | 2.6   | 0.6   | 1.9   |
| Initial Q Delay(d3),s/veh    | 0.0   | 0.0   | 0.0   | 0.0   | 0.0   | 0.0   | 0.0  | 0.0   | 0.0   | 0.0   | 0.0   | 0.0   |
| %ile BackOfQ(50%),veh/ln     | 3.6   | 12.5  | 19.6  | 4.4   | 18.5  | 18.8  | 16.6   | 2.2   | 5.9   | 2.3   | 2.2   | 3.0   |
| LnGrp Delay(d),s/veh         | 41.7  | 32.7  | 72.5  | 42.5  | 51.6  | 52.0  | 97.6   | 25.5  | 30.8  | 42.6  | 37.4  | 39.7  |
| LnGrp LOS                    | D   | C   | F   | D   | D   | D   | F  | C   | C   | D   | D   | D   |
| Approach Vol, veh/h          |   | 1727  |   |   | 1563  |   |  | 1256  |   |   | 313   |   |
| Approach Delay, s/veh        |   | 46.1  |   |   | 49.8  |   |  | 76.9  |   |   | 39.9  |   |
| Approach LOS                 |   | D   |   |   | D   |   |  | E   |   |   | D   |   |
| Timer                        | 1   | 2   | 3   | 4   | 5   | 6   | 7  | 8   |   |   |   |   |
| Assigned Phs                 | 1   | 2   | 3   | 4   | 5   | 6   | 7  | 8   |   |   |   |   |
| Phs Duration (G+Y+Rc), s     | 15.1  | 35.3  | 23.5  | 14.5  | 13.6  | 36.8  | 10.0   | 28.0  |   |   |   |   |
| Change Period (Y+Rc), s      | 4.5   | 5.3   | 3.5   | 4.6   | 4.5   | 5.3   | 3.5  | 4.6   |   |   |   |   |
| Max Green Setting (Gmax), s  | 15.0  | 30.0  | 20.0  | 21.0  | 15.0  | 30.0  | 10.0   | 21.0  |   |   |   |   |
| Max Q Clear Time (g_c+I1), s | 10.5  | 32.0  | 22.0  | 8.7   | 9.0   | 31.3  | 6.5  | 14.9  |   |   |   |   |
| Green Ext Time (p_c), s      | 0.0   | 0.0   | 0.0   | 0.2   | 0.0   | 0.0   | 0.0  | 0.1   |   |   |   |   |
| <b>Intersection Summary</b>  |   |   |   |   |   |   |  |   |   |   |   |   |
| HCM 2010 Ctrl Delay          |   |   | 54.8  |   |   |   |  |   |   |   |   |   |
| HCM 2010 LOS                 |   |   | D   |   |   |   |  |   |   |   |   |   |

HCM 2010 Signalized Intersection Summary  
6: 3rd Avenue & Imjin Parkway

Cumulative with Eastside Parkway, PM  
06/11/2019



| Movement                     | EBL  | EBT  | EBR  | WBL  | WBT  | WBR  | NBL  | NBT  | NBR  | SBL  | SBT  | SBR  |
|------------------------------|------|------|------|------|------|------|------|------|------|------|------|------|
| Lane Configurations          | ↖    | ↗    |      | ↖    | ↗    |      | ↖    | ↗    |      | ↖    | ↗    |      |
| Traffic Volume (veh/h)       | 50   | 1380 | 170  | 90   | 1100 | 20   | 220  | 10   | 140  | 10   | 10   | 50   |
| Future Volume (veh/h)        | 50   | 1380 | 170  | 90   | 1100 | 20   | 220  | 10   | 140  | 10   | 10   | 50   |
| Number                       | 5    | 2    | 12   | 1    | 6    | 16   | 3    | 8    | 18   | 7    | 4    | 14   |
| Initial Q (Qb), veh          | 0    | 0    | 0    | 0    | 0    | 0    | 0    | 0    | 0    | 0    | 0    | 0    |
| Ped-Bike Adj(A_pbT)          | 1.00 |      | 0.98 | 1.00 |      | 1.00 | 1.00 |      | 1.00 | 1.00 |      | 1.00 |
| Parking Bus, Adj             | 1.00 | 1.00 | 1.00 | 1.00 | 1.00 | 1.00 | 1.00 | 1.00 | 1.00 | 1.00 | 1.00 | 1.00 |
| Adj Sat Flow, veh/h/ln       | 1881 | 1881 | 1900 | 1881 | 1881 | 1900 | 1900 | 1900 | 1900 | 1900 | 1900 | 1900 |
| Adj Flow Rate, veh/h         | 51   | 1408 | 165  | 92   | 1122 | 19   | 224  | 10   | 31   | 10   | 10   | 10   |
| Adj No. of Lanes             | 1    | 2    | 0    | 1    | 2    | 0    | 1    | 1    | 0    | 1    | 1    | 0    |
| Peak Hour Factor             | 0.98 | 0.98 | 0.98 | 0.98 | 0.98 | 0.98 | 0.98 | 0.98 | 0.98 | 0.98 | 0.98 | 0.98 |
| Percent Heavy Veh, %         | 1    | 1    | 1    | 1    | 1    | 1    | 0    | 0    | 0    | 0    | 0    | 0    |
| Cap, veh/h                   | 116  | 1546 | 180  | 118  | 1731 | 29   | 407  | 82   | 256  | 387  | 176  | 176  |
| Arrive On Green              | 0.06 | 0.48 | 0.48 | 0.07 | 0.48 | 0.48 | 0.20 | 0.20 | 0.20 | 0.20 | 0.20 | 0.20 |
| Sat Flow, veh/h              | 1792 | 3218 | 374  | 1792 | 3597 | 61   | 1412 | 408  | 1266 | 1386 | 872  | 872  |
| Grp Volume(v), veh/h         | 51   | 776  | 797  | 92   | 557  | 584  | 224  | 0    | 41   | 10   | 0    | 20   |
| Grp Sat Flow(s),veh/h/ln     | 1792 | 1787 | 1805 | 1792 | 1787 | 1870 | 1412 | 0    | 1674 | 1386 | 0    | 1745 |
| Q Serve(g_s), s              | 1.5  | 21.4 | 22.0 | 2.7  | 12.6 | 12.6 | 8.2  | 0.0  | 1.1  | 0.3  | 0.0  | 0.5  |
| Cycle Q Clear(g_c), s        | 1.5  | 21.4 | 22.0 | 2.7  | 12.6 | 12.6 | 8.6  | 0.0  | 1.1  | 1.4  | 0.0  | 0.5  |
| Prop In Lane                 | 1.00 |      | 0.21 | 1.00 |      | 0.03 | 1.00 |      | 0.76 | 1.00 |      | 0.50 |
| Lane Grp Cap(c), veh/h       | 116  | 858  | 867  | 118  | 860  | 900  | 407  | 0    | 338  | 387  | 0    | 352  |
| V/C Ratio(X)                 | 0.44 | 0.90 | 0.92 | 0.78 | 0.65 | 0.65 | 0.55 | 0.00 | 0.12 | 0.03 | 0.00 | 0.06 |
| Avail Cap(c_a), veh/h        | 385  | 1084 | 1095 | 385  | 1084 | 1134 | 846  | 0    | 859  | 818  | 0    | 895  |
| HCM Platoon Ratio            | 1.00 | 1.00 | 1.00 | 1.00 | 1.00 | 1.00 | 1.00 | 1.00 | 1.00 | 1.00 | 1.00 | 1.00 |
| Upstream Filter(I)           | 1.00 | 1.00 | 1.00 | 1.00 | 1.00 | 1.00 | 1.00 | 0.00 | 1.00 | 1.00 | 0.00 | 1.00 |
| Uniform Delay (d), s/veh     | 24.1 | 12.8 | 12.9 | 24.7 | 10.5 | 10.5 | 20.7 | 0.0  | 17.5 | 18.1 | 0.0  | 17.3 |
| Incr Delay (d2), s/veh       | 1.0  | 8.0  | 9.3  | 4.2  | 0.4  | 0.4  | 0.4  | 0.0  | 0.1  | 0.0  | 0.0  | 0.0  |
| Initial Q Delay(d3),s/veh    | 0.0  | 0.0  | 0.0  | 0.0  | 0.0  | 0.0  | 0.0  | 0.0  | 0.0  | 0.0  | 0.0  | 0.0  |
| %ile BackOfQ(50%),veh/ln     | 0.8  | 12.3 | 13.1 | 1.5  | 6.1  | 6.4  | 3.2  | 0.0  | 0.5  | 0.1  | 0.0  | 0.2  |
| LnGrp Delay(d),s/veh         | 25.1 | 20.8 | 22.3 | 28.9 | 10.9 | 10.9 | 21.2 | 0.0  | 17.5 | 18.1 | 0.0  | 17.3 |
| LnGrp LOS                    | C    | C    | C    | C    | B    | B    | C    |      | B    | B    |      | B    |
| Approach Vol, veh/h          |      | 1624 |      |      | 1233 |      |      | 265  |      |      | 30   |      |
| Approach Delay, s/veh        |      | 21.7 |      |      | 12.2 |      |      | 20.6 |      |      | 17.5 |      |
| Approach LOS                 |      | C    |      |      | B    |      |      | C    |      |      | B    |      |
| Timer                        | 1    | 2    | 3    | 4    | 5    | 6    | 7    | 8    |      |      |      |      |
| Assigned Phs                 | 1    | 2    |      | 4    | 5    | 6    |      | 8    |      |      |      |      |
| Phs Duration (G+Y+Rc), s     | 7.0  | 31.2 |      | 15.3 | 7.0  | 31.3 |      | 15.3 |      |      |      |      |
| Change Period (Y+Rc), s      | 3.5  | 5.5  |      | 4.5  | 3.5  | 5.5  |      | 4.5  |      |      |      |      |
| Max Green Setting (Gmax), s  | 1.5  | 32.5 |      | 27.5 | 11.5 | 32.5 |      | 27.5 |      |      |      |      |
| Max Q Clear Time (g_c+14), s | 14.5 | 24.0 |      | 3.4  | 3.5  | 14.6 |      | 10.6 |      |      |      |      |
| Green Ext Time (p_c), s      | 0.0  | 1.7  |      | 0.0  | 0.0  | 0.8  |      | 0.1  |      |      |      |      |
| <b>Intersection Summary</b>  |      |      |      |      |      |      |      |      |      |      |      |      |
| HCM 2010 Ctrl Delay          |      |      |      | 17.8 |      |      |      |      |      |      |      |      |
| HCM 2010 LOS                 |      |      |      | B    |      |      |      |      |      |      |      |      |

HCM 2010 Signalized Intersection Summary  
7: 4th Avenue & Imjin Parkway

Cumulative with Eastside Parkway, PM  
06/11/2019



| Movement                    | EBL  | EBT  | EBR  | WBL  | WBT  | WBR  | NBL  | NBT  | NBR  | SBL  | SBT  | SBR  |
|-----------------------------|------|------|------|------|------|------|------|------|------|------|------|------|
| Lane Configurations         |      |      |      |      |      |      |      |      |      |      |      |      |
| Traffic Volume (veh/h)      | 10   | 1520 | 10   | 10   | 1170 | 10   | 20   | 10   | 10   | 10   | 10   | 10   |
| Future Volume (veh/h)       | 10   | 1520 | 10   | 10   | 1170 | 10   | 20   | 10   | 10   | 10   | 10   | 10   |
| Number                      | 5    | 2    | 12   | 1    | 6    | 16   | 3    | 8    | 18   | 7    | 4    | 14   |
| Initial Q (Qb), veh         | 0    | 0    | 0    | 0    | 0    | 0    | 0    | 0    | 0    | 0    | 0    | 0    |
| Ped-Bike Adj(A_pbT)         | 1.00 |      | 1.00 | 1.00 |      | 0.98 | 1.00 |      | 1.00 | 1.00 |      | 1.00 |
| Parking Bus, Adj            | 1.00 | 1.00 | 1.00 | 1.00 | 1.00 | 1.00 | 1.00 | 1.00 | 1.00 | 1.00 | 1.00 | 1.00 |
| Adj Sat Flow, veh/h/ln      | 1881 | 1881 | 1900 | 1881 | 1881 | 1900 | 1900 | 1900 | 1900 | 1900 | 1900 | 1900 |
| Adj Flow Rate, veh/h        | 10   | 1567 | 10   | 10   | 1206 | 10   | 21   | 10   | 8    | 10   | 10   | 10   |
| Adj No. of Lanes            | 1    | 2    | 0    | 1    | 2    | 0    | 0    | 1    | 0    | 0    | 1    | 0    |
| Peak Hour Factor            | 0.97 | 0.97 | 0.97 | 0.97 | 0.97 | 0.97 | 0.97 | 0.97 | 0.97 | 0.97 | 0.97 | 0.97 |
| Percent Heavy Veh, %        | 1    | 1    | 1    | 1    | 1    | 1    | 0    | 0    | 0    | 0    | 0    | 0    |
| Cap, veh/h                  | 14   | 1789 | 11   | 14   | 1784 | 15   | 233  | 24   | 19   | 191  | 33   | 33   |
| Arrive On Green             | 0.01 | 0.49 | 0.49 | 0.01 | 0.49 | 0.49 | 0.06 | 0.06 | 0.06 | 0.06 | 0.06 | 0.06 |
| Sat Flow, veh/h             | 1792 | 3641 | 23   | 1792 | 3632 | 30   | 880  | 419  | 335  | 570  | 570  | 570  |
| Grp Volume(v), veh/h        | 10   | 769  | 808  | 10   | 593  | 623  | 39   | 0    | 0    | 30   | 0    | 0    |
| Grp Sat Flow(s),veh/h/ln    | 1792 | 1787 | 1877 | 1792 | 1787 | 1875 | 1634 | 0    | 0    | 1711 | 0    | 0    |
| Q Serve(g_s), s             | 0.2  | 11.7 | 11.7 | 0.2  | 7.7  | 7.7  | 0.2  | 0.0  | 0.0  | 0.0  | 0.0  | 0.0  |
| Cycle Q Clear(g_c), s       | 0.2  | 11.7 | 11.7 | 0.2  | 7.7  | 7.7  | 0.6  | 0.0  | 0.0  | 0.5  | 0.0  | 0.0  |
| Prop In Lane                | 1.00 |      | 0.01 | 1.00 |      | 0.02 | 0.54 |      | 0.21 | 0.33 |      | 0.33 |
| Lane Grp Cap(c), veh/h      | 14   | 878  | 922  | 14   | 878  | 921  | 276  | 0    | 0    | 257  | 0    | 0    |
| V/C Ratio(X)                | 0.70 | 0.88 | 0.88 | 0.70 | 0.68 | 0.68 | 0.14 | 0.00 | 0.00 | 0.12 | 0.00 | 0.00 |
| Avail Cap(c_a), veh/h       | 676  | 1904 | 2000 | 676  | 1904 | 1998 | 1589 | 0    | 0    | 1624 | 0    | 0    |
| HCM Platoon Ratio           | 1.00 | 1.00 | 1.00 | 1.00 | 1.00 | 1.00 | 1.00 | 1.00 | 1.00 | 1.00 | 1.00 | 1.00 |
| Upstream Filter(I)          | 1.00 | 1.00 | 1.00 | 1.00 | 1.00 | 1.00 | 1.00 | 0.00 | 0.00 | 1.00 | 0.00 | 0.00 |
| Uniform Delay (d), s/veh    | 15.1 | 6.9  | 6.9  | 15.1 | 5.9  | 5.9  | 13.8 | 0.0  | 0.0  | 13.8 | 0.0  | 0.0  |
| Incr Delay (d2), s/veh      | 20.3 | 1.1  | 1.1  | 20.3 | 0.3  | 0.3  | 0.1  | 0.0  | 0.0  | 0.1  | 0.0  | 0.0  |
| Initial Q Delay(d3),s/veh   | 0.0  | 0.0  | 0.0  | 0.0  | 0.0  | 0.0  | 0.0  | 0.0  | 0.0  | 0.0  | 0.0  | 0.0  |
| %ile BackOfQ(50%),veh/ln    | 0.2  | 5.8  | 6.1  | 0.2  | 3.7  | 3.9  | 0.3  | 0.0  | 0.0  | 0.2  | 0.0  | 0.0  |
| LnGrp Delay(d),s/veh        | 35.4 | 8.1  | 8.0  | 35.4 | 6.2  | 6.2  | 13.9 | 0.0  | 0.0  | 13.8 | 0.0  | 0.0  |
| LnGrp LOS                   | D    | A    | A    | D    | A    | A    | B    |      |      | B    |      |      |
| Approach Vol, veh/h         |      | 1587 |      |      | 1226 |      |      | 39   |      |      | 30   |      |
| Approach Delay, s/veh       |      | 8.2  |      |      | 6.5  |      |      | 13.9 |      |      | 13.8 |      |
| Approach LOS                |      | A    |      |      | A    |      |      | B    |      |      | B    |      |
| Timer                       | 1    | 2    | 3    | 4    | 5    | 6    | 7    | 8    |      |      |      |      |
| Assigned Phs                | 1    | 2    |      | 4    | 5    | 6    |      | 8    |      |      |      |      |
| Phs Duration (G+Y+Rc), s    | 3.7  | 20.5 |      | 6.3  | 3.7  | 20.5 |      | 6.3  |      |      |      |      |
| Change Period (Y+Rc), s     | 3.5  | 5.5  |      | 4.5  | 3.5  | 5.5  |      | 4.5  |      |      |      |      |
| Max Green Setting (Gmax), s | 1.5  | 32.5 |      | 27.5 | 11.5 | 32.5 |      | 27.5 |      |      |      |      |
| Max Q Clear Time (g_c+1), s | 12.2 | 13.7 |      | 2.5  | 2.2  | 9.7  |      | 2.6  |      |      |      |      |
| Green Ext Time (p_c), s     | 0.0  | 1.2  |      | 0.0  | 0.0  | 0.9  |      | 0.0  |      |      |      |      |
| <b>Intersection Summary</b> |      |      |      |      |      |      |      |      |      |      |      |      |
| HCM 2010 Ctrl Delay         |      |      |      | 7.6  |      |      |      |      |      |      |      |      |
| HCM 2010 LOS                |      |      |      | A    |      |      |      |      |      |      |      |      |



HCM 2010 Signalized Intersection Summary  
 8: 5th Avenue/California Avenue & Imjin Parkway

Cumulative with Eastside Parkway, PM  
 06/11/2019



| Movement                      | EBL  | EBT  | EBR  | WBL  | WBT  | WBR  | NBL  | NBT  | NBR  | SBL  | SBT  | SBR  |
|-------------------------------|------|------|------|------|------|------|------|------|------|------|------|------|
| Lane Configurations           |      |      |      |      |      |      |      |      |      |      |      |      |
| Traffic Volume (veh/h)        | 320  | 1140 | 10   | 10   | 950  | 80   | 20   | 50   | 10   | 40   | 40   | 240  |
| Future Volume (veh/h)         | 320  | 1140 | 10   | 10   | 950  | 80   | 20   | 50   | 10   | 40   | 40   | 240  |
| Number                        | 5    | 2    | 12   | 1    | 6    | 16   | 3    | 8    | 18   | 7    | 4    | 14   |
| Initial Q (Qb), veh           | 0    | 0    | 0    | 0    | 0    | 0    | 0    | 0    | 0    | 0    | 0    | 0    |
| Ped-Bike Adj(A_pbT)           | 1.00 |      | 1.00 | 1.00 |      | 1.00 | 1.00 |      | 1.00 | 1.00 |      | 0.98 |
| Parking Bus, Adj              | 1.00 | 1.00 | 1.00 | 1.00 | 1.00 | 1.00 | 1.00 | 1.00 | 1.00 | 1.00 | 1.00 | 1.00 |
| Adj Sat Flow, veh/h/ln        | 1881 | 1881 | 1900 | 1881 | 1881 | 1900 | 1900 | 1900 | 1900 | 1900 | 1881 | 1900 |
| Adj Flow Rate, veh/h          | 330  | 1175 | 10   | 10   | 979  | 76   | 21   | 52   | 7    | 41   | 41   | 78   |
| Adj No. of Lanes              | 1    | 2    | 0    | 1    | 2    | 0    | 0    | 1    | 0    | 0    | 1    | 0    |
| Peak Hour Factor              | 0.97 | 0.97 | 0.97 | 0.97 | 0.97 | 0.97 | 0.97 | 0.97 | 0.97 | 0.97 | 0.97 | 0.97 |
| Percent Heavy Veh, %          | 1    | 1    | 1    | 1    | 1    | 1    | 0    | 0    | 0    | 1    | 1    | 1    |
| Cap, veh/h                    | 393  | 1993 | 17   | 14   | 1134 | 88   | 144  | 186  | 22   | 146  | 72   | 109  |
| Arrive On Green               | 0.22 | 0.55 | 0.55 | 0.01 | 0.34 | 0.34 | 0.14 | 0.14 | 0.14 | 0.14 | 0.14 | 0.14 |
| Sat Flow, veh/h               | 1792 | 3632 | 31   | 1792 | 3360 | 261  | 296  | 1352 | 158  | 308  | 521  | 789  |
| Grp Volume(v), veh/h          | 330  | 578  | 607  | 10   | 521  | 534  | 80   | 0    | 0    | 160  | 0    | 0    |
| Grp Sat Flow(s),veh/h/ln      | 1792 | 1787 | 1876 | 1792 | 1787 | 1834 | 1806 | 0    | 0    | 1618 | 0    | 0    |
| Q Serve(g_s), s               | 7.7  | 9.5  | 9.5  | 0.2  | 11.9 | 11.9 | 0.0  | 0.0  | 0.0  | 2.4  | 0.0  | 0.0  |
| Cycle Q Clear(g_c), s         | 7.7  | 9.5  | 9.5  | 0.2  | 11.9 | 11.9 | 1.7  | 0.0  | 0.0  | 4.1  | 0.0  | 0.0  |
| Prop In Lane                  | 1.00 |      | 0.02 | 1.00 |      | 0.14 | 0.26 |      | 0.09 | 0.26 |      | 0.49 |
| Lane Grp Cap(c), veh/h        | 393  | 980  | 1029 | 14   | 603  | 619  | 352  | 0    | 0    | 326  | 0    | 0    |
| V/C Ratio(X)                  | 0.84 | 0.59 | 0.59 | 0.71 | 0.86 | 0.86 | 0.23 | 0.00 | 0.00 | 0.49 | 0.00 | 0.00 |
| Avail Cap(c_a), veh/h         | 613  | 1224 | 1284 | 613  | 1224 | 1256 | 884  | 0    | 0    | 827  | 0    | 0    |
| HCM Platoon Ratio             | 1.00 | 1.00 | 1.00 | 1.00 | 1.00 | 1.00 | 1.00 | 1.00 | 1.00 | 1.00 | 1.00 | 1.00 |
| Upstream Filter(I)            | 1.00 | 1.00 | 1.00 | 1.00 | 1.00 | 1.00 | 1.00 | 0.00 | 0.00 | 1.00 | 0.00 | 0.00 |
| Uniform Delay (d), s/veh      | 16.4 | 6.6  | 6.6  | 21.7 | 13.6 | 13.6 | 17.0 | 0.0  | 0.0  | 18.0 | 0.0  | 0.0  |
| Incr Delay (d2), s/veh        | 3.5  | 0.2  | 0.2  | 21.6 | 1.5  | 1.4  | 0.1  | 0.0  | 0.0  | 0.4  | 0.0  | 0.0  |
| Initial Q Delay(d3),s/veh     | 0.0  | 0.0  | 0.0  | 0.0  | 0.0  | 0.0  | 0.0  | 0.0  | 0.0  | 0.0  | 0.0  | 0.0  |
| %ile BackOfQ(50%),veh/ln      | 4.1  | 4.6  | 4.8  | 0.2  | 6.0  | 6.2  | 0.9  | 0.0  | 0.0  | 1.9  | 0.0  | 0.0  |
| LnGrp Delay(d),s/veh          | 19.8 | 6.8  | 6.8  | 43.3 | 15.1 | 15.0 | 17.1 | 0.0  | 0.0  | 18.4 | 0.0  | 0.0  |
| LnGrp LOS                     | B    | A    | A    | D    | B    | B    | B    |      |      | B    |      |      |
| Approach Vol, veh/h           |      | 1515 |      |      | 1065 |      |      | 80   |      |      | 160  |      |
| Approach Delay, s/veh         |      | 9.6  |      |      | 15.3 |      |      | 17.1 |      |      | 18.4 |      |
| Approach LOS                  |      | A    |      |      | B    |      |      | B    |      |      | B    |      |
| Timer                         | 1    | 2    | 3    | 4    | 5    | 6    | 7    | 8    |      |      |      |      |
| Assigned Phs                  | 1    | 2    |      | 4    | 5    | 6    |      | 8    |      |      |      |      |
| Phs Duration (G+Y+Rc), s      | 3.8  | 29.3 |      | 10.6 | 13.1 | 20.1 |      | 10.6 |      |      |      |      |
| Change Period (Y+Rc), s       | 3.5  | 5.3  |      | 4.6  | 3.5  | 5.3  |      | 4.6  |      |      |      |      |
| Max Green Setting (Gmax), s   | 30.0 | 30.0 |      | 20.0 | 15.0 | 30.0 |      | 20.0 |      |      |      |      |
| Max Q Clear Time (g_c+1/2), s | 11.5 | 11.5 |      | 6.1  | 9.7  | 13.9 |      | 3.7  |      |      |      |      |
| Green Ext Time (p_c), s       | 0.0  | 0.8  |      | 0.1  | 0.1  | 0.8  |      | 0.1  |      |      |      |      |
| <b>Intersection Summary</b>   |      |      |      |      |      |      |      |      |      |      |      |      |
| HCM 2010 Ctrl Delay           |      |      |      | 12.5 |      |      |      |      |      |      |      |      |
| HCM 2010 LOS                  |      |      |      | B    |      |      |      |      |      |      |      |      |

| Intersection             |      |      |      |      |      |      |
|--------------------------|------|------|------|------|------|------|
| Int Delay, s/veh         | 0.6  |      |      |      |      |      |
| Movement                 | EBL  | EBR  | NBL  | NBT  | SBT  | SBR  |
| Lane Configurations      | W    |      | W    | ↑    | ↑    |      |
| Traffic Vol, veh/h       | 10   | 10   | 20   | 410  | 240  | 10   |
| Future Vol, veh/h        | 10   | 10   | 20   | 410  | 240  | 10   |
| Conflicting Peds, #/hr   | 0    | 0    | 0    | 0    | 0    | 0    |
| Sign Control             | Stop | Stop | Free | Free | Free | Free |
| RT Channelized           | -    | None | -    | None | -    | None |
| Storage Length           | 0    | -    | 155  | -    | -    | -    |
| Veh in Median Storage, # | 0    | -    | -    | 0    | 0    | -    |
| Grade, %                 | 0    | -    | -    | 0    | 0    | -    |
| Peak Hour Factor         | 92   | 92   | 92   | 92   | 92   | 92   |
| Heavy Vehicles, %        | 2    | 2    | 2    | 2    | 2    | 2    |
| Mvmt Flow                | 11   | 11   | 22   | 446  | 261  | 11   |











| Major/Minor          | Minor2 | Major1 |       | Major2 |   |
|----------------------|--------|--------|-------|--------|---|
| Conflicting Flow All | 757    | 267    | 272   | 0      | 0 |
| Stage 1              | 267    | -      | -     | -      | - |
| Stage 2              | 490    | -      | -     | -      | - |
| Critical Hdwy        | 6.42   | 6.22   | 4.12  | -      | - |
| Critical Hdwy Stg 1  | 5.42   | -      | -     | -      | - |
| Critical Hdwy Stg 2  | 5.42   | -      | -     | -      | - |
| Follow-up Hdwy       | 3.518  | 3.318  | 2.218 | -      | - |
| Pot Cap-1 Maneuver   | 375    | 772    | 1291  | -      | - |
| Stage 1              | 778    | -      | -     | -      | - |
| Stage 2              | 616    | -      | -     | -      | - |
| Platoon blocked, %   |        |        |       | -      | - |
| Mov Cap-1 Maneuver   | 369    | 772    | 1291  | -      | - |
| Mov Cap-2 Maneuver   | 369    | -      | -     | -      | - |
| Stage 1              | 765    | -      | -     | -      | - |
| Stage 2              | 616    | -      | -     | -      | - |

| Approach             | EB   | NB  | SB |
|----------------------|------|-----|----|
| HCM Control Delay, s | 12.5 | 0.4 | 0  |
| HCM LOS              | B    |     |    |

| Minor Lane/Major Mvmt | NBL   | NBT | EBLn1 | SBT | SBR |
|-----------------------|-------|-----|-------|-----|-----|
| Capacity (veh/h)      | 1291  | -   | 499   | -   | -   |
| HCM Lane V/C Ratio    | 0.017 | -   | 0.044 | -   | -   |
| HCM Control Delay (s) | 7.8   | -   | 12.5  | -   | -   |
| HCM Lane LOS          | A     | -   | B     | -   | -   |
| HCM 95th %tile Q(veh) | 0.1   | -   | 0.1   | -   | -   |

HCM 2010 Signalized Intersection Summary  
 10: Imjin Road & Imjin Parkway

Cumulative with Eastside Parkway, PM  
 06/11/2019

|                              |  |  |  |  |  |  |   |      |
|------------------------------|---|---|---|---|---|---|---|------|
| Movement                     | EBT   | EBR   | WBL   | WBT   | NBL   | NBR   |   |      |
| Lane Configurations          |  |   |  |  |  |  |   |      |
| Traffic Volume (veh/h)       | 1110  | 70  | 70  | 860   | 150   | 360   |   |      |
| Future Volume (veh/h)        | 1110  | 70  | 70  | 860   | 150   | 360   |   |      |
| Number                       | 2   | 12  | 1   | 6   | 3   | 18  |   |      |
| Initial Q (Qb), veh          | 0   | 0   | 0   | 0   | 0   | 0   |   |      |
| Ped-Bike Adj(A_pbT)          |   | 1.00  | 1.00  |   | 1.00  | 1.00  |   |      |
| Parking Bus, Adj             | 1.00  | 1.00  | 1.00  | 1.00  | 1.00  | 1.00  |   |      |
| Adj Sat Flow, veh/h/ln       | 1881  | 1900  | 1881  | 1881  | 1881  | 1881  |   |      |
| Adj Flow Rate, veh/h         | 1168  | 71  | 74  | 905   | 157   | 314   |   |      |
| Adj No. of Lanes             | 2   | 0   | 1   | 2   | 1   | 2   |   |      |
| Peak Hour Factor             | 0.95  | 0.95  | 0.95  | 0.95  | 0.95  | 0.95  |   |      |
| Percent Heavy Veh, %         | 1   | 1   | 1   | 1   | 1   | 1   |   |      |
| Cap, veh/h                   | 1351  | 82  | 91  | 2118  | 267   | 476   |   |      |
| Arrive On Green              | 0.39  | 0.39  | 0.05  | 0.59  | 0.15  | 0.15  |   |      |
| Sat Flow, veh/h              | 3518  | 208   | 1792  | 3668  | 1792  | 3198  |   |      |
| Grp Volume(v), veh/h         | 609   | 630   | 74  | 905   | 157   | 314   |   |      |
| Grp Sat Flow(s),veh/h/ln     | 1787  | 1844  | 1792  | 1787  | 1792  | 1599  |   |      |
| Q Serve(g_s), s              | 11.3  | 11.3  | 1.5   | 5.0   | 2.9   | 3.3   |   |      |
| Cycle Q Clear(g_c), s        | 11.3  | 11.3  | 1.5   | 5.0   | 2.9   | 3.3   |   |      |
| Prop In Lane                 |   | 0.11  | 1.00  |   | 1.00  | 1.00  |   |      |
| Lane Grp Cap(c), veh/h       | 705   | 728   | 91  | 2118  | 267   | 476   |   |      |
| V/C Ratio(X)                 | 0.86  | 0.86  | 0.82  | 0.43  | 0.59  | 0.66  |   |      |
| Avail Cap(c_a), veh/h        | 1490  | 1538  | 996   | 2979  | 1095  | 1955  |   |      |
| HCM Platoon Ratio            | 1.00  | 1.00  | 1.00  | 1.00  | 1.00  | 1.00  |   |      |
| Upstream Filter(I)           | 1.00  | 1.00  | 1.00  | 1.00  | 1.00  | 1.00  |   |      |
| Uniform Delay (d), s/veh     | 10.0  | 10.0  | 16.9  | 4.0   | 14.3  | 14.5  |   |      |
| Incr Delay (d2), s/veh       | 1.3   | 1.2   | 6.5   | 0.1   | 0.8   | 0.6   |   |      |
| Initial Q Delay(d3),s/veh    | 0.0   | 0.0   | 0.0   | 0.0   | 0.0   | 0.0   |   |      |
| %ile BackOfQ(50%),veh/ln     | 5.7   | 5.8   | 0.9   | 2.4   | 1.5   | 1.5   |   |      |
| LnGrp Delay(d),s/veh         | 11.3  | 11.3  | 23.4  | 4.0   | 15.1  | 15.0  |   |      |
| LnGrp LOS                    | B   | B   | C   | A   | B   | B   |   |      |
| Approach Vol, veh/h          | 1239  |   |   | 979   | 471   |   |   |      |
| Approach Delay, s/veh        | 11.3  |   |   | 5.5   | 15.0  |   |   |      |
| Approach LOS                 | B   |   |   | A   | B   |   |   |      |
| Timer                        | 1   | 2   | 3   | 4   | 5   | 6   | 7 | 8    |
| Assigned Phs                 | 1   | 2   |   |   |   | 6   |   | 8    |
| Phs Duration (G+Y+Rc), s     | 7.1   | 19.5  |   |   |   | 26.6  |   | 9.4  |
| Change Period (Y+Rc), s      | 5.3   | * 5.3   |   |   |   | 5.3   |   | 4.0  |
| Max Green Setting (Gmax), s  | 20.0  | * 30  |   |   |   | 30.0  |   | 22.0 |
| Max Q Clear Time (g_c+I1), s | 3.5   | 13.3  |   |   |   | 7.0   |   | 5.3  |
| Green Ext Time (p_c), s      | 0.0   | 0.9   |   |   |   | 1.0   |   | 0.1  |
| <b>Intersection Summary</b>  |   |   |   |   |   |   |   |      |
| HCM 2010 Ctrl Delay          |   |   | 9.8   |   |   |   |   |      |
| HCM 2010 LOS                 |   |   | A   |   |   |   |   |      |
| <b>Notes</b>                 |   |   |   |   |   |   |   |      |

HCM 2010 Signalized Intersection Summary  
 11: Abrams Drive & Imjin Parkway

Cumulative with Eastside Parkway, PM  
 06/11/2019



| Movement                     | EBL  | EBT  | EBR  | WBL  | WBT  | WBR  | NBL  | NBT  | NBR  | SBL  | SBT  | SBR  |
|------------------------------|------|------|------|------|------|------|------|------|------|------|------|------|
| Lane Configurations          | ↔    | ↕    |      | ↔    | ↕    |      | ↔    | ↕    | ↗    | ↖    | ↕    | ↗    |
| Traffic Volume (veh/h)       | 130  | 1090 | 180  | 160  | 730  | 120  | 120  | 30   | 180  | 60   | 20   | 120  |
| Future Volume (veh/h)        | 130  | 1090 | 180  | 160  | 730  | 120  | 120  | 30   | 180  | 60   | 20   | 120  |
| Number                       | 5    | 2    | 12   | 1    | 6    | 16   | 3    | 8    | 18   | 7    | 4    | 14   |
| Initial Q (Qb), veh          | 0    | 0    | 0    | 0    | 0    | 0    | 0    | 0    | 0    | 0    | 0    | 0    |
| Ped-Bike Adj(A_pbT)          | 1.00 |      | 1.00 | 1.00 |      | 1.00 | 1.00 |      | 1.00 | 1.00 |      | 1.00 |
| Parking Bus, Adj             | 1.00 | 1.00 | 1.00 | 1.00 | 1.00 | 1.00 | 1.00 | 1.00 | 1.00 | 1.00 | 1.00 | 1.00 |
| Adj Sat Flow, veh/h/ln       | 1881 | 1881 | 1900 | 1881 | 1881 | 1900 | 1881 | 1881 | 1881 | 1863 | 1863 | 1863 |
| Adj Flow Rate, veh/h         | 140  | 1172 | 145  | 172  | 785  | 109  | 129  | 32   | 0    | 65   | 22   | 0    |
| Adj No. of Lanes             | 2    | 2    | 0    | 2    | 2    | 0    | 1    | 1    | 1    | 1    | 1    | 1    |
| Peak Hour Factor             | 0.93 | 0.93 | 0.93 | 0.93 | 0.93 | 0.93 | 0.93 | 0.93 | 0.93 | 0.93 | 0.93 | 0.93 |
| Percent Heavy Veh, %         | 1    | 1    | 1    | 1    | 1    | 1    | 1    | 1    | 1    | 2    | 2    | 2    |
| Cap, veh/h                   | 286  | 1937 | 239  | 260  | 1861 | 258  | 275  | 248  | 210  | 266  | 245  | 208  |
| Arrive On Green              | 0.08 | 0.60 | 0.60 | 0.07 | 0.59 | 0.59 | 0.13 | 0.13 | 0.00 | 0.13 | 0.13 | 0.00 |
| Sat Flow, veh/h              | 3476 | 3203 | 395  | 3476 | 3153 | 438  | 1395 | 1881 | 1599 | 1369 | 1863 | 1583 |
| Grp Volume(v), veh/h         | 140  | 653  | 664  | 172  | 445  | 449  | 129  | 32   | 0    | 65   | 22   | 0    |
| Grp Sat Flow(s),veh/h/ln     | 1738 | 1787 | 1811 | 1738 | 1787 | 1804 | 1395 | 1881 | 1599 | 1369 | 1863 | 1583 |
| Q Serve(g_s), s              | 2.6  | 15.4 | 15.5 | 3.3  | 9.2  | 9.2  | 6.1  | 1.0  | 0.0  | 3.0  | 0.7  | 0.0  |
| Cycle Q Clear(g_c), s        | 2.6  | 15.4 | 15.5 | 3.3  | 9.2  | 9.2  | 6.8  | 1.0  | 0.0  | 4.0  | 0.7  | 0.0  |
| Prop In Lane                 | 1.00 |      | 0.22 | 1.00 |      | 0.24 | 1.00 |      | 1.00 | 1.00 |      | 1.00 |
| Lane Grp Cap(c), veh/h       | 286  | 1081 | 1095 | 260  | 1054 | 1064 | 275  | 248  | 210  | 266  | 245  | 208  |
| V/C Ratio(X)                 | 0.49 | 0.60 | 0.61 | 0.66 | 0.42 | 0.42 | 0.47 | 0.13 | 0.00 | 0.24 | 0.09 | 0.00 |
| Avail Cap(c_a), veh/h        | 1025 | 1318 | 1336 | 1025 | 1318 | 1330 | 709  | 832  | 708  | 691  | 824  | 701  |
| HCM Platoon Ratio            | 1.00 | 1.00 | 1.00 | 1.00 | 1.00 | 1.00 | 1.00 | 1.00 | 1.00 | 1.00 | 1.00 | 1.00 |
| Upstream Filter(I)           | 1.00 | 1.00 | 1.00 | 1.00 | 1.00 | 1.00 | 1.00 | 1.00 | 0.00 | 1.00 | 1.00 | 0.00 |
| Uniform Delay (d), s/veh     | 29.8 | 8.3  | 8.4  | 30.5 | 7.6  | 7.6  | 28.8 | 26.0 | 0.0  | 27.8 | 25.9 | 0.0  |
| Incr Delay (d2), s/veh       | 0.5  | 0.2  | 0.2  | 1.1  | 0.1  | 0.1  | 0.5  | 0.1  | 0.0  | 0.2  | 0.1  | 0.0  |
| Initial Q Delay(d3),s/veh    | 0.0  | 0.0  | 0.0  | 0.0  | 0.0  | 0.0  | 0.0  | 0.0  | 0.0  | 0.0  | 0.0  | 0.0  |
| %ile BackOfQ(50%),veh/ln     | 1.3  | 7.5  | 7.6  | 1.6  | 4.5  | 4.5  | 2.4  | 0.5  | 0.0  | 1.1  | 0.4  | 0.0  |
| LnGrp Delay(d),s/veh         | 30.2 | 8.5  | 8.6  | 31.6 | 7.7  | 7.7  | 29.3 | 26.1 | 0.0  | 27.9 | 25.9 | 0.0  |
| LnGrp LOS                    | C    | A    | A    | C    | A    | A    | C    | C    |      | C    | C    |      |
| Approach Vol, veh/h          |      | 1457 |      |      | 1066 |      |      | 161  |      |      | 87   |      |
| Approach Delay, s/veh        |      | 10.6 |      |      | 11.5 |      |      | 28.7 |      |      | 27.4 |      |
| Approach LOS                 |      | B    |      |      | B    |      |      | C    |      |      | C    |      |
| Timer                        | 1    | 2    | 3    | 4    | 5    | 6    | 7    | 8    |      |      |      |      |
| Assigned Phs                 | 1    | 2    |      | 4    | 5    | 6    |      | 8    |      |      |      |      |
| Phs Duration (G+Y+Rc), s     | 8.6  | 46.3 |      | 12.9 | 9.6  | 45.3 |      | 12.9 |      |      |      |      |
| Change Period (Y+Rc), s      | 3.5  | 5.3  |      | 4.0  | 4.0  | 5.3  |      | 4.0  |      |      |      |      |
| Max Green Setting (Gmax), s  | 20.0 | 50.0 |      | 30.0 | 20.0 | 50.0 |      | 30.0 |      |      |      |      |
| Max Q Clear Time (g_c+15), s | 15.3 | 17.5 |      | 6.0  | 4.6  | 11.2 |      | 8.8  |      |      |      |      |
| Green Ext Time (p_c), s      | 0.0  | 1.0  |      | 0.0  | 0.0  | 0.6  |      | 0.0  |      |      |      |      |
| <b>Intersection Summary</b>  |      |      |      |      |      |      |      |      |      |      |      |      |
| HCM 2010 Ctrl Delay          |      |      |      | 12.6 |      |      |      |      |      |      |      |      |
| HCM 2010 LOS                 |      |      |      | B    |      |      |      |      |      |      |      |      |













HCM 2010 Signalized Intersection Summary  
 12: Reservation Road & Imjin Parkway

Cumulative with Eastside Parkway, PM  
 06/11/2019



| Movement                    | EBL  | EBT   | EBR  | WBL  | WBT  | WBR   | NBL   | NBT  | NBR  | SBL  | SBT  | SBR  |
|-----------------------------|------|-------|------|------|------|-------|-------|------|------|------|------|------|
| Lane Configurations         |      |       |      |      |      |       |       |      |      |      |      |      |
| Traffic Volume (veh/h)      | 120  | 20    | 1190 | 10   | 40   | 30    | 780   | 630  | 10   | 20   | 940  | 180  |
| Future Volume (veh/h)       | 120  | 20    | 1190 | 10   | 40   | 30    | 780   | 630  | 10   | 20   | 940  | 180  |
| Number                      | 3    | 8     | 18   | 7    | 4    | 14    | 1     | 6    | 16   | 5    | 2    | 12   |
| Initial Q (Qb), veh         | 0    | 0     | 0    | 0    | 0    | 0     | 0     | 0    | 0    | 0    | 0    | 0    |
| Ped-Bike Adj(A_pbT)         | 1.00 |       | 1.00 | 1.00 |      | 0.99  | 1.00  |      | 1.00 | 1.00 |      | 1.00 |
| Parking Bus, Adj            | 1.00 | 1.00  | 1.00 | 1.00 | 1.00 | 1.00  | 1.00  | 1.00 | 1.00 | 1.00 | 1.00 | 1.00 |
| Adj Sat Flow, veh/h/ln      | 1881 | 1881  | 1881 | 1827 | 1827 | 1827  | 1881  | 1881 | 1881 | 1881 | 1881 | 1881 |
| Adj Flow Rate, veh/h        | 135  | 22    | 936  | 11   | 45   | 12    | 876   | 708  | 10   | 22   | 1056 | 68   |
| Adj No. of Lanes            | 2    | 1     | 2    | 1    | 1    | 1     | 2     | 2    | 1    | 2    | 2    | 1    |
| Peak Hour Factor            | 0.89 | 0.89  | 0.89 | 0.89 | 0.89 | 0.89  | 0.89  | 0.89 | 0.89 | 0.89 | 0.89 | 0.89 |
| Percent Heavy Veh, %        | 1    | 1     | 1    | 4    | 4    | 4     | 1     | 1    | 1    | 1    | 1    | 1    |
| Cap, veh/h                  | 802  | 434   | 1296 | 75   | 79   | 66    | 802   | 2048 | 916  | 55   | 1280 | 572  |
| Arrive On Green             | 0.23 | 0.23  | 0.23 | 0.04 | 0.04 | 0.04  | 0.23  | 0.57 | 0.57 | 0.02 | 0.36 | 0.36 |
| Sat Flow, veh/h             | 3476 | 1881  | 2802 | 1740 | 1827 | 1531  | 3476  | 3574 | 1599 | 3476 | 3574 | 1599 |
| Grp Volume(v), veh/h        | 135  | 22    | 936  | 11   | 45   | 12    | 876   | 708  | 10   | 22   | 1056 | 68   |
| Grp Sat Flow(s),veh/h/ln    | 1738 | 1881  | 1401 | 1740 | 1827 | 1531  | 1738  | 1787 | 1599 | 1738 | 1787 | 1599 |
| Q Serve(g_s), s             | 4.7  | 1.4   | 35.0 | 0.9  | 3.7  | 1.1   | 35.0  | 16.0 | 0.4  | 1.0  | 40.8 | 4.3  |
| Cycle Q Clear(g_c), s       | 4.7  | 1.4   | 35.0 | 0.9  | 3.7  | 1.1   | 35.0  | 16.0 | 0.4  | 1.0  | 40.8 | 4.3  |
| Prop In Lane                | 1.00 |       | 1.00 | 1.00 |      | 1.00  | 1.00  |      | 1.00 | 1.00 |      | 1.00 |
| Lane Grp Cap(c), veh/h      | 802  | 434   | 1296 | 75   | 79   | 66    | 802   | 2048 | 916  | 55   | 1280 | 572  |
| V/C Ratio(X)                | 0.17 | 0.05  | 0.72 | 0.15 | 0.57 | 0.18  | 1.09  | 0.35 | 0.01 | 0.40 | 0.83 | 0.12 |
| Avail Cap(c_a), veh/h       | 802  | 434   | 1296 | 356  | 373  | 313   | 802   | 2048 | 916  | 458  | 1414 | 633  |
| HCM Platoon Ratio           | 1.00 | 1.00  | 1.00 | 1.00 | 1.00 | 1.00  | 1.00  | 1.00 | 1.00 | 1.00 | 1.00 | 1.00 |
| Upstream Filter(I)          | 1.00 | 1.00  | 1.00 | 1.00 | 1.00 | 1.00  | 1.00  | 1.00 | 1.00 | 1.00 | 1.00 | 1.00 |
| Uniform Delay (d), s/veh    | 46.7 | 45.4  | 33.0 | 69.9 | 71.2 | 70.0  | 58.3  | 17.3 | 13.9 | 73.9 | 44.4 | 32.6 |
| Incr Delay (d2), s/veh      | 0.0  | 0.0   | 1.7  | 0.3  | 2.4  | 0.5   | 59.9  | 0.3  | 0.0  | 1.7  | 5.0  | 0.3  |
| Initial Q Delay(d3),s/veh   | 0.0  | 0.0   | 0.0  | 0.0  | 0.0  | 0.0   | 0.0   | 0.0  | 0.0  | 0.0  | 0.0  | 0.0  |
| %ile BackOfQ(50%),veh/ln    | 2.3  | 0.7   | 16.1 | 0.5  | 1.9  | 0.5   | 23.4  | 7.9  | 0.2  | 0.5  | 21.0 | 1.9  |
| LnGrp Delay(d),s/veh        | 46.7 | 45.4  | 34.7 | 70.2 | 73.5 | 70.4  | 118.2 | 17.5 | 13.9 | 75.6 | 49.3 | 32.9 |
| LnGrp LOS                   | D    | D     | C    | E    | E    | E     | F     | B    | B    | E    | D    | C    |
| Approach Vol, veh/h         |      | 1093  |      |      | 68   |       |       | 1594 |      |      | 1146 |      |
| Approach Delay, s/veh       |      | 36.4  |      |      | 72.5 |       |       | 72.8 |      |      | 48.9 |      |
| Approach LOS                |      | D     |      |      | E    |       |       | E    |      |      | D    |      |
| Timer                       | 1    | 2     | 3    | 4    | 5    | 6     | 7     | 8    |      |      |      |      |
| Assigned Phs                | 1    | 2     |      | 4    | 5    | 6     |       | 8    |      |      |      |      |
| Phs Duration (G+Y+Rc), s    | 39.1 | 60.5  |      | 11.6 | 6.5  | 93.1  |       | 40.5 |      |      |      |      |
| Change Period (Y+Rc), s     | 4.1  | * 6.2 |      | 5.0  | 4.1  | * 6.2 |       | 5.5  |      |      |      |      |
| Max Green Setting (Gmax), s | 35.0 | * 60  |      | 31.0 | 20.0 | * 50  |       | 35.0 |      |      |      |      |
| Max Q Clear Time (g_c+Q), s | 37.0 | 42.8  |      | 5.7  | 3.0  | 18.0  |       | 37.0 |      |      |      |      |
| Green Ext Time (p_c), s     | 0.0  | 11.5  |      | 0.2  | 0.0  | 10.6  |       | 0.0  |      |      |      |      |
| <b>Intersection Summary</b> |      |       |      |      |      |       |       |      |      |      |      |      |
| HCM 2010 Ctrl Delay         |      |       | 55.6 |      |      |       |       |      |      |      |      |      |
| HCM 2010 LOS                |      |       | E    |      |      |       |       |      |      |      |      |      |
| <b>Notes</b>                |      |       |      |      |      |       |       |      |      |      |      |      |

HCM 2010 Signalized Intersection Summary  
13: Reservation Road & Blanco Road

|                              |  |  |  |  |  |  |   |   |
|------------------------------|---|---|---|---|---|---|---|---|
| Movement                     | EBL   | EBT   | WBT   | WBR   | SBL   | SBR   |   |   |
| Lane Configurations          |  |  |  |  |  |  |   |   |
| Traffic Volume (veh/h)       | 1120  | 930   | 400   | 50  | 40  | 1030  |   |   |
| Future Volume (veh/h)        | 1120  | 930   | 400   | 50  | 40  | 1030  |   |   |
| Number                       | 5   | 2   | 6   | 16  | 7   | 14  |   |   |
| Initial Q (Qb), veh          | 0   | 0   | 0   | 0   | 0   | 0   |   |   |
| Ped-Bike Adj(A_pbT)          | 1.00  |   |   | 1.00  | 1.00  | 1.00  |   |   |
| Parking Bus, Adj             | 1.00  | 1.00  | 1.00  | 1.00  | 1.00  | 1.00  |   |   |
| Adj Sat Flow, veh/h/ln       | 1881  | 1881  | 1863  | 1863  | 1863  | 1863  |   |   |
| Adj Flow Rate, veh/h         | 1191  | 989   | 426   | 29  | 43  | 0   |   |   |
| Adj No. of Lanes             | 2   | 2   | 1   | 1   | 2   | 2   |   |   |
| Peak Hour Factor             | 0.94  | 0.94  | 0.94  | 0.94  | 0.94  | 0.94  |   |   |
| Percent Heavy Veh, %         | 1   | 1   | 2   | 2   | 2   | 2   |   |   |
| Cap, veh/h                   | 1318  | 2780  | 537   | 457   | 124   | 100   |   |   |
| Arrive On Green              | 0.38  | 0.78  | 0.29  | 0.29  | 0.04  | 0.00  |   |   |
| Sat Flow, veh/h              | 3476  | 3668  | 1863  | 1583  | 3442  | 2787  |   |   |
| Grp Volume(v), veh/h         | 1191  | 989   | 426   | 29  | 43  | 0   |   |   |
| Grp Sat Flow(s),veh/h/ln     | 1738  | 1787  | 1863  | 1583  | 1721  | 1393  |   |   |
| Q Serve(g_s), s              | 16.2  | 4.2   | 10.5  | 0.7   | 0.6   | 0.0   |   |   |
| Cycle Q Clear(g_c), s        | 16.2  | 4.2   | 10.5  | 0.7   | 0.6   | 0.0   |   |   |
| Prop In Lane                 | 1.00  |   |   | 1.00  | 1.00  | 1.00  |   |   |
| Lane Grp Cap(c), veh/h       | 1318  | 2780  | 537   | 457   | 124   | 100   |   |   |
| V/C Ratio(X)                 | 0.90  | 0.36  | 0.79  | 0.06  | 0.35  | 0.00  |   |   |
| Avail Cap(c_a), veh/h        | 2785  | 4295  | 2239  | 1903  | 1861  | 1507  |   |   |
| HCM Platoon Ratio            | 1.00  | 1.00  | 1.00  | 1.00  | 1.00  | 1.00  |   |   |
| Upstream Filter(I)           | 1.00  | 1.00  | 1.00  | 1.00  | 1.00  | 0.00  |   |   |
| Uniform Delay (d), s/veh     | 14.6  | 1.7   | 16.4  | 12.9  | 23.5  | 0.0   |   |   |
| Incr Delay (d2), s/veh       | 1.0   | 0.1   | 2.0   | 0.0   | 0.6   | 0.0   |   |   |
| Initial Q Delay(d3),s/veh    | 0.0   | 0.0   | 0.0   | 0.0   | 0.0   | 0.0   |   |   |
| %ile BackOfQ(50%),veh/ln     | 7.8   | 1.9   | 5.6   | 0.3   | 0.3   | 0.0   |   |   |
| LnGrp Delay(d),s/veh         | 15.6  | 1.8   | 18.4  | 12.9  | 24.1  | 0.0   |   |   |
| LnGrp LOS                    | B   | A   | B   | B   | C   |   |   |   |
| Approach Vol, veh/h          |   | 2180  | 455   |   | 43  |   |   |   |
| Approach Delay, s/veh        |   | 9.3   | 18.0  |   | 24.1  |   |   |   |
| Approach LOS                 |   | A   | B   |   | C   |   |   |   |
| Timer                        | 1   | 2   | 3   | 4   | 5   | 6   | 7 | 8 |
| Assigned Phs                 |   | 2   |   | 4   | 5   | 6   |   |   |
| Phs Duration (G+Y+Rc), s     |   | 44.6  |   | 5.3   | 24.4  | 20.2  |   |   |
| Change Period (Y+Rc), s      |   | 5.8   |   | 3.5   | 5.5   | 5.8   |   |   |
| Max Green Setting (Gmax), s  |   | 60.0  |   | 27.0  | 40.0  | 60.0  |   |   |
| Max Q Clear Time (g_c+I1), s |   | 6.2   |   | 2.6   | 18.2  | 12.5  |   |   |
| Green Ext Time (p_c), s      |   | 5.6   |   | 0.0   | 0.8   | 1.9   |   |   |
| <b>Intersection Summary</b>  |   |   |   |   |   |   |   |   |
| HCM 2010 Ctrl Delay          |   |   | 11.1  |   |   |   |   |   |
| HCM 2010 LOS                 |   |   | B   |   |   |   |   |   |

HCM 2010 Signalized Intersection Summary  
 14: Reservation Road & Inter-Garrison Road

Cumulative with Eastside Parkway, PM  
 06/11/2019



| Movement                     | EBL   | EBR   | NBL   | NBT   | SBT  | SBR  |   |      |
|------------------------------|-------|-------|-------|-------|------|------|---|------|
| Lane Configurations          |       |       |       |       |      |      |   |      |
| Traffic Volume (veh/h)       | 80    | 870   | 510   | 380   | 860  | 210  |   |      |
| Future Volume (veh/h)        | 80    | 870   | 510   | 380   | 860  | 210  |   |      |
| Number                       | 3     | 18    | 1     | 6     | 2    | 12   |   |      |
| Initial Q (Qb), veh          | 0     | 0     | 0     | 0     | 0    | 0    |   |      |
| Ped-Bike Adj(A_pbT)          | 1.00  | 1.00  | 1.00  |       |      | 1.00 |   |      |
| Parking Bus, Adj             | 1.00  | 1.00  | 1.00  | 1.00  | 1.00 | 1.00 |   |      |
| Adj Sat Flow, veh/h/ln       | 1881  | 1881  | 1845  | 1845  | 1881 | 1900 |   |      |
| Adj Flow Rate, veh/h         | 98    | 906   | 622   | 463   | 1049 | 247  |   |      |
| Adj No. of Lanes             | 1     | 1     | 1     | 2     | 2    | 0    |   |      |
| Peak Hour Factor             | 0.82  | 0.82  | 0.82  | 0.82  | 0.82 | 0.82 |   |      |
| Percent Heavy Veh, %         | 1     | 1     | 3     | 3     | 1    | 1    |   |      |
| Cap, veh/h                   | 423   | 658   | 308   | 2342  | 1299 | 305  |   |      |
| Arrive On Green              | 0.24  | 0.24  | 0.18  | 0.67  | 0.45 | 0.45 |   |      |
| Sat Flow, veh/h              | 1792  | 1599  | 1757  | 3597  | 2969 | 674  |   |      |
| Grp Volume(v), veh/h         | 98    | 906   | 622   | 463   | 650  | 646  |   |      |
| Grp Sat Flow(s),veh/h/ln     | 1792  | 1599  | 1757  | 1752  | 1787 | 1762 |   |      |
| Q Serve(g_s), s              | 5.0   | 27.0  | 20.0  | 5.8   | 35.8 | 36.2 |   |      |
| Cycle Q Clear(g_c), s        | 5.0   | 27.0  | 20.0  | 5.8   | 35.8 | 36.2 |   |      |
| Prop In Lane                 | 1.00  | 1.00  | 1.00  |       |      | 0.38 |   |      |
| Lane Grp Cap(c), veh/h       | 423   | 658   | 308   | 2342  | 808  | 796  |   |      |
| V/C Ratio(X)                 | 0.23  | 1.38  | 2.02  | 0.20  | 0.81 | 0.81 |   |      |
| Avail Cap(c_a), veh/h        | 423   | 658   | 308   | 2342  | 939  | 926  |   |      |
| HCM Platoon Ratio            | 1.00  | 1.00  | 1.00  | 1.00  | 1.00 | 1.00 |   |      |
| Upstream Filter(I)           | 1.00  | 1.00  | 1.00  | 1.00  | 1.00 | 1.00 |   |      |
| Uniform Delay (d), s/veh     | 35.2  | 33.6  | 47.1  | 7.2   | 27.0 | 27.1 |   |      |
| Incr Delay (d2), s/veh       | 0.3   | 179.1 | 471.2 | 0.1   | 5.5  | 5.8  |   |      |
| Initial Q Delay(d3),s/veh    | 0.0   | 0.0   | 0.0   | 0.0   | 0.0  | 0.0  |   |      |
| %ile BackOfQ(50%),veh/ln     | 2.5   | 53.4  | 49.9  | 2.8   | 18.8 | 18.9 |   |      |
| LnGrp Delay(d),s/veh         | 35.5  | 212.7 | 518.3 | 7.3   | 32.5 | 32.9 |   |      |
| LnGrp LOS                    | D     | F     | F     | A     | C    | C    |   |      |
| Approach Vol, veh/h          | 1004  |       |       | 1085  | 1296 |      |   |      |
| Approach Delay, s/veh        | 195.4 |       |       | 300.3 | 32.7 |      |   |      |
| Approach LOS                 | F     |       |       | F     | C    |      |   |      |
| Timer                        | 1     | 2     | 3     | 4     | 5    | 6    | 7 | 8    |
| Assigned Phs                 | 1     | 2     |       |       |      | 6    |   | 8    |
| Phs Duration (G+Y+Rc), s     | 4.7   | 58.0  |       |       |      | 82.7 |   | 31.5 |
| Change Period (Y+Rc), s      | 4.7   | 6.4   |       |       |      | 6.4  |   | 4.5  |
| Max Green Setting (Gmax), s  | 26    | 60.0  |       |       |      | 60.0 |   | 27.0 |
| Max Q Clear Time (g_c+Yc), s | 22.5  | 38.2  |       |       |      | 7.8  |   | 29.0 |
| Green Ext Time (p_c), s      | 0.0   | 13.4  |       |       |      | 5.4  |   | 0.0  |
| <b>Intersection Summary</b>  |       |       |       |       |      |      |   |      |
| HCM 2010 Ctrl Delay          |       |       | 166.7 |       |      |      |   |      |
| HCM 2010 LOS                 |       |       | F     |       |      |      |   |      |
| <b>Notes</b>                 |       |       |       |       |      |      |   |      |

HCM 2010 Signalized Intersection Summary  
 15: 2nd Avenue & 9th Street

Cumulative with Eastside Parkway, PM  
 06/11/2019



| Movement                     | EBL  | EBT  | EBR  | WBL  | WBT  | WBR  | NBL  | NBT  | NBR  | SBL  | SBT  | SBR  |
|------------------------------|------|------|------|------|------|------|------|------|------|------|------|------|
| Lane Configurations          |      | ↔    | ↔    |      | ↔    |      | ↔    | ↕    |      | ↔    | ↕    |      |
| Traffic Volume (veh/h)       | 10   | 10   | 30   | 40   | 10   | 20   | 20   | 650  | 50   | 40   | 550  | 10   |
| Future Volume (veh/h)        | 10   | 10   | 30   | 40   | 10   | 20   | 20   | 650  | 50   | 40   | 550  | 10   |
| Number                       | 5    | 2    | 12   | 1    | 6    | 16   | 3    | 8    | 18   | 7    | 4    | 14   |
| Initial Q (Qb), veh          | 0    | 0    | 0    | 0    | 0    | 0    | 0    | 0    | 0    | 0    | 0    | 0    |
| Ped-Bike Adj(A_pbT)          | 1.00 |      | 0.99 | 1.00 |      | 1.00 | 1.00 |      | 0.97 | 1.00 |      | 1.00 |
| Parking Bus, Adj             | 1.00 | 1.00 | 1.00 | 1.00 | 1.00 | 1.00 | 1.00 | 1.00 | 1.00 | 1.00 | 1.00 | 1.00 |
| Adj Sat Flow, veh/h/ln       | 1900 | 1900 | 1900 | 1900 | 1900 | 1900 | 1881 | 1881 | 1900 | 1827 | 1827 | 1900 |
| Adj Flow Rate, veh/h         | 11   | 11   | 23   | 44   | 11   | 3    | 22   | 714  | 51   | 44   | 604  | -1   |
| Adj No. of Lanes             | 0    | 1    | 1    | 0    | 1    | 0    | 1    | 2    | 0    | 1    | 2    | 0    |
| Peak Hour Factor             | 0.91 | 0.91 | 0.91 | 0.91 | 0.91 | 0.91 | 0.91 | 0.91 | 0.91 | 0.91 | 0.91 | 0.91 |
| Percent Heavy Veh, %         | 0    | 0    | 0    | 0    | 0    | 0    | 1    | 1    | 1    | 4    | 4    | 4    |
| Cap, veh/h                   | 267  | 212  | 305  | 375  | 81   | 15   | 49   | 1266 | 90   | 86   | 1379 | 0    |
| Arrive On Green              | 0.19 | 0.19 | 0.19 | 0.19 | 0.19 | 0.19 | 0.03 | 0.38 | 0.38 | 0.05 | 0.40 | 0.00 |
| Sat Flow, veh/h              | 594  | 1102 | 1591 | 1016 | 421  | 78   | 1792 | 3375 | 241  | 1740 | 3563 | 0    |
| Grp Volume(v), veh/h         | 22   | 0    | 23   | 58   | 0    | 0    | 22   | 378  | 387  | 44   | 603  | 0    |
| Grp Sat Flow(s),veh/h/ln     | 1696 | 0    | 1591 | 1515 | 0    | 0    | 1792 | 1787 | 1829 | 1740 | 1736 | 0    |
| Q Serve(g_s), s              | 0.0  | 0.0  | 0.4  | 0.4  | 0.0  | 0.0  | 0.4  | 5.9  | 5.9  | 0.9  | 4.5  | 0.0  |
| Cycle Q Clear(g_c), s        | 0.3  | 0.0  | 0.4  | 1.0  | 0.0  | 0.0  | 0.4  | 5.9  | 5.9  | 0.9  | 4.5  | 0.0  |
| Prop In Lane                 | 0.50 |      | 1.00 | 0.76 |      | 0.05 | 1.00 |      | 0.13 | 1.00 |      | 0.00 |
| Lane Grp Cap(c), veh/h       | 479  | 0    | 305  | 471  | 0    | 0    | 49   | 670  | 686  | 86   | 1379 | 0    |
| V/C Ratio(X)                 | 0.05 | 0.00 | 0.08 | 0.12 | 0.00 | 0.00 | 0.45 | 0.56 | 0.56 | 0.51 | 0.44 | 0.00 |
| Avail Cap(c_a), veh/h        | 1780 | 0    | 1581 | 1655 | 0    | 0    | 585  | 2030 | 2078 | 568  | 3943 | 0    |
| HCM Platoon Ratio            | 1.00 | 1.00 | 1.00 | 1.00 | 1.00 | 1.00 | 1.00 | 1.00 | 1.00 | 1.00 | 1.00 | 1.00 |
| Upstream Filter(I)           | 1.00 | 0.00 | 1.00 | 1.00 | 0.00 | 0.00 | 1.00 | 1.00 | 1.00 | 1.00 | 1.00 | 0.00 |
| Uniform Delay (d), s/veh     | 11.6 | 0.0  | 11.7 | 11.9 | 0.0  | 0.0  | 16.9 | 8.7  | 8.7  | 16.3 | 7.7  | 0.0  |
| Incr Delay (d2), s/veh       | 0.0  | 0.0  | 0.1  | 0.1  | 0.0  | 0.0  | 6.2  | 0.7  | 0.7  | 4.6  | 0.2  | 0.0  |
| Initial Q Delay(d3),s/veh    | 0.0  | 0.0  | 0.0  | 0.0  | 0.0  | 0.0  | 0.0  | 0.0  | 0.0  | 0.0  | 0.0  | 0.0  |
| %ile BackOfQ(50%),veh/ln     | 0.2  | 0.0  | 0.2  | 0.5  | 0.0  | 0.0  | 0.3  | 3.0  | 3.0  | 0.5  | 2.1  | 0.0  |
| LnGrp Delay(d),s/veh         | 11.7 | 0.0  | 11.8 | 12.0 | 0.0  | 0.0  | 23.1 | 9.5  | 9.5  | 20.9 | 8.0  | 0.0  |
| LnGrp LOS                    | B    |      | B    | B    |      |      | C    | A    | A    | C    | A    |      |
| Approach Vol, veh/h          |      | 45   |      |      | 58   |      |      | 787  |      |      | 647  |      |
| Approach Delay, s/veh        |      | 11.7 |      |      | 12.0 |      |      | 9.8  |      |      | 8.8  |      |
| Approach LOS                 |      | B    |      |      | B    |      |      | A    |      |      | A    |      |
| Timer                        | 1    | 2    | 3    | 4    | 5    | 6    | 7    | 8    |      |      |      |      |
| Assigned Phs                 |      | 2    | 3    | 4    |      | 6    | 7    | 8    |      |      |      |      |
| Phs Duration (G+Y+Rc), s     |      | 11.8 | 4.5  | 19.0 |      | 11.8 | 5.2  | 18.2 |      |      |      |      |
| Change Period (Y+Rc), s      |      | 5.0  | 3.5  | 5.0  |      | 5.0  | 3.5  | 5.0  |      |      |      |      |
| Max Green Setting (Gmax), s  |      | 35.0 | 11.5 | 40.0 |      | 35.0 | 11.5 | 40.0 |      |      |      |      |
| Max Q Clear Time (g_c+I1), s |      | 2.4  | 2.4  | 6.5  |      | 3.0  | 2.9  | 7.9  |      |      |      |      |
| Green Ext Time (p_c), s      |      | 0.1  | 0.0  | 4.4  |      | 0.3  | 0.0  | 5.2  |      |      |      |      |
| <b>Intersection Summary</b>  |      |      |      |      |      |      |      |      |      |      |      |      |
| HCM 2010 Ctrl Delay          |      |      | 9.6  |      |      |      |      |      |      |      |      |      |
| HCM 2010 LOS                 |      |      | A    |      |      |      |      |      |      |      |      |      |



HCM 2010 Signalized Intersection Summary  
 16: 2nd Avenue & 8th Street

Cumulative with Eastside Parkway, PM  
 06/11/2019



| Movement                     | WBL  | WBR  | NBT  | NBR  | SBL  | SBT  |      |      |
|------------------------------|------|------|------|------|------|------|------|------|
| Lane Configurations          |      |      |      |      |      |      |      |      |
| Traffic Volume (veh/h)       | 40   | 40   | 580  | 220  | 30   | 480  |      |      |
| Future Volume (veh/h)        | 40   | 40   | 580  | 220  | 30   | 480  |      |      |
| Number                       | 1    | 16   | 8    | 18   | 7    | 4    |      |      |
| Initial Q (Qb), veh          | 0    | 0    | 0    | 0    | 0    | 0    |      |      |
| Ped-Bike Adj(A_pbT)          | 1.00 | 1.00 |      | 0.97 | 1.00 |      |      |      |
| Parking Bus, Adj             | 1.00 | 1.00 | 1.00 | 1.00 | 1.00 | 1.00 |      |      |
| Adj Sat Flow, veh/h/ln       | 1900 | 1900 | 1881 | 1900 | 1827 | 1827 |      |      |
| Adj Flow Rate, veh/h         | 43   | 9    | 617  | 203  | 32   | 511  |      |      |
| Adj No. of Lanes             | 1    | 1    | 2    | 0    | 1    | 2    |      |      |
| Peak Hour Factor             | 0.94 | 0.94 | 0.94 | 0.94 | 0.94 | 0.94 |      |      |
| Percent Heavy Veh, %         | 0    | 0    | 1    | 1    | 4    | 4    |      |      |
| Cap, veh/h                   | 106  | 95   | 1176 | 386  | 68   | 2099 |      |      |
| Arrive On Green              | 0.06 | 0.06 | 0.45 | 0.45 | 0.04 | 0.60 |      |      |
| Sat Flow, veh/h              | 1810 | 1615 | 2721 | 863  | 1740 | 3563 |      |      |
| Grp Volume(v), veh/h         | 43   | 9    | 419  | 401  | 32   | 511  |      |      |
| Grp Sat Flow(s),veh/h/ln     | 1810 | 1615 | 1787 | 1703 | 1740 | 1736 |      |      |
| Q Serve(g_s), s              | 0.7  | 0.2  | 5.0  | 5.0  | 0.5  | 2.0  |      |      |
| Cycle Q Clear(g_c), s        | 0.7  | 0.2  | 5.0  | 5.0  | 0.5  | 2.0  |      |      |
| Prop In Lane                 | 1.00 | 1.00 |      | 0.51 | 1.00 |      |      |      |
| Lane Grp Cap(c), veh/h       | 106  | 95   | 800  | 762  | 68   | 2099 |      |      |
| V/C Ratio(X)                 | 0.40 | 0.09 | 0.52 | 0.53 | 0.47 | 0.24 |      |      |
| Avail Cap(c_a), veh/h        | 1828 | 1631 | 2707 | 2579 | 674  | 7011 |      |      |
| HCM Platoon Ratio            | 1.00 | 1.00 | 1.00 | 1.00 | 1.00 | 1.00 |      |      |
| Upstream Filter(I)           | 1.00 | 1.00 | 1.00 | 1.00 | 1.00 | 1.00 |      |      |
| Uniform Delay (d), s/veh     | 13.5 | 13.2 | 5.9  | 5.9  | 14.0 | 2.7  |      |      |
| Incr Delay (d2), s/veh       | 2.5  | 0.4  | 0.5  | 0.6  | 5.0  | 0.1  |      |      |
| Initial Q Delay(d3),s/veh    | 0.0  | 0.0  | 0.0  | 0.0  | 0.0  | 0.0  |      |      |
| %ile BackOfQ(50%),veh/ln     | 0.4  | 0.2  | 2.6  | 2.5  | 0.3  | 0.9  |      |      |
| LnGrp Delay(d),s/veh         | 15.9 | 13.7 | 6.5  | 6.5  | 19.0 | 2.8  |      |      |
| LnGrp LOS                    | B    | B    | A    | A    | B    | A    |      |      |
| Approach Vol, veh/h          | 52   |      | 820  |      |      | 543  |      |      |
| Approach Delay, s/veh        | 15.5 |      | 6.5  |      |      | 3.7  |      |      |
| Approach LOS                 | B    |      | A    |      |      | A    |      |      |
| Timer                        | 1    | 2    | 3    | 4    | 5    | 6    | 7    | 8    |
| Assigned Phs                 |      |      |      | 4    |      | 6    | 7    | 8    |
| Phs Duration (G+Y+Rc), s     |      |      |      | 23.0 |      | 6.7  | 4.7  | 18.3 |
| Change Period (Y+Rc), s      |      |      |      | 5.0  |      | 5.0  | 3.5  | 5.0  |
| Max Green Setting (Gmax), s  |      |      |      | 60.0 |      | 30.0 | 11.5 | 45.0 |
| Max Q Clear Time (g_c+I1), s |      |      |      | 4.0  |      | 2.7  | 2.5  | 7.0  |
| Green Ext Time (p_c), s      |      |      |      | 3.8  |      | 0.1  | 0.0  | 6.0  |
| <b>Intersection Summary</b>  |      |      |      |      |      |      |      |      |
| HCM 2010 Ctrl Delay          |      |      | 5.8  |      |      |      |      |      |
| HCM 2010 LOS                 |      |      | A    |      |      |      |      |      |

| Intersection              |     |
|---------------------------|-----|
| Intersection Delay, s/veh | 9.2 |
| Intersection LOS          | A   |

| Movement            | EBT  | EBR  | WBL  | WBT  | NBL  | NBR  |
|---------------------|------|------|------|------|------|------|
| Lane Configurations | ↑    | ↑    | ↑    | ↑    | ↑    | ↑    |
| Traffic Vol, veh/h  | 220  | 30   | 70   | 40   | 30   | 90   |
| Future Vol, veh/h   | 220  | 30   | 70   | 40   | 30   | 90   |
| Peak Hour Factor    | 0.92 | 0.92 | 0.92 | 0.92 | 0.92 | 0.92 |
| Heavy Vehicles, %   | 2    | 2    | 2    | 2    | 2    | 2    |
| Mvmt Flow           | 239  | 33   | 76   | 43   | 33   | 98   |
| Number of Lanes     | 1    | 1    | 1    | 1    | 1    | 1    |

| Approach                   | EB  | WB  | NB  |
|----------------------------|-----|-----|-----|
| Opposing Approach          | WB  | EB  |     |
| Opposing Lanes             | 2   | 2   | 0   |
| Conflicting Approach Left  |     | NB  | EB  |
| Conflicting Lanes Left     | 0   | 2   | 2   |
| Conflicting Approach Right | NB  |     | WB  |
| Conflicting Lanes Right    | 2   | 0   | 2   |
| HCM Control Delay          | 9.8 | 8.8 | 8.4 |
| HCM LOS                    | A   | A   | A   |

| Lane                   | NBLn1 | NBLn2 | EBLn1 | EBLn2 | WBLn1 | WBLn2 |
|------------------------|-------|-------|-------|-------|-------|-------|
| Vol Left, %            | 100%  | 0%    | 0%    | 0%    | 100%  | 0%    |
| Vol Thru, %            | 0%    | 0%    | 100%  | 0%    | 0%    | 100%  |
| Vol Right, %           | 0%    | 100%  | 0%    | 100%  | 0%    | 0%    |
| Sign Control           | Stop  | Stop  | Stop  | Stop  | Stop  | Stop  |
| Traffic Vol by Lane    | 30    | 90    | 220   | 30    | 70    | 40    |
| LT Vol                 | 30    | 0     | 0     | 0     | 70    | 0     |
| Through Vol            | 0     | 0     | 220   | 0     | 0     | 40    |
| RT Vol                 | 0     | 90    | 0     | 30    | 0     | 0     |
| Lane Flow Rate         | 33    | 98    | 239   | 33    | 76    | 43    |
| Geometry Grp           | 7     | 7     | 7     | 7     | 7     | 7     |
| Degree of Util (X)     | 0.054 | 0.13  | 0.331 | 0.039 | 0.119 | 0.062 |
| Departure Headway (Hd) | 5.992 | 4.786 | 4.982 | 4.279 | 5.607 | 5.104 |
| Convergence, Y/N       | Yes   | Yes   | Yes   | Yes   | Yes   | Yes   |
| Cap                    | 598   | 748   | 722   | 836   | 640   | 702   |
| Service Time           | 3.725 | 2.519 | 2.71  | 2.007 | 3.339 | 2.836 |
| HCM Lane V/C Ratio     | 0.055 | 0.131 | 0.331 | 0.039 | 0.119 | 0.061 |
| HCM Control Delay      | 9.1   | 8.2   | 10.2  | 7.2   | 9.1   | 8.2   |
| HCM Lane LOS           | A     | A     | B     | A     | A     | A     |
| HCM 95th-tile Q        | 0.2   | 0.4   | 1.4   | 0.1   | 0.4   | 0.2   |

| Intersection                |       |       |       |       |
|-----------------------------|-------|-------|-------|-------|
| Intersection Delay, s/veh   | 6.5   |       |       |       |
| Intersection LOS            | A     |       |       |       |
| Approach                    | EB    | WB    | NB    | SB    |
| Entry Lanes                 | 1     | 1     | 1     | 1     |
| Conflicting Circle Lanes    | 1     | 1     | 1     | 1     |
| Adj Approach Flow, veh/h    | 295   | 228   | 66    | 141   |
| Demand Flow Rate, veh/h     | 304   | 230   | 66    | 144   |
| Vehicles Circulating, veh/h | 129   | 293   | 373   | 74    |
| Vehicles Exiting, veh/h     | 89    | 146   | 60    | 449   |
| Follow-Up Headway, s        | 3.186 | 3.186 | 3.186 | 3.186 |
| Ped Vol Crossing Leg, #/h   | 0     | 0     | 0     | 0     |
| Ped Cap Adj                 | 1.000 | 1.000 | 1.000 | 1.000 |
| Approach Delay, s/veh       | 6.9   | 7.3   | 5.5   | 4.8   |
| Approach LOS                | A     | A     | A     | A     |
| Lane                        | Left  | Left  | Left  | Left  |
| Designated Moves            | LTR   | LTR   | LTR   | LTR   |
| Assumed Moves               | LTR   | LTR   | LTR   | LTR   |
| RT Channelized              |       |       |       |       |
| Lane Util                   | 1.000 | 1.000 | 1.000 | 1.000 |
| Critical Headway, s         | 5.193 | 5.193 | 5.193 | 5.193 |
| Entry Flow, veh/h           | 304   | 230   | 66    | 144   |
| Cap Entry Lane, veh/h       | 993   | 843   | 778   | 1049  |
| Entry HV Adj Factor         | 0.970 | 0.990 | 1.000 | 0.976 |
| Flow Entry, veh/h           | 295   | 228   | 66    | 141   |
| Cap Entry, veh/h            | 964   | 834   | 778   | 1025  |
| V/C Ratio                   | 0.306 | 0.273 | 0.085 | 0.137 |
| Control Delay, s/veh        | 6.9   | 7.3   | 5.5   | 4.8   |
| LOS                         | A     | A     | A     | A     |
| 95th %tile Queue, veh       | 1     | 1     | 0     | 0     |

HCM 2010 Signalized Intersection Summary  
 19: 2nd Avenue & Inter-Garrison Road

Cumulative with Eastside Parkway, PM  
 06/11/2019



| Movement                     | WBL  | WBR  | NBT  | NBR  | SBL  | SBT  |      |      |
|------------------------------|------|------|------|------|------|------|------|------|
| Lane Configurations          |      |      |      |      |      |      |      |      |
| Traffic Volume (veh/h)       | 70   | 30   | 780  | 80   | 30   | 510  |      |      |
| Future Volume (veh/h)        | 70   | 30   | 780  | 80   | 30   | 510  |      |      |
| Number                       | 1    | 16   | 8    | 18   | 7    | 4    |      |      |
| Initial Q (Qb), veh          | 0    | 0    | 0    | 0    | 0    | 0    |      |      |
| Ped-Bike Adj(A_pbT)          | 1.00 | 1.00 |      | 1.00 | 1.00 |      |      |      |
| Parking Bus, Adj             | 1.00 | 1.00 | 1.00 | 1.00 | 1.00 | 1.00 |      |      |
| Adj Sat Flow, veh/h/ln       | 1900 | 1900 | 1881 | 1900 | 1863 | 1863 |      |      |
| Adj Flow Rate, veh/h         | 72   | 7    | 804  | 74   | 31   | 526  |      |      |
| Adj No. of Lanes             | 1    | 1    | 2    | 0    | 1    | 2    |      |      |
| Peak Hour Factor             | 0.97 | 0.97 | 0.97 | 0.97 | 0.97 | 0.97 |      |      |
| Percent Heavy Veh, %         | 0    | 0    | 1    | 1    | 2    | 2    |      |      |
| Cap, veh/h                   | 278  | 248  | 1392 | 128  | 66   | 1977 |      |      |
| Arrive On Green              | 0.15 | 0.15 | 0.42 | 0.42 | 0.04 | 0.56 |      |      |
| Sat Flow, veh/h              | 1810 | 1615 | 3404 | 305  | 1774 | 3632 |      |      |
| Grp Volume(v), veh/h         | 72   | 7    | 434  | 444  | 31   | 526  |      |      |
| Grp Sat Flow(s),veh/h/ln     | 1810 | 1615 | 1787 | 1827 | 1774 | 1770 |      |      |
| Q Serve(g_s), s              | 1.2  | 0.1  | 6.5  | 6.5  | 0.6  | 2.7  |      |      |
| Cycle Q Clear(g_c), s        | 1.2  | 0.1  | 6.5  | 6.5  | 0.6  | 2.7  |      |      |
| Prop In Lane                 | 1.00 | 1.00 |      | 0.17 | 1.00 |      |      |      |
| Lane Grp Cap(c), veh/h       | 278  | 248  | 752  | 769  | 66   | 1977 |      |      |
| V/C Ratio(X)                 | 0.26 | 0.03 | 0.58 | 0.58 | 0.47 | 0.27 |      |      |
| Avail Cap(c_a), veh/h        | 1823 | 1627 | 2058 | 2104 | 587  | 5603 |      |      |
| HCM Platoon Ratio            | 1.00 | 1.00 | 1.00 | 1.00 | 1.00 | 1.00 |      |      |
| Upstream Filter(I)           | 1.00 | 1.00 | 1.00 | 1.00 | 1.00 | 1.00 |      |      |
| Uniform Delay (d), s/veh     | 13.0 | 12.5 | 7.7  | 7.7  | 16.4 | 4.0  |      |      |
| Incr Delay (d2), s/veh       | 0.5  | 0.0  | 0.7  | 0.7  | 5.1  | 0.1  |      |      |
| Initial Q Delay(d3),s/veh    | 0.0  | 0.0  | 0.0  | 0.0  | 0.0  | 0.0  |      |      |
| %ile BackOfQ(50%),veh/ln     | 0.6  | 0.1  | 3.3  | 3.4  | 0.4  | 1.3  |      |      |
| LnGrp Delay(d),s/veh         | 13.4 | 12.5 | 8.4  | 8.4  | 21.5 | 4.0  |      |      |
| LnGrp LOS                    | B    | B    | A    | A    | C    | A    |      |      |
| Approach Vol, veh/h          | 79   |      | 878  |      |      | 557  |      |      |
| Approach Delay, s/veh        | 13.4 |      | 8.4  |      |      | 5.0  |      |      |
| Approach LOS                 | B    |      | A    |      |      | A    |      |      |
| Timer                        | 1    | 2    | 3    | 4    | 5    | 6    | 7    | 8    |
| Assigned Phs                 |      |      |      | 4    |      | 6    | 7    | 8    |
| Phs Duration (G+Y+Rc), s     |      |      |      | 24.4 |      | 10.3 | 4.8  | 19.6 |
| Change Period (Y+Rc), s      |      |      |      | 5.0  |      | 5.0  | 3.5  | 5.0  |
| Max Green Setting (Gmax), s  |      |      |      | 55.0 |      | 35.0 | 11.5 | 40.0 |
| Max Q Clear Time (g_c+I1), s |      |      |      | 4.7  |      | 3.2  | 2.6  | 8.5  |
| Green Ext Time (p_c), s      |      |      |      | 3.9  |      | 0.2  | 0.0  | 6.2  |
| <b>Intersection Summary</b>  |      |      |      |      |      |      |      |      |
| HCM 2010 Ctrl Delay          |      |      | 7.4  |      |      |      |      |      |
| HCM 2010 LOS                 |      |      | A    |      |      |      |      |      |

| Intersection              |      |  |  |  |  |  |  |  |  |  |  |  |
|---------------------------|------|--|--|--|--|--|--|--|--|--|--|--|
| Intersection Delay, s/veh | 10.1 |  |  |  |  |  |  |  |  |  |  |  |
| Intersection LOS          | B    |  |  |  |  |  |  |  |  |  |  |  |























| Movement            | EBL  | EBT  | EBR  | WBL  | WBT  | WBR  | NBL  | NBT  | NBR  | SBL  | SBT  | SBR  |
|---------------------|------|------|------|------|------|------|------|------|------|------|------|------|
| Lane Configurations |      | ↕    |      |      | ↕    |      |      | ↕    |      |      | ↕    |      |
| Traffic Vol, veh/h  | 10   | 60   | 30   | 150  | 40   | 10   | 20   | 50   | 150  | 20   | 60   | 10   |
| Future Vol, veh/h   | 10   | 60   | 30   | 150  | 40   | 10   | 20   | 50   | 150  | 20   | 60   | 10   |
| Peak Hour Factor    | 0.82 | 0.82 | 0.82 | 0.82 | 0.82 | 0.82 | 0.82 | 0.82 | 0.82 | 0.82 | 0.82 | 0.82 |
| Heavy Vehicles, %   | 1    | 1    | 1    | 1    | 1    | 1    | 3    | 3    | 3    | 0    | 0    | 0    |
| Mvmt Flow           | 12   | 73   | 37   | 183  | 49   | 12   | 24   | 61   | 183  | 24   | 73   | 12   |
| Number of Lanes     | 0    | 1    | 0    | 0    | 1    | 0    | 0    | 1    | 0    | 0    | 1    | 0    |

| Approach                   | EB  | WB   | NB   | SB  |
|----------------------------|-----|------|------|-----|
| Opposing Approach          | WB  | EB   | SB   | NB  |
| Opposing Lanes             | 1   | 1    | 1    | 1   |
| Conflicting Approach Left  | SB  | NB   | EB   | WB  |
| Conflicting Lanes Left     | 1   | 1    | 1    | 1   |
| Conflicting Approach Right | NB  | SB   | WB   | EB  |
| Conflicting Lanes Right    | 1   | 1    | 1    | 1   |
| HCM Control Delay          | 9.1 | 10.9 | 10.1 | 9.2 |
| HCM LOS                    | A   | B    | B    | A   |

| Lane                   | NBLn1 | EBLn1 | WBLn1 | SBLn1 |
|------------------------|-------|-------|-------|-------|
| Vol Left, %            | 9%    | 10%   | 75%   | 22%   |
| Vol Thru, %            | 23%   | 60%   | 20%   | 67%   |
| Vol Right, %           | 68%   | 30%   | 5%    | 11%   |
| Sign Control           | Stop  | Stop  | Stop  | Stop  |
| Traffic Vol by Lane    | 220   | 100   | 200   | 90    |
| LT Vol                 | 20    | 10    | 150   | 20    |
| Through Vol            | 50    | 60    | 40    | 60    |
| RT Vol                 | 150   | 30    | 10    | 10    |
| Lane Flow Rate         | 268   | 122   | 244   | 110   |
| Geometry Grp           | 1     | 1     | 1     | 1     |
| Degree of Util (X)     | 0.344 | 0.169 | 0.344 | 0.156 |
| Departure Headway (Hd) | 4.62  | 4.981 | 5.082 | 5.131 |
| Convergence, Y/N       | Yes   | Yes   | Yes   | Yes   |
| Cap                    | 770   | 711   | 700   | 690   |
| Service Time           | 2.695 | 3.077 | 3.168 | 3.225 |
| HCM Lane V/C Ratio     | 0.348 | 0.172 | 0.349 | 0.159 |
| HCM Control Delay      | 10.1  | 9.1   | 10.9  | 9.2   |
| HCM Lane LOS           | B     | A     | B     | A     |
| HCM 95th-tile Q        | 1.5   | 0.6   | 1.5   | 0.6   |

HCM 2010 Signalized Intersection Summary  
 21: 7th Avenue/8th Street & Inter-Garrison Road

Cumulative with Eastside Parkway, PM  
 07/12/2019

|                              |  |  |  |  |  |  |  |  |  |  |  |  |
|------------------------------|---|---|---|---|---|---|--|---|---|---|---|---|
| Movement                     | EBL   | EBT   | EBR   | WBL   | WBT   | WBR   | NBL  | NBT   | NBR   | SBL   | SBT   | SBR   |
| Lane Configurations          |  |  |   |  |  |   |  |  |  |  |  |  |
| Traffic Volume (veh/h)       | 10  | 240   | 70  | 80  | 160   | 30  | 50   | 120   | 170   | 90  | 10  | 10  |
| Future Volume (veh/h)        | 10  | 240   | 70  | 80  | 160   | 30  | 50   | 120   | 170   | 90  | 10  | 10  |
| Number                       | 5   | 2   | 12  | 1   | 6   | 16  | 3  | 8   | 18  | 7   | 4   | 14  |
| Initial Q (Qb), veh          | 0   | 0   | 0   | 0   | 0   | 0   | 0  | 0   | 0   | 0   | 0   | 0   |
| Ped-Bike Adj(A_pbT)          | 1.00  |   | 0.99  | 1.00  |   | 0.99  | 1.00   |   | 0.97  | 1.00  |   | 1.00  |
| Parking Bus, Adj             | 1.00  | 1.00  | 1.00  | 1.00  | 1.00  | 1.00  | 1.00   | 1.00  | 1.00  | 1.00  | 1.00  | 1.00  |
| Adj Sat Flow, veh/h/ln       | 1881  | 1881  | 1900  | 1827  | 1827  | 1900  | 1810   | 1810  | 1810  | 1900  | 1900  | 1900  |
| Adj Flow Rate, veh/h         | 11  | 258   | 69  | 86  | 172   | 17  | 54   | 129   | 111   | 97  | 11  | 2   |
| Adj No. of Lanes             | 1   | 1   | 0   | 1   | 1   | 0   | 1  | 1   | 1   | 1   | 1   | 0   |
| Peak Hour Factor             | 0.93  | 0.93  | 0.93  | 0.93  | 0.93  | 0.93  | 0.93   | 0.93  | 0.93  | 0.93  | 0.93  | 0.93  |
| Percent Heavy Veh, %         | 1   | 1   | 1   | 4   | 4   | 4   | 5  | 5   | 5   | 0   | 0   | 0   |
| Cap, veh/h                   | 21  | 402   | 107   | 108   | 542   | 54  | 215  | 267   | 221   | 191   | 201   | 37  |
| Arrive On Green              | 0.01  | 0.28  | 0.28  | 0.06  | 0.33  | 0.33  | 0.12   | 0.15  | 0.15  | 0.11  | 0.13  | 0.13  |
| Sat Flow, veh/h              | 1792  | 1429  | 382   | 1740  | 1636  | 162   | 1723   | 1810  | 1498  | 1810  | 1564  | 284   |
| Grp Volume(v), veh/h         | 11  | 0   | 327   | 86  | 0   | 189   | 54   | 129   | 111   | 97  | 0   | 13  |
| Grp Sat Flow(s),veh/h/ln     | 1792  | 0   | 1811  | 1740  | 0   | 1797  | 1723   | 1810  | 1498  | 1810  | 0   | 1849  |
| Q Serve(g_s), s              | 0.2   | 0.0   | 6.3   | 1.9   | 0.0   | 3.1   | 1.1  | 2.6   | 2.7   | 2.0   | 0.0   | 0.2   |
| Cycle Q Clear(g_c), s        | 0.2   | 0.0   | 6.3   | 1.9   | 0.0   | 3.1   | 1.1  | 2.6   | 2.7   | 2.0   | 0.0   | 0.2   |
| Prop In Lane                 | 1.00  |   | 0.21  | 1.00  |   | 0.09  | 1.00   |   | 1.00  | 1.00  |   | 0.15  |
| Lane Grp Cap(c), veh/h       | 21  | 0   | 509   | 108   | 0   | 596   | 215  | 267   | 221   | 191   | 0   | 237   |
| V/C Ratio(X)                 | 0.53  | 0.00  | 0.64  | 0.80  | 0.00  | 0.32  | 0.25   | 0.48  | 0.50  | 0.51  | 0.00  | 0.05  |
| Avail Cap(c_a), veh/h        | 181   | 0   | 1477  | 431   | 0   | 1729  | 313  | 1005  | 832   | 452   | 0   | 1153  |
| HCM Platoon Ratio            | 1.00  | 1.00  | 1.00  | 1.00  | 1.00  | 1.00  | 1.00   | 1.00  | 1.00  | 1.00  | 1.00  | 1.00  |
| Upstream Filter(I)           | 1.00  | 0.00  | 1.00  | 1.00  | 0.00  | 1.00  | 1.00   | 1.00  | 1.00  | 1.00  | 0.00  | 1.00  |
| Uniform Delay (d), s/veh     | 19.5  | 0.0   | 12.5  | 18.3  | 0.0   | 9.9   | 15.7   | 15.5  | 15.5  | 16.7  | 0.0   | 15.1  |
| Incr Delay (d2), s/veh       | 19.7  | 0.0   | 1.4   | 12.5  | 0.0   | 0.3   | 0.6  | 1.4   | 1.8   | 2.1   | 0.0   | 0.1   |
| Initial Q Delay(d3),s/veh    | 0.0   | 0.0   | 0.0   | 0.0   | 0.0   | 0.0   | 0.0  | 0.0   | 0.0   | 0.0   | 0.0   | 0.0   |
| %ile BackOfQ(50%),veh/ln     | 0.2   | 0.0   | 3.3   | 1.3   | 0.0   | 1.6   | 0.6  | 1.4   | 1.2   | 1.1   | 0.0   | 0.1   |
| LnGrp Delay(d),s/veh         | 39.2  | 0.0   | 13.9  | 30.9  | 0.0   | 10.2  | 16.3   | 16.9  | 17.3  | 18.8  | 0.0   | 15.2  |
| LnGrp LOS                    | D   |   | B   | C   |   | B   | B  | B   | B   | B   |   | B   |
| Approach Vol, veh/h          |   | 338   |   |   | 275   |   |  | 294   |   |   | 110   |   |
| Approach Delay, s/veh        |   | 14.7  |   |   | 16.7  |   |  | 16.9  |   |   | 18.4  |   |
| Approach LOS                 |   | B   |   |   | B   |   |  | B   |   |   | B   |   |
| Timer                        | 1   | 2   | 3   | 4   | 5   | 6   | 7  | 8   |   |   |   |   |
| Assigned Phs                 | 1   | 2   | 3   | 4   | 5   | 6   | 7  | 8   |   |   |   |   |
| Phs Duration (G+Y+Rc), s     | 6.0   | 16.1  | 8.4   | 9.1   | 4.0   | 18.1  | 7.7  | 9.8   |   |   |   |   |
| Change Period (Y+Rc), s      | 3.5   | 5.0   | 3.5   | 4.0   | 3.5   | 5.0   | 3.5  | 4.0   |   |   |   |   |
| Max Green Setting (Gmax), s  | 9.8   | 32.3  | 7.2   | 24.7  | 4.0   | 38.1  | 9.9  | 22.0  |   |   |   |   |
| Max Q Clear Time (g_c+I1), s | 3.9   | 8.3   | 3.1   | 2.2   | 2.2   | 5.1   | 4.0  | 4.7   |   |   |   |   |
| Green Ext Time (p_c), s      | 0.1   | 1.9   | 0.0   | 0.0   | 0.0   | 1.1   | 0.1  | 1.0   |   |   |   |   |
| <b>Intersection Summary</b>  |   |   |   |   |   |   |  |   |   |   |   |   |
| HCM 2010 Ctrl Delay          |   |   | 16.3  |   |   |   |  |   |   |   |   |   |
| HCM 2010 LOS                 |   |   | B   |   |   |   |  |   |   |   |   |   |

| Intersection                |       |       |       |
|-----------------------------|-------|-------|-------|
| Intersection Delay, s/veh   | 14.7  |       |       |
| Intersection LOS            | B     |       |       |
| Approach                    | EB    | WB    | NB    |
| Entry Lanes                 | 1     | 1     | 1     |
| Conflicting Circle Lanes    | 1     | 1     | 1     |
| Adj Approach Flow, veh/h    | 515   | 567   | 526   |
| Demand Flow Rate, veh/h     | 525   | 578   | 526   |
| Vehicles Circulating, veh/h | 368   | 62    | 378   |
| Vehicles Exiting, veh/h     | 272   | 842   | 515   |
| Follow-Up Headway, s        | 3.186 | 3.186 | 3.186 |
| Ped Vol Crossing Leg, #/h   | 0     | 0     | 0     |
| Ped Cap Adj                 | 1.000 | 1.000 | 1.000 |
| Approach Delay, s/veh       | 17.1  | 10.2  | 17.3  |
| Approach LOS                | C     | B     | C     |
| Lane                        | Left  | Left  | Left  |
| Designated Moves            | TR    | LT    | LR    |
| Assumed Moves               | TR    | LT    | LR    |
| RT Channelized              |       |       |       |
| Lane Util                   | 1.000 | 1.000 | 1.000 |
| Critical Headway, s         | 5.193 | 5.193 | 5.193 |
| Entry Flow, veh/h           | 525   | 578   | 526   |
| Cap Entry Lane, veh/h       | 782   | 1062  | 774   |
| Entry HV Adj Factor         | 0.980 | 0.981 | 1.000 |
| Flow Entry, veh/h           | 515   | 567   | 526   |
| Cap Entry, veh/h            | 767   | 1042  | 774   |
| V/C Ratio                   | 0.671 | 0.544 | 0.679 |
| Control Delay, s/veh        | 17.1  | 10.2  | 17.3  |
| LOS                         | C     | B     | C     |
| 95th %tile Queue, veh       | 5     | 3     | 5     |

HCM 2010 Signalized Intersection Summary  
 23: Inter-Garrison Road & Abrams Drive

Cumulative with Eastside Parkway, PM  
 06/11/2019

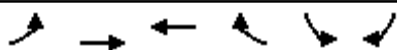

| Movement                     | EBL  | EBT  | WBT  | WBR  | SBL  | SBR  |   |   |
|------------------------------|------|------|------|------|------|------|---|---|
| Lane Configurations          |      |      |      |      |      |      |   |   |
| Traffic Volume (veh/h)       | 300  | 510  | 300  | 140  | 130  | 260  |   |   |
| Future Volume (veh/h)        | 300  | 510  | 300  | 140  | 130  | 260  |   |   |
| Number                       | 5    | 2    | 6    | 16   | 7    | 14   |   |   |
| Initial Q (Qb), veh          | 0    | 0    | 0    | 0    | 0    | 0    |   |   |
| Ped-Bike Adj(A_pbT)          | 1.00 |      |      | 0.98 | 1.00 | 1.00 |   |   |
| Parking Bus, Adj             | 1.00 | 1.00 | 1.00 | 1.00 | 1.00 | 1.00 |   |   |
| Adj Sat Flow, veh/h/ln       | 1863 | 1863 | 1792 | 1792 | 1827 | 1827 |   |   |
| Adj Flow Rate, veh/h         | 316  | 537  | 316  | 121  | 137  | 51   |   |   |
| Adj No. of Lanes             | 1    | 1    | 1    | 1    | 2    | 1    |   |   |
| Peak Hour Factor             | 0.95 | 0.95 | 0.95 | 0.95 | 0.95 | 0.95 |   |   |
| Percent Heavy Veh, %         | 2    | 2    | 6    | 6    | 4    | 4    |   |   |
| Cap, veh/h                   | 388  | 1185 | 554  | 461  | 340  | 157  |   |   |
| Arrive On Green              | 0.22 | 0.64 | 0.31 | 0.31 | 0.10 | 0.10 |   |   |
| Sat Flow, veh/h              | 1774 | 1863 | 1792 | 1491 | 3375 | 1553 |   |   |
| Grp Volume(v), veh/h         | 316  | 537  | 316  | 121  | 137  | 51   |   |   |
| Grp Sat Flow(s),veh/h/ln     | 1774 | 1863 | 1792 | 1491 | 1688 | 1553 |   |   |
| Q Serve(g_s), s              | 5.5  | 4.8  | 4.8  | 2.0  | 1.2  | 1.0  |   |   |
| Cycle Q Clear(g_c), s        | 5.5  | 4.8  | 4.8  | 2.0  | 1.2  | 1.0  |   |   |
| Prop In Lane                 | 1.00 |      |      | 1.00 | 1.00 | 1.00 |   |   |
| Lane Grp Cap(c), veh/h       | 388  | 1185 | 554  | 461  | 340  | 157  |   |   |
| V/C Ratio(X)                 | 0.81 | 0.45 | 0.57 | 0.26 | 0.40 | 0.33 |   |   |
| Avail Cap(c_a), veh/h        | 631  | 3456 | 2494 | 2075 | 3288 | 1513 |   |   |
| HCM Platoon Ratio            | 1.00 | 1.00 | 1.00 | 1.00 | 1.00 | 1.00 |   |   |
| Upstream Filter(I)           | 1.00 | 1.00 | 1.00 | 1.00 | 1.00 | 1.00 |   |   |
| Uniform Delay (d), s/veh     | 12.0 | 3.0  | 9.4  | 8.4  | 13.6 | 13.5 |   |   |
| Incr Delay (d2), s/veh       | 1.6  | 0.1  | 0.3  | 0.1  | 0.3  | 0.4  |   |   |
| Initial Q Delay(d3),s/veh    | 0.0  | 0.0  | 0.0  | 0.0  | 0.0  | 0.0  |   |   |
| %ile BackOfQ(50%),veh/ln     | 2.8  | 2.4  | 2.3  | 0.8  | 0.6  | 0.9  |   |   |
| LnGrp Delay(d),s/veh         | 13.6 | 3.1  | 9.7  | 8.5  | 13.9 | 14.0 |   |   |
| LnGrp LOS                    | B    | A    | A    | A    | B    | B    |   |   |
| Approach Vol, veh/h          |      | 853  | 437  |      | 188  |      |   |   |
| Approach Delay, s/veh        |      | 7.0  | 9.4  |      | 13.9 |      |   |   |
| Approach LOS                 |      | A    | A    |      | B    |      |   |   |
| Timer                        | 1    | 2    | 3    | 4    | 5    | 6    | 7 | 8 |
| Assigned Phs                 |      | 2    |      | 4    | 5    | 6    |   |   |
| Phs Duration (G+Y+Rc), s     |      | 25.6 |      | 6.8  | 10.6 | 15.0 |   |   |
| Change Period (Y+Rc), s      |      | 5.0  |      | 3.5  | 3.5  | 5.0  |   |   |
| Max Green Setting (Gmax), s  |      | 60.0 |      | 31.5 | 11.5 | 45.0 |   |   |
| Max Q Clear Time (g_c+I1), s |      | 6.8  |      | 3.2  | 7.5  | 6.8  |   |   |
| Green Ext Time (p_c), s      |      | 0.5  |      | 0.0  | 0.0  | 0.3  |   |   |
| <b>Intersection Summary</b>  |      |      |      |      |      |      |   |   |
| HCM 2010 Ctrl Delay          |      |      | 8.6  |      |      |      |   |   |
| HCM 2010 LOS                 |      |      | A    |      |      |      |   |   |
| <b>Notes</b>                 |      |      |      |      |      |      |   |   |



HCM 2010 Signalized Intersection Summary  
 24: Inter-Garrison Road & Schoonover Road

Cumulative with Eastside Parkway, PM  
 06/11/2019



| Movement                      | EBL  | EBT  | EBR  | WBL  | WBT  | WBR  | NBL  | NBT  | NBR  | SBL  | SBT  | SBR  |
|-------------------------------|------|------|------|------|------|------|------|------|------|------|------|------|
| Lane Configurations           |      |      |      |      |      |      |      |      |      |      |      |      |
| Traffic Volume (veh/h)        | 110  | 450  | 110  | 330  | 250  | 40   | 120  | 30   | 740  | 30   | 20   | 40   |
| Future Volume (veh/h)         | 110  | 450  | 110  | 330  | 250  | 40   | 120  | 30   | 740  | 30   | 20   | 40   |
| Number                        | 5    | 2    | 12   | 1    | 6    | 16   | 3    | 8    | 18   | 7    | 4    | 14   |
| Initial Q (Qb), veh           | 0    | 0    | 0    | 0    | 0    | 0    | 0    | 0    | 0    | 0    | 0    | 0    |
| Ped-Bike Adj(A_pbT)           | 1.00 |      | 1.00 | 1.00 |      | 1.00 | 1.00 |      | 1.00 | 1.00 |      | 1.00 |
| Parking Bus, Adj              | 1.00 | 1.00 | 1.00 | 1.00 | 1.00 | 1.00 | 1.00 | 1.00 | 1.00 | 1.00 | 1.00 | 1.00 |
| Adj Sat Flow, veh/h/ln        | 1881 | 1878 | 1900 | 1863 | 1810 | 1810 | 1863 | 1863 | 1863 | 1900 | 1711 | 1624 |
| Adj Flow Rate, veh/h          | 128  | 523  | 93   | 384  | 291  | 30   | 140  | 35   | 0    | 35   | 23   | 33   |
| Adj No. of Lanes              | 1    | 2    | 0    | 1    | 2    | 1    | 1    | 1    | 1    | 0    | 1    | 1    |
| Peak Hour Factor              | 0.86 | 0.86 | 0.86 | 0.86 | 0.86 | 0.86 | 0.86 | 0.86 | 0.86 | 0.86 | 0.86 | 0.86 |
| Percent Heavy Veh, %          | 1    | 1    | 1    | 2    | 5    | 5    | 2    | 2    | 2    | 2    | 2    | 17   |
| Cap, veh/h                    | 163  | 623  | 110  | 428  | 1223 | 547  | 260  | 273  | 232  | 124  | 81   | 171  |
| Arrive On Green               | 0.09 | 0.21 | 0.21 | 0.24 | 0.36 | 0.36 | 0.15 | 0.15 | 0.00 | 0.12 | 0.12 | 0.12 |
| Sat Flow, veh/h               | 1792 | 3030 | 537  | 1774 | 3438 | 1538 | 1774 | 1863 | 1583 | 1002 | 659  | 1380 |
| Grp Volume(v), veh/h          | 128  | 307  | 309  | 384  | 291  | 30   | 140  | 35   | 0    | 58   | 0    | 33   |
| Grp Sat Flow(s),veh/h/ln      | 1792 | 1784 | 1783 | 1774 | 1719 | 1538 | 1774 | 1863 | 1583 | 1661 | 0    | 1380 |
| Q Serve(g_s), s               | 4.6  | 10.8 | 10.9 | 13.7 | 3.9  | 0.8  | 4.8  | 1.1  | 0.0  | 2.1  | 0.0  | 1.4  |
| Cycle Q Clear(g_c), s         | 4.6  | 10.8 | 10.9 | 13.7 | 3.9  | 0.8  | 4.8  | 1.1  | 0.0  | 2.1  | 0.0  | 1.4  |
| Prop In Lane                  | 1.00 |      | 0.30 | 1.00 |      | 1.00 | 1.00 |      | 1.00 | 0.60 |      | 1.00 |
| Lane Grp Cap(c), veh/h        | 163  | 367  | 367  | 428  | 1223 | 547  | 260  | 273  | 232  | 205  | 0    | 171  |
| V/C Ratio(X)                  | 0.78 | 0.84 | 0.84 | 0.90 | 0.24 | 0.05 | 0.54 | 0.13 | 0.00 | 0.28 | 0.00 | 0.19 |
| Avail Cap(c_a), veh/h         | 836  | 818  | 818  | 936  | 1735 | 776  | 1085 | 1139 | 969  | 686  | 0    | 570  |
| HCM Platoon Ratio             | 1.00 | 1.00 | 1.00 | 1.00 | 1.00 | 1.00 | 1.00 | 1.00 | 1.00 | 1.00 | 1.00 | 1.00 |
| Upstream Filter(I)            | 1.00 | 1.00 | 1.00 | 1.00 | 1.00 | 1.00 | 1.00 | 1.00 | 0.00 | 1.00 | 0.00 | 1.00 |
| Uniform Delay (d), s/veh      | 29.1 | 24.9 | 25.0 | 24.0 | 14.8 | 13.8 | 25.9 | 24.3 | 0.0  | 26.0 | 0.0  | 25.7 |
| Incr Delay (d2), s/veh        | 3.1  | 2.0  | 2.0  | 2.8  | 0.0  | 0.0  | 0.6  | 0.1  | 0.0  | 0.3  | 0.0  | 0.2  |
| Initial Q Delay(d3),s/veh     | 0.0  | 0.0  | 0.0  | 0.0  | 0.0  | 0.0  | 0.0  | 0.0  | 0.0  | 0.0  | 0.0  | 0.0  |
| %ile BackOfQ(50%),veh/ln      | 2.4  | 5.5  | 5.5  | 7.0  | 1.9  | 0.4  | 2.4  | 0.6  | 0.0  | 1.0  | 0.0  | 0.5  |
| LnGrp Delay(d),s/veh          | 32.2 | 26.9 | 27.0 | 26.8 | 14.9 | 13.9 | 26.5 | 24.3 | 0.0  | 26.3 | 0.0  | 25.9 |
| LnGrp LOS                     | C    | C    | C    | C    | B    | B    | C    | C    |      | C    |      | C    |
| Approach Vol, veh/h           |      | 744  |      |      | 705  |      |      | 175  |      |      | 91   |      |
| Approach Delay, s/veh         |      | 27.9 |      |      | 21.3 |      |      | 26.1 |      |      | 26.2 |      |
| Approach LOS                  |      | C    |      |      | C    |      |      | C    |      |      | C    |      |
| Timer                         | 1    | 2    | 3    | 4    | 5    | 6    | 7    | 8    |      |      |      |      |
| Assigned Phs                  | 1    | 2    |      | 4    | 5    | 6    |      | 8    |      |      |      |      |
| Phs Duration (G+Y+Rc), s      | 19.3 | 18.4 |      | 13.1 | 9.5  | 28.3 |      | 14.6 |      |      |      |      |
| Change Period (Y+Rc), s       | 3.5  | 5.0  |      | 5.0  | 3.5  | 5.0  |      | 5.0  |      |      |      |      |
| Max Green Setting (Gmax), s   | 31.5 | 30.0 |      | 27.0 | 30.5 | 33.0 |      | 40.0 |      |      |      |      |
| Max Q Clear Time (g_c+1.5), s | 11.5 | 12.9 |      | 4.1  | 6.6  | 5.9  |      | 6.8  |      |      |      |      |
| Green Ext Time (p_c), s       | 0.1  | 0.6  |      | 0.0  | 0.0  | 0.3  |      | 0.0  |      |      |      |      |
| <b>Intersection Summary</b>   |      |      |      |      |      |      |      |      |      |      |      |      |
| HCM 2010 Ctrl Delay           |      |      |      | 24.9 |      |      |      |      |      |      |      |      |
| HCM 2010 LOS                  |      |      |      | C    |      |      |      |      |      |      |      |      |

| Intersection              |     |
|---------------------------|-----|
| Intersection Delay, s/veh | 273 |
| Intersection LOS          | F   |

| Movement            | EBL  | EBT  | WBT  | WBR  | SBL  | SBR  |
|---------------------|------|------|------|------|------|------|
| Lane Configurations |      |      |      |      |      |      |
| Traffic Vol, veh/h  | 900  | 270  | 160  | 100  | 130  | 410  |
| Future Vol, veh/h   | 900  | 270  | 160  | 100  | 130  | 410  |
| Peak Hour Factor    | 0.87 | 0.87 | 0.87 | 0.87 | 0.87 | 0.87 |
| Heavy Vehicles, %   | 1    | 1    | 6    | 6    | 3    | 3    |
| Mvmt Flow           | 1034 | 310  | 184  | 115  | 149  | 471  |
| Number of Lanes     | 1    | 1    | 1    | 0    | 1    | 1    |

| Approach                   | EB    | WB   | SB   |
|----------------------------|-------|------|------|
| Opposing Approach          | WB    | EB   |      |
| Opposing Lanes             | 1     | 2    | 0    |
| Conflicting Approach Left  | SB    |      | WB   |
| Conflicting Lanes Left     | 2     | 0    | 1    |
| Conflicting Approach Right |       | SB   | EB   |
| Conflicting Lanes Right    | 0     | 2    | 2    |
| HCM Control Delay          | 437.3 | 21.4 | 38.2 |
| HCM LOS                    | F     | C    | E    |

| Lane                   | EBLn1 | EBLn2 | WBLn1 | SBLn1 | SBLn2 |
|------------------------|-------|-------|-------|-------|-------|
| Vol Left, %            | 100%  | 0%    | 0%    | 100%  | 0%    |
| Vol Thru, %            | 0%    | 100%  | 62%   | 0%    | 0%    |
| Vol Right, %           | 0%    | 0%    | 38%   | 0%    | 100%  |
| Sign Control           | Stop  | Stop  | Stop  | Stop  | Stop  |
| Traffic Vol by Lane    | 900   | 270   | 260   | 130   | 410   |
| LT Vol                 | 900   | 0     | 0     | 130   | 0     |
| Through Vol            | 0     | 270   | 160   | 0     | 0     |
| RT Vol                 | 0     | 0     | 100   | 0     | 410   |
| Lane Flow Rate         | 1034  | 310   | 299   | 149   | 471   |
| Geometry Grp           | 7     | 7     | 4     | 7     | 7     |
| Degree of Util (X)     | 2.196 | 0.615 | 0.589 | 0.328 | 0.878 |
| Departure Headway (Hd) | 7.643 | 7.131 | 7.801 | 9.098 | 7.861 |
| Convergence, Y/N       | Yes   | Yes   | Yes   | Yes   | Yes   |
| Cap                    | 486   | 506   | 466   | 397   | 467   |
| Service Time           | 5.381 | 4.869 | 5.801 | 6.798 | 5.561 |
| HCM Lane V/C Ratio     | 2.128 | 0.613 | 0.642 | 0.375 | 1.009 |
| HCM Control Delay      | 562.3 | 20.6  | 21.4  | 16.2  | 45.2  |
| HCM Lane LOS           | F     | C     | C     | C     | E     |
| HCM 95th-tile Q        | 75.2  | 4.1   | 3.7   | 1.4   | 9.3   |

HCM 2010 Signalized Intersection Summary  
 26: East Garrison Road & Reservation Road

Cumulative with Eastside Parkway, PM  
 06/11/2019



| Movement                      | EBL  | EBT  | EBR  | WBL  | WBT  | WBR  | NBL  | NBT  | NBR  | SBL | SBT | SBR |
|-------------------------------|------|------|------|------|------|------|------|------|------|-----|-----|-----|
| Lane Configurations           |      |      |      |      |      |      |      |      |      |     |     |     |
| Traffic Volume (veh/h)        | 0    | 1510 | 130  | 230  | 760  | 0    | 110  | 0    | 150  | 0   | 0   | 0   |
| Future Volume (veh/h)         | 0    | 1510 | 130  | 230  | 760  | 0    | 110  | 0    | 150  | 0   | 0   | 0   |
| Number                        | 5    | 2    | 12   | 1    | 6    | 16   | 3    | 8    | 18   |     |     |     |
| Initial Q (Qb), veh           | 0    | 0    | 0    | 0    | 0    | 0    | 0    | 0    | 0    |     |     |     |
| Ped-Bike Adj(A_pbT)           | 1.00 |      | 1.00 | 1.00 |      | 1.00 | 1.00 |      | 1.00 |     |     |     |
| Parking Bus, Adj              | 1.00 | 1.00 | 1.00 | 1.00 | 1.00 | 1.00 | 1.00 | 1.00 | 1.00 |     |     |     |
| Adj Sat Flow, veh/h/ln        | 1863 | 1863 | 1900 | 1881 | 1881 | 0    | 1845 | 0    | 1845 |     |     |     |
| Adj Flow Rate, veh/h          | 0    | 1557 | 132  | 237  | 784  | 0    | 113  | 0    | 126  |     |     |     |
| Adj No. of Lanes              | 1    | 2    | 0    | 1    | 2    | 0    | 1    | 0    | 1    |     |     |     |
| Peak Hour Factor              | 0.97 | 0.97 | 0.97 | 0.97 | 0.97 | 0.97 | 0.97 | 0.97 | 0.97 |     |     |     |
| Percent Heavy Veh, %          | 2    | 2    | 2    | 1    | 1    | 0    | 3    | 0    | 3    |     |     |     |
| Cap, veh/h                    | 2    | 1972 | 166  | 271  | 2815 | 0    | 178  | 0    | 159  |     |     |     |
| Arrive On Green               | 0.00 | 0.60 | 0.60 | 0.15 | 0.79 | 0.00 | 0.10 | 0.00 | 0.10 |     |     |     |
| Sat Flow, veh/h               | 1774 | 3305 | 278  | 1792 | 3668 | 0    | 1757 | 0    | 1568 |     |     |     |
| Grp Volume(v), veh/h          | 0    | 828  | 861  | 237  | 784  | 0    | 113  | 0    | 126  |     |     |     |
| Grp Sat Flow(s),veh/h/ln      | 1774 | 1770 | 1814 | 1792 | 1787 | 0    | 1757 | 0    | 1568 |     |     |     |
| Q Serve(g_s), s               | 0.0  | 32.3 | 33.2 | 11.8 | 5.4  | 0.0  | 5.6  | 0.0  | 7.1  |     |     |     |
| Cycle Q Clear(g_c), s         | 0.0  | 32.3 | 33.2 | 11.8 | 5.4  | 0.0  | 5.6  | 0.0  | 7.1  |     |     |     |
| Prop In Lane                  | 1.00 |      | 0.15 | 1.00 |      | 0.00 | 1.00 |      | 1.00 |     |     |     |
| Lane Grp Cap(c), veh/h        | 2    | 1056 | 1082 | 271  | 2815 | 0    | 178  | 0    | 159  |     |     |     |
| V/C Ratio(X)                  | 0.00 | 0.78 | 0.80 | 0.87 | 0.28 | 0.00 | 0.63 | 0.00 | 0.79 |     |     |     |
| Avail Cap(c_a), veh/h         | 390  | 1166 | 1195 | 394  | 2815 | 0    | 521  | 0    | 465  |     |     |     |
| HCM Platoon Ratio             | 1.00 | 1.00 | 1.00 | 1.00 | 1.00 | 1.00 | 1.00 | 1.00 | 1.00 |     |     |     |
| Upstream Filter(I)            | 0.00 | 1.00 | 1.00 | 1.00 | 1.00 | 0.00 | 1.00 | 0.00 | 1.00 |     |     |     |
| Uniform Delay (d), s/veh      | 0.0  | 13.9 | 14.1 | 37.8 | 2.6  | 0.0  | 39.3 | 0.0  | 40.0 |     |     |     |
| Incr Delay (d2), s/veh        | 0.0  | 3.9  | 4.1  | 10.4 | 0.1  | 0.0  | 1.4  | 0.0  | 3.3  |     |     |     |
| Initial Q Delay(d3),s/veh     | 0.0  | 0.0  | 0.0  | 0.0  | 0.0  | 0.0  | 0.0  | 0.0  | 0.0  |     |     |     |
| %ile BackOfQ(50%),veh/ln      | 0.0  | 16.8 | 17.7 | 6.6  | 2.6  | 0.0  | 2.8  | 0.0  | 3.3  |     |     |     |
| LnGrp Delay(d),s/veh          | 0.0  | 17.8 | 18.2 | 48.1 | 2.7  | 0.0  | 40.7 | 0.0  | 43.3 |     |     |     |
| LnGrp LOS                     |      | B    | B    | D    | A    |      | D    |      | D    |     |     |     |
| Approach Vol, veh/h           |      | 1689 |      |      | 1021 |      |      | 239  |      |     |     |     |
| Approach Delay, s/veh         |      | 18.0 |      |      | 13.2 |      |      | 42.0 |      |     |     |     |
| Approach LOS                  |      | B    |      |      | B    |      |      | D    |      |     |     |     |
| Timer                         | 1    | 2    | 3    | 4    | 5    | 6    | 7    | 8    |      |     |     |     |
| Assigned Phs                  | 1    | 2    |      |      | 5    | 6    |      | 8    |      |     |     |     |
| Phs Duration (G+Y+Rc), s      | 7.4  | 59.7 |      |      | 0.0  | 77.1 |      | 13.9 |      |     |     |     |
| Change Period (Y+Rc), s       | 3.6  | 5.4  |      |      | 3.5  | 5.4  |      | 4.7  |      |     |     |     |
| Max Green Setting (Gmax), s   | 20   | 60.0 |      |      | 20.0 | 60.0 |      | 27.0 |      |     |     |     |
| Max Q Clear Time (g_c+113), s | 113  | 35.2 |      |      | 0.0  | 7.4  |      | 9.1  |      |     |     |     |
| Green Ext Time (p_c), s       | 0.0  | 19.1 |      |      | 0.0  | 7.0  |      | 0.1  |      |     |     |     |
| <b>Intersection Summary</b>   |      |      |      |      |      |      |      |      |      |     |     |     |
| HCM 2010 Ctrl Delay           |      |      |      | 18.3 |      |      |      |      |      |     |     |     |
| HCM 2010 LOS                  |      |      |      | B    |      |      |      |      |      |     |     |     |
| <b>Notes</b>                  |      |      |      |      |      |      |      |      |      |     |     |     |

HCM 2010 Signalized Intersection Summary  
27: Reservation Road & Watkins Gate Road

Cumulative with Eastside Parkway, PM  
06/11/2019



| Movement                     | EBL  | EBR  | NBL  | NBT   | SBT  | SBR  |   |       |
|------------------------------|------|------|------|-------|------|------|---|-------|
| Lane Configurations          |      |      |      |       |      |      |   |       |
| Traffic Volume (veh/h)       | 10   | 220  | 210  | 1190  | 2120 | 60   |   |       |
| Future Volume (veh/h)        | 10   | 220  | 210  | 1190  | 2120 | 60   |   |       |
| Number                       | 5    | 12   | 3    | 8     | 4    | 14   |   |       |
| Initial Q (Qb), veh          | 0    | 0    | 0    | 0     | 0    | 0    |   |       |
| Ped-Bike Adj(A_pbT)          | 1.00 | 1.00 | 1.00 |       |      | 1.00 |   |       |
| Parking Bus, Adj             | 1.00 | 1.00 | 1.00 | 1.00  | 1.00 | 1.00 |   |       |
| Adj Sat Flow, veh/h/ln       | 1863 | 1863 | 1881 | 1881  | 1863 | 1900 |   |       |
| Adj Flow Rate, veh/h         | 11   | 32   | 228  | 1293  | 2304 | 62   |   |       |
| Adj No. of Lanes             | 1    | 1    | 1    | 2     | 2    | 0    |   |       |
| Peak Hour Factor             | 0.92 | 0.92 | 0.92 | 0.92  | 0.92 | 0.92 |   |       |
| Percent Heavy Veh, %         | 2    | 2    | 1    | 1     | 2    | 2    |   |       |
| Cap, veh/h                   | 53   | 47   | 243  | 3117  | 2486 | 67   |   |       |
| Arrive On Green              | 0.03 | 0.03 | 0.14 | 0.87  | 0.71 | 0.71 |   |       |
| Sat Flow, veh/h              | 1774 | 1583 | 1792 | 3668  | 3615 | 94   |   |       |
| Grp Volume(v), veh/h         | 11   | 32   | 228  | 1293  | 1153 | 1213 |   |       |
| Grp Sat Flow(s),veh/h/ln     | 1774 | 1583 | 1792 | 1787  | 1770 | 1846 |   |       |
| Q Serve(g_s), s              | 0.8  | 2.7  | 16.7 | 9.6   | 72.8 | 74.7 |   |       |
| Cycle Q Clear(g_c), s        | 0.8  | 2.7  | 16.7 | 9.6   | 72.8 | 74.7 |   |       |
| Prop In Lane                 | 1.00 | 1.00 | 1.00 |       |      | 0.05 |   |       |
| Lane Grp Cap(c), veh/h       | 53   | 47   | 243  | 3117  | 1249 | 1303 |   |       |
| V/C Ratio(X)                 | 0.21 | 0.67 | 0.94 | 0.41  | 0.92 | 0.93 |   |       |
| Avail Cap(c_a), veh/h        | 274  | 245  | 243  | 3140  | 1261 | 1316 |   |       |
| HCM Platoon Ratio            | 1.00 | 1.00 | 1.00 | 1.00  | 1.00 | 1.00 |   |       |
| Upstream Filter(I)           | 1.00 | 1.00 | 1.00 | 1.00  | 1.00 | 1.00 |   |       |
| Uniform Delay (d), s/veh     | 62.8 | 63.7 | 56.7 | 1.7   | 16.4 | 16.7 |   |       |
| Incr Delay (d2), s/veh       | 0.7  | 6.0  | 40.3 | 0.1   | 11.5 | 12.0 |   |       |
| Initial Q Delay(d3),s/veh    | 0.0  | 0.0  | 0.0  | 0.0   | 0.0  | 0.0  |   |       |
| %ile BackOfQ(50%),veh/ln     | 0.4  | 1.2  | 11.0 | 4.7   | 38.9 | 41.8 |   |       |
| LnGrp Delay(d),s/veh         | 63.5 | 69.7 | 97.1 | 1.8   | 27.9 | 28.7 |   |       |
| LnGrp LOS                    | E    | E    | F    | A     | C    | C    |   |       |
| Approach Vol, veh/h          | 43   |      |      | 1521  | 2366 |      |   |       |
| Approach Delay, s/veh        | 68.1 |      |      | 16.1  | 28.3 |      |   |       |
| Approach LOS                 | E    |      |      | B     | C    |      |   |       |
| Timer                        | 1    | 2    | 3    | 4     | 5    | 6    | 7 | 8     |
| Assigned Phs                 |      | 2    | 3    | 4     |      |      |   | 8     |
| Phs Duration (G+Y+Rc), s     |      | 10.5 | 22.0 | 100.1 |      |      |   | 122.1 |
| Change Period (Y+Rc), s      |      | 6.5  | 4.0  | 6.5   |      |      |   | 6.5   |
| Max Green Setting (Gmax), s  |      | 20.5 | 18.0 | 94.5  |      |      |   | 116.5 |
| Max Q Clear Time (g_c+11), s |      | 4.7  | 18.7 | 76.7  |      |      |   | 11.6  |
| Green Ext Time (p_c), s      |      | 0.0  | 0.0  | 16.9  |      |      |   | 22.1  |
| <b>Intersection Summary</b>  |      |      |      |       |      |      |   |       |
| HCM 2010 Ctrl Delay          |      |      | 24.0 |       |      |      |   |       |
| HCM 2010 LOS                 |      |      | C    |       |      |      |   |       |

HCM 2010 Signalized Intersection Summary  
 28: Davis Road & Reservation Road

Cumulative with Eastside Parkway, PM  
 06/11/2019



| Movement                      | EBL   | EBT   | EBR   | WBL  | WBT   | WBR  | NBL  | NBT  | NBR  | SBL  | SBT  | SBR  |
|-------------------------------|-------|-------|-------|------|-------|------|------|------|------|------|------|------|
| Lane Configurations           |       |       |       |      |       |      |      |      |      |      |      |      |
| Traffic Volume (veh/h)        | 1260  | 510   | 10    | 10   | 350   | 100  | 10   | 10   | 10   | 120  | 10   | 720  |
| Future Volume (veh/h)         | 1260  | 510   | 10    | 10   | 350   | 100  | 10   | 10   | 10   | 120  | 10   | 720  |
| Number                        | 5     | 2     | 12    | 1    | 6     | 16   | 3    | 8    | 18   | 7    | 4    | 14   |
| Initial Q (Qb), veh           | 0     | 0     | 0     | 0    | 0     | 0    | 0    | 0    | 0    | 0    | 0    | 0    |
| Ped-Bike Adj(A_pbT)           | 1.00  |       | 1.00  | 1.00 |       | 1.00 | 1.00 |      | 1.00 | 1.00 |      | 1.00 |
| Parking Bus, Adj              | 1.00  | 1.00  | 1.00  | 1.00 | 1.00  | 1.00 | 1.00 | 1.00 | 1.00 | 1.00 | 1.00 | 1.00 |
| Adj Sat Flow, veh/h/ln        | 1863  | 1863  | 1900  | 1827 | 1835  | 1900 | 1900 | 1900 | 1900 | 1900 | 1881 | 1881 |
| Adj Flow Rate, veh/h          | 1340  | 543   | 11    | 11   | 372   | 106  | 11   | 11   | 9    | 128  | 11   | 631  |
| Adj No. of Lanes              | 1     | 2     | 0     | 1    | 1     | 0    | 0    | 1    | 0    | 0    | 1    | 1    |
| Peak Hour Factor              | 0.94  | 0.94  | 0.94  | 0.94 | 0.94  | 0.94 | 0.94 | 0.94 | 0.94 | 0.94 | 0.94 | 0.94 |
| Percent Heavy Veh, %          | 2     | 2     | 2     | 4    | 4     | 4    | 0    | 0    | 0    | 1    | 1    | 1    |
| Cap, veh/h                    | 453   | 1970  | 40    | 18   | 427   | 122  | 17   | 17   | 14   | 423  | 36   | 816  |
| Arrive On Green               | 0.26  | 0.56  | 0.56  | 0.01 | 0.31  | 0.31 | 0.03 | 0.03 | 0.03 | 0.26 | 0.26 | 0.26 |
| Sat Flow, veh/h               | 1774  | 3548  | 72    | 1740 | 1374  | 392  | 631  | 631  | 516  | 1656 | 142  | 1599 |
| Grp Volume(v), veh/h          | 1340  | 271   | 283   | 11   | 0     | 478  | 31   | 0    | 0    | 139  | 0    | 631  |
| Grp Sat Flow(s),veh/h/ln      | 1774  | 1770  | 1850  | 1740 | 0     | 1766 | 1777 | 0    | 0    | 1798 | 0    | 1599 |
| Q Serve(g_s), s               | 30.0  | 9.4   | 9.5   | 0.7  | 0.0   | 30.1 | 2.0  | 0.0  | 0.0  | 7.3  | 0.0  | 30.0 |
| Cycle Q Clear(g_c), s         | 30.0  | 9.4   | 9.5   | 0.7  | 0.0   | 30.1 | 2.0  | 0.0  | 0.0  | 7.3  | 0.0  | 30.0 |
| Prop In Lane                  | 1.00  |       | 0.04  | 1.00 |       | 0.22 | 0.35 |      | 0.29 | 0.92 |      | 1.00 |
| Lane Grp Cap(c), veh/h        | 453   | 982   | 1027  | 18   | 0     | 549  | 48   | 0    | 0    | 459  | 0    | 816  |
| V/C Ratio(X)                  | 2.96  | 0.28  | 0.28  | 0.62 | 0.00  | 0.87 | 0.64 | 0.00 | 0.00 | 0.30 | 0.00 | 0.77 |
| Avail Cap(c_a), veh/h         | 453   | 982   | 1027  | 444  | 0     | 901  | 454  | 0    | 0    | 459  | 0    | 816  |
| HCM Platoon Ratio             | 1.00  | 1.00  | 1.00  | 1.00 | 1.00  | 1.00 | 1.00 | 1.00 | 1.00 | 1.00 | 1.00 | 1.00 |
| Upstream Filter(I)            | 1.00  | 1.00  | 1.00  | 1.00 | 0.00  | 1.00 | 1.00 | 0.00 | 0.00 | 1.00 | 0.00 | 1.00 |
| Uniform Delay (d), s/veh      | 43.8  | 13.7  | 13.7  | 57.9 | 0.0   | 38.3 | 56.6 | 0.0  | 0.0  | 35.3 | 0.0  | 23.3 |
| Incr Delay (d2), s/veh        | 887.8 | 0.2   | 0.2   | 12.1 | 0.0   | 7.5  | 5.2  | 0.0  | 0.0  | 0.1  | 0.0  | 4.2  |
| Initial Q Delay(d3),s/veh     | 0.0   | 0.0   | 0.0   | 0.0  | 0.0   | 0.0  | 0.0  | 0.0  | 0.0  | 0.0  | 0.0  | 0.0  |
| %ile BackOfQ(50%),veh/ln      | 26.2  | 4.7   | 4.9   | 0.4  | 0.0   | 15.7 | 1.1  | 0.0  | 0.0  | 3.6  | 0.0  | 17.3 |
| LnGrp Delay(d),s/veh          | 931.6 | 14.0  | 14.0  | 70.0 | 0.0   | 45.7 | 61.9 | 0.0  | 0.0  | 35.5 | 0.0  | 27.5 |
| LnGrp LOS                     | F     | B     | B     | E    |       | D    | E    |      |      | D    |      | C    |
| Approach Vol, veh/h           |       | 1894  |       |      | 489   |      |      | 31   |      |      | 770  |      |
| Approach Delay, s/veh         |       | 663.2 |       |      | 46.3  |      |      | 61.9 |      |      | 28.9 |      |
| Approach LOS                  |       | F     |       |      | D     |      |      | E    |      |      | C    |      |
| Timer                         | 1     | 2     | 3     | 4    | 5     | 6    | 7    | 8    |      |      |      |      |
| Assigned Phs                  | 1     | 2     |       | 4    | 5     | 6    |      | 8    |      |      |      |      |
| Phs Duration (G+Y+Rc), s      | 5.1   | 70.3  |       | 35.0 | 33.8  | 41.6 |      | 7.2  |      |      |      |      |
| Change Period (Y+Rc), s       | 3.9   | 5.0   |       | 5.0  | * 3.8 | 5.0  |      | 4.0  |      |      |      |      |
| Max Green Setting (Gmax), s   | 30    | 60.0  |       | 30.0 | * 30  | 60.0 |      | 30.0 |      |      |      |      |
| Max Q Clear Time (g_c+1/2), s | 11.5  | 11.5  |       | 32.0 | 32.0  | 32.1 |      | 4.0  |      |      |      |      |
| Green Ext Time (p_c), s       | 0.0   | 5.2   |       | 0.0  | 0.0   | 4.5  |      | 0.0  |      |      |      |      |
| <b>Intersection Summary</b>   |       |       |       |      |       |      |      |      |      |      |      |      |
| HCM 2010 Ctrl Delay           |       |       | 409.2 |      |       |      |      |      |      |      |      |      |
| HCM 2010 LOS                  |       |       | F     |      |       |      |      |      |      |      |      |      |
| <b>Notes</b>                  |       |       |       |      |       |      |      |      |      |      |      |      |

HCM 2010 Signalized Intersection Summary  
29: 2nd Avenue & Divarty Street

Cumulative with Eastside Parkway, PM  
06/11/2019



| Movement                     | EBL  | EBT  | EBR  | WBL  | WBT  | WBR  | NBL  | NBT  | NBR  | SBL  | SBT  | SBR  |
|------------------------------|------|------|------|------|------|------|------|------|------|------|------|------|
| Lane Configurations          |      | ↕    |      |      | ↕    | ↕    | ↕    | ↕↔   |      | ↕    | ↕↔   |      |
| Traffic Volume (veh/h)       | 200  | 10   | 80   | 80   | 10   | 20   | 40   | 640  | 60   | 20   | 460  | 100  |
| Future Volume (veh/h)        | 200  | 10   | 80   | 80   | 10   | 20   | 40   | 640  | 60   | 20   | 460  | 100  |
| Number                       | 5    | 2    | 12   | 1    | 6    | 16   | 3    | 8    | 18   | 7    | 4    | 14   |
| Initial Q (Qb), veh          | 0    | 0    | 0    | 0    | 0    | 0    | 0    | 0    | 0    | 0    | 0    | 0    |
| Ped-Bike Adj(A_pbT)          | 1.00 |      | 1.00 | 1.00 |      | 1.00 | 1.00 |      | 0.99 | 1.00 |      | 0.99 |
| Parking Bus, Adj             | 1.00 | 1.00 | 1.00 | 1.00 | 1.00 | 1.00 | 1.00 | 1.00 | 1.00 | 1.00 | 1.00 | 1.00 |
| Adj Sat Flow, veh/h/ln       | 1900 | 1900 | 1900 | 1900 | 1900 | 1900 | 1900 | 1900 | 1900 | 1881 | 1881 | 1900 |
| Adj Flow Rate, veh/h         | 213  | 11   | 85   | 85   | 11   | 21   | 43   | 681  | 64   | 21   | 489  | 106  |
| Adj No. of Lanes             | 0    | 1    | 0    | 0    | 1    | 1    | 1    | 2    | 0    | 1    | 2    | 0    |
| Peak Hour Factor             | 0.94 | 0.94 | 0.94 | 0.94 | 0.94 | 0.94 | 0.94 | 0.94 | 0.94 | 0.94 | 0.94 | 0.94 |
| Percent Heavy Veh, %         | 0    | 0    | 0    | 0    | 0    | 0    | 0    | 0    | 0    | 1    | 1    | 1    |
| Cap, veh/h                   | 415  | 42   | 119  | 547  | 62   | 510  | 85   | 1136 | 107  | 46   | 934  | 201  |
| Arrive On Green              | 0.32 | 0.32 | 0.32 | 0.32 | 0.32 | 0.32 | 0.05 | 0.34 | 0.34 | 0.03 | 0.32 | 0.32 |
| Sat Flow, veh/h              | 858  | 131  | 375  | 1224 | 195  | 1607 | 1810 | 3334 | 313  | 1792 | 2923 | 630  |
| Grp Volume(v), veh/h         | 309  | 0    | 0    | 96   | 0    | 21   | 43   | 368  | 377  | 21   | 298  | 297  |
| Grp Sat Flow(s),veh/h/ln     | 1365 | 0    | 0    | 1419 | 0    | 1607 | 1810 | 1805 | 1843 | 1792 | 1787 | 1765 |
| Q Serve(g_s), s              | 6.9  | 0.0  | 0.0  | 0.0  | 0.0  | 0.4  | 1.0  | 7.2  | 7.2  | 0.5  | 5.8  | 5.9  |
| Cycle Q Clear(g_c), s        | 8.9  | 0.0  | 0.0  | 2.0  | 0.0  | 0.4  | 1.0  | 7.2  | 7.2  | 0.5  | 5.8  | 5.9  |
| Prop In Lane                 | 0.69 |      | 0.28 | 0.89 |      | 1.00 | 1.00 |      | 0.17 | 1.00 |      | 0.36 |
| Lane Grp Cap(c), veh/h       | 576  | 0    | 0    | 609  | 0    | 510  | 85   | 615  | 628  | 46   | 571  | 564  |
| V/C Ratio(X)                 | 0.54 | 0.00 | 0.00 | 0.16 | 0.00 | 0.04 | 0.51 | 0.60 | 0.60 | 0.45 | 0.52 | 0.53 |
| Avail Cap(c_a), veh/h        | 1309 | 0    | 0    | 1294 | 0    | 1317 | 487  | 1690 | 1725 | 482  | 1464 | 1446 |
| HCM Platoon Ratio            | 1.00 | 1.00 | 1.00 | 1.00 | 1.00 | 1.00 | 1.00 | 1.00 | 1.00 | 1.00 | 1.00 | 1.00 |
| Upstream Filter(I)           | 1.00 | 0.00 | 0.00 | 1.00 | 0.00 | 1.00 | 1.00 | 1.00 | 1.00 | 1.00 | 1.00 | 1.00 |
| Uniform Delay (d), s/veh     | 13.3 | 0.0  | 0.0  | 10.6 | 0.0  | 10.1 | 19.9 | 11.7 | 11.7 | 20.5 | 11.9 | 11.9 |
| Incr Delay (d2), s/veh       | 0.8  | 0.0  | 0.0  | 0.1  | 0.0  | 0.0  | 4.6  | 0.9  | 0.9  | 6.8  | 0.7  | 0.8  |
| Initial Q Delay(d3),s/veh    | 0.0  | 0.0  | 0.0  | 0.0  | 0.0  | 0.0  | 0.0  | 0.0  | 0.0  | 0.0  | 0.0  | 0.0  |
| %ile BackOfQ(50%),veh/ln     | 3.3  | 0.0  | 0.0  | 0.8  | 0.0  | 0.2  | 0.6  | 3.7  | 3.8  | 0.3  | 2.9  | 2.9  |
| LnGrp Delay(d),s/veh         | 14.1 | 0.0  | 0.0  | 10.7 | 0.0  | 10.1 | 24.5 | 12.6 | 12.6 | 27.3 | 12.6 | 12.6 |
| LnGrp LOS                    | B    |      |      | B    |      | B    | C    | B    | B    | C    | B    | B    |
| Approach Vol, veh/h          |      | 309  |      |      | 117  |      |      | 788  |      |      | 616  |      |
| Approach Delay, s/veh        |      | 14.1 |      |      | 10.6 |      |      | 13.3 |      |      | 13.1 |      |
| Approach LOS                 |      | B    |      |      | B    |      |      | B    |      |      | B    |      |
| Timer                        | 1    | 2    | 3    | 4    | 5    | 6    | 7    | 8    |      |      |      |      |
| Assigned Phs                 |      | 2    | 3    | 4    |      | 6    | 7    | 8    |      |      |      |      |
| Phs Duration (G+Y+Rc), s     |      | 18.6 | 5.5  | 18.7 |      | 18.6 | 4.6  | 19.6 |      |      |      |      |
| Change Period (Y+Rc), s      |      | 5.0  | 3.5  | 5.0  |      | 5.0  | 3.5  | 5.0  |      |      |      |      |
| Max Green Setting (Gmax), s  |      | 35.0 | 11.5 | 35.0 |      | 35.0 | 11.5 | 40.0 |      |      |      |      |
| Max Q Clear Time (g_c+I1), s |      | 10.9 | 3.0  | 7.9  |      | 4.0  | 2.5  | 9.2  |      |      |      |      |
| Green Ext Time (p_c), s      |      | 1.9  | 0.0  | 3.7  |      | 0.6  | 0.0  | 4.9  |      |      |      |      |
| <b>Intersection Summary</b>  |      |      |      |      |      |      |      |      |      |      |      |      |
| HCM 2010 Ctrl Delay          |      |      |      | 13.2 |      |      |      |      |      |      |      |      |
| HCM 2010 LOS                 |      |      |      | B    |      |      |      |      |      |      |      |      |

| Intersection              |      |  |  |  |  |  |  |  |  |  |  |  |
|---------------------------|------|--|--|--|--|--|--|--|--|--|--|--|
| Intersection Delay, s/veh | 10.6 |  |  |  |  |  |  |  |  |  |  |  |
| Intersection LOS          | B    |  |  |  |  |  |  |  |  |  |  |  |

| Movement            | EBL  | EBT  | EBR  | WBL  | WBT  | WBR  | NBL  | NBT  | NBR  | SBL  | SBT  | SBR  |
|---------------------|------|------|------|------|------|------|------|------|------|------|------|------|
| Lane Configurations |      | ↕    |      |      | ↕    |      | ↕    | ↕    |      | ↕    | ↕    |      |
| Traffic Vol, veh/h  | 20   | 10   | 30   | 30   | 10   | 10   | 20   | 200  | 60   | 10   | 210  | 20   |
| Future Vol, veh/h   | 20   | 10   | 30   | 30   | 10   | 10   | 20   | 200  | 60   | 10   | 210  | 20   |
| Peak Hour Factor    | 0.85 | 0.85 | 0.85 | 0.85 | 0.85 | 0.85 | 0.85 | 0.85 | 0.85 | 0.85 | 0.85 | 0.85 |
| Heavy Vehicles, %   | 0    | 0    | 0    | 1    | 1    | 1    | 0    | 0    | 0    | 1    | 1    | 1    |
| Mvmt Flow           | 24   | 12   | 35   | 35   | 12   | 12   | 24   | 235  | 71   | 12   | 247  | 24   |
| Number of Lanes     | 0    | 1    | 0    | 0    | 1    | 0    | 1    | 1    | 0    | 1    | 1    | 0    |

| Approach                   | EB  | WB  | NB | SB   |
|----------------------------|-----|-----|----|------|
| Opposing Approach          | WB  | EB  | SB | NB   |
| Opposing Lanes             | 1   | 1   | 2  | 2    |
| Conflicting Approach Left  | SB  | NB  | EB | WB   |
| Conflicting Lanes Left     | 2   | 2   | 1  | 1    |
| Conflicting Approach Right | NB  | SB  | WB | EB   |
| Conflicting Lanes Right    | 2   | 2   | 1  | 1    |
| HCM Control Delay          | 8.9 | 9.1 | 11 | 10.9 |
| HCM LOS                    | A   | A   | B  | B    |

| Lane                   | NBLn1 | NBLn2 | EBLn1 | WBLn1 | SBLn1 | SBLn2 |
|------------------------|-------|-------|-------|-------|-------|-------|
| Vol Left, %            | 100%  | 0%    | 33%   | 60%   | 100%  | 0%    |
| Vol Thru, %            | 0%    | 77%   | 17%   | 20%   | 0%    | 91%   |
| Vol Right, %           | 0%    | 23%   | 50%   | 20%   | 0%    | 9%    |
| Sign Control           | Stop  | Stop  | Stop  | Stop  | Stop  | Stop  |
| Traffic Vol by Lane    | 20    | 260   | 60    | 50    | 10    | 230   |
| LT Vol                 | 20    | 0     | 20    | 30    | 10    | 0     |
| Through Vol            | 0     | 200   | 10    | 10    | 0     | 210   |
| RT Vol                 | 0     | 60    | 30    | 10    | 0     | 20    |
| Lane Flow Rate         | 24    | 306   | 71    | 59    | 12    | 271   |
| Geometry Grp           | 7     | 7     | 2     | 2     | 7     | 7     |
| Degree of Util (X)     | 0.037 | 0.419 | 0.102 | 0.089 | 0.018 | 0.382 |
| Departure Headway (Hd) | 5.595 | 4.93  | 5.204 | 5.472 | 5.649 | 5.085 |
| Convergence, Y/N       | Yes   | Yes   | Yes   | Yes   | Yes   | Yes   |
| Cap                    | 638   | 728   | 684   | 650   | 631   | 704   |
| Service Time           | 3.346 | 2.68  | 3.274 | 3.545 | 3.404 | 2.839 |
| HCM Lane V/C Ratio     | 0.038 | 0.42  | 0.104 | 0.091 | 0.019 | 0.385 |
| HCM Control Delay      | 8.6   | 11.2  | 8.9   | 9.1   | 8.5   | 11    |
| HCM Lane LOS           | A     | B     | A     | A     | A     | B     |
| HCM 95th-tile Q        | 0.1   | 2.1   | 0.3   | 0.3   | 0.1   | 1.8   |

HCM 2010 Signalized Intersection Summary  
 31: 1st Avenue & Lightfighter Drive

Cumulative with Eastside Parkway, PM  
 06/11/2019



| Movement                     | EBL  | EBT  | EBR  | WBL  | WBT  | WBR  | NBL  | NBT  | NBR  | SBL  | SBT  | SBR  |
|------------------------------|------|------|------|------|------|------|------|------|------|------|------|------|
| Lane Configurations          |      | ↑↑   | ↑    | ↑    | ↑↑   |      | ↑    |      | ↑    | ↑    | ↑    | ↑    |
| Traffic Volume (veh/h)       | 0    | 1140 | 110  | 20   | 1430 | 0    | 200  | 0    | 30   | 60   | 50   | 80   |
| Future Volume (veh/h)        | 0    | 1140 | 110  | 20   | 1430 | 0    | 200  | 0    | 30   | 60   | 50   | 80   |
| Number                       | 7    | 4    | 14   | 3    | 8    | 18   | 5    | 2    | 12   | 1    | 6    | 16   |
| Initial Q (Qb), veh          | 0    | 0    | 0    | 0    | 0    | 0    | 0    | 0    | 0    | 0    | 0    | 0    |
| Ped-Bike Adj(A_pbT)          | 1.00 |      | 1.00 | 1.00 |      | 1.00 | 1.00 |      | 1.00 | 1.00 |      | 1.00 |
| Parking Bus, Adj             | 1.00 | 1.00 | 1.00 | 1.00 | 1.00 | 1.00 | 1.00 | 1.00 | 1.00 | 1.00 | 1.00 | 1.00 |
| Adj Sat Flow, veh/h/ln       | 0    | 1881 | 1881 | 1881 | 1881 | 0    | 1881 | 0    | 1881 | 1810 | 1810 | 1810 |
| Adj Flow Rate, veh/h         | 0    | 1200 | 0    | 21   | 1505 | 0    | 211  | 0    | 14   | 63   | 53   | 64   |
| Adj No. of Lanes             | 0    | 2    | 1    | 1    | 2    | 0    | 1    | 0    | 1    | 1    | 1    | 1    |
| Peak Hour Factor             | 0.95 | 0.95 | 0.95 | 0.95 | 0.95 | 0.95 | 0.95 | 0.95 | 0.95 | 0.95 | 0.95 | 0.95 |
| Percent Heavy Veh, %         | 0    | 1    | 1    | 1    | 1    | 0    | 1    | 0    | 1    | 5    | 5    | 5    |
| Cap, veh/h                   | 0    | 2194 | 982  | 23   | 2527 | 0    | 0    | 0    | 0    | 142  | 149  | 127  |
| Arrive On Green              | 0.00 | 0.61 | 0.00 | 0.01 | 0.71 | 0.00 | 0.00 | 0.00 | 0.00 | 0.08 | 0.08 | 0.08 |
| Sat Flow, veh/h              | 0    | 3668 | 1599 | 1792 | 3668 | 0    |      | 0    |      | 1723 | 1810 | 1538 |
| Grp Volume(v), veh/h         | 0    | 1200 | 0    | 21   | 1505 | 0    |      | 0.0  |      | 63   | 53   | 64   |
| Grp Sat Flow(s),veh/h/ln     | 0    | 1787 | 1599 | 1792 | 1787 | 0    |      |      |      | 1723 | 1810 | 1538 |
| Q Serve(g_s), s              | 0.0  | 8.5  | 0.0  | 0.5  | 9.3  | 0.0  |      |      |      | 1.5  | 1.2  | 1.7  |
| Cycle Q Clear(g_c), s        | 0.0  | 8.5  | 0.0  | 0.5  | 9.3  | 0.0  |      |      |      | 1.5  | 1.2  | 1.7  |
| Prop In Lane                 | 0.00 |      | 1.00 | 1.00 |      | 0.00 |      |      |      | 1.00 |      | 1.00 |
| Lane Grp Cap(c), veh/h       | 0    | 2194 | 982  | 23   | 2527 | 0    |      |      |      | 142  | 149  | 127  |
| V/C Ratio(X)                 | 0.00 | 0.55 | 0.00 | 0.90 | 0.60 | 0.00 |      |      |      | 0.44 | 0.36 | 0.50 |
| Avail Cap(c_a), veh/h        | 0    | 3681 | 1647 | 820  | 3681 | 0    |      |      |      | 986  | 1035 | 880  |
| HCM Platoon Ratio            | 1.00 | 1.00 | 1.00 | 1.00 | 1.00 | 1.00 |      |      |      | 1.00 | 1.00 | 1.00 |
| Upstream Filter(I)           | 0.00 | 1.00 | 0.00 | 1.00 | 1.00 | 0.00 |      |      |      | 1.00 | 1.00 | 1.00 |
| Uniform Delay (d), s/veh     | 0.0  | 4.9  | 0.0  | 21.5 | 3.2  | 0.0  |      |      |      | 19.1 | 18.9 | 19.2 |
| Incr Delay (d2), s/veh       | 0.0  | 0.3  | 0.0  | 32.9 | 0.3  | 0.0  |      |      |      | 0.8  | 0.5  | 1.2  |
| Initial Q Delay(d3),s/veh    | 0.0  | 0.0  | 0.0  | 0.0  | 0.0  | 0.0  |      |      |      | 0.0  | 0.0  | 0.0  |
| %ile BackOfQ(50%),veh/ln     | 0.0  | 4.1  | 0.0  | 0.5  | 4.5  | 0.0  |      |      |      | 0.7  | 0.6  | 0.8  |
| LnGrp Delay(d),s/veh         | 0.0  | 5.2  | 0.0  | 54.5 | 3.6  | 0.0  |      |      |      | 19.9 | 19.5 | 20.3 |
| LnGrp LOS                    |      | A    |      | D    | A    |      |      |      |      | B    | B    | C    |
| Approach Vol, veh/h          |      | 1200 |      |      | 1526 |      |      |      |      |      | 180  |      |
| Approach Delay, s/veh        |      | 5.2  |      |      | 4.3  |      |      |      |      |      | 19.9 |      |
| Approach LOS                 |      | A    |      |      | A    |      |      |      |      |      | B    |      |
| Timer                        | 1    | 2    | 3    | 4    | 5    | 6    | 7    | 8    |      |      |      |      |
| Assigned Phs                 |      |      | 3    | 4    |      | 6    |      | 8    |      |      |      |      |
| Phs Duration (G+Y+Rc), s     |      |      | 4.1  | 31.4 |      | 8.2  |      | 35.5 |      |      |      |      |
| Change Period (Y+Rc), s      |      |      | 3.5  | 4.6  |      | 4.6  |      | 4.6  |      |      |      |      |
| Max Green Setting (Gmax), s  |      |      | 20.0 | 45.0 |      | 25.0 |      | 45.0 |      |      |      |      |
| Max Q Clear Time (g_c+I1), s |      |      | 2.5  | 10.5 |      | 3.7  |      | 11.3 |      |      |      |      |
| Green Ext Time (p_c), s      |      |      | 0.0  | 15.8 |      | 0.3  |      | 19.6 |      |      |      |      |
| <b>Intersection Summary</b>  |      |      |      |      |      |      |      |      |      |      |      |      |
| HCM 2010 Ctrl Delay          |      |      | 5.6  |      |      |      |      |      |      |      |      |      |
| HCM 2010 LOS                 |      |      | A    |      |      |      |      |      |      |      |      |      |



HCM 2010 Signalized Intersection Summary  
 32: 2nd Avenue & Lightfighter Drive

Cumulative with Eastside Parkway, PM  
 06/11/2019



| Movement                     | EBL   | EBT  | EBR  | WBL  | WBT  | WBR  | NBL  | NBT  | NBR  | SBL  | SBT  | SBR  |
|------------------------------|-------|------|------|------|------|------|------|------|------|------|------|------|
| Lane Configurations          |       |      |      |      |      |      |      |      |      |      |      |      |
| Traffic Volume (veh/h)       | 290   | 940  | 10   | 80   | 1150 | 220  | 20   | 20   | 50   | 220  | 30   | 330  |
| Future Volume (veh/h)        | 290   | 940  | 10   | 80   | 1150 | 220  | 20   | 20   | 50   | 220  | 30   | 330  |
| Number                       | 5     | 2    | 12   | 1    | 6    | 16   | 3    | 8    | 18   | 7    | 4    | 14   |
| Initial Q (Qb), veh          | 0     | 0    | 0    | 0    | 0    | 0    | 0    | 0    | 0    | 0    | 0    | 0    |
| Ped-Bike Adj(A_pbT)          | 1.00  |      | 1.00 | 1.00 |      | 1.00 | 1.00 |      | 0.99 | 1.00 |      | 0.99 |
| Parking Bus, Adj             | 1.00  | 1.00 | 1.00 | 1.00 | 1.00 | 1.00 | 1.00 | 1.00 | 1.00 | 1.00 | 1.00 | 1.00 |
| Adj Sat Flow, veh/h/ln       | 1881  | 1881 | 1900 | 1881 | 1881 | 1900 | 1900 | 1900 | 1900 | 1845 | 1845 | 1845 |
| Adj Flow Rate, veh/h         | 305   | 989  | 11   | 84   | 1211 | 227  | 21   | 21   | 47   | 232  | 32   | 244  |
| Adj No. of Lanes             | 1     | 2    | 0    | 1    | 2    | 0    | 0    | 1    | 0    | 1    | 1    | 1    |
| Peak Hour Factor             | 0.95  | 0.95 | 0.95 | 0.95 | 0.95 | 0.95 | 0.95 | 0.95 | 0.95 | 0.95 | 0.95 | 0.95 |
| Percent Heavy Veh, %         | 1     | 1    | 1    | 1    | 1    | 1    | 0    | 0    | 0    | 3    | 3    | 3    |
| Cap, veh/h                   | 222   | 2215 | 25   | 108  | 1648 | 307  | 93   | 97   | 163  | 340  | 362  | 306  |
| Arrive On Green              | 0.12  | 0.61 | 0.61 | 0.06 | 0.55 | 0.55 | 0.20 | 0.20 | 0.20 | 0.20 | 0.20 | 0.20 |
| Sat Flow, veh/h              | 1792  | 3621 | 40   | 1792 | 3009 | 560  | 246  | 497  | 831  | 1308 | 1845 | 1558 |
| Grp Volume(v), veh/h         | 305   | 488  | 512  | 84   | 716  | 722  | 89   | 0    | 0    | 232  | 32   | 244  |
| Grp Sat Flow(s),veh/h/ln     | 1792  | 1787 | 1874 | 1792 | 1787 | 1782 | 1574 | 0    | 0    | 1308 | 1845 | 1558 |
| Q Serve(g_s), s              | 12.4  | 14.6 | 14.6 | 4.6  | 30.2 | 30.8 | 0.0  | 0.0  | 0.0  | 12.0 | 1.4  | 14.9 |
| Cycle Q Clear(g_c), s        | 12.4  | 14.6 | 14.6 | 4.6  | 30.2 | 30.8 | 4.4  | 0.0  | 0.0  | 16.3 | 1.4  | 14.9 |
| Prop In Lane                 | 1.00  |      | 0.02 | 1.00 |      | 0.31 | 0.24 |      | 0.53 | 1.00 |      | 1.00 |
| Lane Grp Cap(c), veh/h       | 222   | 1093 | 1146 | 108  | 979  | 976  | 354  | 0    | 0    | 340  | 362  | 306  |
| V/C Ratio(X)                 | 1.37  | 0.45 | 0.45 | 0.78 | 0.73 | 0.74 | 0.25 | 0.00 | 0.00 | 0.68 | 0.09 | 0.80 |
| Avail Cap(c_a), veh/h        | 222   | 1093 | 1146 | 222  | 979  | 976  | 666  | 0    | 0    | 611  | 745  | 630  |
| HCM Platoon Ratio            | 1.00  | 1.00 | 1.00 | 1.00 | 1.00 | 1.00 | 1.00 | 1.00 | 1.00 | 1.00 | 1.00 | 1.00 |
| Upstream Filter(I)           | 0.75  | 0.75 | 0.75 | 0.09 | 0.09 | 0.09 | 1.00 | 0.00 | 0.00 | 0.85 | 0.85 | 0.85 |
| Uniform Delay (d), s/veh     | 43.8  | 10.4 | 10.4 | 46.4 | 17.1 | 17.2 | 34.0 | 0.0  | 0.0  | 38.6 | 32.9 | 38.3 |
| Incr Delay (d2), s/veh       | 187.8 | 1.0  | 0.9  | 0.4  | 0.4  | 0.5  | 0.1  | 0.0  | 0.0  | 0.8  | 0.0  | 1.6  |
| Initial Q Delay(d3),s/veh    | 0.0   | 0.0  | 0.0  | 0.0  | 0.0  | 0.0  | 0.0  | 0.0  | 0.0  | 0.0  | 0.0  | 0.0  |
| %ile BackOfQ(50%),veh/ln     | 7.7   | 7.5  | 7.8  | 2.3  | 14.8 | 15.2 | 2.1  | 0.0  | 0.0  | 6.3  | 0.7  | 6.5  |
| LnGrp Delay(d),s/veh         | 231.6 | 11.4 | 11.3 | 46.8 | 17.5 | 17.7 | 34.2 | 0.0  | 0.0  | 39.3 | 32.9 | 39.9 |
| LnGrp LOS                    | F     | B    | B    | D    | B    | B    | C    |      |      | D    | C    | D    |
| Approach Vol, veh/h          |       | 1305 |      |      | 1522 |      |      | 89   |      |      | 508  |      |
| Approach Delay, s/veh        |       | 62.8 |      |      | 19.2 |      |      | 34.2 |      |      | 39.2 |      |
| Approach LOS                 |       | E    |      |      | B    |      |      | C    |      |      | D    |      |
| Timer                        | 1     | 2    | 3    | 4    | 5    | 6    | 7    | 8    |      |      |      |      |
| Assigned Phs                 | 1     | 2    |      | 4    | 5    | 6    |      | 8    |      |      |      |      |
| Phs Duration (G+Y+Rc), s     | 0.0   | 65.8 |      | 24.2 | 16.4 | 59.4 |      | 24.2 |      |      |      |      |
| Change Period (Y+Rc), s      | 4.0   | 4.6  |      | 4.6  | 4.0  | 4.6  |      | 4.6  |      |      |      |      |
| Max Green Setting (Gmax), s  | 2.4   | 34.0 |      | 40.4 | 12.4 | 24.4 |      | 40.4 |      |      |      |      |
| Max Q Clear Time (g_c+10), s | 16.6  | 16.6 |      | 18.3 | 14.4 | 32.8 |      | 6.4  |      |      |      |      |
| Green Ext Time (p_c), s      | 0.0   | 3.6  |      | 0.9  | 0.0  | 0.0  |      | 0.3  |      |      |      |      |
| <b>Intersection Summary</b>  |       |      |      |      |      |      |      |      |      |      |      |      |
| HCM 2010 Ctrl Delay          |       |      |      | 39.2 |      |      |      |      |      |      |      |      |
| HCM 2010 LOS                 |       |      |      | D    |      |      |      |      |      |      |      |      |

HCM 2010 Signalized Intersection Summary  
 33: General Jim Moore Boulevard & Lightfighter Drive

Cumulative with Eastside Parkway, PM  
 06/11/2019



| Movement                     | EBL  | EBT  | EBR  | WBL  | WBT  | WBR  | NBL  | NBT  | NBR  | SBL  | SBT  | SBR  |
|------------------------------|------|------|------|------|------|------|------|------|------|------|------|------|
| Lane Configurations          |      |      |      |      |      |      |      |      |      |      |      |      |
| Traffic Volume (veh/h)       | 130  | 270  | 740  | 40   | 270  | 50   | 630  | 80   | 20   | 60   | 100  | 70   |
| Future Volume (veh/h)        | 130  | 270  | 740  | 40   | 270  | 50   | 630  | 80   | 20   | 60   | 100  | 70   |
| Number                       | 3    | 8    | 18   | 7    | 4    | 14   | 1    | 6    | 16   | 5    | 2    | 12   |
| Initial Q (Qb), veh          | 0    | 0    | 0    | 0    | 0    | 0    | 0    | 0    | 0    | 0    | 0    | 0    |
| Ped-Bike Adj(A_pbT)          | 1.00 |      | 1.00 | 1.00 |      | 1.00 | 1.00 |      | 1.00 | 1.00 |      | 1.00 |
| Parking Bus, Adj             | 1.00 | 1.00 | 1.00 | 1.00 | 1.00 | 1.00 | 1.00 | 1.00 | 1.00 | 1.00 | 1.00 | 1.00 |
| Adj Sat Flow, veh/h/ln       | 1881 | 1881 | 1881 | 1900 | 1900 | 1900 | 1881 | 1881 | 1900 | 1900 | 1900 | 1900 |
| Adj Flow Rate, veh/h         | 135  | 281  | 0    | 42   | 281  | 51   | 656  | 83   | 19   | 62   | 104  | -39  |
| Adj No. of Lanes             | 1    | 1    | 1    | 1    | 1    | 0    | 2    | 1    | 0    | 1    | 2    | 0    |
| Peak Hour Factor             | 0.96 | 0.96 | 0.96 | 0.96 | 0.96 | 0.96 | 0.96 | 0.96 | 0.96 | 0.96 | 0.96 | 0.96 |
| Percent Heavy Veh, %         | 1    | 1    | 1    | 0    | 0    | 0    | 1    | 1    | 1    | 0    | 0    | 0    |
| Cap, veh/h                   | 179  | 590  | 502  | 63   | 389  | 71   | 666  | 387  | 89   | 82   | 415  | 0    |
| Arrive On Green              | 0.10 | 0.31 | 0.00 | 0.03 | 0.25 | 0.25 | 0.19 | 0.26 | 0.26 | 0.05 | 0.11 | 0.00 |
| Sat Flow, veh/h              | 1792 | 1881 | 1599 | 1810 | 1566 | 284  | 3476 | 1482 | 339  | 1810 | 3705 | 0    |
| Grp Volume(v), veh/h         | 135  | 281  | 0    | 42   | 0    | 332  | 656  | 0    | 102  | 62   | 65   | 0    |
| Grp Sat Flow(s),veh/h/ln     | 1792 | 1881 | 1599 | 1810 | 0    | 1850 | 1738 | 0    | 1821 | 1810 | 1805 | 0    |
| Q Serve(g_s), s              | 3.8  | 6.3  | 0.0  | 1.2  | 0.0  | 8.6  | 9.8  | 0.0  | 2.3  | 1.8  | 0.8  | 0.0  |
| Cycle Q Clear(g_c), s        | 3.8  | 6.3  | 0.0  | 1.2  | 0.0  | 8.6  | 9.8  | 0.0  | 2.3  | 1.8  | 0.8  | 0.0  |
| Prop In Lane                 | 1.00 |      | 1.00 | 1.00 |      | 0.15 | 1.00 |      | 0.19 | 1.00 |      | 0.00 |
| Lane Grp Cap(c), veh/h       | 179  | 590  | 502  | 63   | 0    | 460  | 666  | 0    | 475  | 82   | 415  | 0    |
| V/C Ratio(X)                 | 0.75 | 0.48 | 0.00 | 0.66 | 0.00 | 0.72 | 0.99 | 0.00 | 0.21 | 0.75 | 0.16 | 0.00 |
| Avail Cap(c_a), veh/h        | 686  | 1081 | 919  | 693  | 0    | 1063 | 666  | 0    | 1047 | 520  | 2075 | 0    |
| HCM Platoon Ratio            | 1.00 | 1.00 | 1.00 | 1.00 | 1.00 | 1.00 | 1.00 | 1.00 | 1.00 | 1.00 | 1.00 | 1.00 |
| Upstream Filter(I)           | 1.00 | 1.00 | 0.00 | 1.00 | 0.00 | 1.00 | 1.00 | 0.00 | 1.00 | 1.00 | 1.00 | 0.00 |
| Uniform Delay (d), s/veh     | 22.9 | 14.5 | 0.0  | 24.9 | 0.0  | 18.0 | 21.0 | 0.0  | 15.1 | 24.6 | 20.8 | 0.0  |
| Incr Delay (d2), s/veh       | 6.2  | 0.7  | 0.0  | 4.4  | 0.0  | 2.6  | 31.0 | 0.0  | 0.5  | 5.1  | 0.2  | 0.0  |
| Initial Q Delay(d3),s/veh    | 0.0  | 0.0  | 0.0  | 0.0  | 0.0  | 0.0  | 0.0  | 0.0  | 0.0  | 0.0  | 0.0  | 0.0  |
| %ile BackOfQ(50%),veh/ln     | 2.2  | 3.4  | 0.0  | 0.7  | 0.0  | 4.7  | 7.5  | 0.0  | 1.2  | 1.0  | 0.4  | 0.0  |
| LnGrp Delay(d),s/veh         | 29.1 | 15.2 | 0.0  | 29.3 | 0.0  | 20.6 | 52.1 | 0.0  | 15.6 | 29.8 | 21.0 | 0.0  |
| LnGrp LOS                    | C    | B    |      | C    |      | C    | D    |      | B    | C    | C    |      |
| Approach Vol, veh/h          |      | 416  |      |      | 374  |      |      | 758  |      |      | 127  |      |
| Approach Delay, s/veh        |      | 19.7 |      |      | 21.5 |      |      | 47.2 |      |      | 25.3 |      |
| Approach LOS                 |      | B    |      |      | C    |      |      | D    |      |      | C    |      |
| Timer                        | 1    | 2    | 3    | 4    | 5    | 6    | 7    | 8    |      |      |      |      |
| Assigned Phs                 | 1    | 2    | 3    | 4    | 5    | 6    | 7    | 8    |      |      |      |      |
| Phs Duration (G+Y+Rc), s     | 4.5  | 10.5 | 9.7  | 17.5 | 6.9  | 18.1 | 6.3  | 20.9 |      |      |      |      |
| Change Period (Y+Rc), s      | 4.5  | 4.5  | 4.5  | 4.5  | 4.5  | 4.5  | 4.5  | 4.5  |      |      |      |      |
| Max Green Setting (Gmax), s  | 30.0 | 30.0 | 20.0 | 30.0 | 15.0 | 30.0 | 20.0 | 30.0 |      |      |      |      |
| Max Q Clear Time (g_c+I1), s | 2.8  | 5.8  | 10.6 | 3.8  | 4.3  | 3.2  | 8.3  |      |      |      |      |      |
| Green Ext Time (p_c), s      | 0.0  | 0.4  | 0.3  | 2.4  | 0.0  | 0.9  | 0.0  | 1.8  |      |      |      |      |
| <b>Intersection Summary</b>  |      |      |      |      |      |      |      |      |      |      |      |      |
| HCM 2010 Ctrl Delay          |      |      | 33.0 |      |      |      |      |      |      |      |      |      |
| HCM 2010 LOS                 |      |      | C    |      |      |      |      |      |      |      |      |      |

| Intersection              |      |
|---------------------------|------|
| Intersection Delay, s/veh | 12.3 |
| Intersection LOS          | B    |

| Movement            | WBL  | WBR  | NBT  | NBR  | SBL  | SBT  |
|---------------------|------|------|------|------|------|------|
| Lane Configurations | W    |      | T    |      |      | T    |
| Traffic Vol, veh/h  | 10   | 290  | 60   | 20   | 300  | 50   |
| Future Vol, veh/h   | 10   | 290  | 60   | 20   | 300  | 50   |
| Peak Hour Factor    | 0.88 | 0.88 | 0.88 | 0.88 | 0.88 | 0.88 |
| Heavy Vehicles, %   | 0    | 0    | 2    | 2    | 1    | 1    |
| Mvmt Flow           | 11   | 330  | 68   | 23   | 341  | 57   |
| Number of Lanes     | 1    | 0    | 1    | 0    | 0    | 1    |

| Approach                   | WB | NB | SB   |
|----------------------------|----|----|------|
| Opposing Approach          |    | SB | NB   |
| Opposing Lanes             | 0  | 1  | 1    |
| Conflicting Approach Left  | NB |    | WB   |
| Conflicting Lanes Left     | 1  | 0  | 1    |
| Conflicting Approach Right | SB | WB |      |
| Conflicting Lanes Right    | 1  | 1  | 0    |
| HCM Control Delay          | 11 | 9  | 14.1 |
| HCM LOS                    | B  | A  | B    |

| Lane                   | NBLn1 | WBLn1 | SBLn1 |
|------------------------|-------|-------|-------|
| Vol Left, %            | 0%    | 3%    | 86%   |
| Vol Thru, %            | 75%   | 0%    | 14%   |
| Vol Right, %           | 25%   | 97%   | 0%    |
| Sign Control           | Stop  | Stop  | Stop  |
| Traffic Vol by Lane    | 80    | 300   | 350   |
| LT Vol                 | 0     | 10    | 300   |
| Through Vol            | 60    | 0     | 50    |
| RT Vol                 | 20    | 290   | 0     |
| Lane Flow Rate         | 91    | 341   | 398   |
| Geometry Grp           | 1     | 1     | 1     |
| Degree of Util (X)     | 0.131 | 0.43  | 0.551 |
| Departure Headway (Hd) | 5.19  | 4.538 | 4.984 |
| Convergence, Y/N       | Yes   | Yes   | Yes   |
| Cap                    | 695   | 788   | 716   |
| Service Time           | 3.19  | 2.603 | 3.071 |
| HCM Lane V/C Ratio     | 0.131 | 0.433 | 0.556 |
| HCM Control Delay      | 9     | 11    | 14.1  |
| HCM Lane LOS           | A     | B     | B     |
| HCM 95th-tile Q        | 0.4   | 2.2   | 3.4   |

| Intersection             |      |      |      |      |      |      |
|--------------------------|------|------|------|------|------|------|
| Int Delay, s/veh         | 1.6  |      |      |      |      |      |
| Movement                 | EBT  | EBR  | WBL  | WBT  | NBL  | NBR  |
| Lane Configurations      |      |      |      |      |      |      |
| Traffic Vol, veh/h       | 280  | 40   | 30   | 270  | 30   | 30   |
| Future Vol, veh/h        | 280  | 40   | 30   | 270  | 30   | 30   |
| Conflicting Peds, #/hr   | 0    | 0    | 0    | 0    | 0    | 0    |
| Sign Control             | Free | Free | Free | Free | Stop | Stop |
| RT Channelized           | -    | None | -    | None | -    | None |
| Storage Length           | -    | -    | -    | -    | 0    | -    |
| Veh in Median Storage, # | 0    | -    | -    | 0    | 0    | -    |
| Grade, %                 | 0    | -    | -    | 0    | 0    | -    |
| Peak Hour Factor         | 85   | 85   | 85   | 85   | 85   | 85   |
| Heavy Vehicles, %        | 0    | 0    | 0    | 0    | 0    | 0    |
| Mvmt Flow                | 329  | 47   | 35   | 318  | 35   | 35   |

| Major/Minor          | Major1 | Major2 | Minor1 | Minor2 | Minor3 |
|----------------------|--------|--------|--------|--------|--------|
| Conflicting Flow All | 0      | 0      | 376    | 0      | 741    |
| Stage 1              | -      | -      | -      | -      | 353    |
| Stage 2              | -      | -      | -      | -      | 388    |
| Critical Hdwy        | -      | -      | 4.1    | -      | 6.4    |
| Critical Hdwy Stg 1  | -      | -      | -      | -      | 5.4    |
| Critical Hdwy Stg 2  | -      | -      | -      | -      | 5.4    |
| Follow-up Hdwy       | -      | -      | 2.2    | -      | 3.5    |
| Pot Cap-1 Maneuver   | -      | -      | 1194   | -      | 387    |
| Stage 1              | -      | -      | -      | -      | 716    |
| Stage 2              | -      | -      | -      | -      | 690    |
| Platoon blocked, %   | -      | -      | -      | -      | -      |
| Mov Cap-1 Maneuver   | -      | -      | 1194   | -      | 373    |
| Mov Cap-2 Maneuver   | -      | -      | -      | -      | 373    |
| Stage 1              | -      | -      | -      | -      | 690    |
| Stage 2              | -      | -      | -      | -      | 690    |

| Approach             | EB | WB  | NB   |
|----------------------|----|-----|------|
| HCM Control Delay, s | 0  | 0.8 | 13.7 |
| HCM LOS              |    |     | B    |

| Minor Lane/Major Mvmt | NBLn1 | EBT | EBR | WBL  | WBT |
|-----------------------|-------|-----|-----|------|-----|
| Capacity (veh/h)      | 485   | -   | -   | 1194 | -   |
| HCM Lane V/C Ratio    | 0.146 | -   | -   | 0.03 | -   |
| HCM Control Delay (s) | 13.7  | -   | -   | 8.1  | 0   |
| HCM Lane LOS          | B     | -   | -   | A    | A   |
| HCM 95th %tile Q(veh) | 0.5   | -   | -   | 0.1  | -   |

| Intersection              |      |
|---------------------------|------|
| Intersection Delay, s/veh | 13.1 |
| Intersection LOS          | B    |

| Movement            | EBL  | EBT  | EBR  | WBL  | WBT  | WBR  | NBL  | NBT  | NBR  | SBL  | SBT  | SBR  |
|---------------------|------|------|------|------|------|------|------|------|------|------|------|------|
| Lane Configurations |      | ↕    |      |      | ↕    |      |      | ↕    |      |      | ↕    |      |
| Traffic Vol, veh/h  | 10   | 240  | 60   | 30   | 230  | 10   | 50   | 60   | 20   | 10   | 80   | 20   |
| Future Vol, veh/h   | 10   | 240  | 60   | 30   | 230  | 10   | 50   | 60   | 20   | 10   | 80   | 20   |
| Peak Hour Factor    | 0.82 | 0.82 | 0.82 | 0.82 | 0.82 | 0.82 | 0.82 | 0.82 | 0.82 | 0.82 | 0.82 | 0.82 |
| Heavy Vehicles, %   | 0    | 0    | 0    | 0    | 0    | 0    | 2    | 2    | 2    | 0    | 0    | 0    |
| Mvmt Flow           | 12   | 293  | 73   | 37   | 280  | 12   | 61   | 73   | 24   | 12   | 98   | 24   |
| Number of Lanes     | 0    | 1    | 0    | 0    | 1    | 0    | 0    | 1    | 0    | 0    | 1    | 0    |

| Approach                   | EB   | WB   | NB   | SB   |
|----------------------------|------|------|------|------|
| Opposing Approach          | WB   | EB   | SB   | NB   |
| Opposing Lanes             | 1    | 1    | 1    | 1    |
| Conflicting Approach Left  | SB   | NB   | EB   | WB   |
| Conflicting Lanes Left     | 1    | 1    | 1    | 1    |
| Conflicting Approach Right | NB   | SB   | WB   | EB   |
| Conflicting Lanes Right    | 1    | 1    | 1    | 1    |
| HCM Control Delay          | 14.4 | 13.5 | 11.3 | 10.8 |
| HCM LOS                    | B    | B    | B    | B    |

| Lane                   | NBLn1 | EBLn1 | WBLn1 | SBLn1 |
|------------------------|-------|-------|-------|-------|
| Vol Left, %            | 38%   | 3%    | 11%   | 9%    |
| Vol Thru, %            | 46%   | 77%   | 85%   | 73%   |
| Vol Right, %           | 15%   | 19%   | 4%    | 18%   |
| Sign Control           | Stop  | Stop  | Stop  | Stop  |
| Traffic Vol by Lane    | 130   | 310   | 270   | 110   |
| LT Vol                 | 50    | 10    | 30    | 10    |
| Through Vol            | 60    | 240   | 230   | 80    |
| RT Vol                 | 20    | 60    | 10    | 20    |
| Lane Flow Rate         | 159   | 378   | 329   | 134   |
| Geometry Grp           | 1     | 1     | 1     | 1     |
| Degree of Util (X)     | 0.266 | 0.546 | 0.491 | 0.223 |
| Departure Headway (Hd) | 6.042 | 5.195 | 5.366 | 5.994 |
| Convergence, Y/N       | Yes   | Yes   | Yes   | Yes   |
| Cap                    | 591   | 692   | 668   | 596   |
| Service Time           | 4.11  | 3.248 | 3.42  | 4.065 |
| HCM Lane V/C Ratio     | 0.269 | 0.546 | 0.493 | 0.225 |
| HCM Control Delay      | 11.3  | 14.4  | 13.5  | 10.8  |
| HCM Lane LOS           | B     | B     | B     | B     |
| HCM 95th-tile Q        | 1.1   | 3.3   | 2.7   | 0.8   |

| Intersection             |      |      |      |      |      |      |      |      |      |      |      |      |
|--------------------------|------|------|------|------|------|------|------|------|------|------|------|------|
| Int Delay, s/veh         | 22   |      |      |      |      |      |      |      |      |      |      |      |
| Movement                 | EBL  | EBT  | EBR  | WBL  | WBT  | WBR  | NBL  | NBT  | NBR  | SBL  | SBT  | SBR  |
| Lane Configurations      |      | ↕    |      |      | ↕    |      |      | ↕    |      |      | ↕    |      |
| Traffic Vol, veh/h       | 60   | 160  | 50   | 30   | 130  | 10   | 90   | 60   | 20   | 10   | 20   | 30   |
| Future Vol, veh/h        | 60   | 160  | 50   | 30   | 130  | 10   | 90   | 60   | 20   | 10   | 20   | 30   |
| Conflicting Peds, #/hr   | 0    | 0    | 0    | 0    | 0    | 0    | 0    | 0    | 0    | 0    | 0    | 0    |
| Sign Control             | Stop | Stop | Stop | Stop | Stop | Stop | Free | Free | Free | Free | Free | Free |
| RT Channelized           | -    | -    | None | -    | -    | None | -    | -    | None | -    | -    | None |
| Storage Length           | -    | -    | -    | -    | -    | -    | -    | -    | -    | -    | -    | -    |
| Veh in Median Storage, # | -    | 0    | -    | -    | 0    | -    | -    | 0    | -    | -    | 0    | -    |
| Grade, %                 | -    | 0    | -    | -    | 0    | -    | -    | 0    | -    | -    | 0    | -    |
| Peak Hour Factor         | 74   | 74   | 74   | 74   | 74   | 74   | 74   | 74   | 74   | 74   | 74   | 74   |
| Heavy Vehicles, %        | 3    | 3    | 3    | 2    | 2    | 2    | 3    | 3    | 3    | 8    | 8    | 8    |
| Mvmt Flow                | 81   | 216  | 68   | 41   | 176  | 14   | 122  | 81   | 27   | 14   | 27   | 41   |

| Major/Minor          | Minor2 |       | Minor1 |       | Major1 |       |       | Major2 |   |       |   |   |
|----------------------|--------|-------|--------|-------|--------|-------|-------|--------|---|-------|---|---|
| Conflicting Flow All | 510    | 428   | 48     | 557   | 435    | 95    | 68    | 0      | 0 | 108   | 0 | 0 |
| Stage 1              | 76     | 76    | -      | 339   | 339    | -     | -     | -      | - | -     | - | - |
| Stage 2              | 434    | 352   | -      | 218   | 96     | -     | -     | -      | - | -     | - | - |
| Critical Hdwy        | 7.13   | 6.53  | 6.23   | 7.12  | 6.52   | 6.22  | 4.13  | -      | - | 4.18  | - | - |
| Critical Hdwy Stg 1  | 6.13   | 5.53  | -      | 6.12  | 5.52   | -     | -     | -      | - | -     | - | - |
| Critical Hdwy Stg 2  | 6.13   | 5.53  | -      | 6.12  | 5.52   | -     | -     | -      | - | -     | - | - |
| Follow-up Hdwy       | 3.527  | 4.027 | 3.327  | 3.518 | 4.018  | 3.318 | 2.227 | -      | - | 2.272 | - | - |
| Pot Cap-1 Maneuver   | 472    | 518   | 1018   | 441   | 514    | 962   | 1527  | -      | - | 1446  | - | - |
| Stage 1              | 931    | 830   | -      | 676   | 640    | -     | -     | -      | - | -     | - | - |
| Stage 2              | 598    | 630   | -      | 784   | 815    | -     | -     | -      | - | -     | - | - |
| Platoon blocked, %   |        |       |        |       |        |       |       | -      | - | -     | - | - |
| Mov Cap-1 Maneuver   | 307    | 469   | 1018   | 246   | 466    | 962   | 1527  | -      | - | 1446  | - | - |
| Mov Cap-2 Maneuver   | 307    | 469   | -      | 246   | 466    | -     | -     | -      | - | -     | - | - |
| Stage 1              | 852    | 822   | -      | 619   | 586    | -     | -     | -      | - | -     | - | - |
| Stage 2              | 378    | 576   | -      | 534   | 807    | -     | -     | -      | - | -     | - | - |

| Approach             | EB   |  | WB   |  | NB |  | SB  |  |
|----------------------|------|--|------|--|----|--|-----|--|
| HCM Control Delay, s | 36.5 |  | 24.1 |  | 4  |  | 1.3 |  |
| HCM LOS              | E    |  | C    |  |    |  |     |  |

| Minor Lane/Major Mvmt | NBL  | NBT | NBR | EBLn1WBLn1 | SBL   | SBT   | SBR |
|-----------------------|------|-----|-----|------------|-------|-------|-----|
| Capacity (veh/h)      | 1527 | -   | -   | 461        | 413   | 1446  | -   |
| HCM Lane V/C Ratio    | 0.08 | -   | -   | 0.791      | 0.556 | 0.009 | -   |
| HCM Control Delay (s) | 7.6  | 0   | -   | 36.5       | 24.1  | 7.5   | 0   |
| HCM Lane LOS          | A    | A   | -   | E          | C     | A     | A   |
| HCM 95th %tile Q(veh) | 0.3  | -   | -   | 7.1        | 3.3   | 0     | -   |

| Intersection             |      |      |      |      |      |      |
|--------------------------|------|------|------|------|------|------|
| Int Delay, s/veh         | 4.7  |      |      |      |      |      |
| Movement                 | EBL  | EBR  | NBL  | NBT  | SBT  | SBR  |
| Lane Configurations      | T    |      |      | T    |      | T    |
| Traffic Vol, veh/h       | 180  | 10   | 10   | 250  | 190  | 160  |
| Future Vol, veh/h        | 180  | 10   | 10   | 250  | 190  | 160  |
| Conflicting Peds, #/hr   | 0    | 0    | 0    | 0    | 0    | 0    |
| Sign Control             | Stop | Stop | Free | Free | Free | Free |
| RT Channelized           | -    | None | -    | None | -    | None |
| Storage Length           | 0    | -    | -    | -    | -    | -    |
| Veh in Median Storage, # | 0    | -    | -    | 0    | 0    | -    |
| Grade, %                 | 0    | -    | -    | 0    | 0    | -    |
| Peak Hour Factor         | 88   | 88   | 88   | 88   | 88   | 88   |
| Heavy Vehicles, %        | 0    | 0    | 2    | 2    | 1    | 1    |
| Mvmt Flow                | 205  | 11   | 11   | 284  | 216  | 182  |























| Major/Minor          | Minor2 | Major1 |       | Major2 |   |
|----------------------|--------|--------|-------|--------|---|
| Conflicting Flow All | 613    | 307    | 398   | 0      | 0 |
| Stage 1              | 307    | -      | -     | -      | - |
| Stage 2              | 306    | -      | -     | -      | - |
| Critical Hdwy        | 6.4    | 6.2    | 4.12  | -      | - |
| Critical Hdwy Stg 1  | 5.4    | -      | -     | -      | - |
| Critical Hdwy Stg 2  | 5.4    | -      | -     | -      | - |
| Follow-up Hdwy       | 3.5    | 3.3    | 2.218 | -      | - |
| Pot Cap-1 Maneuver   | 459    | 738    | 1161  | -      | - |
| Stage 1              | 751    | -      | -     | -      | - |
| Stage 2              | 751    | -      | -     | -      | - |
| Platoon blocked, %   |        |        |       | -      | - |
| Mov Cap-1 Maneuver   | 454    | 738    | 1161  | -      | - |
| Mov Cap-2 Maneuver   | 454    | -      | -     | -      | - |
| Stage 1              | 743    | -      | -     | -      | - |
| Stage 2              | 751    | -      | -     | -      | - |

| Approach             | EB   | NB  | SB |
|----------------------|------|-----|----|
| HCM Control Delay, s | 19.4 | 0.3 | 0  |
| HCM LOS              | C    |     |    |

| Minor Lane/Major Mvmt | NBL  | NBT | EBLn1 | SBT | SBR |
|-----------------------|------|-----|-------|-----|-----|
| Capacity (veh/h)      | 1161 | -   | 463   | -   | -   |
| HCM Lane V/C Ratio    | 0.01 | -   | 0.466 | -   | -   |
| HCM Control Delay (s) | 8.1  | 0   | 19.4  | -   | -   |
| HCM Lane LOS          | A    | A   | C     | -   | -   |
| HCM 95th %tile Q(veh) | 0    | -   | 2.4   | -   | -   |

HCM 2010 Signalized Intersection Summary  
 39: General Jim Moore Boulevard & Gigling Road

Cumulative with Eastside Parkway, PM  
 06/11/2019

|                              |  |  |  |  |  |  |   |  |  |  |  |  |
|------------------------------|---|---|---|---|---|---|---|---|---|---|---|---|
| Movement                     | EBL   | EBT   | EBR   | WBL   | WBT   | WBR   | NBL   | NBT   | NBR   | SBL   | SBT   | SBR   |
| Lane Configurations          |  |  |   |  |  |  |  |  |  |  |  |  |
| Traffic Volume (veh/h)       | 20  | 20  | 30  | 220   | 50  | 410   | 60  | 270   | 390   | 540   | 260   | 50  |
| Future Volume (veh/h)        | 20  | 20  | 30  | 220   | 50  | 410   | 60  | 270   | 390   | 540   | 260   | 50  |
| Number                       | 3   | 8   | 18  | 7   | 4   | 14  | 1   | 6   | 16  | 5   | 2   | 12  |
| Initial Q (Qb), veh          | 0   | 0   | 0   | 0   | 0   | 0   | 0   | 0   | 0   | 0   | 0   | 0   |
| Ped-Bike Adj(A_pbT)          | 1.00  |   | 0.99  | 1.00  |   | 1.00  | 1.00  |   | 1.00  | 1.00  |   | 1.00  |
| Parking Bus, Adj             | 1.00  | 1.00  | 1.00  | 1.00  | 1.00  | 1.00  | 1.00  | 1.00  | 1.00  | 1.00  | 1.00  | 1.00  |
| Adj Sat Flow, veh/h/ln       | 1776  | 1776  | 1900  | 1881  | 1881  | 1881  | 1863  | 1863  | 1863  | 1863  | 1863  | 1863  |
| Adj Flow Rate, veh/h         | 22  | 22  | 3   | 247   | 56  | 0   | 67  | 303   | 0   | 607   | 292   | 0   |
| Adj No. of Lanes             | 1   | 2   | 0   | 1   | 2   | 1   | 1   | 2   | 1   | 1   | 2   | 1   |
| Peak Hour Factor             | 0.89  | 0.89  | 0.89  | 0.89  | 0.89  | 0.89  | 0.89  | 0.89  | 0.89  | 0.89  | 0.89  | 0.89  |
| Percent Heavy Veh, %         | 7   | 7   | 7   | 1   | 1   | 1   | 2   | 2   | 2   | 2   | 2   | 2   |
| Cap, veh/h                   | 45  | 268   | 36  | 303   | 831   | 372   | 110   | 494   | 221   | 393   | 1060  | 474   |
| Arrive On Green              | 0.03  | 0.09  | 0.09  | 0.17  | 0.23  | 0.00  | 0.06  | 0.14  | 0.00  | 0.22  | 0.30  | 0.00  |
| Sat Flow, veh/h              | 1691  | 2991  | 399   | 1792  | 3574  | 1599  | 1774  | 3539  | 1583  | 1774  | 3539  | 1583  |
| Grp Volume(v), veh/h         | 22  | 12  | 13  | 247   | 56  | 0   | 67  | 303   | 0   | 607   | 292   | 0   |
| Grp Sat Flow(s),veh/h/ln     | 1691  | 1687  | 1703  | 1792  | 1787  | 1599  | 1774  | 1770  | 1583  | 1774  | 1770  | 1583  |
| Q Serve(g_s), s              | 0.6   | 0.3   | 0.3   | 6.3   | 0.6   | 0.0   | 1.7   | 3.8   | 0.0   | 10.5  | 3.0   | 0.0   |
| Cycle Q Clear(g_c), s        | 0.6   | 0.3   | 0.3   | 6.3   | 0.6   | 0.0   | 1.7   | 3.8   | 0.0   | 10.5  | 3.0   | 0.0   |
| Prop In Lane                 | 1.00  |   | 0.23  | 1.00  |   | 1.00  | 1.00  |   | 1.00  | 1.00  |   | 1.00  |
| Lane Grp Cap(c), veh/h       | 45  | 151   | 153   | 303   | 831   | 372   | 110   | 494   | 221   | 393   | 1060  | 474   |
| V/C Ratio(X)                 | 0.49  | 0.08  | 0.08  | 0.81  | 0.07  | 0.00  | 0.61  | 0.61  | 0.00  | 1.54  | 0.28  | 0.00  |
| Avail Cap(c_a), veh/h        | 732   | 1086  | 1096  | 775   | 2300  | 1029  | 393   | 1904  | 852   | 393   | 1904  | 852   |
| HCM Platoon Ratio            | 1.00  | 1.00  | 1.00  | 1.00  | 1.00  | 1.00  | 1.00  | 1.00  | 1.00  | 1.00  | 1.00  | 1.00  |
| Upstream Filter(I)           | 1.00  | 1.00  | 1.00  | 1.00  | 1.00  | 0.00  | 1.00  | 1.00  | 0.00  | 1.00  | 1.00  | 0.00  |
| Uniform Delay (d), s/veh     | 22.8  | 19.8  | 19.8  | 19.0  | 14.2  | 0.0   | 21.7  | 19.2  | 0.0   | 18.4  | 12.7  | 0.0   |
| Incr Delay (d2), s/veh       | 3.0   | 0.1   | 0.1   | 2.0   | 0.0   | 0.0   | 2.0   | 0.5   | 0.0   | 257.3   | 0.1   | 0.0   |
| Initial Q Delay(d3),s/veh    | 0.0   | 0.0   | 0.0   | 0.0   | 0.0   | 0.0   | 0.0   | 0.0   | 0.0   | 0.0   | 0.0   | 0.0   |
| %ile BackOfQ(50%),veh/ln     | 0.3   | 0.1   | 0.2   | 3.3   | 0.3   | 0.0   | 0.9   | 1.9   | 0.0   | 33.1  | 1.5   | 0.0   |
| LnGrp Delay(d),s/veh         | 25.8  | 19.9  | 19.9  | 21.0  | 14.2  | 0.0   | 23.7  | 19.6  | 0.0   | 275.7   | 12.7  | 0.0   |
| LnGrp LOS                    | C   | B   | B   | C   | B   |   | C   | B   |   | F   | B   |   |
| Approach Vol, veh/h          |   | 47  |   |   | 303   |   |   | 370   |   |   | 899   |   |
| Approach Delay, s/veh        |   | 22.6  |   |   | 19.7  |   |   | 20.4  |   |   | 190.3   |   |
| Approach LOS                 |   | C   |   |   | B   |   |   | C   |   |   | F   |   |
| Timer                        | 1   | 2   | 3   | 4   | 5   | 6   | 7   | 8   |   |   |   |   |
| Assigned Phs                 | 1   | 2   | 3   | 4   | 5   | 6   | 7   | 8   |   |   |   |   |
| Phs Duration (G+Y+Rc), s     | 7.4   | 18.7  | 5.8   | 15.5  | 15.0  | 11.1  | 12.5  | 8.7   |   |   |   |   |
| Change Period (Y+Rc), s      | 4.5   | 4.5   | 4.5   | 4.5   | 4.5   | 4.5   | 4.5   | 4.5   |   |   |   |   |
| Max Green Setting (Gmax), s  | 10.5  | 25.5  | 20.5  | 30.5  | 10.5  | 25.5  | 20.5  | 30.5  |   |   |   |   |
| Max Q Clear Time (g_c+I1), s | 3.7   | 5.0   | 2.6   | 2.6   | 12.5  | 5.8   | 8.3   | 2.3   |   |   |   |   |
| Green Ext Time (p_c), s      | 0.0   | 0.3   | 0.0   | 0.1   | 0.0   | 0.4   | 0.1   | 0.0   |   |   |   |   |
| <b>Intersection Summary</b>  |   |   |   |   |   |   |   |   |   |   |   |   |
| HCM 2010 Ctrl Delay          | 114.7   |   |   |   |   |   |   |   |   |   |   |   |
| HCM 2010 LOS                 | F   |   |   |   |   |   |   |   |   |   |   |   |
| <b>Notes</b>                 |   |   |   |   |   |   |   |   |   |   |   |   |



HCM 2010 Signalized Intersection Summary  
40: Malmedy Road & Gigling Road

Cumulative with Eastside Parkway, PM  
06/11/2019



| Movement                     | EBL  | EBT  | EBR  | WBL  | WBT  | WBR  | NBL  | NBT  | NBR  | SBL  | SBT  | SBR  |
|------------------------------|------|------|------|------|------|------|------|------|------|------|------|------|
| Lane Configurations          |      | ↔    |      |      | ↔    |      |      | ↔    |      |      | ↔    |      |
| Traffic Volume (veh/h)       | 20   | 920  | 10   | 30   | 650  | 10   | 30   | 60   | 50   | 10   | 40   | 10   |
| Future Volume (veh/h)        | 20   | 920  | 10   | 30   | 650  | 10   | 30   | 60   | 50   | 10   | 40   | 10   |
| Number                       | 7    | 4    | 14   | 3    | 8    | 18   | 5    | 2    | 12   | 1    | 6    | 16   |
| Initial Q (Qb), veh          | 0    | 0    | 0    | 0    | 0    | 0    | 0    | 0    | 0    | 0    | 0    | 0    |
| Ped-Bike Adj(A_pbT)          | 1.00 |      | 1.00 | 1.00 |      | 1.00 | 1.00 |      | 1.00 | 1.00 |      | 1.00 |
| Parking Bus, Adj             | 1.00 | 1.00 | 1.00 | 1.00 | 1.00 | 1.00 | 1.00 | 1.00 | 1.00 | 1.00 | 1.00 | 1.00 |
| Adj Sat Flow, veh/h/ln       | 1900 | 1863 | 1900 | 1900 | 1881 | 1900 | 1900 | 1900 | 1900 | 1900 | 1810 | 1900 |
| Adj Flow Rate, veh/h         | 22   | 1011 | 11   | 33   | 714  | 11   | 33   | 66   | 55   | 11   | 44   | 11   |
| Adj No. of Lanes             | 0    | 2    | 0    | 0    | 2    | 0    | 0    | 1    | 0    | 0    | 1    | 0    |
| Peak Hour Factor             | 0.91 | 0.91 | 0.91 | 0.91 | 0.91 | 0.91 | 0.91 | 0.91 | 0.91 | 0.91 | 0.91 | 0.91 |
| Percent Heavy Veh, %         | 2    | 2    | 2    | 1    | 1    | 1    | 0    | 0    | 0    | 5    | 5    | 5    |
| Cap, veh/h                   | 189  | 1386 | 15   | 205  | 1283 | 20   | 256  | 136  | 103  | 232  | 210  | 49   |
| Arrive On Green              | 0.40 | 0.40 | 0.40 | 0.40 | 0.40 | 0.40 | 0.17 | 0.17 | 0.17 | 0.17 | 0.17 | 0.17 |
| Sat Flow, veh/h              | 30   | 3438 | 37   | 50   | 3182 | 50   | 290  | 792  | 601  | 193  | 1222 | 283  |
| Grp Volume(v), veh/h         | 544  | 0    | 500  | 386  | 0    | 372  | 154  | 0    | 0    | 66   | 0    | 0    |
| Grp Sat Flow(s),veh/h/ln     | 1816 | 0    | 1688 | 1580 | 0    | 1703 | 1683 | 0    | 0    | 1699 | 0    | 0    |
| Q Serve(g_s), s              | 0.3  | 0.0  | 5.3  | 0.3  | 0.0  | 3.5  | 1.1  | 0.0  | 0.0  | 0.0  | 0.0  | 0.0  |
| Cycle Q Clear(g_c), s        | 5.2  | 0.0  | 5.3  | 5.6  | 0.0  | 3.5  | 1.7  | 0.0  | 0.0  | 0.7  | 0.0  | 0.0  |
| Prop In Lane                 | 0.04 |      | 0.02 | 0.09 |      | 0.03 | 0.21 |      | 0.36 | 0.17 |      | 0.17 |
| Lane Grp Cap(c), veh/h       | 909  | 0    | 681  | 822  | 0    | 686  | 495  | 0    | 0    | 490  | 0    | 0    |
| V/C Ratio(X)                 | 0.60 | 0.00 | 0.74 | 0.47 | 0.00 | 0.54 | 0.31 | 0.00 | 0.00 | 0.13 | 0.00 | 0.00 |
| Avail Cap(c_a), veh/h        | 4384 | 0    | 4030 | 3920 | 0    | 4065 | 2601 | 0    | 0    | 2564 | 0    | 0    |
| HCM Platoon Ratio            | 1.00 | 1.00 | 1.00 | 1.00 | 1.00 | 1.00 | 1.00 | 1.00 | 1.00 | 1.00 | 1.00 | 1.00 |
| Upstream Filter(I)           | 1.00 | 0.00 | 1.00 | 1.00 | 0.00 | 1.00 | 1.00 | 0.00 | 0.00 | 1.00 | 0.00 | 0.00 |
| Uniform Delay (d), s/veh     | 5.3  | 0.0  | 5.4  | 4.8  | 0.0  | 4.8  | 8.0  | 0.0  | 0.0  | 7.5  | 0.0  | 0.0  |
| Incr Delay (d2), s/veh       | 0.2  | 0.0  | 0.6  | 0.2  | 0.0  | 0.2  | 0.1  | 0.0  | 0.0  | 0.0  | 0.0  | 0.0  |
| Initial Q Delay(d3),s/veh    | 0.0  | 0.0  | 0.0  | 0.0  | 0.0  | 0.0  | 0.0  | 0.0  | 0.0  | 0.0  | 0.0  | 0.0  |
| %ile BackOfQ(50%),veh/ln     | 2.6  | 0.0  | 2.5  | 1.6  | 0.0  | 1.6  | 0.8  | 0.0  | 0.0  | 0.3  | 0.0  | 0.0  |
| LnGrp Delay(d),s/veh         | 5.6  | 0.0  | 5.9  | 4.9  | 0.0  | 5.1  | 8.1  | 0.0  | 0.0  | 7.6  | 0.0  | 0.0  |
| LnGrp LOS                    | A    |      | A    | A    |      | A    | A    |      |      | A    |      |      |
| Approach Vol, veh/h          |      | 1044 |      |      | 758  |      |      | 154  |      |      | 66   |      |
| Approach Delay, s/veh        |      | 5.7  |      |      | 5.0  |      |      | 8.1  |      |      | 7.6  |      |
| Approach LOS                 |      | A    |      |      | A    |      |      | A    |      |      | A    |      |
| Timer                        | 1    | 2    | 3    | 4    | 5    | 6    | 7    | 8    |      |      |      |      |
| Assigned Phs                 |      | 2    |      | 4    |      | 6    |      | 8    |      |      |      |      |
| Phs Duration (G+Y+Rc), s     |      | 8.1  |      | 13.0 |      | 8.1  |      | 13.0 |      |      |      |      |
| Change Period (Y+Rc), s      |      | 4.5  |      | 4.5  |      | 4.5  |      | 4.5  |      |      |      |      |
| Max Green Setting (Gmax), s  |      | 30.5 |      | 50.5 |      | 30.5 |      | 50.5 |      |      |      |      |
| Max Q Clear Time (g_c+I1), s |      | 3.7  |      | 7.3  |      | 2.7  |      | 7.6  |      |      |      |      |
| Green Ext Time (p_c), s      |      | 0.2  |      | 1.0  |      | 0.1  |      | 0.8  |      |      |      |      |
| <b>Intersection Summary</b>  |      |      |      |      |      |      |      |      |      |      |      |      |
| HCM 2010 Ctrl Delay          |      |      |      | 5.7  |      |      |      |      |      |      |      |      |
| HCM 2010 LOS                 |      |      |      | A    |      |      |      |      |      |      |      |      |

HCM 2010 Signalized Intersection Summary  
 41: Parker Flatts Cut Off Road & Gigling Road

Cumulative with Eastside Parkway, PM  
 06/11/2019



| Movement                     | EBL  | EBT  | EBR  | WBL  | WBT  | WBR  | NBL  | NBT  | NBR  | SBL  | SBT  | SBR  |
|------------------------------|------|------|------|------|------|------|------|------|------|------|------|------|
| Lane Configurations          |      | ↔    |      |      | ↔    |      |      | ↔    | ↔    |      | ↔    |      |
| Traffic Volume (veh/h)       | 10   | 940  | 30   | 50   | 600  | 10   | 90   | 20   | 90   | 10   | 20   | 10   |
| Future Volume (veh/h)        | 10   | 940  | 30   | 50   | 600  | 10   | 90   | 20   | 90   | 10   | 20   | 10   |
| Number                       | 7    | 4    | 14   | 3    | 8    | 18   | 5    | 2    | 12   | 1    | 6    | 16   |
| Initial Q (Qb), veh          | 0    | 0    | 0    | 0    | 0    | 0    | 0    | 0    | 0    | 0    | 0    | 0    |
| Ped-Bike Adj(A_pbT)          | 1.00 |      | 1.00 | 1.00 |      | 1.00 | 1.00 |      | 1.00 | 1.00 |      | 1.00 |
| Parking Bus, Adj             | 1.00 | 1.00 | 1.00 | 1.00 | 1.00 | 1.00 | 1.00 | 1.00 | 1.00 | 1.00 | 1.00 | 1.00 |
| Adj Sat Flow, veh/h/ln       | 1900 | 1863 | 1900 | 1900 | 1881 | 1900 | 1900 | 1900 | 1900 | 1900 | 1900 | 1900 |
| Adj Flow Rate, veh/h         | 11   | 1056 | 34   | 56   | 674  | 11   | 101  | 22   | 101  | 11   | 22   | 11   |
| Adj No. of Lanes             | 0    | 2    | 0    | 0    | 2    | 0    | 0    | 1    | 1    | 0    | 1    | 0    |
| Peak Hour Factor             | 0.89 | 0.89 | 0.89 | 0.89 | 0.89 | 0.89 | 0.89 | 0.89 | 0.89 | 0.89 | 0.89 | 0.89 |
| Percent Heavy Veh, %         | 2    | 2    | 2    | 1    | 1    | 1    | 0    | 0    | 0    | 0    | 0    | 0    |
| Cap, veh/h                   | 163  | 1439 | 46   | 213  | 1241 | 21   | 497  | 69   | 302  | 241  | 193  | 80   |
| Arrive On Green              | 0.42 | 0.42 | 0.42 | 0.42 | 0.42 | 0.42 | 0.19 | 0.19 | 0.19 | 0.19 | 0.19 | 0.19 |
| Sat Flow, veh/h              | 11   | 3401 | 109  | 79   | 2933 | 50   | 1139 | 368  | 1611 | 249  | 1029 | 426  |
| Grp Volume(v), veh/h         | 578  | 0    | 523  | 364  | 0    | 377  | 123  | 0    | 101  | 44   | 0    | 0    |
| Grp Sat Flow(s),veh/h/ln     | 1846 | 0    | 1675 | 1359 | 0    | 1703 | 1507 | 0    | 1611 | 1704 | 0    | 0    |
| Q Serve(g_s), s              | 0.0  | 0.0  | 6.0  | 0.6  | 0.0  | 3.8  | 1.1  | 0.0  | 1.3  | 0.0  | 0.0  | 0.0  |
| Cycle Q Clear(g_c), s        | 6.0  | 0.0  | 6.0  | 6.7  | 0.0  | 3.8  | 1.6  | 0.0  | 1.3  | 0.5  | 0.0  | 0.0  |
| Prop In Lane                 | 0.02 |      | 0.07 | 0.15 |      | 0.03 | 0.82 |      | 1.00 | 0.25 |      | 0.25 |
| Lane Grp Cap(c), veh/h       | 940  | 0    | 709  | 754  | 0    | 720  | 566  | 0    | 302  | 514  | 0    | 0    |
| V/C Ratio(X)                 | 0.62 | 0.00 | 0.74 | 0.48 | 0.00 | 0.52 | 0.22 | 0.00 | 0.33 | 0.09 | 0.00 | 0.00 |
| Avail Cap(c_a), veh/h        | 4131 | 0    | 3660 | 3118 | 0    | 3720 | 2222 | 0    | 2125 | 2361 | 0    | 0    |
| HCM Platoon Ratio            | 1.00 | 1.00 | 1.00 | 1.00 | 1.00 | 1.00 | 1.00 | 1.00 | 1.00 | 1.00 | 1.00 | 1.00 |
| Upstream Filter(I)           | 1.00 | 0.00 | 1.00 | 1.00 | 0.00 | 1.00 | 1.00 | 0.00 | 1.00 | 1.00 | 0.00 | 0.00 |
| Uniform Delay (d), s/veh     | 5.6  | 0.0  | 5.6  | 4.9  | 0.0  | 4.9  | 8.2  | 0.0  | 8.1  | 7.8  | 0.0  | 0.0  |
| Incr Delay (d2), s/veh       | 0.2  | 0.0  | 0.6  | 0.2  | 0.0  | 0.2  | 0.1  | 0.0  | 0.2  | 0.0  | 0.0  | 0.0  |
| Initial Q Delay(d3),s/veh    | 0.0  | 0.0  | 0.0  | 0.0  | 0.0  | 0.0  | 0.0  | 0.0  | 0.0  | 0.0  | 0.0  | 0.0  |
| %ile BackOfQ(50%),veh/ln     | 3.0  | 0.0  | 2.9  | 1.7  | 0.0  | 1.7  | 0.7  | 0.0  | 0.6  | 0.2  | 0.0  | 0.0  |
| LnGrp Delay(d),s/veh         | 5.8  | 0.0  | 6.2  | 5.0  | 0.0  | 5.2  | 8.3  | 0.0  | 8.4  | 7.8  | 0.0  | 0.0  |
| LnGrp LOS                    | A    |      | A    | A    |      | A    | A    |      | A    | A    |      |      |
| Approach Vol, veh/h          |      | 1101 |      |      | 741  |      |      | 224  |      |      | 44   |      |
| Approach Delay, s/veh        |      | 6.0  |      |      | 5.1  |      |      | 8.3  |      |      | 7.8  |      |
| Approach LOS                 |      | A    |      |      | A    |      |      | A    |      |      | A    |      |
| Timer                        | 1    | 2    | 3    | 4    | 5    | 6    | 7    | 8    |      |      |      |      |
| Assigned Phs                 |      | 2    |      | 4    |      | 6    |      | 8    |      |      |      |      |
| Phs Duration (G+Y+Rc), s     |      | 8.8  |      | 14.3 |      | 8.8  |      | 14.3 |      |      |      |      |
| Change Period (Y+Rc), s      |      | 4.5  |      | 4.5  |      | 4.5  |      | 4.5  |      |      |      |      |
| Max Green Setting (Gmax), s  |      | 30.5 |      | 50.5 |      | 30.5 |      | 50.5 |      |      |      |      |
| Max Q Clear Time (g_c+I1), s |      | 3.6  |      | 8.0  |      | 2.5  |      | 8.7  |      |      |      |      |
| Green Ext Time (p_c), s      |      | 0.1  |      | 1.1  |      | 0.0  |      | 1.0  |      |      |      |      |
| <b>Intersection Summary</b>  |      |      |      |      |      |      |      |      |      |      |      |      |
| HCM 2010 Ctrl Delay          |      |      |      | 6.0  |      |      |      |      |      |      |      |      |
| HCM 2010 LOS                 |      |      |      | A    |      |      |      |      |      |      |      |      |

HCM 2010 Signalized Intersection Summary  
42: 6th Avenue & Gigling Road

Cumulative with Eastside Parkway, PM  
06/11/2019



| Movement                     | EBL  | EBT  | EBR  | WBL  | WBT  | WBR  | NBL  | NBT  | NBR  | SBL  | SBT  | SBR  |
|------------------------------|------|------|------|------|------|------|------|------|------|------|------|------|
| Lane Configurations          |      | ↔    |      |      | ↔    |      |      | ↔    | ↔    |      | ↔    |      |
| Traffic Volume (veh/h)       | 140  | 900  | 10   | 10   | 520  | 10   | 10   | 10   | 20   | 10   | 10   | 140  |
| Future Volume (veh/h)        | 140  | 900  | 10   | 10   | 520  | 10   | 10   | 10   | 20   | 10   | 10   | 140  |
| Number                       | 7    | 4    | 14   | 3    | 8    | 18   | 5    | 2    | 12   | 1    | 6    | 16   |
| Initial Q (Qb), veh          | 0    | 0    | 0    | 0    | 0    | 0    | 0    | 0    | 0    | 0    | 0    | 0    |
| Ped-Bike Adj(A_pbT)          | 1.00 |      | 1.00 | 1.00 |      | 1.00 | 1.00 |      | 1.00 | 1.00 |      | 1.00 |
| Parking Bus, Adj             | 1.00 | 1.00 | 1.00 | 1.00 | 1.00 | 1.00 | 1.00 | 1.00 | 1.00 | 1.00 | 1.00 | 1.00 |
| Adj Sat Flow, veh/h/ln       | 1900 | 1881 | 1900 | 1900 | 1863 | 1900 | 1900 | 1900 | 1900 | 1900 | 1900 | 1900 |
| Adj Flow Rate, veh/h         | 147  | 947  | 11   | 11   | 547  | 11   | 11   | 11   | 0    | 11   | 11   | 147  |
| Adj No. of Lanes             | 0    | 2    | 0    | 0    | 2    | 0    | 0    | 1    | 1    | 0    | 1    | 0    |
| Peak Hour Factor             | 0.95 | 0.95 | 0.95 | 0.95 | 0.95 | 0.95 | 0.95 | 0.95 | 0.95 | 0.95 | 0.95 | 0.95 |
| Percent Heavy Veh, %         | 1    | 1    | 1    | 2    | 2    | 2    | 0    | 0    | 0    | 0    | 0    | 0    |
| Cap, veh/h                   | 331  | 1287 | 15   | 174  | 1514 | 30   | 327  | 187  | 258  | 181  | 22   | 225  |
| Arrive On Green              | 0.44 | 0.44 | 0.44 | 0.44 | 0.44 | 0.44 | 0.16 | 0.16 | 0.00 | 0.16 | 0.16 | 0.16 |
| Sat Flow, veh/h              | 291  | 2902 | 33   | 20   | 3412 | 68   | 557  | 1175 | 1615 | 74   | 138  | 1412 |
| Grp Volume(v), veh/h         | 544  | 0    | 561  | 297  | 0    | 272  | 22   | 0    | 0    | 169  | 0    | 0    |
| Grp Sat Flow(s),veh/h/ln     | 1520 | 0    | 1706 | 1818 | 0    | 1683 | 1733 | 0    | 1615 | 1624 | 0    | 0    |
| Q Serve(g_s), s              | 4.3  | 0.0  | 6.2  | 0.0  | 0.0  | 2.4  | 0.0  | 0.0  | 0.0  | 1.1  | 0.0  | 0.0  |
| Cycle Q Clear(g_c), s        | 6.7  | 0.0  | 6.2  | 2.4  | 0.0  | 2.4  | 0.2  | 0.0  | 0.0  | 2.2  | 0.0  | 0.0  |
| Prop In Lane                 | 0.27 |      | 0.02 | 0.04 |      | 0.04 | 0.50 |      | 1.00 | 0.07 |      | 0.87 |
| Lane Grp Cap(c), veh/h       | 876  | 0    | 757  | 971  | 0    | 747  | 514  | 0    | 258  | 428  | 0    | 0    |
| V/C Ratio(X)                 | 0.62 | 0.00 | 0.74 | 0.31 | 0.00 | 0.36 | 0.04 | 0.00 | 0.00 | 0.39 | 0.00 | 0.00 |
| Avail Cap(c_a), veh/h        | 3411 | 0    | 3799 | 4043 | 0    | 3748 | 2299 | 0    | 2172 | 2342 | 0    | 0    |
| HCM Platoon Ratio            | 1.00 | 1.00 | 1.00 | 1.00 | 1.00 | 1.00 | 1.00 | 1.00 | 1.00 | 1.00 | 1.00 | 1.00 |
| Upstream Filter(l)           | 1.00 | 0.00 | 1.00 | 1.00 | 0.00 | 1.00 | 1.00 | 0.00 | 0.00 | 1.00 | 0.00 | 0.00 |
| Uniform Delay (d), s/veh     | 5.2  | 0.0  | 5.2  | 4.2  | 0.0  | 4.2  | 8.1  | 0.0  | 0.0  | 8.9  | 0.0  | 0.0  |
| Incr Delay (d2), s/veh       | 0.3  | 0.0  | 0.5  | 0.1  | 0.0  | 0.1  | 0.0  | 0.0  | 0.0  | 0.2  | 0.0  | 0.0  |
| Initial Q Delay(d3),s/veh    | 0.0  | 0.0  | 0.0  | 0.0  | 0.0  | 0.0  | 0.0  | 0.0  | 0.0  | 0.0  | 0.0  | 0.0  |
| %ile BackOfQ(50%),veh/ln     | 2.8  | 0.0  | 2.9  | 1.2  | 0.0  | 1.1  | 0.1  | 0.0  | 0.0  | 1.0  | 0.0  | 0.0  |
| LnGrp Delay(d),s/veh         | 5.5  | 0.0  | 5.8  | 4.2  | 0.0  | 4.3  | 8.1  | 0.0  | 0.0  | 9.2  | 0.0  | 0.0  |
| LnGrp LOS                    | A    |      | A    | A    |      | A    | A    |      |      | A    |      |      |
| Approach Vol, veh/h          |      | 1105 |      |      | 569  |      |      | 22   |      |      | 169  |      |
| Approach Delay, s/veh        |      | 5.6  |      |      | 4.3  |      |      | 8.1  |      |      | 9.2  |      |
| Approach LOS                 |      | A    |      |      | A    |      |      | A    |      |      | A    |      |
| Timer                        | 1    | 2    | 3    | 4    | 5    | 6    | 7    | 8    |      |      |      |      |
| Assigned Phs                 |      | 2    |      | 4    |      | 6    |      | 8    |      |      |      |      |
| Phs Duration (G+Y+Rc), s     |      | 8.1  |      | 14.6 |      | 8.1  |      | 14.6 |      |      |      |      |
| Change Period (Y+Rc), s      |      | 4.5  |      | 4.5  |      | 4.5  |      | 4.5  |      |      |      |      |
| Max Green Setting (Gmax), s  |      | 30.5 |      | 50.5 |      | 30.5 |      | 50.5 |      |      |      |      |
| Max Q Clear Time (g_c+I1), s |      | 2.2  |      | 8.7  |      | 4.2  |      | 4.4  |      |      |      |      |
| Green Ext Time (p_c), s      |      | 0.0  |      | 1.4  |      | 0.2  |      | 0.5  |      |      |      |      |
| <b>Intersection Summary</b>  |      |      |      |      |      |      |      |      |      |      |      |      |
| HCM 2010 Ctrl Delay          |      |      |      | 5.6  |      |      |      |      |      |      |      |      |
| HCM 2010 LOS                 |      |      |      | A    |      |      |      |      |      |      |      |      |

HCM 2010 Signalized Intersection Summary  
43: Gigling Road & 7th Avenue

Cumulative with Eastside Parkway, PM  
06/11/2019

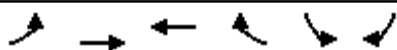

| Movement                     | EBL  | EBT  | WBT  | WBR  | SBL  | SBR  |   |      |
|------------------------------|------|------|------|------|------|------|---|------|
| Lane Configurations          |      | ↑↑   | ↑↑   |      | ↑↑   |      |   |      |
| Traffic Volume (veh/h)       | 140  | 790  | 450  | 10   | 10   | 90   |   |      |
| Future Volume (veh/h)        | 140  | 790  | 450  | 10   | 10   | 90   |   |      |
| Number                       | 7    | 4    | 8    | 18   | 1    | 16   |   |      |
| Initial Q (Qb), veh          | 0    | 0    | 0    | 0    | 0    | 0    |   |      |
| Ped-Bike Adj(A_pbT)          | 1.00 |      |      | 1.00 | 1.00 | 1.00 |   |      |
| Parking Bus, Adj             | 1.00 | 1.00 | 1.00 | 1.00 | 1.00 | 1.00 |   |      |
| Adj Sat Flow, veh/h/ln       | 1900 | 1863 | 1881 | 1900 | 1827 | 1900 |   |      |
| Adj Flow Rate, veh/h         | 146  | 823  | 469  | 10   | 10   | 94   |   |      |
| Adj No. of Lanes             | 0    | 2    | 2    | 0    | 0    | 0    |   |      |
| Peak Hour Factor             | 0.96 | 0.96 | 0.96 | 0.96 | 0.96 | 0.96 |   |      |
| Percent Heavy Veh, %         | 2    | 2    | 1    | 1    | 0    | 0    |   |      |
| Cap, veh/h                   | 376  | 1192 | 1515 | 32   | 17   | 160  |   |      |
| Arrive On Green              | 0.42 | 0.42 | 0.42 | 0.42 | 0.11 | 0.11 |   |      |
| Sat Flow, veh/h              | 322  | 2901 | 3673 | 76   | 149  | 1405 |   |      |
| Grp Volume(v), veh/h         | 497  | 472  | 234  | 245  | 105  | 0    |   |      |
| Grp Sat Flow(s),veh/h/ln     | 1527 | 1610 | 1787 | 1868 | 1570 | 0    |   |      |
| Q Serve(g_s), s              | 3.2  | 4.7  | 1.7  | 1.7  | 1.2  | 0.0  |   |      |
| Cycle Q Clear(g_c), s        | 5.1  | 4.7  | 1.7  | 1.7  | 1.2  | 0.0  |   |      |
| Prop In Lane                 | 0.29 |      |      | 0.04 | 0.10 | 0.90 |   |      |
| Lane Grp Cap(c), veh/h       | 886  | 682  | 757  | 791  | 179  | 0    |   |      |
| V/C Ratio(X)                 | 0.56 | 0.69 | 0.31 | 0.31 | 0.59 | 0.00 |   |      |
| Avail Cap(c_a), veh/h        | 4349 | 4593 | 5098 | 5327 | 2057 | 0    |   |      |
| HCM Platoon Ratio            | 1.00 | 1.00 | 1.00 | 1.00 | 1.00 | 1.00 |   |      |
| Upstream Filter(I)           | 1.00 | 1.00 | 1.00 | 1.00 | 1.00 | 0.00 |   |      |
| Uniform Delay (d), s/veh     | 4.6  | 4.6  | 3.7  | 3.7  | 8.2  | 0.0  |   |      |
| Incr Delay (d2), s/veh       | 0.2  | 0.5  | 0.1  | 0.1  | 1.1  | 0.0  |   |      |
| Initial Q Delay(d3),s/veh    | 0.0  | 0.0  | 0.0  | 0.0  | 0.0  | 0.0  |   |      |
| %ile BackOfQ(50%),veh/ln     | 2.1  | 2.1  | 0.8  | 0.8  | 0.6  | 0.0  |   |      |
| LnGrp Delay(d),s/veh         | 4.8  | 5.1  | 3.8  | 3.8  | 9.3  | 0.0  |   |      |
| LnGrp LOS                    | A    | A    | A    | A    | A    |      |   |      |
| Approach Vol, veh/h          |      | 969  | 479  |      | 105  |      |   |      |
| Approach Delay, s/veh        |      | 4.9  | 3.8  |      | 9.3  |      |   |      |
| Approach LOS                 |      | A    | A    |      | A    |      |   |      |
| Timer                        | 1    | 2    | 3    | 4    | 5    | 6    | 7 | 8    |
| Assigned Phs                 |      |      |      | 4    |      | 6    |   | 8    |
| Phs Duration (G+Y+Rc), s     |      |      |      | 12.7 |      | 6.7  |   | 12.7 |
| Change Period (Y+Rc), s      |      |      |      | 4.5  |      | 4.5  |   | 4.5  |
| Max Green Setting (Gmax), s  |      |      |      | 55.5 |      | 25.5 |   | 55.5 |
| Max Q Clear Time (g_c+I1), s |      |      |      | 7.1  |      | 3.2  |   | 3.7  |
| Green Ext Time (p_c), s      |      |      |      | 1.1  |      | 0.0  |   | 0.4  |
| <b>Intersection Summary</b>  |      |      |      |      |      |      |   |      |
| HCM 2010 Ctrl Delay          |      |      | 4.9  |      |      |      |   |      |
| HCM 2010 LOS                 |      |      | A    |      |      |      |   |      |
| <b>Notes</b>                 |      |      |      |      |      |      |   |      |

HCM 2010 Signalized Intersection Summary  
44: 8th Avenue & Gigling Road

Cumulative with Eastside Parkway, PM  
06/11/2019



| Movement                     | EBL  | EBT  | EBR  | WBL  | WBT  | WBR  | NBL  | NBT  | NBR  | SBL  | SBT  | SBR  |
|------------------------------|------|------|------|------|------|------|------|------|------|------|------|------|
| Lane Configurations          |      | ↔    |      |      | ↔    |      |      | ↔    |      |      | ↔    |      |
| Traffic Volume (veh/h)       | 250  | 550  | 10   | 10   | 280  | 10   | 10   | 10   | 10   | 10   | 10   | 180  |
| Future Volume (veh/h)        | 250  | 550  | 10   | 10   | 280  | 10   | 10   | 10   | 10   | 10   | 10   | 180  |
| Number                       | 7    | 4    | 14   | 3    | 8    | 18   | 5    | 2    | 12   | 1    | 6    | 16   |
| Initial Q (Qb), veh          | 0    | 0    | 0    | 0    | 0    | 0    | 0    | 0    | 0    | 0    | 0    | 0    |
| Ped-Bike Adj(A_pbT)          | 1.00 |      | 1.00 | 1.00 |      | 1.00 | 1.00 |      | 1.00 | 1.00 |      | 1.00 |
| Parking Bus, Adj             | 1.00 | 1.00 | 1.00 | 1.00 | 1.00 | 1.00 | 1.00 | 1.00 | 1.00 | 1.00 | 1.00 | 1.00 |
| Adj Sat Flow, veh/h/ln       | 1900 | 1863 | 1900 | 1900 | 1863 | 1900 | 1900 | 1900 | 1900 | 1900 | 1881 | 1900 |
| Adj Flow Rate, veh/h         | 275  | 604  | 11   | 11   | 308  | 11   | 11   | 11   | 11   | 11   | 11   | 110  |
| Adj No. of Lanes             | 0    | 2    | 0    | 0    | 2    | 0    | 0    | 1    | 0    | 0    | 1    | 0    |
| Peak Hour Factor             | 0.91 | 0.91 | 0.91 | 0.91 | 0.91 | 0.91 | 0.91 | 0.91 | 0.91 | 0.91 | 0.91 | 0.91 |
| Percent Heavy Veh, %         | 2    | 2    | 2    | 2    | 2    | 2    | 0    | 0    | 0    | 1    | 1    | 1    |
| Cap, veh/h                   | 572  | 996  | 19   | 188  | 1507 | 53   | 278  | 101  | 82   | 190  | 24   | 193  |
| Arrive On Green              | 0.45 | 0.45 | 0.45 | 0.45 | 0.45 | 0.45 | 0.14 | 0.14 | 0.14 | 0.14 | 0.14 | 0.14 |
| Sat Flow, veh/h              | 685  | 2206 | 42   | 35   | 3338 | 117  | 433  | 705  | 569  | 103  | 165  | 1341 |
| Grp Volume(v), veh/h         | 443  | 0    | 447  | 173  | 0    | 157  | 33   | 0    | 0    | 132  | 0    | 0    |
| Grp Sat Flow(s),veh/h/ln     | 1245 | 0    | 1688 | 1817 | 0    | 1674 | 1708 | 0    | 0    | 1609 | 0    | 0    |
| Q Serve(g_s), s              | 5.5  | 0.0  | 4.4  | 0.0  | 0.0  | 1.3  | 0.0  | 0.0  | 0.0  | 1.0  | 0.0  | 0.0  |
| Cycle Q Clear(g_c), s        | 6.8  | 0.0  | 4.4  | 1.3  | 0.0  | 1.3  | 0.4  | 0.0  | 0.0  | 1.7  | 0.0  | 0.0  |
| Prop In Lane                 | 0.62 |      | 0.02 | 0.06 |      | 0.07 | 0.33 |      |      | 0.33 | 0.08 | 0.83 |
| Lane Grp Cap(c), veh/h       | 825  | 0    | 762  | 993  | 0    | 756  | 461  | 0    | 0    | 407  | 0    | 0    |
| V/C Ratio(X)                 | 0.54 | 0.00 | 0.59 | 0.17 | 0.00 | 0.21 | 0.07 | 0.00 | 0.00 | 0.32 | 0.00 | 0.00 |
| Avail Cap(c_a), veh/h        | 2837 | 0    | 3453 | 3733 | 0    | 3425 | 2731 | 0    | 0    | 2731 | 0    | 0    |
| HCM Platoon Ratio            | 1.00 | 1.00 | 1.00 | 1.00 | 1.00 | 1.00 | 1.00 | 1.00 | 1.00 | 1.00 | 1.00 | 1.00 |
| Upstream Filter(I)           | 1.00 | 0.00 | 1.00 | 1.00 | 0.00 | 1.00 | 1.00 | 0.00 | 0.00 | 1.00 | 0.00 | 0.00 |
| Uniform Delay (d), s/veh     | 5.2  | 0.0  | 4.6  | 3.7  | 0.0  | 3.7  | 8.3  | 0.0  | 0.0  | 8.9  | 0.0  | 0.0  |
| Incr Delay (d2), s/veh       | 0.2  | 0.0  | 0.3  | 0.0  | 0.0  | 0.0  | 0.0  | 0.0  | 0.0  | 0.2  | 0.0  | 0.0  |
| Initial Q Delay(d3),s/veh    | 0.0  | 0.0  | 0.0  | 0.0  | 0.0  | 0.0  | 0.0  | 0.0  | 0.0  | 0.0  | 0.0  | 0.0  |
| %ile BackOfQ(50%),veh/ln     | 2.3  | 0.0  | 2.0  | 0.6  | 0.0  | 0.6  | 0.2  | 0.0  | 0.0  | 0.8  | 0.0  | 0.0  |
| LnGrp Delay(d),s/veh         | 5.4  | 0.0  | 4.8  | 3.7  | 0.0  | 3.7  | 8.3  | 0.0  | 0.0  | 9.0  | 0.0  | 0.0  |
| LnGrp LOS                    | A    |      | A    | A    |      | A    | A    |      |      | A    |      |      |
| Approach Vol, veh/h          |      | 890  |      |      | 330  |      |      | 33   |      |      | 132  |      |
| Approach Delay, s/veh        |      | 5.1  |      |      | 3.7  |      |      | 8.3  |      |      | 9.0  |      |
| Approach LOS                 |      | A    |      |      | A    |      |      | A    |      |      | A    |      |
| Timer                        | 1    | 2    | 3    | 4    | 5    | 6    | 7    | 8    |      |      |      |      |
| Assigned Phs                 |      | 2    |      | 4    |      | 6    |      | 8    |      |      |      |      |
| Phs Duration (G+Y+Rc), s     |      | 7.7  |      | 14.5 |      | 7.7  |      | 14.5 |      |      |      |      |
| Change Period (Y+Rc), s      |      | 4.5  |      | 4.5  |      | 4.5  |      | 4.5  |      |      |      |      |
| Max Green Setting (Gmax), s  |      | 35.5 |      | 45.5 |      | 35.5 |      | 45.5 |      |      |      |      |
| Max Q Clear Time (g_c+I1), s |      | 2.4  |      | 8.8  |      | 3.7  |      | 3.3  |      |      |      |      |
| Green Ext Time (p_c), s      |      | 0.0  |      | 1.1  |      | 0.2  |      | 0.4  |      |      |      |      |
| <b>Intersection Summary</b>  |      |      |      |      |      |      |      |      |      |      |      |      |
| HCM 2010 Ctrl Delay          |      |      |      | 5.2  |      |      |      |      |      |      |      |      |
| HCM 2010 LOS                 |      |      |      | A    |      |      |      |      |      |      |      |      |

HCM 2010 Signalized Intersection Summary  
45: Eastside Parkway & Gigling Road

Cumulative with Eastside Parkway, PM  
06/11/2019



| Movement                      | EBL  | EBT  | EBR  | WBL  | WBT  | WBR  | NBL  | NBT  | NBR  | SBL  | SBT  | SBR  |
|-------------------------------|------|------|------|------|------|------|------|------|------|------|------|------|
| Lane Configurations           |      |      |      |      |      |      |      |      |      |      |      |      |
| Traffic Volume (veh/h)        | 540  | 10   | 10   | 10   | 10   | 10   | 10   | 350  | 10   | 10   | 190  | 270  |
| Future Volume (veh/h)         | 540  | 10   | 10   | 10   | 10   | 10   | 10   | 350  | 10   | 10   | 190  | 270  |
| Number                        | 7    | 4    | 14   | 3    | 8    | 18   | 5    | 2    | 12   | 1    | 6    | 16   |
| Initial Q (Qb), veh           | 0    | 0    | 0    | 0    | 0    | 0    | 0    | 0    | 0    | 0    | 0    | 0    |
| Ped-Bike Adj(A_pbT)           | 1.00 |      | 1.00 | 1.00 |      | 1.00 | 1.00 |      | 1.00 | 1.00 |      | 1.00 |
| Parking Bus, Adj              | 1.00 | 1.00 | 1.00 | 1.00 | 1.00 | 1.00 | 1.00 | 1.00 | 1.00 | 1.00 | 1.00 | 1.00 |
| Adj Sat Flow, veh/h/ln        | 1863 | 1863 | 1900 | 1900 | 1863 | 1900 | 1863 | 1863 | 1900 | 1863 | 1863 | 1863 |
| Adj Flow Rate, veh/h          | 587  | 11   | 11   | 11   | 11   | 11   | 11   | 380  | 11   | 11   | 207  | 206  |
| Adj No. of Lanes              | 1    | 2    | 0    | 0    | 1    | 0    | 1    | 1    | 0    | 1    | 1    | 1    |
| Peak Hour Factor              | 0.92 | 0.92 | 0.92 | 0.92 | 0.92 | 0.92 | 0.92 | 0.92 | 0.92 | 0.92 | 0.92 | 0.92 |
| Percent Heavy Veh, %          | 2    | 2    | 2    | 2    | 2    | 2    | 2    | 2    | 2    | 2    | 2    | 2    |
| Cap, veh/h                    | 640  | 651  | 561  | 21   | 21   | 21   | 25   | 451  | 13   | 25   | 467  | 397  |
| Arrive On Green               | 0.36 | 0.36 | 0.36 | 0.04 | 0.04 | 0.04 | 0.01 | 0.25 | 0.25 | 0.01 | 0.25 | 0.25 |
| Sat Flow, veh/h               | 1774 | 1803 | 1555 | 577  | 577  | 577  | 1774 | 1801 | 52   | 1774 | 1863 | 1583 |
| Grp Volume(v), veh/h          | 587  | 11   | 11   | 33   | 0    | 0    | 11   | 0    | 391  | 11   | 207  | 206  |
| Grp Sat Flow(s),veh/h/ln      | 1774 | 1770 | 1588 | 1732 | 0    | 0    | 1774 | 0    | 1854 | 1774 | 1863 | 1583 |
| Q Serve(g_s), s               | 15.0 | 0.2  | 0.2  | 0.9  | 0.0  | 0.0  | 0.3  | 0.0  | 9.5  | 0.3  | 4.4  | 5.3  |
| Cycle Q Clear(g_c), s         | 15.0 | 0.2  | 0.2  | 0.9  | 0.0  | 0.0  | 0.3  | 0.0  | 9.5  | 0.3  | 4.4  | 5.3  |
| Prop In Lane                  | 1.00 |      | 0.98 | 0.33 |      | 0.33 | 1.00 |      | 0.03 | 1.00 |      | 1.00 |
| Lane Grp Cap(c), veh/h        | 640  | 639  | 573  | 64   | 0    | 0    | 25   | 0    | 464  | 25   | 467  | 397  |
| V/C Ratio(X)                  | 0.92 | 0.02 | 0.02 | 0.51 | 0.00 | 0.00 | 0.44 | 0.00 | 0.84 | 0.44 | 0.44 | 0.52 |
| Avail Cap(c_a), veh/h         | 1877 | 1872 | 1681 | 821  | 0    | 0    | 209  | 0    | 1008 | 206  | 1009 | 858  |
| HCM Platoon Ratio             | 1.00 | 1.00 | 1.00 | 1.00 | 1.00 | 1.00 | 1.00 | 1.00 | 1.00 | 1.00 | 1.00 | 1.00 |
| Upstream Filter(I)            | 1.00 | 1.00 | 1.00 | 1.00 | 0.00 | 0.00 | 1.00 | 0.00 | 1.00 | 1.00 | 1.00 | 1.00 |
| Uniform Delay (d), s/veh      | 14.5 | 9.7  | 9.8  | 22.4 | 0.0  | 0.0  | 23.2 | 0.0  | 16.9 | 23.2 | 15.0 | 15.3 |
| Incr Delay (d2), s/veh        | 2.3  | 0.0  | 0.0  | 2.3  | 0.0  | 0.0  | 11.4 | 0.0  | 1.6  | 11.4 | 0.2  | 0.4  |
| Initial Q Delay(d3),s/veh     | 0.0  | 0.0  | 0.0  | 0.0  | 0.0  | 0.0  | 0.0  | 0.0  | 0.0  | 0.0  | 0.0  | 0.0  |
| %ile BackOfQ(50%),veh/ln      | 7.6  | 0.1  | 0.1  | 0.5  | 0.0  | 0.0  | 0.2  | 0.0  | 5.0  | 0.2  | 2.3  | 2.3  |
| LnGrp Delay(d),s/veh          | 16.8 | 9.8  | 9.8  | 24.7 | 0.0  | 0.0  | 34.6 | 0.0  | 18.5 | 34.6 | 15.2 | 15.7 |
| LnGrp LOS                     | B    | A    | A    | C    |      |      | C    |      | B    | C    | B    | B    |
| Approach Vol, veh/h           |      | 609  |      |      | 33   |      |      | 402  |      |      | 424  |      |
| Approach Delay, s/veh         |      | 16.6 |      |      | 24.7 |      |      | 19.0 |      |      | 16.0 |      |
| Approach LOS                  |      | B    |      |      | C    |      |      | B    |      |      | B    |      |
| Timer                         | 1    | 2    | 3    | 4    | 5    | 6    | 7    | 8    |      |      |      |      |
| Assigned Phs                  | 1    | 2    |      | 4    | 5    | 6    |      | 8    |      |      |      |      |
| Phs Duration (G+Y+Rc), s      | 4.7  | 15.9 |      | 21.1 | 4.7  | 15.9 |      | 5.8  |      |      |      |      |
| Change Period (Y+Rc), s       | 4.0  | 4.0  |      | 4.0  | 4.0  | 4.0  |      | 4.0  |      |      |      |      |
| Max Green Setting (Gmax), s   | 5.5  | 25.8 |      | 50.2 | 5.6  | 25.7 |      | 22.5 |      |      |      |      |
| Max Q Clear Time (g_c+1/2), s | 12.3 | 11.5 |      | 17.0 | 2.3  | 7.3  |      | 2.9  |      |      |      |      |
| Green Ext Time (p_c), s       | 0.0  | 0.4  |      | 0.1  | 0.0  | 0.2  |      | 0.0  |      |      |      |      |
| <b>Intersection Summary</b>   |      |      |      |      |      |      |      |      |      |      |      |      |
| HCM 2010 Ctrl Delay           |      |      |      | 17.2 |      |      |      |      |      |      |      |      |
| HCM 2010 LOS                  |      |      |      | B    |      |      |      |      |      |      |      |      |

HCM 2010 Signalized Intersection Summary  
46: General Jim Moore Boulevard & Normandy Road

Cumulative with Eastside Parkway, PM  
06/11/2019



| Movement                     | EBL  | EBT  | EBR  | WBL  | WBT  | WBR  | NBL  | NBT  | NBR  | SBL  | SBT  | SBR  |
|------------------------------|------|------|------|------|------|------|------|------|------|------|------|------|
| Lane Configurations          |      | ↕    |      |      | ↕    |      | ↕    | ↕↕   |      | ↕    | ↕↕   | ↕    |
| Traffic Volume (veh/h)       | 150  | 40   | 100  | 300  | 50   | 10   | 90   | 730  | 310  | 30   | 430  | 80   |
| Future Volume (veh/h)        | 150  | 40   | 100  | 300  | 50   | 10   | 90   | 730  | 310  | 30   | 430  | 80   |
| Number                       | 3    | 8    | 18   | 7    | 4    | 14   | 1    | 6    | 16   | 5    | 2    | 12   |
| Initial Q (Qb), veh          | 0    | 0    | 0    | 0    | 0    | 0    | 0    | 0    | 0    | 0    | 0    | 0    |
| Ped-Bike Adj(A_pbT)          | 1.00 |      | 1.00 | 1.00 |      | 1.00 | 1.00 |      | 1.00 | 1.00 |      | 1.00 |
| Parking Bus, Adj             | 1.00 | 1.00 | 1.00 | 1.00 | 1.00 | 1.00 | 1.00 | 1.00 | 1.00 | 1.00 | 1.00 | 1.00 |
| Adj Sat Flow, veh/h/ln       | 1900 | 1863 | 1900 | 1900 | 1881 | 1900 | 1881 | 1881 | 1900 | 1900 | 1900 | 1900 |
| Adj Flow Rate, veh/h         | 163  | 43   | 84   | 326  | 54   | 8    | 98   | 793  | 314  | 33   | 467  | 28   |
| Adj No. of Lanes             | 0    | 1    | 0    | 0    | 1    | 0    | 1    | 2    | 0    | 1    | 2    | 1    |
| Peak Hour Factor             | 0.92 | 0.92 | 0.92 | 0.92 | 0.92 | 0.92 | 0.92 | 0.92 | 0.92 | 0.92 | 0.92 | 0.92 |
| Percent Heavy Veh, %         | 2    | 2    | 2    | 1    | 1    | 1    | 1    | 1    | 1    | 0    | 0    | 0    |
| Cap, veh/h                   | 389  | 112  | 158  | 512  | 63   | 9    | 395  | 901  | 356  | 67   | 637  | 284  |
| Arrive On Green              | 0.33 | 0.33 | 0.33 | 0.33 | 0.33 | 0.33 | 0.22 | 0.36 | 0.36 | 0.04 | 0.18 | 0.18 |
| Sat Flow, veh/h              | 832  | 339  | 477  | 1145 | 190  | 28   | 1792 | 2502 | 990  | 1810 | 3610 | 1610 |
| Grp Volume(v), veh/h         | 290  | 0    | 0    | 388  | 0    | 0    | 98   | 566  | 541  | 33   | 467  | 28   |
| Grp Sat Flow(s),veh/h/ln     | 1648 | 0    | 0    | 1362 | 0    | 0    | 1792 | 1787 | 1705 | 1810 | 1805 | 1610 |
| Q Serve(g_s), s              | 0.0  | 0.0  | 0.0  | 6.3  | 0.0  | 0.0  | 2.2  | 14.7 | 14.7 | 0.9  | 6.1  | 0.7  |
| Cycle Q Clear(g_c), s        | 6.8  | 0.0  | 0.0  | 13.1 | 0.0  | 0.0  | 2.2  | 14.7 | 14.7 | 0.9  | 6.1  | 0.7  |
| Prop In Lane                 | 0.56 |      | 0.29 | 0.84 |      | 0.02 | 1.00 |      | 0.58 | 1.00 |      | 1.00 |
| Lane Grp Cap(c), veh/h       | 659  | 0    | 0    | 584  | 0    | 0    | 395  | 643  | 614  | 67   | 637  | 284  |
| V/C Ratio(X)                 | 0.44 | 0.00 | 0.00 | 0.66 | 0.00 | 0.00 | 0.25 | 0.88 | 0.88 | 0.50 | 0.73 | 0.10 |
| Avail Cap(c_a), veh/h        | 1148 | 0    | 0    | 1031 | 0    | 0    | 395  | 919  | 877  | 292  | 1857 | 828  |
| HCM Platoon Ratio            | 1.00 | 1.00 | 1.00 | 1.00 | 1.00 | 1.00 | 1.00 | 1.00 | 1.00 | 1.00 | 1.00 | 1.00 |
| Upstream Filter(I)           | 1.00 | 0.00 | 0.00 | 1.00 | 0.00 | 0.00 | 1.00 | 1.00 | 1.00 | 1.00 | 1.00 | 1.00 |
| Uniform Delay (d), s/veh     | 13.3 | 0.0  | 0.0  | 15.4 | 0.0  | 0.0  | 15.9 | 14.9 | 14.9 | 23.4 | 19.3 | 17.1 |
| Incr Delay (d2), s/veh       | 0.2  | 0.0  | 0.0  | 0.5  | 0.0  | 0.0  | 0.1  | 5.5  | 5.8  | 2.1  | 0.6  | 0.1  |
| Initial Q Delay(d3),s/veh    | 0.0  | 0.0  | 0.0  | 0.0  | 0.0  | 0.0  | 0.0  | 0.0  | 0.0  | 0.0  | 0.0  | 0.0  |
| %ile BackOfQ(50%),veh/ln     | 3.2  | 0.0  | 0.0  | 4.9  | 0.0  | 0.0  | 1.1  | 8.2  | 7.9  | 0.5  | 3.0  | 0.3  |
| LnGrp Delay(d),s/veh         | 13.5 | 0.0  | 0.0  | 15.9 | 0.0  | 0.0  | 16.1 | 20.3 | 20.7 | 25.5 | 19.9 | 17.2 |
| LnGrp LOS                    | B    |      |      | B    |      |      | B    | C    | C    | C    | B    | B    |
| Approach Vol, veh/h          |      | 290  |      |      | 388  |      |      | 1205 |      |      | 528  |      |
| Approach Delay, s/veh        |      | 13.5 |      |      | 15.9 |      |      | 20.1 |      |      | 20.1 |      |
| Approach LOS                 |      | B    |      |      | B    |      |      | C    |      |      | C    |      |
| Timer                        | 1    | 2    | 3    | 4    | 5    | 6    | 7    | 8    |      |      |      |      |
| Assigned Phs                 | 1    | 2    |      | 4    | 5    | 6    |      | 8    |      |      |      |      |
| Phs Duration (G+Y+Rc), s     | 5.4  | 13.2 |      | 20.9 | 6.3  | 22.3 |      | 20.9 |      |      |      |      |
| Change Period (Y+Rc), s      | 4.5  | 4.5  |      | 4.5  | 4.5  | 4.5  |      | 4.5  |      |      |      |      |
| Max Green Setting (Gmax), s  | 30   | 25.5 |      | 33.0 | 8.0  | 25.5 |      | 33.0 |      |      |      |      |
| Max Q Clear Time (g_c+14), s | 14.2 | 8.1  |      | 15.1 | 2.9  | 16.7 |      | 8.8  |      |      |      |      |
| Green Ext Time (p_c), s      | 0.0  | 0.6  |      | 0.6  | 0.0  | 1.0  |      | 0.4  |      |      |      |      |
| <b>Intersection Summary</b>  |      |      |      |      |      |      |      |      |      |      |      |      |
| HCM 2010 Ctrl Delay          |      |      | 18.7 |      |      |      |      |      |      |      |      |      |
| HCM 2010 LOS                 |      |      | B    |      |      |      |      |      |      |      |      |      |

HCM 2010 Signalized Intersection Summary  
 47: General Jim Moore Boulevard & Coe Avenue

Cumulative with Eastside Parkway, PM  
 06/11/2019



| Movement                    | EBL  | EBT  | EBR  | WBL  | WBT  | WBR  | NBL  | NBT  | NBR  | SBL  | SBT  | SBR  |
|-----------------------------|------|------|------|------|------|------|------|------|------|------|------|------|
| Lane Configurations         |      |      |      |      |      |      |      |      |      |      |      |      |
| Traffic Volume (veh/h)      | 60   | 10   | 100  | 300  | 10   | 10   | 150  | 1030 | 490  | 10   | 490  | 60   |
| Future Volume (veh/h)       | 60   | 10   | 100  | 300  | 10   | 10   | 150  | 1030 | 490  | 10   | 490  | 60   |
| Number                      | 3    | 8    | 18   | 7    | 4    | 14   | 1    | 6    | 16   | 5    | 2    | 12   |
| Initial Q (Qb), veh         | 0    | 0    | 0    | 0    | 0    | 0    | 0    | 0    | 0    | 0    | 0    | 0    |
| Ped-Bike Adj(A_pbT)         | 1.00 |      | 0.99 | 0.99 |      | 1.00 | 1.00 |      | 0.99 | 1.00 |      | 0.99 |
| Parking Bus, Adj            | 1.00 | 1.00 | 1.00 | 1.00 | 1.00 | 1.00 | 1.00 | 1.00 | 1.00 | 1.00 | 1.00 | 1.00 |
| Adj Sat Flow, veh/h/ln      | 1881 | 1863 | 1881 | 1863 | 1863 | 1863 | 1881 | 1881 | 1863 | 1863 | 1881 | 1881 |
| Adj Flow Rate, veh/h        | 67   | 11   | 11   | 337  | 11   | 11   | 169  | 1157 | 524  | 11   | 551  | 31   |
| Adj No. of Lanes            | 1    | 1    | 1    | 1    | 1    | 1    | 1    | 2    | 1    | 1    | 2    | 1    |
| Peak Hour Factor            | 0.89 | 0.89 | 0.89 | 0.89 | 0.89 | 0.89 | 0.89 | 0.89 | 0.89 | 0.89 | 0.89 | 0.89 |
| Percent Heavy Veh, %        | 1    | 2    | 1    | 2    | 2    | 2    | 1    | 1    | 2    | 2    | 1    | 1    |
| Cap, veh/h                  | 574  | 570  | 486  | 567  | 570  | 485  | 208  | 1410 | 621  | 25   | 1046 | 464  |
| Arrive On Green             | 0.31 | 0.31 | 0.31 | 0.31 | 0.31 | 0.31 | 0.12 | 0.39 | 0.39 | 0.01 | 0.29 | 0.29 |
| Sat Flow, veh/h             | 1398 | 1863 | 1586 | 1374 | 1863 | 1583 | 1792 | 3574 | 1573 | 1774 | 3574 | 1585 |
| Grp Volume(v), veh/h        | 67   | 11   | 11   | 337  | 11   | 11   | 169  | 1157 | 524  | 11   | 551  | 31   |
| Grp Sat Flow(s),veh/h/ln    | 1398 | 1863 | 1586 | 1374 | 1863 | 1583 | 1792 | 1787 | 1573 | 1774 | 1787 | 1585 |
| Q Serve(g_s), s             | 1.7  | 0.2  | 0.2  | 10.7 | 0.2  | 0.2  | 4.4  | 13.7 | 14.3 | 0.3  | 6.1  | 0.7  |
| Cycle Q Clear(g_c), s       | 1.9  | 0.2  | 0.2  | 10.9 | 0.2  | 0.2  | 4.4  | 13.7 | 14.3 | 0.3  | 6.1  | 0.7  |
| Prop In Lane                | 1.00 |      | 1.00 | 1.00 |      | 1.00 | 1.00 |      | 1.00 | 1.00 |      | 1.00 |
| Lane Grp Cap(c), veh/h      | 574  | 570  | 486  | 567  | 570  | 485  | 208  | 1410 | 621  | 25   | 1046 | 464  |
| V/C Ratio(X)                | 0.12 | 0.02 | 0.02 | 0.59 | 0.02 | 0.02 | 0.81 | 0.82 | 0.84 | 0.44 | 0.53 | 0.07 |
| Avail Cap(c_a), veh/h       | 1489 | 1790 | 1524 | 1466 | 1790 | 1521 | 208  | 2680 | 1180 | 206  | 2680 | 1189 |
| HCM Platoon Ratio           | 1.00 | 1.00 | 1.00 | 1.00 | 1.00 | 1.00 | 1.00 | 1.00 | 1.00 | 1.00 | 1.00 | 1.00 |
| Upstream Filter(I)          | 1.00 | 1.00 | 1.00 | 1.00 | 1.00 | 1.00 | 1.00 | 1.00 | 1.00 | 1.00 | 1.00 | 1.00 |
| Uniform Delay (d), s/veh    | 12.1 | 11.5 | 11.5 | 15.3 | 11.5 | 11.5 | 20.4 | 12.8 | 13.0 | 23.2 | 14.0 | 12.1 |
| Incr Delay (d2), s/veh      | 0.0  | 0.0  | 0.0  | 0.4  | 0.0  | 0.0  | 19.8 | 0.5  | 1.2  | 4.3  | 0.2  | 0.0  |
| Initial Q Delay(d3),s/veh   | 0.0  | 0.0  | 0.0  | 0.0  | 0.0  | 0.0  | 0.0  | 0.0  | 0.0  | 0.0  | 0.0  | 0.0  |
| %ile BackOfQ(50%),veh/ln    | 0.6  | 0.1  | 0.1  | 4.1  | 0.1  | 0.1  | 3.3  | 6.7  | 6.3  | 0.2  | 3.0  | 0.3  |
| LnGrp Delay(d),s/veh        | 12.1 | 11.5 | 11.5 | 15.7 | 11.5 | 11.5 | 40.2 | 13.3 | 14.3 | 27.5 | 14.2 | 12.1 |
| LnGrp LOS                   | B    | B    | B    | B    | B    | B    | D    | B    | B    | C    | B    | B    |
| Approach Vol, veh/h         |      | 89   |      |      | 359  |      |      | 1850 |      |      | 593  |      |
| Approach Delay, s/veh       |      | 12.0 |      |      | 15.4 |      |      | 16.0 |      |      | 14.3 |      |
| Approach LOS                |      | B    |      |      | B    |      |      | B    |      |      | B    |      |
| Timer                       | 1    | 2    | 3    | 4    | 5    | 6    | 7    | 8    |      |      |      |      |
| Assigned Phs                | 1    | 2    |      | 4    | 5    | 6    |      | 8    |      |      |      |      |
| Phs Duration (G+Y+Rc), s    | 0.0  | 18.4 |      | 19.0 | 5.2  | 23.2 |      | 19.0 |      |      |      |      |
| Change Period (Y+Rc), s     | 4.5  | 4.5  |      | 4.5  | 4.5  | 4.5  |      | 4.5  |      |      |      |      |
| Max Green Setting (Gmax), s | 5.5  | 35.5 |      | 45.5 | 5.5  | 35.5 |      | 45.5 |      |      |      |      |
| Max Q Clear Time (g_c+1), s | 10.4 | 8.1  |      | 12.9 | 2.3  | 16.3 |      | 3.9  |      |      |      |      |
| Green Ext Time (p_c), s     | 0.0  | 0.6  |      | 0.1  | 0.0  | 1.3  |      | 0.0  |      |      |      |      |
| <b>Intersection Summary</b> |      |      |      |      |      |      |      |      |      |      |      |      |
| HCM 2010 Ctrl Delay         |      |      |      | 15.5 |      |      |      |      |      |      |      |      |
| HCM 2010 LOS                |      |      |      | B    |      |      |      |      |      |      |      |      |





| Movement                     | EBL  | EBT  | EBR  | WBL   | WBT  | WBR   | NBL  | NBT  | NBR  | SBL  | SBT   | SBR  |
|------------------------------|------|------|------|-------|------|-------|------|------|------|------|-------|------|
| Lane Configurations          |      |      |      |       |      |       |      |      |      |      |       |      |
| Traffic Volume (veh/h)       | 220  | 170  | 70   | 90    | 100  | 70    | 110  | 1180 | 230  | 40   | 700   | 170  |
| Future Volume (veh/h)        | 220  | 170  | 70   | 90    | 100  | 70    | 110  | 1180 | 230  | 40   | 700   | 170  |
| Number                       | 7    | 4    | 14   | 3     | 8    | 18    | 5    | 2    | 12   | 1    | 6     | 16   |
| Initial Q (Qb), veh          | 0    | 0    | 0    | 0     | 0    | 0     | 0    | 0    | 0    | 0    | 0     | 0    |
| Ped-Bike Adj(A_pbT)          | 1.00 |      | 0.98 | 1.00  |      | 0.99  | 1.00 |      | 0.99 | 1.00 |       | 0.99 |
| Parking Bus, Adj             | 1.00 | 1.00 | 1.00 | 1.00  | 1.00 | 1.00  | 1.00 | 1.00 | 1.00 | 1.00 | 1.00  | 1.00 |
| Adj Sat Flow, veh/h/ln       | 1881 | 1881 | 1881 | 1900  | 1900 | 1900  | 1881 | 1881 | 1900 | 1863 | 1863  | 1863 |
| Adj Flow Rate, veh/h         | 201  | 211  | 25   | 93    | 103  | 66    | 113  | 1216 | 225  | 41   | 722   | 103  |
| Adj No. of Lanes             | 1    | 1    | 1    | 0     | 1    | 0     | 1    | 2    | 0    | 1    | 2     | 1    |
| Peak Hour Factor             | 0.97 | 0.97 | 0.97 | 0.97  | 0.97 | 0.97  | 0.97 | 0.97 | 0.97 | 0.97 | 0.97  | 0.97 |
| Percent Heavy Veh, %         | 1    | 1    | 1    | 0     | 0    | 0     | 1    | 1    | 1    | 2    | 2     | 2    |
| Cap, veh/h                   | 265  | 278  | 231  | 105   | 117  | 75    | 597  | 1512 | 278  | 53   | 671   | 297  |
| Arrive On Green              | 0.15 | 0.15 | 0.15 | 0.17  | 0.17 | 0.17  | 0.33 | 0.50 | 0.50 | 0.03 | 0.19  | 0.19 |
| Sat Flow, veh/h              | 1792 | 1881 | 1565 | 634   | 702  | 450   | 1792 | 3013 | 553  | 1774 | 3539  | 1568 |
| Grp Volume(v), veh/h         | 201  | 211  | 25   | 262   | 0    | 0     | 113  | 717  | 724  | 41   | 722   | 103  |
| Grp Sat Flow(s),veh/h/ln     | 1792 | 1881 | 1565 | 1785  | 0    | 0     | 1792 | 1787 | 1780 | 1774 | 1770  | 1568 |
| Q Serve(g_s), s              | 13.5 | 13.5 | 1.7  | 17.9  | 0.0  | 0.0   | 5.6  | 41.8 | 42.7 | 2.9  | 23.7  | 7.1  |
| Cycle Q Clear(g_c), s        | 13.5 | 13.5 | 1.7  | 17.9  | 0.0  | 0.0   | 5.6  | 41.8 | 42.7 | 2.9  | 23.7  | 7.1  |
| Prop In Lane                 | 1.00 |      | 1.00 | 0.35  |      | 0.25  | 1.00 |      | 0.31 | 1.00 |       | 1.00 |
| Lane Grp Cap(c), veh/h       | 265  | 278  | 231  | 297   | 0    | 0     | 597  | 897  | 893  | 53   | 671   | 297  |
| V/C Ratio(X)                 | 0.76 | 0.76 | 0.11 | 0.88  | 0.00 | 0.00  | 0.19 | 0.80 | 0.81 | 0.78 | 1.08  | 0.35 |
| Avail Cap(c_a), veh/h        | 573  | 602  | 501  | 357   | 0    | 0     | 597  | 897  | 893  | 241  | 671   | 297  |
| HCM Platoon Ratio            | 1.00 | 1.00 | 1.00 | 1.00  | 1.00 | 1.00  | 1.00 | 1.00 | 1.00 | 1.00 | 1.00  | 1.00 |
| Upstream Filter(I)           | 0.69 | 0.69 | 0.69 | 1.00  | 0.00 | 0.00  | 1.00 | 1.00 | 1.00 | 1.00 | 1.00  | 1.00 |
| Uniform Delay (d), s/veh     | 51.1 | 51.1 | 46.1 | 50.9  | 0.0  | 0.0   | 29.7 | 25.9 | 26.1 | 60.2 | 50.7  | 43.9 |
| Incr Delay (d2), s/veh       | 3.1  | 3.0  | 0.1  | 20.8  | 0.0  | 0.0   | 0.1  | 7.4  | 7.9  | 8.8  | 57.0  | 3.2  |
| Initial Q Delay(d3),s/veh    | 0.0  | 0.0  | 0.0  | 0.0   | 0.0  | 0.0   | 0.0  | 0.0  | 0.0  | 0.0  | 0.0   | 0.0  |
| %ile BackOfQ(50%),veh/ln     | 6.9  | 7.2  | 0.8  | 10.6  | 0.0  | 0.0   | 2.8  | 22.4 | 22.9 | 1.5  | 16.9  | 3.4  |
| LnGrp Delay(d),s/veh         | 54.2 | 54.1 | 46.3 | 71.7  | 0.0  | 0.0   | 29.7 | 33.3 | 34.0 | 69.1 | 107.6 | 47.1 |
| LnGrp LOS                    | D    | D    | D    | E     |      |       | C    | C    | C    | E    | F     | D    |
| Approach Vol, veh/h          |      | 437  |      |       | 262  |       |      | 1554 |      |      | 866   |      |
| Approach Delay, s/veh        |      | 53.7 |      |       | 71.7 |       |      | 33.4 |      |      | 98.6  |      |
| Approach LOS                 |      | D    |      |       | E    |       |      | C    |      |      | F     |      |
| Timer                        | 1    | 2    | 3    | 4     | 5    | 6     | 7    | 8    |      |      |       |      |
| Assigned Phs                 | 1    | 2    |      | 4     | 5    | 6     |      | 8    |      |      |       |      |
| Phs Duration (G+Y+Rc), s     | 7.9  | 68.0 |      | 23.2  | 46.9 | 29.0  |      | 25.9 |      |      |       |      |
| Change Period (Y+Rc), s      | 4.2  | 5.3  |      | * 4.7 | 5.3  | * 5.3 |      | 5.1  |      |      |       |      |
| Max Green Setting (Gmax), s  | 13   | 23.7 |      | * 40  | 17.0 | * 24  |      | 25.0 |      |      |       |      |
| Max Q Clear Time (g_c+14), s | 14.5 | 44.7 |      | 15.5  | 7.6  | 25.7  |      | 19.9 |      |      |       |      |
| Green Ext Time (p_c), s      | 0.0  | 0.0  |      | 1.9   | 0.1  | 0.0   |      | 0.8  |      |      |       |      |
| <b>Intersection Summary</b>  |      |      |      |       |      |       |      |      |      |      |       |      |
| HCM 2010 Ctrl Delay          |      |      | 57.6 |       |      |       |      |      |      |      |       |      |
| HCM 2010 LOS                 |      |      | E    |       |      |       |      |      |      |      |       |      |
| <b>Notes</b>                 |      |      |      |       |      |       |      |      |      |      |       |      |



| Movement                     | EBL  | EBT  | EBR  | WBL   | WBT  | WBR   | NBL  | NBT   | NBR  | SBL  | SBT  | SBR  |
|------------------------------|------|------|------|-------|------|-------|------|-------|------|------|------|------|
| Lane Configurations          |      | ↔↔   | ↗    | ↖     |      | ↗     |      | ↑     | ↗    |      | ↖    |      |
| Traffic Volume (veh/h)       | 10   | 150  | 120  | 280   | 0    | 130   | 0    | 120   | 300  | 10   | 10   | 0    |
| Future Volume (veh/h)        | 10   | 150  | 120  | 280   | 0    | 130   | 0    | 120   | 300  | 10   | 10   | 0    |
| Number                       | 1    | 6    | 16   | 5     | 2    | 12    | 7    | 4     | 14   | 3    | 8    | 18   |
| Initial Q (Qb), veh          | 0    | 0    | 0    | 0     | 0    | 0     | 0    | 0     | 0    | 0    | 0    | 0    |
| Ped-Bike Adj(A_pbT)          | 1.00 |      | 1.00 | 1.00  |      | 1.00  | 1.00 |       | 1.00 | 1.00 |      | 1.00 |
| Parking Bus, Adj             | 1.00 | 1.00 | 1.00 | 1.00  | 1.00 | 1.00  | 1.00 | 1.00  | 1.00 | 1.00 | 1.00 | 1.00 |
| Adj Sat Flow, veh/h/ln       | 1900 | 1863 | 1863 | 1900  | 0    | 1900  | 0    | 1881  | 1881 | 1900 | 1900 | 0    |
| Adj Flow Rate, veh/h         | 11   | 165  | 14   | 308   | 0    | 69    | 0    | 132   | 51   | 11   | 11   | 0    |
| Adj No. of Lanes             | 0    | 2    | 1    | 1     | 0    | 1     | 0    | 1     | 1    | 0    | 1    | 0    |
| Peak Hour Factor             | 0.91 | 0.91 | 0.91 | 0.91  | 0.91 | 0.91  | 0.91 | 0.91  | 0.91 | 0.91 | 0.91 | 0.91 |
| Percent Heavy Veh, %         | 2    | 2    | 2    | 0     | 0    | 0     | 0    | 1     | 1    | 0    | 0    | 0    |
| Cap, veh/h                   | 181  | 2850 | 1323 | 0     | 0    | 0     | 0    | 164   | 139  | 57   | 43   | 0    |
| Arrive On Green              | 0.84 | 0.84 | 0.84 | 0.00  | 0.00 | 0.00  | 0.00 | 0.09  | 0.09 | 0.09 | 0.09 | 0.00 |
| Sat Flow, veh/h              | 216  | 3406 | 1580 |       | 0    |       | 0    | 1881  | 1599 | 155  | 496  | 0    |
| Grp Volume(v), veh/h         | 94   | 82   | 14   |       | 0.0  |       | 0    | 132   | 51   | 22   | 0    | 0    |
| Grp Sat Flow(s),veh/h/ln     | 1852 | 1770 | 1580 |       |      |       | 0    | 1881  | 1599 | 651  | 0    | 0    |
| Q Serve(g_s), s              | 1.1  | 1.0  | 0.2  |       |      |       | 0.0  | 8.6   | 3.8  | 0.1  | 0.0  | 0.0  |
| Cycle Q Clear(g_c), s        | 1.1  | 1.0  | 0.2  |       |      |       | 0.0  | 8.6   | 3.8  | 8.7  | 0.0  | 0.0  |
| Prop In Lane                 | 0.12 |      | 1.00 |       |      |       | 0.00 |       | 1.00 | 0.50 |      | 0.00 |
| Lane Grp Cap(c), veh/h       | 1550 | 1481 | 1323 |       |      |       | 0    | 164   | 139  | 100  | 0    | 0    |
| V/C Ratio(X)                 | 0.06 | 0.06 | 0.01 |       |      |       | 0.00 | 0.81  | 0.37 | 0.22 | 0.00 | 0.00 |
| Avail Cap(c_a), veh/h        | 1550 | 1481 | 1323 |       |      |       | 0    | 271   | 230  | 125  | 0    | 0    |
| HCM Platoon Ratio            | 1.00 | 1.00 | 1.00 |       |      |       | 1.00 | 1.00  | 1.00 | 1.00 | 1.00 | 1.00 |
| Upstream Filter(I)           | 1.00 | 1.00 | 1.00 |       |      |       | 0.00 | 1.00  | 1.00 | 1.00 | 0.00 | 0.00 |
| Uniform Delay (d), s/veh     | 1.8  | 1.7  | 1.7  |       |      |       | 0.0  | 56.0  | 53.8 | 52.9 | 0.0  | 0.0  |
| Incr Delay (d2), s/veh       | 0.0  | 0.0  | 0.0  |       |      |       | 0.0  | 3.5   | 0.6  | 0.4  | 0.0  | 0.0  |
| Initial Q Delay(d3),s/veh    | 0.0  | 0.0  | 0.0  |       |      |       | 0.0  | 0.0   | 0.0  | 0.0  | 0.0  | 0.0  |
| %ile BackOfQ(50%),veh/ln     | 0.6  | 0.5  | 0.1  |       |      |       | 0.0  | 4.6   | 1.7  | 0.7  | 0.0  | 0.0  |
| LnGrp Delay(d),s/veh         | 1.8  | 1.7  | 1.7  |       |      |       | 0.0  | 59.5  | 54.4 | 53.3 | 0.0  | 0.0  |
| LnGrp LOS                    | A    | A    | A    |       |      |       |      | E     | D    | D    |      |      |
| Approach Vol, veh/h          |      | 190  |      |       |      |       |      | 183   |      |      | 22   |      |
| Approach Delay, s/veh        |      | 1.7  |      |       |      |       |      | 58.1  |      |      | 53.3 |      |
| Approach LOS                 |      | A    |      |       |      |       |      | E     |      |      | D    |      |
| Timer                        | 1    | 2    | 3    | 4     | 5    | 6     | 7    | 8     |      |      |      |      |
| Assigned Phs                 |      |      |      | 4     |      | 6     |      | 8     |      |      |      |      |
| Phs Duration (G+Y+Rc), s     |      |      |      | 15.1  |      | 109.9 |      | 15.1  |      |      |      |      |
| Change Period (Y+Rc), s      |      |      |      | * 4.2 |      | 5.3   |      | * 4.2 |      |      |      |      |
| Max Green Setting (Gmax), s  |      |      |      | * 18  |      | 21.0  |      | * 13  |      |      |      |      |
| Max Q Clear Time (g_c+I1), s |      |      |      | 10.6  |      | 3.1   |      | 10.7  |      |      |      |      |
| Green Ext Time (p_c), s      |      |      |      | 0.3   |      | 0.6   |      | 0.0   |      |      |      |      |
| <b>Intersection Summary</b>  |      |      |      |       |      |       |      |       |      |      |      |      |
| HCM 2010 Ctrl Delay          |      |      | 30.7 |       |      |       |      |       |      |      |      |      |
| HCM 2010 LOS                 |      |      | C    |       |      |       |      |       |      |      |      |      |
| <b>Notes</b>                 |      |      |      |       |      |       |      |       |      |      |      |      |





















| Movement                      | EBL | EBT  | EBR | WBL  | WBT  | WBR  | NBL  | NBT  | NBR  | SBL  | SBT  | SBR  |
|-------------------------------|-----|------|-----|------|------|------|------|------|------|------|------|------|
| Lane Configurations           |     |      |     |      | ↕    | ↕    | ↕    | ↕    |      |      | ↕    |      |
| Traffic Volume (veh/h)        | 0   | 0    | 0   | 410  | 10   | 250  | 130  | 240  | 0    | 0    | 520  | 170  |
| Future Volume (veh/h)         | 0   | 0    | 0   | 410  | 10   | 250  | 130  | 240  | 0    | 0    | 520  | 170  |
| Number                        |     |      |     | 7    | 4    | 14   | 1    | 6    | 16   | 5    | 2    | 12   |
| Initial Q (Qb), veh           |     |      |     | 0    | 0    | 0    | 0    | 0    | 0    | 0    | 0    | 0    |
| Ped-Bike Adj(A_pbT)           |     |      |     | 1.00 |      | 1.00 | 1.00 |      | 1.00 | 1.00 |      | 1.00 |
| Parking Bus, Adj              |     |      |     | 1.00 | 1.00 | 1.00 | 1.00 | 1.00 | 1.00 | 1.00 | 1.00 | 1.00 |
| Adj Sat Flow, veh/h/ln        |     |      |     | 1900 | 1863 | 1863 | 1845 | 1845 | 0    | 0    | 1827 | 1900 |
| Adj Flow Rate, veh/h          |     |      |     | 436  | 11   | 84   | 138  | 255  | 0    | 0    | 553  | 171  |
| Adj No. of Lanes              |     |      |     | 0    | 1    | 1    | 1    | 1    | 0    | 0    | 1    | 0    |
| Peak Hour Factor              |     |      |     | 0.94 | 0.94 | 0.94 | 0.94 | 0.94 | 0.94 | 0.94 | 0.94 | 0.94 |
| Percent Heavy Veh, %          |     |      |     | 2    | 2    | 2    | 3    | 3    | 0    | 0    | 4    | 4    |
| Cap, veh/h                    |     |      |     | 485  | 12   | 443  | 172  | 1091 | 0    | 0    | 606  | 187  |
| Arrive On Green               |     |      |     | 0.28 | 0.28 | 0.28 | 0.03 | 0.20 | 0.00 | 0.00 | 0.45 | 0.45 |
| Sat Flow, veh/h               |     |      |     | 1732 | 44   | 1581 | 1757 | 1845 | 0    | 0    | 1340 | 414  |
| Grp Volume(v), veh/h          |     |      |     | 447  | 0    | 84   | 138  | 255  | 0    | 0    | 0    | 724  |
| Grp Sat Flow(s),veh/h/ln      |     |      |     | 1776 | 0    | 1581 | 1757 | 1845 | 0    | 0    | 0    | 1754 |
| Q Serve(g_s), s               |     |      |     | 20.6 | 0.0  | 3.4  | 6.6  | 9.9  | 0.0  | 0.0  | 0.0  | 32.7 |
| Cycle Q Clear(g_c), s         |     |      |     | 20.6 | 0.0  | 3.4  | 6.6  | 9.9  | 0.0  | 0.0  | 0.0  | 32.7 |
| Prop In Lane                  |     |      |     | 0.98 |      | 1.00 | 1.00 |      | 0.00 | 0.00 |      | 0.24 |
| Lane Grp Cap(c), veh/h        |     |      |     | 498  | 0    | 443  | 172  | 1091 | 0    | 0    | 0    | 793  |
| V/C Ratio(X)                  |     |      |     | 0.90 | 0.00 | 0.19 | 0.80 | 0.23 | 0.00 | 0.00 | 0.00 | 0.91 |
| Avail Cap(c_a), veh/h         |     |      |     | 564  | 0    | 502  | 248  | 1091 | 0    | 0    | 0    | 793  |
| HCM Platoon Ratio             |     |      |     | 1.00 | 1.00 | 1.00 | 0.33 | 0.33 | 1.00 | 1.00 | 1.00 | 1.00 |
| Upstream Filter(I)            |     |      |     | 1.00 | 0.00 | 1.00 | 0.95 | 0.95 | 0.00 | 0.00 | 0.00 | 1.00 |
| Uniform Delay (d), s/veh      |     |      |     | 29.4 | 0.0  | 23.3 | 40.3 | 18.0 | 0.0  | 0.0  | 0.0  | 21.7 |
| Incr Delay (d2), s/veh        |     |      |     | 15.9 | 0.0  | 0.2  | 6.8  | 0.5  | 0.0  | 0.0  | 0.0  | 16.7 |
| Initial Q Delay(d3),s/veh     |     |      |     | 0.0  | 0.0  | 0.0  | 0.0  | 0.0  | 0.0  | 0.0  | 0.0  | 0.0  |
| %ile BackOfQ(50%),veh/ln      |     |      |     | 12.3 | 0.0  | 1.5  | 3.6  | 5.2  | 0.0  | 0.0  | 0.0  | 19.4 |
| LnGrp Delay(d),s/veh          |     |      |     | 45.4 | 0.0  | 23.5 | 47.1 | 18.4 | 0.0  | 0.0  | 0.0  | 38.4 |
| LnGrp LOS                     |     |      |     | D    |      | C    | D    | B    |      |      |      | D    |
| Approach Vol, veh/h           |     |      |     |      | 531  |      |      | 393  |      |      | 724  |      |
| Approach Delay, s/veh         |     |      |     |      | 41.9 |      |      | 28.5 |      |      | 38.4 |      |
| Approach LOS                  |     |      |     |      | D    |      |      | C    |      |      | D    |      |
| Timer                         | 1   | 2    | 3   | 4    | 5    | 6    | 7    | 8    |      |      |      |      |
| Assigned Phs                  | 1   | 2    |     | 4    |      | 6    |      |      |      |      |      |      |
| Phs Duration (G+Y+Rc), s      | 1.8 | 44.4 |     | 28.7 |      | 56.3 |      |      |      |      |      |      |
| Change Period (Y+Rc), s       | 3.5 | 6.0  |     | 4.9  |      | 6.0  |      |      |      |      |      |      |
| Max Green Setting (Gmax), s   | 2.0 | 31.6 |     | 27.0 |      | 47.1 |      |      |      |      |      |      |
| Max Q Clear Time (g_c+1.0), s | 1.6 | 34.7 |     | 22.6 |      | 11.9 |      |      |      |      |      |      |
| Green Ext Time (p_c), s       | 0.0 | 0.0  |     | 1.2  |      | 1.3  |      |      |      |      |      |      |
| <b>Intersection Summary</b>   |     |      |     |      |      |      |      |      |      |      |      |      |
| HCM 2010 Ctrl Delay           |     |      |     | 37.2 |      |      |      |      |      |      |      |      |
| HCM 2010 LOS                  |     |      |     | D    |      |      |      |      |      |      |      |      |



| Movement                     | EBL  | EBT  | EBR  | WBL | WBT  | WBR  | NBL  | NBT  | NBR  | SBL  | SBT  | SBR  |
|------------------------------|------|------|------|-----|------|------|------|------|------|------|------|------|
| Lane Configurations          |      | ↕    | ↗    |     |      |      |      | ↑    | ↗    | ↖    | ↑    |      |
| Traffic Volume (veh/h)       | 100  | 10   | 180  | 0   | 0    | 0    | 0    | 300  | 320  | 260  | 670  | 0    |
| Future Volume (veh/h)        | 100  | 10   | 180  | 0   | 0    | 0    | 0    | 300  | 320  | 260  | 670  | 0    |
| Number                       | 3    | 8    | 18   |     |      |      | 1    | 6    | 16   | 5    | 2    | 12   |
| Initial Q (Qb), veh          | 0    | 0    | 0    |     |      |      | 0    | 0    | 0    | 0    | 0    | 0    |
| Ped-Bike Adj(A_pbT)          | 1.00 |      | 1.00 |     |      |      | 1.00 |      | 1.00 | 1.00 |      | 1.00 |
| Parking Bus, Adj             | 1.00 | 1.00 | 1.00 |     |      |      | 1.00 | 1.00 | 1.00 | 1.00 | 1.00 | 1.00 |
| Adj Sat Flow, veh/h/ln       | 1900 | 1863 | 1863 |     |      |      | 0    | 1845 | 1845 | 1827 | 1827 | 0    |
| Adj Flow Rate, veh/h         | 106  | 11   | 12   |     |      |      | 0    | 319  | 201  | 277  | 713  | 0    |
| Adj No. of Lanes             | 0    | 1    | 1    |     |      |      | 0    | 1    | 1    | 1    | 1    | 0    |
| Peak Hour Factor             | 0.94 | 0.94 | 0.94 |     |      |      | 0.94 | 0.94 | 0.94 | 0.94 | 0.94 | 0.94 |
| Percent Heavy Veh, %         | 2    | 2    | 2    |     |      |      | 0    | 3    | 3    | 4    | 4    | 0    |
| Cap, veh/h                   | 144  | 15   | 141  |     |      |      | 0    | 1038 | 882  | 307  | 1430 | 0    |
| Arrive On Green              | 0.09 | 0.09 | 0.09 |     |      |      | 0.00 | 0.56 | 0.56 | 0.35 | 1.00 | 0.00 |
| Sat Flow, veh/h              | 1614 | 168  | 1583 |     |      |      | 0    | 1845 | 1568 | 1740 | 1827 | 0    |
| Grp Volume(v), veh/h         | 117  | 0    | 12   |     |      |      | 0    | 319  | 201  | 277  | 713  | 0    |
| Grp Sat Flow(s),veh/h/ln     | 1782 | 0    | 1583 |     |      |      | 0    | 1845 | 1568 | 1740 | 1827 | 0    |
| Q Serve(g_s), s              | 5.4  | 0.0  | 0.6  |     |      |      | 0.0  | 7.8  | 5.5  | 12.8 | 0.0  | 0.0  |
| Cycle Q Clear(g_c), s        | 5.4  | 0.0  | 0.6  |     |      |      | 0.0  | 7.8  | 5.5  | 12.8 | 0.0  | 0.0  |
| Prop In Lane                 | 0.91 |      | 1.00 |     |      |      | 0.00 |      | 1.00 | 1.00 |      | 0.00 |
| Lane Grp Cap(c), veh/h       | 159  | 0    | 141  |     |      |      | 0    | 1038 | 882  | 307  | 1430 | 0    |
| V/C Ratio(X)                 | 0.74 | 0.00 | 0.08 |     |      |      | 0.00 | 0.31 | 0.23 | 0.90 | 0.50 | 0.00 |
| Avail Cap(c_a), veh/h        | 524  | 0    | 466  |     |      |      | 0    | 1038 | 882  | 348  | 1430 | 0    |
| HCM Platoon Ratio            | 1.00 | 1.00 | 1.00 |     |      |      | 1.00 | 1.00 | 1.00 | 2.00 | 2.00 | 1.00 |
| Upstream Filter(I)           | 1.00 | 0.00 | 1.00 |     |      |      | 0.00 | 1.00 | 1.00 | 0.15 | 0.15 | 0.00 |
| Uniform Delay (d), s/veh     | 37.7 | 0.0  | 35.5 |     |      |      | 0.0  | 9.8  | 9.3  | 26.8 | 0.0  | 0.0  |
| Incr Delay (d2), s/veh       | 6.5  | 0.0  | 0.3  |     |      |      | 0.0  | 0.8  | 0.6  | 5.0  | 0.2  | 0.0  |
| Initial Q Delay(d3),s/veh    | 0.0  | 0.0  | 0.0  |     |      |      | 0.0  | 0.0  | 0.0  | 0.0  | 0.0  | 0.0  |
| %ile BackOfQ(50%),veh/ln     | 3.0  | 0.0  | 0.3  |     |      |      | 0.0  | 4.1  | 2.5  | 6.5  | 0.1  | 0.0  |
| LnGrp Delay(d),s/veh         | 44.2 | 0.0  | 35.8 |     |      |      | 0.0  | 10.6 | 9.9  | 31.8 | 0.2  | 0.0  |
| LnGrp LOS                    | D    |      | D    |     |      |      |      | B    | A    | C    | A    |      |
| Approach Vol, veh/h          |      | 129  |      |     |      |      |      | 520  |      |      | 990  |      |
| Approach Delay, s/veh        |      | 43.4 |      |     |      |      |      | 10.3 |      |      | 9.0  |      |
| Approach LOS                 |      | D    |      |     |      |      |      | B    |      |      | A    |      |
| Timer                        | 1    | 2    | 3    | 4   | 5    | 6    | 7    | 8    |      |      |      |      |
| Assigned Phs                 |      | 2    |      |     | 5    | 6    |      | 8    |      |      |      |      |
| Phs Duration (G+Y+Rc), s     |      | 72.5 |      |     | 18.7 | 53.8 |      | 12.5 |      |      |      |      |
| Change Period (Y+Rc), s      |      | 6.0  |      |     | 3.7  | 6.0  |      | 4.9  |      |      |      |      |
| Max Green Setting (Gmax), s  |      | 43.1 |      |     | 17.0 | 28.4 |      | 25.0 |      |      |      |      |
| Max Q Clear Time (g_c+I1), s |      | 2.0  |      |     | 14.8 | 9.8  |      | 7.4  |      |      |      |      |
| Green Ext Time (p_c), s      |      | 4.9  |      |     | 0.2  | 2.1  |      | 0.5  |      |      |      |      |
| <b>Intersection Summary</b>  |      |      |      |     |      |      |      |      |      |      |      |      |
| HCM 2010 Ctrl Delay          |      |      | 12.1 |     |      |      |      |      |      |      |      |      |
| HCM 2010 LOS                 |      |      | B    |     |      |      |      |      |      |      |      |      |

HCM 2010 Signalized Intersection Summary Cumulative with Eastside Parkway with Project, AM  
 1: Del Monte Boulevard & Reindollar Avenue 06/11/2019

|                              |  |  |  |  |  |  |   |  |  |  |  |  |  |
|------------------------------|---|---|---|---|---|---|---|---|---|---|---|---|--|
| Movement                     | EBL   | EBT   | EBR   | WBL   | WBT   | WBR   | NBL   | NBT   | NBR   | SBL   | SBT   | SBR   |  |
| Lane Configurations          |   |   |   |  |  |   |  |  |  |  |  |   |  |
| Traffic Volume (veh/h)       | 0   | 0   | 0   | 450   | 0   | 420   | 10  | 650   | 120   | 410   | 1180  | 0   |  |
| Future Volume (veh/h)        | 0   | 0   | 0   | 450   | 0   | 420   | 10  | 650   | 120   | 410   | 1180  | 0   |  |
| Number                       |   |   |   | 3   | 8   | 18  | 1   | 6   | 16  | 5   | 2   | 12  |  |
| Initial Q (Qb), veh          |   |   |   | 0   | 0   | 0   | 0   | 0   | 0   | 0   | 0   | 0   |  |
| Ped-Bike Adj(A_pbT)          |   |   |   | 1.00  |   | 0.99  | 1.00  |   | 1.00  | 1.00  |   | 1.00  |  |
| Parking Bus, Adj             |   |   |   | 1.00  | 1.00  | 1.00  | 1.00  | 1.00  | 1.00  | 1.00  | 1.00  | 1.00  |  |
| Adj Sat Flow, veh/h/ln       |   |   |   | 1900  | 1900  | 1900  | 1863  | 1863  | 1863  | 1845  | 1845  | 0   |  |
| Adj Flow Rate, veh/h         |   |   |   | 468   | 54  | 429   | 11  | 730   | 68  | 461   | 1326  | 0   |  |
| Adj No. of Lanes             |   |   |   | 1   | 1   | 0   | 1   | 2   | 1   | 1   | 2   | 0   |  |
| Peak Hour Factor             |   |   |   | 0.89  | 0.89  | 0.89  | 0.89  | 0.89  | 0.89  | 0.89  | 0.89  | 0.89  |  |
| Percent Heavy Veh, %         |   |   |   | 0   | 0   | 0   | 2   | 2   | 2   | 3   | 3   | 0   |  |
| Cap, veh/h                   |   |   |   | 573   | 58  | 459   | 24  | 900   | 401   | 498   | 1839  | 0   |  |
| Arrive On Green              |   |   |   | 0.32  | 0.32  | 0.32  | 0.01  | 0.25  | 0.25  | 0.28  | 0.52  | 0.00  |  |
| Sat Flow, veh/h              |   |   |   | 1810  | 183   | 1451  | 1774  | 3539  | 1577  | 1757  | 3597  | 0   |  |
| Grp Volume(v), veh/h         |   |   |   | 468   | 0   | 483   | 11  | 730   | 68  | 461   | 1326  | 0   |  |
| Grp Sat Flow(s),veh/h/ln     |   |   |   | 1810  | 0   | 1634  | 1774  | 1770  | 1577  | 1757  | 1752  | 0   |  |
| Q Serve(g_s), s              |   |   |   | 22.1  | 0.0   | 26.6  | 0.6   | 18.0  | 3.1   | 23.6  | 26.8  | 0.0   |  |
| Cycle Q Clear(g_c), s        |   |   |   | 22.1  | 0.0   | 26.6  | 0.6   | 18.0  | 3.1   | 23.6  | 26.8  | 0.0   |  |
| Prop In Lane                 |   |   |   | 1.00  |   | 0.89  | 1.00  |   | 1.00  | 1.00  |   | 0.00  |  |
| Lane Grp Cap(c), veh/h       |   |   |   | 573   | 0   | 517   | 24  | 900   | 401   | 498   | 1839  | 0   |  |
| V/C Ratio(X)                 |   |   |   | 0.82  | 0.00  | 0.93  | 0.47  | 0.81  | 0.17  | 0.92  | 0.72  | 0.00  |  |
| Avail Cap(c_a), veh/h        |   |   |   | 585   | 0   | 529   | 574   | 1145  | 510   | 568   | 1839  | 0   |  |
| HCM Platoon Ratio            |   |   |   | 1.00  | 1.00  | 1.00  | 1.00  | 1.00  | 1.00  | 1.00  | 1.00  | 1.00  |  |
| Upstream Filter(I)           |   |   |   | 1.00  | 0.00  | 1.00  | 1.00  | 1.00  | 1.00  | 1.00  | 1.00  | 0.00  |  |
| Uniform Delay (d), s/veh     |   |   |   | 29.2  | 0.0   | 30.8  | 45.4  | 32.5  | 27.0  | 32.3  | 16.9  | 0.0   |  |
| Incr Delay (d2), s/veh       |   |   |   | 8.7   | 0.0   | 23.7  | 13.6  | 3.6   | 0.2   | 19.8  | 1.4   | 0.0   |  |
| Initial Q Delay(d3),s/veh    |   |   |   | 0.0   | 0.0   | 0.0   | 0.0   | 0.0   | 0.0   | 0.0   | 0.0   | 0.0   |  |
| %ile BackOfQ(50%),veh/ln     |   |   |   | 12.4  | 0.0   | 15.3  | 0.4   | 9.2   | 1.4   | 14.1  | 13.3  | 0.0   |  |
| LnGrp Delay(d),s/veh         |   |   |   | 37.9  | 0.0   | 54.4  | 59.0  | 36.1  | 27.2  | 52.0  | 18.3  | 0.0   |  |
| LnGrp LOS                    |   |   |   | D   |   | D   | E   | D   | C   | D   | B   |   |  |
| Approach Vol, veh/h          |   |   |   |   | 951   |   |   | 809   |   |   | 1787  |   |  |
| Approach Delay, s/veh        |   |   |   |   | 46.3  |   |   | 35.6  |   |   | 27.0  |   |  |
| Approach LOS                 |   |   |   |   | D   |   |   | D   |   |   | C   |   |  |
| Timer                        | 1   | 2   | 3   | 4   | 5   | 6   | 7   | 8   |   |   |   |   |  |
| Assigned Phs                 | 1   | 2   |   |   | 5   | 6   |   | 8   |   |   |   |   |  |
| Phs Duration (G+Y+Rc), s     | 4.7   | 53.7  |   |   | 29.8  | 28.6  |   | 34.4  |   |   |   |   |  |
| Change Period (Y+Rc), s      | 3.5   | 5.0   |   |   | 3.5   | 5.0   |   | 5.0   |   |   |   |   |  |
| Max Green Setting (Gmax), s  | 30.0  | 30.0  |   |   | 30.0  | 30.0  |   | 30.0  |   |   |   |   |  |
| Max Q Clear Time (g_c+I1), s | 2.6   | 28.8  |   |   | 25.6  | 20.0  |   | 28.6  |   |   |   |   |  |
| Green Ext Time (p_c), s      | 0.0   | 0.9   |   |   | 0.7   | 3.6   |   | 0.8   |   |   |   |   |  |
| <b>Intersection Summary</b>  |   |   |   |   |   |   |   |   |   |   |   |   |  |
| HCM 2010 Ctrl Delay          |   |   |   | 34.1  |   |   |   |   |   |   |   |   |  |
| HCM 2010 LOS                 |   |   |   | C   |   |   |   |   |   |   |   |   |  |
| <b>Notes</b>                 |   |   |   |   |   |   |   |   |   |   |   |   |  |

HCM 2010 Signalized Intersection Summary Cumulative with Eastside Parkway with Project, AM  
 2: 2nd Avenue & Patton Parkway 06/11/2019



| Movement                       | EBL  | EBT  | EBR  | WBL  | WBT  | WBR  | NBL  | NBT  | NBR  | SBL  | SBT  | SBR  |
|--------------------------------|------|------|------|------|------|------|------|------|------|------|------|------|
| Lane Configurations            | ↖    | ↗    |      | ↖    | ↗    |      | ↖    | ↗    |      | ↖    | ↗    |      |
| Traffic Volume (veh/h)         | 50   | 90   | 60   | 30   | 90   | 100  | 70   | 220  | 100  | 90   | 200  | 50   |
| Future Volume (veh/h)          | 50   | 90   | 60   | 30   | 90   | 100  | 70   | 220  | 100  | 90   | 200  | 50   |
| Number                         | 7    | 4    | 14   | 3    | 8    | 18   | 5    | 2    | 12   | 1    | 6    | 16   |
| Initial Q (Qb), veh            | 0    | 0    | 0    | 0    | 0    | 0    | 0    | 0    | 0    | 0    | 0    | 0    |
| Ped-Bike Adj(A_pbT)            | 1.00 |      | 1.00 | 1.00 |      | 1.00 | 1.00 |      | 1.00 | 1.00 |      | 1.00 |
| Parking Bus, Adj               | 1.00 | 1.00 | 1.00 | 1.00 | 1.00 | 1.00 | 1.00 | 1.00 | 1.00 | 1.00 | 1.00 | 1.00 |
| Adj Sat Flow, veh/h/ln         | 1863 | 1863 | 1900 | 1863 | 1863 | 1900 | 1863 | 1863 | 1900 | 1863 | 1863 | 1900 |
| Adj Flow Rate, veh/h           | 54   | 98   | 65   | 33   | 98   | 109  | 76   | 239  | 109  | 98   | 217  | 54   |
| Adj No. of Lanes               | 1    | 1    | 0    | 1    | 1    | 0    | 1    | 1    | 0    | 1    | 1    | 0    |
| Peak Hour Factor               | 0.92 | 0.92 | 0.92 | 0.92 | 0.92 | 0.92 | 0.92 | 0.92 | 0.92 | 0.92 | 0.92 | 0.92 |
| Percent Heavy Veh, %           | 2    | 2    | 2    | 2    | 2    | 2    | 2    | 2    | 2    | 2    | 2    | 2    |
| Cap, veh/h                     | 97   | 247  | 164  | 67   | 177  | 197  | 121  | 330  | 151  | 139  | 407  | 101  |
| Arrive On Green                | 0.05 | 0.24 | 0.24 | 0.04 | 0.22 | 0.22 | 0.07 | 0.27 | 0.27 | 0.08 | 0.28 | 0.28 |
| Sat Flow, veh/h                | 1774 | 1046 | 694  | 1774 | 807  | 897  | 1774 | 1212 | 553  | 1774 | 1441 | 359  |
| Grp Volume(v), veh/h           | 54   | 0    | 163  | 33   | 0    | 207  | 76   | 0    | 348  | 98   | 0    | 271  |
| Grp Sat Flow(s),veh/h/ln       | 1774 | 0    | 1740 | 1774 | 0    | 1704 | 1774 | 0    | 1765 | 1774 | 0    | 1799 |
| Q Serve(g_s), s                | 1.3  | 0.0  | 3.6  | 0.8  | 0.0  | 4.9  | 1.9  | 0.0  | 8.1  | 2.4  | 0.0  | 5.8  |
| Cycle Q Clear(g_c), s          | 1.3  | 0.0  | 3.6  | 0.8  | 0.0  | 4.9  | 1.9  | 0.0  | 8.1  | 2.4  | 0.0  | 5.8  |
| Prop In Lane                   | 1.00 |      | 0.40 | 1.00 |      | 0.53 | 1.00 |      | 0.31 | 1.00 |      | 0.20 |
| Lane Grp Cap(c), veh/h         | 97   | 0    | 411  | 67   | 0    | 374  | 121  | 0    | 481  | 139  | 0    | 509  |
| V/C Ratio(X)                   | 0.56 | 0.00 | 0.40 | 0.50 | 0.00 | 0.55 | 0.63 | 0.00 | 0.72 | 0.71 | 0.00 | 0.53 |
| Avail Cap(c_a), veh/h          | 235  | 0    | 1364 | 235  | 0    | 1336 | 235  | 0    | 1384 | 235  | 0    | 1411 |
| HCM Platoon Ratio              | 1.00 | 1.00 | 1.00 | 1.00 | 1.00 | 1.00 | 1.00 | 1.00 | 1.00 | 1.00 | 1.00 | 1.00 |
| Upstream Filter(I)             | 1.00 | 0.00 | 1.00 | 1.00 | 0.00 | 1.00 | 1.00 | 0.00 | 1.00 | 1.00 | 0.00 | 1.00 |
| Uniform Delay (d), s/veh       | 20.9 | 0.0  | 14.6 | 21.4 | 0.0  | 15.7 | 20.5 | 0.0  | 14.9 | 20.4 | 0.0  | 13.7 |
| Incr Delay (d2), s/veh         | 5.0  | 0.0  | 0.6  | 5.6  | 0.0  | 1.3  | 5.3  | 0.0  | 2.1  | 6.4  | 0.0  | 0.9  |
| Initial Q Delay(d3),s/veh      | 0.0  | 0.0  | 0.0  | 0.0  | 0.0  | 0.0  | 0.0  | 0.0  | 0.0  | 0.0  | 0.0  | 0.0  |
| %ile BackOfQ(50%),veh/ln       | 0.8  | 0.0  | 1.8  | 0.5  | 0.0  | 2.4  | 1.1  | 0.0  | 4.1  | 1.4  | 0.0  | 3.0  |
| LnGrp Delay(d),s/veh           | 25.9 | 0.0  | 15.2 | 27.0 | 0.0  | 17.0 | 25.9 | 0.0  | 17.0 | 26.8 | 0.0  | 14.6 |
| LnGrp LOS                      | C    |      | B    | C    |      | B    | C    |      | B    | C    |      | B    |
| Approach Vol, veh/h            |      | 217  |      |      | 240  |      |      | 424  |      |      | 369  |      |
| Approach Delay, s/veh          |      | 17.8 |      |      | 18.4 |      |      | 18.6 |      |      | 17.8 |      |
| Approach LOS                   |      | B    |      |      | B    |      |      | B    |      |      | B    |      |
| Timer                          | 1    | 2    | 3    | 4    | 5    | 6    | 7    | 8    |      |      |      |      |
| Assigned Phs                   | 1    | 2    | 3    | 4    | 5    | 6    | 7    | 8    |      |      |      |      |
| Phs Duration (G+Y+Rc), s       | 7.5  | 16.8 | 5.7  | 15.2 | 7.1  | 17.3 | 6.5  | 14.4 |      |      |      |      |
| Change Period (Y+Rc), s        | 4.0  | 4.5  | 4.0  | 4.5  | 4.0  | 4.5  | 4.0  | 4.5  |      |      |      |      |
| Max Green Setting (Gmax), s    | 35.5 | 35.5 | 6.0  | 35.5 | 6.0  | 35.5 | 6.0  | 35.5 |      |      |      |      |
| Max Q Clear Time (g_c+14.4), s | 10.1 | 10.1 | 2.8  | 5.6  | 3.9  | 7.8  | 3.3  | 6.9  |      |      |      |      |
| Green Ext Time (p_c), s        | 0.0  | 2.2  | 0.0  | 1.0  | 0.0  | 1.7  | 0.0  | 1.3  |      |      |      |      |
| <b>Intersection Summary</b>    |      |      |      |      |      |      |      |      |      |      |      |      |
| HCM 2010 Ctrl Delay            |      |      | 18.2 |      |      |      |      |      |      |      |      |      |
| HCM 2010 LOS                   |      |      | B    |      |      |      |      |      |      |      |      |      |

HCM 2010 Signalized Intersection Summary Cumulative with Eastside Parkway with Project, AM  
 3: SR 1 SB On-Ramp/SR 1 SB Off-Ramp & Imjin Parkway 06/11/2019



| Movement                     | EBL | EBT | EBR | WBL   | WBT   | WBR  | NBL | NBT | NBR | SBL   | SBT   | SBR  |
|------------------------------|-----|-----|-----|-------|-------|------|-----|-----|-----|-------|-------|------|
| Lane Configurations          |     |     |     |       | ↕     |      |     |     |     |       | ↕     |      |
| Traffic Volume (veh/h)       | 0   | 0   | 0   | 1040  | 0     | 0    | 0   | 0   | 0   | 1000  | 10    | 0    |
| Future Volume (veh/h)        | 0   | 0   | 0   | 1040  | 0     | 0    | 0   | 0   | 0   | 1000  | 10    | 0    |
| Number                       |     |     |     | 1     | 6     | 16   |     |     |     | 7     | 4     | 14   |
| Initial Q (Qb), veh          |     |     |     | 0     | 0     | 0    |     |     |     | 0     | 0     | 0    |
| Ped-Bike Adj(A_pbT)          |     |     |     | 1.00  |       | 1.00 |     |     |     | 1.00  |       | 1.00 |
| Parking Bus, Adj             |     |     |     | 1.00  | 1.00  | 1.00 |     |     |     | 1.00  | 1.00  | 1.00 |
| Adj Sat Flow, veh/h/ln       |     |     |     | 1900  | 1845  | 0    |     |     |     | 1900  | 1845  | 0    |
| Adj Flow Rate, veh/h         |     |     |     | 1143  | 0     | 0    |     |     |     | 1099  | 11    | 0    |
| Adj No. of Lanes             |     |     |     | 0     | 1     | 0    |     |     |     | 0     | 1     | 0    |
| Peak Hour Factor             |     |     |     | 0.91  | 0.91  | 0.91 |     |     |     | 0.91  | 0.91  | 0.91 |
| Percent Heavy Veh, %         |     |     |     | 3     | 3     | 0    |     |     |     | 3     | 3     | 0    |
| Cap, veh/h                   |     |     |     | 996   | 0     | 0    |     |     |     | 658   | 7     | 0    |
| Arrive On Green              |     |     |     | 0.57  | 0.00  | 0.00 |     |     |     | 0.38  | 0.38  | 0.00 |
| Sat Flow, veh/h              |     |     |     | 1757  | 0     | 0    |     |     |     | 1740  | 17    | 0    |
| Grp Volume(v), veh/h         |     |     |     | 1143  | 0     | 0    |     |     |     | 1110  | 0     | 0    |
| Grp Sat Flow(s),veh/h/ln     |     |     |     | 1757  | 0     | 0    |     |     |     | 1758  | 0     | 0    |
| Q Serve(g_s), s              |     |     |     | 90.0  | 0.0   | 0.0  |     |     |     | 60.0  | 0.0   | 0.0  |
| Cycle Q Clear(g_c), s        |     |     |     | 90.0  | 0.0   | 0.0  |     |     |     | 60.0  | 0.0   | 0.0  |
| Prop In Lane                 |     |     |     | 1.00  |       | 0.00 |     |     |     | 0.99  |       | 0.00 |
| Lane Grp Cap(c), veh/h       |     |     |     | 996   | 0     | 0    |     |     |     | 664   | 0     | 0    |
| V/C Ratio(X)                 |     |     |     | 1.15  | 0.00  | 0.00 |     |     |     | 1.67  | 0.00  | 0.00 |
| Avail Cap(c_a), veh/h        |     |     |     | 996   | 0     | 0    |     |     |     | 664   | 0     | 0    |
| HCM Platoon Ratio            |     |     |     | 1.00  | 1.00  | 1.00 |     |     |     | 1.00  | 1.00  | 1.00 |
| Upstream Filter(I)           |     |     |     | 1.00  | 0.00  | 0.00 |     |     |     | 1.00  | 0.00  | 0.00 |
| Uniform Delay (d), s/veh     |     |     |     | 34.4  | 0.0   | 0.0  |     |     |     | 49.4  | 0.0   | 0.0  |
| Incr Delay (d2), s/veh       |     |     |     | 78.5  | 0.0   | 0.0  |     |     |     | 308.7 | 0.0   | 0.0  |
| Initial Q Delay(d3),s/veh    |     |     |     | 0.0   | 0.0   | 0.0  |     |     |     | 0.0   | 0.0   | 0.0  |
| %ile BackOfQ(50%),veh/ln     |     |     |     | 65.1  | 0.0   | 0.0  |     |     |     | 85.9  | 0.0   | 0.0  |
| LnGrp Delay(d),s/veh         |     |     |     | 112.9 | 0.0   | 0.0  |     |     |     | 358.1 | 0.0   | 0.0  |
| LnGrp LOS                    |     |     |     | F     |       |      |     |     |     | F     |       |      |
| Approach Vol, veh/h          |     |     |     |       | 1143  |      |     |     |     |       | 1110  |      |
| Approach Delay, s/veh        |     |     |     |       | 112.9 |      |     |     |     |       | 358.1 |      |
| Approach LOS                 |     |     |     |       | F     |      |     |     |     |       | F     |      |
| Timer                        | 1   | 2   | 3   | 4     | 5     | 6    | 7   | 8   |     |       |       |      |
| Assigned Phs                 |     |     |     | 4     |       | 6    |     |     |     |       |       |      |
| Phs Duration (G+Y+Rc), s     |     |     |     | 64.4  |       | 94.4 |     |     |     |       |       |      |
| Change Period (Y+Rc), s      |     |     |     | 4.4   |       | 4.4  |     |     |     |       |       |      |
| Max Green Setting (Gmax), s  |     |     |     | 60.0  |       | 90.0 |     |     |     |       |       |      |
| Max Q Clear Time (g_c+I1), s |     |     |     | 62.0  |       | 92.0 |     |     |     |       |       |      |
| Green Ext Time (p_c), s      |     |     |     | 0.0   |       | 0.0  |     |     |     |       |       |      |
| <b>Intersection Summary</b>  |     |     |     |       |       |      |     |     |     |       |       |      |
| HCM 2010 Ctrl Delay          |     |     |     | 233.7 |       |      |     |     |     |       |       |      |
| HCM 2010 LOS                 |     |     |     | F     |       |      |     |     |     |       |       |      |

| Intersection             |      |      |      |      |      |      |      |      |      |      |       |      |
|--------------------------|------|------|------|------|------|------|------|------|------|------|-------|------|
| Int Delay, s/veh         | 1.1  |      |      |      |      |      |      |      |      |      |       |      |
| Movement                 | EBL  | EBT  | EBR  | WBL  | WBT  | WBR  | NBL  | NBT  | NBR  | SBL  | SBT   | SBR  |
| Lane Configurations      |      | ↕    |      |      | ↑    | ↗    |      | ↕    | ↗    |      |       |      |
| Traffic Vol, veh/h       | 10   | 1010 | 0    | 0    | 990  | 470  | 10   | 10   | 960  | 0    | 0     | 0    |
| Future Vol, veh/h        | 10   | 1010 | 0    | 0    | 990  | 470  | 10   | 10   | 960  | 0    | 0     | 0    |
| Conflicting Peds, #/hr   | 0    | 0    | 3    | 3    | 0    | 0    | 0    | 0    | 0    | 0    | 0     | 0    |
| Sign Control             | Free | Free | Free | Free | Free | Free | Stop | Stop | Stop | Stop | Stop  | Stop |
| RT Channelized           | -    | -    | None | -    | -    | Free | -    | -    | Free | -    | -     | None |
| Storage Length           | -    | -    | -    | -    | -    | 0    | -    | -    | 800  | -    | -     | -    |
| Veh in Median Storage, # | -    | 0    | -    | -    | 0    | -    | -    | 0    | -    | -    | 16965 | -    |
| Grade, %                 | -    | 0    | -    | -    | 0    | -    | -    | 0    | -    | -    | 0     | -    |
| Peak Hour Factor         | 97   | 97   | 97   | 97   | 97   | 97   | 97   | 97   | 97   | 97   | 97    | 97   |
| Heavy Vehicles, %        | 3    | 3    | 3    | 3    | 3    | 3    | 2    | 2    | 2    | 2    | 2     | 2    |
| Mvmt Flow                | 10   | 1041 | 0    | 0    | 1021 | 485  | 10   | 10   | 990  | 0    | 0     | 0    |























| Major/Minor          | Major1 | Major2 | Minor1 |
|----------------------|--------|--------|--------|
| Conflicting Flow All | 1021   | 0      | -      |
| Stage 1              | -      | -      | -      |
| Stage 2              | -      | -      | -      |
| Critical Hdwy        | 4.13   | -      | -      |
| Critical Hdwy Stg 1  | -      | -      | -      |
| Critical Hdwy Stg 2  | -      | -      | -      |
| Follow-up Hdwy       | 2.227  | -      | -      |
| Pot Cap-1 Maneuver   | 676    | 0      | 0      |
| Stage 1              | -      | 0      | 0      |
| Stage 2              | -      | 0      | 0      |
| Platoon blocked, %   | -      | -      | -      |
| Mov Cap-1 Maneuver   | 676    | -      | -      |
| Mov Cap-2 Maneuver   | -      | -      | -      |
| Stage 1              | -      | -      | -      |
| Stage 2              | -      | -      | -      |

| Approach             | EB  | WB | NB    |
|----------------------|-----|----|-------|
| HCM Control Delay, s | 0.1 | 0  | 102.8 |
| HCM LOS              |     |    | F     |

| Minor Lane/Major Mvmt | NBLn1 | NBLn2 | EBL   | EBT | WBT |
|-----------------------|-------|-------|-------|-----|-----|
| Capacity (veh/h)      | 56    | -     | 676   | -   | -   |
| HCM Lane V/C Ratio    | 0.368 | -     | 0.015 | -   | -   |
| HCM Control Delay (s) | 102.8 | 0     | 10.4  | 0   | -   |
| HCM Lane LOS          | F     | A     | B     | A   | -   |
| HCM 95th %tile Q(veh) | 1.3   | -     | 0     | -   | -   |



HCM 2010 Signalized Intersection Summary Cumulative with Eastside Parkway with Project, AM  
 5: 2nd Avenue & Imjin Parkway 06/11/2019

|                              |  |  |  |  |  |  |  |  |  |  |  |  |
|------------------------------|---|---|---|---|---|---|--|---|---|---|---|---|
| Movement                     | EBL   | EBT   | EBR   | WBL   | WBT   | WBR   | NBL  | NBT   | NBR   | SBL   | SBT   | SBR   |
| Lane Configurations          |  |  |  |  |  |   |  |  |  |  |  |  |
| Traffic Volume (veh/h)       | 180   | 1050  | 910   | 460   | 860   | 120   | 420  | 90  | 200   | 50  | 100   | 210   |
| Future Volume (veh/h)        | 180   | 1050  | 910   | 460   | 860   | 120   | 420  | 90  | 200   | 50  | 100   | 210   |
| Number                       | 5   | 2   | 12  | 1   | 6   | 16  | 3  | 8   | 18  | 7   | 4   | 14  |
| Initial Q (Qb), veh          | 0   | 0   | 0   | 0   | 0   | 0   | 0  | 0   | 0   | 0   | 0   | 0   |
| Ped-Bike Adj(A_pbT)          | 1.00  |   | 1.00  | 1.00  |   | 1.00  | 1.00   |   | 1.00  | 1.00  |   | 1.00  |
| Parking Bus, Adj             | 1.00  | 1.00  | 1.00  | 1.00  | 1.00  | 1.00  | 1.00   | 1.00  | 1.00  | 1.00  | 1.00  | 1.00  |
| Adj Sat Flow, veh/h/ln       | 1863  | 1863  | 1863  | 1863  | 1863  | 1900  | 1810   | 1810  | 1810  | 1900  | 1900  | 1900  |
| Adj Flow Rate, veh/h         | 184   | 1071  | 710   | 469   | 878   | 122   | 429  | 92  | 82  | 51  | 102   | 209   |
| Adj No. of Lanes             | 1   | 2   | 1   | 2   | 2   | 0   | 2  | 1   | 1   | 1   | 2   | 0   |
| Peak Hour Factor             | 0.98  | 0.98  | 0.98  | 0.98  | 0.98  | 0.98  | 0.98   | 0.98  | 0.98  | 0.98  | 0.98  | 0.98  |
| Percent Heavy Veh, %         | 2   | 2   | 2   | 2   | 2   | 2   | 5  | 5   | 5   | 0   | 0   | 0   |
| Cap, veh/h                   | 220   | 1202  | 538   | 537   | 1160  | 161   | 497  | 455   | 386   | 91  | 276   | 246   |
| Arrive On Green              | 0.12  | 0.34  | 0.34  | 0.16  | 0.37  | 0.37  | 0.15   | 0.25  | 0.25  | 0.05  | 0.15  | 0.15  |
| Sat Flow, veh/h              | 1774  | 3539  | 1583  | 3442  | 3122  | 434   | 3343   | 1810  | 1536  | 1810  | 1805  | 1612  |
| Grp Volume(v), veh/h         | 184   | 1071  | 710   | 469   | 498   | 502   | 429  | 92  | 82  | 51  | 102   | 209   |
| Grp Sat Flow(s),veh/h/ln     | 1774  | 1770  | 1583  | 1721  | 1770  | 1786  | 1672   | 1810  | 1536  | 1810  | 1805  | 1612  |
| Q Serve(g_s), s              | 8.9   | 25.3  | 30.0  | 11.8  | 21.7  | 21.7  | 11.1   | 3.5   | 3.7   | 2.4   | 4.5   | 11.1  |
| Cycle Q Clear(g_c), s        | 8.9   | 25.3  | 30.0  | 11.8  | 21.7  | 21.7  | 11.1   | 3.5   | 3.7   | 2.4   | 4.5   | 11.1  |
| Prop In Lane                 | 1.00  |   | 1.00  | 1.00  |   | 0.24  | 1.00   |   | 1.00  | 1.00  |   | 1.00  |
| Lane Grp Cap(c), veh/h       | 220   | 1202  | 538   | 537   | 658   | 664   | 497  | 455   | 386   | 91  | 276   | 246   |
| V/C Ratio(X)                 | 0.83  | 0.89  | 1.32  | 0.87  | 0.76  | 0.76  | 0.86   | 0.20  | 0.21  | 0.56  | 0.37  | 0.85  |
| Avail Cap(c_a), veh/h        | 301   | 1202  | 538   | 585   | 658   | 664   | 757  | 455   | 386   | 205   | 429   | 383   |
| HCM Platoon Ratio            | 1.00  | 1.00  | 1.00  | 1.00  | 1.00  | 1.00  | 1.00   | 1.00  | 1.00  | 1.00  | 1.00  | 1.00  |
| Upstream Filter(I)           | 1.00  | 1.00  | 1.00  | 1.00  | 1.00  | 1.00  | 1.00   | 1.00  | 1.00  | 1.00  | 1.00  | 1.00  |
| Uniform Delay (d), s/veh     | 37.8  | 27.6  | 29.2  | 36.4  | 24.3  | 24.3  | 36.7   | 26.1  | 26.1  | 41.0  | 33.6  | 36.4  |
| Incr Delay (d2), s/veh       | 10.3  | 8.3   | 156.7   | 12.1  | 4.5   | 4.5   | 4.3  | 0.1   | 0.1   | 2.0   | 0.3   | 6.1   |
| Initial Q Delay(d3),s/veh    | 0.0   | 0.0   | 0.0   | 0.0   | 0.0   | 0.0   | 0.0  | 0.0   | 0.0   | 0.0   | 0.0   | 0.0   |
| %ile BackOfQ(50%),veh/ln     | 5.0   | 13.7  | 36.5  | 6.5   | 11.3  | 11.4  | 5.4  | 1.8   | 1.6   | 1.3   | 2.3   | 5.4   |
| LnGrp Delay(d),s/veh         | 48.1  | 35.9  | 185.8   | 48.5  | 28.8  | 28.7  | 41.0   | 26.2  | 26.2  | 43.0  | 33.9  | 42.5  |
| LnGrp LOS                    | D   | D   | F   | D   | C   | C   | D  | C   | C   | D   | C   | D   |
| Approach Vol, veh/h          |   | 1965  |   |   | 1469  |   |  | 603   |   |   | 362   |   |
| Approach Delay, s/veh        |   | 91.2  |   |   | 35.1  |   |  | 36.8  |   |   | 40.2  |   |
| Approach LOS                 |   | F   |   |   | D   |   |  | D   |   |   | D   |   |
| Timer                        | 1   | 2   | 3   | 4   | 5   | 6   | 7  | 8   |   |   |   |   |
| Assigned Phs                 | 1   | 2   | 3   | 4   | 5   | 6   | 7  | 8   |   |   |   |   |
| Phs Duration (G+Y+Rc), s     | 18.3  | 35.3  | 16.6  | 18.1  | 15.5  | 38.1  | 7.9  | 26.8  |   |   |   |   |
| Change Period (Y+Rc), s      | 4.5   | 5.3   | 3.5   | 4.6   | 4.5   | 5.3   | 3.5  | 4.6   |   |   |   |   |
| Max Green Setting (Gmax), s  | 15.0  | 30.0  | 20.0  | 21.0  | 15.0  | 30.0  | 10.0   | 21.0  |   |   |   |   |
| Max Q Clear Time (g_c+I1), s | 13.8  | 32.0  | 13.1  | 13.1  | 10.9  | 23.7  | 4.4  | 5.7   |   |   |   |   |
| Green Ext Time (p_c), s      | 0.0   | 0.0   | 0.1   | 0.3   | 0.0   | 0.9   | 0.0  | 0.1   |   |   |   |   |
| <b>Intersection Summary</b>  |   |   |   |   |   |   |  |   |   |   |   |   |
| HCM 2010 Ctrl Delay          |   |   | 60.8  |   |   |   |  |   |   |   |   |   |
| HCM 2010 LOS                 |   |   | E   |   |   |   |  |   |   |   |   |   |

HCM 2010 Signalized Intersection Summary Cumulative with Eastside Parkway with Project, AM  
6: 3rd Avenue & Imjin Parkway

06/11/2019



| Movement                     | EBL  | EBT  | EBR  | WBL  | WBT  | WBR  | NBL  | NBT  | NBR  | SBL  | SBT  | SBR  |
|------------------------------|------|------|------|------|------|------|------|------|------|------|------|------|
| Lane Configurations          | ↖    | ↗    |      | ↖    | ↗    |      | ↖    | ↗    |      | ↖    | ↗    |      |
| Traffic Volume (veh/h)       | 50   | 900  | 220  | 340  | 1300 | 30   | 130  | 10   | 60   | 10   | 10   | 40   |
| Future Volume (veh/h)        | 50   | 900  | 220  | 340  | 1300 | 30   | 130  | 10   | 60   | 10   | 10   | 40   |
| Number                       | 5    | 2    | 12   | 1    | 6    | 16   | 3    | 8    | 18   | 7    | 4    | 14   |
| Initial Q (Qb), veh          | 0    | 0    | 0    | 0    | 0    | 0    | 0    | 0    | 0    | 0    | 0    | 0    |
| Ped-Bike Adj(A_pbT)          | 1.00 |      | 1.00 | 1.00 |      | 1.00 | 1.00 |      | 1.00 | 1.00 |      | 1.00 |
| Parking Bus, Adj             | 1.00 | 1.00 | 1.00 | 1.00 | 1.00 | 1.00 | 1.00 | 1.00 | 1.00 | 1.00 | 1.00 | 1.00 |
| Adj Sat Flow, veh/h/ln       | 1863 | 1863 | 1900 | 1863 | 1863 | 1900 | 1810 | 1810 | 1900 | 1863 | 1863 | 1900 |
| Adj Flow Rate, veh/h         | 52   | 938  | 200  | 354  | 1354 | 30   | 135  | 10   | 8    | 10   | 10   | 7    |
| Adj No. of Lanes             | 1    | 2    | 0    | 1    | 2    | 0    | 1    | 1    | 0    | 1    | 1    | 0    |
| Peak Hour Factor             | 0.96 | 0.96 | 0.96 | 0.96 | 0.96 | 0.96 | 0.96 | 0.96 | 0.96 | 0.96 | 0.96 | 0.96 |
| Percent Heavy Veh, %         | 2    | 2    | 2    | 2    | 2    | 2    | 5    | 5    | 5    | 2    | 2    | 2    |
| Cap, veh/h                   | 63   | 1066 | 227  | 398  | 1969 | 44   | 324  | 135  | 108  | 328  | 147  | 103  |
| Arrive On Green              | 0.04 | 0.37 | 0.37 | 0.22 | 0.56 | 0.56 | 0.14 | 0.14 | 0.14 | 0.14 | 0.14 | 0.14 |
| Sat Flow, veh/h              | 1774 | 2904 | 618  | 1774 | 3540 | 78   | 1345 | 930  | 744  | 1384 | 1020 | 714  |
| Grp Volume(v), veh/h         | 52   | 571  | 567  | 354  | 676  | 708  | 135  | 0    | 18   | 10   | 0    | 17   |
| Grp Sat Flow(s),veh/h/ln     | 1774 | 1770 | 1753 | 1774 | 1770 | 1849 | 1345 | 0    | 1675 | 1384 | 0    | 1733 |
| Q Serve(g_s), s              | 1.5  | 15.4 | 15.5 | 9.9  | 14.1 | 14.1 | 4.9  | 0.0  | 0.5  | 0.3  | 0.0  | 0.4  |
| Cycle Q Clear(g_c), s        | 1.5  | 15.4 | 15.5 | 9.9  | 14.1 | 14.1 | 5.4  | 0.0  | 0.5  | 0.8  | 0.0  | 0.4  |
| Prop In Lane                 | 1.00 |      | 0.35 | 1.00 |      | 0.04 | 1.00 |      | 0.44 | 1.00 |      | 0.41 |
| Lane Grp Cap(c), veh/h       | 63   | 650  | 644  | 398  | 984  | 1028 | 324  | 0    | 242  | 328  | 0    | 251  |
| V/C Ratio(X)                 | 0.82 | 0.88 | 0.88 | 0.89 | 0.69 | 0.69 | 0.42 | 0.00 | 0.07 | 0.03 | 0.00 | 0.07 |
| Avail Cap(c_a), veh/h        | 398  | 1123 | 1112 | 398  | 1123 | 1173 | 852  | 0    | 899  | 871  | 0    | 931  |
| HCM Platoon Ratio            | 1.00 | 1.00 | 1.00 | 1.00 | 1.00 | 1.00 | 1.00 | 1.00 | 1.00 | 1.00 | 1.00 | 1.00 |
| Upstream Filter(I)           | 1.00 | 1.00 | 1.00 | 1.00 | 1.00 | 1.00 | 1.00 | 0.00 | 1.00 | 1.00 | 0.00 | 1.00 |
| Uniform Delay (d), s/veh     | 24.5 | 15.1 | 15.2 | 19.2 | 8.2  | 8.2  | 21.2 | 0.0  | 18.9 | 19.3 | 0.0  | 18.9 |
| Incr Delay (d2), s/veh       | 9.4  | 1.9  | 1.9  | 20.4 | 1.1  | 1.0  | 0.3  | 0.0  | 0.0  | 0.0  | 0.0  | 0.0  |
| Initial Q Delay(d3),s/veh    | 0.0  | 0.0  | 0.0  | 0.0  | 0.0  | 0.0  | 0.0  | 0.0  | 0.0  | 0.0  | 0.0  | 0.0  |
| %ile BackOfQ(50%),veh/ln     | 0.9  | 7.8  | 7.7  | 7.1  | 7.1  | 7.4  | 1.9  | 0.0  | 0.2  | 0.1  | 0.0  | 0.2  |
| LnGrp Delay(d),s/veh         | 33.9 | 17.0 | 17.1 | 39.6 | 9.2  | 9.2  | 21.6 | 0.0  | 19.0 | 19.3 | 0.0  | 19.0 |
| LnGrp LOS                    | C    | B    | B    | D    | A    | A    | C    |      | B    | B    |      | B    |
| Approach Vol, veh/h          |      | 1190 |      |      | 1738 |      |      | 153  |      |      | 27   |      |
| Approach Delay, s/veh        |      | 17.8 |      |      | 15.4 |      |      | 21.3 |      |      | 19.1 |      |
| Approach LOS                 |      | B    |      |      | B    |      |      | C    |      |      | B    |      |
| Timer                        | 1    | 2    | 3    | 4    | 5    | 6    | 7    | 8    |      |      |      |      |
| Assigned Phs                 | 1    | 2    |      | 4    | 5    | 6    |      | 8    |      |      |      |      |
| Phs Duration (G+Y+Rc), s     | 5.0  | 24.3 |      | 11.9 | 5.3  | 34.0 |      | 11.9 |      |      |      |      |
| Change Period (Y+Rc), s      | 3.5  | 5.5  |      | 4.5  | 3.5  | 5.5  |      | 4.5  |      |      |      |      |
| Max Green Setting (Gmax), s  | 1.5  | 32.5 |      | 27.5 | 11.5 | 32.5 |      | 27.5 |      |      |      |      |
| Max Q Clear Time (g_c+I1), s | 1.5  | 17.5 |      | 2.8  | 3.5  | 16.1 |      | 7.4  |      |      |      |      |
| Green Ext Time (p_c), s      | 0.0  | 1.3  |      | 0.0  | 0.0  | 1.0  |      | 0.0  |      |      |      |      |
| <b>Intersection Summary</b>  |      |      |      |      |      |      |      |      |      |      |      |      |
| HCM 2010 Ctrl Delay          |      |      |      | 16.6 |      |      |      |      |      |      |      |      |
| HCM 2010 LOS                 |      |      |      | B    |      |      |      |      |      |      |      |      |

HCM 2010 Signalized Intersection Summary Cumulative with Eastside Parkway with Project, AM  
7: 4th Avenue & Imjin Parkway

06/11/2019



| Movement                    | EBL  | EBT  | EBR  | WBL  | WBT  | WBR  | NBL  | NBT  | NBR  | SBL  | SBT  | SBR  |
|-----------------------------|------|------|------|------|------|------|------|------|------|------|------|------|
| Lane Configurations         |      |      |      |      |      |      |      |      |      |      |      |      |
| Traffic Volume (veh/h)      | 10   | 990  | 20   | 10   | 1590 | 10   | 10   | 10   | 10   | 10   | 10   | 10   |
| Future Volume (veh/h)       | 10   | 990  | 20   | 10   | 1590 | 10   | 10   | 10   | 10   | 10   | 10   | 10   |
| Number                      | 5    | 2    | 12   | 1    | 6    | 16   | 3    | 8    | 18   | 7    | 4    | 14   |
| Initial Q (Qb), veh         | 0    | 0    | 0    | 0    | 0    | 0    | 0    | 0    | 0    | 0    | 0    | 0    |
| Ped-Bike Adj(A_pbT)         | 1.00 |      | 1.00 | 1.00 |      | 1.00 | 1.00 |      | 1.00 | 1.00 |      | 1.00 |
| Parking Bus, Adj            | 1.00 | 1.00 | 1.00 | 1.00 | 1.00 | 1.00 | 1.00 | 1.00 | 1.00 | 1.00 | 1.00 | 1.00 |
| Adj Sat Flow, veh/h/ln      | 1863 | 1863 | 1900 | 1863 | 1863 | 1900 | 1900 | 1267 | 1900 | 1900 | 1900 | 1900 |
| Adj Flow Rate, veh/h        | 10   | 1031 | 20   | 10   | 1656 | 9    | 10   | 10   | 9    | 10   | 10   | 10   |
| Adj No. of Lanes            | 1    | 2    | 0    | 1    | 2    | 0    | 0    | 1    | 0    | 0    | 1    | 0    |
| Peak Hour Factor            | 0.96 | 0.96 | 0.96 | 0.96 | 0.96 | 0.96 | 0.96 | 0.96 | 0.96 | 0.96 | 0.96 | 0.96 |
| Percent Heavy Veh, %        | 2    | 2    | 2    | 2    | 2    | 2    | 50   | 50   | 50   | 0    | 0    | 0    |
| Cap, veh/h                  | 14   | 1831 | 36   | 14   | 1861 | 10   | 172  | 20   | 18   | 181  | 30   | 30   |
| Arrive On Green             | 0.01 | 0.52 | 0.52 | 0.01 | 0.52 | 0.52 | 0.05 | 0.05 | 0.05 | 0.05 | 0.05 | 0.05 |
| Sat Flow, veh/h             | 1774 | 3551 | 69   | 1774 | 3609 | 20   | 390  | 390  | 351  | 579  | 579  | 579  |
| Grp Volume(v), veh/h        | 10   | 514  | 537  | 10   | 812  | 853  | 29   | 0    | 0    | 30   | 0    | 0    |
| Grp Sat Flow(s),veh/h/ln    | 1774 | 1770 | 1851 | 1774 | 1770 | 1859 | 1130 | 0    | 0    | 1736 | 0    | 0    |
| Q Serve(g_s), s             | 0.2  | 6.3  | 6.3  | 0.2  | 13.0 | 13.0 | 0.3  | 0.0  | 0.0  | 0.0  | 0.0  | 0.0  |
| Cycle Q Clear(g_c), s       | 0.2  | 6.3  | 6.3  | 0.2  | 13.0 | 13.0 | 0.8  | 0.0  | 0.0  | 0.5  | 0.0  | 0.0  |
| Prop In Lane                | 1.00 |      | 0.04 | 1.00 |      | 0.01 | 0.34 |      | 0.31 | 0.33 |      | 0.33 |
| Lane Grp Cap(c), veh/h      | 14   | 912  | 954  | 14   | 912  | 959  | 210  | 0    | 0    | 240  | 0    | 0    |
| V/C Ratio(X)                | 0.71 | 0.56 | 0.56 | 0.71 | 0.89 | 0.89 | 0.14 | 0.00 | 0.00 | 0.13 | 0.00 | 0.00 |
| Avail Cap(c_a), veh/h       | 643  | 1812 | 1895 | 643  | 1812 | 1904 | 1090 | 0    | 0    | 1560 | 0    | 0    |
| HCM Platoon Ratio           | 1.00 | 1.00 | 1.00 | 1.00 | 1.00 | 1.00 | 1.00 | 1.00 | 1.00 | 1.00 | 1.00 | 1.00 |
| Upstream Filter(I)          | 1.00 | 1.00 | 1.00 | 1.00 | 1.00 | 1.00 | 1.00 | 0.00 | 0.00 | 1.00 | 0.00 | 0.00 |
| Uniform Delay (d), s/veh    | 15.7 | 5.2  | 5.2  | 15.7 | 6.9  | 6.9  | 14.6 | 0.0  | 0.0  | 14.5 | 0.0  | 0.0  |
| Incr Delay (d2), s/veh      | 21.1 | 0.2  | 0.2  | 21.1 | 1.2  | 1.2  | 0.1  | 0.0  | 0.0  | 0.1  | 0.0  | 0.0  |
| Initial Q Delay(d3),s/veh   | 0.0  | 0.0  | 0.0  | 0.0  | 0.0  | 0.0  | 0.0  | 0.0  | 0.0  | 0.0  | 0.0  | 0.0  |
| %ile BackOfQ(50%),veh/ln    | 0.2  | 3.0  | 3.2  | 0.2  | 6.4  | 6.7  | 0.2  | 0.0  | 0.0  | 0.3  | 0.0  | 0.0  |
| LnGrp Delay(d),s/veh        | 36.8 | 5.5  | 5.4  | 36.8 | 8.1  | 8.1  | 14.7 | 0.0  | 0.0  | 14.6 | 0.0  | 0.0  |
| LnGrp LOS                   | D    | A    | A    | D    | A    | A    | B    |      |      | B    |      |      |
| Approach Vol, veh/h         |      | 1061 |      |      | 1675 |      |      | 29   |      |      | 30   |      |
| Approach Delay, s/veh       |      | 5.7  |      |      | 8.3  |      |      | 14.7 |      |      | 14.6 |      |
| Approach LOS                |      | A    |      |      | A    |      |      | B    |      |      | B    |      |
| Timer                       | 1    | 2    | 3    | 4    | 5    | 6    | 7    | 8    |      |      |      |      |
| Assigned Phs                | 1    | 2    |      | 4    | 5    | 6    |      | 8    |      |      |      |      |
| Phs Duration (G+Y+Rc), s    | 3.8  | 21.9 |      | 6.1  | 3.8  | 21.9 |      | 6.1  |      |      |      |      |
| Change Period (Y+Rc), s     | 3.5  | 5.5  |      | 4.5  | 3.5  | 5.5  |      | 4.5  |      |      |      |      |
| Max Green Setting (Gmax), s | 1.5  | 32.5 |      | 27.5 | 11.5 | 32.5 |      | 27.5 |      |      |      |      |
| Max Q Clear Time (g_c+1), s | 1.2  | 8.3  |      | 2.5  | 2.2  | 15.0 |      | 2.8  |      |      |      |      |
| Green Ext Time (p_c), s     | 0.0  | 0.7  |      | 0.0  | 0.0  | 1.3  |      | 0.0  |      |      |      |      |
| <b>Intersection Summary</b> |      |      |      |      |      |      |      |      |      |      |      |      |
| HCM 2010 Ctrl Delay         |      |      |      | 7.4  |      |      |      |      |      |      |      |      |
| HCM 2010 LOS                |      |      |      | A    |      |      |      |      |      |      |      |      |

HCM 2010 Signalized Intersection Summary Cumulative with Eastside Parkway with Project, AM  
 8: 5th Avenue/California Avenue & Imjin Parkway 06/11/2019



| Movement                    | EBL  | EBT  | EBR  | WBL  | WBT  | WBR  | NBL  | NBT  | NBR  | SBL  | SBT  | SBR  |
|-----------------------------|------|------|------|------|------|------|------|------|------|------|------|------|
| Lane Configurations         |      |      |      |      |      |      |      |      |      |      |      |      |
| Traffic Volume (veh/h)      | 140  | 890  | 20   | 10   | 1000 | 80   | 20   | 20   | 10   | 100  | 160  | 460  |
| Future Volume (veh/h)       | 140  | 890  | 20   | 10   | 1000 | 80   | 20   | 20   | 10   | 100  | 160  | 460  |
| Number                      | 5    | 2    | 12   | 1    | 6    | 16   | 3    | 8    | 18   | 7    | 4    | 14   |
| Initial Q (Qb), veh         | 0    | 0    | 0    | 0    | 0    | 0    | 0    | 0    | 0    | 0    | 0    | 0    |
| Ped-Bike Adj(A_pbT)         | 1.00 |      | 0.98 | 1.00 |      | 1.00 | 1.00 |      | 0.99 | 1.00 |      | 1.00 |
| Parking Bus, Adj            | 1.00 | 1.00 | 1.00 | 1.00 | 1.00 | 1.00 | 1.00 | 1.00 | 1.00 | 1.00 | 1.00 | 1.00 |
| Adj Sat Flow, veh/h/ln      | 1881 | 1881 | 1900 | 1863 | 1863 | 1900 | 1900 | 1624 | 1900 | 1900 | 1881 | 1900 |
| Adj Flow Rate, veh/h        | 147  | 937  | 19   | 11   | 1053 | 78   | 21   | 21   | 10   | 105  | 168  | 410  |
| Adj No. of Lanes            | 1    | 2    | 0    | 1    | 2    | 0    | 0    | 1    | 0    | 0    | 1    | 0    |
| Peak Hour Factor            | 0.95 | 0.95 | 0.95 | 0.95 | 0.95 | 0.95 | 0.95 | 0.95 | 0.95 | 0.95 | 0.95 | 0.95 |
| Percent Heavy Veh, %        | 1    | 1    | 1    | 2    | 2    | 2    | 17   | 17   | 17   | 1    | 1    | 1    |
| Cap, veh/h                  | 186  | 1583 | 32   | 15   | 1158 | 86   | 174  | 152  | 58   | 135  | 149  | 323  |
| Arrive On Green             | 0.10 | 0.44 | 0.44 | 0.01 | 0.35 | 0.35 | 0.33 | 0.33 | 0.33 | 0.33 | 0.33 | 0.33 |
| Sat Flow, veh/h             | 1792 | 3581 | 73   | 1774 | 3341 | 247  | 275  | 461  | 175  | 201  | 452  | 981  |
| Grp Volume(v), veh/h        | 147  | 468  | 488  | 11   | 558  | 573  | 52   | 0    | 0    | 683  | 0    | 0    |
| Grp Sat Flow(s),veh/h/ln    | 1792 | 1787 | 1867 | 1774 | 1770 | 1819 | 912  | 0    | 0    | 1634 | 0    | 0    |
| Q Serve(g_s), s             | 4.9  | 12.0 | 12.0 | 0.4  | 18.3 | 18.3 | 0.0  | 0.0  | 0.0  | 16.2 | 0.0  | 0.0  |
| Cycle Q Clear(g_c), s       | 4.9  | 12.0 | 12.0 | 0.4  | 18.3 | 18.3 | 1.4  | 0.0  | 0.0  | 20.0 | 0.0  | 0.0  |
| Prop In Lane                | 1.00 |      | 0.04 | 1.00 |      | 0.14 | 0.40 |      | 0.19 | 0.15 |      | 0.60 |
| Lane Grp Cap(c), veh/h      | 186  | 790  | 825  | 15   | 613  | 630  | 383  | 0    | 0    | 606  | 0    | 0    |
| V/C Ratio(X)                | 0.79 | 0.59 | 0.59 | 0.74 | 0.91 | 0.91 | 0.14 | 0.00 | 0.00 | 1.13 | 0.00 | 0.00 |
| Avail Cap(c_a), veh/h       | 442  | 882  | 921  | 438  | 873  | 898  | 383  | 0    | 0    | 606  | 0    | 0    |
| HCM Platoon Ratio           | 1.00 | 1.00 | 1.00 | 1.00 | 1.00 | 1.00 | 1.00 | 1.00 | 1.00 | 1.00 | 1.00 | 1.00 |
| Upstream Filter(I)          | 1.00 | 1.00 | 1.00 | 1.00 | 1.00 | 1.00 | 1.00 | 0.00 | 0.00 | 1.00 | 0.00 | 0.00 |
| Uniform Delay (d), s/veh    | 26.6 | 12.8 | 12.8 | 30.1 | 18.9 | 18.9 | 14.2 | 0.0  | 0.0  | 21.5 | 0.0  | 0.0  |
| Incr Delay (d2), s/veh      | 2.8  | 0.4  | 0.4  | 23.2 | 8.2  | 8.0  | 0.1  | 0.0  | 0.0  | 76.9 | 0.0  | 0.0  |
| Initial Q Delay(d3),s/veh   | 0.0  | 0.0  | 0.0  | 0.0  | 0.0  | 0.0  | 0.0  | 0.0  | 0.0  | 0.0  | 0.0  | 0.0  |
| %ile BackOfQ(50%),veh/ln    | 2.6  | 5.9  | 6.2  | 0.3  | 10.2 | 10.5 | 0.6  | 0.0  | 0.0  | 22.9 | 0.0  | 0.0  |
| LnGrp Delay(d),s/veh        | 29.4 | 13.3 | 13.2 | 53.2 | 27.1 | 27.0 | 14.2 | 0.0  | 0.0  | 98.3 | 0.0  | 0.0  |
| LnGrp LOS                   | C    | B    | B    | D    | C    | C    | B    |      |      | F    |      |      |
| Approach Vol, veh/h         |      | 1103 |      |      | 1142 |      |      | 52   |      |      | 683  |      |
| Approach Delay, s/veh       |      | 15.4 |      |      | 27.3 |      |      | 14.2 |      |      | 98.3 |      |
| Approach LOS                |      | B    |      |      | C    |      |      | B    |      |      | F    |      |
| Timer                       | 1    | 2    | 3    | 4    | 5    | 6    | 7    | 8    |      |      |      |      |
| Assigned Phs                | 1    | 2    |      | 4    | 5    | 6    |      | 8    |      |      |      |      |
| Phs Duration (G+Y+Rc), s    | 4.0  | 32.2 |      | 24.6 | 9.8  | 26.4 |      | 24.6 |      |      |      |      |
| Change Period (Y+Rc), s     | 3.5  | 5.3  |      | 4.6  | 3.5  | 5.3  |      | 4.6  |      |      |      |      |
| Max Green Setting (Gmax), s | 30.0 | 30.0 |      | 20.0 | 15.0 | 30.0 |      | 20.0 |      |      |      |      |
| Max Q Clear Time (g_c+1), s | 12.4 | 14.0 |      | 22.0 | 6.9  | 20.3 |      | 3.4  |      |      |      |      |
| Green Ext Time (p_c), s     | 0.0  | 0.7  |      | 0.0  | 0.0  | 0.8  |      | 0.1  |      |      |      |      |
| <b>Intersection Summary</b> |      |      |      |      |      |      |      |      |      |      |      |      |
| HCM 2010 Ctrl Delay         |      |      | 38.9 |      |      |      |      |      |      |      |      |      |
| HCM 2010 LOS                |      |      | D    |      |      |      |      |      |      |      |      |      |

| Intersection             |      |      |      |      |      |      |
|--------------------------|------|------|------|------|------|------|
| Int Delay, s/veh         | 1.4  |      |      |      |      |      |
| Movement                 | EBL  | EBR  | NBL  | NBT  | SBT  | SBR  |
| Lane Configurations      | Y    |      | Y    | ↑    | ↑    |      |
| Traffic Vol, veh/h       | 30   | 30   | 30   | 230  | 630  | 80   |
| Future Vol, veh/h        | 30   | 30   | 30   | 230  | 630  | 80   |
| Conflicting Peds, #/hr   | 0    | 0    | 0    | 0    | 0    | 0    |
| Sign Control             | Stop | Stop | Free | Free | Free | Free |
| RT Channelized           | -    | None | -    | None | -    | None |
| Storage Length           | 0    | -    | 155  | -    | -    | -    |
| Veh in Median Storage, # | 0    | -    | -    | 0    | 0    | -    |
| Grade, %                 | 0    | -    | -    | 0    | 0    | -    |
| Peak Hour Factor         | 92   | 92   | 92   | 92   | 92   | 92   |
| Heavy Vehicles, %        | 2    | 2    | 2    | 2    | 2    | 2    |
| Mvmt Flow                | 33   | 33   | 33   | 250  | 685  | 87   |











| Major/Minor          | Minor2 | Major1 | Major2 |   |   |   |
|----------------------|--------|--------|--------|---|---|---|
| Conflicting Flow All | 1045   | 729    | 772    | 0 | - | 0 |
| Stage 1              | 729    | -      | -      | - | - | - |
| Stage 2              | 316    | -      | -      | - | - | - |
| Critical Hdwy        | 6.42   | 6.22   | 4.12   | - | - | - |
| Critical Hdwy Stg 1  | 5.42   | -      | -      | - | - | - |
| Critical Hdwy Stg 2  | 5.42   | -      | -      | - | - | - |
| Follow-up Hdwy       | 3.518  | 3.318  | 2.218  | - | - | - |
| Pot Cap-1 Maneuver   | 253    | 423    | 843    | - | - | - |
| Stage 1              | 477    | -      | -      | - | - | - |
| Stage 2              | 739    | -      | -      | - | - | - |
| Platoon blocked, %   |        |        |        | - | - | - |
| Mov Cap-1 Maneuver   | 243    | 423    | 843    | - | - | - |
| Mov Cap-2 Maneuver   | 243    | -      | -      | - | - | - |
| Stage 1              | 458    | -      | -      | - | - | - |
| Stage 2              | 739    | -      | -      | - | - | - |

| Approach             | EB   | NB  | SB |
|----------------------|------|-----|----|
| HCM Control Delay, s | 19.7 | 1.1 | 0  |
| HCM LOS              | C    |     |    |

| Minor Lane/Major Mvmt | NBL   | NBT | EBLn1 | SBT | SBR |
|-----------------------|-------|-----|-------|-----|-----|
| Capacity (veh/h)      | 843   | -   | 309   | -   | -   |
| HCM Lane V/C Ratio    | 0.039 | -   | 0.211 | -   | -   |
| HCM Control Delay (s) | 9.4   | -   | 19.7  | -   | -   |
| HCM Lane LOS          | A     | -   | C     | -   | -   |
| HCM 95th %tile Q(veh) | 0.1   | -   | 0.8   | -   | -   |

HCM 2010 Signalized Intersection Summary Cumulative with Eastside Parkway with Project, AM  
 10: Imjin Road & Imjin Parkway

06/11/2019

|                              |  |  |  |  |  |  |   |      |
|------------------------------|---|---|---|---|---|---|---|------|
| Movement                     | EBT   | EBR   | WBL   | WBT   | NBL   | NBR   |   |      |
| Lane Configurations          |  |   |  |  |  |  |   |      |
| Traffic Volume (veh/h)       | 790   | 230   | 420   | 990   | 110   | 120   |   |      |
| Future Volume (veh/h)        | 790   | 230   | 420   | 990   | 110   | 120   |   |      |
| Number                       | 2   | 12  | 1   | 6   | 3   | 18  |   |      |
| Initial Q (Qb), veh          | 0   | 0   | 0   | 0   | 0   | 0   |   |      |
| Ped-Bike Adj(A_pbT)          |   | 1.00  | 1.00  |   | 1.00  | 1.00  |   |      |
| Parking Bus, Adj             | 1.00  | 1.00  | 1.00  | 1.00  | 1.00  | 1.00  |   |      |
| Adj Sat Flow, veh/h/ln       | 1863  | 1900  | 1845  | 1845  | 1810  | 1810  |   |      |
| Adj Flow Rate, veh/h         | 832   | 229   | 442   | 1042  | 158   | 81  |   |      |
| Adj No. of Lanes             | 2   | 0   | 1   | 2   | 2   | 1   |   |      |
| Peak Hour Factor             | 0.95  | 0.95  | 0.95  | 0.95  | 0.95  | 0.95  |   |      |
| Percent Heavy Veh, %         | 2   | 2   | 3   | 3   | 5   | 5   |   |      |
| Cap, veh/h                   | 938   | 258   | 495   | 2554  | 302   | 135   |   |      |
| Arrive On Green              | 0.34  | 0.34  | 0.28  | 0.73  | 0.09  | 0.09  |   |      |
| Sat Flow, veh/h              | 2837  | 755   | 1757  | 3597  | 3447  | 1538  |   |      |
| Grp Volume(v), veh/h         | 536   | 525   | 442   | 1042  | 158   | 81  |   |      |
| Grp Sat Flow(s),veh/h/ln     | 1770  | 1730  | 1757  | 1752  | 1723  | 1538  |   |      |
| Q Serve(g_s), s              | 14.5  | 14.5  | 12.2  | 5.8   | 2.2   | 2.6   |   |      |
| Cycle Q Clear(g_c), s        | 14.5  | 14.5  | 12.2  | 5.8   | 2.2   | 2.6   |   |      |
| Prop In Lane                 |   | 0.44  | 1.00  |   | 1.00  | 1.00  |   |      |
| Lane Grp Cap(c), veh/h       | 605   | 591   | 495   | 2554  | 302   | 135   |   |      |
| V/C Ratio(X)                 | 0.89  | 0.89  | 0.89  | 0.41  | 0.52  | 0.60  |   |      |
| Avail Cap(c_a), veh/h        | 1049  | 1025  | 694   | 2554  | 1498  | 668   |   |      |
| HCM Platoon Ratio            | 1.00  | 1.00  | 1.00  | 1.00  | 1.00  | 1.00  |   |      |
| Upstream Filter(I)           | 1.00  | 1.00  | 1.00  | 1.00  | 1.00  | 1.00  |   |      |
| Uniform Delay (d), s/veh     | 15.7  | 15.7  | 17.4  | 2.7   | 22.1  | 22.2  |   |      |
| Incr Delay (d2), s/veh       | 2.2   | 2.3   | 8.5   | 0.0   | 0.5   | 1.6   |   |      |
| Initial Q Delay(d3),s/veh    | 0.0   | 0.0   | 0.0   | 0.0   | 0.0   | 0.0   |   |      |
| %ile BackOfQ(50%),veh/ln     | 7.4   | 7.2   | 7.1   | 2.8   | 1.1   | 1.1   |   |      |
| LnGrp Delay(d),s/veh         | 18.0  | 18.1  | 25.9  | 2.7   | 22.6  | 23.8  |   |      |
| LnGrp LOS                    | B   | B   | C   | A   | C   | C   |   |      |
| Approach Vol, veh/h          | 1061  |   |   | 1484  | 239   |   |   |      |
| Approach Delay, s/veh        | 18.0  |   |   | 9.6   | 23.0  |   |   |      |
| Approach LOS                 | B   |   |   | A   | C   |   |   |      |
| Timer                        | 1   | 2   | 3   | 4   | 5   | 6   | 7 | 8    |
| Assigned Phs                 | 1   | 2   |   |   |   | 6   |   | 8    |
| Phs Duration (G+Y+Rc), s     | 19.6  | 22.6  |   |   |   | 42.2  |   | 8.4  |
| Change Period (Y+Rc), s      | 5.3   | * 5.3   |   |   |   | 5.3   |   | 4.0  |
| Max Green Setting (Gmax), s  | 20.0  | * 30  |   |   |   | 30.0  |   | 22.0 |
| Max Q Clear Time (g_c+I1), s | 14.2  | 16.5  |   |   |   | 7.8   |   | 4.6  |
| Green Ext Time (p_c), s      | 0.1   | 0.8   |   |   |   | 1.2   |   | 0.0  |
| <b>Intersection Summary</b>  |   |   |   |   |   |   |   |      |
| HCM 2010 Ctrl Delay          |   |   | 14.0  |   |   |   |   |      |
| HCM 2010 LOS                 |   |   | B   |   |   |   |   |      |
| <b>Notes</b>                 |   |   |   |   |   |   |   |      |

HCM 2010 Signalized Intersection Summary Cumulative with Eastside Parkway with Project, AM  
 11: Abrams Drive & Imjin Parkway

06/11/2019



| Movement                     | EBL  | EBT  | EBR  | WBL  | WBT  | WBR  | NBL  | NBT  | NBR  | SBL  | SBT  | SBR  |
|------------------------------|------|------|------|------|------|------|------|------|------|------|------|------|
| Lane Configurations          | ↖↗   | ↖↗   |      | ↖↗   | ↖↗   |      | ↖    | ↖    | ↖    | ↖    | ↖    | ↖    |
| Traffic Volume (veh/h)       | 50   | 630  | 70   | 80   | 970  | 70   | 290  | 30   | 160  | 90   | 50   | 250  |
| Future Volume (veh/h)        | 50   | 630  | 70   | 80   | 970  | 70   | 290  | 30   | 160  | 90   | 50   | 250  |
| Number                       | 5    | 2    | 12   | 1    | 6    | 16   | 3    | 8    | 18   | 7    | 4    | 14   |
| Initial Q (Qb), veh          | 0    | 0    | 0    | 0    | 0    | 0    | 0    | 0    | 0    | 0    | 0    | 0    |
| Ped-Bike Adj(A_pbT)          | 1.00 |      | 1.00 | 1.00 |      | 1.00 | 1.00 |      | 1.00 | 1.00 |      | 1.00 |
| Parking Bus, Adj             | 1.00 | 1.00 | 1.00 | 1.00 | 1.00 | 1.00 | 1.00 | 1.00 | 1.00 | 1.00 | 1.00 | 1.00 |
| Adj Sat Flow, veh/h/ln       | 1881 | 1881 | 1900 | 1863 | 1863 | 1900 | 1845 | 1845 | 1845 | 1863 | 1863 | 1863 |
| Adj Flow Rate, veh/h         | 54   | 677  | 63   | 86   | 1043 | 70   | 312  | 32   | 0    | 97   | 54   | 0    |
| Adj No. of Lanes             | 2    | 2    | 0    | 2    | 2    | 0    | 1    | 1    | 1    | 1    | 1    | 1    |
| Peak Hour Factor             | 0.93 | 0.93 | 0.93 | 0.93 | 0.93 | 0.93 | 0.93 | 0.93 | 0.93 | 0.93 | 0.93 | 0.93 |
| Percent Heavy Veh, %         | 1    | 1    | 1    | 2    | 2    | 2    | 3    | 3    | 3    | 2    | 2    | 2    |
| Cap, veh/h                   | 183  | 1721 | 160  | 146  | 1696 | 114  | 429  | 509  | 433  | 451  | 514  | 437  |
| Arrive On Green              | 0.05 | 0.52 | 0.52 | 0.04 | 0.50 | 0.50 | 0.28 | 0.28 | 0.00 | 0.28 | 0.28 | 0.00 |
| Sat Flow, veh/h              | 3476 | 3306 | 307  | 3442 | 3366 | 226  | 1330 | 1845 | 1568 | 1370 | 1863 | 1583 |
| Grp Volume(v), veh/h         | 54   | 366  | 374  | 86   | 548  | 565  | 312  | 32   | 0    | 97   | 54   | 0    |
| Grp Sat Flow(s),veh/h/ln     | 1738 | 1787 | 1827 | 1721 | 1770 | 1823 | 1330 | 1845 | 1568 | 1370 | 1863 | 1583 |
| Q Serve(g_s), s              | 1.2  | 9.8  | 9.8  | 1.9  | 17.7 | 17.7 | 18.1 | 1.0  | 0.0  | 4.5  | 1.7  | 0.0  |
| Cycle Q Clear(g_c), s        | 1.2  | 9.8  | 9.8  | 1.9  | 17.7 | 17.7 | 19.9 | 1.0  | 0.0  | 5.5  | 1.7  | 0.0  |
| Prop In Lane                 | 1.00 |      | 0.17 | 1.00 |      | 0.12 | 1.00 |      | 1.00 | 1.00 |      | 1.00 |
| Lane Grp Cap(c), veh/h       | 183  | 930  | 951  | 146  | 892  | 918  | 429  | 509  | 433  | 451  | 514  | 437  |
| V/C Ratio(X)                 | 0.30 | 0.39 | 0.39 | 0.59 | 0.61 | 0.62 | 0.73 | 0.06 | 0.00 | 0.21 | 0.11 | 0.00 |
| Avail Cap(c_a), veh/h        | 876  | 1125 | 1150 | 867  | 1114 | 1148 | 565  | 697  | 592  | 591  | 704  | 598  |
| HCM Platoon Ratio            | 1.00 | 1.00 | 1.00 | 1.00 | 1.00 | 1.00 | 1.00 | 1.00 | 1.00 | 1.00 | 1.00 | 1.00 |
| Upstream Filter(I)           | 1.00 | 1.00 | 1.00 | 1.00 | 1.00 | 1.00 | 1.00 | 1.00 | 0.00 | 1.00 | 1.00 | 0.00 |
| Uniform Delay (d), s/veh     | 36.2 | 11.5 | 11.5 | 37.3 | 14.2 | 14.2 | 28.8 | 21.2 | 0.0  | 23.2 | 21.4 | 0.0  |
| Incr Delay (d2), s/veh       | 0.3  | 0.1  | 0.1  | 1.4  | 0.3  | 0.3  | 1.9  | 0.0  | 0.0  | 0.1  | 0.0  | 0.0  |
| Initial Q Delay(d3),s/veh    | 0.0  | 0.0  | 0.0  | 0.0  | 0.0  | 0.0  | 0.0  | 0.0  | 0.0  | 0.0  | 0.0  | 0.0  |
| %ile BackOfQ(50%),veh/ln     | 0.6  | 4.8  | 4.9  | 1.0  | 8.6  | 8.9  | 6.9  | 0.5  | 0.0  | 1.7  | 0.9  | 0.0  |
| LnGrp Delay(d),s/veh         | 36.5 | 11.6 | 11.6 | 38.7 | 14.4 | 14.4 | 30.8 | 21.2 | 0.0  | 23.3 | 21.5 | 0.0  |
| LnGrp LOS                    | D    | B    | B    | D    | B    | B    | C    | C    |      | C    | C    |      |
| Approach Vol, veh/h          |      | 794  |      |      | 1199 |      |      | 344  |      |      | 151  |      |
| Approach Delay, s/veh        |      | 13.3 |      |      | 16.2 |      |      | 29.9 |      |      | 22.6 |      |
| Approach LOS                 |      | B    |      |      | B    |      |      | C    |      |      | C    |      |
| Timer                        | 1    | 2    | 3    | 4    | 5    | 6    | 7    | 8    |      |      |      |      |
| Assigned Phs                 | 1    | 2    |      | 4    | 5    | 6    |      | 8    |      |      |      |      |
| Phs Duration (G+Y+Rc), s     | 6.9  | 46.6 |      | 25.9 | 8.2  | 45.3 |      | 25.9 |      |      |      |      |
| Change Period (Y+Rc), s      | 3.5  | 5.3  |      | 4.0  | 4.0  | 5.3  |      | 4.0  |      |      |      |      |
| Max Green Setting (Gmax), s  | 20.0 | 50.0 |      | 30.0 | 20.0 | 50.0 |      | 30.0 |      |      |      |      |
| Max Q Clear Time (g_c+13), s | 13.5 | 11.8 |      | 7.5  | 3.2  | 19.7 |      | 21.9 |      |      |      |      |
| Green Ext Time (p_c), s      | 0.0  | 0.5  |      | 0.0  | 0.0  | 0.8  |      | 0.1  |      |      |      |      |
| <b>Intersection Summary</b>  |      |      |      |      |      |      |      |      |      |      |      |      |
| HCM 2010 Ctrl Delay          |      |      | 17.5 |      |      |      |      |      |      |      |      |      |
| HCM 2010 LOS                 |      |      | B    |      |      |      |      |      |      |      |      |      |

HCM 2010 Signalized Intersection Summary Cumulative with Eastside Parkway with Project, AM  
 12: Reservation Road & Imjin Parkway

06/11/2019



| Movement                    | EBL  | EBT   | EBR  | WBL  | WBT  | WBR   | NBL  | NBT  | NBR  | SBL  | SBT  | SBR  |
|-----------------------------|------|-------|------|------|------|-------|------|------|------|------|------|------|
| Lane Configurations         |      |       |      |      |      |       |      |      |      |      |      |      |
| Traffic Volume (veh/h)      | 190  | 50    | 670  | 10   | 20   | 30    | 950  | 880  | 20   | 60   | 590  | 90   |
| Future Volume (veh/h)       | 190  | 50    | 670  | 10   | 20   | 30    | 950  | 880  | 20   | 60   | 590  | 90   |
| Number                      | 3    | 8     | 18   | 7    | 4    | 14    | 1    | 6    | 16   | 5    | 2    | 12   |
| Initial Q (Qb), veh         | 0    | 0     | 0    | 0    | 0    | 0     | 0    | 0    | 0    | 0    | 0    | 0    |
| Ped-Bike Adj(A_pbT)         | 1.00 |       | 1.00 | 1.00 |      | 0.99  | 1.00 |      | 1.00 | 1.00 |      | 0.98 |
| Parking Bus, Adj            | 1.00 | 1.00  | 1.00 | 1.00 | 1.00 | 1.00  | 1.00 | 1.00 | 1.00 | 1.00 | 1.00 | 1.00 |
| Adj Sat Flow, veh/h/ln      | 1863 | 1863  | 1863 | 1638 | 1638 | 1638  | 1863 | 1863 | 1863 | 1863 | 1863 | 1863 |
| Adj Flow Rate, veh/h        | 204  | 54    | 306  | 11   | 22   | 19    | 1022 | 946  | 16   | 65   | 634  | 34   |
| Adj No. of Lanes            | 2    | 1     | 2    | 1    | 1    | 1     | 2    | 2    | 1    | 2    | 2    | 1    |
| Peak Hour Factor            | 0.93 | 0.93  | 0.93 | 0.93 | 0.93 | 0.93  | 0.93 | 0.93 | 0.93 | 0.93 | 0.93 | 0.93 |
| Percent Heavy Veh, %        | 2    | 2     | 2    | 16   | 16   | 16    | 2    | 2    | 2    | 2    | 2    | 2    |
| Cap, veh/h                  | 378  | 205   | 1200 | 57   | 60   | 51    | 1105 | 2057 | 919  | 124  | 1048 | 462  |
| Arrive On Green             | 0.11 | 0.11  | 0.11 | 0.04 | 0.04 | 0.04  | 0.32 | 0.58 | 0.58 | 0.04 | 0.30 | 0.30 |
| Sat Flow, veh/h             | 3442 | 1863  | 2774 | 1560 | 1638 | 1383  | 3442 | 3539 | 1581 | 3442 | 3539 | 1558 |
| Grp Volume(v), veh/h        | 204  | 54    | 306  | 11   | 22   | 19    | 1022 | 946  | 16   | 65   | 634  | 34   |
| Grp Sat Flow(s),veh/h/ln    | 1721 | 1863  | 1387 | 1560 | 1638 | 1383  | 1721 | 1770 | 1581 | 1721 | 1770 | 1558 |
| Q Serve(g_s), s             | 4.9  | 2.3   | 6.2  | 0.6  | 1.2  | 1.2   | 25.3 | 13.5 | 0.4  | 1.6  | 13.5 | 1.4  |
| Cycle Q Clear(g_c), s       | 4.9  | 2.3   | 6.2  | 0.6  | 1.2  | 1.2   | 25.3 | 13.5 | 0.4  | 1.6  | 13.5 | 1.4  |
| Prop In Lane                | 1.00 |       | 1.00 | 1.00 |      | 1.00  | 1.00 |      | 1.00 | 1.00 |      | 1.00 |
| Lane Grp Cap(c), veh/h      | 378  | 205   | 1200 | 57   | 60   | 51    | 1105 | 2057 | 919  | 124  | 1048 | 462  |
| V/C Ratio(X)                | 0.54 | 0.26  | 0.26 | 0.19 | 0.37 | 0.37  | 0.92 | 0.46 | 0.02 | 0.52 | 0.60 | 0.07 |
| Avail Cap(c_a), veh/h       | 1367 | 740   | 1997 | 549  | 576  | 486   | 1367 | 2057 | 919  | 781  | 2409 | 1061 |
| HCM Platoon Ratio           | 1.00 | 1.00  | 1.00 | 1.00 | 1.00 | 1.00  | 1.00 | 1.00 | 1.00 | 1.00 | 1.00 | 1.00 |
| Upstream Filter(I)          | 1.00 | 1.00  | 1.00 | 1.00 | 1.00 | 1.00  | 1.00 | 1.00 | 1.00 | 1.00 | 1.00 | 1.00 |
| Uniform Delay (d), s/veh    | 37.1 | 36.0  | 16.0 | 41.2 | 41.5 | 41.5  | 28.9 | 10.5 | 7.8  | 41.7 | 26.6 | 22.3 |
| Incr Delay (d2), s/veh      | 0.4  | 0.3   | 0.0  | 0.6  | 1.4  | 1.7   | 8.5  | 0.4  | 0.0  | 1.3  | 1.6  | 0.2  |
| Initial Q Delay(d3),s/veh   | 0.0  | 0.0   | 0.0  | 0.0  | 0.0  | 0.0   | 0.0  | 0.0  | 0.0  | 0.0  | 0.0  | 0.0  |
| %ile BackOfQ(50%),veh/ln    | 2.4  | 1.2   | 2.4  | 0.3  | 0.5  | 0.5   | 13.2 | 6.7  | 0.2  | 0.8  | 6.8  | 0.6  |
| LnGrp Delay(d),s/veh        | 37.6 | 36.2  | 16.1 | 41.8 | 42.8 | 43.2  | 37.4 | 11.0 | 7.8  | 43.0 | 28.1 | 22.5 |
| LnGrp LOS                   | D    | D     | B    | D    | D    | D     | D    | B    | A    | D    | C    | C    |
| Approach Vol, veh/h         |      | 564   |      |      | 52   |       |      | 1984 |      |      | 733  |      |
| Approach Delay, s/veh       |      | 25.8  |      |      | 42.7 |       |      | 24.6 |      |      | 29.2 |      |
| Approach LOS                |      | C     |      |      | D    |       |      | C    |      |      | C    |      |
| Timer                       | 1    | 2     | 3    | 4    | 5    | 6     | 7    | 8    |      |      |      |      |
| Assigned Phs                | 1    | 2     |      | 4    | 5    | 6     |      | 8    |      |      |      |      |
| Phs Duration (G+Y+Rc), s    | 32.4 | 32.3  |      | 8.2  | 7.3  | 57.4  |      | 15.2 |      |      |      |      |
| Change Period (Y+Rc), s     | 4.1  | * 6.2 |      | 5.0  | 4.1  | * 6.2 |      | 5.5  |      |      |      |      |
| Max Green Setting (Gmax), s | 35.0 | * 60  |      | 31.0 | 20.0 | * 50  |      | 35.0 |      |      |      |      |
| Max Q Clear Time (g_c+T), s | 27.3 | 15.5  |      | 3.2  | 3.6  | 15.5  |      | 8.2  |      |      |      |      |
| Green Ext Time (p_c), s     | 1.0  | 10.6  |      | 0.1  | 0.0  | 15.5  |      | 1.2  |      |      |      |      |
| <b>Intersection Summary</b> |      |       |      |      |      |       |      |      |      |      |      |      |
| HCM 2010 Ctrl Delay         |      |       | 26.1 |      |      |       |      |      |      |      |      |      |
| HCM 2010 LOS                |      |       | C    |      |      |       |      |      |      |      |      |      |
| <b>Notes</b>                |      |       |      |      |      |       |      |      |      |      |      |      |



HCM 2010 Signalized Intersection Summary Cumulative with Eastside Parkway with Project, AM  
 13: Reservation Road & Blanco Road

06/11/2019

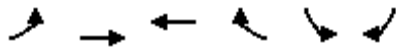

| Movement                     | EBL  | EBT  | WBT  | WBR  | SBL  | SBR  |   |   |
|------------------------------|------|------|------|------|------|------|---|---|
| Lane Configurations          | ↖↖   | ↑↑   | ↑    | ↑    | ↘↘   | ↘↘   |   |   |
| Traffic Volume (veh/h)       | 990  | 300  | 500  | 40   | 40   | 1340 |   |   |
| Future Volume (veh/h)        | 990  | 300  | 500  | 40   | 40   | 1340 |   |   |
| Number                       | 5    | 2    | 6    | 16   | 7    | 14   |   |   |
| Initial Q (Qb), veh          | 0    | 0    | 0    | 0    | 0    | 0    |   |   |
| Ped-Bike Adj(A_pbT)          | 1.00 |      |      | 1.00 | 1.00 | 1.00 |   |   |
| Parking Bus, Adj             | 1.00 | 1.00 | 1.00 | 1.00 | 1.00 | 1.00 |   |   |
| Adj Sat Flow, veh/h/ln       | 1863 | 1863 | 1845 | 1845 | 1845 | 1845 |   |   |
| Adj Flow Rate, veh/h         | 1065 | 323  | 538  | 24   | 43   | 0    |   |   |
| Adj No. of Lanes             | 2    | 2    | 1    | 1    | 2    | 2    |   |   |
| Peak Hour Factor             | 0.93 | 0.93 | 0.93 | 0.93 | 0.93 | 0.93 |   |   |
| Percent Heavy Veh, %         | 2    | 2    | 3    | 3    | 3    | 3    |   |   |
| Cap, veh/h                   | 1182 | 2811 | 645  | 548  | 120  | 97   |   |   |
| Arrive On Green              | 0.34 | 0.79 | 0.35 | 0.35 | 0.04 | 0.00 |   |   |
| Sat Flow, veh/h              | 3442 | 3632 | 1845 | 1568 | 3408 | 2760 |   |   |
| Grp Volume(v), veh/h         | 1065 | 323  | 538  | 24   | 43   | 0    |   |   |
| Grp Sat Flow(s),veh/h/ln     | 1721 | 1770 | 1845 | 1568 | 1704 | 1380 |   |   |
| Q Serve(g_s), s              | 16.0 | 1.1  | 14.6 | 0.6  | 0.7  | 0.0  |   |   |
| Cycle Q Clear(g_c), s        | 16.0 | 1.1  | 14.6 | 0.6  | 0.7  | 0.0  |   |   |
| Prop In Lane                 | 1.00 |      |      | 1.00 | 1.00 | 1.00 |   |   |
| Lane Grp Cap(c), veh/h       | 1182 | 2811 | 645  | 548  | 120  | 97   |   |   |
| V/C Ratio(X)                 | 0.90 | 0.11 | 0.83 | 0.04 | 0.36 | 0.00 |   |   |
| Avail Cap(c_a), veh/h        | 2527 | 3899 | 2032 | 1727 | 1689 | 1368 |   |   |
| HCM Platoon Ratio            | 1.00 | 1.00 | 1.00 | 1.00 | 1.00 | 1.00 |   |   |
| Upstream Filter(I)           | 1.00 | 1.00 | 1.00 | 1.00 | 1.00 | 0.00 |   |   |
| Uniform Delay (d), s/veh     | 17.0 | 1.3  | 16.3 | 11.7 | 25.7 | 0.0  |   |   |
| Incr Delay (d2), s/veh       | 1.1  | 0.0  | 2.2  | 0.0  | 0.7  | 0.0  |   |   |
| Initial Q Delay(d3),s/veh    | 0.0  | 0.0  | 0.0  | 0.0  | 0.0  | 0.0  |   |   |
| %ile BackOfQ(50%),veh/ln     | 7.7  | 0.5  | 7.7  | 0.2  | 0.3  | 0.0  |   |   |
| LnGrp Delay(d),s/veh         | 18.1 | 1.3  | 18.4 | 11.7 | 26.4 | 0.0  |   |   |
| LnGrp LOS                    | B    | A    | B    | B    | C    |      |   |   |
| Approach Vol, veh/h          |      | 1388 | 562  |      | 43   |      |   |   |
| Approach Delay, s/veh        |      | 14.2 | 18.1 |      | 26.4 |      |   |   |
| Approach LOS                 |      | B    | B    |      | C    |      |   |   |
| Timer                        | 1    | 2    | 3    | 4    | 5    | 6    | 7 | 8 |
| Assigned Phs                 |      | 2    |      | 4    | 5    | 6    |   |   |
| Phs Duration (G+Y+Rc), s     |      | 49.1 |      | 5.4  | 24.2 | 24.9 |   |   |
| Change Period (Y+Rc), s      |      | 5.8  |      | 3.5  | 5.5  | 5.8  |   |   |
| Max Green Setting (Gmax), s  |      | 60.0 |      | 27.0 | 40.0 | 60.0 |   |   |
| Max Q Clear Time (g_c+I1), s |      | 3.1  |      | 2.7  | 18.0 | 16.6 |   |   |
| Green Ext Time (p_c), s      |      | 1.5  |      | 0.0  | 0.7  | 2.5  |   |   |
| <b>Intersection Summary</b>  |      |      |      |      |      |      |   |   |
| HCM 2010 Ctrl Delay          |      |      | 15.6 |      |      |      |   |   |
| HCM 2010 LOS                 |      |      | B    |      |      |      |   |   |

HCM 2010 Signalized Intersection Summary Cumulative with Eastside Parkway with Project, AM  
 14: Reservation Road & Inter-Garrison Road

06/11/2019



| Movement                     | EBL  | EBR  | NBL   | NBT   | SBT  | SBR  |   |      |
|------------------------------|------|------|-------|-------|------|------|---|------|
| Lane Configurations          |      |      |       |       |      |      |   |      |
| Traffic Volume (veh/h)       | 110  | 610  | 900   | 460   | 260  | 160  |   |      |
| Future Volume (veh/h)        | 110  | 610  | 900   | 460   | 260  | 160  |   |      |
| Number                       | 3    | 18   | 1     | 6     | 2    | 12   |   |      |
| Initial Q (Qb), veh          | 0    | 0    | 0     | 0     | 0    | 0    |   |      |
| Ped-Bike Adj(A_pbT)          | 1.00 | 1.00 | 1.00  |       |      | 1.00 |   |      |
| Parking Bus, Adj             | 1.00 | 1.00 | 1.00  | 1.00  | 1.00 | 1.00 |   |      |
| Adj Sat Flow, veh/h/ln       | 1845 | 1845 | 1863  | 1863  | 1845 | 1900 |   |      |
| Adj Flow Rate, veh/h         | 117  | 610  | 957   | 489   | 277  | 154  |   |      |
| Adj No. of Lanes             | 1    | 1    | 1     | 2     | 2    | 0    |   |      |
| Peak Hour Factor             | 0.94 | 0.94 | 0.94  | 0.94  | 0.94 | 0.94 |   |      |
| Percent Heavy Veh, %         | 3    | 3    | 2     | 2     | 3    | 3    |   |      |
| Cap, veh/h                   | 550  | 913  | 478   | 1912  | 456  | 247  |   |      |
| Arrive On Green              | 0.31 | 0.31 | 0.27  | 0.54  | 0.21 | 0.21 |   |      |
| Sat Flow, veh/h              | 1757 | 1568 | 1774  | 3632  | 2291 | 1188 |   |      |
| Grp Volume(v), veh/h         | 117  | 610  | 957   | 489   | 219  | 212  |   |      |
| Grp Sat Flow(s),veh/h/ln     | 1757 | 1568 | 1774  | 1770  | 1752 | 1635 |   |      |
| Q Serve(g_s), s              | 3.6  | 19.7 | 20.0  | 5.5   | 8.4  | 8.8  |   |      |
| Cycle Q Clear(g_c), s        | 3.6  | 19.7 | 20.0  | 5.5   | 8.4  | 8.8  |   |      |
| Prop In Lane                 | 1.00 | 1.00 | 1.00  |       |      | 0.73 |   |      |
| Lane Grp Cap(c), veh/h       | 550  | 913  | 478   | 1912  | 364  | 339  |   |      |
| V/C Ratio(X)                 | 0.21 | 0.67 | 2.00  | 0.26  | 0.60 | 0.62 |   |      |
| Avail Cap(c_a), veh/h        | 639  | 993  | 478   | 2861  | 1416 | 1322 |   |      |
| HCM Platoon Ratio            | 1.00 | 1.00 | 1.00  | 1.00  | 1.00 | 1.00 |   |      |
| Upstream Filter(I)           | 1.00 | 1.00 | 1.00  | 1.00  | 1.00 | 1.00 |   |      |
| Uniform Delay (d), s/veh     | 18.8 | 10.6 | 27.1  | 9.1   | 26.6 | 26.8 |   |      |
| Incr Delay (d2), s/veh       | 0.2  | 1.6  | 458.4 | 0.1   | 3.0  | 3.5  |   |      |
| Initial Q Delay(d3),s/veh    | 0.0  | 0.0  | 0.0   | 0.0   | 0.0  | 0.0  |   |      |
| %ile BackOfQ(50%),veh/ln     | 1.8  | 8.9  | 70.6  | 2.7   | 4.4  | 4.3  |   |      |
| LnGrp Delay(d),s/veh         | 19.0 | 12.2 | 485.5 | 9.2   | 29.6 | 30.3 |   |      |
| LnGrp LOS                    | B    | B    | F     | A     | C    | C    |   |      |
| Approach Vol, veh/h          | 727  |      |       | 1446  | 431  |      |   |      |
| Approach Delay, s/veh        | 13.2 |      |       | 324.4 | 29.9 |      |   |      |
| Approach LOS                 | B    |      |       | F     | C    |      |   |      |
| Timer                        | 1    | 2    | 3     | 4     | 5    | 6    | 7 | 8    |
| Assigned Phs                 | 1    | 2    |       |       |      | 6    |   | 8    |
| Phs Duration (G+Y+Rc), s     | 4.7  | 21.8 |       |       |      | 46.5 |   | 27.7 |
| Change Period (Y+Rc), s      | 4.7  | 6.4  |       |       |      | 6.4  |   | 4.5  |
| Max Green Setting (Gmax), s  | 26   | 60.0 |       |       |      | 60.0 |   | 27.0 |
| Max Q Clear Time (g_c+Yc), s | 22.5 | 10.8 |       |       |      | 7.5  |   | 21.7 |
| Green Ext Time (p_c), s      | 0.0  | 4.6  |       |       |      | 5.8  |   | 1.5  |
| <b>Intersection Summary</b>  |      |      |       |       |      |      |   |      |
| HCM 2010 Ctrl Delay          |      |      | 188.8 |       |      |      |   |      |
| HCM 2010 LOS                 |      |      | F     |       |      |      |   |      |
| <b>Notes</b>                 |      |      |       |       |      |      |   |      |

HCM 2010 Signalized Intersection Summary Cumulative with Eastside Parkway with Project, AM  
 15: 2nd Avenue & 9th Street

06/11/2019



| Movement                     | EBL  | EBT    | EBR   | WBL  | WBT  | WBR  | NBL  | NBT  | NBR  | SBL  | SBT  | SBR  |
|------------------------------|------|--------|-------|------|------|------|------|------|------|------|------|------|
| Lane Configurations          |      | ↖      | ↗     |      | ↔    |      | ↖    | ↗    |      | ↖    | ↗    |      |
| Traffic Volume (veh/h)       | 10   | 10     | 10    | 260  | 10   | 20   | 20   | 400  | 30   | 40   | 880  | 10   |
| Future Volume (veh/h)        | 10   | 10     | 10    | 260  | 10   | 20   | 20   | 400  | 30   | 40   | 880  | 10   |
| Number                       | 5    | 2      | 12    | 1    | 6    | 16   | 3    | 8    | 18   | 7    | 4    | 14   |
| Initial Q (Qb), veh          | 0    | 0      | 0     | 0    | 0    | 0    | 0    | 0    | 0    | 0    | 0    | 0    |
| Ped-Bike Adj(A_pbT)          | 0.99 |        | 1.00  | 0.99 |      | 0.99 | 1.00 |      | 0.99 | 1.00 |      | 0.99 |
| Parking Bus, Adj             | 1.00 | 1.00   | 1.00  | 1.00 | 1.00 | 1.00 | 1.00 | 1.00 | 1.00 | 1.00 | 1.00 | 1.00 |
| Adj Sat Flow, veh/h/ln       | 1900 | 1881   | 1881  | 1900 | 1900 | 1900 | 1881 | 1881 | 1900 | 1863 | 1863 | 1900 |
| Adj Flow Rate, veh/h         | 11   | 11     | -24   | 277  | 11   | 20   | 21   | 426  | 27   | 43   | 936  | 4    |
| Adj No. of Lanes             | 0    | 1      | 1     | 0    | 1    | 0    | 1    | 2    | 0    | 1    | 2    | 0    |
| Peak Hour Factor             | 0.94 | 0.94   | 0.94  | 0.94 | 0.94 | 0.94 | 0.94 | 0.94 | 0.94 | 0.94 | 0.94 | 0.94 |
| Percent Heavy Veh, %         | 1    | 1      | 1     | 0    | 0    | 0    | 1    | 1    | 1    | 2    | 2    | 2    |
| Cap, veh/h                   | 322  | 286    | 453   | 520  | 15   | 27   | 46   | 1303 | 82   | 81   | 1453 | 6    |
| Arrive On Green              | 0.28 | 0.28   | 0.00  | 0.28 | 0.28 | 0.28 | 0.03 | 0.38 | 0.38 | 0.05 | 0.40 | 0.40 |
| Sat Flow, veh/h              | 728  | 1009   | 1599  | 1318 | 52   | 95   | 1792 | 3413 | 216  | 1774 | 3614 | 15   |
| Grp Volume(v), veh/h         | 22   | 0      | -24   | 308  | 0    | 0    | 21   | 222  | 231  | 43   | 458  | 482  |
| Grp Sat Flow(s),veh/h/ln     | 1737 | 0      | 1599  | 1466 | 0    | 0    | 1792 | 1787 | 1841 | 1774 | 1770 | 1860 |
| Q Serve(g_s), s              | 0.0  | 0.0    | 0.0   | 8.5  | 0.0  | 0.0  | 0.5  | 4.1  | 4.1  | 1.1  | 9.8  | 9.8  |
| Cycle Q Clear(g_c), s        | 0.4  | 0.0    | 0.0   | 8.9  | 0.0  | 0.0  | 0.5  | 4.1  | 4.1  | 1.1  | 9.8  | 9.8  |
| Prop In Lane                 | 0.50 |        | 1.00  | 0.90 |      | 0.06 | 1.00 |      | 0.12 | 1.00 |      | 0.01 |
| Lane Grp Cap(c), veh/h       | 607  | 0      | 453   | 561  | 0    | 0    | 46   | 682  | 703  | 81   | 712  | 748  |
| V/C Ratio(X)                 | 0.04 | 0.00   | -0.05 | 0.55 | 0.00 | 0.00 | 0.46 | 0.33 | 0.33 | 0.53 | 0.64 | 0.64 |
| Avail Cap(c_a), veh/h        | 1180 | 0      | 1028  | 1085 | 0    | 0    | 441  | 1723 | 1775 | 437  | 1706 | 1793 |
| HCM Platoon Ratio            | 1.00 | 1.00   | 1.00  | 1.00 | 1.00 | 1.00 | 1.00 | 1.00 | 1.00 | 1.00 | 1.00 | 1.00 |
| Upstream Filter(I)           | 1.00 | 0.00   | 0.00  | 1.00 | 0.00 | 0.00 | 1.00 | 1.00 | 1.00 | 1.00 | 1.00 | 1.00 |
| Uniform Delay (d), s/veh     | 12.1 | 0.0    | 0.0   | 15.1 | 0.0  | 0.0  | 22.4 | 10.2 | 10.2 | 21.8 | 11.3 | 11.3 |
| Incr Delay (d2), s/veh       | 0.0  | 0.0    | 0.0   | 0.8  | 0.0  | 0.0  | 7.0  | 0.3  | 0.3  | 5.3  | 1.0  | 0.9  |
| Initial Q Delay(d3),s/veh    | 0.0  | 0.0    | 0.0   | 0.0  | 0.0  | 0.0  | 0.0  | 0.0  | 0.0  | 0.0  | 0.0  | 0.0  |
| %ile BackOfQ(50%),veh/ln     | 0.2  | 0.0    | 0.0   | 3.7  | 0.0  | 0.0  | 0.4  | 2.0  | 2.1  | 0.7  | 4.9  | 5.1  |
| LnGrp Delay(d),s/veh         | 12.2 | 0.0    | 0.0   | 16.0 | 0.0  | 0.0  | 29.4 | 10.5 | 10.5 | 27.0 | 12.2 | 12.2 |
| LnGrp LOS                    | B    |        |       | B    |      |      | C    | B    | B    | C    | B    | B    |
| Approach Vol, veh/h          |      | -2     |       |      | 308  |      |      | 474  |      |      | 983  |      |
| Approach Delay, s/veh        |      | -133.8 |       |      | 16.0 |      |      | 11.3 |      |      | 12.9 |      |
| Approach LOS                 |      | A      |       |      | B    |      |      | B    |      |      | B    |      |
| Timer                        | 1    | 2      | 3     | 4    | 5    | 6    | 7    | 8    |      |      |      |      |
| Assigned Phs                 |      | 2      | 3     | 4    |      | 6    | 7    | 8    |      |      |      |      |
| Phs Duration (G+Y+Rc), s     |      | 18.2   | 4.7   | 23.8 |      | 18.2 | 5.6  | 22.8 |      |      |      |      |
| Change Period (Y+Rc), s      |      | 5.0    | 3.5   | 5.0  |      | 5.0  | 3.5  | 5.0  |      |      |      |      |
| Max Green Setting (Gmax), s  |      | 30.0   | 11.5  | 45.0 |      | 30.0 | 11.5 | 45.0 |      |      |      |      |
| Max Q Clear Time (g_c+I1), s |      | 2.4    | 2.5   | 11.8 |      | 10.9 | 3.1  | 6.1  |      |      |      |      |
| Green Ext Time (p_c), s      |      | 0.1    | 0.0   | 6.7  |      | 1.6  | 0.0  | 2.8  |      |      |      |      |
| <b>Intersection Summary</b>  |      |        |       |      |      |      |      |      |      |      |      |      |
| HCM 2010 Ctrl Delay          |      |        |       | 13.2 |      |      |      |      |      |      |      |      |
| HCM 2010 LOS                 |      |        |       | B    |      |      |      |      |      |      |      |      |

HCM 2010 Signalized Intersection Summary Cumulative with Eastside Parkway with Project, AM  
 16: 2nd Avenue & 8th Street

06/11/2019



| Movement                     | WBL  | WBR  | NBT  | NBR  | SBL  | SBT  |      |      |
|------------------------------|------|------|------|------|------|------|------|------|
| Lane Configurations          |      |      |      |      |      |      |      |      |
| Traffic Volume (veh/h)       | 230  | 40   | 480  | 130  | 80   | 920  |      |      |
| Future Volume (veh/h)        | 230  | 40   | 480  | 130  | 80   | 920  |      |      |
| Number                       | 1    | 16   | 8    | 18   | 7    | 4    |      |      |
| Initial Q (Qb), veh          | 0    | 0    | 0    | 0    | 0    | 0    |      |      |
| Ped-Bike Adj(A_pbT)          | 1.00 | 1.00 |      | 1.00 | 1.00 |      |      |      |
| Parking Bus, Adj             | 1.00 | 1.00 | 1.00 | 1.00 | 1.00 | 1.00 |      |      |
| Adj Sat Flow, veh/h/ln       | 1583 | 1583 | 1863 | 1900 | 1881 | 1881 |      |      |
| Adj Flow Rate, veh/h         | 242  | 26   | 505  | 121  | 84   | 968  |      |      |
| Adj No. of Lanes             | 1    | 1    | 2    | 0    | 1    | 2    |      |      |
| Peak Hour Factor             | 0.95 | 0.95 | 0.95 | 0.95 | 0.95 | 0.95 |      |      |
| Percent Heavy Veh, %         | 20   | 20   | 2    | 2    | 1    | 1    |      |      |
| Cap, veh/h                   | 321  | 286  | 917  | 219  | 143  | 1796 |      |      |
| Arrive On Green              | 0.21 | 0.21 | 0.32 | 0.32 | 0.08 | 0.50 |      |      |
| Sat Flow, veh/h              | 1508 | 1346 | 2930 | 676  | 1792 | 3668 |      |      |
| Grp Volume(v), veh/h         | 242  | 26   | 314  | 312  | 84   | 968  |      |      |
| Grp Sat Flow(s),veh/h/ln     | 1508 | 1346 | 1770 | 1743 | 1792 | 1787 |      |      |
| Q Serve(g_s), s              | 5.3  | 0.5  | 5.1  | 5.2  | 1.6  | 6.5  |      |      |
| Cycle Q Clear(g_c), s        | 5.3  | 0.5  | 5.1  | 5.2  | 1.6  | 6.5  |      |      |
| Prop In Lane                 | 1.00 | 1.00 |      | 0.39 | 1.00 |      |      |      |
| Lane Grp Cap(c), veh/h       | 321  | 286  | 572  | 563  | 143  | 1796 |      |      |
| V/C Ratio(X)                 | 0.75 | 0.09 | 0.55 | 0.55 | 0.59 | 0.54 |      |      |
| Avail Cap(c_a), veh/h        | 1288 | 1150 | 2268 | 2234 | 587  | 6107 |      |      |
| HCM Platoon Ratio            | 1.00 | 1.00 | 1.00 | 1.00 | 1.00 | 1.00 |      |      |
| Upstream Filter(I)           | 1.00 | 1.00 | 1.00 | 1.00 | 1.00 | 1.00 |      |      |
| Uniform Delay (d), s/veh     | 13.0 | 11.1 | 9.8  | 9.8  | 15.6 | 6.0  |      |      |
| Incr Delay (d2), s/veh       | 3.6  | 0.1  | 0.8  | 0.9  | 3.8  | 0.3  |      |      |
| Initial Q Delay(d3),s/veh    | 0.0  | 0.0  | 0.0  | 0.0  | 0.0  | 0.0  |      |      |
| %ile BackOfQ(50%),veh/ln     | 2.5  | 0.5  | 2.6  | 2.6  | 0.9  | 3.2  |      |      |
| LnGrp Delay(d),s/veh         | 16.6 | 11.2 | 10.6 | 10.6 | 19.4 | 6.2  |      |      |
| LnGrp LOS                    | B    | B    | B    | B    | B    | A    |      |      |
| Approach Vol, veh/h          | 268  |      | 626  |      |      | 1052 |      |      |
| Approach Delay, s/veh        | 16.0 |      | 10.6 |      |      | 7.3  |      |      |
| Approach LOS                 | B    |      | B    |      |      | A    |      |      |
| Timer                        | 1    | 2    | 3    | 4    | 5    | 6    | 7    | 8    |
| Assigned Phs                 |      |      |      | 4    |      | 6    | 7    | 8    |
| Phs Duration (G+Y+Rc), s     |      |      |      | 22.6 |      | 12.5 | 6.3  | 16.3 |
| Change Period (Y+Rc), s      |      |      |      | 5.0  |      | 5.0  | 3.5  | 5.0  |
| Max Green Setting (Gmax), s  |      |      |      | 60.0 |      | 30.0 | 11.5 | 45.0 |
| Max Q Clear Time (g_c+11), s |      |      |      | 8.5  |      | 7.3  | 3.6  | 7.2  |
| Green Ext Time (p_c), s      |      |      |      | 8.5  |      | 0.8  | 0.1  | 4.2  |
| <b>Intersection Summary</b>  |      |      |      |      |      |      |      |      |
| HCM 2010 Ctrl Delay          |      |      | 9.6  |      |      |      |      |      |
| HCM 2010 LOS                 |      |      | A    |      |      |      |      |      |

| Intersection              |    |
|---------------------------|----|
| Intersection Delay, s/veh | 12 |
| Intersection LOS          | B  |

| Movement            | EBT  | EBR  | WBL  | WBT  | NBL  | NBR  |
|---------------------|------|------|------|------|------|------|
| Lane Configurations | ↑    | ↑    | ↑    | ↑    | ↑    | ↑    |
| Traffic Vol, veh/h  | 130  | 80   | 270  | 230  | 40   | 180  |
| Future Vol, veh/h   | 130  | 80   | 270  | 230  | 40   | 180  |
| Peak Hour Factor    | 0.92 | 0.92 | 0.92 | 0.92 | 0.92 | 0.92 |
| Heavy Vehicles, %   | 2    | 2    | 2    | 2    | 2    | 2    |
| Mvmt Flow           | 141  | 87   | 293  | 250  | 43   | 196  |
| Number of Lanes     | 1    | 1    | 1    | 1    | 1    | 1    |

| Approach                   | EB  | WB   | NB |
|----------------------------|-----|------|----|
| Opposing Approach          | WB  | EB   |    |
| Opposing Lanes             | 2   | 2    | 0  |
| Conflicting Approach Left  |     | NB   | EB |
| Conflicting Lanes Left     | 0   | 2    | 2  |
| Conflicting Approach Right | NB  |      | WB |
| Conflicting Lanes Right    | 2   | 0    | 2  |
| HCM Control Delay          | 9.9 | 13.3 | 11 |
| HCM LOS                    | A   | B    | B  |

| Lane                   | NBLn1 | NBLn2 | EBLn1 | EBLn2 | WBLn1 | WBLn2 |
|------------------------|-------|-------|-------|-------|-------|-------|
| Vol Left, %            | 100%  | 0%    | 0%    | 0%    | 100%  | 0%    |
| Vol Thru, %            | 0%    | 0%    | 100%  | 0%    | 0%    | 100%  |
| Vol Right, %           | 0%    | 100%  | 0%    | 100%  | 0%    | 0%    |
| Sign Control           | Stop  | Stop  | Stop  | Stop  | Stop  | Stop  |
| Traffic Vol by Lane    | 40    | 180   | 130   | 80    | 270   | 230   |
| LT Vol                 | 40    | 0     | 0     | 0     | 270   | 0     |
| Through Vol            | 0     | 0     | 130   | 0     | 0     | 230   |
| RT Vol                 | 0     | 180   | 0     | 80    | 0     | 0     |
| Lane Flow Rate         | 43    | 196   | 141   | 87    | 293   | 250   |
| Geometry Grp           | 7     | 7     | 7     | 7     | 7     | 7     |
| Degree of Util (X)     | 0.084 | 0.312 | 0.234 | 0.127 | 0.494 | 0.385 |
| Departure Headway (Hd) | 6.953 | 5.74  | 5.965 | 5.255 | 6.056 | 5.551 |
| Convergence, Y/N       | Yes   | Yes   | Yes   | Yes   | Yes   | Yes   |
| Cap                    | 516   | 626   | 603   | 683   | 596   | 650   |
| Service Time           | 4.683 | 3.47  | 3.693 | 2.983 | 3.777 | 3.272 |
| HCM Lane V/C Ratio     | 0.083 | 0.313 | 0.234 | 0.127 | 0.492 | 0.385 |
| HCM Control Delay      | 10.3  | 11.1  | 10.5  | 8.8   | 14.6  | 11.7  |
| HCM Lane LOS           | B     | B     | B     | A     | B     | B     |
| HCM 95th-tile Q        | 0.3   | 1.3   | 0.9   | 0.4   | 2.7   | 1.8   |

| Intersection                |       |       |       |       |
|-----------------------------|-------|-------|-------|-------|
| Intersection Delay, s/veh   | 10.3  |       |       |       |
| Intersection LOS            | B     |       |       |       |
| Approach                    | EB    | WB    | NB    | SB    |
| Entry Lanes                 | 1     | 1     | 1     | 1     |
| Conflicting Circle Lanes    | 1     | 1     | 1     | 1     |
| Adj Approach Flow, veh/h    | 197   | 321   | 49    | 605   |
| Demand Flow Rate, veh/h     | 203   | 338   | 49    | 611   |
| Vehicles Circulating, veh/h | 412   | 126   | 578   | 142   |
| Vehicles Exiting, veh/h     | 341   | 501   | 37    | 322   |
| Follow-Up Headway, s        | 3.186 | 3.186 | 3.186 | 3.186 |
| Ped Vol Crossing Leg, #/h   | 0     | 0     | 0     | 0     |
| Ped Cap Adj                 | 1.000 | 1.000 | 1.000 | 1.000 |
| Approach Delay, s/veh       | 8.1   | 7.4   | 6.5   | 12.8  |
| Approach LOS                | A     | A     | A     | B     |
| Lane                        | Left  | Left  | Left  | Left  |
| Designated Moves            | LTR   | LTR   | LTR   | LTR   |
| Assumed Moves               | LTR   | LTR   | LTR   | LTR   |
| RT Channelized              |       |       |       |       |
| Lane Util                   | 1.000 | 1.000 | 1.000 | 1.000 |
| Critical Headway, s         | 5.193 | 5.193 | 5.193 | 5.193 |
| Entry Flow, veh/h           | 203   | 338   | 49    | 611   |
| Cap Entry Lane, veh/h       | 748   | 996   | 634   | 980   |
| Entry HV Adj Factor         | 0.971 | 0.951 | 1.000 | 0.990 |
| Flow Entry, veh/h           | 197   | 321   | 49    | 605   |
| Cap Entry, veh/h            | 726   | 947   | 634   | 971   |
| V/C Ratio                   | 0.271 | 0.339 | 0.077 | 0.623 |
| Control Delay, s/veh        | 8.1   | 7.4   | 6.5   | 12.8  |
| LOS                         | A     | A     | A     | B     |
| 95th %tile Queue, veh       | 1     | 2     | 0     | 5     |

HCM 2010 Signalized Intersection Summary Cumulative with Eastside Parkway with Project, AM  
 19: 2nd Avenue & Inter-Garrison Road

06/11/2019



| Movement                     | WBL  | WBR  | NBT  | NBR  | SBL  | SBT  |      |      |
|------------------------------|------|------|------|------|------|------|------|------|
| Lane Configurations          |      |      |      |      |      |      |      |      |
| Traffic Volume (veh/h)       | 30   | 30   | 620  | 60   | 30   | 1140 |      |      |
| Future Volume (veh/h)        | 30   | 30   | 620  | 60   | 30   | 1140 |      |      |
| Number                       | 1    | 16   | 8    | 18   | 7    | 4    |      |      |
| Initial Q (Qb), veh          | 0    | 0    | 0    | 0    | 0    | 0    |      |      |
| Ped-Bike Adj(A_pbT)          | 1.00 | 1.00 |      | 1.00 | 1.00 |      |      |      |
| Parking Bus, Adj             | 1.00 | 1.00 | 1.00 | 1.00 | 1.00 | 1.00 |      |      |
| Adj Sat Flow, veh/h/ln       | 1900 | 1900 | 1881 | 1900 | 1881 | 1881 |      |      |
| Adj Flow Rate, veh/h         | 32   | 8    | 667  | 57   | 32   | 1226 |      |      |
| Adj No. of Lanes             | 1    | 1    | 2    | 0    | 1    | 2    |      |      |
| Peak Hour Factor             | 0.93 | 0.93 | 0.93 | 0.93 | 0.93 | 0.93 |      |      |
| Percent Heavy Veh, %         | 0    | 0    | 1    | 1    | 1    | 1    |      |      |
| Cap, veh/h                   | 167  | 149  | 1573 | 134  | 69   | 2192 |      |      |
| Arrive On Green              | 0.09 | 0.09 | 0.47 | 0.47 | 0.04 | 0.61 |      |      |
| Sat Flow, veh/h              | 1810 | 1615 | 3428 | 285  | 1792 | 3668 |      |      |
| Grp Volume(v), veh/h         | 32   | 8    | 357  | 367  | 32   | 1226 |      |      |
| Grp Sat Flow(s),veh/h/ln     | 1810 | 1615 | 1787 | 1831 | 1792 | 1787 |      |      |
| Q Serve(g_s), s              | 0.6  | 0.2  | 4.5  | 4.5  | 0.6  | 6.9  |      |      |
| Cycle Q Clear(g_c), s        | 0.6  | 0.2  | 4.5  | 4.5  | 0.6  | 6.9  |      |      |
| Prop In Lane                 | 1.00 | 1.00 |      | 0.16 | 1.00 |      |      |      |
| Lane Grp Cap(c), veh/h       | 167  | 149  | 843  | 864  | 69   | 2192 |      |      |
| V/C Ratio(X)                 | 0.19 | 0.05 | 0.42 | 0.42 | 0.47 | 0.56 |      |      |
| Avail Cap(c_a), veh/h        | 1863 | 1663 | 2103 | 2155 | 606  | 5783 |      |      |
| HCM Platoon Ratio            | 1.00 | 1.00 | 1.00 | 1.00 | 1.00 | 1.00 |      |      |
| Upstream Filter(I)           | 1.00 | 1.00 | 1.00 | 1.00 | 1.00 | 1.00 |      |      |
| Uniform Delay (d), s/veh     | 14.2 | 14.1 | 5.9  | 5.9  | 16.0 | 3.9  |      |      |
| Incr Delay (d2), s/veh       | 0.5  | 0.1  | 0.3  | 0.3  | 4.8  | 0.2  |      |      |
| Initial Q Delay(d3),s/veh    | 0.0  | 0.0  | 0.0  | 0.0  | 0.0  | 0.0  |      |      |
| %ile BackOfQ(50%),veh/ln     | 0.3  | 0.1  | 2.3  | 2.3  | 0.4  | 3.3  |      |      |
| LnGrp Delay(d),s/veh         | 14.8 | 14.2 | 6.3  | 6.3  | 20.8 | 4.1  |      |      |
| LnGrp LOS                    | B    | B    | A    | A    | C    | A    |      |      |
| Approach Vol, veh/h          | 40   |      | 724  |      |      | 1258 |      |      |
| Approach Delay, s/veh        | 14.7 |      | 6.3  |      |      | 4.5  |      |      |
| Approach LOS                 | B    |      | A    |      |      | A    |      |      |
| Timer                        | 1    | 2    | 3    | 4    | 5    | 6    | 7    | 8    |
| Assigned Phs                 |      |      |      | 4    |      | 6    | 7    | 8    |
| Phs Duration (G+Y+Rc), s     |      |      |      | 25.8 |      | 8.1  | 4.8  | 21.0 |
| Change Period (Y+Rc), s      |      |      |      | 5.0  |      | 5.0  | 3.5  | 5.0  |
| Max Green Setting (Gmax), s  |      |      |      | 55.0 |      | 35.0 | 11.5 | 40.0 |
| Max Q Clear Time (g_c+I1), s |      |      |      | 8.9  |      | 2.6  | 2.6  | 6.5  |
| Green Ext Time (p_c), s      |      |      |      | 12.0 |      | 0.1  | 0.0  | 4.8  |
| <b>Intersection Summary</b>  |      |      |      |      |      |      |      |      |
| HCM 2010 Ctrl Delay          |      |      | 5.3  |      |      |      |      |      |
| HCM 2010 LOS                 |      |      | A    |      |      |      |      |      |

| Intersection              |      |  |  |  |  |  |  |  |  |  |  |  |
|---------------------------|------|--|--|--|--|--|--|--|--|--|--|--|
| Intersection Delay, s/veh | 10.4 |  |  |  |  |  |  |  |  |  |  |  |
| Intersection LOS          | B    |  |  |  |  |  |  |  |  |  |  |  |

| Movement            | EBL  | EBT  | EBR  | WBL  | WBT  | WBR  | NBL  | NBT  | NBR  | SBL  | SBT  | SBR  |
|---------------------|------|------|------|------|------|------|------|------|------|------|------|------|
| Lane Configurations |      | ↕    |      |      | ↕    |      |      | ↕    |      |      | ↕    |      |
| Traffic Vol, veh/h  | 10   | 20   | 10   | 70   | 10   | 30   | 20   | 180  | 100  | 30   | 160  | 10   |
| Future Vol, veh/h   | 10   | 20   | 10   | 70   | 10   | 30   | 20   | 180  | 100  | 30   | 160  | 10   |
| Peak Hour Factor    | 0.85 | 0.85 | 0.85 | 0.85 | 0.85 | 0.85 | 0.85 | 0.85 | 0.85 | 0.85 | 0.85 | 0.85 |
| Heavy Vehicles, %   | 6    | 6    | 6    | 2    | 2    | 2    | 4    | 4    | 4    | 0    | 0    | 0    |
| Mvmt Flow           | 12   | 24   | 12   | 82   | 12   | 35   | 24   | 212  | 118  | 35   | 188  | 12   |
| Number of Lanes     | 0    | 1    | 0    | 0    | 1    | 0    | 0    | 1    | 0    | 0    | 1    | 0    |





















| Approach                   | EB | WB  | NB   | SB |
|----------------------------|----|-----|------|----|
| Opposing Approach          | WB | EB  | SB   | NB |
| Opposing Lanes             | 1  | 1   | 1    | 1  |
| Conflicting Approach Left  | SB | NB  | EB   | WB |
| Conflicting Lanes Left     | 1  | 1   | 1    | 1  |
| Conflicting Approach Right | NB | SB  | WB   | EB |
| Conflicting Lanes Right    | 1  | 1   | 1    | 1  |
| HCM Control Delay          | 9  | 9.6 | 11.2 | 10 |
| HCM LOS                    | A  | A   | B    | A  |

| Lane                   | NBLn1 | EBLn1 | WBLn1 | SBLn1 |
|------------------------|-------|-------|-------|-------|
| Vol Left, %            | 7%    | 25%   | 64%   | 15%   |
| Vol Thru, %            | 60%   | 50%   | 9%    | 80%   |
| Vol Right, %           | 33%   | 25%   | 27%   | 5%    |
| Sign Control           | Stop  | Stop  | Stop  | Stop  |
| Traffic Vol by Lane    | 300   | 40    | 110   | 200   |
| LT Vol                 | 20    | 10    | 70    | 30    |
| Through Vol            | 180   | 20    | 10    | 160   |
| RT Vol                 | 100   | 10    | 30    | 10    |
| Lane Flow Rate         | 353   | 47    | 129   | 235   |
| Geometry Grp           | 1     | 1     | 1     | 1     |
| Degree of Util (X)     | 0.444 | 0.071 | 0.19  | 0.312 |
| Departure Headway (Hd) | 4.527 | 5.436 | 5.292 | 4.766 |
| Convergence, Y/N       | Yes   | Yes   | Yes   | Yes   |
| Cap                    | 791   | 651   | 672   | 748   |
| Service Time           | 2.582 | 3.534 | 3.376 | 2.828 |
| HCM Lane V/C Ratio     | 0.446 | 0.072 | 0.192 | 0.314 |
| HCM Control Delay      | 11.2  | 9     | 9.6   | 10    |
| HCM Lane LOS           | B     | A     | A     | A     |
| HCM 95th-tile Q        | 2.3   | 0.2   | 0.7   | 1.3   |



HCM 2010 Signalized Intersection Summary  
 21: 7th Avenue/8th Street & Inter-Garrison Road

07/12/2019

|                              |  |  |  |  |  |  |   |  |  |  |  |  |
|------------------------------|---|---|---|---|---|---|---|---|---|---|---|---|
| Movement                     | EBL   | EBT   | EBR   | WBL   | WBT   | WBR   | NBL   | NBT   | NBR   | SBL   | SBT   | SBR   |
| Lane Configurations          |  |  |   |  |  |   |  |  |  |  |  |   |
| Traffic Volume (veh/h)       | 10  | 90  | 50  | 340   | 210   | 30  | 80  | 160   | 140   | 120   | 170   | 10  |
| Future Volume (veh/h)        | 10  | 90  | 50  | 340   | 210   | 30  | 80  | 160   | 140   | 120   | 170   | 10  |
| Number                       | 5   | 2   | 12  | 1   | 6   | 16  | 3   | 8   | 18  | 7   | 4   | 14  |
| Initial Q (Qb), veh          | 0   | 0   | 0   | 0   | 0   | 0   | 0   | 0   | 0   | 0   | 0   | 0   |
| Ped-Bike Adj(A_pbT)          | 1.00  |   | 0.99  | 1.00  |   | 0.98  | 1.00  |   | 1.00  | 1.00  |   | 1.00  |
| Parking Bus, Adj             | 1.00  | 1.00  | 1.00  | 1.00  | 1.00  | 1.00  | 1.00  | 1.00  | 1.00  | 1.00  | 1.00  | 1.00  |
| Adj Sat Flow, veh/h/ln       | 1759  | 1759  | 1900  | 1845  | 1845  | 1900  | 1597  | 1597  | 1597  | 1776  | 1776  | 1900  |
| Adj Flow Rate, veh/h         | 12  | 111   | 53  | 420   | 259   | 22  | 99  | 198   | 140   | 148   | 210   | 5   |
| Adj No. of Lanes             | 1   | 1   | 0   | 1   | 1   | 0   | 1   | 1   | 1   | 1   | 1   | 0   |
| Peak Hour Factor             | 0.81  | 0.81  | 0.81  | 0.81  | 0.81  | 0.81  | 0.81  | 0.81  | 0.81  | 0.81  | 0.81  | 0.81  |
| Percent Heavy Veh, %         | 8   | 8   | 8   | 3   | 3   | 3   | 19  | 19  | 19  | 7   | 7   | 7   |
| Cap, veh/h                   | 20  | 206   | 98  | 478   | 741   | 63  | 120   | 274   | 233   | 185   | 349   | 8   |
| Arrive On Green              | 0.01  | 0.18  | 0.18  | 0.27  | 0.44  | 0.44  | 0.08  | 0.17  | 0.17  | 0.11  | 0.20  | 0.20  |
| Sat Flow, veh/h              | 1675  | 1123  | 536   | 1757  | 1673  | 142   | 1521  | 1597  | 1357  | 1691  | 1727  | 41  |
| Grp Volume(v), veh/h         | 12  | 0   | 164   | 420   | 0   | 281   | 99  | 198   | 140   | 148   | 0   | 215   |
| Grp Sat Flow(s),veh/h/ln     | 1675  | 0   | 1659  | 1757  | 0   | 1815  | 1521  | 1597  | 1357  | 1691  | 0   | 1768  |
| Q Serve(g_s), s              | 0.4   | 0.0   | 5.4   | 13.9  | 0.0   | 6.2   | 3.9   | 7.1   | 5.8   | 5.2   | 0.0   | 6.7   |
| Cycle Q Clear(g_c), s        | 0.4   | 0.0   | 5.4   | 13.9  | 0.0   | 6.2   | 3.9   | 7.1   | 5.8   | 5.2   | 0.0   | 6.7   |
| Prop In Lane                 | 1.00  |   | 0.32  | 1.00  |   | 0.08  | 1.00  |   | 1.00  | 1.00  |   | 0.02  |
| Lane Grp Cap(c), veh/h       | 20  | 0   | 304   | 478   | 0   | 804   | 120   | 274   | 233   | 185   | 0   | 357   |
| V/C Ratio(X)                 | 0.59  | 0.00  | 0.54  | 0.88  | 0.00  | 0.35  | 0.82  | 0.72  | 0.60  | 0.80  | 0.00  | 0.60  |
| Avail Cap(c_a), veh/h        | 111   | 0   | 903   | 594   | 0   | 1482  | 188   | 579   | 493   | 237   | 0   | 671   |
| HCM Platoon Ratio            | 1.00  | 1.00  | 1.00  | 1.00  | 1.00  | 1.00  | 1.00  | 1.00  | 1.00  | 1.00  | 1.00  | 1.00  |
| Upstream Filter(I)           | 1.00  | 0.00  | 1.00  | 1.00  | 0.00  | 1.00  | 1.00  | 1.00  | 1.00  | 1.00  | 0.00  | 1.00  |
| Uniform Delay (d), s/veh     | 29.8  | 0.0   | 22.4  | 21.1  | 0.0   | 11.1  | 27.5  | 23.7  | 23.2  | 26.4  | 0.0   | 22.0  |
| Incr Delay (d2), s/veh       | 24.7  | 0.0   | 1.5   | 12.1  | 0.0   | 0.3   | 15.0  | 3.6   | 2.5   | 13.9  | 0.0   | 1.6   |
| Initial Q Delay(d3),s/veh    | 0.0   | 0.0   | 0.0   | 0.0   | 0.0   | 0.0   | 0.0   | 0.0   | 0.0   | 0.0   | 0.0   | 0.0   |
| %ile BackOfQ(50%),veh/ln     | 0.3   | 0.0   | 2.6   | 8.3   | 0.0   | 3.1   | 2.1   | 3.4   | 2.3   | 3.1   | 0.0   | 3.4   |
| LnGrp Delay(d),s/veh         | 54.5  | 0.0   | 23.9  | 33.3  | 0.0   | 11.4  | 42.5  | 27.3  | 25.7  | 40.2  | 0.0   | 23.6  |
| LnGrp LOS                    | D   |   | C   | C   |   | B   | D   | C   | C   | D   |   | C   |
| Approach Vol, veh/h          |   | 176   |   |   | 701   |   |   | 437   |   |   | 363   |   |
| Approach Delay, s/veh        |   | 26.0  |   |   | 24.5  |   |   | 30.2  |   |   | 30.4  |   |
| Approach LOS                 |   | C   |   |   | C   |   |   | C   |   |   | C   |   |
| Timer                        | 1   | 2   | 3   | 4   | 5   | 6   | 7   | 8   |   |   |   |   |
| Assigned Phs                 | 1   | 2   | 3   | 4   | 5   | 6   | 7   | 8   |   |   |   |   |
| Phs Duration (G+Y+Rc), s     | 20.0  | 16.1  | 8.3   | 16.2  | 4.2   | 31.8  | 10.1  | 14.4  |   |   |   |   |
| Change Period (Y+Rc), s      | 3.5   | 5.0   | 3.5   | 4.0   | 3.5   | 5.0   | 3.5   | 4.0   |   |   |   |   |
| Max Green Setting (Gmax), s  | 20.5  | 33.0  | 7.5   | 23.0  | 4.0   | 49.5  | 8.5   | 22.0  |   |   |   |   |
| Max Q Clear Time (g_c+I1), s | 15.9  | 7.4   | 5.9   | 8.7   | 2.4   | 8.2   | 7.2   | 9.1   |   |   |   |   |
| Green Ext Time (p_c), s      | 0.6   | 0.9   | 0.0   | 0.9   | 0.0   | 1.8   | 0.0   | 1.3   |   |   |   |   |
| <b>Intersection Summary</b>  |   |   |   |   |   |   |   |   |   |   |   |   |
| HCM 2010 Ctrl Delay          |   |   | 27.4  |   |   |   |   |   |   |   |   |   |
| HCM 2010 LOS                 |   |   | C   |   |   |   |   |   |   |   |   |   |

| Intersection                |       |       |       |
|-----------------------------|-------|-------|-------|
| Intersection Delay, s/veh   | 65.8  |       |       |
| Intersection LOS            | F     |       |       |
| Approach                    | EB    | WB    | NB    |
| Entry Lanes                 | 1     | 1     | 1     |
| Conflicting Circle Lanes    | 1     | 1     | 1     |
| Adj Approach Flow, veh/h    | 391   | 1207  | 390   |
| Demand Flow Rate, veh/h     | 488   | 1219  | 402   |
| Vehicles Circulating, veh/h | 604   | 59    | 316   |
| Vehicles Exiting, veh/h     | 674   | 659   | 776   |
| Follow-Up Headway, s        | 3.186 | 3.186 | 3.186 |
| Ped Vol Crossing Leg, #/h   | 0     | 0     | 0     |
| Ped Cap Adj                 | 1.000 | 1.000 | 1.000 |
| Approach Delay, s/veh       | 33.4  | 93.9  | 11.2  |
| Approach LOS                | D     | F     | B     |
| Lane                        | Left  | Left  | Left  |
| Designated Moves            | TR    | LT    | LR    |
| Assumed Moves               | TR    | LT    | LR    |
| RT Channelized              |       |       |       |
| Lane Util                   | 1.000 | 1.000 | 1.000 |
| Critical Headway, s         | 5.193 | 5.193 | 5.193 |
| Entry Flow, veh/h           | 488   | 1219  | 402   |
| Cap Entry Lane, veh/h       | 618   | 1065  | 824   |
| Entry HV Adj Factor         | 0.801 | 0.990 | 0.970 |
| Flow Entry, veh/h           | 391   | 1207  | 390   |
| Cap Entry, veh/h            | 495   | 1055  | 799   |
| V/C Ratio                   | 0.790 | 1.144 | 0.488 |
| Control Delay, s/veh        | 33.4  | 93.9  | 11.2  |
| LOS                         | D     | F     | B     |
| 95th %tile Queue, veh       | 7     | 33    | 3     |

HCM 2010 Signalized Intersection Summary Cumulative with Eastside Parkway with Project, AM  
 23: Inter-Garrison Road & Abrams Drive

06/11/2019

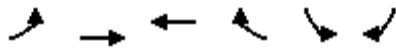

| Movement                     | EBL  | EBT  | WBT  | WBR  | SBL  | SBR  |   |   |
|------------------------------|------|------|------|------|------|------|---|---|
| Lane Configurations          |      |      |      |      |      |      |   |   |
| Traffic Volume (veh/h)       | 170  | 340  | 700  | 70   | 100  | 350  |   |   |
| Future Volume (veh/h)        | 170  | 340  | 700  | 70   | 100  | 350  |   |   |
| Number                       | 5    | 2    | 6    | 16   | 7    | 14   |   |   |
| Initial Q (Qb), veh          | 0    | 0    | 0    | 0    | 0    | 0    |   |   |
| Ped-Bike Adj(A_pbT)          | 1.00 |      |      | 1.00 | 1.00 | 1.00 |   |   |
| Parking Bus, Adj             | 1.00 | 1.00 | 1.00 | 1.00 | 1.00 | 1.00 |   |   |
| Adj Sat Flow, veh/h/ln       | 1759 | 1759 | 1881 | 1881 | 1881 | 1881 |   |   |
| Adj Flow Rate, veh/h         | 200  | 400  | 824  | 76   | 118  | 194  |   |   |
| Adj No. of Lanes             | 1    | 1    | 1    | 1    | 2    | 1    |   |   |
| Peak Hour Factor             | 0.85 | 0.85 | 0.85 | 0.85 | 0.85 | 0.85 |   |   |
| Percent Heavy Veh, %         | 8    | 8    | 1    | 1    | 1    | 1    |   |   |
| Cap, veh/h                   | 245  | 1200 | 881  | 749  | 536  | 247  |   |   |
| Arrive On Green              | 0.15 | 0.68 | 0.47 | 0.47 | 0.15 | 0.15 |   |   |
| Sat Flow, veh/h              | 1675 | 1759 | 1881 | 1599 | 3476 | 1599 |   |   |
| Grp Volume(v), veh/h         | 200  | 400  | 824  | 76   | 118  | 194  |   |   |
| Grp Sat Flow(s),veh/h/ln     | 1675 | 1759 | 1881 | 1599 | 1738 | 1599 |   |   |
| Q Serve(g_s), s              | 6.0  | 4.9  | 21.5 | 1.4  | 1.5  | 6.1  |   |   |
| Cycle Q Clear(g_c), s        | 6.0  | 4.9  | 21.5 | 1.4  | 1.5  | 6.1  |   |   |
| Prop In Lane                 | 1.00 |      |      | 1.00 | 1.00 | 1.00 |   |   |
| Lane Grp Cap(c), veh/h       | 245  | 1200 | 881  | 749  | 536  | 247  |   |   |
| V/C Ratio(X)                 | 0.82 | 0.33 | 0.93 | 0.10 | 0.22 | 0.79 |   |   |
| Avail Cap(c_a), veh/h        | 371  | 2033 | 1630 | 1386 | 2108 | 970  |   |   |
| HCM Platoon Ratio            | 1.00 | 1.00 | 1.00 | 1.00 | 1.00 | 1.00 |   |   |
| Upstream Filter(I)           | 1.00 | 1.00 | 1.00 | 1.00 | 1.00 | 1.00 |   |   |
| Uniform Delay (d), s/veh     | 21.5 | 3.4  | 13.0 | 7.7  | 19.2 | 21.1 |   |   |
| Incr Delay (d2), s/veh       | 4.7  | 0.1  | 2.4  | 0.0  | 0.1  | 2.1  |   |   |
| Initial Q Delay(d3),s/veh    | 0.0  | 0.0  | 0.0  | 0.0  | 0.0  | 0.0  |   |   |
| %ile BackOfQ(50%),veh/ln     | 3.1  | 2.4  | 11.6 | 0.6  | 0.7  | 5.3  |   |   |
| LnGrp Delay(d),s/veh         | 26.2 | 3.5  | 15.5 | 7.7  | 19.3 | 23.2 |   |   |
| LnGrp LOS                    | C    | A    | B    | A    | B    | C    |   |   |
| Approach Vol, veh/h          |      | 600  | 900  |      | 312  |      |   |   |
| Approach Delay, s/veh        |      | 11.0 | 14.8 |      | 21.7 |      |   |   |
| Approach LOS                 |      | B    | B    |      | C    |      |   |   |
| Timer                        | 1    | 2    | 3    | 4    | 5    | 6    | 7 | 8 |
| Assigned Phs                 |      | 2    |      | 4    | 5    | 6    |   |   |
| Phs Duration (G+Y+Rc), s     |      | 40.4 |      | 11.5 | 11.1 | 29.3 |   |   |
| Change Period (Y+Rc), s      |      | 5.0  |      | 3.5  | 3.5  | 5.0  |   |   |
| Max Green Setting (Gmax), s  |      | 60.0 |      | 31.5 | 11.5 | 45.0 |   |   |
| Max Q Clear Time (g_c+I1), s |      | 6.9  |      | 8.1  | 8.0  | 23.5 |   |   |
| Green Ext Time (p_c), s      |      | 0.4  |      | 0.0  | 0.0  | 0.8  |   |   |
| <b>Intersection Summary</b>  |      |      |      |      |      |      |   |   |
| HCM 2010 Ctrl Delay          |      |      | 14.8 |      |      |      |   |   |
| HCM 2010 LOS                 |      |      | B    |      |      |      |   |   |

HCM 2010 Signalized Intersection Summary Cumulative with Eastside Parkway with Project, AM  
 24: Inter-Garrison Road & Schoonover Road

06/11/2019



| Movement                      | EBL  | EBT  | EBR  | WBL  | WBT  | WBR  | NBL  | NBT  | NBR  | SBL  | SBT  | SBR  |
|-------------------------------|------|------|------|------|------|------|------|------|------|------|------|------|
| Lane Configurations           |      |      |      |      |      |      |      |      |      |      |      |      |
| Traffic Volume (veh/h)        | 70   | 330  | 60   | 640  | 540  | 10   | 60   | 20   | 380  | 60   | 100  | 160  |
| Future Volume (veh/h)         | 70   | 330  | 60   | 640  | 540  | 10   | 60   | 20   | 380  | 60   | 100  | 160  |
| Number                        | 5    | 2    | 12   | 1    | 6    | 16   | 3    | 8    | 18   | 7    | 4    | 14   |
| Initial Q (Qb), veh           | 0    | 0    | 0    | 0    | 0    | 0    | 0    | 0    | 0    | 0    | 0    | 0    |
| Ped-Bike Adj(A_pbT)           | 1.00 |      | 1.00 | 1.00 |      | 1.00 | 1.00 |      | 1.00 | 1.00 |      | 1.00 |
| Parking Bus, Adj              | 1.00 | 1.00 | 1.00 | 1.00 | 1.00 | 1.00 | 1.00 | 1.00 | 1.00 | 1.00 | 1.00 | 1.00 |
| Adj Sat Flow, veh/h/ln        | 1810 | 1818 | 1900 | 1863 | 1881 | 1881 | 1863 | 1863 | 1863 | 1900 | 1856 | 1845 |
| Adj Flow Rate, veh/h          | 89   | 418  | 51   | 810  | 684  | 9    | 76   | 25   | 0    | 76   | 127  | 140  |
| Adj No. of Lanes              | 1    | 2    | 0    | 1    | 2    | 1    | 1    | 1    | 1    | 0    | 1    | 1    |
| Peak Hour Factor              | 0.79 | 0.79 | 0.79 | 0.79 | 0.79 | 0.79 | 0.79 | 0.79 | 0.79 | 0.79 | 0.79 | 0.79 |
| Percent Heavy Veh, %          | 5    | 5    | 5    | 2    | 1    | 1    | 2    | 2    | 2    | 2    | 2    | 3    |
| Cap, veh/h                    | 112  | 481  | 58   | 797  | 1928 | 862  | 159  | 167  | 142  | 90   | 150  | 205  |
| Arrive On Green               | 0.06 | 0.16 | 0.16 | 0.45 | 0.54 | 0.54 | 0.09 | 0.09 | 0.00 | 0.13 | 0.13 | 0.13 |
| Sat Flow, veh/h               | 1723 | 3101 | 376  | 1774 | 3574 | 1599 | 1774 | 1863 | 1583 | 682  | 1140 | 1564 |
| Grp Volume(v), veh/h          | 89   | 232  | 237  | 810  | 684  | 9    | 76   | 25   | 0    | 203  | 0    | 140  |
| Grp Sat Flow(s),veh/h/ln      | 1723 | 1727 | 1751 | 1774 | 1787 | 1599 | 1774 | 1863 | 1583 | 1822 | 0    | 1564 |
| Q Serve(g_s), s               | 5.4  | 13.9 | 14.0 | 47.5 | 11.5 | 0.3  | 4.3  | 1.3  | 0.0  | 11.5 | 0.0  | 9.0  |
| Cycle Q Clear(g_c), s         | 5.4  | 13.9 | 14.0 | 47.5 | 11.5 | 0.3  | 4.3  | 1.3  | 0.0  | 11.5 | 0.0  | 9.0  |
| Prop In Lane                  | 1.00 |      | 0.21 | 1.00 |      | 1.00 | 1.00 |      | 1.00 | 0.37 |      | 1.00 |
| Lane Grp Cap(c), veh/h        | 112  | 268  | 272  | 797  | 1928 | 862  | 159  | 167  | 142  | 239  | 0    | 205  |
| V/C Ratio(X)                  | 0.80 | 0.87 | 0.87 | 1.02 | 0.35 | 0.01 | 0.48 | 0.15 | 0.00 | 0.85 | 0.00 | 0.68 |
| Avail Cap(c_a), veh/h         | 252  | 490  | 497  | 797  | 2095 | 937  | 453  | 475  | 404  | 465  | 0    | 399  |
| HCM Platoon Ratio             | 1.00 | 1.00 | 1.00 | 1.00 | 1.00 | 1.00 | 1.00 | 1.00 | 1.00 | 1.00 | 1.00 | 1.00 |
| Upstream Filter(I)            | 1.00 | 1.00 | 1.00 | 1.00 | 1.00 | 1.00 | 1.00 | 1.00 | 0.00 | 1.00 | 0.00 | 1.00 |
| Uniform Delay (d), s/veh      | 48.8 | 43.6 | 43.7 | 29.1 | 13.9 | 11.3 | 45.8 | 44.4 | 0.0  | 44.9 | 0.0  | 43.8 |
| Incr Delay (d2), s/veh        | 4.8  | 3.3  | 3.5  | 36.2 | 0.0  | 0.0  | 0.8  | 0.2  | 0.0  | 3.2  | 0.0  | 1.5  |
| Initial Q Delay(d3),s/veh     | 0.0  | 0.0  | 0.0  | 0.0  | 0.0  | 0.0  | 0.0  | 0.0  | 0.0  | 0.0  | 0.0  | 0.0  |
| %ile BackOfQ(50%),veh/ln      | 2.7  | 6.9  | 7.1  | 31.0 | 5.7  | 0.1  | 2.1  | 0.7  | 0.0  | 6.0  | 0.0  | 4.0  |
| LnGrp Delay(d),s/veh          | 53.6 | 46.9 | 47.1 | 65.3 | 13.9 | 11.3 | 46.6 | 44.6 | 0.0  | 48.1 | 0.0  | 45.3 |
| LnGrp LOS                     | D    | D    | D    | F    | B    | B    | D    | D    |      | D    |      | D    |
| Approach Vol, veh/h           |      | 558  |      |      | 1503 |      |      | 101  |      |      | 343  |      |
| Approach Delay, s/veh         |      | 48.1 |      |      | 41.6 |      |      | 46.1 |      |      | 47.0 |      |
| Approach LOS                  |      | D    |      |      | D    |      |      | D    |      |      | D    |      |
| Timer                         | 1    | 2    | 3    | 4    | 5    | 6    | 7    | 8    |      |      |      |      |
| Assigned Phs                  | 1    | 2    |      | 4    | 5    | 6    |      | 8    |      |      |      |      |
| Phs Duration (G+Y+Rc), s      | 51.0 | 21.4 |      | 18.9 | 10.4 | 62.1 |      | 14.5 |      |      |      |      |
| Change Period (Y+Rc), s       | 3.5  | 5.0  |      | 5.0  | 3.5  | 5.0  |      | 5.0  |      |      |      |      |
| Max Green Setting (Gmax), s   | 47.5 | 30.0 |      | 27.0 | 15.5 | 62.0 |      | 27.0 |      |      |      |      |
| Max Q Clear Time (g_c+1.5), s | 19.5 | 16.0 |      | 13.5 | 7.4  | 13.5 |      | 6.3  |      |      |      |      |
| Green Ext Time (p_c), s       | 0.0  | 0.4  |      | 0.2  | 0.0  | 0.9  |      | 0.0  |      |      |      |      |
| <b>Intersection Summary</b>   |      |      |      |      |      |      |      |      |      |      |      |      |
| HCM 2010 Ctrl Delay           |      |      |      | 44.0 |      |      |      |      |      |      |      |      |
| HCM 2010 LOS                  |      |      |      | D    |      |      |      |      |      |      |      |      |

|                           |       |
|---------------------------|-------|
| <b>Intersection</b>       |       |
| Intersection Delay, s/veh | 296.6 |
| Intersection LOS          | F     |

| Movement            | EBL  | EBT  | WBT  | WBR  | SBL  | SBR  |
|---------------------|------|------|------|------|------|------|
| Lane Configurations |      |      |      |      |      |      |
| Traffic Vol, veh/h  | 600  | 130  | 310  | 130  | 90   | 820  |
| Future Vol, veh/h   | 600  | 130  | 310  | 130  | 90   | 820  |
| Peak Hour Factor    | 0.82 | 0.82 | 0.82 | 0.82 | 0.82 | 0.82 |
| Heavy Vehicles, %   | 5    | 5    | 1    | 1    | 0    | 0    |
| Mvmt Flow           | 732  | 159  | 378  | 159  | 110  | 1000 |
| Number of Lanes     | 1    | 1    | 1    | 0    | 1    | 1    |

| Approach                   | EB  | WB    | SB    |
|----------------------------|-----|-------|-------|
| Opposing Approach          | WB  | EB    |       |
| Opposing Lanes             | 1   | 2     | 0     |
| Conflicting Approach Left  | SB  |       | WB    |
| Conflicting Lanes Left     | 2   | 0     | 1     |
| Conflicting Approach Right |     | SB    | EB    |
| Conflicting Lanes Right    | 0   | 2     | 2     |
| HCM Control Delay          | 282 | 101.2 | 402.8 |
| HCM LOS                    | F   | F     | F     |

| Lane                   | EBLn1  | EBLn2 | WBLn1 | SBLn1 | SBLn2 |
|------------------------|--------|-------|-------|-------|-------|
| Vol Left, %            | 100%   | 0%    | 0%    | 100%  | 0%    |
| Vol Thru, %            | 0%     | 100%  | 70%   | 0%    | 0%    |
| Vol Right, %           | 0%     | 0%    | 30%   | 0%    | 100%  |
| Sign Control           | Stop   | Stop  | Stop  | Stop  | Stop  |
| Traffic Vol by Lane    | 600    | 130   | 440   | 90    | 820   |
| LT Vol                 | 600    | 0     | 0     | 90    | 0     |
| Through Vol            | 0      | 130   | 310   | 0     | 0     |
| RT Vol                 | 0      | 0     | 130   | 0     | 820   |
| Lane Flow Rate         | 732    | 159   | 537   | 110   | 1000  |
| Geometry Grp           | 7      | 7     | 4     | 7     | 7     |
| Degree of Util (X)     | 1.671  | 0.34  | 1.077 | 0.249 | 1.932 |
| Departure Headway (Hd) | 10.487 | 9.96  | 9.811 | 9.013 | 7.762 |
| Convergence, Y/N       | Yes    | Yes   | Yes   | Yes   | Yes   |
| Cap                    | 351    | 363   | 376   | 401   | 480   |
| Service Time           | 8.187  | 7.66  | 7.811 | 6.713 | 5.462 |
| HCM Lane V/C Ratio     | 2.085  | 0.438 | 1.428 | 0.274 | 2.083 |
| HCM Control Delay      | 339.3  | 17.7  | 101.2 | 14.7  | 445.4 |
| HCM Lane LOS           | F      | C     | F     | B     | F     |
| HCM 95th-tile Q        | 34.9   | 1.5   | 14.1  | 1     | 59.7  |

HCM 2010 Signalized Intersection Summary Cumulative with Eastside Parkway with Project, AM  
 26: East Garrison Road & Reservation Road

06/11/2019



| Movement                     | EBL  | EBT  | EBR  | WBL  | WBT  | WBR  | NBL  | NBT  | NBR  | SBL | SBT | SBR |
|------------------------------|------|------|------|------|------|------|------|------|------|-----|-----|-----|
| Lane Configurations          | ↖    | ↗    |      | ↖    | ↗    |      | ↖    |      | ↗    |     |     |     |
| Traffic Volume (veh/h)       | 0    | 730  | 80   | 150  | 1210 | 0    | 130  | 0    | 260  | 0   | 0   | 0   |
| Future Volume (veh/h)        | 0    | 730  | 80   | 150  | 1210 | 0    | 130  | 0    | 260  | 0   | 0   | 0   |
| Number                       | 5    | 2    | 12   | 1    | 6    | 16   | 3    | 8    | 18   |     |     |     |
| Initial Q (Qb), veh          | 0    | 0    | 0    | 0    | 0    | 0    | 0    | 0    | 0    |     |     |     |
| Ped-Bike Adj(A_pbT)          | 1.00 |      | 1.00 | 1.00 |      | 1.00 | 1.00 |      | 1.00 |     |     |     |
| Parking Bus, Adj             | 1.00 | 1.00 | 1.00 | 1.00 | 1.00 | 1.00 | 1.00 | 1.00 | 1.00 |     |     |     |
| Adj Sat Flow, veh/h/ln       | 1827 | 1827 | 1900 | 1863 | 1863 | 0    | 1881 | 0    | 1881 |     |     |     |
| Adj Flow Rate, veh/h         | 0    | 820  | 88   | 169  | 1360 | 0    | 146  | 0    | 220  |     |     |     |
| Adj No. of Lanes             | 1    | 2    | 0    | 1    | 2    | 0    | 1    | 0    | 1    |     |     |     |
| Peak Hour Factor             | 0.89 | 0.89 | 0.89 | 0.89 | 0.89 | 0.89 | 0.89 | 0.89 | 0.89 |     |     |     |
| Percent Heavy Veh, %         | 4    | 4    | 4    | 2    | 2    | 0    | 1    | 0    | 1    |     |     |     |
| Cap, veh/h                   | 3    | 1425 | 153  | 213  | 2259 | 0    | 309  | 0    | 275  |     |     |     |
| Arrive On Green              | 0.00 | 0.45 | 0.45 | 0.12 | 0.64 | 0.00 | 0.17 | 0.00 | 0.17 |     |     |     |
| Sat Flow, veh/h              | 1740 | 3163 | 339  | 1774 | 3632 | 0    | 1792 | 0    | 1599 |     |     |     |
| Grp Volume(v), veh/h         | 0    | 450  | 458  | 169  | 1360 | 0    | 146  | 0    | 220  |     |     |     |
| Grp Sat Flow(s),veh/h/ln     | 1740 | 1736 | 1767 | 1774 | 1770 | 0    | 1792 | 0    | 1599 |     |     |     |
| Q Serve(g_s), s              | 0.0  | 10.3 | 10.3 | 4.9  | 12.0 | 0.0  | 3.9  | 0.0  | 7.0  |     |     |     |
| Cycle Q Clear(g_c), s        | 0.0  | 10.3 | 10.3 | 4.9  | 12.0 | 0.0  | 3.9  | 0.0  | 7.0  |     |     |     |
| Prop In Lane                 | 1.00 |      | 0.19 | 1.00 |      | 0.00 | 1.00 |      | 1.00 |     |     |     |
| Lane Grp Cap(c), veh/h       | 3    | 782  | 796  | 213  | 2259 | 0    | 309  | 0    | 275  |     |     |     |
| V/C Ratio(X)                 | 0.00 | 0.58 | 0.58 | 0.79 | 0.60 | 0.00 | 0.47 | 0.00 | 0.80 |     |     |     |
| Avail Cap(c_a), veh/h        | 653  | 1953 | 1988 | 665  | 3982 | 0    | 907  | 0    | 810  |     |     |     |
| HCM Platoon Ratio            | 1.00 | 1.00 | 1.00 | 1.00 | 1.00 | 1.00 | 1.00 | 1.00 | 1.00 |     |     |     |
| Upstream Filter(I)           | 0.00 | 1.00 | 1.00 | 1.00 | 1.00 | 0.00 | 1.00 | 0.00 | 1.00 |     |     |     |
| Uniform Delay (d), s/veh     | 0.0  | 10.9 | 10.9 | 22.8 | 5.7  | 0.0  | 19.9 | 0.0  | 21.2 |     |     |     |
| Incr Delay (d2), s/veh       | 0.0  | 1.2  | 1.2  | 2.5  | 0.3  | 0.0  | 0.4  | 0.0  | 2.0  |     |     |     |
| Initial Q Delay(d3),s/veh    | 0.0  | 0.0  | 0.0  | 0.0  | 0.0  | 0.0  | 0.0  | 0.0  | 0.0  |     |     |     |
| %ile BackOfQ(50%),veh/ln     | 0.0  | 5.1  | 5.2  | 2.5  | 5.8  | 0.0  | 2.0  | 0.0  | 3.2  |     |     |     |
| LnGrp Delay(d),s/veh         | 0.0  | 12.1 | 12.1 | 25.3 | 6.0  | 0.0  | 20.3 | 0.0  | 23.2 |     |     |     |
| LnGrp LOS                    |      | B    | B    | C    | A    |      | C    |      | C    |     |     |     |
| Approach Vol, veh/h          |      | 908  |      |      | 1529 |      |      | 366  |      |     |     |     |
| Approach Delay, s/veh        |      | 12.1 |      |      | 8.1  |      |      | 22.1 |      |     |     |     |
| Approach LOS                 |      | B    |      |      | A    |      |      | C    |      |     |     |     |
| Timer                        | 1    | 2    | 3    | 4    | 5    | 6    | 7    | 8    |      |     |     |     |
| Assigned Phs                 | 1    | 2    |      |      | 5    | 6    |      | 8    |      |     |     |     |
| Phs Duration (G+Y+Rc), s     | 0.0  | 29.4 |      |      | 0.0  | 39.4 |      | 13.9 |      |     |     |     |
| Change Period (Y+Rc), s      | 3.6  | 5.4  |      |      | 3.5  | 5.4  |      | 4.7  |      |     |     |     |
| Max Green Setting (Gmax), s  | 20   | 60.0 |      |      | 20.0 | 60.0 |      | 27.0 |      |     |     |     |
| Max Q Clear Time (g_c+10), s | 12.3 |      |      |      | 0.0  | 14.0 |      | 9.0  |      |     |     |     |
| Green Ext Time (p_c), s      | 0.0  | 11.8 |      |      | 0.0  | 15.5 |      | 0.2  |      |     |     |     |
| <b>Intersection Summary</b>  |      |      |      |      |      |      |      |      |      |     |     |     |
| HCM 2010 Ctrl Delay          |      |      |      | 11.2 |      |      |      |      |      |     |     |     |
| HCM 2010 LOS                 |      |      |      | B    |      |      |      |      |      |     |     |     |
| <b>Notes</b>                 |      |      |      |      |      |      |      |      |      |     |     |     |

HCM 2010 Signalized Intersection Summary Cumulative with Eastside Parkway with Project, AM  
 27: Reservation Road & Watkins Gate Road

06/11/2019



| Movement                     | EBL  | EBR  | NBL  | NBT  | SBT  | SBR  |   |      |
|------------------------------|------|------|------|------|------|------|---|------|
| Lane Configurations          |      |      |      |      |      |      |   |      |
| Traffic Volume (veh/h)       | 10   | 250  | 160  | 1600 | 1100 | 60   |   |      |
| Future Volume (veh/h)        | 10   | 250  | 160  | 1600 | 1100 | 60   |   |      |
| Number                       | 5    | 12   | 3    | 8    | 4    | 14   |   |      |
| Initial Q (Qb), veh          | 0    | 0    | 0    | 0    | 0    | 0    |   |      |
| Ped-Bike Adj(A_pbT)          | 1.00 | 1.00 | 1.00 |      |      | 1.00 |   |      |
| Parking Bus, Adj             | 1.00 | 1.00 | 1.00 | 1.00 | 1.00 | 1.00 |   |      |
| Adj Sat Flow, veh/h/ln       | 1863 | 1863 | 1863 | 1863 | 1863 | 1900 |   |      |
| Adj Flow Rate, veh/h         | 11   | 44   | 174  | 1739 | 1196 | 58   |   |      |
| Adj No. of Lanes             | 1    | 1    | 1    | 2    | 2    | 0    |   |      |
| Peak Hour Factor             | 0.92 | 0.92 | 0.92 | 0.92 | 0.92 | 0.92 |   |      |
| Percent Heavy Veh, %         | 2    | 2    | 2    | 2    | 2    | 2    |   |      |
| Cap, veh/h                   | 86   | 77   | 216  | 2651 | 1942 | 94   |   |      |
| Arrive On Green              | 0.05 | 0.05 | 0.12 | 0.75 | 0.57 | 0.57 |   |      |
| Sat Flow, veh/h              | 1774 | 1583 | 1774 | 3632 | 3530 | 167  |   |      |
| Grp Volume(v), veh/h         | 11   | 44   | 174  | 1739 | 615  | 639  |   |      |
| Grp Sat Flow(s),veh/h/ln     | 1774 | 1583 | 1774 | 1770 | 1770 | 1833 |   |      |
| Q Serve(g_s), s              | 0.4  | 1.7  | 6.1  | 15.6 | 14.9 | 14.9 |   |      |
| Cycle Q Clear(g_c), s        | 0.4  | 1.7  | 6.1  | 15.6 | 14.9 | 14.9 |   |      |
| Prop In Lane                 | 1.00 | 1.00 | 1.00 |      |      | 0.09 |   |      |
| Lane Grp Cap(c), veh/h       | 86   | 77   | 216  | 2651 | 1000 | 1036 |   |      |
| V/C Ratio(X)                 | 0.13 | 0.57 | 0.81 | 0.66 | 0.62 | 0.62 |   |      |
| Avail Cap(c_a), veh/h        | 511  | 456  | 497  | 3773 | 1281 | 1327 |   |      |
| HCM Platoon Ratio            | 1.00 | 1.00 | 1.00 | 1.00 | 1.00 | 1.00 |   |      |
| Upstream Filter(I)           | 1.00 | 1.00 | 1.00 | 1.00 | 1.00 | 1.00 |   |      |
| Uniform Delay (d), s/veh     | 29.3 | 29.9 | 27.5 | 4.0  | 9.3  | 9.3  |   |      |
| Incr Delay (d2), s/veh       | 0.2  | 2.5  | 2.7  | 0.4  | 1.0  | 1.0  |   |      |
| Initial Q Delay(d3),s/veh    | 0.0  | 0.0  | 0.0  | 0.0  | 0.0  | 0.0  |   |      |
| %ile BackOfQ(50%),veh/lr     | 0.2  | 0.8  | 3.2  | 7.4  | 7.5  | 7.7  |   |      |
| LnGrp Delay(d),s/veh         | 29.5 | 32.4 | 30.2 | 4.4  | 10.3 | 10.3 |   |      |
| LnGrp LOS                    | C    | C    | C    | A    | B    | B    |   |      |
| Approach Vol, veh/h          | 55   |      |      | 1913 | 1254 |      |   |      |
| Approach Delay, s/veh        | 31.8 |      |      | 6.8  | 10.3 |      |   |      |
| Approach LOS                 | C    |      |      | A    | B    |      |   |      |
| Timer                        | 1    | 2    | 3    | 4    | 5    | 6    | 7 | 8    |
| Assigned Phs                 |      | 2    | 3    | 4    |      |      |   | 8    |
| Phs Duration (G+Y+Rc), s     |      | 9.6  | 11.8 | 42.8 |      |      |   | 54.6 |
| Change Period (Y+Rc), s      |      | 6.5  | 4.0  | 6.5  |      |      |   | 6.5  |
| Max Green Setting (Gmax), s  |      | 18.5 | 18.0 | 46.5 |      |      |   | 68.5 |
| Max Q Clear Time (g_c+I1), s |      | 3.7  | 8.1  | 16.9 |      |      |   | 17.6 |
| Green Ext Time (p_c), s      |      | 0.0  | 0.0  | 13.8 |      |      |   | 30.6 |
| <b>Intersection Summary</b>  |      |      |      |      |      |      |   |      |
| HCM 2010 Ctrl Delay          |      |      | 8.6  |      |      |      |   |      |
| HCM 2010 LOS                 |      |      | A    |      |      |      |   |      |

HCM 2010 Signalized Intersection Summary Cumulative with Eastside Parkway with Project, AM  
 28: Davis Road & Reservation Road

06/11/2019



| Movement                     | EBL   | EBT   | EBR   | WBL  | WBT   | WBR  | NBL  | NBT  | NBR  | SBL  | SBT   | SBR   |
|------------------------------|-------|-------|-------|------|-------|------|------|------|------|------|-------|-------|
| Lane Configurations          |       |       |       |      |       |      |      |      |      |      |       |       |
| Traffic Volume (veh/h)       | 750   | 320   | 10    | 10   | 570   | 90   | 10   | 10   | 10   | 150  | 10    | 850   |
| Future Volume (veh/h)        | 750   | 320   | 10    | 10   | 570   | 90   | 10   | 10   | 10   | 150  | 10    | 850   |
| Number                       | 5     | 2     | 12    | 1    | 6     | 16   | 3    | 8    | 18   | 7    | 4     | 14    |
| Initial Q (Qb), veh          | 0     | 0     | 0     | 0    | 0     | 0    | 0    | 0    | 0    | 0    | 0     | 0     |
| Ped-Bike Adj(A_pbT)          | 1.00  |       | 1.00  | 1.00 |       | 1.00 | 1.00 |      | 1.00 | 1.00 |       | 1.00  |
| Parking Bus, Adj             | 1.00  | 1.00  | 1.00  | 1.00 | 1.00  | 1.00 | 1.00 | 1.00 | 1.00 | 1.00 | 1.00  | 1.00  |
| Adj Sat Flow, veh/h/ln       | 1863  | 1863  | 1900  | 1863 | 1863  | 1900 | 1900 | 1900 | 1900 | 1900 | 1845  | 1845  |
| Adj Flow Rate, veh/h         | 872   | 372   | 12    | 12   | 663   | 105  | 12   | 12   | 9    | 174  | 12    | 746   |
| Adj No. of Lanes             | 1     | 2     | 0     | 1    | 1     | 0    | 0    | 1    | 0    | 0    | 1     | 1     |
| Peak Hour Factor             | 0.86  | 0.86  | 0.86  | 0.86 | 0.86  | 0.86 | 0.86 | 0.86 | 0.86 | 0.86 | 0.86  | 0.86  |
| Percent Heavy Veh, %         | 2     | 2     | 2     | 2    | 2     | 2    | 0    | 0    | 0    | 3    | 3     | 3     |
| Cap, veh/h                   | 376   | 2187  | 70    | 19   | 666   | 105  | 17   | 17   | 12   | 350  | 24    | 665   |
| Arrive On Green              | 0.21  | 0.63  | 0.63  | 0.01 | 0.42  | 0.42 | 0.03 | 0.03 | 0.03 | 0.21 | 0.21  | 0.21  |
| Sat Flow, veh/h              | 1774  | 3500  | 113   | 1774 | 1570  | 249  | 648  | 648  | 486  | 1649 | 114   | 1568  |
| Grp Volume(v), veh/h         | 872   | 188   | 196   | 12   | 0     | 768  | 33   | 0    | 0    | 186  | 0     | 746   |
| Grp Sat Flow(s),veh/h/ln     | 1774  | 1770  | 1843  | 1774 | 0     | 1819 | 1782 | 0    | 0    | 1762 | 0     | 1568  |
| Q Serve(g_s), s              | 30.0  | 6.3   | 6.3   | 1.0  | 0.0   | 59.5 | 2.6  | 0.0  | 0.0  | 13.1 | 0.0   | 30.0  |
| Cycle Q Clear(g_c), s        | 30.0  | 6.3   | 6.3   | 1.0  | 0.0   | 59.5 | 2.6  | 0.0  | 0.0  | 13.1 | 0.0   | 30.0  |
| Prop In Lane                 | 1.00  |       | 0.06  | 1.00 |       | 0.14 | 0.36 |      | 0.27 | 0.94 |       | 1.00  |
| Lane Grp Cap(c), veh/h       | 376   | 1106  | 1152  | 19   | 0     | 772  | 46   | 0    | 0    | 374  | 0     | 665   |
| V/C Ratio(X)                 | 2.32  | 0.17  | 0.17  | 0.64 | 0.00  | 1.00 | 0.72 | 0.00 | 0.00 | 0.50 | 0.00  | 1.12  |
| Avail Cap(c_a), veh/h        | 376   | 1106  | 1152  | 376  | 0     | 772  | 378  | 0    | 0    | 374  | 0     | 665   |
| HCM Platoon Ratio            | 1.00  | 1.00  | 1.00  | 1.00 | 1.00  | 1.00 | 1.00 | 1.00 | 1.00 | 1.00 | 1.00  | 1.00  |
| Upstream Filter(I)           | 1.00  | 1.00  | 1.00  | 1.00 | 0.00  | 1.00 | 1.00 | 0.00 | 0.00 | 1.00 | 0.00  | 1.00  |
| Uniform Delay (d), s/veh     | 55.7  | 11.1  | 11.1  | 69.7 | 0.0   | 40.6 | 68.4 | 0.0  | 0.0  | 49.1 | 0.0   | 40.7  |
| Incr Delay (d2), s/veh       | 601.1 | 0.1   | 0.1   | 12.4 | 0.0   | 31.2 | 7.7  | 0.0  | 0.0  | 0.4  | 0.0   | 73.3  |
| Initial Q Delay(d3),s/veh    | 0.0   | 0.0   | 0.0   | 0.0  | 0.0   | 0.0  | 0.0  | 0.0  | 0.0  | 0.0  | 0.0   | 0.0   |
| %ile BackOfQ(50%),veh/ln     | 17.5  | 3.1   | 3.3   | 0.5  | 0.0   | 36.6 | 1.4  | 0.0  | 0.0  | 6.4  | 0.0   | 39.5  |
| LnGrp Delay(d),s/veh         | 656.8 | 11.2  | 11.2  | 82.1 | 0.0   | 71.8 | 76.1 | 0.0  | 0.0  | 49.5 | 0.0   | 114.0 |
| LnGrp LOS                    | F     | B     | B     | F    |       | E    | E    |      |      | D    |       | F     |
| Approach Vol, veh/h          |       | 1256  |       |      | 780   |      |      | 33   |      |      | 932   |       |
| Approach Delay, s/veh        |       | 459.4 |       |      | 71.9  |      |      | 76.1 |      |      | 101.1 |       |
| Approach LOS                 |       | F     |       |      | E     |      |      | E    |      |      | F     |       |
| Timer                        | 1     | 2     | 3     | 4    | 5     | 6    | 7    | 8    |      |      |       |       |
| Assigned Phs                 | 1     | 2     |       | 4    | 5     | 6    |      | 8    |      |      |       |       |
| Phs Duration (G+Y+Rc), s     | 5.4   | 93.4  |       | 35.0 | 33.8  | 65.0 |      | 7.6  |      |      |       |       |
| Change Period (Y+Rc), s      | 3.9   | 5.0   |       | 5.0  | * 3.8 | 5.0  |      | 4.0  |      |      |       |       |
| Max Green Setting (Gmax), s  | 30    | 60.0  |       | 30.0 | * 30  | 60.0 |      | 30.0 |      |      |       |       |
| Max Q Clear Time (g_c+13), s | 3.0   | 8.3   |       | 32.0 | 32.0  | 61.5 |      | 4.6  |      |      |       |       |
| Green Ext Time (p_c), s      | 0.0   | 3.4   |       | 0.0  | 0.0   | 0.0  |      | 0.0  |      |      |       |       |
| <b>Intersection Summary</b>  |       |       |       |      |       |      |      |      |      |      |       |       |
| HCM 2010 Ctrl Delay          |       |       | 243.2 |      |       |      |      |      |      |      |       |       |
| HCM 2010 LOS                 |       |       | F     |      |       |      |      |      |      |      |       |       |
| <b>Notes</b>                 |       |       |       |      |       |      |      |      |      |      |       |       |



HCM 2010 Signalized Intersection Summary Cumulative with Eastside Parkway with Project, AM  
 29: 2nd Avenue & Divarty Street 06/11/2019



| Movement                     | EBL  | EBT  | EBR  | WBL  | WBT  | WBR  | NBL  | NBT  | NBR  | SBL  | SBT  | SBR  |
|------------------------------|------|------|------|------|------|------|------|------|------|------|------|------|
| Lane Configurations          |      | ↕    |      |      | ↕    | ↕    | ↕    | ↕↔   |      | ↕    | ↕↔   |      |
| Traffic Volume (veh/h)       | 80   | 10   | 40   | 70   | 20   | 20   | 130  | 580  | 130  | 20   | 900  | 250  |
| Future Volume (veh/h)        | 80   | 10   | 40   | 70   | 20   | 20   | 130  | 580  | 130  | 20   | 900  | 250  |
| Number                       | 5    | 2    | 12   | 1    | 6    | 16   | 3    | 8    | 18   | 7    | 4    | 14   |
| Initial Q (Qb), veh          | 0    | 0    | 0    | 0    | 0    | 0    | 0    | 0    | 0    | 0    | 0    | 0    |
| Ped-Bike Adj(A_pbT)          | 1.00 |      | 1.00 | 1.00 |      | 1.00 | 1.00 |      | 1.00 | 1.00 |      | 1.00 |
| Parking Bus, Adj             | 1.00 | 1.00 | 1.00 | 1.00 | 1.00 | 1.00 | 1.00 | 1.00 | 1.00 | 1.00 | 1.00 | 1.00 |
| Adj Sat Flow, veh/h/ln       | 1900 | 1667 | 1900 | 1900 | 1900 | 1900 | 1863 | 1863 | 1900 | 1881 | 1881 | 1900 |
| Adj Flow Rate, veh/h         | 88   | 11   | 44   | 77   | 22   | 22   | 143  | 637  | 143  | 22   | 989  | 275  |
| Adj No. of Lanes             | 0    | 1    | 0    | 0    | 1    | 1    | 1    | 2    | 0    | 1    | 2    | 0    |
| Peak Hour Factor             | 0.91 | 0.91 | 0.91 | 0.91 | 0.91 | 0.91 | 0.91 | 0.91 | 0.91 | 0.91 | 0.91 | 0.91 |
| Percent Heavy Veh, %         | 14   | 14   | 14   | 0    | 0    | 0    | 2    | 2    | 2    | 1    | 1    | 1    |
| Cap, veh/h                   | 202  | 36   | 62   | 308  | 75   | 298  | 184  | 1603 | 359  | 46   | 1327 | 367  |
| Arrive On Green              | 0.18 | 0.18 | 0.18 | 0.18 | 0.18 | 0.18 | 0.10 | 0.56 | 0.56 | 0.03 | 0.48 | 0.48 |
| Sat Flow, veh/h              | 555  | 196  | 334  | 1073 | 407  | 1612 | 1774 | 2873 | 644  | 1792 | 2766 | 766  |
| Grp Volume(v), veh/h         | 143  | 0    | 0    | 99   | 0    | 22   | 143  | 392  | 388  | 22   | 638  | 626  |
| Grp Sat Flow(s),veh/h/ln1084 | 0    | 0    | 1480 | 0    | 1612 | 1774 | 1770 | 1748 | 1792 | 1787 | 1744 |      |
| Q Serve(g_s), s              | 4.6  | 0.0  | 0.0  | 0.0  | 0.0  | 0.7  | 4.6  | 7.3  | 7.4  | 0.7  | 16.8 | 17.0 |
| Cycle Q Clear(g_c), s        | 7.9  | 0.0  | 0.0  | 3.3  | 0.0  | 0.7  | 4.6  | 7.3  | 7.4  | 0.7  | 16.8 | 17.0 |
| Prop In Lane                 | 0.62 |      | 0.31 | 0.78 |      | 1.00 | 1.00 |      | 0.37 | 1.00 |      | 0.44 |
| Lane Grp Cap(c), veh/h       | 300  | 0    | 0    | 383  | 0    | 298  | 184  | 987  | 975  | 46   | 857  | 837  |
| V/C Ratio(X)                 | 0.48 | 0.00 | 0.00 | 0.26 | 0.00 | 0.07 | 0.78 | 0.40 | 0.40 | 0.48 | 0.74 | 0.75 |
| Avail Cap(c_a), veh/h        | 839  | 0    | 0    | 991  | 0    | 969  | 350  | 1215 | 1200 | 354  | 1227 | 1198 |
| HCM Platoon Ratio            | 1.00 | 1.00 | 1.00 | 1.00 | 1.00 | 1.00 | 1.00 | 1.00 | 1.00 | 1.00 | 1.00 | 1.00 |
| Upstream Filter(I)           | 1.00 | 0.00 | 0.00 | 1.00 | 0.00 | 1.00 | 1.00 | 1.00 | 1.00 | 1.00 | 1.00 | 1.00 |
| Uniform Delay (d), s/veh     | 23.0 | 0.0  | 0.0  | 20.6 | 0.0  | 19.6 | 25.4 | 7.3  | 7.3  | 28.0 | 12.3 | 12.3 |
| Incr Delay (d2), s/veh       | 1.2  | 0.0  | 0.0  | 0.4  | 0.0  | 0.1  | 6.8  | 0.3  | 0.3  | 7.5  | 1.5  | 1.6  |
| Initial Q Delay(d3),s/veh    | 0.0  | 0.0  | 0.0  | 0.0  | 0.0  | 0.0  | 0.0  | 0.0  | 0.0  | 0.0  | 0.0  | 0.0  |
| %ile BackOfQ(50%),veh/ln2.3  | 0.0  | 0.0  | 1.4  | 0.0  | 0.3  | 2.6  | 3.6  | 3.5  | 0.4  | 8.5  | 8.4  |      |
| LnGrp Delay(d),s/veh         | 24.1 | 0.0  | 0.0  | 21.0 | 0.0  | 19.7 | 32.3 | 7.6  | 7.6  | 35.5 | 13.7 | 13.9 |
| LnGrp LOS                    | C    |      |      | C    |      | B    | C    | A    | A    | D    | B    | B    |
| Approach Vol, veh/h          |      | 143  |      |      | 121  |      |      | 923  |      |      | 1286 |      |
| Approach Delay, s/veh        |      | 24.1 |      |      | 20.8 |      |      | 11.4 |      |      | 14.2 |      |
| Approach LOS                 |      | C    |      |      | C    |      |      | B    |      |      | B    |      |
| Timer                        | 1    | 2    | 3    | 4    | 5    | 6    | 7    | 8    |      |      |      |      |
| Assigned Phs                 |      | 2    | 3    | 4    |      | 6    | 7    | 8    |      |      |      |      |
| Phs Duration (G+Y+Rc), s     |      | 15.8 | 9.6  | 32.9 |      | 15.8 | 5.0  | 37.5 |      |      |      |      |
| Change Period (Y+Rc), s      |      | 5.0  | 3.5  | 5.0  |      | 5.0  | 3.5  | 5.0  |      |      |      |      |
| Max Green Setting (Gmax), s  |      | 35.0 | 11.5 | 40.0 |      | 35.0 | 11.5 | 40.0 |      |      |      |      |
| Max Q Clear Time (g_c+I1), s |      | 9.9  | 6.6  | 19.0 |      | 5.3  | 2.7  | 9.4  |      |      |      |      |
| Green Ext Time (p_c), s      |      | 0.8  | 0.1  | 9.0  |      | 0.6  | 0.0  | 5.3  |      |      |      |      |
| <b>Intersection Summary</b>  |      |      |      |      |      |      |      |      |      |      |      |      |
| HCM 2010 Ctrl Delay          |      |      |      | 14.0 |      |      |      |      |      |      |      |      |
| HCM 2010 LOS                 |      |      |      | B    |      |      |      |      |      |      |      |      |

| Intersection              |      |  |  |  |  |  |  |  |  |  |  |  |
|---------------------------|------|--|--|--|--|--|--|--|--|--|--|--|
| Intersection Delay, s/veh | 10.2 |  |  |  |  |  |  |  |  |  |  |  |
| Intersection LOS          | B    |  |  |  |  |  |  |  |  |  |  |  |

| Movement            | EBL  | EBT  | EBR  | WBL  | WBT  | WBR  | NBL  | NBT  | NBR  | SBL  | SBT  | SBR  |
|---------------------|------|------|------|------|------|------|------|------|------|------|------|------|
| Lane Configurations |      | ↕    |      |      | ↕    |      | ↗    | ↘    |      | ↗    | ↘    |      |
| Traffic Vol, veh/h  | 10   | 10   | 20   | 10   | 10   | 20   | 30   | 260  | 10   | 20   | 200  | 20   |
| Future Vol, veh/h   | 10   | 10   | 20   | 10   | 10   | 20   | 30   | 260  | 10   | 20   | 200  | 20   |
| Peak Hour Factor    | 0.91 | 0.91 | 0.91 | 0.91 | 0.91 | 0.91 | 0.91 | 0.91 | 0.91 | 0.91 | 0.91 | 0.91 |
| Heavy Vehicles, %   | 0    | 0    | 0    | 1    | 1    | 1    | 2    | 2    | 2    | 1    | 1    | 1    |
| Mvmt Flow           | 11   | 11   | 22   | 11   | 11   | 22   | 33   | 286  | 11   | 22   | 220  | 22   |
| Number of Lanes     | 0    | 1    | 0    | 0    | 1    | 0    | 1    | 1    | 0    | 1    | 1    | 0    |

| Approach                   | EB  | WB  | NB   | SB   |
|----------------------------|-----|-----|------|------|
| Opposing Approach          | WB  | EB  | SB   | NB   |
| Opposing Lanes             | 1   | 1   | 2    | 2    |
| Conflicting Approach Left  | SB  | NB  | EB   | WB   |
| Conflicting Lanes Left     | 2   | 2   | 1    | 1    |
| Conflicting Approach Right | NB  | SB  | WB   | EB   |
| Conflicting Lanes Right    | 2   | 2   | 1    | 1    |
| HCM Control Delay          | 8.5 | 8.5 | 10.8 | 10.1 |
| HCM LOS                    | A   | A   | B    | B    |

| Lane                   | NBLn1 | NBLn2 | EBLn1 | WBLn1 | SBLn1 | SBLn2 |
|------------------------|-------|-------|-------|-------|-------|-------|
| Vol Left, %            | 100%  | 0%    | 25%   | 25%   | 100%  | 0%    |
| Vol Thru, %            | 0%    | 96%   | 25%   | 25%   | 0%    | 91%   |
| Vol Right, %           | 0%    | 4%    | 50%   | 50%   | 0%    | 9%    |
| Sign Control           | Stop  | Stop  | Stop  | Stop  | Stop  | Stop  |
| Traffic Vol by Lane    | 30    | 270   | 40    | 40    | 20    | 220   |
| LT Vol                 | 30    | 0     | 10    | 10    | 20    | 0     |
| Through Vol            | 0     | 260   | 10    | 10    | 0     | 200   |
| RT Vol                 | 0     | 10    | 20    | 20    | 0     | 20    |
| Lane Flow Rate         | 33    | 297   | 44    | 44    | 22    | 242   |
| Geometry Grp           | 7     | 7     | 2     | 2     | 7     | 7     |
| Degree of Util (X)     | 0.05  | 0.408 | 0.062 | 0.063 | 0.034 | 0.333 |
| Departure Headway (Hd) | 5.481 | 4.953 | 5.103 | 5.121 | 5.524 | 4.958 |
| Convergence, Y/N       | Yes   | Yes   | Yes   | Yes   | Yes   | Yes   |
| Cap                    | 653   | 727   | 699   | 697   | 648   | 725   |
| Service Time           | 3.214 | 2.685 | 3.153 | 3.169 | 3.258 | 2.691 |
| HCM Lane V/C Ratio     | 0.051 | 0.409 | 0.063 | 0.063 | 0.034 | 0.334 |
| HCM Control Delay      | 8.5   | 11.1  | 8.5   | 8.5   | 8.5   | 10.2  |
| HCM Lane LOS           | A     | B     | A     | A     | A     | B     |
| HCM 95th-tile Q        | 0.2   | 2     | 0.2   | 0.2   | 0.1   | 1.5   |

HCM 2010 Signalized Intersection Summary Cumulative with Eastside Parkway with Project, AM  
 31: 1st Avenue & Lightfighter Drive

06/11/2019



| Movement                     | EBL  | EBT  | EBR  | WBL  | WBT  | WBR  | NBL  | NBT  | NBR  | SBL  | SBT  | SBR  |
|------------------------------|------|------|------|------|------|------|------|------|------|------|------|------|
| Lane Configurations          |      | ↑↑   | ↑    | ↑    | ↑↑   |      | ↑    |      | ↑    | ↑    | ↑    | ↑    |
| Traffic Volume (veh/h)       | 0    | 1310 | 130  | 20   | 1300 | 0    | 160  | 0    | 20   | 120  | 30   | 100  |
| Future Volume (veh/h)        | 0    | 1310 | 130  | 20   | 1300 | 0    | 160  | 0    | 20   | 120  | 30   | 100  |
| Number                       | 7    | 4    | 14   | 3    | 8    | 18   | 5    | 2    | 12   | 1    | 6    | 16   |
| Initial Q (Qb), veh          | 0    | 0    | 0    | 0    | 0    | 0    | 0    | 0    | 0    | 0    | 0    | 0    |
| Ped-Bike Adj(A_pbT)          | 1.00 |      | 1.00 | 1.00 |      | 1.00 | 1.00 |      | 1.00 | 1.00 |      | 1.00 |
| Parking Bus, Adj             | 1.00 | 1.00 | 1.00 | 1.00 | 1.00 | 1.00 | 1.00 | 1.00 | 1.00 | 1.00 | 1.00 | 1.00 |
| Adj Sat Flow, veh/h/ln       | 0    | 1863 | 1863 | 1863 | 1863 | 0    | 1863 | 0    | 1863 | 1792 | 1792 | 1792 |
| Adj Flow Rate, veh/h         | 0    | 1560 | 0    | 24   | 1548 | 0    | 190  | 0    | 10   | 143  | 36   | 100  |
| Adj No. of Lanes             | 0    | 2    | 1    | 1    | 2    | 0    | 1    | 0    | 1    | 1    | 1    | 1    |
| Peak Hour Factor             | 0.84 | 0.84 | 0.84 | 0.84 | 0.84 | 0.84 | 0.84 | 0.84 | 0.84 | 0.84 | 0.84 | 0.84 |
| Percent Heavy Veh, %         | 0    | 2    | 2    | 2    | 2    | 0    | 2    | 0    | 2    | 6    | 6    | 6    |
| Cap, veh/h                   | 0    | 2268 | 1015 | 27   | 2540 | 0    | 0    | 0    | 0    | 207  | 218  | 185  |
| Arrive On Green              | 0.00 | 0.64 | 0.00 | 0.02 | 0.72 | 0.00 | 0.00 | 0.00 | 0.00 | 0.12 | 0.12 | 0.12 |
| Sat Flow, veh/h              | 0    | 3632 | 1583 | 1774 | 3632 | 0    |      | 0    |      | 1707 | 1792 | 1524 |
| Grp Volume(v), veh/h         | 0    | 1560 | 0    | 24   | 1548 | 0    |      | 0.0  |      | 143  | 36   | 100  |
| Grp Sat Flow(s),veh/h/ln     | 0    | 1770 | 1583 | 1774 | 1770 | 0    |      |      |      | 1707 | 1792 | 1524 |
| Q Serve(g_s), s              | 0.0  | 16.2 | 0.0  | 0.8  | 12.5 | 0.0  |      |      |      | 4.6  | 1.0  | 3.5  |
| Cycle Q Clear(g_c), s        | 0.0  | 16.2 | 0.0  | 0.8  | 12.5 | 0.0  |      |      |      | 4.6  | 1.0  | 3.5  |
| Prop In Lane                 | 0.00 |      | 1.00 | 1.00 |      | 0.00 |      |      |      | 1.00 |      | 1.00 |
| Lane Grp Cap(c), veh/h       | 0    | 2268 | 1015 | 27   | 2540 | 0    |      |      |      | 207  | 218  | 185  |
| V/C Ratio(X)                 | 0.00 | 0.69 | 0.00 | 0.88 | 0.61 | 0.00 |      |      |      | 0.69 | 0.17 | 0.54 |
| Avail Cap(c_a), veh/h        | 0    | 2787 | 1247 | 621  | 2787 | 0    |      |      |      | 747  | 784  | 666  |
| HCM Platoon Ratio            | 1.00 | 1.00 | 1.00 | 1.00 | 1.00 | 1.00 |      |      |      | 1.00 | 1.00 | 1.00 |
| Upstream Filter(I)           | 0.00 | 1.00 | 0.00 | 1.00 | 1.00 | 0.00 |      |      |      | 1.00 | 1.00 | 1.00 |
| Uniform Delay (d), s/veh     | 0.0  | 6.6  | 0.0  | 28.1 | 4.1  | 0.0  |      |      |      | 24.1 | 22.5 | 23.6 |
| Incr Delay (d2), s/veh       | 0.0  | 0.7  | 0.0  | 25.7 | 0.4  | 0.0  |      |      |      | 1.5  | 0.1  | 0.9  |
| Initial Q Delay(d3),s/veh    | 0.0  | 0.0  | 0.0  | 0.0  | 0.0  | 0.0  |      |      |      | 0.0  | 0.0  | 0.0  |
| %ile BackOfQ(50%),veh/ln     | 0.0  | 8.0  | 0.0  | 0.6  | 6.2  | 0.0  |      |      |      | 2.2  | 0.5  | 1.5  |
| LnGrp Delay(d),s/veh         | 0.0  | 7.3  | 0.0  | 53.7 | 4.5  | 0.0  |      |      |      | 25.6 | 22.6 | 24.5 |
| LnGrp LOS                    |      | A    |      | D    | A    |      |      |      |      | C    | C    | C    |
| Approach Vol, veh/h          |      | 1560 |      |      | 1572 |      |      |      |      |      | 279  |      |
| Approach Delay, s/veh        |      | 7.3  |      |      | 5.2  |      |      |      |      |      | 24.8 |      |
| Approach LOS                 |      | A    |      |      | A    |      |      |      |      |      | C    |      |
| Timer                        | 1    | 2    | 3    | 4    | 5    | 6    | 7    | 8    |      |      |      |      |
| Assigned Phs                 |      |      | 3    | 4    |      | 6    |      | 8    |      |      |      |      |
| Phs Duration (G+Y+Rc), s     |      |      | 4.4  | 41.2 |      | 11.5 |      | 45.6 |      |      |      |      |
| Change Period (Y+Rc), s      |      |      | 3.5  | 4.6  |      | 4.6  |      | 4.6  |      |      |      |      |
| Max Green Setting (Gmax), s  |      |      | 20.0 | 45.0 |      | 25.0 |      | 45.0 |      |      |      |      |
| Max Q Clear Time (g_c+I1), s |      |      | 2.8  | 18.2 |      | 6.6  |      | 14.5 |      |      |      |      |
| Green Ext Time (p_c), s      |      |      | 0.0  | 18.5 |      | 0.4  |      | 19.0 |      |      |      |      |
| <b>Intersection Summary</b>  |      |      |      |      |      |      |      |      |      |      |      |      |
| HCM 2010 Ctrl Delay          |      |      | 7.8  |      |      |      |      |      |      |      |      |      |
| HCM 2010 LOS                 |      |      | A    |      |      |      |      |      |      |      |      |      |

HCM 2010 Signalized Intersection Summary Cumulative with Eastside Parkway with Project, AM  
 32: 2nd Avenue & Lightfighter Drive

06/11/2019



| Movement                     | EBL   | EBT  | EBR  | WBL  | WBT  | WBR  | NBL  | NBT  | NBR  | SBL  | SBT  | SBR  |
|------------------------------|-------|------|------|------|------|------|------|------|------|------|------|------|
| Lane Configurations          |       |      |      |      |      |      |      |      |      |      |      |      |
| Traffic Volume (veh/h)       | 330   | 1100 | 10   | 40   | 870  | 190  | 20   | 20   | 50   | 350  | 10   | 490  |
| Future Volume (veh/h)        | 330   | 1100 | 10   | 40   | 870  | 190  | 20   | 20   | 50   | 350  | 10   | 490  |
| Number                       | 5     | 2    | 12   | 1    | 6    | 16   | 3    | 8    | 18   | 7    | 4    | 14   |
| Initial Q (Qb), veh          | 0     | 0    | 0    | 0    | 0    | 0    | 0    | 0    | 0    | 0    | 0    | 0    |
| Ped-Bike Adj(A_pbT)          | 1.00  |      | 1.00 | 1.00 |      | 1.00 | 1.00 |      | 1.00 | 1.00 |      | 1.00 |
| Parking Bus, Adj             | 1.00  | 1.00 | 1.00 | 1.00 | 1.00 | 1.00 | 1.00 | 1.00 | 1.00 | 1.00 | 1.00 | 1.00 |
| Adj Sat Flow, veh/h/ln       | 1863  | 1863 | 1900 | 1827 | 1827 | 1900 | 1900 | 1900 | 1900 | 1881 | 1881 | 1881 |
| Adj Flow Rate, veh/h         | 367   | 1222 | 11   | 44   | 967  | 202  | 22   | 22   | 55   | 389  | 11   | 268  |
| Adj No. of Lanes             | 1     | 2    | 0    | 1    | 2    | 0    | 0    | 1    | 0    | 1    | 1    | 1    |
| Peak Hour Factor             | 0.90  | 0.90 | 0.90 | 0.90 | 0.90 | 0.90 | 0.90 | 0.90 | 0.90 | 0.90 | 0.90 | 0.90 |
| Percent Heavy Veh, %         | 2     | 2    | 2    | 4    | 4    | 4    | 0    | 0    | 0    | 1    | 1    | 1    |
| Cap, veh/h                   | 220   | 1912 | 17   | 56   | 1258 | 262  | 123  | 132  | 264  | 489  | 572  | 486  |
| Arrive On Green              | 0.12  | 0.53 | 0.53 | 0.03 | 0.44 | 0.44 | 0.30 | 0.30 | 0.30 | 0.30 | 0.30 | 0.30 |
| Sat Flow, veh/h              | 1774  | 3594 | 32   | 1740 | 2861 | 597  | 261  | 434  | 869  | 1330 | 1881 | 1599 |
| Grp Volume(v), veh/h         | 367   | 602  | 631  | 44   | 586  | 583  | 99   | 0    | 0    | 389  | 11   | 268  |
| Grp Sat Flow(s),veh/h/ln     | 1774  | 1770 | 1857 | 1740 | 1736 | 1722 | 1564 | 0    | 0    | 1330 | 1881 | 1599 |
| Q Serve(g_s), s              | 12.4  | 24.1 | 24.1 | 2.5  | 28.6 | 28.7 | 0.0  | 0.0  | 0.0  | 23.2 | 0.4  | 14.0 |
| Cycle Q Clear(g_c), s        | 12.4  | 24.1 | 24.1 | 2.5  | 28.6 | 28.7 | 4.2  | 0.0  | 0.0  | 27.4 | 0.4  | 14.0 |
| Prop In Lane                 | 1.00  |      | 0.02 | 1.00 |      | 0.35 | 0.22 |      | 0.56 | 1.00 |      | 1.00 |
| Lane Grp Cap(c), veh/h       | 220   | 941  | 988  | 56   | 763  | 757  | 520  | 0    | 0    | 489  | 572  | 486  |
| V/C Ratio(X)                 | 1.67  | 0.64 | 0.64 | 0.79 | 0.77 | 0.77 | 0.19 | 0.00 | 0.00 | 0.79 | 0.02 | 0.55 |
| Avail Cap(c_a), veh/h        | 220   | 941  | 988  | 216  | 763  | 757  | 671  | 0    | 0    | 622  | 760  | 646  |
| HCM Platoon Ratio            | 1.00  | 1.00 | 1.00 | 1.00 | 1.00 | 1.00 | 1.00 | 1.00 | 1.00 | 1.00 | 1.00 | 1.00 |
| Upstream Filter(I)           | 0.43  | 0.43 | 0.43 | 0.09 | 0.09 | 0.09 | 1.00 | 0.00 | 0.00 | 0.56 | 0.56 | 0.56 |
| Uniform Delay (d), s/veh     | 43.8  | 16.6 | 16.6 | 48.1 | 23.7 | 23.7 | 25.7 | 0.0  | 0.0  | 33.4 | 24.4 | 29.1 |
| Incr Delay (d2), s/veh       | 309.4 | 1.5  | 1.4  | 0.9  | 0.7  | 0.7  | 0.1  | 0.0  | 0.0  | 2.4  | 0.0  | 0.2  |
| Initial Q Delay(d3),s/veh    | 0.0   | 0.0  | 0.0  | 0.0  | 0.0  | 0.0  | 0.0  | 0.0  | 0.0  | 0.0  | 0.0  | 0.0  |
| %ile BackOfQ(50%),veh/ln     | 25.0  | 12.1 | 12.7 | 1.2  | 13.8 | 13.7 | 2.0  | 0.0  | 0.0  | 10.7 | 0.2  | 6.2  |
| LnGrp Delay(d),s/veh         | 353.2 | 18.0 | 18.0 | 49.0 | 24.4 | 24.4 | 25.7 | 0.0  | 0.0  | 35.8 | 24.4 | 29.3 |
| LnGrp LOS                    | F     | B    | B    | D    | C    | C    | C    |      |      | D    | C    | C    |
| Approach Vol, veh/h          |       | 1600 |      |      | 1213 |      |      | 99   |      |      | 668  |      |
| Approach Delay, s/veh        |       | 94.9 |      |      | 25.3 |      |      | 25.7 |      |      | 33.0 |      |
| Approach LOS                 |       | F    |      |      | C    |      |      | C    |      |      | C    |      |
| Timer                        | 1     | 2    | 3    | 4    | 5    | 6    | 7    | 8    |      |      |      |      |
| Assigned Phs                 | 1     | 2    |      | 4    | 5    | 6    |      | 8    |      |      |      |      |
| Phs Duration (G+Y+Rc), s     | 7.2   | 57.8 |      | 35.0 | 16.4 | 48.6 |      | 35.0 |      |      |      |      |
| Change Period (Y+Rc), s      | 4.0   | 4.6  |      | 4.6  | 4.0  | 4.6  |      | 4.6  |      |      |      |      |
| Max Green Setting (Gmax), s  | 2.4   | 34.0 |      | 40.4 | 12.4 | 24.4 |      | 40.4 |      |      |      |      |
| Max Q Clear Time (g_c+14), s | 14.5  | 26.1 |      | 29.4 | 14.4 | 30.7 |      | 6.2  |      |      |      |      |
| Green Ext Time (p_c), s      | 0.0   | 3.3  |      | 1.0  | 0.0  | 0.0  |      | 0.4  |      |      |      |      |
| <b>Intersection Summary</b>  |       |      |      |      |      |      |      |      |      |      |      |      |
| HCM 2010 Ctrl Delay          |       |      |      | 57.8 |      |      |      |      |      |      |      |      |
| HCM 2010 LOS                 |       |      |      | E    |      |      |      |      |      |      |      |      |

HCM 2010 Signalized Intersection Summary Cumulative with Eastside Parkway with Project, AM  
 33: General Jim Moore Boulevard & Lightfighter Drive

06/11/2019



| Movement                    | EBL  | EBT  | EBR   | WBL  | WBT  | WBR  | NBL   | NBT   | NBR  | SBL  | SBT  | SBR  |
|-----------------------------|------|------|-------|------|------|------|-------|-------|------|------|------|------|
| Lane Configurations         |      |      |       |      |      |      |       |       |      |      |      |      |
| Traffic Volume (veh/h)      | 50   | 280  | 830   | 20   | 170  | 70   | 960   | 60    | 10   | 40   | 50   | 20   |
| Future Volume (veh/h)       | 50   | 280  | 830   | 20   | 170  | 70   | 960   | 60    | 10   | 40   | 50   | 20   |
| Number                      | 3    | 8    | 18    | 7    | 4    | 14   | 1     | 6     | 16   | 5    | 2    | 12   |
| Initial Q (Qb), veh         | 0    | 0    | 0     | 0    | 0    | 0    | 0     | 0     | 0    | 0    | 0    | 0    |
| Ped-Bike Adj(A_pbT)         | 1.00 |      | 1.00  | 1.00 |      | 1.00 | 1.00  |       | 1.00 | 1.00 |      | 1.00 |
| Parking Bus, Adj            | 1.00 | 1.00 | 1.00  | 1.00 | 1.00 | 1.00 | 1.00  | 1.00  | 1.00 | 1.00 | 1.00 | 1.00 |
| Adj Sat Flow, veh/h/ln      | 1863 | 1863 | 1863  | 1792 | 1792 | 1900 | 1881  | 1881  | 1900 | 1863 | 1863 | 1900 |
| Adj Flow Rate, veh/h        | 56   | 315  | 0     | 22   | 191  | 77   | 1079  | 67    | 10   | 45   | 56   | 22   |
| Adj No. of Lanes            | 1    | 1    | 1     | 1    | 1    | 0    | 2     | 1     | 0    | 1    | 2    | 0    |
| Peak Hour Factor            | 0.89 | 0.89 | 0.89  | 0.89 | 0.89 | 0.89 | 0.89  | 0.89  | 0.89 | 0.89 | 0.89 | 0.89 |
| Percent Heavy Veh, %        | 2    | 2    | 2     | 6    | 6    | 6    | 1     | 1     | 1    | 2    | 2    | 2    |
| Cap, veh/h                  | 78   | 467  | 397   | 36   | 277  | 111  | 735   | 495   | 74   | 67   | 343  | 127  |
| Arrive On Green             | 0.04 | 0.25 | 0.00  | 0.02 | 0.23 | 0.23 | 0.21  | 0.31  | 0.31 | 0.04 | 0.14 | 0.14 |
| Sat Flow, veh/h             | 1774 | 1863 | 1583  | 1707 | 1214 | 489  | 3476  | 1600  | 239  | 1774 | 2524 | 938  |
| Grp Volume(v), veh/h        | 56   | 315  | 0     | 22   | 0    | 268  | 1079  | 0     | 77   | 45   | 38   | 40   |
| Grp Sat Flow(s),veh/h/ln    | 1774 | 1863 | 1583  | 1707 | 0    | 1704 | 1738  | 0     | 1839 | 1774 | 1770 | 1692 |
| Q Serve(g_s), s             | 1.5  | 7.2  | 0.0   | 0.6  | 0.0  | 6.8  | 10.0  | 0.0   | 1.4  | 1.2  | 0.9  | 1.0  |
| Cycle Q Clear(g_c), s       | 1.5  | 7.2  | 0.0   | 0.6  | 0.0  | 6.8  | 10.0  | 0.0   | 1.4  | 1.2  | 0.9  | 1.0  |
| Prop In Lane                | 1.00 |      | 1.00  | 1.00 |      | 0.29 | 1.00  |       | 0.13 | 1.00 |      | 0.55 |
| Lane Grp Cap(c), veh/h      | 78   | 467  | 397   | 36   | 0    | 388  | 735   | 0     | 569  | 67   | 240  | 230  |
| V/C Ratio(X)                | 0.72 | 0.67 | 0.00  | 0.61 | 0.00 | 0.69 | 1.47  | 0.00  | 0.14 | 0.67 | 0.16 | 0.17 |
| Avail Cap(c_a), veh/h       | 751  | 1182 | 1005  | 722  | 0    | 1081 | 735   | 0     | 1167 | 563  | 1123 | 1074 |
| HCM Platoon Ratio           | 1.00 | 1.00 | 1.00  | 1.00 | 1.00 | 1.00 | 1.00  | 1.00  | 1.00 | 1.00 | 1.00 | 1.00 |
| Upstream Filter(I)          | 1.00 | 1.00 | 0.00  | 1.00 | 0.00 | 1.00 | 1.00  | 0.00  | 1.00 | 1.00 | 1.00 | 1.00 |
| Uniform Delay (d), s/veh    | 22.3 | 16.0 | 0.0   | 22.9 | 0.0  | 16.7 | 18.6  | 0.0   | 11.8 | 22.5 | 18.0 | 18.1 |
| Incr Delay (d2), s/veh      | 11.5 | 2.1  | 0.0   | 5.9  | 0.0  | 2.7  | 217.8 | 0.0   | 0.2  | 4.3  | 0.4  | 0.4  |
| Initial Q Delay(d3),s/veh   | 0.0  | 0.0  | 0.0   | 0.0  | 0.0  | 0.0  | 0.0   | 0.0   | 0.0  | 0.0  | 0.0  | 0.0  |
| %ile BackOfQ(50%),veh/ln    | 1.0  | 3.9  | 0.0   | 0.3  | 0.0  | 3.5  | 26.9  | 0.0   | 0.8  | 0.7  | 0.5  | 0.5  |
| LnGrp Delay(d),s/veh        | 33.8 | 18.0 | 0.0   | 28.9 | 0.0  | 19.4 | 236.4 | 0.0   | 12.0 | 26.7 | 18.4 | 18.5 |
| LnGrp LOS                   | C    | B    |       | C    |      | B    | F     |       | B    | C    | B    | B    |
| Approach Vol, veh/h         |      | 371  |       |      | 290  |      |       | 1156  |      |      | 123  |      |
| Approach Delay, s/veh       |      | 20.4 |       |      | 20.1 |      |       | 221.5 |      |      | 21.5 |      |
| Approach LOS                |      | C    |       |      | C    |      |       | F     |      |      | C    |      |
| Timer                       | 1    | 2    | 3     | 4    | 5    | 6    | 7     | 8     |      |      |      |      |
| Assigned Phs                | 1    | 2    | 3     | 4    | 5    | 6    | 7     | 8     |      |      |      |      |
| Phs Duration (G+Y+Rc), s    | 4.5  | 10.9 | 6.6   | 15.3 | 6.3  | 19.1 | 5.5   | 16.3  |      |      |      |      |
| Change Period (Y+Rc), s     | 4.5  | 4.5  | 4.5   | 4.5  | 4.5  | 4.5  | 4.5   | 4.5   |      |      |      |      |
| Max Green Setting (Gmax), s | 30.0 | 30.0 | 20.0  | 30.0 | 15.0 | 30.0 | 20.0  | 30.0  |      |      |      |      |
| Max Q Clear Time (g_c+1), s | 3.0  | 3.5  | 8.8   | 3.2  | 3.4  | 2.6  | 9.2   |       |      |      |      |      |
| Green Ext Time (p_c), s     | 0.0  | 0.4  | 0.1   | 2.0  | 0.0  | 0.6  | 0.0   | 2.0   |      |      |      |      |
| <b>Intersection Summary</b> |      |      |       |      |      |      |       |       |      |      |      |      |
| HCM 2010 Ctrl Delay         |      |      | 140.2 |      |      |      |       |       |      |      |      |      |
| HCM 2010 LOS                |      |      | F     |      |      |      |       |       |      |      |      |      |

**Intersection**

Intersection Delay, s/veh 12.5

Intersection LOS B

| Movement            | WBL  | WBR  | NBT  | NBR  | SBL  | SBT  |
|---------------------|------|------|------|------|------|------|
| Lane Configurations |      |      |      |      |      |      |
| Traffic Vol, veh/h  | 20   | 200  | 60   | 10   | 260  | 70   |
| Future Vol, veh/h   | 20   | 200  | 60   | 10   | 260  | 70   |
| Peak Hour Factor    | 0.77 | 0.77 | 0.77 | 0.77 | 0.77 | 0.77 |
| Heavy Vehicles, %   | 4    | 4    | 3    | 3    | 2    | 2    |
| Mvmt Flow           | 26   | 260  | 78   | 13   | 338  | 91   |
| Number of Lanes     | 1    | 0    | 1    | 0    | 0    | 1    |

| Approach                      | WB   | NB  | SB   |
|-------------------------------|------|-----|------|
| Opposing Approach             |      | SB  | NB   |
| Opposing Lanes                | 0    | 1   | 1    |
| Conflicting Approach Left NB  |      |     | WB   |
| Conflicting Lanes Left        | 1    | 0   | 1    |
| Conflicting Approach Right SB |      | WB  |      |
| Conflicting Lanes Right       | 1    | 1   | 0    |
| HCM Control Delay             | 10.6 | 8.9 | 14.6 |
| HCM LOS                       | B    | A   | B    |

| Lane                   | NBLn1 | WBLn1 | SBLn1 |
|------------------------|-------|-------|-------|
| Vol Left, %            | 0%    | 9%    | 79%   |
| Vol Thru, %            | 86%   | 0%    | 21%   |
| Vol Right, %           | 14%   | 91%   | 0%    |
| Sign Control           | Stop  | Stop  | Stop  |
| Traffic Vol by Lane    | 70    | 220   | 330   |
| LT Vol                 | 0     | 20    | 260   |
| Through Vol            | 60    | 0     | 70    |
| RT Vol                 | 10    | 200   | 0     |
| Lane Flow Rate         | 91    | 286   | 429   |
| Geometry Grp           | 1     | 1     | 1     |
| Degree of Util (X)     | 0.128 | 0.374 | 0.582 |
| Departure Headway (Hd) | 5.086 | 4.709 | 4.886 |
| Convergence, Y/N       | Yes   | Yes   | Yes   |
| Cap                    | 696   | 760   | 733   |
| Service Time           | 3.18  | 2.771 | 2.958 |
| HCM Lane V/C Ratio     | 0.131 | 0.376 | 0.585 |
| HCM Control Delay      | 8.9   | 10.6  | 14.6  |
| HCM Lane LOS           | A     | B     | B     |
| HCM 95th-tile Q        | 0.4   | 1.7   | 3.8   |

| Intersection             |      |      |      |      |      |      |
|--------------------------|------|------|------|------|------|------|
| Int Delay, s/veh         | 1.7  |      |      |      |      |      |
| Movement                 | EBT  | EBR  | WBL  | WBT  | NBL  | NBR  |
| Lane Configurations      |      |      |      |      |      |      |
| Traffic Vol, veh/h       | 240  | 30   | 20   | 190  | 30   | 30   |
| Future Vol, veh/h        | 240  | 30   | 20   | 190  | 30   | 30   |
| Conflicting Peds, #/hr   | 0    | 0    | 0    | 0    | 0    | 0    |
| Sign Control             | Free | Free | Free | Free | Stop | Stop |
| RT Channelized           | -    | None | -    | None | -    | None |
| Storage Length           | -    | -    | -    | -    | 0    | -    |
| Veh in Median Storage, # | 0    | -    | -    | 0    | 0    | -    |
| Grade, %                 | 0    | -    | -    | 0    | 0    | -    |
| Peak Hour Factor         | 78   | 78   | 78   | 78   | 78   | 78   |
| Heavy Vehicles, %        | 5    | 5    | 4    | 4    | 0    | 0    |
| Mvmt Flow                | 308  | 38   | 26   | 244  | 38   | 38   |

| Major/Minor          | Major1 | Major2 | Minor1 |   |     |
|----------------------|--------|--------|--------|---|-----|
| Conflicting Flow All | 0      | 0      | 346    | 0 | 623 |
| Stage 1              | -      | -      | -      | - | 327 |
| Stage 2              | -      | -      | -      | - | 296 |
| Critical Hdwy        | -      | -      | 4.14   | - | 6.4 |
| Critical Hdwy Stg 1  | -      | -      | -      | - | 5.4 |
| Critical Hdwy Stg 2  | -      | -      | -      | - | 5.4 |
| Follow-up Hdwy       | -      | -      | 2.236  | - | 3.5 |
| Pot Cap-1 Maneuver   | -      | -      | 1202   | - | 453 |
| Stage 1              | -      | -      | -      | - | 735 |
| Stage 2              | -      | -      | -      | - | 759 |
| Platoon blocked, %   | -      | -      | -      | - | -   |
| Mov Cap-1 Maneuver   | -      | -      | 1202   | - | 442 |
| Mov Cap-2 Maneuver   | -      | -      | -      | - | 442 |
| Stage 1              | -      | -      | -      | - | 717 |
| Stage 2              | -      | -      | -      | - | 759 |

| Approach             | EB | WB  | NB   |
|----------------------|----|-----|------|
| HCM Control Delay, s | 0  | 0.8 | 12.7 |
| HCM LOS              |    |     | B    |

| Minor Lane/Major Mvmt | NBLn1 | EBT | EBR | WBL   | WBT |
|-----------------------|-------|-----|-----|-------|-----|
| Capacity (veh/h)      | 547   | -   | -   | 1202  | -   |
| HCM Lane V/C Ratio    | 0.141 | -   | -   | 0.021 | -   |
| HCM Control Delay (s) | 12.7  | -   | -   | 8.1   | 0   |
| HCM Lane LOS          | B     | -   | -   | A     | A   |
| HCM 95th %tile Q(veh) | 0.5   | -   | -   | 0.1   | -   |

| Intersection              |      |
|---------------------------|------|
| Intersection Delay, s/veh | 12.3 |
| Intersection LOS          | B    |

| Movement            | EBL  | EBT  | EBR  | WBL  | WBT  | WBR  | NBL  | NBT  | NBR  | SBL  | SBT  | SBR  |
|---------------------|------|------|------|------|------|------|------|------|------|------|------|------|
| Lane Configurations |      | ↕    |      |      | ↕    |      |      | ↕    |      |      | ↕    |      |
| Traffic Vol, veh/h  | 10   | 230  | 30   | 10   | 120  | 10   | 50   | 100  | 20   | 10   | 80   | 40   |
| Future Vol, veh/h   | 10   | 230  | 30   | 10   | 120  | 10   | 50   | 100  | 20   | 10   | 80   | 40   |
| Peak Hour Factor    | 0.79 | 0.79 | 0.79 | 0.79 | 0.79 | 0.79 | 0.79 | 0.79 | 0.79 | 0.79 | 0.79 | 0.79 |
| Heavy Vehicles, %   | 6    | 6    | 6    | 4    | 4    | 4    | 20   | 20   | 20   | 2    | 2    | 2    |
| Mvmt Flow           | 13   | 291  | 38   | 13   | 152  | 13   | 63   | 127  | 25   | 13   | 101  | 51   |
| Number of Lanes     | 0    | 1    | 0    | 0    | 1    | 0    | 0    | 1    | 0    | 0    | 1    | 0    |

| Approach                   | EB   | WB   | NB   | SB   |
|----------------------------|------|------|------|------|
| Opposing Approach          | WB   | EB   | SB   | NB   |
| Opposing Lanes             | 1    | 1    | 1    | 1    |
| Conflicting Approach Left  | SB   | NB   | EB   | WB   |
| Conflicting Lanes Left     | 1    | 1    | 1    | 1    |
| Conflicting Approach Right | NB   | SB   | WB   | EB   |
| Conflicting Lanes Right    | 1    | 1    | 1    | 1    |
| HCM Control Delay          | 13.9 | 10.8 | 12.3 | 10.6 |
| HCM LOS                    | B    | B    | B    | B    |

| Lane                   | NBLn1 | EBLn1 | WBLn1 | SBLn1 |
|------------------------|-------|-------|-------|-------|
| Vol Left, %            | 29%   | 4%    | 7%    | 8%    |
| Vol Thru, %            | 59%   | 85%   | 86%   | 62%   |
| Vol Right, %           | 12%   | 11%   | 7%    | 31%   |
| Sign Control           | Stop  | Stop  | Stop  | Stop  |
| Traffic Vol by Lane    | 170   | 270   | 140   | 130   |
| LT Vol                 | 50    | 10    | 10    | 10    |
| Through Vol            | 100   | 230   | 120   | 80    |
| RT Vol                 | 20    | 30    | 10    | 40    |
| Lane Flow Rate         | 215   | 342   | 177   | 165   |
| Geometry Grp           | 1     | 1     | 1     | 1     |
| Degree of Util (X)     | 0.356 | 0.509 | 0.277 | 0.257 |
| Departure Headway (Hd) | 5.958 | 5.363 | 5.626 | 5.614 |
| Convergence, Y/N       | Yes   | Yes   | Yes   | Yes   |
| Cap                    | 603   | 670   | 636   | 637   |
| Service Time           | 4.014 | 3.411 | 3.683 | 3.672 |
| HCM Lane V/C Ratio     | 0.357 | 0.51  | 0.278 | 0.259 |
| HCM Control Delay      | 12.3  | 13.9  | 10.8  | 10.6  |
| HCM Lane LOS           | B     | B     | B     | B     |
| HCM 95th-tile Q        | 1.6   | 2.9   | 1.1   | 1     |



| Intersection             |      |      |      |      |      |      |      |      |      |      |      |      |
|--------------------------|------|------|------|------|------|------|------|------|------|------|------|------|
| Int Delay, s/veh         | 10   |      |      |      |      |      |      |      |      |      |      |      |
| Movement                 | EBL  | EBT  | EBR  | WBL  | WBT  | WBR  | NBL  | NBT  | NBR  | SBL  | SBT  | SBR  |
| Lane Configurations      |      | ↕    |      |      | ↕    |      |      | ↕    |      |      | ↕    |      |
| Traffic Vol, veh/h       | 80   | 80   | 90   | 10   | 70   | 20   | 50   | 120  | 20   | 0    | 0    | 0    |
| Future Vol, veh/h        | 80   | 80   | 90   | 10   | 70   | 20   | 50   | 120  | 20   | 0    | 0    | 0    |
| Conflicting Peds, #/hr   | 0    | 0    | 0    | 0    | 0    | 0    | 0    | 0    | 1    | 1    | 0    | 0    |
| Sign Control             | Stop | Stop | Stop | Stop | Stop | Stop | Free | Free | Free | Free | Free | Free |
| RT Channelized           | -    | -    | None | -    | -    | None | -    | -    | None | -    | -    | None |
| Storage Length           | -    | -    | -    | -    | -    | -    | -    | -    | -    | -    | -    | -    |
| Veh in Median Storage, # | -    | 0    | -    | -    | 0    | -    | -    | 0    | -    | -    | 0    | -    |
| Grade, %                 | -    | 0    | -    | -    | 0    | -    | -    | 0    | -    | -    | 0    | -    |
| Peak Hour Factor         | 82   | 82   | 82   | 82   | 82   | 82   | 82   | 82   | 82   | 82   | 82   | 82   |
| Heavy Vehicles, %        | 12   | 12   | 12   | 0    | 0    | 0    | 10   | 10   | 10   | 10   | 10   | 10   |
| Mvmt Flow                | 98   | 98   | 110  | 12   | 85   | 24   | 61   | 146  | 24   | 0    | 0    | 0    |

| Major/Minor          | Minor2 |       | Minor1 |     | Major1 |     |      | Major2 |   |      |   |   |
|----------------------|--------|-------|--------|-----|--------|-----|------|--------|---|------|---|---|
| Conflicting Flow All | 336    | 294   | 1      | 386 | 282    | 159 | 1    | 0      | 0 | 171  | 0 | 0 |
| Stage 1              | 1      | 1     | -      | 281 | 281    | -   | -    | -      | - | -    | - | - |
| Stage 2              | 335    | 293   | -      | 105 | 1      | -   | -    | -      | - | -    | - | - |
| Critical Hdwy        | 7.22   | 6.62  | 6.32   | 7.1 | 6.5    | 6.2 | 4.2  | -      | - | 4.2  | - | - |
| Critical Hdwy Stg 1  | 6.22   | 5.62  | -      | 6.1 | 5.5    | -   | -    | -      | - | -    | - | - |
| Critical Hdwy Stg 2  | 6.22   | 5.62  | -      | 6.1 | 5.5    | -   | -    | -      | - | -    | - | - |
| Follow-up Hdwy       | 3.608  | 4.108 | 3.408  | 3.5 | 4      | 3.3 | 2.29 | -      | - | 2.29 | - | - |
| Pot Cap-1 Maneuver   | 599    | 601   | 1055   | 576 | 630    | 892 | 1571 | -      | - | 1359 | - | - |
| Stage 1              | 997    | 875   | -      | 730 | 682    | -   | -    | -      | - | -    | - | - |
| Stage 2              | 658    | 653   | -      | 906 | 899    | -   | -    | -      | - | -    | - | - |
| Platoon blocked, %   |        |       |        |     |        |     |      | -      | - | -    | - | - |
| Mov Cap-1 Maneuver   | 503    | 575   | 1055   | 434 | 602    | 891 | 1571 | -      | - | 1358 | - | - |
| Mov Cap-2 Maneuver   | 503    | 575   | -      | 434 | 602    | -   | -    | -      | - | -    | - | - |
| Stage 1              | 954    | 875   | -      | 698 | 652    | -   | -    | -      | - | -    | - | - |
| Stage 2              | 532    | 624   | -      | 721 | 899    | -   | -    | -      | - | -    | - | - |

| Approach             | EB   |  | WB   |  | NB  |  | SB |  |
|----------------------|------|--|------|--|-----|--|----|--|
| HCM Control Delay, s | 15.3 |  | 12.3 |  | 1.9 |  | 0  |  |
| HCM LOS              | C    |  | B    |  |     |  |    |  |

| Minor Lane/Major Mvmt | NBL   | NBT | NBR | EBLn1WBLn1 | SBL   | SBT  | SBR |
|-----------------------|-------|-----|-----|------------|-------|------|-----|
| Capacity (veh/h)      | 1571  | -   | -   | 652        | 618   | 1358 | -   |
| HCM Lane V/C Ratio    | 0.039 | -   | -   | 0.468      | 0.197 | -    | -   |
| HCM Control Delay (s) | 7.4   | 0   | -   | 15.3       | 12.3  | 0    | -   |
| HCM Lane LOS          | A     | A   | -   | C          | B     | A    | -   |
| HCM 95th %tile Q(veh) | 0.1   | -   | -   | 2.5        | 0.7   | 0    | -   |

| Intersection             |      |      |      |      |      |      |
|--------------------------|------|------|------|------|------|------|
| Int Delay, s/veh         | 3    |      |      |      |      |      |
| Movement                 | EBL  | EBR  | NBL  | NBT  | SBT  | SBR  |
| Lane Configurations      | T    |      |      | T    |      | T    |
| Traffic Vol, veh/h       | 100  | 10   | 10   | 230  | 510  | 100  |
| Future Vol, veh/h        | 100  | 10   | 10   | 230  | 510  | 100  |
| Conflicting Peds, #/hr   | 0    | 0    | 0    | 0    | 0    | 0    |
| Sign Control             | Stop | Stop | Free | Free | Free | Free |
| RT Channelized           | -    | None | -    | None | -    | None |
| Storage Length           | 0    | -    | -    | -    | -    | -    |
| Veh in Median Storage, # | 0    | -    | -    | 0    | 0    | -    |
| Grade, %                 | 0    | -    | -    | 0    | 0    | -    |
| Peak Hour Factor         | 89   | 89   | 89   | 89   | 89   | 89   |
| Heavy Vehicles, %        | 13   | 13   | 2    | 2    | 0    | 0    |
| Mvmt Flow                | 112  | 11   | 11   | 258  | 573  | 112  |























| Major/Minor          | Minor2 | Major1 | Major2 |   |   |   |
|----------------------|--------|--------|--------|---|---|---|
| Conflicting Flow All | 909    | 629    | 685    | 0 | - | 0 |
| Stage 1              | 629    | -      | -      | - | - | - |
| Stage 2              | 280    | -      | -      | - | - | - |
| Critical Hdwy        | 6.53   | 6.33   | 4.12   | - | - | - |
| Critical Hdwy Stg 1  | 5.53   | -      | -      | - | - | - |
| Critical Hdwy Stg 2  | 5.53   | -      | -      | - | - | - |
| Follow-up Hdwy       | 3.617  | 3.417  | 2.218  | - | - | - |
| Pot Cap-1 Maneuver   | 292    | 463    | 908    | - | - | - |
| Stage 1              | 511    | -      | -      | - | - | - |
| Stage 2              | 743    | -      | -      | - | - | - |
| Platoon blocked, %   |        |        |        | - | - | - |
| Mov Cap-1 Maneuver   | 288    | 463    | 908    | - | - | - |
| Mov Cap-2 Maneuver   | 288    | -      | -      | - | - | - |
| Stage 1              | 504    | -      | -      | - | - | - |
| Stage 2              | 743    | -      | -      | - | - | - |

| Approach             | EB   | NB  | SB |
|----------------------|------|-----|----|
| HCM Control Delay, s | 25.4 | 0.4 | 0  |
| HCM LOS              | D    |     |    |

| Minor Lane/Major Mvmt | NBL   | NBT | EBLn1 | SBT | SBR |
|-----------------------|-------|-----|-------|-----|-----|
| Capacity (veh/h)      | 908   | -   | 298   | -   | -   |
| HCM Lane V/C Ratio    | 0.012 | -   | 0.415 | -   | -   |
| HCM Control Delay (s) | 9     | 0   | 25.4  | -   | -   |
| HCM Lane LOS          | A     | A   | D     | -   | -   |
| HCM 95th %tile Q(veh) | 0     | -   | 2     | -   | -   |

HCM 2010 Signalized Intersection Summary Cumulative with Eastside Parkway with Project, AM  
 39: General Jim Moore Boulevard & Gigling Road

06/11/2019

|                              |  |  |  |  |  |  |  |  |  |  |  |  |
|------------------------------|---|---|---|---|---|---|--|---|---|---|---|---|
| Movement                     | EBL   | EBT   | EBR   | WBL   | WBT   | WBR   | NBL  | NBT   | NBR   | SBL   | SBT   | SBR   |
| Lane Configurations          |  |  |   |  |  |  |  |  |  |  |  |  |
| Traffic Volume (veh/h)       | 30  | 100   | 80  | 460   | 40  | 630   | 50   | 340   | 300   | 430   | 470   | 50  |
| Future Volume (veh/h)        | 30  | 100   | 80  | 460   | 40  | 630   | 50   | 340   | 300   | 430   | 470   | 50  |
| Number                       | 3   | 8   | 18  | 7   | 4   | 14  | 1  | 6   | 16  | 5   | 2   | 12  |
| Initial Q (Qb), veh          | 0   | 0   | 0   | 0   | 0   | 0   | 0  | 0   | 0   | 0   | 0   | 0   |
| Ped-Bike Adj(A_pbT)          | 1.00  |   | 1.00  | 1.00  |   | 1.00  | 1.00   |   | 1.00  | 1.00  |   | 1.00  |
| Parking Bus, Adj             | 1.00  | 1.00  | 1.00  | 1.00  | 1.00  | 1.00  | 1.00   | 1.00  | 1.00  | 1.00  | 1.00  | 1.00  |
| Adj Sat Flow, veh/h/ln       | 1810  | 1810  | 1900  | 1863  | 1863  | 1863  | 1881   | 1881  | 1881  | 1863  | 1863  | 1863  |
| Adj Flow Rate, veh/h         | 34  | 115   | 60  | 529   | 46  | 0   | 57   | 391   | 0   | 494   | 540   | 0   |
| Adj No. of Lanes             | 1   | 2   | 0   | 1   | 2   | 1   | 1  | 2   | 1   | 1   | 2   | 1   |
| Peak Hour Factor             | 0.87  | 0.87  | 0.87  | 0.87  | 0.87  | 0.87  | 0.87   | 0.87  | 0.87  | 0.87  | 0.87  | 0.87  |
| Percent Heavy Veh, %         | 5   | 5   | 5   | 2   | 2   | 2   | 1  | 1   | 1   | 2   | 2   | 2   |
| Cap, veh/h                   | 60  | 194   | 95  | 520   | 1223  | 547   | 86   | 503   | 225   | 393   | 1113  | 498   |
| Arrive On Green              | 0.03  | 0.09  | 0.09  | 0.29  | 0.35  | 0.00  | 0.05   | 0.14  | 0.00  | 0.22  | 0.31  | 0.00  |
| Sat Flow, veh/h              | 1723  | 2232  | 1098  | 1774  | 3539  | 1583  | 1792   | 3574  | 1599  | 1774  | 3539  | 1583  |
| Grp Volume(v), veh/h         | 34  | 87  | 88  | 529   | 46  | 0   | 57   | 391   | 0   | 494   | 540   | 0   |
| Grp Sat Flow(s),veh/h/ln     | 1723  | 1719  | 1611  | 1774  | 1770  | 1583  | 1792   | 1787  | 1599  | 1774  | 1770  | 1583  |
| Q Serve(g_s), s              | 1.4   | 3.4   | 3.7   | 20.5  | 0.6   | 0.0   | 2.2  | 7.4   | 0.0   | 15.5  | 8.6   | 0.0   |
| Cycle Q Clear(g_c), s        | 1.4   | 3.4   | 3.7   | 20.5  | 0.6   | 0.0   | 2.2  | 7.4   | 0.0   | 15.5  | 8.6   | 0.0   |
| Prop In Lane                 | 1.00  |   | 0.68  | 1.00  |   | 1.00  | 1.00   |   | 1.00  | 1.00  |   | 1.00  |
| Lane Grp Cap(c), veh/h       | 60  | 149   | 140   | 520   | 1223  | 547   | 86   | 503   | 225   | 393   | 1113  | 498   |
| V/C Ratio(X)                 | 0.57  | 0.58  | 0.63  | 1.02  | 0.04  | 0.00  | 0.66   | 0.78  | 0.00  | 1.26  | 0.49  | 0.00  |
| Avail Cap(c_a), veh/h        | 259   | 762   | 715   | 520   | 2076  | 929   | 141  | 1278  | 572   | 393   | 1772  | 793   |
| HCM Platoon Ratio            | 1.00  | 1.00  | 1.00  | 1.00  | 1.00  | 1.00  | 1.00   | 1.00  | 1.00  | 1.00  | 1.00  | 1.00  |
| Upstream Filter(I)           | 1.00  | 1.00  | 1.00  | 1.00  | 1.00  | 0.00  | 1.00   | 1.00  | 0.00  | 1.00  | 1.00  | 0.00  |
| Uniform Delay (d), s/veh     | 33.2  | 30.7  | 30.8  | 24.7  | 15.2  | 0.0   | 32.7   | 29.0  | 0.0   | 27.2  | 19.4  | 0.0   |
| Incr Delay (d2), s/veh       | 3.2   | 1.3   | 1.7   | 43.7  | 0.0   | 0.0   | 3.3  | 1.0   | 0.0   | 134.3   | 0.1   | 0.0   |
| Initial Q Delay(d3),s/veh    | 0.0   | 0.0   | 0.0   | 0.0   | 0.0   | 0.0   | 0.0  | 0.0   | 0.0   | 0.0   | 0.0   | 0.0   |
| %ile BackOfQ(50%),veh/ln     | 0.7   | 1.7   | 1.7   | 16.1  | 0.3   | 0.0   | 1.2  | 3.7   | 0.0   | 22.1  | 4.2   | 0.0   |
| LnGrp Delay(d),s/veh         | 36.4  | 32.0  | 32.6  | 68.4  | 15.2  | 0.0   | 36.0   | 30.0  | 0.0   | 161.5   | 19.5  | 0.0   |
| LnGrp LOS                    | D   | C   | C   | F   | B   |   | D  | C   |   | F   | B   |   |
| Approach Vol, veh/h          |   | 209   |   |   | 575   |   |  | 448   |   |   | 1034  |   |
| Approach Delay, s/veh        |   | 33.0  |   |   | 64.2  |   |  | 30.7  |   |   | 87.4  |   |
| Approach LOS                 |   | C   |   |   | E   |   |  | C   |   |   | F   |   |
| Timer                        | 1   | 2   | 3   | 4   | 5   | 6   | 7  | 8   |   |   |   |   |
| Assigned Phs                 | 1   | 2   | 3   | 4   | 5   | 6   | 7  | 8   |   |   |   |   |
| Phs Duration (G+Y+Rc), s     | 7.8   | 26.5  | 6.9   | 28.6  | 20.0  | 14.3  | 25.0   | 10.6  |   |   |   |   |
| Change Period (Y+Rc), s      | 4.5   | 4.5   | 4.5   | 4.5   | 4.5   | 4.5   | 4.5  | 4.5   |   |   |   |   |
| Max Green Setting (Gmax), s  | 5.5   | 35.0  | 10.5  | 41.0  | 15.5  | 25.0  | 20.5   | 31.0  |   |   |   |   |
| Max Q Clear Time (g_c+I1), s | 4.2   | 10.6  | 3.4   | 2.6   | 17.5  | 9.4   | 22.5   | 5.7   |   |   |   |   |
| Green Ext Time (p_c), s      | 0.0   | 0.7   | 0.0   | 0.1   | 0.0   | 0.5   | 0.0  | 0.2   |   |   |   |   |
| <b>Intersection Summary</b>  |   |   |   |   |   |   |  |   |   |   |   |   |
| HCM 2010 Ctrl Delay          |   |   |   | 65.3  |   |   |  |   |   |   |   |   |
| HCM 2010 LOS                 |   |   |   | E   |   |   |  |   |   |   |   |   |

HCM 2010 Signalized Intersection Summary Cumulative with Eastside Parkway with Project, AM  
 40: Malmedy Road & Gigling Road

06/11/2019



| Movement                     | EBL  | EBT  | EBR  | WBL  | WBT  | WBR  | NBL  | NBT  | NBR  | SBL  | SBT  | SBR  |
|------------------------------|------|------|------|------|------|------|------|------|------|------|------|------|
| Lane Configurations          |      | ↔↑   |      |      | ↔↑   |      |      | ↔    |      |      | ↔    |      |
| Traffic Volume (veh/h)       | 10   | 740  | 30   | 50   | 1080 | 20   | 20   | 30   | 30   | 20   | 60   | 20   |
| Future Volume (veh/h)        | 10   | 740  | 30   | 50   | 1080 | 20   | 20   | 30   | 30   | 20   | 60   | 20   |
| Number                       | 7    | 4    | 14   | 3    | 8    | 18   | 5    | 2    | 12   | 1    | 6    | 16   |
| Initial Q (Qb), veh          | 0    | 0    | 0    | 0    | 0    | 0    | 0    | 0    | 0    | 0    | 0    | 0    |
| Ped-Bike Adj(A_pbT)          | 1.00 |      | 1.00 | 1.00 |      | 1.00 | 1.00 |      | 1.00 | 1.00 |      | 1.00 |
| Parking Bus, Adj             | 1.00 | 1.00 | 1.00 | 1.00 | 1.00 | 1.00 | 1.00 | 1.00 | 1.00 | 1.00 | 1.00 | 1.00 |
| Adj Sat Flow, veh/h/ln       | 1900 | 1845 | 1900 | 1900 | 1845 | 1900 | 1900 | 1863 | 1900 | 1900 | 1827 | 1900 |
| Adj Flow Rate, veh/h         | 11   | 841  | 34   | 57   | 1227 | 23   | 23   | 34   | 34   | 23   | 68   | 23   |
| Adj No. of Lanes             | 0    | 2    | 0    | 0    | 2    | 0    | 0    | 1    | 0    | 0    | 1    | 0    |
| Peak Hour Factor             | 0.88 | 0.88 | 0.88 | 0.88 | 0.88 | 0.88 | 0.88 | 0.88 | 0.88 | 0.88 | 0.88 | 0.88 |
| Percent Heavy Veh, %         | 3    | 3    | 3    | 3    | 3    | 3    | 2    | 2    | 2    | 4    | 4    | 4    |
| Cap, veh/h                   | 158  | 1572 | 63   | 195  | 1537 | 29   | 235  | 112  | 96   | 218  | 167  | 52   |
| Arrive On Green              | 0.47 | 0.47 | 0.47 | 0.47 | 0.47 | 0.47 | 0.15 | 0.15 | 0.15 | 0.15 | 0.15 | 0.15 |
| Sat Flow, veh/h              | 12   | 3315 | 133  | 72   | 3241 | 60   | 317  | 723  | 621  | 256  | 1083 | 338  |
| Grp Volume(v), veh/h         | 463  | 0    | 423  | 669  | 0    | 638  | 91   | 0    | 0    | 114  | 0    | 0    |
| Grp Sat Flow(s),veh/h/ln     | 1805 | 0    | 1655 | 1704 | 0    | 1668 | 1661 | 0    | 0    | 1677 | 0    | 0    |
| Q Serve(g_s), s              | 0.0  | 0.0  | 4.4  | 2.4  | 0.0  | 7.9  | 0.0  | 0.0  | 0.0  | 0.3  | 0.0  | 0.0  |
| Cycle Q Clear(g_c), s        | 4.3  | 0.0  | 4.4  | 7.8  | 0.0  | 7.9  | 1.1  | 0.0  | 0.0  | 1.4  | 0.0  | 0.0  |
| Prop In Lane                 | 0.02 |      | 0.08 | 0.09 |      | 0.04 | 0.25 |      | 0.37 | 0.20 |      | 0.20 |
| Lane Grp Cap(c), veh/h       | 1008 | 0    | 785  | 970  | 0    | 791  | 443  | 0    | 0    | 437  | 0    | 0    |
| V/C Ratio(X)                 | 0.46 | 0.00 | 0.54 | 0.69 | 0.00 | 0.81 | 0.21 | 0.00 | 0.00 | 0.26 | 0.00 | 0.00 |
| Avail Cap(c_a), veh/h        | 3766 | 0    | 3448 | 3514 | 0    | 3475 | 2192 | 0    | 0    | 2243 | 0    | 0    |
| HCM Platoon Ratio            | 1.00 | 1.00 | 1.00 | 1.00 | 1.00 | 1.00 | 1.00 | 1.00 | 1.00 | 1.00 | 1.00 | 1.00 |
| Upstream Filter(I)           | 1.00 | 0.00 | 1.00 | 1.00 | 0.00 | 1.00 | 1.00 | 0.00 | 0.00 | 1.00 | 0.00 | 0.00 |
| Uniform Delay (d), s/veh     | 4.5  | 0.0  | 4.5  | 5.3  | 0.0  | 5.4  | 9.1  | 0.0  | 0.0  | 9.3  | 0.0  | 0.0  |
| Incr Delay (d2), s/veh       | 0.1  | 0.0  | 0.2  | 0.3  | 0.0  | 0.8  | 0.1  | 0.0  | 0.0  | 0.1  | 0.0  | 0.0  |
| Initial Q Delay(d3),s/veh    | 0.0  | 0.0  | 0.0  | 0.0  | 0.0  | 0.0  | 0.0  | 0.0  | 0.0  | 0.0  | 0.0  | 0.0  |
| %ile BackOfQ(50%),veh/ln     | 2.1  | 0.0  | 1.9  | 3.6  | 0.0  | 3.7  | 0.5  | 0.0  | 0.0  | 0.7  | 0.0  | 0.0  |
| LnGrp Delay(d),s/veh         | 4.6  | 0.0  | 4.7  | 5.6  | 0.0  | 6.2  | 9.2  | 0.0  | 0.0  | 9.4  | 0.0  | 0.0  |
| LnGrp LOS                    | A    |      | A    | A    |      | A    | A    |      |      | A    |      |      |
| Approach Vol, veh/h          |      | 886  |      |      | 1307 |      |      | 91   |      |      | 114  |      |
| Approach Delay, s/veh        |      | 4.7  |      |      | 5.9  |      |      | 9.2  |      |      | 9.4  |      |
| Approach LOS                 |      | A    |      |      | A    |      |      | A    |      |      | A    |      |
| Timer                        | 1    | 2    | 3    | 4    | 5    | 6    | 7    | 8    |      |      |      |      |
| Assigned Phs                 |      | 2    |      | 4    |      | 6    |      | 8    |      |      |      |      |
| Phs Duration (G+Y+Rc), s     |      | 8.2  |      | 16.0 |      | 8.2  |      | 16.0 |      |      |      |      |
| Change Period (Y+Rc), s      |      | 4.5  |      | 4.5  |      | 4.5  |      | 4.5  |      |      |      |      |
| Max Green Setting (Gmax), s  |      | 30.5 |      | 50.5 |      | 30.5 |      | 50.5 |      |      |      |      |
| Max Q Clear Time (g_c+I1), s |      | 3.1  |      | 6.4  |      | 3.4  |      | 9.9  |      |      |      |      |
| Green Ext Time (p_c), s      |      | 0.1  |      | 0.9  |      | 0.1  |      | 1.6  |      |      |      |      |
| <b>Intersection Summary</b>  |      |      |      |      |      |      |      |      |      |      |      |      |
| HCM 2010 Ctrl Delay          |      |      |      | 5.7  |      |      |      |      |      |      |      |      |
| HCM 2010 LOS                 |      |      |      | A    |      |      |      |      |      |      |      |      |

HCM 2010 Signalized Intersection Summary Cumulative with Eastside Parkway with Project, AM  
 41: Parker Flatts Cut Off Road & Gigling Road

06/11/2019



| Movement                     | EBL  | EBT  | EBR  | WBL  | WBT  | WBR  | NBL  | NBT  | NBR  | SBL  | SBT  | SBR  |
|------------------------------|------|------|------|------|------|------|------|------|------|------|------|------|
| Lane Configurations          |      | ↕↕   |      |      | ↕↕   |      |      | ↕    | ↕    |      | ↕↕   |      |
| Traffic Volume (veh/h)       | 10   | 700  | 80   | 110  | 1090 | 10   | 40   | 10   | 50   | 10   | 30   | 10   |
| Future Volume (veh/h)        | 10   | 700  | 80   | 110  | 1090 | 10   | 40   | 10   | 50   | 10   | 30   | 10   |
| Number                       | 7    | 4    | 14   | 3    | 8    | 18   | 5    | 2    | 12   | 1    | 6    | 16   |
| Initial Q (Qb), veh          | 0    | 0    | 0    | 0    | 0    | 0    | 0    | 0    | 0    | 0    | 0    | 0    |
| Ped-Bike Adj(A_pbT)          | 1.00 |      | 1.00 | 1.00 |      | 1.00 | 1.00 |      | 1.00 | 1.00 |      | 1.00 |
| Parking Bus, Adj             | 1.00 | 1.00 | 1.00 | 1.00 | 1.00 | 1.00 | 1.00 | 1.00 | 1.00 | 1.00 | 1.00 | 1.00 |
| Adj Sat Flow, veh/h/ln       | 1900 | 1845 | 1900 | 1900 | 1863 | 1900 | 1900 | 1863 | 1863 | 1900 | 1900 | 1900 |
| Adj Flow Rate, veh/h         | 12   | 833  | 95   | 131  | 1298 | 12   | 48   | 12   | 60   | 12   | 36   | 12   |
| Adj No. of Lanes             | 0    | 2    | 0    | 0    | 2    | 0    | 0    | 1    | 1    | 0    | 1    | 0    |
| Peak Hour Factor             | 0.84 | 0.84 | 0.84 | 0.84 | 0.84 | 0.84 | 0.84 | 0.84 | 0.84 | 0.84 | 0.84 | 0.84 |
| Percent Heavy Veh, %         | 3    | 3    | 3    | 2    | 2    | 2    | 2    | 2    | 2    | 0    | 0    | 0    |
| Cap, veh/h                   | 136  | 1685 | 191  | 246  | 1611 | 15   | 367  | 64   | 211  | 184  | 154  | 46   |
| Arrive On Green              | 0.55 | 0.55 | 0.55 | 0.55 | 0.55 | 0.55 | 0.13 | 0.13 | 0.13 | 0.13 | 0.13 | 0.13 |
| Sat Flow, veh/h              | 11   | 3065 | 346  | 173  | 2929 | 27   | 1040 | 478  | 1583 | 240  | 1153 | 348  |
| Grp Volume(v), veh/h         | 496  | 0    | 444  | 698  | 0    | 743  | 60   | 0    | 60   | 60   | 0    | 0    |
| Grp Sat Flow(s),veh/h/ln     | 1805 | 0    | 1617 | 1439 | 0    | 1690 | 1518 | 0    | 1583 | 1741 | 0    | 0    |
| Q Serve(g_s), s              | 0.0  | 0.0  | 4.8  | 6.6  | 0.0  | 10.0 | 0.0  | 0.0  | 1.0  | 0.0  | 0.0  | 0.0  |
| Cycle Q Clear(g_c), s        | 4.7  | 0.0  | 4.8  | 11.5 | 0.0  | 10.0 | 0.8  | 0.0  | 1.0  | 0.8  | 0.0  | 0.0  |
| Prop In Lane                 | 0.02 |      | 0.21 | 0.19 |      | 0.02 | 0.80 |      | 1.00 | 0.20 |      | 0.20 |
| Lane Grp Cap(c), veh/h       | 1122 | 0    | 889  | 942  | 0    | 929  | 431  | 0    | 211  | 384  | 0    | 0    |
| V/C Ratio(X)                 | 0.44 | 0.00 | 0.50 | 0.74 | 0.00 | 0.80 | 0.14 | 0.00 | 0.28 | 0.16 | 0.00 | 0.00 |
| Avail Cap(c_a), veh/h        | 3511 | 0    | 3159 | 2816 | 0    | 3301 | 1523 | 0    | 1421 | 1684 | 0    | 0    |
| HCM Platoon Ratio            | 1.00 | 1.00 | 1.00 | 1.00 | 1.00 | 1.00 | 1.00 | 1.00 | 1.00 | 1.00 | 1.00 | 1.00 |
| Upstream Filter(I)           | 1.00 | 0.00 | 1.00 | 1.00 | 0.00 | 1.00 | 1.00 | 0.00 | 1.00 | 1.00 | 0.00 | 0.00 |
| Uniform Delay (d), s/veh     | 3.9  | 0.0  | 4.0  | 5.1  | 0.0  | 5.1  | 11.0 | 0.0  | 11.1 | 11.0 | 0.0  | 0.0  |
| Incr Delay (d2), s/veh       | 0.1  | 0.0  | 0.2  | 0.4  | 0.0  | 0.6  | 0.1  | 0.0  | 0.3  | 0.1  | 0.0  | 0.0  |
| Initial Q Delay(d3),s/veh    | 0.0  | 0.0  | 0.0  | 0.0  | 0.0  | 0.0  | 0.0  | 0.0  | 0.0  | 0.0  | 0.0  | 0.0  |
| %ile BackOfQ(50%),veh/ln     | 2.4  | 0.0  | 2.1  | 4.6  | 0.0  | 4.7  | 0.4  | 0.0  | 0.4  | 0.4  | 0.0  | 0.0  |
| LnGrp Delay(d),s/veh         | 4.0  | 0.0  | 4.1  | 5.5  | 0.0  | 5.7  | 11.1 | 0.0  | 11.4 | 11.1 | 0.0  | 0.0  |
| LnGrp LOS                    | A    |      | A    | A    |      | A    | B    |      | B    | B    |      |      |
| Approach Vol, veh/h          |      | 940  |      |      | 1441 |      |      | 120  |      |      | 60   |      |
| Approach Delay, s/veh        |      | 4.1  |      |      | 5.6  |      |      | 11.2 |      |      | 11.1 |      |
| Approach LOS                 |      | A    |      |      | A    |      |      | B    |      |      | B    |      |
| Timer                        | 1    | 2    | 3    | 4    | 5    | 6    | 7    | 8    |      |      |      |      |
| Assigned Phs                 |      | 2    |      | 4    |      | 6    |      | 8    |      |      |      |      |
| Phs Duration (G+Y+Rc), s     |      | 8.3  |      | 20.1 |      | 8.3  |      | 20.1 |      |      |      |      |
| Change Period (Y+Rc), s      |      | 4.5  |      | 4.5  |      | 4.5  |      | 4.5  |      |      |      |      |
| Max Green Setting (Gmax), s  |      | 25.5 |      | 55.5 |      | 25.5 |      | 55.5 |      |      |      |      |
| Max Q Clear Time (g_c+11), s |      | 3.0  |      | 6.8  |      | 2.8  |      | 13.5 |      |      |      |      |
| Green Ext Time (p_c), s      |      | 0.0  |      | 1.0  |      | 0.0  |      | 2.1  |      |      |      |      |
| <b>Intersection Summary</b>  |      |      |      |      |      |      |      |      |      |      |      |      |
| HCM 2010 Ctrl Delay          |      |      |      | 5.5  |      |      |      |      |      |      |      |      |
| HCM 2010 LOS                 |      |      |      | A    |      |      |      |      |      |      |      |      |

HCM 2010 Signalized Intersection Summary Cumulative with Eastside Parkway with Project, AM  
42: 6th Avenue & Gigling Road

06/11/2019



| Movement                     | EBL  | EBT  | EBR  | WBL  | WBT  | WBR  | NBL  | NBT  | NBR  | SBL  | SBT  | SBR  |
|------------------------------|------|------|------|------|------|------|------|------|------|------|------|------|
| Lane Configurations          |      | ↔    |      |      | ↔    |      |      | ↔    | ↔    |      | ↔    |      |
| Traffic Volume (veh/h)       | 120  | 640  | 10   | 30   | 1060 | 10   | 10   | 10   | 10   | 10   | 10   | 150  |
| Future Volume (veh/h)        | 120  | 640  | 10   | 30   | 1060 | 10   | 10   | 10   | 10   | 10   | 10   | 150  |
| Number                       | 7    | 4    | 14   | 3    | 8    | 18   | 5    | 2    | 12   | 1    | 6    | 16   |
| Initial Q (Qb), veh          | 0    | 0    | 0    | 0    | 0    | 0    | 0    | 0    | 0    | 0    | 0    | 0    |
| Ped-Bike Adj(A_pbT)          | 1.00 |      | 1.00 | 1.00 |      | 1.00 | 1.00 |      | 1.00 | 1.00 |      | 1.00 |
| Parking Bus, Adj             | 1.00 | 1.00 | 1.00 | 1.00 | 1.00 | 1.00 | 1.00 | 1.00 | 1.00 | 1.00 | 1.00 | 1.00 |
| Adj Sat Flow, veh/h/ln       | 1900 | 1845 | 1900 | 1900 | 1863 | 1900 | 1900 | 1429 | 1429 | 1900 | 1863 | 1900 |
| Adj Flow Rate, veh/h         | 135  | 719  | 11   | 34   | 1191 | 11   | 11   | 11   | 0    | 11   | 11   | 169  |
| Adj No. of Lanes             | 0    | 2    | 0    | 0    | 2    | 0    | 0    | 1    | 1    | 0    | 1    | 0    |
| Peak Hour Factor             | 0.89 | 0.89 | 0.89 | 0.89 | 0.89 | 0.89 | 0.89 | 0.89 | 0.89 | 0.89 | 0.89 | 0.89 |
| Percent Heavy Veh, %         | 3    | 3    | 3    | 2    | 2    | 2    | 33   | 33   | 33   | 2    | 2    | 2    |
| Cap, veh/h                   | 255  | 1192 | 19   | 154  | 1759 | 16   | 260  | 151  | 203  | 144  | 22   | 235  |
| Arrive On Green              | 0.51 | 0.51 | 0.51 | 0.51 | 0.51 | 0.51 | 0.17 | 0.17 | 0.00 | 0.17 | 0.17 | 0.17 |
| Sat Flow, veh/h              | 157  | 2319 | 37   | 39   | 3421 | 31   | 414  | 902  | 1214 | 54   | 129  | 1407 |
| Grp Volume(v), veh/h         | 365  | 0    | 500  | 641  | 0    | 595  | 22   | 0    | 0    | 191  | 0    | 0    |
| Grp Sat Flow(s),veh/h/ln     | 840  | 0    | 1672 | 1801 | 0    | 1690 | 1316 | 0    | 1214 | 1591 | 0    | 0    |
| Q Serve(g_s), s              | 3.3  | 0.0  | 5.9  | 0.0  | 0.0  | 7.5  | 0.0  | 0.0  | 0.0  | 1.3  | 0.0  | 0.0  |
| Cycle Q Clear(g_c), s        | 10.8 | 0.0  | 5.9  | 7.2  | 0.0  | 7.5  | 0.4  | 0.0  | 0.0  | 3.2  | 0.0  | 0.0  |
| Prop In Lane                 | 0.37 |      | 0.02 | 0.05 |      | 0.02 | 0.50 |      | 1.00 | 0.06 |      | 0.88 |
| Lane Grp Cap(c), veh/h       | 607  | 0    | 860  | 1060 | 0    | 869  | 411  | 0    | 203  | 401  | 0    | 0    |
| V/C Ratio(X)                 | 0.60 | 0.00 | 0.58 | 0.60 | 0.00 | 0.69 | 0.05 | 0.00 | 0.00 | 0.48 | 0.00 | 0.00 |
| Avail Cap(c_a), veh/h        | 1716 | 0    | 2990 | 3250 | 0    | 3021 | 1432 | 0    | 1311 | 1843 | 0    | 0    |
| HCM Platoon Ratio            | 1.00 | 1.00 | 1.00 | 1.00 | 1.00 | 1.00 | 1.00 | 1.00 | 1.00 | 1.00 | 1.00 | 1.00 |
| Upstream Filter(I)           | 1.00 | 0.00 | 1.00 | 1.00 | 0.00 | 1.00 | 1.00 | 0.00 | 0.00 | 1.00 | 0.00 | 0.00 |
| Uniform Delay (d), s/veh     | 4.8  | 0.0  | 4.8  | 5.1  | 0.0  | 5.1  | 9.9  | 0.0  | 0.0  | 11.1 | 0.0  | 0.0  |
| Incr Delay (d2), s/veh       | 0.4  | 0.0  | 0.2  | 0.2  | 0.0  | 0.4  | 0.0  | 0.0  | 0.0  | 0.3  | 0.0  | 0.0  |
| Initial Q Delay(d3),s/veh    | 0.0  | 0.0  | 0.0  | 0.0  | 0.0  | 0.0  | 0.0  | 0.0  | 0.0  | 0.0  | 0.0  | 0.0  |
| %ile BackOfQ(50%),veh/ln     | 1.7  | 0.0  | 2.7  | 3.6  | 0.0  | 3.4  | 0.1  | 0.0  | 0.0  | 1.4  | 0.0  | 0.0  |
| LnGrp Delay(d),s/veh         | 5.1  | 0.0  | 5.0  | 5.3  | 0.0  | 5.5  | 10.0 | 0.0  | 0.0  | 11.4 | 0.0  | 0.0  |
| LnGrp LOS                    | A    |      | A    | A    |      | A    | A    |      |      | B    |      |      |
| Approach Vol, veh/h          |      | 865  |      |      | 1236 |      |      | 22   |      |      | 191  |      |
| Approach Delay, s/veh        |      | 5.1  |      |      | 5.4  |      |      | 10.0 |      |      | 11.4 |      |
| Approach LOS                 |      | A    |      |      | A    |      |      | A    |      |      | B    |      |
| Timer                        | 1    | 2    | 3    | 4    | 5    | 6    | 7    | 8    |      |      |      |      |
| Assigned Phs                 |      | 2    |      | 4    |      | 6    |      | 8    |      |      |      |      |
| Phs Duration (G+Y+Rc), s     |      | 9.2  |      | 19.0 |      | 9.2  |      | 19.0 |      |      |      |      |
| Change Period (Y+Rc), s      |      | 4.5  |      | 4.5  |      | 4.5  |      | 4.5  |      |      |      |      |
| Max Green Setting (Gmax), s  |      | 30.5 |      | 50.5 |      | 30.5 |      | 50.5 |      |      |      |      |
| Max Q Clear Time (g_c+I1), s |      | 2.4  |      | 12.8 |      | 5.2  |      | 9.5  |      |      |      |      |
| Green Ext Time (p_c), s      |      | 0.0  |      | 1.8  |      | 0.3  |      | 1.3  |      |      |      |      |
| <b>Intersection Summary</b>  |      |      |      |      |      |      |      |      |      |      |      |      |
| HCM 2010 Ctrl Delay          |      |      |      | 5.8  |      |      |      |      |      |      |      |      |
| HCM 2010 LOS                 |      |      |      | A    |      |      |      |      |      |      |      |      |

HCM 2010 Signalized Intersection Summary Cumulative with Eastside Parkway with Project, AM  
 43: Gigling Road & 7th Avenue

06/11/2019

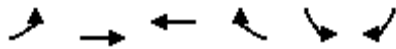

| Movement                     | EBL  | EBT  | WBT  | WBR  | SBL  | SBR  |   |      |
|------------------------------|------|------|------|------|------|------|---|------|
| Lane Configurations          |      | ↑↑   | ↑↑   |      | ↑↑   |      |   |      |
| Traffic Volume (veh/h)       | 160  | 500  | 1020 | 10   | 10   | 70   |   |      |
| Future Volume (veh/h)        | 160  | 500  | 1020 | 10   | 10   | 70   |   |      |
| Number                       | 7    | 4    | 8    | 18   | 1    | 16   |   |      |
| Initial Q (Qb), veh          | 0    | 0    | 0    | 0    | 0    | 0    |   |      |
| Ped-Bike Adj(A_pbT)          | 1.00 |      |      | 1.00 | 1.00 | 1.00 |   |      |
| Parking Bus, Adj             | 1.00 | 1.00 | 1.00 | 1.00 | 1.00 | 1.00 |   |      |
| Adj Sat Flow, veh/h/ln       | 1900 | 1845 | 1900 | 1900 | 1759 | 1900 |   |      |
| Adj Flow Rate, veh/h         | 186  | 581  | 1186 | 12   | 12   | 81   |   |      |
| Adj No. of Lanes             | 0    | 2    | 2    | 0    | 0    | 0    |   |      |
| Peak Hour Factor             | 0.86 | 0.86 | 0.86 | 0.86 | 0.86 | 0.86 |   |      |
| Percent Heavy Veh, %         | 3    | 3    | 0    | 0    | 0    | 0    |   |      |
| Cap, veh/h                   | 374  | 1126 | 2250 | 23   | 17   | 118  |   |      |
| Arrive On Green              | 0.61 | 0.61 | 0.61 | 0.61 | 0.09 | 0.09 |   |      |
| Sat Flow, veh/h              | 287  | 1916 | 3756 | 37   | 194  | 1309 |   |      |
| Grp Volume(v), veh/h         | 277  | 490  | 585  | 613  | 94   | 0    |   |      |
| Grp Sat Flow(s),veh/h/ln     | 525  | 1595 | 1805 | 1893 | 1519 | 0    |   |      |
| Q Serve(g_s), s              | 9.0  | 5.2  | 5.6  | 5.6  | 1.8  | 0.0  |   |      |
| Cycle Q Clear(g_c), s        | 14.6 | 5.2  | 5.6  | 5.6  | 1.8  | 0.0  |   |      |
| Prop In Lane                 | 0.67 |      |      | 0.02 | 0.13 | 0.86 |   |      |
| Lane Grp Cap(c), veh/h       | 520  | 980  | 1109 | 1164 | 137  | 0    |   |      |
| V/C Ratio(X)                 | 0.53 | 0.50 | 0.53 | 0.53 | 0.69 | 0.00 |   |      |
| Avail Cap(c_a), veh/h        | 1258 | 2905 | 3288 | 3449 | 1271 | 0    |   |      |
| HCM Platoon Ratio            | 1.00 | 1.00 | 1.00 | 1.00 | 1.00 | 1.00 |   |      |
| Upstream Filter(I)           | 1.00 | 1.00 | 1.00 | 1.00 | 1.00 | 0.00 |   |      |
| Uniform Delay (d), s/veh     | 5.4  | 3.3  | 3.3  | 3.3  | 13.4 | 0.0  |   |      |
| Incr Delay (d2), s/veh       | 0.3  | 0.1  | 0.1  | 0.1  | 2.3  | 0.0  |   |      |
| Initial Q Delay(d3),s/veh    | 0.0  | 0.0  | 0.0  | 0.0  | 0.0  | 0.0  |   |      |
| %ile BackOfQ(50%),veh/ln     | 2.0  | 2.2  | 2.6  | 2.8  | 0.8  | 0.0  |   |      |
| LnGrp Delay(d),s/veh         | 5.8  | 3.4  | 3.5  | 3.5  | 15.7 | 0.0  |   |      |
| LnGrp LOS                    | A    | A    | A    | A    | B    |      |   |      |
| Approach Vol, veh/h          |      | 767  | 1198 |      | 94   |      |   |      |
| Approach Delay, s/veh        |      | 4.3  | 3.5  |      | 15.7 |      |   |      |
| Approach LOS                 |      | A    | A    |      | B    |      |   |      |
| Timer                        | 1    | 2    | 3    | 4    | 5    | 6    | 7 | 8    |
| Assigned Phs                 |      |      |      | 4    |      | 6    |   | 8    |
| Phs Duration (G+Y+Rc), s     |      |      |      | 23.2 |      | 7.2  |   | 23.2 |
| Change Period (Y+Rc), s      |      |      |      | 4.5  |      | 4.5  |   | 4.5  |
| Max Green Setting (Gmax), s  |      |      |      | 55.5 |      | 25.5 |   | 55.5 |
| Max Q Clear Time (g_c+I1), s |      |      |      | 16.6 |      | 3.8  |   | 7.6  |
| Green Ext Time (p_c), s      |      |      |      | 2.1  |      | 0.0  |   | 1.2  |
| <b>Intersection Summary</b>  |      |      |      |      |      |      |   |      |
| HCM 2010 Ctrl Delay          |      |      | 4.3  |      |      |      |   |      |
| HCM 2010 LOS                 |      |      | A    |      |      |      |   |      |
| <b>Notes</b>                 |      |      |      |      |      |      |   |      |

HCM 2010 Signalized Intersection Summary Cumulative with Eastside Parkway with Project, AM  
 44: 8th Avenue & Gigling Road 06/11/2019



| Movement                     | EBL  | EBT  | EBR  | WBL  | WBT  | WBR  | NBL  | NBT  | NBR  | SBL  | SBT  | SBR  |
|------------------------------|------|------|------|------|------|------|------|------|------|------|------|------|
| Lane Configurations          |      | ↔    |      |      | ↔    |      |      | ↔    |      |      | ↔    |      |
| Traffic Volume (veh/h)       | 220  | 290  | 10   | 10   | 530  | 10   | 10   | 10   | 10   | 10   | 10   | 510  |
| Future Volume (veh/h)        | 220  | 290  | 10   | 10   | 530  | 10   | 10   | 10   | 10   | 10   | 10   | 510  |
| Number                       | 7    | 4    | 14   | 3    | 8    | 18   | 5    | 2    | 12   | 1    | 6    | 16   |
| Initial Q (Qb), veh          | 0    | 0    | 0    | 0    | 0    | 0    | 0    | 0    | 0    | 0    | 0    | 0    |
| Ped-Bike Adj(A_pbT)          | 1.00 |      | 1.00 | 1.00 |      | 1.00 | 1.00 |      | 1.00 | 1.00 |      | 1.00 |
| Parking Bus, Adj             | 1.00 | 1.00 | 1.00 | 1.00 | 1.00 | 1.00 | 1.00 | 1.00 | 1.00 | 1.00 | 1.00 | 1.00 |
| Adj Sat Flow, veh/h/ln       | 1900 | 1863 | 1900 | 1900 | 1863 | 1900 | 1900 | 1900 | 1900 | 1900 | 1900 | 1900 |
| Adj Flow Rate, veh/h         | 259  | 341  | 12   | 12   | 624  | 12   | 12   | 12   | 12   | 12   | 12   | 247  |
| Adj No. of Lanes             | 0    | 2    | 0    | 0    | 2    | 0    | 0    | 1    | 0    | 0    | 1    | 0    |
| Peak Hour Factor             | 0.85 | 0.85 | 0.85 | 0.85 | 0.85 | 0.85 | 0.85 | 0.85 | 0.85 | 0.85 | 0.85 | 0.85 |
| Percent Heavy Veh, %         | 2    | 2    | 2    | 2    | 2    | 2    | 0    | 0    | 0    | 0    | 0    | 0    |
| Cap, veh/h                   | 531  | 829  | 29   | 125  | 1742 | 33   | 217  | 180  | 124  | 124  | 24   | 319  |
| Arrive On Green              | 0.51 | 0.51 | 0.51 | 0.51 | 0.51 | 0.51 | 0.22 | 0.22 | 0.22 | 0.22 | 0.22 | 0.22 |
| Sat Flow, veh/h              | 611  | 1640 | 58   | 18   | 3447 | 66   | 316  | 838  | 577  | 34   | 110  | 1482 |
| Grp Volume(v), veh/h         | 263  | 0    | 349  | 340  | 0    | 308  | 36   | 0    | 0    | 271  | 0    | 0    |
| Grp Sat Flow(s),veh/h/ln     | 625  | 0    | 1685 | 1848 | 0    | 1684 | 1731 | 0    | 0    | 1626 | 0    | 0    |
| Q Serve(g_s), s              | 9.5  | 0.0  | 4.2  | 0.0  | 0.0  | 3.6  | 0.0  | 0.0  | 0.0  | 1.4  | 0.0  | 0.0  |
| Cycle Q Clear(g_c), s        | 13.1 | 0.0  | 4.2  | 3.6  | 0.0  | 3.6  | 0.5  | 0.0  | 0.0  | 5.0  | 0.0  | 0.0  |
| Prop In Lane                 | 0.98 |      | 0.03 | 0.04 |      | 0.04 | 0.33 |      | 0.33 | 0.04 |      | 0.91 |
| Lane Grp Cap(c), veh/h       | 538  | 0    | 851  | 1049 | 0    | 851  | 522  | 0    | 0    | 467  | 0    | 0    |
| V/C Ratio(X)                 | 0.49 | 0.00 | 0.41 | 0.32 | 0.00 | 0.36 | 0.07 | 0.00 | 0.00 | 0.58 | 0.00 | 0.00 |
| Avail Cap(c_a), veh/h        | 1013 | 0    | 1858 | 2131 | 0    | 1856 | 2297 | 0    | 0    | 2402 | 0    | 0    |
| HCM Platoon Ratio            | 1.00 | 1.00 | 1.00 | 1.00 | 1.00 | 1.00 | 1.00 | 1.00 | 1.00 | 1.00 | 1.00 | 1.00 |
| Upstream Filter(I)           | 1.00 | 0.00 | 1.00 | 1.00 | 0.00 | 1.00 | 1.00 | 0.00 | 0.00 | 1.00 | 0.00 | 0.00 |
| Uniform Delay (d), s/veh     | 8.7  | 0.0  | 5.0  | 4.8  | 0.0  | 4.8  | 10.1 | 0.0  | 0.0  | 11.9 | 0.0  | 0.0  |
| Incr Delay (d2), s/veh       | 0.3  | 0.0  | 0.1  | 0.1  | 0.0  | 0.1  | 0.0  | 0.0  | 0.0  | 0.4  | 0.0  | 0.0  |
| Initial Q Delay(d3),s/veh    | 0.0  | 0.0  | 0.0  | 0.0  | 0.0  | 0.0  | 0.0  | 0.0  | 0.0  | 0.0  | 0.0  | 0.0  |
| %ile BackOfQ(50%),veh/ln     | 2.1  | 0.0  | 1.9  | 1.8  | 0.0  | 1.6  | 0.3  | 0.0  | 0.0  | 2.3  | 0.0  | 0.0  |
| LnGrp Delay(d),s/veh         | 9.0  | 0.0  | 5.1  | 4.9  | 0.0  | 4.9  | 10.1 | 0.0  | 0.0  | 12.3 | 0.0  | 0.0  |
| LnGrp LOS                    | A    |      | A    | A    |      | A    | B    |      |      | B    |      |      |
| Approach Vol, veh/h          |      | 612  |      |      | 648  |      |      | 36   |      |      | 271  |      |
| Approach Delay, s/veh        |      | 6.8  |      |      | 4.9  |      |      | 10.1 |      |      | 12.3 |      |
| Approach LOS                 |      | A    |      |      | A    |      |      | B    |      |      | B    |      |
| Timer                        | 1    | 2    | 3    | 4    | 5    | 6    | 7    | 8    |      |      |      |      |
| Assigned Phs                 |      | 2    |      | 4    |      | 6    |      | 8    |      |      |      |      |
| Phs Duration (G+Y+Rc), s     |      | 11.4 |      | 20.8 |      | 11.4 |      | 20.8 |      |      |      |      |
| Change Period (Y+Rc), s      |      | 4.5  |      | 4.5  |      | 4.5  |      | 4.5  |      |      |      |      |
| Max Green Setting (Gmax), s  |      | 45.5 |      | 35.5 |      | 45.5 |      | 35.5 |      |      |      |      |
| Max Q Clear Time (g_c+I1), s |      | 2.5  |      | 15.1 |      | 7.0  |      | 5.6  |      |      |      |      |
| Green Ext Time (p_c), s      |      | 0.0  |      | 1.2  |      | 0.4  |      | 0.8  |      |      |      |      |
| <b>Intersection Summary</b>  |      |      |      |      |      |      |      |      |      |      |      |      |
| HCM 2010 Ctrl Delay          |      |      |      | 7.0  |      |      |      |      |      |      |      |      |
| HCM 2010 LOS                 |      |      |      | A    |      |      |      |      |      |      |      |      |



HCM 2010 Signalized Intersection Summary Cumulative with Eastside Parkway with Project, AM  
 45: Eastside Parkway & Gigling Road

06/11/2019



| Movement                      | EBL  | EBT  | EBR  | WBL  | WBT  | WBR  | NBL  | NBT  | NBR  | SBL  | SBT  | SBR  |
|-------------------------------|------|------|------|------|------|------|------|------|------|------|------|------|
| Lane Configurations           |      |      |      |      |      |      |      |      |      |      |      |      |
| Traffic Volume (veh/h)        | 280  | 10   | 10   | 10   | 10   | 10   | 20   | 180  | 10   | 10   | 280  | 520  |
| Future Volume (veh/h)         | 280  | 10   | 10   | 10   | 10   | 10   | 20   | 180  | 10   | 10   | 280  | 520  |
| Number                        | 7    | 4    | 14   | 3    | 8    | 18   | 5    | 2    | 12   | 1    | 6    | 16   |
| Initial Q (Qb), veh           | 0    | 0    | 0    | 0    | 0    | 0    | 0    | 0    | 0    | 0    | 0    | 0    |
| Ped-Bike Adj(A_pbT)           | 1.00 |      | 1.00 | 1.00 |      | 1.00 | 1.00 |      | 1.00 | 1.00 |      | 1.00 |
| Parking Bus, Adj              | 1.00 | 1.00 | 1.00 | 1.00 | 1.00 | 1.00 | 1.00 | 1.00 | 1.00 | 1.00 | 1.00 | 1.00 |
| Adj Sat Flow, veh/h/ln        | 1863 | 1863 | 1900 | 1900 | 1863 | 1900 | 1863 | 1863 | 1900 | 1863 | 1863 | 1863 |
| Adj Flow Rate, veh/h          | 304  | 11   | 11   | 11   | 11   | 11   | 22   | 196  | 11   | 11   | 304  | 402  |
| Adj No. of Lanes              | 1    | 2    | 0    | 0    | 1    | 0    | 1    | 1    | 0    | 1    | 1    | 1    |
| Peak Hour Factor              | 0.92 | 0.92 | 0.92 | 0.92 | 0.92 | 0.92 | 0.92 | 0.92 | 0.92 | 0.92 | 0.92 | 0.92 |
| Percent Heavy Veh, %          | 2    | 2    | 2    | 2    | 2    | 2    | 2    | 2    | 2    | 2    | 2    | 2    |
| Cap, veh/h                    | 374  | 381  | 328  | 22   | 22   | 22   | 48   | 542  | 30   | 26   | 553  | 470  |
| Arrive On Green               | 0.21 | 0.21 | 0.21 | 0.04 | 0.04 | 0.04 | 0.03 | 0.31 | 0.31 | 0.01 | 0.30 | 0.30 |
| Sat Flow, veh/h               | 1774 | 1803 | 1555 | 577  | 577  | 577  | 1774 | 1747 | 98   | 1774 | 1863 | 1583 |
| Grp Volume(v), veh/h          | 304  | 11   | 11   | 33   | 0    | 0    | 22   | 0    | 207  | 11   | 304  | 402  |
| Grp Sat Flow(s),veh/h/ln      | 1774 | 1770 | 1588 | 1732 | 0    | 0    | 1774 | 0    | 1845 | 1774 | 1863 | 1583 |
| Q Serve(g_s), s               | 6.1  | 0.2  | 0.2  | 0.7  | 0.0  | 0.0  | 0.5  | 0.0  | 3.3  | 0.2  | 5.2  | 9.0  |
| Cycle Q Clear(g_c), s         | 6.1  | 0.2  | 0.2  | 0.7  | 0.0  | 0.0  | 0.5  | 0.0  | 3.3  | 0.2  | 5.2  | 9.0  |
| Prop In Lane                  | 1.00 |      | 0.98 | 0.33 |      | 0.33 | 1.00 |      | 0.05 | 1.00 |      | 1.00 |
| Lane Grp Cap(c), veh/h        | 374  | 373  | 335  | 67   | 0    | 0    | 48   | 0    | 572  | 26   | 553  | 470  |
| V/C Ratio(X)                  | 0.81 | 0.03 | 0.03 | 0.49 | 0.00 | 0.00 | 0.45 | 0.00 | 0.36 | 0.43 | 0.55 | 0.85 |
| Avail Cap(c_a), veh/h         | 1133 | 1130 | 1014 | 853  | 0    | 0    | 260  | 0    | 1277 | 260  | 1289 | 1096 |
| HCM Platoon Ratio             | 1.00 | 1.00 | 1.00 | 1.00 | 1.00 | 1.00 | 1.00 | 1.00 | 1.00 | 1.00 | 1.00 | 1.00 |
| Upstream Filter(I)            | 1.00 | 1.00 | 1.00 | 1.00 | 0.00 | 0.00 | 1.00 | 0.00 | 1.00 | 1.00 | 1.00 | 1.00 |
| Uniform Delay (d), s/veh      | 14.1 | 11.8 | 11.8 | 17.7 | 0.0  | 0.0  | 18.0 | 0.0  | 10.1 | 18.4 | 11.1 | 12.4 |
| Incr Delay (d2), s/veh        | 1.6  | 0.0  | 0.0  | 2.1  | 0.0  | 0.0  | 6.5  | 0.0  | 0.1  | 11.0 | 0.3  | 1.8  |
| Initial Q Delay(d3),s/veh     | 0.0  | 0.0  | 0.0  | 0.0  | 0.0  | 0.0  | 0.0  | 0.0  | 0.0  | 0.0  | 0.0  | 0.0  |
| %ile BackOfQ(50%),veh/ln      | 3.1  | 0.1  | 0.1  | 0.4  | 0.0  | 0.0  | 0.3  | 0.0  | 1.7  | 0.2  | 2.7  | 4.1  |
| LnGrp Delay(d),s/veh          | 15.7 | 11.8 | 11.8 | 19.8 | 0.0  | 0.0  | 24.5 | 0.0  | 10.2 | 29.3 | 11.4 | 14.2 |
| LnGrp LOS                     | B    | B    | B    | B    |      |      | C    |      | B    | C    | B    | B    |
| Approach Vol, veh/h           |      | 326  |      |      | 33   |      |      | 229  |      |      | 717  |      |
| Approach Delay, s/veh         |      | 15.5 |      |      | 19.8 |      |      | 11.6 |      |      | 13.2 |      |
| Approach LOS                  |      | B    |      |      | B    |      |      | B    |      |      | B    |      |
| Timer                         | 1    | 2    | 3    | 4    | 5    | 6    | 7    | 8    |      |      |      |      |
| Assigned Phs                  | 1    | 2    |      | 4    | 5    | 6    |      | 8    |      |      |      |      |
| Phs Duration (G+Y+Rc), s      | 4.5  | 15.6 |      | 11.9 | 5.0  | 15.2 |      | 5.5  |      |      |      |      |
| Change Period (Y+Rc), s       | 4.0  | 4.0  |      | 4.0  | 4.0  | 4.0  |      | 4.0  |      |      |      |      |
| Max Green Setting (Gmax), s   | 5.5  | 26.0 |      | 24.0 | 5.5  | 26.0 |      | 18.5 |      |      |      |      |
| Max Q Clear Time (g_c+1/2), s | 12.2 | 5.3  |      | 8.1  | 2.5  | 11.0 |      | 2.7  |      |      |      |      |
| Green Ext Time (p_c), s       | 0.0  | 0.1  |      | 0.1  | 0.0  | 0.2  |      | 0.0  |      |      |      |      |
| <b>Intersection Summary</b>   |      |      |      |      |      |      |      |      |      |      |      |      |
| HCM 2010 Ctrl Delay           |      |      | 13.7 |      |      |      |      |      |      |      |      |      |
| HCM 2010 LOS                  |      |      | B    |      |      |      |      |      |      |      |      |      |

HCM 2010 Signalized Intersection Summary Cumulative with Eastside Parkway with Project, AM  
 46: General Jim Moore Boulevard & Normandy Road

06/11/2019



| Movement                      | EBL  | EBT  | EBR  | WBL   | WBT  | WBR  | NBL   | NBT  | NBR  | SBL  | SBT  | SBR  |
|-------------------------------|------|------|------|-------|------|------|-------|------|------|------|------|------|
| Lane Configurations           |      | ↕    |      |       | ↕    |      | ↕     | ↕↕   |      | ↕    | ↕↕   | ↕    |
| Traffic Volume (veh/h)        | 90   | 110  | 150  | 380   | 80   | 40   | 200   | 420  | 310  | 80   | 760  | 250  |
| Future Volume (veh/h)         | 90   | 110  | 150  | 380   | 80   | 40   | 200   | 420  | 310  | 80   | 760  | 250  |
| Number                        | 3    | 8    | 18   | 7     | 4    | 14   | 1     | 6    | 16   | 5    | 2    | 12   |
| Initial Q (Qb), veh           | 0    | 0    | 0    | 0     | 0    | 0    | 0     | 0    | 0    | 0    | 0    | 0    |
| Ped-Bike Adj(A_pbT)           | 0.99 |      | 0.98 | 0.99  |      | 0.98 | 1.00  |      | 0.99 | 1.00 |      | 0.99 |
| Parking Bus, Adj              | 1.00 | 1.00 | 1.00 | 1.00  | 1.00 | 1.00 | 1.00  | 1.00 | 1.00 | 1.00 | 1.00 | 1.00 |
| Adj Sat Flow, veh/h/ln        | 1900 | 1881 | 1900 | 1900  | 1863 | 1900 | 1881  | 1881 | 1900 | 1863 | 1863 | 1863 |
| Adj Flow Rate, veh/h          | 115  | 141  | 163  | 487   | 103  | 47   | 256   | 538  | 370  | 103  | 974  | 252  |
| Adj No. of Lanes              | 0    | 1    | 0    | 0     | 1    | 0    | 1     | 2    | 0    | 1    | 2    | 1    |
| Peak Hour Factor              | 0.78 | 0.78 | 0.78 | 0.78  | 0.78 | 0.78 | 0.78  | 0.78 | 0.78 | 0.78 | 0.78 | 0.78 |
| Percent Heavy Veh, %          | 1    | 1    | 1    | 2     | 2    | 2    | 1     | 1    | 1    | 2    | 2    | 2    |
| Cap, veh/h                    | 229  | 279  | 286  | 412   | 70   | 32   | 184   | 588  | 404  | 197  | 1061 | 469  |
| Arrive On Green               | 0.42 | 0.42 | 0.42 | 0.42  | 0.42 | 0.42 | 0.10  | 0.29 | 0.29 | 0.11 | 0.30 | 0.30 |
| Sat Flow, veh/h               | 400  | 658  | 674  | 779   | 165  | 75   | 1792  | 2017 | 1387 | 1774 | 3539 | 1565 |
| Grp Volume(v), veh/h          | 419  | 0    | 0    | 637   | 0    | 0    | 256   | 477  | 431  | 103  | 974  | 252  |
| Grp Sat Flow(s),veh/h/ln      | 1732 | 0    | 0    | 1019  | 0    | 0    | 1792  | 1787 | 1617 | 1774 | 1770 | 1565 |
| Q Serve(g_s), s               | 0.0  | 0.0  | 0.0  | 18.7  | 0.0  | 0.0  | 8.0   | 20.1 | 20.1 | 4.3  | 20.7 | 10.5 |
| Cycle Q Clear(g_c), s         | 14.3 | 0.0  | 0.0  | 33.0  | 0.0  | 0.0  | 8.0   | 20.1 | 20.1 | 4.3  | 20.7 | 10.5 |
| Prop In Lane                  | 0.27 |      | 0.39 | 0.76  |      | 0.07 | 1.00  |      | 0.86 | 1.00 |      | 1.00 |
| Lane Grp Cap(c), veh/h        | 793  | 0    | 0    | 514   | 0    | 0    | 184   | 521  | 471  | 197  | 1061 | 469  |
| V/C Ratio(X)                  | 0.53 | 0.00 | 0.00 | 1.24  | 0.00 | 0.00 | 1.39  | 0.92 | 0.92 | 0.52 | 0.92 | 0.54 |
| Avail Cap(c_a), veh/h         | 793  | 0    | 0    | 514   | 0    | 0    | 184   | 586  | 530  | 197  | 1160 | 513  |
| HCM Platoon Ratio             | 1.00 | 1.00 | 1.00 | 1.00  | 1.00 | 1.00 | 1.00  | 1.00 | 1.00 | 1.00 | 1.00 | 1.00 |
| Upstream Filter(l)            | 1.00 | 0.00 | 0.00 | 1.00  | 0.00 | 0.00 | 1.00  | 1.00 | 1.00 | 1.00 | 1.00 | 1.00 |
| Uniform Delay (d), s/veh      | 17.0 | 0.0  | 0.0  | 26.2  | 0.0  | 0.0  | 34.9  | 26.6 | 26.7 | 32.6 | 26.3 | 22.7 |
| Incr Delay (d2), s/veh        | 0.3  | 0.0  | 0.0  | 123.9 | 0.0  | 0.0  | 205.4 | 17.0 | 18.4 | 1.2  | 10.4 | 0.4  |
| Initial Q Delay(d3),s/veh     | 0.0  | 0.0  | 0.0  | 0.0   | 0.0  | 0.0  | 0.0   | 0.0  | 0.0  | 0.0  | 0.0  | 0.0  |
| %ile BackOfQ(50%),veh/ln      | 6.8  | 0.0  | 0.0  | 28.5  | 0.0  | 0.0  | 14.4  | 12.3 | 11.3 | 2.2  | 11.5 | 4.5  |
| LnGrp Delay(d),s/veh          | 17.3 | 0.0  | 0.0  | 150.1 | 0.0  | 0.0  | 240.3 | 43.6 | 45.1 | 33.8 | 36.8 | 23.1 |
| LnGrp LOS                     | B    |      |      | F     |      |      | F     | D    | D    | C    | D    | C    |
| Approach Vol, veh/h           |      | 419  |      | 637   |      |      | 1164  |      |      | 1329 |      |      |
| Approach Delay, s/veh         |      | 17.3 |      | 150.1 |      |      | 87.4  |      |      | 34.0 |      |      |
| Approach LOS                  |      | B    |      | F     |      |      | F     |      |      | C    |      |      |
| Timer                         | 1    | 2    | 3    | 4     | 5    | 6    | 7     | 8    |      |      |      |      |
| Assigned Phs                  | 1    | 2    |      | 4     | 5    | 6    |       | 8    |      |      |      |      |
| Phs Duration (G+Y+Rc), s      | 2.5  | 27.8 |      | 37.5  | 13.2 | 27.2 |       | 37.5 |      |      |      |      |
| Change Period (Y+Rc), s       | 4.5  | 4.5  |      | 4.5   | 4.5  | 4.5  |       | 4.5  |      |      |      |      |
| Max Green Setting (Gmax), s   | 30.0 | 25.5 |      | 33.0  | 8.0  | 25.5 |       | 33.0 |      |      |      |      |
| Max Q Clear Time (g_c+110), s | 11.0 | 22.7 |      | 35.0  | 6.3  | 22.1 |       | 16.3 |      |      |      |      |
| Green Ext Time (p_c), s       | 0.0  | 0.6  |      | 0.0   | 0.0  | 0.5  |       | 0.6  |      |      |      |      |
| <b>Intersection Summary</b>   |      |      |      |       |      |      |       |      |      |      |      |      |
| HCM 2010 Ctrl Delay           |      |      |      | 70.4  |      |      |       |      |      |      |      |      |
| HCM 2010 LOS                  |      |      |      | E     |      |      |       |      |      |      |      |      |

HCM 2010 Signalized Intersection Summary Cumulative with Eastside Parkway with Project, AM  
 47: General Jim Moore Boulevard & Coe Avenue 06/11/2019



| Movement                     | EBL  | EBT  | EBR  | WBL  | WBT  | WBR  | NBL   | NBT  | NBR  | SBL  | SBT  | SBR  |
|------------------------------|------|------|------|------|------|------|-------|------|------|------|------|------|
| Lane Configurations          |      |      |      |      |      |      |       |      |      |      |      |      |
| Traffic Volume (veh/h)       | 100  | 10   | 430  | 380  | 10   | 10   | 230   | 480  | 260  | 10   | 1060 | 90   |
| Future Volume (veh/h)        | 100  | 10   | 430  | 380  | 10   | 10   | 230   | 480  | 260  | 10   | 1060 | 90   |
| Number                       | 3    | 8    | 18   | 7    | 4    | 14   | 1     | 6    | 16   | 5    | 2    | 12   |
| Initial Q (Qb), veh          | 0    | 0    | 0    | 0    | 0    | 0    | 0     | 0    | 0    | 0    | 0    | 0    |
| Ped-Bike Adj(A_pbT)          | 1.00 |      | 1.00 | 1.00 |      | 1.00 | 1.00  |      | 1.00 | 1.00 |      | 1.00 |
| Parking Bus, Adj             | 1.00 | 1.00 | 1.00 | 1.00 | 1.00 | 1.00 | 1.00  | 1.00 | 1.00 | 1.00 | 1.00 | 1.00 |
| Adj Sat Flow, veh/h/ln       | 1881 | 1863 | 1881 | 1863 | 1863 | 1863 | 1881  | 1881 | 1863 | 1863 | 1863 | 1863 |
| Adj Flow Rate, veh/h         | 111  | 11   | 367  | 422  | 11   | 11   | 256   | 533  | 255  | 11   | 1178 | 39   |
| Adj No. of Lanes             | 1    | 1    | 1    | 1    | 1    | 1    | 1     | 2    | 1    | 1    | 2    | 1    |
| Peak Hour Factor             | 0.90 | 0.90 | 0.90 | 0.90 | 0.90 | 0.90 | 0.90  | 0.90 | 0.90 | 0.90 | 0.90 | 0.90 |
| Percent Heavy Veh, %         | 1    | 2    | 1    | 2    | 2    | 2    | 1     | 1    | 2    | 2    | 2    | 2    |
| Cap, veh/h                   | 625  | 750  | 644  | 466  | 750  | 638  | 257   | 1641 | 727  | 23   | 1163 | 520  |
| Arrive On Green              | 0.40 | 0.40 | 0.40 | 0.40 | 0.40 | 0.40 | 0.14  | 0.46 | 0.46 | 0.01 | 0.33 | 0.33 |
| Sat Flow, veh/h              | 1398 | 1863 | 1598 | 1000 | 1863 | 1583 | 1792  | 3574 | 1583 | 1774 | 3539 | 1583 |
| Grp Volume(v), veh/h         | 111  | 11   | 367  | 422  | 11   | 11   | 256   | 533  | 255  | 11   | 1178 | 39   |
| Grp Sat Flow(s),veh/h/ln     | 1398 | 1863 | 1598 | 1000 | 1863 | 1583 | 1792  | 1787 | 1583 | 1774 | 1770 | 1583 |
| Q Serve(g_s), s              | 5.6  | 0.4  | 19.2 | 43.1 | 0.4  | 0.5  | 15.4  | 10.2 | 11.2 | 0.7  | 35.5 | 1.8  |
| Cycle Q Clear(g_c), s        | 6.0  | 0.4  | 19.2 | 43.5 | 0.4  | 0.5  | 15.4  | 10.2 | 11.2 | 0.7  | 35.5 | 1.8  |
| Prop In Lane                 | 1.00 |      | 1.00 | 1.00 |      | 1.00 | 1.00  |      | 1.00 | 1.00 |      | 1.00 |
| Lane Grp Cap(c), veh/h       | 625  | 750  | 644  | 466  | 750  | 638  | 257   | 1641 | 727  | 23   | 1163 | 520  |
| V/C Ratio(X)                 | 0.18 | 0.01 | 0.57 | 0.91 | 0.01 | 0.02 | 1.00  | 0.32 | 0.35 | 0.48 | 1.01 | 0.07 |
| Avail Cap(c_a), veh/h        | 625  | 750  | 644  | 466  | 750  | 638  | 257   | 1641 | 727  | 90   | 1163 | 520  |
| HCM Platoon Ratio            | 1.00 | 1.00 | 1.00 | 1.00 | 1.00 | 1.00 | 1.00  | 1.00 | 1.00 | 1.00 | 1.00 | 1.00 |
| Upstream Filter(I)           | 1.00 | 1.00 | 1.00 | 1.00 | 1.00 | 1.00 | 1.00  | 1.00 | 1.00 | 1.00 | 1.00 | 1.00 |
| Uniform Delay (d), s/veh     | 21.2 | 19.4 | 25.0 | 33.6 | 19.4 | 19.4 | 46.2  | 18.6 | 18.8 | 52.9 | 36.3 | 24.9 |
| Incr Delay (d2), s/veh       | 0.0  | 0.0  | 0.8  | 20.6 | 0.0  | 0.0  | 54.8  | 0.0  | 0.1  | 5.5  | 29.5 | 0.0  |
| Initial Q Delay(d3),s/veh    | 0.0  | 0.0  | 0.0  | 0.0  | 0.0  | 0.0  | 0.0   | 0.0  | 0.0  | 0.0  | 0.0  | 0.0  |
| %ile BackOfQ(50%),veh/ln     | 2.2  | 0.2  | 8.5  | 15.2 | 0.2  | 0.2  | 11.5  | 5.0  | 4.9  | 0.4  | 22.1 | 0.8  |
| LnGrp Delay(d),s/veh         | 21.2 | 19.4 | 25.8 | 54.2 | 19.4 | 19.4 | 101.0 | 18.6 | 18.9 | 58.5 | 65.8 | 25.0 |
| LnGrp LOS                    | C    | B    | C    | D    | B    | B    | F     | B    | B    | E    | F    | C    |
| Approach Vol, veh/h          |      | 489  |      |      | 444  |      |       | 1044 |      |      | 1228 |      |
| Approach Delay, s/veh        |      | 24.6 |      |      | 52.5 |      |       | 38.9 |      |      | 64.4 |      |
| Approach LOS                 |      | C    |      |      | D    |      |       | D    |      |      | E    |      |
| Timer                        | 1    | 2    | 3    | 4    | 5    | 6    | 7     | 8    |      |      |      |      |
| Assigned Phs                 | 1    | 2    |      | 4    | 5    | 6    |       | 8    |      |      |      |      |
| Phs Duration (G+Y+Rc), s     | 30.0 | 40.0 |      | 48.0 | 5.9  | 54.1 |       | 48.0 |      |      |      |      |
| Change Period (Y+Rc), s      | 4.5  | 4.5  |      | 4.5  | 4.5  | 4.5  |       | 4.5  |      |      |      |      |
| Max Green Setting (Gmax), s  | 5.5  | 35.5 |      | 43.5 | 5.5  | 45.5 |       | 43.5 |      |      |      |      |
| Max Q Clear Time (g_c+11), s | 11.4 | 37.5 |      | 45.5 | 2.7  | 13.2 |       | 21.2 |      |      |      |      |
| Green Ext Time (p_c), s      | 0.0  | 0.0  |      | 0.0  | 0.0  | 0.5  |       | 0.1  |      |      |      |      |
| <b>Intersection Summary</b>  |      |      |      |      |      |      |       |      |      |      |      |      |
| HCM 2010 Ctrl Delay          |      |      | 48.4 |      |      |      |       |      |      |      |      |      |
| HCM 2010 LOS                 |      |      | D    |      |      |      |       |      |      |      |      |      |

HCM 2010 Signalized Intersection Summary Cumulative with Eastside Parkway with Project, AM  
 48: Fremont Boulevard/Hwy 1 SB Off-Ramp/ NB On-Ramp & Monterey Road 06/11/2019



| Movement                      | EBL  | EBT  | EBR  | WBL   | WBT  | WBR   | NBL  | NBT  | NBR  | SBL  | SBT   | SBR  |
|-------------------------------|------|------|------|-------|------|-------|------|------|------|------|-------|------|
| Lane Configurations           |      |      |      |       |      |       |      |      |      |      |       |      |
| Traffic Volume (veh/h)        | 80   | 100  | 140  | 120   | 210  | 30    | 230  | 690  | 140  | 10   | 1020  | 70   |
| Future Volume (veh/h)         | 80   | 100  | 140  | 120   | 210  | 30    | 230  | 690  | 140  | 10   | 1020  | 70   |
| Number                        | 7    | 4    | 14   | 3     | 8    | 18    | 5    | 2    | 12   | 1    | 6     | 16   |
| Initial Q (Qb), veh           | 0    | 0    | 0    | 0     | 0    | 0     | 0    | 0    | 0    | 0    | 0     | 0    |
| Ped-Bike Adj(A_pbT)           | 1.00 |      | 0.95 | 1.00  |      | 0.97  | 1.00 |      | 0.99 | 1.00 |       | 0.98 |
| Parking Bus, Adj              | 1.00 | 1.00 | 1.00 | 1.00  | 1.00 | 1.00  | 1.00 | 1.00 | 1.00 | 1.00 | 1.00  | 1.00 |
| Adj Sat Flow, veh/h/ln        | 1845 | 1845 | 1845 | 1900  | 1881 | 1900  | 1827 | 1827 | 1900 | 1827 | 1827  | 1827 |
| Adj Flow Rate, veh/h          | 88   | 110  | 65   | 132   | 231  | 31    | 253  | 758  | 139  | 11   | 1121  | 10   |
| Adj No. of Lanes              | 1    | 1    | 1    | 0     | 1    | 0     | 1    | 2    | 0    | 1    | 2     | 1    |
| Peak Hour Factor              | 0.91 | 0.91 | 0.91 | 0.91  | 0.91 | 0.91  | 0.91 | 0.91 | 0.91 | 0.91 | 0.91  | 0.91 |
| Percent Heavy Veh, %          | 3    | 3    | 3    | 1     | 1    | 1     | 4    | 4    | 4    | 4    | 4     | 4    |
| Cap, veh/h                    | 202  | 212  | 172  | 137   | 239  | 32    | 425  | 1452 | 266  | 18   | 880   | 388  |
| Arrive On Green               | 0.11 | 0.11 | 0.11 | 0.22  | 0.22 | 0.22  | 0.24 | 0.50 | 0.50 | 0.01 | 0.25  | 0.25 |
| Sat Flow, veh/h               | 1757 | 1845 | 1494 | 610   | 1067 | 143   | 1740 | 2924 | 536  | 1740 | 3471  | 1529 |
| Grp Volume(v), veh/h          | 88   | 110  | 65   | 394   | 0    | 0     | 253  | 450  | 447  | 11   | 1121  | 10   |
| Grp Sat Flow(s),veh/h/ln      | 1757 | 1845 | 1494 | 1820  | 0    | 0     | 1740 | 1736 | 1724 | 1740 | 1736  | 1529 |
| Q Serve(g_s), s               | 5.8  | 7.0  | 5.0  | 26.8  | 0.0  | 0.0   | 16.1 | 22.0 | 22.0 | 0.8  | 31.7  | 0.6  |
| Cycle Q Clear(g_c), s         | 5.8  | 7.0  | 5.0  | 26.8  | 0.0  | 0.0   | 16.1 | 22.0 | 22.0 | 0.8  | 31.7  | 0.6  |
| Prop In Lane                  | 1.00 |      | 1.00 | 0.34  |      | 0.08  | 1.00 |      | 0.31 | 1.00 |       | 1.00 |
| Lane Grp Cap(c), veh/h        | 202  | 212  | 172  | 408   | 0    | 0     | 425  | 862  | 856  | 18   | 880   | 388  |
| V/C Ratio(X)                  | 0.44 | 0.52 | 0.38 | 0.97  | 0.00 | 0.00  | 0.59 | 0.52 | 0.52 | 0.62 | 1.27  | 0.03 |
| Avail Cap(c_a), veh/h         | 436  | 457  | 371  | 408   | 0    | 0     | 425  | 862  | 856  | 209  | 880   | 388  |
| HCM Platoon Ratio             | 1.00 | 1.00 | 1.00 | 1.00  | 1.00 | 1.00  | 1.00 | 1.00 | 1.00 | 1.00 | 1.00  | 1.00 |
| Upstream Filter(I)            | 0.76 | 0.76 | 0.76 | 1.00  | 0.00 | 0.00  | 1.00 | 1.00 | 1.00 | 1.00 | 1.00  | 1.00 |
| Uniform Delay (d), s/veh      | 51.6 | 52.1 | 51.2 | 48.0  | 0.0  | 0.0   | 41.8 | 21.4 | 21.4 | 61.6 | 46.7  | 35.0 |
| Incr Delay (d2), s/veh        | 1.1  | 1.5  | 1.1  | 35.9  | 0.0  | 0.0   | 1.6  | 2.3  | 2.3  | 12.5 | 131.9 | 0.1  |
| Initial Q Delay(d3),s/veh     | 0.0  | 0.0  | 0.0  | 0.0   | 0.0  | 0.0   | 0.0  | 0.0  | 0.0  | 0.0  | 0.0   | 0.0  |
| %ile BackOfQ(50%),veh/ln      | 2.9  | 3.7  | 2.1  | 17.5  | 0.0  | 0.0   | 7.9  | 11.0 | 11.0 | 0.4  | 31.3  | 0.3  |
| LnGrp Delay(d),s/veh          | 52.7 | 53.6 | 52.3 | 83.9  | 0.0  | 0.0   | 43.3 | 23.6 | 23.7 | 74.2 | 178.6 | 35.2 |
| LnGrp LOS                     | D    | D    | D    | F     |      |       | D    | C    | C    | E    | F     | D    |
| Approach Vol, veh/h           |      | 263  |      |       | 394  |       |      | 1150 |      |      | 1142  |      |
| Approach Delay, s/veh         |      | 53.0 |      |       | 83.9 |       |      | 28.0 |      |      | 176.3 |      |
| Approach LOS                  |      | D    |      |       | F    |       |      | C    |      |      | F     |      |
| Timer                         | 1    | 2    | 3    | 4     | 5    | 6     | 7    | 8    |      |      |       |      |
| Assigned Phs                  | 1    | 2    |      | 4     | 5    | 6     |      | 8    |      |      |       |      |
| Phs Duration (G+Y+Rc), s      | 5.5  | 67.4 |      | 19.0  | 35.9 | 37.0  |      | 33.1 |      |      |       |      |
| Change Period (Y+Rc), s       | 4.2  | 5.3  |      | * 4.7 | 5.3  | * 5.3 |      | 5.1  |      |      |       |      |
| Max Green Setting (Gmax), s   | 15   | 31.7 |      | * 31  | 15.0 | * 32  |      | 28.0 |      |      |       |      |
| Max Q Clear Time (g_c+1/2), s | 12.8 | 24.0 |      | 9.0   | 18.1 | 33.7  |      | 28.8 |      |      |       |      |
| Green Ext Time (p_c), s       | 0.0  | 2.9  |      | 1.0   | 0.0  | 0.0   |      | 0.0  |      |      |       |      |
| <b>Intersection Summary</b>   |      |      |      |       |      |       |      |      |      |      |       |      |
| HCM 2010 Ctrl Delay           |      |      |      | 95.1  |      |       |      |      |      |      |       |      |
| HCM 2010 LOS                  |      |      |      | F     |      |       |      |      |      |      |       |      |
| <b>Notes</b>                  |      |      |      |       |      |       |      |      |      |      |       |      |

HCM 2010 Signalized Intersection Summary Cumulative with Eastside Parkway with Project, AM  
 49: Highway 1 SB On-Ramp & Highway 1 NB Off-Ramp/Monterey Road 06/11/2019



| Movement                     | EBL  | EBT  | EBR  | WBL   | WBT  | WBR   | NBL  | NBT   | NBR  | SBL  | SBT  | SBR  |
|------------------------------|------|------|------|-------|------|-------|------|-------|------|------|------|------|
| Lane Configurations          |      | ↕↕   | ↗    | ↖     |      | ↗     |      | ↕     | ↗    |      | ↕    |      |
| Traffic Volume (veh/h)       | 10   | 200  | 100  | 240   | 0    | 370   | 0    | 50    | 120  | 10   | 10   | 0    |
| Future Volume (veh/h)        | 10   | 200  | 100  | 240   | 0    | 370   | 0    | 50    | 120  | 10   | 10   | 0    |
| Number                       | 1    | 6    | 16   | 5     | 2    | 12    | 7    | 4     | 14   | 3    | 8    | 18   |
| Initial Q (Qb), veh          | 0    | 0    | 0    | 0     | 0    | 0     | 0    | 0     | 0    | 0    | 0    | 0    |
| Ped-Bike Adj(A_pbT)          | 1.00 |      | 1.00 | 1.00  |      | 1.00  | 1.00 |       | 1.00 | 1.00 |      | 1.00 |
| Parking Bus, Adj             | 1.00 | 1.00 | 1.00 | 1.00  | 1.00 | 1.00  | 1.00 | 1.00  | 1.00 | 1.00 | 1.00 | 1.00 |
| Adj Sat Flow, veh/h/ln       | 1900 | 1845 | 1845 | 1863  | 0    | 1863  | 0    | 1845  | 1845 | 1900 | 1900 | 0    |
| Adj Flow Rate, veh/h         | 10   | 206  | 9    | 247   | 0    | 242   | 0    | 52    | 21   | 10   | 10   | 0    |
| Adj No. of Lanes             | 0    | 2    | 1    | 1     | 0    | 1     | 0    | 1     | 1    | 0    | 1    | 0    |
| Peak Hour Factor             | 0.97 | 0.97 | 0.97 | 0.97  | 0.97 | 0.97  | 0.97 | 0.97  | 0.97 | 0.97 | 0.97 | 0.97 |
| Percent Heavy Veh, %         | 3    | 3    | 3    | 2     | 0    | 2     | 0    | 3     | 3    | 0    | 0    | 0    |
| Cap, veh/h                   | 136  | 2942 | 1343 | 0     | 0    | 0     | 0    | 122   | 104  | 74   | 60   | 0    |
| Arrive On Green              | 0.86 | 0.86 | 0.86 | 0.00  | 0.00 | 0.00  | 0.00 | 0.07  | 0.07 | 0.07 | 0.07 | 0.00 |
| Sat Flow, veh/h              | 159  | 3430 | 1566 |       |      |       | 0    | 1845  | 1568 | 466  | 899  | 0    |
| Grp Volume(v), veh/h         | 116  | 100  | 9    |       | 0.0  |       | 0    | 52    | 21   | 20   | 0    | 0    |
| Grp Sat Flow(s),veh/h/ln     | 1837 | 1752 | 1566 |       |      |       | 0    | 1845  | 1568 | 1365 | 0    | 0    |
| Q Serve(g_s), s              | 1.2  | 1.1  | 0.1  |       |      |       | 0.0  | 3.4   | 1.6  | 0.0  | 0.0  | 0.0  |
| Cycle Q Clear(g_c), s        | 1.2  | 1.1  | 0.1  |       |      |       | 0.0  | 3.4   | 1.6  | 3.4  | 0.0  | 0.0  |
| Prop In Lane                 | 0.09 |      | 1.00 |       |      |       | 0.00 |       | 1.00 | 0.50 |      | 0.00 |
| Lane Grp Cap(c), veh/h       | 1575 | 1503 | 1343 |       |      |       | 0    | 122   | 104  | 134  | 0    | 0    |
| V/C Ratio(X)                 | 0.07 | 0.07 | 0.01 |       |      |       | 0.00 | 0.43  | 0.20 | 0.15 | 0.00 | 0.00 |
| Avail Cap(c_a), veh/h        | 1575 | 1503 | 1343 |       |      |       | 0    | 148   | 125  | 155  | 0    | 0    |
| HCM Platoon Ratio            | 1.00 | 1.00 | 1.00 |       |      |       | 1.00 | 1.00  | 1.00 | 1.00 | 1.00 | 1.00 |
| Upstream Filter(I)           | 1.00 | 1.00 | 1.00 |       |      |       | 0.00 | 1.00  | 1.00 | 1.00 | 0.00 | 0.00 |
| Uniform Delay (d), s/veh     | 1.4  | 1.3  | 1.3  |       |      |       | 0.0  | 56.1  | 55.2 | 55.1 | 0.0  | 0.0  |
| Incr Delay (d2), s/veh       | 0.0  | 0.0  | 0.0  |       |      |       | 0.0  | 0.9   | 0.4  | 0.2  | 0.0  | 0.0  |
| Initial Q Delay(d3),s/veh    | 0.0  | 0.0  | 0.0  |       |      |       | 0.0  | 0.0   | 0.0  | 0.0  | 0.0  | 0.0  |
| %ile BackOfQ(50%),veh/ln     | 0.6  | 0.5  | 0.0  |       |      |       | 0.0  | 1.8   | 0.7  | 0.7  | 0.0  | 0.0  |
| LnGrp Delay(d),s/veh         | 1.4  | 1.3  | 1.3  |       |      |       | 0.0  | 56.9  | 55.6 | 55.3 | 0.0  | 0.0  |
| LnGrp LOS                    | A    | A    | A    |       |      |       |      | E     | E    | E    |      |      |
| Approach Vol, veh/h          |      | 225  |      |       |      |       |      | 73    |      |      | 20   |      |
| Approach Delay, s/veh        |      | 1.4  |      |       |      |       |      | 56.5  |      |      | 55.3 |      |
| Approach LOS                 |      | A    |      |       |      |       |      | E     |      |      | E    |      |
| Timer                        | 1    | 2    | 3    | 4     | 5    | 6     | 7    | 8     |      |      |      |      |
| Assigned Phs                 |      |      |      | 4     |      | 6     |      | 8     |      |      |      |      |
| Phs Duration (G+Y+Rc), s     |      |      |      | 12.5  |      | 112.5 |      | 12.5  |      |      |      |      |
| Change Period (Y+Rc), s      |      |      |      | * 4.2 |      | 5.3   |      | * 4.2 |      |      |      |      |
| Max Green Setting (Gmax), s  |      |      |      | * 10  |      | 21.0  |      | * 10  |      |      |      |      |
| Max Q Clear Time (g_c+I1), s |      |      |      | 5.4   |      | 3.2   |      | 5.4   |      |      |      |      |
| Green Ext Time (p_c), s      |      |      |      | 0.1   |      | 0.7   |      | 0.0   |      |      |      |      |
| <b>Intersection Summary</b>  |      |      |      |       |      |       |      |       |      |      |      |      |
| HCM 2010 Ctrl Delay          |      |      | 17.4 |       |      |       |      |       |      |      |      |      |
| HCM 2010 LOS                 |      |      | B    |       |      |       |      |       |      |      |      |      |
| <b>Notes</b>                 |      |      |      |       |      |       |      |       |      |      |      |      |

HCM 2010 Signalized Intersection Summary Cumulative with Eastside Parkway with Project, AM  
 50: Reservation Road & SR 68 WB On Ramp/SR 68 WB Off Ramp

06/11/2019



| Movement                    | EBL  | EBT  | EBR | WBL  | WBT  | WBR  | NBL  | NBT  | NBR  | SBL  | SBT  | SBR  |
|-----------------------------|------|------|-----|------|------|------|------|------|------|------|------|------|
| Lane Configurations         |      |      |     |      | ↕    | ↕    | ↕    | ↕    |      |      | ↕    |      |
| Traffic Volume (veh/h)      | 0    | 0    | 0   | 260  | 10   | 310  | 120  | 410  | 0    | 0    | 360  | 130  |
| Future Volume (veh/h)       | 0    | 0    | 0   | 260  | 10   | 310  | 120  | 410  | 0    | 0    | 360  | 130  |
| Number                      |      |      |     | 7    | 4    | 14   | 1    | 6    | 16   | 5    | 2    | 12   |
| Initial Q (Qb), veh         |      |      |     | 0    | 0    | 0    | 0    | 0    | 0    | 0    | 0    | 0    |
| Ped-Bike Adj(A_pbT)         |      |      |     | 1.00 |      | 1.00 | 1.00 |      | 1.00 | 1.00 |      | 1.00 |
| Parking Bus, Adj            |      |      |     | 1.00 | 1.00 | 1.00 | 1.00 | 1.00 | 1.00 | 1.00 | 1.00 | 1.00 |
| Adj Sat Flow, veh/h/ln      |      |      |     | 1900 | 1827 | 1827 | 1863 | 1863 | 0    | 0    | 1827 | 1900 |
| Adj Flow Rate, veh/h        |      |      |     | 274  | 11   | 74   | 126  | 432  | 0    | 0    | 379  | 128  |
| Adj No. of Lanes            |      |      |     | 0    | 1    | 1    | 1    | 1    | 0    | 0    | 1    | 0    |
| Peak Hour Factor            |      |      |     | 0.95 | 0.95 | 0.95 | 0.95 | 0.95 | 0.95 | 0.95 | 0.95 | 0.95 |
| Percent Heavy Veh, %        |      |      |     | 4    | 4    | 4    | 2    | 2    | 0    | 0    | 4    | 4    |
| Cap, veh/h                  |      |      |     | 386  | 15   | 357  | 208  | 1021 | 0    | 0    | 470  | 159  |
| Arrive On Green             |      |      |     | 0.23 | 0.23 | 0.23 | 0.12 | 0.55 | 0.00 | 0.00 | 0.36 | 0.36 |
| Sat Flow, veh/h             |      |      |     | 1676 | 67   | 1553 | 1774 | 1863 | 0    | 0    | 1307 | 442  |
| Grp Volume(v), veh/h        |      |      |     | 285  | 0    | 74   | 126  | 432  | 0    | 0    | 0    | 507  |
| Grp Sat Flow(s),veh/h/ln    |      |      |     | 1743 | 0    | 1553 | 1774 | 1863 | 0    | 0    | 0    | 1749 |
| Q Serve(g_s), s             |      |      |     | 7.4  | 0.0  | 1.9  | 3.3  | 6.7  | 0.0  | 0.0  | 0.0  | 12.8 |
| Cycle Q Clear(g_c), s       |      |      |     | 7.4  | 0.0  | 1.9  | 3.3  | 6.7  | 0.0  | 0.0  | 0.0  | 12.8 |
| Prop In Lane                |      |      |     | 0.96 |      | 1.00 | 1.00 |      | 0.00 | 0.00 |      | 0.25 |
| Lane Grp Cap(c), veh/h      |      |      |     | 401  | 0    | 357  | 208  | 1021 | 0    | 0    | 0    | 629  |
| V/C Ratio(X)                |      |      |     | 0.71 | 0.00 | 0.21 | 0.61 | 0.42 | 0.00 | 0.00 | 0.00 | 0.81 |
| Avail Cap(c_a), veh/h       |      |      |     | 1420 | 0    | 1265 | 939  | 1442 | 0    | 0    | 0    | 1354 |
| HCM Platoon Ratio           |      |      |     | 1.00 | 1.00 | 1.00 | 1.00 | 1.00 | 1.00 | 1.00 | 1.00 | 1.00 |
| Upstream Filter(I)          |      |      |     | 1.00 | 0.00 | 1.00 | 1.00 | 1.00 | 0.00 | 0.00 | 0.00 | 1.00 |
| Uniform Delay (d), s/veh    |      |      |     | 17.4 | 0.0  | 15.3 | 20.6 | 6.5  | 0.0  | 0.0  | 0.0  | 14.2 |
| Incr Delay (d2), s/veh      |      |      |     | 2.3  | 0.0  | 0.3  | 1.1  | 0.3  | 0.0  | 0.0  | 0.0  | 2.5  |
| Initial Q Delay(d3),s/veh   |      |      |     | 0.0  | 0.0  | 0.0  | 0.0  | 0.0  | 0.0  | 0.0  | 0.0  | 0.0  |
| %ile BackOfQ(50%),veh/ln    |      |      |     | 3.7  | 0.0  | 0.8  | 1.7  | 3.4  | 0.0  | 0.0  | 0.0  | 6.5  |
| LnGrp Delay(d),s/veh        |      |      |     | 19.7 | 0.0  | 15.6 | 21.7 | 6.8  | 0.0  | 0.0  | 0.0  | 16.7 |
| LnGrp LOS                   |      |      |     | B    |      | B    | C    | A    |      |      |      | B    |
| Approach Vol, veh/h         |      |      |     |      | 359  |      |      | 558  |      |      | 507  |      |
| Approach Delay, s/veh       |      |      |     |      | 18.9 |      |      | 10.2 |      |      | 16.7 |      |
| Approach LOS                |      |      |     |      | B    |      |      | B    |      |      | B    |      |
| Timer                       | 1    | 2    | 3   | 4    | 5    | 6    | 7    | 8    |      |      |      |      |
| Assigned Phs                | 1    | 2    |     | 4    |      | 6    |      |      |      |      |      |      |
| Phs Duration (G+Y+Rc), s    | 9.2  | 23.7 |     | 16.2 |      | 32.9 |      |      |      |      |      |      |
| Change Period (Y+Rc), s     | 3.5  | 6.0  |     | 4.9  |      | 6.0  |      |      |      |      |      |      |
| Max Green Setting (Gmax), s | 26.0 | 38.0 |     | 40.0 |      | 38.0 |      |      |      |      |      |      |
| Max Q Clear Time (g_c+1), s | 15.3 | 14.8 |     | 9.4  |      | 8.7  |      |      |      |      |      |      |
| Green Ext Time (p_c), s     | 0.1  | 2.8  |     | 2.0  |      | 2.3  |      |      |      |      |      |      |
| <b>Intersection Summary</b> |      |      |     |      |      |      |      |      |      |      |      |      |
| HCM 2010 Ctrl Delay         |      |      |     | 14.7 |      |      |      |      |      |      |      |      |
| HCM 2010 LOS                |      |      |     | B    |      |      |      |      |      |      |      |      |



















HCM 2010 Signalized Intersection Summary Cumulative with Eastside Parkway with Project, AM  
 51: River Road/Reservation Road & SR 68 Off Ramp/SR 68 EB On Ramp 06/11/2019



| Movement                     | EBL  | EBT  | EBR  | WBL | WBT  | WBR  | NBL  | NBT  | NBR  | SBL  | SBT  | SBR  |
|------------------------------|------|------|------|-----|------|------|------|------|------|------|------|------|
| Lane Configurations          |      | ↕    | ↗    |     |      |      |      | ↑    | ↗    | ↖    | ↑    |      |
| Traffic Volume (veh/h)       | 130  | 10   | 110  | 0   | 0    | 0    | 0    | 390  | 660  | 240  | 370  | 0    |
| Future Volume (veh/h)        | 130  | 10   | 110  | 0   | 0    | 0    | 0    | 390  | 660  | 240  | 370  | 0    |
| Number                       | 3    | 8    | 18   |     |      |      | 1    | 6    | 16   | 5    | 2    | 12   |
| Initial Q (Qb), veh          | 0    | 0    | 0    |     |      |      | 0    | 0    | 0    | 0    | 0    | 0    |
| Ped-Bike Adj(A_pbT)          | 1.00 |      | 1.00 |     |      |      | 1.00 |      | 1.00 | 1.00 |      | 1.00 |
| Parking Bus, Adj             | 1.00 | 1.00 | 1.00 |     |      |      | 1.00 | 1.00 | 1.00 | 1.00 | 1.00 | 1.00 |
| Adj Sat Flow, veh/h/ln       | 1900 | 1881 | 1881 |     |      |      | 0    | 1881 | 1881 | 1827 | 1827 | 0    |
| Adj Flow Rate, veh/h         | 141  | 11   | 19   |     |      |      | 0    | 424  | 388  | 261  | 402  | 0    |
| Adj No. of Lanes             | 0    | 1    | 1    |     |      |      | 0    | 1    | 1    | 1    | 1    | 0    |
| Peak Hour Factor             | 0.92 | 0.92 | 0.92 |     |      |      | 0.92 | 0.92 | 0.92 | 0.92 | 0.92 | 0.92 |
| Percent Heavy Veh, %         | 1    | 1    | 1    |     |      |      | 0    | 1    | 1    | 4    | 4    | 0    |
| Cap, veh/h                   | 204  | 16   | 196  |     |      |      | 0    | 644  | 547  | 338  | 1138 | 0    |
| Arrive On Green              | 0.12 | 0.12 | 0.12 |     |      |      | 0.00 | 0.34 | 0.34 | 0.19 | 0.62 | 0.00 |
| Sat Flow, veh/h              | 1668 | 130  | 1599 |     |      |      | 0    | 1881 | 1599 | 1740 | 1827 | 0    |
| Grp Volume(v), veh/h         | 152  | 0    | 19   |     |      |      | 0    | 424  | 388  | 261  | 402  | 0    |
| Grp Sat Flow(s),veh/h/ln     | 1798 | 0    | 1599 |     |      |      | 0    | 1881 | 1599 | 1740 | 1827 | 0    |
| Q Serve(g_s), s              | 3.5  | 0.0  | 0.5  |     |      |      | 0.0  | 8.2  | 9.0  | 6.1  | 4.6  | 0.0  |
| Cycle Q Clear(g_c), s        | 3.5  | 0.0  | 0.5  |     |      |      | 0.0  | 8.2  | 9.0  | 6.1  | 4.6  | 0.0  |
| Prop In Lane                 | 0.93 |      | 1.00 |     |      |      | 0.00 |      | 1.00 | 1.00 |      | 0.00 |
| Lane Grp Cap(c), veh/h       | 220  | 0    | 196  |     |      |      | 0    | 644  | 547  | 338  | 1138 | 0    |
| V/C Ratio(X)                 | 0.69 | 0.00 | 0.10 |     |      |      | 0.00 | 0.66 | 0.71 | 0.77 | 0.35 | 0.00 |
| Avail Cap(c_a), veh/h        | 1680 | 0    | 1494 |     |      |      | 0    | 1626 | 1382 | 975  | 1579 | 0    |
| HCM Platoon Ratio            | 1.00 | 1.00 | 1.00 |     |      |      | 1.00 | 1.00 | 1.00 | 1.00 | 1.00 | 1.00 |
| Upstream Filter(I)           | 1.00 | 0.00 | 1.00 |     |      |      | 0.00 | 1.00 | 1.00 | 1.00 | 1.00 | 0.00 |
| Uniform Delay (d), s/veh     | 18.0 | 0.0  | 16.7 |     |      |      | 0.0  | 12.0 | 12.2 | 16.4 | 3.9  | 0.0  |
| Incr Delay (d2), s/veh       | 1.4  | 0.0  | 0.1  |     |      |      | 0.0  | 1.2  | 1.7  | 3.8  | 0.2  | 0.0  |
| Initial Q Delay(d3),s/veh    | 0.0  | 0.0  | 0.0  |     |      |      | 0.0  | 0.0  | 0.0  | 0.0  | 0.0  | 0.0  |
| %ile BackOfQ(50%),veh/ln     | 1.8  | 0.0  | 0.2  |     |      |      | 0.0  | 4.4  | 4.1  | 3.3  | 2.3  | 0.0  |
| LnGrp Delay(d),s/veh         | 19.4 | 0.0  | 16.8 |     |      |      | 0.0  | 13.1 | 13.9 | 20.1 | 4.1  | 0.0  |
| LnGrp LOS                    | B    |      | B    |     |      |      |      | B    | B    | C    | A    |      |
| Approach Vol, veh/h          |      | 171  |      |     |      |      |      | 812  |      |      | 663  |      |
| Approach Delay, s/veh        |      | 19.2 |      |     |      |      |      | 13.5 |      |      | 10.4 |      |
| Approach LOS                 |      | B    |      |     |      |      |      | B    |      |      | B    |      |
| Timer                        | 1    | 2    | 3    | 4   | 5    | 6    | 7    | 8    |      |      |      |      |
| Assigned Phs                 |      | 2    |      |     | 5    | 6    |      | 8    |      |      |      |      |
| Phs Duration (G+Y+Rc), s     |      | 32.7 |      |     | 12.0 | 20.7 |      | 10.1 |      |      |      |      |
| Change Period (Y+Rc), s      |      | 6.0  |      |     | 3.7  | 6.0  |      | 4.9  |      |      |      |      |
| Max Green Setting (Gmax), s  |      | 37.0 |      |     | 24.0 | 37.0 |      | 40.0 |      |      |      |      |
| Max Q Clear Time (g_c+I1), s |      | 6.6  |      |     | 8.1  | 11.0 |      | 5.5  |      |      |      |      |
| Green Ext Time (p_c), s      |      | 2.2  |      |     | 0.6  | 3.6  |      | 0.6  |      |      |      |      |
| <b>Intersection Summary</b>  |      |      |      |     |      |      |      |      |      |      |      |      |
| HCM 2010 Ctrl Delay          |      |      | 12.8 |     |      |      |      |      |      |      |      |      |
| HCM 2010 LOS                 |      |      | B    |     |      |      |      |      |      |      |      |      |

HCM 2010 Signalized Intersection Summary Cumulative with Eastside Parkway with Project, PM  
 1: Del Monte Boulevard & Reindollar Avenue

06/11/2019

|                              |  |  |  |  |  |  |   |  |  |  |  |  |
|------------------------------|---|---|---|---|---|---|---|---|---|---|---|---|
| Movement                     | EBL   | EBT   | EBR   | WBL   | WBT   | WBR   | NBL   | NBT   | NBR   | SBL   | SBT   | SBR   |
| Lane Configurations          |   |   |   |  |  |   |  |  |  |  |  |   |
| Traffic Volume (veh/h)       | 0   | 0   | 0   | 190   | 0   | 450   | 10  | 1310  | 340   | 400   | 850   | 0   |
| Future Volume (veh/h)        | 0   | 0   | 0   | 190   | 0   | 450   | 10  | 1310  | 340   | 400   | 850   | 0   |
| Number                       |   |   |   | 3   | 8   | 18  | 1   | 6   | 16  | 5   | 2   | 12  |
| Initial Q (Qb), veh          |   |   |   | 0   | 0   | 0   | 0   | 0   | 0   | 0   | 0   | 0   |
| Ped-Bike Adj(A_pbT)          |   |   |   | 1.00  |   | 0.99  | 1.00  |   | 1.00  | 1.00  |   | 1.00  |
| Parking Bus, Adj             |   |   |   | 1.00  | 1.00  | 1.00  | 1.00  | 1.00  | 1.00  | 1.00  | 1.00  | 1.00  |
| Adj Sat Flow, veh/h/ln       |   |   |   | 1881  | 1881  | 1900  | 1881  | 1881  | 1881  | 1881  | 1881  | 0   |
| Adj Flow Rate, veh/h         |   |   |   | 198   | 0   | 397   | 10  | 1365  | 271   | 417   | 885   | 0   |
| Adj No. of Lanes             |   |   |   | 1   | 1   | 0   | 1   | 2   | 1   | 1   | 2   | 0   |
| Peak Hour Factor             |   |   |   | 0.96  | 0.96  | 0.96  | 0.96  | 0.96  | 0.96  | 0.96  | 0.96  | 0.96  |
| Percent Heavy Veh, %         |   |   |   | 1   | 1   | 1   | 1   | 1   | 1   | 1   | 1   | 0   |
| Cap, veh/h                   |   |   |   | 501   | 0   | 444   | 22  | 1145  | 512   | 458   | 2015  | 0   |
| Arrive On Green              |   |   |   | 0.28  | 0.00  | 0.28  | 0.01  | 0.32  | 0.32  | 0.26  | 0.56  | 0.00  |
| Sat Flow, veh/h              |   |   |   | 1792  | 0   | 1585  | 1792  | 3574  | 1599  | 1792  | 3668  | 0   |
| Grp Volume(v), veh/h         |   |   |   | 198   | 0   | 397   | 10  | 1365  | 271   | 417   | 885   | 0   |
| Grp Sat Flow(s),veh/h/ln     |   |   |   | 1792  | 0   | 1585  | 1792  | 1787  | 1599  | 1792  | 1787  | 0   |
| Q Serve(g_s), s              |   |   |   | 8.4   | 0.0   | 22.5  | 0.5   | 30.0  | 13.0  | 21.1  | 13.4  | 0.0   |
| Cycle Q Clear(g_c), s        |   |   |   | 8.4   | 0.0   | 22.5  | 0.5   | 30.0  | 13.0  | 21.1  | 13.4  | 0.0   |
| Prop In Lane                 |   |   |   | 1.00  |   | 1.00  | 1.00  |   | 1.00  | 1.00  |   | 0.00  |
| Lane Grp Cap(c), veh/h       |   |   |   | 501   | 0   | 444   | 22  | 1145  | 512   | 458   | 2015  | 0   |
| V/C Ratio(X)                 |   |   |   | 0.39  | 0.00  | 0.89  | 0.46  | 1.19  | 0.53  | 0.91  | 0.44  | 0.00  |
| Avail Cap(c_a), veh/h        |   |   |   | 574   | 0   | 508   | 574   | 1145  | 512   | 574   | 2015  | 0   |
| HCM Platoon Ratio            |   |   |   | 1.00  | 1.00  | 1.00  | 1.00  | 1.00  | 1.00  | 1.00  | 1.00  | 1.00  |
| Upstream Filter(I)           |   |   |   | 1.00  | 0.00  | 1.00  | 1.00  | 1.00  | 1.00  | 1.00  | 1.00  | 0.00  |
| Uniform Delay (d), s/veh     |   |   |   | 27.3  | 0.0   | 32.4  | 45.9  | 31.8  | 26.0  | 33.8  | 11.8  | 0.0   |
| Incr Delay (d2), s/veh       |   |   |   | 0.5   | 0.0   | 16.8  | 14.1  | 95.4  | 1.0   | 16.2  | 0.2   | 0.0   |
| Initial Q Delay(d3),s/veh    |   |   |   | 0.0   | 0.0   | 0.0   | 0.0   | 0.0   | 0.0   | 0.0   | 0.0   | 0.0   |
| %ile BackOfQ(50%),veh/ln     |   |   |   | 4.2   | 0.0   | 11.9  | 0.3   | 29.8  | 5.9   | 12.5  | 6.7   | 0.0   |
| LnGrp Delay(d),s/veh         |   |   |   | 27.8  | 0.0   | 49.2  | 60.0  | 127.2   | 27.1  | 50.0  | 12.0  | 0.0   |
| LnGrp LOS                    |   |   |   | C   |   | D   | E   | F   | C   | D   | B   |   |
| Approach Vol, veh/h          |   |   |   |   | 595   |   |   | 1646  |   |   | 1302  |   |
| Approach Delay, s/veh        |   |   |   |   | 42.1  |   |   | 110.3   |   |   | 24.2  |   |
| Approach LOS                 |   |   |   |   | D   |   |   | F   |   |   | C   |   |
| Timer                        | 1   | 2   | 3   | 4   | 5   | 6   | 7   | 8   |   |   |   |   |
| Assigned Phs                 | 1   | 2   |   |   | 5   | 6   |   | 8   |   |   |   |   |
| Phs Duration (G+Y+Rc), s     | 4.6   | 57.8  |   |   | 27.5  | 35.0  |   | 31.2  |   |   |   |   |
| Change Period (Y+Rc), s      | 3.5   | 5.0   |   |   | 3.5   | 5.0   |   | 5.0   |   |   |   |   |
| Max Green Setting (Gmax), s  | 30.0  | 30.0  |   |   | 30.0  | 30.0  |   | 30.0  |   |   |   |   |
| Max Q Clear Time (g_c+I1), s | 2.5   | 15.4  |   |   | 23.1  | 32.0  |   | 24.5  |   |   |   |   |
| Green Ext Time (p_c), s      | 0.0   | 5.4   |   |   | 0.8   | 0.0   |   | 1.7   |   |   |   |   |
| <b>Intersection Summary</b>  |   |   |   |   |   |   |   |   |   |   |   |   |
| HCM 2010 Ctrl Delay          |   |   |   | 67.2  |   |   |   |   |   |   |   |   |
| HCM 2010 LOS                 |   |   |   | E   |   |   |   |   |   |   |   |   |
| <b>Notes</b>                 |   |   |   |   |   |   |   |   |   |   |   |   |



HCM 2010 Signalized Intersection Summary Cumulative with Eastside Parkway with Project, PM  
 2: 2nd Avenue & Patton Parkway

06/11/2019



| Movement                     | EBL  | EBT  | EBR  | WBL  | WBT  | WBR  | NBL  | NBT  | NBR  | SBL  | SBT  | SBR  |
|------------------------------|------|------|------|------|------|------|------|------|------|------|------|------|
| Lane Configurations          |      |      |      |      |      |      |      |      |      |      |      |      |
| Traffic Volume (veh/h)       | 50   | 50   | 60   | 90   | 80   | 80   | 70   | 240  | 90   | 80   | 200  | 50   |
| Future Volume (veh/h)        | 50   | 50   | 60   | 90   | 80   | 80   | 70   | 240  | 90   | 80   | 200  | 50   |
| Number                       | 7    | 4    | 14   | 3    | 8    | 18   | 5    | 2    | 12   | 1    | 6    | 16   |
| Initial Q (Qb), veh          | 0    | 0    | 0    | 0    | 0    | 0    | 0    | 0    | 0    | 0    | 0    | 0    |
| Ped-Bike Adj(A_pbT)          | 1.00 |      | 1.00 | 1.00 |      | 1.00 | 1.00 |      | 1.00 | 1.00 |      | 1.00 |
| Parking Bus, Adj             | 1.00 | 1.00 | 1.00 | 1.00 | 1.00 | 1.00 | 1.00 | 1.00 | 1.00 | 1.00 | 1.00 | 1.00 |
| Adj Sat Flow, veh/h/ln       | 1863 | 1863 | 1900 | 1863 | 1863 | 1900 | 1863 | 1863 | 1900 | 1863 | 1863 | 1900 |
| Adj Flow Rate, veh/h         | 54   | 54   | 65   | 98   | 87   | 87   | 76   | 261  | 98   | 87   | 217  | 54   |
| Adj No. of Lanes             | 1    | 1    | 0    | 1    | 1    | 0    | 1    | 1    | 0    | 1    | 1    | 0    |
| Peak Hour Factor             | 0.92 | 0.92 | 0.92 | 0.92 | 0.92 | 0.92 | 0.92 | 0.92 | 0.92 | 0.92 | 0.92 | 0.92 |
| Percent Heavy Veh, %         | 2    | 2    | 2    | 2    | 2    | 2    | 2    | 2    | 2    | 2    | 2    | 2    |
| Cap, veh/h                   | 96   | 163  | 196  | 137  | 201  | 201  | 119  | 356  | 134  | 128  | 405  | 101  |
| Arrive On Green              | 0.05 | 0.21 | 0.21 | 0.08 | 0.23 | 0.23 | 0.07 | 0.28 | 0.28 | 0.07 | 0.28 | 0.28 |
| Sat Flow, veh/h              | 1774 | 771  | 928  | 1774 | 856  | 856  | 1774 | 1292 | 485  | 1774 | 1441 | 359  |
| Grp Volume(v), veh/h         | 54   | 0    | 119  | 98   | 0    | 174  | 76   | 0    | 359  | 87   | 0    | 271  |
| Grp Sat Flow(s),veh/h/ln     | 1774 | 0    | 1699 | 1774 | 0    | 1712 | 1774 | 0    | 1777 | 1774 | 0    | 1799 |
| Q Serve(g_s), s              | 1.4  | 0.0  | 2.8  | 2.5  | 0.0  | 4.0  | 2.0  | 0.0  | 8.6  | 2.2  | 0.0  | 6.0  |
| Cycle Q Clear(g_c), s        | 1.4  | 0.0  | 2.8  | 2.5  | 0.0  | 4.0  | 2.0  | 0.0  | 8.6  | 2.2  | 0.0  | 6.0  |
| Prop In Lane                 | 1.00 |      | 0.55 | 1.00 |      | 0.50 | 1.00 |      | 0.27 | 1.00 |      | 0.20 |
| Lane Grp Cap(c), veh/h       | 96   | 0    | 359  | 137  | 0    | 402  | 119  | 0    | 490  | 128  | 0    | 505  |
| V/C Ratio(X)                 | 0.56 | 0.00 | 0.33 | 0.72 | 0.00 | 0.43 | 0.64 | 0.00 | 0.73 | 0.68 | 0.00 | 0.54 |
| Avail Cap(c_a), veh/h        | 228  | 0    | 1290 | 228  | 0    | 1300 | 228  | 0    | 1349 | 228  | 0    | 1366 |
| HCM Platoon Ratio            | 1.00 | 1.00 | 1.00 | 1.00 | 1.00 | 1.00 | 1.00 | 1.00 | 1.00 | 1.00 | 1.00 | 1.00 |
| Upstream Filter(I)           | 1.00 | 0.00 | 1.00 | 1.00 | 0.00 | 1.00 | 1.00 | 0.00 | 1.00 | 1.00 | 0.00 | 1.00 |
| Uniform Delay (d), s/veh     | 21.6 | 0.0  | 15.6 | 21.1 | 0.0  | 15.2 | 21.3 | 0.0  | 15.4 | 21.2 | 0.0  | 14.2 |
| Incr Delay (d2), s/veh       | 5.1  | 0.0  | 0.5  | 6.9  | 0.0  | 0.7  | 5.6  | 0.0  | 2.1  | 6.1  | 0.0  | 0.9  |
| Initial Q Delay(d3),s/veh    | 0.0  | 0.0  | 0.0  | 0.0  | 0.0  | 0.0  | 0.0  | 0.0  | 0.0  | 0.0  | 0.0  | 0.0  |
| %ile BackOfQ(50%),veh/ln     | 0.8  | 0.0  | 1.3  | 1.5  | 0.0  | 2.0  | 1.1  | 0.0  | 4.5  | 1.3  | 0.0  | 3.1  |
| LnGrp Delay(d),s/veh         | 26.7 | 0.0  | 16.2 | 27.9 | 0.0  | 16.0 | 26.8 | 0.0  | 17.5 | 27.3 | 0.0  | 15.1 |
| LnGrp LOS                    | C    |      | B    | C    |      | B    | C    |      | B    | C    |      | B    |
| Approach Vol, veh/h          |      | 173  |      |      | 272  |      |      | 435  |      |      | 358  |      |
| Approach Delay, s/veh        |      | 19.5 |      |      | 20.3 |      |      | 19.1 |      |      | 18.1 |      |
| Approach LOS                 |      | B    |      |      | C    |      |      | B    |      |      | B    |      |
| Timer                        | 1    | 2    | 3    | 4    | 5    | 6    | 7    | 8    |      |      |      |      |
| Assigned Phs                 | 1    | 2    | 3    | 4    | 5    | 6    | 7    | 8    |      |      |      |      |
| Phs Duration (G+Y+Rc), s     | 7.4  | 17.4 | 7.6  | 14.4 | 7.1  | 17.6 | 6.5  | 15.5 |      |      |      |      |
| Change Period (Y+Rc), s      | 4.0  | 4.5  | 4.0  | 4.5  | 4.0  | 4.5  | 4.0  | 4.5  |      |      |      |      |
| Max Green Setting (Gmax), s  | 35.5 | 35.5 | 6.0  | 35.5 | 6.0  | 35.5 | 6.0  | 35.5 |      |      |      |      |
| Max Q Clear Time (g_c+14), s | 10.6 | 10.6 | 4.5  | 4.8  | 4.0  | 8.0  | 3.4  | 6.0  |      |      |      |      |
| Green Ext Time (p_c), s      | 0.0  | 2.3  | 0.0  | 0.7  | 0.0  | 1.7  | 0.0  | 1.1  |      |      |      |      |
| <b>Intersection Summary</b>  |      |      |      |      |      |      |      |      |      |      |      |      |
| HCM 2010 Ctrl Delay          |      |      |      | 19.1 |      |      |      |      |      |      |      |      |
| HCM 2010 LOS                 |      |      |      | B    |      |      |      |      |      |      |      |      |

HCM 2010 Signalized Intersection Summary Cumulative with Eastside Parkway with Project, PM  
 3: SR 1 SB On-Ramp/SR 1 SB Off-Ramp & Imjin Parkway 06/11/2019



| Movement                     | EBL | EBT | EBR | WBL   | WBT   | WBR  | NBL | NBT | NBR | SBL   | SBT   | SBR  |
|------------------------------|-----|-----|-----|-------|-------|------|-----|-----|-----|-------|-------|------|
| Lane Configurations          |     |     |     |       | ↕     |      |     |     |     |       | ↕     |      |
| Traffic Volume (veh/h)       | 0   | 0   | 0   | 1170  | 0     | 0    | 0   | 0   | 0   | 720   | 10    | 0    |
| Future Volume (veh/h)        | 0   | 0   | 0   | 1170  | 0     | 0    | 0   | 0   | 0   | 720   | 10    | 0    |
| Number                       |     |     |     | 1     | 6     | 16   |     |     |     | 7     | 4     | 14   |
| Initial Q (Qb), veh          |     |     |     | 0     | 0     | 0    |     |     |     | 0     | 0     | 0    |
| Ped-Bike Adj(A_pbT)          |     |     |     | 1.00  |       | 1.00 |     |     |     | 1.00  |       | 1.00 |
| Parking Bus, Adj             |     |     |     | 1.00  | 1.00  | 1.00 |     |     |     | 1.00  | 1.00  | 1.00 |
| Adj Sat Flow, veh/h/ln       |     |     |     | 1900  | 1881  | 0    |     |     |     | 1900  | 1863  | 0    |
| Adj Flow Rate, veh/h         |     |     |     | 1286  | 0     | 0    |     |     |     | 791   | 11    | 0    |
| Adj No. of Lanes             |     |     |     | 0     | 1     | 0    |     |     |     | 0     | 1     | 0    |
| Peak Hour Factor             |     |     |     | 0.91  | 0.91  | 0.91 |     |     |     | 0.91  | 0.91  | 0.91 |
| Percent Heavy Veh, %         |     |     |     | 1     | 1     | 0    |     |     |     | 2     | 2     | 0    |
| Cap, veh/h                   |     |     |     | 1015  | 0     | 0    |     |     |     | 662   | 9     | 0    |
| Arrive On Green              |     |     |     | 0.57  | 0.00  | 0.00 |     |     |     | 0.38  | 0.38  | 0.00 |
| Sat Flow, veh/h              |     |     |     | 1792  | 0     | 0    |     |     |     | 1751  | 24    | 0    |
| Grp Volume(v), veh/h         |     |     |     | 1286  | 0     | 0    |     |     |     | 802   | 0     | 0    |
| Grp Sat Flow(s),veh/h/ln     |     |     |     | 1792  | 0     | 0    |     |     |     | 1775  | 0     | 0    |
| Q Serve(g_s), s              |     |     |     | 90.0  | 0.0   | 0.0  |     |     |     | 60.0  | 0.0   | 0.0  |
| Cycle Q Clear(g_c), s        |     |     |     | 90.0  | 0.0   | 0.0  |     |     |     | 60.0  | 0.0   | 0.0  |
| Prop In Lane                 |     |     |     | 1.00  |       | 0.00 |     |     |     | 0.99  |       | 0.00 |
| Lane Grp Cap(c), veh/h       |     |     |     | 1015  | 0     | 0    |     |     |     | 671   | 0     | 0    |
| V/C Ratio(X)                 |     |     |     | 1.27  | 0.00  | 0.00 |     |     |     | 1.20  | 0.00  | 0.00 |
| Avail Cap(c_a), veh/h        |     |     |     | 1015  | 0     | 0    |     |     |     | 671   | 0     | 0    |
| HCM Platoon Ratio            |     |     |     | 1.00  | 1.00  | 1.00 |     |     |     | 1.00  | 1.00  | 1.00 |
| Upstream Filter(l)           |     |     |     | 1.00  | 0.00  | 0.00 |     |     |     | 1.00  | 0.00  | 0.00 |
| Uniform Delay (d), s/veh     |     |     |     | 34.4  | 0.0   | 0.0  |     |     |     | 49.4  | 0.0   | 0.0  |
| Incr Delay (d2), s/veh       |     |     |     | 127.8 | 0.0   | 0.0  |     |     |     | 102.2 | 0.0   | 0.0  |
| Initial Q Delay(d3),s/veh    |     |     |     | 0.0   | 0.0   | 0.0  |     |     |     | 0.0   | 0.0   | 0.0  |
| %ile BackOfQ(50%),veh/ln     |     |     |     | 80.3  | 0.0   | 0.0  |     |     |     | 48.3  | 0.0   | 0.0  |
| LnGrp Delay(d),s/veh         |     |     |     | 162.2 | 0.0   | 0.0  |     |     |     | 151.6 | 0.0   | 0.0  |
| LnGrp LOS                    |     |     |     | F     |       |      |     |     |     | F     |       |      |
| Approach Vol, veh/h          |     |     |     |       | 1286  |      |     |     |     |       | 802   |      |
| Approach Delay, s/veh        |     |     |     |       | 162.2 |      |     |     |     |       | 151.6 |      |
| Approach LOS                 |     |     |     |       | F     |      |     |     |     |       | F     |      |
| Timer                        | 1   | 2   | 3   | 4     | 5     | 6    | 7   | 8   |     |       |       |      |
| Assigned Phs                 |     |     |     | 4     |       | 6    |     |     |     |       |       |      |
| Phs Duration (G+Y+Rc), s     |     |     |     | 64.4  |       | 94.4 |     |     |     |       |       |      |
| Change Period (Y+Rc), s      |     |     |     | 4.4   |       | 4.4  |     |     |     |       |       |      |
| Max Green Setting (Gmax), s  |     |     |     | 60.0  |       | 90.0 |     |     |     |       |       |      |
| Max Q Clear Time (g_c+I1), s |     |     |     | 62.0  |       | 92.0 |     |     |     |       |       |      |
| Green Ext Time (p_c), s      |     |     |     | 0.0   |       | 0.0  |     |     |     |       |       |      |
| <b>Intersection Summary</b>  |     |     |     |       |       |      |     |     |     |       |       |      |
| HCM 2010 Ctrl Delay          |     |     |     | 158.1 |       |      |     |     |     |       |       |      |
| HCM 2010 LOS                 |     |     |     | F     |       |      |     |     |     |       |       |      |

| Intersection             |      |      |      |      |      |      |      |      |      |      |       |      |
|--------------------------|------|------|------|------|------|------|------|------|------|------|-------|------|
| Int Delay, s/veh         | 0.9  |      |      |      |      |      |      |      |      |      |       |      |
| Movement                 | EBL  | EBT  | EBR  | WBL  | WBT  | WBR  | NBL  | NBT  | NBR  | SBL  | SBT   | SBR  |
| Lane Configurations      |      | ↔    |      |      | ↑    | ↗    |      | ↔    | ↗    |      |       |      |
| Traffic Vol, veh/h       | 10   | 700  | 0    | 0    | 1150 | 950  | 10   | 10   | 1210 | 0    | 0     | 0    |
| Future Vol, veh/h        | 10   | 700  | 0    | 0    | 1150 | 950  | 10   | 10   | 1210 | 0    | 0     | 0    |
| Conflicting Peds, #/hr   | 0    | 0    | 1    | 1    | 0    | 0    | 0    | 0    | 0    | 0    | 0     | 0    |
| Sign Control             | Free | Free | Free | Free | Free | Free | Stop | Stop | Stop | Stop | Stop  | Stop |
| RT Channelized           | -    | -    | None | -    | -    | Free | -    | -    | Free | -    | -     | None |
| Storage Length           | -    | -    | -    | -    | -    | 0    | -    | -    | 800  | -    | -     | -    |
| Veh in Median Storage, # | -    | 0    | -    | -    | 0    | -    | -    | 0    | -    | -    | 16965 | -    |
| Grade, %                 | -    | 0    | -    | -    | 0    | -    | -    | 0    | -    | -    | 0     | -    |
| Peak Hour Factor         | 95   | 95   | 95   | 95   | 95   | 95   | 95   | 95   | 95   | 95   | 95    | 95   |
| Heavy Vehicles, %        | 2    | 2    | 2    | 1    | 1    | 1    | 1    | 1    | 1    | 2    | 2     | 2    |
| Mvmt Flow                | 11   | 737  | 0    | 0    | 1211 | 1000 | 11   | 11   | 1274 | 0    | 0     | 0    |

| Major/Minor          | Major1 | Major2 | Minor1 |
|----------------------|--------|--------|--------|
| Conflicting Flow All | 1211   | 0      | -      |
| Stage 1              | -      | -      | -      |
| Stage 2              | -      | -      | -      |
| Critical Hdwy        | 4.12   | -      | -      |
| Critical Hdwy Stg 1  | -      | -      | -      |
| Critical Hdwy Stg 2  | -      | -      | -      |
| Follow-up Hdwy       | 2.218  | -      | -      |
| Pot Cap-1 Maneuver   | 576    | 0      | 0      |
| Stage 1              | -      | 0      | 0      |
| Stage 2              | -      | 0      | 0      |
| Platoon blocked, %   | -      | -      | -      |
| Mov Cap-1 Maneuver   | 576    | -      | -      |
| Mov Cap-2 Maneuver   | -      | -      | -      |
| Stage 1              | -      | -      | -      |
| Stage 2              | -      | -      | -      |

| Approach             | EB  | WB | NB   |
|----------------------|-----|----|------|
| HCM Control Delay, s | 0.2 | 0  | 81.6 |
| HCM LOS              |     |    | F    |

| Minor Lane/Major Mvmt | NBLn1 | NBLn2 | EBL   | EBT | WBT |
|-----------------------|-------|-------|-------|-----|-----|
| Capacity (veh/h)      | 67    | -     | 576   | -   | -   |
| HCM Lane V/C Ratio    | 0.314 | -     | 0.018 | -   | -   |
| HCM Control Delay (s) | 81.6  | 0     | 11.4  | 0   | -   |
| HCM Lane LOS          | F     | A     | B     | A   | -   |
| HCM 95th %tile Q(veh) | 1.1   | -     | 0.1   | -   | -   |

HCM 2010 Signalized Intersection Summary Cumulative with Eastside Parkway with Project, PM  
 5: 2nd Avenue & Imjin Parkway 06/11/2019

| Movement                     | EBL  | EBT  | EBR  | WBL  | WBT  | WBR  | NBL   | NBT  | NBR  | SBL  | SBT  | SBR  |
|------------------------------|------|------|------|------|------|------|-------|------|------|------|------|------|
| Lane Configurations          |      |      |      |      |      |      |       |      |      |      |      |      |
| Traffic Volume (veh/h)       | 140  | 1010 | 760  | 330  | 1060 | 140  | 900   | 110  | 500  | 90   | 100  | 150  |
| Future Volume (veh/h)        | 140  | 1010 | 760  | 330  | 1060 | 140  | 900   | 110  | 500  | 90   | 100  | 150  |
| Number                       | 5    | 2    | 12   | 1    | 6    | 16   | 3     | 8    | 18   | 7    | 4    | 14   |
| Initial Q (Qb), veh          | 0    | 0    | 0    | 0    | 0    | 0    | 0     | 0    | 0    | 0    | 0    | 0    |
| Ped-Bike Adj(A_pbT)          | 1.00 |      | 1.00 | 1.00 |      | 0.99 | 1.00  |      | 0.99 | 1.00 |      | 0.98 |
| Parking Bus, Adj             | 1.00 | 1.00 | 1.00 | 1.00 | 1.00 | 1.00 | 1.00  | 1.00 | 1.00 | 1.00 | 1.00 | 1.00 |
| Adj Sat Flow, veh/h/ln       | 1881 | 1881 | 1881 | 1881 | 1881 | 1900 | 1900  | 1900 | 1900 | 1900 | 1900 | 1900 |
| Adj Flow Rate, veh/h         | 146  | 1052 | 592  | 344  | 1104 | 146  | 938   | 115  | 287  | 94   | 104  | 125  |
| Adj No. of Lanes             | 1    | 2    | 1    | 2    | 2    | 0    | 2     | 1    | 1    | 1    | 2    | 0    |
| Peak Hour Factor             | 0.96 | 0.96 | 0.96 | 0.96 | 0.96 | 0.96 | 0.96  | 0.96 | 0.96 | 0.96 | 0.96 | 0.96 |
| Percent Heavy Veh, %         | 1    | 1    | 1    | 1    | 1    | 1    | 0     | 0    | 0    | 0    | 0    | 0    |
| Cap, veh/h                   | 184  | 1213 | 540  | 416  | 1131 | 149  | 794   | 503  | 425  | 133  | 203  | 178  |
| Arrive On Green              | 0.10 | 0.34 | 0.34 | 0.12 | 0.36 | 0.36 | 0.23  | 0.26 | 0.26 | 0.07 | 0.11 | 0.11 |
| Sat Flow, veh/h              | 1792 | 3574 | 1592 | 3476 | 3172 | 419  | 3510  | 1900 | 1602 | 1810 | 1805 | 1585 |
| Grp Volume(v), veh/h         | 146  | 1052 | 592  | 344  | 621  | 629  | 938   | 115  | 287  | 94   | 104  | 125  |
| Grp Sat Flow(s),veh/h/ln     | 1792 | 1787 | 1592 | 1738 | 1787 | 1804 | 1755  | 1900 | 1602 | 1810 | 1805 | 1585 |
| Q Serve(g_s), s              | 7.0  | 24.4 | 30.0 | 8.5  | 30.3 | 30.4 | 20.0  | 4.2  | 14.2 | 4.5  | 4.8  | 6.7  |
| Cycle Q Clear(g_c), s        | 7.0  | 24.4 | 30.0 | 8.5  | 30.3 | 30.4 | 20.0  | 4.2  | 14.2 | 4.5  | 4.8  | 6.7  |
| Prop In Lane                 | 1.00 |      | 1.00 | 1.00 |      | 0.23 | 1.00  |      | 1.00 | 1.00 |      | 1.00 |
| Lane Grp Cap(c), veh/h       | 184  | 1213 | 540  | 416  | 637  | 643  | 794   | 503  | 425  | 133  | 203  | 178  |
| V/C Ratio(X)                 | 0.80 | 0.87 | 1.10 | 0.83 | 0.97 | 0.98 | 1.18  | 0.23 | 0.68 | 0.71 | 0.51 | 0.70 |
| Avail Cap(c_a), veh/h        | 304  | 1213 | 540  | 590  | 637  | 643  | 794   | 503  | 425  | 205  | 429  | 376  |
| HCM Platoon Ratio            | 1.00 | 1.00 | 1.00 | 1.00 | 1.00 | 1.00 | 1.00  | 1.00 | 1.00 | 1.00 | 1.00 | 1.00 |
| Upstream Filter(I)           | 1.00 | 1.00 | 1.00 | 1.00 | 1.00 | 1.00 | 1.00  | 1.00 | 1.00 | 1.00 | 1.00 | 1.00 |
| Uniform Delay (d), s/veh     | 38.8 | 27.3 | 29.2 | 38.0 | 28.0 | 28.1 | 34.2  | 25.4 | 29.1 | 40.0 | 37.0 | 37.8 |
| Incr Delay (d2), s/veh       | 3.0  | 6.6  | 67.5 | 4.5  | 29.1 | 29.7 | 94.3  | 0.1  | 3.5  | 2.6  | 0.7  | 1.9  |
| Initial Q Delay(d3),s/veh    | 0.0  | 0.0  | 0.0  | 0.0  | 0.0  | 0.0  | 0.0   | 0.0  | 0.0  | 0.0  | 0.0  | 0.0  |
| %ile BackOfQ(50%),veh/ln     | 3.6  | 13.1 | 23.2 | 4.4  | 20.0 | 20.3 | 20.0  | 2.2  | 6.6  | 2.3  | 2.4  | 3.0  |
| LnGrp Delay(d),s/veh         | 41.7 | 33.9 | 96.7 | 42.6 | 57.1 | 57.8 | 128.5 | 25.5 | 32.6 | 42.6 | 37.7 | 39.7 |
| LnGrp LOS                    | D    | C    | F    | D    | E    | E    | F     | C    | C    | D    | D    | D    |
| Approach Vol, veh/h          |      | 1790 |      |      | 1594 |      |       | 1340 |      |      | 323  |      |
| Approach Delay, s/veh        |      | 55.3 |      |      | 54.3 |      |       | 99.1 |      |      | 39.9 |      |
| Approach LOS                 |      | E    |      |      | D    |      |       | F    |      |      | D    |      |
| Timer                        | 1    | 2    | 3    | 4    | 5    | 6    | 7     | 8    |      |      |      |      |
| Assigned Phs                 | 1    | 2    | 3    | 4    | 5    | 6    | 7     | 8    |      |      |      |      |
| Phs Duration (G+Y+Rc), s     | 15.1 | 35.3 | 23.5 | 14.5 | 13.6 | 36.8 | 10.0  | 28.0 |      |      |      |      |
| Change Period (Y+Rc), s      | 4.5  | 5.3  | 3.5  | 4.6  | 4.5  | 5.3  | 3.5   | 4.6  |      |      |      |      |
| Max Green Setting (Gmax), s  | 15.0 | 30.0 | 20.0 | 21.0 | 15.0 | 30.0 | 10.0  | 21.0 |      |      |      |      |
| Max Q Clear Time (g_c+I1), s | 10.5 | 32.0 | 22.0 | 8.7  | 9.0  | 32.4 | 6.5   | 16.2 |      |      |      |      |
| Green Ext Time (p_c), s      | 0.0  | 0.0  | 0.0  | 0.2  | 0.0  | 0.0  | 0.0   | 0.1  |      |      |      |      |
| <b>Intersection Summary</b>  |      |      |      |      |      |      |       |      |      |      |      |      |
| HCM 2010 Ctrl Delay          |      |      | 65.6 |      |      |      |       |      |      |      |      |      |
| HCM 2010 LOS                 |      |      | E    |      |      |      |       |      |      |      |      |      |

HCM 2010 Signalized Intersection Summary Cumulative with Eastside Parkway with Project, PM  
6: 3rd Avenue & Imjin Parkway

06/11/2019



| Movement                     | EBL  | EBT  | EBR  | WBL  | WBT  | WBR  | NBL  | NBT  | NBR  | SBL  | SBT  | SBR  |
|------------------------------|------|------|------|------|------|------|------|------|------|------|------|------|
| Lane Configurations          | ↖    | ↗    |      | ↖    | ↗    |      | ↖    | ↗    |      | ↖    | ↗    |      |
| Traffic Volume (veh/h)       | 50   | 1430 | 160  | 90   | 1150 | 20   | 220  | 10   | 140  | 10   | 10   | 50   |
| Future Volume (veh/h)        | 50   | 1430 | 160  | 90   | 1150 | 20   | 220  | 10   | 140  | 10   | 10   | 50   |
| Number                       | 5    | 2    | 12   | 1    | 6    | 16   | 3    | 8    | 18   | 7    | 4    | 14   |
| Initial Q (Qb), veh          | 0    | 0    | 0    | 0    | 0    | 0    | 0    | 0    | 0    | 0    | 0    | 0    |
| Ped-Bike Adj(A_pbT)          | 1.00 |      | 0.98 | 1.00 |      | 1.00 | 1.00 |      | 1.00 | 1.00 |      | 1.00 |
| Parking Bus, Adj             | 1.00 | 1.00 | 1.00 | 1.00 | 1.00 | 1.00 | 1.00 | 1.00 | 1.00 | 1.00 | 1.00 | 1.00 |
| Adj Sat Flow, veh/h/ln       | 1881 | 1881 | 1900 | 1881 | 1881 | 1900 | 1900 | 1900 | 1900 | 1900 | 1900 | 1900 |
| Adj Flow Rate, veh/h         | 51   | 1459 | 155  | 92   | 1173 | 19   | 224  | 10   | 31   | 10   | 10   | 10   |
| Adj No. of Lanes             | 1    | 2    | 0    | 1    | 2    | 0    | 1    | 1    | 0    | 1    | 1    | 0    |
| Peak Hour Factor             | 0.98 | 0.98 | 0.98 | 0.98 | 0.98 | 0.98 | 0.98 | 0.98 | 0.98 | 0.98 | 0.98 | 0.98 |
| Percent Heavy Veh, %         | 1    | 1    | 1    | 1    | 1    | 1    | 0    | 0    | 0    | 0    | 0    | 0    |
| Cap, veh/h                   | 114  | 1591 | 168  | 118  | 1767 | 29   | 401  | 82   | 255  | 381  | 176  | 176  |
| Arrive On Green              | 0.06 | 0.49 | 0.49 | 0.07 | 0.49 | 0.49 | 0.20 | 0.20 | 0.20 | 0.20 | 0.20 | 0.20 |
| Sat Flow, veh/h              | 1792 | 3256 | 343  | 1792 | 3600 | 58   | 1412 | 408  | 1266 | 1386 | 872  | 872  |
| Grp Volume(v), veh/h         | 51   | 795  | 819  | 92   | 582  | 610  | 224  | 0    | 41   | 10   | 0    | 20   |
| Grp Sat Flow(s),veh/h/ln     | 1792 | 1787 | 1811 | 1792 | 1787 | 1871 | 1412 | 0    | 1674 | 1386 | 0    | 1745 |
| Q Serve(g_s), s              | 1.5  | 22.6 | 23.3 | 2.8  | 13.6 | 13.6 | 8.4  | 0.0  | 1.1  | 0.3  | 0.0  | 0.5  |
| Cycle Q Clear(g_c), s        | 1.5  | 22.6 | 23.3 | 2.8  | 13.6 | 13.6 | 8.9  | 0.0  | 1.1  | 1.4  | 0.0  | 0.5  |
| Prop In Lane                 | 1.00 |      | 0.19 | 1.00 |      | 0.03 | 1.00 |      | 0.76 | 1.00 |      | 0.50 |
| Lane Grp Cap(c), veh/h       | 114  | 873  | 885  | 118  | 877  | 918  | 401  | 0    | 337  | 381  | 0    | 351  |
| V/C Ratio(X)                 | 0.45 | 0.91 | 0.93 | 0.78 | 0.66 | 0.66 | 0.56 | 0.00 | 0.12 | 0.03 | 0.00 | 0.06 |
| Avail Cap(c_a), veh/h        | 373  | 1051 | 1065 | 373  | 1051 | 1100 | 820  | 0    | 833  | 792  | 0    | 868  |
| HCM Platoon Ratio            | 1.00 | 1.00 | 1.00 | 1.00 | 1.00 | 1.00 | 1.00 | 1.00 | 1.00 | 1.00 | 1.00 | 1.00 |
| Upstream Filter(I)           | 1.00 | 1.00 | 1.00 | 1.00 | 1.00 | 1.00 | 1.00 | 0.00 | 1.00 | 1.00 | 0.00 | 1.00 |
| Uniform Delay (d), s/veh     | 24.9 | 13.0 | 13.2 | 25.4 | 10.6 | 10.6 | 21.4 | 0.0  | 18.1 | 18.7 | 0.0  | 17.8 |
| Incr Delay (d2), s/veh       | 1.0  | 9.4  | 10.9 | 4.2  | 0.7  | 0.7  | 0.5  | 0.0  | 0.1  | 0.0  | 0.0  | 0.0  |
| Initial Q Delay(d3),s/veh    | 0.0  | 0.0  | 0.0  | 0.0  | 0.0  | 0.0  | 0.0  | 0.0  | 0.0  | 0.0  | 0.0  | 0.0  |
| %ile BackOfQ(50%),veh/ln     | 0.8  | 13.3 | 14.1 | 1.5  | 6.8  | 7.1  | 3.3  | 0.0  | 0.5  | 0.1  | 0.0  | 0.2  |
| LnGrp Delay(d),s/veh         | 26.0 | 22.4 | 24.1 | 29.6 | 11.4 | 11.3 | 21.9 | 0.0  | 18.1 | 18.7 | 0.0  | 17.9 |
| LnGrp LOS                    | C    | C    | C    | C    | B    | B    | C    |      | B    | B    |      | B    |
| Approach Vol, veh/h          |      | 1665 |      |      | 1284 |      |      | 265  |      |      | 30   |      |
| Approach Delay, s/veh        |      | 23.3 |      |      | 12.6 |      |      | 21.3 |      |      | 18.1 |      |
| Approach LOS                 |      | C    |      |      | B    |      |      | C    |      |      | B    |      |
| Timer                        | 1    | 2    | 3    | 4    | 5    | 6    | 7    | 8    |      |      |      |      |
| Assigned Phs                 | 1    | 2    |      | 4    | 5    | 6    |      | 8    |      |      |      |      |
| Phs Duration (G+Y+Rc), s     | 7.1  | 32.5 |      | 15.6 | 7.0  | 32.6 |      | 15.6 |      |      |      |      |
| Change Period (Y+Rc), s      | 3.5  | 5.5  |      | 4.5  | 3.5  | 5.5  |      | 4.5  |      |      |      |      |
| Max Green Setting (Gmax), s  | 1.5  | 32.5 |      | 27.5 | 11.5 | 32.5 |      | 27.5 |      |      |      |      |
| Max Q Clear Time (g_c+14), s | 14.8 | 25.3 |      | 3.4  | 3.5  | 15.6 |      | 10.9 |      |      |      |      |
| Green Ext Time (p_c), s      | 0.0  | 1.7  |      | 0.0  | 0.0  | 0.9  |      | 0.1  |      |      |      |      |
| <b>Intersection Summary</b>  |      |      |      |      |      |      |      |      |      |      |      |      |
| HCM 2010 Ctrl Delay          |      |      |      | 18.9 |      |      |      |      |      |      |      |      |
| HCM 2010 LOS                 |      |      |      | B    |      |      |      |      |      |      |      |      |

HCM 2010 Signalized Intersection Summary Cumulative with Eastside Parkway with Project, PM  
7: 4th Avenue & Imjin Parkway

06/11/2019



| Movement                      | EBL  | EBT  | EBR  | WBL  | WBT  | WBR  | NBL  | NBT  | NBR  | SBL  | SBT  | SBR  |
|-------------------------------|------|------|------|------|------|------|------|------|------|------|------|------|
| Lane Configurations           |      |      |      |      |      |      |      |      |      |      |      |      |
| Traffic Volume (veh/h)        | 10   | 1580 | 10   | 10   | 1220 | 10   | 20   | 10   | 10   | 10   | 10   | 10   |
| Future Volume (veh/h)         | 10   | 1580 | 10   | 10   | 1220 | 10   | 20   | 10   | 10   | 10   | 10   | 10   |
| Number                        | 5    | 2    | 12   | 1    | 6    | 16   | 3    | 8    | 18   | 7    | 4    | 14   |
| Initial Q (Qb), veh           | 0    | 0    | 0    | 0    | 0    | 0    | 0    | 0    | 0    | 0    | 0    | 0    |
| Ped-Bike Adj(A_pbT)           | 1.00 |      | 1.00 | 1.00 |      | 0.98 | 1.00 |      | 1.00 | 1.00 |      | 1.00 |
| Parking Bus, Adj              | 1.00 | 1.00 | 1.00 | 1.00 | 1.00 | 1.00 | 1.00 | 1.00 | 1.00 | 1.00 | 1.00 | 1.00 |
| Adj Sat Flow, veh/h/ln        | 1881 | 1881 | 1900 | 1881 | 1881 | 1900 | 1900 | 1900 | 1900 | 1900 | 1900 | 1900 |
| Adj Flow Rate, veh/h          | 10   | 1629 | 10   | 10   | 1258 | 10   | 21   | 10   | 8    | 10   | 10   | 10   |
| Adj No. of Lanes              | 1    | 2    | 0    | 1    | 2    | 0    | 0    | 1    | 0    | 0    | 1    | 0    |
| Peak Hour Factor              | 0.97 | 0.97 | 0.97 | 0.97 | 0.97 | 0.97 | 0.97 | 0.97 | 0.97 | 0.97 | 0.97 | 0.97 |
| Percent Heavy Veh, %          | 1    | 1    | 1    | 1    | 1    | 1    | 0    | 0    | 0    | 0    | 0    | 0    |
| Cap, veh/h                    | 14   | 1841 | 11   | 14   | 1837 | 15   | 227  | 24   | 19   | 185  | 33   | 33   |
| Arrive On Green               | 0.01 | 0.51 | 0.51 | 0.01 | 0.51 | 0.51 | 0.06 | 0.06 | 0.06 | 0.06 | 0.06 | 0.06 |
| Sat Flow, veh/h               | 1792 | 3642 | 22   | 1792 | 3634 | 29   | 880  | 419  | 335  | 571  | 571  | 571  |
| Grp Volume(v), veh/h          | 10   | 799  | 840  | 10   | 619  | 649  | 39   | 0    | 0    | 30   | 0    | 0    |
| Grp Sat Flow(s),veh/h/ln      | 1792 | 1787 | 1877 | 1792 | 1787 | 1875 | 1634 | 0    | 0    | 1712 | 0    | 0    |
| Q Serve(g_s), s               | 0.2  | 12.6 | 12.6 | 0.2  | 8.2  | 8.2  | 0.2  | 0.0  | 0.0  | 0.0  | 0.0  | 0.0  |
| Cycle Q Clear(g_c), s         | 0.2  | 12.6 | 12.6 | 0.2  | 8.2  | 8.2  | 0.7  | 0.0  | 0.0  | 0.5  | 0.0  | 0.0  |
| Prop In Lane                  | 1.00 |      | 0.01 | 1.00 |      | 0.02 | 0.54 |      | 0.21 | 0.33 |      | 0.33 |
| Lane Grp Cap(c), veh/h        | 14   | 903  | 949  | 14   | 903  | 948  | 270  | 0    | 0    | 251  | 0    | 0    |
| V/C Ratio(X)                  | 0.70 | 0.88 | 0.89 | 0.70 | 0.68 | 0.69 | 0.14 | 0.00 | 0.00 | 0.12 | 0.00 | 0.00 |
| Avail Cap(c_a), veh/h         | 655  | 1846 | 1939 | 655  | 1846 | 1937 | 1540 | 0    | 0    | 1574 | 0    | 0    |
| HCM Platoon Ratio             | 1.00 | 1.00 | 1.00 | 1.00 | 1.00 | 1.00 | 1.00 | 1.00 | 1.00 | 1.00 | 1.00 | 1.00 |
| Upstream Filter(l)            | 1.00 | 1.00 | 1.00 | 1.00 | 1.00 | 1.00 | 1.00 | 0.00 | 0.00 | 1.00 | 0.00 | 0.00 |
| Uniform Delay (d), s/veh      | 15.6 | 7.0  | 7.0  | 15.6 | 5.9  | 5.9  | 14.3 | 0.0  | 0.0  | 14.2 | 0.0  | 0.0  |
| Incr Delay (d2), s/veh        | 20.4 | 1.2  | 1.1  | 20.4 | 0.3  | 0.3  | 0.1  | 0.0  | 0.0  | 0.1  | 0.0  | 0.0  |
| Initial Q Delay(d3),s/veh     | 0.0  | 0.0  | 0.0  | 0.0  | 0.0  | 0.0  | 0.0  | 0.0  | 0.0  | 0.0  | 0.0  | 0.0  |
| %ile BackOfQ(50%),veh/ln      | 0.2  | 6.3  | 6.6  | 0.2  | 4.0  | 4.2  | 0.3  | 0.0  | 0.0  | 0.3  | 0.0  | 0.0  |
| LnGrp Delay(d),s/veh          | 35.9 | 8.2  | 8.1  | 35.9 | 6.2  | 6.2  | 14.4 | 0.0  | 0.0  | 14.3 | 0.0  | 0.0  |
| LnGrp LOS                     | D    | A    | A    | D    | A    | A    | B    |      |      | B    |      |      |
| Approach Vol, veh/h           |      | 1649 |      |      | 1278 |      |      | 39   |      |      | 30   |      |
| Approach Delay, s/veh         |      | 8.3  |      |      | 6.5  |      |      | 14.4 |      |      | 14.3 |      |
| Approach LOS                  |      | A    |      |      | A    |      |      | B    |      |      | B    |      |
| Timer                         | 1    | 2    | 3    | 4    | 5    | 6    | 7    | 8    |      |      |      |      |
| Assigned Phs                  | 1    | 2    |      | 4    | 5    | 6    |      | 8    |      |      |      |      |
| Phs Duration (G+Y+Rc), s      | 3.8  | 21.4 |      | 6.3  | 3.8  | 21.4 |      | 6.3  |      |      |      |      |
| Change Period (Y+Rc), s       | 3.5  | 5.5  |      | 4.5  | 3.5  | 5.5  |      | 4.5  |      |      |      |      |
| Max Green Setting (Gmax), s   | 1.5  | 32.5 |      | 27.5 | 11.5 | 32.5 |      | 27.5 |      |      |      |      |
| Max Q Clear Time (g_c+1/2), s | 12.2 | 14.6 |      | 2.5  | 2.2  | 10.2 |      | 2.7  |      |      |      |      |
| Green Ext Time (p_c), s       | 0.0  | 1.3  |      | 0.0  | 0.0  | 0.9  |      | 0.0  |      |      |      |      |
| <b>Intersection Summary</b>   |      |      |      |      |      |      |      |      |      |      |      |      |
| HCM 2010 Ctrl Delay           |      |      |      | 7.7  |      |      |      |      |      |      |      |      |
| HCM 2010 LOS                  |      |      |      | A    |      |      |      |      |      |      |      |      |

HCM 2010 Signalized Intersection Summary Cumulative with Eastside Parkway with Project, PM  
 8: 5th Avenue/California Avenue & Imjin Parkway

06/11/2019



| Movement                      | EBL  | EBT  | EBR  | WBL  | WBT  | WBR  | NBL  | NBT  | NBR  | SBL  | SBT  | SBR  |
|-------------------------------|------|------|------|------|------|------|------|------|------|------|------|------|
| Lane Configurations           |      |      |      |      |      |      |      |      |      |      |      |      |
| Traffic Volume (veh/h)        | 300  | 1230 | 10   | 10   | 990  | 100  | 20   | 50   | 10   | 70   | 40   | 230  |
| Future Volume (veh/h)         | 300  | 1230 | 10   | 10   | 990  | 100  | 20   | 50   | 10   | 70   | 40   | 230  |
| Number                        | 5    | 2    | 12   | 1    | 6    | 16   | 3    | 8    | 18   | 7    | 4    | 14   |
| Initial Q (Qb), veh           | 0    | 0    | 0    | 0    | 0    | 0    | 0    | 0    | 0    | 0    | 0    | 0    |
| Ped-Bike Adj(A_pbT)           | 1.00 |      | 1.00 | 1.00 |      | 1.00 | 1.00 |      | 1.00 | 1.00 |      | 0.98 |
| Parking Bus, Adj              | 1.00 | 1.00 | 1.00 | 1.00 | 1.00 | 1.00 | 1.00 | 1.00 | 1.00 | 1.00 | 1.00 | 1.00 |
| Adj Sat Flow, veh/h/ln        | 1881 | 1881 | 1900 | 1881 | 1881 | 1900 | 1900 | 1900 | 1900 | 1900 | 1881 | 1900 |
| Adj Flow Rate, veh/h          | 309  | 1268 | 10   | 10   | 1021 | 97   | 21   | 52   | 7    | 72   | 41   | 68   |
| Adj No. of Lanes              | 1    | 2    | 0    | 1    | 2    | 0    | 0    | 1    | 0    | 0    | 1    | 0    |
| Peak Hour Factor              | 0.97 | 0.97 | 0.97 | 0.97 | 0.97 | 0.97 | 0.97 | 0.97 | 0.97 | 0.97 | 0.97 | 0.97 |
| Percent Heavy Veh, %          | 1    | 1    | 1    | 1    | 1    | 1    | 0    | 0    | 0    | 1    | 1    | 1    |
| Cap, veh/h                    | 369  | 2000 | 16   | 14   | 1162 | 110  | 141  | 208  | 24   | 189  | 71   | 90   |
| Arrive On Green               | 0.21 | 0.55 | 0.55 | 0.01 | 0.35 | 0.35 | 0.15 | 0.15 | 0.15 | 0.15 | 0.15 | 0.15 |
| Sat Flow, veh/h               | 1792 | 3635 | 29   | 1792 | 3298 | 313  | 280  | 1375 | 159  | 526  | 469  | 599  |
| Grp Volume(v), veh/h          | 309  | 623  | 655  | 10   | 553  | 565  | 80   | 0    | 0    | 181  | 0    | 0    |
| Grp Sat Flow(s),veh/h/ln      | 1792 | 1787 | 1876 | 1792 | 1787 | 1824 | 1814 | 0    | 0    | 1594 | 0    | 0    |
| Q Serve(g_s), s               | 7.6  | 11.1 | 11.1 | 0.3  | 13.4 | 13.4 | 0.0  | 0.0  | 0.0  | 3.2  | 0.0  | 0.0  |
| Cycle Q Clear(g_c), s         | 7.6  | 11.1 | 11.1 | 0.3  | 13.4 | 13.4 | 1.7  | 0.0  | 0.0  | 4.9  | 0.0  | 0.0  |
| Prop In Lane                  | 1.00 |      | 0.02 | 1.00 |      | 0.17 | 0.26 |      | 0.09 | 0.40 |      | 0.38 |
| Lane Grp Cap(c), veh/h        | 369  | 984  | 1033 | 14   | 630  | 643  | 373  | 0    | 0    | 350  | 0    | 0    |
| V/C Ratio(X)                  | 0.84 | 0.63 | 0.63 | 0.71 | 0.88 | 0.88 | 0.21 | 0.00 | 0.00 | 0.52 | 0.00 | 0.00 |
| Avail Cap(c_a), veh/h         | 583  | 1163 | 1221 | 583  | 1163 | 1187 | 846  | 0    | 0    | 783  | 0    | 0    |
| HCM Platoon Ratio             | 1.00 | 1.00 | 1.00 | 1.00 | 1.00 | 1.00 | 1.00 | 1.00 | 1.00 | 1.00 | 1.00 | 1.00 |
| Upstream Filter(I)            | 1.00 | 1.00 | 1.00 | 1.00 | 1.00 | 1.00 | 1.00 | 0.00 | 0.00 | 1.00 | 0.00 | 0.00 |
| Uniform Delay (d), s/veh      | 17.6 | 7.2  | 7.2  | 22.8 | 14.0 | 14.0 | 17.4 | 0.0  | 0.0  | 18.6 | 0.0  | 0.0  |
| Incr Delay (d2), s/veh        | 3.3  | 0.5  | 0.4  | 21.9 | 1.6  | 1.6  | 0.1  | 0.0  | 0.0  | 0.4  | 0.0  | 0.0  |
| Initial Q Delay(d3),s/veh     | 0.0  | 0.0  | 0.0  | 0.0  | 0.0  | 0.0  | 0.0  | 0.0  | 0.0  | 0.0  | 0.0  | 0.0  |
| %ile BackOfQ(50%),veh/ln      | 4.1  | 5.5  | 5.8  | 0.2  | 6.7  | 6.9  | 0.9  | 0.0  | 0.0  | 2.3  | 0.0  | 0.0  |
| LnGrp Delay(d),s/veh          | 20.8 | 7.6  | 7.6  | 44.7 | 15.6 | 15.6 | 17.5 | 0.0  | 0.0  | 19.1 | 0.0  | 0.0  |
| LnGrp LOS                     | C    | A    | A    | D    | B    | B    | B    |      |      | B    |      |      |
| Approach Vol, veh/h           |      | 1587 |      |      | 1128 |      |      | 80   |      |      | 181  |      |
| Approach Delay, s/veh         |      | 10.2 |      |      | 15.9 |      |      | 17.5 |      |      | 19.1 |      |
| Approach LOS                  |      | B    |      |      | B    |      |      | B    |      |      | B    |      |
| Timer                         | 1    | 2    | 3    | 4    | 5    | 6    | 7    | 8    |      |      |      |      |
| Assigned Phs                  | 1    | 2    |      | 4    | 5    | 6    |      | 8    |      |      |      |      |
| Phs Duration (G+Y+Rc), s      | 3.9  | 30.7 |      | 11.6 | 13.0 | 21.5 |      | 11.6 |      |      |      |      |
| Change Period (Y+Rc), s       | 3.5  | 5.3  |      | 4.6  | 3.5  | 5.3  |      | 4.6  |      |      |      |      |
| Max Green Setting (Gmax), s   | 5.0  | 30.0 |      | 20.0 | 15.0 | 30.0 |      | 20.0 |      |      |      |      |
| Max Q Clear Time (g_c+1/2), s | 12.3 | 13.1 |      | 6.9  | 9.6  | 15.4 |      | 3.7  |      |      |      |      |
| Green Ext Time (p_c), s       | 0.0  | 0.9  |      | 0.1  | 0.0  | 0.8  |      | 0.1  |      |      |      |      |
| <b>Intersection Summary</b>   |      |      |      |      |      |      |      |      |      |      |      |      |
| HCM 2010 Ctrl Delay           |      |      |      | 13.1 |      |      |      |      |      |      |      |      |
| HCM 2010 LOS                  |      |      |      | B    |      |      |      |      |      |      |      |      |

| Intersection             |      |      |      |      |      |      |
|--------------------------|------|------|------|------|------|------|
| Int Delay, s/veh         | 0.6  |      |      |      |      |      |
| Movement                 | EBL  | EBR  | NBL  | NBT  | SBT  | SBR  |
| Lane Configurations      |      |      |      |      |      |      |
| Traffic Vol, veh/h       | 10   | 10   | 20   | 420  | 270  | 10   |
| Future Vol, veh/h        | 10   | 10   | 20   | 420  | 270  | 10   |
| Conflicting Peds, #/hr   | 0    | 0    | 0    | 0    | 0    | 0    |
| Sign Control             | Stop | Stop | Free | Free | Free | Free |
| RT Channelized           | -    | None | -    | None | -    | None |
| Storage Length           | 0    | -    | 155  | -    | -    | -    |
| Veh in Median Storage, # | 0    | -    | -    | 0    | 0    | -    |
| Grade, %                 | 0    | -    | -    | 0    | 0    | -    |
| Peak Hour Factor         | 92   | 92   | 92   | 92   | 92   | 92   |
| Heavy Vehicles, %        | 2    | 2    | 2    | 2    | 2    | 2    |
| Mvmt Flow                | 11   | 11   | 22   | 457  | 293  | 11   |

| Major/Minor          | Minor2 | Major1 | Major2 |   |   |   |
|----------------------|--------|--------|--------|---|---|---|
| Conflicting Flow All | 800    | 299    | 304    | 0 | - | 0 |
| Stage 1              | 299    | -      | -      | - | - | - |
| Stage 2              | 501    | -      | -      | - | - | - |
| Critical Hdwy        | 6.42   | 6.22   | 4.12   | - | - | - |
| Critical Hdwy Stg 1  | 5.42   | -      | -      | - | - | - |
| Critical Hdwy Stg 2  | 5.42   | -      | -      | - | - | - |
| Follow-up Hdwy       | 3.518  | 3.318  | 2.218  | - | - | - |
| Pot Cap-1 Maneuver   | 354    | 741    | 1257   | - | - | - |
| Stage 1              | 752    | -      | -      | - | - | - |
| Stage 2              | 609    | -      | -      | - | - | - |
| Platoon blocked, %   |        |        |        | - | - | - |
| Mov Cap-1 Maneuver   | 348    | 741    | 1257   | - | - | - |
| Mov Cap-2 Maneuver   | 348    | -      | -      | - | - | - |
| Stage 1              | 738    | -      | -      | - | - | - |
| Stage 2              | 609    | -      | -      | - | - | - |

















| Approach             | EB | NB  | SB |
|----------------------|----|-----|----|
| HCM Control Delay, s | 13 | 0.4 | 0  |
| HCM LOS              | B  |     |    |

| Minor Lane/Major Mvmt | NBL   | NBT | EBLn1 | SBT | SBR |
|-----------------------|-------|-----|-------|-----|-----|
| Capacity (veh/h)      | 1257  | -   | 474   | -   | -   |
| HCM Lane V/C Ratio    | 0.017 | -   | 0.046 | -   | -   |
| HCM Control Delay (s) | 7.9   | -   | 13    | -   | -   |
| HCM Lane LOS          | A     | -   | B     | -   | -   |
| HCM 95th %tile Q(veh) | 0.1   | -   | 0.1   | -   | -   |



HCM 2010 Signalized Intersection Summary Cumulative with Eastside Parkway with Project, PM  
 10: Imjin Road & Imjin Parkway

06/11/2019

|                              |    |  |  |    |    |    |   |      |
|------------------------------|---|---|---|---|---|---|---|------|
| Movement                     | EBT   | EBR   | WBL   | WBT   | NBL   | NBR   |   |      |
| Lane Configurations          |   |   |  |   |    |   |   |      |
| Traffic Volume (veh/h)       | 1170  | 130   | 160   | 830   | 270   | 610   |   |      |
| Future Volume (veh/h)        | 1170  | 130   | 160   | 830   | 270   | 610   |   |      |
| Number                       | 2   | 12  | 1   | 6   | 3   | 18  |   |      |
| Initial Q (Qb), veh          | 0   | 0   | 0   | 0   | 0   | 0   |   |      |
| Ped-Bike Adj(A_pbT)          |   | 1.00  | 1.00  |   | 1.00  | 1.00  |   |      |
| Parking Bus, Adj             | 1.00  | 1.00  | 1.00  | 1.00  | 1.00  | 1.00  |   |      |
| Adj Sat Flow, veh/h/ln       | 1881  | 1900  | 1881  | 1881  | 1881  | 1881  |   |      |
| Adj Flow Rate, veh/h         | 1232  | 134   | 168   | 874   | 284   | 576   |   |      |
| Adj No. of Lanes             | 2   | 0   | 1   | 2   | 1   | 2   |   |      |
| Peak Hour Factor             | 0.95  | 0.95  | 0.95  | 0.95  | 0.95  | 0.95  |   |      |
| Percent Heavy Veh, %         | 1   | 1   | 1   | 1   | 1   | 1   |   |      |
| Cap, veh/h                   | 1341  | 145   | 212   | 2231  | 378   | 675   |   |      |
| Arrive On Green              | 0.41  | 0.41  | 0.12  | 0.62  | 0.21  | 0.21  |   |      |
| Sat Flow, veh/h              | 3347  | 353   | 1792  | 3668  | 1792  | 3198  |   |      |
| Grp Volume(v), veh/h         | 675   | 691   | 168   | 874   | 284   | 576   |   |      |
| Grp Sat Flow(s),veh/h/ln     | 1787  | 1819  | 1792  | 1787  | 1792  | 1599  |   |      |
| Q Serve(g_s), s              | 20.2  | 20.3  | 5.2   | 6.9   | 8.4   | 9.8   |   |      |
| Cycle Q Clear(g_c), s        | 20.2  | 20.3  | 5.2   | 6.9   | 8.4   | 9.8   |   |      |
| Prop In Lane                 |   | 0.19  | 1.00  |   | 1.00  | 1.00  |   |      |
| Lane Grp Cap(c), veh/h       | 737   | 750   | 212   | 2231  | 378   | 675   |   |      |
| V/C Ratio(X)                 | 0.92  | 0.92  | 0.79  | 0.39  | 0.75  | 0.85  |   |      |
| Avail Cap(c_a), veh/h        | 949   | 966   | 634   | 2231  | 698   | 1246  |   |      |
| HCM Platoon Ratio            | 1.00  | 1.00  | 1.00  | 1.00  | 1.00  | 1.00  |   |      |
| Upstream Filter(I)           | 1.00  | 1.00  | 1.00  | 1.00  | 1.00  | 1.00  |   |      |
| Uniform Delay (d), s/veh     | 15.7  | 15.7  | 24.2  | 5.3   | 20.9  | 21.4  |   |      |
| Incr Delay (d2), s/veh       | 9.9   | 10.4  | 2.6   | 0.0   | 1.1   | 1.2   |   |      |
| Initial Q Delay(d3),s/veh    | 0.0   | 0.0   | 0.0   | 0.0   | 0.0   | 0.0   |   |      |
| %ile BackOfQ(50%),veh/ln     | 11.8  | 12.1  | 2.7   | 3.3   | 4.2   | 4.4   |   |      |
| LnGrp Delay(d),s/veh         | 25.6  | 26.1  | 26.8  | 5.3   | 22.0  | 22.6  |   |      |
| LnGrp LOS                    | C   | C   | C   | A   | C   | C   |   |      |
| Approach Vol, veh/h          | 1366  |   |   | 1042  | 860   |   |   |      |
| Approach Delay, s/veh        | 25.9  |   |   | 8.8   | 22.4  |   |   |      |
| Approach LOS                 | C   |   |   | A   | C   |   |   |      |
| Timer                        | 1   | 2   | 3   | 4   | 5   | 6   | 7 | 8    |
| Assigned Phs                 | 1   | 2   |   |   |   | 6   |   | 8    |
| Phs Duration (G+Y+Rc), s     | 12.0  | 28.6  |   |   |   | 40.6  |   | 15.9 |
| Change Period (Y+Rc), s      | 5.3   | * 5.3   |   |   |   | 5.3   |   | 4.0  |
| Max Green Setting (Gmax), s  | 20.0  | * 30  |   |   |   | 30.0  |   | 22.0 |
| Max Q Clear Time (g_c+I1), s | 7.2   | 22.3  |   |   |   | 8.9   |   | 11.8 |
| Green Ext Time (p_c), s      | 0.0   | 0.9   |   |   |   | 0.9   |   | 0.1  |
| <b>Intersection Summary</b>  |   |   |   |   |   |   |   |      |
| HCM 2010 Ctrl Delay          |   |   | 19.5  |   |   |   |   |      |
| HCM 2010 LOS                 |   |   | B   |   |   |   |   |      |
| <b>Notes</b>                 |   |   |   |   |   |   |   |      |

HCM 2010 Signalized Intersection Summary Cumulative with Eastside Parkway with Project, PM  
 11: Abrams Drive & Imjin Parkway

06/11/2019



| Movement                     | EBL  | EBT  | EBR  | WBL  | WBT  | WBR  | NBL  | NBT  | NBR  | SBL  | SBT  | SBR  |
|------------------------------|------|------|------|------|------|------|------|------|------|------|------|------|
| Lane Configurations          | ↖ ↗  | ↗    |      | ↖ ↗  | ↗    |      | ↖    | ↗    | ↗    | ↖    | ↗    | ↗    |
| Traffic Volume (veh/h)       | 130  | 1180 | 250  | 170  | 770  | 120  | 170  | 30   | 200  | 60   | 20   | 130  |
| Future Volume (veh/h)        | 130  | 1180 | 250  | 170  | 770  | 120  | 170  | 30   | 200  | 60   | 20   | 130  |
| Number                       | 5    | 2    | 12   | 1    | 6    | 16   | 3    | 8    | 18   | 7    | 4    | 14   |
| Initial Q (Qb), veh          | 0    | 0    | 0    | 0    | 0    | 0    | 0    | 0    | 0    | 0    | 0    | 0    |
| Ped-Bike Adj(A_pbT)          | 1.00 |      | 1.00 | 1.00 |      | 1.00 | 1.00 |      | 1.00 | 1.00 |      | 1.00 |
| Parking Bus, Adj             | 1.00 | 1.00 | 1.00 | 1.00 | 1.00 | 1.00 | 1.00 | 1.00 | 1.00 | 1.00 | 1.00 | 1.00 |
| Adj Sat Flow, veh/h/ln       | 1881 | 1881 | 1900 | 1881 | 1881 | 1900 | 1881 | 1881 | 1881 | 1863 | 1863 | 1863 |
| Adj Flow Rate, veh/h         | 140  | 1269 | 220  | 183  | 828  | 109  | 183  | 32   | 0    | 65   | 22   | 0    |
| Adj No. of Lanes             | 2    | 2    | 0    | 2    | 2    | 0    | 1    | 1    | 1    | 1    | 1    | 1    |
| Peak Hour Factor             | 0.93 | 0.93 | 0.93 | 0.93 | 0.93 | 0.93 | 0.93 | 0.93 | 0.93 | 0.93 | 0.93 | 0.93 |
| Percent Heavy Veh, %         | 1    | 1    | 1    | 1    | 1    | 1    | 1    | 1    | 1    | 2    | 2    | 2    |
| Cap, veh/h                   | 276  | 1751 | 301  | 270  | 1795 | 236  | 322  | 315  | 268  | 312  | 312  | 265  |
| Arrive On Green              | 0.08 | 0.57 | 0.57 | 0.08 | 0.57 | 0.57 | 0.17 | 0.17 | 0.00 | 0.17 | 0.17 | 0.00 |
| Sat Flow, veh/h              | 3476 | 3051 | 525  | 3476 | 3176 | 418  | 1395 | 1881 | 1599 | 1369 | 1863 | 1583 |
| Grp Volume(v), veh/h         | 140  | 739  | 750  | 183  | 466  | 471  | 183  | 32   | 0    | 65   | 22   | 0    |
| Grp Sat Flow(s),veh/h/ln     | 1738 | 1787 | 1789 | 1738 | 1787 | 1807 | 1395 | 1881 | 1599 | 1369 | 1863 | 1583 |
| Q Serve(g_s), s              | 2.7  | 21.3 | 21.8 | 3.6  | 10.9 | 10.9 | 9.0  | 1.0  | 0.0  | 3.0  | 0.7  | 0.0  |
| Cycle Q Clear(g_c), s        | 2.7  | 21.3 | 21.8 | 3.6  | 10.9 | 10.9 | 9.7  | 1.0  | 0.0  | 4.0  | 0.7  | 0.0  |
| Prop In Lane                 | 1.00 |      | 0.29 | 1.00 |      | 0.23 | 1.00 |      | 1.00 | 1.00 |      | 1.00 |
| Lane Grp Cap(c), veh/h       | 276  | 1026 | 1027 | 270  | 1010 | 1021 | 322  | 315  | 268  | 312  | 312  | 265  |
| V/C Ratio(X)                 | 0.51 | 0.72 | 0.73 | 0.68 | 0.46 | 0.46 | 0.57 | 0.10 | 0.00 | 0.21 | 0.07 | 0.00 |
| Avail Cap(c_a), veh/h        | 982  | 1262 | 1263 | 982  | 1262 | 1277 | 679  | 797  | 678  | 662  | 790  | 671  |
| HCM Platoon Ratio            | 1.00 | 1.00 | 1.00 | 1.00 | 1.00 | 1.00 | 1.00 | 1.00 | 1.00 | 1.00 | 1.00 | 1.00 |
| Upstream Filter(I)           | 1.00 | 1.00 | 1.00 | 1.00 | 1.00 | 1.00 | 1.00 | 1.00 | 0.00 | 1.00 | 1.00 | 0.00 |
| Uniform Delay (d), s/veh     | 31.3 | 11.0 | 11.1 | 31.8 | 9.1  | 9.1  | 28.9 | 24.9 | 0.0  | 26.6 | 24.8 | 0.0  |
| Incr Delay (d2), s/veh       | 0.5  | 1.1  | 1.2  | 1.1  | 0.1  | 0.1  | 0.6  | 0.1  | 0.0  | 0.1  | 0.0  | 0.0  |
| Initial Q Delay(d3),s/veh    | 0.0  | 0.0  | 0.0  | 0.0  | 0.0  | 0.0  | 0.0  | 0.0  | 0.0  | 0.0  | 0.0  | 0.0  |
| %ile BackOfQ(50%),veh/ln     | 1.3  | 10.6 | 11.0 | 1.8  | 5.3  | 5.4  | 3.5  | 0.5  | 0.0  | 1.1  | 0.4  | 0.0  |
| LnGrp Delay(d),s/veh         | 31.8 | 12.0 | 12.3 | 32.9 | 9.2  | 9.2  | 29.5 | 25.0 | 0.0  | 26.8 | 24.8 | 0.0  |
| LnGrp LOS                    | C    | B    | B    | C    | A    | A    | C    | C    |      | C    | C    |      |
| Approach Vol, veh/h          |      | 1629 |      |      | 1120 |      |      | 215  |      |      | 87   |      |
| Approach Delay, s/veh        |      | 13.8 |      |      | 13.1 |      |      | 28.8 |      |      | 26.3 |      |
| Approach LOS                 |      | B    |      |      | B    |      |      | C    |      |      | C    |      |
| Timer                        | 1    | 2    | 3    | 4    | 5    | 6    | 7    | 8    |      |      |      |      |
| Assigned Phs                 | 1    | 2    |      | 4    | 5    | 6    |      | 8    |      |      |      |      |
| Phs Duration (G+Y+Rc), s     | 9.0  | 45.9 |      | 15.9 | 9.6  | 45.3 |      | 15.9 |      |      |      |      |
| Change Period (Y+Rc), s      | 3.5  | 5.3  |      | 4.0  | 4.0  | 5.3  |      | 4.0  |      |      |      |      |
| Max Green Setting (Gmax), s  | 20.0 | 50.0 |      | 30.0 | 20.0 | 50.0 |      | 30.0 |      |      |      |      |
| Max Q Clear Time (g_c+15), s | 15.6 | 23.8 |      | 6.0  | 4.7  | 12.9 |      | 11.7 |      |      |      |      |
| Green Ext Time (p_c), s      | 0.0  | 1.2  |      | 0.0  | 0.0  | 0.7  |      | 0.0  |      |      |      |      |
| <b>Intersection Summary</b>  |      |      |      |      |      |      |      |      |      |      |      |      |
| HCM 2010 Ctrl Delay          |      |      |      | 15.0 |      |      |      |      |      |      |      |      |
| HCM 2010 LOS                 |      |      |      | B    |      |      |      |      |      |      |      |      |













HCM 2010 Signalized Intersection Summary Cumulative with Eastside Parkway with Project, PM  
 12: Reservation Road & Imjin Parkway

06/11/2019



| Movement                    | EBL  | EBT   | EBR  | WBL  | WBT  | WBR   | NBL   | NBT  | NBR  | SBL  | SBT  | SBR  |
|-----------------------------|------|-------|------|------|------|-------|-------|------|------|------|------|------|
| Lane Configurations         | ↖↗   | ↑     | ↖↗   | ↖    | ↑    | ↖     | ↖↗    | ↑↑   | ↖    | ↖↗   | ↑↑   | ↖    |
| Traffic Volume (veh/h)      | 110  | 20    | 1280 | 10   | 40   | 30    | 820   | 630  | 10   | 20   | 940  | 190  |
| Future Volume (veh/h)       | 110  | 20    | 1280 | 10   | 40   | 30    | 820   | 630  | 10   | 20   | 940  | 190  |
| Number                      | 3    | 8     | 18   | 7    | 4    | 14    | 1     | 6    | 16   | 5    | 2    | 12   |
| Initial Q (Qb), veh         | 0    | 0     | 0    | 0    | 0    | 0     | 0     | 0    | 0    | 0    | 0    | 0    |
| Ped-Bike Adj(A_pbT)         | 1.00 |       | 1.00 | 1.00 |      | 0.99  | 1.00  |      | 1.00 | 1.00 |      | 1.00 |
| Parking Bus, Adj            | 1.00 | 1.00  | 1.00 | 1.00 | 1.00 | 1.00  | 1.00  | 1.00 | 1.00 | 1.00 | 1.00 | 1.00 |
| Adj Sat Flow, veh/h/ln      | 1881 | 1881  | 1881 | 1827 | 1827 | 1827  | 1881  | 1881 | 1881 | 1881 | 1881 | 1881 |
| Adj Flow Rate, veh/h        | 124  | 22    | 1037 | 11   | 45   | 12    | 921   | 708  | 10   | 22   | 1056 | 79   |
| Adj No. of Lanes            | 2    | 1     | 2    | 1    | 1    | 1     | 2     | 2    | 1    | 2    | 2    | 1    |
| Peak Hour Factor            | 0.89 | 0.89  | 0.89 | 0.89 | 0.89 | 0.89  | 0.89  | 0.89 | 0.89 | 0.89 | 0.89 | 0.89 |
| Percent Heavy Veh, %        | 1    | 1     | 1    | 4    | 4    | 4     | 1     | 1    | 1    | 1    | 1    | 1    |
| Cap, veh/h                  | 802  | 434   | 1296 | 75   | 79   | 66    | 802   | 2048 | 916  | 55   | 1281 | 573  |
| Arrive On Green             | 0.23 | 0.23  | 0.23 | 0.04 | 0.04 | 0.04  | 0.23  | 0.57 | 0.57 | 0.02 | 0.36 | 0.36 |
| Sat Flow, veh/h             | 3476 | 1881  | 2802 | 1740 | 1827 | 1531  | 3476  | 3574 | 1599 | 3476 | 3574 | 1599 |
| Grp Volume(v), veh/h        | 124  | 22    | 1037 | 11   | 45   | 12    | 921   | 708  | 10   | 22   | 1056 | 79   |
| Grp Sat Flow(s),veh/h/ln    | 1738 | 1881  | 1401 | 1740 | 1827 | 1531  | 1738  | 1787 | 1599 | 1738 | 1787 | 1599 |
| Q Serve(g_s), s             | 4.3  | 1.4   | 35.0 | 0.9  | 3.7  | 1.1   | 35.0  | 16.0 | 0.4  | 1.0  | 40.8 | 5.1  |
| Cycle Q Clear(g_c), s       | 4.3  | 1.4   | 35.0 | 0.9  | 3.7  | 1.1   | 35.0  | 16.0 | 0.4  | 1.0  | 40.8 | 5.1  |
| Prop In Lane                | 1.00 |       | 1.00 | 1.00 |      | 1.00  | 1.00  |      | 1.00 | 1.00 |      | 1.00 |
| Lane Grp Cap(c), veh/h      | 802  | 434   | 1296 | 75   | 79   | 66    | 802   | 2048 | 916  | 55   | 1281 | 573  |
| V/C Ratio(X)                | 0.15 | 0.05  | 0.80 | 0.15 | 0.57 | 0.18  | 1.15  | 0.35 | 0.01 | 0.40 | 0.82 | 0.14 |
| Avail Cap(c_a), veh/h       | 802  | 434   | 1296 | 356  | 373  | 313   | 802   | 2048 | 916  | 458  | 1414 | 632  |
| HCM Platoon Ratio           | 1.00 | 1.00  | 1.00 | 1.00 | 1.00 | 1.00  | 1.00  | 1.00 | 1.00 | 1.00 | 1.00 | 1.00 |
| Upstream Filter(I)          | 1.00 | 1.00  | 1.00 | 1.00 | 1.00 | 1.00  | 1.00  | 1.00 | 1.00 | 1.00 | 1.00 | 1.00 |
| Uniform Delay (d), s/veh    | 46.6 | 45.4  | 34.9 | 69.9 | 71.2 | 70.0  | 58.4  | 17.2 | 13.9 | 73.9 | 44.3 | 32.9 |
| Incr Delay (d2), s/veh      | 0.0  | 0.0   | 3.4  | 0.3  | 2.4  | 0.5   | 81.2  | 0.3  | 0.0  | 1.7  | 5.0  | 0.3  |
| Initial Q Delay(d3),s/veh   | 0.0  | 0.0   | 0.0  | 0.0  | 0.0  | 0.0   | 0.0   | 0.0  | 0.0  | 0.0  | 0.0  | 0.0  |
| %ile BackOfQ(50%),veh/ln    | 2.1  | 0.7   | 19.1 | 0.5  | 1.9  | 0.5   | 25.7  | 7.9  | 0.2  | 0.5  | 21.0 | 2.3  |
| LnGrp Delay(d),s/veh        | 46.6 | 45.4  | 38.3 | 70.2 | 73.6 | 70.5  | 139.5 | 17.5 | 13.9 | 75.6 | 49.3 | 33.2 |
| LnGrp LOS                   | D    | D     | D    | E    | E    | E     | F     | B    | B    | E    | D    | C    |
| Approach Vol, veh/h         |      | 1183  |      |      | 68   |       |       | 1639 |      |      | 1157 |      |
| Approach Delay, s/veh       |      | 39.3  |      |      | 72.5 |       |       | 86.1 |      |      | 48.7 |      |
| Approach LOS                |      | D     |      |      | E    |       |       | F    |      |      | D    |      |
| Timer                       | 1    | 2     | 3    | 4    | 5    | 6     | 7     | 8    |      |      |      |      |
| Assigned Phs                | 1    | 2     |      | 4    | 5    | 6     |       | 8    |      |      |      |      |
| Phs Duration (G+Y+Rc), s    | 39.1 | 60.6  |      | 11.6 | 6.5  | 93.1  |       | 40.5 |      |      |      |      |
| Change Period (Y+Rc), s     | 4.1  | * 6.2 |      | 5.0  | 4.1  | * 6.2 |       | 5.5  |      |      |      |      |
| Max Green Setting (Gmax), s | 35.0 | * 60  |      | 31.0 | 20.0 | * 50  |       | 35.0 |      |      |      |      |
| Max Q Clear Time (g_c+Q), s | 37.0 | 42.8  |      | 5.7  | 3.0  | 18.0  |       | 37.0 |      |      |      |      |
| Green Ext Time (p_c), s     | 0.0  | 11.5  |      | 0.2  | 0.0  | 10.6  |       | 0.0  |      |      |      |      |
| <b>Intersection Summary</b> |      |       |      |      |      |       |       |      |      |      |      |      |
| HCM 2010 Ctrl Delay         |      |       | 61.5 |      |      |       |       |      |      |      |      |      |
| HCM 2010 LOS                |      |       | E    |      |      |       |       |      |      |      |      |      |
| <b>Notes</b>                |      |       |      |      |      |       |       |      |      |      |      |      |

HCM 2010 Signalized Intersection Summary  
 13: Reservation Road & Blanco Road

|                              |  |  |  |  |  |  |   |   |
|------------------------------|---|---|---|---|---|---|---|---|
| Movement                     | EBL   | EBT   | WBT   | WBR   | SBL   | SBR   |   |   |
| Lane Configurations          |  |  |  |  |  |  |   |   |
| Traffic Volume (veh/h)       | 1140  | 1010  | 400   | 50  | 40  | 1060  |   |   |
| Future Volume (veh/h)        | 1140  | 1010  | 400   | 50  | 40  | 1060  |   |   |
| Number                       | 5   | 2   | 6   | 16  | 7   | 14  |   |   |
| Initial Q (Qb), veh          | 0   | 0   | 0   | 0   | 0   | 0   |   |   |
| Ped-Bike Adj(A_pbT)          | 1.00  |   |   | 1.00  | 1.00  | 1.00  |   |   |
| Parking Bus, Adj             | 1.00  | 1.00  | 1.00  | 1.00  | 1.00  | 1.00  |   |   |
| Adj Sat Flow, veh/h/ln       | 1881  | 1881  | 1863  | 1863  | 1863  | 1863  |   |   |
| Adj Flow Rate, veh/h         | 1213  | 1074  | 426   | 29  | 43  | 0   |   |   |
| Adj No. of Lanes             | 2   | 2   | 1   | 1   | 2   | 2   |   |   |
| Peak Hour Factor             | 0.94  | 0.94  | 0.94  | 0.94  | 0.94  | 0.94  |   |   |
| Percent Heavy Veh, %         | 1   | 1   | 2   | 2   | 2   | 2   |   |   |
| Cap, veh/h                   | 1337  | 2791  | 536   | 455   | 123   | 100   |   |   |
| Arrive On Green              | 0.38  | 0.78  | 0.29  | 0.29  | 0.04  | 0.00  |   |   |
| Sat Flow, veh/h              | 3476  | 3668  | 1863  | 1583  | 3442  | 2787  |   |   |
| Grp Volume(v), veh/h         | 1213  | 1074  | 426   | 29  | 43  | 0   |   |   |
| Grp Sat Flow(s),veh/h/ln     | 1738  | 1787  | 1863  | 1583  | 1721  | 1393  |   |   |
| Q Serve(g_s), s              | 16.7  | 4.8   | 10.7  | 0.7   | 0.6   | 0.0   |   |   |
| Cycle Q Clear(g_c), s        | 16.7  | 4.8   | 10.7  | 0.7   | 0.6   | 0.0   |   |   |
| Prop In Lane                 | 1.00  |   |   | 1.00  | 1.00  | 1.00  |   |   |
| Lane Grp Cap(c), veh/h       | 1337  | 2791  | 536   | 455   | 123   | 100   |   |   |
| V/C Ratio(X)                 | 0.91  | 0.38  | 0.80  | 0.06  | 0.35  | 0.00  |   |   |
| Avail Cap(c_a), veh/h        | 2742  | 4229  | 2204  | 1873  | 1832  | 1484  |   |   |
| HCM Platoon Ratio            | 1.00  | 1.00  | 1.00  | 1.00  | 1.00  | 1.00  |   |   |
| Upstream Filter(I)           | 1.00  | 1.00  | 1.00  | 1.00  | 1.00  | 0.00  |   |   |
| Uniform Delay (d), s/veh     | 14.7  | 1.7   | 16.7  | 13.1  | 23.9  | 0.0   |   |   |
| Incr Delay (d2), s/veh       | 1.0   | 0.1   | 2.0   | 0.0   | 0.6   | 0.0   |   |   |
| Initial Q Delay(d3),s/veh    | 0.0   | 0.0   | 0.0   | 0.0   | 0.0   | 0.0   |   |   |
| %ile BackOfQ(50%),veh/ln     | 8.1   | 2.3   | 5.7   | 0.3   | 0.3   | 0.0   |   |   |
| LnGrp Delay(d),s/veh         | 15.8  | 1.8   | 18.7  | 13.2  | 24.5  | 0.0   |   |   |
| LnGrp LOS                    | B   | A   | B   | B   | C   |   |   |   |
| Approach Vol, veh/h          |   | 2287  | 455   |   | 43  |   |   |   |
| Approach Delay, s/veh        |   | 9.2   | 18.4  |   | 24.5  |   |   |   |
| Approach LOS                 |   | A   | B   |   | C   |   |   |   |
| Timer                        | 1   | 2   | 3   | 4   | 5   | 6   | 7 | 8 |
| Assigned Phs                 |   | 2   |   | 4   | 5   | 6   |   |   |
| Phs Duration (G+Y+Rc), s     |   | 45.4  |   | 5.3   | 25.0  | 20.4  |   |   |
| Change Period (Y+Rc), s      |   | 5.8   |   | 3.5   | 5.5   | 5.8   |   |   |
| Max Green Setting (Gmax), s  |   | 60.0  |   | 27.0  | 40.0  | 60.0  |   |   |
| Max Q Clear Time (g_c+I1), s |   | 6.8   |   | 2.6   | 18.7  | 12.7  |   |   |
| Green Ext Time (p_c), s      |   | 6.3   |   | 0.0   | 0.8   | 1.9   |   |   |
| <b>Intersection Summary</b>  |   |   |   |   |   |   |   |   |
| HCM 2010 Ctrl Delay          |   |   | 10.9  |   |   |   |   |   |
| HCM 2010 LOS                 |   |   | B   |   |   |   |   |   |

HCM 2010 Signalized Intersection Summary Cumulative with Eastside Parkway with Project, PM  
 14: Reservation Road & Inter-Garrison Road

06/11/2019



| Movement                     | EBL   | EBR   | NBL   | NBT   | SBT  | SBR  |   |      |
|------------------------------|-------|-------|-------|-------|------|------|---|------|
| Lane Configurations          |       |       |       |       |      |      |   |      |
| Traffic Volume (veh/h)       | 80    | 960   | 620   | 380   | 940  | 210  |   |      |
| Future Volume (veh/h)        | 80    | 960   | 620   | 380   | 940  | 210  |   |      |
| Number                       | 3     | 18    | 1     | 6     | 2    | 12   |   |      |
| Initial Q (Qb), veh          | 0     | 0     | 0     | 0     | 0    | 0    |   |      |
| Ped-Bike Adj(A_pbT)          | 1.00  | 1.00  | 1.00  |       |      | 1.00 |   |      |
| Parking Bus, Adj             | 1.00  | 1.00  | 1.00  | 1.00  | 1.00 | 1.00 |   |      |
| Adj Sat Flow, veh/h/ln       | 1881  | 1881  | 1845  | 1845  | 1881 | 1900 |   |      |
| Adj Flow Rate, veh/h         | 98    | 1016  | 756   | 463   | 1146 | 247  |   |      |
| Adj No. of Lanes             | 1     | 1     | 1     | 2     | 2    | 0    |   |      |
| Peak Hour Factor             | 0.82  | 0.82  | 0.82  | 0.82  | 0.82 | 0.82 |   |      |
| Percent Heavy Veh, %         | 1     | 1     | 3     | 3     | 1    | 1    |   |      |
| Cap, veh/h                   | 412   | 640   | 299   | 2374  | 1368 | 293  |   |      |
| Arrive On Green              | 0.23  | 0.23  | 0.17  | 0.68  | 0.47 | 0.47 |   |      |
| Sat Flow, veh/h              | 1792  | 1599  | 1757  | 3597  | 3024 | 627  |   |      |
| Grp Volume(v), veh/h         | 98    | 1016  | 756   | 463   | 696  | 697  |   |      |
| Grp Sat Flow(s),veh/h/ln     | 1792  | 1599  | 1757  | 1752  | 1787 | 1770 |   |      |
| Q Serve(g_s), s              | 5.2   | 27.0  | 20.0  | 5.8   | 39.9 | 40.7 |   |      |
| Cycle Q Clear(g_c), s        | 5.2   | 27.0  | 20.0  | 5.8   | 39.9 | 40.7 |   |      |
| Prop In Lane                 | 1.00  | 1.00  | 1.00  |       |      | 0.35 |   |      |
| Lane Grp Cap(c), veh/h       | 412   | 640   | 299   | 2374  | 835  | 827  |   |      |
| V/C Ratio(X)                 | 0.24  | 1.59  | 2.53  | 0.20  | 0.83 | 0.84 |   |      |
| Avail Cap(c_a), veh/h        | 412   | 640   | 299   | 2374  | 913  | 904  |   |      |
| HCM Platoon Ratio            | 1.00  | 1.00  | 1.00  | 1.00  | 1.00 | 1.00 |   |      |
| Upstream Filter(I)           | 1.00  | 1.00  | 1.00  | 1.00  | 1.00 | 1.00 |   |      |
| Uniform Delay (d), s/veh     | 36.8  | 35.2  | 48.7  | 7.0   | 27.3 | 27.5 |   |      |
| Incr Delay (d2), s/veh       | 0.3   | 271.9 | 697.0 | 0.1   | 7.1  | 7.7  |   |      |
| Initial Q Delay(d3),s/veh    | 0.0   | 0.0   | 0.0   | 0.0   | 0.0  | 0.0  |   |      |
| %ile BackOfQ(50%),veh/ln     | 2.6   | 69.0  | 67.6  | 2.8   | 21.2 | 21.5 |   |      |
| LnGrp Delay(d),s/veh         | 37.1  | 307.1 | 745.7 | 7.1   | 34.4 | 35.2 |   |      |
| LnGrp LOS                    | D     | F     | F     | A     | C    | D    |   |      |
| Approach Vol, veh/h          | 1114  |       |       | 1219  | 1393 |      |   |      |
| Approach Delay, s/veh        | 283.4 |       |       | 465.2 | 34.8 |      |   |      |
| Approach LOS                 | F     |       |       | F     | C    |      |   |      |
| Timer                        | 1     | 2     | 3     | 4     | 5    | 6    | 7 | 8    |
| Assigned Phs                 | 1     | 2     |       |       |      | 6    |   | 8    |
| Phs Duration (G+Y+Rc), s     | 4.7   | 61.2  |       |       |      | 85.9 |   | 31.5 |
| Change Period (Y+Rc), s      | 4.7   | 6.4   |       |       |      | 6.4  |   | 4.5  |
| Max Green Setting (Gmax), s  | 20    | 60.0  |       |       |      | 60.0 |   | 27.0 |
| Max Q Clear Time (g_c+Yc), s | 42.7  |       |       |       |      | 7.8  |   | 29.0 |
| Green Ext Time (p_c), s      | 0.0   | 12.2  |       |       |      | 5.4  |   | 0.0  |
| <b>Intersection Summary</b>  |       |       |       |       |      |      |   |      |
| HCM 2010 Ctrl Delay          |       |       | 249.9 |       |      |      |   |      |
| HCM 2010 LOS                 |       |       | F     |       |      |      |   |      |
| <b>Notes</b>                 |       |       |       |       |      |      |   |      |

HCM 2010 Signalized Intersection Summary Cumulative with Eastside Parkway with Project, PM  
 15: 2nd Avenue & 9th Street

06/11/2019



| Movement                     | EBL  | EBT  | EBR  | WBL  | WBT  | WBR  | NBL  | NBT  | NBR  | SBL  | SBT  | SBR  |
|------------------------------|------|------|------|------|------|------|------|------|------|------|------|------|
| Lane Configurations          |      | ↔    | ↔    |      | ↔    |      | ↔    | ↕↔   |      | ↔    | ↕↔   |      |
| Traffic Volume (veh/h)       | 10   | 10   | 30   | 40   | 10   | 20   | 20   | 750  | 50   | 40   | 610  | 10   |
| Future Volume (veh/h)        | 10   | 10   | 30   | 40   | 10   | 20   | 20   | 750  | 50   | 40   | 610  | 10   |
| Number                       | 5    | 2    | 12   | 1    | 6    | 16   | 3    | 8    | 18   | 7    | 4    | 14   |
| Initial Q (Qb), veh          | 0    | 0    | 0    | 0    | 0    | 0    | 0    | 0    | 0    | 0    | 0    | 0    |
| Ped-Bike Adj(A_pbT)          | 1.00 |      | 0.98 | 1.00 |      | 1.00 | 1.00 |      | 0.97 | 1.00 |      | 1.00 |
| Parking Bus, Adj             | 1.00 | 1.00 | 1.00 | 1.00 | 1.00 | 1.00 | 1.00 | 1.00 | 1.00 | 1.00 | 1.00 | 1.00 |
| Adj Sat Flow, veh/h/ln       | 1900 | 1900 | 1900 | 1900 | 1900 | 1900 | 1881 | 1881 | 1900 | 1827 | 1827 | 1900 |
| Adj Flow Rate, veh/h         | 11   | 11   | 23   | 44   | 11   | 3    | 22   | 824  | 51   | 44   | 670  | -1   |
| Adj No. of Lanes             | 0    | 1    | 1    | 0    | 1    | 0    | 1    | 2    | 0    | 1    | 2    | 0    |
| Peak Hour Factor             | 0.91 | 0.91 | 0.91 | 0.91 | 0.91 | 0.91 | 0.91 | 0.91 | 0.91 | 0.91 | 0.91 | 0.91 |
| Percent Heavy Veh, %         | 0    | 0    | 0    | 0    | 0    | 0    | 1    | 1    | 1    | 4    | 4    | 4    |
| Cap, veh/h                   | 256  | 204  | 297  | 359  | 78   | 15   | 49   | 1381 | 85   | 85   | 1481 | 0    |
| Arrive On Green              | 0.19 | 0.19 | 0.19 | 0.19 | 0.19 | 0.19 | 0.03 | 0.40 | 0.40 | 0.05 | 0.43 | 0.00 |
| Sat Flow, veh/h              | 600  | 1094 | 1591 | 1020 | 416  | 78   | 1792 | 3412 | 211  | 1740 | 3563 | 0    |
| Grp Volume(v), veh/h         | 22   | 0    | 23   | 58   | 0    | 0    | 22   | 432  | 443  | 44   | 669  | 0    |
| Grp Sat Flow(s),veh/h/ln     | 1694 | 0    | 1591 | 1514 | 0    | 0    | 1792 | 1787 | 1836 | 1740 | 1736 | 0    |
| Q Serve(g_s), s              | 0.0  | 0.0  | 0.4  | 0.4  | 0.0  | 0.0  | 0.5  | 7.1  | 7.1  | 0.9  | 5.1  | 0.0  |
| Cycle Q Clear(g_c), s        | 0.4  | 0.0  | 0.4  | 1.1  | 0.0  | 0.0  | 0.5  | 7.1  | 7.1  | 0.9  | 5.1  | 0.0  |
| Prop In Lane                 | 0.50 |      | 1.00 | 0.76 |      | 0.05 | 1.00 |      | 0.12 | 1.00 |      | 0.00 |
| Lane Grp Cap(c), veh/h       | 460  | 0    | 297  | 451  | 0    | 0    | 49   | 724  | 743  | 85   | 1481 | 0    |
| V/C Ratio(X)                 | 0.05 | 0.00 | 0.08 | 0.13 | 0.00 | 0.00 | 0.45 | 0.60 | 0.60 | 0.52 | 0.45 | 0.00 |
| Avail Cap(c_a), veh/h        | 1668 | 0    | 1482 | 1552 | 0    | 0    | 548  | 1903 | 1955 | 533  | 3696 | 0    |
| HCM Platoon Ratio            | 1.00 | 1.00 | 1.00 | 1.00 | 1.00 | 1.00 | 1.00 | 1.00 | 1.00 | 1.00 | 1.00 | 1.00 |
| Upstream Filter(I)           | 1.00 | 0.00 | 1.00 | 1.00 | 0.00 | 0.00 | 1.00 | 1.00 | 1.00 | 1.00 | 1.00 | 0.00 |
| Uniform Delay (d), s/veh     | 12.6 | 0.0  | 12.6 | 12.8 | 0.0  | 0.0  | 18.0 | 8.8  | 8.8  | 17.4 | 7.7  | 0.0  |
| Incr Delay (d2), s/veh       | 0.0  | 0.0  | 0.1  | 0.1  | 0.0  | 0.0  | 6.3  | 0.8  | 0.8  | 4.8  | 0.2  | 0.0  |
| Initial Q Delay(d3),s/veh    | 0.0  | 0.0  | 0.0  | 0.0  | 0.0  | 0.0  | 0.0  | 0.0  | 0.0  | 0.0  | 0.0  | 0.0  |
| %ile BackOfQ(50%),veh/ln     | 0.2  | 0.0  | 0.2  | 0.5  | 0.0  | 0.0  | 0.3  | 3.6  | 3.7  | 0.6  | 2.5  | 0.0  |
| LnGrp Delay(d),s/veh         | 12.6 | 0.0  | 12.7 | 13.0 | 0.0  | 0.0  | 24.3 | 9.6  | 9.5  | 22.2 | 7.9  | 0.0  |
| LnGrp LOS                    | B    |      | B    | B    |      |      | C    | A    | A    | C    | A    |      |
| Approach Vol, veh/h          |      | 45   |      |      | 58   |      |      | 897  |      |      | 713  |      |
| Approach Delay, s/veh        |      | 12.7 |      |      | 13.0 |      |      | 9.9  |      |      | 8.8  |      |
| Approach LOS                 |      | B    |      |      | B    |      |      | A    |      |      | A    |      |
| Timer                        | 1    | 2    | 3    | 4    | 5    | 6    | 7    | 8    |      |      |      |      |
| Assigned Phs                 |      | 2    | 3    | 4    |      | 6    | 7    | 8    |      |      |      |      |
| Phs Duration (G+Y+Rc), s     |      | 12.0 | 4.5  | 21.0 |      | 12.0 | 5.3  | 20.2 |      |      |      |      |
| Change Period (Y+Rc), s      |      | 5.0  | 3.5  | 5.0  |      | 5.0  | 3.5  | 5.0  |      |      |      |      |
| Max Green Setting (Gmax), s  |      | 35.0 | 11.5 | 40.0 |      | 35.0 | 11.5 | 40.0 |      |      |      |      |
| Max Q Clear Time (g_c+I1), s |      | 2.4  | 2.5  | 7.1  |      | 3.1  | 2.9  | 9.1  |      |      |      |      |
| Green Ext Time (p_c), s      |      | 0.1  | 0.0  | 5.0  |      | 0.3  | 0.0  | 6.1  |      |      |      |      |
| <b>Intersection Summary</b>  |      |      |      |      |      |      |      |      |      |      |      |      |
| HCM 2010 Ctrl Delay          |      |      | 9.6  |      |      |      |      |      |      |      |      |      |
| HCM 2010 LOS                 |      |      | A    |      |      |      |      |      |      |      |      |      |

HCM 2010 Signalized Intersection Summary Cumulative with Eastside Parkway with Project, PM  
 16: 2nd Avenue & 8th Street

06/11/2019



| Movement                     | WBL  | WBR  | NBT  | NBR  | SBL  | SBT  |      |      |
|------------------------------|------|------|------|------|------|------|------|------|
| Lane Configurations          |      |      |      |      |      |      |      |      |
| Traffic Volume (veh/h)       | 40   | 80   | 600  | 220  | 70   | 490  |      |      |
| Future Volume (veh/h)        | 40   | 80   | 600  | 220  | 70   | 490  |      |      |
| Number                       | 1    | 16   | 8    | 18   | 7    | 4    |      |      |
| Initial Q (Qb), veh          | 0    | 0    | 0    | 0    | 0    | 0    |      |      |
| Ped-Bike Adj(A_pbT)          | 1.00 | 1.00 |      | 0.97 | 1.00 |      |      |      |
| Parking Bus, Adj             | 1.00 | 1.00 | 1.00 | 1.00 | 1.00 | 1.00 |      |      |
| Adj Sat Flow, veh/h/ln       | 1900 | 1900 | 1881 | 1900 | 1827 | 1827 |      |      |
| Adj Flow Rate, veh/h         | 43   | 51   | 638  | 203  | 74   | 521  |      |      |
| Adj No. of Lanes             | 1    | 1    | 2    | 0    | 1    | 2    |      |      |
| Peak Hour Factor             | 0.94 | 0.94 | 0.94 | 0.94 | 0.94 | 0.94 |      |      |
| Percent Heavy Veh, %         | 0    | 0    | 1    | 1    | 4    | 4    |      |      |
| Cap, veh/h                   | 158  | 141  | 1148 | 365  | 129  | 2126 |      |      |
| Arrive On Green              | 0.09 | 0.09 | 0.43 | 0.43 | 0.07 | 0.61 |      |      |
| Sat Flow, veh/h              | 1810 | 1615 | 2745 | 843  | 1740 | 3563 |      |      |
| Grp Volume(v), veh/h         | 43   | 51   | 430  | 411  | 74   | 521  |      |      |
| Grp Sat Flow(s),veh/h/ln     | 1810 | 1615 | 1787 | 1707 | 1740 | 1736 |      |      |
| Q Serve(g_s), s              | 0.7  | 1.0  | 6.0  | 6.0  | 1.4  | 2.3  |      |      |
| Cycle Q Clear(g_c), s        | 0.7  | 1.0  | 6.0  | 6.0  | 1.4  | 2.3  |      |      |
| Prop In Lane                 | 1.00 | 1.00 |      | 0.49 | 1.00 |      |      |      |
| Lane Grp Cap(c), veh/h       | 158  | 141  | 774  | 739  | 129  | 2126 |      |      |
| V/C Ratio(X)                 | 0.27 | 0.36 | 0.56 | 0.56 | 0.57 | 0.25 |      |      |
| Avail Cap(c_a), veh/h        | 1630 | 1455 | 2415 | 2306 | 601  | 6254 |      |      |
| HCM Platoon Ratio            | 1.00 | 1.00 | 1.00 | 1.00 | 1.00 | 1.00 |      |      |
| Upstream Filter(I)           | 1.00 | 1.00 | 1.00 | 1.00 | 1.00 | 1.00 |      |      |
| Uniform Delay (d), s/veh     | 14.2 | 14.3 | 7.0  | 7.1  | 14.9 | 2.9  |      |      |
| Incr Delay (d2), s/veh       | 0.9  | 1.6  | 0.6  | 0.7  | 3.9  | 0.1  |      |      |
| Initial Q Delay(d3),s/veh    | 0.0  | 0.0  | 0.0  | 0.0  | 0.0  | 0.0  |      |      |
| %ile BackOfQ(50%),veh/ln     | 0.4  | 1.0  | 3.0  | 2.9  | 0.8  | 1.1  |      |      |
| LnGrp Delay(d),s/veh         | 15.1 | 15.9 | 7.7  | 7.7  | 18.8 | 3.0  |      |      |
| LnGrp LOS                    | B    | B    | A    | A    | B    | A    |      |      |
| Approach Vol, veh/h          | 94   |      | 841  |      |      | 595  |      |      |
| Approach Delay, s/veh        | 15.5 |      | 7.7  |      |      | 5.0  |      |      |
| Approach LOS                 | B    |      | A    |      |      | A    |      |      |
| Timer                        | 1    | 2    | 3    | 4    | 5    | 6    | 7    | 8    |
| Assigned Phs                 |      |      |      | 4    |      | 6    | 7    | 8    |
| Phs Duration (G+Y+Rc), s     |      |      |      | 25.4 |      | 7.9  | 6.0  | 19.4 |
| Change Period (Y+Rc), s      |      |      |      | 5.0  |      | 5.0  | 3.5  | 5.0  |
| Max Green Setting (Gmax), s  |      |      |      | 60.0 |      | 30.0 | 11.5 | 45.0 |
| Max Q Clear Time (g_c+I1), s |      |      |      | 4.3  |      | 3.0  | 3.4  | 8.0  |
| Green Ext Time (p_c), s      |      |      |      | 3.8  |      | 0.2  | 0.1  | 6.1  |
| <b>Intersection Summary</b>  |      |      |      |      |      |      |      |      |
| HCM 2010 Ctrl Delay          |      |      | 7.1  |      |      |      |      |      |
| HCM 2010 LOS                 |      |      | A    |      |      |      |      |      |

| Intersection              |      |
|---------------------------|------|
| Intersection Delay, s/veh | 11.3 |
| Intersection LOS          | B    |

| Movement            | EBT  | EBR  | WBL  | WBT  | NBL  | NBR  |
|---------------------|------|------|------|------|------|------|
| Lane Configurations | ↑    | ↑    | ↑    | ↑    | ↑    | ↑    |
| Traffic Vol, veh/h  | 220  | 70   | 180  | 40   | 80   | 220  |
| Future Vol, veh/h   | 220  | 70   | 180  | 40   | 80   | 220  |
| Peak Hour Factor    | 0.92 | 0.92 | 0.92 | 0.92 | 0.92 | 0.92 |
| Heavy Vehicles, %   | 2    | 2    | 2    | 2    | 2    | 2    |
| Mvmt Flow           | 239  | 76   | 196  | 43   | 87   | 239  |
| Number of Lanes     | 1    | 1    | 1    | 1    | 1    | 1    |

| Approach                   | EB   | WB   | NB   |
|----------------------------|------|------|------|
| Opposing Approach          | WB   | EB   |      |
| Opposing Lanes             | 2    | 2    | 0    |
| Conflicting Approach Left  |      | NB   | EB   |
| Conflicting Lanes Left     | 0    | 2    | 2    |
| Conflicting Approach Right | NB   |      | WB   |
| Conflicting Lanes Right    | 2    | 0    | 2    |
| HCM Control Delay          | 11.2 | 11.8 | 10.9 |
| HCM LOS                    | B    | B    | B    |

| Lane                   | NBLn1 | NBLn2 | EBLn1 | EBLn2 | WBLn1 | WBLn2 |
|------------------------|-------|-------|-------|-------|-------|-------|
| Vol Left, %            | 100%  | 0%    | 0%    | 0%    | 100%  | 0%    |
| Vol Thru, %            | 0%    | 0%    | 100%  | 0%    | 0%    | 100%  |
| Vol Right, %           | 0%    | 100%  | 0%    | 100%  | 0%    | 0%    |
| Sign Control           | Stop  | Stop  | Stop  | Stop  | Stop  | Stop  |
| Traffic Vol by Lane    | 80    | 220   | 220   | 70    | 180   | 40    |
| LT Vol                 | 80    | 0     | 0     | 0     | 180   | 0     |
| Through Vol            | 0     | 0     | 220   | 0     | 0     | 40    |
| RT Vol                 | 0     | 220   | 0     | 70    | 0     | 0     |
| Lane Flow Rate         | 87    | 239   | 239   | 76    | 196   | 43    |
| Geometry Grp           | 7     | 7     | 7     | 7     | 7     | 7     |
| Degree of Util (X)     | 0.158 | 0.355 | 0.386 | 0.108 | 0.346 | 0.071 |
| Departure Headway (Hd) | 6.555 | 5.345 | 5.806 | 5.097 | 6.374 | 5.867 |
| Convergence, Y/N       | Yes   | Yes   | Yes   | Yes   | Yes   | Yes   |
| Cap                    | 548   | 674   | 622   | 704   | 565   | 611   |
| Service Time           | 4.283 | 3.072 | 3.53  | 2.821 | 4.101 | 3.594 |
| HCM Lane V/C Ratio     | 0.159 | 0.355 | 0.384 | 0.108 | 0.347 | 0.07  |
| HCM Control Delay      | 10.5  | 11    | 12.1  | 8.4   | 12.4  | 9     |
| HCM Lane LOS           | B     | B     | B     | A     | B     | A     |
| HCM 95th-tile Q        | 0.6   | 1.6   | 1.8   | 0.4   | 1.5   | 0.2   |



| Intersection                |       |       |       |       |
|-----------------------------|-------|-------|-------|-------|
| Intersection Delay, s/veh   | 8.2   |       |       |       |
| Intersection LOS            | A     |       |       |       |
| Approach                    | EB    | WB    | NB    | SB    |
| Entry Lanes                 | 1     | 1     | 1     | 1     |
| Conflicting Circle Lanes    | 1     | 1     | 1     | 1     |
| Adj Approach Flow, veh/h    | 353   | 352   | 61    | 232   |
| Demand Flow Rate, veh/h     | 364   | 356   | 61    | 236   |
| Vehicles Circulating, veh/h | 202   | 302   | 508   | 98    |
| Vehicles Exiting, veh/h     | 132   | 267   | 58    | 560   |
| Follow-Up Headway, s        | 3.186 | 3.186 | 3.186 | 3.186 |
| Ped Vol Crossing Leg, #/h   | 0     | 0     | 0     | 0     |
| Ped Cap Adj                 | 1.000 | 1.000 | 1.000 | 1.000 |
| Approach Delay, s/veh       | 8.6   | 9.7   | 6.3   | 5.8   |
| Approach LOS                | A     | A     | A     | A     |
| Lane                        | Left  | Left  | Left  | Left  |
| Designated Moves            | LTR   | LTR   | LTR   | LTR   |
| Assumed Moves               | LTR   | LTR   | LTR   | LTR   |
| RT Channelized              |       |       |       |       |
| Lane Util                   | 1.000 | 1.000 | 1.000 | 1.000 |
| Critical Headway, s         | 5.193 | 5.193 | 5.193 | 5.193 |
| Entry Flow, veh/h           | 364   | 356   | 61    | 236   |
| Cap Entry Lane, veh/h       | 923   | 835   | 680   | 1024  |
| Entry HV Adj Factor         | 0.969 | 0.990 | 1.000 | 0.981 |
| Flow Entry, veh/h           | 353   | 352   | 61    | 232   |
| Cap Entry, veh/h            | 895   | 827   | 680   | 1005  |
| V/C Ratio                   | 0.394 | 0.426 | 0.090 | 0.230 |
| Control Delay, s/veh        | 8.6   | 9.7   | 6.3   | 5.8   |
| LOS                         | A     | A     | A     | A     |
| 95th %tile Queue, veh       | 2     | 2     | 0     | 1     |

HCM 2010 Signalized Intersection Summary Cumulative with Eastside Parkway with Project, PM  
 19: 2nd Avenue & Inter-Garrison Road

06/11/2019



| Movement                     | WBL  | WBR  | NBT  | NBR  | SBL  | SBT  |      |      |
|------------------------------|------|------|------|------|------|------|------|------|
| Lane Configurations          |      |      |      |      |      |      |      |      |
| Traffic Volume (veh/h)       | 70   | 30   | 790  | 50   | 30   | 510  |      |      |
| Future Volume (veh/h)        | 70   | 30   | 790  | 50   | 30   | 510  |      |      |
| Number                       | 1    | 16   | 8    | 18   | 7    | 4    |      |      |
| Initial Q (Qb), veh          | 0    | 0    | 0    | 0    | 0    | 0    |      |      |
| Ped-Bike Adj(A_pbT)          | 1.00 | 1.00 |      | 1.00 | 1.00 |      |      |      |
| Parking Bus, Adj             | 1.00 | 1.00 | 1.00 | 1.00 | 1.00 | 1.00 |      |      |
| Adj Sat Flow, veh/h/ln       | 1900 | 1900 | 1881 | 1900 | 1863 | 1863 |      |      |
| Adj Flow Rate, veh/h         | 72   | 7    | 814  | 44   | 31   | 526  |      |      |
| Adj No. of Lanes             | 1    | 1    | 2    | 0    | 1    | 2    |      |      |
| Peak Hour Factor             | 0.97 | 0.97 | 0.97 | 0.97 | 0.97 | 0.97 |      |      |
| Percent Heavy Veh, %         | 0    | 0    | 1    | 1    | 2    | 2    |      |      |
| Cap, veh/h                   | 279  | 249  | 1427 | 77   | 66   | 1958 |      |      |
| Arrive On Green              | 0.15 | 0.15 | 0.41 | 0.41 | 0.04 | 0.55 |      |      |
| Sat Flow, veh/h              | 1810 | 1615 | 3543 | 186  | 1774 | 3632 |      |      |
| Grp Volume(v), veh/h         | 72   | 7    | 422  | 436  | 31   | 526  |      |      |
| Grp Sat Flow(s),veh/h/ln     | 1810 | 1615 | 1787 | 1848 | 1774 | 1770 |      |      |
| Q Serve(g_s), s              | 1.2  | 0.1  | 6.2  | 6.2  | 0.6  | 2.7  |      |      |
| Cycle Q Clear(g_c), s        | 1.2  | 0.1  | 6.2  | 6.2  | 0.6  | 2.7  |      |      |
| Prop In Lane                 | 1.00 | 1.00 |      | 0.10 | 1.00 |      |      |      |
| Lane Grp Cap(c), veh/h       | 279  | 249  | 739  | 764  | 66   | 1958 |      |      |
| V/C Ratio(X)                 | 0.26 | 0.03 | 0.57 | 0.57 | 0.47 | 0.27 |      |      |
| Avail Cap(c_a), veh/h        | 1852 | 1653 | 2090 | 2162 | 597  | 5692 |      |      |
| HCM Platoon Ratio            | 1.00 | 1.00 | 1.00 | 1.00 | 1.00 | 1.00 |      |      |
| Upstream Filter(I)           | 1.00 | 1.00 | 1.00 | 1.00 | 1.00 | 1.00 |      |      |
| Uniform Delay (d), s/veh     | 12.7 | 12.3 | 7.7  | 7.7  | 16.1 | 4.0  |      |      |
| Incr Delay (d2), s/veh       | 0.5  | 0.0  | 0.7  | 0.7  | 5.1  | 0.1  |      |      |
| Initial Q Delay(d3),s/veh    | 0.0  | 0.0  | 0.0  | 0.0  | 0.0  | 0.0  |      |      |
| %ile BackOfQ(50%),veh/ln     | 0.6  | 0.1  | 3.1  | 3.3  | 0.4  | 1.3  |      |      |
| LnGrp Delay(d),s/veh         | 13.2 | 12.3 | 8.4  | 8.4  | 21.2 | 4.1  |      |      |
| LnGrp LOS                    | B    | B    | A    | A    | C    | A    |      |      |
| Approach Vol, veh/h          | 79   |      | 858  |      |      | 557  |      |      |
| Approach Delay, s/veh        | 13.1 |      | 8.4  |      |      | 5.0  |      |      |
| Approach LOS                 | B    |      | A    |      |      | A    |      |      |
| Timer                        | 1    | 2    | 3    | 4    | 5    | 6    | 7    | 8    |
| Assigned Phs                 |      |      |      | 4    |      | 6    | 7    | 8    |
| Phs Duration (G+Y+Rc), s     |      |      |      | 23.9 |      | 10.3 | 4.8  | 19.1 |
| Change Period (Y+Rc), s      |      |      |      | 5.0  |      | 5.0  | 3.5  | 5.0  |
| Max Green Setting (Gmax), s  |      |      |      | 55.0 |      | 35.0 | 11.5 | 40.0 |
| Max Q Clear Time (g_c+I1), s |      |      |      | 4.7  |      | 3.2  | 2.6  | 8.2  |
| Green Ext Time (p_c), s      |      |      |      | 3.9  |      | 0.2  | 0.0  | 5.9  |
| <b>Intersection Summary</b>  |      |      |      |      |      |      |      |      |
| HCM 2010 Ctrl Delay          |      |      | 7.4  |      |      |      |      |      |
| HCM 2010 LOS                 |      |      | A    |      |      |      |      |      |

|                           |     |  |  |  |  |  |  |  |  |  |  |  |
|---------------------------|-----|--|--|--|--|--|--|--|--|--|--|--|
| <b>Intersection</b>       |     |  |  |  |  |  |  |  |  |  |  |  |
| Intersection Delay, s/veh | 9.5 |  |  |  |  |  |  |  |  |  |  |  |
| Intersection LOS          | A   |  |  |  |  |  |  |  |  |  |  |  |























| Movement            | EBL  | EBT  | EBR  | WBL  | WBT  | WBR  | NBL  | NBT  | NBR  | SBL  | SBT  | SBR  |
|---------------------|------|------|------|------|------|------|------|------|------|------|------|------|
| Lane Configurations |      | ↕    |      |      | ↕    |      |      | ↕    |      |      | ↕    |      |
| Traffic Vol, veh/h  | 10   | 20   | 30   | 120  | 30   | 20   | 20   | 80   | 100  | 20   | 90   | 10   |
| Future Vol, veh/h   | 10   | 20   | 30   | 120  | 30   | 20   | 20   | 80   | 100  | 20   | 90   | 10   |
| Peak Hour Factor    | 0.82 | 0.82 | 0.82 | 0.82 | 0.82 | 0.82 | 0.82 | 0.82 | 0.82 | 0.82 | 0.82 | 0.82 |
| Heavy Vehicles, %   | 1    | 1    | 1    | 1    | 1    | 1    | 3    | 3    | 3    | 0    | 0    | 0    |
| Mvmt Flow           | 12   | 24   | 37   | 146  | 37   | 24   | 24   | 98   | 122  | 24   | 110  | 12   |
| Number of Lanes     | 0    | 1    | 0    | 0    | 1    | 0    | 0    | 1    | 0    | 0    | 1    | 0    |

| Approach                   | EB  | WB   | NB  | SB  |
|----------------------------|-----|------|-----|-----|
| Opposing Approach          | WB  | EB   | SB  | NB  |
| Opposing Lanes             | 1   | 1    | 1   | 1   |
| Conflicting Approach Left  | SB  | NB   | EB  | WB  |
| Conflicting Lanes Left     | 1   | 1    | 1   | 1   |
| Conflicting Approach Right | NB  | SB   | WB  | EB  |
| Conflicting Lanes Right    | 1   | 1    | 1   | 1   |
| HCM Control Delay          | 8.4 | 10.1 | 9.6 | 9.1 |
| HCM LOS                    | A   | B    | A   | A   |

| Lane                   | NBLn1 | EBLn1 | WBLn1 | SBLn1 |
|------------------------|-------|-------|-------|-------|
| Vol Left, %            | 10%   | 17%   | 71%   | 17%   |
| Vol Thru, %            | 40%   | 33%   | 18%   | 75%   |
| Vol Right, %           | 50%   | 50%   | 12%   | 8%    |
| Sign Control           | Stop  | Stop  | Stop  | Stop  |
| Traffic Vol by Lane    | 200   | 60    | 170   | 120   |
| LT Vol                 | 20    | 10    | 120   | 20    |
| Through Vol            | 80    | 20    | 30    | 90    |
| RT Vol                 | 100   | 30    | 20    | 10    |
| Lane Flow Rate         | 244   | 73    | 207   | 146   |
| Geometry Grp           | 1     | 1     | 1     | 1     |
| Degree of Util (X)     | 0.308 | 0.098 | 0.287 | 0.198 |
| Departure Headway (Hd) | 4.552 | 4.838 | 4.982 | 4.871 |
| Convergence, Y/N       | Yes   | Yes   | Yes   | Yes   |
| Cap                    | 785   | 733   | 717   | 732   |
| Service Time           | 2.608 | 2.916 | 3.047 | 2.935 |
| HCM Lane V/C Ratio     | 0.311 | 0.1   | 0.289 | 0.199 |
| HCM Control Delay      | 9.6   | 8.4   | 10.1  | 9.1   |
| HCM Lane LOS           | A     | A     | B     | A     |
| HCM 95th-tile Q        | 1.3   | 0.3   | 1.2   | 0.7   |

HCM 2010 Signalized Intersection Summary  
 21: 7th Avenue/8th Street & Inter-Garrison Road

07/12/2019

|                              |  |  |  |  |  |  |   |  |  |  |  |  |
|------------------------------|---|---|---|---|---|---|---|---|---|---|---|---|
| Movement                     | EBL   | EBT   | EBR   | WBL   | WBT   | WBR   | NBL   | NBT   | NBR   | SBL   | SBT   | SBR   |
| Lane Configurations          |  |  |   |  |  |   |  |  |  |  |  |  |
| Traffic Volume (veh/h)       | 10  | 230   | 80  | 230   | 150   | 50  | 60  | 180   | 370   | 60  | 110   | 10  |
| Future Volume (veh/h)        | 10  | 230   | 80  | 230   | 150   | 50  | 60  | 180   | 370   | 60  | 110   | 10  |
| Number                       | 5   | 2   | 12  | 1   | 6   | 16  | 3   | 8   | 18  | 7   | 4   | 14  |
| Initial Q (Qb), veh          | 0   | 0   | 0   | 0   | 0   | 0   | 0   | 0   | 0   | 0   | 0   | 0   |
| Ped-Bike Adj(A_pbT)          | 1.00  |   | 0.99  | 1.00  |   | 1.00  | 1.00  |   | 0.98  | 1.00  |   | 1.00  |
| Parking Bus, Adj             | 1.00  | 1.00  | 1.00  | 1.00  | 1.00  | 1.00  | 1.00  | 1.00  | 1.00  | 1.00  | 1.00  | 1.00  |
| Adj Sat Flow, veh/h/ln       | 1881  | 1881  | 1900  | 1827  | 1827  | 1900  | 1810  | 1810  | 1810  | 1900  | 1900  | 1900  |
| Adj Flow Rate, veh/h         | 11  | 247   | 80  | 247   | 161   | 39  | 65  | 194   | 326   | 65  | 118   | 2   |
| Adj No. of Lanes             | 1   | 1   | 0   | 1   | 1   | 0   | 1   | 1   | 1   | 1   | 1   | 0   |
| Peak Hour Factor             | 0.93  | 0.93  | 0.93  | 0.93  | 0.93  | 0.93  | 0.93  | 0.93  | 0.93  | 0.93  | 0.93  | 0.93  |
| Percent Heavy Veh, %         | 1   | 1   | 1   | 4   | 4   | 4   | 5   | 5   | 5   | 0   | 0   | 0   |
| Cap, veh/h                   | 20  | 341   | 110   | 300   | 585   | 142   | 81  | 478   | 397   | 83  | 490   | 8   |
| Arrive On Green              | 0.01  | 0.25  | 0.25  | 0.17  | 0.41  | 0.41  | 0.05  | 0.26  | 0.26  | 0.05  | 0.26  | 0.26  |
| Sat Flow, veh/h              | 1792  | 1359  | 440   | 1740  | 1420  | 344   | 1723  | 1810  | 1502  | 1810  | 1863  | 32  |
| Grp Volume(v), veh/h         | 11  | 0   | 327   | 247   | 0   | 200   | 65  | 194   | 326   | 65  | 0   | 120   |
| Grp Sat Flow(s),veh/h/ln     | 1792  | 0   | 1799  | 1740  | 0   | 1764  | 1723  | 1810  | 1502  | 1810  | 0   | 1894  |
| Q Serve(g_s), s              | 0.4   | 0.0   | 10.0  | 8.2   | 0.0   | 4.5   | 2.2   | 5.3   | 12.2  | 2.1   | 0.0   | 3.0   |
| Cycle Q Clear(g_c), s        | 0.4   | 0.0   | 10.0  | 8.2   | 0.0   | 4.5   | 2.2   | 5.3   | 12.2  | 2.1   | 0.0   | 3.0   |
| Prop In Lane                 | 1.00  |   | 0.24  | 1.00  |   | 0.19  | 1.00  |   | 1.00  | 1.00  |   | 0.02  |
| Lane Grp Cap(c), veh/h       | 20  | 0   | 451   | 300   | 0   | 727   | 81  | 478   | 397   | 83  | 0   | 498   |
| V/C Ratio(X)                 | 0.55  | 0.00  | 0.72  | 0.82  | 0.00  | 0.28  | 0.81  | 0.41  | 0.82  | 0.79  | 0.00  | 0.24  |
| Avail Cap(c_a), veh/h        | 120   | 0   | 992   | 421   | 0   | 1282  | 130   | 665   | 552   | 136   | 0   | 696   |
| HCM Platoon Ratio            | 1.00  | 1.00  | 1.00  | 1.00  | 1.00  | 1.00  | 1.00  | 1.00  | 1.00  | 1.00  | 1.00  | 1.00  |
| Upstream Filter(I)           | 1.00  | 0.00  | 1.00  | 1.00  | 0.00  | 1.00  | 1.00  | 1.00  | 1.00  | 1.00  | 0.00  | 1.00  |
| Uniform Delay (d), s/veh     | 29.4  | 0.0   | 20.5  | 23.9  | 0.0   | 11.7  | 28.3  | 18.2  | 20.7  | 28.3  | 0.0   | 17.4  |
| Incr Delay (d2), s/veh       | 21.5  | 0.0   | 2.2   | 8.9   | 0.0   | 0.2   | 17.0  | 0.6   | 6.9   | 15.1  | 0.0   | 0.2   |
| Initial Q Delay(d3),s/veh    | 0.0   | 0.0   | 0.0   | 0.0   | 0.0   | 0.0   | 0.0   | 0.0   | 0.0   | 0.0   | 0.0   | 0.0   |
| %ile BackOfQ(50%),veh/ln     | 0.3   | 0.0   | 5.2   | 4.7   | 0.0   | 2.2   | 1.4   | 2.7   | 5.7   | 1.4   | 0.0   | 1.6   |
| LnGrp Delay(d),s/veh         | 50.9  | 0.0   | 22.8  | 32.8  | 0.0   | 11.9  | 45.3  | 18.7  | 27.6  | 43.4  | 0.0   | 17.6  |
| LnGrp LOS                    | D   |   | C   | C   |   | B   | D   | B   | C   | D   |   | B   |
| Approach Vol, veh/h          |   | 338   |   |   | 447   |   |   | 585   |   |   | 185   |   |
| Approach Delay, s/veh        |   | 23.7  |   |   | 23.4  |   |   | 26.6  |   |   | 26.7  |   |
| Approach LOS                 |   | C   |   |   | C   |   |   | C   |   |   | C   |   |
| Timer                        | 1   | 2   | 3   | 4   | 5   | 6   | 7   | 8   |   |   |   |   |
| Assigned Phs                 | 1   | 2   | 3   | 4   | 5   | 6   | 7   | 8   |   |   |   |   |
| Phs Duration (G+Y+Rc), s     | 13.8  | 20.0  | 6.3   | 19.7  | 4.2   | 29.7  | 6.2   | 19.8  |   |   |   |   |
| Change Period (Y+Rc), s      | 3.5   | 5.0   | 3.5   | 4.0   | 3.5   | 5.0   | 3.5   | 4.0   |   |   |   |   |
| Max Green Setting (Gmax), s  | 14.5  | 33.0  | 4.5   | 22.0  | 4.0   | 43.5  | 4.5   | 22.0  |   |   |   |   |
| Max Q Clear Time (g_c+I1), s | 10.2  | 12.0  | 4.2   | 5.0   | 2.4   | 6.5   | 4.1   | 14.2  |   |   |   |   |
| Green Ext Time (p_c), s      | 0.3   | 1.9   | 0.0   | 0.5   | 0.0   | 1.3   | 0.0   | 1.5   |   |   |   |   |
| <b>Intersection Summary</b>  |   |   |   |   |   |   |   |   |   |   |   |   |
| HCM 2010 Ctrl Delay          |   |   | 25.1  |   |   |   |   |   |   |   |   |   |
| HCM 2010 LOS                 |   |   | C   |   |   |   |   |   |   |   |   |   |

| Intersection                |       |       |       |
|-----------------------------|-------|-------|-------|
| Intersection Delay, s/veh   | 22.0  |       |       |
| Intersection LOS            | C     |       |       |
| Approach                    | EB    | WB    | NB    |
| Entry Lanes                 | 1     | 1     | 1     |
| Conflicting Circle Lanes    | 1     | 1     | 1     |
| Adj Approach Flow, veh/h    | 680   | 681   | 495   |
| Demand Flow Rate, veh/h     | 694   | 695   | 495   |
| Vehicles Circulating, veh/h | 295   | 62    | 610   |
| Vehicles Exiting, veh/h     | 462   | 1043  | 379   |
| Follow-Up Headway, s        | 3.186 | 3.186 | 3.186 |
| Ped Vol Crossing Leg, #/h   | 0     | 0     | 0     |
| Ped Cap Adj                 | 1.000 | 1.000 | 1.000 |
| Approach Delay, s/veh       | 25.4  | 13.0  | 29.8  |
| Approach LOS                | D     | B     | D     |
| Lane                        | Left  | Left  | Left  |
| Designated Moves            | TR    | LT    | LR    |
| Assumed Moves               | TR    | LT    | LR    |
| RT Channelized              |       |       |       |
| Lane Util                   | 1.000 | 1.000 | 1.000 |
| Critical Headway, s         | 5.193 | 5.193 | 5.193 |
| Entry Flow, veh/h           | 694   | 695   | 495   |
| Cap Entry Lane, veh/h       | 841   | 1062  | 614   |
| Entry HV Adj Factor         | 0.980 | 0.980 | 1.000 |
| Flow Entry, veh/h           | 680   | 681   | 495   |
| Cap Entry, veh/h            | 824   | 1041  | 614   |
| V/C Ratio                   | 0.825 | 0.654 | 0.806 |
| Control Delay, s/veh        | 25.4  | 13.0  | 29.8  |
| LOS                         | D     | B     | D     |
| 95th %tile Queue, veh       | 9     | 5     | 8     |

| Intersection                |       |       |       |
|-----------------------------|-------|-------|-------|
| Intersection Delay, s/veh   | 33.9  |       |       |
| Intersection LOS            | D     |       |       |
| Approach                    | EB    | WB    | NB    |
| Entry Lanes                 | 1     | 1     | 1     |
| Conflicting Circle Lanes    | 1     | 1     | 1     |
| Adj Approach Flow, veh/h    | 608   | 680   | 711   |
| Demand Flow Rate, veh/h     | 620   | 693   | 711   |
| Vehicles Circulating, veh/h | 525   | 72    | 410   |
| Vehicles Exiting, veh/h     | 240   | 1049  | 735   |
| Follow-Up Headway, s        | 3.186 | 3.186 | 3.186 |
| Ped Vol Crossing Leg, #/h   | 0     | 0     | 0     |
| Ped Cap Adj                 | 1.000 | 1.000 | 1.000 |
| Approach Delay, s/veh       | 44.4  | 13.3  | 44.6  |
| Approach LOS                | E     | B     | E     |
| Lane                        | Left  | Left  | Left  |
| Designated Moves            | TR    | LT    | LR    |
| Assumed Moves               | TR    | LT    | LR    |
| RT Channelized              |       |       |       |
| Lane Util                   | 1.000 | 1.000 | 1.000 |
| Critical Headway, s         | 5.193 | 5.193 | 5.193 |
| Entry Flow, veh/h           | 620   | 693   | 711   |
| Cap Entry Lane, veh/h       | 668   | 1051  | 750   |
| Entry HV Adj Factor         | 0.981 | 0.981 | 1.000 |
| Flow Entry, veh/h           | 608   | 680   | 711   |
| Cap Entry, veh/h            | 655   | 1031  | 750   |
| V/C Ratio                   | 0.928 | 0.659 | 0.948 |
| Control Delay, s/veh        | 44.4  | 13.3  | 44.6  |
| LOS                         | E     | B     | E     |
| 95th %tile Queue, veh       | 12    | 5     | 14    |

HCM 2010 Signalized Intersection Summary Cumulative with Eastside Parkway with Project, PM  
 23: Inter-Garrison Road & Abrams Drive

06/11/2019

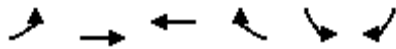

| Movement                     | EBL  | EBT  | WBT  | WBR  | SBL  | SBR  |   |   |
|------------------------------|------|------|------|------|------|------|---|---|
| Lane Configurations          |      |      |      |      |      |      |   |   |
| Traffic Volume (veh/h)       | 390  | 620  | 400  | 140  | 120  | 260  |   |   |
| Future Volume (veh/h)        | 390  | 620  | 400  | 140  | 120  | 260  |   |   |
| Number                       | 5    | 2    | 6    | 16   | 7    | 14   |   |   |
| Initial Q (Qb), veh          | 0    | 0    | 0    | 0    | 0    | 0    |   |   |
| Ped-Bike Adj(A_pbT)          | 1.00 |      |      | 0.98 | 1.00 | 1.00 |   |   |
| Parking Bus, Adj             | 1.00 | 1.00 | 1.00 | 1.00 | 1.00 | 1.00 |   |   |
| Adj Sat Flow, veh/h/ln       | 1863 | 1863 | 1792 | 1792 | 1827 | 1827 |   |   |
| Adj Flow Rate, veh/h         | 411  | 653  | 421  | 121  | 126  | 51   |   |   |
| Adj No. of Lanes             | 1    | 1    | 1    | 1    | 2    | 1    |   |   |
| Peak Hour Factor             | 0.95 | 0.95 | 0.95 | 0.95 | 0.95 | 0.95 |   |   |
| Percent Heavy Veh, %         | 2    | 2    | 6    | 6    | 4    | 4    |   |   |
| Cap, veh/h                   | 484  | 1232 | 516  | 429  | 318  | 146  |   |   |
| Arrive On Green              | 0.27 | 0.66 | 0.29 | 0.29 | 0.09 | 0.09 |   |   |
| Sat Flow, veh/h              | 1774 | 1863 | 1792 | 1491 | 3375 | 1553 |   |   |
| Grp Volume(v), veh/h         | 411  | 653  | 421  | 121  | 126  | 51   |   |   |
| Grp Sat Flow(s),veh/h/ln     | 1774 | 1863 | 1792 | 1491 | 1688 | 1553 |   |   |
| Q Serve(g_s), s              | 7.6  | 6.4  | 7.6  | 2.2  | 1.2  | 1.1  |   |   |
| Cycle Q Clear(g_c), s        | 7.6  | 6.4  | 7.6  | 2.2  | 1.2  | 1.1  |   |   |
| Prop In Lane                 | 1.00 |      |      | 1.00 | 1.00 | 1.00 |   |   |
| Lane Grp Cap(c), veh/h       | 484  | 1232 | 516  | 429  | 318  | 146  |   |   |
| V/C Ratio(X)                 | 0.85 | 0.53 | 0.82 | 0.28 | 0.40 | 0.35 |   |   |
| Avail Cap(c_a), veh/h        | 587  | 3216 | 2321 | 1931 | 3060 | 1408 |   |   |
| HCM Platoon Ratio            | 1.00 | 1.00 | 1.00 | 1.00 | 1.00 | 1.00 |   |   |
| Upstream Filter(I)           | 1.00 | 1.00 | 1.00 | 1.00 | 1.00 | 1.00 |   |   |
| Uniform Delay (d), s/veh     | 12.0 | 3.1  | 11.5 | 9.6  | 14.8 | 14.7 |   |   |
| Incr Delay (d2), s/veh       | 8.4  | 0.1  | 1.2  | 0.1  | 0.3  | 0.5  |   |   |
| Initial Q Delay(d3),s/veh    | 0.0  | 0.0  | 0.0  | 0.0  | 0.0  | 0.0  |   |   |
| %ile BackOfQ(50%),veh/ln     | 4.8  | 3.1  | 3.9  | 0.9  | 0.6  | 0.9  |   |   |
| LnGrp Delay(d),s/veh         | 20.4 | 3.2  | 12.7 | 9.7  | 15.1 | 15.3 |   |   |
| LnGrp LOS                    | C    | A    | B    | A    | B    | B    |   |   |
| Approach Vol, veh/h          |      | 1064 | 542  |      | 177  |      |   |   |
| Approach Delay, s/veh        |      | 9.8  | 12.1 |      | 15.1 |      |   |   |
| Approach LOS                 |      | A    | B    |      | B    |      |   |   |
| Timer                        | 1    | 2    | 3    | 4    | 5    | 6    | 7 | 8 |
| Assigned Phs                 |      | 2    |      | 4    | 5    | 6    |   |   |
| Phs Duration (G+Y+Rc), s     |      | 28.0 |      | 6.8  | 13.0 | 15.0 |   |   |
| Change Period (Y+Rc), s      |      | 5.0  |      | 3.5  | 3.5  | 5.0  |   |   |
| Max Green Setting (Gmax), s  |      | 60.0 |      | 31.5 | 11.5 | 45.0 |   |   |
| Max Q Clear Time (g_c+I1), s |      | 8.4  |      | 3.2  | 9.6  | 9.6  |   |   |
| Green Ext Time (p_c), s      |      | 0.6  |      | 0.0  | 0.0  | 0.4  |   |   |
| <b>Intersection Summary</b>  |      |      |      |      |      |      |   |   |
| HCM 2010 Ctrl Delay          |      |      | 11.0 |      |      |      |   |   |
| HCM 2010 LOS                 |      |      | B    |      |      |      |   |   |
| <b>Notes</b>                 |      |      |      |      |      |      |   |   |

HCM 2010 Signalized Intersection Summary Cumulative with Eastside Parkway with Project, PM  
 24: Inter-Garrison Road & Schoonover Road 06/11/2019



| Movement                    | EBL  | EBT  | EBR  | WBL  | WBT  | WBR  | NBL  | NBT  | NBR  | SBL  | SBT  | SBR  |
|-----------------------------|------|------|------|------|------|------|------|------|------|------|------|------|
| Lane Configurations         |      |      |      |      |      |      |      |      |      |      |      |      |
| Traffic Volume (veh/h)      | 200  | 470  | 110  | 380  | 330  | 40   | 120  | 60   | 870  | 20   | 30   | 70   |
| Future Volume (veh/h)       | 200  | 470  | 110  | 380  | 330  | 40   | 120  | 60   | 870  | 20   | 30   | 70   |
| Number                      | 5    | 2    | 12   | 1    | 6    | 16   | 3    | 8    | 18   | 7    | 4    | 14   |
| Initial Q (Qb), veh         | 0    | 0    | 0    | 0    | 0    | 0    | 0    | 0    | 0    | 0    | 0    | 0    |
| Ped-Bike Adj(A_pbT)         | 1.00 |      | 1.00 | 1.00 |      | 1.00 | 1.00 |      | 1.00 | 1.00 |      | 1.00 |
| Parking Bus, Adj            | 1.00 | 1.00 | 1.00 | 1.00 | 1.00 | 1.00 | 1.00 | 1.00 | 1.00 | 1.00 | 1.00 | 1.00 |
| Adj Sat Flow, veh/h/ln      | 1881 | 1878 | 1900 | 1863 | 1810 | 1810 | 1863 | 1863 | 1863 | 1900 | 1760 | 1624 |
| Adj Flow Rate, veh/h        | 233  | 547  | 93   | 442  | 384  | 33   | 140  | 70   | 0    | 23   | 35   | 57   |
| Adj No. of Lanes            | 1    | 2    | 0    | 1    | 2    | 1    | 1    | 1    | 1    | 0    | 1    | 1    |
| Peak Hour Factor            | 0.86 | 0.86 | 0.86 | 0.86 | 0.86 | 0.86 | 0.86 | 0.86 | 0.86 | 0.86 | 0.86 | 0.86 |
| Percent Heavy Veh, %        | 1    | 1    | 1    | 2    | 5    | 5    | 2    | 2    | 2    | 2    | 2    | 17   |
| Cap, veh/h                  | 275  | 639  | 108  | 481  | 1123 | 502  | 243  | 255  | 217  | 86   | 130  | 173  |
| Arrive On Green             | 0.15 | 0.21 | 0.21 | 0.27 | 0.33 | 0.33 | 0.14 | 0.14 | 0.00 | 0.13 | 0.13 | 0.13 |
| Sat Flow, veh/h             | 1792 | 3053 | 517  | 1774 | 3438 | 1538 | 1774 | 1863 | 1583 | 684  | 1041 | 1380 |
| Grp Volume(v), veh/h        | 233  | 319  | 321  | 442  | 384  | 33   | 140  | 70   | 0    | 58   | 0    | 57   |
| Grp Sat Flow(s),veh/h/ln    | 1792 | 1784 | 1786 | 1774 | 1719 | 1538 | 1774 | 1863 | 1583 | 1726 | 0    | 1380 |
| Q Serve(g_s), s             | 9.1  | 12.4 | 12.5 | 17.4 | 6.1  | 1.1  | 5.3  | 2.4  | 0.0  | 2.2  | 0.0  | 2.7  |
| Cycle Q Clear(g_c), s       | 9.1  | 12.4 | 12.5 | 17.4 | 6.1  | 1.1  | 5.3  | 2.4  | 0.0  | 2.2  | 0.0  | 2.7  |
| Prop In Lane                | 1.00 |      | 0.29 | 1.00 |      | 1.00 | 1.00 |      | 1.00 | 0.40 |      | 1.00 |
| Lane Grp Cap(c), veh/h      | 275  | 373  | 374  | 481  | 1123 | 502  | 243  | 255  | 217  | 216  | 0    | 173  |
| V/C Ratio(X)                | 0.85 | 0.85 | 0.86 | 0.92 | 0.34 | 0.07 | 0.58 | 0.27 | 0.00 | 0.27 | 0.00 | 0.33 |
| Avail Cap(c_a), veh/h       | 761  | 745  | 746  | 852  | 1579 | 707  | 988  | 1037 | 882  | 649  | 0    | 519  |
| HCM Platoon Ratio           | 1.00 | 1.00 | 1.00 | 1.00 | 1.00 | 1.00 | 1.00 | 1.00 | 1.00 | 1.00 | 1.00 | 1.00 |
| Upstream Filter(I)          | 1.00 | 1.00 | 1.00 | 1.00 | 1.00 | 1.00 | 1.00 | 1.00 | 0.00 | 1.00 | 0.00 | 1.00 |
| Uniform Delay (d), s/veh    | 29.6 | 27.4 | 27.4 | 25.4 | 18.3 | 16.6 | 29.0 | 27.8 | 0.0  | 28.4 | 0.0  | 28.7 |
| Incr Delay (d2), s/veh      | 2.8  | 2.2  | 2.3  | 4.4  | 0.1  | 0.0  | 0.8  | 0.2  | 0.0  | 0.2  | 0.0  | 0.4  |
| Initial Q Delay(d3),s/veh   | 0.0  | 0.0  | 0.0  | 0.0  | 0.0  | 0.0  | 0.0  | 0.0  | 0.0  | 0.0  | 0.0  | 0.0  |
| %ile BackOfQ(50%),veh/ln    | 4.7  | 6.3  | 6.4  | 9.1  | 2.9  | 0.5  | 2.7  | 1.3  | 0.0  | 1.1  | 0.0  | 1.0  |
| LnGrp Delay(d),s/veh        | 32.4 | 29.5 | 29.7 | 29.8 | 18.4 | 16.7 | 29.8 | 28.0 | 0.0  | 28.7 | 0.0  | 29.1 |
| LnGrp LOS                   | C    | C    | C    | C    | B    | B    | C    | C    |      | C    |      | C    |
| Approach Vol, veh/h         |      | 873  |      |      | 859  |      |      | 210  |      |      | 115  |      |
| Approach Delay, s/veh       |      | 30.3 |      |      | 24.2 |      |      | 29.2 |      |      | 28.9 |      |
| Approach LOS                |      | C    |      |      | C    |      |      | C    |      |      | C    |      |
| Timer                       | 1    | 2    | 3    | 4    | 5    | 6    | 7    | 8    |      |      |      |      |
| Assigned Phs                | 1    | 2    |      | 4    | 5    | 6    |      | 8    |      |      |      |      |
| Phs Duration (G+Y+Rc), s    | 23.0 | 20.0 |      | 14.0 | 14.5 | 28.5 |      | 14.8 |      |      |      |      |
| Change Period (Y+Rc), s     | 3.5  | 5.0  |      | 5.0  | 3.5  | 5.0  |      | 5.0  |      |      |      |      |
| Max Green Setting (Gmax), s | 31.5 | 30.0 |      | 27.0 | 30.5 | 33.0 |      | 40.0 |      |      |      |      |
| Max Q Clear Time (g_c+1), s | 19.4 | 14.5 |      | 4.7  | 11.1 | 8.1  |      | 7.3  |      |      |      |      |
| Green Ext Time (p_c), s     | 0.1  | 0.6  |      | 0.0  | 0.1  | 0.5  |      | 0.0  |      |      |      |      |
| <b>Intersection Summary</b> |      |      |      |      |      |      |      |      |      |      |      |      |
| HCM 2010 Ctrl Delay         |      |      | 27.6 |      |      |      |      |      |      |      |      |      |
| HCM 2010 LOS                |      |      | C    |      |      |      |      |      |      |      |      |      |



|                           |      |
|---------------------------|------|
| <b>Intersection</b>       |      |
| Intersection Delay, s/veh | 37.1 |
| Intersection LOS          | F    |

| Movement            | EBL  | EBT  | WBT  | WBR  | SBL  | SBR  |
|---------------------|------|------|------|------|------|------|
| Lane Configurations | ↙    | ↑    | ↘    |      | ↙    | ↘    |
| Traffic Vol, veh/h  | 990  | 270  | 160  | 100  | 120  | 520  |
| Future Vol, veh/h   | 990  | 270  | 160  | 100  | 120  | 520  |
| Peak Hour Factor    | 0.87 | 0.87 | 0.87 | 0.87 | 0.87 | 0.87 |
| Heavy Vehicles, %   | 1    | 1    | 6    | 6    | 3    | 3    |
| Mvmt Flow           | 1138 | 310  | 184  | 115  | 138  | 598  |
| Number of Lanes     | 1    | 1    | 1    | 0    | 1    | 1    |

| Approach                   | EB    | WB   | SB   |
|----------------------------|-------|------|------|
| Opposing Approach          | WB    | EB   |      |
| Opposing Lanes             | 1     | 2    | 0    |
| Conflicting Approach Left  | SB    |      | WB   |
| Conflicting Lanes Left     | 2     | 0    | 1    |
| Conflicting Approach Right |       | SB   | EB   |
| Conflicting Lanes Right    | 0     | 2    | 2    |
| HCM Control Delay          | 527.6 | 23.2 | 89.6 |
| HCM LOS                    | F     | C    | F    |

| Lane                   | EBLn1 | EBLn2 | WBLn1 | SBLn1 | SBLn2 |
|------------------------|-------|-------|-------|-------|-------|
| Vol Left, %            | 100%  | 0%    | 0%    | 100%  | 0%    |
| Vol Thru, %            | 0%    | 100%  | 62%   | 0%    | 0%    |
| Vol Right, %           | 0%    | 0%    | 38%   | 0%    | 100%  |
| Sign Control           | Stop  | Stop  | Stop  | Stop  | Stop  |
| Traffic Vol by Lane    | 990   | 270   | 260   | 120   | 520   |
| LT Vol                 | 990   | 0     | 0     | 120   | 0     |
| Through Vol            | 0     | 270   | 160   | 0     | 0     |
| RT Vol                 | 0     | 0     | 100   | 0     | 520   |
| Lane Flow Rate         | 1138  | 310   | 299   | 138   | 598   |
| Geometry Grp           | 7     | 7     | 4     | 7     | 7     |
| Degree of Util (X)     | 2.425 | 0.618 | 0.603 | 0.304 | 1.119 |
| Departure Headway (Hd) | 8.119 | 7.605 | 8.349 | 9.298 | 8.059 |
| Convergence, Y/N       | Yes   | Yes   | Yes   | Yes   | Yes   |
| Cap                    | 455   | 478   | 436   | 389   | 454   |
| Service Time           | 5.819 | 5.305 | 6.349 | 6.998 | 5.759 |
| HCM Lane V/C Ratio     | 2.501 | 0.649 | 0.686 | 0.355 | 1.317 |
| HCM Control Delay      | 665.6 | 21.8  | 23.2  | 16    | 106.6 |
| HCM Lane LOS           | F     | C     | C     | C     | F     |
| HCM 95th-tile Q        | 83.8  | 4.1   | 3.9   | 1.3   | 17.4  |

HCM 2010 Signalized Intersection Summary Cumulative with Eastside Parkway with Project, PM  
 26: East Garrison Road & Reservation Road

06/11/2019



| Movement                       | EBL  | EBT  | EBR  | WBL  | WBT  | WBR  | NBL  | NBT  | NBR  | SBL | SBT | SBR |
|--------------------------------|------|------|------|------|------|------|------|------|------|-----|-----|-----|
| Lane Configurations            | ↖    | ↗    |      | ↖    | ↗    |      | ↖    |      | ↗    |     |     |     |
| Traffic Volume (veh/h)         | 0    | 1680 | 130  | 230  | 880  | 0    | 110  | 0    | 150  | 0   | 0   | 0   |
| Future Volume (veh/h)          | 0    | 1680 | 130  | 230  | 880  | 0    | 110  | 0    | 150  | 0   | 0   | 0   |
| Number                         | 5    | 2    | 12   | 1    | 6    | 16   | 3    | 8    | 18   |     |     |     |
| Initial Q (Qb), veh            | 0    | 0    | 0    | 0    | 0    | 0    | 0    | 0    | 0    |     |     |     |
| Ped-Bike Adj(A_pbT)            | 1.00 |      | 1.00 | 1.00 |      | 1.00 | 1.00 |      | 1.00 |     |     |     |
| Parking Bus, Adj               | 1.00 | 1.00 | 1.00 | 1.00 | 1.00 | 1.00 | 1.00 | 1.00 | 1.00 |     |     |     |
| Adj Sat Flow, veh/h/ln         | 1863 | 1863 | 1900 | 1881 | 1881 | 0    | 1845 | 0    | 1845 |     |     |     |
| Adj Flow Rate, veh/h           | 0    | 1732 | 132  | 237  | 907  | 0    | 113  | 0    | 126  |     |     |     |
| Adj No. of Lanes               | 1    | 2    | 0    | 1    | 2    | 0    | 1    | 0    | 1    |     |     |     |
| Peak Hour Factor               | 0.97 | 0.97 | 0.97 | 0.97 | 0.97 | 0.97 | 0.97 | 0.97 | 0.97 |     |     |     |
| Percent Heavy Veh, %           | 2    | 2    | 2    | 1    | 1    | 0    | 3    | 0    | 3    |     |     |     |
| Cap, veh/h                     | 2    | 2021 | 152  | 270  | 2838 | 0    | 177  | 0    | 158  |     |     |     |
| Arrive On Green                | 0.00 | 0.61 | 0.61 | 0.15 | 0.79 | 0.00 | 0.10 | 0.00 | 0.10 |     |     |     |
| Sat Flow, veh/h                | 1774 | 3336 | 252  | 1792 | 3668 | 0    | 1757 | 0    | 1568 |     |     |     |
| Grp Volume(v), veh/h           | 0    | 910  | 954  | 237  | 907  | 0    | 113  | 0    | 126  |     |     |     |
| Grp Sat Flow(s),veh/h/ln       | 1774 | 1770 | 1818 | 1792 | 1787 | 0    | 1757 | 0    | 1568 |     |     |     |
| Q Serve(g_s), s                | 0.0  | 39.9 | 41.7 | 12.4 | 6.7  | 0.0  | 5.9  | 0.0  | 7.5  |     |     |     |
| Cycle Q Clear(g_c), s          | 0.0  | 39.9 | 41.7 | 12.4 | 6.7  | 0.0  | 5.9  | 0.0  | 7.5  |     |     |     |
| Prop In Lane                   | 1.00 |      | 0.14 | 1.00 |      | 0.00 | 1.00 |      | 1.00 |     |     |     |
| Lane Grp Cap(c), veh/h         | 2    | 1072 | 1102 | 270  | 2838 | 0    | 177  | 0    | 158  |     |     |     |
| V/C Ratio(X)                   | 0.00 | 0.85 | 0.87 | 0.88 | 0.32 | 0.00 | 0.64 | 0.00 | 0.80 |     |     |     |
| Avail Cap(c_a), veh/h          | 371  | 1109 | 1139 | 374  | 2838 | 0    | 495  | 0    | 442  |     |     |     |
| HCM Platoon Ratio              | 1.00 | 1.00 | 1.00 | 1.00 | 1.00 | 1.00 | 1.00 | 1.00 | 1.00 |     |     |     |
| Upstream Filter(I)             | 0.00 | 1.00 | 1.00 | 1.00 | 1.00 | 0.00 | 1.00 | 0.00 | 1.00 |     |     |     |
| Uniform Delay (d), s/veh       | 0.0  | 15.3 | 15.6 | 39.8 | 2.7  | 0.0  | 41.4 | 0.0  | 42.1 |     |     |     |
| Incr Delay (d2), s/veh         | 0.0  | 6.7  | 7.6  | 12.7 | 0.1  | 0.0  | 1.4  | 0.0  | 3.5  |     |     |     |
| Initial Q Delay(d3),s/veh      | 0.0  | 0.0  | 0.0  | 0.0  | 0.0  | 0.0  | 0.0  | 0.0  | 0.0  |     |     |     |
| %ile BackOfQ(50%),veh/ln       | 0.0  | 21.2 | 23.0 | 7.1  | 3.3  | 0.0  | 3.0  | 0.0  | 3.4  |     |     |     |
| LnGrp Delay(d),s/veh           | 0.0  | 22.0 | 23.2 | 52.5 | 2.8  | 0.0  | 42.8 | 0.0  | 45.6 |     |     |     |
| LnGrp LOS                      |      | C    | C    | D    | A    |      | D    |      | D    |     |     |     |
| Approach Vol, veh/h            |      | 1864 |      |      | 1144 |      |      | 239  |      |     |     |     |
| Approach Delay, s/veh          |      | 22.6 |      |      | 13.1 |      |      | 44.3 |      |     |     |     |
| Approach LOS                   |      | C    |      |      | B    |      |      | D    |      |     |     |     |
| Timer                          | 1    | 2    | 3    | 4    | 5    | 6    | 7    | 8    |      |     |     |     |
| Assigned Phs                   | 1    | 2    |      |      | 5    | 6    |      | 8    |      |     |     |     |
| Phs Duration (G+Y+Rc), s       | 8.0  | 63.4 |      |      | 0.0  | 81.4 |      | 14.3 |      |     |     |     |
| Change Period (Y+Rc), s        | 3.6  | 5.4  |      |      | 3.5  | 5.4  |      | 4.7  |      |     |     |     |
| Max Green Setting (Gmax), s    | 20   | 60.0 |      |      | 20.0 | 60.0 |      | 27.0 |      |     |     |     |
| Max Q Clear Time (g_c+14.4), s | 14.4 | 43.7 |      |      | 0.0  | 8.7  |      | 9.5  |      |     |     |     |
| Green Ext Time (p_c), s        | 0.0  | 14.4 |      |      | 0.0  | 8.5  |      | 0.1  |      |     |     |     |
| <b>Intersection Summary</b>    |      |      |      |      |      |      |      |      |      |     |     |     |
| HCM 2010 Ctrl Delay            |      |      |      | 20.9 |      |      |      |      |      |     |     |     |
| HCM 2010 LOS                   |      |      |      | C    |      |      |      |      |      |     |     |     |
| <b>Notes</b>                   |      |      |      |      |      |      |      |      |      |     |     |     |

HCM 2010 Signalized Intersection Summary Cumulative with Eastside Parkway with Project, PM  
 27: Reservation Road & Watkins Gate Road

06/11/2019



| Movement                     | EBL  | EBR  | NBL  | NBT   | SBT  | SBR  |   |       |
|------------------------------|------|------|------|-------|------|------|---|-------|
| Lane Configurations          |      |      |      |       |      |      |   |       |
| Traffic Volume (veh/h)       | 10   | 220  | 210  | 1310  | 2280 | 60   |   |       |
| Future Volume (veh/h)        | 10   | 220  | 210  | 1310  | 2280 | 60   |   |       |
| Number                       | 5    | 12   | 3    | 8     | 4    | 14   |   |       |
| Initial Q (Qb), veh          | 0    | 0    | 0    | 0     | 0    | 0    |   |       |
| Ped-Bike Adj(A_pbT)          | 1.00 | 1.00 | 1.00 |       |      | 1.00 |   |       |
| Parking Bus, Adj             | 1.00 | 1.00 | 1.00 | 1.00  | 1.00 | 1.00 |   |       |
| Adj Sat Flow, veh/h/ln       | 1863 | 1863 | 1881 | 1881  | 1863 | 1900 |   |       |
| Adj Flow Rate, veh/h         | 11   | 32   | 228  | 1424  | 2478 | 62   |   |       |
| Adj No. of Lanes             | 1    | 1    | 1    | 2     | 2    | 0    |   |       |
| Peak Hour Factor             | 0.92 | 0.92 | 0.92 | 0.92  | 0.92 | 0.92 |   |       |
| Percent Heavy Veh, %         | 2    | 2    | 1    | 1     | 2    | 2    |   |       |
| Cap, veh/h                   | 53   | 47   | 242  | 3119  | 2498 | 62   |   |       |
| Arrive On Green              | 0.03 | 0.03 | 0.13 | 0.87  | 0.71 | 0.71 |   |       |
| Sat Flow, veh/h              | 1774 | 1583 | 1792 | 3668  | 3622 | 88   |   |       |
| Grp Volume(v), veh/h         | 11   | 32   | 228  | 1424  | 1237 | 1303 |   |       |
| Grp Sat Flow(s),veh/h/ln     | 1774 | 1583 | 1792 | 1787  | 1770 | 1847 |   |       |
| Q Serve(g_s), s              | 0.8  | 2.7  | 16.8 | 11.2  | 90.6 | 93.2 |   |       |
| Cycle Q Clear(g_c), s        | 0.8  | 2.7  | 16.8 | 11.2  | 90.6 | 93.2 |   |       |
| Prop In Lane                 | 1.00 | 1.00 | 1.00 |       |      | 0.05 |   |       |
| Lane Grp Cap(c), veh/h       | 53   | 47   | 242  | 3119  | 1253 | 1308 |   |       |
| V/C Ratio(X)                 | 0.21 | 0.68 | 0.94 | 0.46  | 0.99 | 1.00 |   |       |
| Avail Cap(c_a), veh/h        | 272  | 243  | 242  | 3119  | 1253 | 1308 |   |       |
| HCM Platoon Ratio            | 1.00 | 1.00 | 1.00 | 1.00  | 1.00 | 1.00 |   |       |
| Upstream Filter(I)           | 1.00 | 1.00 | 1.00 | 1.00  | 1.00 | 1.00 |   |       |
| Uniform Delay (d), s/veh     | 63.2 | 64.1 | 57.2 | 1.8   | 18.9 | 19.3 |   |       |
| Incr Delay (d2), s/veh       | 0.7  | 6.1  | 42.1 | 0.2   | 22.5 | 23.9 |   |       |
| Initial Q Delay(d3),s/veh    | 0.0  | 0.0  | 0.0  | 0.0   | 0.0  | 0.0  |   |       |
| %ile BackOfQ(50%),veh/ln     | 0.4  | 1.2  | 11.2 | 5.4   | 51.5 | 55.4 |   |       |
| LnGrp Delay(d),s/veh         | 63.9 | 70.2 | 99.3 | 2.0   | 41.4 | 43.2 |   |       |
| LnGrp LOS                    | E    | E    | F    | A     | D    | D    |   |       |
| Approach Vol, veh/h          | 43   |      |      | 1652  | 2540 |      |   |       |
| Approach Delay, s/veh        | 68.6 |      |      | 15.4  | 42.3 |      |   |       |
| Approach LOS                 | E    |      |      | B     | D    |      |   |       |
| Timer                        | 1    | 2    | 3    | 4     | 5    | 6    | 7 | 8     |
| Assigned Phs                 |      | 2    | 3    | 4     |      |      |   | 8     |
| Phs Duration (G+Y+Rc), s     |      | 10.5 | 22.0 | 101.0 |      |      |   | 123.0 |
| Change Period (Y+Rc), s      |      | 6.5  | 4.0  | 6.5   |      |      |   | 6.5   |
| Max Green Setting (Gmax), s  |      | 20.5 | 18.0 | 94.5  |      |      |   | 116.5 |
| Max Q Clear Time (g_c+I1), s |      | 4.7  | 18.8 | 95.2  |      |      |   | 13.2  |
| Green Ext Time (p_c), s      |      | 0.0  | 0.0  | 0.0   |      |      |   | 27.0  |
| <b>Intersection Summary</b>  |      |      |      |       |      |      |   |       |
| HCM 2010 Ctrl Delay          |      |      | 32.1 |       |      |      |   |       |
| HCM 2010 LOS                 |      |      | C    |       |      |      |   |       |

HCM 2010 Signalized Intersection Summary Cumulative with Eastside Parkway with Project, PM  
 28: Davis Road & Reservation Road

06/11/2019



| Movement                      | EBL    | EBT  | EBR  | WBL  | WBT   | WBR  | NBL  | NBT  | NBR  | SBL  | SBT  | SBR  |
|-------------------------------|--------|------|------|------|-------|------|------|------|------|------|------|------|
| Lane Configurations           |        |      |      |      |       |      |      |      |      |      |      |      |
| Traffic Volume (veh/h)        | 1410   | 520  | 10   | 10   | 370   | 100  | 10   | 10   | 10   | 120  | 10   | 830  |
| Future Volume (veh/h)         | 1410   | 520  | 10   | 10   | 370   | 100  | 10   | 10   | 10   | 120  | 10   | 830  |
| Number                        | 5      | 2    | 12   | 1    | 6     | 16   | 3    | 8    | 18   | 7    | 4    | 14   |
| Initial Q (Qb), veh           | 0      | 0    | 0    | 0    | 0     | 0    | 0    | 0    | 0    | 0    | 0    | 0    |
| Ped-Bike Adj(A_pbT)           | 1.00   |      | 1.00 | 1.00 |       | 1.00 | 1.00 |      | 1.00 | 1.00 |      | 1.00 |
| Parking Bus, Adj              | 1.00   | 1.00 | 1.00 | 1.00 | 1.00  | 1.00 | 1.00 | 1.00 | 1.00 | 1.00 | 1.00 | 1.00 |
| Adj Sat Flow, veh/h/ln        | 1863   | 1863 | 1900 | 1827 | 1834  | 1900 | 1900 | 1900 | 1900 | 1900 | 1881 | 1881 |
| Adj Flow Rate, veh/h          | 1500   | 553  | 11   | 11   | 394   | 106  | 11   | 11   | 9    | 128  | 11   | 748  |
| Adj No. of Lanes              | 1      | 2    | 0    | 1    | 1     | 0    | 0    | 1    | 0    | 0    | 1    | 1    |
| Peak Hour Factor              | 0.94   | 0.94 | 0.94 | 0.94 | 0.94  | 0.94 | 0.94 | 0.94 | 0.94 | 0.94 | 0.94 | 0.94 |
| Percent Heavy Veh, %          | 2      | 2    | 2    | 4    | 4     | 4    | 0    | 0    | 0    | 1    | 1    | 1    |
| Cap, veh/h                    | 445    | 1996 | 40   | 18   | 450   | 121  | 17   | 17   | 14   | 415  | 36   | 802  |
| Arrive On Green               | 0.25   | 0.56 | 0.56 | 0.01 | 0.32  | 0.32 | 0.03 | 0.03 | 0.03 | 0.25 | 0.25 | 0.25 |
| Sat Flow, veh/h               | 1774   | 3549 | 71   | 1740 | 1393  | 375  | 631  | 631  | 516  | 1656 | 142  | 1599 |
| Grp Volume(v), veh/h          | 1500   | 276  | 288  | 11   | 0     | 500  | 31   | 0    | 0    | 139  | 0    | 748  |
| Grp Sat Flow(s),veh/h/ln      | 1774   | 1770 | 1850 | 1740 | 0     | 1768 | 1777 | 0    | 0    | 1798 | 0    | 1599 |
| Q Serve(g_s), s               | 30.0   | 9.7  | 9.7  | 0.8  | 0.0   | 31.9 | 2.1  | 0.0  | 0.0  | 7.5  | 0.0  | 30.0 |
| Cycle Q Clear(g_c), s         | 30.0   | 9.7  | 9.7  | 0.8  | 0.0   | 31.9 | 2.1  | 0.0  | 0.0  | 7.5  | 0.0  | 30.0 |
| Prop In Lane                  | 1.00   |      | 0.04 | 1.00 |       | 0.21 | 0.35 |      | 0.29 | 0.92 |      | 1.00 |
| Lane Grp Cap(c), veh/h        | 445    | 995  | 1041 | 18   | 0     | 571  | 48   | 0    | 0    | 451  | 0    | 802  |
| V/C Ratio(X)                  | 3.37   | 0.28 | 0.28 | 0.62 | 0.00  | 0.88 | 0.65 | 0.00 | 0.00 | 0.31 | 0.00 | 0.93 |
| Avail Cap(c_a), veh/h         | 445    | 995  | 1041 | 436  | 0     | 887  | 446  | 0    | 0    | 451  | 0    | 802  |
| HCM Platoon Ratio             | 1.00   | 1.00 | 1.00 | 1.00 | 1.00  | 1.00 | 1.00 | 1.00 | 1.00 | 1.00 | 1.00 | 1.00 |
| Upstream Filter(I)            | 1.00   | 1.00 | 1.00 | 1.00 | 0.00  | 1.00 | 1.00 | 0.00 | 0.00 | 1.00 | 0.00 | 1.00 |
| Uniform Delay (d), s/veh      | 44.8   | 13.6 | 13.6 | 59.0 | 0.0   | 38.2 | 57.6 | 0.0  | 0.0  | 36.4 | 0.0  | 27.9 |
| Incr Delay (d2), s/veh        | 1072.9 | 0.2  | 0.2  | 12.2 | 0.0   | 8.3  | 5.4  | 0.0  | 0.0  | 0.1  | 0.0  | 17.3 |
| Initial Q Delay(d3),s/veh     | 0.0    | 0.0  | 0.0  | 0.0  | 0.0   | 0.0  | 0.0  | 0.0  | 0.0  | 0.0  | 0.0  | 0.0  |
| %ile BackOfQ(50%),veh/ln      | 17.2   | 4.7  | 5.0  | 0.4  | 0.0   | 16.9 | 1.1  | 0.0  | 0.0  | 3.8  | 0.0  | 26.8 |
| LnGrp Delay(d),s/veh          | 1117.7 | 13.8 | 13.8 | 71.2 | 0.0   | 46.5 | 63.0 | 0.0  | 0.0  | 36.5 | 0.0  | 45.2 |
| LnGrp LOS                     | F      | B    | B    | E    |       | D    | E    |      |      | D    |      | D    |
| Approach Vol, veh/h           | 2064   |      |      | 511  |       |      | 31   |      |      | 887  |      |      |
| Approach Delay, s/veh         | 816.1  |      |      | 47.1 |       |      | 63.0 |      |      | 43.9 |      |      |
| Approach LOS                  | F      |      |      | D    |       |      | E    |      |      | D    |      |      |
| Timer                         | 1      | 2    | 3    | 4    | 5     | 6    | 7    | 8    |      |      |      |      |
| Assigned Phs                  | 1      | 2    |      | 4    | 5     | 6    |      | 8    |      |      |      |      |
| Phs Duration (G+Y+Rc), s      | 5.1    | 72.3 |      | 35.0 | 33.8  | 43.6 |      | 7.2  |      |      |      |      |
| Change Period (Y+Rc), s       | 3.9    | 5.0  |      | 5.0  | * 3.8 | 5.0  |      | 4.0  |      |      |      |      |
| Max Green Setting (Gmax), s   | 30     | 60.0 |      | 30.0 | * 30  | 60.0 |      | 30.0 |      |      |      |      |
| Max Q Clear Time (g_c+1/2), s | 11.7   | 11.7 |      | 32.0 | 32.0  | 33.9 |      | 4.1  |      |      |      |      |
| Green Ext Time (p_c), s       | 0.0    | 5.3  |      | 0.0  | 0.0   | 4.7  |      | 0.0  |      |      |      |      |
| <b>Intersection Summary</b>   |        |      |      |      |       |      |      |      |      |      |      |      |
| HCM 2010 Ctrl Delay           | 500.8  |      |      |      |       |      |      |      |      |      |      |      |
| HCM 2010 LOS                  | F      |      |      |      |       |      |      |      |      |      |      |      |
| <b>Notes</b>                  |        |      |      |      |       |      |      |      |      |      |      |      |

HCM 2010 Signalized Intersection Summary Cumulative with Eastside Parkway with Project, PM  
 29: 2nd Avenue & Divarty Street

06/11/2019



| Movement                     | EBL  | EBT  | EBR  | WBL  | WBT  | WBR  | NBL  | NBT  | NBR  | SBL  | SBT  | SBR  |
|------------------------------|------|------|------|------|------|------|------|------|------|------|------|------|
| Lane Configurations          |      | ↕    |      |      | ↕    | ↕    | ↕    | ↕    |      | ↕    | ↕    |      |
| Traffic Volume (veh/h)       | 200  | 10   | 80   | 150  | 10   | 30   | 40   | 610  | 110  | 30   | 460  | 100  |
| Future Volume (veh/h)        | 200  | 10   | 80   | 150  | 10   | 30   | 40   | 610  | 110  | 30   | 460  | 100  |
| Number                       | 5    | 2    | 12   | 1    | 6    | 16   | 3    | 8    | 18   | 7    | 4    | 14   |
| Initial Q (Qb), veh          | 0    | 0    | 0    | 0    | 0    | 0    | 0    | 0    | 0    | 0    | 0    | 0    |
| Ped-Bike Adj(A_pbT)          | 1.00 |      | 1.00 | 1.00 |      | 1.00 | 1.00 |      | 0.99 | 1.00 |      | 0.99 |
| Parking Bus, Adj             | 1.00 | 1.00 | 1.00 | 1.00 | 1.00 | 1.00 | 1.00 | 1.00 | 1.00 | 1.00 | 1.00 | 1.00 |
| Adj Sat Flow, veh/h/ln       | 1900 | 1900 | 1900 | 1900 | 1900 | 1900 | 1900 | 1900 | 1900 | 1881 | 1881 | 1900 |
| Adj Flow Rate, veh/h         | 213  | 11   | 85   | 160  | 11   | 32   | 43   | 649  | 117  | 32   | 489  | 106  |
| Adj No. of Lanes             | 0    | 1    | 0    | 0    | 1    | 1    | 1    | 2    | 0    | 1    | 2    | 0    |
| Peak Hour Factor             | 0.94 | 0.94 | 0.94 | 0.94 | 0.94 | 0.94 | 0.94 | 0.94 | 0.94 | 0.94 | 0.94 | 0.94 |
| Percent Heavy Veh, %         | 0    | 0    | 0    | 0    | 0    | 0    | 0    | 0    | 0    | 1    | 1    | 1    |
| Cap, veh/h                   | 387  | 38   | 114  | 587  | 36   | 569  | 82   | 1018 | 183  | 65   | 947  | 204  |
| Arrive On Green              | 0.35 | 0.35 | 0.35 | 0.35 | 0.35 | 0.35 | 0.05 | 0.33 | 0.33 | 0.04 | 0.32 | 0.32 |
| Sat Flow, veh/h              | 740  | 107  | 321  | 1255 | 101  | 1608 | 1810 | 3054 | 550  | 1792 | 2923 | 630  |
| Grp Volume(v), veh/h         | 309  | 0    | 0    | 171  | 0    | 32   | 43   | 383  | 383  | 32   | 298  | 297  |
| Grp Sat Flow(s),veh/h/ln     | 1168 | 0    | 0    | 1356 | 0    | 1608 | 1810 | 1805 | 1799 | 1792 | 1787 | 1765 |
| Q Serve(g_s), s              | 8.3  | 0.0  | 0.0  | 0.0  | 0.0  | 0.6  | 1.1  | 8.8  | 8.8  | 0.9  | 6.6  | 6.7  |
| Cycle Q Clear(g_c), s        | 12.8 | 0.0  | 0.0  | 4.5  | 0.0  | 0.6  | 1.1  | 8.8  | 8.8  | 0.9  | 6.6  | 6.7  |
| Prop In Lane                 | 0.69 |      | 0.28 | 0.94 |      | 1.00 | 1.00 |      | 0.31 | 1.00 |      | 0.36 |
| Lane Grp Cap(c), veh/h       | 538  | 0    | 0    | 623  | 0    | 569  | 82   | 601  | 599  | 65   | 579  | 572  |
| V/C Ratio(X)                 | 0.57 | 0.00 | 0.00 | 0.27 | 0.00 | 0.06 | 0.52 | 0.64 | 0.64 | 0.50 | 0.51 | 0.52 |
| Avail Cap(c_a), veh/h        | 1066 | 0    | 0    | 1112 | 0    | 1155 | 427  | 1481 | 1476 | 423  | 1283 | 1267 |
| HCM Platoon Ratio            | 1.00 | 1.00 | 1.00 | 1.00 | 1.00 | 1.00 | 1.00 | 1.00 | 1.00 | 1.00 | 1.00 | 1.00 |
| Upstream Filter(I)           | 1.00 | 0.00 | 0.00 | 1.00 | 0.00 | 1.00 | 1.00 | 1.00 | 1.00 | 1.00 | 1.00 | 1.00 |
| Uniform Delay (d), s/veh     | 15.5 | 0.0  | 0.0  | 11.6 | 0.0  | 10.4 | 22.8 | 13.8 | 13.8 | 23.1 | 13.4 | 13.4 |
| Incr Delay (d2), s/veh       | 1.0  | 0.0  | 0.0  | 0.2  | 0.0  | 0.0  | 5.1  | 1.1  | 1.1  | 5.8  | 0.7  | 0.7  |
| Initial Q Delay(d3),s/veh    | 0.0  | 0.0  | 0.0  | 0.0  | 0.0  | 0.0  | 0.0  | 0.0  | 0.0  | 0.0  | 0.0  | 0.0  |
| %ile BackOfQ(50%),veh/ln     | 3.9  | 0.0  | 0.0  | 1.7  | 0.0  | 0.3  | 0.7  | 4.6  | 4.5  | 0.5  | 3.3  | 3.3  |
| LnGrp Delay(d),s/veh         | 16.4 | 0.0  | 0.0  | 11.8 | 0.0  | 10.4 | 27.9 | 14.9 | 14.9 | 28.8 | 14.1 | 14.1 |
| LnGrp LOS                    | B    |      |      | B    |      | B    | C    | B    | B    | C    | B    | B    |
| Approach Vol, veh/h          |      | 309  |      |      | 203  |      |      | 809  |      |      | 627  |      |
| Approach Delay, s/veh        |      | 16.4 |      |      | 11.6 |      |      | 15.6 |      |      | 14.9 |      |
| Approach LOS                 |      | B    |      |      | B    |      |      | B    |      |      | B    |      |
| Timer                        | 1    | 2    | 3    | 4    | 5    | 6    | 7    | 8    |      |      |      |      |
| Assigned Phs                 |      | 2    | 3    | 4    |      | 6    | 7    | 8    |      |      |      |      |
| Phs Duration (G+Y+Rc), s     |      | 22.3 | 5.7  | 20.8 |      | 22.3 | 5.3  | 21.2 |      |      |      |      |
| Change Period (Y+Rc), s      |      | 5.0  | 3.5  | 5.0  |      | 5.0  | 3.5  | 5.0  |      |      |      |      |
| Max Green Setting (Gmax), s  |      | 35.0 | 11.5 | 35.0 |      | 35.0 | 11.5 | 40.0 |      |      |      |      |
| Max Q Clear Time (g_c+I1), s |      | 14.8 | 3.1  | 8.7  |      | 6.5  | 2.9  | 10.8 |      |      |      |      |
| Green Ext Time (p_c), s      |      | 1.8  | 0.0  | 3.7  |      | 1.1  | 0.0  | 5.1  |      |      |      |      |
| <b>Intersection Summary</b>  |      |      |      |      |      |      |      |      |      |      |      |      |
| HCM 2010 Ctrl Delay          |      |      |      | 15.1 |      |      |      |      |      |      |      |      |
| HCM 2010 LOS                 |      |      |      | B    |      |      |      |      |      |      |      |      |

| Intersection              |    |
|---------------------------|----|
| Intersection Delay, s/veh | 10 |
| Intersection LOS          | A  |

| Movement            | EBL  | EBT  | EBR  | WBL  | WBT  | WBR  | NBL  | NBT  | NBR  | SBL  | SBT  | SBR  |
|---------------------|------|------|------|------|------|------|------|------|------|------|------|------|
| Lane Configurations |      | ↕    |      |      | ↕    |      | ↕    | ↕    |      | ↕    | ↕    |      |
| Traffic Vol, veh/h  | 20   | 10   | 40   | 10   | 10   | 10   | 30   | 180  | 10   | 10   | 220  | 20   |
| Future Vol, veh/h   | 20   | 10   | 40   | 10   | 10   | 10   | 30   | 180  | 10   | 10   | 220  | 20   |
| Peak Hour Factor    | 0.85 | 0.85 | 0.85 | 0.85 | 0.85 | 0.85 | 0.85 | 0.85 | 0.85 | 0.85 | 0.85 | 0.85 |
| Heavy Vehicles, %   | 0    | 0    | 0    | 1    | 1    | 1    | 0    | 0    | 0    | 1    | 1    | 1    |
| Mvmt Flow           | 24   | 12   | 47   | 12   | 12   | 12   | 35   | 212  | 12   | 12   | 259  | 24   |
| Number of Lanes     | 0    | 1    | 0    | 0    | 1    | 0    | 1    | 1    | 0    | 1    | 1    | 0    |

| Approach                   | EB  | WB  | NB  | SB   |
|----------------------------|-----|-----|-----|------|
| Opposing Approach          | WB  | EB  | SB  | NB   |
| Opposing Lanes             | 1   | 1   | 2   | 2    |
| Conflicting Approach Left  | SB  | NB  | EB  | WB   |
| Conflicting Lanes Left     | 2   | 2   | 1   | 1    |
| Conflicting Approach Right | NB  | SB  | WB  | EB   |
| Conflicting Lanes Right    | 2   | 2   | 1   | 1    |
| HCM Control Delay          | 8.7 | 8.6 | 9.8 | 10.8 |
| HCM LOS                    | A   | A   | A   | B    |

| Lane                   | NBLn1 | NBLn2 | EBLn1 | WBLn1 | SBLn1 | SBLn2 |
|------------------------|-------|-------|-------|-------|-------|-------|
| Vol Left, %            | 100%  | 0%    | 29%   | 33%   | 100%  | 0%    |
| Vol Thru, %            | 0%    | 95%   | 14%   | 33%   | 0%    | 92%   |
| Vol Right, %           | 0%    | 5%    | 57%   | 33%   | 0%    | 8%    |
| Sign Control           | Stop  | Stop  | Stop  | Stop  | Stop  | Stop  |
| Traffic Vol by Lane    | 30    | 190   | 70    | 30    | 10    | 240   |
| LT Vol                 | 30    | 0     | 20    | 10    | 10    | 0     |
| Through Vol            | 0     | 180   | 10    | 10    | 0     | 220   |
| RT Vol                 | 0     | 10    | 40    | 10    | 0     | 20    |
| Lane Flow Rate         | 35    | 224   | 82    | 35    | 12    | 282   |
| Geometry Grp           | 7     | 7     | 2     | 2     | 7     | 7     |
| Degree of Util (X)     | 0.054 | 0.311 | 0.114 | 0.051 | 0.018 | 0.391 |
| Departure Headway (Hd) | 5.554 | 5.014 | 4.978 | 5.223 | 5.548 | 4.986 |
| Convergence, Y/N       | Yes   | Yes   | Yes   | Yes   | Yes   | Yes   |
| Cap                    | 644   | 715   | 717   | 682   | 645   | 720   |
| Service Time           | 3.295 | 2.754 | 3.027 | 3.28  | 3.287 | 2.725 |
| HCM Lane V/C Ratio     | 0.054 | 0.313 | 0.114 | 0.051 | 0.019 | 0.392 |
| HCM Control Delay      | 8.6   | 10    | 8.7   | 8.6   | 8.4   | 10.9  |
| HCM Lane LOS           | A     | A     | A     | A     | A     | B     |
| HCM 95th-tile Q        | 0.2   | 1.3   | 0.4   | 0.2   | 0.1   | 1.9   |

HCM 2010 Signalized Intersection Summary Cumulative with Eastside Parkway with Project, PM  
 31: 1st Avenue & Lightfighter Drive

06/11/2019



| Movement                     | EBL  | EBT  | EBR  | WBL  | WBT  | WBR  | NBL  | NBT  | NBR  | SBL  | SBT  | SBR  |
|------------------------------|------|------|------|------|------|------|------|------|------|------|------|------|
| Lane Configurations          |      | ↑↑   | ↑    | ↑    | ↑↑   |      | ↑    |      | ↑    | ↑    | ↑    | ↑    |
| Traffic Volume (veh/h)       | 0    | 1250 | 110  | 20   | 1560 | 0    | 200  | 0    | 30   | 60   | 50   | 80   |
| Future Volume (veh/h)        | 0    | 1250 | 110  | 20   | 1560 | 0    | 200  | 0    | 30   | 60   | 50   | 80   |
| Number                       | 7    | 4    | 14   | 3    | 8    | 18   | 5    | 2    | 12   | 1    | 6    | 16   |
| Initial Q (Qb), veh          | 0    | 0    | 0    | 0    | 0    | 0    | 0    | 0    | 0    | 0    | 0    | 0    |
| Ped-Bike Adj(A_pbT)          | 1.00 |      | 1.00 | 1.00 |      | 1.00 | 1.00 |      | 1.00 | 1.00 |      | 1.00 |
| Parking Bus, Adj             | 1.00 | 1.00 | 1.00 | 1.00 | 1.00 | 1.00 | 1.00 | 1.00 | 1.00 | 1.00 | 1.00 | 1.00 |
| Adj Sat Flow, veh/h/ln       | 0    | 1881 | 1881 | 1881 | 1881 | 0    | 1881 | 0    | 1881 | 1810 | 1810 | 1810 |
| Adj Flow Rate, veh/h         | 0    | 1316 | 0    | 21   | 1642 | 0    | 211  | 0    | 14   | 63   | 53   | 64   |
| Adj No. of Lanes             | 0    | 2    | 1    | 1    | 2    | 0    | 1    | 0    | 1    | 1    | 1    | 1    |
| Peak Hour Factor             | 0.95 | 0.95 | 0.95 | 0.95 | 0.95 | 0.95 | 0.95 | 0.95 | 0.95 | 0.95 | 0.95 | 0.95 |
| Percent Heavy Veh, %         | 0    | 1    | 1    | 1    | 1    | 0    | 1    | 0    | 1    | 5    | 5    | 5    |
| Cap, veh/h                   | 0    | 2274 | 1017 | 23   | 2586 | 0    | 0    | 0    | 0    | 139  | 146  | 124  |
| Arrive On Green              | 0.00 | 0.64 | 0.00 | 0.01 | 0.72 | 0.00 | 0.00 | 0.00 | 0.00 | 0.08 | 0.08 | 0.08 |
| Sat Flow, veh/h              | 0    | 3668 | 1599 | 1792 | 3668 | 0    |      | 0    |      | 1723 | 1810 | 1538 |
| Grp Volume(v), veh/h         | 0    | 1316 | 0    | 21   | 1642 | 0    |      | 0.0  |      | 63   | 53   | 64   |
| Grp Sat Flow(s),veh/h/ln     | 0    | 1787 | 1599 | 1792 | 1787 | 0    |      |      |      | 1723 | 1810 | 1538 |
| Q Serve(g_s), s              | 0.0  | 10.0 | 0.0  | 0.6  | 11.0 | 0.0  |      |      |      | 1.6  | 1.3  | 1.9  |
| Cycle Q Clear(g_c), s        | 0.0  | 10.0 | 0.0  | 0.6  | 11.0 | 0.0  |      |      |      | 1.6  | 1.3  | 1.9  |
| Prop In Lane                 | 0.00 |      | 1.00 | 1.00 |      | 0.00 |      |      |      | 1.00 |      | 1.00 |
| Lane Grp Cap(c), veh/h       | 0    | 2274 | 1017 | 23   | 2586 | 0    |      |      |      | 139  | 146  | 124  |
| V/C Ratio(X)                 | 0.00 | 0.58 | 0.00 | 0.90 | 0.63 | 0.00 |      |      |      | 0.45 | 0.36 | 0.52 |
| Avail Cap(c_a), veh/h        | 0    | 3420 | 1530 | 762  | 3420 | 0    |      |      |      | 916  | 962  | 818  |
| HCM Platoon Ratio            | 1.00 | 1.00 | 1.00 | 1.00 | 1.00 | 1.00 |      |      |      | 1.00 | 1.00 | 1.00 |
| Upstream Filter(I)           | 0.00 | 1.00 | 0.00 | 1.00 | 1.00 | 0.00 |      |      |      | 1.00 | 1.00 | 1.00 |
| Uniform Delay (d), s/veh     | 0.0  | 4.9  | 0.0  | 23.2 | 3.3  | 0.0  |      |      |      | 20.6 | 20.5 | 20.7 |
| Incr Delay (d2), s/veh       | 0.0  | 0.3  | 0.0  | 31.9 | 0.4  | 0.0  |      |      |      | 0.9  | 0.6  | 1.2  |
| Initial Q Delay(d3),s/veh    | 0.0  | 0.0  | 0.0  | 0.0  | 0.0  | 0.0  |      |      |      | 0.0  | 0.0  | 0.0  |
| %ile BackOfQ(50%),veh/lr0.0  | 0.0  | 4.9  | 0.0  | 0.5  | 5.4  | 0.0  |      |      |      | 0.8  | 0.7  | 0.8  |
| LnGrp Delay(d),s/veh         | 0.0  | 5.3  | 0.0  | 55.1 | 3.7  | 0.0  |      |      |      | 21.5 | 21.0 | 22.0 |
| LnGrp LOS                    |      | A    |      | E    | A    |      |      |      |      | C    | C    | C    |
| Approach Vol, veh/h          |      | 1316 |      |      | 1663 |      |      |      |      |      | 180  |      |
| Approach Delay, s/veh        |      | 5.3  |      |      | 4.3  |      |      |      |      |      | 21.5 |      |
| Approach LOS                 |      | A    |      |      | A    |      |      |      |      |      | C    |      |
| Timer                        | 1    | 2    | 3    | 4    | 5    | 6    | 7    | 8    |      |      |      |      |
| Assigned Phs                 |      |      | 3    | 4    |      | 6    |      | 8    |      |      |      |      |
| Phs Duration (G+Y+Rc), s     |      |      | 4.1  | 34.5 |      | 8.4  |      | 38.6 |      |      |      |      |
| Change Period (Y+Rc), s      |      |      | 3.5  | 4.6  |      | 4.6  |      | 4.6  |      |      |      |      |
| Max Green Setting (Gmax), s  |      |      | 20.0 | 45.0 |      | 25.0 |      | 45.0 |      |      |      |      |
| Max Q Clear Time (g_c+I1), s |      |      | 2.6  | 12.0 |      | 3.9  |      | 13.0 |      |      |      |      |
| Green Ext Time (p_c), s      |      |      | 0.0  | 17.4 |      | 0.3  |      | 21.0 |      |      |      |      |
| <b>Intersection Summary</b>  |      |      |      |      |      |      |      |      |      |      |      |      |
| HCM 2010 Ctrl Delay          |      |      | 5.7  |      |      |      |      |      |      |      |      |      |
| HCM 2010 LOS                 |      |      | A    |      |      |      |      |      |      |      |      |      |

HCM 2010 Signalized Intersection Summary Cumulative with Eastside Parkway with Project, PM  
 32: 2nd Avenue & Lightfighter Drive 06/11/2019



| Movement                     | EBL   | EBT  | EBR  | WBL  | WBT  | WBR  | NBL  | NBT  | NBR  | SBL  | SBT  | SBR  |
|------------------------------|-------|------|------|------|------|------|------|------|------|------|------|------|
| Lane Configurations          |       |      |      |      |      |      |      |      |      |      |      |      |
| Traffic Volume (veh/h)       | 290   | 1050 | 10   | 80   | 1290 | 220  | 20   | 20   | 50   | 220  | 30   | 330  |
| Future Volume (veh/h)        | 290   | 1050 | 10   | 80   | 1290 | 220  | 20   | 20   | 50   | 220  | 30   | 330  |
| Number                       | 5     | 2    | 12   | 1    | 6    | 16   | 3    | 8    | 18   | 7    | 4    | 14   |
| Initial Q (Qb), veh          | 0     | 0    | 0    | 0    | 0    | 0    | 0    | 0    | 0    | 0    | 0    | 0    |
| Ped-Bike Adj(A_pbT)          | 1.00  |      | 1.00 | 1.00 |      | 1.00 | 1.00 |      | 0.99 | 1.00 |      | 0.99 |
| Parking Bus, Adj             | 1.00  | 1.00 | 1.00 | 1.00 | 1.00 | 1.00 | 1.00 | 1.00 | 1.00 | 1.00 | 1.00 | 1.00 |
| Adj Sat Flow, veh/h/ln       | 1881  | 1881 | 1900 | 1881 | 1881 | 1900 | 1900 | 1900 | 1900 | 1845 | 1845 | 1845 |
| Adj Flow Rate, veh/h         | 305   | 1105 | 11   | 84   | 1358 | 227  | 21   | 21   | 47   | 232  | 32   | 244  |
| Adj No. of Lanes             | 1     | 2    | 0    | 1    | 2    | 0    | 0    | 1    | 0    | 1    | 1    | 1    |
| Peak Hour Factor             | 0.95  | 0.95 | 0.95 | 0.95 | 0.95 | 0.95 | 0.95 | 0.95 | 0.95 | 0.95 | 0.95 | 0.95 |
| Percent Heavy Veh, %         | 1     | 1    | 1    | 1    | 1    | 1    | 0    | 0    | 0    | 3    | 3    | 3    |
| Cap, veh/h                   | 222   | 2218 | 22   | 108  | 1682 | 278  | 93   | 97   | 163  | 340  | 362  | 306  |
| Arrive On Green              | 0.12  | 0.61 | 0.61 | 0.06 | 0.55 | 0.55 | 0.20 | 0.20 | 0.20 | 0.20 | 0.20 | 0.20 |
| Sat Flow, veh/h              | 1792  | 3626 | 36   | 1792 | 3070 | 508  | 246  | 497  | 831  | 1308 | 1845 | 1558 |
| Grp Volume(v), veh/h         | 305   | 545  | 571  | 84   | 784  | 801  | 89   | 0    | 0    | 232  | 32   | 244  |
| Grp Sat Flow(s),veh/h/ln     | 1792  | 1787 | 1875 | 1792 | 1787 | 1791 | 1574 | 0    | 0    | 1308 | 1845 | 1558 |
| Q Serve(g_s), s              | 12.4  | 17.0 | 17.0 | 4.6  | 35.4 | 36.6 | 0.0  | 0.0  | 0.0  | 12.0 | 1.4  | 14.9 |
| Cycle Q Clear(g_c), s        | 12.4  | 17.0 | 17.0 | 4.6  | 35.4 | 36.6 | 4.4  | 0.0  | 0.0  | 16.3 | 1.4  | 14.9 |
| Prop In Lane                 | 1.00  |      | 0.02 | 1.00 |      | 0.28 | 0.24 |      | 0.53 | 1.00 |      | 1.00 |
| Lane Grp Cap(c), veh/h       | 222   | 1093 | 1147 | 108  | 979  | 981  | 354  | 0    | 0    | 340  | 362  | 306  |
| V/C Ratio(X)                 | 1.37  | 0.50 | 0.50 | 0.78 | 0.80 | 0.82 | 0.25 | 0.00 | 0.00 | 0.68 | 0.09 | 0.80 |
| Avail Cap(c_a), veh/h        | 222   | 1093 | 1147 | 222  | 979  | 981  | 666  | 0    | 0    | 611  | 745  | 630  |
| HCM Platoon Ratio            | 1.00  | 1.00 | 1.00 | 1.00 | 1.00 | 1.00 | 1.00 | 1.00 | 1.00 | 1.00 | 1.00 | 1.00 |
| Upstream Filter(I)           | 0.70  | 0.70 | 0.70 | 0.09 | 0.09 | 0.09 | 1.00 | 0.00 | 0.00 | 0.86 | 0.86 | 0.86 |
| Uniform Delay (d), s/veh     | 43.8  | 10.8 | 10.8 | 46.4 | 18.2 | 18.5 | 34.0 | 0.0  | 0.0  | 38.6 | 32.9 | 38.3 |
| Incr Delay (d2), s/veh       | 186.6 | 1.1  | 1.1  | 0.4  | 0.7  | 0.7  | 0.1  | 0.0  | 0.0  | 0.8  | 0.0  | 1.6  |
| Initial Q Delay(d3),s/veh    | 0.0   | 0.0  | 0.0  | 0.0  | 0.0  | 0.0  | 0.0  | 0.0  | 0.0  | 0.0  | 0.0  | 0.0  |
| %ile BackOfQ(50%),veh/ln     | 7.6   | 8.7  | 9.1  | 2.3  | 17.4 | 18.2 | 2.1  | 0.0  | 0.0  | 6.3  | 0.7  | 6.5  |
| LnGrp Delay(d),s/veh         | 230.4 | 12.0 | 11.9 | 46.8 | 18.9 | 19.2 | 34.2 | 0.0  | 0.0  | 39.4 | 32.9 | 39.9 |
| LnGrp LOS                    | F     | B    | B    | D    | B    | B    | C    |      |      | D    | C    | D    |
| Approach Vol, veh/h          |       | 1421 |      |      | 1669 |      |      | 89   |      |      | 508  |      |
| Approach Delay, s/veh        |       | 58.8 |      |      | 20.5 |      |      | 34.2 |      |      | 39.2 |      |
| Approach LOS                 |       | E    |      |      | C    |      |      | C    |      |      | D    |      |
| Timer                        | 1     | 2    | 3    | 4    | 5    | 6    | 7    | 8    |      |      |      |      |
| Assigned Phs                 | 1     | 2    |      | 4    | 5    | 6    |      | 8    |      |      |      |      |
| Phs Duration (G+Y+Rc), s     | 0.0   | 65.8 |      | 24.2 | 16.4 | 59.4 |      | 24.2 |      |      |      |      |
| Change Period (Y+Rc), s      | 4.0   | 4.6  |      | 4.6  | 4.0  | 4.6  |      | 4.6  |      |      |      |      |
| Max Green Setting (Gmax), s  | 2.4   | 34.0 |      | 40.4 | 12.4 | 24.4 |      | 40.4 |      |      |      |      |
| Max Q Clear Time (g_c+10), s | 6.6   | 19.0 |      | 18.3 | 14.4 | 38.6 |      | 6.4  |      |      |      |      |
| Green Ext Time (p_c), s      | 0.0   | 4.0  |      | 0.9  | 0.0  | 0.0  |      | 0.3  |      |      |      |      |
| <b>Intersection Summary</b>  |       |      |      |      |      |      |      |      |      |      |      |      |
| HCM 2010 Ctrl Delay          |       |      |      | 38.2 |      |      |      |      |      |      |      |      |
| HCM 2010 LOS                 |       |      |      | D    |      |      |      |      |      |      |      |      |



HCM 2010 Signalized Intersection Summary Cumulative with Eastside Parkway with Project, PM  
 33: General Jim Moore Boulevard & Lightfighter Drive

06/11/2019



| Movement                    | EBL  | EBT  | EBR  | WBL  | WBT  | WBR  | NBL  | NBT  | NBR  | SBL  | SBT  | SBR  |
|-----------------------------|------|------|------|------|------|------|------|------|------|------|------|------|
| Lane Configurations         |      |      |      |      |      |      |      |      |      |      |      |      |
| Traffic Volume (veh/h)      | 50   | 230  | 940  | 40   | 240  | 50   | 750  | 60   | 20   | 60   | 100  | 40   |
| Future Volume (veh/h)       | 50   | 230  | 940  | 40   | 240  | 50   | 750  | 60   | 20   | 60   | 100  | 40   |
| Number                      | 3    | 8    | 18   | 7    | 4    | 14   | 1    | 6    | 16   | 5    | 2    | 12   |
| Initial Q (Qb), veh         | 0    | 0    | 0    | 0    | 0    | 0    | 0    | 0    | 0    | 0    | 0    | 0    |
| Ped-Bike Adj(A_pbT)         | 1.00 |      | 1.00 | 1.00 |      | 1.00 | 1.00 |      | 1.00 | 1.00 |      | 1.00 |
| Parking Bus, Adj            | 1.00 | 1.00 | 1.00 | 1.00 | 1.00 | 1.00 | 1.00 | 1.00 | 1.00 | 1.00 | 1.00 | 1.00 |
| Adj Sat Flow, veh/h/ln      | 1881 | 1881 | 1881 | 1900 | 1900 | 1900 | 1881 | 1881 | 1900 | 1900 | 1900 | 1900 |
| Adj Flow Rate, veh/h        | 52   | 240  | 0    | 42   | 250  | 51   | 781  | 62   | 19   | 62   | 104  | -70  |
| Adj No. of Lanes            | 1    | 1    | 1    | 1    | 1    | 0    | 2    | 1    | 0    | 1    | 2    | 0    |
| Peak Hour Factor            | 0.96 | 0.96 | 0.96 | 0.96 | 0.96 | 0.96 | 0.96 | 0.96 | 0.96 | 0.96 | 0.96 | 0.96 |
| Percent Heavy Veh, %        | 1    | 1    | 1    | 0    | 0    | 0    | 1    | 1    | 1    | 0    | 0    | 0    |
| Cap, veh/h                  | 75   | 458  | 389  | 65   | 364  | 74   | 737  | 404  | 124  | 85   | 459  | 0    |
| Arrive On Green             | 0.04 | 0.24 | 0.00 | 0.04 | 0.24 | 0.24 | 0.21 | 0.29 | 0.29 | 0.05 | 0.13 | 0.00 |
| Sat Flow, veh/h             | 1792 | 1881 | 1599 | 1810 | 1532 | 313  | 3476 | 1383 | 424  | 1810 | 3705 | 0    |
| Grp Volume(v), veh/h        | 52   | 240  | 0    | 42   | 0    | 301  | 781  | 0    | 81   | 62   | 34   | 0    |
| Grp Sat Flow(s),veh/h/ln    | 1792 | 1881 | 1599 | 1810 | 0    | 1845 | 1738 | 0    | 1806 | 1810 | 1805 | 0    |
| Q Serve(g_s), s             | 1.4  | 5.2  | 0.0  | 1.1  | 0.0  | 7.0  | 10.0 | 0.0  | 1.6  | 1.6  | 0.4  | 0.0  |
| Cycle Q Clear(g_c), s       | 1.4  | 5.2  | 0.0  | 1.1  | 0.0  | 7.0  | 10.0 | 0.0  | 1.6  | 1.6  | 0.4  | 0.0  |
| Prop In Lane                | 1.00 |      | 1.00 | 1.00 |      | 0.17 | 1.00 |      | 0.23 | 1.00 |      | 0.00 |
| Lane Grp Cap(c), veh/h      | 75   | 458  | 389  | 65   | 0    | 438  | 737  | 0    | 527  | 85   | 459  | 0    |
| V/C Ratio(X)                | 0.69 | 0.52 | 0.00 | 0.65 | 0.00 | 0.69 | 1.06 | 0.00 | 0.15 | 0.73 | 0.07 | 0.00 |
| Avail Cap(c_a), veh/h       | 759  | 1196 | 1017 | 767  | 0    | 1173 | 737  | 0    | 1149 | 575  | 2296 | 0    |
| HCM Platoon Ratio           | 1.00 | 1.00 | 1.00 | 1.00 | 1.00 | 1.00 | 1.00 | 1.00 | 1.00 | 1.00 | 1.00 | 1.00 |
| Upstream Filter(I)          | 1.00 | 1.00 | 0.00 | 1.00 | 0.00 | 1.00 | 1.00 | 0.00 | 1.00 | 1.00 | 1.00 | 0.00 |
| Uniform Delay (d), s/veh    | 22.3 | 15.5 | 0.0  | 22.4 | 0.0  | 16.4 | 18.6 | 0.0  | 12.4 | 22.2 | 18.1 | 0.0  |
| Incr Delay (d2), s/veh      | 10.8 | 1.1  | 0.0  | 4.0  | 0.0  | 2.3  | 50.3 | 0.0  | 0.3  | 4.3  | 0.1  | 0.0  |
| Initial Q Delay(d3),s/veh   | 0.0  | 0.0  | 0.0  | 0.0  | 0.0  | 0.0  | 0.0  | 0.0  | 0.0  | 0.0  | 0.0  | 0.0  |
| %ile BackOfQ(50%),veh/ln    | 0.9  | 2.8  | 0.0  | 0.6  | 0.0  | 3.8  | 9.8  | 0.0  | 0.8  | 0.9  | 0.2  | 0.0  |
| LnGrp Delay(d),s/veh        | 33.1 | 16.6 | 0.0  | 26.4 | 0.0  | 18.7 | 68.8 | 0.0  | 12.7 | 26.5 | 18.2 | 0.0  |
| LnGrp LOS                   | C    | B    |      | C    |      | B    | F    |      | B    | C    | B    |      |
| Approach Vol, veh/h         |      | 292  |      |      | 343  |      |      | 862  |      |      | 96   |      |
| Approach Delay, s/veh       |      | 19.5 |      |      | 19.7 |      |      | 63.6 |      |      | 23.6 |      |
| Approach LOS                |      | B    |      |      | B    |      |      | E    |      |      | C    |      |
| Timer                       | 1    | 2    | 3    | 4    | 5    | 6    | 7    | 8    |      |      |      |      |
| Assigned Phs                | 1    | 2    | 3    | 4    | 5    | 6    | 7    | 8    |      |      |      |      |
| Phs Duration (G+Y+Rc), s    | 4.5  | 10.5 | 6.5  | 15.7 | 6.7  | 18.3 | 6.2  | 16.0 |      |      |      |      |
| Change Period (Y+Rc), s     | 4.5  | 4.5  | 4.5  | 4.5  | 4.5  | 4.5  | 4.5  | 4.5  |      |      |      |      |
| Max Green Setting (Gmax), s | 30.0 | 30.0 | 20.0 | 30.0 | 15.0 | 30.0 | 20.0 | 30.0 |      |      |      |      |
| Max Q Clear Time (g_c+1), s | 2.4  | 3.4  | 3.4  | 9.0  | 3.6  | 3.6  | 3.1  | 7.2  |      |      |      |      |
| Green Ext Time (p_c), s     | 0.0  | 0.1  | 0.1  | 2.2  | 0.0  | 0.7  | 0.0  | 1.5  |      |      |      |      |
| <b>Intersection Summary</b> |      |      |      |      |      |      |      |      |      |      |      |      |
| HCM 2010 Ctrl Delay         |      |      | 43.6 |      |      |      |      |      |      |      |      |      |
| HCM 2010 LOS                |      |      | D    |      |      |      |      |      |      |      |      |      |

**Intersection**

Intersection Delay, s/veh 10.9  
 Intersection LOS B

| Movement            | WBL  | WBR  | NBT  | NBR  | SBL  | SBT  |
|---------------------|------|------|------|------|------|------|
| Lane Configurations |      |      |      |      |      |      |
| Traffic Vol, veh/h  | 10   | 240  | 90   | 10   | 240  | 70   |
| Future Vol, veh/h   | 10   | 240  | 90   | 10   | 240  | 70   |
| Peak Hour Factor    | 0.88 | 0.88 | 0.88 | 0.88 | 0.88 | 0.88 |
| Heavy Vehicles, %   | 0    | 0    | 2    | 2    | 1    | 1    |
| Mvmt Flow           | 11   | 273  | 102  | 11   | 273  | 80   |
| Number of Lanes     | 1    | 0    | 1    | 0    | 0    | 1    |

| Approach                      | WB  | NB | SB   |
|-------------------------------|-----|----|------|
| Opposing Approach             |     | SB | NB   |
| Opposing Lanes                | 0   | 1  | 1    |
| Conflicting Approach Left NB  |     |    | WB   |
| Conflicting Lanes Left        | 1   | 0  | 1    |
| Conflicting Approach Right SB |     | WB |      |
| Conflicting Lanes Right       | 1   | 1  | 0    |
| HCM Control Delay             | 9.9 | 9  | 12.3 |
| HCM LOS                       | A   | A  | B    |

| Lane                   | NBLn1 | WBLn1 | SBLn1 |
|------------------------|-------|-------|-------|
| Vol Left, %            | 0%    | 4%    | 77%   |
| Vol Thru, %            | 90%   | 0%    | 23%   |
| Vol Right, %           | 10%   | 96%   | 0%    |
| Sign Control           | Stop  | Stop  | Stop  |
| Traffic Vol by Lane    | 100   | 250   | 310   |
| LT Vol                 | 0     | 10    | 240   |
| Through Vol            | 90    | 0     | 70    |
| RT Vol                 | 10    | 240   | 0     |
| Lane Flow Rate         | 114   | 284   | 352   |
| Geometry Grp           | 1     | 1     | 1     |
| Degree of Util (X)     | 0.157 | 0.352 | 0.475 |
| Departure Headway (Hd) | 4.959 | 4.46  | 4.857 |
| Convergence, Y/N       | Yes   | Yes   | Yes   |
| Cap                    | 717   | 801   | 736   |
| Service Time           | 3.035 | 2.51  | 2.922 |
| HCM Lane V/C Ratio     | 0.159 | 0.355 | 0.478 |
| HCM Control Delay      | 9     | 9.9   | 12.3  |
| HCM Lane LOS           | A     | A     | B     |
| HCM 95th-tile Q        | 0.6   | 1.6   | 2.6   |

| Intersection             |      |      |      |      |      |      |
|--------------------------|------|------|------|------|------|------|
| Int Delay, s/veh         | 1.7  |      |      |      |      |      |
| Movement                 | EBT  | EBR  | WBL  | WBT  | NBL  | NBR  |
| Lane Configurations      |      |      |      |      |      |      |
| Traffic Vol, veh/h       | 210  | 40   | 30   | 220  | 30   | 30   |
| Future Vol, veh/h        | 210  | 40   | 30   | 220  | 30   | 30   |
| Conflicting Peds, #/hr   | 0    | 0    | 0    | 0    | 0    | 0    |
| Sign Control             | Free | Free | Free | Free | Stop | Stop |
| RT Channelized           | -    | None | -    | None | -    | None |
| Storage Length           | -    | -    | -    | -    | 0    | -    |
| Veh in Median Storage, # | 0    | -    | -    | 0    | 0    | -    |
| Grade, %                 | 0    | -    | -    | 0    | 0    | -    |
| Peak Hour Factor         | 85   | 85   | 85   | 85   | 85   | 85   |
| Heavy Vehicles, %        | 0    | 0    | 0    | 0    | 0    | 0    |
| Mvmt Flow                | 247  | 47   | 35   | 259  | 35   | 35   |

| Major/Minor          | Major1 | Major2 | Minor1 | Minor2 | Minor3 |
|----------------------|--------|--------|--------|--------|--------|
| Conflicting Flow All | 0      | 0      | 294    | 0      | 600    |
| Stage 1              | -      | -      | -      | -      | 271    |
| Stage 2              | -      | -      | -      | -      | 329    |
| Critical Hdwy        | -      | -      | 4.1    | -      | 6.4    |
| Critical Hdwy Stg 1  | -      | -      | -      | -      | 5.4    |
| Critical Hdwy Stg 2  | -      | -      | -      | -      | 5.4    |
| Follow-up Hdwy       | -      | -      | 2.2    | -      | 3.5    |
| Pot Cap-1 Maneuver   | -      | -      | 1279   | -      | 467    |
| Stage 1              | -      | -      | -      | -      | 779    |
| Stage 2              | -      | -      | -      | -      | 734    |
| Platoon blocked, %   | -      | -      | -      | -      | -      |
| Mov Cap-1 Maneuver   | -      | -      | 1279   | -      | 452    |
| Mov Cap-2 Maneuver   | -      | -      | -      | -      | 452    |
| Stage 1              | -      | -      | -      | -      | 754    |
| Stage 2              | -      | -      | -      | -      | 734    |

| Approach             | EB | WB  | NB   |
|----------------------|----|-----|------|
| HCM Control Delay, s | 0  | 0.9 | 12.2 |
| HCM LOS              |    |     | B    |

| Minor Lane/Major Mvmt | NBLn1 | EBT | EBR | WBL   | WBT |
|-----------------------|-------|-----|-----|-------|-----|
| Capacity (veh/h)      | 570   | -   | -   | 1279  | -   |
| HCM Lane V/C Ratio    | 0.124 | -   | -   | 0.028 | -   |
| HCM Control Delay (s) | 12.2  | -   | -   | 7.9   | 0   |
| HCM Lane LOS          | B     | -   | -   | A     | A   |
| HCM 95th %tile Q(veh) | 0.4   | -   | -   | 0.1   | -   |

| Intersection              |      |
|---------------------------|------|
| Intersection Delay, s/veh | 12.3 |
| Intersection LOS          | B    |

| Movement            | EBL  | EBT  | EBR  | WBL  | WBT  | WBR  | NBL  | NBT  | NBR  | SBL  | SBT  | SBR  |
|---------------------|------|------|------|------|------|------|------|------|------|------|------|------|
| Lane Configurations |      | ↕    |      |      | ↕    |      |      | ↕    |      |      | ↕    |      |
| Traffic Vol, veh/h  | 10   | 170  | 60   | 30   | 180  | 10   | 50   | 100  | 20   | 10   | 130  | 30   |
| Future Vol, veh/h   | 10   | 170  | 60   | 30   | 180  | 10   | 50   | 100  | 20   | 10   | 130  | 30   |
| Peak Hour Factor    | 0.82 | 0.82 | 0.82 | 0.82 | 0.82 | 0.82 | 0.82 | 0.82 | 0.82 | 0.82 | 0.82 | 0.82 |
| Heavy Vehicles, %   | 0    | 0    | 0    | 0    | 0    | 0    | 2    | 2    | 2    | 0    | 0    | 0    |
| Mvmt Flow           | 12   | 207  | 73   | 37   | 220  | 12   | 61   | 122  | 24   | 12   | 159  | 37   |
| Number of Lanes     | 0    | 1    | 0    | 0    | 1    | 0    | 0    | 1    | 0    | 0    | 1    | 0    |

| Approach                   | EB   | WB   | NB   | SB   |
|----------------------------|------|------|------|------|
| Opposing Approach          | WB   | EB   | SB   | NB   |
| Opposing Lanes             | 1    | 1    | 1    | 1    |
| Conflicting Approach Left  | SB   | NB   | EB   | WB   |
| Conflicting Lanes Left     | 1    | 1    | 1    | 1    |
| Conflicting Approach Right | NB   | SB   | WB   | EB   |
| Conflicting Lanes Right    | 1    | 1    | 1    | 1    |
| HCM Control Delay          | 12.8 | 12.7 | 11.9 | 11.7 |
| HCM LOS                    | B    | B    | B    | B    |

| Lane                   | NBLn1 | EBLn1 | WBLn1 | SBLn1 |
|------------------------|-------|-------|-------|-------|
| Vol Left, %            | 29%   | 4%    | 14%   | 6%    |
| Vol Thru, %            | 59%   | 71%   | 82%   | 76%   |
| Vol Right, %           | 12%   | 25%   | 5%    | 18%   |
| Sign Control           | Stop  | Stop  | Stop  | Stop  |
| Traffic Vol by Lane    | 170   | 240   | 220   | 170   |
| LT Vol                 | 50    | 10    | 30    | 10    |
| Through Vol            | 100   | 170   | 180   | 130   |
| RT Vol                 | 20    | 60    | 10    | 30    |
| Lane Flow Rate         | 207   | 293   | 268   | 207   |
| Geometry Grp           | 1     | 1     | 1     | 1     |
| Degree of Util (X)     | 0.338 | 0.442 | 0.418 | 0.332 |
| Departure Headway (Hd) | 5.866 | 5.439 | 5.611 | 5.757 |
| Convergence, Y/N       | Yes   | Yes   | Yes   | Yes   |
| Cap                    | 610   | 659   | 639   | 620   |
| Service Time           | 3.941 | 3.507 | 3.681 | 3.83  |
| HCM Lane V/C Ratio     | 0.339 | 0.445 | 0.419 | 0.334 |
| HCM Control Delay      | 11.9  | 12.8  | 12.7  | 11.7  |
| HCM Lane LOS           | B     | B     | B     | B     |
| HCM 95th-tile Q        | 1.5   | 2.3   | 2.1   | 1.5   |

| Intersection             |      |      |      |      |      |      |      |      |      |      |      |      |
|--------------------------|------|------|------|------|------|------|------|------|------|------|------|------|
| Int Delay, s/veh         | 12.4 |      |      |      |      |      |      |      |      |      |      |      |
| Movement                 | EBL  | EBT  | EBR  | WBL  | WBT  | WBR  | NBL  | NBT  | NBR  | SBL  | SBT  | SBR  |
| Lane Configurations      |      | ↕    |      |      | ↕    |      |      | ↕    |      |      | ↕    |      |
| Traffic Vol, veh/h       | 60   | 90   | 50   | 30   | 80   | 10   | 90   | 120  | 20   | 0    | 0    | 0    |
| Future Vol, veh/h        | 60   | 90   | 50   | 30   | 80   | 10   | 90   | 120  | 20   | 0    | 0    | 0    |
| Conflicting Peds, #/hr   | 0    | 0    | 0    | 0    | 0    | 0    | 0    | 0    | 0    | 0    | 0    | 0    |
| Sign Control             | Stop | Stop | Stop | Stop | Stop | Stop | Free | Free | Free | Free | Free | Free |
| RT Channelized           | -    | -    | None | -    | -    | None | -    | -    | None | -    | -    | None |
| Storage Length           | -    | -    | -    | -    | -    | -    | -    | -    | -    | -    | -    | -    |
| Veh in Median Storage, # | -    | 0    | -    | -    | 0    | -    | -    | 0    | -    | -    | 0    | -    |
| Grade, %                 | -    | 0    | -    | -    | 0    | -    | -    | 0    | -    | -    | 0    | -    |
| Peak Hour Factor         | 74   | 74   | 74   | 74   | 74   | 74   | 74   | 74   | 74   | 74   | 74   | 74   |
| Heavy Vehicles, %        | 3    | 3    | 3    | 2    | 2    | 2    | 3    | 3    | 3    | 8    | 8    | 8    |
| Mvmt Flow                | 81   | 122  | 68   | 41   | 108  | 14   | 122  | 162  | 27   | 0    | 0    | 0    |

| Major/Minor          | Minor2 |       | Minor1 |       | Major1 |       |       | Major2 |   |       |   |   |
|----------------------|--------|-------|--------|-------|--------|-------|-------|--------|---|-------|---|---|
| Conflicting Flow All | 482    | 434   | 1      | 516   | 421    | 176   | 1     | 0      | 0 | 189   | 0 | 0 |
| Stage 1              | 1      | 1     | -      | 420   | 420    | -     | -     | -      | - | -     | - | - |
| Stage 2              | 481    | 433   | -      | 96    | 1      | -     | -     | -      | - | -     | - | - |
| Critical Hdwy        | 7.13   | 6.53  | 6.23   | 7.12  | 6.52   | 6.22  | 4.13  | -      | - | 4.18  | - | - |
| Critical Hdwy Stg 1  | 6.13   | 5.53  | -      | 6.12  | 5.52   | -     | -     | -      | - | -     | - | - |
| Critical Hdwy Stg 2  | 6.13   | 5.53  | -      | 6.12  | 5.52   | -     | -     | -      | - | -     | - | - |
| Follow-up Hdwy       | 3.527  | 4.027 | 3.327  | 3.518 | 4.018  | 3.318 | 2.227 | -      | - | 2.272 | - | - |
| Pot Cap-1 Maneuver   | 493    | 514   | 1081   | 470   | 524    | 867   | 1615  | -      | - | 1350  | - | - |
| Stage 1              | 1019   | 893   | -      | 611   | 589    | -     | -     | -      | - | -     | - | - |
| Stage 2              | 564    | 580   | -      | 911   | 895    | -     | -     | -      | - | -     | - | - |
| Platoon blocked, %   |        |       |        |       |        |       |       | -      | - | -     | - | - |
| Mov Cap-1 Maneuver   | 376    | 470   | 1081   | 331   | 479    | 867   | 1615  | -      | - | 1350  | - | - |
| Mov Cap-2 Maneuver   | 376    | 470   | -      | 331   | 479    | -     | -     | -      | - | -     | - | - |
| Stage 1              | 932    | 893   | -      | 559   | 539    | -     | -     | -      | - | -     | - | - |
| Stage 2              | 406    | 531   | -      | 738   | 895    | -     | -     | -      | - | -     | - | - |

| Approach             | EB   |  | WB   |  | NB  |  | SB |  |
|----------------------|------|--|------|--|-----|--|----|--|
| HCM Control Delay, s | 20.2 |  | 17.6 |  | 2.9 |  | 0  |  |
| HCM LOS              | C    |  | C    |  |     |  |    |  |

| Minor Lane/Major Mvmt | NBL   | NBT | NBR | EBLn1 | WBLn1 | SBL  | SBT | SBR |
|-----------------------|-------|-----|-----|-------|-------|------|-----|-----|
| Capacity (veh/h)      | 1615  | -   | -   | 503   | 446   | 1350 | -   | -   |
| HCM Lane V/C Ratio    | 0.075 | -   | -   | 0.537 | 0.364 | -    | -   | -   |
| HCM Control Delay (s) | 7.4   | 0   | -   | 20.2  | 17.6  | 0    | -   | -   |
| HCM Lane LOS          | A     | A   | -   | C     | C     | A    | -   | -   |
| HCM 95th %tile Q(veh) | 0.2   | -   | -   | 3.1   | 1.6   | 0    | -   | -   |

| Intersection             |      |      |      |      |      |      |
|--------------------------|------|------|------|------|------|------|
| Int Delay, s/veh         | 2.9  |      |      |      |      |      |
| Movement                 | EBL  | EBR  | NBL  | NBT  | SBT  | SBR  |
| Lane Configurations      | T    |      |      | T    |      | T    |
| Traffic Vol, veh/h       | 110  | 10   | 10   | 280  | 290  | 110  |
| Future Vol, veh/h        | 110  | 10   | 10   | 280  | 290  | 110  |
| Conflicting Peds, #/hr   | 0    | 0    | 0    | 0    | 0    | 0    |
| Sign Control             | Stop | Stop | Free | Free | Free | Free |
| RT Channelized           | -    | None | -    | None | -    | None |
| Storage Length           | 0    | -    | -    | -    | -    | -    |
| Veh in Median Storage, # | 0    | -    | -    | 0    | 0    | -    |
| Grade, %                 | 0    | -    | -    | 0    | 0    | -    |
| Peak Hour Factor         | 88   | 88   | 88   | 88   | 88   | 88   |
| Heavy Vehicles, %        | 0    | 0    | 2    | 2    | 1    | 1    |
| Mvmt Flow                | 125  | 11   | 11   | 318  | 330  | 125  |























| Major/Minor          | Minor2 | Major1 |       | Major2 |   |
|----------------------|--------|--------|-------|--------|---|
| Conflicting Flow All | 733    | 393    | 455   | 0      | 0 |
| Stage 1              | 393    | -      | -     | -      | - |
| Stage 2              | 340    | -      | -     | -      | - |
| Critical Hdwy        | 6.4    | 6.2    | 4.12  | -      | - |
| Critical Hdwy Stg 1  | 5.4    | -      | -     | -      | - |
| Critical Hdwy Stg 2  | 5.4    | -      | -     | -      | - |
| Follow-up Hdwy       | 3.5    | 3.3    | 2.218 | -      | - |
| Pot Cap-1 Maneuver   | 391    | 660    | 1106  | -      | - |
| Stage 1              | 686    | -      | -     | -      | - |
| Stage 2              | 725    | -      | -     | -      | - |
| Platoon blocked, %   |        |        |       | -      | - |
| Mov Cap-1 Maneuver   | 386    | 660    | 1106  | -      | - |
| Mov Cap-2 Maneuver   | 386    | -      | -     | -      | - |
| Stage 1              | 678    | -      | -     | -      | - |
| Stage 2              | 725    | -      | -     | -      | - |

| Approach             | EB   | NB  | SB |
|----------------------|------|-----|----|
| HCM Control Delay, s | 18.6 | 0.3 | 0  |
| HCM LOS              | C    |     |    |

| Minor Lane/Major Mvmt | NBL  | NBT | EBLn1 | SBT | SBR |
|-----------------------|------|-----|-------|-----|-----|
| Capacity (veh/h)      | 1106 | -   | 400   | -   | -   |
| HCM Lane V/C Ratio    | 0.01 | -   | 0.341 | -   | -   |
| HCM Control Delay (s) | 8.3  | 0   | 18.6  | -   | -   |
| HCM Lane LOS          | A    | A   | C     | -   | -   |
| HCM 95th %tile Q(veh) | 0    | -   | 1.5   | -   | -   |

HCM 2010 Signalized Intersection Summary Cumulative with Eastside Parkway with Project, PM  
 39: General Jim Moore Boulevard & Gigling Road

06/11/2019

|                              |  |  |  |  |  |  |  |  |  |  |  |  |
|------------------------------|---|---|---|---|---|---|---|---|---|---|---|---|
| Movement                     | EBL   | EBT   | EBR   | WBL   | WBT   | WBR   | NBL   | NBT   | NBR   | SBL   | SBT   | SBR   |
| Lane Configurations          |  |  |   |  |  |  |  |  |  |  |  |  |
| Traffic Volume (veh/h)       | 20  | 20  | 30  | 270   | 50  | 530   | 60  | 260   | 430   | 750   | 250   | 50  |
| Future Volume (veh/h)        | 20  | 20  | 30  | 270   | 50  | 530   | 60  | 260   | 430   | 750   | 250   | 50  |
| Number                       | 3   | 8   | 18  | 7   | 4   | 14  | 1   | 6   | 16  | 5   | 2   | 12  |
| Initial Q (Qb), veh          | 0   | 0   | 0   | 0   | 0   | 0   | 0   | 0   | 0   | 0   | 0   | 0   |
| Ped-Bike Adj(A_pbT)          | 1.00  |   | 0.99  | 1.00  |   | 1.00  | 1.00  |   | 1.00  | 1.00  |   | 1.00  |
| Parking Bus, Adj             | 1.00  | 1.00  | 1.00  | 1.00  | 1.00  | 1.00  | 1.00  | 1.00  | 1.00  | 1.00  | 1.00  | 1.00  |
| Adj Sat Flow, veh/h/ln       | 1776  | 1776  | 1900  | 1881  | 1881  | 1881  | 1863  | 1863  | 1863  | 1863  | 1863  | 1863  |
| Adj Flow Rate, veh/h         | 22  | 22  | 3   | 303   | 56  | 0   | 67  | 292   | 0   | 843   | 281   | 0   |
| Adj No. of Lanes             | 1   | 2   | 0   | 1   | 2   | 1   | 1   | 2   | 1   | 1   | 2   | 1   |
| Peak Hour Factor             | 0.89  | 0.89  | 0.89  | 0.89  | 0.89  | 0.89  | 0.89  | 0.89  | 0.89  | 0.89  | 0.89  | 0.89  |
| Percent Heavy Veh, %         | 7   | 7   | 7   | 1   | 1   | 1   | 2   | 2   | 2   | 2   | 2   | 2   |
| Cap, veh/h                   | 45  | 263   | 35  | 360   | 939   | 420   | 108   | 476   | 213   | 377   | 1013  | 453   |
| Arrive On Green              | 0.03  | 0.09  | 0.09  | 0.20  | 0.26  | 0.00  | 0.06  | 0.13  | 0.00  | 0.21  | 0.29  | 0.00  |
| Sat Flow, veh/h              | 1691  | 2991  | 399   | 1792  | 3574  | 1599  | 1774  | 3539  | 1583  | 1774  | 3539  | 1583  |
| Grp Volume(v), veh/h         | 22  | 12  | 13  | 303   | 56  | 0   | 67  | 292   | 0   | 843   | 281   | 0   |
| Grp Sat Flow(s),veh/h/ln     | 1691  | 1687  | 1703  | 1792  | 1787  | 1599  | 1774  | 1770  | 1583  | 1774  | 1770  | 1583  |
| Q Serve(g_s), s              | 0.6   | 0.3   | 0.3   | 8.0   | 0.6   | 0.0   | 1.8   | 3.8   | 0.0   | 10.5  | 3.0   | 0.0   |
| Cycle Q Clear(g_c), s        | 0.6   | 0.3   | 0.3   | 8.0   | 0.6   | 0.0   | 1.8   | 3.8   | 0.0   | 10.5  | 3.0   | 0.0   |
| Prop In Lane                 | 1.00  |   | 0.23  | 1.00  |   | 1.00  | 1.00  |   | 1.00  | 1.00  |   | 1.00  |
| Lane Grp Cap(c), veh/h       | 45  | 148   | 150   | 360   | 939   | 420   | 108   | 476   | 213   | 377   | 1013  | 453   |
| V/C Ratio(X)                 | 0.49  | 0.08  | 0.09  | 0.84  | 0.06  | 0.00  | 0.62  | 0.61  | 0.00  | 2.24  | 0.28  | 0.00  |
| Avail Cap(c_a), veh/h        | 701   | 1041  | 1050  | 743   | 2205  | 986   | 377   | 1825  | 817   | 377   | 1825  | 817   |
| HCM Platoon Ratio            | 1.00  | 1.00  | 1.00  | 1.00  | 1.00  | 1.00  | 1.00  | 1.00  | 1.00  | 1.00  | 1.00  | 1.00  |
| Upstream Filter(I)           | 1.00  | 1.00  | 1.00  | 1.00  | 1.00  | 0.00  | 1.00  | 1.00  | 0.00  | 1.00  | 1.00  | 0.00  |
| Uniform Delay (d), s/veh     | 23.7  | 20.7  | 20.7  | 19.0  | 13.7  | 0.0   | 22.7  | 20.2  | 0.0   | 19.5  | 13.7  | 0.0   |
| Incr Delay (d2), s/veh       | 3.1   | 0.1   | 0.1   | 2.1   | 0.0   | 0.0   | 2.2   | 0.5   | 0.0   | 565.3   | 0.1   | 0.0   |
| Initial Q Delay(d3),s/veh    | 0.0   | 0.0   | 0.0   | 0.0   | 0.0   | 0.0   | 0.0   | 0.0   | 0.0   | 0.0   | 0.0   | 0.0   |
| %ile BackOfQ(50%),veh/ln     | 0.3   | 0.2   | 0.2   | 4.2   | 0.3   | 0.0   | 1.0   | 1.9   | 0.0   | 64.2  | 1.5   | 0.0   |
| LnGrp Delay(d),s/veh         | 26.8  | 20.8  | 20.8  | 21.0  | 13.7  | 0.0   | 24.8  | 20.7  | 0.0   | 584.8   | 13.7  | 0.0   |
| LnGrp LOS                    | C   | C   | C   | C   | B   |   | C   | C   |   | F   | B   |   |
| Approach Vol, veh/h          |   | 47  |   |   | 359   |   |   | 359   |   |   | 1124  |   |
| Approach Delay, s/veh        |   | 23.6  |   |   | 19.9  |   |   | 21.4  |   |   | 442.0   |   |
| Approach LOS                 |   | C   |   |   | B   |   |   | C   |   |   | F   |   |
| Timer                        | 1   | 2   | 3   | 4   | 5   | 6   | 7   | 8   |   |   |   |   |
| Assigned Phs                 | 1   | 2   | 3   | 4   | 5   | 6   | 7   | 8   |   |   |   |   |
| Phs Duration (G+Y+Rc), s     | 7.5   | 18.6  | 5.8   | 17.5  | 15.0  | 11.2  | 14.4  | 8.8   |   |   |   |   |
| Change Period (Y+Rc), s      | 4.5   | 4.5   | 4.5   | 4.5   | 4.5   | 4.5   | 4.5   | 4.5   |   |   |   |   |
| Max Green Setting (Gmax), s  | 10.5  | 25.5  | 20.5  | 30.5  | 10.5  | 25.5  | 20.5  | 30.5  |   |   |   |   |
| Max Q Clear Time (g_c+I1), s | 3.8   | 5.0   | 2.6   | 2.6   | 12.5  | 5.8   | 10.0  | 2.3   |   |   |   |   |
| Green Ext Time (p_c), s      | 0.0   | 0.3   | 0.0   | 0.1   | 0.0   | 0.3   | 0.1   | 0.0   |   |   |   |   |
| <b>Intersection Summary</b>  |   |   |   |   |   |   |   |   |   |   |   |   |
| HCM 2010 Ctrl Delay          |   |   |   | 271.5   |   |   |   |   |   |   |   |   |
| HCM 2010 LOS                 |   |   |   | F   |   |   |   |   |   |   |   |   |
| <b>Notes</b>                 |   |   |   |   |   |   |   |   |   |   |   |   |

HCM 2010 Signalized Intersection Summary Cumulative with Eastside Parkway with Project, PM  
 40: Malmedy Road & Gigling Road

06/11/2019



| Movement                     | EBL  | EBT  | EBR  | WBL  | WBT  | WBR  | NBL  | NBT  | NBR  | SBL  | SBT  | SBR  |
|------------------------------|------|------|------|------|------|------|------|------|------|------|------|------|
| Lane Configurations          |      | ↕↕   |      |      | ↕↕   |      |      | ↕    |      |      | ↕    |      |
| Traffic Volume (veh/h)       | 10   | 1180 | 10   | 30   | 820  | 30   | 30   | 60   | 50   | 30   | 40   | 10   |
| Future Volume (veh/h)        | 10   | 1180 | 10   | 30   | 820  | 30   | 30   | 60   | 50   | 30   | 40   | 10   |
| Number                       | 7    | 4    | 14   | 3    | 8    | 18   | 5    | 2    | 12   | 1    | 6    | 16   |
| Initial Q (Qb), veh          | 0    | 0    | 0    | 0    | 0    | 0    | 0    | 0    | 0    | 0    | 0    | 0    |
| Ped-Bike Adj(A_pbT)          | 1.00 |      | 1.00 | 1.00 |      | 1.00 | 1.00 |      | 1.00 | 1.00 |      | 1.00 |
| Parking Bus, Adj             | 1.00 | 1.00 | 1.00 | 1.00 | 1.00 | 1.00 | 1.00 | 1.00 | 1.00 | 1.00 | 1.00 | 1.00 |
| Adj Sat Flow, veh/h/ln       | 1900 | 1863 | 1900 | 1900 | 1881 | 1900 | 1900 | 1900 | 1900 | 1900 | 1810 | 1900 |
| Adj Flow Rate, veh/h         | 11   | 1297 | 11   | 33   | 901  | 33   | 33   | 66   | 55   | 33   | 44   | 11   |
| Adj No. of Lanes             | 0    | 2    | 0    | 0    | 2    | 0    | 0    | 1    | 0    | 0    | 1    | 0    |
| Peak Hour Factor             | 0.91 | 0.91 | 0.91 | 0.91 | 0.91 | 0.91 | 0.91 | 0.91 | 0.91 | 0.91 | 0.91 | 0.91 |
| Percent Heavy Veh, %         | 2    | 2    | 2    | 1    | 1    | 1    | 0    | 0    | 0    | 5    | 5    | 5    |
| Cap, veh/h                   | 153  | 1642 | 14   | 172  | 1459 | 55   | 224  | 133  | 100  | 278  | 159  | 34   |
| Arrive On Green              | 0.47 | 0.47 | 0.47 | 0.47 | 0.47 | 0.47 | 0.16 | 0.16 | 0.16 | 0.16 | 0.16 | 0.16 |
| Sat Flow, veh/h              | 9    | 3496 | 30   | 34   | 3107 | 117  | 280  | 811  | 606  | 469  | 966  | 205  |
| Grp Volume(v), veh/h         | 690  | 0    | 629  | 492  | 0    | 475  | 154  | 0    | 0    | 88   | 0    | 0    |
| Grp Sat Flow(s),veh/h/ln     | 1844 | 0    | 1690 | 1567 | 0    | 1691 | 1697 | 0    | 0    | 1640 | 0    | 0    |
| Q Serve(g_s), s              | 0.0  | 0.0  | 7.7  | 0.6  | 0.0  | 5.1  | 0.9  | 0.0  | 0.0  | 0.0  | 0.0  | 0.0  |
| Cycle Q Clear(g_c), s        | 7.7  | 0.0  | 7.7  | 8.3  | 0.0  | 5.1  | 2.0  | 0.0  | 0.0  | 1.1  | 0.0  | 0.0  |
| Prop In Lane                 | 0.02 |      | 0.02 | 0.07 |      | 0.07 | 0.21 |      | 0.36 | 0.37 |      | 0.12 |
| Lane Grp Cap(c), veh/h       | 1015 | 0    | 794  | 892  | 0    | 794  | 457  | 0    | 0    | 471  | 0    | 0    |
| V/C Ratio(X)                 | 0.68 | 0.00 | 0.79 | 0.55 | 0.00 | 0.60 | 0.34 | 0.00 | 0.00 | 0.19 | 0.00 | 0.00 |
| Avail Cap(c_a), veh/h        | 3868 | 0    | 3469 | 3312 | 0    | 3472 | 2240 | 0    | 0    | 2094 | 0    | 0    |
| HCM Platoon Ratio            | 1.00 | 1.00 | 1.00 | 1.00 | 1.00 | 1.00 | 1.00 | 1.00 | 1.00 | 1.00 | 1.00 | 1.00 |
| Upstream Filter(I)           | 1.00 | 0.00 | 1.00 | 1.00 | 0.00 | 1.00 | 1.00 | 0.00 | 0.00 | 1.00 | 0.00 | 0.00 |
| Uniform Delay (d), s/veh     | 5.5  | 0.0  | 5.5  | 4.7  | 0.0  | 4.8  | 9.4  | 0.0  | 0.0  | 9.0  | 0.0  | 0.0  |
| Incr Delay (d2), s/veh       | 0.3  | 0.0  | 0.7  | 0.2  | 0.0  | 0.3  | 0.2  | 0.0  | 0.0  | 0.1  | 0.0  | 0.0  |
| Initial Q Delay(d3),s/veh    | 0.0  | 0.0  | 0.0  | 0.0  | 0.0  | 0.0  | 0.0  | 0.0  | 0.0  | 0.0  | 0.0  | 0.0  |
| %ile BackOfQ(50%),veh/ln     | 3.9  | 0.0  | 3.6  | 2.4  | 0.0  | 2.3  | 1.0  | 0.0  | 0.0  | 0.5  | 0.0  | 0.0  |
| LnGrp Delay(d),s/veh         | 5.8  | 0.0  | 6.2  | 4.9  | 0.0  | 5.1  | 9.6  | 0.0  | 0.0  | 9.1  | 0.0  | 0.0  |
| LnGrp LOS                    | A    |      | A    | A    |      | A    | A    |      |      | A    |      |      |
| Approach Vol, veh/h          |      | 1319 |      |      | 967  |      |      | 154  |      |      | 88   |      |
| Approach Delay, s/veh        |      | 6.0  |      |      | 5.0  |      |      | 9.6  |      |      | 9.1  |      |
| Approach LOS                 |      | A    |      |      | A    |      |      | A    |      |      | A    |      |
| Timer                        | 1    | 2    | 3    | 4    | 5    | 6    | 7    | 8    |      |      |      |      |
| Assigned Phs                 |      | 2    |      | 4    |      | 6    |      | 8    |      |      |      |      |
| Phs Duration (G+Y+Rc), s     |      | 8.5  |      | 16.1 |      | 8.5  |      | 16.1 |      |      |      |      |
| Change Period (Y+Rc), s      |      | 4.5  |      | 4.5  |      | 4.5  |      | 4.5  |      |      |      |      |
| Max Green Setting (Gmax), s  |      | 30.5 |      | 50.5 |      | 30.5 |      | 50.5 |      |      |      |      |
| Max Q Clear Time (g_c+I1), s |      | 4.0  |      | 9.7  |      | 3.1  |      | 10.3 |      |      |      |      |
| Green Ext Time (p_c), s      |      | 0.2  |      | 1.4  |      | 0.1  |      | 1.1  |      |      |      |      |
| <b>Intersection Summary</b>  |      |      |      |      |      |      |      |      |      |      |      |      |
| HCM 2010 Ctrl Delay          |      |      |      | 5.9  |      |      |      |      |      |      |      |      |
| HCM 2010 LOS                 |      |      |      | A    |      |      |      |      |      |      |      |      |



HCM 2010 Signalized Intersection Summary Cumulative with Eastside Parkway with Project, PM  
 41: Parker Flatts Cut Off Road & Gigling Road

06/11/2019



| Movement                     | EBL  | EBT  | EBR  | WBL  | WBT  | WBR  | NBL  | NBT  | NBR  | SBL  | SBT  | SBR  |
|------------------------------|------|------|------|------|------|------|------|------|------|------|------|------|
| Lane Configurations          |      | ↔    |      |      | ↔    |      |      | ↑    | ↗    |      | ↔    |      |
| Traffic Volume (veh/h)       | 10   | 1220 | 30   | 50   | 780  | 10   | 90   | 20   | 90   | 10   | 20   | 10   |
| Future Volume (veh/h)        | 10   | 1220 | 30   | 50   | 780  | 10   | 90   | 20   | 90   | 10   | 20   | 10   |
| Number                       | 7    | 4    | 14   | 3    | 8    | 18   | 5    | 2    | 12   | 1    | 6    | 16   |
| Initial Q (Qb), veh          | 0    | 0    | 0    | 0    | 0    | 0    | 0    | 0    | 0    | 0    | 0    | 0    |
| Ped-Bike Adj(A_pbT)          | 1.00 |      | 1.00 | 1.00 |      | 1.00 | 1.00 |      | 1.00 | 1.00 |      | 1.00 |
| Parking Bus, Adj             | 1.00 | 1.00 | 1.00 | 1.00 | 1.00 | 1.00 | 1.00 | 1.00 | 1.00 | 1.00 | 1.00 | 1.00 |
| Adj Sat Flow, veh/h/ln       | 1900 | 1863 | 1900 | 1900 | 1881 | 1900 | 1900 | 1900 | 1900 | 1900 | 1900 | 1900 |
| Adj Flow Rate, veh/h         | 11   | 1371 | 34   | 56   | 876  | 11   | 101  | 22   | 101  | 11   | 22   | 11   |
| Adj No. of Lanes             | 0    | 2    | 0    | 0    | 2    | 0    | 0    | 1    | 1    | 0    | 1    | 0    |
| Peak Hour Factor             | 0.89 | 0.89 | 0.89 | 0.89 | 0.89 | 0.89 | 0.89 | 0.89 | 0.89 | 0.89 | 0.89 | 0.89 |
| Percent Heavy Veh, %         | 2    | 2    | 2    | 1    | 1    | 1    | 0    | 0    | 0    | 0    | 0    | 0    |
| Cap, veh/h                   | 136  | 1739 | 43   | 174  | 1492 | 19   | 436  | 59   | 270  | 204  | 174  | 72   |
| Arrive On Green              | 0.51 | 0.51 | 0.51 | 0.51 | 0.51 | 0.51 | 0.17 | 0.17 | 0.17 | 0.17 | 0.17 | 0.17 |
| Sat Flow, veh/h              | 8    | 3435 | 85   | 54   | 2947 | 39   | 1181 | 349  | 1610 | 244  | 1036 | 427  |
| Grp Volume(v), veh/h         | 742  | 0    | 674  | 456  | 0    | 487  | 123  | 0    | 101  | 44   | 0    | 0    |
| Grp Sat Flow(s),veh/h/ln     | 1848 | 0    | 1680 | 1335 | 0    | 1705 | 1530 | 0    | 1610 | 1706 | 0    | 0    |
| Q Serve(g_s), s              | 0.0  | 0.0  | 9.1  | 1.4  | 0.0  | 5.4  | 1.1  | 0.0  | 1.5  | 0.0  | 0.0  | 0.0  |
| Cycle Q Clear(g_c), s        | 9.0  | 0.0  | 9.1  | 10.5 | 0.0  | 5.4  | 1.9  | 0.0  | 1.5  | 0.6  | 0.0  | 0.0  |
| Prop In Lane                 | 0.01 |      | 0.05 | 0.12 |      | 0.02 | 0.82 |      | 1.00 | 0.25 |      | 0.25 |
| Lane Grp Cap(c), veh/h       | 1067 | 0    | 850  | 822  | 0    | 863  | 494  | 0    | 270  | 449  | 0    | 0    |
| V/C Ratio(X)                 | 0.70 | 0.00 | 0.79 | 0.55 | 0.00 | 0.56 | 0.25 | 0.00 | 0.37 | 0.10 | 0.00 | 0.00 |
| Avail Cap(c_a), veh/h        | 3462 | 0    | 3073 | 2508 | 0    | 3119 | 1866 | 0    | 1779 | 1978 | 0    | 0    |
| HCM Platoon Ratio            | 1.00 | 1.00 | 1.00 | 1.00 | 1.00 | 1.00 | 1.00 | 1.00 | 1.00 | 1.00 | 1.00 | 1.00 |
| Upstream Filter(I)           | 1.00 | 0.00 | 1.00 | 1.00 | 0.00 | 1.00 | 1.00 | 0.00 | 1.00 | 1.00 | 0.00 | 0.00 |
| Uniform Delay (d), s/veh     | 5.6  | 0.0  | 5.6  | 4.6  | 0.0  | 4.7  | 10.3 | 0.0  | 10.2 | 9.8  | 0.0  | 0.0  |
| Incr Delay (d2), s/veh       | 0.3  | 0.0  | 0.6  | 0.2  | 0.0  | 0.2  | 0.1  | 0.0  | 0.3  | 0.0  | 0.0  | 0.0  |
| Initial Q Delay(d3),s/veh    | 0.0  | 0.0  | 0.0  | 0.0  | 0.0  | 0.0  | 0.0  | 0.0  | 0.0  | 0.0  | 0.0  | 0.0  |
| %ile BackOfQ(50%),veh/ln     | 4.6  | 0.0  | 4.3  | 2.2  | 0.0  | 2.5  | 0.8  | 0.0  | 0.7  | 0.3  | 0.0  | 0.0  |
| LnGrp Delay(d),s/veh         | 5.9  | 0.0  | 6.3  | 4.8  | 0.0  | 4.9  | 10.4 | 0.0  | 10.5 | 9.8  | 0.0  | 0.0  |
| LnGrp LOS                    | A    |      | A    | A    |      | A    | B    |      | B    | A    |      |      |
| Approach Vol, veh/h          |      | 1416 |      |      | 943  |      |      | 224  |      |      | 44   |      |
| Approach Delay, s/veh        |      | 6.1  |      |      | 4.9  |      |      | 10.4 |      |      | 9.8  |      |
| Approach LOS                 |      | A    |      |      | A    |      |      | B    |      |      | A    |      |
| Timer                        | 1    | 2    | 3    | 4    | 5    | 6    | 7    | 8    |      |      |      |      |
| Assigned Phs                 |      | 2    |      | 4    |      | 6    |      | 8    |      |      |      |      |
| Phs Duration (G+Y+Rc), s     |      | 9.1  |      | 18.5 |      | 9.1  |      | 18.5 |      |      |      |      |
| Change Period (Y+Rc), s      |      | 4.5  |      | 4.5  |      | 4.5  |      | 4.5  |      |      |      |      |
| Max Green Setting (Gmax), s  |      | 30.5 |      | 50.5 |      | 30.5 |      | 50.5 |      |      |      |      |
| Max Q Clear Time (g_c+I1), s |      | 3.9  |      | 11.1 |      | 2.6  |      | 12.5 |      |      |      |      |
| Green Ext Time (p_c), s      |      | 0.1  |      | 1.5  |      | 0.0  |      | 1.4  |      |      |      |      |
| <b>Intersection Summary</b>  |      |      |      |      |      |      |      |      |      |      |      |      |
| HCM 2010 Ctrl Delay          |      |      |      | 6.1  |      |      |      |      |      |      |      |      |
| HCM 2010 LOS                 |      |      |      | A    |      |      |      |      |      |      |      |      |

HCM 2010 Signalized Intersection Summary Cumulative with Eastside Parkway with Project, PM  
 42: 6th Avenue & Gigling Road

06/11/2019



| Movement                     | EBL  | EBT  | EBR  | WBL  | WBT  | WBR  | NBL  | NBT  | NBR  | SBL  | SBT  | SBR  |
|------------------------------|------|------|------|------|------|------|------|------|------|------|------|------|
| Lane Configurations          |      | ↔    |      |      | ↔    |      |      | ↑    | ↗    |      | ↔    |      |
| Traffic Volume (veh/h)       | 180  | 1140 | 10   | 10   | 660  | 10   | 10   | 10   | 20   | 10   | 10   | 180  |
| Future Volume (veh/h)        | 180  | 1140 | 10   | 10   | 660  | 10   | 10   | 10   | 20   | 10   | 10   | 180  |
| Number                       | 7    | 4    | 14   | 3    | 8    | 18   | 5    | 2    | 12   | 1    | 6    | 16   |
| Initial Q (Qb), veh          | 0    | 0    | 0    | 0    | 0    | 0    | 0    | 0    | 0    | 0    | 0    | 0    |
| Ped-Bike Adj(A_pbT)          | 1.00 |      | 1.00 | 1.00 |      | 1.00 | 1.00 |      | 1.00 | 1.00 |      | 1.00 |
| Parking Bus, Adj             | 1.00 | 1.00 | 1.00 | 1.00 | 1.00 | 1.00 | 1.00 | 1.00 | 1.00 | 1.00 | 1.00 | 1.00 |
| Adj Sat Flow, veh/h/ln       | 1900 | 1881 | 1900 | 1900 | 1863 | 1900 | 1900 | 1900 | 1900 | 1900 | 1900 | 1900 |
| Adj Flow Rate, veh/h         | 189  | 1200 | 11   | 11   | 695  | 11   | 11   | 11   | 0    | 11   | 11   | 189  |
| Adj No. of Lanes             | 0    | 2    | 0    | 0    | 2    | 0    | 0    | 1    | 1    | 0    | 1    | 0    |
| Peak Hour Factor             | 0.95 | 0.95 | 0.95 | 0.95 | 0.95 | 0.95 | 0.95 | 0.95 | 0.95 | 0.95 | 0.95 | 0.95 |
| Percent Heavy Veh, %         | 1    | 1    | 1    | 2    | 2    | 2    | 0    | 0    | 0    | 0    | 0    | 0    |
| Cap, veh/h                   | 304  | 1507 | 14   | 120  | 1901 | 30   | 267  | 203  | 282  | 123  | 22   | 254  |
| Arrive On Green              | 0.55 | 0.55 | 0.55 | 0.55 | 0.55 | 0.55 | 0.17 | 0.17 | 0.00 | 0.17 | 0.17 | 0.17 |
| Sat Flow, veh/h              | 297  | 2727 | 25   | 13   | 3440 | 54   | 592  | 1162 | 1615 | 45   | 125  | 1456 |
| Grp Volume(v), veh/h         | 662  | 0    | 738  | 373  | 0    | 344  | 22   | 0    | 0    | 211  | 0    | 0    |
| Grp Sat Flow(s),veh/h/ln     | 1342 | 0    | 1707 | 1822 | 0    | 1686 | 1754 | 0    | 1615 | 1625 | 0    | 0    |
| Q Serve(g_s), s              | 10.4 | 0.0  | 11.2 | 0.0  | 0.0  | 3.8  | 0.0  | 0.0  | 0.0  | 1.4  | 0.0  | 0.0  |
| Cycle Q Clear(g_c), s        | 14.2 | 0.0  | 11.2 | 3.7  | 0.0  | 3.8  | 0.3  | 0.0  | 0.0  | 4.0  | 0.0  | 0.0  |
| Prop In Lane                 | 0.29 |      | 0.01 | 0.03 |      | 0.03 | 0.50 |      | 1.00 | 0.05 |      | 0.90 |
| Lane Grp Cap(c), veh/h       | 882  | 0    | 943  | 1119 | 0    | 931  | 470  | 0    | 282  | 398  | 0    | 0    |
| V/C Ratio(X)                 | 0.75 | 0.00 | 0.78 | 0.33 | 0.00 | 0.37 | 0.05 | 0.00 | 0.00 | 0.53 | 0.00 | 0.00 |
| Avail Cap(c_a), veh/h        | 2166 | 0    | 2615 | 2792 | 0    | 2582 | 1574 | 0    | 1494 | 1610 | 0    | 0    |
| HCM Platoon Ratio            | 1.00 | 1.00 | 1.00 | 1.00 | 1.00 | 1.00 | 1.00 | 1.00 | 1.00 | 1.00 | 1.00 | 1.00 |
| Upstream Filter(I)           | 1.00 | 0.00 | 1.00 | 1.00 | 0.00 | 1.00 | 1.00 | 0.00 | 0.00 | 1.00 | 0.00 | 0.00 |
| Uniform Delay (d), s/veh     | 6.2  | 0.0  | 5.8  | 4.1  | 0.0  | 4.1  | 11.4 | 0.0  | 0.0  | 12.9 | 0.0  | 0.0  |
| Incr Delay (d2), s/veh       | 0.5  | 0.0  | 0.5  | 0.1  | 0.0  | 0.1  | 0.0  | 0.0  | 0.0  | 0.4  | 0.0  | 0.0  |
| Initial Q Delay(d3),s/veh    | 0.0  | 0.0  | 0.0  | 0.0  | 0.0  | 0.0  | 0.0  | 0.0  | 0.0  | 0.0  | 0.0  | 0.0  |
| %ile BackOfQ(50%),veh/ln     | 5.3  | 0.0  | 5.3  | 1.9  | 0.0  | 1.7  | 0.2  | 0.0  | 0.0  | 1.9  | 0.0  | 0.0  |
| LnGrp Delay(d),s/veh         | 6.7  | 0.0  | 6.4  | 4.2  | 0.0  | 4.2  | 11.4 | 0.0  | 0.0  | 13.3 | 0.0  | 0.0  |
| LnGrp LOS                    | A    |      | A    | A    |      | A    | B    |      |      | B    |      |      |
| Approach Vol, veh/h          |      | 1400 |      |      | 717  |      |      | 22   |      |      | 211  |      |
| Approach Delay, s/veh        |      | 6.5  |      |      | 4.2  |      |      | 11.4 |      |      | 13.3 |      |
| Approach LOS                 |      | A    |      |      | A    |      |      | B    |      |      | B    |      |
| Timer                        | 1    | 2    | 3    | 4    | 5    | 6    | 7    | 8    |      |      |      |      |
| Assigned Phs                 |      | 2    |      | 4    |      | 6    |      | 8    |      |      |      |      |
| Phs Duration (G+Y+Rc), s     |      | 10.3 |      | 22.7 |      | 10.3 |      | 22.7 |      |      |      |      |
| Change Period (Y+Rc), s      |      | 4.5  |      | 4.5  |      | 4.5  |      | 4.5  |      |      |      |      |
| Max Green Setting (Gmax), s  |      | 30.5 |      | 50.5 |      | 30.5 |      | 50.5 |      |      |      |      |
| Max Q Clear Time (g_c+I1), s |      | 2.3  |      | 16.2 |      | 6.0  |      | 5.8  |      |      |      |      |
| Green Ext Time (p_c), s      |      | 0.0  |      | 2.0  |      | 0.3  |      | 0.7  |      |      |      |      |
| <b>Intersection Summary</b>  |      |      |      |      |      |      |      |      |      |      |      |      |
| HCM 2010 Ctrl Delay          |      |      |      | 6.5  |      |      |      |      |      |      |      |      |
| HCM 2010 LOS                 |      |      |      | A    |      |      |      |      |      |      |      |      |

HCM 2010 Signalized Intersection Summary Cumulative with Eastside Parkway with Project, PM  
 43: Gigling Road & 7th Avenue

06/11/2019

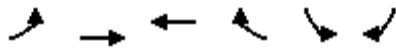

| Movement                     | EBL  | EBT  | WBT  | WBR  | SBL  | SBR  |   |      |
|------------------------------|------|------|------|------|------|------|---|------|
| Lane Configurations          |      | ↑↑   | ↑↑   |      | ↘    |      |   |      |
| Traffic Volume (veh/h)       | 200  | 970  | 610  | 10   | 10   | 70   |   |      |
| Future Volume (veh/h)        | 200  | 970  | 610  | 10   | 10   | 70   |   |      |
| Number                       | 7    | 4    | 8    | 18   | 1    | 16   |   |      |
| Initial Q (Qb), veh          | 0    | 0    | 0    | 0    | 0    | 0    |   |      |
| Ped-Bike Adj(A_pbT)          | 1.00 |      |      | 1.00 | 1.00 | 1.00 |   |      |
| Parking Bus, Adj             | 1.00 | 1.00 | 1.00 | 1.00 | 1.00 | 1.00 |   |      |
| Adj Sat Flow, veh/h/ln       | 1900 | 1863 | 1881 | 1900 | 1827 | 1900 |   |      |
| Adj Flow Rate, veh/h         | 208  | 1010 | 635  | 10   | 10   | 73   |   |      |
| Adj No. of Lanes             | 0    | 2    | 2    | 0    | 0    | 0    |   |      |
| Peak Hour Factor             | 0.96 | 0.96 | 0.96 | 0.96 | 0.96 | 0.96 |   |      |
| Percent Heavy Veh, %         | 2    | 2    | 1    | 1    | 0    | 0    |   |      |
| Cap, veh/h                   | 394  | 1355 | 1889 | 30   | 17   | 127  |   |      |
| Arrive On Green              | 0.52 | 0.52 | 0.52 | 0.52 | 0.09 | 0.09 |   |      |
| Sat Flow, veh/h              | 356  | 2668 | 3696 | 57   | 187  | 1368 |   |      |
| Grp Volume(v), veh/h         | 591  | 627  | 315  | 330  | 84   | 0    |   |      |
| Grp Sat Flow(s),veh/h/ln     | 1329 | 1610 | 1787 | 1871 | 1574 | 0    |   |      |
| Q Serve(g_s), s              | 6.2  | 7.1  | 2.4  | 2.4  | 1.2  | 0.0  |   |      |
| Cycle Q Clear(g_c), s        | 8.6  | 7.1  | 2.4  | 2.4  | 1.2  | 0.0  |   |      |
| Prop In Lane                 | 0.35 |      |      | 0.03 | 0.12 | 0.87 |   |      |
| Lane Grp Cap(c), veh/h       | 904  | 845  | 937  | 981  | 146  | 0    |   |      |
| V/C Ratio(X)                 | 0.65 | 0.74 | 0.34 | 0.34 | 0.58 | 0.00 |   |      |
| Avail Cap(c_a), veh/h        | 3205 | 3802 | 4220 | 4418 | 1707 | 0    |   |      |
| HCM Platoon Ratio            | 1.00 | 1.00 | 1.00 | 1.00 | 1.00 | 1.00 |   |      |
| Upstream Filter(I)           | 1.00 | 1.00 | 1.00 | 1.00 | 1.00 | 0.00 |   |      |
| Uniform Delay (d), s/veh     | 4.4  | 4.4  | 3.2  | 3.2  | 10.2 | 0.0  |   |      |
| Incr Delay (d2), s/veh       | 0.3  | 0.5  | 0.1  | 0.1  | 1.3  | 0.0  |   |      |
| Initial Q Delay(d3),s/veh    | 0.0  | 0.0  | 0.0  | 0.0  | 0.0  | 0.0  |   |      |
| %ile BackOfQ(50%),veh/ln     | 3.0  | 3.1  | 1.2  | 1.2  | 0.6  | 0.0  |   |      |
| LnGrp Delay(d),s/veh         | 4.7  | 4.8  | 3.3  | 3.3  | 11.6 | 0.0  |   |      |
| LnGrp LOS                    | A    | A    | A    | A    | B    |      |   |      |
| Approach Vol, veh/h          |      | 1218 | 645  |      | 84   |      |   |      |
| Approach Delay, s/veh        |      | 4.8  | 3.3  |      | 11.6 |      |   |      |
| Approach LOS                 |      | A    | A    |      | B    |      |   |      |
| Timer                        | 1    | 2    | 3    | 4    | 5    | 6    | 7 | 8    |
| Assigned Phs                 |      |      |      | 4    |      | 6    |   | 8    |
| Phs Duration (G+Y+Rc), s     |      |      |      | 16.8 |      | 6.7  |   | 16.8 |
| Change Period (Y+Rc), s      |      |      |      | 4.5  |      | 4.5  |   | 4.5  |
| Max Green Setting (Gmax), s  |      |      |      | 55.5 |      | 25.5 |   | 55.5 |
| Max Q Clear Time (g_c+I1), s |      |      |      | 10.6 |      | 3.2  |   | 4.4  |
| Green Ext Time (p_c), s      |      |      |      | 1.8  |      | 0.0  |   | 0.6  |
| <b>Intersection Summary</b>  |      |      |      |      |      |      |   |      |
| HCM 2010 Ctrl Delay          |      |      | 4.6  |      |      |      |   |      |
| HCM 2010 LOS                 |      |      | A    |      |      |      |   |      |
| <b>Notes</b>                 |      |      |      |      |      |      |   |      |

HCM 2010 Signalized Intersection Summary Cumulative with Eastside Parkway with Project, PM  
 44: 8th Avenue & Gigling Road 06/11/2019



| Movement                     | EBL  | EBT  | EBR  | WBL  | WBT  | WBR  | NBL  | NBT  | NBR  | SBL  | SBT  | SBR  |
|------------------------------|------|------|------|------|------|------|------|------|------|------|------|------|
| Lane Configurations          |      | ↔    |      |      | ↔    |      |      | ↔    |      |      | ↔    |      |
| Traffic Volume (veh/h)       | 270  | 710  | 10   | 10   | 340  | 10   | 10   | 10   | 10   | 10   | 10   | 280  |
| Future Volume (veh/h)        | 270  | 710  | 10   | 10   | 340  | 10   | 10   | 10   | 10   | 10   | 10   | 280  |
| Number                       | 7    | 4    | 14   | 3    | 8    | 18   | 5    | 2    | 12   | 1    | 6    | 16   |
| Initial Q (Qb), veh          | 0    | 0    | 0    | 0    | 0    | 0    | 0    | 0    | 0    | 0    | 0    | 0    |
| Ped-Bike Adj(A_pbT)          | 1.00 |      | 1.00 | 1.00 |      | 1.00 | 1.00 |      | 1.00 | 1.00 |      | 1.00 |
| Parking Bus, Adj             | 1.00 | 1.00 | 1.00 | 1.00 | 1.00 | 1.00 | 1.00 | 1.00 | 1.00 | 1.00 | 1.00 | 1.00 |
| Adj Sat Flow, veh/h/ln       | 1900 | 1863 | 1900 | 1900 | 1863 | 1900 | 1900 | 1900 | 1900 | 1900 | 1881 | 1900 |
| Adj Flow Rate, veh/h         | 297  | 780  | 11   | 11   | 374  | 11   | 11   | 11   | 11   | 11   | 11   | 132  |
| Adj No. of Lanes             | 0    | 2    | 0    | 0    | 2    | 0    | 0    | 1    | 0    | 0    | 1    | 0    |
| Peak Hour Factor             | 0.91 | 0.91 | 0.91 | 0.91 | 0.91 | 0.91 | 0.91 | 0.91 | 0.91 | 0.91 | 0.91 | 0.91 |
| Percent Heavy Veh, %         | 2    | 2    | 2    | 2    | 2    | 2    | 0    | 0    | 0    | 1    | 1    | 1    |
| Cap, veh/h                   | 537  | 1142 | 17   | 160  | 1715 | 50   | 243  | 108  | 82   | 161  | 21   | 197  |
| Arrive On Green              | 0.51 | 0.51 | 0.51 | 0.51 | 0.51 | 0.51 | 0.14 | 0.14 | 0.14 | 0.14 | 0.14 | 0.14 |
| Sat Flow, veh/h              | 624  | 2245 | 33   | 26   | 3372 | 98   | 398  | 755  | 576  | 80   | 150  | 1380 |
| Grp Volume(v), veh/h         | 518  | 0    | 570  | 207  | 0    | 189  | 33   | 0    | 0    | 154  | 0    | 0    |
| Grp Sat Flow(s),veh/h/ln     | 1213 | 0    | 1689 | 1818 | 0    | 1678 | 1729 | 0    | 0    | 1610 | 0    | 0    |
| Q Serve(g_s), s              | 8.0  | 0.0  | 6.5  | 0.0  | 0.0  | 1.6  | 0.0  | 0.0  | 0.0  | 1.2  | 0.0  | 0.0  |
| Cycle Q Clear(g_c), s        | 9.6  | 0.0  | 6.5  | 1.6  | 0.0  | 1.6  | 0.4  | 0.0  | 0.0  | 2.3  | 0.0  | 0.0  |
| Prop In Lane                 | 0.57 |      | 0.02 | 0.05 |      | 0.06 | 0.33 |      | 0.33 | 0.07 |      | 0.86 |
| Lane Grp Cap(c), veh/h       | 836  | 0    | 859  | 1071 | 0    | 853  | 433  | 0    | 0    | 379  | 0    | 0    |
| V/C Ratio(X)                 | 0.62 | 0.00 | 0.66 | 0.19 | 0.00 | 0.22 | 0.08 | 0.00 | 0.00 | 0.41 | 0.00 | 0.00 |
| Avail Cap(c_a), veh/h        | 2389 | 0    | 2975 | 3208 | 0    | 2955 | 2341 | 0    | 0    | 2349 | 0    | 0    |
| HCM Platoon Ratio            | 1.00 | 1.00 | 1.00 | 1.00 | 1.00 | 1.00 | 1.00 | 1.00 | 1.00 | 1.00 | 1.00 | 1.00 |
| Upstream Filter(I)           | 1.00 | 0.00 | 1.00 | 1.00 | 0.00 | 1.00 | 1.00 | 0.00 | 0.00 | 1.00 | 0.00 | 0.00 |
| Uniform Delay (d), s/veh     | 5.5  | 0.0  | 4.7  | 3.5  | 0.0  | 3.5  | 9.7  | 0.0  | 0.0  | 10.5 | 0.0  | 0.0  |
| Incr Delay (d2), s/veh       | 0.3  | 0.0  | 0.3  | 0.0  | 0.0  | 0.0  | 0.0  | 0.0  | 0.0  | 0.3  | 0.0  | 0.0  |
| Initial Q Delay(d3),s/veh    | 0.0  | 0.0  | 0.0  | 0.0  | 0.0  | 0.0  | 0.0  | 0.0  | 0.0  | 0.0  | 0.0  | 0.0  |
| %ile BackOfQ(50%),veh/ln     | 3.1  | 0.0  | 2.9  | 0.8  | 0.0  | 0.7  | 0.2  | 0.0  | 0.0  | 1.1  | 0.0  | 0.0  |
| LnGrp Delay(d),s/veh         | 5.8  | 0.0  | 5.0  | 3.5  | 0.0  | 3.6  | 9.7  | 0.0  | 0.0  | 10.7 | 0.0  | 0.0  |
| LnGrp LOS                    | A    |      | A    | A    |      | A    | A    |      |      | B    |      |      |
| Approach Vol, veh/h          |      | 1088 |      |      | 396  |      |      | 33   |      |      | 154  |      |
| Approach Delay, s/veh        |      | 5.4  |      |      | 3.6  |      |      | 9.7  |      |      | 10.7 |      |
| Approach LOS                 |      | A    |      |      | A    |      |      | A    |      |      | B    |      |
| Timer                        | 1    | 2    | 3    | 4    | 5    | 6    | 7    | 8    |      |      |      |      |
| Assigned Phs                 |      | 2    |      | 4    |      | 6    |      | 8    |      |      |      |      |
| Phs Duration (G+Y+Rc), s     |      | 8.2  |      | 17.6 |      | 8.2  |      | 17.6 |      |      |      |      |
| Change Period (Y+Rc), s      |      | 4.5  |      | 4.5  |      | 4.5  |      | 4.5  |      |      |      |      |
| Max Green Setting (Gmax), s  |      | 35.5 |      | 45.5 |      | 35.5 |      | 45.5 |      |      |      |      |
| Max Q Clear Time (g_c+I1), s |      | 2.4  |      | 11.6 |      | 4.3  |      | 3.6  |      |      |      |      |
| Green Ext Time (p_c), s      |      | 0.0  |      | 1.4  |      | 0.2  |      | 0.5  |      |      |      |      |
| <b>Intersection Summary</b>  |      |      |      |      |      |      |      |      |      |      |      |      |
| HCM 2010 Ctrl Delay          |      |      |      | 5.5  |      |      |      |      |      |      |      |      |
| HCM 2010 LOS                 |      |      |      | A    |      |      |      |      |      |      |      |      |

HCM 2010 Signalized Intersection Summary Cumulative with Eastside Parkway with Project, PM  
 45: Eastside Parkway & Gigling Road

06/11/2019



| Movement                    | EBL  | EBT  | EBR  | WBL  | WBT  | WBR  | NBL  | NBT  | NBR  | SBL  | SBT  | SBR  |
|-----------------------------|------|------|------|------|------|------|------|------|------|------|------|------|
| Lane Configurations         |      |      |      |      |      |      |      |      |      |      |      |      |
| Traffic Volume (veh/h)      | 700  | 10   | 20   | 10   | 10   | 10   | 20   | 350  | 10   | 10   | 190  | 330  |
| Future Volume (veh/h)       | 700  | 10   | 20   | 10   | 10   | 10   | 20   | 350  | 10   | 10   | 190  | 330  |
| Number                      | 7    | 4    | 14   | 3    | 8    | 18   | 5    | 2    | 12   | 1    | 6    | 16   |
| Initial Q (Qb), veh         | 0    | 0    | 0    | 0    | 0    | 0    | 0    | 0    | 0    | 0    | 0    | 0    |
| Ped-Bike Adj(A_pbT)         | 1.00 |      | 1.00 | 1.00 |      | 1.00 | 1.00 |      | 1.00 | 1.00 |      | 1.00 |
| Parking Bus, Adj            | 1.00 | 1.00 | 1.00 | 1.00 | 1.00 | 1.00 | 1.00 | 1.00 | 1.00 | 1.00 | 1.00 | 1.00 |
| Adj Sat Flow, veh/h/ln      | 1863 | 1863 | 1900 | 1900 | 1863 | 1900 | 1863 | 1863 | 1900 | 1863 | 1863 | 1863 |
| Adj Flow Rate, veh/h        | 761  | 11   | 15   | 11   | 11   | 11   | 22   | 380  | 11   | 11   | 207  | 250  |
| Adj No. of Lanes            | 1    | 2    | 0    | 0    | 1    | 0    | 1    | 1    | 0    | 1    | 1    | 1    |
| Peak Hour Factor            | 0.92 | 0.92 | 0.92 | 0.92 | 0.92 | 0.92 | 0.92 | 0.92 | 0.92 | 0.92 | 0.92 | 0.92 |
| Percent Heavy Veh, %        | 2    | 2    | 2    | 2    | 2    | 2    | 2    | 2    | 2    | 2    | 2    | 2    |
| Cap, veh/h                  | 797  | 795  | 711  | 20   | 20   | 20   | 45   | 432  | 13   | 25   | 425  | 361  |
| Arrive On Green             | 0.45 | 0.45 | 0.45 | 0.04 | 0.04 | 0.04 | 0.03 | 0.24 | 0.24 | 0.01 | 0.23 | 0.23 |
| Sat Flow, veh/h             | 1774 | 1770 | 1583 | 577  | 577  | 577  | 1774 | 1801 | 52   | 1774 | 1863 | 1583 |
| Grp Volume(v), veh/h        | 761  | 11   | 15   | 33   | 0    | 0    | 22   | 0    | 391  | 11   | 207  | 250  |
| Grp Sat Flow(s),veh/h/ln    | 1774 | 1770 | 1583 | 1732 | 0    | 0    | 1774 | 0    | 1854 | 1774 | 1863 | 1583 |
| Q Serve(g_s), s             | 25.3 | 0.2  | 0.3  | 1.1  | 0.0  | 0.0  | 0.7  | 0.0  | 12.4 | 0.4  | 5.9  | 8.8  |
| Cycle Q Clear(g_c), s       | 25.3 | 0.2  | 0.3  | 1.1  | 0.0  | 0.0  | 0.7  | 0.0  | 12.4 | 0.4  | 5.9  | 8.8  |
| Prop In Lane                | 1.00 |      | 1.00 | 0.33 |      | 0.33 | 1.00 |      | 0.03 | 1.00 |      | 1.00 |
| Lane Grp Cap(c), veh/h      | 797  | 795  | 711  | 61   | 0    | 0    | 45   | 0    | 445  | 25   | 425  | 361  |
| V/C Ratio(X)                | 0.95 | 0.01 | 0.02 | 0.54 | 0.00 | 0.00 | 0.49 | 0.00 | 0.88 | 0.44 | 0.49 | 0.69 |
| Avail Cap(c_a), veh/h       | 1457 | 1453 | 1300 | 638  | 0    | 0    | 163  | 0    | 782  | 160  | 783  | 666  |
| HCM Platoon Ratio           | 1.00 | 1.00 | 1.00 | 1.00 | 1.00 | 1.00 | 1.00 | 1.00 | 1.00 | 1.00 | 1.00 | 1.00 |
| Upstream Filter(I)          | 1.00 | 1.00 | 1.00 | 1.00 | 0.00 | 0.00 | 1.00 | 0.00 | 1.00 | 1.00 | 1.00 | 1.00 |
| Uniform Delay (d), s/veh    | 16.2 | 9.3  | 9.4  | 29.0 | 0.0  | 0.0  | 29.4 | 0.0  | 22.4 | 29.9 | 20.5 | 21.6 |
| Incr Delay (d2), s/veh      | 4.7  | 0.0  | 0.0  | 2.8  | 0.0  | 0.0  | 7.9  | 0.0  | 2.3  | 12.0 | 0.3  | 0.9  |
| Initial Q Delay(d3),s/veh   | 0.0  | 0.0  | 0.0  | 0.0  | 0.0  | 0.0  | 0.0  | 0.0  | 0.0  | 0.0  | 0.0  | 0.0  |
| %ile BackOfQ(50%),veh/ln    | 8.3  | 0.1  | 0.1  | 0.6  | 0.0  | 0.0  | 0.5  | 0.0  | 6.6  | 0.3  | 3.0  | 3.9  |
| LnGrp Delay(d),s/veh        | 20.9 | 9.3  | 9.4  | 31.8 | 0.0  | 0.0  | 37.3 | 0.0  | 24.6 | 41.9 | 20.8 | 22.5 |
| LnGrp LOS                   | C    | A    | A    | C    |      |      | D    |      | C    | D    | C    | C    |
| Approach Vol, veh/h         |      | 787  |      |      | 33   |      |      | 413  |      |      | 468  |      |
| Approach Delay, s/veh       |      | 20.5 |      |      | 31.8 |      |      | 25.3 |      |      | 22.2 |      |
| Approach LOS                |      | C    |      |      | C    |      |      | C    |      |      | C    |      |
| Timer                       | 1    | 2    | 3    | 4    | 5    | 6    | 7    | 8    |      |      |      |      |
| Assigned Phs                | 1    | 2    |      | 4    | 5    | 6    |      | 8    |      |      |      |      |
| Phs Duration (G+Y+Rc), s    | 4.9  | 18.7 |      | 31.5 | 5.6  | 18.0 |      | 6.1  |      |      |      |      |
| Change Period (Y+Rc), s     | 4.0  | 4.0  |      | 4.0  | 4.0  | 4.0  |      | 4.0  |      |      |      |      |
| Max Green Setting (Gmax), s | 5.5  | 25.8 |      | 50.2 | 5.6  | 25.7 |      | 22.5 |      |      |      |      |
| Max Q Clear Time (g_c+1), s | 12.4 | 14.4 |      | 27.3 | 2.7  | 10.8 |      | 3.1  |      |      |      |      |
| Green Ext Time (p_c), s     | 0.0  | 0.2  |      | 0.2  | 0.0  | 0.1  |      | 0.0  |      |      |      |      |
| <b>Intersection Summary</b> |      |      |      |      |      |      |      |      |      |      |      |      |
| HCM 2010 Ctrl Delay         |      |      |      | 22.4 |      |      |      |      |      |      |      |      |
| HCM 2010 LOS                |      |      |      | C    |      |      |      |      |      |      |      |      |
| <b>Notes</b>                |      |      |      |      |      |      |      |      |      |      |      |      |

HCM 2010 Signalized Intersection Summary Cumulative with Eastside Parkway with Project, PM  
 46: General Jim Moore Boulevard & Normandy Road

06/11/2019



| Movement                     | EBL  | EBT  | EBR  | WBL  | WBT  | WBR  | NBL  | NBT  | NBR  | SBL  | SBT  | SBR  |
|------------------------------|------|------|------|------|------|------|------|------|------|------|------|------|
| Lane Configurations          |      | ↕    |      |      | ↕    |      | ↕    | ↕↕   |      | ↕    | ↕↕   | ↕    |
| Traffic Volume (veh/h)       | 140  | 40   | 100  | 290  | 50   | 10   | 90   | 790  | 320  | 30   | 480  | 80   |
| Future Volume (veh/h)        | 140  | 40   | 100  | 290  | 50   | 10   | 90   | 790  | 320  | 30   | 480  | 80   |
| Number                       | 3    | 8    | 18   | 7    | 4    | 14   | 1    | 6    | 16   | 5    | 2    | 12   |
| Initial Q (Qb), veh          | 0    | 0    | 0    | 0    | 0    | 0    | 0    | 0    | 0    | 0    | 0    | 0    |
| Ped-Bike Adj(A_pbT)          | 1.00 |      | 1.00 | 1.00 |      | 1.00 | 1.00 |      | 1.00 | 1.00 |      | 1.00 |
| Parking Bus, Adj             | 1.00 | 1.00 | 1.00 | 1.00 | 1.00 | 1.00 | 1.00 | 1.00 | 1.00 | 1.00 | 1.00 | 1.00 |
| Adj Sat Flow, veh/h/ln       | 1900 | 1863 | 1900 | 1900 | 1881 | 1900 | 1881 | 1881 | 1900 | 1900 | 1900 | 1900 |
| Adj Flow Rate, veh/h         | 152  | 43   | 84   | 315  | 54   | 8    | 98   | 859  | 325  | 33   | 522  | 28   |
| Adj No. of Lanes             | 0    | 1    | 0    | 0    | 1    | 0    | 1    | 2    | 0    | 1    | 2    | 1    |
| Peak Hour Factor             | 0.92 | 0.92 | 0.92 | 0.92 | 0.92 | 0.92 | 0.92 | 0.92 | 0.92 | 0.92 | 0.92 | 0.92 |
| Percent Heavy Veh, %         | 2    | 2    | 2    | 1    | 1    | 1    | 1    | 1    | 1    | 0    | 0    | 0    |
| Cap, veh/h                   | 367  | 113  | 160  | 494  | 63   | 9    | 403  | 962  | 363  | 66   | 686  | 306  |
| Arrive On Green              | 0.32 | 0.32 | 0.32 | 0.32 | 0.32 | 0.32 | 0.23 | 0.38 | 0.38 | 0.04 | 0.19 | 0.19 |
| Sat Flow, veh/h              | 802  | 351  | 497  | 1134 | 194  | 29   | 1792 | 2540 | 958  | 1810 | 3610 | 1611 |
| Grp Volume(v), veh/h         | 279  | 0    | 0    | 377  | 0    | 0    | 98   | 604  | 580  | 33   | 522  | 28   |
| Grp Sat Flow(s),veh/h/ln     | 1649 | 0    | 0    | 1357 | 0    | 0    | 1792 | 1787 | 1711 | 1810 | 1805 | 1611 |
| Q Serve(g_s), s              | 0.0  | 0.0  | 0.0  | 6.5  | 0.0  | 0.0  | 2.3  | 16.3 | 16.4 | 0.9  | 7.1  | 0.7  |
| Cycle Q Clear(g_c), s        | 6.8  | 0.0  | 0.0  | 13.4 | 0.0  | 0.0  | 2.3  | 16.3 | 16.4 | 0.9  | 7.1  | 0.7  |
| Prop In Lane                 | 0.54 |      | 0.30 | 0.84 |      | 0.02 | 1.00 |      | 0.56 | 1.00 |      | 1.00 |
| Lane Grp Cap(c), veh/h       | 640  | 0    | 0    | 566  | 0    | 0    | 403  | 677  | 648  | 66   | 686  | 306  |
| V/C Ratio(X)                 | 0.44 | 0.00 | 0.00 | 0.67 | 0.00 | 0.00 | 0.24 | 0.89 | 0.90 | 0.50 | 0.76 | 0.09 |
| Avail Cap(c_a), veh/h        | 1106 | 0    | 0    | 991  | 0    | 0    | 403  | 884  | 846  | 281  | 1786 | 797  |
| HCM Platoon Ratio            | 1.00 | 1.00 | 1.00 | 1.00 | 1.00 | 1.00 | 1.00 | 1.00 | 1.00 | 1.00 | 1.00 | 1.00 |
| Upstream Filter(l)           | 1.00 | 0.00 | 0.00 | 1.00 | 0.00 | 0.00 | 1.00 | 1.00 | 1.00 | 1.00 | 1.00 | 1.00 |
| Uniform Delay (d), s/veh     | 14.1 | 0.0  | 0.0  | 16.3 | 0.0  | 0.0  | 16.4 | 15.0 | 15.0 | 24.4 | 19.8 | 17.2 |
| Incr Delay (d2), s/veh       | 0.2  | 0.0  | 0.0  | 0.5  | 0.0  | 0.0  | 0.1  | 7.8  | 8.5  | 2.2  | 0.7  | 0.0  |
| Initial Q Delay(d3),s/veh    | 0.0  | 0.0  | 0.0  | 0.0  | 0.0  | 0.0  | 0.0  | 0.0  | 0.0  | 0.0  | 0.0  | 0.0  |
| %ile BackOfQ(50%),veh/ln     | 3.2  | 0.0  | 0.0  | 5.0  | 0.0  | 0.0  | 1.2  | 9.4  | 9.3  | 0.5  | 3.5  | 0.3  |
| LnGrp Delay(d),s/veh         | 14.3 | 0.0  | 0.0  | 16.8 | 0.0  | 0.0  | 16.5 | 22.9 | 23.5 | 26.5 | 20.4 | 17.2 |
| LnGrp LOS                    | B    |      |      | B    |      |      | B    | C    | C    | C    | C    | B    |
| Approach Vol, veh/h          |      | 279  |      |      | 377  |      |      | 1282 |      |      | 583  |      |
| Approach Delay, s/veh        |      | 14.3 |      |      | 16.8 |      |      | 22.7 |      |      | 20.6 |      |
| Approach LOS                 |      | B    |      |      | B    |      |      | C    |      |      | C    |      |
| Timer                        | 1    | 2    | 3    | 4    | 5    | 6    | 7    | 8    |      |      |      |      |
| Assigned Phs                 | 1    | 2    |      | 4    | 5    | 6    |      | 8    |      |      |      |      |
| Phs Duration (G+Y+Rc), s     | 6.1  | 14.3 |      | 21.1 | 6.4  | 24.0 |      | 21.1 |      |      |      |      |
| Change Period (Y+Rc), s      | 4.5  | 4.5  |      | 4.5  | 4.5  | 4.5  |      | 4.5  |      |      |      |      |
| Max Green Setting (Gmax), s  | 30.0 | 25.5 |      | 33.0 | 8.0  | 25.5 |      | 33.0 |      |      |      |      |
| Max Q Clear Time (g_c+14), s | 14.3 | 9.1  |      | 15.4 | 2.9  | 18.4 |      | 8.8  |      |      |      |      |
| Green Ext Time (p_c), s      | 0.0  | 0.6  |      | 0.5  | 0.0  | 1.1  |      | 0.4  |      |      |      |      |
| <b>Intersection Summary</b>  |      |      |      |      |      |      |      |      |      |      |      |      |
| HCM 2010 Ctrl Delay          |      |      | 20.4 |      |      |      |      |      |      |      |      |      |
| HCM 2010 LOS                 |      |      | C    |      |      |      |      |      |      |      |      |      |

HCM 2010 Signalized Intersection Summary Cumulative with Eastside Parkway with Project, PM  
 47: General Jim Moore Boulevard & Coe Avenue 06/11/2019



| Movement                     | EBL  | EBT  | EBR  | WBL  | WBT  | WBR  | NBL  | NBT  | NBR  | SBL  | SBT  | SBR  |
|------------------------------|------|------|------|------|------|------|------|------|------|------|------|------|
| Lane Configurations          | ↖    | ↑    | ↗    | ↖    | ↑    | ↗    | ↖    | ↑↑   | ↗    | ↖    | ↑↑   | ↗    |
| Traffic Volume (veh/h)       | 60   | 10   | 100  | 310  | 10   | 10   | 150  | 1080 | 500  | 10   | 530  | 60   |
| Future Volume (veh/h)        | 60   | 10   | 100  | 310  | 10   | 10   | 150  | 1080 | 500  | 10   | 530  | 60   |
| Number                       | 3    | 8    | 18   | 7    | 4    | 14   | 1    | 6    | 16   | 5    | 2    | 12   |
| Initial Q (Qb), veh          | 0    | 0    | 0    | 0    | 0    | 0    | 0    | 0    | 0    | 0    | 0    | 0    |
| Ped-Bike Adj(A_pbT)          | 1.00 |      | 0.99 | 0.99 |      | 1.00 | 1.00 |      | 0.99 | 1.00 |      | 0.99 |
| Parking Bus, Adj             | 1.00 | 1.00 | 1.00 | 1.00 | 1.00 | 1.00 | 1.00 | 1.00 | 1.00 | 1.00 | 1.00 | 1.00 |
| Adj Sat Flow, veh/h/ln       | 1881 | 1863 | 1881 | 1863 | 1863 | 1863 | 1881 | 1881 | 1863 | 1863 | 1881 | 1881 |
| Adj Flow Rate, veh/h         | 67   | 11   | 11   | 348  | 11   | 11   | 169  | 1213 | 535  | 11   | 596  | 31   |
| Adj No. of Lanes             | 1    | 1    | 1    | 1    | 1    | 1    | 1    | 2    | 1    | 1    | 2    | 1    |
| Peak Hour Factor             | 0.89 | 0.89 | 0.89 | 0.89 | 0.89 | 0.89 | 0.89 | 0.89 | 0.89 | 0.89 | 0.89 | 0.89 |
| Percent Heavy Veh, %         | 1    | 2    | 1    | 2    | 2    | 2    | 1    | 1    | 2    | 2    | 1    | 1    |
| Cap, veh/h                   | 577  | 581  | 495  | 569  | 581  | 494  | 200  | 1427 | 628  | 25   | 1078 | 478  |
| Arrive On Green              | 0.31 | 0.31 | 0.31 | 0.31 | 0.31 | 0.31 | 0.11 | 0.40 | 0.40 | 0.01 | 0.30 | 0.30 |
| Sat Flow, veh/h              | 1398 | 1863 | 1587 | 1374 | 1863 | 1583 | 1792 | 3574 | 1573 | 1774 | 3574 | 1586 |
| Grp Volume(v), veh/h         | 67   | 11   | 11   | 348  | 11   | 11   | 169  | 1213 | 535  | 11   | 596  | 31   |
| Grp Sat Flow(s),veh/h/ln     | 1398 | 1863 | 1587 | 1374 | 1863 | 1583 | 1792 | 1787 | 1573 | 1774 | 1787 | 1586 |
| Q Serve(g_s), s              | 1.7  | 0.2  | 0.2  | 11.5 | 0.2  | 0.2  | 4.5  | 15.2 | 15.2 | 0.3  | 6.9  | 0.7  |
| Cycle Q Clear(g_c), s        | 1.9  | 0.2  | 0.2  | 11.7 | 0.2  | 0.2  | 4.5  | 15.2 | 15.2 | 0.3  | 6.9  | 0.7  |
| Prop In Lane                 | 1.00 |      | 1.00 | 1.00 |      | 1.00 | 1.00 |      | 1.00 | 1.00 |      | 1.00 |
| Lane Grp Cap(c), veh/h       | 577  | 581  | 495  | 569  | 581  | 494  | 200  | 1427 | 628  | 25   | 1078 | 478  |
| V/C Ratio(X)                 | 0.12 | 0.02 | 0.02 | 0.61 | 0.02 | 0.02 | 0.84 | 0.85 | 0.85 | 0.44 | 0.55 | 0.06 |
| Avail Cap(c_a), veh/h        | 1435 | 1724 | 1469 | 1412 | 1724 | 1466 | 200  | 2581 | 1136 | 199  | 2581 | 1145 |
| HCM Platoon Ratio            | 1.00 | 1.00 | 1.00 | 1.00 | 1.00 | 1.00 | 1.00 | 1.00 | 1.00 | 1.00 | 1.00 | 1.00 |
| Upstream Filter(I)           | 1.00 | 1.00 | 1.00 | 1.00 | 1.00 | 1.00 | 1.00 | 1.00 | 1.00 | 1.00 | 1.00 | 1.00 |
| Uniform Delay (d), s/veh     | 12.4 | 11.7 | 11.7 | 15.8 | 11.7 | 11.7 | 21.4 | 13.4 | 13.4 | 24.0 | 14.4 | 12.2 |
| Incr Delay (d2), s/veh       | 0.0  | 0.0  | 0.0  | 0.4  | 0.0  | 0.0  | 25.3 | 0.6  | 1.3  | 4.4  | 0.2  | 0.0  |
| Initial Q Delay(d3),s/veh    | 0.0  | 0.0  | 0.0  | 0.0  | 0.0  | 0.0  | 0.0  | 0.0  | 0.0  | 0.0  | 0.0  | 0.0  |
| %ile BackOfQ(50%),veh/ln     | 0.7  | 0.1  | 0.1  | 4.4  | 0.1  | 0.1  | 3.7  | 7.5  | 6.8  | 0.2  | 3.4  | 0.3  |
| LnGrp Delay(d),s/veh         | 12.4 | 11.7 | 11.7 | 16.2 | 11.7 | 11.7 | 46.7 | 14.0 | 14.7 | 28.4 | 14.6 | 12.2 |
| LnGrp LOS                    | B    | B    | B    | B    | B    | B    | D    | B    | B    | C    | B    | B    |
| Approach Vol, veh/h          |      | 89   |      |      | 370  |      |      | 1917 |      |      | 638  |      |
| Approach Delay, s/veh        |      | 12.2 |      |      | 15.9 |      |      | 17.1 |      |      | 14.7 |      |
| Approach LOS                 |      | B    |      |      | B    |      |      | B    |      |      | B    |      |
| Timer                        | 1    | 2    | 3    | 4    | 5    | 6    | 7    | 8    |      |      |      |      |
| Assigned Phs                 | 1    | 2    |      | 4    | 5    | 6    |      | 8    |      |      |      |      |
| Phs Duration (G+Y+Rc), s     | 0.0  | 19.3 |      | 19.8 | 5.2  | 24.1 |      | 19.8 |      |      |      |      |
| Change Period (Y+Rc), s      | 4.5  | 4.5  |      | 4.5  | 4.5  | 4.5  |      | 4.5  |      |      |      |      |
| Max Green Setting (Gmax), s  | 5.5  | 35.5 |      | 45.5 | 5.5  | 35.5 |      | 45.5 |      |      |      |      |
| Max Q Clear Time (g_c+10), s | 5.5  | 8.9  |      | 13.7 | 2.3  | 17.2 |      | 3.9  |      |      |      |      |
| Green Ext Time (p_c), s      | 0.0  | 0.7  |      | 0.1  | 0.0  | 1.4  |      | 0.0  |      |      |      |      |
| <b>Intersection Summary</b>  |      |      |      |      |      |      |      |      |      |      |      |      |
| HCM 2010 Ctrl Delay          |      |      |      | 16.3 |      |      |      |      |      |      |      |      |
| HCM 2010 LOS                 |      |      |      | B    |      |      |      |      |      |      |      |      |

HCM 2010 Signalized Intersection Summary Cumulative with Eastside Parkway with Project, PM  
 48: Fremont Boulevard/Highway 1 Southbound Off-Ramp & Monterey Road 06/11/2019



| Movement                     | EBL  | EBT  | EBR  | WBL   | WBT  | WBR   | NBL  | NBT  | NBR  | SBL  | SBT   | SBR  |
|------------------------------|------|------|------|-------|------|-------|------|------|------|------|-------|------|
| Lane Configurations          |      |      |      |       |      |       |      |      |      |      |       |      |
| Traffic Volume (veh/h)       | 230  | 160  | 70   | 90    | 100  | 70    | 110  | 1200 | 230  | 50   | 720   | 170  |
| Future Volume (veh/h)        | 230  | 160  | 70   | 90    | 100  | 70    | 110  | 1200 | 230  | 50   | 720   | 170  |
| Number                       | 7    | 4    | 14   | 3     | 8    | 18    | 5    | 2    | 12   | 1    | 6     | 16   |
| Initial Q (Qb), veh          | 0    | 0    | 0    | 0     | 0    | 0     | 0    | 0    | 0    | 0    | 0     | 0    |
| Ped-Bike Adj(A_pbT)          | 1.00 |      | 0.98 | 1.00  |      | 0.99  | 1.00 |      | 0.99 | 1.00 |       | 0.99 |
| Parking Bus, Adj             | 1.00 | 1.00 | 1.00 | 1.00  | 1.00 | 1.00  | 1.00 | 1.00 | 1.00 | 1.00 | 1.00  | 1.00 |
| Adj Sat Flow, veh/h/ln       | 1881 | 1881 | 1881 | 1900  | 1900 | 1900  | 1881 | 1881 | 1900 | 1863 | 1863  | 1863 |
| Adj Flow Rate, veh/h         | 201  | 215  | 25   | 93    | 103  | 66    | 113  | 1237 | 225  | 52   | 742   | 103  |
| Adj No. of Lanes             | 1    | 1    | 1    | 0     | 1    | 0     | 1    | 2    | 0    | 1    | 2     | 1    |
| Peak Hour Factor             | 0.97 | 0.97 | 0.97 | 0.97  | 0.97 | 0.97  | 0.97 | 0.97 | 0.97 | 0.97 | 0.97  | 0.97 |
| Percent Heavy Veh, %         | 1    | 1    | 1    | 0     | 0    | 0     | 1    | 1    | 1    | 2    | 2     | 2    |
| Cap, veh/h                   | 269  | 282  | 235  | 105   | 117  | 75    | 593  | 1486 | 268  | 67   | 671   | 297  |
| Arrive On Green              | 0.15 | 0.15 | 0.15 | 0.17  | 0.17 | 0.17  | 0.33 | 0.49 | 0.49 | 0.04 | 0.19  | 0.19 |
| Sat Flow, veh/h              | 1792 | 1881 | 1565 | 634   | 702  | 450   | 1792 | 3023 | 545  | 1774 | 3539  | 1568 |
| Grp Volume(v), veh/h         | 201  | 215  | 25   | 262   | 0    | 0     | 113  | 727  | 735  | 52   | 742   | 103  |
| Grp Sat Flow(s),veh/h/ln     | 1792 | 1881 | 1565 | 1785  | 0    | 0     | 1792 | 1787 | 1781 | 1774 | 1770  | 1568 |
| Q Serve(g_s), s              | 13.4 | 13.7 | 1.7  | 17.9  | 0.0  | 0.0   | 5.6  | 43.6 | 44.6 | 3.6  | 23.7  | 7.1  |
| Cycle Q Clear(g_c), s        | 13.4 | 13.7 | 1.7  | 17.9  | 0.0  | 0.0   | 5.6  | 43.6 | 44.6 | 3.6  | 23.7  | 7.1  |
| Prop In Lane                 | 1.00 |      | 1.00 | 0.35  |      | 0.25  | 1.00 |      | 0.31 | 1.00 |       | 1.00 |
| Lane Grp Cap(c), veh/h       | 269  | 282  | 235  | 297   | 0    | 0     | 593  | 879  | 876  | 67   | 671   | 297  |
| V/C Ratio(X)                 | 0.75 | 0.76 | 0.11 | 0.88  | 0.00 | 0.00  | 0.19 | 0.83 | 0.84 | 0.77 | 1.11  | 0.35 |
| Avail Cap(c_a), veh/h        | 573  | 602  | 501  | 357   | 0    | 0     | 593  | 879  | 876  | 241  | 671   | 297  |
| HCM Platoon Ratio            | 1.00 | 1.00 | 1.00 | 1.00  | 1.00 | 1.00  | 1.00 | 1.00 | 1.00 | 1.00 | 1.00  | 1.00 |
| Upstream Filter(I)           | 0.69 | 0.69 | 0.69 | 1.00  | 0.00 | 0.00  | 1.00 | 1.00 | 1.00 | 1.00 | 1.00  | 1.00 |
| Uniform Delay (d), s/veh     | 50.9 | 51.0 | 45.9 | 50.9  | 0.0  | 0.0   | 29.8 | 27.2 | 27.5 | 59.6 | 50.7  | 43.9 |
| Incr Delay (d2), s/veh       | 2.9  | 3.0  | 0.1  | 20.8  | 0.0  | 0.0   | 0.1  | 8.8  | 9.5  | 6.9  | 67.4  | 3.2  |
| Initial Q Delay(d3),s/veh    | 0.0  | 0.0  | 0.0  | 0.0   | 0.0  | 0.0   | 0.0  | 0.0  | 0.0  | 0.0  | 0.0   | 0.0  |
| %ile BackOfQ(50%),veh/ln     | 6.9  | 7.3  | 0.8  | 10.6  | 0.0  | 0.0   | 2.8  | 23.6 | 24.1 | 1.9  | 17.8  | 3.4  |
| LnGrp Delay(d),s/veh         | 53.8 | 54.0 | 46.0 | 71.7  | 0.0  | 0.0   | 29.9 | 36.1 | 37.0 | 66.5 | 118.0 | 47.1 |
| LnGrp LOS                    | D    | D    | D    | E     |      |       | C    | D    | D    | E    | F     | D    |
| Approach Vol, veh/h          |      | 441  |      |       | 262  |       |      | 1575 |      |      | 897   |      |
| Approach Delay, s/veh        |      | 53.4 |      |       | 71.7 |       |      | 36.1 |      |      | 106.9 |      |
| Approach LOS                 |      | D    |      |       | E    |       |      | D    |      |      | F     |      |
| Timer                        | 1    | 2    | 3    | 4     | 5    | 6     | 7    | 8    |      |      |       |      |
| Assigned Phs                 | 1    | 2    |      | 4     | 5    | 6     |      | 8    |      |      |       |      |
| Phs Duration (G+Y+Rc), s     | 8.9  | 66.8 |      | 23.4  | 46.7 | 29.0  |      | 25.9 |      |      |       |      |
| Change Period (Y+Rc), s      | 4.2  | 5.3  |      | * 4.7 | 5.3  | * 5.3 |      | 5.1  |      |      |       |      |
| Max Green Setting (Gmax), s  | 15   | 23.7 |      | * 40  | 17.0 | * 24  |      | 25.0 |      |      |       |      |
| Max Q Clear Time (g_c+15), s | 15   | 46.6 |      | 15.7  | 7.6  | 25.7  |      | 19.9 |      |      |       |      |
| Green Ext Time (p_c), s      | 0.0  | 0.0  |      | 1.9   | 0.1  | 0.0   |      | 0.8  |      |      |       |      |
| <b>Intersection Summary</b>  |      |      |      |       |      |       |      |      |      |      |       |      |
| HCM 2010 Ctrl Delay          |      |      |      | 61.4  |      |       |      |      |      |      |       |      |
| HCM 2010 LOS                 |      |      |      | E     |      |       |      |      |      |      |       |      |
| <b>Notes</b>                 |      |      |      |       |      |       |      |      |      |      |       |      |



HCM 2010 Signalized Intersection Summary Cumulative with Eastside Parkway with Project, PM  
 49: Highway 1 SB On-Ramp & Highway 1 NB Off-Ramp/Monterey Road 06/11/2019



| Movement                     | EBL  | EBT  | EBR  | WBL   | WBT  | WBR   | NBL  | NBT   | NBR  | SBL  | SBT  | SBR  |
|------------------------------|------|------|------|-------|------|-------|------|-------|------|------|------|------|
| Lane Configurations          |      | ↕↕   | ↗    | ↖     |      | ↗     |      | ↕     | ↗    |      | ↖    |      |
| Traffic Volume (veh/h)       | 10   | 140  | 120  | 280   | 0    | 130   | 0    | 120   | 300  | 10   | 10   | 0    |
| Future Volume (veh/h)        | 10   | 140  | 120  | 280   | 0    | 130   | 0    | 120   | 300  | 10   | 10   | 0    |
| Number                       | 1    | 6    | 16   | 5     | 2    | 12    | 7    | 4     | 14   | 3    | 8    | 18   |
| Initial Q (Qb), veh          | 0    | 0    | 0    | 0     | 0    | 0     | 0    | 0     | 0    | 0    | 0    | 0    |
| Ped-Bike Adj(A_pbT)          | 1.00 |      | 1.00 | 1.00  |      | 1.00  | 1.00 |       | 1.00 | 1.00 |      | 1.00 |
| Parking Bus, Adj             | 1.00 | 1.00 | 1.00 | 1.00  | 1.00 | 1.00  | 1.00 | 1.00  | 1.00 | 1.00 | 1.00 | 1.00 |
| Adj Sat Flow, veh/h/ln       | 1900 | 1863 | 1863 | 1900  | 0    | 1900  | 0    | 1881  | 1881 | 1900 | 1900 | 0    |
| Adj Flow Rate, veh/h         | 11   | 154  | 14   | 308   | 0    | 69    | 0    | 132   | 51   | 11   | 11   | 0    |
| Adj No. of Lanes             | 0    | 2    | 1    | 1     | 0    | 1     | 0    | 1     | 1    | 0    | 1    | 0    |
| Peak Hour Factor             | 0.91 | 0.91 | 0.91 | 0.91  | 0.91 | 0.91  | 0.91 | 0.91  | 0.91 | 0.91 | 0.91 | 0.91 |
| Percent Heavy Veh, %         | 2    | 2    | 2    | 0     | 0    | 0     | 0    | 1     | 1    | 0    | 0    | 0    |
| Cap, veh/h                   | 193  | 2838 | 1323 | 0     | 0    | 0     | 0    | 164   | 139  | 57   | 43   | 0    |
| Arrive On Green              | 0.84 | 0.84 | 0.84 | 0.00  | 0.00 | 0.00  | 0.00 | 0.09  | 0.09 | 0.09 | 0.09 | 0.00 |
| Sat Flow, veh/h              | 230  | 3391 | 1580 |       |      |       | 0    | 1881  | 1599 | 155  | 496  | 0    |
| Grp Volume(v), veh/h         | 88   | 77   | 14   |       | 0.0  |       | 0    | 132   | 51   | 22   | 0    | 0    |
| Grp Sat Flow(s),veh/h/ln     | 1851 | 1770 | 1580 |       |      |       | 0    | 1881  | 1599 | 651  | 0    | 0    |
| Q Serve(g_s), s              | 1.0  | 0.9  | 0.2  |       |      |       | 0.0  | 8.6   | 3.8  | 0.1  | 0.0  | 0.0  |
| Cycle Q Clear(g_c), s        | 1.0  | 0.9  | 0.2  |       |      |       | 0.0  | 8.6   | 3.8  | 8.7  | 0.0  | 0.0  |
| Prop In Lane                 | 0.12 |      | 1.00 |       |      |       | 0.00 |       | 1.00 | 0.50 |      | 0.00 |
| Lane Grp Cap(c), veh/h       | 1549 | 1481 | 1323 |       |      |       | 0    | 164   | 139  | 100  | 0    | 0    |
| V/C Ratio(X)                 | 0.06 | 0.05 | 0.01 |       |      |       | 0.00 | 0.81  | 0.37 | 0.22 | 0.00 | 0.00 |
| Avail Cap(c_a), veh/h        | 1549 | 1481 | 1323 |       |      |       | 0    | 271   | 230  | 125  | 0    | 0    |
| HCM Platoon Ratio            | 1.00 | 1.00 | 1.00 |       |      |       | 1.00 | 1.00  | 1.00 | 1.00 | 1.00 | 1.00 |
| Upstream Filter(I)           | 1.00 | 1.00 | 1.00 |       |      |       | 0.00 | 1.00  | 1.00 | 1.00 | 0.00 | 0.00 |
| Uniform Delay (d), s/veh     | 1.7  | 1.7  | 1.7  |       |      |       | 0.0  | 56.0  | 53.8 | 52.9 | 0.0  | 0.0  |
| Incr Delay (d2), s/veh       | 0.0  | 0.0  | 0.0  |       |      |       | 0.0  | 3.5   | 0.6  | 0.4  | 0.0  | 0.0  |
| Initial Q Delay(d3),s/veh    | 0.0  | 0.0  | 0.0  |       |      |       | 0.0  | 0.0   | 0.0  | 0.0  | 0.0  | 0.0  |
| %ile BackOfQ(50%),veh/lnr0.5 | 0.4  | 0.1  |      |       |      |       | 0.0  | 4.6   | 1.7  | 0.7  | 0.0  | 0.0  |
| LnGrp Delay(d),s/veh         | 1.8  | 1.7  | 1.7  |       |      |       | 0.0  | 59.5  | 54.4 | 53.3 | 0.0  | 0.0  |
| LnGrp LOS                    | A    | A    | A    |       |      |       |      | E     | D    | D    |      |      |
| Approach Vol, veh/h          |      | 179  |      |       |      |       |      | 183   |      |      | 22   |      |
| Approach Delay, s/veh        |      | 1.7  |      |       |      |       |      | 58.1  |      |      | 53.3 |      |
| Approach LOS                 |      | A    |      |       |      |       |      | E     |      |      | D    |      |
| Timer                        | 1    | 2    | 3    | 4     | 5    | 6     | 7    | 8     |      |      |      |      |
| Assigned Phs                 |      |      |      | 4     |      | 6     |      | 8     |      |      |      |      |
| Phs Duration (G+Y+Rc), s     |      |      |      | 15.1  |      | 109.9 |      | 15.1  |      |      |      |      |
| Change Period (Y+Rc), s      |      |      |      | * 4.2 |      | 5.3   |      | * 4.2 |      |      |      |      |
| Max Green Setting (Gmax), s  |      |      |      | * 18  |      | 21.0  |      | * 13  |      |      |      |      |
| Max Q Clear Time (g_c+I1), s |      |      |      | 10.6  |      | 3.0   |      | 10.7  |      |      |      |      |
| Green Ext Time (p_c), s      |      |      |      | 0.3   |      | 0.5   |      | 0.0   |      |      |      |      |
| <b>Intersection Summary</b>  |      |      |      |       |      |       |      |       |      |      |      |      |
| HCM 2010 Ctrl Delay          |      |      | 31.6 |       |      |       |      |       |      |      |      |      |
| HCM 2010 LOS                 |      |      | C    |       |      |       |      |       |      |      |      |      |
| <b>Notes</b>                 |      |      |      |       |      |       |      |       |      |      |      |      |

HCM 2010 Signalized Intersection Summary Cumulative with Eastside Parkway with Project, PM  
 50: Reservation Road & SR 68 WB On Ramp/SR 68 WB Off Ramp

06/11/2019



| Movement                      | EBL | EBT  | EBR | WBL  | WBT  | WBR  | NBL  | NBT  | NBR  | SBL  | SBT  | SBR  |
|-------------------------------|-----|------|-----|------|------|------|------|------|------|------|------|------|
| Lane Configurations           |     |      |     |      | ↕    | ↕    | ↕    | ↕    |      |      | ↕    |      |
| Traffic Volume (veh/h)        | 0   | 0    | 0   | 410  | 10   | 250  | 130  | 250  | 0    | 0    | 530  | 180  |
| Future Volume (veh/h)         | 0   | 0    | 0   | 410  | 10   | 250  | 130  | 250  | 0    | 0    | 530  | 180  |
| Number                        |     |      |     | 7    | 4    | 14   | 1    | 6    | 16   | 5    | 2    | 12   |
| Initial Q (Qb), veh           |     |      |     | 0    | 0    | 0    | 0    | 0    | 0    | 0    | 0    | 0    |
| Ped-Bike Adj(A_pbT)           |     |      |     | 1.00 |      | 1.00 | 1.00 |      | 1.00 | 1.00 |      | 1.00 |
| Parking Bus, Adj              |     |      |     | 1.00 | 1.00 | 1.00 | 1.00 | 1.00 | 1.00 | 1.00 | 1.00 | 1.00 |
| Adj Sat Flow, veh/h/ln        |     |      |     | 1900 | 1863 | 1863 | 1845 | 1845 | 0    | 0    | 1827 | 1900 |
| Adj Flow Rate, veh/h          |     |      |     | 436  | 11   | 84   | 138  | 266  | 0    | 0    | 564  | 181  |
| Adj No. of Lanes              |     |      |     | 0    | 1    | 1    | 1    | 1    | 0    | 0    | 1    | 0    |
| Peak Hour Factor              |     |      |     | 0.94 | 0.94 | 0.94 | 0.94 | 0.94 | 0.94 | 0.94 | 0.94 | 0.94 |
| Percent Heavy Veh, %          |     |      |     | 2    | 2    | 2    | 3    | 3    | 0    | 0    | 4    | 4    |
| Cap, veh/h                    |     |      |     | 485  | 12   | 443  | 172  | 1091 | 0    | 0    | 600  | 192  |
| Arrive On Green               |     |      |     | 0.28 | 0.28 | 0.28 | 0.03 | 0.20 | 0.00 | 0.00 | 0.45 | 0.45 |
| Sat Flow, veh/h               |     |      |     | 1732 | 44   | 1581 | 1757 | 1845 | 0    | 0    | 1326 | 426  |
| Grp Volume(v), veh/h          |     |      |     | 447  | 0    | 84   | 138  | 266  | 0    | 0    | 0    | 745  |
| Grp Sat Flow(s),veh/h/ln      |     |      |     | 1776 | 0    | 1581 | 1757 | 1845 | 0    | 0    | 0    | 1752 |
| Q Serve(g_s), s               |     |      |     | 20.6 | 0.0  | 3.4  | 6.6  | 10.4 | 0.0  | 0.0  | 0.0  | 34.5 |
| Cycle Q Clear(g_c), s         |     |      |     | 20.6 | 0.0  | 3.4  | 6.6  | 10.4 | 0.0  | 0.0  | 0.0  | 34.5 |
| Prop In Lane                  |     |      |     | 0.98 |      | 1.00 | 1.00 |      | 0.00 | 0.00 |      | 0.24 |
| Lane Grp Cap(c), veh/h        |     |      |     | 498  | 0    | 443  | 172  | 1091 | 0    | 0    | 0    | 792  |
| V/C Ratio(X)                  |     |      |     | 0.90 | 0.00 | 0.19 | 0.80 | 0.24 | 0.00 | 0.00 | 0.00 | 0.94 |
| Avail Cap(c_a), veh/h         |     |      |     | 564  | 0    | 502  | 248  | 1091 | 0    | 0    | 0    | 792  |
| HCM Platoon Ratio             |     |      |     | 1.00 | 1.00 | 1.00 | 0.33 | 0.33 | 1.00 | 1.00 | 1.00 | 1.00 |
| Upstream Filter(I)            |     |      |     | 1.00 | 0.00 | 1.00 | 0.95 | 0.95 | 0.00 | 0.00 | 0.00 | 1.00 |
| Uniform Delay (d), s/veh      |     |      |     | 29.4 | 0.0  | 23.3 | 40.3 | 18.1 | 0.0  | 0.0  | 0.0  | 22.2 |
| Incr Delay (d2), s/veh        |     |      |     | 15.9 | 0.0  | 0.2  | 6.8  | 0.5  | 0.0  | 0.0  | 0.0  | 20.4 |
| Initial Q Delay(d3),s/veh     |     |      |     | 0.0  | 0.0  | 0.0  | 0.0  | 0.0  | 0.0  | 0.0  | 0.0  | 0.0  |
| %ile BackOfQ(50%),veh/ln      |     |      |     | 12.3 | 0.0  | 1.5  | 3.6  | 5.5  | 0.0  | 0.0  | 0.0  | 21.0 |
| LnGrp Delay(d),s/veh          |     |      |     | 45.4 | 0.0  | 23.5 | 47.1 | 18.6 | 0.0  | 0.0  | 0.0  | 42.6 |
| LnGrp LOS                     |     |      |     | D    |      | C    | D    | B    |      |      |      | D    |
| Approach Vol, veh/h           |     |      |     |      | 531  |      |      | 404  |      |      | 745  |      |
| Approach Delay, s/veh         |     |      |     |      | 41.9 |      |      | 28.4 |      |      | 42.6 |      |
| Approach LOS                  |     |      |     |      | D    |      |      | C    |      |      | D    |      |
| Timer                         | 1   | 2    | 3   | 4    | 5    | 6    | 7    | 8    |      |      |      |      |
| Assigned Phs                  | 1   | 2    |     | 4    |      | 6    |      |      |      |      |      |      |
| Phs Duration (G+Y+Rc), s      | 1.8 | 44.4 |     | 28.7 |      | 56.3 |      |      |      |      |      |      |
| Change Period (Y+Rc), s       | 3.5 | 6.0  |     | 4.9  |      | 6.0  |      |      |      |      |      |      |
| Max Green Setting (Gmax), s   | 2.0 | 31.6 |     | 27.0 |      | 47.1 |      |      |      |      |      |      |
| Max Q Clear Time (g_c+1.0), s | 1.6 | 36.5 |     | 22.6 |      | 12.4 |      |      |      |      |      |      |
| Green Ext Time (p_c), s       | 0.0 | 0.0  |     | 1.2  |      | 1.3  |      |      |      |      |      |      |
| <b>Intersection Summary</b>   |     |      |     |      |      |      |      |      |      |      |      |      |
| HCM 2010 Ctrl Delay           |     |      |     | 38.9 |      |      |      |      |      |      |      |      |
| HCM 2010 LOS                  |     |      |     | D    |      |      |      |      |      |      |      |      |

HCM 2010 Signalized Intersection Summary Cumulative with Eastside Parkway with Project, PM  
 51: River Road/Reservation Road & SR 68 Off Ramp/SR 68 EB On Ramp 06/11/2019



| Movement                     | EBL  | EBT  | EBR  | WBL | WBT  | WBR  | NBL  | NBT  | NBR  | SBL  | SBT  | SBR  |
|------------------------------|------|------|------|-----|------|------|------|------|------|------|------|------|
| Lane Configurations          |      | ↔    | ↗    |     |      |      |      | ↑    | ↗    | ↘    | ↑    |      |
| Traffic Volume (veh/h)       | 100  | 10   | 180  | 0   | 0    | 0    | 0    | 300  | 320  | 260  | 680  | 0    |
| Future Volume (veh/h)        | 100  | 10   | 180  | 0   | 0    | 0    | 0    | 300  | 320  | 260  | 680  | 0    |
| Number                       | 3    | 8    | 18   |     |      |      | 1    | 6    | 16   | 5    | 2    | 12   |
| Initial Q (Qb), veh          | 0    | 0    | 0    |     |      |      | 0    | 0    | 0    | 0    | 0    | 0    |
| Ped-Bike Adj(A_pbT)          | 1.00 |      | 1.00 |     |      |      | 1.00 |      | 1.00 | 1.00 |      | 1.00 |
| Parking Bus, Adj             | 1.00 | 1.00 | 1.00 |     |      |      | 1.00 | 1.00 | 1.00 | 1.00 | 1.00 | 1.00 |
| Adj Sat Flow, veh/h/ln       | 1900 | 1863 | 1863 |     |      |      | 0    | 1845 | 1845 | 1827 | 1827 | 0    |
| Adj Flow Rate, veh/h         | 106  | 11   | 12   |     |      |      | 0    | 319  | 201  | 277  | 723  | 0    |
| Adj No. of Lanes             | 0    | 1    | 1    |     |      |      | 0    | 1    | 1    | 1    | 1    | 0    |
| Peak Hour Factor             | 0.94 | 0.94 | 0.94 |     |      |      | 0.94 | 0.94 | 0.94 | 0.94 | 0.94 | 0.94 |
| Percent Heavy Veh, %         | 2    | 2    | 2    |     |      |      | 0    | 3    | 3    | 4    | 4    | 0    |
| Cap, veh/h                   | 144  | 15   | 141  |     |      |      | 0    | 1038 | 882  | 307  | 1430 | 0    |
| Arrive On Green              | 0.09 | 0.09 | 0.09 |     |      |      | 0.00 | 0.56 | 0.56 | 0.35 | 1.00 | 0.00 |
| Sat Flow, veh/h              | 1614 | 168  | 1583 |     |      |      | 0    | 1845 | 1568 | 1740 | 1827 | 0    |
| Grp Volume(v), veh/h         | 117  | 0    | 12   |     |      |      | 0    | 319  | 201  | 277  | 723  | 0    |
| Grp Sat Flow(s),veh/h/ln     | 1782 | 0    | 1583 |     |      |      | 0    | 1845 | 1568 | 1740 | 1827 | 0    |
| Q Serve(g_s), s              | 5.4  | 0.0  | 0.6  |     |      |      | 0.0  | 7.8  | 5.5  | 12.8 | 0.0  | 0.0  |
| Cycle Q Clear(g_c), s        | 5.4  | 0.0  | 0.6  |     |      |      | 0.0  | 7.8  | 5.5  | 12.8 | 0.0  | 0.0  |
| Prop In Lane                 | 0.91 |      | 1.00 |     |      |      | 0.00 |      | 1.00 | 1.00 |      | 0.00 |
| Lane Grp Cap(c), veh/h       | 159  | 0    | 141  |     |      |      | 0    | 1038 | 882  | 307  | 1430 | 0    |
| V/C Ratio(X)                 | 0.74 | 0.00 | 0.08 |     |      |      | 0.00 | 0.31 | 0.23 | 0.90 | 0.51 | 0.00 |
| Avail Cap(c_a), veh/h        | 524  | 0    | 466  |     |      |      | 0    | 1038 | 882  | 348  | 1430 | 0    |
| HCM Platoon Ratio            | 1.00 | 1.00 | 1.00 |     |      |      | 1.00 | 1.00 | 1.00 | 2.00 | 2.00 | 1.00 |
| Upstream Filter(l)           | 1.00 | 0.00 | 1.00 |     |      |      | 0.00 | 1.00 | 1.00 | 0.09 | 0.09 | 0.00 |
| Uniform Delay (d), s/veh     | 37.7 | 0.0  | 35.5 |     |      |      | 0.0  | 9.8  | 9.3  | 26.8 | 0.0  | 0.0  |
| Incr Delay (d2), s/veh       | 6.5  | 0.0  | 0.3  |     |      |      | 0.0  | 0.8  | 0.6  | 3.1  | 0.1  | 0.0  |
| Initial Q Delay(d3),s/veh    | 0.0  | 0.0  | 0.0  |     |      |      | 0.0  | 0.0  | 0.0  | 0.0  | 0.0  | 0.0  |
| %ile BackOfQ(50%),veh/ln     | 3.0  | 0.0  | 0.3  |     |      |      | 0.0  | 4.1  | 2.5  | 6.3  | 0.0  | 0.0  |
| LnGrp Delay(d),s/veh         | 44.2 | 0.0  | 35.8 |     |      |      | 0.0  | 10.6 | 9.9  | 29.9 | 0.1  | 0.0  |
| LnGrp LOS                    | D    |      | D    |     |      |      |      | B    | A    | C    | A    |      |
| Approach Vol, veh/h          |      | 129  |      |     |      |      |      | 520  |      |      | 1000 |      |
| Approach Delay, s/veh        |      | 43.4 |      |     |      |      |      | 10.3 |      |      | 8.4  |      |
| Approach LOS                 |      | D    |      |     |      |      |      | B    |      |      | A    |      |
| Timer                        | 1    | 2    | 3    | 4   | 5    | 6    | 7    | 8    |      |      |      |      |
| Assigned Phs                 |      | 2    |      |     | 5    | 6    |      | 8    |      |      |      |      |
| Phs Duration (G+Y+Rc), s     |      | 72.5 |      |     | 18.7 | 53.8 |      | 12.5 |      |      |      |      |
| Change Period (Y+Rc), s      |      | 6.0  |      |     | 3.7  | 6.0  |      | 4.9  |      |      |      |      |
| Max Green Setting (Gmax), s  |      | 43.1 |      |     | 17.0 | 28.4 |      | 25.0 |      |      |      |      |
| Max Q Clear Time (g_c+I1), s |      | 2.0  |      |     | 14.8 | 9.8  |      | 7.4  |      |      |      |      |
| Green Ext Time (p_c), s      |      | 5.0  |      |     | 0.2  | 2.1  |      | 0.5  |      |      |      |      |
| <b>Intersection Summary</b>  |      |      |      |     |      |      |      |      |      |      |      |      |
| HCM 2010 Ctrl Delay          |      |      | 11.7 |     |      |      |      |      |      |      |      |      |
| HCM 2010 LOS                 |      |      | B    |     |      |      |      |      |      |      |      |      |

**APPENDIX F: ASSOCIATION OF MONTEREY BAY AREA GOVERNMENTS  
TRAVEL MODEL VALIDATION**





## MEMORANDUM

Date: June 10, 2019

To: Anya Spear and Matt McCluney, California State University Monterey Bay  
Steve Lohr and Dawn Theodora, California State University Office of the Chancellor  
Ann Sansevero, Dudek

From: Bryan Esparza, Daniel Rubins, and Matt Haynes, Fehr & Peers

**Subject: California State University Monterey Bay Master Plan EIR – AMBAG Model Review and Documentation**

*SJ17-1728*

---

Fehr & Peers reviewed the Association of Bay Area Governments (AMBAG) regional travel model to evaluate its suitability for developing long-range traffic forecast for streets and highways within the greater Monterey Bay Area. Fehr & Peers reviewed the primary model inputs in the project area (such as base and future year land use inputs and roadway network assumptions) and also checked the performance of the model against typical validation thresholds. Modifications to the AMBAG regional travel model land use and transportation network inputs were completed to improve the validation of the daily, peak period and peak hour travel models. These changes to the AMBAG regional travel model are documented in this memorandum for application within the CSUMB study area.

### **REVIEW OF AMBAG REGIONAL TRAVEL MODEL INPUTS**

The AMBAG regional travel model was fully updated in 2014, with minor updates incorporating more recent estimates of existing and future land uses per the Fort Ord Reuse Authority (FORA) travel model update completed in 2017. The AMBAG regional travel model as-received includes a 2010 base year and a 2035 future year. A screen capture of the 2010 base year model near the CSUMB campus and region wide is shown in **Attachments A** and **B**, respectively. The 2010 base year model contains freeways, arterials, and local streets within the Monterey County and the land use is summarized in traffic analysis zones. The model includes similar detail in the rest of the AMBAG region of Santa Cruz and San Benito counties. Fehr & Peers reviewed the street network coding including the number of lanes, vehicle speed, and vehicle capacity, and the land use in puts in the traffic analysis zones near the CSUMB campus.



The existing and future land use inputs are summarized into traffic analysis zones (TAZs). **Table 1** summarizes the as-received version of the land use inputs under existing and future years for the AMBAG regional travel model. The AMBAG regional travel model is based on the *2014 Regional Growth Forecast* (AMBAG, 2014) with land use projections for 2010 and 2035. The AMBAG base travel model (2010) includes social and demographic information from the 2010 Census (*Association of Monterey Bay Area Governments Regional Travel Demand Model Technical Report*, 2014).

**TABLE 1: AMBAG Model Residential and Employment Land Uses**

| Land Use Category  | 2010            |                   |                   | 2035            |                   |                   |
|--------------------|-----------------|-------------------|-------------------|-----------------|-------------------|-------------------|
|                    | Monterey County | Santa Cruz County | San Benito County | Monterey County | Santa Cruz County | San Benito County |
| <b>Residential</b> |                 |                   |                   |                 |                   |                   |
| Total Households   | 126,180         | 94,130            | 16,910            | 143,390         | 111,000           | 23,970            |
| Total Population   | 385,050         | 246,240           | 54,400            | 444,080         | 292,790           | 75,830            |
| <b>Employment</b>  |                 |                   |                   |                 |                   |                   |
| Agricultural       | 45,100          | 9,600             | 1,600             | 48,670          | 10,230            | 1,500             |
| Construction       | 4,300           | 3,000             | 800               | 6,220           | 4,320             | 960               |
| Industrial         | 5,600           | 5,300             | 2,500             | 5,420           | 4,490             | 2,790             |
| Retail             | 20,100          | 14,900            | 2,400             | 23,910          | 15,640            | 2,790             |
| Service            | 60,900          | 43,700            | 5,100             | 77,810          | 50,370            | 6,730             |
| Public             | 46,000          | 33,700            | 3,800             | 60,140          | 46,090            | 4,780             |
| <b>Total</b>       | <b>182,000</b>  | <b>110,200</b>    | <b>16,200</b>     | <b>222,170</b>  | <b>131,140</b>    | <b>19,550</b>     |

Notes: All values have been rounded to the nearest 10.

Monterey County TAZs in **Attachment M**

Santa Cruz County TAZs in **Attachment N**

San Benito County TAZs in **Attachment O**

Based on summary of AMBAG TAZs ranging between 3 and 1839.

Source: AMBAG regional travel model.

The review and update of the AMBAG regional travel model involved several steps. The land use allocation for the base year (2010) model and future year was reviewed. The travel model land use changes from base year to future year (2035) models were updated to be consistent with the FORA version of the AMBAG model and adjacent city approved and pending project lists. All of these steps are described in more detail in the following sections of the memorandum.

## MODEL VALIDATION GUIDELINES

The AMBAG regional travel model is one of the only tools available for estimating long-range traffic forecasts for streets and highways in the greater Monterey Bay area. The review and refinement of



the AMBAG regional travel model is intended to provide more accurate forecasts than are currently available for non-regional (i.e., local) streets in Marina, Salinas, and Seaside. Since it would be impossible for any travel forecasting model to precisely replicate all counts within a given roadway network, two-way morning peak hour, evening peak hour, and daily validation guidelines have been established by Caltrans and other agencies. These guidelines are meant to measure the travel model's relative performance in forecasting existing travel volumes as compared to existing counts while maintaining sensitivity to land use and roadway network changes. Key static validation standards for daily travel models based on Caltrans guidelines<sup>1</sup> are summarized below.

- At least 75 percent of the roadway links for which counts are available should be within the maximum desirable deviation, which ranges from approximately 13 to 68 percent depending on total roadway volume (the larger the volume, the less deviation is permitted).
- The correlation coefficient between the actual ground counts and the estimated traffic volumes should be greater than 88 percent.
- The Root Mean Square Error (RMSE) should not exceed 40 percent. This measure of effectiveness (MOE) is most important for screenlines, but is also used to describe the certainty of functional classification and volume ranges.

Although not stated in the Caltrans standards, additional Fehr & Peers validation guidelines were applied to the TDF model:

- The two-way sum of the volumes on all roadway links for which counts are available should be within 10 percent of the counts.
- All roadway screenlines should be within the maximum desirable deviation, which ranges from approximately 17 to 64 percent depending on total screenline volume.

## INITIAL BASE MODEL RUN

We began with the base year (Year 2010) model provided by AMBAG. This as-is model represents the model as received from AMBAG, with no changes made. The initial sub-area validation results from this version of the model are presented in **Table 2** for daily and the morning and evening peak hours. The statistics show that while most of the measures are met, some are not.

The AMBAG model generates volumes for four time periods. These periods are the Morning Peak Period (6:00 to 9:00 AM), Midday Peak Period (9:00 AM to 4:00 PM), Evening Peak Period (4:00 to 7:00 PM), and Nighttime (7:00 PM to 6:00 AM). In order to convert these period volumes to peak hour volumes, Fehr & Peers used a peak period to peak hour factor of 0.51 for the morning peak

---

<sup>1</sup> Static Validation Criteria and Thresholds, *2017 California Regional Transportation Plan Guidelines*, California Transportation Commission, January 2017.



hour and 0.40 for the evening peak hour informed by the volume-to-count ratio of all the 2017 validation count locations. This is a similar method to how the AMBAG regional travel model converts peak period volumes to peak hour volume within the travel model.

Fehr & Peers collected traffic count data in between 2015 and 2017 specifically for the purpose of model validation of the roadways within the study area. These roadway counts were supplemented with annual monitoring counts from the Transportation Agency Monterey County (TAMC) for calibration of regional freeways and ramps.

As shown in **Table 2**, for each of the validation periods, some of the static validation statistics (i.e., percent of links within Caltrans deviation allowance and percent of screenlines within maximum deviation) are not met. And for the daily model results the volume-to-count ratio is not met. In addition to the model-wide statistics, the detailed results by Functional Classification, Volume Range, Two-Way Total Traffic Volume, and Screenlines are attached **Attachment C, D, E** and **F**.

**Table 2: SUB-AREA TDF MODEL STATIC VALIDATION SUMMARY (RUN 00)**

| Validation Item  | Threshold                        | AM Peak Hour | PM Peak Hour | Daily       |
|--|----------------------------------|--------------|--------------|-------------|
| <b>Summary Statistics</b>                              |                                  |              |              |             |
| Local Street Count Locations                           | N/A                              | 40           | 40           | 40          |
| Freeway and Ramp Count Locations                       | N/A                              | 10           | 10           | 10          |
| Model/Count Ratio                                      | N/A                              | 1.00         | 1.00         | 0.87        |
| <b>Static Validation Statistics</b>                    |                                  |              |              |             |
| Percent of Links Within Caltrans Deviation Allowance = | At Least 75%                     | 48%          | 42%          | 54%         |
| Correlation Coefficient =                              | At Least 0.88                    | <b>0.98</b>  | <b>0.98</b>  | <b>0.99</b> |
| Percent Root Mean Square Error (RMSE) =                | Below 40%                        | <b>32%</b>   | <b>32%</b>   | <b>26%</b>  |
| Volume-to-Count Ratio (Sum of all Locations) =         | Within ±10%                      | <b>0</b>     | <b>0</b>     | -13%        |
| Percent of Screenlines Within Maximum Deviation =      | 100% of links between 17% to 64% | 80%          | 65%          | 79%         |

Notes:

1. **Bold text** indicates model validation meets guidelines.

Source: Fehr & Peers, 2019.





In general, the base year model overestimated volumes on most freeway facilities in the project area for the daily, AM peak hour, and PM peak hour model runs. The local roadways were generally underestimated for each time period too.

## BASE MODEL INPUT ADJUSTMENTS

To improve model validation, adjustments were made to several model components, including the roadway network inputs and CSUMB campus trip generation. These changes are described below and include land use and population changes, as well as roadway network changes.

### BASE MODEL LAND USE CHANGES

Based on information received from CSUMB staff and comparing land uses in the model to aeriels of Existing Conditions, land use and population adjustments were made to the as-is Existing Conditions TDF model (Run 00). These edits are presented in **Table 3**.

**TABLE 3: BASE MODEL LAND USE CHANGES**

| TAZ  | Jurisdiction      | Description of Edit  |
|------|-------------------|--|
| 1056 | Monterey County   | <ul style="list-style-type: none"> <li>Increase Public Employment from 0 to 13</li> <li>Increase K-12 enrollment from 0 to 30</li> </ul>                       |
| 808  | Marina            | <ul style="list-style-type: none"> <li>Adjust Industry Employment to 30 employees</li> <li>Adjust Administrative Employment to 7 employees</li> </ul>          |
| 878  | Monterey County   | <ul style="list-style-type: none"> <li>Adjust Service Employment to 50 employees</li> </ul>  |
| 863  | Monterey County   | <ul style="list-style-type: none"> <li>Adjust Employment to zero</li> </ul>  |
| 806  | CSUMB             | <ul style="list-style-type: none"> <li>Adjusted University Enrollment to 2,322</li> </ul>  |
| 826  | CSUMB             | <ul style="list-style-type: none"> <li>Adjusted University Enrollment to 995</li> </ul>  |
| 847  | CSUMB             | <ul style="list-style-type: none"> <li>Increase University Enrollment from 0 to 3,317</li> </ul>   |
| 765  | Seaside           | <ul style="list-style-type: none"> <li>Shift 56 Public Employees from TAZ 765 to TAZ 762</li> </ul>  |
| 749  | Seaside           | <ul style="list-style-type: none"> <li>Increase Public Employment 0 to 150</li> </ul>  |
| 743  | Seaside           | <ul style="list-style-type: none"> <li>Shift 304 K-12 Enrollment from TAZ 743 to TAZ 749</li> </ul>  |
| 729  | Santa Cruz County | <ul style="list-style-type: none"> <li>Shift 47 Public Employees from TAZ 729 to TAZ 755</li> <li>Shift 229 K-12 Enrollment from TAZ 729 to TAZ 755</li> </ul> |



## BASE MODEL ROADWAY NETWORK CHANGES

Roadway network edits were made to improve model validation, improve consistency with local traffic counts, and more accurately represent existing roadways within the study area. These changes are presented on **Table 4**.

**TABLE 4: BASE MODEL ROADWAY NETWORK CHANGES**

| Facility Type   | Attribute Edited | Description  |
|-----------------|------------------|--|
| Roadway Network | Road Expansion   | Changed Imjin Parkway from Reservation Road to Imjin Road to be a 2-lane minor arterial.   |
| Roadway Network | Road Expansion   | Changed Imjin Parkway from Imjin Road to Highway 1 to be a 4-lane minor arterial.  |
| Roadway Network | Speed Increase   | Increase speed on Del Monte Boulevard from Reservation Road to Marina Green Road from 35 miles per hour (mph) to 40 mph.                                       |
| Roadway Network | Bike Class       | Adjust bicycle facility type on Imjin Road from Imjin Road to Reservation Parkway to Bike Class II.  |
| Roadway Network | Node             | Adjust centroid connector placement from node 3568 to node 37011.  |
| Roadway Network | Node             | Adjust centroid connector placement from node 8071 to node 37004.  |
| Roadway Network | Node             | Adjust centroid connector placement from node 33033 to node 37006.   |
| Roadway Network | Node             | Adjust centroid connector placement from node 33036 to node 37005.   |
| Roadway Network | Node             | Adjust centroid connector placement from node 33034 to node 37007.   |
| Roadway Network | Node             | Adjust centroid connector placement from node 3087 to node 37008.  |
| Roadway Network | Node             | Adjust centroid connector placement from node 3190 to node 37009.  |
| Roadway Network | Node             | Adjust centroid connector placement from node 2672 to node 37010.  |
| Roadway Network | Functional Class | Changed from Local Road to Transit Only Link on Divarty Street between Engineer Lane and 4 <sup>th</sup> Street to reflect existing limited access conditions. |
| Roadway Network | Functional Class | Changed from Local Road to Transit Only Link on 6 <sup>th</sup> Avenue between A Street and B Street to reflect existing limited access conditions.            |

Source: Fehr & Peers, 2019.



## CSUMB CAMPUS TRIP GENERATION CHANGES

The Existing Conditions external trip generation for the CSUMB campus described in the *California State University Monterey Bay Master Plan EIR – Trip Generation Evaluation Methods and Estimates* memorandum is implemented by factoring the morning and evening peak hour vehicle trip matrices for the traffic analysis zones 806, 826, 847, 908, and 913.

## UPDATED BASE MODEL RUN (RUN 01) VALIDATION RESULTS

By making adjustments described in the previous sections, the model performance was slightly improved for each time period. The revised base year model sub-area validation results classified by Functional Class Volume Range, Two-Way Total Traffic Volume, and Screenlines are attached (see **Attachments G, H, I and J**), and are referred to as Run 01, which includes daily, AM and PM peak hour. For all time periods the amount of two-way roadway model to count volume ratios within deviation increased. Validation results by functional class for both the PM peak hour and Daily show increase number of RSME values within deviation. AM peak hour and Daily have more screenlines within deviation. The model validation results for the updated base model given in **Table 5** presents the validation results for all validation locations regardless of functional class or volume.



**ABLE 5: SUB-AREA TDF MODEL STATIC VALIDATION SUMMARY (Run 01)**

| Validation Item  | Threshold                        | AM Peak Hour | PM Peak Hour | Daily       |
|--|----------------------------------|--------------|--------------|-------------|
| <b>Summary Statistics</b>                              |                                  |              |              |             |
| Local Street Count Locations                           | N/A                              | 40           | 40           | 40          |
| Freeway and Ramp Count Locations                       | N/A                              | 10           | 10           | 10          |
| Model/Count Ratio                                      | N/A                              | 1.02         | 1.02         | 0.88        |
| <b>Static Validation Statistics</b>                    |                                  |              |              |             |
| Percent of Links Within Caltrans Deviation Allowance = | At Least 75%                     | <u>48%</u>   | <u>48%</u>   | <u>58%</u>  |
| Correlation Coefficient =                              | At Least 0.88                    | <b>0.98</b>  | <b>0.98</b>  | <b>0.99</b> |
| Percent Root Mean Square Error (RMSE) =                | Below 40%                        | <b>34%</b>   | <b>35%</b>   | <b>24%</b>  |
| Volume-to-Count Ratio (Sum of all Locations) =         | Within ±10%                      | <b>2%</b>    | <b>2%</b>    | <u>-11%</u> |
| Percent of Screenlines Within Maximum Deviation =      | 100% of links between 17% to 64% | <u>75%</u>   | 85%          | 79%         |

Notes:

1. **Bold text** indicates model validation meet guidelines.
  2. Underlined text indicates model validation results improved from Run 00.
- Source Fehr & Peers, 2019

For each of the validation periods, some of the static validation statistics (i.e., percent of links within Caltrans deviation allowance and percent of screenlines within maximum deviation) are not met; however, the results do show improvement compared to Run 00. Percent root mean square error is still below the 40% threshold and has shown further improvement in Run 01. Similar to the Run 00 results, the revised base year TDF model (Run 01) overestimated volumes on most freeway/expressway facilities in the Marina area for the daily, AM peak hour, and PM peak hour model runs. The local roadways were generally underestimated for the three time periods.

Fehr & Peers was able to improve the validation and reduce the overall error in the model for street and highway segments within the study area. Therefore, this updated Association of Bay Area Governments (AMBAG) regional travel model is the best tool available for developing long-range traffic forecast for streets and highways within the greater Monterey Bay Area.



## FUTURE YEAR MODEL INPUT ADJUSTMENTS

The future year (Year 2035) model was provided by AMBAG. This as-is model represents the model as received from AMBAG, with no changes made. Fehr & Peers updated and added land use and roadway coding according to the Regional Transportation Plan (RTP) planned and funded street improvements planned by the Fort Ord Reuse Authority (FORA), City of Marina, and the AMBAG Regional Transportation Plan (RTP). The future year model update incorporates land use and network changes per the (FORA) travel model update completed in 2017. Fehr & Peers also adjusted the external trip generation for the CSUMB campus to represent future conditions.

## FUTURE MODEL LAND USE CHANGES

Land use and population refinements were made based on information received from CSUMB staff and comparing land uses in the model to other models including the FORA AMBAG regional travel model. **Table 6** presents these changes.



**TABLE 6: FUTURE YEAR MODEL LAND USE CHANGES**

| TAZ  | Jurisdiction       | Description  |
|--|--------------------|--|
| 826  | Marina             | <ul style="list-style-type: none"> <li>Add 508 K-12 Student Enrollment</li> </ul>  |
| 1803   | Seaside            | <ul style="list-style-type: none"> <li>Add 214 Retail Employment</li> <li>Add 375 Service Employment</li> <li>Add 100 Industrial Employment</li> </ul>   |
| 1035,<br>1039,<br>1042,<br>1052,<br>1063,<br>1065,<br>1068,<br>1070, | Monterey<br>County | <p>The following land uses were spread amongst the listed TAZs:</p> <ul style="list-style-type: none"> <li>Add 167 Public Employment</li> <li>Add 167 Service Employment</li> <li>Add 161 Industrial Employment</li> </ul>                                   |
| 790  | Marina             | <ul style="list-style-type: none"> <li>Add 500 Hotel Rooms</li> </ul>  |
| 832  | Marina             | <ul style="list-style-type: none"> <li>Add 21 Public Employment</li> <li>Add 135 Industrial Employment</li> </ul>  |
| 836  | Marina             | <ul style="list-style-type: none"> <li>Add 48 Public Employment</li> <li>Add 135 Industrial Employment</li> </ul>  |
| 819  | Marina             | <ul style="list-style-type: none"> <li>Edit number of K-12 Enrollment to be 86 from 3</li> <li>Edit Retail Employment to be 86 from 0</li> <li>Edit Service Employment to be 360 from 233</li> <li>Edit Industrial Employment to be 1,304 from 24</li> </ul> |
| 788  | Marina             | <ul style="list-style-type: none"> <li>Edit number of Retail Employment to be 127 from 0</li> <li>Edit number of Hotel Rooms to be 100 from 0</li> </ul>   |
| 791  | Marina             | <ul style="list-style-type: none"> <li>Edit number of Retail Employment to be 126 from 0</li> <li>Edit number of Hotel Rooms to be 100 from 0</li> </ul>   |
| 710  | Seaside            | <ul style="list-style-type: none"> <li>Edit number of Industrial Employment to be 148 from 0</li> </ul>  |
| 761  | Seaside            | <ul style="list-style-type: none"> <li>Edit number of Service Employment to be 74 from 0</li> </ul>  |

Source: Fehr & Peers, 2019.

## FUTURE YEAR ROADWAY NETWORK CHANGES

The future year transportation network includes the planned and funded street improvements planned by the Fort Ord Reuse Authority (FORA), City of Marina, and the AMBAG Regional Transportation Plan (RTP) (see **Attachment K** and **L** for a description of the Cumulative without Project Conditions transportation improvements list). **Table 7** summarizes the roadway network edits to the 2035 roadway network near the study area.



**TABLE 7: FUTURE YEAR MODEL ROADWAY NETWORK CORRECTIONS**

| Attributes Edited            | Description   |
|------------------------------|---|
| Road Classification/Speed    | Changed Eastside Parkway classification from a Local Road to a Minor Arterial with posted speeds of 45 mph from the end of the existing Eucalyptus Road to Inter Garrison Road. |
| Road Addition                | Add Watkins Gate Road to the model from Sloat Street to Reservation Road. Classification is coded in as a local road with two lanes.  |
| Road Expansion               | Changed Imjin Parkway from Reservation Road to Highway 1 from a Local Road classification to a 4-lane Minor Arterial with a posted speed of 40 mph.                             |
| Road Classification/Speed    | Changed Lightfighter Drive from Highway 1 SB Ramps to General Jim Moore Boulevard from a Local Roadway to a Principal Arterial with a posted speed of 40 mph.                   |
| Road Expansion               | Widened 2 <sup>nd</sup> Avenue between Lightfighter Drive to Imjin Parkway to four lanes.   |
| Bike Facility Classification | Change Bike Lane Facility to Class II on Imjin Parkway from Imjin Road to 2nd Avenue.   |
| Bike Facility Classification | Change Bike Lane Facility to Class II on Giggling Road from 6th Division Road to General Jim Moore Boulevard.   |
| Bike Facility Classification | Change Bike Lane Facility to Class II on General Jim Moore Boulevard from Giggling Road to Inter-Garrison Road.   |
| Bike Facility Classification | Change Bike Lane Facility to Class III on A Street from 7th Avenue to Divarty Street.   |
| Bike Facility Classification | Change Bike Lane Facility to Class III on Divarty Street from General Jim Moore Boulevard to 5th Avenue.  |
| Bike Facility Classification | Change Bike Lane Facility to Class I on Beach Range Road from 1st Street to Highway 1.  |
| Node                         | Adjust centroid connector placement for node 39023 in order to correctly load volumes onto roadway network.   |
| Node                         | Adjust centroid connector placement from node 33033 to node 39025.  |
| Node                         | Adjust centroid connector placement from node 33036 to node 39024.  |
| Node                         | Adjust centroid connector placement from node 33034 to node 39026.  |
| Node                         | Adjust centroid connector placement from node 3087 to node 39027.   |
| Node                         | Adjust centroid connector placement from node 3190 to node 39028.   |
| Node                         | Adjust centroid connector placement from node 2672 to node 39029.   |
| Node                         | Adjust centroid connector placement from node 3568 to node 39030.   |

Source: Fehr & Peers, 2019



## ATTACHMENTS:

- Attachment A: AMBAG Base Year Model Network and TAZs Near the CSUMB Campus
- Attachment B: AMBAG Base Year Model Network and TAZs Regionwide
- Attachment C: Initial Model Validation Results: Functional Classification, Run 00
- Attachment D: Initial Model Validation Results: Roadway Volume Range, Run 00
- Attachment E: Initial Model Validation Results: Screenlines Using Two-Way Volume, Run 00
- Attachment F: Initial Model Validation Results: By Link Using Two-Way Volume, Run 00
- Attachment G: Final Model Validation Results: Functional Classification, Run 01
- Attachment H: Final Model Validation Results: Roadway Volume Range, Run 01
- Attachment I: Final Model Validation Results: Screenlines Using Two-Way Volume, Run 01
- Attachment J: Final Model Validation Results: By Link Using Two-Way Volume, Run 01
- Attachment K: Cumulative without Project Conditions Roadway Improvements
- Attachment L: Cumulative without Project Conditions Intersection Improvements
- Attachment M: Monterey County List of TAZs
- Attachment N: San Benito County List of TAZs
- Attachment O: Santa Cruz County List of TAZs



**ATTACHMENT A: AMBAG BASE YEAR MODEL NETWORK AND  
TAZS NEAR THE CSUMB CAMPUS**

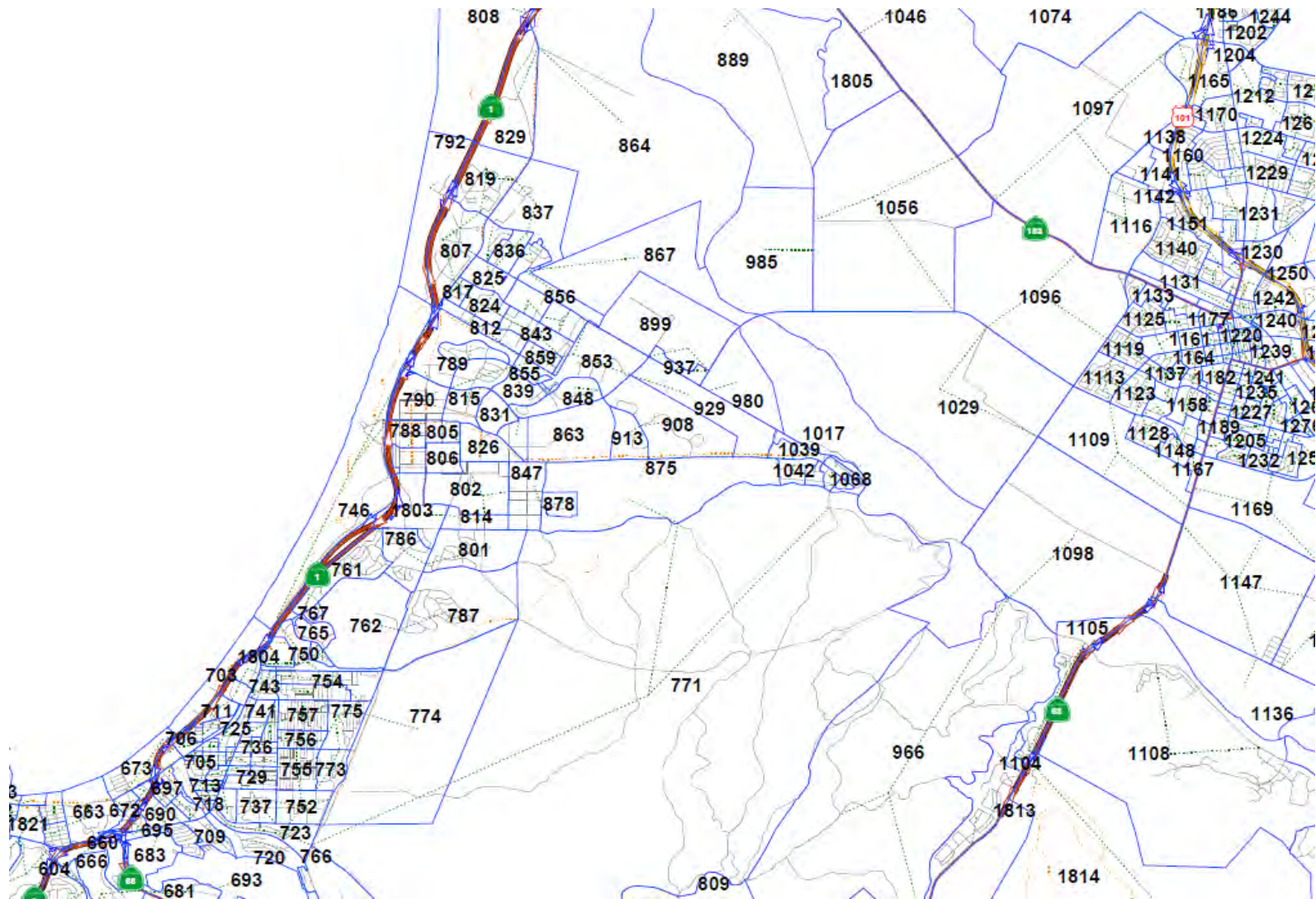

**ATTACHMENT B: AMBAG BASE YEAR MODEL NETWORK AND  
TAZS REGIONWIDE**

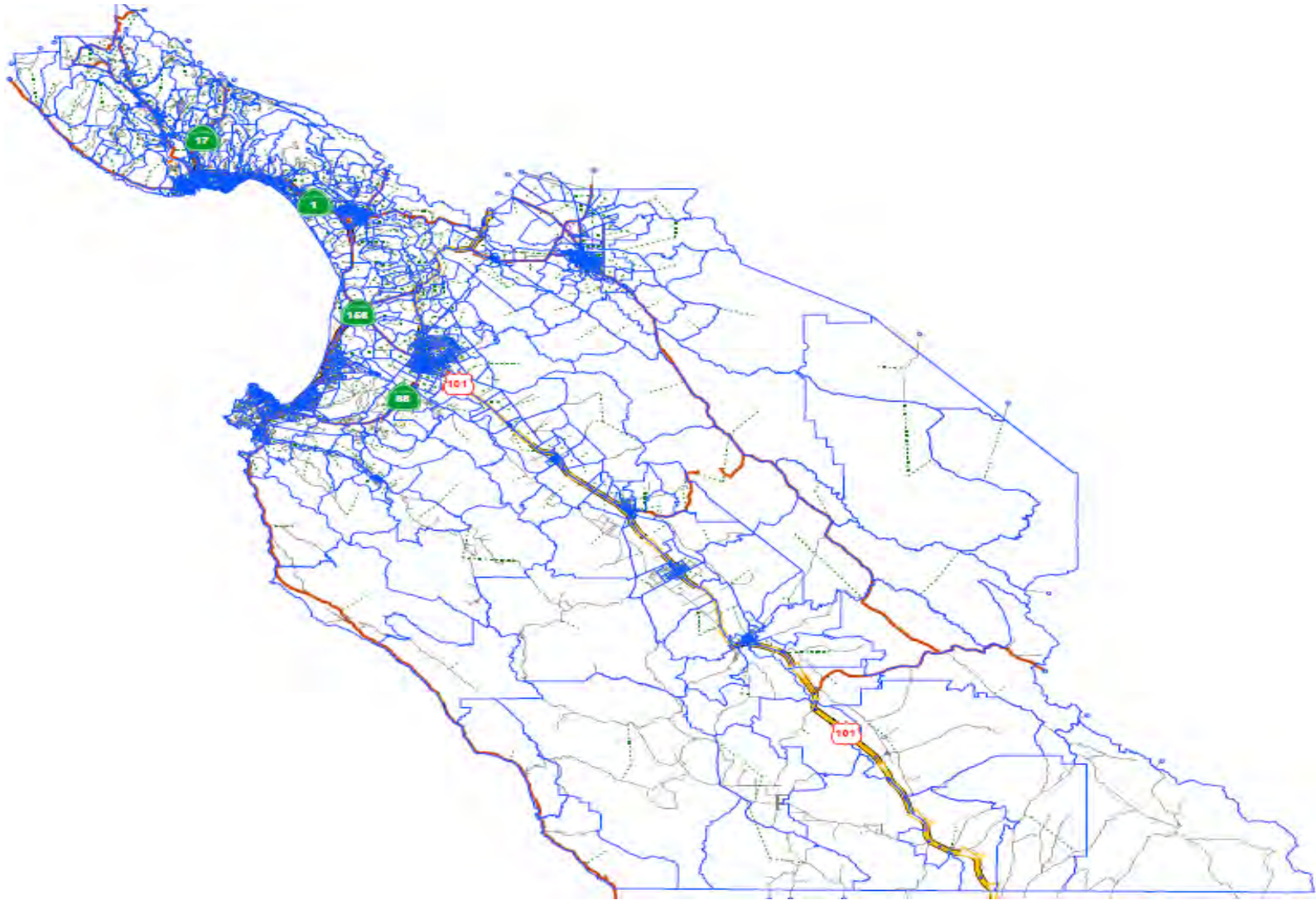

**ATTACHMENT C: INITIAL MODEL VALIDATION RESULTS:  
FUNCTIONAL CLASSIFICATION, RUN 00**

| Table C1: Results of AM Peak-Hour Model Area Validation by Functional Class, Run 00 |       |                       |      |        |                        |         |        |
|---|-------|-----------------------|------|--------|------------------------|---------|--------|
| Functional Class  | Links | Volume-to-Count Ratio |      |        | Root Mean Square Error |         |        |
|   |       | Criteria              | %    | Valid? | %                      | Maximum | Valid? |
| Freeway or Expressway   | 9     | 16%                   | 10%  | Yes    | 14%                    | 40%     | Yes    |
| Principal Arterial  | 10    | 29%                   | 3%   | Yes    | 35%                    | 40%     | Yes    |
| Minor Arterial  | 6     | 48%                   | -3%  | Yes    | 39%                    | 40%     | Yes    |
| Local Roadway   | 18    | 48%                   | -58% | No     | 89%                    | 40%     | No     |
| Major Collector   | 6     | 48%                   | -11% | Yes    | 91%                    | 40%     | No     |
| Ramp  | 1     | 28%                   | -23% | Yes    | 23%                    | 40%     | Yes    |
| Total   | 50    | 10%                   | 0%   | Yes    | 32%                    | 40%     | Yes    |

| Table C2: Results of PM Peak-Hour Model Area Validation by Functional Class, Run 00 |       |                       |      |        |                        |         |        |
|---|-------|-----------------------|------|--------|------------------------|---------|--------|
| Functional Class  | Links | Volume-to-Count Ratio |      |        | Root Mean Square Error |         |        |
|   |       | Criteria              | %    | Valid? | %                      | Maximum | Valid? |
| Freeway or Expressway   | 9     | 16%                   | 14%  | Yes    | 18%                    | 40%     | Yes    |
| Principal Arterial  | 10    | 29%                   | -9%  | Yes    | 28%                    | 40%     | Yes    |
| Minor Arterial  | 6     | 48%                   | -1%  | Yes    | 41%                    | 40%     | No     |
| Local Roadway   | 18    | 48%                   | -53% | No     | 87%                    | 40%     | No     |
| Major Collector   | 6     | 48%                   | -25% | Yes    | 42%                    | 40%     | No     |
| Ramp  | 1     | 28%                   | -13% | Yes    | 13%                    | 40%     | Yes    |
| Total   | 50    | 10%                   | 0%   | Yes    | 32%                    | 40%     | Yes    |

| Table C3: Results of Daily Model Area Validation by Functional Class, Run 00 |       |                       |      |        |                        |         |        |
|--|-------|-----------------------|------|--------|------------------------|---------|--------|
| Functional Class   | Links | Volume-to-Count Ratio |      |        | Root Mean Square Error |         |        |
|  |       | Criteria              | %    | Valid? | %                      | Maximum | Valid? |
| Freeway or Expressway  | 9     | 16%                   | -5%  | Yes    | 12%                    | 40%     | Yes    |
| Principal Arterial   | 10    | 29%                   | -20% | Yes    | 27%                    | 40%     | Yes    |
| Minor Arterial   | 6     | 48%                   | -13% | Yes    | 36%                    | 40%     | Yes    |
| Local Roadway  | 18    | 48%                   | -51% | No     | 88%                    | 40%     | No     |
| Major Collector  | 6     | 48%                   | -29% | Yes    | 43%                    | 40%     | No     |
| Ramp   | 1     | 28%                   | -39% | No     | 39%                    | 40%     | Yes    |
| Total  | 50    | 10%                   | -13% | No     | 26%                    | 40%     | Yes    |

**ATTACHMENT D: INITIAL MODEL VALIDATION RESULTS:  
ROADWAY VOLUME RANGE, RUN 00**

| Table D1: Results of AM Peak-Hour Model Area Validation by Roadway Volume, Run 00 |        |                       |      |        |                        |         |        |
|---|--------|-----------------------|------|--------|------------------------|---------|--------|
| Functional Class  | Counts | Volume-to-Count Ratio |      |        | Root Mean Square Error |         |        |
|   |        | Criteria              | %    | Valid? | %                      | Maximum | Valid? |
| Less than 1,000   | 30     | 34%                   | -30% | Yes    | 81%                    | 116%    | Yes    |
| 1,000 to 2,499  | 10     | 25%                   | -6%  | Yes    | 38%                    | 116%    | Yes    |
| 2,500 to 4,999  | 2      | 19%                   | 9%   | Yes    | 28%                    | 116%    | Yes    |
| 5,000 to 10,000   | 8      | 14%                   | 9%   | Yes    | 13%                    | 43%     | Yes    |
| Total   | 50     |                       |      |        |                        |         |        |

| Table D2: Results of PM Peak-Hour Model Area Validation by Roadway Volume, Run 00 |       |                       |      |       |                        |         |        |
|---|-------|-----------------------|------|-------|------------------------|---------|--------|
| Functional Class  | Links | Volume-to-Count Ratio |      |       | Root Mean Square Error |         |        |
|   |       | Criteria              | %    | Valid | %                      | Maximum | Valid? |
| Less than 1,000   | 27    | 34%                   | -33% | Yes   | 69%                    | 116%    | Yes    |
| 1,000 to 2,499  | 13    | 25%                   | -12% | Yes   | 32%                    | 116%    | Yes    |
| 2,500 to 4,999  | 3     | 19%                   | 20%  | No    | 36%                    | 116%    | Yes    |
| 5,000 to 10,000   | 7     | 14%                   | 10%  | Yes   | 13%                    | 43%     | Yes    |
| Total   | 50    |                       |      |       |                        |         |        |

| Table D3: Results of Daily Model Area Validation by Roadway Volume, Run 00 |        |                       |      |        |                        |         |        |
|--|--------|-----------------------|------|--------|------------------------|---------|--------|
| Functional Class   | Counts | Volume-to-Count Ratio |      |        | Root Mean Square Error |         |        |
|  |        | Criteria              | %    | Valid? | %                      | Maximum | Valid? |
| Less than 1,000  | 3      | 34%                   | 291% | No     | 81%                    | 116%    | Yes    |
| 1,000 to 2,499   | 0      | 25%                   | NA   | N/A    | 68%                    | 116%    | N/A    |
| 2,500 to 4,999   | 11     | 19%                   | -56% | No     | 74%                    | 116%    | Yes    |
| 5,000 to 9,999   | 15     | 14%                   | -30% | No     | 48%                    | 43%     | No     |
| 10,000 to 19,999   | 5      | 14%                   | -26% | No     | 38%                    | 28%     | No     |
| 20,000 to 24,999   | 3      | 14%                   | -36% | No     | 36%                    | 25%     | No     |
| 25,000 to 39,999   | 4      | 14%                   | -21% | No     | 25%                    | 25%     | Yes    |
| 40,000 to 49,999   | 0      | 14%                   | N/A  | N/A    | NA                     | 30%     | N/A    |
| 50,000 to 59,999   | 1      | 14%                   | 2%   | Yes    | 2%                     | 30%     | Yes    |
| 60,000 to 89,999   | 5      | 14%                   | 2%   | Yes    | 8%                     | 19%     | Yes    |
| Total  | 47     |                       |      |        |                        |         |        |



**ATTACHMENT E: INITIAL MODEL VALIDATION RESULTS:  
SCREENLINES USING TWO-WAY VOLUME, RUN 00**

| Table E1: Results of Screenline AM Peak Hour - Two-Way Volume, Run 00       |           |  |              |               |          |                |                   |                  |             |                    |              |
|---|-----------|--|--------------|---------------|----------|----------------|-------------------|------------------|-------------|--------------------|--------------|
| Count ID  | Direction | Location   | Model Volume | Traffic Count | Delta AM | Delta/Count AM | Maximum Deviation | Within Deviation | Model-Count | Difference Squared | Percent RSME |
| <b>Screenline 1: East of Reservation Road between Blanco Road and SR-68</b> |           |  |              |               |          |                |                   |                  |             |                    |              |
| 40543   | NB        | Blanco Road between Cooper Road and Reservation Road   | 1,090        | 997           | 93       | 0.093          | 0.55              | YES              | 93          | 8,632              |              |
| 40543   | SB        | Blanco Road between Cooper Road and Reservation Road   | 1,179        | 998           | 181      | 0.181          | 0.55              | YES              | 181         | 32,610             |              |
| 13421   | NB        | Davis Road just north of Reservation Road              | 413          | 280           | 133      | 0.476          | 0.63              | YES              | 133         | 17,757             |              |
| 13421   | SB        | Davis Road just north of Reservation Road              | 563          | 406           | 157      | 0.386          | 0.62              | YES              | 157         | 24,545             |              |
| 4810  | EB        | Reservation Road just west of SR-68                    | 224          | 420           | -196     | -0.466         | 0.62              | YES              | -196        | 38,289             |              |
| 4810  | WB        | Reservation Road just west of SR-68                    | 274          | 648           | -374     | -0.577         | 0.59              | YES              | -374        | 139,971            |              |
| <b>Screenline 1: East of Reservation Road between Blanco Road and SR-68</b> |           |  | 3,743        | 3,749         | -6       | -0.002         | 0.35              | YES              | -6          | 41                 | 0%           |
| <b>Screenline 2: 6th Ave between Inter-Garrison Road and Imjin Parkway</b>  |           |  |              |               |          |                |                   |                  |             |                    |              |
| 12644   | SB        | Imjin Road between Imjin Parkway and Eight Street      | 65           | 50            | 15       | 0.291          | 0.64              | YES              | 15          | 212                |              |
| 12644   | NB        | Imjin Road between Imjin Parkway and Eight Street      | 31           | 310           | -279     | -0.899         | 0.63              | NO               | -279        | 77,665             |              |
| 4020  | NB        | Inter-Garrison between Eight Avenue and Abrams Drive   | 418          | 139           | 279      | 2.006          | 0.64              | NO               | 279         | 77,716             |              |
| 4020  | EB        | Inter-Garrison between Eight Avenue and Abrams Drive   | 262          | 990           | -728     | -0.735         | 0.55              | NO               | -728        | 530,167            |              |
| 3700  | WB        | Imjin Parkway between Abrams Drive and Imjin Road      | 741          | 797           | -56      | -0.070         | 0.57              | YES              | -56         | 3,154              |              |
| 3700  | EB        | Imjin Parkway between Abrams Drive and Imjin Road      | 575          | 1,127         | -552     | -0.490         | 0.54              | YES              | -552        | 304,582            |              |
| <b>Screenline 2: 6th Ave between Inter-Garrison Road and Imjin Parkway</b>  |           |  | 2,091        | 3,413         | -1,322   | -0.387         | 0.37              | NO               | -1,322      | 1,746,479          | 39%          |
| <b>Screenline 3: US-1 between Del Monte Boulevard and Fremont Boulevard</b> |           |  |              |               |          |                |                   |                  |             |                    |              |
| 41432   | NB        | Del Monte Boulevard between Reindollar Avenue and SR 1 | 477          | 953           | -476     | -0.500         | 0.56              | YES              | -476        | 226,797            |              |
| 10104   | SB        | Del Monte Boulevard between Reindollar Avenue and SR 1 | 959          | 901           | 58       | 0.064          | 0.56              | YES              | 58          | 3,364              |              |
| 45007   | EB        | Imjin Parkway between Second Avenue and Highway 1      | 932          | 1,288         | -356     | -0.276         | 0.52              | YES              | -356        | 126,776            |              |
| 45007   | WB        | Imjin Parkway between Second Avenue and Highway 1      | 1,032        | 1,212         | -180     | -0.149         | 0.53              | YES              | -180        | 32,397             |              |
| 10078   | WB        | Light Fighter Drive between Highway 1 and First Avenue | 308          | 382           | -74      | -0.195         | 0.62              | YES              | -74         | 5,536              |              |
| 10078   | EB        | Light Fighter Drive between Highway 1 and First Avenue | 121          | 587           | -466     | -0.793         | 0.6               | NO               | -466        | 216,906            |              |
| 13637   | NB        | Fremont Boulevard                                      | 574          | 826           | -252     | -0.305         | 0.57              | YES              | -252        | 63,361             |              |
| 13637   | SB        | Fremont Boulevard                                      | 786          | 943           | -157     | -0.166         | 0.56              | YES              | -157        | 24,515             |              |
| <b>Screenline 3: US-1 between Del Monte Boulevard and Fremont Boulevard</b> |           |  | 5,189        | 7,092         | -1,903   | -0.268         | 0.26              | NO               | -1,903      | 3,620,287          | 38%          |

| Table E2: Results of Screenline PM Peak Hour - Two-Way Volume, Run 00       |           |  |              |               |               |                |                   |                  |               |                    |              |
|---|-----------|--|--------------|---------------|---------------|----------------|-------------------|------------------|---------------|--------------------|--------------|
| Count ID  | Direction | Location   | Model Volume | Traffic Count | Delta AM      | Delta/Count AM | Maximum Deviation | Within Deviation | Model-Count   | Difference Squared | Percent RSME |
| <b>Screenline 1: East of Reservation Road between Blanco Road and SR-68</b> |           |  |              |               |               |                |                   |                  |               |                    |              |
| 40543   | NB        | Blanco Road between Cooper Road and Reservation Road   | 1,145        | 972           | 173           | 0.178          | 0.55              | YES              | 173           | 30,038             |              |
| 40543   | SB        | Blanco Road between Cooper Road and Reservation Road   | 1,054        | 972           | 82            | 0.084          | 0.55              | YES              | 82            | 6,678              |              |
| 13421   | NB        | Davis Road just north of Reservation Road              | 693          | 392           | 301           | 0.767          | 0.62              | NO               | 301           | 90,322             |              |
| 13421   | SB        | Davis Road just north of Reservation Road              | 547          | 282           | 265           | 0.939          | 0.63              | NO               | 265           | 70,188             |              |
| 4810  | EB        | Reservation Road just west of SR-68                    | 280          | 615           | -335          | -0.544         | 0.6               | YES              | -335          | 112,083            |              |
| 4810  | WB        | Reservation Road just west of SR-68                    | 255          | 455           | -200          | -0.439         | 0.61              | YES              | -200          | 39,947             |              |
| <b>Screenline 1: East of Reservation Road between Blanco Road and SR-68</b> |           |  | <b>3,974</b> | <b>3,688</b>  | <b>286</b>    | <b>0.078</b>   | <b>0.36</b>       | <b>YES</b>       | <b>286</b>    | <b>81,707</b>      | <b>11%</b>   |
| <b>Screenline 2: 6th Ave between Inter-Garrison Road and Imjin Parkway</b>  |           |  |              |               |               |                |                   |                  |               |                    |              |
| 12644   | SB        | Imjin Road between Imjin Parkway and Eight Street      | 47           | 197           | -150          | -0.762         | 0.64              | NO               | -150          | 22,552             |              |
| 12644   | NB        | Imjin Road between Imjin Parkway and Eight Street      | 37           | 153           | -116          | -0.759         | 0.64              | NO               | -116          | 13,473             |              |
| 4020  | WB        | Inter-Garrison between Eight Avenue and Abrams Drive   | 284          | 782           | -498          | -0.636         | 0.58              | NO               | -498          | 247,709            |              |
| 4020  | EB        | Inter-Garrison between Eight Avenue and Abrams Drive   | 405          | 244           | 161           | 0.661          | 0.64              | NO               | 161           | 26,032             |              |
| 3700  | WB        | Imjin Parkway between Abrams Drive and Imjin Road      | 576          | 980           | -404          | -0.412         | 0.55              | YES              | -404          | 163,412            |              |
| 3700  | EB        | Imjin Parkway between Abrams Drive and Imjin Road      | 678          | 840           | -162          | -0.193         | 0.57              | YES              | -162          | 26,330             |              |
| <b>Screenline 2: 6th Ave between Inter-Garrison Road and Imjin Parkway</b>  |           |  | <b>2,027</b> | <b>3,196</b>  | <b>-1,169</b> | <b>-0.366</b>  | <b>0.38</b>       | <b>YES</b>       | <b>-1,169</b> | <b>1,366,827</b>   | <b>37%</b>   |
| <b>Screenline 3: US-1 between Del Monte Boulevard and Fremont Boulevard</b> |           |  |              |               |               |                |                   |                  |               |                    |              |
| 41432   | NB        | Del Monte Boulevard between Reindollar Avenue and SR 1 | 1,132        | 1,071         | 61            | 0.057          | 0.54              | YES              | 61            | 3,715              |              |
| 10104   | SB        | Del Monte Boulevard between Reindollar Avenue and SR 1 | 699          | 1,033         | -334          | -0.324         | 0.55              | YES              | -334          | 111,717            |              |
| 45007   | EB        | Imjin Parkway between Second Avenue and Highway 1      | 1,036        | 1,326         | -290          | -0.219         | 0.51              | YES              | -290          | 84,266             |              |
| 45007   | WB        | Imjin Parkway between Second Avenue and Highway 1      | 940          | 1,398         | -458          | -0.328         | 0.5               | YES              | -458          | 210,056            |              |
| 10078   | WB        | Light Fighter Drive between Highway 1 and First Avenue | 248          | 572           | -324          | -0.567         | 0.6               | YES              | -324          | 105,269            |              |
| 10078   | EB        | Light Fighter Drive between Highway 1 and First Avenue | 117          | 733           | -616          | -0.841         | 0.58              | NO               | -616          | 379,955            |              |
| 13637   | NB        | Fremont Boulevard                                      | 894          | 1,317         | -423          | -0.321         | 0.52              | YES              | -423          | 178,783            |              |
| 13637   | SB        | Fremont Boulevard                                      | 568          | 717           | -149          | -0.208         | 0.58              | YES              | -149          | 22,300             |              |
| <b>Screenline 3: US-1 between Del Monte Boulevard and Fremont Boulevard</b> |           |  | <b>5,632</b> | <b>8,167</b>  | <b>-2,535</b> | <b>-0.310</b>  | <b>0.25</b>       | <b>NO</b>        | <b>-2,535</b> | <b>6,425,771</b>   | <b>44%</b>   |

| Table E3: Results of Screenline Daily - Two-Way Volume, Run 00              |           |  |              |               |          |                |                   |                  |             |                    |              |
|---|-----------|--|--------------|---------------|----------|----------------|-------------------|------------------|-------------|--------------------|--------------|
| Count ID  | Direction | Location   | Model Volume | Traffic Count | Delta AM | Delta/Count AM | Maximum Deviation | Within Deviation | Model-Count | Difference Squared | Percent RSME |
| <b>Screenline 1: East of Reservation Road between Blanco Road and SR-68</b> |           |  |              |               |          |                |                   |                  |             |                    |              |
| 40543   | NB        | Blanco Road between Cooper Road and Reservation Road   | 11,511       | 13,770        | -2,259   | -0.164         | 0.53              | YES              | 173         | 30,038             |              |
| 40543   | SB        | Blanco Road between Cooper Road and Reservation Road   | 11,225       | 13,769        | -2,544   | -0.185         | 0.53              | YES              | 82          | 6,678              |              |
| 13421   | NB        | Davis Road just north of Reservation Road              | 5,063        | N/A           | N/A      | 0.000          | N/A               | N/A              | 301         | 90,322             |              |
| 13421   | SB        | Davis Road just north of Reservation Road              | 5,093        | N/A           | N/A      | 0.000          | N/A               | N/A              | 265         | 70,188             |              |
| 4810  | EB        | Reservation Road just west of SR-68                    | 2,678        | N/A           | N/A      | 0.000          | N/A               | N/A              | -335        | 112,083            |              |
| 4810  | WB        | Reservation Road just west of SR-68                    | 2,824        | N/A           | N/A      | 0.000          | N/A               | N/A              | -200        | 39,947             |              |
| <b>Screenline 1: East of Reservation Road between Blanco Road and SR-68</b> |           |  | 38,395       | 27,539        | -4,804   | -0.174         | 0.17              | NO               | 10,856      | 117,852,409        | 56%          |
| <b>Screenline 2: 6th Ave between Inter-Garrison Road and Imjin Parkway</b>  |           |  |              |               |          |                |                   |                  |             |                    |              |
| 12644   | SB        | Imjin Road between Imjin Parkway and Eight Street      | 65           | 50            | 15       | 0.291          | 0.64              | YES              | 15          | 212                |              |
| 12644   | NB        | Imjin Road between Imjin Parkway and Eight Street      | 31           | 310           | -279     | -0.899         | 0.63              | NO               | -279        | 77,665             |              |
| 4020  | WB        | Inter-Garrison between Eight Avenue and Abrams Drive   | 418          | 139           | 279      | 2.006          | 0.64              | NO               | 279         | 77,716             |              |
| 4020  | EB        | Inter-Garrison between Eight Avenue and Abrams Drive   | 262          | 990           | -728     | -0.735         | 0.55              | NO               | -728        | 530,167            |              |
| 3700  | WB        | Imjin Parkway between Abrams Drive and Imjin Road      | 741          | 797           | -56      | -0.070         | 0.57              | YES              | -56         | 3,154              |              |
| 3700  | EB        | Imjin Parkway between Abrams Drive and Imjin Road      | 575          | 1,127         | -552     | -0.490         | 0.54              | YES              | -552        | 304,582            |              |
| <b>Screenline 2: 6th Ave between Inter-Garrison Road and Imjin Parkway</b>  |           |  | 2,091        | 3,413         | -1,322   | -0.387         | 0.37              | NO               | -1,322      | 1,746,479          | 39%          |
| <b>Screenline 3: US-1 between Del Monte Boulevard and Fremont Boulevard</b> |           |  |              |               |          |                |                   |                  |             |                    |              |
| 41432   | NB        | Del Monte Boulevard between Reindollar Avenue and SR 1 | 8,061        | 13,945        | -5,884   | -0.422         | 0.54              | YES              | -5,884      | 3,715              |              |
| 10104   | SB        | Del Monte Boulevard between Reindollar Avenue and SR 1 | 8,393        | 12,841        | -4,448   | -0.346         | 0.55              | YES              | -4,448      | 111,717            |              |
| 45007   | EB        | Imjin Parkway between Second Avenue and Highway 1      | 10,630       | 14,435        | -3,805   | -0.264         | 0.51              | YES              | -3,805      | 84,266             |              |
| 45007   | WB        | Imjin Parkway between Second Avenue and Highway 1      | 10,176       | 13,788        | -3,612   | -0.262         | 0.5               | YES              | -3,612      | 210,056            |              |
| 10078   | WB        | Light Fighter Drive between Highway 1 and First Avenue | 3,104        | 6,315         | -3,211   | -0.508         | 0.6               | YES              | -3,211      | 105,269            |              |
| 10078   | EB        | Light Fighter Drive between Highway 1 and First Avenue | 1,207        | 8,687         | -7,480   | -0.861         | 0.58              | NO               | -7,480      | 379,955            |              |
| 13637   | NB        | Fremont Boulevard                                      | 8,055        | N/A           | N/A      | N/A            | 0.52              | N/A              | N/A         | 178,783            |              |
| 13637   | SB        | Fremont Boulevard                                      | 7,567        | N/A           | N/A      | N/A            | 0.58              | N/A              | N/A         | 22,300             |              |
| <b>Screenline 3: US-1 between Del Monte Boulevard and Fremont Boulevard</b> |           |  | 57,193       | 70,011        | -28,439  | -0.406         | 0.17              | NO               | -12,818     | 164,288,520        | 26%          |

**ATTACHMENT F: INITIAL MODEL VALIDATION RESULTS: BY LINK  
USING TWO-WAY VOLUME, RUN 00**

Table F1: Results of AM Peak-Hour Model Area Validation by Two-Way Volume, Run 00

| ID | Direction | Description                 |  | Model Volume | Traffic Count | Model/Count | Maximum Deviation | Withing Deviation | Model-Count | Difference Squared |
|----|-----------|-----------------------------|--|--------------|---------------|-------------|-------------------|-------------------|-------------|--------------------|
|    |           | Roadway                     | Location   |              |               |             |                   |                   |             |                    |
| 1  | SB/NB     | Highway 1                   | between Del Monte Boulevard and Reservation Road         | 5,016        | 3,875         | 1.295       | 0.21              | NO                | 1,141       | 1,302,556          |
| 2  | SB/NB     | Highway 1                   | between Imjin Parkway and Del Monte Boulevard            | 6,452        | 5,777         | 1.117       | 0.17              | YES               | 675         | 455,713            |
| 3  | SB/NB     | Highway 1                   | between Light Fighter Drive and Imjin Parkway            | 7,728        | 6,955         | 1.111       | 0.15              | YES               | 773         | 597,656            |
| 4  | SB/NB     | Highway 1                   | between Del Monte Boulevard and Light Fighter Drive      | 8,047        | 7,484         | 1.075       | 0.14              | YES               | 563         | 316,696            |
| 5  | SB/NB     | Highway 1                   | between Canyon Del Rey Boulevard and Del Monte Boulevard | 7,072        | 6,296         | 1.123       | 0.16              | YES               | 776         | 602,928            |
| 6  | SB/NB     | Highway 1                   | between Del Monte Boulevard and Canyon Del Rey Boulevard | 7,242        | 6,388         | 1.134       | 0.16              | YES               | 854         | 729,527            |
| 7  | SB/NB     | Highway 1                   | between Casa Verde Way and Del Monte Boulevard           | 6,606        | 5,620         | 1.175       | 0.18              | NO                | 986         | 972,328            |
| 8  | SB/NB     | Highway 1                   | between SR 68 and Casa Verde Way                         | 6,758        | 5,600         | 1.207       | 0.18              | NO                | 1,158       | 1,339,990          |
| 9  | SB/NB     | Highway 1                   | between SR 68 and Fremont Street                         | 7,546        | 8,584         | 0.879       | 0.14              | YES               | -1,038      | 1,077,881          |
| 10 | NB/SB     | Del Monte Boulevard         | between Beach Road and Reservation Road                  | 112          | 609           | 0.185       | 0.44              | NO                | -497        | 246,644            |
| 11 | NB/SB     | Del Monte Boulevard         | between Reindollar Avenue and SR 1                       | 1,436        | 1,854         | 0.774       | 0.28              | YES               | -418        | 174,917            |
| 12 | SB/NB     | Second Avenue               | between Imjin Parkway and Tenth Street                   | 480          | 217           | 2.212       | 0.63              | NO                | 263         | 69,203             |
| 13 | NB/SB     | Second Avenue               | between Eight Street and Fifth Street                    | 127          | 817           | 0.156       | 0.38              | NO                | -690        | 476,023            |
| 14 | SB/NB     | Second Avenue               | between Divarty Street and Light Fighter Drive           | 110          | 147           | 0.746       | 0.63              | YES               | -37         | 1,389              |
| 15 | SB/NB     | General Jim Moore           | between Divarty Street and Light Fighter Drive           | 802          | 441           | 1.818       | 0.48              | NO                | 361         | 130,167            |
| 16 | NB/SB     | General Jim Moore Boulevard | between Light Fighter Drive and Gigling Road             | 536          | 730           | 0.735       | 0.41              | YES               | -194        | 37,497             |
| 17 | SB/NB     | General Jim Moore Boulevard | between Normandy Road and Coe Avenue                     | 545          | 700           | 0.779       | 0.41              | YES               | -155        | 23,914             |
| 18 | SB/NB     | General Jim Moore Boulevard | between Coe Avenue and San Pablo Avenue                  | 625          | 432           | 1.447       | 0.52              | YES               | 193         | 37,352             |
| 19 | NB/SB     | California Avenue           | between Reservation Road and Windsor Court               | 218          | 430           | 0.506       | 0.52              | YES               | -212        | 45,126             |
| 20 | NB/SB     | California Avenue           | between Reindollar Avenue and Imjin Parkway              | 294          | 398           | 0.738       | 0.52              | YES               | -104        | 10,914             |
| 21 | SB/NB     | California Avenue           | between Imjin Parkway and Fifth Avenue                   | 51           | 158           | 0.322       | 0.63              | NO                | -107        | 11,478             |
| 22 | SB/NB     | Imjin Road                  | between Imjin Parkway and Eight Street                   | 96           | 360           | 0.266       | 0.52              | NO                | -264        | 69,770             |
| 23 | NB/SB     | Abram Drive                 | between Imjin Parkway and Bunker Hill Drive              | 185          | 389           | 0.475       | 0.52              | NO                | -204        | 41,728             |
| 24 | NB/SB     | Abram Drive                 | between Manassas Drive and Inter-Garrison Road           | 178          | 466           | 0.383       | 0.48              | NO                | -288        | 82,665             |
| 25 | NB/SB     | Blanco Road                 | between Cooper Road and Reservation Road                 | 2,268        | 1,995         | 1.137       | 0.27              | YES               | 273         | 74,797             |
| 26 | EB/WB     | Reservation Road            | between Highway 1 and Cardoza Avenue                     | 1,239        | 418           | 2.964       | 0.52              | NO                | 821         | 673,846            |
| 27 | WB/EB     | Reservation Road            | between Robinin Drive and Del Monte Boulevard            | 787          | 557           | 1.413       | 0.44              | YES               | 230         | 53,009             |
| 28 | WB/EB     | Reservation Road            | between Del Monte Boulevard and Vista Del Camino         | 1,460        | 1,606         | 0.909       | 0.29              | YES               | -146        | 21,246             |
| 29 | EB/WB     | Reservation Road            | between Salinas Avenue and Imjin Parkway                 | 1,432        | 1,526         | 0.938       | 0.29              | YES               | -94         | 8,918              |
| 30 | EB/WB     | Reservation Road            | between Imjin Parkway and Blanco Road                    | 2,587        | 1,224         | 2.113       | 0.31              | NO                | 1,363       | 1,857,546          |
| 31 | EB/WB     | Reservation Road            | between Blanco Road and Inter-Garrison Road              | 535          | 752           | 0.712       | 0.41              | YES               | -217        | 46,915             |
| 32 | EB/WB     | Reservation Road            | between Inter-Garrison Road and East Garrison Road       | 1,118        | 1,160         | 0.964       | 0.33              | YES               | -42         | 1,772              |
| 33 | WB/NB     | Reindollar Avenue           | between Del Monte Boulevard and Sunset Avenue            | 251          | 371           | 0.677       | 0.52              | YES               | -120        | 14,376             |
| 34 | EB/WB     | Imjin Parkway               | between Second Avenue and Highway 1                      | 1,964        | 2,500         | 0.786       | 0.25              | YES               | -536        | 287,346            |
| 35 | EB/WB     | Imjin Parkway               | between Fourth Avenue and Third Avenue                   | 1,656        | 1,570         | 1.055       | 0.29              | YES               | 86          | 7,456              |
| 36 | WB/EB     | Imjin Parkway               | between Abrams Drive and Imjin Road                      | 1,316        | 1,924         | 0.684       | 0.27              | NO                | -608        | 369,729            |
| 37 | SB/NB     | Imjin Parkway               | between Reservation Road and Preston Drive               | 1,284        | 934           | 1.375       | 0.36              | NO                | 350         | 122,825            |
| 38 | WB/EB     | Inter-Garrison Road         | between Second Avenue and Third Avenue                   | 152          | 147           | 1.033       | 0.63              | YES               | 5           | 24                 |
| 39 | WB/EB     | Inter-Garrison Road         | between Sixth Avenue and Seventh Avenue                  | 620          | 277           | 2.240       | 0.58              | NO                | 343         | 117,943            |
| 40 | WB/EB     | Inter-Garrison Road         | between Eight Avenue and Abrams Drive                    | 680          | 1,129         | 0.602       | 0.33              | NO                | -449        | 201,916            |
| 41 | WB/EB     | Lightfighter Drive          | between Highway 1 and First Avenue                       | 429          | 969           | 0.443       | 0.36              | NO                | -540        | 291,750            |
| 42 | EB/WB     | Lightfighter Drive          | between Second Avenue and General Jim Moore Boulevard    | 628          | 1,503         | 0.418       | 0.29              | NO                | -875        | 766,146            |
| 43 | EB/WB     | Lightfighter Drive          | between General Jim Moore Blvd and Colonel Durham Street | 0            | 463           | 0.000       | 0.48              | NO                | -463        | 214,249            |
| 44 | WB/EB     | Gigling Road                | between General Jim Moore Boulevard and Malmedy Road     | 0            | 895           | 0.000       | 0.36              | NO                | -895        | 800,640            |
| 45 | NB/SB     | Monterey Road               | between Buna Road and Noumea Road                        | 26           | 217           | 0.118       | 0.63              | NO                | -191        | 36,592             |
| 46 | WB/EB     | Coe Avenue                  | between Buttercup Boulevard and Coe Avenue               | 98           | 506           | 0.193       | 0.48              | NO                | -408        | 166,705            |
| 47 | EB/WB     | San Pablo                   | between Nadina Street and General Jim Moore Boulevard    | 169          | 728           | 0.232       | 0.41              | NO                | -559        | 312,463            |
| 48 | EB/WB     | Broadway Avenue             | between Mescal Street and General Jim Moore Boulevard    | 398          | 582           | 0.684       | 0.44              | YES               | -184        | 33,885             |
| 49 | SB/NB     | Eight Avenue                | between Inter-Garrison Road and A Street                 | 25           | 828           | 0.030       | 0.38              | NO                | -803        | 645,591            |

**Local Roadway/Freeway/Ramp Results:**

**89,384 89,508**

Model/Count Ratio = 1.00 0%  
 Percent Within Caltrans Maximum Deviation = 48% <75%  
 Percent Root Mean Square Error = 0.32 <40%  
 Correlation Coefficient = 0.98 >0.88

Total Count= 49  
 Link within Deviation= 24  
 Link Outside Deviation= 25

**Local Roadway Results:**

**25,481 31,075**

Model/Count Ratio = 0.82 -28%  
 Percent Within Caltrans Maximum Deviation = 43% <75%  
 Percent Root Mean Square Error = 32% <40%  
 Correlation Coefficient = 0.98 >0.88

Total Count= 39  
 Link within Deviation= 17  
 Link Outside Deviation= 22

Table F2: Results of PM Peak Hour Two-Way Total Traffic Volumes, Run 00

| ID | Direction | Description                 |  | Model Volume | Traffic Count | Model/Count | Maximum Deviation | Withing Deviation | Model-Count | Difference Squared |
|----|-----------|-----------------------------|--|--------------|---------------|-------------|-------------------|-------------------|-------------|--------------------|
|    |           | Roadway                     | Location   |              |               |             |                   |                   |             |                    |
| 1  | SB/NB     | Highway 1                   | between Del Monte Boulevard and Reservation Road         | 4,945        | 4,088         | 1.210       | 0.21              | NO                | 857         | 733,817            |
| 2  | SB/NB     | Highway 1                   | between Imjin Parkway and Del Monte Boulevard            | 6,775        | 6,318         | 1.072       | 0.16              | YES               | 457         | 209,160            |
| 3  | SB/NB     | Highway 1                   | between Light Fighter Drive and Imjin Parkway            | 8,000        | 7,763         | 1.031       | 0.14              | YES               | 237         | 56,124             |
| 4  | SB/NB     | Highway 1                   | between Del Monte Boulevard and Light Fighter Drive      | 8,187        | 7,903         | 1.036       | 0.14              | YES               | 284         | 80,667             |
| 5  | SB/NB     | Highway 1                   | between Canyon Del Rey Boulevard and Del Monte Boulevard | 7,057        | 5,729         | 1.232       | 0.17              | NO                | 1,328       | 1,764,186          |
| 6  | SB/NB     | Highway 1                   | between Del Monte Boulevard and Canyon Del Rey Boulevard | 7,207        | 5,945         | 1.212       | 0.17              | NO                | 1,262       | 1,592,780          |
| 7  | SB/NB     | Highway 1                   | between Casa Verde Way and Del Monte Boulevard           | 6,257        | 5,027         | 1.245       | 0.19              | NO                | 1,230       | 1,512,766          |
| 8  | SB/NB     | Highway 1                   | between SR 68 and Casa Verde Way                         | 6,930        | 4,774         | 1.452       | 0.20              | NO                | 2,156       | 4,646,740          |
| 9  | SB/NB     | Highway 1                   | between SR 68 and Fremont Street                         | 7,601        | 7,792         | 0.976       | 0.14              | YES               | -191        | 36,436             |
| 10 | NB/SB     | Del Monte Boulevard         | between Beach Road and Reservation Road                  | 152          | 634           | 0.240       | 0.44              | NO                | -482        | 231,992            |
| 11 | NB/SB     | Del Monte Boulevard         | between Reindollar Avenue and SR 1                       | 1,831        | 2,104         | 0.870       | 0.26              | YES               | -273        | 74,688             |
| 12 | SB/NB     | Second Avenue               | between Imjin Parkway and Tenth Street                   | 567          | 290           | 1.955       | 0.58              | NO                | 277         | 76,652             |
| 13 | NB/SB     | Second Avenue               | between Eight Street and Fifth Street                    | 138          | 554           | 0.250       | 0.44              | NO                | -416        | 172,835            |
| 14 | SB/NB     | Second Avenue               | between Divarty Street and Light Fighter Drive           | 130          | 142           | 0.912       | 0.63              | YES               | -12         | 156                |
| 15 | SB/NB     | General Jim Moore           | between Divarty Street and Light Fighter Drive           | 793          | 384           | 2.065       | 0.52              | NO                | 409         | 167,132            |
| 16 | NB/SB     | General Jim Moore Boulevard | between Light Fighter Drive and Gigling Road             | 630          | 896           | 0.704       | 0.36              | YES               | -266        | 70,504             |
| 17 | SB/NB     | General Jim Moore Boulevard | between Normandy Road and Coe Avenue                     | 706          | 722           | 0.977       | 0.41              | YES               | -16         | 266                |
| 18 | SB/NB     | General Jim Moore Boulevard | between Coe Avenue and San Pablo Avenue                  | 806          | 554           | 1.454       | 0.44              | NO                | 252         | 63,314             |
| 19 | NB/SB     | California Avenue           | between Reservation Road and Windsor Court               | 233          | 505           | 0.461       | 0.48              | NO                | -272        | 74,053             |
| 20 | NB/SB     | California Avenue           | between Reindollar Avenue and Imjin Parkway              | 329          | 562           | 0.586       | 0.44              | YES               | -233        | 54,159             |
| 21 | SB/NB     | California Avenue           | between Imjin Parkway and Fifth Avenue                   | 57           | 77            | 0.738       | 0.68              | YES               | -20         | 409                |
| 22 | SB/NB     | Imjin Road                  | between Imjin Parkway and Eight Street                   | 84           | 350           | 0.239       | 0.52              | NO                | -266        | 70,887             |
| 23 | NB/SB     | Abram Drive                 | between Imjin Parkway and Bunker Hill Drive              | 198          | 496           | 0.400       | 0.48              | NO                | -298        | 88,546             |
| 24 | NB/SB     | Abram Drive                 | between Manassas Drive and Inter-Garrison Road           | 198          | 446           | 0.445       | 0.48              | NO                | -248        | 61,308             |
| 25 | NB/SB     | Blanco Road                 | between Cooper Road and Reservation Road                 | 2,199        | 1,944         | 1.131       | 0.27              | YES               | 255         | 65,041             |
| 26 | EB/WB     | Reservation Road            | between Highway 1 and Cardoza Avenue                     | 1,267        | 1,104         | 1.148       | 0.33              | YES               | 163         | 26,719             |
| 27 | WB/EB     | Reservation Road            | between Robinin Drive and Del Monte Boulevard            | 821          | 734           | 1.119       | 0.41              | YES               | 87          | 7,648              |
| 28 | WB/EB     | Reservation Road            | between Del Monte Boulevard and Vista Del Camino         | 1,775        | 1,873         | 0.948       | 0.27              | YES               | -98         | 9,515              |
| 29 | EB/WB     | Reservation Road            | between Salinas Avenue and Imjin Parkway                 | 1,717        | 1,670         | 1.028       | 0.28              | YES               | 47          | 2,212              |
| 30 | EB/WB     | Reservation Road            | between Imjin Parkway and Blanco Road                    | 2,783        | 2,001         | 1.391       | 0.27              | NO                | 782         | 612,245            |
| 31 | EB/WB     | Reservation Road            | between Blanco Road and Inter-Garrison Road              | 480          | 789           | 0.609       | 0.38              | NO                | -309        | 95,414             |
| 32 | EB/WB     | Reservation Road            | between Inter-Garrison Road and East Garrison Road       | 1,393        | 1,166         | 1.195       | 0.33              | YES               | 227         | 51,586             |
| 33 | WB/NB     | Reindollar Avenue           | between Del Monte Boulevard and Sunset Avenue            | 283          | 581           | 0.487       | 0.44              | NO                | -298        | 88,860             |
| 34 | EB/WB     | Imjin Parkway               | between Second Avenue and Highway 1                      | 1,975        | 2,724         | 0.725       | 0.24              | NO                | -749        | 560,408            |
| 35 | EB/WB     | Imjin Parkway               | between Fourth Avenue and Third Avenue                   | 1,643        | 2,001         | 0.821       | 0.27              | YES               | -358        | 128,364            |
| 36 | WB/EB     | Imjin Parkway               | between Abrams Drive and Imjin Road                      | 1,253        | 1,820         | 0.689       | 0.28              | NO                | -567        | 320,930            |
| 37 | SB/NB     | Imjin Parkway               | between Reservation Road and Preston Drive               | 1,211        | 2,098         | 0.577       | 0.26              | NO                | -887        | 786,426            |
| 38 | WB/EB     | Inter-Garrison Road         | between Second Avenue and Third Avenue                   | 159          | 169           | 0.943       | 0.63              | YES               | -10         | 93                 |
| 39 | WB/EB     | Inter-Garrison Road         | between Sixth Avenue and Seventh Avenue                  | 621          | 230           | 2.700       | 0.58              | NO                | 391         | 152,812            |
| 40 | WB/EB     | Inter-Garrison Road         | between Eight Avenue and Abrams Drive                    | 690          | 1,026         | 0.672       | 0.34              | YES               | -336        | 113,138            |
| 41 | WB/EB     | Lightfighter Drive          | between Highway 1 and First Avenue                       | 364          | 1,305         | 0.279       | 0.31              | NO                | -941        | 885,212            |
| 42 | EB/WB     | Lightfighter Drive          | between Second Avenue and General Jim Moore Boulevard    | 635          | 1,326         | 0.479       | 0.30              | NO                | -691        | 477,302            |
| 43 | EB/WB     | Lightfighter Drive          | between General Jim Moore Blvd and Colonel Durham Street | 0            | 390           | 0.000       | 0.52              | NO                | -390        | 152,040            |
| 44 | WB/EB     | Gigling Road                | between General Jim Moore Boulevard and Malmedy Road     | 20           | 786           | 0.026       | 0.38              | NO                | -766        | 586,164            |
| 45 | NB/SB     | Monterey Road               | between Buna Road and Noumea Road                        | 31           | 307           | 0.101       | 0.58              | NO                | -276        | 76,212             |
| 46 | WB/EB     | Coe Avenue                  | between Buttercup Boulevard and Coe Avenue               | 113          | 279           | 0.405       | 0.58              | NO                | -166        | 27,535             |
| 47 | EB/WB     | San Pablo                   | between Nadina Street and General Jim Moore Boulevard    | 201          | 391           | 0.514       | 0.52              | YES               | -190        | 36,101             |
| 48 | EB/WB     | Broadway Avenue             | between Mescal Street and General Jim Moore Boulevard    | 436          | 612           | 0.713       | 0.44              | YES               | -176        | 30,912             |
| 49 | SB/NB     | Eight Avenue                | between Inter-Garrison Road and A Street                 | 41           | 635           | 0.065       | 0.44              | NO                | -594        | 352,789            |

**Local Roadway/Freeway/Ramp Results:**

91,925 92,016

Model/Count Ratio= 1.00 0%  
 Percent within Caltrans Maximum Deviation= 100% <75%  
 Percent Root Mean Square Error (RSME)= 32% <40%  
 Correlation Coefficient = 98% >0.88

Total Count= 49  
 Link within Deviation= 21  
 Link Outside Deviation= 28

**Local Roadway Results:**

27,136 34,573

Model/Count Ratio = 0.78 -32%  
 Percent Within Caltrans Maximum Deviation = 45% <75%  
 Percent Root Mean Square Error = 32% <40%  
 Correlation Coefficient = 0.26 <0.88

Total Count= 39  
 Link within Deviation= 16  
 Link Outside Deviation= 23

Table F3: Results of Daily Two-Way Total Traffic Volumes, Run 00

| ID | Direction | Description                 |  | Model Volume | Traffic Count | Model Delta | Model Delta/Count | Maximum Deviation | Withing Deviation | Model-Count | Difference Squared |
|----|-----------|-----------------------------|--|--------------|---------------|-------------|-------------------|-------------------|-------------------|-------------|--------------------|
|    |           | Roadway                     | Location   |              |               |             |                   |                   |                   |             |                    |
| 1  | SB/NB     | Highway 1                   | between Del Monte Boulevard and Reservation Road         | 5,016        | 3,875         | 1,141       | 0.295             | 0.20              | NO                | 1,141       | 1,145,744          |
| 2  | SB/NB     | Highway 1                   | between Imjin Parkway and Del Monte Boulevard            | 69,091       | 76,532        | -7,441      | -0.097            | 0.15              | YES               | -7,441      | 55,368,834         |
| 3  | SB/NB     | Highway 1                   | between Light Fighter Drive and Imjin Parkway            | 82,256       | 93,403        | -11,147     | -0.119            | 0.14              | YES               | -11,147     | 124,247,799        |
| 4  | SB/NB     | Highway 1                   | between Del Monte Boulevard and Light Fighter Drive      | 85,460       | 96,962        | -11,502     | -0.119            | 0.14              | YES               | -11,502     | 132,304,298        |
| 5  | SB/NB     | Highway 1                   | between Canyon Del Rey Boulevard and Del Monte Boulevard | 75,157       | 69,564        | 5,593       | 0.080             | 0.17              | YES               | 5,593       | 31,276,992         |
| 6  | SB/NB     | Highway 1                   | between Del Monte Boulevard and Canyon Del Rey Boulevard | 77,936       | 77,104        | 832         | 0.011             | 0.15              | YES               | 832         | 692,144            |
| 7  | SB/NB     | Highway 1                   | between Casa Verde Way and Del Monte Boulevard           | 69,306       | 68,590        | 716         | 0.010             | 0.17              | YES               | 716         | 512,955            |
| 8  | SB/NB     | Highway 1                   | between SR 68 and Casa Verde Way                         | 73,941       | 66,292        | 7,649       | 0.115             | 0.17              | YES               | 7,649       | 58,506,054         |
| 9  | SB/NB     | Highway 1                   | between SR 68 and Fremont Street                         | 81,385       | 100,509       | -19,124     | -0.190            | 0.14              | NO                | -19,124     | 365,738,798        |
| 10 | NB/SB     | Del Monte Boulevard         | between Beach Road and Reservation Road                  | 1,614        | 7,580         | -5,966      | -0.787            | 0.41              | NO                | -5,966      | 35,589,710         |
| 11 | NB/SB     | Del Monte Boulevard         | between Reindollar Avenue and SR 1                       | 16,455       | 26,786        | -10,331     | -0.386            | 0.25              | NO                | -10,331     | 106,738,197        |
| 12 | SB/NB     | Second Avenue               | between Imjin Parkway and Tenth Street                   | 5,999        | 3,274         | 2,725       | 0.832             | 0.58              | NO                | 2,725       | 7,424,982          |
| 13 | NB/SB     | Second Avenue               | between Eight Street and Fifth Street                    | 1,412        | 6,331         | -4,919      | -0.777            | 0.44              | NO                | -4,919      | 24,198,334         |
| 14 | SB/NB     | Second Avenue               | between Divarty Street and Light Fighter Drive           | 1,486        | 2,502         | -1,016      | -0.406            | 0.58              | YES               | -1,016      | 1,031,457          |
| 15 | SB/NB     | General Jim Moore           | between Divarty Street and Light Fighter Drive           | 8,304        | 5,232         | 3,072       | 0.587             | 0.48              | NO                | 3,072       | 9,434,882          |
| 16 | NB/SB     | General Jim Moore Boulevard | between Light Fighter Drive and Gigling Road             | 5,835        | 9,611         | -3,776      | -0.393            | 0.38              | NO                | -3,776      | 14,256,535         |
| 17 | SB/NB     | General Jim Moore Boulevard | between Normandy Road and Coe Avenue                     | 6,384        | 6,683         | -299        | -0.045            | 0.44              | YES               | -299        | 89,661             |
| 18 | SB/NB     | General Jim Moore Boulevard | between Coe Avenue and San Pablo Avenue                  | 7,752        | 7,004         | 748         | 0.107             | 0.44              | YES               | 748         | 559,265            |
| 19 | NB/SB     | California Avenue           | between Reservation Road and Windsor Court               | 2,318        | 4,672         | -2,354      | -0.504            | 0.52              | YES               | -2,354      | 5,543,078          |
| 20 | NB/SB     | California Avenue           | between Reindollar Avenue and Imjin Parkway              | 3,373        | 5,915         | -2,542      | -0.430            | 0.48              | YES               | -2,542      | 6,464,031          |
| 21 | SB/NB     | California Avenue           | between Imjin Parkway and Fifth Avenue                   | 562          | 992           | -430        | -0.433            | 0.68              | YES               | -430        | 184,820            |
| 22 | SB/NB     | Imjin Road                  | between Imjin Parkway and Eight Street                   | 1,126        | 4,122         | -2,996      | -0.727            | 0.52              | NO                | -2,996      | 8,975,291          |
| 23 | NB/SB     | Abram Drive                 | between Imjin Parkway and Bunker Hill Drive              | 2,033        | 5,616         | -3,583      | -0.638            | 0.48              | NO                | -3,583      | 12,836,338         |
| 24 | NB/SB     | Abram Drive                 | between Manassas Drive and Inter-Garrison Road           | 1,842        | 4,486         | -2,644      | -0.589            | 0.52              | NO                | -2,644      | 6,992,550          |
| 25 | NB/SB     | Blanco Road                 | between Cooper Road and Reservation Road                 | 22,735       | 27,539        | -4,804      | -0.174            | 0.25              | YES               | -4,804      | 23,073,720         |
| 26 | EB/WB     | Reservation Road            | between Highway 1 and Cardoza Avenue                     | 13,571       | 12,776        | 795         | 0.062             | 0.33              | YES               | 795         | 631,535            |
| 27 | WB/EB     | Reservation Road            | between Robinin Drive and Del Monte Boulevard            | 8,706        | 8,470         | 236         | 0.028             | 0.41              | YES               | 236         | 55,668             |
| 28 | WB/EB     | Reservation Road            | between Del Monte Boulevard and Vista Del Camino         | 15,968       | 17,396        | -1,428      | -0.082            | 0.29              | YES               | -1,428      | 2,038,365          |
| 29 | EB/WB     | Reservation Road            | between Salinas Avenue and Imjin Parkway                 | 14,726       | 16,489        | -1,763      | -0.107            | 0.29              | YES               | -1,763      | 3,107,636          |
| 30 | EB/WB     | Reservation Road            | between Imjin Parkway and Blanco Road                    | 26,211       | 26,567        | -356        | -0.013            | 0.25              | YES               | -356        | 126,736            |
| 31 | EB/WB     | Reservation Road            | between Blanco Road and Inter-Garrison Road              | 4,057        | 6,224         | -2,167      | -0.348            | 0.48              | YES               | -2,167      | 4,697,697          |
| 32 | EB/WB     | Reservation Road            | between Inter-Garrison Road and East Garrison Road       | 11,526       | 9,844         | 1,682       | 0.171             | 0.38              | YES               | 1,682       | 2,828,111          |
| 33 | WB/NB     | Reindollar Avenue           | between Del Monte Boulevard and Sunset Avenue            | 2,865        | 6,441         | -3,576      | -0.555            | 0.44              | NO                | -3,576      | 12,787,665         |
| 34 | EB/WB     | Imjin Parkway               | between Second Avenue and Highway 1                      | 20,806       | 28,223        | -7,417      | -0.263            | 0.25              | NO                | -7,417      | 55,007,516         |
| 35 | EB/WB     | Imjin Parkway               | between Fourth Avenue and Third Avenue                   | 17,056       | 22,817        | -5,761      | -0.252            | 0.27              | YES               | -5,761      | 33,192,375         |
| 36 | WB/EB     | Imjin Parkway               | between Abrams Drive and Imjin Road                      | 13,312       | 23,570        | -10,258     | -0.435            | 0.27              | NO                | -10,258     | 105,231,784        |
| 37 | SB/NB     | Imjin Parkway               | between Reservation Road and Preston Drive               | 13,005       | 20,860        | -7,855      | -0.377            | 0.28              | NO                | -7,855      | 61,703,185         |
| 38 | WB/EB     | Inter-Garrison Road         | between Second Avenue and Third Avenue                   | 1,722        | 2,630         | -908        | -0.345            | 0.58              | YES               | -908        | 825,229            |
| 39 | WB/EB     | Inter-Garrison Road         | between Sixth Avenue and Seventh Avenue                  | 6,398        | 665           | 5,733       | 8.621             | 0.68              | NO                | 5,733       | 32,863,491         |
| 40 | WB/EB     | Inter-Garrison Road         | between Eighth Avenue and Abrams Drive                   | 6,762        | 8,450         | -1,688      | -0.200            | 0.41              | YES               | -1,688      | 2,849,131          |
| 41 | WB/EB     | Lightfighter Drive          | between Highway 1 and First Avenue                       | 4,311        | 15,002        | -10,691     | -0.713            | 0.30              | NO                | -10,691     | 114,291,943        |
| 42 | EB/WB     | Lightfighter Drive          | between Second Avenue and General Jim Moore Boulevard    | 6,865        | 13,257        | -6,392      | -0.482            | 0.33              | NO                | -6,392      | 40,852,192         |
| 43 | EB/WB     | Lightfighter Drive          | between General Jim Moore Blvd and Colonel Durham Street | 1            | 3,746         | -3,745      | -1.000            | 0.58              | NO                | -3,745      | 14,027,031         |
| 44 | WB/EB     | Gigling Road                | between General Jim Moore Boulevard and Malmedy Road     | 53           | 6,281         | -6,228      | -0.992            | 0.44              | NO                | -6,228      | 38,789,101         |
| 45 | NB/SB     | Monterey Road               | between Buna Road and Noumea Road                        | 270          | 3,280         | -3,010      | -0.918            | 0.58              | NO                | -3,010      | 9,059,431          |
| 46 | WB/EB     | Coe Avenue                  | between Buttercup Boulevard and Coe Avenue               | 993          | 2,950         | -1,957      | -0.663            | 0.58              | NO                | -1,957      | 3,827,956          |
| 47 | EB/WB     | San Pablo                   | between Nadina Street and General Jim Moore Boulevard    | 1,948        | 3,963         | -2,015      | -0.508            | 0.52              | YES               | -2,015      | 4,060,689          |
| 48 | EB/WB     | Broadway Avenue             | between Mescal Street and General Jim Moore Boulevard    | 4,622        | 7,304         | -2,682      | -0.367            | 0.44              | YES               | -2,682      | 7,192,084          |
| 49 | SB/NB     | Eight Avenue                | between Inter-Garrison Road and A Street                 | 151          | 4,578         | -4,427      | -0.967            | 0.52              | NO                | -4,427      | 19,601,879         |

Local Roadway/Freeway/Ramp Results:

904,681 1,052,959

Model/Count Ratio = 0.86  
 Percent within Caltrans Maximum Deviation = 100% <75%  
 Percent Root Mean Square Error (RSME) = 26% <40%  
 Correlation Coefficient = 99% >0.88

Total Count = 49  
 Link within Deviation = 26  
 Link Outside Deviation = 23

Local Roadway Results:

268,678 373,342

Model/Count Ratio = 0.72  
 Percent Within Caltrans Maximum Deviation = 43% <75%  
 Percent Root Mean Square Error = 27% <40%  
 Correlation Coefficient = 0.99 >0.88

Total Count = 39  
 Link within Deviation = 19  
 Link Outside Deviation = 20



**ATTACHMENT G: FINAL MODEL VALIDATION RESULTS: FUNCTIONAL  
CLASSIFICATION, RUN 01**

| Table C1: Results of AM Peak-Hour Model Area Validation by Functional Class, Run 01 |       |                       |      |        |                        |         |        |
|---|-------|-----------------------|------|--------|------------------------|---------|--------|
| Functional Class  | Links | Volume-to-Count Ratio |      |        | Root Mean Square Error |         |        |
|   |       | Criteria              | %    | Valid? | %                      | Maximum | Valid? |
| Freeway or Expressway   | 9     | 16%                   | 11%  | Yes    | 14%                    | 40%     | Yes    |
| Principal Arterial  | 10    | 29%                   | 9%   | Yes    | 47%                    | 40%     | No     |
| Minor Arterial  | 6     | 48%                   | -14% | Yes    | 32%                    | 40%     | Yes    |
| Local Roadway   | 18    | 48%                   | -52% | No     | 90%                    | 40%     | No     |
| Major Collector   | 6     | 48%                   | -16% | Yes    | 82%                    | 40%     | No     |
| Ramp  | 1     | 28%                   | -26% | Yes    | 26%                    | 40%     | Yes    |
| Total   | 50    | 10%                   | 2%   | Yes    | 34%                    | 40%     | Yes    |

| Table C2: Results of PM Peak-Hour Model Area Validation by Functional Class, Run 01 |       |                       |      |        |                        |         |        |
|---|-------|-----------------------|------|--------|------------------------|---------|--------|
| Functional Class  | Links | Volume-to-Count Ratio |      |        | Root Mean Square Error |         |        |
|   |       | Criteria              | %    | Valid? | %                      | Maximum | Valid? |
| Freeway or Expressway   | 9     | 16%                   | 16%  | Yes    | 21%                    | 40%     | Yes    |
| Principal Arterial  | 10    | 29%                   | -6%  | Yes    | 25%                    | 40%     | Yes    |
| Minor Arterial  | 6     | 48%                   | -17% | Yes    | 38%                    | 40%     | Yes    |
| Local Roadway   | 18    | 48%                   | -43% | Yes    | 86%                    | 40%     | No     |
| Major Collector   | 6     | 48%                   | -30% | Yes    | 46%                    | 40%     | No     |
| Ramp  | 1     | 28%                   | -31% | No     | 31%                    | 40%     | Yes    |
| Total   | 50    | 10%                   | 0%   | Yes    | 35%                    | 40%     | Yes    |

| Table C3: Results of Daily Model Area Validation by Functional Class, Run 01 |       |                       |      |        |                        |         |        |
|--|-------|-----------------------|------|--------|------------------------|---------|--------|
| Functional Class   | Links | Volume-to-Count Ratio |      |        | Root Mean Square Error |         |        |
|  |       | Criteria              | %    | Valid? | %                      | Maximum | Valid? |
| Freeway or Expressway  | 9     | 16%                   | -4%  | Yes    | 11%                    | 40%     | Yes    |
| Principal Arterial   | 10    | 29%                   | -12% | Yes    | 18%                    | 40%     | Yes    |
| Minor Arterial   | 6     | 48%                   | -15% | Yes    | 29%                    | 40%     | Yes    |
| Local Roadway  | 18    | 48%                   | -47% | Yes    | 88%                    | 40%     | No     |
| Major Collector  | 6     | 48%                   | -32% | Yes    | 44%                    | 40%     | No     |
| Ramp   | 1     | 28%                   | -37% | No     | 37%                    | 40%     | Yes    |
| Total  | 50    | 10%                   | -11% | No     | 24%                    | 40%     | Yes    |

**ATTACHMENT H: FINAL MODEL VALIDATION RESULTS: ROADWAY  
VOLUME RANGE, RUN 01**

| Table D1: Results of AM Peak-Hour Model Area Validation by Roadway Volume, Run 01 |        |                       |      |        |                        |         |        |
|---|--------|-----------------------|------|--------|------------------------|---------|--------|
| Functional Class  | Counts | Volume-to-Count Ratio |      |        | Root Mean Square Error |         |        |
|   |        | Criteria              | %    | Valid? | %                      | Maximum | Valid? |
| Less than 1,000   | 30     | 34%                   | -27% | Yes    | 86%                    | 116%    | Yes    |
| 1,000 to 2,499  | 10     | 25%                   | -6%  | Yes    | 47%                    | 116%    | Yes    |
| 2,500 to 4,999  | 2      | 19%                   | 17%  | Yes    | 26%                    | 116%    | Yes    |
| 5,000 to 10,000   | 8      | 14%                   | 10%  | Yes    | 13%                    | 43%     | Yes    |
| Total   | 50     |                       |      |        |                        |         |        |

| Table D2: Results of PM Peak-Hour Model Area Validation by Roadway Volume, Run 01 |       |                       |      |       |                        |         |        |
|---|-------|-----------------------|------|-------|------------------------|---------|--------|
| Functional Class  | Links | Volume-to-Count Ratio |      |       | Root Mean Square Error |         |        |
|   |       | Criteria              | %    | Valid | %                      | Maximum | Valid? |
| Less than 1,000   | 27    | 34%                   | -36% | No    | 74%                    | 116%    | Yes    |
| 1,000 to 2,499  | 13    | 25%                   | -13% | Yes   | 31%                    | 116%    | Yes    |
| 2,500 to 4,999  | 3     | 19%                   | 27%  | No    | 35%                    | 116%    | Yes    |
| 5,000 to 10,000   | 7     | 14%                   | 12%  | Yes   | 17%                    | 43%     | Yes    |
| Total   | 50    |                       |      |       |                        |         |        |

| Table D3: Results of Daily Model Area Validation by Roadway Volume, Run 01 |        |                       |      |        |                        |         |        |
|--|--------|-----------------------|------|--------|------------------------|---------|--------|
| Functional Class   | Counts | Volume-to-Count Ratio |      |        | Root Mean Square Error |         |        |
|  |        | Criteria              | %    | Valid? | %                      | Maximum | Valid? |
| Less than 1,000  | 3      | 34%                   | 186% | No     | 86%                    | 116%    | Yes    |
| 1,000 to 2,499   | 0      | 25%                   | NA   | N/A    | 84%                    | 116%    | N/A    |
| 2,500 to 4,999   | 11     | 19%                   | -48% | No     | 96%                    | 116%    | Yes    |
| 5,000 to 9,999   | 15     | 14%                   | -28% | No     | 45%                    | 43%     | No     |
| 10,000 to 19,999   | 5      | 14%                   | -25% | No     | 35%                    | 28%     | No     |
| 20,000 to 24,999   | 3      | 14%                   | -22% | No     | 23%                    | 25%     | Yes    |
| 25,000 to 39,999   | 4      | 14%                   | -14% | No     | 21%                    | 25%     | Yes    |
| 40,000 to 49,999   | 0      | 14%                   | N/A  | N/A    | NA                     | 30%     | N/A    |
| 50,000 to 59,999   | 1      | 14%                   | 4%   | Yes    | 4%                     | 30%     | Yes    |
| 60,000 to 89,999   | 5      | 14%                   | 3%   | Yes    | 7%                     | 19%     | Yes    |
| Total  | 47     |                       |      |        |                        |         |        |

**ATTACHMENT I: FINAL MODEL VALIDATION RESULTS: SCREENLINES  
USING TWO-WAY VOLUME, RUN 01**

| Table E1: Results of Screenline AM Peak Hour - Two-Way Volume, Run 01       |           |  |              |               |          |                |                   |                  |             |                    |              |
|---|-----------|--|--------------|---------------|----------|----------------|-------------------|------------------|-------------|--------------------|--------------|
| Count ID  | Direction | Location   | Model Volume | Traffic Count | Delta AM | Delta/Count AM | Maximum Deviation | Within Deviation | Model-Count | Difference Squared | Percent RSME |
| <b>Screenline 1: East of Reservation Road between Blanco Road and SR-68</b> |           |  |              |               |          |                |                   |                  |             |                    |              |
| 40543   | NB        | Blanco Road between Cooper Road and Reservation Road   | 1,223        | 997           | 226      | 0.227          | 0.55              | YES              | 226         | 51,044             |              |
| 40543   | SB        | Blanco Road between Cooper Road and Reservation Road   | 1,453        | 998           | 455      | 0.456          | 0.55              | YES              | 455         | 207,189            |              |
| 13421   | NB        | Davis Road just north of Reservation Road              | 123          | 280           | -157     | -0.560         | 0.63              | YES              | -157        | 24,553             |              |
| 13421   | SB        | Davis Road just north of Reservation Road              | 206          | 406           | -200     | -0.492         | 0.62              | YES              | -200        | 39,920             |              |
| 4810  | EB        | Reservation Road just west of SR-68                    | 231          | 420           | -189     | -0.449         | 0.62              | YES              | -189        | 35,540             |              |
| 4810  | WB        | Reservation Road just west of SR-68                    | 267          | 648           | -381     | -0.588         | 0.59              | YES              | -381        | 145,273            |              |
| <b>Screenline 1: East of Reservation Road between Blanco Road and SR-68</b> |           |  | 3,504        | 3,749         | -245     | -0.065         | 0.35              | YES              | -245        | 60,051             | 9%           |
| <b>Screenline 2: 6th Ave between Inter-Garrison Road and Imjin Parkway</b>  |           |  |              |               |          |                |                   |                  |             |                    |              |
| 12644   | SB        | Imjin Road between Imjin Parkway and Eight Street      | 171          | 50            | 121      | 2.422          | 0.64              | NO               | 121         | 14,669             |              |
| 12644   | NB        | Imjin Road between Imjin Parkway and Eight Street      | 43           | 310           | -267     | -0.861         | 0.63              | NO               | -267        | 71,276             |              |
| 4020  | WB        | Inter-Garrison between Eight Avenue and Abrams Drive   | 338          | 139           | 199      | 1.435          | 0.64              | NO               | 199         | 39,764             |              |
| 4020  | EB        | Inter-Garrison between Eight Avenue and Abrams Drive   | 85           | 990           | -905     | -0.915         | 0.55              | NO               | -905        | 819,736            |              |
| 3700  | WB        | Imjin Parkway between Abrams Drive and Imjin Road      | 1,035        | 797           | 238      | 0.299          | 0.57              | YES              | 238         | 56,787             |              |
| 3700  | EB        | Imjin Parkway between Abrams Drive and Imjin Road      | 588          | 1,127         | -539     | -0.478         | 0.54              | YES              | -539        | 290,273            |              |
| <b>Screenline 2: 6th Ave between Inter-Garrison Road and Imjin Parkway</b>  |           |  | 2,261        | 3,413         | -1,152   | -0.338         | 0.37              | YES              | -1,152      | 1,327,826          | 34%          |
| <b>Screenline 3: US-1 between Del Monte Boulevard and Fremont Boulevard</b> |           |  |              |               |          |                |                   |                  |             |                    |              |
| 41432   | NB        | Del Monte Boulevard between Reindollar Avenue and SR 1 | 486          | 953           | -467     | -0.490         | 0.56              | YES              | -467        | 218,447            |              |
| 10104   | SB        | Del Monte Boulevard between Reindollar Avenue and SR 1 | 889          | 901           | -12      | -0.013         | 0.56              | YES              | -12         | 136                |              |
| 45007   | EB        | Imjin Parkway between Second Avenue and Highway 1      | 1,126        | 1,288         | -162     | -0.126         | 0.52              | YES              | -162        | 26,379             |              |
| 45007   | WB        | Imjin Parkway between Second Avenue and Highway 1      | 1,329        | 1,212         | 117      | 0.096          | 0.53              | YES              | 117         | 13,607             |              |
| 10078   | WB        | Light Fighter Drive between Highway 1 and First Avenue | 234          | 382           | -148     | -0.388         | 0.62              | YES              | -148        | 22,022             |              |
| 10078   | EB        | Light Fighter Drive between Highway 1 and First Avenue | 121          | 587           | -466     | -0.795         | 0.6               | NO               | -466        | 217,559            |              |
| 13637   | NB        | Fremont Boulevard                                      | 570          | 826           | -256     | -0.310         | 0.57              | YES              | -256        | 65,740             |              |
| 13637   | SB        | Fremont Boulevard                                      | 756          | 943           | -187     | -0.199         | 0.56              | YES              | -187        | 35,154             |              |
| <b>Screenline 3: US-1 between Del Monte Boulevard and Fremont Boulevard</b> |           |  | 5,508        | 7,092         | -1,584   | -0.223         | 0.26              | YES              | -1,584      | 2,507,536          | 32%          |

| Table E2: Results of Screenline PM Peak Hour - Two-Way Volume, Run 01       |           |  |              |               |               |                |                   |                  |               |                    |              |
|---|-----------|--|--------------|---------------|---------------|----------------|-------------------|------------------|---------------|--------------------|--------------|
| Count ID  | Direction | Location   | Model Volume | Traffic Count | Delta AM      | Delta/Count AM | Maximum Deviation | Within Deviation | Model-Count   | Difference Squared | Percent RSME |
| <b>Screenline 1: East of Reservation Road between Blanco Road and SR-68</b> |           |  |              |               |               |                |                   |                  |               |                    |              |
| 40543   | NB        | Blanco Road between Cooper Road and Reservation Road   | 1,307        | 972           | 335           | 0.345          | 0.55              | YES              | 335           | 112,276            |              |
| 40543   | SB        | Blanco Road between Cooper Road and Reservation Road   | 1,225        | 972           | 253           | 0.260          | 0.55              | YES              | 253           | 63,783             |              |
| 13421   | NB        | Davis Road just north of Reservation Road              | 395          | 392           | 3             | 0.009          | 0.62              | YES              | 3             | 12                 |              |
| 13421   | SB        | Davis Road just north of Reservation Road              | 185          | 282           | -97           | -0.345         | 0.63              | YES              | -97           | 9,486              |              |
| 4810  | EB        | Reservation Road just west of SR-68                    | 268          | 615           | -347          | -0.564         | 0.6               | YES              | -347          | 120,436            |              |
| 4810  | WB        | Reservation Road just west of SR-68                    | 251          | 455           | -204          | -0.449         | 0.61              | YES              | -204          | 41,782             |              |
| <b>Screenline 1: East of Reservation Road between Blanco Road and SR-68</b> |           |  | <b>3,630</b> | <b>3,688</b>  | <b>-58</b>    | <b>-0.016</b>  | <b>0.36</b>       | <b>YES</b>       | <b>-58</b>    | <b>3,342</b>       | <b>2%</b>    |
| <b>Screenline 2: 6th Ave between Inter-Garrison Road and Imjin Parkway</b>  |           |  |              |               |               |                |                   |                  |               |                    |              |
| 12644   | SB        | Imjin Road between Imjin Parkway and Eight Street      | 84           | 197           | -113          | -0.576         | 0.64              | YES              | -113          | 12,865             |              |
| 12644   | NB        | Imjin Road between Imjin Parkway and Eight Street      | 145          | 153           | -8            | -0.052         | 0.64              | YES              | -8            | 64                 |              |
| 4020  | WB        | Inter-Garrison between Eight Avenue and Abrams Drive   | 138          | 782           | -644          | -0.823         | 0.58              | NO               | -644          | 414,341            |              |
| 4020  | EB        | Inter-Garrison between Eight Avenue and Abrams Drive   | 441          | 244           | 197           | 0.807          | 0.64              | NO               | 197           | 38,747             |              |
| 3700  | WB        | Imjin Parkway between Abrams Drive and Imjin Road      | 703          | 980           | -277          | -0.283         | 0.55              | YES              | -277          | 76,761             |              |
| 3700  | EB        | Imjin Parkway between Abrams Drive and Imjin Road      | 1,051        | 840           | 211           | 0.251          | 0.57              | YES              | 211           | 44,438             |              |
| <b>Screenline 2: 6th Ave between Inter-Garrison Road and Imjin Parkway</b>  |           |  | <b>2,561</b> | <b>3,196</b>  | <b>-635</b>   | <b>-0.199</b>  | <b>0.38</b>       | <b>YES</b>       | <b>-635</b>   | <b>402,602</b>     | <b>20%</b>   |
| <b>Screenline 3: US-1 between Del Monte Boulevard and Fremont Boulevard</b> |           |  |              |               |               |                |                   |                  |               |                    |              |
| 41432   | NB        | Del Monte Boulevard between Reindollar Avenue and SR 1 | 805          | 1,071         | -266          | -0.248         | 0.54              | YES              | -266          | 70,770             |              |
| 10104   | SB        | Del Monte Boulevard between Reindollar Avenue and SR 1 | 647          | 1,033         | -386          | -0.374         | 0.55              | YES              | -386          | 149,081            |              |
| 45007   | EB        | Imjin Parkway between Second Avenue and Highway 1      | 1,504        | 1,326         | 178           | 0.134          | 0.51              | YES              | 178           | 31,605             |              |
| 45007   | WB        | Imjin Parkway between Second Avenue and Highway 1      | 1,187        | 1,398         | -211          | -0.151         | 0.5               | YES              | -211          | 44,713             |              |
| 10078   | WB        | Light Fighter Drive between Highway 1 and First Avenue | 279          | 572           | -293          | -0.511         | 0.6               | YES              | -293          | 85,580             |              |
| 10078   | EB        | Light Fighter Drive between Highway 1 and First Avenue | 111          | 733           | -622          | -0.849         | 0.58              | NO               | -622          | 387,008            |              |
| 13637   | NB        | Fremont Boulevard                                      | 816          | 1,317         | -501          | -0.380         | 0.52              | YES              | -501          | 250,889            |              |
| 13637   | SB        | Fremont Boulevard                                      | 676          | 717           | -41           | -0.057         | 0.58              | YES              | -41           | 1,683              |              |
| <b>Screenline 3: US-1 between Del Monte Boulevard and Fremont Boulevard</b> |           |  | <b>6,025</b> | <b>8,167</b>  | <b>-2,142</b> | <b>-0.262</b>  | <b>0.25</b>       | <b>NO</b>        | <b>-2,142</b> | <b>4,589,730</b>   | <b>37%</b>   |

| Table E3: Results of Screenline Daily - Two-Way Volume, Run 01              |           |  |               |               |                |                |                   |                  |               |                    |              |
|---|-----------|--|---------------|---------------|----------------|----------------|-------------------|------------------|---------------|--------------------|--------------|
| Count ID  | Direction | Location   | Model Volume  | Traffic Count | Delta AM       | Delta/Count AM | Maximum Deviation | Within Deviation | Model-Count   | Difference Squared | Percent RSME |
| <b>Screenline 1: East of Reservation Road between Blanco Road and SR-68</b> |           |  |               |               |                |                |                   |                  |               |                    |              |
| 40543   | NB        | Blanco Road between Cooper Road and Reservation Road   | 11,537        | 13,770        | -2,233         | -0.162         | 0.53              | YES              | 335           | 112,276            |              |
| 40543   | SB        | Blanco Road between Cooper Road and Reservation Road   | 11,141        | 13,769        | -2,628         | -0.191         | 0.53              | YES              | 253           | 63,783             |              |
| 13421   | NB        | Davis Road just north of Reservation Road              | 5,077         | N/A           | N/A            | 0.000          | N/A               | N/A              | 3             | 12                 |              |
| 13421   | SB        | Davis Road just north of Reservation Road              | 5,261         | N/A           | N/A            | 0.000          | N/A               | N/A              | -97           | 9,486              |              |
| 4810  | EB        | Reservation Road just west of SR-68                    | 2,690         | N/A           | N/A            | 0.000          | N/A               | N/A              | -347          | 120,436            |              |
| 4810  | WB        | Reservation Road just west of SR-68                    | 2,856         | N/A           | N/A            | 0.000          | N/A               | N/A              | -204          | 41,782             |              |
| <b>Screenline 1: East of Reservation Road between Blanco Road and SR-68</b> |           |  | <b>38,561</b> | <b>27,539</b> | <b>-4,861</b>  | <b>-0.177</b>  | <b>0.17</b>       | <b>NO</b>        | <b>11,022</b> | <b>121,494,873</b> | <b>57%</b>   |
| <b>Screenline 2: 6th Ave between Inter-Garrison Road and Imjin Parkway</b>  |           |  |               |               |                |                |                   |                  |               |                    |              |
| 12644   | SB        | Imjin Road between Imjin Parkway and Eight Street      | 171           | 50            | 121            | 2.422          | 0.64              | NO               | 121           | 14,669             |              |
| 12644   | NB        | Imjin Road between Imjin Parkway and Eight Street      | 43            | 310           | -267           | -0.861         | 0.63              | NO               | -267          | 71,276             |              |
| 4020  | WB        | Inter-Garrison between Eight Avenue and Abrams Drive   | 338           | 139           | 199            | 1.435          | 0.64              | NO               | 199           | 39,764             |              |
| 4020  | EB        | Inter-Garrison between Eight Avenue and Abrams Drive   | 85            | 990           | -905           | -0.915         | 0.55              | NO               | -905          | 819,736            |              |
| 3700  | WB        | Imjin Parkway between Abrams Drive and Imjin Road      | 1,035         | 797           | 238            | 0.299          | 0.57              | YES              | 238           | 56,787             |              |
| 3700  | EB        | Imjin Parkway between Abrams Drive and Imjin Road      | 588           | 1,127         | -539           | -0.478         | 0.54              | YES              | -539          | 290,273            |              |
| <b>Screenline 2: 6th Ave between Inter-Garrison Road and Imjin Parkway</b>  |           |  | <b>2,261</b>  | <b>3,413</b>  | <b>-1,152</b>  | <b>-0.338</b>  | <b>0.37</b>       | <b>YES</b>       | <b>-1,152</b> | <b>1,327,826</b>   | <b>34%</b>   |
| <b>Screenline 3: US-1 between Del Monte Boulevard and Fremont Boulevard</b> |           |  |               |               |                |                |                   |                  |               |                    |              |
| 41432   | NB        | Del Monte Boulevard between Reindollar Avenue and SR 1 | 8,137         | 13,945        | -5,808         | -0.416         | 0.54              | YES              | -5,808        | 70,770             |              |
| 10104   | SB        | Del Monte Boulevard between Reindollar Avenue and SR 1 | 8,871         | 12,841        | -3,970         | -0.309         | 0.55              | YES              | -3,970        | 149,081            |              |
| 45007   | EB        | Imjin Parkway between Second Avenue and Highway 1      | 13,230        | 14,435        | -1,205         | -0.083         | 0.51              | YES              | -1,205        | 31,605             |              |
| 45007   | WB        | Imjin Parkway between Second Avenue and Highway 1      | 11,885        | 13,788        | -1,903         | -0.138         | 0.5               | YES              | -1,903        | 44,713             |              |
| 10078   | WB        | Light Fighter Drive between Highway 1 and First Avenue | 2,986         | 6,315         | -3,329         | -0.527         | 0.6               | YES              | -3,329        | 85,580             |              |
| 10078   | EB        | Light Fighter Drive between Highway 1 and First Avenue | 1,344         | 8,687         | -7,343         | -0.845         | 0.58              | NO               | -7,343        | 387,008            |              |
| 13637   | NB        | Fremont Boulevard                                      | 7,970         | N/A           | N/A            | N/A            | 0.52              | N/A              | N/A           | 250,889            |              |
| 13637   | SB        | Fremont Boulevard                                      | 7,531         | N/A           | N/A            | N/A            | 0.58              | N/A              | N/A           | 1,683              |              |
| <b>Screenline 3: US-1 between Del Monte Boulevard and Fremont Boulevard</b> |           |  | <b>61,954</b> | <b>70,011</b> | <b>-23,558</b> | <b>-0.336</b>  | <b>0.17</b>       | <b>NO</b>        | <b>-8,057</b> | <b>64,917,957</b>  | <b>16%</b>   |



**ATTACHMENT J: FINAL MODEL VALIDATION RESULTS: BY LINK USING  
TWO-WAY VOLUME, RUN 01**

Table F1: Results of AM Peak-Hour Model Area Validation by Two-Way Volume, Run 01

| ID | Direction | Description                 |  | Model Volume | Traffic Count | Model Delta | Model Delta/Count | Maximum Deviation | Withing Deviation | Model-Count | Difference Squared |
|----|-----------|-----------------------------|--|--------------|---------------|-------------|-------------------|-------------------|-------------------|-------------|--------------------|
|    |           | Roadway                     | Location   |              |               |             |                   |                   |                   |             |                    |
| 1  | SB/NB     | Highway 1                   | between Del Monte Boulevard and Reservation Road         | 5,032        | 3,875         | 1,157       | 0.299             | 0.21              | NO                | 1,157       | 1,338,354          |
| 2  | SB/NB     | Highway 1                   | between Imjin Parkway and Del Monte Boulevard            | 6,407        | 5,777         | 630         | 0.109             | 0.17              | YES               | 630         | 396,696            |
| 3  | SB/NB     | Highway 1                   | between Light Fighter Drive and Imjin Parkway            | 7,596        | 6,955         | 641         | 0.092             | 0.15              | YES               | 641         | 411,052            |
| 4  | SB/NB     | Highway 1                   | between Del Monte Boulevard and Light Fighter Drive      | 7,861        | 7,484         | 377         | 0.050             | 0.14              | YES               | 377         | 141,866            |
| 5  | SB/NB     | Highway 1                   | between Canyon Del Rey Boulevard and Del Monte Boulevard | 6,963        | 6,296         | 667         | 0.106             | 0.16              | YES               | 667         | 445,228            |
| 6  | SB/NB     | Highway 1                   | between Del Monte Boulevard and Canyon Del Rey Boulevard | 7,529        | 6,388         | 1,141       | 0.179             | 0.16              | NO                | 1,141       | 1,301,752          |
| 7  | SB/NB     | Highway 1                   | between Casa Verde Way and Del Monte Boulevard           | 6,728        | 5,620         | 1,108       | 0.197             | 0.18              | NO                | 1,108       | 1,228,432          |
| 8  | SB/NB     | Highway 1                   | between SR 68 and Casa Verde Way                         | 6,914        | 5,600         | 1,314       | 0.235             | 0.18              | NO                | 1,314       | 1,727,244          |
| 9  | SB/NB     | Highway 1                   | between SR 68 and Fremont Street                         | 8,027        | 8,584         | -557        | -0.065            | 0.14              | YES               | -557        | 310,316            |
| 10 | NB/SB     | Del Monte Boulevard         | between Beach Road and Reservation Road                  | 749          | 609           | 140         | 0.230             | 0.44              | YES               | 140         | 19,563             |
| 11 | NB/SB     | Del Monte Boulevard         | between Reindollar Avenue and SR 1                       | 1,375        | 1,854         | -479        | -0.258            | 0.28              | YES               | -479        | 229,474            |
| 12 | NB/SB     | Second Avenue               | between Imjin Parkway and Tenth Street                   | 976          | 217           | 759         | 3.500             | 0.63              | NO                | 759         | 576,724            |
| 13 | NB/SB     | Second Avenue               | between Eight Street and Fifth Street                    | 231          | 817           | -586        | -0.718            | 0.38              | NO                | -586        | 343,944            |
| 14 | SB/NB     | Second Avenue               | between Divarty Street and Light Fighter Drive           | 51           | 147           | -96         | -0.651            | 0.63              | NO                | -96         | 9,171              |
| 15 | SB/NB     | General Jim Moore           | between Divarty Street and Light Fighter Drive           | 629          | 441           | 188         | 0.427             | 0.48              | YES               | 188         | 35,397             |
| 16 | NB/SB     | General Jim Moore Boulevard | between Light Fighter Drive and Gigling Road             | 611          | 730           | -119        | -0.163            | 0.41              | YES               | -119        | 14,244             |
| 17 | SB/NB     | General Jim Moore Boulevard | between Normandy Road and Coe Avenue                     | 487          | 700           | -213        | -0.304            | 0.41              | YES               | -213        | 45,166             |
| 18 | SB/NB     | General Jim Moore Boulevard | between Coe Avenue and San Pablo Avenue                  | 496          | 432           | 64          | 0.148             | 0.52              | YES               | 64          | 4,103              |
| 19 | NB/SB     | California Avenue           | between Reservation Road and Windsor Court               | 207          | 430           | -223        | -0.519            | 0.52              | YES               | -223        | 49,840             |
| 20 | NB/SB     | California Avenue           | between Reindollar Avenue and Imjin Parkway              | 263          | 398           | -135        | -0.338            | 0.52              | YES               | -135        | 18,124             |
| 21 | SB/NB     | California Avenue           | between Imjin Parkway and Fifth Avenue                   | 53           | 158           | -105        | -0.666            | 0.63              | NO                | -105        | 11,065             |
| 22 | SB/NB     | Imjin Road                  | between Imjin Parkway and Eight Street                   | 214          | 360           | -146        | -0.405            | 0.52              | YES               | -146        | 21,275             |
| 23 | NB/SB     | Abram Drive                 | between Imjin Parkway and Bunker Hill Drive              | 493          | 389           | 104         | 0.267             | 0.52              | YES               | 104         | 10,752             |
| 24 | NB/SB     | Abram Drive                 | between Manassas Drive and Inter-Garrison Road           | 287          | 466           | -179        | -0.383            | 0.48              | YES               | -179        | 31,868             |
| 25 | NB/SB     | Blanco Road                 | between Cooper Road and Reservation Road                 | 2,676        | 1,995         | 681         | 0.341             | 0.27              | NO                | 681         | 463,909            |
| 26 | EB/WB     | Reservation Road            | between Highway 1 and Cardoza Avenue                     | 1,119        | 418           | 701         | 1.677             | 0.52              | NO                | 701         | 491,434            |
| 27 | WB/EB     | Reservation Road            | between Robinin Drive and Del Monte Boulevard            | 175          | 557           | -382        | -0.685            | 0.44              | NO                | -382        | 145,638            |
| 28 | WB/EB     | Reservation Road            | between Del Monte Boulevard and Vista Del Camino         | 1,267        | 1,606         | -339        | -0.211            | 0.29              | YES               | -339        | 114,596            |
| 29 | EB/WB     | Reservation Road            | between Salinas Avenue and Imjin Parkway                 | 1,166        | 1,526         | -360        | -0.236            | 0.29              | YES               | -360        | 129,341            |
| 30 | EB/WB     | Reservation Road            | between Imjin Parkway and Blanco Road                    | 2,881        | 1,224         | 1,657       | 1.354             | 0.31              | NO                | 1,657       | 2,745,640          |
| 31 | EB/WB     | Reservation Road            | between Blanco Road and Inter-Garrison Road              | 281          | 752           | -471        | -0.626            | 0.41              | NO                | -471        | 221,689            |
| 32 | EB/WB     | Reservation Road            | between Inter-Garrison Road and East Garrison Road       | 470          | 1,160         | -690        | -0.594            | 0.33              | NO                | -690        | 475,559            |
| 33 | WB/NB     | Reindollar Avenue           | between Del Monte Boulevard and Sunset Avenue            | 251          | 371           | -120        | -0.322            | 0.52              | YES               | -120        | 14,311             |
| 34 | EB/WB     | Imjin Parkway               | between Second Avenue and Highway 1                      | 2,454        | 2,500         | -46         | -0.018            | 0.25              | YES               | -46         | 2,095              |
| 35 | EB/WB     | Imjin Parkway               | between Fourth Avenue and Third Avenue                   | 1,861        | 1,570         | 291         | 0.185             | 0.29              | YES               | 291         | 84,413             |
| 36 | WB/EB     | Imjin Parkway               | between Abrams Drive and Imjin Road                      | 1,624        | 1,924         | -300        | -0.156            | 0.27              | YES               | -300        | 90,282             |
| 37 | SB/NB     | Imjin Parkway               | between Reservation Road and Preston Drive               | 1,849        | 934           | 915         | 0.979             | 0.36              | NO                | 915         | 836,580            |
| 38 | WB/EB     | Inter-Garrison Road         | between Second Avenue and Third Avenue                   | 0            | 147           | -147        | -0.999            | 0.63              | NO                | -147        | 21,546             |
| 39 | WB/EB     | Inter-Garrison Road         | between Sixth Avenue and Seventh Avenue                  | 174          | 277           | -103        | -0.371            | 0.58              | YES               | -103        | 10,579             |
| 40 | WB/EB     | Inter-Garrison Road         | between Eighth Avenue and Abrams Drive                   | 423          | 1,129         | -706        | -0.625            | 0.33              | NO                | -706        | 498,413            |
| 41 | WB/EB     | Lightfighter Drive          | between Highway 1 and First Avenue                       | 354          | 969           | -615        | -0.634            | 0.36              | NO                | -615        | 378,016            |
| 42 | EB/WB     | Lightfighter Drive          | between Second Avenue and General Jim Moore Boulevard    | 851          | 1,503         | -652        | -0.434            | 0.29              | NO                | -652        | 425,683            |
| 43 | EB/WB     | Lightfighter Drive          | between General Jim Moore Blvd and Colonel Durham Street | 87           | 463           | -376        | -0.813            | 0.48              | NO                | -376        | 141,693            |
| 44 | WB/EB     | Gigling Road                | between General Jim Moore Boulevard and Malmedy Road     | 38           | 895           | -857        | -0.958            | 0.36              | NO                | -857        | 735,189            |
| 45 | NB/SB     | Monterey Road               | between Buna Road and Noumea Road                        | 14           | 217           | -203        | -0.937            | 0.63              | NO                | -203        | 41,385             |
| 46 | WB/EB     | Coe Avenue                  | between Buttercup Boulevard and Coe Avenue               | 131          | 506           | -375        | -0.740            | 0.48              | NO                | -375        | 140,284            |
| 47 | EB/WB     | San Pablo                   | between Nadina Street and General Jim Moore Boulevard    | 128          | 728           | -600        | -0.824            | 0.41              | NO                | -600        | 359,435            |
| 48 | EB/WB     | Broadway Avenue             | between Mescal Street and General Jim Moore Boulevard    | 331          | 582           | -251        | -0.431            | 0.44              | YES               | -251        | 62,783             |
| 49 | SB/NB     | Eight Avenue                | between Inter-Garrison Road and A Street                 | 8            | 828           | -820        | -0.990            | 0.38              | NO                | -820        | 671,803            |

Local Roadway/Freeway/Ramp Results:

90,795 89,508

Model/Count Ratio = 1.02  
 Percent Within Caltrans Maximum Deviation = 48% <75%  
 Percent Root Mean Square Error = 0.34 <40%  
 Correlation Coefficient = 0.98 >0.88

Total Count= 49  
 Link within Deviation= 24  
 Link Outside Deviation= 25

Local Roadway Results:

26,362 31,075

Model/Count Ratio = 0.85  
 Percent Within Caltrans Maximum Deviation = 43% <75%  
 Percent Root Mean Square Error = 34% <40%  
 Correlation Coefficient = 0.98 >0.88

Total Count= 39  
 Link within Deviation= 17  
 Link Outside Deviation= 22

Table F2: Results of PM Peak Hour Two-Way Total Traffic Volumes, Run 01

| ID | Direction | Description                 |  | Model Volume | Traffic Count | Model Delta | Model Delta/Count | Maximum Deviation | Withing Deviation | Model-Count | Difference Squared |
|----|-----------|-----------------------------|--|--------------|---------------|-------------|-------------------|-------------------|-------------------|-------------|--------------------|
|    |           | Roadway                     | Location   |              |               |             |                   |                   |                   |             |                    |
| 1  | SB/NB     | Highway 1                   | between Del Monte Boulevard and Reservation Road         | 5,032        | 3,875         | 1,157       | 0.299             | 0.21              | NO                | 1,157       | 955,546            |
| 2  | SB/NB     | Highway 1                   | between Imjin Parkway and Del Monte Boulevard            | 6,517        | 6,318         | 199         | 0.032             | 0.16              | YES               | 199         | 39,754             |
| 3  | SB/NB     | Highway 1                   | between Light Fighter Drive and Imjin Parkway            | 7,800        | 7,763         | 37          | 0.005             | 0.14              | YES               | 37          | 1,364              |
| 4  | SB/NB     | Highway 1                   | between Del Monte Boulevard and Light Fighter Drive      | 8,036        | 7,903         | 133         | 0.017             | 0.14              | YES               | 133         | 17,613             |
| 5  | SB/NB     | Highway 1                   | between Canyon Del Rey Boulevard and Del Monte Boulevard | 7,170        | 5,729         | 1,441       | 0.252             | 0.17              | NO                | 1,441       | 2,077,581          |
| 6  | SB/NB     | Highway 1                   | between Del Monte Boulevard and Canyon Del Rey Boulevard | 7,785        | 5,945         | 1,840       | 0.310             | 0.17              | NO                | 1,840       | 3,386,106          |
| 7  | SB/NB     | Highway 1                   | between Casa Verde Way and Del Monte Boulevard           | 6,862        | 5,027         | 1,835       | 0.365             | 0.19              | NO                | 1,835       | 3,367,686          |
| 8  | SB/NB     | Highway 1                   | between SR 68 and Casa Verde Way                         | 6,914        | 4,774         | 2,140       | 0.448             | 0.20              | NO                | 2,140       | 4,580,283          |
| 9  | SB/NB     | Highway 1                   | between SR 68 and Fremont Street                         | 7,949        | 7,792         | 157         | 0.020             | 0.14              | YES               | 157         | 24,774             |
| 10 | NB/SB     | Del Monte Boulevard         | between Beach Road and Reservation Road                  | 714          | 634           | 80          | -0.126            | 0.44              | YES               | 80          | 6,360              |
| 11 | NB/SB     | Del Monte Boulevard         | between Reindollar Avenue and SR 1                       | 1,452        | 2,104         | -652        | -0.310            | 0.26              | NO                | -652        | 425,281            |
| 12 | SB/NB     | Second Avenue               | between Imjin Parkway and Tenth Street                   | 1,113        | 290           | 823         | 2.840             | 0.58              | NO                | 823         | 678,125            |
| 13 | NB/SB     | Second Avenue               | between Eight Street and Fifth Street                    | 215          | 554           | -339        | -0.611            | 0.44              | NO                | -339        | 114,597            |
| 14 | SB/NB     | Second Avenue               | between Divarty Street and Light Fighter Drive           | 71           | 142           | -71         | -0.499            | 0.63              | YES               | -71         | 5,022              |
| 15 | SB/NB     | General Jim Moore           | between Divarty Street and Light Fighter Drive           | 707          | 384           | 323         | 0.842             | 0.52              | NO                | 323         | 104,515            |
| 16 | NB/SB     | General Jim Moore Boulevard | between Light Fighter Drive and Gigling Road             | 653          | 896           | -243        | -0.272            | 0.36              | YES               | -243        | 59,212             |
| 17 | SB/NB     | General Jim Moore Boulevard | between Normandy Road and Coe Avenue                     | 518          | 722           | -204        | -0.282            | 0.41              | YES               | -204        | 41,475             |
| 18 | SB/NB     | General Jim Moore Boulevard | between Coe Avenue and San Pablo Avenue                  | 546          | 554           | -8          | -0.014            | 0.44              | YES               | -8          | 59                 |
| 19 | NB/SB     | California Avenue           | between Reservation Road and Windsor Court               | 215          | 505           | -290        | -0.574            | 0.48              | NO                | -290        | 84,086             |
| 20 | NB/SB     | California Avenue           | between Reindollar Avenue and Imjin Parkway              | 322          | 562           | -240        | -0.427            | 0.44              | YES               | -240        | 57,645             |
| 21 | SB/NB     | California Avenue           | between Imjin Parkway and Fifth Avenue                   | 54           | 77            | -23         | -0.297            | 0.68              | YES               | -23         | 523                |
| 22 | SB/NB     | Imjin Road                  | between Imjin Parkway and Eight Street                   | 229          | 350           | -121        | -0.347            | 0.52              | YES               | -121        | 14,739             |
| 23 | NB/SB     | Abram Drive                 | between Imjin Parkway and Bunker Hill Drive              | 380          | 496           | -116        | -0.234            | 0.48              | YES               | -116        | 13,528             |
| 24 | NB/SB     | Abram Drive                 | between Manassas Drive and Inter-Garrison Road           | 367          | 446           | -79         | -0.176            | 0.48              | YES               | -79         | 6,170              |
| 25 | NB/SB     | Blanco Road                 | between Cooper Road and Reservation Road                 | 2,532        | 1,944         | 588         | 0.302             | 0.27              | NO                | 588         | 345,307            |
| 26 | EB/WB     | Reservation Road            | between Highway 1 and Cardoza Avenue                     | 1,199        | 1,104         | 95          | 0.086             | 0.33              | YES               | 95          | 9,022              |
| 27 | WB/EB     | Reservation Road            | between Robinin Drive and Del Monte Boulevard            | 192          | 734           | -542        | -0.738            | 0.41              | NO                | -542        | 293,538            |
| 28 | WB/EB     | Reservation Road            | between Del Monte Boulevard and Vista Del Camino         | 1,331        | 1,873         | -542        | -0.289            | 0.27              | NO                | -542        | 293,432            |
| 29 | EB/WB     | Reservation Road            | between Salinas Avenue and Imjin Parkway                 | 1,205        | 1,670         | -465        | -0.278            | 0.28              | YES               | -465        | 216,178            |
| 30 | EB/WB     | Reservation Road            | between Imjin Parkway and Blanco Road                    | 2,754        | 2,001         | 753         | 0.376             | 0.27              | NO                | 753         | 566,829            |
| 31 | EB/WB     | Reservation Road            | between Blanco Road and Inter-Garrison Road              | 235          | 789           | -554        | -0.702            | 0.38              | NO                | -554        | 307,026            |
| 32 | EB/WB     | Reservation Road            | between Inter-Garrison Road and East Garrison Road       | 746          | 1,166         | -420        | -0.360            | 0.33              | NO                | -420        | 175,997            |
| 33 | WB/NB     | Reindollar Avenue           | between Del Monte Boulevard and Sunset Avenue            | 279          | 581           | -302        | -0.520            | 0.44              | NO                | -302        | 91,170             |
| 34 | EB/WB     | Imjin Parkway               | between Second Avenue and Highway 1                      | 2,690        | 2,724         | -34         | -0.012            | 0.24              | YES               | -34         | 1,134              |
| 35 | EB/WB     | Imjin Parkway               | between Fourth Avenue and Third Avenue                   | 2,061        | 2,001         | 60          | 0.030             | 0.27              | YES               | 60          | 3,637              |
| 36 | WB/EB     | Imjin Parkway               | between Abrams Drive and Imjin Road                      | 1,754        | 1,820         | -66         | -0.036            | 0.28              | YES               | -66         | 4,390              |
| 37 | SB/NB     | Imjin Parkway               | between Reservation Road and Preston Drive               | 1,693        | 2,098         | -405        | -0.193            | 0.26              | YES               | -405        | 164,227            |
| 38 | WB/EB     | Inter-Garrison Road         | between Second Avenue and Third Avenue                   | 1            | 169           | -168        | -0.997            | 0.63              | NO                | -168        | 28,382             |
| 39 | WB/EB     | Inter-Garrison Road         | between Sixth Avenue and Seventh Avenue                  | 343          | 230           | 113         | 0.492             | 0.58              | YES               | 113         | 12,825             |
| 40 | WB/EB     | Inter-Garrison Road         | between Eight Avenue and Abrams Drive                    | 579          | 1,026         | -447        | -0.436            | 0.34              | NO                | -447        | 199,674            |
| 41 | WB/EB     | Lightfighter Drive          | between Highway 1 and First Avenue                       | 390          | 1,305         | -915        | -0.701            | 0.31              | NO                | -915        | 836,567            |
| 42 | EB/WB     | Lightfighter Drive          | between Second Avenue and General Jim Moore Boulevard    | 936          | 1,326         | -390        | -0.294            | 0.30              | YES               | -390        | 152,100            |
| 43 | EB/WB     | Lightfighter Drive          | between General Jim Moore Blvd and Colonel Durham Street | 82           | 390           | -308        | -0.789            | 0.52              | NO                | -308        | 94,744             |
| 44 | WB/EB     | Gigling Road                | between General Jim Moore Boulevard and Malmedy Road     | 38           | 786           | -748        | -0.951            | 0.38              | NO                | -748        | 559,201            |
| 45 | NB/SB     | Monterey Road               | between Buna Road and Noumea Road                        | 16           | 307           | -291        | -0.947            | 0.58              | NO                | -291        | 84,514             |
| 46 | WB/EB     | Coe Avenue                  | between Buttercup Boulevard and Coe Avenue               | 140          | 279           | -139        | -0.498            | 0.58              | YES               | -139        | 19,306             |
| 47 | EB/WB     | San Pablo                   | between Nadina Street and General Jim Moore Boulevard    | 149          | 391           | -242        | -0.620            | 0.52              | NO                | -242        | 58,797             |
| 48 | EB/WB     | Broadway Avenue             | between Mescal Street and General Jim Moore Boulevard    | 358          | 612           | -254        | -0.416            | 0.44              | YES               | -254        | 64,747             |
| 49 | SB/NB     | Eight Avenue                | between Inter-Garrison Road and A Street                 | 9            | 635           | -626        | -0.986            | 0.44              | NO                | -626        | 392,117            |

Local Roadway/Freeway/Ramp Results: 93,336 91,803 Model/Count Ratio= 1.02  
 Percent within Caltrans Maximum Deviation= 48% <75%  
 Percent Root Mean Square Error (RSME)= 35% <40%  
 Correlation Coefficient = 98% >0.88

Total Count= 49  
 Link within Deviation= 24  
 Link Outside Deviation= 25

Local Roadway Results: 27,818 34,573 Model/Count Ratio = 0.80  
 Percent Within Caltrans Maximum Deviation = 45% <75%  
 Percent Root Mean Square Error = 35% <40%  
 Correlation Coefficient = 0.25 <0.88

Total Count= 39  
 Link within Deviation= 16  
 Link Outside Deviation= 23

Table F3: Results of Daily Two-Way Total Traffic Volumes, Run 01

| ID   | Direction | Description                 |  | Model Volume   | Traffic Count    | Model Delta | Model Delta/Count  | Maximum Deviation | Withing Deviation               | Model-Count | Difference Squared |
|--|-----------|-----------------------------|--|----------------|------------------|-------------|--|-------------------|---------------------------------|-------------|--------------------|
|  |           | Roadway                     | Location   |                |                  |             |  |                   |                                 |             |                    |
| 1  | SB/NB     | Highway 1                   | between Del Monte Boulevard and Reservation Road         | 5,032          | 3,875            | 1,157       | 0.299  | 0.20              | NO                              | 1,157       | 4,639,956          |
| 2  | SB/NB     | Highway 1                   | between Imjin Parkway and Del Monte Boulevard            | 70,728         | 76,532           | -5,804      | -0.076   | 0.15              | YES                             | -5,804      | 33,680,668         |
| 3  | SB/NB     | Highway 1                   | between Light Fighter Drive and Imjin Parkway            | 84,273         | 93,403           | -9,130      | -0.098   | 0.14              | YES                             | -9,130      | 83,357,546         |
| 4  | SB/NB     | Highway 1                   | between Del Monte Boulevard and Light Fighter Drive      | 86,270         | 96,962           | -10,692     | -0.110   | 0.14              | YES                             | -10,692     | 114,321,860        |
| 5  | SB/NB     | Highway 1                   | between Canyon Del Rey Boulevard and Del Monte Boulevard | 75,470         | 69,564           | 5,906       | 0.085  | 0.17              | YES                             | 5,906       | 34,876,378         |
| 6  | SB/NB     | Highway 1                   | between Del Monte Boulevard and Canyon Del Rey Boulevard | 77,964         | 77,104           | 860         | 0.011  | 0.15              | YES                             | 860         | 739,346            |
| 7  | SB/NB     | Highway 1                   | between Casa Verde Way and Del Monte Boulevard           | 69,295         | 68,590           | 705         | 0.010  | 0.17              | YES                             | 705         | 497,188            |
| 8  | SB/NB     | Highway 1                   | between SR 68 and Casa Verde Way                         | 73,901         | 66,292           | 7,609       | 0.115  | 0.17              | YES                             | 7,609       | 57,898,475         |
| 9  | SB/NB     | Highway 1                   | between SR 68 and Fremont Street                         | 81,515         | 100,509          | -18,994     | -0.189   | 0.14              | NO                              | -18,994     | 360,759,040        |
| 10   | NB/SB     | Del Monte Boulevard         | between Beach Road and Reservation Road                  | 8,054          | 7,580            | 474         | 0.063  | 0.41              | YES                             | 474         | 224,762            |
| 11   | NB/SB     | Del Monte Boulevard         | between Reindollar Avenue and SR 1                       | 17,008         | 26,786           | -9,778      | -0.365   | 0.25              | NO                              | -9,778      | 95,600,690         |
| 12   | SB/NB     | Second Avenue               | between Imjin Parkway and Tenth Street                   | 10,768         | 3,274            | 7,494       | 2.289  | 0.58              | NO                              | 7,494       | 56,158,747         |
| 13   | NB/SB     | Second Avenue               | between Eight Street and Fifth Street                    | 1,822          | 6,331            | -4,509      | -0.712   | 0.44              | NO                              | -4,509      | 20,330,549         |
| 14   | SB/NB     | Second Avenue               | between Divarty Street and Light Fighter Drive           | 1,294          | 2,502            | -1,208      | -0.483   | 0.58              | YES                             | -1,208      | 1,459,429          |
| 15   | SB/NB     | General Jim Moore           | between Divarty Street and Light Fighter Drive           | 6,722          | 5,232            | 1,490       | 0.285  | 0.48              | YES                             | 1,490       | 2,220,977          |
| 16   | NB/SB     | General Jim Moore Boulevard | between Light Fighter Drive and Gigling Road             | 7,554          | 9,611            | -2,057      | -0.214   | 0.38              | YES                             | -2,057      | 4,229,235          |
| 17   | SB/NB     | General Jim Moore Boulevard | between Normandy Road and Coe Avenue                     | 6,486          | 6,683            | -197        | -0.029   | 0.44              | YES                             | -197        | 38,736             |
| 18   | SB/NB     | General Jim Moore Boulevard | between Coe Avenue and San Pablo Avenue                  | 7,653          | 7,004            | 649         | 0.093  | 0.44              | YES                             | 649         | 420,864            |
| 19   | NB/SB     | California Avenue           | between Reservation Road and Windsor Court               | 2,289          | 4,672            | -2,383      | -0.510   | 0.52              | YES                             | -2,383      | 5,677,280          |
| 20   | NB/SB     | California Avenue           | between Reindollar Avenue and Imjin Parkway              | 2,682          | 5,915            | -3,233      | -0.547   | 0.48              | NO                              | -3,233      | 10,455,452         |
| 21   | SB/NB     | California Avenue           | between Imjin Parkway and Fifth Avenue                   | 535            | 992              | -457        | -0.461   | 0.68              | YES                             | -457        | 208,735            |
| 22   | SB/NB     | Imjin Road                  | between Imjin Parkway and Eight Street                   | 300            | 4,122            | -3,822      | -0.927   | 0.52              | NO                              | -3,822      | 14,611,359         |
| 23   | NB/SB     | Abram Drive                 | between Imjin Parkway and Bunker Hill Drive              | 1,873          | 5,616            | -3,743      | -0.666   | 0.48              | NO                              | -3,743      | 14,008,267         |
| 24   | NB/SB     | Abram Drive                 | between Manassas Drive and Inter-Garrison Road           | 1,995          | 4,486            | -2,491      | -0.555   | 0.52              | NO                              | -2,491      | 6,204,223          |
| 25   | NB/SB     | Blanco Road                 | between Cooper Road and Reservation Road                 | 22,678         | 27,539           | -4,861      | -0.177   | 0.25              | YES                             | -4,861      | 23,299,870         |
| 26   | EB/WB     | Reservation Road            | between Highway 1 and Cardoza Avenue                     | 12,612         | 12,776           | -164        | -0.013   | 0.33              | YES                             | -164        | 26,924             |
| 27   | WB/EB     | Reservation Road            | between Robinin Drive and Del Monte Boulevard            | 2,247          | 8,470            | -6,223      | -0.735   | 0.41              | NO                              | -6,223      | 38,731,652         |
| 28   | WB/EB     | Reservation Road            | between Del Monte Boulevard and Vista Del Camino         | 15,574         | 17,396           | -1,822      | -0.105   | 0.29              | YES                             | -1,822      | 3,321,463          |
| 29   | EB/WB     | Reservation Road            | between Salinas Avenue and Imjin Parkway                 | 13,629         | 16,489           | -2,860      | -0.173   | 0.29              | YES                             | -2,860      | 8,178,238          |
| 30   | EB/WB     | Reservation Road            | between Imjin Parkway and Blanco Road                    | 28,507         | 26,567           | 1,940       | 0.073  | 0.25              | YES                             | 1,940       | 3,764,027          |
| 31   | EB/WB     | Reservation Road            | between Blanco Road and Inter-Garrison Road              | 6,589          | 6,224            | 365         | 0.059  | 0.48              | YES                             | 365         | 133,545            |
| 32   | EB/WB     | Reservation Road            | between Inter-Garrison Road and East Garrison Road       | 11,862         | 9,844            | 2,018       | 0.205  | 0.38              | YES                             | 2,018       | 4,074,212          |
| 33   | WB/NB     | Reindollar Avenue           | between Del Monte Boulevard and Sunset Avenue            | 2,906          | 6,441            | -3,535      | -0.549   | 0.44              | NO                              | -3,535      | 12,498,625         |
| 34   | EB/WB     | Imjin Parkway               | between Second Avenue and Highway 1                      | 25,115         | 28,223           | -3,108      | -0.110   | 0.25              | YES                             | -3,108      | 9,659,074          |
| 35   | EB/WB     | Imjin Parkway               | between Fourth Avenue and Third Avenue                   | 19,390         | 22,817           | -3,427      | -0.150   | 0.27              | YES                             | -3,427      | 11,744,532         |
| 36   | WB/EB     | Imjin Parkway               | between Abrams Drive and Imjin Road                      | 16,832         | 23,570           | -6,738      | -0.286   | 0.27              | NO                              | -6,738      | 45,400,059         |
| 37   | SB/NB     | Imjin Parkway               | between Reservation Road and Preston Drive               | 16,307         | 20,860           | -4,553      | -0.218   | 0.28              | YES                             | -4,553      | 20,731,768         |
| 38   | WB/EB     | Inter-Garrison Road         | between Second Avenue and Third Avenue                   | 6              | 2,630            | -2,624      | -0.998   | 0.58              | NO                              | -2,624      | 6,885,675          |
| 39   | WB/EB     | Inter-Garrison Road         | between Sixth Avenue and Seventh Avenue                  | 3,844          | 665              | 3,179       | 4.781  | 0.68              | NO                              | 3,179       | 10,107,214         |
| 40   | WB/EB     | Inter-Garrison Road         | between Eighth Avenue and Abrams Drive                   | 5,508          | 8,450            | -2,942      | -0.348   | 0.41              | YES                             | -2,942      | 8,654,687          |
| 41   | WB/EB     | Lightfighter Drive          | between Highway 1 and First Avenue                       | 4,329          | 15,002           | -10,673     | -0.711   | 0.30              | NO                              | -10,673     | 113,905,231        |
| 42   | EB/WB     | Lightfighter Drive          | between Second Avenue and General Jim Moore Boulevard    | 9,936          | 13,257           | -3,321      | -0.251   | 0.33              | YES                             | -3,321      | 11,029,613         |
| 43   | EB/WB     | Lightfighter Drive          | between General Jim Moore Blvd and Colonel Durham Street | 780            | 3,746            | -2,966      | -0.792   | 0.58              | NO                              | -2,966      | 8,799,186          |
| 44   | WB/EB     | Gigling Road                | between General Jim Moore Boulevard and Malmedy Road     | 638            | 6,281            | -5,643      | -0.898   | 0.44              | NO                              | -5,643      | 31,846,968         |
| 45   | NB/SB     | Monterey Road               | between Buna Road and Noumea Road                        | 258            | 3,280            | -3,022      | -0.921   | 0.58              | NO                              | -3,022      | 9,130,486          |
| 46   | WB/EB     | Coe Avenue                  | between Buttercup Boulevard and Coe Avenue               | 1,000          | 2,950            | -1,950      | -0.661   | 0.58              | NO                              | -1,950      | 3,802,154          |
| 47   | EB/WB     | San Pablo                   | between Nadina Street and General Jim Moore Boulevard    | 1,780          | 3,963            | -2,183      | -0.551   | 0.52              | NO                              | -2,183      | 4,765,298          |
| 48   | EB/WB     | Broadway Avenue             | between Mescal Street and General Jim Moore Boulevard    | 4,526          | 7,304            | -2,778      | -0.380   | 0.44              | YES                             | -2,778      | 7,716,210          |
| 49   | SB/NB     | Eight Avenue                | between Inter-Garrison Road and A Street                 | 371            | 4,578            | -4,207      | -0.919   | 0.52              | NO                              | -4,207      | 17,700,546         |
| <b>Local Roadway/Freeway/Ramp Results:</b> |           |                             |  | <b>928,708</b> | <b>1,052,959</b> |             |  |                   | <b>Model/Count Ratio= 0.88</b>  |             |                    |
|  |           |                             |  |                |                  |             | <b>Percent within Caltrans Maximum Deviation= 48% &lt;75%</b>  |                   |                                 |             |                    |
|  |           |                             |  |                |                  |             | <b>Percent Root Mean Square Error (RSME)= 24% &lt;40%</b>      |                   |                                 |             |                    |
|  |           |                             |  |                |                  |             | <b>Correlation Coefficient = 99% &gt;0.88</b>                  |                   |                                 |             |                    |
|  |           |                             |  |                |                  |             | <b>Total Count= 49</b>   |                   |                                 |             |                    |
|  |           |                             |  |                |                  |             | <b>Link within Deviation= 28</b>                               |                   |                                 |             |                    |
|  |           |                             |  |                |                  |             | <b>Link Outside Deviation= 21</b>                              |                   |                                 |             |                    |
| <b>Local Roadway Results:</b>              |           |                             |  | <b>287,252</b> | <b>373,342</b>   |             |  |                   | <b>Model/Count Ratio = 0.77</b> |             |                    |
|  |           |                             |  |                |                  |             | <b>Percent Within Caltrans Maximum Deviation = 43% &lt;75%</b> |                   |                                 |             |                    |
|  |           |                             |  |                |                  |             | <b>Percent Root Mean Square Error = 25% &lt;40%</b>            |                   |                                 |             |                    |
|  |           |                             |  |                |                  |             | <b>Correlation Coefficient = 0.99 &gt;0.88</b>                 |                   |                                 |             |                    |
|  |           |                             |  |                |                  |             | <b>Total Count= 39</b>   |                   |                                 |             |                    |
|  |           |                             |  |                |                  |             | <b>Link within Deviation= 19</b>                               |                   |                                 |             |                    |
|  |           |                             |  |                |                  |             | <b>Link Outside Deviation= 20</b>                              |                   |                                 |             |                    |

**ATTACHMENT K: CUMULATIVE WITHOUT PROJECT CONDITIONS  
ROADWAY IMPROVEMENTS**

**TABLE K: CUMULATIVE WITHOUT PROJECT CONDITIONS ROADWAY IMPROVEMENTS**

| Project Number <sup>1</sup>                       | Name                                       | Description  | Sources <sup>2</sup> |                   |                  | Included in Cumulative without Project Conditions? | Included in Cumulative without Project Conditions and Eastside Parkway? | Notes  |
|---|--|--|----------------------|-------------------|------------------|--|---|--|
|   |  |  | City <sup>3</sup>    | FORA <sup>4</sup> | RTP <sup>5</sup> |  |   |  |
| <b>City of Marina Capital Improvement Program</b> |  |  |                      |                   |                  |  |   |  |
| R 05  | Second Avenue Extension                    | Extend Second Avenue as a 2-lane arterial between Imjin Parkway and Reindollar Avenue  | X                    | X                 |                  | Yes  | Yes   |  |
| R 34  | Eighth Street                              | Upgrade/construct Eighth Street as a 2-lane arterial from Second Avenue to Inter-Garrison Road   | X                    | X                 |                  | Yes  | Yes   |  |
| R 37  | Patton Parkway Extension                   | Extension of Patton Parkway from Del Monte Boulevard to Crescent Street  | X                    | X                 |                  | Yes  | Yes   |  |
| R49   | Del Monte/Imjin Parkway & SR 1 Interchange | Construct new/consolidate interchange. On Caltrans Regional Transportation Improvement Program   | X                    |                   |                  | No   | No  | Project is planned, funding projected between 2020 to 2035. Marina Capital Improvement Plan (CIP) describes project as being on the Caltrans Regional Transportation Improvement Program, though this improvement is not found in Caltrans State Transportation Improvement Program (2016) and Interregional Transportation Strategic Plan (2016). |
| R59   | Imjin Road Widening                        | Reconstruct and widen Imjin Road to four lanes from Imjin Parkway to Eighth Street   | X                    |                   |                  | No   | No  | Project is planned, funding projected between 2020 and 2035.   |
| R 61  | Second Avenue Widening                     | Widen Second Avenue from Tenth street to Inter-Garrison Road. Remove Class II bike lanes and restripe for two lanes each direction   | X                    |                   |                  | Yes  | Yes   | Project is planned, funding projected between 2020 and 2035.   |
| T 22 / T 23                                       | Imjin Parkway/SR 1 Improvements            | Accommodate a second westbound left turn lane onto SR 1 southbound. Convert SR 1 southbound off-ramp to a loop ramp (or the functional equivalent). Widen SR 1 southbound on-ramp from 1 lane to 2 lanes | X                    |                   |                  | No   | No  |  |
| <b>Fort Ord Reuse Authority (FORA)</b>            |  |  |                      |                   |                  |  |   |  |
| FO 6  | Inter-Garrison Road Widening               | Widen Inter-Garrison Road to a 4-lane arterial from Eastside Parkway to Reservation Road   |                      | X                 |                  | Yes  | Yes   | Partially completed between Sherman Blvd to Reservation Road   |
| FO 7  | Gigling Road                               | Widen Gigling Road to a 4-lane arterial from General Jim Moore Boulevard to Future Eastside Parkway near Eighth Avenue   |                      | X                 |                  | Yes  | Yes   |  |
| FO 12   | Eucalyptus Road                            | Upgrade Eucalyptus Road to 2-lane collector from General Jim Moore Blvd to Eastside Parkway to Parker Flatts Cut-Off Road  |                      | X                 |                  | No   | Yes   | Partially completed from General Jim Moore Boulevard to approx. 700 feet east of Parker Flatts Cut-Off Road.   |

**TABLE K: CUMULATIVE WITHOUT PROJECT CONDITIONS ROADWAY IMPROVEMENTS**

| Project Number <sup>1</sup>                     | Name  | Description  | Sources <sup>2</sup> |                   |                  | Included in Cumulative without Project Conditions? | Included in Cumulative without Project Conditions and Eastside Parkway? | Notes   |
|---|---|--|----------------------|-------------------|------------------|--|---|---|
|   |   |  | City <sup>3</sup>    | FORA <sup>4</sup> | RTP <sup>5</sup> |  |   |   |
| FO 13B  | Eastside Parkway                            | Construct new 2-lane arterial from Eucalyptus Road at Parker Flatts Cut-Off Road to Schoonover Drive                           |                      | X                 |                  | No   | Yes   |   |
| <b>AMBAG Regional Transportation Plan (RTP)</b> |   |  |                      |                   |                  |  |   |   |
| MON-MAR001-MA                                   | Reservation Road Widening                   | Widen Reservation Road to 4 lanes between East Garrison Gate and Davis Road  |                      | X                 | X                | Yes  | Yes   |   |
| MON-MAR001-MA                                   | Imjin Parkway Widening                      | Widen Imjin Parkway to four lanes from Imjin Road to Reservation Road  | X                    |                   | X                | Yes  | Yes   |   |
| MON-MAR115-MA                                   | Imjin Parkway Widening                      | Widen Imjin Parkway from 4 lanes to 6 lanes and construct turning lanes at intersections between Second Avenue and Imjin Road. | X                    |                   | X                | No   | No  | Described as obligatory in Marina 5 year Capital Improvement Plan (CIP), and as an unconstrained transportation project in the 2035 Metropolitan Transportation Plan / Sustainable Communities Strategy (2014). |
| MON-CT045-MA                                    | SR 1/Monterey Road Interchange Improvements | New interchange at Monterey Road between Lightfighter Road interchange and the Fremont Boulevard Interchange                   |                      | X                 | X                | No   | No  | All on- and off-ramps shown as diagonal ramps in Fort Ord Reuse Authority Fee Reallocation Study: Deficiency Analysis and Fee Reallocation (2017).  |

Notes:

1. Project ID Number based on leading agency from source document.
2. Projects appearing in multiple source lists are described and denoted by source.
3. Listed in City of Marina's 5 Year Capital Improvement Project List, Revised March 2016.
4. Listed in Fort Ord Reuse Authority's Capital Improvement Program Fiscal Year 2017/18 through 2027/28, and Fort Ord Reuse Authority Fee Reallocation Study: Deficiency Analysis and Fee Reallocation (2017).
5. Listed in the 2035 Metropolitan Transportation Plan / Sustainable Communities Strategy (2014).

Source: Fehr & Peers, 2019.

**ATTACHMENT L: CUMULATIVE WITHOUT PROJECT CONDITIONS  
INTERSECTION IMPROVEMENTS**



**TABLE L. CUMULATIVE WITHOUT PROJECT CONDITIONS INTERSECTION IMPROVEMENTS**

| Project Number <sup>1</sup>                       | Project Name             | Project Description  | Sources <sup>2</sup> |                   |                  | Estimated Construction Date | Intersection   | Geometry Changes   | Intersection Control Changes | Included in Cumulative without Project Conditions? | Included in Cumulative without Project Conditions and Eastside Parkway? | Notes   |
|---|--------------------------|--|----------------------|-------------------|------------------|-----------------------------|--|--|------------------------------|--|---|---|
|   |                          |  | City <sup>3</sup>    | FORA <sup>4</sup> | RTP <sup>5</sup> |                             |  |  |                              |  |   |   |
| <b>City of Marina Capital Improvement Program</b> |                          |  |                      |                   |                  |                             |  |  |                              |  |   |   |
| R 05  | Second Avenue Extension  | Extend Second Avenue as a 2 lane arterial between Imjin Parkway and Reindollar Avenue  | X                    | X                 |                  | 2035                        | 2 Patton Parkway and Second Avenue Extension (Future Intersection) | 3-way signalized intersection (NB, SB, and EB legs), one lane in each direction with left turn pockets with 120 feet of vehicle storage  | Signalized <sup>6</sup>      | Yes  | Yes   |   |
| R 34  | Eighth Street            | Upgrade/construct Eighth Street as a 2-lane arterial from Second Avenue to Inter-Garrison Road                                     | X                    | X                 |                  | 2035                        | 16 Eighth Street and Second Avenue                                 | See Improvement R 61   | Signalized                   | Yes  | Yes   | Signalization part of project TI 18 in the City of Marina Capital Improvement Program |
|   |                          |  |                      |                   |                  |                             | 18 Eighth Street and Imjin Road                                    | Southbound: change from a shared through-left and right turn to one lane entering the roundabout<br>Eastbound: change from a shared through-left and right turn to one lane entering the roundabout<br>Westbound: change from a shared through-left and right turn to one lane entering the roundabout | Roundabout                   | Yes  | Yes   | Roundabout part of project TI 08 in the City of Marina Capital Improvement Program    |
| R 37  | Patton Parkway Extension | Extension of Patton Parkway from Del Monte Boulevard to Crescent Street  | X                    | X                 |                  | 2035                        | 2 Patton Parkway and Second Avenue Extension (Future Intersection) | See Improvement R 05   | See Improvement 1            | Yes  | Yes   |   |
| R 61  | Second Avenue Widening   | Widen Second Avenue from Tenth Street to Inter-Garrison Road. Remove Class II bike lanes and restripe for two lanes each direction | X                    |                   |                  | 2035                        | 15 Ninth Street and Second Avenue                                  | Southbound: change from a shared through-left and 1 right turn to 1 left, 1 through, 1 shared through-right<br>Northbound: change from 1 left turn and 1 through/right to 1 left, 1 through and 1 a shared through-right   | Signalized                   | Yes  | Yes   |   |
|   |                          |  |                      |                   |                  |                             | 16 Eighth Street and Second Avenue                                 | Southbound: Change to 2 through lanes and 1 left turn lane Northbound: Change to 2 through lanes and 1 right turn lane   | Signalized                   | Yes  | Yes   | Signalization part of project TI 18 in the City of Marina Capital Improvement Program |
|   |                          |  |                      |                   |                  |                             | 19 Inter-Garrison Road and Second Avenue                           | Southbound: from 1 left turn and 1 through to 1 left, 2 through lanes<br>Northbound: from 1 through and 1 right turn lanes to 1 through and 1 shared through-right lanes   | Signalized                   | Yes  | Yes   |   |

**TABLE L. CUMULATIVE WITHOUT PROJECT CONDITIONS INTERSECTION IMPROVEMENTS**

| Project Number <sup>1</sup>            | Project Name                 | Project Description  | Sources <sup>2</sup> |                   |                  | Estimated Construction Date | Intersection | Geometry Changes   | Intersection Control Changes   | Included in Cumulative without Project Conditions? | Included in Cumulative without Project Conditions and Eastside Parkway? | Notes |
|--|------------------------------|--|----------------------|-------------------|------------------|-----------------------------|--------------|--|--|--|---|-------|
|  |                              |  | City <sup>3</sup>    | FORA <sup>4</sup> | RTP <sup>5</sup> |                             |              |  |  |  |   |       |
| TI 06                                  | Traffic Intersection         | Intersection Improvement   | X                    |                   |                  | 2035                        | 6            | Imjin Parkway and Third Avenue                                 | No geometry changes  | Signalized   | Yes   | Yes   |
| TI 09                                  | Traffic Intersection         | Intersection Improvement   | X                    |                   |                  | 2035                        | 7            | Imjin Parkway and Fourth Avenue                                | No geometry changes  | Signalized   | Yes   | Yes   |
| TI 27                                  | Traffic Intersection         | Intersection Improvement   | X                    |                   |                  | 2035                        | 11           | Imjin Parkway and Abrams Drive                                 | Install double left turn and right turn lanes on Imjin Pkwy, left and right turn lanes on Abrams Drive, signalize, and restripe  | Signalized   | Yes   | Yes   |
| TI 44                                  | Traffic Intersection         | Intersection Improvement   | X                    |                   |                  | 2035                        | 23           | Inter-Garrison Road and Abrams Drive                           | Signalize, add southbound free right turn, 2nd southbound left-turn.   | Signalized   | Yes   | Yes   |
| TI 42                                  | Traffic Intersection         | Intersection Improvement   | X                    |                   |                  | 2035                        | 21           | Inter-Garrison Road and Eighth Street/Seventh Avenue           | Signalize, add eastbound and westbound left-turn pockets, westbound free right   | Signalized   | Yes   | Yes   |
| TI 45                                  | Traffic Intersection         | Intersection Improvement   | X                    |                   |                  | 2035                        | 30           | Divarty Street and Second Avenue                               | No geometry changes  | Signalized   | Yes   | Yes   |
| <b>Fort Ord Reuse Authority (FORA)</b> |                              |  |                      |                   |                  |                             |              |  |  |  |   |       |
| FO 13B                                 | Eastside Parkway             | Construct new 2 lane arterial from Eucalyptus Road at Parker Flats Cut-Off Road to Schoonover Drive                    |                      | X                 |                  | 2035                        | 48           | Coe Avenue and General Jim Moore Boulevard                     | Westbound: through lane, right turn lane, and left turn pocket<br>Eastbound: left turn pocket, through lane, and right lane<br>Southbound: add left turn pocket<br>Northbound: add right turn pocket | AWSC <sup>6</sup>                                  | No  | Yes   |
| FO 12                                  | Eucalyptus Road              | Upgrade Eucalyptus Road to 2 lane collector from General Jim Moore Blvd to Eastside Rd to Parker Flats Cut-Off Road    |                      | X                 |                  | 2025                        | 46           | Gigling Road and Eastside Parkway                              | All approaches: 1 shared right-through-left lane   | AWSC <sup>6</sup>                                  | No  | Yes   |
|  |                              |  |                      |                   |                  |                             | 25           | Inter-Garrison Road and Eastside Parkway (Future Intersection) | Northbound: right turn lane and left turn pocket<br>Westbound: left turn pocket and 2 through lanes<br>Eastbound: left turn pocket, 1 through right  | AWSC <sup>6</sup>                                  | No  | Yes   |
| FO 6                                   | Inter-Garrison Road Widening | Widen Inter-Garrison Road to a 4 lane arterial from Eastside Parkway to Reservation Road                               |                      | X                 |                  | 2035                        | 26           | Inter-Garrison Road and Inter-Garrison Road Connection         | Westbound: 1 through, 1 shared through-right<br>Eastbound: 1 left turn lane and 1 through lane   | AWSC   | Yes   | Yes   |
| FO 7                                   | Gigling Road                 | Widen Gigling Road to a 4-lane arterial from General Jim Moore Boulevard to Future Eastside Parkway near Eighth Avenue |                      | X                 |                  | 2035                        | 40-45        | Gigling from General Jim Moore Boulevard to Eastside Parkway   | Add a through lane both eastbound/westbound on Gigling   | AWSC   | Yes   | Yes   |

**TABLE L. CUMULATIVE WITHOUT PROJECT CONDITIONS INTERSECTION IMPROVEMENTS**

| Project Number <sup>1</sup>                     | Project Name              | Project Description   | Sources <sup>2</sup> |                   |                  | Estimated Construction Date | Intersection                           | Geometry Changes  | Intersection Control Changes | Included in Cumulative without Project Conditions? | Included in Cumulative without Project Conditions and Eastside Parkway? | Notes               |
|---|---------------------------|---|----------------------|-------------------|------------------|-----------------------------|--|---|------------------------------|--|---|---------------------|
|   |                           |   | City <sup>3</sup>    | FORA <sup>4</sup> | RTP <sup>5</sup> |                             |  |   |                              |  |   |                     |
| <b>AMBAG Regional Transportation Plan (RTP)</b> |                           |   |                      |                   |                  |                             |  |   |                              |  |   |                     |
| MON-MAR001-MA                                   | Reservation Road Widening | Widen Reservation Road to 4 lanes between East Garrison Gate and Davis Road | X                    | X                 | 2035             | 28                          | Watkins Gate Road and Reservation Road | Northbound: from one shared through/right/left lane to 1 through, 1 through/right and 1 left turn lane<br>Southbound: from one shared through/right/left lane to 1 through, 1 through/right and 1 left turn lane<br>Eastbound: 1 left turn and 1 right turn lane                    | None                         | Yes  | Yes   |                     |
|   |                           |   |                      |                   |                  | 29                          | Reservation Road and Davis Road        | Southbound: from 1 left turn lane and a through lane to 1 left turn lane, 1 through lane, and 1 shared through-right<br>Northbound: from 1 left turn lane and a through lane to 1 left turn lane, 1 through lane, 1 shared through-right<br>Eastbound and westbound remain the same | None                         | Yes  | Yes   |                     |
| MON-MAR001-MA                                   | Imjin Parkway Widening    | Widen Imjin Parkway to four lanes from Imjin Road to Reservation Road       | X                    | X                 | 2025             | 11                          | Imjin Parkway and Abrams Drive         | Eastbound and westbound: Install 1 left turn lane, 1 through lane, and 1 shared through/right<br>Northbound and Southbound: left and right turn lanes on Abrams Drive   | None                         | Yes  | Yes   | Marina CIP - Funded |
|   |                           |   |                      |                   |                  | 12                          | Imjin Parkway and Reservation Road     | Westbound: Change to 2 left turn lanes, 1 through lane, and 2 right turn lanes  | None                         | Yes  | Yes   |                     |

Notes:

1. Project ID Number based on leading agency from source document.
2. Projects appearing in multiple source lists are described and denoted by source.
3. Listed in City of Marina's 5 Year Capital Improvement Project List, Revised March 2016.
4. Listed in Fort Ord Reuse Authority's Capital Improvement Program Fiscal Year 2017/18 through 2027/28, and *Fort Ord Reuse Authority Fee Reallocation Study: Deficiency Analysis and Fee Reallocation* (2017).
5. Listed in the *2035 Metropolitan Transportation Plan / Sustainable Communities Strategy* (2014).
6. Improvement from source does not define control.

Source: Fehr & Peers, 2019.

**ATTACHMENT M: MONTEREY COUNTY LIST OF TAZS**

| List of Monterey County TAZs |            |
|------------------------------|------------|
| ID                           | TAZ Number |
| 1                            | 375        |
| 2                            | 383        |
| 3                            | 415        |
| 4                            | 439        |
| 5                            | 448        |
| 6                            | 457        |
| 7                            | 469        |
| 8                            | 471        |
| 9                            | 479        |
| 10                           | 486        |
| 11                           | 489        |
| 12                           | 502        |
| 13                           | 507        |
| 14                           | 512        |
| 15                           | 527        |
| 16                           | 538        |
| 17                           | 539        |
| 18                           | 547        |
| 19                           | 551        |
| 20                           | 553        |
| 21                           | 554        |
| 22                           | 556        |
| 23                           | 562        |
| 24                           | 563        |
| 25                           | 564        |
| 26                           | 566        |
| 27                           | 569        |
| 28                           | 572        |
| 29                           | 573        |
| 30                           | 574        |
| 31                           | 575        |
| 32                           | 576        |
| 33                           | 577        |
| 34                           | 579        |
| 35                           | 580        |
| 36                           | 581        |
| 37                           | 582        |
| 38                           | 585        |
| 39                           | 586        |
| 40                           | 587        |
| 41                           | 588        |
| 42                           | 591        |
| 43                           | 595        |
| 44                           | 597        |
| 45                           | 601        |

| List of Monterey County TAZs |            |
|------------------------------|------------|
| ID                           | TAZ Number |
| 46                           | 603        |
| 47                           | 604        |
| 48                           | 607        |
| 49                           | 608        |
| 50                           | 609        |
| 51                           | 611        |
| 52                           | 612        |
| 53                           | 613        |
| 54                           | 615        |
| 55                           | 616        |
| 56                           | 619        |
| 57                           | 620        |
| 58                           | 621        |
| 59                           | 622        |
| 60                           | 623        |
| 61                           | 625        |
| 62                           | 627        |
| 63                           | 628        |
| 64                           | 629        |
| 65                           | 630        |
| 66                           | 633        |
| 67                           | 634        |
| 68                           | 635        |
| 69                           | 637        |
| 70                           | 638        |
| 71                           | 639        |
| 72                           | 640        |
| 73                           | 642        |
| 74                           | 643        |
| 75                           | 645        |
| 76                           | 658        |
| 77                           | 660        |
| 78                           | 661        |
| 79                           | 663        |
| 80                           | 666        |
| 81                           | 669        |
| 82                           | 670        |
| 83                           | 672        |
| 84                           | 673        |
| 85                           | 674        |
| 86                           | 675        |
| 87                           | 679        |
| 88                           | 680        |
| 89                           | 681        |
| 90                           | 683        |

| List of Monterey County TAZs |            |
|------------------------------|------------|
| ID                           | TAZ Number |
| 91                           | 684        |
| 92                           | 687        |
| 93                           | 690        |
| 94                           | 693        |
| 95                           | 695        |
| 96                           | 697        |
| 97                           | 698        |
| 98                           | 702        |
| 99                           | 704        |
| 100                          | 709        |
| 101                          | 714        |
| 102                          | 726        |
| 103                          | 742        |
| 104                          | 746        |
| 105                          | 766        |
| 106                          | 770        |
| 107                          | 771        |
| 108                          | 778        |
| 109                          | 779        |
| 110                          | 795        |
| 111                          | 796        |
| 112                          | 799        |
| 113                          | 804        |
| 114                          | 809        |
| 115                          | 818        |
| 116                          | 829        |
| 117                          | 850        |
| 118                          | 851        |
| 119                          | 861        |
| 120                          | 863        |
| 121                          | 864        |
| 122                          | 868        |
| 123                          | 875        |
| 124                          | 876        |
| 125                          | 878        |
| 126                          | 880        |
| 127                          | 887        |
| 128                          | 889        |
| 129                          | 908        |
| 130                          | 909        |
| 131                          | 913        |
| 132                          | 917        |
| 133                          | 922        |
| 134                          | 923        |
| 135                          | 925        |

| List of Monterey County TAZs |            |
|------------------------------|------------|
| ID                           | TAZ Number |
| 136                          | 928        |
| 137                          | 929        |
| 138                          | 930        |
| 139                          | 936        |
| 140                          | 943        |
| 141                          | 954        |
| 142                          | 965        |
| 143                          | 966        |
| 144                          | 971        |
| 145                          | 973        |
| 146                          | 977        |
| 147                          | 980        |
| 148                          | 981        |
| 149                          | 985        |
| 150                          | 987        |
| 151                          | 992        |
| 152                          | 995        |
| 153                          | 997        |
| 154                          | 1002       |
| 155                          | 1003       |
| 156                          | 1006       |
| 157                          | 1012       |
| 158                          | 1015       |
| 159                          | 1017       |
| 160                          | 1018       |
| 161                          | 1022       |
| 162                          | 1028       |
| 163                          | 1029       |
| 164                          | 1035       |
| 165                          | 1039       |
| 166                          | 1042       |
| 167                          | 1044       |
| 168                          | 1045       |
| 169                          | 1046       |
| 170                          | 1047       |
| 171                          | 1050       |
| 172                          | 1051       |
| 173                          | 1052       |
| 174                          | 1054       |
| 175                          | 1055       |
| 176                          | 1056       |
| 177                          | 1058       |
| 178                          | 1059       |
| 179                          | 1060       |
| 180                          | 1062       |

| List of Monterey County TAZs |            |
|------------------------------|------------|
| ID                           | TAZ Number |
| 181                          | 1063       |
| 182                          | 1064       |
| 183                          | 1065       |
| 184                          | 1066       |
| 185                          | 1068       |
| 186                          | 1069       |
| 187                          | 1070       |
| 188                          | 1071       |
| 189                          | 1072       |
| 190                          | 1073       |
| 191                          | 1074       |
| 192                          | 1075       |
| 193                          | 1076       |
| 194                          | 1078       |
| 195                          | 1081       |
| 196                          | 1082       |
| 197                          | 1083       |
| 198                          | 1084       |
| 199                          | 1086       |
| 200                          | 1088       |
| 201                          | 1096       |
| 202                          | 1097       |
| 203                          | 1098       |
| 204                          | 1100       |
| 205                          | 1104       |
| 206                          | 1105       |
| 207                          | 1106       |
| 208                          | 1108       |
| 209                          | 1109       |
| 210                          | 1110       |
| 211                          | 1111       |
| 212                          | 1112       |
| 213                          | 1114       |
| 214                          | 1118       |
| 215                          | 1122       |
| 216                          | 1124       |
| 217                          | 1126       |
| 218                          | 1130       |
| 219                          | 1132       |
| 220                          | 1134       |
| 221                          | 1136       |
| 222                          | 1146       |
| 223                          | 1147       |
| 224                          | 1149       |
| 225                          | 1150       |

| List of Monterey County TAZs |            |
|------------------------------|------------|
| ID                           | TAZ Number |
| 226                          | 1155       |
| 227                          | 1156       |
| 228                          | 1159       |
| 229                          | 1166       |
| 230                          | 1169       |
| 231                          | 1178       |
| 232                          | 1181       |
| 233                          | 1193       |
| 234                          | 1233       |
| 235                          | 1243       |
| 236                          | 1248       |
| 237                          | 1256       |
| 238                          | 1258       |
| 239                          | 1265       |
| 240                          | 1266       |
| 241                          | 1269       |
| 242                          | 1271       |
| 243                          | 1279       |
| 244                          | 1286       |
| 245                          | 1292       |
| 246                          | 1293       |
| 247                          | 1301       |
| 248                          | 1304       |
| 249                          | 1314       |
| 250                          | 1316       |
| 251                          | 1335       |
| 252                          | 1339       |
| 253                          | 1346       |
| 254                          | 1350       |
| 255                          | 1355       |
| 256                          | 1359       |
| 257                          | 1362       |
| 258                          | 1364       |
| 259                          | 1365       |
| 260                          | 1366       |
| 261                          | 1367       |
| 262                          | 1368       |
| 263                          | 1369       |
| 264                          | 1372       |
| 265                          | 1373       |
| 266                          | 1375       |
| 267                          | 1376       |
| 268                          | 1379       |
| 269                          | 1383       |
| 270                          | 1393       |

| List of Monterey County TAZs |            |
|------------------------------|------------|
| ID                           | TAZ Number |
| 271                          | 1395       |
| 272                          | 1403       |
| 273                          | 1406       |
| 274                          | 1407       |
| 275                          | 1408       |
| 276                          | 1411       |
| 277                          | 1413       |
| 278                          | 1418       |
| 279                          | 1423       |
| 280                          | 1428       |
| 281                          | 1429       |
| 282                          | 1438       |
| 283                          | 1475       |
| 284                          | 1551       |
| 285                          | 1604       |
| 286                          | 1631       |
| 287                          | 1635       |
| 288                          | 1640       |
| 289                          | 1643       |
| 290                          | 1645       |
| 291                          | 1649       |
| 292                          | 1652       |
| 293                          | 1663       |
| 294                          | 1667       |
| 295                          | 1675       |
| 296                          | 1677       |
| 297                          | 1679       |
| 298                          | 1685       |
| 299                          | 1686       |
| 300                          | 1700       |
| 301                          | 1704       |
| 302                          | 1711       |
| 303                          | 1714       |
| 304                          | 1716       |
| 305                          | 1718       |
| 306                          | 1720       |
| 307                          | 1728       |
| 308                          | 1749       |
| 309                          | 1756       |
| 310                          | 1761       |
| 311                          | 1764       |
| 312                          | 1769       |
| 313                          | 1774       |
| 314                          | 1777       |
| 315                          | 1782       |

| List of Monterey County TAZs |            |
|------------------------------|------------|
| ID                           | TAZ Number |
| 316                          | 1792       |
| 317                          | 1799       |
| 318                          | 1805       |
| 319                          | 1808       |
| 320                          | 1809       |
| 321                          | 1810       |
| 322                          | 1813       |
| 323                          | 1814       |
| 324                          | 1815       |
| 325                          | 1816       |
| 326                          | 1817       |
| 327                          | 1819       |
| 328                          | 1820       |
| 329                          | 1821       |
| 330                          | 1822       |
| 331                          | 1823       |
| 332                          | 1826       |
| 333                          | 1827       |
| 334                          | 1828       |
| 335                          | 1829       |
| 336                          | 1830       |
| 337                          | 1831       |
| 338                          | 1835       |
| 339                          | 1837       |
| 340                          | 1838       |
| 341                          | 1839       |



**ATTACHMENT N: SAN BENITO COUNTY LIST OF TAZS**

| List of San Benito County TAZs |            |
|--------------------------------|------------|
| ID                             | TAZ Number |
| 1                              | 1275       |
| 2                              | 1303       |
| 3                              | 1321       |
| 4                              | 1322       |
| 5                              | 1349       |
| 6                              | 1361       |
| 7                              | 1370       |
| 8                              | 1371       |
| 9                              | 1374       |
| 10                             | 1377       |
| 11                             | 1378       |
| 12                             | 1380       |
| 13                             | 1381       |
| 14                             | 1385       |
| 15                             | 1402       |
| 16                             | 1404       |
| 17                             | 1409       |
| 18                             | 1410       |
| 19                             | 1412       |
| 20                             | 1414       |
| 21                             | 1415       |
| 22                             | 1419       |
| 23                             | 1420       |
| 24                             | 1421       |
| 25                             | 1424       |
| 26                             | 1425       |
| 27                             | 1431       |
| 28                             | 1439       |
| 29                             | 1444       |
| 30                             | 1452       |
| 31                             | 1453       |
| 32                             | 1458       |
| 33                             | 1465       |
| 34                             | 1466       |
| 35                             | 1474       |
| 36                             | 1490       |
| 37                             | 1492       |
| 38                             | 1505       |
| 39                             | 1512       |
| 40                             | 1514       |
| 41                             | 1521       |
| 42                             | 1539       |
| 43                             | 1570       |
| 44                             | 1575       |
| 45                             | 1578       |

| List of San Benito County TAZs |            |
|--------------------------------|------------|
| ID                             | TAZ Number |
| 46                             | 1581       |
| 47                             | 1583       |
| 48                             | 1584       |
| 49                             | 1588       |
| 50                             | 1593       |
| 51                             | 1597       |
| 52                             | 1606       |
| 53                             | 1607       |
| 54                             | 1619       |
| 55                             | 1621       |
| 56                             | 1623       |
| 57                             | 1624       |
| 58                             | 1625       |
| 59                             | 1626       |
| 60                             | 1627       |
| 61                             | 1628       |
| 62                             | 1629       |
| 63                             | 1630       |
| 64                             | 1632       |
| 65                             | 1633       |
| 66                             | 1634       |
| 67                             | 1636       |
| 68                             | 1639       |
| 69                             | 1642       |
| 70                             | 1644       |
| 71                             | 1646       |
| 72                             | 1655       |
| 73                             | 1669       |
| 74                             | 1673       |
| 75                             | 1676       |
| 76                             | 1680       |
| 77                             | 1681       |
| 78                             | 1687       |
| 79                             | 1754       |
| 80                             | 1760       |
| 81                             | 1767       |
| 82                             | 1768       |
| 83                             | 1770       |
| 84                             | 1781       |

**ATTACHMENT O: SANTA CRUZ COUNTY LIST OF TAZS**

| Santa Cruz County |            |
|-------------------|------------|
| ID                | TAZ Number |
| 1                 | 3          |
| 2                 | 5          |
| 3                 | 7          |
| 4                 | 9          |
| 5                 | 11         |
| 6                 | 12         |
| 7                 | 13         |
| 8                 | 14         |
| 9                 | 15         |
| 10                | 16         |
| 11                | 17         |
| 12                | 18         |
| 13                | 19         |
| 14                | 20         |
| 15                | 21         |
| 16                | 22         |
| 17                | 25         |
| 18                | 27         |
| 19                | 28         |
| 20                | 29         |
| 21                | 30         |
| 22                | 31         |
| 23                | 32         |
| 24                | 33         |
| 25                | 34         |
| 26                | 35         |
| 27                | 36         |
| 28                | 37         |
| 29                | 38         |
| 30                | 39         |
| 31                | 40         |
| 32                | 41         |
| 33                | 42         |
| 34                | 43         |
| 35                | 44         |
| 36                | 45         |
| 37                | 46         |
| 38                | 47         |
| 39                | 48         |
| 40                | 49         |
| 41                | 50         |
| 42                | 51         |
| 43                | 52         |
| 44                | 53         |
| 45                | 54         |

| Santa Cruz County |            |
|-------------------|------------|
| ID                | TAZ Number |
| 46                | 55         |
| 47                | 56         |
| 48                | 57         |
| 49                | 59         |
| 50                | 60         |
| 51                | 61         |
| 52                | 62         |
| 53                | 63         |
| 54                | 64         |
| 55                | 65         |
| 56                | 66         |
| 57                | 68         |
| 58                | 69         |
| 59                | 70         |
| 60                | 72         |
| 61                | 73         |
| 62                | 74         |
| 63                | 75         |
| 64                | 76         |
| 65                | 77         |
| 66                | 78         |
| 67                | 79         |
| 68                | 80         |
| 69                | 81         |
| 70                | 82         |
| 71                | 83         |
| 72                | 84         |
| 73                | 85         |
| 74                | 86         |
| 75                | 87         |
| 76                | 88         |
| 77                | 89         |
| 78                | 91         |
| 79                | 92         |
| 80                | 93         |
| 81                | 94         |
| 82                | 96         |
| 83                | 97         |
| 84                | 98         |
| 85                | 100        |
| 86                | 103        |
| 87                | 105        |
| 88                | 114        |
| 89                | 119        |
| 90                | 134        |

| Santa Cruz County |            |
|-------------------|------------|
| ID                | TAZ Number |
| 91                | 135        |
| 92                | 138        |
| 93                | 163        |
| 94                | 178        |
| 95                | 180        |
| 96                | 197        |
| 97                | 207        |
| 98                | 226        |
| 99                | 227        |
| 100               | 238        |
| 101               | 240        |
| 102               | 265        |
| 103               | 286        |
| 104               | 295        |
| 105               | 307        |
| 106               | 309        |
| 107               | 310        |
| 108               | 311        |
| 109               | 312        |
| 110               | 314        |
| 111               | 315        |
| 112               | 318        |
| 113               | 319        |
| 114               | 321        |
| 115               | 324        |
| 116               | 326        |
| 117               | 327        |
| 118               | 328        |
| 119               | 330        |
| 120               | 331        |
| 121               | 332        |
| 122               | 333        |
| 123               | 334        |
| 124               | 335        |
| 125               | 336        |
| 126               | 337        |
| 127               | 338        |
| 128               | 339        |
| 129               | 340        |
| 130               | 341        |
| 131               | 342        |
| 132               | 343        |
| 133               | 344        |
| 134               | 345        |
| 135               | 348        |

| Santa Cruz County |            |
|-------------------|------------|
| ID                | TAZ Number |
| 136               | 349        |
| 137               | 350        |
| 138               | 351        |
| 139               | 352        |
| 140               | 353        |
| 141               | 354        |
| 142               | 355        |
| 143               | 356        |
| 144               | 357        |
| 145               | 358        |
| 146               | 360        |
| 147               | 361        |
| 148               | 362        |
| 149               | 363        |
| 150               | 364        |
| 151               | 365        |
| 152               | 366        |
| 153               | 367        |
| 154               | 368        |
| 155               | 369        |
| 156               | 371        |
| 157               | 372        |
| 158               | 373        |
| 159               | 374        |
| 160               | 376        |
| 161               | 377        |
| 162               | 378        |
| 163               | 379        |
| 164               | 380        |
| 165               | 381        |
| 166               | 384        |
| 167               | 385        |
| 168               | 386        |
| 169               | 387        |
| 170               | 388        |
| 171               | 389        |
| 172               | 390        |
| 173               | 392        |
| 174               | 394        |
| 175               | 395        |
| 176               | 397        |
| 177               | 399        |
| 178               | 400        |
| 179               | 406        |
| 180               | 407        |

| Santa Cruz County |            |
|-------------------|------------|
| ID                | TAZ Number |
| 181               | 408        |
| 182               | 409        |
| 183               | 414        |
| 184               | 422        |
| 185               | 424        |
| 186               | 426        |
| 187               | 431        |
| 188               | 432        |
| 189               | 442        |
| 190               | 443        |
| 191               | 447        |
| 192               | 454        |
| 193               | 456        |
| 194               | 458        |
| 195               | 462        |
| 196               | 466        |
| 197               | 467        |
| 198               | 468        |
| 199               | 470        |
| 200               | 476        |
| 201               | 481        |
| 202               | 488        |
| 203               | 492        |
| 204               | 496        |
| 205               | 498        |
| 206               | 508        |
| 207               | 515        |
| 208               | 526        |
| 209               | 529        |
| 210               | 530        |
| 211               | 536        |
| 212               | 548        |
| 213               | 549        |
| 214               | 558        |
| 215               | 560        |
| 216               | 578        |
| 217               | 584        |
| 218               | 590        |
| 219               | 593        |
| 220               | 594        |
| 221               | 596        |
| 222               | 598        |
| 223               | 600        |
| 224               | 605        |
| 225               | 606        |

| Santa Cruz County |            |
|-------------------|------------|
| ID                | TAZ Number |
| 226               | 614        |
| 227               | 617        |
| 228               | 618        |
| 229               | 624        |
| 230               | 626        |
| 231               | 631        |
| 232               | 632        |
| 233               | 641        |
| 234               | 647        |
| 235               | 649        |
| 236               | 650        |
| 237               | 651        |
| 238               | 653        |
| 239               | 654        |
| 240               | 655        |
| 241               | 657        |
| 242               | 662        |
| 243               | 664        |
| 244               | 665        |
| 245               | 668        |
| 246               | 671        |
| 247               | 676        |
| 248               | 682        |
| 249               | 685        |
| 250               | 686        |
| 251               | 688        |
| 252               | 689        |
| 253               | 691        |
| 254               | 692        |
| 255               | 694        |
| 256               | 696        |
| 257               | 699        |
| 258               | 700        |
| 259               | 701        |
| 260               | 708        |
| 261               | 717        |
| 262               | 719        |
| 263               | 722        |
| 264               | 730        |
| 265               | 735        |
| 266               | 739        |
| 267               | 740        |
| 268               | 751        |
| 269               | 758        |
| 270               | 759        |

**Santa Cruz County**

| <b>ID</b> | <b>TAZ Number</b> |
|-----------|-------------------|
| 271       | 763               |
| 272       | 764               |
| 273       | 768               |
| 274       | 772               |
| 275       | 776               |
| 276       | 777               |
| 277       | 780               |
| 278       | 782               |
| 279       | 783               |
| 280       | 785               |
| 281       | 793               |
| 282       | 798               |
| 283       | 800               |
| 284       | 803               |
| 285       | 810               |
| 286       | 811               |
| 287       | 820               |
| 288       | 828               |
| 289       | 830               |
| 290       | 834               |
| 291       | 844               |
| 292       | 857               |
| 293       | 901               |
| 294       | 903               |
| 295       | 905               |
| 296       | 911               |
| 297       | 932               |
| 298       | 940               |
| 299       | 945               |
| 300       | 946               |
| 301       | 1020              |
| 302       | 1027              |
| 303       | 1036              |
| 304       | 1037              |
| 305       | 1061              |
| 306       | 1077              |
| 307       | 1080              |
| 308       | 1089              |
| 309       | 1099              |
| 310       | 1811              |
| 311       | 1812              |

**APPENDIX G: VMT ANALYSIS FOR GREENHOUSE GASES AND VMT  
FORECASTING OUTLINE**





# VMT ANALYSIS FOR GREENHOUSE GASES

## VMT ESTIMATION PROCESS FOR GHG ANALYSIS

Daily VMT estimates are used as an input into the air quality, noise and greenhouse gas (GHG) analyses. The process by which daily VMT is estimated for these uses is described below.

### TOTAL VMT ACCOUNTING METHOD

The total VMT accounting method is often used as an input for the air quality and greenhouse gas analysis and is the method to be used in analyzing the Project's air quality, noise, and GHG analyses

Under the total VMT accounting method, vehicle trips are placed into three categories based on whether their origin and destination are internal or external to the geographic area in question. Trips that have an origin and a destination outside the area are not included in the VMT estimate under this method. Other trips are either wholly or partially included as described below:

- Internal-internal (II): The full length of all trips made entirely within the geographic area limits is counted.
- Internal-external (IX): The full length of trips with an origin within the geographic area and destination outside of the area is counted. This assumes that the geographic area bears all the responsibility for trips traveling to other areas.
- External-internal (XI): The full length of trips with an origin outside of the geographic area and destination within the area is counted. Similar to the IX trips, this assumes that the geographic area bears the full responsibility for trips traveling to it from other areas.

This "total accounting" method therefore captures the complete length of all trips that begin or end within the geographic area of study. This method is similar, but not identical, to the Project generated VMT estimation used for the SB 743 VMT assessment.

## VMT ESTIMATES FOR GHG ANALYSIS

The results of the total VMT accounting methods are presented in **Table G-1**. This VMT is used for the GHG analysis.

The Existing and Existing with Project Conditions results support the concept that providing housing near jobs increases the likelihood that trips can remain within a local area, thus shortening travel distances and increasing residents' ability to accomplish some travel needs by walking, cycling, or using short-distance transit. The Cumulative with Project and without Eastside Parkway Conditions provide more housing near

jobs, which results in VMT per service population that is closer to that without the Project, with a difference of 0.1.

**TABLE G-1: TOTAL VMT ACCOUNTING**

|   | <b>Existing Conditions</b> | <b>Existing with Project Conditions</b> | <b>Cumulative Conditions</b> | <b>Cumulative with Project and without Eastside Parkway Conditions</b> |
|---|----------------------------|---|------------------------------|--|
| <b>CSUMB Campus</b>                     |                            |   |                              |  |
| Vehicle Miles Traveled (A) <sup>1</sup> | 160,800                    | 279,400                                 | 162,400                      | 297,800  |
| Service Population (B) <sup>1,2</sup>   | 8,000                      | 14,600                                  | 8,000                        | 14,600   |
| VMT per Service Population (A/B = C)    | 20.10                      | 19.13                                   | 20.30                        | 20.40  |

Notes:

1. Rounded service population and VMT to nearest 100.
2. Service population is defined as the sum of all employees, residents and students (K to University).

Source: Fehr & Peers, June 2019.

## VMT Forecasting Outline Using the AMBAG Regional Travel Model

The AMBAG regional travel forecasting model was used to develop daily vehicle miles traveled (VMT) and traffic forecasts within the CSUMB campus and the Project study area. The travel forecasting model used for this analysis includes a 2017 base year, and a 2035 future year that reflect growth in the AMBAG region (Santa Cruz, Monterey and San Benito counties). The weekday daily model assignment is the sum of four time periods including: 1) morning peak period (6:00 to 9:00 AM), 2) mid-day peak period (9:00 AM to 4:00 PM), 3) evening peak period (4:00 to 7:00 PM), and 4) evening off-peak period (7:00 PM to 6:00 AM).

Fehr & Peers reviewed the Association of Bay Area Governments (AMBAG) regional travel model to evaluate its suitability for developing long-range traffic forecast for streets and highways within the greater Monterey Bay Area. Fehr & Peers reviewed the primary model inputs in the project area (such as base and future year land use inputs and roadway network assumptions) and also checked the performance of the model against typical validation thresholds. Modifications to the AMBAG regional travel model land use and transportation network inputs were completed to improve the validation of the daily, peak period and peak hour travel models. These changes to the AMBAG regional travel model are documented in a memorandum included in **Appendix F**.

The following steps were taken estimate the Project generated VMT and Project effect on VMT within specified geographic areas.

- Land Use Inputs: CSUMB transportation analysis (TAZ) land use inputs for base year and future year are summarized in **Table G-2**. The base and future land use by county is shown in **Table G-3**. The data dictionary for the land use codes is shown **Table G-4**. **Appendix F** also documents the land use changes.

**TABLE G-2: CSUMB LAND USE CHANGES**

| TAZ                | Description of Edit   |
|--------------------|---|
| <b>Main Campus</b> |   |
| 806                | <ul style="list-style-type: none"> <li>• Baseline University Enrollment is 2,322</li> <li>• Project University Enrollment is 4,445</li> </ul>   |
| 826                | <ul style="list-style-type: none"> <li>• Baseline University Enrollment is 995</li> <li>• Project University Enrollment is 1,905</li> </ul>   |
| 847                | <ul style="list-style-type: none"> <li>• Baseline University Enrollment is 3,317</li> <li>• Project University Enrollment is 6,350</li> </ul>   |
| <b>East Campus</b> |   |
| 908 and 913        | <ul style="list-style-type: none"> <li>• Baseline Students is 1,380</li> <li>• Baseline Faculty, Staff and Community Partners is 743</li> <li>• Project Students is 0</li> <li>• Project Faculty, Staff, and Community Housing Partners is 1,220</li> </ul> |

Note: Land use added to the TAZs where the campus parking locations are located.  
Source: Fehr & Peers, 2019.

**TABLE G-3: AMBAG Model Residential and Employment Land Uses**

| Land Use Category  | 2010            |                   |                   | 2035            |                   |                   |
|--------------------|-----------------|-------------------|-------------------|-----------------|-------------------|-------------------|
|                    | Monterey County | Santa Cruz County | San Benito County | Monterey County | Santa Cruz County | San Benito County |
| <b>Residential</b> |                 |                   |                   |                 |                   |                   |
| Total Households   | 126,180         | 94,130            | 16,910            | 143,390         | 111,000           | 23,970            |
| Total Population   | 385,050         | 246,240           | 54,400            | 444,080         | 292,790           | 75,830            |
| <b>Employment</b>  |                 |                   |                   |                 |                   |                   |
| Agricultural       | 45,100          | 9,600             | 1,600             | 48,670          | 10,230            | 1,500             |
| Construction       | 4,300           | 3,000             | 800               | 6,220           | 4,320             | 960               |
| Industrial         | 5,600           | 5,300             | 2,500             | 5,420           | 4,490             | 2,790             |
| Retail             | 20,100          | 14,900            | 2,400             | 23,910          | 15,640            | 2,790             |
| Service            | 60,900          | 43,700            | 5,100             | 77,810          | 50,370            | 6,730             |
| Public             | 46,000          | 33,700            | 3,800             | 60,140          | 46,090            | 4,780             |
| Total              | 182,000         | 110,200           | 16,200            | 222,170         | 131,140           | 19,550            |

Notes: All values have been rounded to the nearest 10.

Source: AMBAG regional travel model. Fehr & Peers, 2019.

**TABLE G-4: LAND USE CATEGORIES**

| Attribute             | Description             | Unit      |
|-----------------------|-------------------------|-----------|
| Population            | Total population in TAZ | People    |
| Households            | Total households in TAZ | Household |
| Retail Employment     | Retail trade            | Job       |
| Service Employment    | Service trade           | Job       |
| Public Employment     | Public trade            | Job       |
| University Enrollment | University students     | Student   |

Source: Fehr & Peers, 2019

- **Transportation Network Inputs:** The future year travel mode includes funded street improvements planned by the Fort Ord Reuse Authority (FORA), City of Marina, and the *2040 Metropolitan Transportation Plan / Sustainable Communities Strategy (2018)* as described in **Chapter 4** of the Transportation Analysis Report. The project specific transportation improvements are described in **Chapter 1** of the Transportation Analysis report. **Appendix F** also documents the network changes.
- **Campus Trip Generation Adjustments:** The AMBAG base and future models without and with the project were run. Each peak period vehicle trip matrix was adjusted using the Fratar method for the traffic analysis zones (TAZs) 802, 806, 826, 847, 908, and 913 to match the daily and peak hour

trip generation estimates presented in **Appendix A**. This method included factoring the morning and evening peak hour vehicle trip matrices until the trip generation from the CSUMB campus TAZs matched the estimated project trip generation values. A map showing TAZs for the CSUMB campus is shown in **Figure G-1**.

- **Project Generated VMT Estimation:** A select zone analysis was conducted for each geographic area (e.g., City, County or Region) to estimate Project generated VMT as specified in **Chapter 4**. The Project generated VMT was adjusted at the model edges to include the full length of trips that leave the AMBAG region (Santa Cruz County, Monterey County, and San Benito County). Adjacent jurisdictions (e.g., San Mateo County, Santa Clara County, Merced County, Fresno County, Kings County, and San Luis Obispo County) are represented by external stations or gateways where major roadways provide access into the overall model area. These stations capture the traffic entering, exiting, or passing through the model area on major county and state roadways (e.g. Highway 1, US 101, State Route 9, State Route 25, State Route 152, State Route 156, State Route 198, Skyline Boulevard, Frazier Lake Road, and San Felipe Road). To include VMT outside of the AMBAG region, the distances listed in **Table G-5** were used to estimate VMT for CSUMB campus or Monterey County trips occurring outside of the AMBAG region. The Project generated VMT metric for Monterey County is illustrated in **Figure G-2**.

**TABLE G-5: EXTERNAL STATION DISTANCES**

| External Station Location | Distance (miles) | Origin/Destination City <sup>1</sup> |
|---------------------------|------------------|--------------------------------------|
| Highway 1 Northbound      | 75               | Marin County                         |
| State Route 9             | 25               | San Jose                             |
| Skyline Boulevard         | 20               | San Jose                             |
| State Route 152           | 40               | San Jose                             |
| US 101 Northbound         | 40               | San Jose                             |
| State Route 25            | 40               | San Jose                             |
| Frazier Lake Road         | 40               | San Jose                             |
| San Felipe Road           | 40               | San Jose                             |
| State Route 156           | 75               | Merced                               |
| State Route 198           | 90               | Fresno                               |
| Highway 1 Southbound      | 95               | Santa Maria                          |
| US 101 Southbound         | 60               | Santa Maria                          |

Notes:

1. Distances measured from external station edge of AMBAG region to larger urban destination.

Source: Fehr & Peers, 2019

- **Project Effect on VMT (Boundary VMT):** As described in **Chapter 4**, the Project's effect on VMT, or cumulative impact, is evaluated using the boundary VMT, which captures all VMT on a roadway network within a specified geographic area, including local trips plus interregional travel that does not have an origin or destination within the area. The geographical boundary method only considers traffic within the physical limits of the selected study area and does not include the impact of vehicles once they travel outside the area limits. The use of boundary VMT is a more

complete evaluation of the potential effects of the project because it captures the combined effect of new VMT, shifting existing VMT to/from other neighborhoods, and/or shifts in existing traffic to alternate travel routes or modes. The Project generated VMT metric for Monterey County is illustrated in **Figure G-2**.

- VMT for Greenhouse Gas (GHG) Analysis (Total VMT Accounting): As described earlier in **Appendix G**, vehicle trips are placed into three categories based on whether their origin and destination are internal or external to the geographic area in question. Trips that have an origin and destination outside the area are not included in the VMT estimates under this method. The “total accounting” method therefore captures the complete length of all trips that begin or end within the geographic area to study.

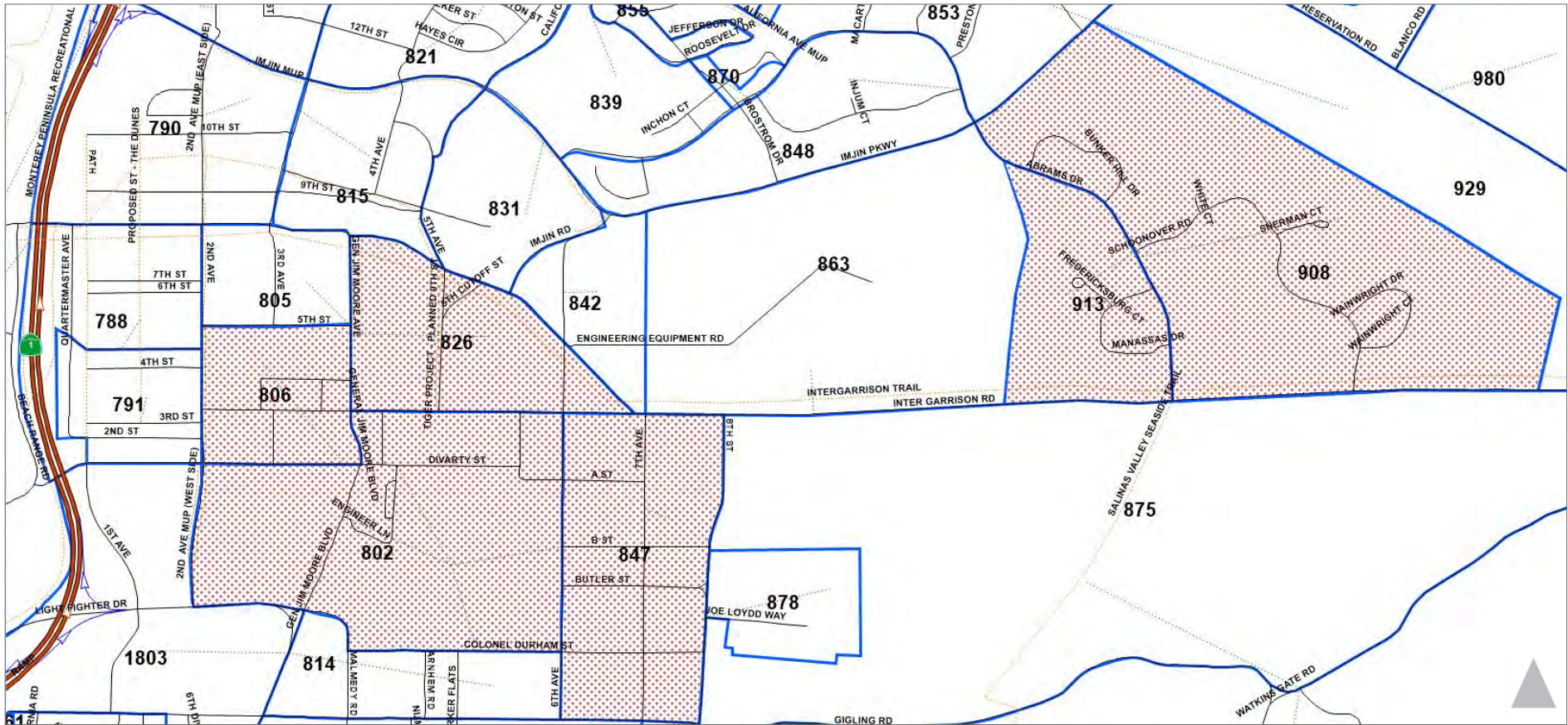

 CSUMB Campus TAZs selected based on Parking Locations



Figure G-1  
TAZs used for CSUMB Campus

W:\Projects\03\pamc\localData\Projects\SJ17\_1728\_CSUMB\_Master\_Plan\_EIR\Graphics\GIS\WXDS\SJ17\_1728\_VMT\_Basemap.mxd

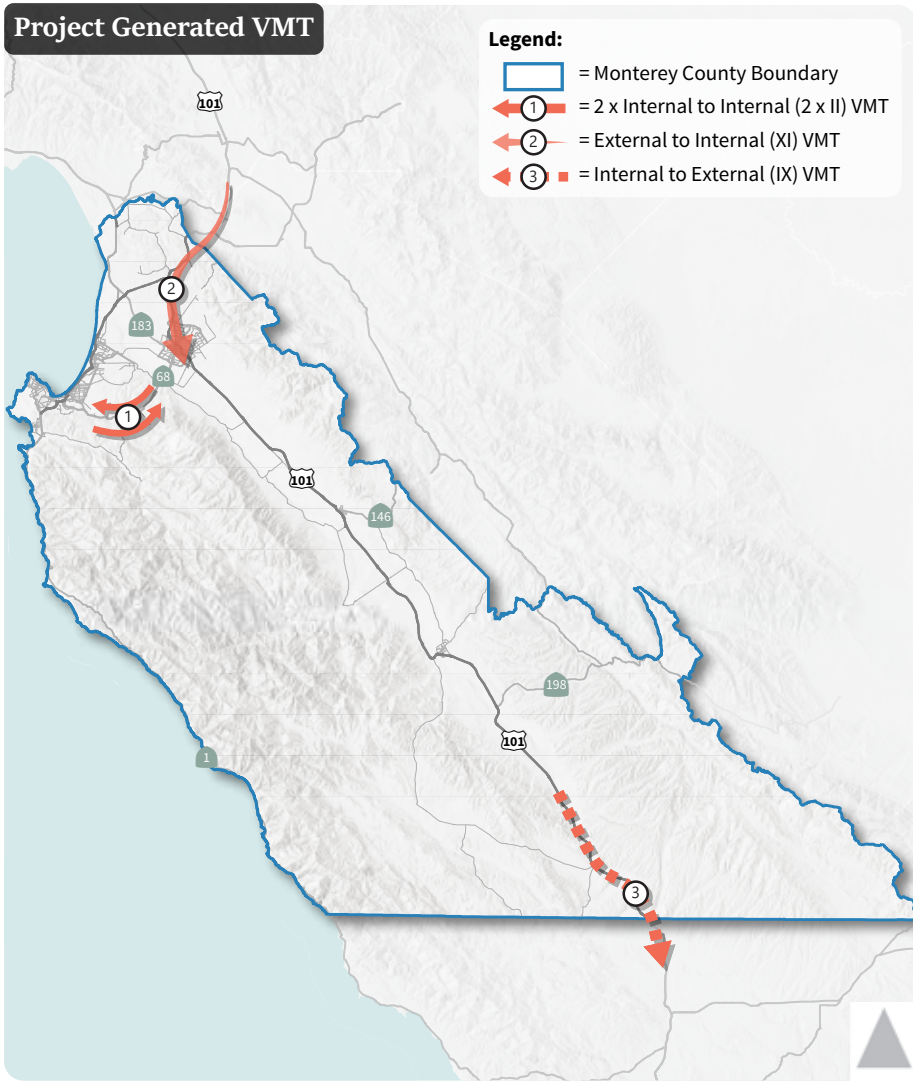

**Notes:** External to External (XX) trips are excluded from this VMT metric. Adjustments to project generated VMT made to include the full length of trips that leave Monterey County to capture inter-regional travel.

Monterey County Boundary



**Notes:** Boundary VMT is all the VMT within Monterey County.

Monterey County Boundary



Figure 1  
Title

Figure 2  
Title  
Measuring Vehicle Miles Traveled (VMT)



**APPENDIX H: CSUMB DRAFT PARKING SUPPLY SCENARIOS**





## MEMORANDUM

Date: August 25, 2015  
To: Philip Perlin, Page/BMS  
From: Anais Schenk and Matt Haynes, Fehr & Peers  
Subject: **CSUMB Draft Parking Supply Scenarios**

*SJ15-1576*

---

The following parking scenarios were developed for the California State University, Monterey Bay (CSUMB) Master Plan update planning process. CSUMB currently has the highest parking ratio in the CSU system at approximately 0.65 spaces per full time equivalent (FTE).<sup>1</sup> However, CSUMB stakeholders have expressed a strong desire to transition the campus from being mostly auto-oriented to a bicycle, pedestrian and transit friendly environment consistent with the Master Plan's sustainability goals. In order to help achieve this goal, the new Master Plan will seek to proactively manage campus parking supply and reduce the corresponding number of single occupancy vehicles entering campus.

As part of the Master Plan, the campus will also be considering new transportation demand management (TDM) measures as part of the overall effort to increase the use of alternative transportation modes. Currently, CSUMB offers a limited range of TDM measures such as rideshare matching services and resources for commuters wishing to use transit or bicycle to campus. While these TDM measures are responsive to the needs of commuters, the new Master Plan will need to include a broader and more comprehensive TDM program to improve transportation choices for students, staff and faculty.

In a campus setting, the most effective TDM measures relate to managing parking supply and pricing. The strategies presented below therefore seek to better manage both the supply and price of parking on the CSUMB campus.

---

<sup>1</sup> The current CSUMB parking ratio varies from 0.6 to 0.7 depending on the source of information for full time equivalent students and the existing number of parking spaces.



## PARKING SUPPLY ALTERNATIVES

Three parking scenarios are provided below for consideration in developing the land use program for the CSUMB Master Plan. The parking ratios are within the range of those achieved by other CSU campuses in suburban land use contexts. Cal State East Bay, Fullerton, Humboldt and Stanislaus all currently have parking ratios around 0.3 per FTE. CSUs that currently have a ratio close to 0.4 include Bakersfield, Fresno, Long Beach and San Diego. See **Figure 1** below.

**Figure 1: CSU Parking Ratios per FTE**

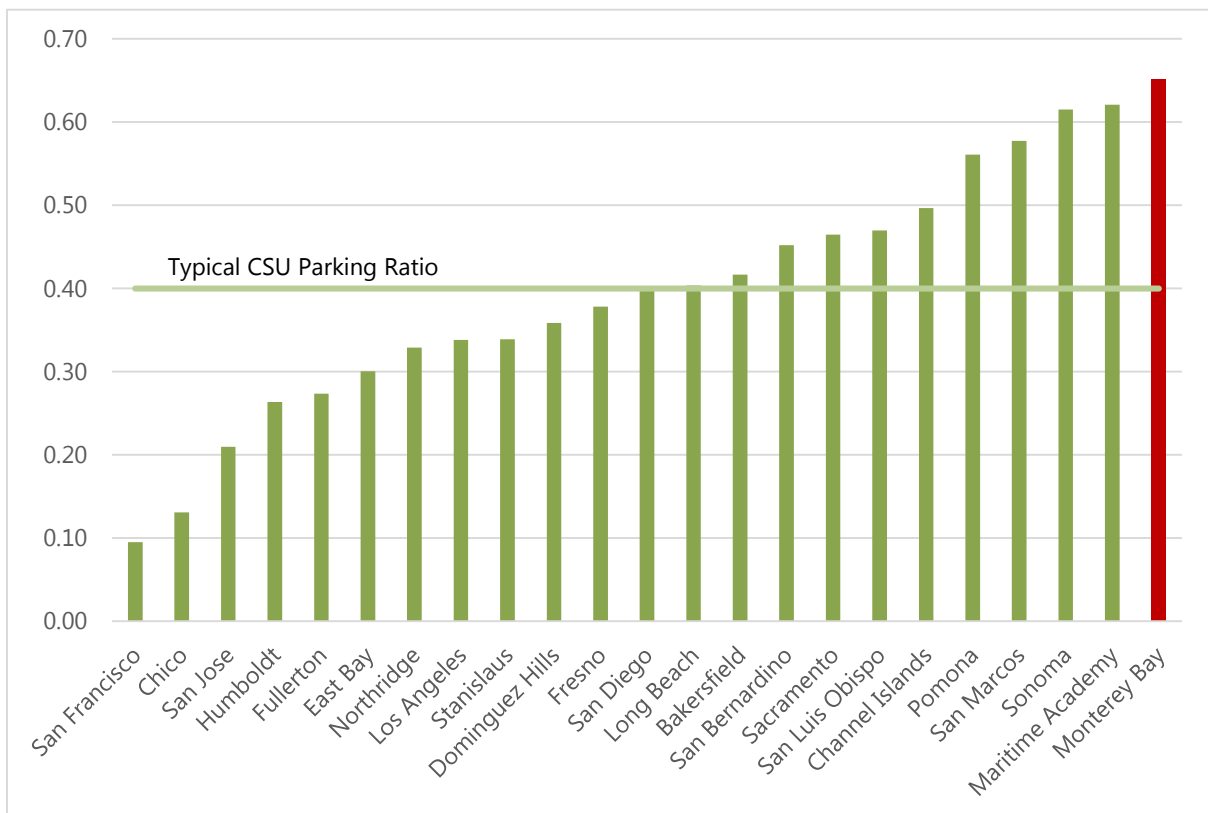

Source: California State University Financing and Treasury Department (July 2013) and California State University Analytic Studies (2013-2014).

Examples from other CSUs demonstrate that parking ratios between 0.3 and 0.4 are realistic and achievable within the context of suburban campus environments. **Table 1** below shows the results of three different parking ratios: 0.3, 0.35 and 0.4.



**TABLE 1: PARKING SUPPLY SCENARIOS AT MASTER PLAN BUILDOUT<sup>1</sup>**

| Scenario  | Parking Pricing Strategy <sup>2</sup>     | Parking Ratio per FTE | Residential Parking Supply | Non-Residential Parking Supply | Total Campus Stalls | Total Supply in Acres <sup>3</sup> |
|---|---|-----------------------|----------------------------|--------------------------------|---------------------|------------------------------------|
| <b>Alternative 1: Aggressive Parking Management</b> | High Cost with Tiered Pricing             | 0.30                  | 1,020                      | 2,770                          | 3,790               | 27                                 |
| <b>Alternative 2: Moderate Parking Management</b>   | Moderate Cost with Limited Tiered Pricing | 0.35                  | 1,650                      | 2,770                          | 4,420               | 32                                 |
| <b>Alternative 3: Typical CSU Parking Supply</b>    | Moderate Cost (Comparable to Other CSUs)  | 0.40                  | 1,760                      | 3,290                          | 5,050               | 36                                 |

Notes:

1. The number of spaces shown are for stalls on campus (excluding East Campus) and do not include parking spaces provided by garages or driveways in campus faculty/staff housing.
  2. See Table 2 for details on pricing and corresponding strategies.
  3. The total number of acres was calculated assuming 140 parking spaces are accommodated in one acre for surface lots.
- Source: Fehr & Peers, 2015

The total number of parking stalls for each scenario were divided amongst residential and non-residential users based on the following assumptions:

- Population totals of 12,631 full time equivalent students and 1,421 staff/faculty positions as provided by Page/BMS.
- Sixty percent of students will be housed on campus.
- Campus housing for staff and faculty provides driveways or garages to house their vehicles.
- In addition to current on-campus housing for staff and faculty, we assume East Campus housing will be converted to staff and faculty housing.
- In order to achieve the Moderate and Aggressive parking alternatives, the Master Plan will need to incorporate a robust TDM program that achieves a 45-50 percent single occupancy vehicle mode share target along with a 10 percent rideshare mode share. The Typical CSU Parking Supply alternative will need to achieve an approximately 55 percent single occupancy vehicle mode share.



There are varying sources of information for existing parking spaces on the CSUMB campus. Current parking estimates range from 3,645<sup>2</sup> to 4,398.<sup>3</sup> If the actual parking supply is on the higher end of this range of estimates than CSUMB may already have enough parking supply to accommodate either the aggressive or the moderate scenarios shown above. If CSUMB chose to adopt the aggressive scenario than new buildings could be constructed by removing surface lots without replacing lost parking stalls. An aggressive approach to managing campus parking supply, along with a robust TDM program, would therefore limit the amount of resources needed to construct additional surface parking during buildout of the Master Plan.

## PARKING PRICING OPTIONS

There are several options for parking pricing that can be considered in conjunction with each parking supply scenario. These options are closely linked to the parking supply options presented above. For example, an aggressive parking supply alternative will also necessitate an aggressive approach to parking pricing.

Most CSUs charge for parking on a semester or quarter basis and have lower cost parking for evening and summer sessions when there is less overall demand for parking. CSUMB recently raised the price of parking permits to \$108 per semester for students and \$54 to \$58 per semester for employees. Current parking permit costs for other CSUs range anywhere from \$80 to over \$300 per semester. Some CSUs such as Chico, San Luis Obispo and San Jose charge more for on campus resident permits which discourage student auto ownership. Some universities offer location and time-based parking pricing such as MIT, UCLA and University of Colorado, Boulder. Because there are numerous ways to structure pricing to disincentivize driving the suggested pricing alternatives below are presented as ranges that would need to be refined as part of a future more detailed parking management and implementation strategy.

---

<sup>2</sup> California State University Financing and Treasury Department (July 2013). The ratio of 0.65 per FTE is from the CSU data as shown above in Figure 1.

<sup>3</sup> California State University, Monterey Bay: Draft Parking Management Plan (2012).



**TABLE 2: PARKING PRICING SCENARIOS PER SEMESTER**

| Scenario  | Parking Ratio per FTE | Range of Permit Cost (Student) | Range of Permit Cost (Staff/Faculty) | Pricing and Management Strategies  |
|---|-----------------------|--------------------------------|--------------------------------------|--|
| <b>Alternative 1:<br/>Aggressive Parking Management</b> | 0.30                  | \$425-500                      | \$200-250                            | <ul style="list-style-type: none"> <li>• Higher prices for on-campus resident permits.</li> <li>• No vehicles for freshman on campus.</li> <li>• No on-campus permits for East Campus residents.</li> <li>• Tiered parking pricing based on distance to academic core.</li> <li>• Tiered pricing for limited days of week. (1 day, 2 days, etc.)</li> <li>• Increased citation costs.</li> </ul> |
| <b>Alternative 2:<br/>Moderate Parking Management</b>   | 0.35                  | \$325-400                      | \$150-200                            | <ul style="list-style-type: none"> <li>• Higher prices for on campus resident permits.</li> <li>• No vehicles for freshman on campus.</li> <li>• No on-campus permits for East Campus residents.</li> <li>• Tiered parking pricing based on distance to academic core.</li> </ul>  |
| <b>Alternative 3:<br/>Typical CSU Parking Supply</b>    | 0.40                  | \$200-250                      | \$100-150                            | <ul style="list-style-type: none"> <li>• Higher prices for on campus resident permits.</li> <li>• No vehicles for freshman on campus.</li> <li>• Limited on-campus permits for East Campus residents.</li> </ul>   |

Source: Fehr & Peers, 2015

## SUMMARY

Fehr & Peers has provided these preliminary parking ratios and pricing schemes in order to engage stakeholders and University staff in a conversation about a proactive approach to parking. Subsequent to Master Plan adoption, CSUMB should develop a Parking Management Plan to guide and implement campus wide parking policies including pricing, permitting and enforcement. This would be best achieved through a Transportation and Parking Services (TAPS) department which would be charged with implementing the parking management strategies and managing parking revenue. Under this structure, parking revenue could be directed towards transportation systems that reinforce the long term sustainable transportation goals of the campus.

## **APPENDIX I: PARKING DEMAND AND SUPPLY CALCULATIONS**



**TABLE 11: CSUMB EXISTING AND FUTURE ACADEMIC PARKING DEMAND AND SUPPLY**

| Item  | Value                |
|---|----------------------|
| Existing Peak Parking Demand (A)                    | 2,396 spaces         |
| Existing Students, Faculty and Staff Population (B) | 7,886 FTE            |
| Existing Parking Demand Rate (A/B = C)              | 0.313 spaces per FTE |
| Future Students, Faculty and Staff (D)              | 14,476 FTE           |
| Future Base Parking Demand (D x C = E)              | 4,531 spaces         |
| Circulation Factor (F)                              | 0.05                 |
| Future Parking Supply (E x (1+F)=G)                 | 4,758 spaces         |
| Existing Parking Supply                             | 3,730 spaces         |
| Excess/Shortage Parking Supply                      | -1,028 spaces        |

Source: Fehr & Peers, June 2019.

**TABLE 12: CSUMB EXISTING AND FUTURE RESIDENTIAL PARKING DEMAND AND SUPPLY**

| Item  | Value                       |
|---|-----------------------------|
| Existing Peak Parking Demand (A)                                | 525 spaces                  |
| Existing Residential Students, Faculty and Staff Population (B) | 2,600 Main Campus Residents |
| Existing Parking Demand Rate (A/B = C)                          | 0.202 spaces per resident   |
| Future Students, Faculty and Staff (D)                          | 7,620 Main Campus Residents |
| Future Base Parking Demand (D x C = E)                          | 1,539 spaces                |
| Circulation Factor (F)  | 0.05                        |
| Future Parking Supply (E x (1+F)=G)                             | 1,616 spaces                |
| Existing Parking Supply   | 991 spaces                  |
| Excess/Shortage Parking Supply                                  | -625 spaces                 |

Source: Fehr & Peers, June 2019.

**TABLE 13: FUTURE PARKING SUPPLY SUMMARY**

| Parking Summary                                     | Academic | Residential | Total |
|---|----------|-------------|-------|
| Existing  | 3,730    | 991         | 4,721 |
| Future Base on Land Area Allocated in MP Guidelines | 4,451    | 1,200       | 5,651 |
| Future Based on Existing Parking Demand             | 4,758    | 1,616       | 6,374 |

Source: Fehr & Peers, June 2019.



**Table 15: CSUMB Main Campus External AM Vehicle Trips**

| Parking Areas  | Students       |              |           |                        | Faculty/Staff |             |           |                        |
|----------------|----------------|--------------|-----------|------------------------|---------------|-------------|-----------|------------------------|
|                | SOV            | Carpool      | Transit   | Percent of total trips | SOV           | Carpool     | Transit   | Percent of total trips |
| Parking Area 1 | 416<br>(28%)   | 0<br>(0%)    | 0<br>(0%) | 416<br>(28%)           | 100<br>(14%)  | 0<br>(0%)   | 0<br>(0%) | 100<br>(7%)            |
| Parking Area 2 | 164<br>(11%)   | 67<br>(5%)   | 4<br>(0%) | 235<br>(16%)           | 35<br>(5%)    | 31<br>(4%)  | 1<br>(0%) | 67<br>(5%)             |
| Parking Area 3 | 100<br>(7%)    | 93<br>(6%)   | 5<br>(0%) | 198<br>(14%)           | 102<br>(15%)  | 44<br>(6%)  | 2<br>(0%) | 148<br>(10%)           |
| Parking Area 4 | 416<br>(28%)   | 0<br>(0%)    | 0<br>(0%) | 416<br>(28%)           | 198<br>(28%)  | 0<br>(0%)   | 0<br>(0%) | 198<br>(14%)           |
| Parking Area 5 | 52<br>(4%)     | 0<br>(0%)    | 0<br>(0%) | 52<br>(4%)             | 105<br>(15%)  | 0<br>(0%)   | 0<br>(0%) | 105<br>(7%)            |
| Parking Area 6 | 103<br>(7%)    | 0<br>(0%)    | 0<br>(0%) | 103<br>(7%)            | 77<br>(11%)   | 0<br>(0%)   | 0<br>(0%) | 77<br>(5%)             |
| Parking Area 7 | 44<br>(3%)     | 0<br>(0%)    | 0<br>(0%) | 44<br>(3%)             | 0<br>(0%)     | 0<br>(0%)   | 0<br>(0%) | 0<br>(0%)              |
| <b>Total</b>   | 1,295<br>(88%) | 160<br>(11%) | 9<br>(1%) | 1,464<br>(100%)        | 617<br>(89%)  | 75<br>(11%) | 3<br>(0%) | 695<br>(47%)           |

Notes:

1. Promontory is a residential only lot for students living on the Main Campus. Trips are only for travel off-campus and east-campus, trips into the campus are not expected to occur for students living on the Main Campus.

Source: Fehr & Peers, June 2019.

**TABLE 16. PARKING DEMAND BY LOT**

| Parking Lot    | Future Parking Supply based on Land Area Allocated in Master Plan <sup>1</sup> [A] |               |                | Future Parking Supply Based on Existing Parking Demand for Use in TA <sup>2</sup> [B] |                |                | Excess/ Supply Shortage [A-B] |             |        |
|----------------|--|---------------|----------------|---|----------------|----------------|-------------------------------|-------------|--------|
|                | Academic   | Residential   | Total          | Academic  | Residential    | Total          | Academic                      | Residential | Total  |
| Parking Area 1 | 475<br>(11%)   | 775<br>(65%)  | 1,250<br>(22%) | 1,190<br>(25%)  | 1,234<br>(76%) | 2,424<br>(38%) | -715                          | -459        | -1,174 |
| Parking Area 2 | 1,188<br>(27%)   | -             | 1,188<br>(21%) | 714<br>(15%)  | -              | 714<br>(11%)   | 474                           | -           | 474    |
| Parking Area 3 | 463<br>(10%)   | -             | 463<br>(8%)    | 760<br>(16%)  | -              | 760<br>(12%)   | -297                          | -           | -297   |
| Parking Area 4 | 1,450<br>(33%)   | -             | 1,450<br>(26%) | 1,380<br>(29%)  | -              | 1,380<br>(22%) | 70                            | -           | 70     |
| Parking Area 5 | 500<br>(11%)   | -             | 500<br>(9%)    | 333<br>(7%)   | -              | 333<br>(5%)    | 167                           | -           | 167    |
| Parking Area 6 | 375<br>(8%)  | -             | 375<br>(7%)    | 381<br>(8%)   | -              | 381<br>(6%)    | -6                            | -           | -6     |
| Parking Area 7 | -  | 425<br>(35%)  | 425<br>(8%)    | -   | 382<br>(24%)   | 382<br>(6%)    | -                             | 43          | 43     |
| <b>Total</b>   | 4,451<br>100%  | 1,200<br>100% | 5,651<br>100%  | 4,758<br>100%   | 1,616<br>100%  | 6374<br>100%   | -308                          | -416        | -723   |

Notes:

1. Future Parking Supply estimated by Master Plan land are allocation provided by CSUMB on June 2018.
2. Future Parking Supply estimated by campus population growth based on estimated parking area size calculated using methodology described in **Chapter 2 and Chapter 7**.

Source: CSUMB, June 2018. Fehr & Peers, June 2019.

**APPENDIX J: CALIFORNIA STATE UNIVERSITY, MONTEREY BAY  
HOUSING AND PARKING MANAGEMENT GUIDELINES**

Refer to Appendix C-2 of the CSUMB Master Plan EIR



## **APPENDIX K: INTERSECTION VOLUME FIGURES**



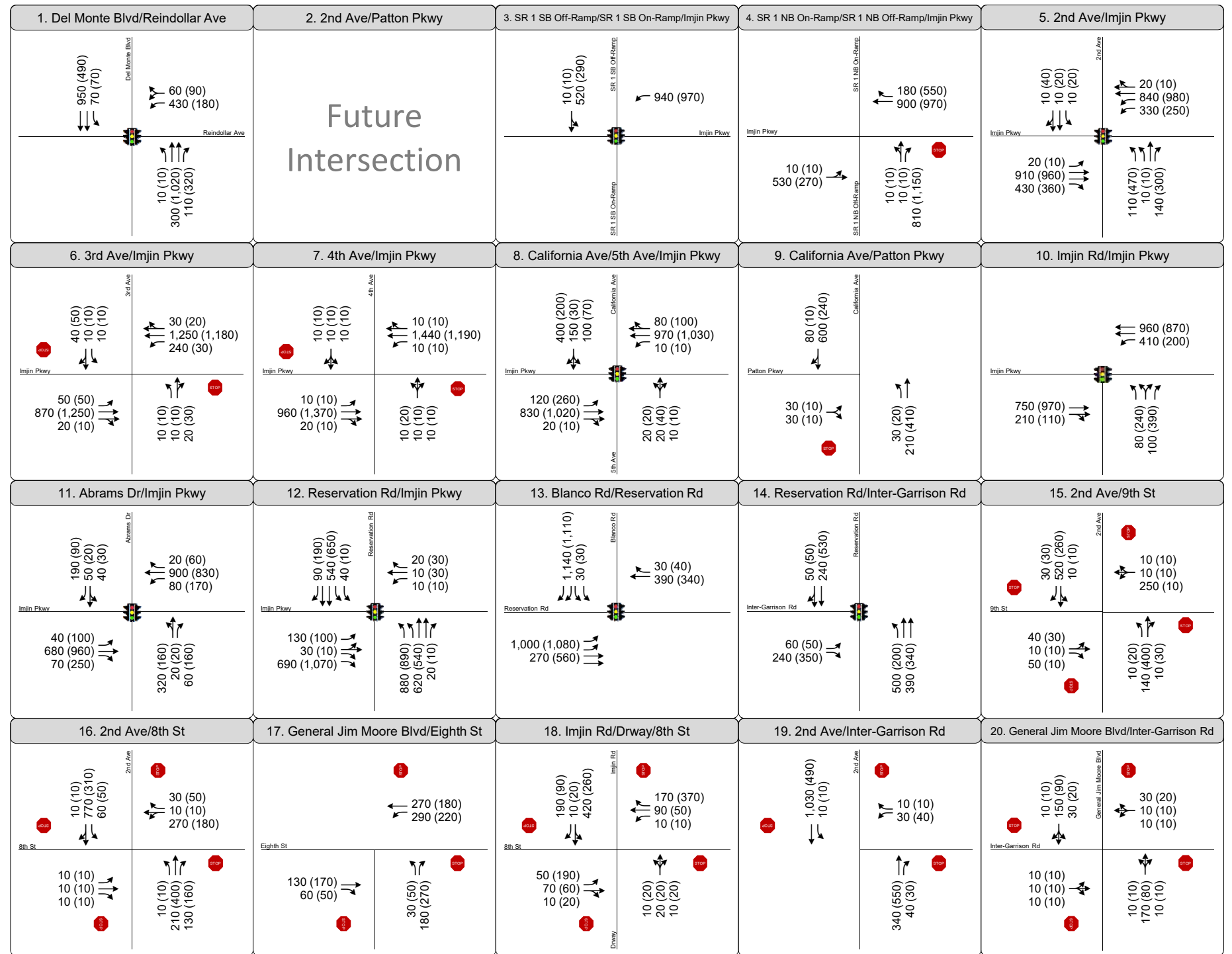
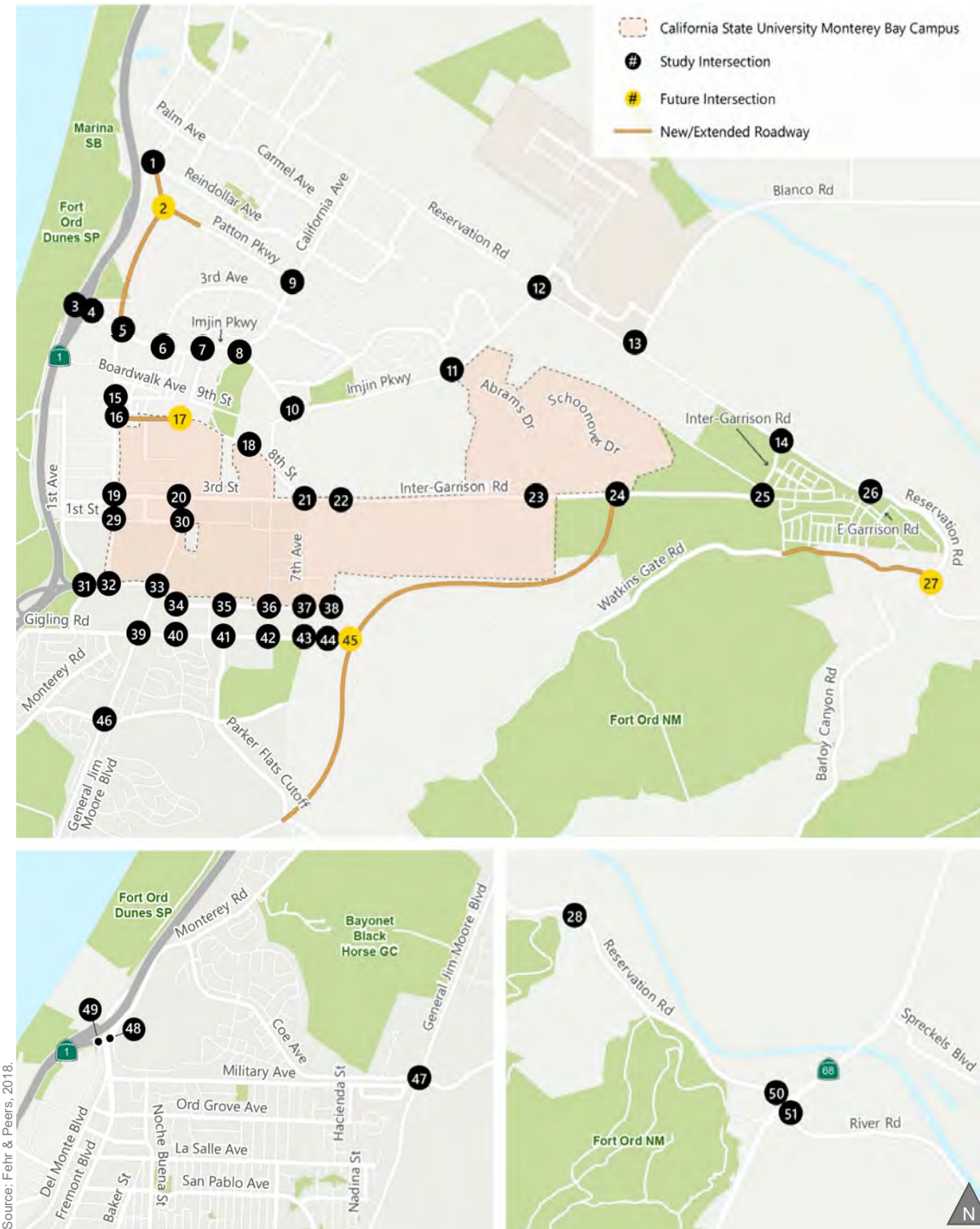

- LEGEND**
- AM (PM) Peak Hour Traffic Volume
  - Lane Configuration
  - Stop Sign Controlled
  - Signalized
  - Roundabout

Figure K-1a  
Study Intersection Peak Hour Traffic Volumes and Lane Configurations  
Existing with Project Conditions



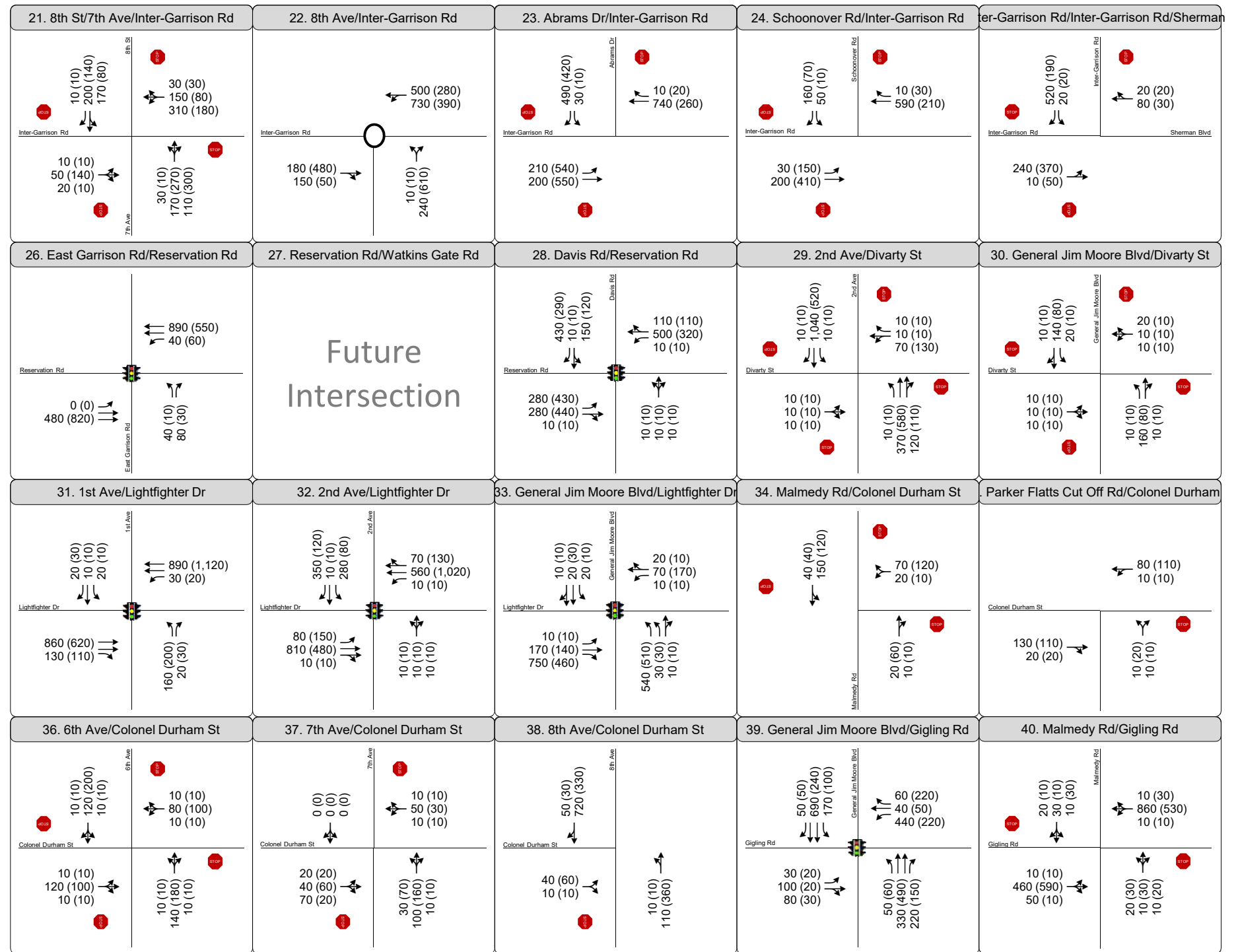
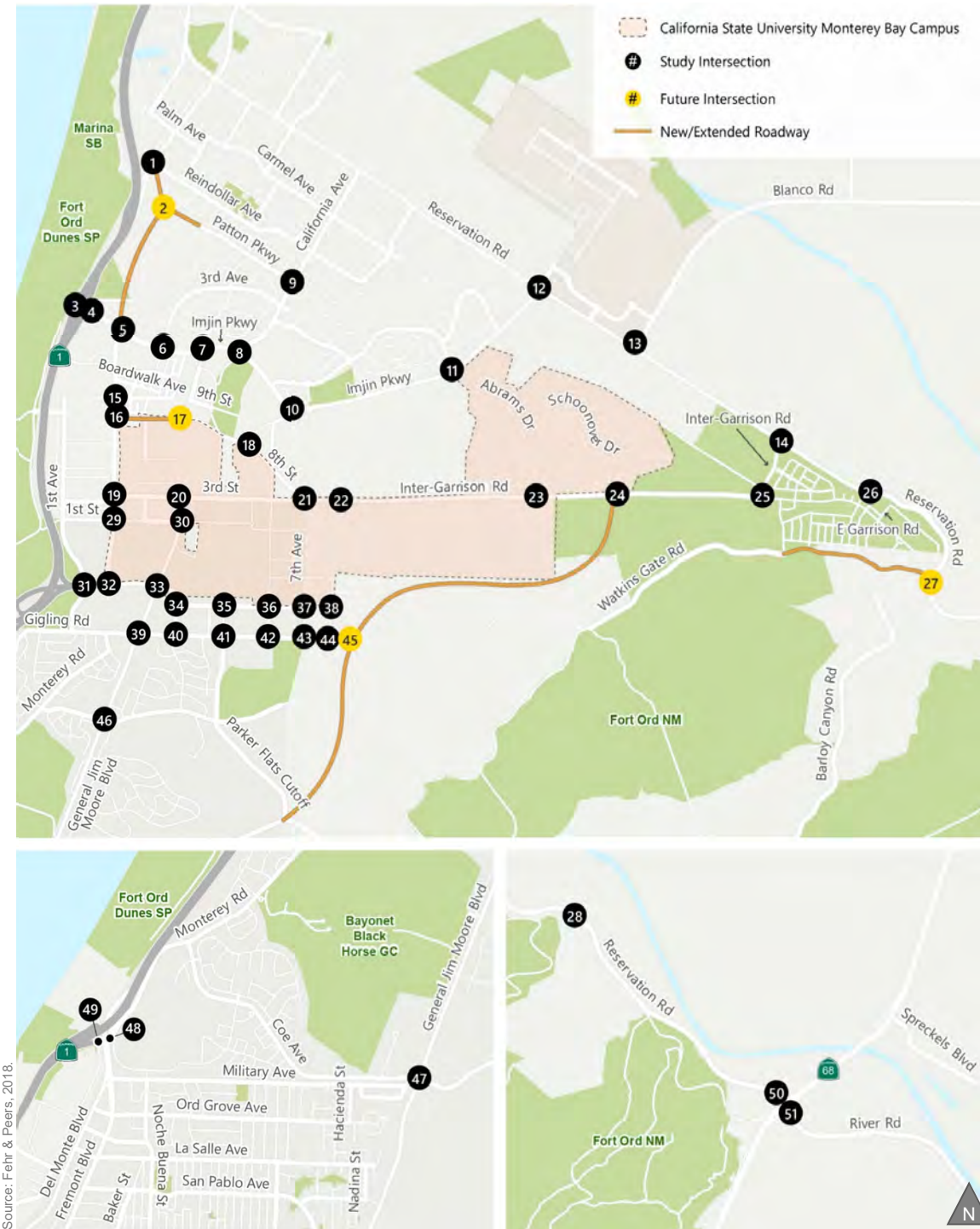

- LEGEND**
- AM (PM) Peak Hour Traffic Volume
  - Lane Configuration
  - Stop Sign Controlled
  - Signalized
  - Roundabout

Figure K-1b  
Study Intersection Peak Hour Traffic Volumes and Lane Configurations  
Existing with Project Conditions



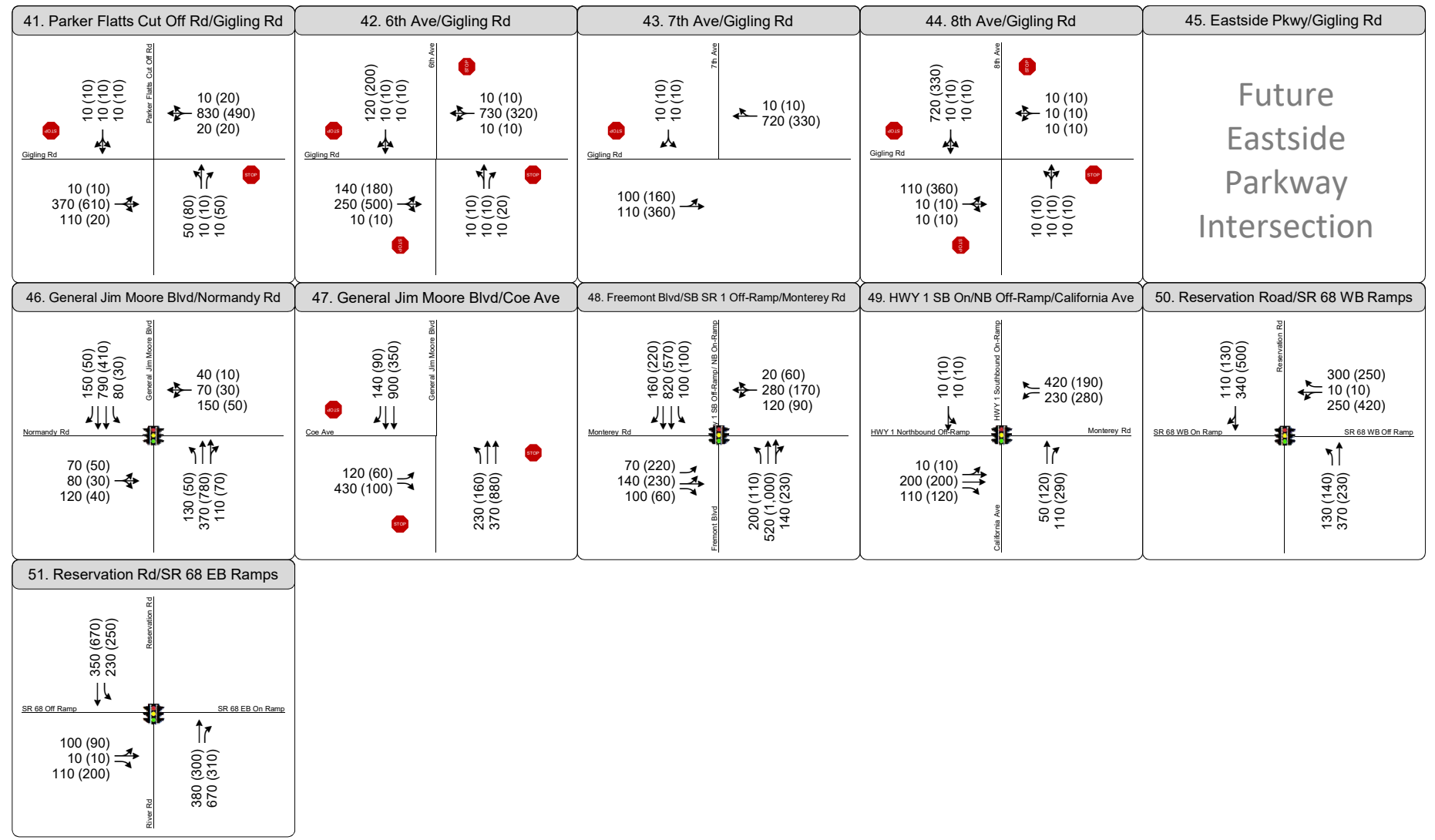
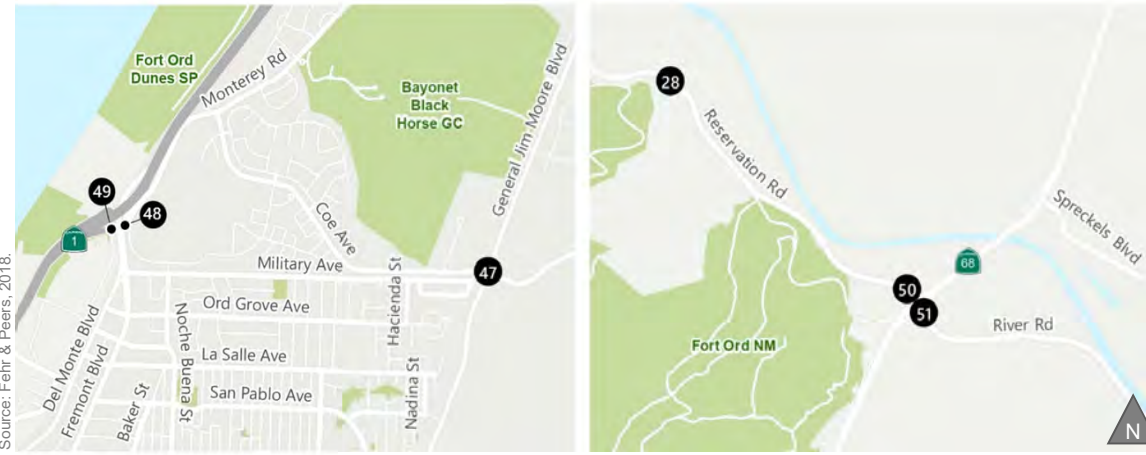
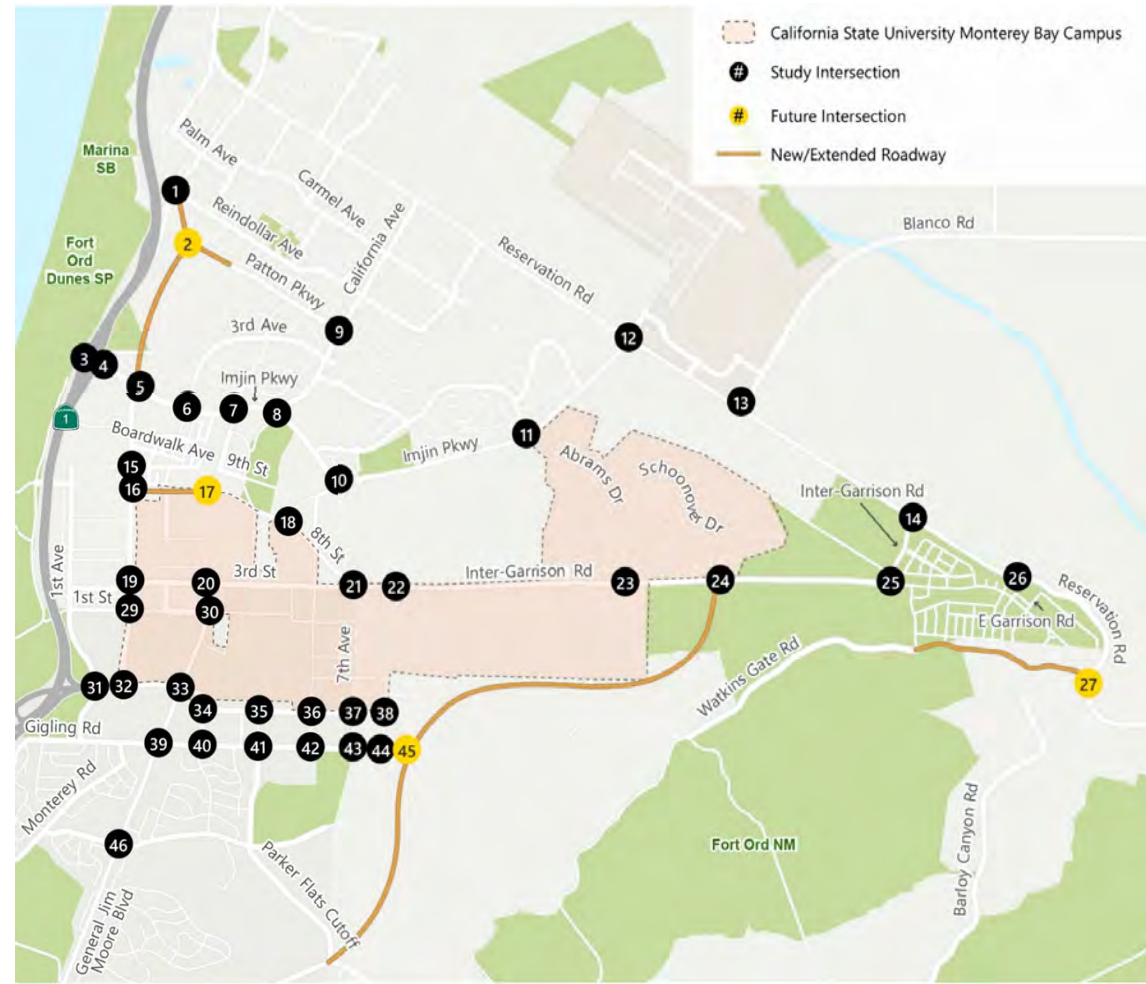

- LEGEND**
- AM (PM) Peak Hour Traffic Volume
  - Lane Configuration
  - Stop Sign Controlled
  - Signalized
  - Roundabout

Figure K-1c  
Study Intersection Peak Hour Traffic Volumes and Lane Configurations  
Existing with Project Conditions



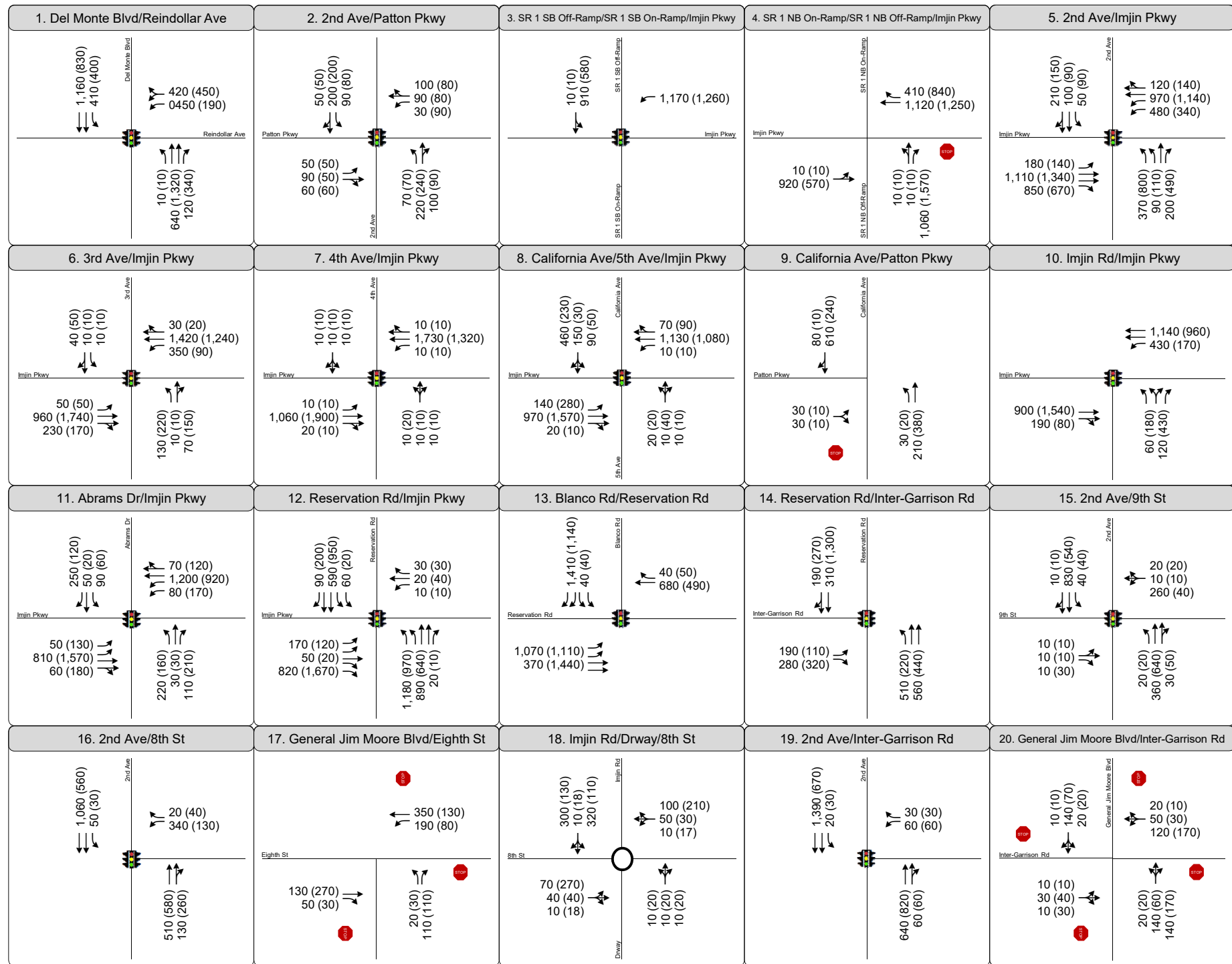
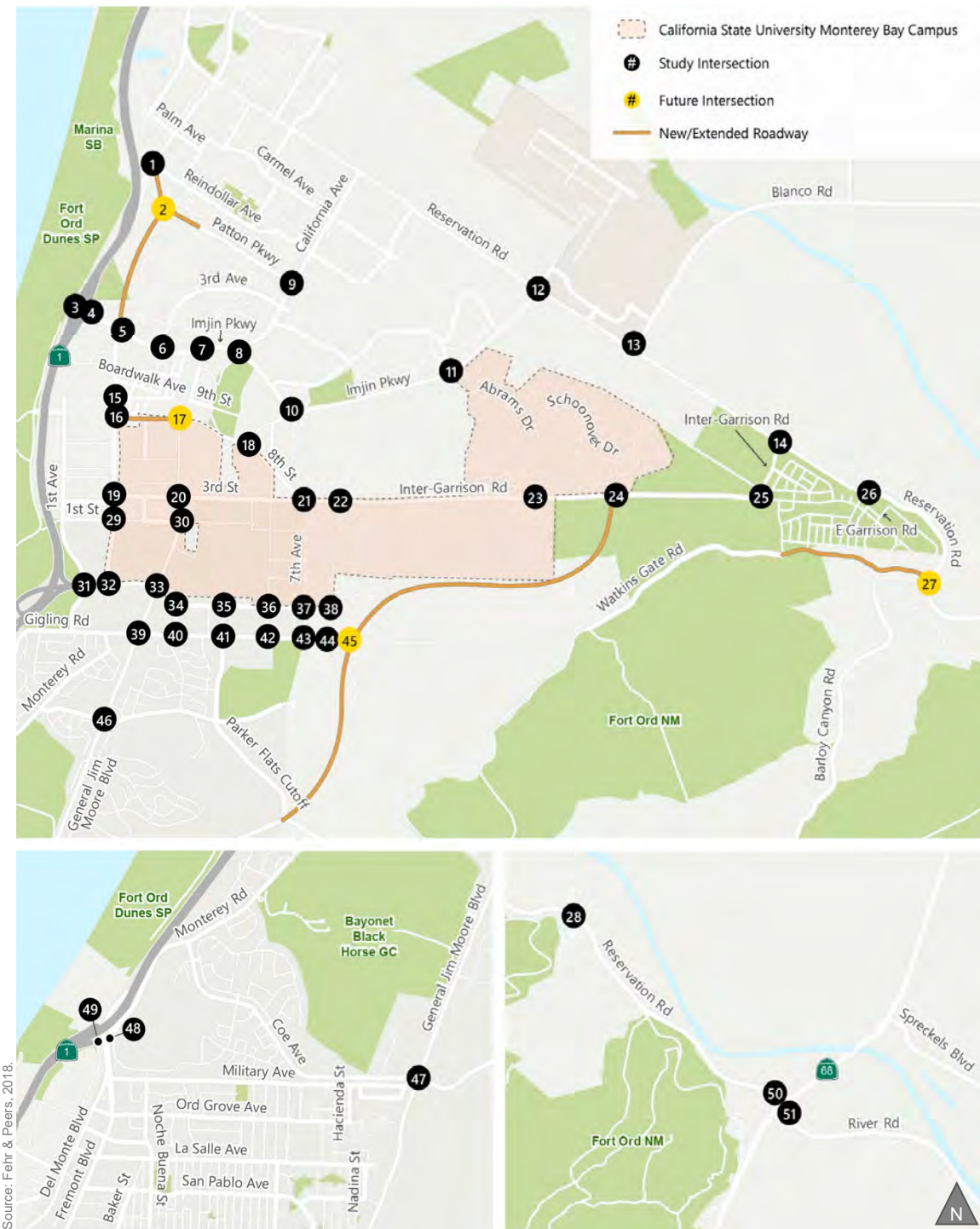

**LEGEND**

- AM (PM) Peak Hour Traffic Volume
- Lane Configuration
- Stop Sign Controlled
- Signalized
- Roundabout

Figure K-2a  
Study Intersection Peak Hour Traffic Volumes and Lane Configurations  
Cumulative without Project and without Eastside Parkway Conditions





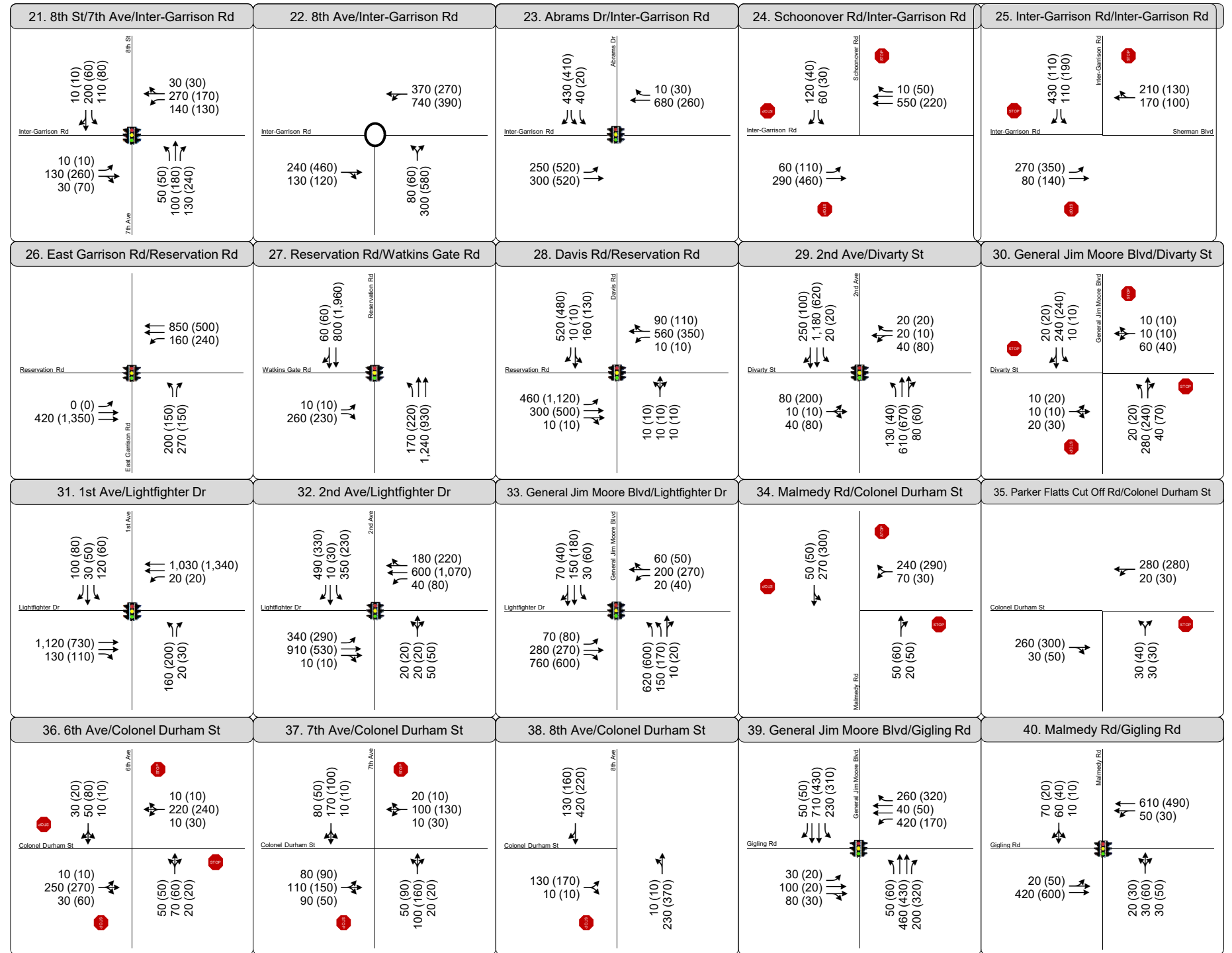
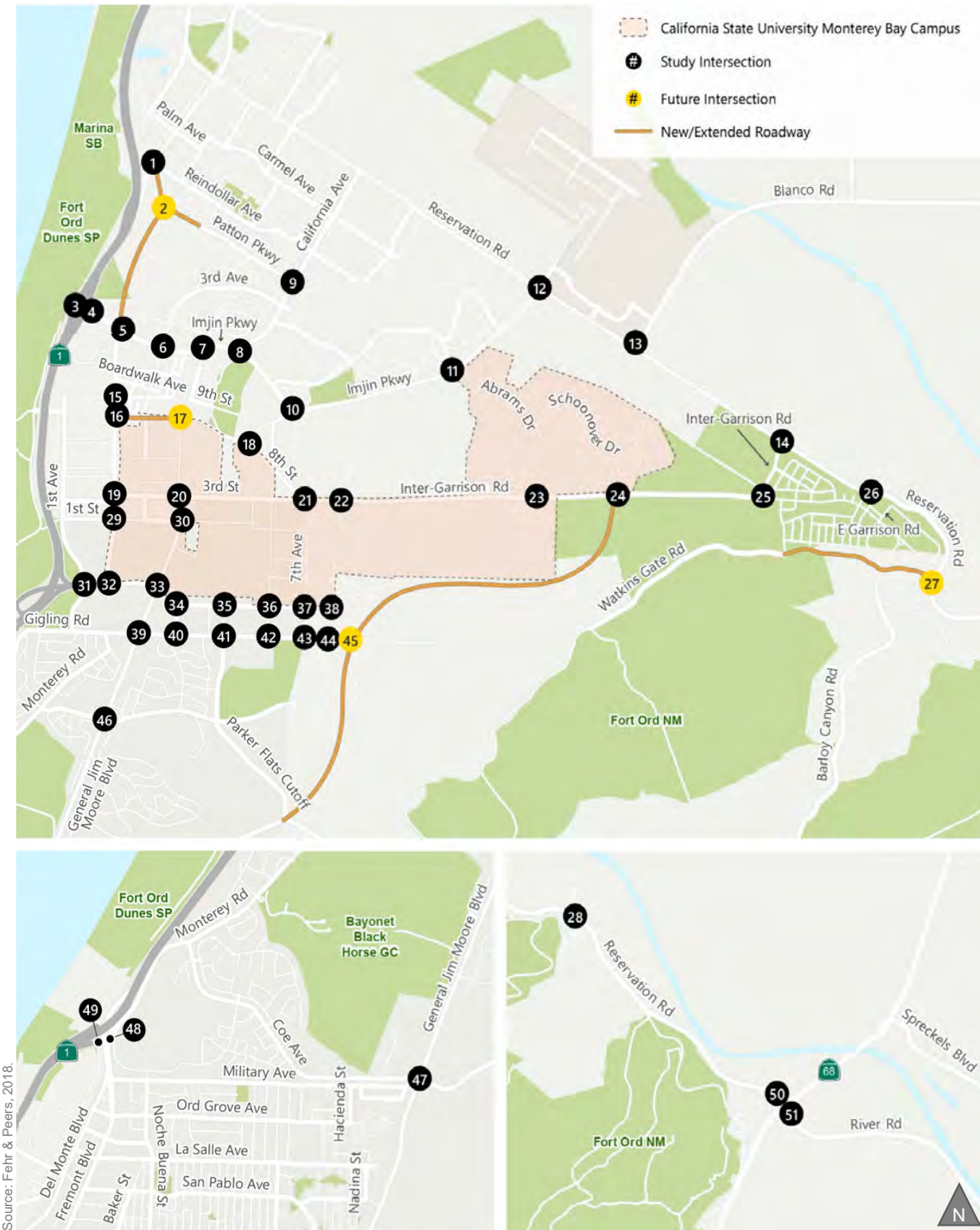

- LEGEND**
- AM (PM) Peak Hour Traffic Volume
  - Lane Configuration
  - Stop Sign Controlled
  - Signalized
  - Roundabout

Figure K-2b  
Study Intersection Peak Hour Traffic Volumes and Lane Configurations  
Cumulative without Project and without Eastside Parkway Conditions

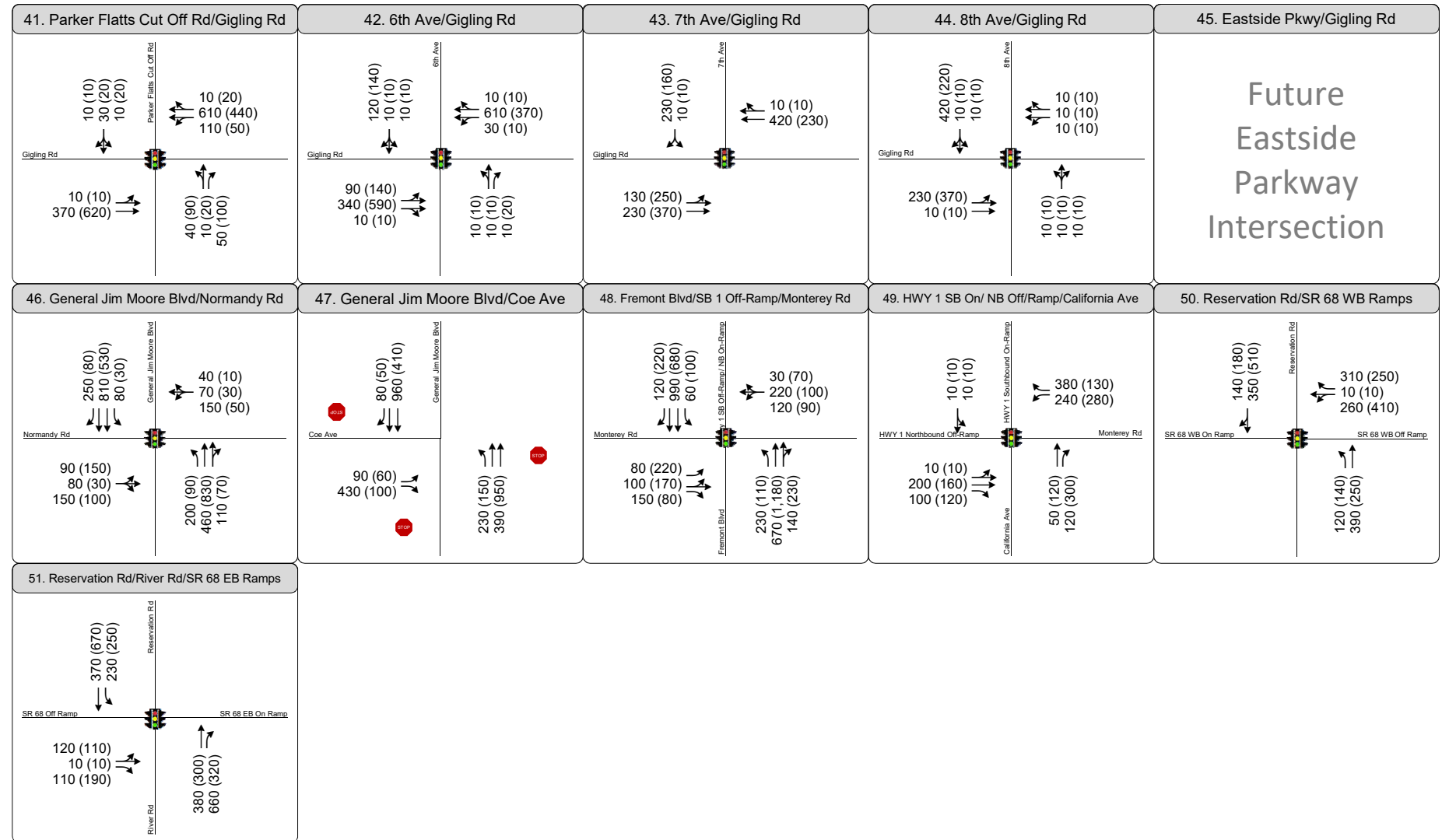
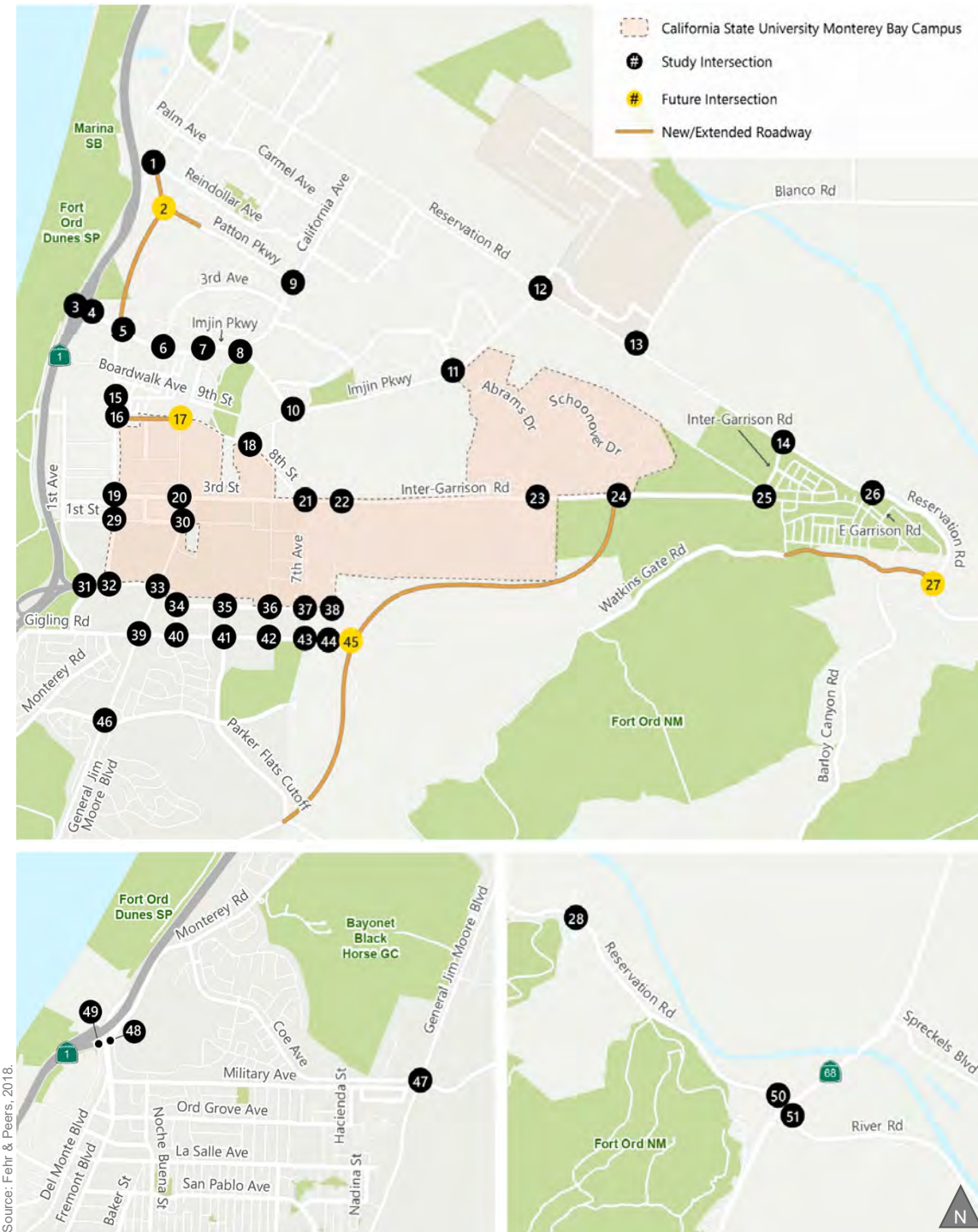

**LEGEND**

AM (PM) Peak Hour Traffic Volume

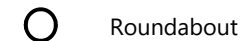
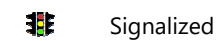

Source: Fehr & Peers, 2018.



Figure K-2C  
Study Intersection Peak Hour Traffic Volumes and Lane Configurations  
Cumulative without Project and without Eastside Parkway Conditions

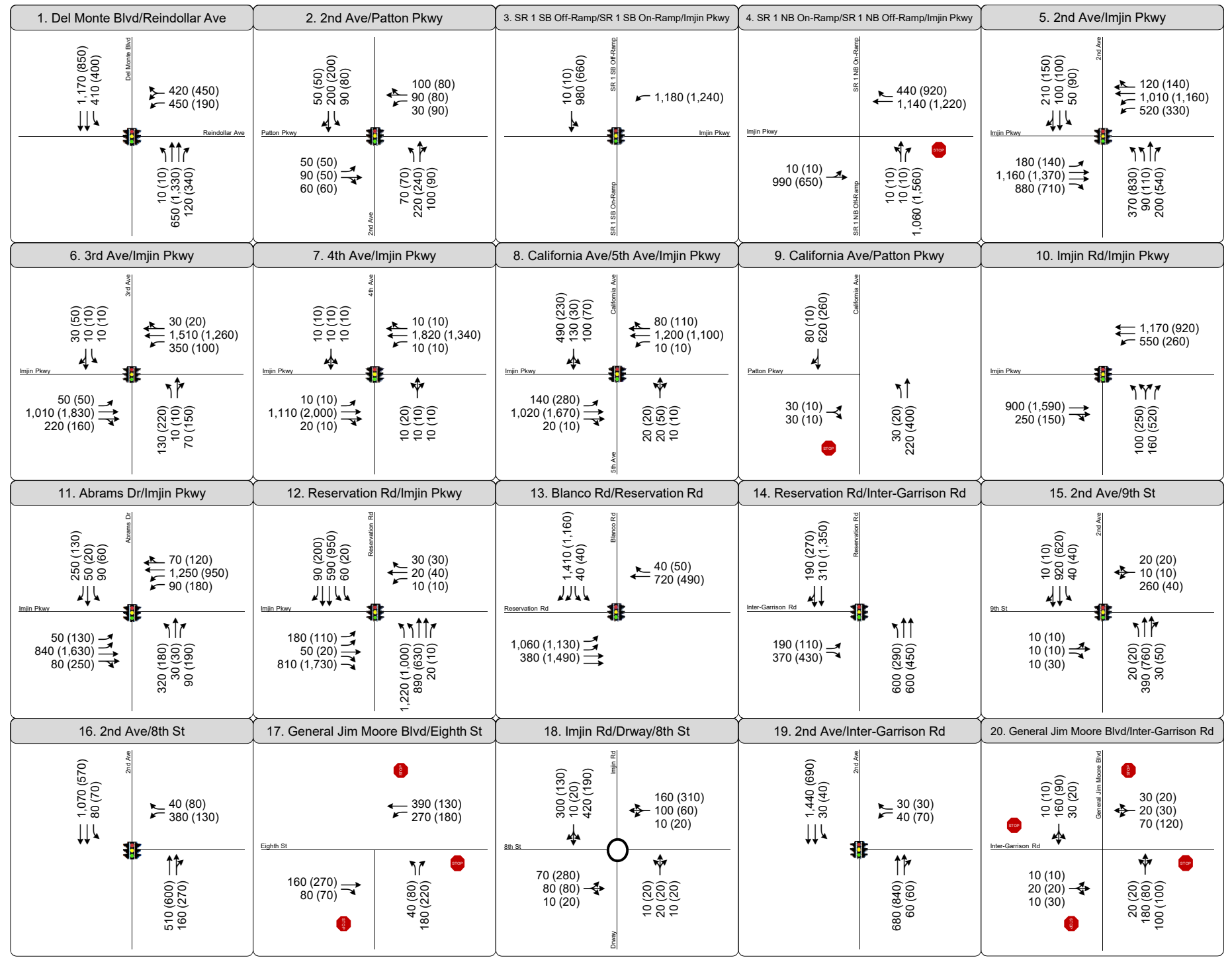
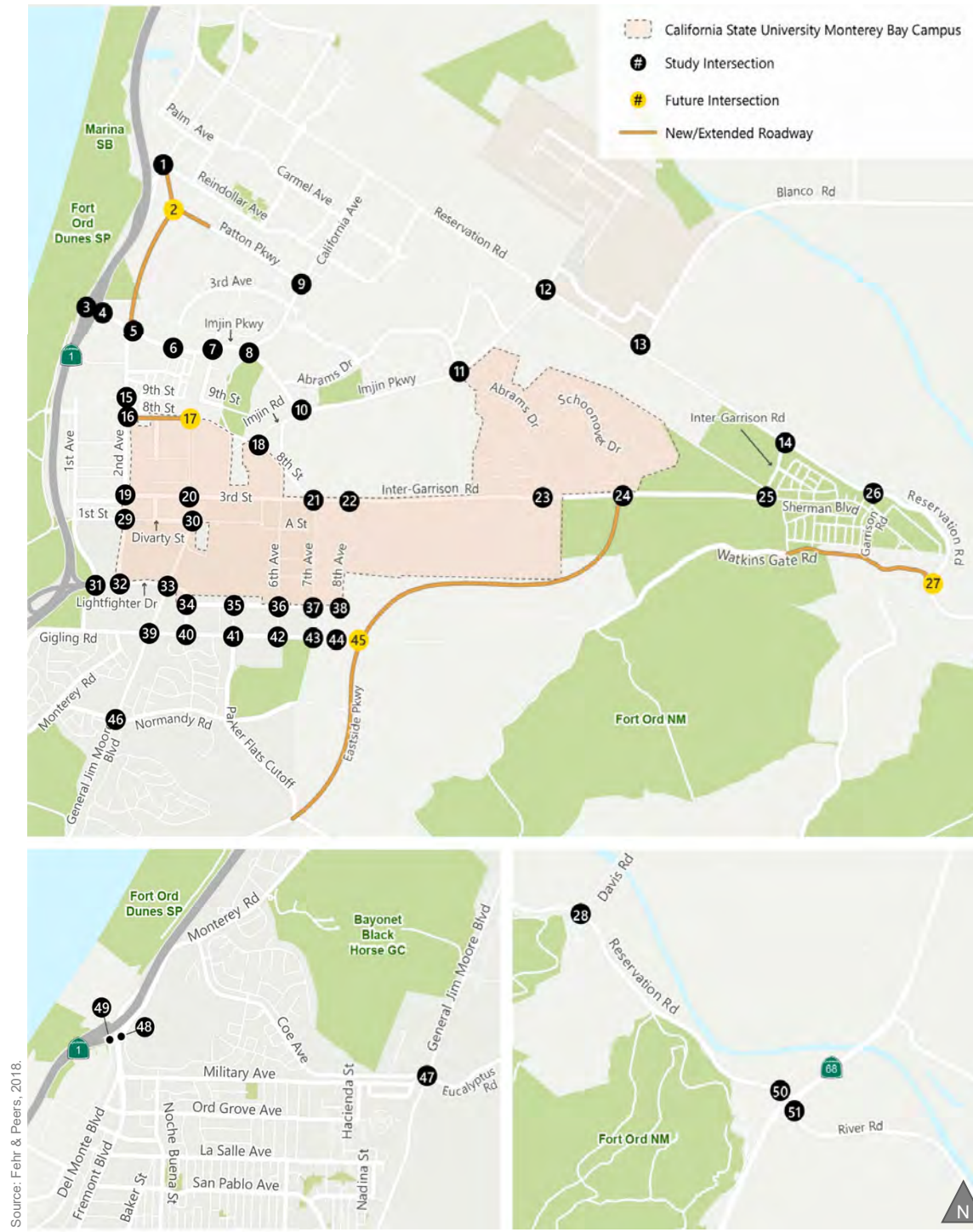

- LEGEND**
- AM (PM) Peak Hour Traffic Volume
  - Lane Configuration
  - Stop Sign Controlled
  - Signalized
  - Roundabout

Figure K-3a  
Study Intersection Peak Hour Traffic Volumes and Lane Configurations  
Cumulative with Project and without Eastside Parkway Conditions



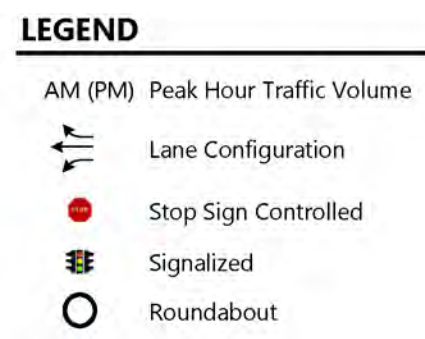
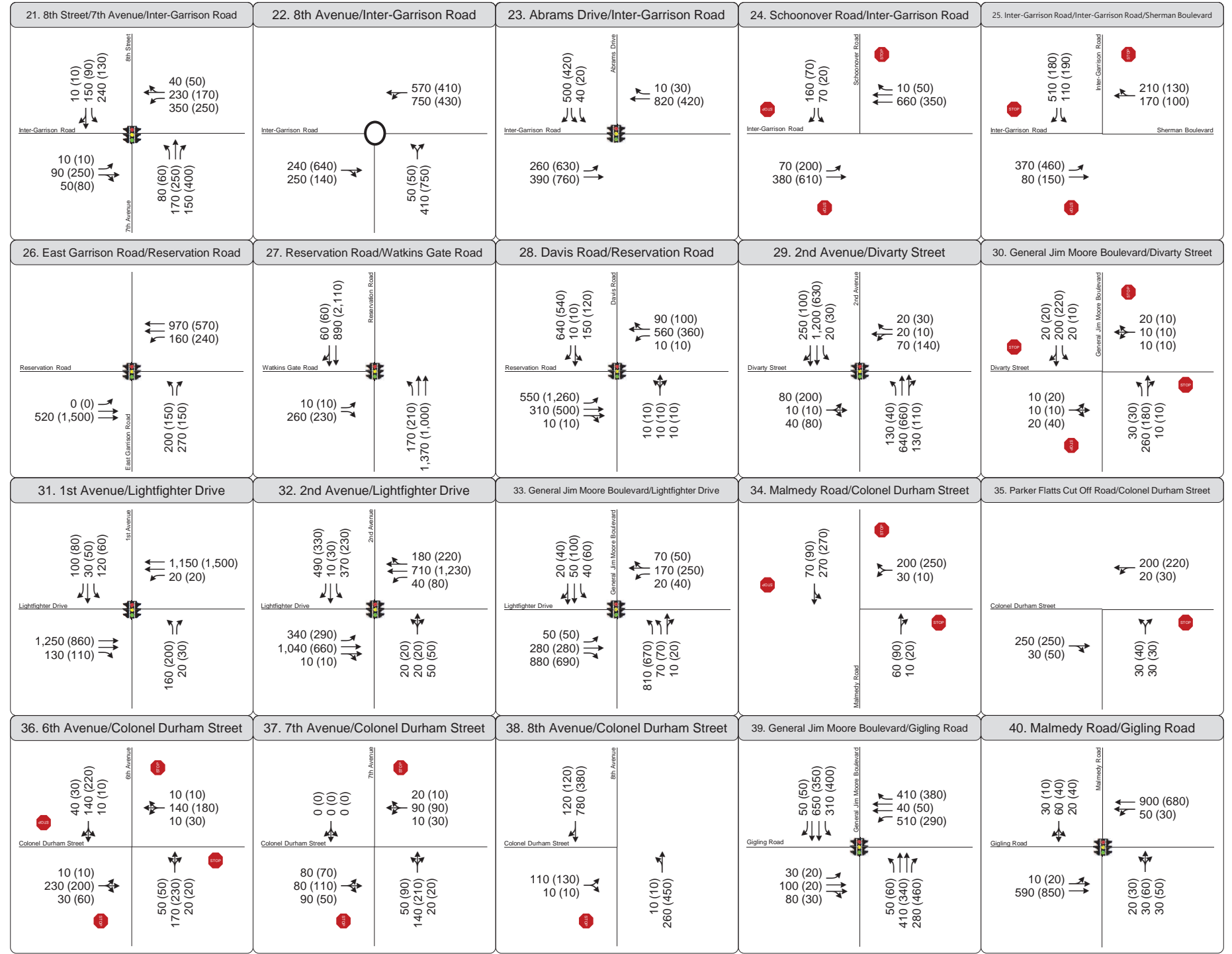
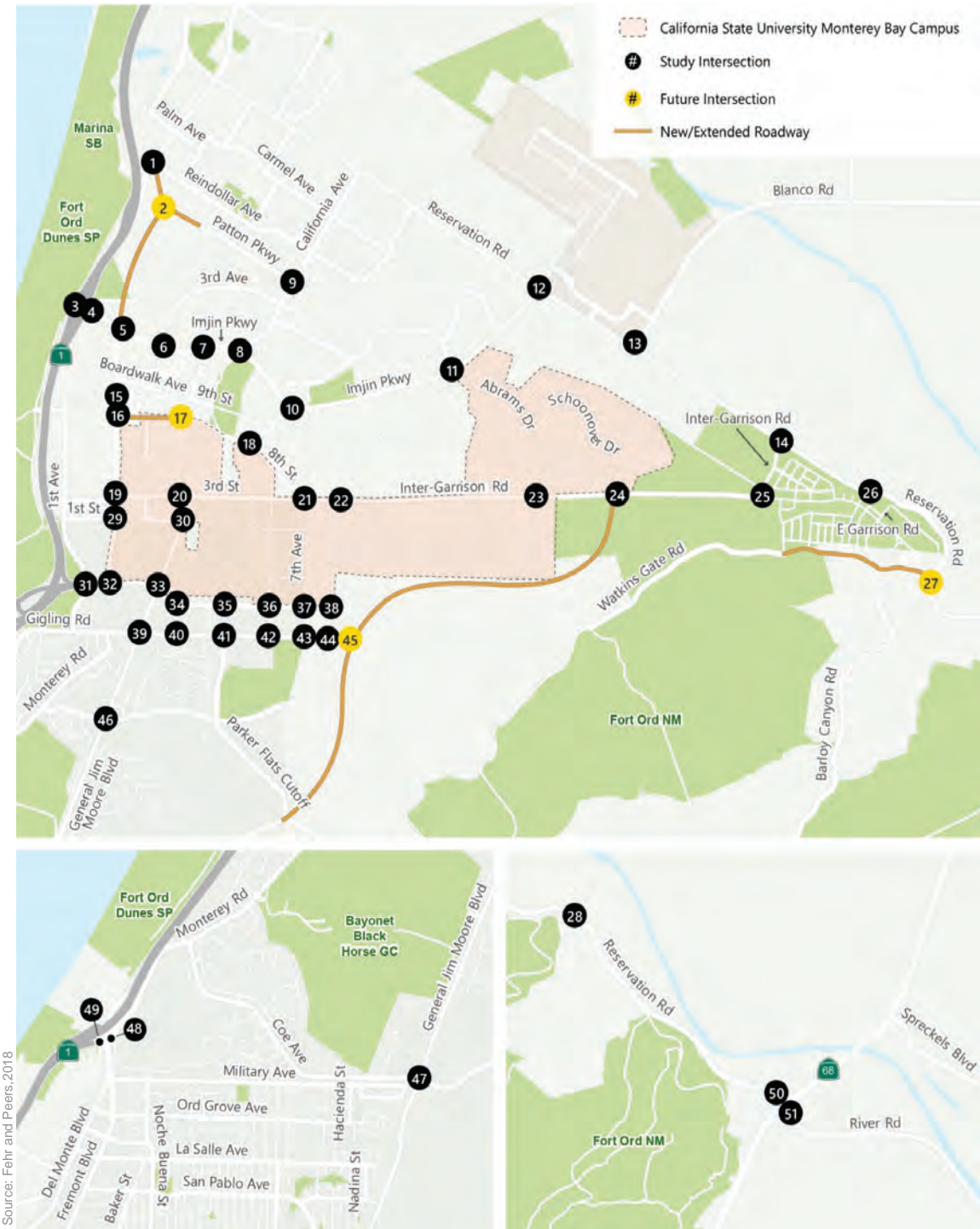
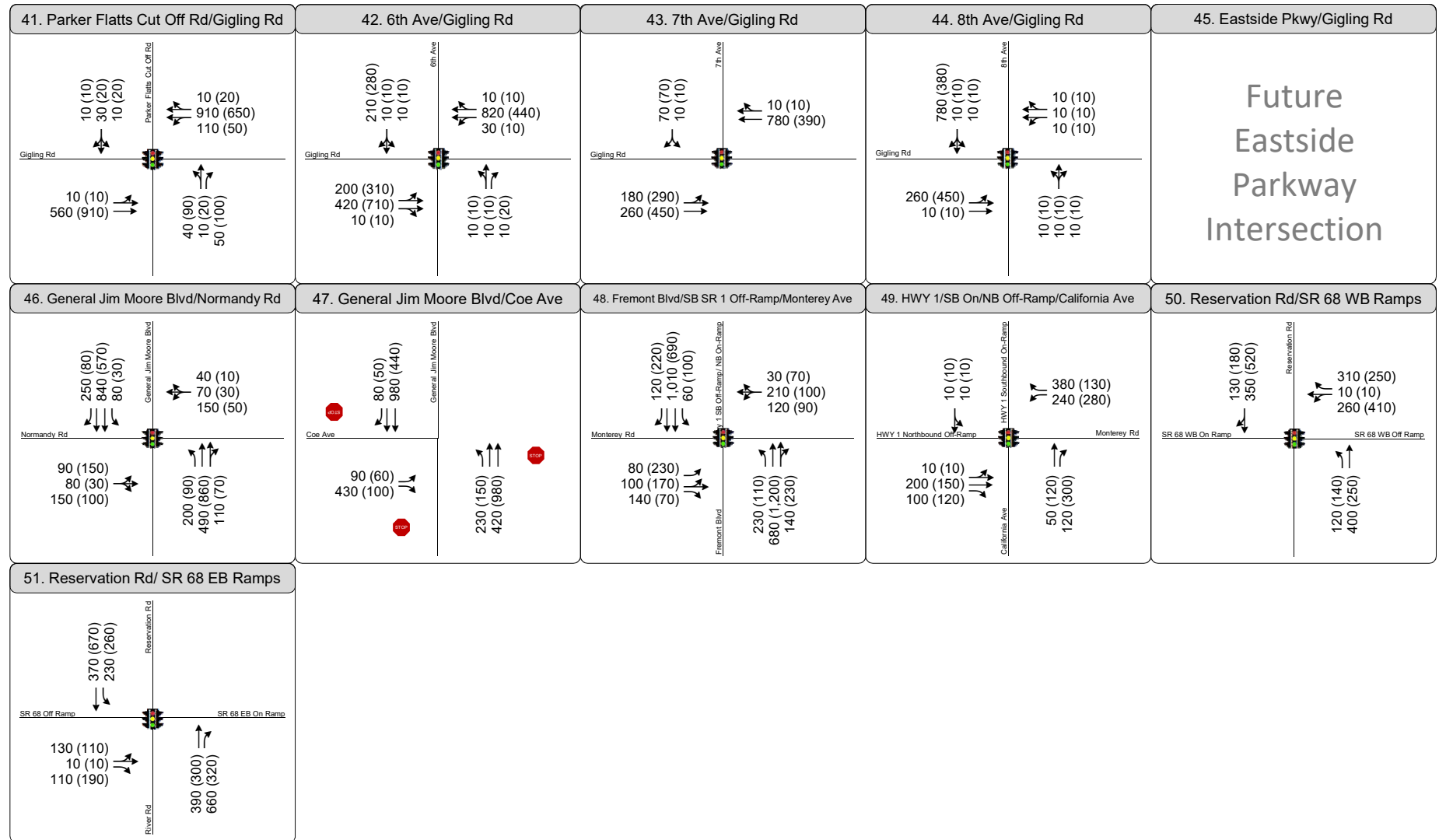
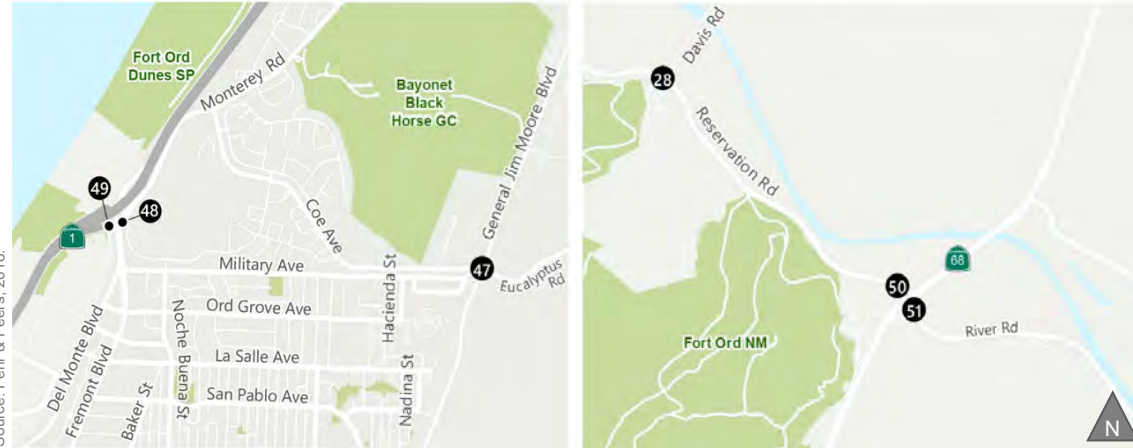

Figure K-3b  
Study Intersection Peak Hour Traffic Volumes and Lane Configurations  
Cumulative with Project and without East Parkway Conditions





**LEGEND**

AM (PM) Peak Hour Traffic Volume



Stop Sign Controlled



Roundabout



Figure K-3c  
Study Intersection Peak Hour Traffic Volumes and Lane Configurations  
Cumulative with Project and without Eastside Parkway Conditions

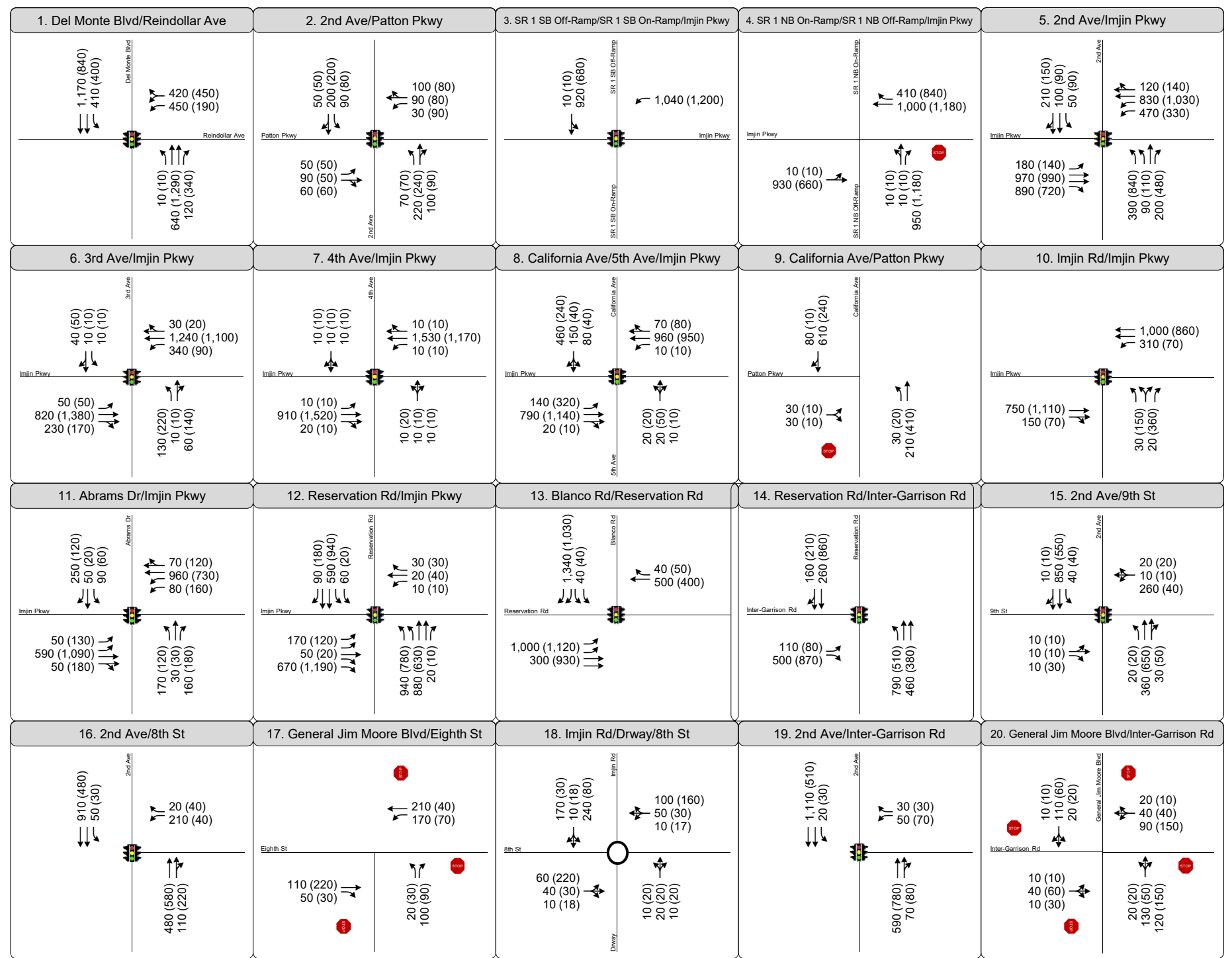
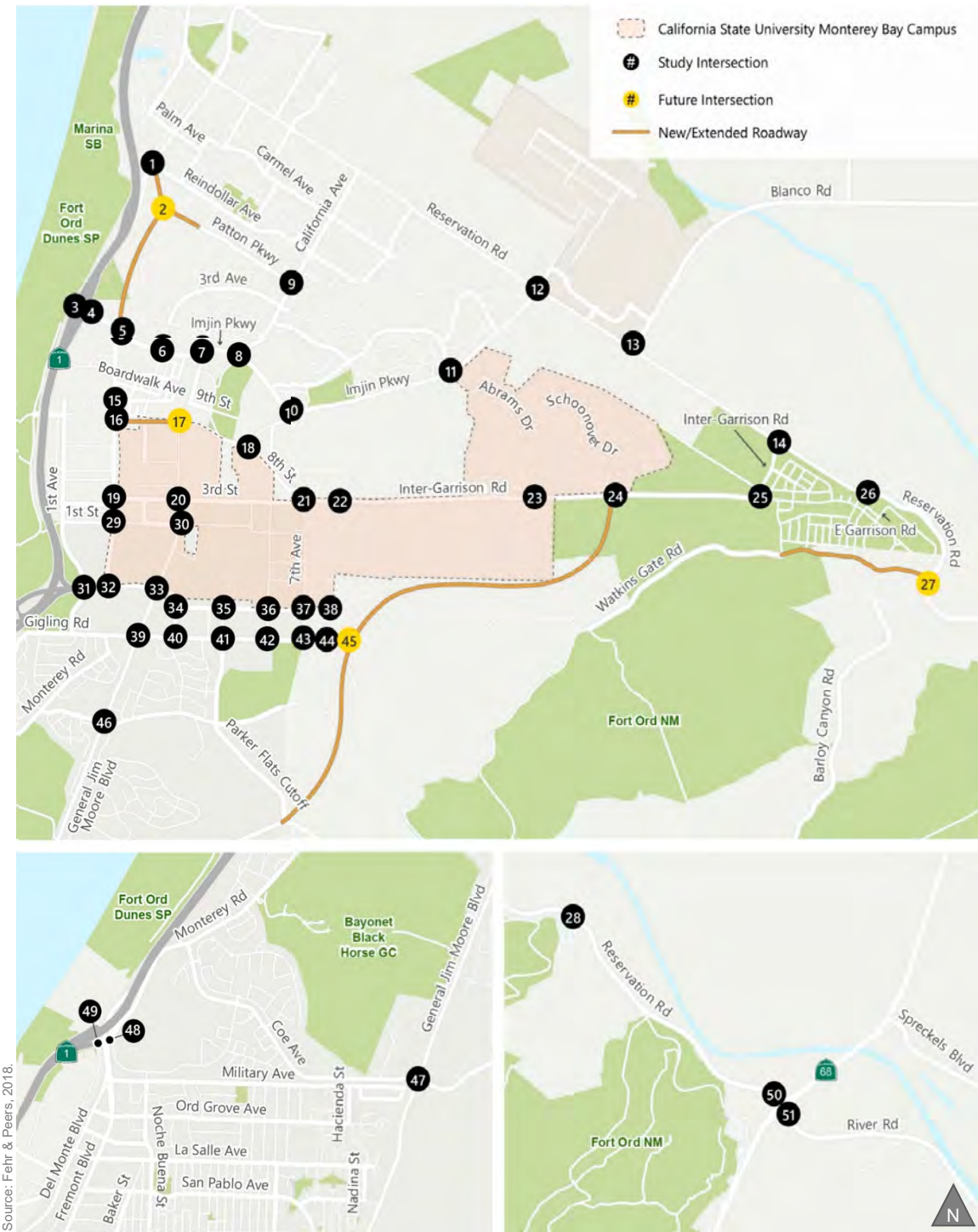

- LEGEND**
- AM (PM) Peak Hour Traffic Volume
  - Lane Configuration
  - Stop Sign Controlled
  - Signalized
  - Roundabout

Figure K-4a  
Study Intersection Peak Hour Traffic Volumes and Lane Configurations  
Cumulative without Project and with Eastside Parkway Conditions



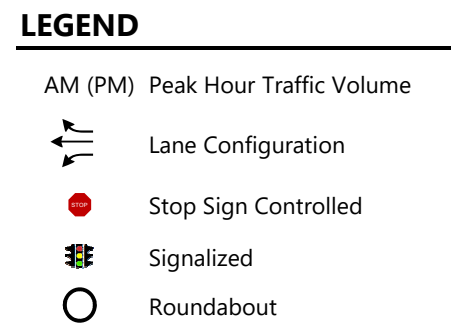
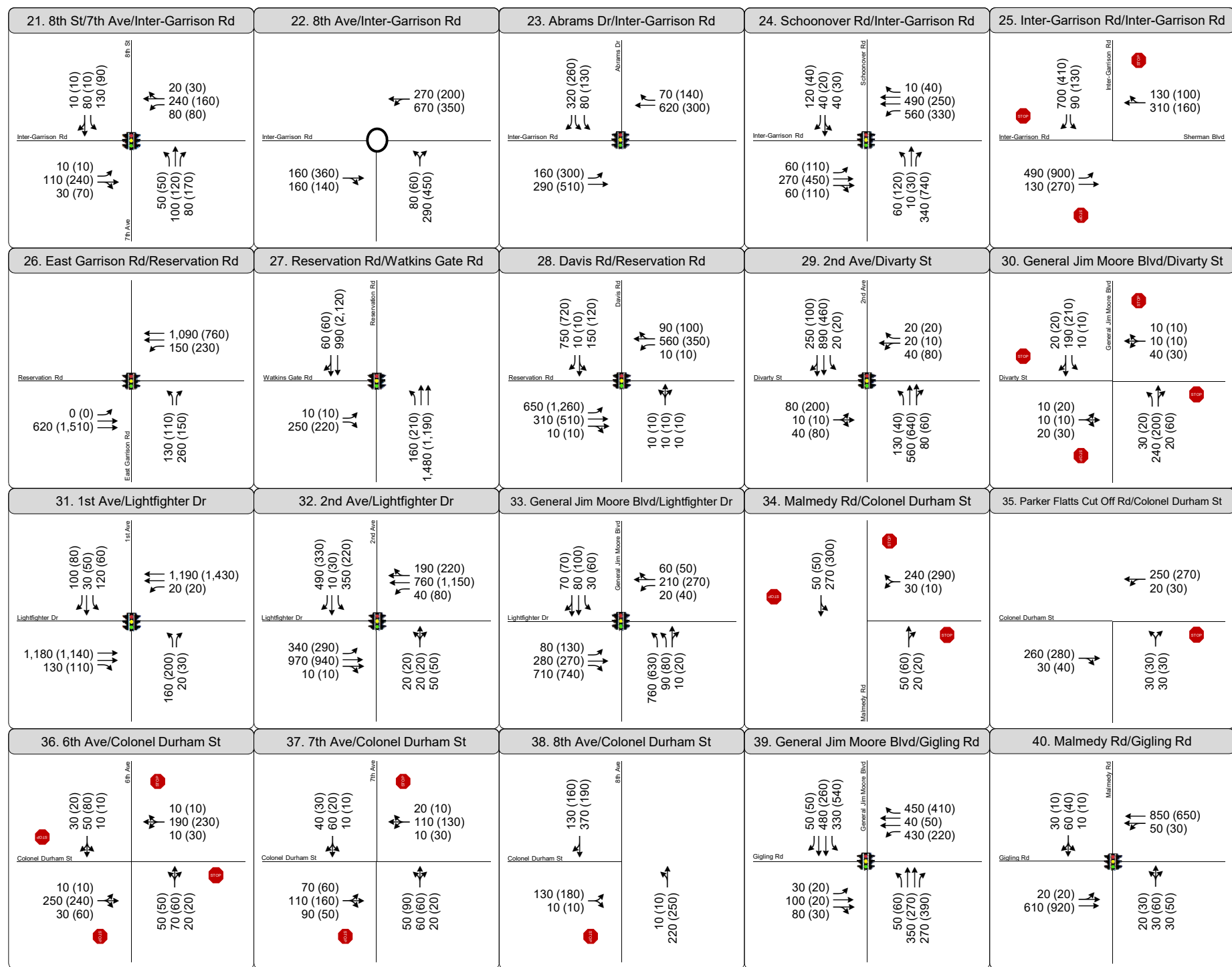
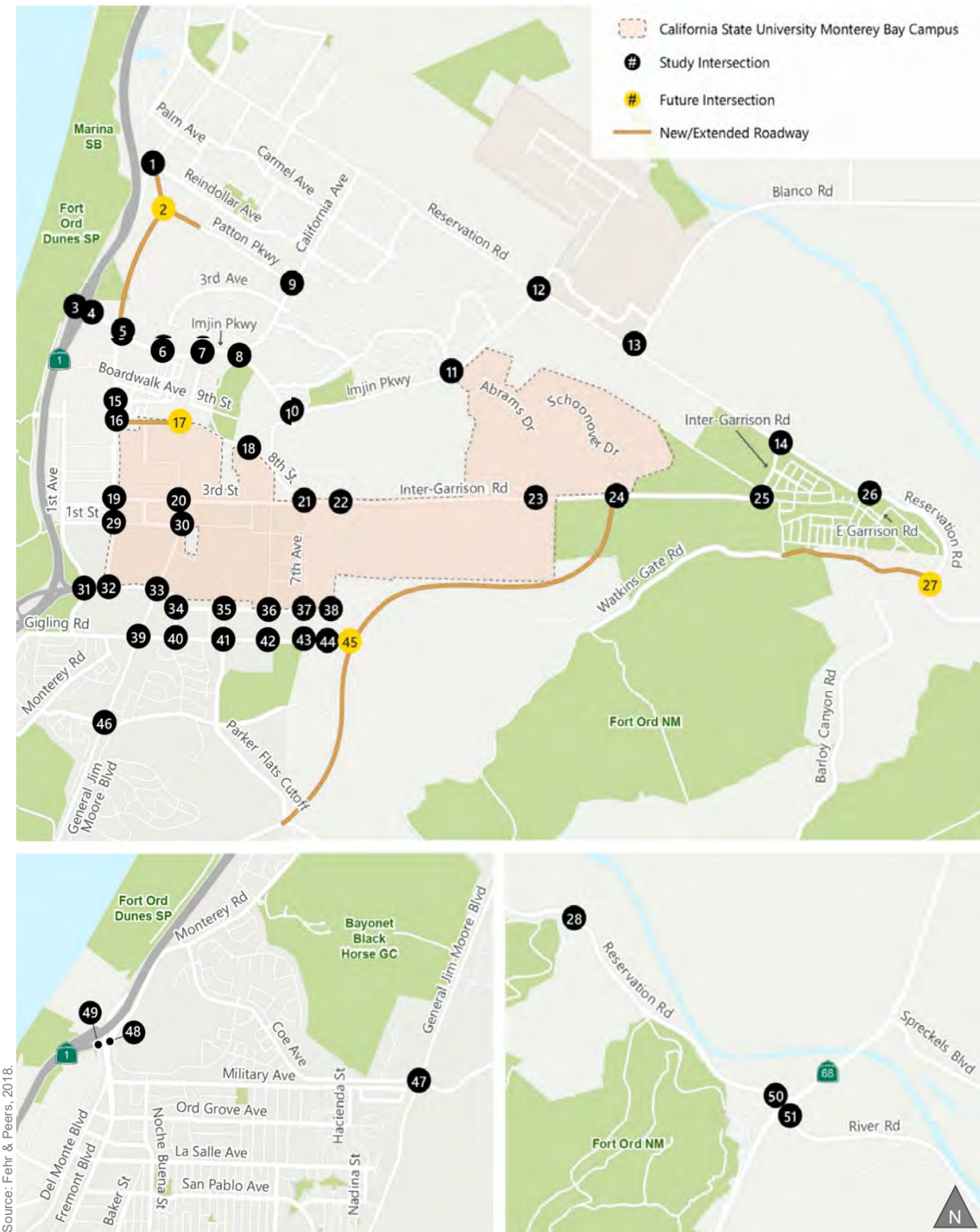

Figure K-4b  
Study Intersection Peak Hour Traffic Volumes and Lane Configurations  
Cumulative without Project and with Eastside Parkway Conditions



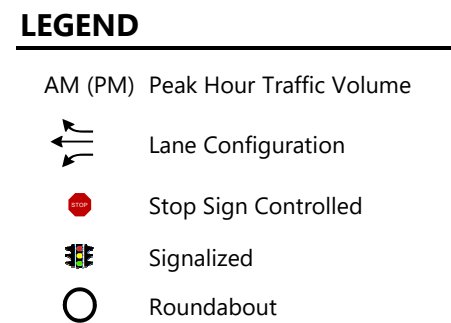
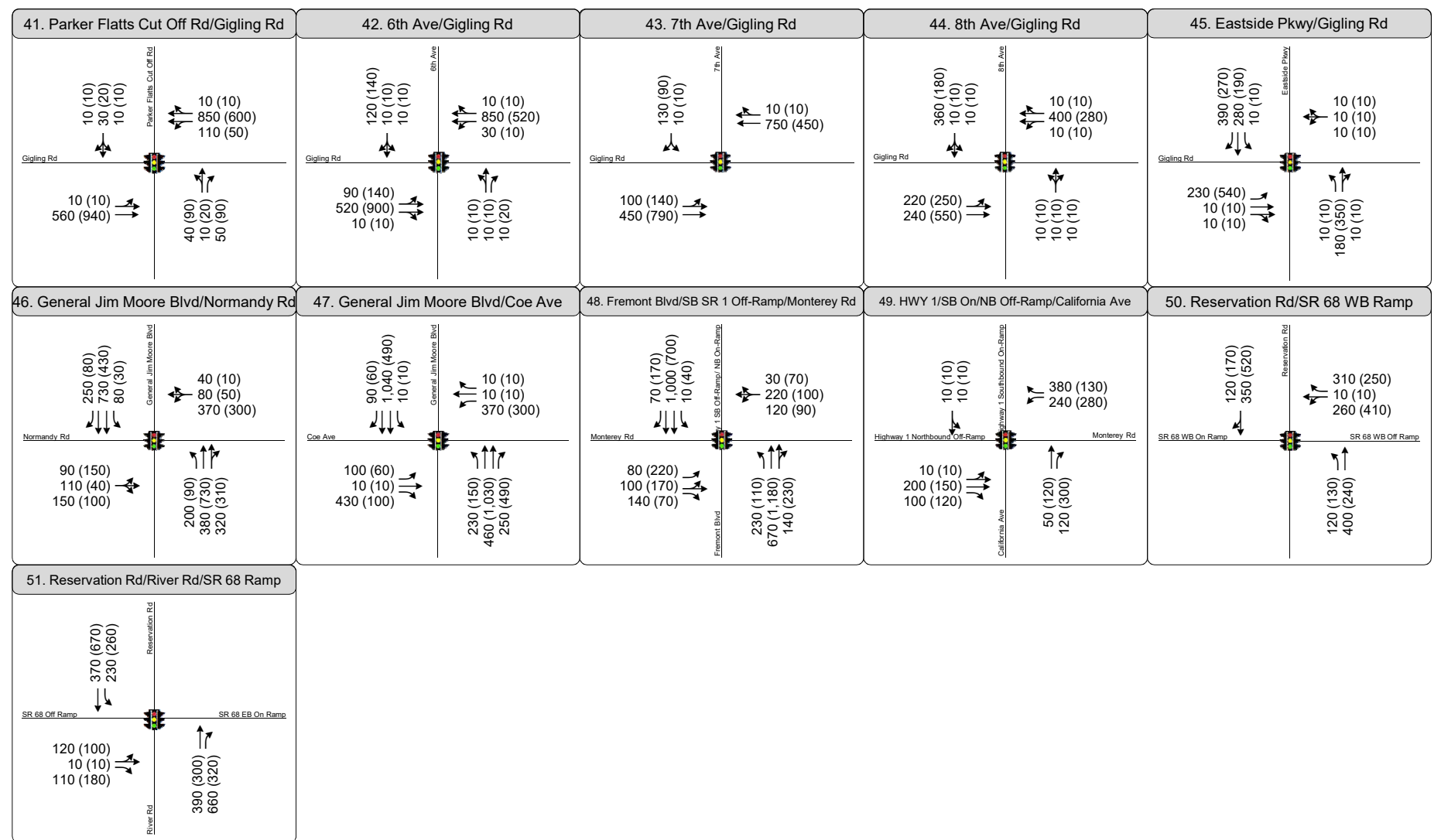
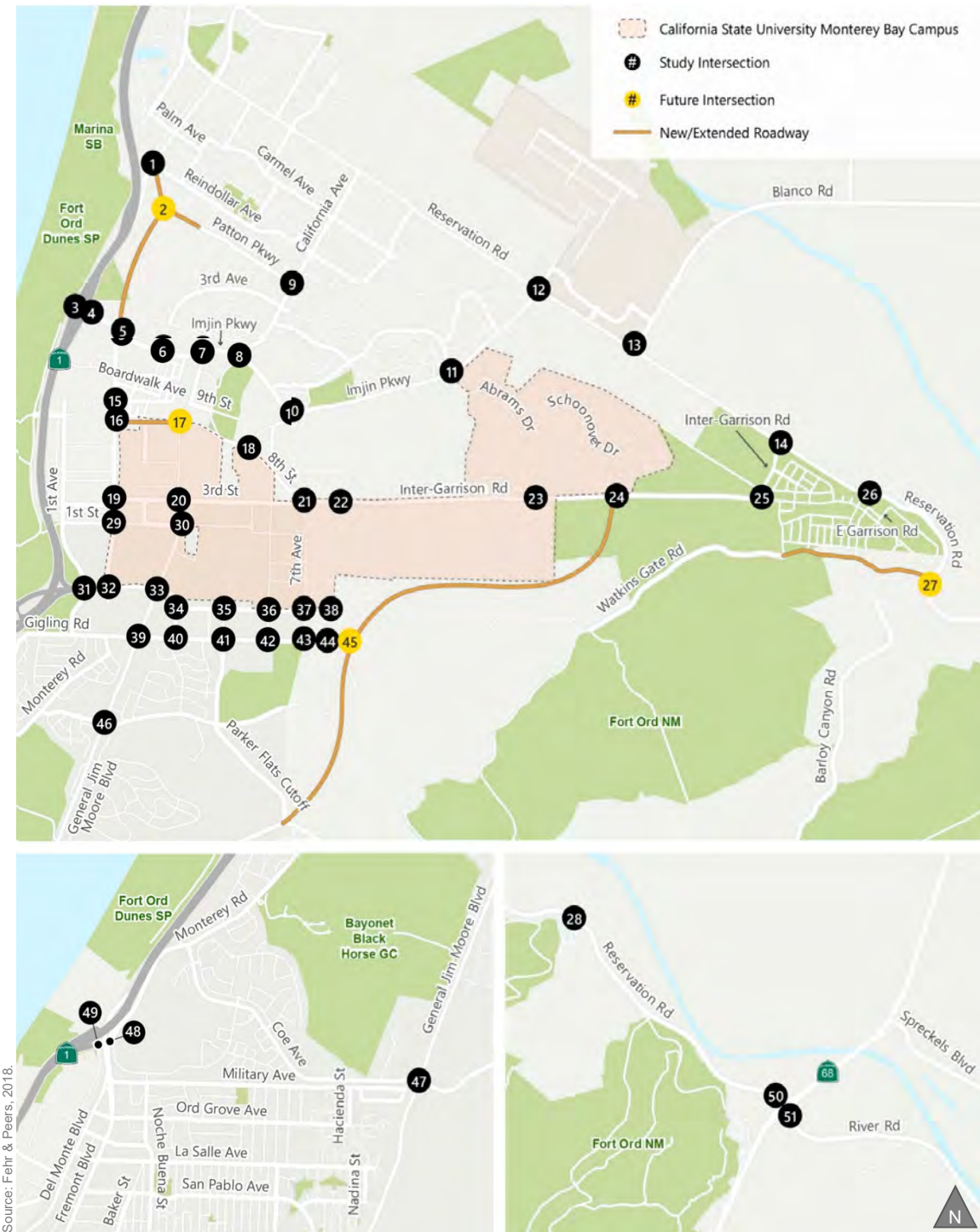
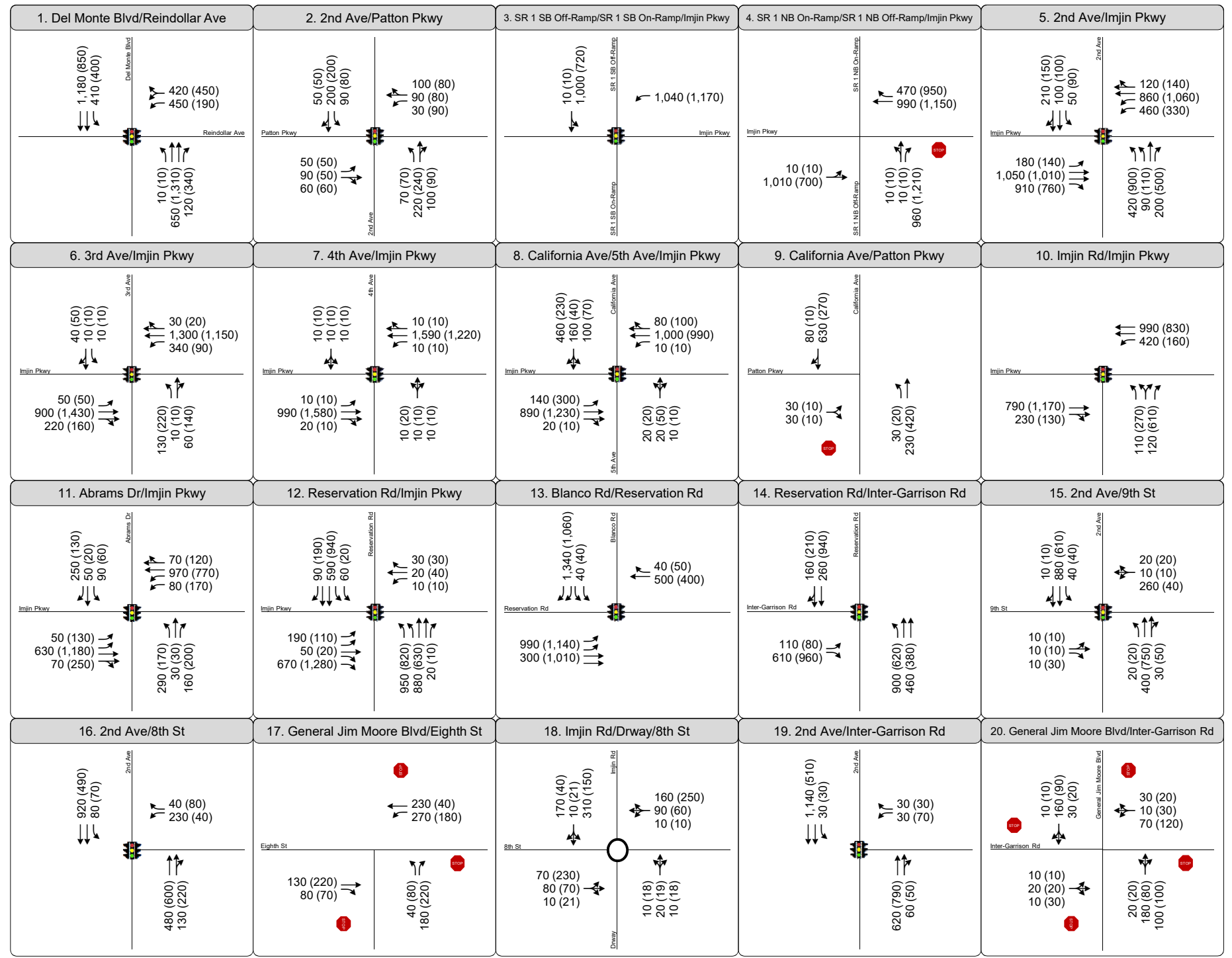
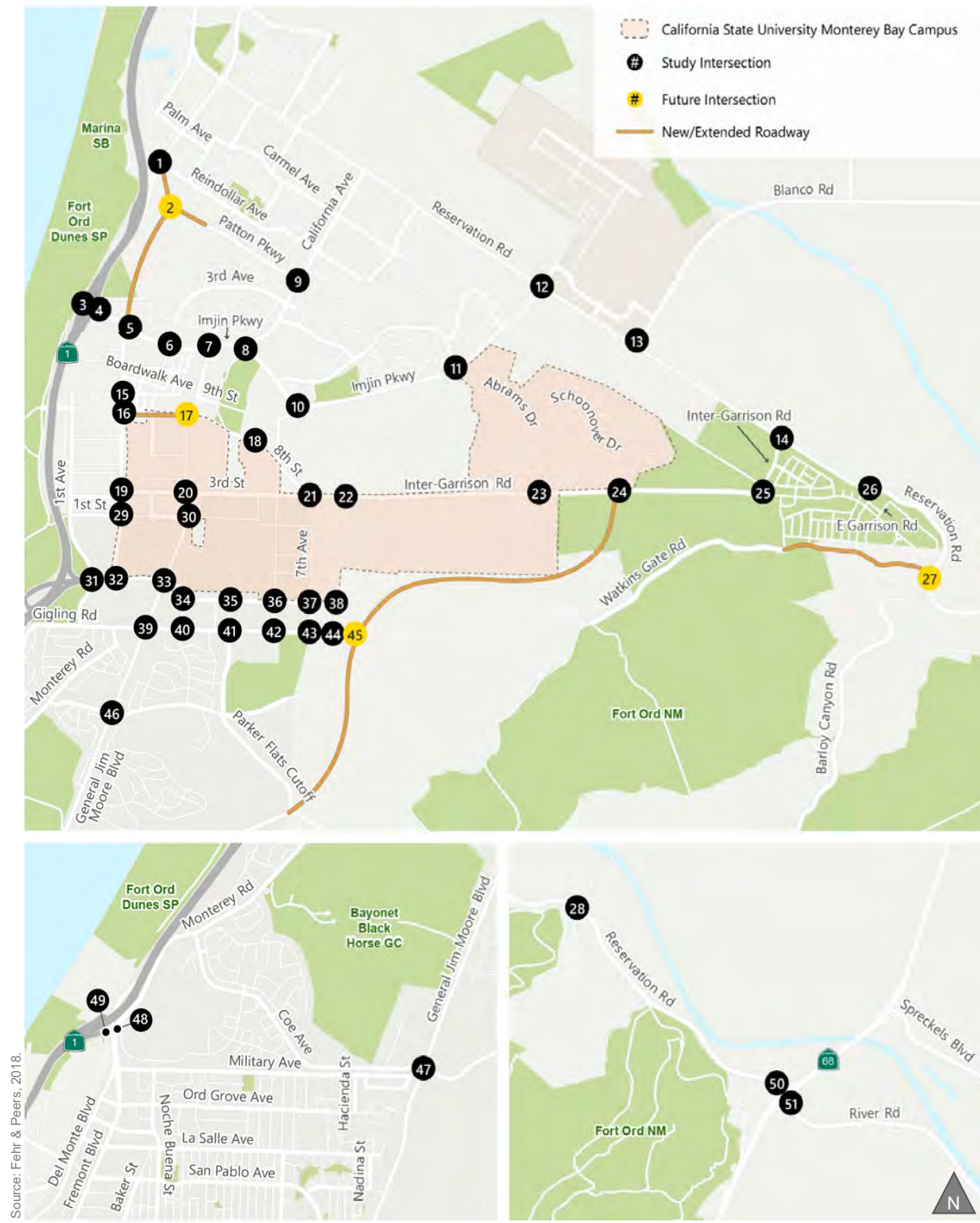

Figure K-4c  
Study Intersection Peak Hour Traffic Volumes and Lane Configurations  
Cumulative without Project and with Eastside Parkway Conditions





- LEGEND**
- AM (PM) Peak Hour Traffic Volume
  - Lane Configuration
  - Stop Sign Controlled
  - Signalized
  - Roundabout

Figure K-5a  
Study Intersection Peak Hour Traffic Volumes and Lane Configurations  
Cumulative with Project and with Eastside Parkway Conditions



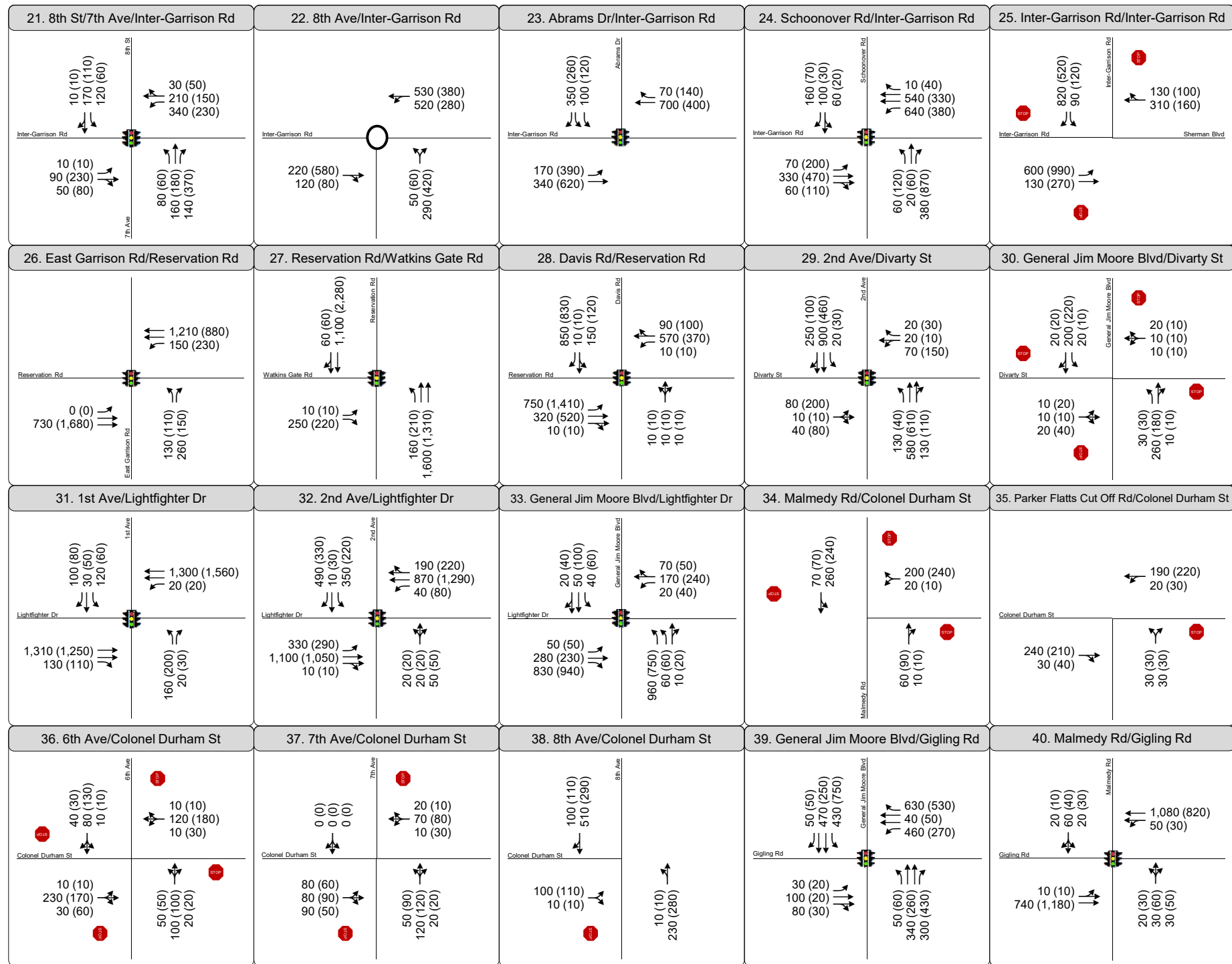
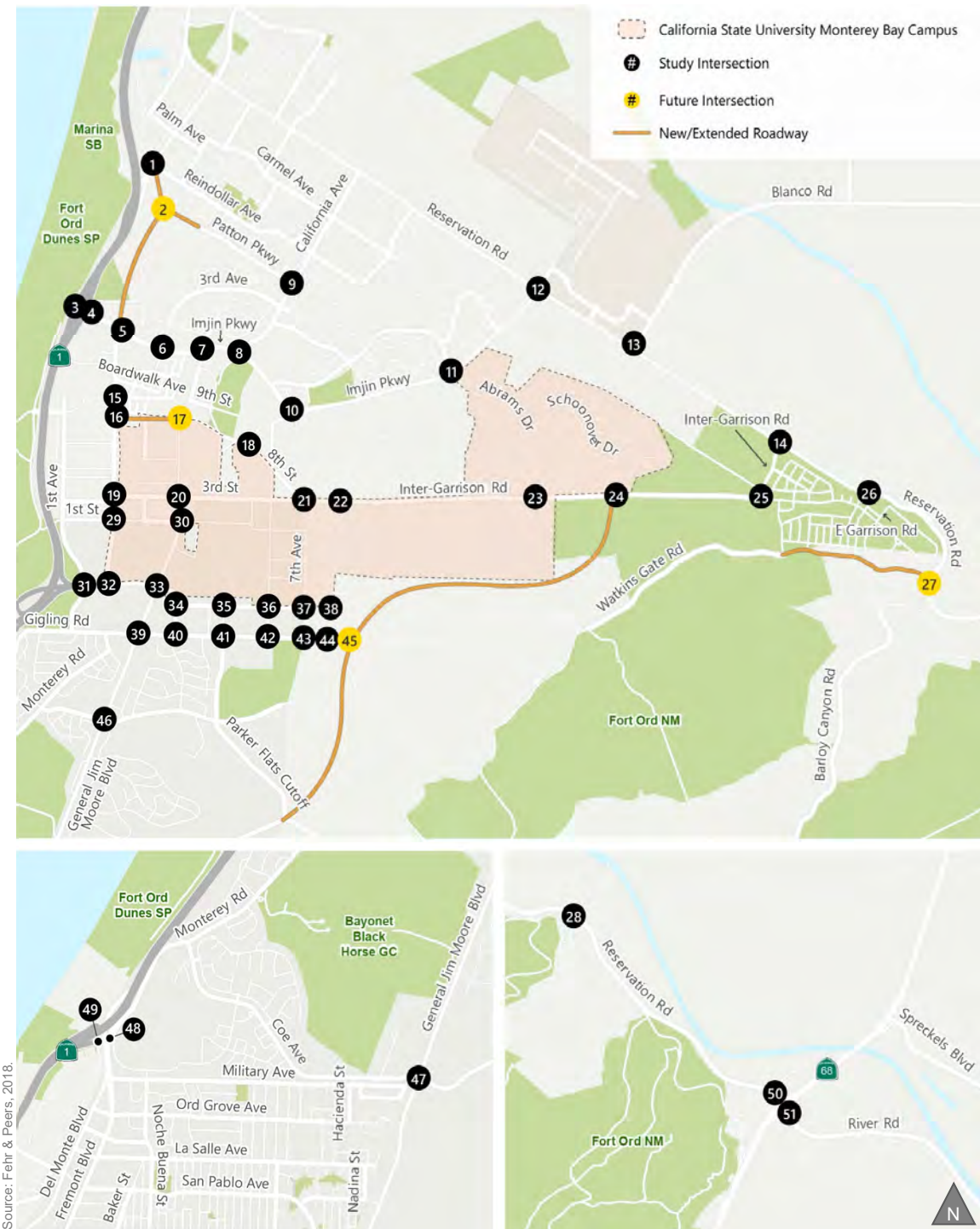

**LEGEND**

- AM (PM) Peak Hour Traffic Volume
- Lane Configuration
- Stop Sign Controlled
- Signalized
- Roundabout

Figure K-5b  
 Study Intersection Peak Hour Traffic Volumes and Lane Configurations  
 Cumulative with Project and with Eastside Parkway Conditions



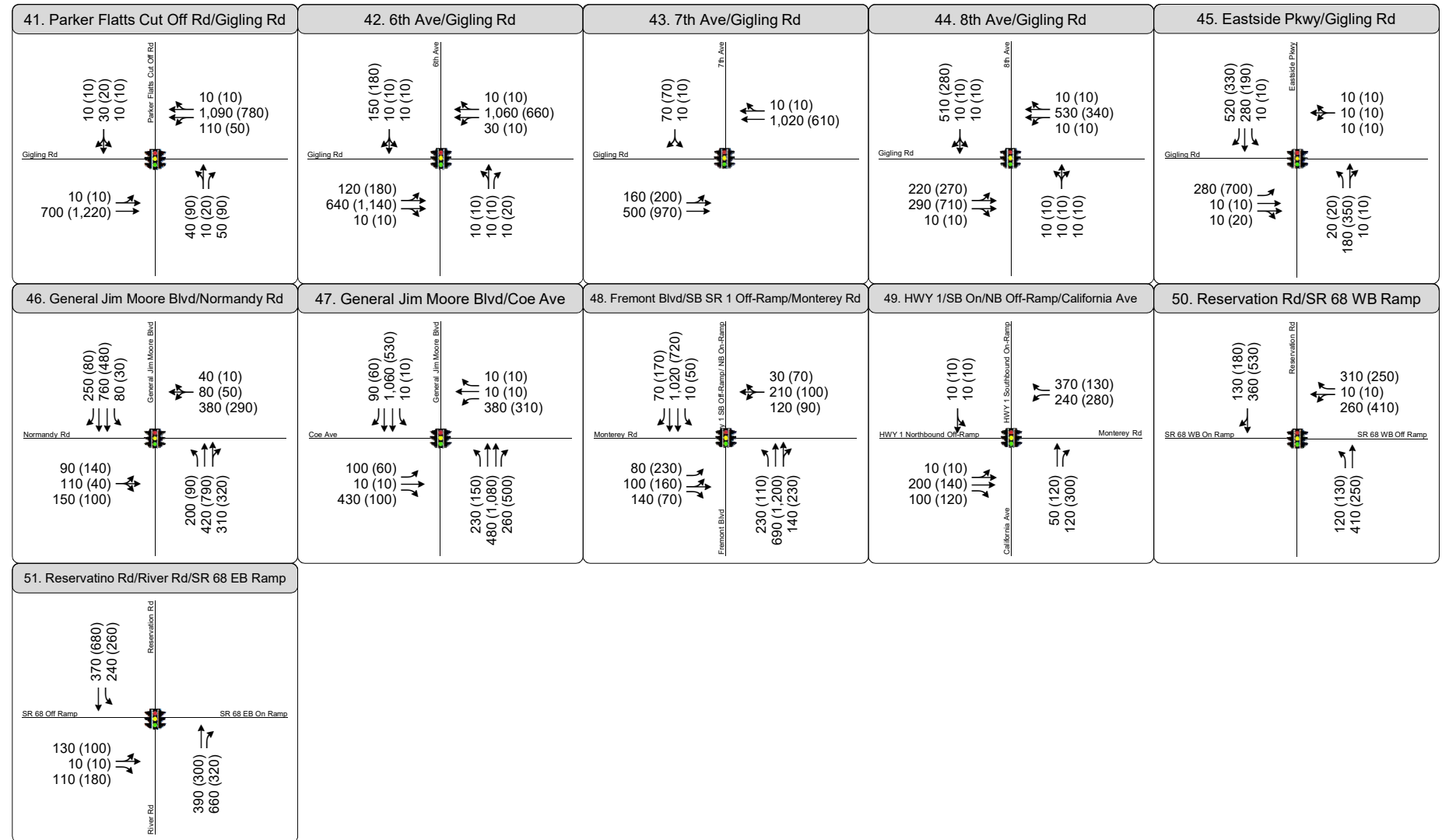
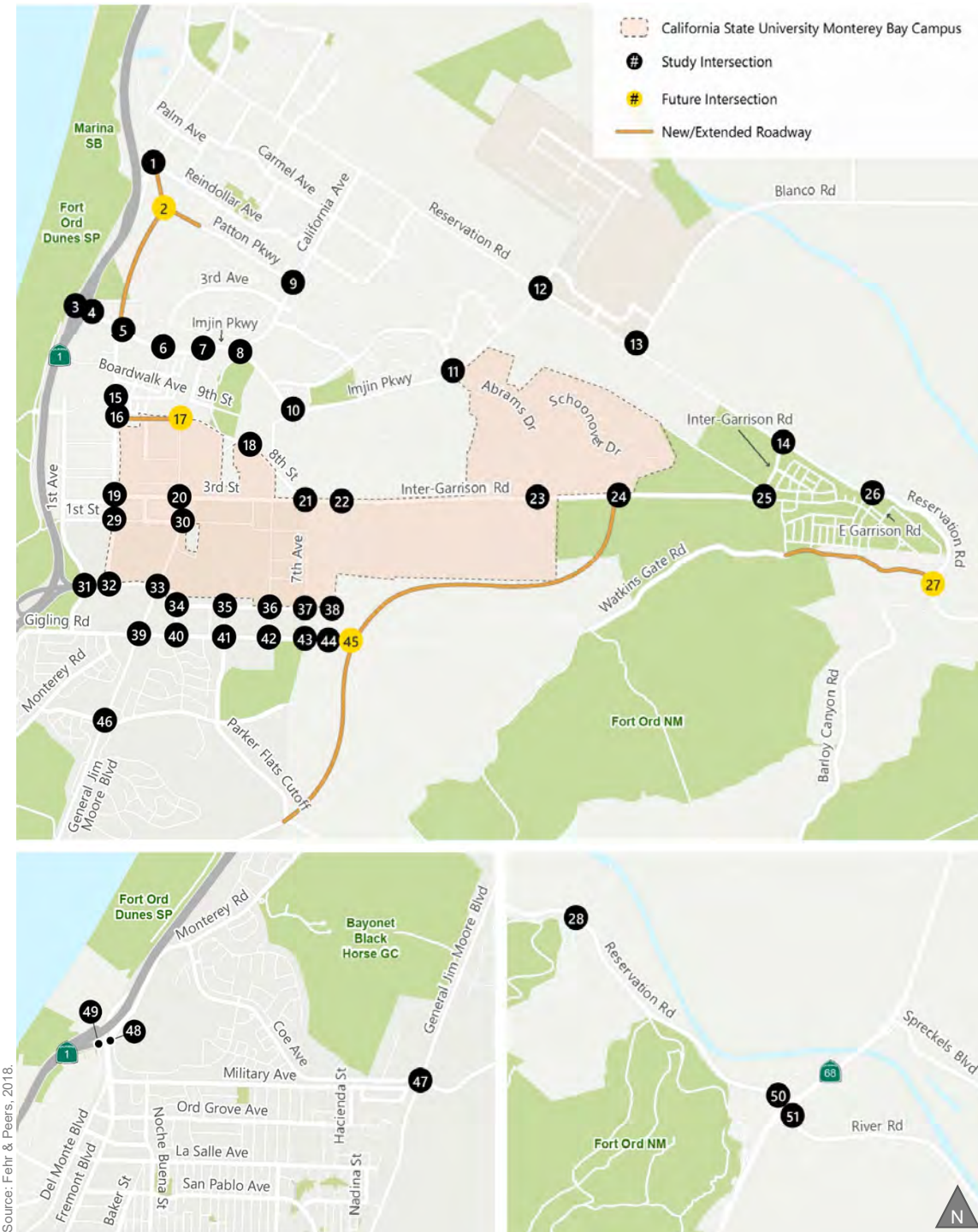

**LEGEND**

- AM (PM) Peak Hour Traffic Volume
- Lane Configuration
- Stop Sign Controlled
- Signalized
- Roundabout

Figure K-5c  
Study Intersection Peak Hour Traffic Volumes and Lane Configurations  
Cumulative with Project and with Eastside Parkway Conditions

**APPENDIX L: INTERSECTION LEVEL OF SERVICE TABLES**



## EXISTING INTERSECTION LEVELS OF SERVICE

**TABLE L-1: EXISTING INTERSECTION LEVEL OF SERVICE**

| #  | Intersection                               | Count Date | Intersection Control <sup>1</sup> | Jurisdiction (LOS Standard) <sup>2</sup> | Peak Hour <sup>3</sup> | Delay <sup>4</sup>                            | LOS <sup>5</sup>                 |
|----|--|------------|-----------------------------------|--|------------------------|---|----------------------------------|
| 1  | Del Monte Boulevard and Reindollar Avenue  | 4/25/2018  | Signalized                        | M (D)                                    | AM<br>PM               | 11.6<br>8.9                                   | B<br>A                           |
| 2  | Second Avenue Extension and Patton Parkway | Future     | Signalized                        | M (D)                                    | AM<br>PM               | Future Intersection                           |                                  |
| 3  | SR 1 Southbound Ramps and Imjin Parkway    | 5/3/2017   | Signalized                        | M (D)                                    | AM<br>PM               | <b>36.6</b><br>17.2                           | <b>D</b><br>B                    |
| 4  | SR 1 Northbound Ramps and Imjin Parkway    | 5/3/2017   | SSS                               | M (D)                                    | AM<br>PM               | 0.0 (0.1)<br><b>0.2 (26.7)</b>                | A (A)<br><b>A (D)</b>            |
| 5  | Second Avenue and Imjin Parkway            | 4/27/2017  | Signalized                        | M (D)                                    | AM<br>PM               | 12.5<br>16.3                                  | B<br>B                           |
| 6  | Third Avenue and Imjin Parkway             | 4/27/2017  | SSS                               | M (D)                                    | AM<br>PM               | 3.7 ( <b>103.6</b> )<br>1.3 ( <b>43.2</b> )   | A ( <b>F</b> )<br>A ( <b>E</b> ) |
| 7  | Fourth Avenue and Imjin Parkway            | 5/3/2017   | SSS                               | M (D)                                    | AM<br>PM               | 0.4 ( <b>88.9</b> )<br>1.4 ( <b>&gt;120</b> ) | A ( <b>F</b> )<br>A ( <b>F</b> ) |
| 8  | California Avenue and Imjin Parkway        | 4/27/2017  | Signalized                        | M (D)                                    | AM<br>PM               | 20.2<br>10.0                                  | C<br>A                           |
| 9  | California Avenue and Patton Parkway       | 4/25/2018  | SSS                               | MC (D)                                   | AM<br>PM               | 1.4 (17.4)<br>0.4 (10.4)                      | A (C)<br>A (B)                   |
| 10 | Imjin Road and Imjin Parkway               | 4/27/2017  | Signalized                        | MC (D)                                   | AM<br>PM               | 7.4<br>7.6                                    | A<br>A                           |
| 11 | Abrams Drive and Imjin Parkway             | 4/27/2017  | Signalized                        | M (D)                                    | AM<br>PM               | 14.5<br>17.4                                  | B<br>B                           |
| 12 | Reservation Road and Imjin Parkway         | 4/27/2017  | Signalized                        | M (D)                                    | AM<br>PM               | 22.5<br>32.9                                  | C<br>C                           |
| 13 | Blanco Road and Reservation Road           | 4/25/2018  | Signalized                        | M /<br>CSUMB (D)                         | AM<br>PM               | 13.1<br>11.0                                  | B<br>B                           |
| 14 | Inter-Garrison Road and Reservation Road   | 4/27/2017  | Signalized                        | M (D)                                    | AM<br>PM               | 10.4<br>10.2                                  | B<br>B                           |
| 15 | Second Avenue and Ninth Street             | 4/27/2017  | AWSC                              | M (D)                                    | AM<br>PM               | 21.9<br>11.4                                  | C<br>B                           |
| 16 | Second Avenue and Eighth Street            | 4/27/2017  | AWSC                              | M/ CSUMB<br>(D)                          | AM<br>PM               | <b>56.3</b><br>12.8                           | <b>F</b><br>B                    |
| 17 | Fourth Avenue and Eighth Street            | Future     | AWSC                              | MC / M /<br>CSUMB (D)                    | AM<br>PM               | Project Intersection                          |                                  |
| 18 | Imjin Road and Eighth Street               | 4/27/2017  | AWSC                              | CSUMB (D)                                | AM<br>PM               | 17.9<br>9.3                                   | C<br>A                           |
| 19 | Second Avenue and Inter-Garrison Road      | 4/27/2017  | AWSC                              | MC /<br>CSUMB (D)                        | AM<br>PM               | 26.5<br>9.8                                   | D<br>A                           |

**TABLE L-1: EXISTING INTERSECTION LEVEL OF SERVICE**

| #  | Intersection   | Count Date | Intersection Control <sup>1</sup> | Jurisdiction (LOS Standard) <sup>2</sup> | Peak Hour <sup>3</sup> | Delay <sup>4</sup>       | LOS <sup>5</sup> |
|----|--|------------|-----------------------------------|--|------------------------|--------------------------|------------------|
| 20 | General Jim Moore Boulevard and Inter-Garrison Road    | 4/25/2018  | AWSC                              | MC (D)                                   | AM<br>PM               | 8.5<br>9.9               | A<br>A           |
| 21 | Eighth Street/Seventh Avenue and Inter-Garrison Road   | 4/25/2018  | AWSC                              | MC (D)                                   | AM<br>PM               | 12.9<br>8.9              | B<br>A           |
| 22 | Eighth Avenue and Inter-Garrison Road                  | 4/25/2018  | Roundabout                        | MC (D)                                   | AM<br>PM               | 32.1<br>8.6              | D<br>A           |
| 23 | Abrams Drive and Inter-Garrison Road                   | 4/27/2017  | AWSC                              | MC (D)                                   | AM<br>PM               | <b>60.3</b><br>12.8      | <b>F</b><br>B    |
| 24 | Schoonover Road and Inter-Garrison Road                | 4/27/2017  | AWSC                              | MC (D)                                   | AM<br>PM               | 20.8<br>11.1             | C<br>B           |
| 25 | Inter-Garrison Road Connection and Inter-Garrison Road | 4/27/2017  | AWSC                              | M /<br>CSUMB (D)                         | AM<br>PM               | 11.8<br>11.1             | B<br>B           |
| 26 | East Garrison Road and Reservation Road                | 4/25/2018  | Signalized                        | M /<br>CSUMB (D)                         | AM<br>PM               | 5.0<br>5.6               | A<br>A           |
| 27 | Reservation Road and Watkins Gate Road                 | Future     | Signalized                        | S (C)                                    | AM<br>PM               | Future Intersection      |                  |
| 28 | Davis Road and Reservation Road                        | 4/25/2018  | Signalized                        | S (C)                                    | AM<br>PM               | 18.2<br>15.9             | B<br>B           |
| 29 | Second Avenue and Divarty Street                       | 4/27/2017  | AWSC                              | S (C)                                    | AM<br>PM               | 31.1<br>9.4              | D<br>A           |
| 30 | General Jim Moore Boulevard and Divarty Street         | 4/27/2017  | AWSC                              | S (C)                                    | AM<br>PM               | 9.1<br>10.2              | A<br>B           |
| 31 | First Avenue and Lightfighter Drive                    | 4/27/2017  | Signalized                        | S (C)                                    | AM<br>PM               | 4.0<br>3.4               | A<br>A           |
| 32 | Second Avenue and Lightfighter Drive                   | 4/27/2017  | Signalized                        | S (C)                                    | AM<br>PM               | 18.3<br>14.2             | B<br>B           |
| 33 | General Jim Moore Boulevard and Lightfighter Drive     | 4/27/2017  | Signalized                        | S (C)                                    | AM<br>PM               | 20.0<br>22.6             | B<br>C           |
| 34 | Malmedy Road and Colonel Durham Street                 | 4/25/2018  | AWSC                              | MC (D)                                   | AM<br>PM               | 9.9<br>8.3               | A<br>A           |
| 35 | Parker Flatts Cut Off Road and Colonel Durham Street   | 4/25/2018  | SSS                               | S (C)                                    | AM<br>PM               | 0.4 (10.9)<br>1.1 (10.1) | A (B)<br>A (B)   |
| 36 | Sixth Avenue and Colonel Durham Street                 | 4/25/2018  | AWSC                              | S (C)                                    | AM<br>PM               | 8.9<br>7.8               | A<br>A           |
| 37 | Seventh Avenue and Colonel Durham Street               | 4/25/2018  | SSS                               | S (C)                                    | AM<br>PM               | 6.6 (12.3)<br>7.0 (10.5) | A (B)<br>A (B)   |
| 38 | Eighth Avenue and Colonel Durham Street                | 4/25/2018  | SSS                               | S (C)                                    | AM<br>PM               | 0.6 (14.5)<br>2.0 (13.9) | A (B)<br>A (B)   |
| 39 | General Jim Moore Boulevard and Gigling Road           | 4/27/2017  | Signalized                        | S (C)                                    | AM<br>PM               | 25.9<br>14.8             | C<br>B           |
| 40 | Malmedy Road and Gigling Road                          | 4/25/2018  | SSS                               | MC (D)                                   | AM<br>PM               | 3.7 (24.9)<br>2.0 (18.0) | A (C)<br>A (C)   |

**TABLE L-1: EXISTING INTERSECTION LEVEL OF SERVICE**

| #  | Intersection   | Count Date | Intersection Control <sup>1</sup> | Jurisdiction (LOS Standard) <sup>2</sup> | Peak Hour <sup>3</sup> | Delay <sup>4</sup>         | LOS <sup>5</sup>     |
|----|--|------------|-----------------------------------|--|------------------------|----------------------------|----------------------|
| 41 | Parker Flatts Cut Off Road and Gigling Road                    | 4/25/2018  | SSS                               | MC (D)                                   | AM<br>PM               | 2.0 (23.6)<br>2.8 (17.6)   | A (C)<br>A (C)       |
| 42 | Sixth Avenue and Gigling Road                                  | 4/25/2018  | AWSC                              | S (C)                                    | AM<br>PM               | 13.3<br>10.2               | B<br>B               |
| 43 | Seventh Avenue and Gigling Road                                | 4/25/2018  | SSS                               | S (C)                                    | AM<br>PM               | 2.1 (12.7)<br>0.9 (9.0)    | A (B)<br>A (A)       |
| 44 | Eighth Avenue and Gigling Road                                 | 4/25/2018  | AWSC                              | Cal / Sand City (C)                      | AM<br>PM               | 9.9<br>10.3                | A<br>B               |
| 45 | Eastside Parkway and Gigling Road                              | Future     | AWSC                              | Cal / S (C)                              | AM<br>PM               | Future Intersection        |                      |
| 46 | General Jim Moore Boulevard and Normandy Road                  | 4/25/2018  | Signalized                        | Cal / MC (C)                             | AM<br>PM               | 22.0<br>9.9                | C<br>A               |
| 47 | General Jim Moore Boulevard and Coe Avenue                     | 4/25/2018  | AWSC                              | Cal / MC (C)                             | AM<br>PM               | <b>92.2</b><br>18.4        | <b>F</b><br>C        |
| 48 | Fremont Boulevard - Southbound SR 1 Off-Ramp and Monterey Road | 4/25/2018  | Signalized                        | M (D)                                    | AM<br>PM               | <b>65.8</b><br><b>50.5</b> | <b>E</b><br><b>D</b> |
| 49 | California Avenue and Monterey Road - Northbound SR 1 Off-Ramp | 4/25/2018  | Signalized                        | M (D)                                    | AM<br>PM               | 12.1<br>24.5               | B<br>C               |
| 50 | Reservation Road and State Route 68 Westbound Ramps            | 4/25/2018  | Signalized                        | M (D)                                    | AM<br>PM               | 13.6<br>33.0               | B<br>C               |
| 51 | Reservation Road and State Route 68 Eastbound Ramps            | 4/25/2018  | Signalized                        | M (D)                                    | AM<br>PM               | 11.4<br>12.2               | B<br>B               |

Notes: **Bold text** indicates intersection operates at unacceptable level of service.

1. SSS = Side Street Stop Controlled, AWSC = All Way Stop Controlled, Signalized = Signalized intersection
2. Intersection jurisdiction and associated LOS threshold applied.
  - i. City of Marina = M
  - ii. City of Seaside = S
  - iii. California State University Monterey Bay = CSUMB
  - iv. Monterey County = MC
  - v. Caltrans = Cal
3. AM = morning peak hour, PM = evening peak hour.
4. Whole intersection weighted average control delay expressed in seconds per vehicle calculated using methods described in the 2010 *Highway Capacity Manual* for signalized intersections and all-way stop-controlled intersections. For side-street stop-controlled intersections, average control delay and total delay for the worst movement are reported as "average control delay (worst movement total delay)."
5. LOS = Level of Service. LOS calculations conducted using the Synchro 10 analysis software packages, which apply the methods described in the 2010 *Highway Capacity Manual*. For side-street stop-controlled intersections, average control LOS and total LOS for the worst movement are reported as "average control LOS (worst movement total LOS)."

Source: Fehr & Peers, June 2019.

## EXISTING WITH PROJECT INTERSECTION LEVELS OF SERVICE

The results of the LOS calculations indicate many of the study intersections will operate at levels of service meeting the applicable local jurisdiction’s LOS threshold under Existing with Project Conditions.

Intersections that exceed the applicable LOS thresholds are:

- Int 3. SR 1 Southbound Ramps and Imjin Parkway (AM peak hour)
- Int 4. SR 1 Northbound Ramps and Imjin Parkway (AM and PM peak hour)
- Int 6. Third Avenue and Imjin Parkway (AM peak hour)
- Int 7. Fourth Avenue and Imjin Parkway (AM and PM peak hour)
- Int 15. Second Avenue and Ninth Street (AM peak hour)
- Int 16. Second Avenue and Eighth Street (AM peak hour)
- Int 18. Imjin Road and Eighth Street (AM peak hour)
- Int 19. Second Avenue and Inter-Garrison Road (AM peak hour)
- Int 21. Eighth Street/Seventh Avenue and Inter-Garrison Road (AM and PM peak hour)
- Int 22. Eighth Avenue and Inter-Garrison Road (AM and PM peak hour)
- Int 23. Abrams Drive and Inter-Garrison Road (AM and PM peak hour)
- Int 24. Schoonover Road and Inter-Garrison Road (AM peak hour)
- Int 29. Second Avenue and Divarty Street (AM and PM peak hour)
- Int 40. Malmedy Road and Gigling Road (AM and PM peak hour)
- Int 41. Parker Flatts Cut Off Road and Gigling Road (AM and PM peak hour)
- Int 42. Sixth Avenue and Gigling Road (AM and PM peak hour)
- Int 44. Eighth Avenue and Gigling Road (AM peak hour)
- Int 47. General Jim Moore Boulevard and Coe Avenue (AM peak hour)
- Int 48. Fremont Boulevard - Southbound SR 1 Off-Ramp and Monterey Road (AM peak hour)

**TABLE L-2: EXISTING INTERSECTION LEVEL OF SERVICE WITH AND WITHOUT PROJECT**

| # | Intersection                               | Intersect-<br>ion<br>Control <sup>1</sup> | Jurisdiction<br>(LOS<br>Standard) <sup>2</sup> | Peak<br>Hour <sup>3</sup> | Existing                         |                         | Existing with Project                      |                                  |
|---|--|---|--|---------------------------|----------------------------------|-------------------------|--|----------------------------------|
|   |  |   |  |                           | Delay <sup>4</sup>               | LOS <sup>5</sup>        | Delay <sup>4</sup>                         | LOS <sup>5</sup>                 |
| 1 | Del Monte Boulevard and Reindollar Avenue  | Signalized                                | M (D)  | AM<br>PM                  | 11.6<br>8.9                      | B<br>A                  | 11.9<br>9.0                                | B<br>A                           |
| 2 | Second Avenue Extension and Patton Parkway | Signalized                                | M (D)  | AM<br>PM                  |                                  | Future Intersection     |  |                                  |
| 3 | SR 1 Southbound Ramps and Imjin Parkway    | Signalized                                | M (D)  | AM<br>PM                  | <b>36.6</b><br>17.2              | <b>D</b><br>B           | <b>61.3</b><br>19.6                        | <b>E</b><br>B                    |
| 4 | SR 1 Northbound Ramps and Imjin Parkway    | SSS                                       | M (D)  | AM<br>PM                  | 0.0 (0.1)<br>0.2 ( <b>26.7</b> ) | A (A)<br>A ( <b>D</b> ) | 0.6 ( <b>37.0</b> )<br>0.5 ( <b>29.3</b> ) | A ( <b>E</b> )<br>A ( <b>D</b> ) |
| 5 | Second Avenue and Imjin Parkway            | Signalized                                | M (D)  | AM<br>PM                  | 12.5<br>16.3                     | B<br>B                  | 13.0<br>17.3                               | B<br>B                           |



**TABLE L-2: EXISTING INTERSECTION LEVEL OF SERVICE WITH AND WITHOUT PROJECT**

| #  | Intersection   | Intersect-<br>ion<br>Control <sup>1</sup> | Jurisdiction<br>(LOS<br>Standard) <sup>2</sup> | Peak<br>Hour <sup>3</sup> | Existing                                |                              | Existing with Project                      |                              |
|----|--|---|--|---------------------------|---|------------------------------|--|------------------------------|
|    |  |   |  |                           | Delay <sup>4</sup>                      | LOS <sup>5</sup>             | Delay <sup>4</sup>                         | LOS <sup>5</sup>             |
| 6  | Third Avenue and Imjin Parkway                         | SSS                                       | M (D)  | AM<br>PM                  | 3.7 <b>(103.6)</b><br>1.3 <b>(43.2)</b> | A <b>(F)</b><br>A <b>(E)</b> | 1.4 (2)<br>7.1 (>120)                      | A (A)<br>A (F)               |
| 7  | Fourth Avenue and Imjin Parkway                        | SSS                                       | M (D)  | AM<br>PM                  | 0.4 <b>(88.9)</b><br>1.4 (>120)         | A <b>(F)</b><br>A <b>(F)</b> | 17.3<br>(>120)<br>13.1<br>(>120)           | C <b>(F)</b><br>B <b>(F)</b> |
| 8  | California Avenue and Imjin Parkway                    | Signalized                                | M (D)  | AM<br>PM                  | 20.2<br>10.0                            | C<br>A                       | 26.1<br>11.5                               | C<br>B                       |
| 9  | California Avenue and Patton Parkway                   | SSS                                       | MC (D)   | AM<br>PM                  | 1.4 (17.4)<br>0.4 (10.4)                | A (C)<br>A (B)               | 1.4 (18.6)<br>0.6 (12.5)                   | A (C)<br>A (B)               |
| 10 | Imjin Road and Imjin Parkway                           | Signalized                                | MC (D)   | AM<br>PM                  | 7.4<br>7.6                              | A<br>A                       | 12.1<br>12.7                               | B<br>B                       |
| 11 | Abrams Drive and Imjin Parkway                         | Signalized                                | M (D)  | AM<br>PM                  | 14.5<br>17.4                            | B<br>B                       | 33.6<br>28.1                               | C<br>C                       |
| 12 | Reservation Road and Imjin Parkway                     | Signalized                                | M (D)  | AM<br>PM                  | 22.5<br>32.9                            | C<br>C                       | 22.5<br>40.1                               | C<br>D                       |
| 13 | Blanco Road and Reservation Road                       | Signalized                                | M / CSUMB<br>(D)                               | AM<br>PM                  | 13.1<br>11.0                            | B<br>B                       | 13.1<br>11.0                               | B<br>B                       |
| 14 | Inter-Garrison Road and Reservation Road               | Signalized                                | M (D)  | AM<br>PM                  | 10.4<br>10.2                            | B<br>B                       | 14.6<br>13.8                               | B<br>B                       |
| 15 | Second Avenue and Ninth Street                         | AWSC                                      | M (D)  | AM<br>PM                  | 21.9<br>11.4                            | C<br>B                       | <b>39.4</b><br>14.3                        | <b>E</b><br>B                |
| 16 | Second Avenue and Eighth Street                        | AWSC                                      | M/ CSUMB<br>(D)                                | AM<br>PM                  | <b>56.3</b><br>12.8                     | <b>F</b><br>B                | <b>&gt;120</b><br>23.3                     | <b>F</b><br>C                |
| 17 | Fourth Avenue and Eighth Street                        | AWSC                                      | MC / M /<br>CSUMB (D)                          | AM<br>PM                  | Project Intersection                    |                              | 12.5<br>12.3                               | B<br>B                       |
| 18 | Imjin Road and Eighth Street                           | AWSC                                      | CSUMB (D)                                      | AM<br>PM                  | 17.9<br>9.3                             | C<br>A                       | <b>374.3</b><br>21.6                       | <b>ED</b><br>C               |
| 19 | Second Avenue and Inter-Garrison Road                  | AWSC                                      | MC /<br>CSUMB (D)                              | AM<br>PM                  | 26.5<br>9.8                             | D<br>A                       | <b>&gt;120</b><br>22.3                     | <b>F</b><br>C                |
| 20 | General Jim Moore Boulevard and Inter-Garrison Road    | AWSC                                      | MC (D)   | AM<br>PM                  | 8.5<br>9.9                              | A<br>A                       | 8.9<br>7.9                                 | A<br>A                       |
| 21 | Eighth Street/Seventh Avenue and Inter-Garrison Road   | AWSC                                      | MC (D)   | AM<br>PM                  | 12.9<br>8.9                             | B<br>A                       | <b>98.4</b><br><b>51.6</b><br><b>114.3</b> | <b>F</b><br><b>F</b>         |
| 22 | Eighth Avenue and Inter-Garrison Road                  | Round-about                               | MC (D)   | AM<br>PM                  | 32.1<br>8.6                             | D<br>A                       | <b>114.3</b><br><b>51.6</b><br><b>25.9</b> | <b>F</b><br><b>D</b>         |
| 23 | Abrams Drive and Inter-Garrison Road                   | AWSC                                      | MC (D)   | AM<br>PM                  | <b>60.3</b><br>12.8                     | <b>F</b><br>B                | <b>&gt;120</b><br><b>78.8</b>              | <b>F</b><br><b>F</b>         |
| 24 | Schoonover Road and Inter-Garrison Road                | AWSC                                      | MC (D)   | AM<br>PM                  | 20.8<br>11.1                            | C<br>B                       | <b>79.1</b><br>13.9                        | <b>F</b><br>B                |
| 25 | Inter-Garrison Road Connection and Inter-Garrison Road | AWSC                                      | M / CSUMB<br>(D)                               | AM<br>PM                  | 11.8<br>11.1                            | B<br>B                       | 27.0<br>13.7                               | D<br>B                       |

**TABLE L-2: EXISTING INTERSECTION LEVEL OF SERVICE WITH AND WITHOUT PROJECT**

| #  | Intersection   | Intersect-<br>ion<br>Control <sup>1</sup> | Jurisdiction<br>(LOS<br>Standard) <sup>2</sup> | Peak<br>Hour <sup>3</sup> | Existing                 |                  | Existing with Project    |                  |
|----|--|---|--|---------------------------|--------------------------|------------------|--------------------------|------------------|
|    |  |   |  |                           | Delay <sup>4</sup>       | LOS <sup>5</sup> | Delay <sup>4</sup>       | LOS <sup>5</sup> |
| 26 | East Garrison Road and Reservation Road              | Signalized                                | M / CSUMB (D)                                  | AM<br>PM                  | 5.0<br>5.6               | A<br>A           | 5.2<br>4.9               | A<br>A           |
| 27 | Reservation Road and Watkins Gate Road               | Signalized                                | S (C)  | AM<br>PM                  | Future Intersection      |                  |                          |                  |
| 28 | Davis Road and Reservation Road                      | Signalized                                | S (C)  | AM<br>PM                  | 18.2<br>15.9             | B<br>B           | 30.7<br>23.4             | C<br>C           |
| 29 | Second Avenue and Divarty Street                     | AWSC                                      | S (C)  | AM<br>PM                  | 31.1<br>9.4              | D<br>A           | >120<br>50.9             | F<br>F           |
| 30 | General Jim Moore Boulevard and Divarty Street       | AWSC                                      | S (C)  | AM<br>PM                  | 9.1<br>10.2              | A<br>B           | 8.8<br>8.0               | A<br>A           |
| 31 | First Avenue and Lightfighter Drive                  | Signalized                                | S (C)  | AM<br>PM                  | 4.0<br>3.4               | A<br>A           | 4.1<br>3.8               | A<br>A           |
| 32 | Second Avenue and Lightfighter Drive                 | Signalized                                | S (C)  | AM<br>PM                  | 18.3<br>14.2             | B<br>B           | 18.4<br>14.6             | B<br>B           |
| 33 | General Jim Moore Boulevard and Lightfighter Drive   | Signalized                                | S (C)  | AM<br>PM                  | 20.0<br>22.6             | B<br>C           | 17.8<br>15.7             | B<br>B           |
| 34 | Malmedy Road and Colonel Durham Street               | AWSC                                      | MC (D)   | AM<br>PM                  | 9.9<br>8.3               | A<br>A           | 8.7<br>8.2               | A<br>A           |
| 35 | Parker Flatts Cut Off Road and Colonel Durham Street | SSS                                       | S (C)  | AM<br>PM                  | 0.4 (10.9)<br>1.1 (10.1) | A (B)<br>A (B)   | 1.1 (9.9)<br>1.3 (10)    | A (A)<br>A (A)   |
| 36 | Sixth Avenue and Colonel Durham Street               | AWSC                                      | S (C)  | AM<br>PM                  | 8.9<br>7.8               | A<br>A           | 9.9<br>10.6              | A<br>B           |
| 37 | Seventh Avenue and Colonel Durham Street             | SSS                                       | S (C)  | AM<br>PM                  | 6.6 (12.3)<br>7.0 (10.5) | A (B)<br>A (B)   | 6.9 (11)<br>6.5 (13.9)   | A (B)<br>A (B)   |
| 38 | Eighth Avenue and Colonel Durham Street              | SSS                                       | S (C)  | AM<br>PM                  | 0.6 (14.5)<br>2.0 (13.9) | A (B)<br>A (B)   | 1.3 (21.6)<br>1.6 (17.5) | A (C)<br>A (C)   |
| 39 | General Jim Moore Boulevard and Gigling Road         | Signalized                                | S (C)  | AM<br>PM                  | 25.9<br>14.8             | C<br>B           | 32.8<br>16.4             | C<br>B           |
| 40 | Malmedy Road and Gigling Road                        | SSS                                       | MC (D)   | AM<br>PM                  | 3.7 (24.9)<br>2.0 (18.0) | A (C)<br>A (C)   | 5.4 (91.7)<br>5.1 (51)   | A (F)<br>A (F)   |
| 41 | Parker Flatts Cut Off Road and Gigling Road          | SSS                                       | MC (D)   | AM<br>PM                  | 2.0 (23.6)<br>2.8 (17.6) | A (C)<br>A (C)   | 8.9 (>120)<br>9.1 (78.5) | A (F)<br>A (F)   |
| 42 | Sixth Avenue and Gigling Road                        | AWSC                                      | S (C)  | AM<br>PM                  | 13.3<br>10.2             | B<br>B           | 86.8<br>55.1             | F<br>F           |
| 43 | Seventh Avenue and Gigling Road                      | SSS                                       | S (C)  | AM<br>PM                  | 2.1 (12.7)<br>0.9 (9.0)  | A (B)<br>A (A)   | 1.5 (22.7)<br>1.9 (17.2) | A (C)<br>A (C)   |
| 44 | Eighth Avenue and Gigling Road                       | AWSC                                      | Cal / Sand City (C)                            | AM<br>PM                  | 9.9<br>10.3              | A<br>B           | 32.8<br>13.6             | D<br>B           |
| 45 | Eastside Parkway and Gigling Road                    | AWSC                                      | Cal / S (C)                                    | AM<br>PM                  | Future Intersection      |                  |                          |                  |
| 46 | General Jim Moore Boulevard and Normandy Road        | Signalized                                | Cal / MC (C)                                   | AM<br>PM                  | 22.0<br>9.9              | C<br>A           | 25.1<br>10.1             | C<br>B           |

**TABLE L-2: EXISTING INTERSECTION LEVEL OF SERVICE WITH AND WITHOUT PROJECT**

| #  | Intersection   | Intersect-<br>ion<br>Control <sup>1</sup> | Jurisdiction<br>(LOS<br>Standard) <sup>2</sup> | Peak<br>Hour <sup>3</sup> | Existing            |                  | Existing with Project |                  |
|----|--|---|--|---------------------------|---------------------|------------------|-----------------------|------------------|
|    |  |   |  |                           | Delay <sup>4</sup>  | LOS <sup>5</sup> | Delay <sup>4</sup>    | LOS <sup>5</sup> |
| 47 | General Jim Moore Boulevard and Coe Avenue                     | AWSC                                      | Cal / MC (C)                                   | AM<br>PM                  | <b>92.2</b><br>18.4 | <b>F</b><br>C    | <b>103.2</b><br>23.0  | <b>F</b><br>C    |
| 48 | Fremont Boulevard - Southbound SR 1 Off-Ramp and Monterey Road | Signalized                                | M (D)  | AM<br>PM                  | <b>65.8</b><br>50.5 | <b>E</b><br>D    | <b>68.5</b><br>53.7   | <b>E</b><br>D    |
| 49 | California Avenue and Monterey Road - Northbound SR 1 Off-Ramp | Signalized                                | M (D)  | AM<br>PM                  | 12.1<br>24.5        | B<br>C           | 15.6<br>26.5          | B<br>C           |
| 50 | Reservation Road and State Route 68 Westbound Ramps            | Signalized                                | M (D)  | AM<br>PM                  | 13.6<br>33.0        | B<br>C           | 14.2<br>35.3          | B<br>D           |
| 51 | Reservation Road and State Route 68 Eastbound Ramps            | Signalized                                | M (D)  | AM<br>PM                  | 11.4<br>12.2        | B<br>B           | 11.9<br>12.8          | B<br>B           |

Notes: **Bold text** indicates intersection operates at unacceptable level of service. **Bold and highlighted text** indicates an intersection deficiency when the addition of Project traffic degrades the operations from acceptable level of service to unacceptable level of service; or when the addition of Project traffic further exacerbates unacceptable operations.

1. SSS = Side Street Stop Controlled, AWSC = All Way Stop Controlled, Signalized = Signalized intersection
2. Intersection jurisdiction and associated LOS threshold applied.
  - i. City of Marina = M
  - ii. City of Seaside = S
  - iii. California State University Monterey Bay = CSUMB
  - iv. Monterey County = MC
  - v. Caltrans = Cal
3. AM = morning peak hour, PM = evening peak hour.
4. Whole intersection weighted average control delay expressed in seconds per vehicle calculated using methods described in the 2010 *Highway Capacity Manual* for signalized intersections and all-way stop-controlled intersections. For side-street stop-controlled intersections, average control delay and total delay for the worst movement are reported as "average control delay (worst movement total delay)."
5. LOS = Level of Service. LOS calculations conducted using the Synchro 10 analysis software packages, which apply the methods described in the 2010 *Highway Capacity Manual*. For side-street stop-controlled intersections, average control LOS and total LOS for the worst movement are reported as "average control LOS (worst movement total LOS)."

Source: Fehr & Peers, June 2019.

## **CUMULATIVE WITHOUT AND WITH PROJECT AND WITHOUT EASTSIDE PARKWAY CONDITIONS INTERSECTION LEVELS OF SERVICE**

The results of the LOS calculations indicate many of the study intersections will operate at levels of service meeting the applicable local jurisdiction's LOS threshold under Cumulative with Project and without Eastside Parkway Conditions. Intersections that exceed the applicable LOS thresholds under Cumulative with Project and without Eastside Parkway Conditions are:

- Int 1. Del Monte Boulevard and Reindollar Avenue (PM peak hour)
- Int 3. SR 1 Southbound Ramps and Imjin Parkway (AM and PM peak hour)
- Int 4. SR 1 Northbound Ramps and Imjin Parkway (AM and PM peak hour)
- Int 5. Second Avenue and Imjin Parkway (AM and PM peak hour)
- Int 10. Imjin Road and Imjin Parkway (PM peak hour)
- Int 12. Reservation Road and Imjin Parkway (PM peak hour)
- Int 14. Inter-Garrison Road and Reservation Road (AM and PM peak hour)
- Int 17. Fourth Avenue and Eighth Street (AM peak hour)
- Int 21. Eighth Street/Seventh Avenue and Inter-Garrison Road (AM peak hour)
- Int 22. Eighth Avenue and Inter-Garrison Road (AM and PM peak hour)
- Int 23. Abrams Drive and Inter-Garrison Road (AM and PM peak hour)
- Int 24. Schoonover Road and Inter-Garrison Road (AM and PM peak hour)
- Int 25. Inter-Garrison Road Connection and Inter-Garrison Road (AM peak hour)
- Int 28. Davis Road and Reservation Road (AM and PM peak hour)
- Int 32. Second Avenue and Lightfighter Drive (AM and PM peak hour)
- Int 33. General Jim Moore Boulevard and Lightfighter Drive (AM peak hour)
- Int 37. Seventh Avenue and Colonel Durham Street (PM peak hour)
- Int 38. Eighth Avenue and Colonel Durham Street (AM and PM peak hour)
- Int 39. General Jim Moore Boulevard and Gigling Road (AM and PM peak hour)
- Int 46. General Jim Moore Boulevard and Normandy Road (AM peak hour)
- Int 47. General Jim Moore Boulevard and Coe Avenue (AM and PM peak hour)
- Int 48. Fremont Boulevard - Southbound SR 1 Off-Ramp and Monterey Road (AM and PM peak hour)
- Int 50. Reservation Road and State Route 68 Westbound Ramps (PM peak hour)

**TABLE L-3: CUMULATIVE INTERSECTION LEVEL OF SERVICE**

| #  | Intersection  | Intersect-<br>ion<br>Control <sup>1</sup> | Jurisdiction<br>(LOS<br>Standard) <sup>2</sup> | Peak<br>Hour <sup>3</sup> | Cumulative without<br>Project               |                  | Cumulative with<br>Project                 |                  |
|----|---|---|--|---------------------------|---|------------------|--|------------------|
|    |   |   |  |                           | Delay <sup>4</sup>                          | LOS <sup>5</sup> | Delay <sup>4</sup>                         | LOS <sup>5</sup> |
| 1  | Del Monte Boulevard and Reindollar Avenue           | Signalized                                | M (D)  | AM<br>PM                  | 33.8<br><b>69.1</b>                         | C<br>E           | 34.1<br><b>70.4</b>                        | C<br>E           |
| 2  | Second Avenue Extension and Patton Parkway          | Signalized                                | M (D)  | AM<br>PM                  | 18.2<br>19.1                                | B<br>B           | 18.2<br>19.1                               | B<br>B           |
| 3  | SR 1 Southbound Ramps and Imjin Parkway             | Signalized                                | M (D)  | AM<br>PM                  | > <b>120</b><br>> <b>120</b>                | F<br>F           | > <b>120</b><br>> <b>120</b>               | F<br>F           |
| 4  | SR 1 Northbound Ramps and Imjin Parkway             | SSS                                       | M (D)  | AM<br>PM                  | 1.1 ( <b>110.9</b> )<br>0.9 ( <b>77.2</b> ) | A (F)<br>A (F)   | 1.3 (> <b>120</b> )<br>1.0 ( <b>84.9</b> ) | A (F)<br>A (F)   |
| 5  | Second Avenue and Imjin Parkway                     | Signalized                                | M (D)  | AM<br>PM                  | 51.2<br><b>73.6</b>                         | D<br>E           | <b>59.9</b><br><b>81.2</b>                 | E<br>F           |
| 6  | Third Avenue and Imjin Parkway                      | SSS                                       | M (D)  | AM<br>PM                  | 19.6<br>36.1                                | B<br>D           | 20.2<br>45.7                               | C<br>D           |
| 7  | Fourth Avenue and Imjin Parkway                     | SSS                                       | M (D)  | AM<br>PM                  | 8.0<br>10.1                                 | A<br>B           | 9.2<br>11.7                                | A<br>B           |
| 8  | California Avenue and Imjin Parkway                 | Signalized                                | M (D)  | AM<br>PM                  | 40.2<br>13.2                                | D<br>B           | 52.1<br>15.7                               | D<br>B           |
| 9  | California Avenue and Patton Parkway                | SSS                                       | MC (D)   | AM<br>PM                  | 1.4 (18.8)<br>0.6 (12.3)                    | A (C)<br>A (B)   | 1.4 (19.3)<br>0.6 (12.7)                   | A (C)<br>A (B)   |
| 10 | Imjin Road and Imjin Parkway                        | Signalized                                | MC (D)   | AM<br>PM                  | 14.4<br>24.7                                | B<br>C           | 28.3<br><b>62.2</b>                        | C<br>E           |
| 11 | Abrams Drive and Imjin Parkway                      | Signalized                                | M (D)  | AM<br>PM                  | 15.3<br>17.4                                | B<br>B           | 20.9<br>23.9                               | C<br>C           |
| 12 | Reservation Road and Imjin Parkway                  | Signalized                                | M (D)  | AM<br>PM                  | 43.8<br><b>107.0</b>                        | D<br>F           | 48.4<br><b>119.7</b>                       | D<br>F           |
| 13 | Blanco Road and Reservation Road                    | Signalized                                | M / CSUMB (D)                                  | AM<br>PM                  | 26.1<br>11.1                                | C<br>B           | 29.4<br>11.1                               | C<br>B           |
| 14 | Inter-Garrison Road and Reservation Road            | Signalized                                | M (D)  | AM<br>PM                  | 22.1<br><b>41.8</b>                         | C<br>D           | <b>43.3</b><br><b>80.4</b>                 | D<br>F           |
| 15 | Second Avenue and Ninth Street                      | Signalized                                | M (D)  | AM<br>PM                  | 12.7<br>9.5                                 | B<br>A           | 13.3<br>9.6                                | B<br>A           |
| 16 | Second Avenue and Eighth Street                     | Signalized                                | M/ CSUMB (D)                                   | AM<br>PM                  | 12.0<br>7.2                                 | B<br>A           | 13.7<br>8.3                                | B<br>A           |
| 17 | Fourth Avenue and Eighth Street                     | AWSC                                      | MC / M / CSUMB (D)                             | AM<br>PM                  | 11.7<br>10.2                                | B<br>B           | 14.9<br>12.3                               | B<br>B           |
| 18 | Imjin Road and Eighth Street                        | Round-about                               | CSUMB (D)                                      | AM<br>PM                  | 13.9<br>7.7                                 | B<br>A           | 25.7<br>10.4                               | D<br>B           |
| 19 | Second Avenue and Inter-Garrison Road               | Signalized                                | MC / CSUMB (D)                                 | AM<br>PM                  | 6.1<br>6.9                                  | A<br>A           | 5.6<br>7.4                                 | A<br>A           |
| 20 | General Jim Moore Boulevard and Inter-Garrison Road | AWSC                                      | MC (D)   | AM<br>PM                  | 11.3<br>10.5                                | B<br>B           | 10.5<br>9.5                                | B<br>A           |

**TABLE L-3: CUMULATIVE INTERSECTION LEVEL OF SERVICE**

| #  | Intersection   | Intersect-<br>ion<br>Control <sup>1</sup> | Jurisdiction<br>(LOS<br>Standard) <sup>2</sup> | Peak<br>Hour <sup>3</sup> | Cumulative without<br>Project         |                       | Cumulative with<br>Project                 |                                  |
|----|--|---|--|---------------------------|---------------------------------------|-----------------------|--|----------------------------------|
|    |  |   |  |                           | Delay <sup>4</sup>                    | LOS <sup>5</sup>      | Delay <sup>4</sup>                         | LOS <sup>5</sup>                 |
| 21 | Eighth Street/Seventh Avenue and Inter-Garrison Road   | Signalized                                | MC (D)   | AM<br>PM                  | 17.7<br>17.8                          | B<br>B                | 33.5<br>33.7                               | C<br>C                           |
| 22 | Eighth Avenue and Inter-Garrison Road                  | Round-about                               | MC (D)   | AM<br>PM                  | <b>107.6</b><br>28.5                  | <b>F</b><br>D         | <b>&gt; 120</b><br><b>&gt;120114.3</b>     | <b>F</b><br><b>F</b>             |
| 23 | Abrams Drive and Inter-Garrison Road                   | Signalized                                | MC (D)   | AM<br>PM                  | 33.4<br>32.6                          | C<br>C                | <b>76.9</b><br><b>74.1</b>                 | <b>E</b><br><b>E</b>             |
| 24 | Schoonover Road and Inter-Garrison Road                | AWSC                                      | MC (D)   | AM<br>PM                  | 21.1<br>19.8                          | C<br>C                | <b>49.4</b><br><b>67.1</b>                 | <b>E</b><br><b>F</b>             |
| 25 | Inter-Garrison Road Connection and Inter-Garrison Road | AWSC                                      | M / CSUMB (D)                                  | AM<br>PM                  | <b>39.9</b><br>17.3                   | <b>E</b><br>C         | <b>80.7</b><br>34.5                        | <b>F</b><br>D                    |
| 26 | East Garrison Road and Reservation Road                | Signalized                                | M / CSUMB (D)                                  | AM<br>PM                  | 10.8<br>20.1                          | B<br>C                | 11.3<br>22.4                               | B<br>C                           |
| 27 | Reservation Road and Watkins Gate Road                 | Signalized                                | S (C)  | AM<br>PM                  | 8.6<br>22.6                           | A<br>C                | 8.6<br>26.0                                | A<br>C                           |
| 28 | Davis Road and Reservation Road                        | Signalized                                | S (C)  | AM<br>PM                  | <b>88.8</b><br><b>&gt; 120</b>        | <b>F</b><br><b>F</b>  | <b>&gt; 120</b><br><b>&gt; 120</b>         | <b>F</b><br><b>F</b>             |
| 29 | Second Avenue and Divarty Street                       | Signalized                                | S (C)  | AM<br>PM                  | 16.5<br>13.5                          | B<br>B                | 19.3<br>15.5                               | B<br>B                           |
| 30 | General Jim Moore Boulevard and Divarty Street         | AWSC                                      | S (C)  | AM<br>PM                  | 11.6<br>11.9                          | B<br>B                | 10.2<br>10.0                               | B<br>A                           |
| 31 | First Avenue and Lightfighter Drive                    | Signalized                                | S (C)  | AM<br>PM                  | 7.3<br>5.4                            | A<br>A                | 7.5<br>5.4                                 | A<br>A                           |
| 32 | Second Avenue and Lightfighter Drive                   | Signalized                                | S (C)  | AM<br>PM                  | <b>66.7</b><br><b>44.0</b>            | <b>E</b><br><b>D</b>  | <b>63.7</b><br><b>42.2</b>                 | <b>E</b><br><b>D</b>             |
| 33 | General Jim Moore Boulevard and Lightfighter Drive     | Signalized                                | S (C)  | AM<br>PM                  | 33.7<br>24.4                          | C<br>C                | <b>79.6</b><br>29.1                        | <b>E</b><br>C                    |
| 34 | Malmedy Road and Colonel Durham Street                 | AWSC                                      | MC (D)   | AM<br>PM                  | 14.6<br>13.0                          | B<br>B                | 13.1<br>12.1                               | B<br>B                           |
| 35 | Parker Flatts Cut Off Road and Colonel Durham Street   | SSS                                       | S (C)  | AM<br>PM                  | 1.5 (13.9)<br>1.8 (15)                | A (B)<br>A (B)        | 1.7 (12.9)<br>1.9 (13.4)                   | A (B)<br>A (B)                   |
| 36 | Sixth Avenue and Colonel Durham Street                 | AWSC                                      | S (C)  | AM<br>PM                  | 13.1<br>14.2                          | B<br>B                | 15.9<br>22.0                               | C<br>C                           |
| 37 | Seventh Avenue and Colonel Durham Street               | SSS                                       | S (C)  | AM<br>PM                  | 18.3 (44.1)<br><b>97.6 (&gt; 120)</b> | C (E)<br><b>F (F)</b> | 10.4 (16.4)<br><b>18.5 (38)</b>            | B (C)<br><b>C (E)</b>            |
| 38 | Eighth Avenue and Colonel Durham Street                | SSS                                       | S (C)  | AM<br>PM                  | 3.9 (25.1)<br>5.1 (26.1)              | A (D)<br>A (D)        | 6.3 ( <b>66.4</b> )<br>4.7 ( <b>36.6</b> ) | A ( <b>F</b> )<br>A ( <b>E</b> ) |
| 39 | General Jim Moore Boulevard and Gigling Road           | Signalized                                | S (C)  | AM<br>PM                  | 30.6<br>22.5                          | C<br>C                | <b>51.8</b><br><b>56.0</b>                 | <b>D</b><br><b>E</b>             |
| 40 | Malmedy Road and Gigling Road                          | Signalized                                | MC (D)   | AM<br>PM                  | 5.7<br>5.6                            | A<br>A                | 5.7<br>5.9                                 | A<br>A                           |

**TABLE L-3: CUMULATIVE INTERSECTION LEVEL OF SERVICE**

| #  | Intersection   | Intersect-<br>ion<br>Control <sup>1</sup> | Jurisdiction<br>(LOS<br>Standard) <sup>2</sup> | Peak<br>Hour <sup>3</sup> | Cumulative without<br>Project             |                      | Cumulative with<br>Project     |                      |
|----|--|---|--|---------------------------|---|----------------------|--------------------------------|----------------------|
|    |  |   |  |                           | Delay <sup>4</sup>                        | LOS <sup>5</sup>     | Delay <sup>4</sup>             | LOS <sup>5</sup>     |
| 41 | Parker Flatts Cut Off Road and Gigling Road                    | Signalized                                | MC (D)   | AM<br>PM                  | 5.3<br>5.9                                | A<br>A               | 5.4<br>6.0                     | A<br>A               |
| 42 | Sixth Avenue and Gigling Road                                  | Signalized                                | S (C)  | AM<br>PM                  | 5.4<br>5.4                                | A<br>A               | 7.7<br>8.8                     | A<br>A               |
| 43 | Seventh Avenue and Gigling Road                                | Signalized                                | S (C)  | AM<br>PM                  | 6.5<br>5.6                                | A<br>A               | 4.4<br>4.5                     | A<br>A               |
| 44 | Eighth Avenue and Gigling Road                                 | Signalized                                | Cal / Sand<br>City (C)                         | AM<br>PM                  | 7.7<br>6.9                                | A<br>A               | 21.1<br>10.2                   | C<br>B               |
| 45 | Eastside Parkway and Gigling Road                              | AWSC                                      | Cal / S (C)                                    | AM<br>PM                  | Future Intersection with Eastside Parkway |                      |                                |                      |
| 46 | General Jim Moore Boulevard and Normandy Road                  | Signalized                                | Cal / MC (C)                                   | AM<br>PM                  | <b>38.2</b><br>11.8                       | <b>D</b><br>B        | <b>40.6</b><br>12.0            | <b>D</b><br>B        |
| 47 | General Jim Moore Boulevard and Coe Avenue                     | AWSC                                      | Cal / MC (C)                                   | AM<br>PM                  | <b>113.7</b><br><b>30.4</b>               | <b>F</b><br><b>D</b> | <b>&gt; 120</b><br><b>35.2</b> | <b>F</b><br><b>E</b> |
| 48 | Fremont Boulevard - Southbound SR 1 Off-Ramp and Monterey Road | Signalized                                | M (D)  | AM<br>PM                  | <b>89.2</b><br><b>59.5</b>                | <b>F</b><br><b>E</b> | <b>92.6</b><br><b>61.7</b>     | <b>F</b><br><b>E</b> |
| 49 | California Avenue and Monterey Road - Northbound SR 1 Off-Ramp | Signalized                                | M (D)  | AM<br>PM                  | 17.4<br>29.9                              | B<br>C               | 17.4<br>30.7                   | B<br>C               |
| 50 | Reservation Road and State Route 68 Westbound Ramps            | Signalized                                | M (D)  | AM<br>PM                  | 14.7<br><b>38.5</b>                       | B<br><b>D</b>        | 14.6<br><b>39.5</b>            | B<br><b>D</b>        |
| 51 | Reservation Road and State Route 68 Eastbound Ramps            | Signalized                                | M (D)  | AM<br>PM                  | 12.3<br>12.2                              | B<br>B               | 12.6<br>12.3                   | B<br>B               |

Notes: **Bold text** indicates intersection operates at unacceptable level of service. **Bold and highlighted text** indicates an intersection deficiency when the addition of Project traffic degrades the operations from acceptable level of service to unacceptable level of service; or when the addition of Project traffic further exacerbates unacceptable operations.

SSS = Side Street Stop Controlled, AWSC = All Way Stop Controlled, Signalized = Signalized intersection

1. Intersection jurisdiction and associated LOS threshold applied.
  - i. City of Marina = M
  - ii. City of Seaside = S
  - iii. California State University Monterey Bay = CSUMB
  - iv. Monterey County = MC
  - v. Caltrans = Cal
2. AM = morning peak hour, PM = evening peak hour.
3. Whole intersection weighted average control delay expressed in seconds per vehicle calculated using methods described in the 2010 *Highway Capacity Manual* for signalized intersections and all-way stop-controlled intersections. For side-street stop-controlled intersections, average control delay and total delay for the worst movement are reported as "average control delay (worst movement total delay)."
4. LOS = Level of Service. LOS calculations conducted using the Synchro 10 analysis software packages, which apply the methods described in the 2010 *Highway Capacity Manual*. For side-street stop-controlled intersections, average control LOS and total LOS for the worst movement are reported as "average control LOS (worst movement total LOS)."

Source: Fehr & Peers, June 2019.

## CUMULATIVE WITHOUT AND WITH PROJECT AND WITH EASTSIDE PARKWAY CONDITIONS INTERSECTION LEVELS OF SERVICE

**TABLE L-4: CUMULATIVE WITH EASTSIDE PARKWAY INTERSECTION LEVEL OF SERVICE**

| #  | Intersection                               | Intersect-<br>ion<br>Control | Jurisdiction<br>(LOS<br>Standard) <sup>1</sup> | Peak<br>Hour <sup>2</sup> | Cumulative without<br>Project and with<br>Eastside Parkway |                  | Cumulative with<br>Project and with<br>Eastside Parkway |                  |
|----|--|------------------------------|--|---------------------------|--|------------------|---|------------------|
|    |  |                              |  |                           | Delay <sup>3</sup>   | LOS <sup>4</sup> | Delay <sup>3</sup>                                      | LOS <sup>4</sup> |
| 1  | Del Monte Boulevard and Reindollar Avenue  | Signalized                   | M (D)  | AM<br>PM                  | 33.8<br><b>64.1</b>  | C<br>E           | 34.1<br><b>67.2</b>                                     | C<br>E           |
| 2  | Second Avenue Extension and Patton Parkway | Future                       | M (D)  | AM<br>PM                  | 18.2<br>19.1   | B<br>B           | 18.2<br>19.1  | B<br>B           |
| 3  | SR 1 Southbound Ramps and Imjin Parkway    | Signalized                   | M (D)  | AM<br>PM                  | > 120<br>> 120   | F<br>F           | > 120<br>> 120  | F<br>F           |
| 4  | SR 1 Northbound Ramps and Imjin Parkway    | SSS                          | M (D)  | AM<br>PM                  | 0.9 ( <b>87.8</b> )<br>0.9 ( <b>80.1</b> )                 | A (F)<br>A (F)   | 1.1 ( <b>102.8</b> )<br>0.9 ( <b>81.6</b> )             | A (F)<br>A (F)   |
| 5  | Second Avenue and Imjin Parkway            | Signalized                   | M (D)  | AM<br>PM                  | <b>55.3</b><br>54.8  | E<br>D           | <b>60.8</b><br><b>65.6</b>                              | E<br>E           |
| 6  | Third Avenue and Imjin Parkway             | SSS                          | M (D)  | AM<br>PM                  | 15.6<br>17.8   | B<br>B           | 16.6<br>18.9  | B<br>B           |
| 7  | Fourth Avenue and Imjin Parkway            | SSS                          | M (D)  | AM<br>PM                  | 7.4<br>7.6   | A<br>A           | 7.4<br>7.7  | A<br>A           |
| 8  | California Avenue and Imjin Parkway        | Signalized                   | M (D)  | AM<br>PM                  | 32.0<br>12.5   | C<br>B           | 38.9<br>13.1  | D<br>B           |
| 9  | California Avenue and Patton Parkway       | SSS                          | MC (D)   | AM<br>PM                  | 1.4 (18.8)<br>0.6 (12.5)                                   | A (C)<br>A (B)   | 1.4 (19.7)<br>0.6 (13)                                  | A (C)<br>A (B)   |
| 10 | Imjin Road and Imjin Parkway               | Signalized                   | MC (D)   | AM<br>PM                  | 8.2<br>9.8   | A<br>A           | 14.0<br>19.5  | B<br>B           |
| 11 | Abrams Drive and Imjin Parkway             | Signalized                   | M (D)  | AM<br>PM                  | 13.3<br>12.6   | B<br>B           | 17.5<br>15.0  | B<br>B           |
| 12 | Reservation Road and Imjin Parkway         | Signalized                   | M (D)  | AM<br>PM                  | 25.7<br><b>55.6</b>  | C<br>E           | 26.1<br><b>61.5</b>                                     | C<br>E           |
| 13 | Blanco Road and Reservation Road           | Signalized                   | M / CSUMB<br>(D)                               | AM<br>PM                  | 15.7<br>11.1   | B<br>B           | 15.6<br>10.9  | B<br>B           |
| 14 | Inter-Garrison Road and Reservation Road   | Signalized                   | M (D)  | AM<br>PM                  | <b>117.8</b><br>> 120                                      | F<br>F           | > 120<br>> 120  | F<br>F           |
| 15 | Second Avenue and Ninth Street             | Signalized                   | M (D)  | AM<br>PM                  | 13.1<br>9.6  | B<br>A           | 13.2<br>9.6   | B<br>A           |
| 16 | Second Avenue and Eighth Street            | Signalized                   | M/ CSUMB<br>(D)                                | AM<br>PM                  | 8.6<br>5.8   | A<br>A           | 9.6<br>7.1  | A<br>A           |
| 17 | Fourth Avenue and Eighth Street            | AWSC                         | MC / M /<br>CSUMB (D)                          | AM<br>PM                  | 9.7<br>9.2   | A<br>A           | 12.0<br>11.3  | B<br>B           |



**TABLE L-4: CUMULATIVE WITH EASTSIDE PARKWAY INTERSECTION LEVEL OF SERVICE**

| #  | Intersection  | Intersect-<br>ion<br>Control | Jurisdiction<br>(LOS<br>Standard) <sup>1</sup> | Peak<br>Hour <sup>2</sup> | Cumulative without<br>Project and with<br>Eastside Parkway |                      | Cumulative with<br>Project and with<br>Eastside Parkway |                      |
|----|---|------------------------------|--|---------------------------|--|----------------------|---|----------------------|
|    |   |                              |  |                           | Delay <sup>3</sup>   | LOS <sup>4</sup>     | Delay <sup>3</sup>                                      | LOS <sup>4</sup>     |
| 18 | Imjin Road and Eighth Street                                  | Round-<br>about              | CSUMB (D)                                      | AM<br>PM                  | 8.0<br>6.5   | A<br>A               | 10.3<br>8.2   | B<br>A               |
| 19 | Second Avenue and Inter-<br>Garrison Road                     | Signalized                   | MC /<br>CSUMB (D)                              | AM<br>PM                  | 5.9<br>7.4   | A<br>A               | 5.3<br>7.4  | A<br>A               |
| 20 | General Jim Moore<br>Boulevard and Inter-Garrison<br>Road     | AWSC                         | MC (D)   | AM<br>PM                  | 10.1<br>10.1   | B<br>B               | 10.4<br>9.5   | B<br>A               |
| 21 | Eighth Street/Seventh<br>Avenue and Inter-Garrison<br>Road    | Signalized                   | MC (D)   | AM<br>PM                  | 17.9<br>16.3   | B<br>B               | 27.4<br>25.1  | C<br>C               |
| 22 | Eighth Avenue and Inter-<br>Garrison Road                     | Round-<br>about              | MC (D)   | AM<br>PM                  | <b>50.5</b><br>14.7  | <b>F</b><br>B        | <b>65.8</b><br>22.0                                     | <b>F</b><br>C        |
| 23 | Abrams Drive and Inter-<br>Garrison Road                      | Signalized                   | MC (D)   | AM<br>PM                  | 11.8<br>8.6  | B<br>A               | 14.8<br>11.0  | B<br>B               |
| 24 | Schoonover Road and Inter-<br>Garrison Road                   | Signalized                   | MC (D)   | AM<br>PM                  | 30.5<br>24.9   | C<br>C               | 44.0<br>27.6  | D<br>C               |
| 25 | Inter-Garrison Road<br>Connection and Inter-<br>Garrison Road | AWSC                         | M / CSUMB<br>(D)                               | AM<br>PM                  | > <b>120</b><br>> <b>120</b>                               | <b>F</b><br><b>F</b> | > <b>120</b><br>> <b>120</b>                            | <b>F</b><br><b>F</b> |
| 26 | East Garrison Road and<br>Reservation Road                    | Signalized                   | M / CSUMB<br>(D)                               | AM<br>PM                  | 10.7<br>18.3   | B<br>B               | 11.2<br>20.9  | B<br>C               |
| 27 | Reservation Road and<br>Watkins Gate Road                     | Signalized                   | S (C)  | AM<br>PM                  | 8.4<br>24.0  | A<br>C               | 8.6<br>32.1   | A<br>C               |
| 28 | Davis Road and Reservation<br>Road                            | Signalized                   | S (C)  | AM<br>PM                  | > <b>120</b><br>> <b>120</b>                               | <b>F</b><br><b>F</b> | > <b>120</b><br>> <b>120</b>                            | <b>F</b><br><b>F</b> |
| 29 | Second Avenue and Divarty<br>Street                           | Signalized                   | S (C)  | AM<br>PM                  | 13.5<br>13.2   | B<br>B               | 14.0<br>15.1  | B<br>B               |
| 30 | General Jim Moore<br>Boulevard and Divarty Street             | AWSC                         | S (C)  | AM<br>PM                  | 10.1<br>10.6   | B<br>B               | 10.2<br>10.0  | B<br>A               |
| 31 | First Avenue and Lightfighter<br>Drive                        | Signalized                   | S (C)  | AM<br>PM                  | 7.4<br>5.6   | A<br>A               | 7.8<br>5.7  | A<br>A               |
| 32 | Second Avenue and<br>Lightfighter Drive                       | Signalized                   | S (C)  | AM<br>PM                  | <b>63.8</b><br><b>39.2</b>                                 | <b>E</b><br><b>D</b> | <b>57.8</b><br><b>38.2</b>                              | <b>E</b><br><b>D</b> |
| 33 | General Jim Moore<br>Boulevard and Lightfighter<br>Drive      | Signalized                   | S (C)  | AM<br>PM                  | <b>71.6</b><br>33.0  | <b>E</b><br>C        | > <b>120</b><br><b>43.6</b>                             | <b>F</b><br><b>D</b> |
| 34 | Malmedy Road and Colonel<br>Durham Street                     | AWSC                         | MC (D)   | AM<br>PM                  | 13.1<br>12.3   | B<br>B               | 12.5<br>10.9  | B<br>B               |
| 35 | Parker Flatts Cut Off Road<br>and Colonel Durham Street       | SSS                          | S (C)  | AM<br>PM                  | 1.6 (13.6)<br>1.6 (13.7)                                   | A (B)<br>A (B)       | 1.7 (12.7)<br>1.7 (12.2)                                | A (B)<br>A (B)       |
| 36 | Sixth Avenue and Colonel<br>Durham Street                     | AWSC                         | S (C)  | AM<br>PM                  | 12.7<br>13.1   | B<br>B               | 12.3<br>12.3  | B<br>B               |

**TABLE L-4: CUMULATIVE WITH EASTSIDE PARKWAY INTERSECTION LEVEL OF SERVICE**

| #  | Intersection   | Intersect-<br>ion<br>Control | Jurisdiction<br>(LOS<br>Standard) <sup>1</sup> | Peak<br>Hour <sup>2</sup> | Cumulative without<br>Project and with<br>Eastside Parkway |                      | Cumulative with<br>Project and with<br>Eastside Parkway |                      |
|----|--|------------------------------|--|---------------------------|--|----------------------|---|----------------------|
|    |  |                              |  |                           | Delay <sup>3</sup>   | LOS <sup>4</sup>     | Delay <sup>3</sup>                                      | LOS <sup>4</sup>     |
| 37 | Seventh Avenue and Colonel Durham Street                       | SSS                          | S (C)  | AM<br>PM                  | 12.0 (19.8)<br>22.0 (36.5)                                 | B (C)<br>C (E)       | 10.0 (15.3)<br>12.4 (20.2)                              | A (C)<br>B (C)       |
| 38 | Eighth Avenue and Colonel Durham Street                        | SSS                          | S (C)  | AM<br>PM                  | 3.7 (22.2)<br>4.7 (19.4)                                   | A (C)<br>A (C)       | 3.0 (25.4)<br>2.9 (18.6)                                | A (D)<br>A (C)       |
| 39 | General Jim Moore Boulevard and Gigling Road                   | Signalized                   | S (C)  | AM<br>PM                  | <b>38.5</b><br><b>114.7</b>                                | <b>D</b><br><b>F</b> | <b>65.3</b><br><b>&gt;120</b>                           | <b>E</b><br><b>F</b> |
| 40 | Malmedy Road and Gigling Road                                  | Signalized                   | MC (D)   | AM<br>PM                  | 5.6<br>5.7   | A<br>A               | 5.7<br>5.9  | A<br>A               |
| 41 | Parker Flatts Cut Off Road and Gigling Road                    | Signalized                   | MC (D)   | AM<br>PM                  | 5.4<br>6.0   | A<br>A               | 5.5<br>6.1  | A<br>A               |
| 42 | Sixth Avenue and Gigling Road                                  | Signalized                   | S (C)  | AM<br>PM                  | 5.5<br>5.6   | A<br>A               | 5.8<br>6.5  | A<br>A               |
| 43 | Seventh Avenue and Gigling Road                                | Signalized                   | S (C)  | AM<br>PM                  | 5.4<br>4.9   | A<br>A               | 4.3<br>4.6  | A<br>A               |
| 44 | Eighth Avenue and Gigling Road                                 | Signalized                   | Cal / Sand City (C)                            | AM<br>PM                  | 6.7<br>5.2   | A<br>A               | 7.0<br>5.5  | A<br>A               |
| 45 | Eastside Parkway and Gigling Road                              | Signalized                   | Cal / S (C)                                    | AM<br>PM                  | 12.1<br>17.2   | B<br>B               | 13.7<br>22.4  | B<br>C               |
| 46 | General Jim Moore Boulevard and Normandy Road                  | Signalized                   | Cal / MC (C)                                   | AM<br>PM                  | <b>65.3</b><br>18.7  | <b>E</b><br>B        | <b>70.4</b><br>20.4                                     | <b>E</b><br>C        |
| 47 | General Jim Moore Boulevard and Coe Avenue                     | Signalized                   | Cal / MC (C)                                   | AM<br>PM                  | <b>46.2</b><br>15.5  | <b>D</b><br>B        | <b>48.4</b><br>16.3                                     | <b>D</b><br>B        |
| 48 | Fremont Boulevard - Southbound SR 1 Off-Ramp and Monterey Road | Signalized                   | M (D)  | AM<br>PM                  | <b>91.9</b><br><b>57.6</b>                                 | <b>F</b><br><b>E</b> | <b>95.1</b><br><b>61.4</b>                              | <b>F</b><br><b>E</b> |
| 49 | California Avenue and Monterey Road - Northbound SR 1 Off-Ramp | Signalized                   | M (D)  | AM<br>PM                  | 17.4<br>30.7   | B<br>C               | 17.4<br>31.6  | B<br>C               |
| 50 | Reservation Road and State Route 68 Westbound Ramps            | Signalized                   | M (D)  | AM<br>PM                  | 14.4<br><b>37.2</b>  | B<br><b>D</b>        | 14.7<br><b>38.9</b>                                     | B<br><b>D</b>        |
| 51 | Reservation Road and State Route 68 Eastbound Ramps            | Signalized                   | M (D)  | AM<br>PM                  | 12.4<br>12.1   | B<br>B               | 12.8<br>11.7  | B<br>B               |

Notes: **Bold text** indicates intersection operates at unacceptable level of service. **Bold and highlighted text** indicates an intersection deficiency when the addition of Project traffic degrades the operations from acceptable level of service to unacceptable level of service; or when the addition of Project traffic further exacerbates unacceptable operations.

1. Intersection jurisdiction and associated LOS threshold applied.
  - i. City of Marina = M
  - ii. City of Seaside = S
  - iii. California State University Monterey Bay = CSUMB
  - iv. Monterey County = MC
  - v. Caltrans = Cal
2. AM = morning peak hour, PM = evening peak hour.

3. Whole intersection weighted average control delay expressed in seconds per vehicle calculated using methods described in the 2010 *Highway Capacity Manual* for signalized intersections and all-way stop-controlled intersections. For side-street stop-controlled intersections, average control delay and total delay for the worst movement are reported as "average control delay (worst movement total delay)."

4. LOS = Level of Service. LOS calculations conducted using the Synchro 10 analysis software packages, which apply the methods described in the 2010 *Highway Capacity Manual*. For side-street stop-controlled intersections, average control LOS and total LOS for the worst movement are reported as "average control LOS (worst movement total LOS)."

Source: Fehr & Peers, June 2019.

**TABLE L-5: CUMULATIVE INTERSECTION LEVEL OF SERVICE**

| #  | Intersection                               | Intersection Control <sup>1</sup> | Jurisdiction (LOS Standard) <sup>2</sup> | Peak Hour <sup>3</sup> | Cumulative without Project                    |                      | Cumulative with Project                       |                      | Cumulative without Project and with Eastside Parkway |                      | Cumulative with Project and with Eastside Parkway |                      |
|----|--|-----------------------------------|--|------------------------|---|----------------------|---|----------------------|--|----------------------|---|----------------------|
|    |  |                                   |  |                        | Delay <sup>4</sup>                            | LOS <sup>5</sup>     | Delay <sup>4</sup>                            | LOS <sup>5</sup>     | Average Delay <sup>4</sup>                           | LOS <sup>5</sup>     | Average Delay <sup>4</sup>                        | LOS <sup>5</sup>     |
| 1  | Del Monte Boulevard and Reindollar Avenue  | Signalized                        | M (D)                                    | AM<br>PM               | 33.8<br><b>69.1</b>                           | C<br><b>E</b>        | 34.1<br><b>70.4</b>                           | C<br><b>E</b>        | 33.8<br><b>64.1</b>                                  | C<br><b>E</b>        | 34.1<br><b>67.2</b>                               | C<br><b>E</b>        |
| 2  | Second Avenue Extension and Patton Parkway | Future                            | M (D)                                    | AM<br>PM               | 18.2<br>19.1                                  | B<br>B               | 18.2<br>19.1                                  | B<br>B               | 18.2<br>19.1   | B<br>B               | 18.2<br>19.1                                      | B<br>B               |
| 3  | SR 1 Southbound Ramps and Imjin Parkway    | Signalized                        | M (D)                                    | AM<br>PM               | > 120<br>> 120                                | <b>F</b><br><b>F</b> | > 120<br>> 120                                | <b>F</b><br><b>F</b> | > 120<br>> 120                                       | <b>F</b><br><b>F</b> | > 120<br>> 120                                    | <b>F</b><br><b>F</b> |
| 4  | SR 1 Northbound Ramps and Imjin Parkway    | SSS                               | M (D)                                    | AM<br>PM               | 1.1<br><b>(110.9)</b><br>0.9<br><b>(77.2)</b> | A (F)<br>A (F)       | 1.3<br><b>(&gt;120)</b><br>1<br><b>(84.9)</b> | A (F)<br>A (F)       | 0.9<br><b>(87.8)</b><br>0.9<br><b>(80.1)</b>         | A (F)<br>A (F)       | 1.1<br><b>(102.8)</b><br>0.9<br><b>(81.6)</b>     | A (F)<br>A (F)       |
| 5  | Second Avenue and Imjin Parkway            | Signalized                        | M (D)                                    | AM<br>PM               | 51.2<br><b>73.6</b>                           | D<br><b>E</b>        | <b>59.9</b><br><b>81.2</b>                    | <b>E</b><br><b>F</b> | <b>55.3</b><br>54.8                                  | <b>E</b><br>D        | <b>60.8</b><br><b>65.6</b>                        | <b>E</b><br><b>E</b> |
| 6  | Third Avenue and Imjin Parkway             | SSS                               | M (D)                                    | AM<br>PM               | 19.6<br>36.1                                  | B<br>D               | 20.2<br>45.7                                  | C<br>D               | 15.6<br>17.8   | B<br>B               | 16.6<br>18.9                                      | B<br>B               |
| 7  | Fourth Avenue and Imjin Parkway            | SSS                               | M (D)                                    | AM<br>PM               | 8.0<br>10.1                                   | A<br>B               | 9.2<br>11.7                                   | A<br>B               | 7.4<br>7.6   | A<br>A               | 7.4<br>7.7  | A<br>A               |
| 8  | California Avenue and Imjin Parkway        | Signalized                        | M (D)                                    | AM<br>PM               | 40.2<br>13.2                                  | D<br>B               | 52.1<br>15.7                                  | D<br>B               | 32.0<br>12.5   | C<br>B               | 38.9<br>13.1                                      | D<br>B               |
| 9  | California Avenue and Patton Parkway       | SSS                               | MC (D)                                   | AM<br>PM               | 1.4 (18.8)<br>0.6 (12.3)                      | A (C)<br>A (B)       | 1.4 (19.3)<br>0.6 (12.7)                      | A (C)<br>A (B)       | 1.4 (18.8)<br>0.6 (12.5)                             | A (C)<br>A (B)       | 1.4 (19.7)<br>0.6 (13)                            | A (C)<br>A (B)       |
| 10 | Imjin Road and Imjin Parkway               | Signalized                        | MC (D)                                   | AM<br>PM               | 14.4<br>24.7                                  | B<br>C               | 28.3<br><b>62.2</b>                           | C<br><b>E</b>        | 8.2<br>9.8   | A<br>A               | 14.0<br>19.5                                      | B<br>B               |
| 11 | Abrams Drive and Imjin Parkway             | Signalized                        | M (D)                                    | AM<br>PM               | 15.3<br>17.4                                  | B<br>B               | 20.9<br>23.9                                  | C<br>C               | 13.3<br>12.6   | B<br>B               | 17.5<br>15.0                                      | B<br>B               |
| 12 | Reservation Road and Imjin Parkway         | Signalized                        | M (D)                                    | AM<br>PM               | 43.8<br><b>107.0</b>                          | D<br><b>F</b>        | 48.4<br><b>119.7</b>                          | D<br><b>F</b>        | 25.7<br><b>55.6</b>                                  | C<br><b>E</b>        | 26.1<br><b>61.5</b>                               | C<br><b>E</b>        |

**TABLE L-5: CUMULATIVE INTERSECTION LEVEL OF SERVICE**

| #  | Intersection   | Intersection Control <sup>1</sup> | Jurisdiction (LOS Standard) <sup>2</sup> | Peak Hour <sup>3</sup> | Cumulative without Project |                  | Cumulative with Project                                    |                      | Cumulative without Project and with Eastside Parkway |                      | Cumulative with Project and with Eastside Parkway |                      |
|----|--|-----------------------------------|--|------------------------|----------------------------|------------------|--|----------------------|--|----------------------|---|----------------------|
|    |  |                                   |  |                        | Delay <sup>4</sup>         | LOS <sup>5</sup> | Delay <sup>4</sup>   | LOS <sup>5</sup>     | Average Delay <sup>4</sup>                           | LOS <sup>5</sup>     | Average Delay <sup>4</sup>                        | LOS <sup>5</sup>     |
| 13 | Blanco Road and Reservation Road                     | Signalized                        | M / CSUMB (D)                            | AM<br>PM               | 26.1<br>11.1               | C<br>B           | 29.4<br>11.1   | C<br>B               | 15.7<br>11.1   | B<br>B               | 15.6<br>10.9                                      | B<br>B               |
| 14 | Inter-Garrison Road and Reservation Road             | Signalized                        | M (D)                                    | AM<br>PM               | 22.1<br><b>41.8</b>        | C<br><b>D</b>    | <b>43.3</b><br><b>80.4</b>                                 | <b>D</b><br><b>F</b> | <b>117.8</b><br><b>&gt;120</b>                       | <b>F</b><br><b>F</b> | <b>&gt;120</b><br><b>&gt;120</b>                  | <b>F</b><br><b>F</b> |
| 15 | Second Avenue and Ninth Street                       | Signalized                        | M (D)                                    | AM<br>PM               | 12.7<br>9.5                | B<br>A           | 13.3<br>9.6  | B<br>A               | 13.1<br>9.6  | B<br>A               | 13.2<br>9.6                                       | B<br>A               |
| 16 | Second Avenue and Eighth Street                      | Signalized                        | M/ CSUMB (D)                             | AM<br>PM               | 12.0<br>7.2                | B<br>A           | 13.7<br>8.3  | B<br>A               | 8.6<br>5.8   | A<br>A               | 9.6<br>7.1  | A<br>A               |
| 17 | Fourth Avenue and Eighth Street                      | AWSC                              | MC / M / CSUMB (D)                       | AM<br>PM               | 11.7<br>102                | B<br>B           | 14.9<br>12.3   | B<br>B               | 9.7<br>9.2   | A<br>A               | 12.0<br>11.3                                      | B<br>B               |
| 18 | Imjin Road and Eighth Street                         | Round-about                       | CSUMB (D)                                | AM<br>PM               | 13.9<br>7.7                | B<br>A           | 25.7<br>10.4   | D<br>B               | 8.0<br>6.5   | A<br>A               | 10.3<br>8.2                                       | B<br>A               |
| 19 | Second Avenue and Inter-Garrison Road                | Signalized                        | MC / CSUMB (D)                           | AM<br>PM               | 6.1<br>6.9                 | A<br>A           | 5.6<br>7.4   | A<br>A               | 5.9<br>7.4   | A<br>A               | 5.3<br>7.4  | A<br>A               |
| 20 | General Jim Moore Boulevard and Inter-Garrison Road  | AWSC                              | MC (D)                                   | AM<br>PM               | 11.3<br>10.5               | B<br>B           | 10.5<br>9.5  | B<br>A               | 10.1<br>10.1   | B<br>B               | 10.4<br>9.5                                       | B<br>A               |
| 21 | Eighth Street/Seventh Avenue and Inter-Garrison Road | Signalized                        | MC (D)                                   | AM<br>PM               | 17.7<br>17.8               | B<br>B           | 33.5<br>33.7   | C<br>C               | 17.9<br>16.3   | B<br>B               | 27.4<br>25.1                                      | C<br>C               |
| 22 | Eighth Avenue and Inter-Garrison Road                | Round-about                       | MC (D)                                   | AM<br>PM               | <b>107.6</b><br>28.5       | <b>F</b><br>D    | <b>&gt;120</b><br><b>&gt;120</b><br><b>114</b><br><b>3</b> | <b>F</b><br><b>F</b> | <b>50.5</b><br>14.7                                  | <b>F</b><br>B        | <b>65.8</b><br>22.0                               | <b>F</b><br>C        |
| 23 | Abrams Drive and Inter-Garrison Road                 | Signalized                        | MC (D)                                   | AM<br>PM               | 33.4<br>32.6               | C<br>C           | <b>76.9</b><br><b>74.1</b>                                 | <b>E</b><br><b>E</b> | 11.8<br>8.6  | B<br>A               | 14.8<br>11.0                                      | B<br>B               |
| 24 | Schoonover Road and Inter-Garrison Road              | Signalized                        | MC (D)                                   | AM<br>PM               | 21.1<br>19.8               | C<br>C           | <b>49.4</b><br><b>67.1</b>                                 | <b>E</b><br><b>F</b> | 30.5<br>24.9   | C<br>C               | 44.0<br>27.6                                      | D<br>C               |

**TABLE L-5: CUMULATIVE INTERSECTION LEVEL OF SERVICE**

| #  | Intersection   | Intersection Control <sup>1</sup> | Jurisdiction (LOS Standard) <sup>2</sup> | Peak Hour <sup>3</sup> | Cumulative without Project |                      | Cumulative with Project    |                      | Cumulative without Project and with Eastside Parkway |                      | Cumulative with Project and with Eastside Parkway |                      |
|----|--|-----------------------------------|--|------------------------|----------------------------|----------------------|----------------------------|----------------------|--|----------------------|---|----------------------|
|    |  |                                   |  |                        | Delay <sup>4</sup>         | LOS <sup>5</sup>     | Delay <sup>4</sup>         | LOS <sup>5</sup>     | Average Delay <sup>4</sup>                           | LOS <sup>5</sup>     | Average Delay <sup>4</sup>                        | LOS <sup>5</sup>     |
| 25 | Inter-Garrison Road Connection and Inter-Garrison Road | AWSC                              | M / CSUMB (D)                            | AM<br>PM               | <b>39.9</b><br>17.3        | <b>E</b><br>C        | <b>80.7</b><br>34.5        | <b>F</b><br>D        | >120<br>>120   | <b>F</b><br><b>F</b> | >120<br>>120                                      | <b>F</b><br><b>F</b> |
| 26 | East Garrison Road and Reservation Road                | Signalized                        | M / CSUMB (D)                            | AM<br>PM               | 10.8<br>20.1               | B<br>C               | 11.3<br>22.4               | B<br>C               | 10.7<br>18.3   | B<br>B               | 11.2<br>20.9                                      | B<br>C               |
| 27 | Reservation Road and Watkins Gate Road                 | Signalized                        | S (C)                                    | AM<br>PM               | 8.6<br>22.6                | A<br>C               | 8.6<br>26.0                | A<br>C               | 8.4<br>24.0  | A<br>C               | 8.6<br>32.1                                       | A<br>C               |
| 28 | Davis Road and Reservation Road                        | Signalized                        | S (C)                                    | AM<br>PM               | <b>88.8</b><br>>120        | <b>F</b><br><b>F</b> | >120<br>>120               | <b>F</b><br><b>F</b> | >120<br>>120   | <b>F</b><br><b>F</b> | >120<br>>120                                      | <b>F</b><br><b>F</b> |
| 29 | Second Avenue and Divarty Street                       | Signalized                        | S (C)                                    | AM<br>PM               | 16.5<br>13.5               | B<br>B               | 19.3<br>15.5               | B<br>B               | 13.5<br>13.2   | B<br>B               | 14.0<br>15.1                                      | B<br>B               |
| 30 | General Jim Moore Boulevard and Divarty Street         | AWSC                              | S (C)                                    | AM<br>PM               | 11.6<br>11.9               | B<br>B               | 10.2<br>10.0               | B<br>A               | 10.1<br>10.6   | B<br>B               | 10.2<br>10.0                                      | B<br>A               |
| 31 | First Avenue and Lightfighter Drive                    | Signalized                        | S (C)                                    | AM<br>PM               | 7.3<br>5.4                 | A<br>A               | 7.5<br>5.4                 | A<br>A               | 7.4<br>5.6   | A<br>A               | 7.8<br>5.7  | A<br>A               |
| 32 | Second Avenue and Lightfighter Drive                   | Signalized                        | S (C)                                    | AM<br>PM               | <b>66.7</b><br><b>44.0</b> | <b>E</b><br><b>D</b> | <b>63.7</b><br><b>42.2</b> | <b>E</b><br><b>D</b> | <b>63.8</b><br><b>39.2</b>                           | <b>E</b><br><b>D</b> | <b>57.8</b><br><b>38.2</b>                        | <b>E</b><br><b>D</b> |
| 33 | General Jim Moore Boulevard and Lightfighter Drive     | Signalized                        | S (C)                                    | AM<br>PM               | 33.7<br>24.4               | C<br>C               | <b>79.6</b><br>29.1        | <b>E</b><br>C        | <b>71.6</b><br>33.0                                  | <b>E</b><br>C        | >120<br><b>43.6</b>                               | <b>F</b><br><b>D</b> |
| 34 | Malmedy Road and Colonel Durham Street                 | AWSC                              | MC (D)                                   | AM<br>PM               | 14.6<br>13.0               | B<br>B               | 13.1<br>12.1               | B<br>B               | 13.1<br>12.3   | B<br>B               | 12.5<br>10.9                                      | B<br>B               |
| 35 | Parker Flatts Cut Off Road and Colonel Durham Street   | SSS                               | S (C)                                    | AM<br>PM               | 1.5 (13.9)<br>1.8 (15)     | A (B)<br>A (B)       | 1.7 (12.9)<br>1.9 (13.4)   | A (B)<br>A (B)       | 1.6 (13.6)<br>1.6 (13.7)                             | A (B)<br>A (B)       | 1.7 (12.7)<br>1.7 (12.2)                          | A (B)<br>A (B)       |
| 36 | Sixth Avenue and Colonel Durham Street                 | AWSC                              | S (C)                                    | AM<br>PM               | 13.1<br>14.2               | B<br>B               | 15.9<br>22.0               | C<br>C               | 12.7<br>13.1   | B<br>B               | 12.3<br>12.3                                      | B<br>B               |

**TABLE L-5: CUMULATIVE INTERSECTION LEVEL OF SERVICE**

| #  | Intersection                                  | Intersection Control <sup>1</sup> | Jurisdiction (LOS Standard) <sup>2</sup> | Peak Hour <sup>3</sup> | Cumulative without Project                |                  | Cumulative with Project |                  | Cumulative without Project and with Eastside Parkway |                  | Cumulative with Project and with Eastside Parkway |                  |
|----|---|-----------------------------------|--|------------------------|---|------------------|-------------------------|------------------|--|------------------|---|------------------|
|    |   |                                   |  |                        | Delay <sup>4</sup>                        | LOS <sup>5</sup> | Delay <sup>4</sup>      | LOS <sup>5</sup> | Average Delay <sup>4</sup>                           | LOS <sup>5</sup> | Average Delay <sup>4</sup>                        | LOS <sup>5</sup> |
| 37 | Seventh Avenue and Colonel Durham Street      | SSS                               | S (C)                                    | AM                     | 18.3                                      | C (E)            | 10.4                    | B (C)            | 12.0   | B (C)            | 10.0  | A (C)            |
|    |   |                                   |  | PM                     | (44.1)                                    | F (F)            | (16.4)                  | C (E)            | (19.8)   | C (E)            | (15.3)  | B (C)            |
|    |   |                                   |  |                        | <b>97.6</b>                               |                  | <b>18.5 (38)</b>        |                  | <b>22.0</b>  |                  | <b>12.4</b>                                       | <b>(20.2)</b>    |
|    |   |                                   |  |                        |   |                  |                         |                  | <b>(36.5)</b>  |                  |   |                  |
| 38 | Eighth Avenue and Colonel Durham Street       | SSS                               | S (C)                                    | AM                     | 3.9 (25.1)                                | A (D)            | 6.3                     | A (F)            | 3.7 (22.2)   | A (C)            | 3.0 (25.4)  | A (D)            |
|    |   |                                   |  | PM                     | 5.1 (26.1)                                | A (D)            | <b>(66.4)</b>           | A (E)            | 4.7 (19.4)   | A (C)            | 2.9 (18.6)  | A (C)            |
|    |   |                                   |  |                        |   |                  | <b>4.7</b>              |                  |  |                  |   |                  |
|    |   |                                   |  |                        |   |                  | <b>(36.6)</b>           |                  |  |                  |   |                  |
| 39 | General Jim Moore Boulevard and Gigling Road  | Signalized                        | S (C)                                    | AM                     | 30.6                                      | C                | <b>51.8</b>             | <b>D</b>         | <b>38.5</b>  | <b>D</b>         | <b>65.3</b>                                       | <b>E</b>         |
|    |   |                                   |  | PM                     | 22.5                                      | C                | <b>56.0</b>             | <b>E</b>         | <b>114.7</b>   | <b>F</b>         | <b>&gt;120</b>                                    | <b>F</b>         |
| 40 | Malmedy Road and Gigling Road                 | Signalized                        | MC (D)                                   | AM                     | 5.7                                       | A                | 5.7                     | A                | 5.6  | A                | 5.7   | A                |
|    |   |                                   |  | PM                     | 5.6                                       | A                | 5.9                     | A                | 5.7  | A                | 5.9   | A                |
| 41 | Parker Flatts Cut Off Road and Gigling Road   | Signalized                        | MC (D)                                   | AM                     | 5.3                                       | A                | 5.4                     | A                | 5.4  | A                | 5.5   | A                |
|    |   |                                   |  | PM                     | 5.9                                       | A                | 6.0                     | A                | 6.0  | A                | 6.1   | A                |
| 42 | Sixth Avenue and Gigling Road                 | Signalized                        | S (C)                                    | AM                     | 5.4                                       | A                | 7.7                     | A                | 5.5  | A                | 5.8   | A                |
|    |   |                                   |  | PM                     | 5.4                                       | A                | 8.8                     | A                | 5.6  | A                | 6.5   | A                |
| 43 | Seventh Avenue and Gigling Road               | Signalized                        | S (C)                                    | AM                     | 6.5                                       | A                | 4.4                     | A                | 5.4  | A                | 4.3   | A                |
|    |   |                                   |  | PM                     | 5.6                                       | A                | 4.5                     | A                | 4.9  | A                | 4.6   | A                |
| 44 | Eighth Avenue and Gigling Road                | Signalized                        | Cal / Sand City (C)                      | AM                     | 7.7                                       | A                | 21.1                    | C                | 6.7  | A                | 7.0   | A                |
|    |   |                                   |  | PM                     | 6.9                                       | A                | 10.2                    | B                | 5.2  | A                | 5.5   | A                |
| 45 | Eastside Parkway and Gigling Road             | Signalized                        | Cal / S (C)                              | AM                     | Future Intersection with Eastside Parkway |                  |                         |                  | 12.1   | B                | 13.7  | 12.1             |
|    |   |                                   |  | PM                     |   |                  |                         |                  | 17.2   | B                | 22.4  | 17.2             |
| 46 | General Jim Moore Boulevard and Normandy Road | Signalized                        | Cal / MC (C)                             | AM                     | <b>38.2</b>                               | <b>D</b>         | <b>40.6</b>             | <b>D</b>         | <b>65.3</b>  | <b>E</b>         | <b>70.4</b>                                       | <b>E</b>         |
|    |   |                                   |  | PM                     | 11.8                                      | B                | 12.0                    | B                | 18.7   | B                | 20.4  | C                |
| 47 | General Jim Moore Boulevard and Coe Avenue    | AWSC/Signalized                   | Cal / MC (C)                             | AM                     | <b>113.7</b>                              | <b>F</b>         | <b>&gt;120</b>          | <b>F</b>         | <b>46.2</b>  | <b>D</b>         | <b>48.4</b>                                       | <b>D</b>         |
|    |   |                                   |  | PM                     | <b>30.4</b>                               | <b>D</b>         | <b>35.2</b>             | <b>E</b>         | 15.5   | B                | 16.3  | B                |

**TABLE L-5: CUMULATIVE INTERSECTION LEVEL OF SERVICE**

| #  | Intersection   | Intersection Control <sup>1</sup> | Jurisdiction (LOS Standard) <sup>2</sup> | Peak Hour <sup>3</sup> | Cumulative without Project |                  | Cumulative with Project |                  | Cumulative without Project and with Eastside Parkway |                  | Cumulative with Project and with Eastside Parkway |                  |
|----|--|-----------------------------------|--|------------------------|----------------------------|------------------|-------------------------|------------------|--|------------------|---|------------------|
|    |  |                                   |  |                        | Delay <sup>4</sup>         | LOS <sup>5</sup> | Delay <sup>4</sup>      | LOS <sup>5</sup> | Average Delay <sup>4</sup>                           | LOS <sup>5</sup> | Average Delay <sup>4</sup>                        | LOS <sup>5</sup> |
| 48 | Fremont Boulevard - Southbound SR 1 Off-Ramp and Monterey Road | Signalized                        | M (D)                                    | AM                     | <b>89.2</b>                | <b>F</b>         | <b>92.6</b>             | <b>F</b>         | <b>91.9</b>  | <b>F</b>         | <b>95.1</b>                                       | <b>F</b>         |
|    |  |                                   |  | PM                     | <b>59.5</b>                | <b>E</b>         | <b>61.7</b>             | <b>E</b>         | <b>57.6</b>  | <b>E</b>         | <b>61.4</b>                                       | <b>E</b>         |
| 49 | California Avenue and Monterey Road - Northbound SR 1 Off-Ramp | Signalized                        | M (D)                                    | AM                     | 17.4                       | B                | 17.4                    | B                | 17.4   | B                | 17.4  | B                |
|    |  |                                   |  | PM                     | 29.9                       | C                | 30.7                    | C                | 30.7   | C                | 31.6  | C                |
| 50 | Reservation Road and State Route 68 Westbound Ramps            | Signalized                        | M (D)                                    | AM                     | 14.7                       | B                | 14.6                    | B                | 14.4   | B                | 14.7  | B                |
|    |  |                                   |  | PM                     | <b>38.5</b>                | <b>D</b>         | <b>39.5</b>             | <b>D</b>         | <b>37.2</b>  | <b>D</b>         | <b>38.9</b>                                       | <b>D</b>         |
| 51 | Reservation Road and State Route 68 Eastbound Ramps            | Signalized                        | M (D)                                    | AM                     | 12.3                       | B                | 12.6                    | B                | 12.4   | B                | 12.8  | B                |
|    |  |                                   |  | PM                     | 12.2                       | B                | 12.3                    | B                | 12.1   | B                | 11.7  | B                |

Notes: **Bold text** indicates intersection operates at unacceptable level of service. **Bold and highlighted text** indicates an intersection deficiency when the addition of Project traffic degrades the operations from acceptable level of service to unacceptable level of service; or when the addition of Project traffic further exacerbates unacceptable operations.

1. SSS = Side Street Stop Controlled, AWSC = All Way Stop Controlled, Signalized = Signalized intersection
2. Intersection jurisdiction and associated LOS threshold applied.
  - i. City of Marina = M
  - ii. City of Seaside = S
  - iii. California State University Monterey Bay = CSUMB
  - iv. Monterey County = MC
  - v. Caltrans = Cal
3. AM = morning peak hour, PM = evening peak hour.
4. Whole intersection weighted average control delay expressed in seconds per vehicle calculated using methods described in the 2010 *Highway Capacity Manual* for signalized intersections and all-way stop-controlled intersections. For side-street stop-controlled intersections, average control delay and total delay for the worst movement are reported as "average control delay (worst movement total delay)."
5. LOS = Level of Service. LOS calculations conducted using the Synchro 10 analysis software packages, which apply the methods described in the 2010 *Highway Capacity Manual*. For side-street stop-controlled intersections, average control LOS and total LOS for the worst movement are reported as "average control LOS (worst movement total LOS)."

Source: Fehr & Peers, June 2019.



## **APPENDIX M: FREEWAY ANALYSIS**



HCM 2010: Freeway Basic Segment

Basic Operational Analysis

|             |   |
|-------------|---|
| Project     | CSUMB Master Plan EIR                                 |
| Freeway     | Southbound State Route 1                              |
| Segment     | SR 1 between Reservation Road and Del Monte Boulevard |
| Alternative | Existing  |
| Time period | AM Peak Hour  |

Flow Inputs and Adjustments

|                                    |       |      |
|------------------------------------|-------|------|
| Volume, V                          | 2,705 | vph  |
| Peak-hour factor, PHF              | 0.76  |      |
| Peak 15-min volume, $v_{15}$       | 890   | veh  |
| Trucks and buses                   | 4.7%  |      |
| Recreational vehicles              | 0.0%  |      |
| Terrain type                       | Level |      |
| Grade                              |       |      |
| Length                             |       | mi   |
| Trucks and buses PCE, $E_T$        | 1.5   |      |
| Recreational vehicle PCE, $E_R$    | 1.2   |      |
| Heavy vehicle adjustment, $f_{HV}$ | 0.977 |      |
| Driver population factor, $f_p$    | 1.00  |      |
| Flow rate, $v_p$                   | 3,642 | pcph |
| Number of lanes, N                 | 2     |      |

Speed Inputs and Adjustments

|  |      |          |
|--|------|----------|
| Lane width                             | 12.0 | ft       |
| Right-side lateral clearance           | >6   | ft       |
| Total ramp density, TRD                | 1.00 | ramps/mi |
| Lane width adjustment, $f_{LW}$        | 0.0  | mph      |
| Lateral clearance adjustment, $f_{LC}$ | 0.0  | mph      |
| TRD adjustment                         | 3.2  | mph      |
| Calculated free-flow speed, FFS        | 72.2 | mph      |
| Measured free-flow speed, FFS          | 65.0 | mph      |
| Free-flow speed curve                  | 65   | mph      |

Capacity Checks for Segments with Ramps

|                         | Actual |      | Maximum |      | Violation? |
|-------------------------|--------|------|---------|------|------------|
| Entering freeway volume |        | pcph |         | pcph |            |
| Exiting freeway volume  |        | pcph |         | pcph |            |
| On-ramp volume          |        | pcph |         | pcph |            |
| Off-ramp volume         |        | pcph |         | pcph |            |

LOS and Performance Measures

|                                |       |        |
|--------------------------------|-------|--------|
| Flow rate, $v_p$               | 1,821 | pcphpl |
| Average passenger-car speed, S | 62.5  | mph    |
| Volume-to-capacity ratio, v/c  | 0.77  |        |
| Density, D                     | 29.1  | pcpmpl |
| Level of service, LOS          | D     |        |

HCM 2010: Freeway Basic Segment

Basic Operational Analysis

|             |   |
|-------------|---|
| Project     | CSUMB Master Plan EIR                                 |
| Freeway     | Southbound SR 1                                       |
| Segment     | SR 1 between Reservation Road and Del Monte Boulevard |
| Alternative | Existing  |
| Time period | PM Peak Hour  |

Flow Inputs and Adjustments

|                                    |       |      |
|------------------------------------|-------|------|
| Volume, V                          | 1,418 | vph  |
| Peak-hour factor, PHF              | 0.97  |      |
| Peak 15-min volume, $v_{15}$       | 365   | veh  |
| Trucks and buses                   | 1.0%  |      |
| Recreational vehicles              | 0.0%  |      |
| Terrain type                       | Level |      |
| Grade                              |       |      |
| Length                             |       | mi   |
| Trucks and buses PCE, $E_T$        | 1.5   |      |
| Recreational vehicle PCE, $E_R$    | 1.2   |      |
| Heavy vehicle adjustment, $f_{HV}$ | 0.995 |      |
| Driver population factor, $f_p$    | 1.00  |      |
| Flow rate, $v_p$                   | 1,469 | pcph |
| Number of lanes, N                 | 2     |      |

Speed Inputs and Adjustments

|  |      |          |
|--|------|----------|
| Lane width                             | 12.0 | ft       |
| Right-side lateral clearance           | >6   | ft       |
| Total ramp density, TRD                | 1.00 | ramps/mi |
| Lane width adjustment, $f_{LW}$        | 0.0  | mph      |
| Lateral clearance adjustment, $f_{LC}$ | 0.0  | mph      |
| TRD adjustment                         | 3.2  | mph      |
| Calculated free-flow speed, FFS        | 72.2 | mph      |
| Measured free-flow speed, FFS          | 65.0 | mph      |
| Free-flow speed curve                  | 65   | mph      |

Capacity Checks for Segments with Ramps

|                         | Actual |      | Maximum |      | Violation? |
|-------------------------|--------|------|---------|------|------------|
| Entering freeway volume |        | pcph |         | pcph |            |
| Exiting freeway volume  |        | pcph |         | pcph |            |
| On-ramp volume          |        | pcph |         | pcph |            |
| Off-ramp volume         |        | pcph |         | pcph |            |

LOS and Performance Measures

|                                |      |        |
|--------------------------------|------|--------|
| Flow rate, $v_p$               | 735  | pcphpl |
| Average passenger-car speed, S | 65.0 | mph    |
| Volume-to-capacity ratio, v/c  | 0.31 |        |
| Density, D                     | 11.3 | pcpmpl |
| Level of service, LOS          | B    |        |

HCM 2010: Freeway Basic Segment

Basic Operational Analysis

|             |  |
|-------------|--|
| Project     | CSUMB Master Plan EIR                              |
| Freeway     | Southbound State Route 1                           |
| Segment     | SR 1 between Del Monte Boulevard and Imjin Parkway |
| Alternative | Existing   |
| Time period | AM Peak Hour                                       |

Flow Inputs and Adjustments

|                                    |       |      |
|------------------------------------|-------|------|
| Volume, V                          | 4,055 | vph  |
| Peak-hour factor, PHF              | 0.81  |      |
| Peak 15-min volume, $v_{15}$       | 1,252 | veh  |
| Trucks and buses                   | 3.9%  |      |
| Recreational vehicles              | 0.0%  |      |
| Terrain type                       | Level |      |
| Grade                              |       |      |
| Length                             |       | mi   |
| Trucks and buses PCE, $E_T$        | 1.5   |      |
| Recreational vehicle PCE, $E_R$    | 1.2   |      |
| Heavy vehicle adjustment, $f_{HV}$ | 0.981 |      |
| Driver population factor, $f_p$    | 1.00  |      |
| Flow rate, $v_p$                   | 5,104 | pcph |
| Number of lanes, N                 | 3     |      |

Speed Inputs and Adjustments

|  |      |          |
|--|------|----------|
| Lane width                             | 12.0 | ft       |
| Right-side lateral clearance           | >6   | ft       |
| Total ramp density, TRD                | 1.17 | ramps/mi |
| Lane width adjustment, $f_{LW}$        | 0.0  | mph      |
| Lateral clearance adjustment, $f_{LC}$ | 0.0  | mph      |
| TRD adjustment                         | 3.7  | mph      |
| Calculated free-flow speed, FFS        | 71.7 | mph      |
| Measured free-flow speed, FFS          | 65.0 | mph      |
| Free-flow speed curve                  | 65   | mph      |

Capacity Checks for Segments with Ramps

|                         | Actual |      | Maximum |      | Violation? |
|-------------------------|--------|------|---------|------|------------|
| Entering freeway volume |        | pcph |         | pcph |            |
| Exiting freeway volume  |        | pcph |         | pcph |            |
| On-ramp volume          |        | pcph |         | pcph |            |
| Off-ramp volume         |        | pcph |         | pcph |            |

LOS and Performance Measures

|                                |       |        |
|--------------------------------|-------|--------|
| Flow rate, $v_p$               | 1,701 | pcphpl |
| Average passenger-car speed, S | 63.7  | mph    |
| Volume-to-capacity ratio, v/c  | 0.72  |        |
| Density, D                     | 26.7  | pcpmpl |
| Level of service, LOS          | D     |        |

HCM 2010: Freeway Basic Segment

Basic Operational Analysis

|             |  |
|-------------|--|
| Project     | CSUMB Master Plan EIR                              |
| Freeway     | Southbound SR 1                                    |
| Segment     | SR 1 between Del Monte Boulevard and Imjin Parkway |
| Alternative | Existing   |
| Time period | PM Peak Hour                                       |

Flow Inputs and Adjustments

|                                    |       |      |
|------------------------------------|-------|------|
| Volume, V                          | 2,088 | vph  |
| Peak-hour factor, PHF              | 0.95  |      |
| Peak 15-min volume, $v_{15}$       | 549   | veh  |
| Trucks and buses                   | 1.4%  |      |
| Recreational vehicles              | 0.0%  |      |
| Terrain type                       | Level |      |
| Grade                              |       |      |
| Length                             |       | mi   |
| Trucks and buses PCE, $E_T$        | 1.5   |      |
| Recreational vehicle PCE, $E_R$    | 1.2   |      |
| Heavy vehicle adjustment, $f_{HV}$ | 0.993 |      |
| Driver population factor, $f_p$    | 1.00  |      |
| Flow rate, $v_p$                   | 2,213 | pcph |
| Number of lanes, N                 | 3     |      |

Speed Inputs and Adjustments

|  |      |          |
|--|------|----------|
| Lane width                             | 12.0 | ft       |
| Right-side lateral clearance           | >6   | ft       |
| Total ramp density, TRD                | 1.17 | ramps/mi |
| Lane width adjustment, $f_{LW}$        | 0.0  | mph      |
| Lateral clearance adjustment, $f_{LC}$ | 0.0  | mph      |
| TRD adjustment                         | 3.7  | mph      |
| Calculated free-flow speed, FFS        | 71.7 | mph      |
| Measured free-flow speed, FFS          | 65.0 | mph      |
| Free-flow speed curve                  | 65   | mph      |

Capacity Checks for Segments with Ramps

|                         | Actual |      | Maximum |      | Violation? |
|-------------------------|--------|------|---------|------|------------|
| Entering freeway volume |        | pcph |         | pcph |            |
| Exiting freeway volume  |        | pcph |         | pcph |            |
| On-ramp volume          |        | pcph |         | pcph |            |
| Off-ramp volume         |        | pcph |         | pcph |            |

LOS and Performance Measures

|                                |      |        |
|--------------------------------|------|--------|
| Flow rate, $v_p$               | 738  | pcphpl |
| Average passenger-car speed, S | 65.0 | mph    |
| Volume-to-capacity ratio, v/c  | 0.31 |        |
| Density, D                     | 11.3 | pcpmpl |
| Level of service, LOS          | B    |        |

HCM 2010: Freeway Basic Segment

Basic Operational Analysis

|             |   |
|-------------|---|
| Project     | CSUMB Master Plan EIR                             |
| Freeway     | Southbound State Route 1                          |
| Segment     | SR 1 between Imjin Parkway and Lightfighter Drive |
| Alternative | Existing  |
| Time period | AM Peak Hour                                      |

Flow Inputs and Adjustments

|                                    |       |      |
|------------------------------------|-------|------|
| Volume, V                          | 4,560 | vph  |
| Peak-hour factor, PHF              | 0.83  |      |
| Peak 15-min volume, $v_{15}$       | 1,373 | veh  |
| Trucks and buses                   | 3.5%  |      |
| Recreational vehicles              | 0.0%  |      |
| Terrain type                       | Level |      |
| Grade                              |       |      |
| Length                             |       | mi   |
| Trucks and buses PCE, $E_T$        | 1.5   |      |
| Recreational vehicle PCE, $E_R$    | 1.2   |      |
| Heavy vehicle adjustment, $f_{HV}$ | 0.983 |      |
| Driver population factor, $f_p$    | 1.00  |      |
| Flow rate, $v_p$                   | 5,591 | pcph |
| Number of lanes, N                 | 3     |      |

Speed Inputs and Adjustments

|  |      |          |
|--|------|----------|
| Lane width                             | 12.0 | ft       |
| Right-side lateral clearance           | >6   | ft       |
| Total ramp density, TRD                | 1.17 | ramps/mi |
| Lane width adjustment, $f_{LW}$        | 0.0  | mph      |
| Lateral clearance adjustment, $f_{LC}$ | 0.0  | mph      |
| TRD adjustment                         | 3.7  | mph      |
| Calculated free-flow speed, FFS        | 71.7 | mph      |
| Measured free-flow speed, FFS          | 65.0 | mph      |
| Free-flow speed curve                  | 65   | mph      |

Capacity Checks for Segments with Ramps

|                         | Actual |      | Maximum |      | Violation? |
|-------------------------|--------|------|---------|------|------------|
| Entering freeway volume |        | pcph |         | pcph |            |
| Exiting freeway volume  |        | pcph |         | pcph |            |
| On-ramp volume          |        | pcph |         | pcph |            |
| Off-ramp volume         |        | pcph |         | pcph |            |

LOS and Performance Measures

|                                |       |        |
|--------------------------------|-------|--------|
| Flow rate, $v_p$               | 1,864 | pcphpl |
| Average passenger-car speed, S | 62.0  | mph    |
| Volume-to-capacity ratio, v/c  | 0.79  |        |
| Density, D                     | 30.1  | pcpmpl |
| Level of service, LOS          | D     |        |

HCM 2010: Freeway Basic Segment

Basic Operational Analysis

|             |   |
|-------------|---|
| Project     | CSUMB Master Plan EIR                             |
| Freeway     | Southbound SR 1                                   |
| Segment     | SR 1 between Imjin Parkway and Lightfighter Drive |
| Alternative | Existing  |
| Time period | PM Peak Hour                                      |

Flow Inputs and Adjustments

|                                    |       |      |
|------------------------------------|-------|------|
| Volume, V                          | 2,859 | vph  |
| Peak-hour factor, PHF              | 0.95  |      |
| Peak 15-min volume, $v_{15}$       | 752   | veh  |
| Trucks and buses                   | 1.3%  |      |
| Recreational vehicles              | 0.0%  |      |
| Terrain type                       | Level |      |
| Grade                              |       |      |
| Length                             |       | mi   |
| Trucks and buses PCE, $E_T$        | 1.5   |      |
| Recreational vehicle PCE, $E_R$    | 1.2   |      |
| Heavy vehicle adjustment, $f_{HV}$ | 0.994 |      |
| Driver population factor, $f_p$    | 1.00  |      |
| Flow rate, $v_p$                   | 3,028 | pcph |
| Number of lanes, N                 | 3     |      |

Speed Inputs and Adjustments

|  |      |          |
|--|------|----------|
| Lane width                             | 12.0 | ft       |
| Right-side lateral clearance           | >6   | ft       |
| Total ramp density, TRD                | 1.17 | ramps/mi |
| Lane width adjustment, $f_{LW}$        | 0.0  | mph      |
| Lateral clearance adjustment, $f_{LC}$ | 0.0  | mph      |
| TRD adjustment                         | 3.7  | mph      |
| Calculated free-flow speed, FFS        | 71.7 | mph      |
| Measured free-flow speed, FFS          | 65.0 | mph      |
| Free-flow speed curve                  | 65   | mph      |

Capacity Checks for Segments with Ramps

|                         | Actual |      | Maximum |      | Violation? |
|-------------------------|--------|------|---------|------|------------|
| Entering freeway volume |        | pcph |         | pcph |            |
| Exiting freeway volume  |        | pcph |         | pcph |            |
| On-ramp volume          |        | pcph |         | pcph |            |
| Off-ramp volume         |        | pcph |         | pcph |            |

LOS and Performance Measures

|                                |       |        |
|--------------------------------|-------|--------|
| Flow rate, $v_p$               | 1,009 | pcphpl |
| Average passenger-car speed, S | 65.0  | mph    |
| Volume-to-capacity ratio, v/c  | 0.43  |        |
| Density, D                     | 15.5  | pcpmpl |
| Level of service, LOS          | B     |        |

HCM 2010: Freeway Basic Segment

Basic Operational Analysis

|             |   |
|-------------|---|
| Project     | CSUMB Master Plan EIR                                   |
| Freeway     | Southbound State Route 1                                |
| Segment     | SR 1 between Lightfighter Drive and Del Monte Boulevard |
| Alternative | Existing  |
| Time period | AM Peak Hour  |

Flow Inputs and Adjustments

|                                    |       |      |
|------------------------------------|-------|------|
| Volume, V                          | 4,778 | vph  |
| Peak-hour factor, PHF              | 0.86  |      |
| Peak 15-min volume, $v_{15}$       | 1,389 | veh  |
| Trucks and buses                   | 3.2%  |      |
| Recreational vehicles              | 0.0%  |      |
| Terrain type                       | Level |      |
| Grade                              |       |      |
| Length                             |       | mi   |
| Trucks and buses PCE, $E_T$        | 1.5   |      |
| Recreational vehicle PCE, $E_R$    | 1.2   |      |
| Heavy vehicle adjustment, $f_{HV}$ | 0.984 |      |
| Driver population factor, $f_p$    | 1.00  |      |
| Flow rate, $v_p$                   | 5,645 | pcph |
| Number of lanes, N                 | 3     |      |

Speed Inputs and Adjustments

|  |      |          |
|--|------|----------|
| Lane width                             | 12.0 | ft       |
| Right-side lateral clearance           | >6   | ft       |
| Total ramp density, TRD                | 1.33 | ramps/mi |
| Lane width adjustment, $f_{LW}$        | 0.0  | mph      |
| Lateral clearance adjustment, $f_{LC}$ | 0.0  | mph      |
| TRD adjustment                         | 4.1  | mph      |
| Calculated free-flow speed, FFS        | 71.3 | mph      |
| Measured free-flow speed, FFS          | 65.0 | mph      |
| Free-flow speed curve                  | 65   | mph      |

Capacity Checks for Segments with Ramps

|                         | Actual |      | Maximum |      | Violation? |
|-------------------------|--------|------|---------|------|------------|
| Entering freeway volume |        | pcph |         | pcph |            |
| Exiting freeway volume  |        | pcph |         | pcph |            |
| On-ramp volume          |        | pcph |         | pcph |            |
| Off-ramp volume         |        | pcph |         | pcph |            |

LOS and Performance Measures

|                                |       |        |
|--------------------------------|-------|--------|
| Flow rate, $v_p$               | 1,882 | pcphpl |
| Average passenger-car speed, S | 61.7  | mph    |
| Volume-to-capacity ratio, v/c  | 0.80  |        |
| Density, D                     | 30.5  | pcpmpl |
| Level of service, LOS          | D     |        |



HCM 2010: Freeway Basic Segment

Basic Operational Analysis

|             |   |
|-------------|---|
| Project     | CSUMB Master Plan EIR                                   |
| Freeway     | Southbound SR 1   |
| Segment     | SR 1 between Lightfighter Drive and Del Monte Boulevard |
| Alternative | Existing  |
| Time period | PM Peak Hour  |

Flow Inputs and Adjustments

|                                    |       |      |
|------------------------------------|-------|------|
| Volume, V                          | 3,177 | vph  |
| Peak-hour factor, PHF              | 0.97  |      |
| Peak 15-min volume, $v_{15}$       | 819   | veh  |
| Trucks and buses                   | 1.1%  |      |
| Recreational vehicles              | 0.0%  |      |
| Terrain type                       | Level |      |
| Grade                              |       |      |
| Length                             |       | mi   |
| Trucks and buses PCE, $E_T$        | 1.5   |      |
| Recreational vehicle PCE, $E_R$    | 1.2   |      |
| Heavy vehicle adjustment, $f_{HV}$ | 0.994 |      |
| Driver population factor, $f_p$    | 1.00  |      |
| Flow rate, $v_p$                   | 3,294 | pcph |
| Number of lanes, N                 | 3     |      |

Speed Inputs and Adjustments

|  |      |          |
|--|------|----------|
| Lane width                             | 12.0 | ft       |
| Right-side lateral clearance           | >6   | ft       |
| Total ramp density, TRD                | 1.33 | ramps/mi |
| Lane width adjustment, $f_{LW}$        | 0.0  | mph      |
| Lateral clearance adjustment, $f_{LC}$ | 0.0  | mph      |
| TRD adjustment                         | 4.1  | mph      |
| Calculated free-flow speed, FFS        | 71.3 | mph      |
| Measured free-flow speed, FFS          | 65.0 | mph      |
| Free-flow speed curve                  | 65   | mph      |

Capacity Checks for Segments with Ramps

|                         | Actual |      | Maximum |      | Violation? |
|-------------------------|--------|------|---------|------|------------|
| Entering freeway volume |        | pcph |         | pcph |            |
| Exiting freeway volume  |        | pcph |         | pcph |            |
| On-ramp volume          |        | pcph |         | pcph |            |
| Off-ramp volume         |        | pcph |         | pcph |            |

LOS and Performance Measures

|                                |       |        |
|--------------------------------|-------|--------|
| Flow rate, $v_p$               | 1,098 | pcphpl |
| Average passenger-car speed, S | 65.0  | mph    |
| Volume-to-capacity ratio, v/c  | 0.47  |        |
| Density, D                     | 16.9  | pcpmpl |
| Level of service, LOS          | B     |        |

HCM 2010: Freeway Basic Segment

Basic Operational Analysis

|             |   |
|-------------|---|
| Project     | CSUMB Master Plan EIR   |
| Freeway     | Southbound State Route 1                                      |
| Segment     | SR 1 between Del Monte Boulevard and Canyon Del Rey Boulevard |
| Alternative | Existing  |
| Time period | AM Peak Hour  |

Flow Inputs and Adjustments

|                                    |       |      |
|------------------------------------|-------|------|
| Volume, V                          | 3,843 | vph  |
| Peak-hour factor, PHF              | 0.95  |      |
| Peak 15-min volume, $v_{15}$       | 1,011 | veh  |
| Trucks and buses                   | 2.4%  |      |
| Recreational vehicles              | 0.0%  |      |
| Terrain type                       | Level |      |
| Grade                              |       |      |
| Length                             |       | mi   |
| Trucks and buses PCE, $E_T$        | 1.5   |      |
| Recreational vehicle PCE, $E_R$    | 1.2   |      |
| Heavy vehicle adjustment, $f_{HV}$ | 0.988 |      |
| Driver population factor, $f_p$    | 1.00  |      |
| Flow rate, $v_p$                   | 4,095 | pcph |
| Number of lanes, N                 | 2     |      |

Speed Inputs and Adjustments

|  |      |          |
|--|------|----------|
| Lane width                             | 12.0 | ft       |
| Right-side lateral clearance           | 5.0  | ft       |
| Total ramp density, TRD                | 2.17 | ramps/mi |
| Lane width adjustment, $f_{LW}$        | 0.0  | mph      |
| Lateral clearance adjustment, $f_{LC}$ | 0.6  | mph      |
| TRD adjustment                         | 6.2  | mph      |
| Calculated free-flow speed, FFS        | 68.6 | mph      |
| Measured free-flow speed, FFS          | 65.0 | mph      |
| Free-flow speed curve                  | 65   | mph      |

Capacity Checks for Segments with Ramps

|                         | Actual |      | Maximum |      | Violation? |
|-------------------------|--------|------|---------|------|------------|
| Entering freeway volume |        | pcph |         | pcph |            |
| Exiting freeway volume  |        | pcph |         | pcph |            |
| On-ramp volume          |        | pcph |         | pcph |            |
| Off-ramp volume         |        | pcph |         | pcph |            |

LOS and Performance Measures

|                                |       |        |
|--------------------------------|-------|--------|
| Flow rate, $v_p$               | 2,047 | pcphpl |
| Average passenger-car speed, S | 59.1  | mph    |
| Volume-to-capacity ratio, v/c  | 0.87  |        |
| Density, D                     | 34.7  | pcpmpl |
| Level of service, LOS          | D     |        |

HCM 2010: Freeway Basic Segment

Basic Operational Analysis

|             |   |
|-------------|---|
| Project     | CSUMB Master Plan EIR   |
| Freeway     | Southbound SR 1   |
| Segment     | SR 1 between Del Monte Boulevard and Canyon Del Rey Boulevard |
| Alternative | Existing  |
| Time period | PM Peak Hour  |

Flow Inputs and Adjustments

|                                    |       |      |
|------------------------------------|-------|------|
| Volume, V                          | 2,629 | vph  |
| Peak-hour factor, PHF              | 0.96  |      |
| Peak 15-min volume, $v_{15}$       | 685   | veh  |
| Trucks and buses                   | 1.0%  |      |
| Recreational vehicles              | 0.0%  |      |
| Terrain type                       | Level |      |
| Grade                              |       |      |
| Length                             |       | mi   |
| Trucks and buses PCE, $E_T$        | 1.5   |      |
| Recreational vehicle PCE, $E_R$    | 1.2   |      |
| Heavy vehicle adjustment, $f_{HV}$ | 0.995 |      |
| Driver population factor, $f_p$    | 1.00  |      |
| Flow rate, $v_p$                   | 2,752 | pcph |
| Number of lanes, N                 | 2     |      |

Speed Inputs and Adjustments

|  |      |          |
|--|------|----------|
| Lane width                             | 12.0 | ft       |
| Right-side lateral clearance           | 5.0  | ft       |
| Total ramp density, TRD                | 2.17 | ramps/mi |
| Lane width adjustment, $f_{LW}$        | 0.0  | mph      |
| Lateral clearance adjustment, $f_{LC}$ | 0.6  | mph      |
| TRD adjustment                         | 6.2  | mph      |
| Calculated free-flow speed, FFS        | 68.6 | mph      |
| Measured free-flow speed, FFS          | 65.0 | mph      |
| Free-flow speed curve                  | 65   | mph      |

Capacity Checks for Segments with Ramps

|                         | Actual |      | Maximum |      | Violation? |
|-------------------------|--------|------|---------|------|------------|
| Entering freeway volume |        | pcph |         | pcph |            |
| Exiting freeway volume  |        | pcph |         | pcph |            |
| On-ramp volume          |        | pcph |         | pcph |            |
| Off-ramp volume         |        | pcph |         | pcph |            |

LOS and Performance Measures

|                                |       |        |
|--------------------------------|-------|--------|
| Flow rate, $v_p$               | 1,376 | pcphpl |
| Average passenger-car speed, S | 65.0  | mph    |
| Volume-to-capacity ratio, v/c  | 0.59  |        |
| Density, D                     | 21.2  | pcpmpl |
| Level of service, LOS          | C     |        |

HCM 2010: Freeway Basic Segment

Basic Operational Analysis

|             |   |
|-------------|---|
| Project     | CSUMB Master Plan EIR                                 |
| Freeway     | Northbound State Route 1                              |
| Segment     | SR 1 between Reservation Road and Del Monte Boulevard |
| Alternative | Existing  |
| Time period | AM Peak Hour  |

Flow Inputs and Adjustments

|                                    |       |      |
|------------------------------------|-------|------|
| Volume, V                          | 1,172 | vph  |
| Peak-hour factor, PHF              | 0.97  |      |
| Peak 15-min volume, $v_{15}$       | 302   | veh  |
| Trucks and buses                   | 6.4%  |      |
| Recreational vehicles              | 0.0%  |      |
| Terrain type                       | Level |      |
| Grade                              |       |      |
| Length                             |       | mi   |
| Trucks and buses PCE, $E_T$        | 1.5   |      |
| Recreational vehicle PCE, $E_R$    | 1.2   |      |
| Heavy vehicle adjustment, $f_{HV}$ | 0.969 |      |
| Driver population factor, $f_p$    | 1.00  |      |
| Flow rate, $v_p$                   | 1,247 | pcph |
| Number of lanes, N                 | 2     |      |

Speed Inputs and Adjustments

|  |      |          |
|--|------|----------|
| Lane width                             | 12.0 | ft       |
| Right-side lateral clearance           | >6   | ft       |
| Total ramp density, TRD                | 1.00 | ramps/mi |
| Lane width adjustment, $f_{LW}$        | 0.0  | mph      |
| Lateral clearance adjustment, $f_{LC}$ | 0.0  | mph      |
| TRD adjustment                         | 3.2  | mph      |
| Calculated free-flow speed, FFS        | 72.2 | mph      |
| Measured free-flow speed, FFS          | 65.0 | mph      |
| Free-flow speed curve                  | 65   | mph      |

Capacity Checks for Segments with Ramps

|                         | Actual |      | Maximum |      | Violation? |
|-------------------------|--------|------|---------|------|------------|
| Entering freeway volume |        | pcph |         | pcph |            |
| Exiting freeway volume  |        | pcph |         | pcph |            |
| On-ramp volume          |        | pcph |         | pcph |            |
| Off-ramp volume         |        | pcph |         | pcph |            |

LOS and Performance Measures

|                                |      |        |
|--------------------------------|------|--------|
| Flow rate, $v_p$               | 623  | pcphpl |
| Average passenger-car speed, S | 65.0 | mph    |
| Volume-to-capacity ratio, v/c  | 0.27 |        |
| Density, D                     | 9.6  | pcpmpl |
| Level of service, LOS          | A    |        |

HCM 2010: Freeway Basic Segment

Basic Operational Analysis

|             |   |
|-------------|---|
| Project     | CSUMB Master Plan EIR                                 |
| Freeway     | Northbound State Route 1                              |
| Segment     | SR 1 between Reservation Road and Del Monte Boulevard |
| Alternative | Existing  |
| Time period | PM Peak Hour  |

Flow Inputs and Adjustments

|                                    |       |      |
|------------------------------------|-------|------|
| Volume, V                          | 2,671 | vph  |
| Peak-hour factor, PHF              | 0.98  |      |
| Peak 15-min volume, $v_{15}$       | 681   | veh  |
| Trucks and buses                   | 2.2%  |      |
| Recreational vehicles              | 0.0%  |      |
| Terrain type                       | Level |      |
| Grade                              |       |      |
| Length                             |       | mi   |
| Trucks and buses PCE, $E_T$        | 1.5   |      |
| Recreational vehicle PCE, $E_R$    | 1.2   |      |
| Heavy vehicle adjustment, $f_{HV}$ | 0.989 |      |
| Driver population factor, $f_p$    | 1.00  |      |
| Flow rate, $v_p$                   | 2,755 | pcph |
| Number of lanes, N                 | 2     |      |

Speed Inputs and Adjustments

|  |      |          |
|--|------|----------|
| Lane width                             | 12.0 | ft       |
| Right-side lateral clearance           | >6   | ft       |
| Total ramp density, TRD                | 1.00 | ramps/mi |
| Lane width adjustment, $f_{LW}$        | 0.0  | mph      |
| Lateral clearance adjustment, $f_{LC}$ | 0.0  | mph      |
| TRD adjustment                         | 3.2  | mph      |
| Calculated free-flow speed, FFS        | 72.2 | mph      |
| Measured free-flow speed, FFS          | 65.0 | mph      |
| Free-flow speed curve                  | 65   | mph      |

Capacity Checks for Segments with Ramps

|                         | Actual |      | Maximum |      | Violation? |
|-------------------------|--------|------|---------|------|------------|
| Entering freeway volume |        | pcph |         | pcph |            |
| Exiting freeway volume  |        | pcph |         | pcph |            |
| On-ramp volume          |        | pcph |         | pcph |            |
| Off-ramp volume         |        | pcph |         | pcph |            |

LOS and Performance Measures

|                                |       |        |
|--------------------------------|-------|--------|
| Flow rate, $v_p$               | 1,378 | pcphpl |
| Average passenger-car speed, S | 65.0  | mph    |
| Volume-to-capacity ratio, v/c  | 0.59  |        |
| Density, D                     | 21.2  | pcpmpl |
| Level of service, LOS          | C     |        |

HCM 2010: Freeway Basic Segment

Basic Operational Analysis

|             |  |
|-------------|--|
| Project     | CSUMB Master Plan EIR                              |
| Freeway     | Northbound State Route 1                           |
| Segment     | SR 1 between Del Monte Boulevard and Imjin Parkway |
| Alternative | Existing   |
| Time period | AM Peak Hour                                       |

Flow Inputs and Adjustments

|                                    |       |      |
|------------------------------------|-------|------|
| Volume, V                          | 1,725 | vph  |
| Peak-hour factor, PHF              | 0.92  |      |
| Peak 15-min volume, $v_{15}$       | 469   | veh  |
| Trucks and buses                   | 5.7%  |      |
| Recreational vehicles              | 0.0%  |      |
| Terrain type                       | Level |      |
| Grade                              |       |      |
| Length                             |       | mi   |
| Trucks and buses PCE, $E_T$        | 1.5   |      |
| Recreational vehicle PCE, $E_R$    | 1.2   |      |
| Heavy vehicle adjustment, $f_{HV}$ | 0.972 |      |
| Driver population factor, $f_p$    | 1.00  |      |
| Flow rate, $v_p$                   | 1,929 | pcph |
| Number of lanes, N                 | 3     |      |

Speed Inputs and Adjustments

|  |      |          |
|--|------|----------|
| Lane width                             | 12.0 | ft       |
| Right-side lateral clearance           | >6   | ft       |
| Total ramp density, TRD                | 1.20 | ramps/mi |
| Lane width adjustment, $f_{LW}$        | 0.0  | mph      |
| Lateral clearance adjustment, $f_{LC}$ | 0.0  | mph      |
| TRD adjustment                         | 3.8  | mph      |
| Calculated free-flow speed, FFS        | 71.6 | mph      |
| Measured free-flow speed, FFS          | 65.0 | mph      |
| Free-flow speed curve                  | 65   | mph      |

Capacity Checks for Segments with Ramps

|                         | Actual |      | Maximum |      | Violation? |
|-------------------------|--------|------|---------|------|------------|
| Entering freeway volume |        | pcph |         | pcph |            |
| Exiting freeway volume  |        | pcph |         | pcph |            |
| On-ramp volume          |        | pcph |         | pcph |            |
| Off-ramp volume         |        | pcph |         | pcph |            |

LOS and Performance Measures

|                                |      |        |
|--------------------------------|------|--------|
| Flow rate, $v_p$               | 643  | pcphpl |
| Average passenger-car speed, S | 65.0 | mph    |
| Volume-to-capacity ratio, v/c  | 0.27 |        |
| Density, D                     | 9.9  | pcpmpl |
| Level of service, LOS          | A    |        |

HCM 2010: Freeway Basic Segment

Basic Operational Analysis

|             |  |
|-------------|--|
| Project     | CSUMB Master Plan EIR                              |
| Freeway     | Northbound State Route 1                           |
| Segment     | SR 1 between Del Monte Boulevard and Imjin Parkway |
| Alternative | Existing   |
| Time period | PM Peak Hour                                       |

Flow Inputs and Adjustments

|                                    |       |      |
|------------------------------------|-------|------|
| Volume, V                          | 4,231 | vph  |
| Peak-hour factor, PHF              | 0.96  |      |
| Peak 15-min volume, $v_{15}$       | 1,102 | veh  |
| Trucks and buses                   | 1.9%  |      |
| Recreational vehicles              | 0.0%  |      |
| Terrain type                       | Level |      |
| Grade                              |       |      |
| Length                             |       | mi   |
| Trucks and buses PCE, $E_T$        | 1.5   |      |
| Recreational vehicle PCE, $E_R$    | 1.2   |      |
| Heavy vehicle adjustment, $f_{HV}$ | 0.991 |      |
| Driver population factor, $f_p$    | 1.00  |      |
| Flow rate, $v_p$                   | 4,449 | pcph |
| Number of lanes, N                 | 3     |      |

Speed Inputs and Adjustments

|  |      |          |
|--|------|----------|
| Lane width                             | 12.0 | ft       |
| Right-side lateral clearance           | >6   | ft       |
| Total ramp density, TRD                | 1.17 | ramps/mi |
| Lane width adjustment, $f_{LW}$        | 0.0  | mph      |
| Lateral clearance adjustment, $f_{LC}$ | 0.0  | mph      |
| TRD adjustment                         | 3.7  | mph      |
| Calculated free-flow speed, FFS        | 71.7 | mph      |
| Measured free-flow speed, FFS          | 65.0 | mph      |
| Free-flow speed curve                  | 65   | mph      |

Capacity Checks for Segments with Ramps

|                         | Actual |      | Maximum |      | Violation? |
|-------------------------|--------|------|---------|------|------------|
| Entering freeway volume |        | pcph |         | pcph |            |
| Exiting freeway volume  |        | pcph |         | pcph |            |
| On-ramp volume          |        | pcph |         | pcph |            |
| Off-ramp volume         |        | pcph |         | pcph |            |

LOS and Performance Measures

|                                |       |        |
|--------------------------------|-------|--------|
| Flow rate, $v_p$               | 1,483 | pcphpl |
| Average passenger-car speed, S | 64.9  | mph    |
| Volume-to-capacity ratio, v/c  | 0.63  |        |
| Density, D                     | 22.8  | pcpmpl |
| Level of service, LOS          | C     |        |

HCM 2010: Freeway Basic Segment

Basic Operational Analysis

|             |   |
|-------------|---|
| Project     | CSUMB Master Plan EIR                             |
| Freeway     | Northbound State Route 1                          |
| Segment     | SR 1 between Imjin Parkway and Lightfighter Drive |
| Alternative | Existing  |
| Time period | AM Peak Hour                                      |

Flow Inputs and Adjustments

|                                    |       |      |
|------------------------------------|-------|------|
| Volume, V                          | 2,397 | vph  |
| Peak-hour factor, PHF              | 0.92  |      |
| Peak 15-min volume, $v_{15}$       | 653   | veh  |
| Trucks and buses                   | 3.8%  |      |
| Recreational vehicles              | 0.0%  |      |
| Terrain type                       | Level |      |
| Grade                              |       |      |
| Length                             |       | mi   |
| Trucks and buses PCE, $E_T$        | 1.5   |      |
| Recreational vehicle PCE, $E_R$    | 1.2   |      |
| Heavy vehicle adjustment, $f_{HV}$ | 0.982 |      |
| Driver population factor, $f_p$    | 1.00  |      |
| Flow rate, $v_p$                   | 2,661 | pcph |
| Number of lanes, N                 | 3     |      |

Speed Inputs and Adjustments

|  |      |          |
|--|------|----------|
| Lane width                             | 12.0 | ft       |
| Right-side lateral clearance           | >6   | ft       |
| Total ramp density, TRD                | 1.17 | ramps/mi |
| Lane width adjustment, $f_{LW}$        | 0.0  | mph      |
| Lateral clearance adjustment, $f_{LC}$ | 0.0  | mph      |
| TRD adjustment                         | 3.7  | mph      |
| Calculated free-flow speed, FFS        | 71.7 | mph      |
| Measured free-flow speed, FFS          | 65.0 | mph      |
| Free-flow speed curve                  | 65   | mph      |

Capacity Checks for Segments with Ramps

|                         | Actual |      | Maximum |      | Violation? |
|-------------------------|--------|------|---------|------|------------|
| Entering freeway volume |        | pcph |         | pcph |            |
| Exiting freeway volume  |        | pcph |         | pcph |            |
| On-ramp volume          |        | pcph |         | pcph |            |
| Off-ramp volume         |        | pcph |         | pcph |            |

LOS and Performance Measures

|                                |      |        |
|--------------------------------|------|--------|
| Flow rate, $v_p$               | 887  | pcphpl |
| Average passenger-car speed, S | 65.0 | mph    |
| Volume-to-capacity ratio, v/c  | 0.38 |        |
| Density, D                     | 13.6 | pcpmpl |
| Level of service, LOS          | B    |        |



HCM 2010: Freeway Basic Segment

Basic Operational Analysis

|             |   |
|-------------|---|
| Project     | CSUMB Master Plan EIR                             |
| Freeway     | Northbound State Route 1                          |
| Segment     | SR 1 between Imjin Parkway and Lightfighter Drive |
| Alternative | Existing  |
| Time period | PM Peak Hour                                      |

Flow Inputs and Adjustments

|                                    |       |      |
|------------------------------------|-------|------|
| Volume, V                          | 4,906 | vph  |
| Peak-hour factor, PHF              | 0.97  |      |
| Peak 15-min volume, $v_{15}$       | 1,264 | veh  |
| Trucks and buses                   | 1.7%  |      |
| Recreational vehicles              | 0.0%  |      |
| Terrain type                       | Level |      |
| Grade                              |       |      |
| Length                             |       | mi   |
| Trucks and buses PCE, $E_T$        | 1.5   |      |
| Recreational vehicle PCE, $E_R$    | 1.2   |      |
| Heavy vehicle adjustment, $f_{HV}$ | 0.991 |      |
| Driver population factor, $f_p$    | 1.00  |      |
| Flow rate, $v_p$                   | 5,102 | pcph |
| Number of lanes, N                 | 3     |      |

Speed Inputs and Adjustments

|  |      |          |
|--|------|----------|
| Lane width                             | 12.0 | ft       |
| Right-side lateral clearance           | >6   | ft       |
| Total ramp density, TRD                | 1.17 | ramps/mi |
| Lane width adjustment, $f_{LW}$        | 0.0  | mph      |
| Lateral clearance adjustment, $f_{LC}$ | 0.0  | mph      |
| TRD adjustment                         | 3.7  | mph      |
| Calculated free-flow speed, FFS        | 71.7 | mph      |
| Measured free-flow speed, FFS          | 65.0 | mph      |
| Free-flow speed curve                  | 65   | mph      |

Capacity Checks for Segments with Ramps

|                         | Actual |      | Maximum |      | Violation? |
|-------------------------|--------|------|---------|------|------------|
| Entering freeway volume |        | pcph |         | pcph |            |
| Exiting freeway volume  |        | pcph |         | pcph |            |
| On-ramp volume          |        | pcph |         | pcph |            |
| Off-ramp volume         |        | pcph |         | pcph |            |

LOS and Performance Measures

|                                |       |        |
|--------------------------------|-------|--------|
| Flow rate, $v_p$               | 1,701 | pcphpl |
| Average passenger-car speed, S | 63.7  | mph    |
| Volume-to-capacity ratio, v/c  | 0.72  |        |
| Density, D                     | 26.7  | pcpmpl |
| Level of service, LOS          | D     |        |

HCM 2010: Freeway Basic Segment

Basic Operational Analysis

|             |   |
|-------------|---|
| Project     | CSUMB Master Plan EIR                                   |
| Freeway     | Northbound State Route 1                                |
| Segment     | SR 1 between Lightfighter Drive and Del Monte Boulevard |
| Alternative | Existing  |
| Time period | AM Peak Hour  |

Flow Inputs and Adjustments

|                                    |       |      |
|------------------------------------|-------|------|
| Volume, V                          | 2,708 | vph  |
| Peak-hour factor, PHF              | 0.93  |      |
| Peak 15-min volume, $v_{15}$       | 725   | veh  |
| Trucks and buses                   | 3.8%  |      |
| Recreational vehicles              | 0.0%  |      |
| Terrain type                       | Level |      |
| Grade                              |       |      |
| Length                             |       | mi   |
| Trucks and buses PCE, $E_T$        | 1.5   |      |
| Recreational vehicle PCE, $E_R$    | 1.2   |      |
| Heavy vehicle adjustment, $f_{HV}$ | 0.982 |      |
| Driver population factor, $f_p$    | 1.00  |      |
| Flow rate, $v_p$                   | 2,955 | pcph |
| Number of lanes, N                 | 3     |      |

Speed Inputs and Adjustments

|  |      |          |
|--|------|----------|
| Lane width                             | 12.0 | ft       |
| Right-side lateral clearance           | >6   | ft       |
| Total ramp density, TRD                | 1.17 | ramps/mi |
| Lane width adjustment, $f_{LW}$        | 0.0  | mph      |
| Lateral clearance adjustment, $f_{LC}$ | 0.0  | mph      |
| TRD adjustment                         | 3.7  | mph      |
| Calculated free-flow speed, FFS        | 71.7 | mph      |
| Measured free-flow speed, FFS          | 65.0 | mph      |
| Free-flow speed curve                  | 65   | mph      |

Capacity Checks for Segments with Ramps

|                         | Actual |      | Maximum |      | Violation? |
|-------------------------|--------|------|---------|------|------------|
| Entering freeway volume |        | pcph |         | pcph |            |
| Exiting freeway volume  |        | pcph |         | pcph |            |
| On-ramp volume          |        | pcph |         | pcph |            |
| Off-ramp volume         |        | pcph |         | pcph |            |

LOS and Performance Measures

|                                |      |        |
|--------------------------------|------|--------|
| Flow rate, $v_p$               | 985  | pcphpl |
| Average passenger-car speed, S | 65.0 | mph    |
| Volume-to-capacity ratio, v/c  | 0.42 |        |
| Density, D                     | 15.2 | pcpmpl |
| Level of service, LOS          | B    |        |

HCM 2010: Freeway Basic Segment

Basic Operational Analysis

|             |   |
|-------------|---|
| Project     | CSUMB Master Plan EIR                                   |
| Freeway     | Northbound State Route 1                                |
| Segment     | SR 1 between Lightfighter Drive and Del Monte Boulevard |
| Alternative | Existing  |
| Time period | PM Peak Hour  |

Flow Inputs and Adjustments

|                                    |       |      |
|------------------------------------|-------|------|
| Volume, V                          | 4,728 | vph  |
| Peak-hour factor, PHF              | 0.98  |      |
| Peak 15-min volume, $v_{15}$       | 1,206 | veh  |
| Trucks and buses                   | 1.9%  |      |
| Recreational vehicles              | 0.0%  |      |
| Terrain type                       | Level |      |
| Grade                              |       |      |
| Length                             |       | mi   |
| Trucks and buses PCE, $E_T$        | 1.5   |      |
| Recreational vehicle PCE, $E_R$    | 1.2   |      |
| Heavy vehicle adjustment, $f_{HV}$ | 0.991 |      |
| Driver population factor, $f_p$    | 1.00  |      |
| Flow rate, $v_p$                   | 4,870 | pcph |
| Number of lanes, N                 | 3     |      |

Speed Inputs and Adjustments

|  |      |          |
|--|------|----------|
| Lane width                             | 12.0 | ft       |
| Right-side lateral clearance           | >6   | ft       |
| Total ramp density, TRD                | 1.17 | ramps/mi |
| Lane width adjustment, $f_{LW}$        | 0.0  | mph      |
| Lateral clearance adjustment, $f_{LC}$ | 0.0  | mph      |
| TRD adjustment                         | 3.7  | mph      |
| Calculated free-flow speed, FFS        | 71.7 | mph      |
| Measured free-flow speed, FFS          | 65.0 | mph      |
| Free-flow speed curve                  | 65   | mph      |

Capacity Checks for Segments with Ramps

|                         | Actual |      | Maximum |      | Violation? |
|-------------------------|--------|------|---------|------|------------|
| Entering freeway volume |        | pcph |         | pcph |            |
| Exiting freeway volume  |        | pcph |         | pcph |            |
| On-ramp volume          |        | pcph |         | pcph |            |
| Off-ramp volume         |        | pcph |         | pcph |            |

LOS and Performance Measures

|                                |       |        |
|--------------------------------|-------|--------|
| Flow rate, $v_p$               | 1,623 | pcphpl |
| Average passenger-car speed, S | 64.3  | mph    |
| Volume-to-capacity ratio, v/c  | 0.69  |        |
| Density, D                     | 25.2  | pcpmpl |
| Level of service, LOS          | C     |        |

HCM 2010: Freeway Basic Segment

Basic Operational Analysis

|             |   |
|-------------|---|
| Project     | CSUMB Master Plan EIR   |
| Freeway     | Northbound State Route 1                                      |
| Segment     | SR 1 between Del Monte Boulevard and Canyon Del Rey Boulevard |
| Alternative | Existing  |
| Time period | AM Peak Hour  |

Flow Inputs and Adjustments

|                                    |       |      |
|------------------------------------|-------|------|
| Volume, V                          | 2,355 | vph  |
| Peak-hour factor, PHF              | 0.92  |      |
| Peak 15-min volume, $v_{15}$       | 643   | veh  |
| Trucks and buses                   | 3.2%  |      |
| Recreational vehicles              | 0.0%  |      |
| Terrain type                       | Level |      |
| Grade                              |       |      |
| Length                             |       | mi   |
| Trucks and buses PCE, $E_T$        | 1.5   |      |
| Recreational vehicle PCE, $E_R$    | 1.2   |      |
| Heavy vehicle adjustment, $f_{HV}$ | 0.984 |      |
| Driver population factor, $f_p$    | 1.00  |      |
| Flow rate, $v_p$                   | 2,613 | pcph |
| Number of lanes, N                 | 2     |      |

Speed Inputs and Adjustments

|  |      |          |
|--|------|----------|
| Lane width                             | 12.0 | ft       |
| Right-side lateral clearance           | >6   | ft       |
| Total ramp density, TRD                | 2.00 | ramps/mi |
| Lane width adjustment, $f_{LW}$        | 0.0  | mph      |
| Lateral clearance adjustment, $f_{LC}$ | 0.0  | mph      |
| TRD adjustment                         | 5.8  | mph      |
| Calculated free-flow speed, FFS        | 69.6 | mph      |
| Measured free-flow speed, FFS          | 65.0 | mph      |
| Free-flow speed curve                  | 65   | mph      |

Capacity Checks for Segments with Ramps

|                         | Actual |      | Maximum |      | Violation? |
|-------------------------|--------|------|---------|------|------------|
| Entering freeway volume |        | pcph |         | pcph |            |
| Exiting freeway volume  |        | pcph |         | pcph |            |
| On-ramp volume          |        | pcph |         | pcph |            |
| Off-ramp volume         |        | pcph |         | pcph |            |

LOS and Performance Measures

|                                |       |        |
|--------------------------------|-------|--------|
| Flow rate, $v_p$               | 1,307 | pcphpl |
| Average passenger-car speed, S | 65.0  | mph    |
| Volume-to-capacity ratio, v/c  | 0.56  |        |
| Density, D                     | 20.1  | pcpmpl |
| Level of service, LOS          | C     |        |

HCM 2010: Freeway Basic Segment

Basic Operational Analysis

|             |   |
|-------------|---|
| Project     | CSUMB Master Plan EIR   |
| Freeway     | Northbound State Route 1                                      |
| Segment     | SR 1 between Del Monte Boulevard and Canyon Del Rey Boulevard |
| Alternative | Existing  |
| Time period | PM Peak Hour  |

Flow Inputs and Adjustments

|                                    |       |      |
|------------------------------------|-------|------|
| Volume, V                          | 3,745 | vph  |
| Peak-hour factor, PHF              | 0.97  |      |
| Peak 15-min volume, $v_{15}$       | 965   | veh  |
| Trucks and buses                   | 2.0%  |      |
| Recreational vehicles              | 0.0%  |      |
| Terrain type                       | Level |      |
| Grade                              |       |      |
| Length                             |       | mi   |
| Trucks and buses PCE, $E_T$        | 1.5   |      |
| Recreational vehicle PCE, $E_R$    | 1.2   |      |
| Heavy vehicle adjustment, $f_{HV}$ | 0.990 |      |
| Driver population factor, $f_p$    | 1.00  |      |
| Flow rate, $v_p$                   | 3,900 | pcph |
| Number of lanes, N                 | 2     |      |

Speed Inputs and Adjustments

|  |      |          |
|--|------|----------|
| Lane width                             | 12.0 | ft       |
| Right-side lateral clearance           | >6   | ft       |
| Total ramp density, TRD                | 2.00 | ramps/mi |
| Lane width adjustment, $f_{LW}$        | 0.0  | mph      |
| Lateral clearance adjustment, $f_{LC}$ | 0.0  | mph      |
| TRD adjustment                         | 5.8  | mph      |
| Calculated free-flow speed, FFS        | 69.6 | mph      |
| Measured free-flow speed, FFS          | 65.0 | mph      |
| Free-flow speed curve                  | 65   | mph      |

Capacity Checks for Segments with Ramps

|                         | Actual |      | Maximum |      | Violation? |
|-------------------------|--------|------|---------|------|------------|
| Entering freeway volume |        | pcph |         | pcph |            |
| Exiting freeway volume  |        | pcph |         | pcph |            |
| On-ramp volume          |        | pcph |         | pcph |            |
| Off-ramp volume         |        | pcph |         | pcph |            |

LOS and Performance Measures

|                                |       |        |
|--------------------------------|-------|--------|
| Flow rate, $v_p$               | 1,950 | pcphpl |
| Average passenger-car speed, S | 60.7  | mph    |
| Volume-to-capacity ratio, v/c  | 0.83  |        |
| Density, D                     | 32.1  | pcpmpl |
| Level of service, LOS          | D     |        |

HCM 2010: Freeway Basic Segment

Basic Operational Analysis

|             |   |
|-------------|---|
| Project     | CSUMB Master Plan EIR                                 |
| Freeway     | Southbound State Route 1                              |
| Segment     | SR 1 between Reservation Road and Del Monte Boulevard |
| Alternative | Existing with Project                                 |
| Time period | AM Peak Hour  |

Flow Inputs and Adjustments

|                                    |       |      |
|------------------------------------|-------|------|
| Volume, V                          | 2,790 | vph  |
| Peak-hour factor, PHF              | 0.76  |      |
| Peak 15-min volume, $v_{15}$       | 918   | veh  |
| Trucks and buses                   | 4.7%  |      |
| Recreational vehicles              | 0.0%  |      |
| Terrain type                       | Level |      |
| Grade                              |       |      |
| Length                             |       | mi   |
| Trucks and buses PCE, $E_T$        | 1.5   |      |
| Recreational vehicle PCE, $E_R$    | 1.2   |      |
| Heavy vehicle adjustment, $f_{HV}$ | 0.977 |      |
| Driver population factor, $f_P$    | 1.00  |      |
| Flow rate, $v_p$                   | 3,757 | pcph |
| Number of lanes, N                 | 2     |      |

Speed Inputs and Adjustments

|  |      |          |
|--|------|----------|
| Lane width                             | 12.0 | ft       |
| Right-side lateral clearance           | >6   | ft       |
| Total ramp density, TRD                | 1.00 | ramps/mi |
| Lane width adjustment, $f_{LW}$        | 0.0  | mph      |
| Lateral clearance adjustment, $f_{LC}$ | 0.0  | mph      |
| TRD adjustment                         | 3.2  | mph      |
| Calculated free-flow speed, FFS        | 72.2 | mph      |
| Measured free-flow speed, FFS          | 65.0 | mph      |
| Free-flow speed curve                  | 65   | mph      |

Capacity Checks for Segments with Ramps

|                         | <u>Actual</u> |      | <u>Maximum</u> |      | <u>Violation?</u> |
|-------------------------|---------------|------|----------------|------|-------------------|
| Entering freeway volume |               | pcph |                | pcph |                   |
| Exiting freeway volume  |               | pcph |                | pcph |                   |
| On-ramp volume          |               | pcph |                | pcph |                   |
| Off-ramp volume         |               | pcph |                | pcph |                   |

LOS and Performance Measures

|                                |       |        |
|--------------------------------|-------|--------|
| Flow rate, $v_p$               | 1,878 | pcphpl |
| Average passenger-car speed, S | 61.8  | mph    |
| Volume-to-capacity ratio, v/c  | 0.80  |        |
| Density, D                     | 30.4  | pcpmpl |
| Level of service, LOS          | D     |        |

HCM 2010: Freeway Basic Segment

Basic Operational Analysis

|             |   |
|-------------|---|
| Project     | CSUMB Master Plan EIR                                 |
| Freeway     | Southbound SR 1                                       |
| Segment     | SR 1 between Reservation Road and Del Monte Boulevard |
| Alternative | Existing with Project                                 |
| Time period | PM Peak Hour  |

Flow Inputs and Adjustments

|                                    |       |      |
|------------------------------------|-------|------|
| Volume, V                          | 1,420 | vph  |
| Peak-hour factor, PHF              | 0.97  |      |
| Peak 15-min volume, $v_{15}$       | 366   | veh  |
| Trucks and buses                   | 1.0%  |      |
| Recreational vehicles              | 0.0%  |      |
| Terrain type                       | Level |      |
| Grade                              |       |      |
| Length                             |       | mi   |
| Trucks and buses PCE, $E_T$        | 1.5   |      |
| Recreational vehicle PCE, $E_R$    | 1.2   |      |
| Heavy vehicle adjustment, $f_{HV}$ | 0.995 |      |
| Driver population factor, $f_p$    | 1.00  |      |
| Flow rate, $v_p$                   | 1,471 | pcph |
| Number of lanes, N                 | 2     |      |

Speed Inputs and Adjustments

|  |      |          |
|--|------|----------|
| Lane width                             | 12.0 | ft       |
| Right-side lateral clearance           | >6   | ft       |
| Total ramp density, TRD                | 1.00 | ramps/mi |
| Lane width adjustment, $f_{LW}$        | 0.0  | mph      |
| Lateral clearance adjustment, $f_{LC}$ | 0.0  | mph      |
| TRD adjustment                         | 3.2  | mph      |
| Calculated free-flow speed, FFS        | 72.2 | mph      |
| Measured free-flow speed, FFS          | 65.0 | mph      |
| Free-flow speed curve                  | 65   | mph      |

Capacity Checks for Segments with Ramps

|                         | <u>Actual</u> |      | <u>Maximum</u> |      | <u>Violation?</u> |
|-------------------------|---------------|------|----------------|------|-------------------|
| Entering freeway volume |               | pcph |                | pcph |                   |
| Exiting freeway volume  |               | pcph |                | pcph |                   |
| On-ramp volume          |               | pcph |                | pcph |                   |
| Off-ramp volume         |               | pcph |                | pcph |                   |

LOS and Performance Measures

|                                |      |        |
|--------------------------------|------|--------|
| Flow rate, $v_p$               | 736  | pcphpl |
| Average passenger-car speed, S | 65.0 | mph    |
| Volume-to-capacity ratio, v/c  | 0.31 |        |
| Density, D                     | 11.3 | pcpmpl |
| Level of service, LOS          | B    |        |

HCM 2010: Freeway Basic Segment

Basic Operational Analysis

|             |  |
|-------------|--|
| Project     | CSUMB Master Plan EIR                              |
| Freeway     | Southbound State Route 1                           |
| Segment     | SR 1 between Del Monte Boulevard and Imjin Parkway |
| Alternative | Existing with Project                              |
| Time period | AM Peak Hour                                       |

Flow Inputs and Adjustments

|                                    |       |      |
|------------------------------------|-------|------|
| Volume, V                          | 3,430 | vph  |
| Peak-hour factor, PHF              | 0.81  |      |
| Peak 15-min volume, $v_{15}$       | 1,059 | veh  |
| Trucks and buses                   | 3.9%  |      |
| Recreational vehicles              | 0.0%  |      |
| Terrain type                       | Level |      |
| Grade                              |       |      |
| Length                             |       | mi   |
| Trucks and buses PCE, $E_T$        | 1.5   |      |
| Recreational vehicle PCE, $E_R$    | 1.2   |      |
| Heavy vehicle adjustment, $f_{HV}$ | 0.981 |      |
| Driver population factor, $f_P$    | 1.00  |      |
| Flow rate, $v_p$                   | 4,317 | pcph |
| Number of lanes, N                 | 3     |      |

Speed Inputs and Adjustments

|  |      |          |
|--|------|----------|
| Lane width                             | 12.0 | ft       |
| Right-side lateral clearance           | >6   | ft       |
| Total ramp density, TRD                | 1.17 | ramps/mi |
| Lane width adjustment, $f_{LW}$        | 0.0  | mph      |
| Lateral clearance adjustment, $f_{LC}$ | 0.0  | mph      |
| TRD adjustment                         | 3.7  | mph      |
| Calculated free-flow speed, FFS        | 71.7 | mph      |
| Measured free-flow speed, FFS          | 65.0 | mph      |
| Free-flow speed curve                  | 65   | mph      |

Capacity Checks for Segments with Ramps

|                         | <u>Actual</u> |      | <u>Maximum</u> |      | <u>Violation?</u> |
|-------------------------|---------------|------|----------------|------|-------------------|
| Entering freeway volume |               | pcph |                | pcph |                   |
| Exiting freeway volume  |               | pcph |                | pcph |                   |
| On-ramp volume          |               | pcph |                | pcph |                   |
| Off-ramp volume         |               | pcph |                | pcph |                   |

LOS and Performance Measures

|                                |       |        |
|--------------------------------|-------|--------|
| Flow rate, $v_p$               | 1,439 | pcphpl |
| Average passenger-car speed, S | 65.0  | mph    |
| Volume-to-capacity ratio, v/c  | 0.61  |        |
| Density, D                     | 22.1  | pcpmpl |
| Level of service, LOS          | C     |        |



HCM 2010: Freeway Basic Segment

Basic Operational Analysis

|             |  |
|-------------|--|
| Project     | CSUMB Master Plan EIR                              |
| Freeway     | Southbound SR 1                                    |
| Segment     | SR 1 between Del Monte Boulevard and Imjin Parkway |
| Alternative | Existing with Project                              |
| Time period | PM Peak Hour                                       |

Flow Inputs and Adjustments

|                                    |       |      |
|------------------------------------|-------|------|
| Volume, V                          | 2,110 | vph  |
| Peak-hour factor, PHF              | 0.95  |      |
| Peak 15-min volume, $v_{15}$       | 555   | veh  |
| Trucks and buses                   | 1.4%  |      |
| Recreational vehicles              | 0.0%  |      |
| Terrain type                       | Level |      |
| Grade                              |       |      |
| Length                             |       | mi   |
| Trucks and buses PCE, $E_T$        | 1.5   |      |
| Recreational vehicle PCE, $E_R$    | 1.2   |      |
| Heavy vehicle adjustment, $f_{HV}$ | 0.993 |      |
| Driver population factor, $f_p$    | 1.00  |      |
| Flow rate, $v_p$                   | 2,236 | pcph |
| Number of lanes, N                 | 3     |      |

Speed Inputs and Adjustments

|  |      |          |
|--|------|----------|
| Lane width                             | 12.0 | ft       |
| Right-side lateral clearance           | >6   | ft       |
| Total ramp density, TRD                | 1.17 | ramps/mi |
| Lane width adjustment, $f_{LW}$        | 0.0  | mph      |
| Lateral clearance adjustment, $f_{LC}$ | 0.0  | mph      |
| TRD adjustment                         | 3.7  | mph      |
| Calculated free-flow speed, FFS        | 71.7 | mph      |
| Measured free-flow speed, FFS          | 65.0 | mph      |
| Free-flow speed curve                  | 65   | mph      |

Capacity Checks for Segments with Ramps

|                         | <u>Actual</u> |      | <u>Maximum</u> |      | <u>Violation?</u> |
|-------------------------|---------------|------|----------------|------|-------------------|
| Entering freeway volume |               | pcph |                | pcph |                   |
| Exiting freeway volume  |               | pcph |                | pcph |                   |
| On-ramp volume          |               | pcph |                | pcph |                   |
| Off-ramp volume         |               | pcph |                | pcph |                   |

LOS and Performance Measures

|                                |      |        |
|--------------------------------|------|--------|
| Flow rate, $v_p$               | 745  | pcphpl |
| Average passenger-car speed, S | 65.0 | mph    |
| Volume-to-capacity ratio, v/c  | 0.32 |        |
| Density, D                     | 11.5 | pcpmpl |
| Level of service, LOS          | B    |        |

HCM 2010: Freeway Basic Segment

Basic Operational Analysis

|             |   |
|-------------|---|
| Project     | CSUMB Master Plan EIR                             |
| Freeway     | Southbound State Route 1                          |
| Segment     | SR 1 between Imjin Parkway and Lightfighter Drive |
| Alternative | Existing with Project                             |
| Time period | AM Peak Hour                                      |

Flow Inputs and Adjustments

|                                    |       |      |
|------------------------------------|-------|------|
| Volume, V                          | 4,530 | vph  |
| Peak-hour factor, PHF              | 0.83  |      |
| Peak 15-min volume, $v_{15}$       | 1,364 | veh  |
| Trucks and buses                   | 3.5%  |      |
| Recreational vehicles              | 0.0%  |      |
| Terrain type                       | Level |      |
| Grade                              |       |      |
| Length                             |       | mi   |
| Trucks and buses PCE, $E_T$        | 1.5   |      |
| Recreational vehicle PCE, $E_R$    | 1.2   |      |
| Heavy vehicle adjustment, $f_{HV}$ | 0.983 |      |
| Driver population factor, $f_p$    | 1.00  |      |
| Flow rate, $v_p$                   | 5,554 | pcph |
| Number of lanes, N                 | 3     |      |

Speed Inputs and Adjustments

|  |      |          |
|--|------|----------|
| Lane width                             | 12.0 | ft       |
| Right-side lateral clearance           | >6   | ft       |
| Total ramp density, TRD                | 1.17 | ramps/mi |
| Lane width adjustment, $f_{LW}$        | 0.0  | mph      |
| Lateral clearance adjustment, $f_{LC}$ | 0.0  | mph      |
| TRD adjustment                         | 3.7  | mph      |
| Calculated free-flow speed, FFS        | 71.7 | mph      |
| Measured free-flow speed, FFS          | 65.0 | mph      |
| Free-flow speed curve                  | 65   | mph      |

Capacity Checks for Segments with Ramps

|                         | <u>Actual</u> |      | <u>Maximum</u> |      | <u>Violation?</u> |
|-------------------------|---------------|------|----------------|------|-------------------|
| Entering freeway volume |               | pcph |                | pcph |                   |
| Exiting freeway volume  |               | pcph |                | pcph |                   |
| On-ramp volume          |               | pcph |                | pcph |                   |
| Off-ramp volume         |               | pcph |                | pcph |                   |

LOS and Performance Measures

|                                |       |        |
|--------------------------------|-------|--------|
| Flow rate, $v_p$               | 1,851 | pcphpl |
| Average passenger-car speed, S | 62.1  | mph    |
| Volume-to-capacity ratio, v/c  | 0.79  |        |
| Density, D                     | 29.8  | pcpmpl |
| Level of service, LOS          | D     |        |

HCM 2010: Freeway Basic Segment

Basic Operational Analysis

|             |   |
|-------------|---|
| Project     | CSUMB Master Plan EIR                             |
| Freeway     | Southbound SR 1                                   |
| Segment     | SR 1 between Imjin Parkway and Lightfighter Drive |
| Alternative | Existing with Project                             |
| Time period | PM Peak Hour                                      |

Flow Inputs and Adjustments

|                                    |       |      |
|------------------------------------|-------|------|
| Volume, V                          | 2,820 | vph  |
| Peak-hour factor, PHF              | 0.95  |      |
| Peak 15-min volume, $v_{15}$       | 742   | veh  |
| Trucks and buses                   | 1.3%  |      |
| Recreational vehicles              | 0.0%  |      |
| Terrain type                       | Level |      |
| Grade                              |       |      |
| Length                             |       | mi   |
| Trucks and buses PCE, $E_T$        | 1.5   |      |
| Recreational vehicle PCE, $E_R$    | 1.2   |      |
| Heavy vehicle adjustment, $f_{HV}$ | 0.994 |      |
| Driver population factor, $f_p$    | 1.00  |      |
| Flow rate, $v_p$                   | 2,987 | pcph |
| Number of lanes, N                 | 3     |      |

Speed Inputs and Adjustments

|  |      |          |
|--|------|----------|
| Lane width                             | 12.0 | ft       |
| Right-side lateral clearance           | >6   | ft       |
| Total ramp density, TRD                | 1.17 | ramps/mi |
| Lane width adjustment, $f_{LW}$        | 0.0  | mph      |
| Lateral clearance adjustment, $f_{LC}$ | 0.0  | mph      |
| TRD adjustment                         | 3.7  | mph      |
| Calculated free-flow speed, FFS        | 71.7 | mph      |
| Measured free-flow speed, FFS          | 65.0 | mph      |
| Free-flow speed curve                  | 65   | mph      |

Capacity Checks for Segments with Ramps

|                         | <u>Actual</u> |      | <u>Maximum</u> |      | <u>Violation?</u> |
|-------------------------|---------------|------|----------------|------|-------------------|
| Entering freeway volume |               | pcph |                | pcph |                   |
| Exiting freeway volume  |               | pcph |                | pcph |                   |
| On-ramp volume          |               | pcph |                | pcph |                   |
| Off-ramp volume         |               | pcph |                | pcph |                   |

LOS and Performance Measures

|                                |      |        |
|--------------------------------|------|--------|
| Flow rate, $v_p$               | 996  | pcphpl |
| Average passenger-car speed, S | 65.0 | mph    |
| Volume-to-capacity ratio, v/c  | 0.42 |        |
| Density, D                     | 15.3 | pcpmpl |
| Level of service, LOS          | B    |        |

HCM 2010: Freeway Basic Segment

Basic Operational Analysis

|             |   |
|-------------|---|
| Project     | CSUMB Master Plan EIR                                   |
| Freeway     | Southbound State Route 1                                |
| Segment     | SR 1 between Lightfighter Drive and Del Monte Boulevard |
| Alternative | Existing with Project                                   |
| Time period | AM Peak Hour  |

Flow Inputs and Adjustments

|                                    |       |      |
|------------------------------------|-------|------|
| Volume, V                          | 4,850 | vph  |
| Peak-hour factor, PHF              | 0.86  |      |
| Peak 15-min volume, $v_{15}$       | 1,410 | veh  |
| Trucks and buses                   | 3.2%  |      |
| Recreational vehicles              | 0.0%  |      |
| Terrain type                       | Level |      |
| Grade                              |       |      |
| Length                             |       | mi   |
| Trucks and buses PCE, $E_T$        | 1.5   |      |
| Recreational vehicle PCE, $E_R$    | 1.2   |      |
| Heavy vehicle adjustment, $f_{HV}$ | 0.984 |      |
| Driver population factor, $f_p$    | 1.00  |      |
| Flow rate, $v_p$                   | 5,730 | pcph |
| Number of lanes, N                 | 3     |      |

Speed Inputs and Adjustments

|  |      |          |
|--|------|----------|
| Lane width                             | 12.0 | ft       |
| Right-side lateral clearance           | >6   | ft       |
| Total ramp density, TRD                | 1.33 | ramps/mi |
| Lane width adjustment, $f_{LW}$        | 0.0  | mph      |
| Lateral clearance adjustment, $f_{LC}$ | 0.0  | mph      |
| TRD adjustment                         | 4.1  | mph      |
| Calculated free-flow speed, FFS        | 71.3 | mph      |
| Measured free-flow speed, FFS          | 65.0 | mph      |
| Free-flow speed curve                  | 65   | mph      |

Capacity Checks for Segments with Ramps

|                         | <u>Actual</u> |      | <u>Maximum</u> |      | <u>Violation?</u> |
|-------------------------|---------------|------|----------------|------|-------------------|
| Entering freeway volume |               | pcph |                | pcph |                   |
| Exiting freeway volume  |               | pcph |                | pcph |                   |
| On-ramp volume          |               | pcph |                | pcph |                   |
| Off-ramp volume         |               | pcph |                | pcph |                   |

LOS and Performance Measures

|                                |       |        |
|--------------------------------|-------|--------|
| Flow rate, $v_p$               | 1,910 | pcphpl |
| Average passenger-car speed, S | 61.3  | mph    |
| Volume-to-capacity ratio, v/c  | 0.81  |        |
| Density, D                     | 31.2  | pcpmpl |
| Level of service, LOS          | D     |        |

HCM 2010: Freeway Basic Segment

Basic Operational Analysis

|             |   |
|-------------|---|
| Project     | CSUMB Master Plan EIR                                   |
| Freeway     | Southbound SR 1   |
| Segment     | SR 1 between Lightfighter Drive and Del Monte Boulevard |
| Alternative | Existing with Project                                   |
| Time period | PM Peak Hour  |

Flow Inputs and Adjustments

|                                    |       |      |
|------------------------------------|-------|------|
| Volume, V                          | 3,270 | vph  |
| Peak-hour factor, PHF              | 0.97  |      |
| Peak 15-min volume, $v_{15}$       | 843   | veh  |
| Trucks and buses                   | 1.1%  |      |
| Recreational vehicles              | 0.0%  |      |
| Terrain type                       | Level |      |
| Grade                              |       |      |
| Length                             |       | mi   |
| Trucks and buses PCE, $E_T$        | 1.5   |      |
| Recreational vehicle PCE, $E_R$    | 1.2   |      |
| Heavy vehicle adjustment, $f_{HV}$ | 0.994 |      |
| Driver population factor, $f_p$    | 1.00  |      |
| Flow rate, $v_p$                   | 3,390 | pcph |
| Number of lanes, N                 | 3     |      |

Speed Inputs and Adjustments

|  |      |          |
|--|------|----------|
| Lane width                             | 12.0 | ft       |
| Right-side lateral clearance           | >6   | ft       |
| Total ramp density, TRD                | 1.33 | ramps/mi |
| Lane width adjustment, $f_{LW}$        | 0.0  | mph      |
| Lateral clearance adjustment, $f_{LC}$ | 0.0  | mph      |
| TRD adjustment                         | 4.1  | mph      |
| Calculated free-flow speed, FFS        | 71.3 | mph      |
| Measured free-flow speed, FFS          | 65.0 | mph      |
| Free-flow speed curve                  | 65   | mph      |

Capacity Checks for Segments with Ramps

|                         | <u>Actual</u> |      | <u>Maximum</u> |      | <u>Violation?</u> |
|-------------------------|---------------|------|----------------|------|-------------------|
| Entering freeway volume |               | pcph |                | pcph |                   |
| Exiting freeway volume  |               | pcph |                | pcph |                   |
| On-ramp volume          |               | pcph |                | pcph |                   |
| Off-ramp volume         |               | pcph |                | pcph |                   |

LOS and Performance Measures

|                                |       |        |
|--------------------------------|-------|--------|
| Flow rate, $v_p$               | 1,130 | pcphpl |
| Average passenger-car speed, S | 65.0  | mph    |
| Volume-to-capacity ratio, v/c  | 0.48  |        |
| Density, D                     | 17.4  | pcpmpl |
| Level of service, LOS          | B     |        |

HCM 2010: Freeway Basic Segment

Basic Operational Analysis

|             |   |
|-------------|---|
| Project     | CSUMB Master Plan EIR   |
| Freeway     | Southbound State Route 1                                      |
| Segment     | SR 1 between Del Monte Boulevard and Canyon Del Rey Boulevard |
| Alternative | Existing with Project   |
| Time period | AM Peak Hour  |

Flow Inputs and Adjustments

|                                    |       |      |
|------------------------------------|-------|------|
| Volume, V                          | 3,890 | vph  |
| Peak-hour factor, PHF              | 0.95  |      |
| Peak 15-min volume, $v_{15}$       | 1,024 | veh  |
| Trucks and buses                   | 2.4%  |      |
| Recreational vehicles              | 0.0%  |      |
| Terrain type                       | Level |      |
| Grade                              |       |      |
| Length                             |       | mi   |
| Trucks and buses PCE, $E_T$        | 1.5   |      |
| Recreational vehicle PCE, $E_R$    | 1.2   |      |
| Heavy vehicle adjustment, $f_{HV}$ | 0.988 |      |
| Driver population factor, $f_p$    | 1.00  |      |
| Flow rate, $v_p$                   | 4,145 | pcph |
| Number of lanes, N                 | 2     |      |

Speed Inputs and Adjustments

|  |      |          |
|--|------|----------|
| Lane width                             | 12.0 | ft       |
| Right-side lateral clearance           | 5.0  | ft       |
| Total ramp density, TRD                | 2.17 | ramps/mi |
| Lane width adjustment, $f_{LW}$        | 0.0  | mph      |
| Lateral clearance adjustment, $f_{LC}$ | 0.6  | mph      |
| TRD adjustment                         | 6.2  | mph      |
| Calculated free-flow speed, FFS        | 68.6 | mph      |
| Measured free-flow speed, FFS          | 65.0 | mph      |
| Free-flow speed curve                  | 65   | mph      |

Capacity Checks for Segments with Ramps

|                         | <u>Actual</u> |      | <u>Maximum</u> |      | <u>Violation?</u> |
|-------------------------|---------------|------|----------------|------|-------------------|
| Entering freeway volume |               | pcph |                | pcph |                   |
| Exiting freeway volume  |               | pcph |                | pcph |                   |
| On-ramp volume          |               | pcph |                | pcph |                   |
| Off-ramp volume         |               | pcph |                | pcph |                   |

LOS and Performance Measures

|                                |       |        |
|--------------------------------|-------|--------|
| Flow rate, $v_p$               | 2,072 | pcphpl |
| Average passenger-car speed, S | 58.6  | mph    |
| Volume-to-capacity ratio, v/c  | 0.88  |        |
| Density, D                     | 35.4  | pcpmpl |
| Level of service, LOS          | E     |        |

HCM 2010: Freeway Basic Segment

Basic Operational Analysis

|             |   |
|-------------|---|
| Project     | CSUMB Master Plan EIR   |
| Freeway     | Southbound SR 1   |
| Segment     | SR 1 between Del Monte Boulevard and Canyon Del Rey Boulevard |
| Alternative | Existing with Project   |
| Time period | PM Peak Hour  |

Flow Inputs and Adjustments

|                                    |       |      |
|------------------------------------|-------|------|
| Volume, V                          | 2,700 | vph  |
| Peak-hour factor, PHF              | 0.96  |      |
| Peak 15-min volume, $v_{15}$       | 703   | veh  |
| Trucks and buses                   | 1.0%  |      |
| Recreational vehicles              | 0.0%  |      |
| Terrain type                       | Level |      |
| Grade                              |       |      |
| Length                             |       | mi   |
| Trucks and buses PCE, $E_T$        | 1.5   |      |
| Recreational vehicle PCE, $E_R$    | 1.2   |      |
| Heavy vehicle adjustment, $f_{HV}$ | 0.995 |      |
| Driver population factor, $f_p$    | 1.00  |      |
| Flow rate, $v_p$                   | 2,827 | pcph |
| Number of lanes, N                 | 2     |      |

Speed Inputs and Adjustments

|  |      |          |
|--|------|----------|
| Lane width                             | 12.0 | ft       |
| Right-side lateral clearance           | 5.0  | ft       |
| Total ramp density, TRD                | 2.17 | ramps/mi |
| Lane width adjustment, $f_{LW}$        | 0.0  | mph      |
| Lateral clearance adjustment, $f_{LC}$ | 0.6  | mph      |
| TRD adjustment                         | 6.2  | mph      |
| Calculated free-flow speed, FFS        | 68.6 | mph      |
| Measured free-flow speed, FFS          | 65.0 | mph      |
| Free-flow speed curve                  | 65   | mph      |

Capacity Checks for Segments with Ramps

|                         | <u>Actual</u> |      | <u>Maximum</u> |      | <u>Violation?</u> |
|-------------------------|---------------|------|----------------|------|-------------------|
| Entering freeway volume |               | pcph |                | pcph |                   |
| Exiting freeway volume  |               | pcph |                | pcph |                   |
| On-ramp volume          |               | pcph |                | pcph |                   |
| Off-ramp volume         |               | pcph |                | pcph |                   |

LOS and Performance Measures

|                                |       |        |
|--------------------------------|-------|--------|
| Flow rate, $v_p$               | 1,413 | pcphpl |
| Average passenger-car speed, S | 65.0  | mph    |
| Volume-to-capacity ratio, v/c  | 0.60  |        |
| Density, D                     | 21.7  | pcpmpl |
| Level of service, LOS          | C     |        |

HCM 2010: Freeway Basic Segment

Basic Operational Analysis

|             |   |
|-------------|---|
| Project     | CSUMB Master Plan EIR                                 |
| Freeway     | Northbound State Route 1                              |
| Segment     | SR 1 between Reservation Road and Del Monte Boulevard |
| Alternative | Existing with Project                                 |
| Time period | AM Peak Hour  |

Flow Inputs and Adjustments

|                                    |       |      |
|------------------------------------|-------|------|
| Volume, V                          | 1,230 | vph  |
| Peak-hour factor, PHF              | 0.97  |      |
| Peak 15-min volume, $v_{15}$       | 317   | veh  |
| Trucks and buses                   | 6.4%  |      |
| Recreational vehicles              | 0.0%  |      |
| Terrain type                       | Level |      |
| Grade                              |       |      |
| Length                             |       | mi   |
| Trucks and buses PCE, $E_T$        | 1.5   |      |
| Recreational vehicle PCE, $E_R$    | 1.2   |      |
| Heavy vehicle adjustment, $f_{HV}$ | 0.969 |      |
| Driver population factor, $f_p$    | 1.00  |      |
| Flow rate, $v_p$                   | 1,308 | pcph |
| Number of lanes, N                 | 2     |      |

Speed Inputs and Adjustments

|  |      |          |
|--|------|----------|
| Lane width                             | 12.0 | ft       |
| Right-side lateral clearance           | >6   | ft       |
| Total ramp density, TRD                | 1.00 | ramps/mi |
| Lane width adjustment, $f_{LW}$        | 0.0  | mph      |
| Lateral clearance adjustment, $f_{LC}$ | 0.0  | mph      |
| TRD adjustment                         | 3.2  | mph      |
| Calculated free-flow speed, FFS        | 72.2 | mph      |
| Measured free-flow speed, FFS          | 65.0 | mph      |
| Free-flow speed curve                  | 65   | mph      |

Capacity Checks for Segments with Ramps

|                         | <u>Actual</u> |      | <u>Maximum</u> |      | <u>Violation?</u> |
|-------------------------|---------------|------|----------------|------|-------------------|
| Entering freeway volume |               | pcph |                | pcph |                   |
| Exiting freeway volume  |               | pcph |                | pcph |                   |
| On-ramp volume          |               | pcph |                | pcph |                   |
| Off-ramp volume         |               | pcph |                | pcph |                   |

LOS and Performance Measures

|                                |      |        |
|--------------------------------|------|--------|
| Flow rate, $v_p$               | 654  | pcphpl |
| Average passenger-car speed, S | 65.0 | mph    |
| Volume-to-capacity ratio, v/c  | 0.28 |        |
| Density, D                     | 10.1 | pcpmpl |
| Level of service, LOS          | A    |        |



HCM 2010: Freeway Basic Segment

Basic Operational Analysis

|             |   |
|-------------|---|
| Project     | CSUMB Master Plan EIR                                 |
| Freeway     | Northbound State Route 1                              |
| Segment     | SR 1 between Reservation Road and Del Monte Boulevard |
| Alternative | Existing with Project                                 |
| Time period | PM Peak Hour  |

Flow Inputs and Adjustments

|                                    |       |      |
|------------------------------------|-------|------|
| Volume, V                          | 2,790 | vph  |
| Peak-hour factor, PHF              | 0.98  |      |
| Peak 15-min volume, $v_{15}$       | 712   | veh  |
| Trucks and buses                   | 2.2%  |      |
| Recreational vehicles              | 0.0%  |      |
| Terrain type                       | Level |      |
| Grade                              |       |      |
| Length                             |       | mi   |
| Trucks and buses PCE, $E_T$        | 1.5   |      |
| Recreational vehicle PCE, $E_R$    | 1.2   |      |
| Heavy vehicle adjustment, $f_{HV}$ | 0.989 |      |
| Driver population factor, $f_p$    | 1.00  |      |
| Flow rate, $v_p$                   | 2,878 | pcph |
| Number of lanes, N                 | 2     |      |

Speed Inputs and Adjustments

|  |      |          |
|--|------|----------|
| Lane width                             | 12.0 | ft       |
| Right-side lateral clearance           | >6   | ft       |
| Total ramp density, TRD                | 1.00 | ramps/mi |
| Lane width adjustment, $f_{LW}$        | 0.0  | mph      |
| Lateral clearance adjustment, $f_{LC}$ | 0.0  | mph      |
| TRD adjustment                         | 3.2  | mph      |
| Calculated free-flow speed, FFS        | 72.2 | mph      |
| Measured free-flow speed, FFS          | 65.0 | mph      |
| Free-flow speed curve                  | 65   | mph      |

Capacity Checks for Segments with Ramps

|                         | <u>Actual</u> |      | <u>Maximum</u> |      | <u>Violation?</u> |
|-------------------------|---------------|------|----------------|------|-------------------|
| Entering freeway volume |               | pcph |                | pcph |                   |
| Exiting freeway volume  |               | pcph |                | pcph |                   |
| On-ramp volume          |               | pcph |                | pcph |                   |
| Off-ramp volume         |               | pcph |                | pcph |                   |

LOS and Performance Measures

|                                |       |        |
|--------------------------------|-------|--------|
| Flow rate, $v_p$               | 1,439 | pcphpl |
| Average passenger-car speed, S | 65.0  | mph    |
| Volume-to-capacity ratio, v/c  | 0.61  |        |
| Density, D                     | 22.1  | pcpmpl |
| Level of service, LOS          | C     |        |

HCM 2010: Freeway Basic Segment

Basic Operational Analysis

|             |  |
|-------------|--|
| Project     | CSUMB Master Plan EIR                              |
| Freeway     | Northbound State Route 1                           |
| Segment     | SR 1 between Del Monte Boulevard and Imjin Parkway |
| Alternative | Existing with Project                              |
| Time period | AM Peak Hour                                       |

Flow Inputs and Adjustments

|                                    |       |      |
|------------------------------------|-------|------|
| Volume, V                          | 1,790 | vph  |
| Peak-hour factor, PHF              | 0.92  |      |
| Peak 15-min volume, $v_{15}$       | 487   | veh  |
| Trucks and buses                   | 5.7%  |      |
| Recreational vehicles              | 0.0%  |      |
| Terrain type                       | Level |      |
| Grade                              |       |      |
| Length                             |       | mi   |
| Trucks and buses PCE, $E_T$        | 1.5   |      |
| Recreational vehicle PCE, $E_R$    | 1.2   |      |
| Heavy vehicle adjustment, $f_{HV}$ | 0.972 |      |
| Driver population factor, $f_p$    | 1.00  |      |
| Flow rate, $v_p$                   | 2,002 | pcph |
| Number of lanes, N                 | 3     |      |

Speed Inputs and Adjustments

|  |      |          |
|--|------|----------|
| Lane width                             | 12.0 | ft       |
| Right-side lateral clearance           | >6   | ft       |
| Total ramp density, TRD                | 1.20 | ramps/mi |
| Lane width adjustment, $f_{LW}$        | 0.0  | mph      |
| Lateral clearance adjustment, $f_{LC}$ | 0.0  | mph      |
| TRD adjustment                         | 3.8  | mph      |
| Calculated free-flow speed, FFS        | 71.6 | mph      |
| Measured free-flow speed, FFS          | 65.0 | mph      |
| Free-flow speed curve                  | 65   | mph      |

Capacity Checks for Segments with Ramps

|                         | <u>Actual</u> |      | <u>Maximum</u> |      | <u>Violation?</u> |
|-------------------------|---------------|------|----------------|------|-------------------|
| Entering freeway volume |               | pcph |                | pcph |                   |
| Exiting freeway volume  |               | pcph |                | pcph |                   |
| On-ramp volume          |               | pcph |                | pcph |                   |
| Off-ramp volume         |               | pcph |                | pcph |                   |

LOS and Performance Measures

|                                |      |        |
|--------------------------------|------|--------|
| Flow rate, $v_p$               | 667  | pcphpl |
| Average passenger-car speed, S | 65.0 | mph    |
| Volume-to-capacity ratio, v/c  | 0.28 |        |
| Density, D                     | 10.3 | pcpmpl |
| Level of service, LOS          | A    |        |

HCM 2010: Freeway Basic Segment

Basic Operational Analysis

|             |  |
|-------------|--|
| Project     | CSUMB Master Plan EIR                              |
| Freeway     | Northbound State Route 1                           |
| Segment     | SR 1 between Del Monte Boulevard and Imjin Parkway |
| Alternative | Existing with Project                              |
| Time period | PM Peak Hour                                       |

Flow Inputs and Adjustments

|                                    |       |      |
|------------------------------------|-------|------|
| Volume, V                          | 4,360 | vph  |
| Peak-hour factor, PHF              | 0.96  |      |
| Peak 15-min volume, $v_{15}$       | 1,135 | veh  |
| Trucks and buses                   | 1.9%  |      |
| Recreational vehicles              | 0.0%  |      |
| Terrain type                       | Level |      |
| Grade                              |       |      |
| Length                             |       | mi   |
| Trucks and buses PCE, $E_T$        | 1.5   |      |
| Recreational vehicle PCE, $E_R$    | 1.2   |      |
| Heavy vehicle adjustment, $f_{HV}$ | 0.991 |      |
| Driver population factor, $f_p$    | 1.00  |      |
| Flow rate, $v_p$                   | 4,585 | pcph |
| Number of lanes, N                 | 3     |      |

Speed Inputs and Adjustments

|  |      |          |
|--|------|----------|
| Lane width                             | 12.0 | ft       |
| Right-side lateral clearance           | >6   | ft       |
| Total ramp density, TRD                | 1.17 | ramps/mi |
| Lane width adjustment, $f_{LW}$        | 0.0  | mph      |
| Lateral clearance adjustment, $f_{LC}$ | 0.0  | mph      |
| TRD adjustment                         | 3.7  | mph      |
| Calculated free-flow speed, FFS        | 71.7 | mph      |
| Measured free-flow speed, FFS          | 65.0 | mph      |
| Free-flow speed curve                  | 65   | mph      |

Capacity Checks for Segments with Ramps

|                         | <u>Actual</u> |      | <u>Maximum</u> |      | <u>Violation?</u> |
|-------------------------|---------------|------|----------------|------|-------------------|
| Entering freeway volume |               | pcph |                | pcph |                   |
| Exiting freeway volume  |               | pcph |                | pcph |                   |
| On-ramp volume          |               | pcph |                | pcph |                   |
| Off-ramp volume         |               | pcph |                | pcph |                   |

LOS and Performance Measures

|                                |       |        |
|--------------------------------|-------|--------|
| Flow rate, $v_p$               | 1,528 | pcphpl |
| Average passenger-car speed, S | 64.8  | mph    |
| Volume-to-capacity ratio, v/c  | 0.65  |        |
| Density, D                     | 23.6  | pcpmpl |
| Level of service, LOS          | C     |        |

HCM 2010: Freeway Basic Segment

Basic Operational Analysis

|             |   |
|-------------|---|
| Project     | CSUMB Master Plan EIR                             |
| Freeway     | Northbound State Route 1                          |
| Segment     | SR 1 between Imjin Parkway and Lightfighter Drive |
| Alternative | Existing with Project                             |
| Time period | AM Peak Hour                                      |

Flow Inputs and Adjustments

|                                    |       |      |
|------------------------------------|-------|------|
| Volume, V                          | 2,410 | vph  |
| Peak-hour factor, PHF              | 0.92  |      |
| Peak 15-min volume, $v_{15}$       | 657   | veh  |
| Trucks and buses                   | 3.8%  |      |
| Recreational vehicles              | 0.0%  |      |
| Terrain type                       | Level |      |
| Grade                              |       |      |
| Length                             |       | mi   |
| Trucks and buses PCE, $E_T$        | 1.5   |      |
| Recreational vehicle PCE, $E_R$    | 1.2   |      |
| Heavy vehicle adjustment, $f_{HV}$ | 0.982 |      |
| Driver population factor, $f_p$    | 1.00  |      |
| Flow rate, $v_p$                   | 2,675 | pcph |
| Number of lanes, N                 | 3     |      |

Speed Inputs and Adjustments

|  |      |          |
|--|------|----------|
| Lane width                             | 12.0 | ft       |
| Right-side lateral clearance           | >6   | ft       |
| Total ramp density, TRD                | 1.17 | ramps/mi |
| Lane width adjustment, $f_{LW}$        | 0.0  | mph      |
| Lateral clearance adjustment, $f_{LC}$ | 0.0  | mph      |
| TRD adjustment                         | 3.7  | mph      |
| Calculated free-flow speed, FFS        | 71.7 | mph      |
| Measured free-flow speed, FFS          | 65.0 | mph      |
| Free-flow speed curve                  | 65   | mph      |

Capacity Checks for Segments with Ramps

|                         | <u>Actual</u> |      | <u>Maximum</u> |      | <u>Violation?</u> |
|-------------------------|---------------|------|----------------|------|-------------------|
| Entering freeway volume |               | pcph |                | pcph |                   |
| Exiting freeway volume  |               | pcph |                | pcph |                   |
| On-ramp volume          |               | pcph |                | pcph |                   |
| Off-ramp volume         |               | pcph |                | pcph |                   |

LOS and Performance Measures

|                                |      |        |
|--------------------------------|------|--------|
| Flow rate, $v_p$               | 892  | pcphpl |
| Average passenger-car speed, S | 65.0 | mph    |
| Volume-to-capacity ratio, v/c  | 0.38 |        |
| Density, D                     | 13.7 | pcpmpl |
| Level of service, LOS          | B    |        |

HCM 2010: Freeway Basic Segment

Basic Operational Analysis

|             |   |
|-------------|---|
| Project     | CSUMB Master Plan EIR                             |
| Freeway     | Northbound State Route 1                          |
| Segment     | SR 1 between Imjin Parkway and Lightfighter Drive |
| Alternative | Existing with Project                             |
| Time period | PM Peak Hour                                      |

Flow Inputs and Adjustments

|                                    |       |      |
|------------------------------------|-------|------|
| Volume, V                          | 4,880 | vph  |
| Peak-hour factor, PHF              | 0.97  |      |
| Peak 15-min volume, $v_{15}$       | 1,258 | veh  |
| Trucks and buses                   | 1.7%  |      |
| Recreational vehicles              | 0.0%  |      |
| Terrain type                       | Level |      |
| Grade                              |       |      |
| Length                             |       | mi   |
| Trucks and buses PCE, $E_T$        | 1.5   |      |
| Recreational vehicle PCE, $E_R$    | 1.2   |      |
| Heavy vehicle adjustment, $f_{HV}$ | 0.991 |      |
| Driver population factor, $f_p$    | 1.00  |      |
| Flow rate, $v_p$                   | 5,075 | pcph |
| Number of lanes, N                 | 3     |      |

Speed Inputs and Adjustments

|  |      |          |
|--|------|----------|
| Lane width                             | 12.0 | ft       |
| Right-side lateral clearance           | >6   | ft       |
| Total ramp density, TRD                | 1.17 | ramps/mi |
| Lane width adjustment, $f_{LW}$        | 0.0  | mph      |
| Lateral clearance adjustment, $f_{LC}$ | 0.0  | mph      |
| TRD adjustment                         | 3.7  | mph      |
| Calculated free-flow speed, FFS        | 71.7 | mph      |
| Measured free-flow speed, FFS          | 65.0 | mph      |
| Free-flow speed curve                  | 65   | mph      |

Capacity Checks for Segments with Ramps

|                         | <u>Actual</u> |      | <u>Maximum</u> |      | <u>Violation?</u> |
|-------------------------|---------------|------|----------------|------|-------------------|
| Entering freeway volume |               | pcph |                | pcph |                   |
| Exiting freeway volume  |               | pcph |                | pcph |                   |
| On-ramp volume          |               | pcph |                | pcph |                   |
| Off-ramp volume         |               | pcph |                | pcph |                   |

LOS and Performance Measures

|                                |       |        |
|--------------------------------|-------|--------|
| Flow rate, $v_p$               | 1,692 | pcphpl |
| Average passenger-car speed, S | 63.8  | mph    |
| Volume-to-capacity ratio, v/c  | 0.72  |        |
| Density, D                     | 26.5  | pcpmpl |
| Level of service, LOS          | D     |        |

HCM 2010: Freeway Basic Segment

Basic Operational Analysis

|             |   |
|-------------|---|
| Project     | CSUMB Master Plan EIR                                   |
| Freeway     | Northbound State Route 1                                |
| Segment     | SR 1 between Lightfighter Drive and Del Monte Boulevard |
| Alternative | Existing with Project                                   |
| Time period | AM Peak Hour  |

Flow Inputs and Adjustments

|                                    |       |      |
|------------------------------------|-------|------|
| Volume, V                          | 2,810 | vph  |
| Peak-hour factor, PHF              | 0.93  |      |
| Peak 15-min volume, $v_{15}$       | 752   | veh  |
| Trucks and buses                   | 3.8%  |      |
| Recreational vehicles              | 0.0%  |      |
| Terrain type                       | Level |      |
| Grade                              |       |      |
| Length                             |       | mi   |
| Trucks and buses PCE, $E_T$        | 1.5   |      |
| Recreational vehicle PCE, $E_R$    | 1.2   |      |
| Heavy vehicle adjustment, $f_{HV}$ | 0.982 |      |
| Driver population factor, $f_p$    | 1.00  |      |
| Flow rate, $v_p$                   | 3,066 | pcph |
| Number of lanes, N                 | 3     |      |

Speed Inputs and Adjustments

|  |      |          |
|--|------|----------|
| Lane width                             | 12.0 | ft       |
| Right-side lateral clearance           | >6   | ft       |
| Total ramp density, TRD                | 1.17 | ramps/mi |
| Lane width adjustment, $f_{LW}$        | 0.0  | mph      |
| Lateral clearance adjustment, $f_{LC}$ | 0.0  | mph      |
| TRD adjustment                         | 3.7  | mph      |
| Calculated free-flow speed, FFS        | 71.7 | mph      |
| Measured free-flow speed, FFS          | 65.0 | mph      |
| Free-flow speed curve                  | 65   | mph      |

Capacity Checks for Segments with Ramps

|                         | <u>Actual</u> |      | <u>Maximum</u> |      | <u>Violation?</u> |
|-------------------------|---------------|------|----------------|------|-------------------|
| Entering freeway volume |               | pcph |                | pcph |                   |
| Exiting freeway volume  |               | pcph |                | pcph |                   |
| On-ramp volume          |               | pcph |                | pcph |                   |
| Off-ramp volume         |               | pcph |                | pcph |                   |

LOS and Performance Measures

|                                |       |        |
|--------------------------------|-------|--------|
| Flow rate, $v_p$               | 1,022 | pcphpl |
| Average passenger-car speed, S | 65.0  | mph    |
| Volume-to-capacity ratio, v/c  | 0.43  |        |
| Density, D                     | 15.7  | pcpmpl |
| Level of service, LOS          | B     |        |

HCM 2010: Freeway Basic Segment

Basic Operational Analysis

|             |   |
|-------------|---|
| Project     | CSUMB Master Plan EIR                                   |
| Freeway     | Northbound State Route 1                                |
| Segment     | SR 1 between Lightfighter Drive and Del Monte Boulevard |
| Alternative | Existing with Project                                   |
| Time period | PM Peak Hour  |

Flow Inputs and Adjustments

|                                    |       |      |
|------------------------------------|-------|------|
| Volume, V                          | 4,840 | vph  |
| Peak-hour factor, PHF              | 0.98  |      |
| Peak 15-min volume, $v_{15}$       | 1,235 | veh  |
| Trucks and buses                   | 1.9%  |      |
| Recreational vehicles              | 0.0%  |      |
| Terrain type                       | Level |      |
| Grade                              |       |      |
| Length                             |       | mi   |
| Trucks and buses PCE, $E_T$        | 1.5   |      |
| Recreational vehicle PCE, $E_R$    | 1.2   |      |
| Heavy vehicle adjustment, $f_{HV}$ | 0.991 |      |
| Driver population factor, $f_p$    | 1.00  |      |
| Flow rate, $v_p$                   | 4,985 | pcph |
| Number of lanes, N                 | 3     |      |

Speed Inputs and Adjustments

|  |      |          |
|--|------|----------|
| Lane width                             | 12.0 | ft       |
| Right-side lateral clearance           | >6   | ft       |
| Total ramp density, TRD                | 1.17 | ramps/mi |
| Lane width adjustment, $f_{LW}$        | 0.0  | mph      |
| Lateral clearance adjustment, $f_{LC}$ | 0.0  | mph      |
| TRD adjustment                         | 3.7  | mph      |
| Calculated free-flow speed, FFS        | 71.7 | mph      |
| Measured free-flow speed, FFS          | 65.0 | mph      |
| Free-flow speed curve                  | 65   | mph      |

Capacity Checks for Segments with Ramps

|                         | <u>Actual</u> |      | <u>Maximum</u> |      | <u>Violation?</u> |
|-------------------------|---------------|------|----------------|------|-------------------|
| Entering freeway volume |               | pcph |                | pcph |                   |
| Exiting freeway volume  |               | pcph |                | pcph |                   |
| On-ramp volume          |               | pcph |                | pcph |                   |
| Off-ramp volume         |               | pcph |                | pcph |                   |

LOS and Performance Measures

|                                |       |        |
|--------------------------------|-------|--------|
| Flow rate, $v_p$               | 1,662 | pcphpl |
| Average passenger-car speed, S | 64.0  | mph    |
| Volume-to-capacity ratio, v/c  | 0.71  |        |
| Density, D                     | 26.0  | pcpmpl |
| Level of service, LOS          | C     |        |

HCM 2010: Freeway Basic Segment

Basic Operational Analysis

|             |   |
|-------------|---|
| Project     | CSUMB Master Plan EIR   |
| Freeway     | Northbound State Route 1                                      |
| Segment     | SR 1 between Del Monte Boulevard and Canyon Del Rey Boulevard |
| Alternative | Existing with Project   |
| Time period | AM Peak Hour  |

Flow Inputs and Adjustments

|                                    |       |      |
|------------------------------------|-------|------|
| Volume, V                          | 2,440 | vph  |
| Peak-hour factor, PHF              | 0.92  |      |
| Peak 15-min volume, $v_{15}$       | 666   | veh  |
| Trucks and buses                   | 3.2%  |      |
| Recreational vehicles              | 0.0%  |      |
| Terrain type                       | Level |      |
| Grade                              |       |      |
| Length                             |       | mi   |
| Trucks and buses PCE, $E_T$        | 1.5   |      |
| Recreational vehicle PCE, $E_R$    | 1.2   |      |
| Heavy vehicle adjustment, $f_{HV}$ | 0.984 |      |
| Driver population factor, $f_p$    | 1.00  |      |
| Flow rate, $v_p$                   | 2,708 | pcph |
| Number of lanes, N                 | 2     |      |

Speed Inputs and Adjustments

|  |      |          |
|--|------|----------|
| Lane width                             | 12.0 | ft       |
| Right-side lateral clearance           | >6   | ft       |
| Total ramp density, TRD                | 2.00 | ramps/mi |
| Lane width adjustment, $f_{LW}$        | 0.0  | mph      |
| Lateral clearance adjustment, $f_{LC}$ | 0.0  | mph      |
| TRD adjustment                         | 5.8  | mph      |
| Calculated free-flow speed, FFS        | 69.6 | mph      |
| Measured free-flow speed, FFS          | 65.0 | mph      |
| Free-flow speed curve                  | 65   | mph      |

Capacity Checks for Segments with Ramps

|                         | <u>Actual</u> |      | <u>Maximum</u> |      | <u>Violation?</u> |
|-------------------------|---------------|------|----------------|------|-------------------|
| Entering freeway volume |               | pcph |                | pcph |                   |
| Exiting freeway volume  |               | pcph |                | pcph |                   |
| On-ramp volume          |               | pcph |                | pcph |                   |
| Off-ramp volume         |               | pcph |                | pcph |                   |

LOS and Performance Measures

|                                |       |        |
|--------------------------------|-------|--------|
| Flow rate, $v_p$               | 1,354 | pcphpl |
| Average passenger-car speed, S | 65.0  | mph    |
| Volume-to-capacity ratio, v/c  | 0.58  |        |
| Density, D                     | 20.8  | pcpmpl |
| Level of service, LOS          | C     |        |



HCM 2010: Freeway Basic Segment

Basic Operational Analysis

|             |   |
|-------------|---|
| Project     | CSUMB Master Plan EIR   |
| Freeway     | Northbound State Route 1                                      |
| Segment     | SR 1 between Del Monte Boulevard and Canyon Del Rey Boulevard |
| Alternative | Existing with Project   |
| Time period | PM Peak Hour  |

Flow Inputs and Adjustments

|                                    |       |      |
|------------------------------------|-------|------|
| Volume, V                          | 3,820 | vph  |
| Peak-hour factor, PHF              | 0.97  |      |
| Peak 15-min volume, $v_{15}$       | 985   | veh  |
| Trucks and buses                   | 2.0%  |      |
| Recreational vehicles              | 0.0%  |      |
| Terrain type                       | Level |      |
| Grade                              |       |      |
| Length                             |       | mi   |
| Trucks and buses PCE, $E_T$        | 1.5   |      |
| Recreational vehicle PCE, $E_R$    | 1.2   |      |
| Heavy vehicle adjustment, $f_{HV}$ | 0.990 |      |
| Driver population factor, $f_p$    | 1.00  |      |
| Flow rate, $v_p$                   | 3,978 | pcph |
| Number of lanes, N                 | 2     |      |

Speed Inputs and Adjustments

|  |      |          |
|--|------|----------|
| Lane width                             | 12.0 | ft       |
| Right-side lateral clearance           | >6   | ft       |
| Total ramp density, TRD                | 2.00 | ramps/mi |
| Lane width adjustment, $f_{LW}$        | 0.0  | mph      |
| Lateral clearance adjustment, $f_{LC}$ | 0.0  | mph      |
| TRD adjustment                         | 5.8  | mph      |
| Calculated free-flow speed, FFS        | 69.6 | mph      |
| Measured free-flow speed, FFS          | 65.0 | mph      |
| Free-flow speed curve                  | 65   | mph      |

Capacity Checks for Segments with Ramps

|                         | <u>Actual</u> |      | <u>Maximum</u> |      | <u>Violation?</u> |
|-------------------------|---------------|------|----------------|------|-------------------|
| Entering freeway volume |               | pcph |                | pcph |                   |
| Exiting freeway volume  |               | pcph |                | pcph |                   |
| On-ramp volume          |               | pcph |                | pcph |                   |
| Off-ramp volume         |               | pcph |                | pcph |                   |

LOS and Performance Measures

|                                |       |        |
|--------------------------------|-------|--------|
| Flow rate, $v_p$               | 1,989 | pcphpl |
| Average passenger-car speed, S | 60.1  | mph    |
| Volume-to-capacity ratio, v/c  | 0.85  |        |
| Density, D                     | 33.1  | pcpmpl |
| Level of service, LOS          | D     |        |

HCM 2010: Freeway Basic Segment

Basic Operational Analysis

|             |   |
|-------------|---|
| Project     | CSUMB Master Plan EIR                                 |
| Freeway     | Southbound State Route 1                              |
| Segment     | SR 1 between Reservation Road and Del Monte Boulevard |
| Alternative | Cumulative  |
| Time period | AM Peak Hour  |

Flow Inputs and Adjustments

|                                    |       |      |
|------------------------------------|-------|------|
| Volume, V                          | 3,480 | vph  |
| Peak-hour factor, PHF              | 0.76  |      |
| Peak 15-min volume, $v_{15}$       | 1,145 | veh  |
| Trucks and buses                   | 4.7%  |      |
| Recreational vehicles              | 0.0%  |      |
| Terrain type                       | Level |      |
| Grade                              |       |      |
| Length                             |       | mi   |
| Trucks and buses PCE, $E_T$        | 1.5   |      |
| Recreational vehicle PCE, $E_R$    | 1.2   |      |
| Heavy vehicle adjustment, $f_{HV}$ | 0.977 |      |
| Driver population factor, $f_p$    | 1.00  |      |
| Flow rate, $v_p$                   | 4,686 | pcph |
| Number of lanes, N                 | 2     |      |

Speed Inputs and Adjustments

|  |      |          |
|--|------|----------|
| Lane width                             | 12.0 | ft       |
| Right-side lateral clearance           | >6   | ft       |
| Total ramp density, TRD                | 1.00 | ramps/mi |
| Lane width adjustment, $f_{LW}$        | 0.0  | mph      |
| Lateral clearance adjustment, $f_{LC}$ | 0.0  | mph      |
| TRD adjustment                         | 3.2  | mph      |
| Calculated free-flow speed, FFS        | 72.2 | mph      |
| Measured free-flow speed, FFS          | 65.0 | mph      |
| Free-flow speed curve                  | 65   | mph      |

Capacity Checks for Segments with Ramps

|                         | <u>Actual</u> |      | <u>Maximum</u> |      | <u>Violation?</u> |
|-------------------------|---------------|------|----------------|------|-------------------|
| Entering freeway volume |               | pcph |                | pcph |                   |
| Exiting freeway volume  |               | pcph |                | pcph |                   |
| On-ramp volume          |               | pcph |                | pcph |                   |
| Off-ramp volume         |               | pcph |                | pcph |                   |

LOS and Performance Measures

|                                |       |        |
|--------------------------------|-------|--------|
| Flow rate, $v_p$               | 2,343 | pcphpl |
| Average passenger-car speed, S | 52.4  | mph    |
| Volume-to-capacity ratio, v/c  | 1.00  |        |
| Density, D                     | 44.7  | pcpmpl |
| Level of service, LOS          | E     |        |

HCM 2010: Freeway Basic Segment

Basic Operational Analysis

|             |   |
|-------------|---|
| Project     | CSUMB Master Plan EIR                                 |
| Freeway     | Southbound SR 1                                       |
| Segment     | SR 1 between Reservation Road and Del Monte Boulevard |
| Alternative | Cumulative  |
| Time period | PM Peak Hour  |

Flow Inputs and Adjustments

|                                    |       |      |
|------------------------------------|-------|------|
| Volume, V                          | 1,830 | vph  |
| Peak-hour factor, PHF              | 0.97  |      |
| Peak 15-min volume, $v_{15}$       | 472   | veh  |
| Trucks and buses                   | 1.0%  |      |
| Recreational vehicles              | 0.0%  |      |
| Terrain type                       | Level |      |
| Grade                              |       |      |
| Length                             |       | mi   |
| Trucks and buses PCE, $E_T$        | 1.5   |      |
| Recreational vehicle PCE, $E_R$    | 1.2   |      |
| Heavy vehicle adjustment, $f_{HV}$ | 0.995 |      |
| Driver population factor, $f_p$    | 1.00  |      |
| Flow rate, $v_p$                   | 1,896 | pcph |
| Number of lanes, N                 | 2     |      |

Speed Inputs and Adjustments

|  |      |          |
|--|------|----------|
| Lane width                             | 12.0 | ft       |
| Right-side lateral clearance           | >6   | ft       |
| Total ramp density, TRD                | 1.00 | ramps/mi |
| Lane width adjustment, $f_{LW}$        | 0.0  | mph      |
| Lateral clearance adjustment, $f_{LC}$ | 0.0  | mph      |
| TRD adjustment                         | 3.2  | mph      |
| Calculated free-flow speed, FFS        | 72.2 | mph      |
| Measured free-flow speed, FFS          | 65.0 | mph      |
| Free-flow speed curve                  | 65   | mph      |

Capacity Checks for Segments with Ramps

|                         | Actual |      | Maximum |      | Violation? |
|-------------------------|--------|------|---------|------|------------|
| Entering freeway volume |        | pcph |         | pcph |            |
| Exiting freeway volume  |        | pcph |         | pcph |            |
| On-ramp volume          |        | pcph |         | pcph |            |
| Off-ramp volume         |        | pcph |         | pcph |            |

LOS and Performance Measures

|                                |      |        |
|--------------------------------|------|--------|
| Flow rate, $v_p$               | 948  | pcphpl |
| Average passenger-car speed, S | 65.0 | mph    |
| Volume-to-capacity ratio, v/c  | 0.40 |        |
| Density, D                     | 14.6 | pcpmpl |
| Level of service, LOS          | B    |        |

HCM 2010: Freeway Basic Segment

Basic Operational Analysis

|             |  |
|-------------|--|
| Project     | CSUMB Master Plan EIR                              |
| Freeway     | Southbound State Route 1                           |
| Segment     | SR 1 between Del Monte Boulevard and Imjin Parkway |
| Alternative | Cumulative   |
| Time period | AM Peak Hour                                       |

Flow Inputs and Adjustments

|                                    |       |      |
|------------------------------------|-------|------|
| Volume, V                          | 5,060 | vph  |
| Peak-hour factor, PHF              | 0.81  |      |
| Peak 15-min volume, $v_{15}$       | 1,562 | veh  |
| Trucks and buses                   | 3.9%  |      |
| Recreational vehicles              | 0.0%  |      |
| Terrain type                       | Level |      |
| Grade                              |       |      |
| Length                             |       | mi   |
| Trucks and buses PCE, $E_T$        | 1.5   |      |
| Recreational vehicle PCE, $E_R$    | 1.2   |      |
| Heavy vehicle adjustment, $f_{HV}$ | 0.981 |      |
| Driver population factor, $f_p$    | 1.00  |      |
| Flow rate, $v_p$                   | 6,369 | pcph |
| Number of lanes, N                 | 3     |      |

Speed Inputs and Adjustments

|  |      |          |
|--|------|----------|
| Lane width                             | 12.0 | ft       |
| Right-side lateral clearance           | >6   | ft       |
| Total ramp density, TRD                | 1.17 | ramps/mi |
| Lane width adjustment, $f_{LW}$        | 0.0  | mph      |
| Lateral clearance adjustment, $f_{LC}$ | 0.0  | mph      |
| TRD adjustment                         | 3.7  | mph      |
| Calculated free-flow speed, FFS        | 71.7 | mph      |
| Measured free-flow speed, FFS          | 65.0 | mph      |
| Free-flow speed curve                  | 65   | mph      |

Capacity Checks for Segments with Ramps

|                         | <u>Actual</u> |      | <u>Maximum</u> |      | <u>Violation?</u> |
|-------------------------|---------------|------|----------------|------|-------------------|
| Entering freeway volume |               | pcph |                | pcph |                   |
| Exiting freeway volume  |               | pcph |                | pcph |                   |
| On-ramp volume          |               | pcph |                | pcph |                   |
| Off-ramp volume         |               | pcph |                | pcph |                   |

LOS and Performance Measures

|                                |       |        |
|--------------------------------|-------|--------|
| Flow rate, $v_p$               | 2,123 | pcphpl |
| Average passenger-car speed, S | 57.6  | mph    |
| Volume-to-capacity ratio, v/c  | 0.90  |        |
| Density, D                     | 36.9  | pcpmpl |
| Level of service, LOS          | E     |        |

HCM 2010: Freeway Basic Segment

Basic Operational Analysis

|             |  |
|-------------|--|
| Project     | CSUMB Master Plan EIR                              |
| Freeway     | Southbound SR 1                                    |
| Segment     | SR 1 between Del Monte Boulevard and Imjin Parkway |
| Alternative | Cumulative   |
| Time period | PM Peak Hour                                       |

Flow Inputs and Adjustments

|                                    |       |      |
|------------------------------------|-------|------|
| Volume, V                          | 2,860 | vph  |
| Peak-hour factor, PHF              | 0.95  |      |
| Peak 15-min volume, $v_{15}$       | 753   | veh  |
| Trucks and buses                   | 1.4%  |      |
| Recreational vehicles              | 0.0%  |      |
| Terrain type                       | Level |      |
| Grade                              |       |      |
| Length                             |       | mi   |
| Trucks and buses PCE, $E_T$        | 1.5   |      |
| Recreational vehicle PCE, $E_R$    | 1.2   |      |
| Heavy vehicle adjustment, $f_{HV}$ | 0.993 |      |
| Driver population factor, $f_p$    | 1.00  |      |
| Flow rate, $v_p$                   | 3,031 | pcph |
| Number of lanes, N                 | 3     |      |

Speed Inputs and Adjustments

|  |      |          |
|--|------|----------|
| Lane width                             | 12.0 | ft       |
| Right-side lateral clearance           | >6   | ft       |
| Total ramp density, TRD                | 1.17 | ramps/mi |
| Lane width adjustment, $f_{LW}$        | 0.0  | mph      |
| Lateral clearance adjustment, $f_{LC}$ | 0.0  | mph      |
| TRD adjustment                         | 3.7  | mph      |
| Calculated free-flow speed, FFS        | 71.7 | mph      |
| Measured free-flow speed, FFS          | 65.0 | mph      |
| Free-flow speed curve                  | 65   | mph      |

Capacity Checks for Segments with Ramps

|                         | Actual |      | Maximum |      | Violation? |
|-------------------------|--------|------|---------|------|------------|
| Entering freeway volume |        | pcph |         | pcph |            |
| Exiting freeway volume  |        | pcph |         | pcph |            |
| On-ramp volume          |        | pcph |         | pcph |            |
| Off-ramp volume         |        | pcph |         | pcph |            |

LOS and Performance Measures

|                                |       |        |
|--------------------------------|-------|--------|
| Flow rate, $v_p$               | 1,010 | pcphpl |
| Average passenger-car speed, S | 65.0  | mph    |
| Volume-to-capacity ratio, v/c  | 0.43  |        |
| Density, D                     | 15.5  | pcpmpl |
| Level of service, LOS          | B     |        |

HCM 2010: Freeway Basic Segment

Basic Operational Analysis

|             |   |
|-------------|---|
| Project     | CSUMB Master Plan EIR                             |
| Freeway     | Southbound State Route 1                          |
| Segment     | SR 1 between Imjin Parkway and Lightfighter Drive |
| Alternative | Cumulative  |
| Time period | AM Peak Hour                                      |

Flow Inputs and Adjustments

|                                    |       |      |
|------------------------------------|-------|------|
| Volume, V                          | 5,230 | vph  |
| Peak-hour factor, PHF              | 0.83  |      |
| Peak 15-min volume, $v_{15}$       | 1,575 | veh  |
| Trucks and buses                   | 3.5%  |      |
| Recreational vehicles              | 0.0%  |      |
| Terrain type                       | Level |      |
| Grade                              |       |      |
| Length                             |       | mi   |
| Trucks and buses PCE, $E_T$        | 1.5   |      |
| Recreational vehicle PCE, $E_R$    | 1.2   |      |
| Heavy vehicle adjustment, $f_{HV}$ | 0.983 |      |
| Driver population factor, $f_p$    | 1.00  |      |
| Flow rate, $v_p$                   | 6,412 | pcph |
| Number of lanes, N                 | 3     |      |

Speed Inputs and Adjustments

|  |      |          |
|--|------|----------|
| Lane width                             | 12.0 | ft       |
| Right-side lateral clearance           | >6   | ft       |
| Total ramp density, TRD                | 1.17 | ramps/mi |
| Lane width adjustment, $f_{LW}$        | 0.0  | mph      |
| Lateral clearance adjustment, $f_{LC}$ | 0.0  | mph      |
| TRD adjustment                         | 3.7  | mph      |
| Calculated free-flow speed, FFS        | 71.7 | mph      |
| Measured free-flow speed, FFS          | 65.0 | mph      |
| Free-flow speed curve                  | 65   | mph      |

Capacity Checks for Segments with Ramps

|                         | <u>Actual</u> |      | <u>Maximum</u> |      | <u>Violation?</u> |
|-------------------------|---------------|------|----------------|------|-------------------|
| Entering freeway volume |               | pcph |                | pcph |                   |
| Exiting freeway volume  |               | pcph |                | pcph |                   |
| On-ramp volume          |               | pcph |                | pcph |                   |
| Off-ramp volume         |               | pcph |                | pcph |                   |

LOS and Performance Measures

|                                 |       |        |
|---------------------------------|-------|--------|
| Flow rate, $v_p$                | 2,137 | pcphpl |
| Average passenger-car speed, S  | 57.3  | mph    |
| Volume-to-capacity ratio, $v/c$ | 0.91  |        |
| Density, D                      | 37.3  | pcpmpl |
| Level of service, LOS           | E     |        |

HCM 2010: Freeway Basic Segment

Basic Operational Analysis

|             |   |
|-------------|---|
| Project     | CSUMB Master Plan EIR                             |
| Freeway     | Southbound SR 1                                   |
| Segment     | SR 1 between Imjin Parkway and Lightfighter Drive |
| Alternative | Cumulative  |
| Time period | PM Peak Hour                                      |

Flow Inputs and Adjustments

|                                    |       |      |
|------------------------------------|-------|------|
| Volume, V                          | 3,490 | vph  |
| Peak-hour factor, PHF              | 0.95  |      |
| Peak 15-min volume, $v_{15}$       | 918   | veh  |
| Trucks and buses                   | 1.3%  |      |
| Recreational vehicles              | 0.0%  |      |
| Terrain type                       | Level |      |
| Grade                              |       |      |
| Length                             |       | mi   |
| Trucks and buses PCE, $E_T$        | 1.5   |      |
| Recreational vehicle PCE, $E_R$    | 1.2   |      |
| Heavy vehicle adjustment, $f_{HV}$ | 0.994 |      |
| Driver population factor, $f_p$    | 1.00  |      |
| Flow rate, $v_p$                   | 3,697 | pcph |
| Number of lanes, N                 | 3     |      |

Speed Inputs and Adjustments

|  |      |          |
|--|------|----------|
| Lane width                             | 12.0 | ft       |
| Right-side lateral clearance           | >6   | ft       |
| Total ramp density, TRD                | 1.17 | ramps/mi |
| Lane width adjustment, $f_{LW}$        | 0.0  | mph      |
| Lateral clearance adjustment, $f_{LC}$ | 0.0  | mph      |
| TRD adjustment                         | 3.7  | mph      |
| Calculated free-flow speed, FFS        | 71.7 | mph      |
| Measured free-flow speed, FFS          | 65.0 | mph      |
| Free-flow speed curve                  | 65   | mph      |

Capacity Checks for Segments with Ramps

|                         | Actual |      | Maximum |      | Violation? |
|-------------------------|--------|------|---------|------|------------|
| Entering freeway volume |        | pcph |         | pcph |            |
| Exiting freeway volume  |        | pcph |         | pcph |            |
| On-ramp volume          |        | pcph |         | pcph |            |
| Off-ramp volume         |        | pcph |         | pcph |            |

LOS and Performance Measures

|                                |       |        |
|--------------------------------|-------|--------|
| Flow rate, $v_p$               | 1,232 | pcphpl |
| Average passenger-car speed, S | 65.0  | mph    |
| Volume-to-capacity ratio, v/c  | 0.52  |        |
| Density, D                     | 19.0  | pcpmpl |
| Level of service, LOS          | C     |        |

HCM 2010: Freeway Basic Segment

Basic Operational Analysis

|             |   |
|-------------|---|
| Project     | CSUMB Master Plan EIR                                   |
| Freeway     | Southbound State Route 1                                |
| Segment     | SR 1 between Lightfighter Drive and Del Monte Boulevard |
| Alternative | Cumulative  |
| Time period | AM Peak Hour  |

Flow Inputs and Adjustments

|                                    |       |      |
|------------------------------------|-------|------|
| Volume, V                          | 5,450 | vph  |
| Peak-hour factor, PHF              | 0.86  |      |
| Peak 15-min volume, $v_{15}$       | 1,584 | veh  |
| Trucks and buses                   | 3.2%  |      |
| Recreational vehicles              | 0.0%  |      |
| Terrain type                       | Level |      |
| Grade                              |       |      |
| Length                             |       | mi   |
| Trucks and buses PCE, $E_T$        | 1.5   |      |
| Recreational vehicle PCE, $E_R$    | 1.2   |      |
| Heavy vehicle adjustment, $f_{HV}$ | 0.984 |      |
| Driver population factor, $f_p$    | 1.00  |      |
| Flow rate, $v_p$                   | 6,439 | pcph |
| Number of lanes, N                 | 3     |      |

Speed Inputs and Adjustments

|  |      |          |
|--|------|----------|
| Lane width                             | 12.0 | ft       |
| Right-side lateral clearance           | >6   | ft       |
| Total ramp density, TRD                | 1.33 | ramps/mi |
| Lane width adjustment, $f_{LW}$        | 0.0  | mph      |
| Lateral clearance adjustment, $f_{LC}$ | 0.0  | mph      |
| TRD adjustment                         | 4.1  | mph      |
| Calculated free-flow speed, FFS        | 71.3 | mph      |
| Measured free-flow speed, FFS          | 65.0 | mph      |
| Free-flow speed curve                  | 65   | mph      |

Capacity Checks for Segments with Ramps

|                         | <u>Actual</u> |      | <u>Maximum</u> |      | <u>Violation?</u> |
|-------------------------|---------------|------|----------------|------|-------------------|
| Entering freeway volume |               | pcph |                | pcph |                   |
| Exiting freeway volume  |               | pcph |                | pcph |                   |
| On-ramp volume          |               | pcph |                | pcph |                   |
| Off-ramp volume         |               | pcph |                | pcph |                   |

LOS and Performance Measures

|                                |       |        |
|--------------------------------|-------|--------|
| Flow rate, $v_p$               | 2,146 | pcphpl |
| Average passenger-car speed, S | 57.1  | mph    |
| Volume-to-capacity ratio, v/c  | 0.91  |        |
| Density, D                     | 37.6  | pcpmpl |
| Level of service, LOS          | E     |        |



HCM 2010: Freeway Basic Segment

Basic Operational Analysis

|             |   |
|-------------|---|
| Project     | CSUMB Master Plan EIR                                   |
| Freeway     | Southbound SR 1   |
| Segment     | SR 1 between Lightfighter Drive and Del Monte Boulevard |
| Alternative | Cumulative  |
| Time period | PM Peak Hour  |

Flow Inputs and Adjustments

|                                    |       |      |
|------------------------------------|-------|------|
| Volume, V                          | 3,920 | vph  |
| Peak-hour factor, PHF              | 0.97  |      |
| Peak 15-min volume, $v_{15}$       | 1,010 | veh  |
| Trucks and buses                   | 1.1%  |      |
| Recreational vehicles              | 0.0%  |      |
| Terrain type                       | Level |      |
| Grade                              |       |      |
| Length                             |       | mi   |
| Trucks and buses PCE, $E_T$        | 1.5   |      |
| Recreational vehicle PCE, $E_R$    | 1.2   |      |
| Heavy vehicle adjustment, $f_{HV}$ | 0.994 |      |
| Driver population factor, $f_p$    | 1.00  |      |
| Flow rate, $v_p$                   | 4,064 | pcph |
| Number of lanes, N                 | 3     |      |

Speed Inputs and Adjustments

|  |      |          |
|--|------|----------|
| Lane width                             | 12.0 | ft       |
| Right-side lateral clearance           | >6   | ft       |
| Total ramp density, TRD                | 1.33 | ramps/mi |
| Lane width adjustment, $f_{LW}$        | 0.0  | mph      |
| Lateral clearance adjustment, $f_{LC}$ | 0.0  | mph      |
| TRD adjustment                         | 4.1  | mph      |
| Calculated free-flow speed, FFS        | 71.3 | mph      |
| Measured free-flow speed, FFS          | 65.0 | mph      |
| Free-flow speed curve                  | 65   | mph      |

Capacity Checks for Segments with Ramps

|                         | Actual |      | Maximum |      | Violation? |
|-------------------------|--------|------|---------|------|------------|
| Entering freeway volume |        | pcph |         | pcph |            |
| Exiting freeway volume  |        | pcph |         | pcph |            |
| On-ramp volume          |        | pcph |         | pcph |            |
| Off-ramp volume         |        | pcph |         | pcph |            |

LOS and Performance Measures

|                                |       |        |
|--------------------------------|-------|--------|
| Flow rate, $v_p$               | 1,355 | pcphpl |
| Average passenger-car speed, S | 65.0  | mph    |
| Volume-to-capacity ratio, v/c  | 0.58  |        |
| Density, D                     | 20.8  | pcpmpl |
| Level of service, LOS          | C     |        |

HCM 2010: Freeway Basic Segment

Basic Operational Analysis

|             |   |
|-------------|---|
| Project     | CSUMB Master Plan EIR   |
| Freeway     | Southbound State Route 1                                      |
| Segment     | SR 1 between Del Monte Boulevard and Canyon Del Rey Boulevard |
| Alternative | Cumulative  |
| Time period | AM Peak Hour  |

Flow Inputs and Adjustments

|                                    |       |      |
|------------------------------------|-------|------|
| Volume, V                          | 4,470 | vph  |
| Peak-hour factor, PHF              | 0.95  |      |
| Peak 15-min volume, $v_{15}$       | 1,176 | veh  |
| Trucks and buses                   | 2.4%  |      |
| Recreational vehicles              | 0.0%  |      |
| Terrain type                       | Level |      |
| Grade                              |       |      |
| Length                             |       | mi   |
| Trucks and buses PCE, $E_T$        | 1.5   |      |
| Recreational vehicle PCE, $E_R$    | 1.2   |      |
| Heavy vehicle adjustment, $f_{HV}$ | 0.988 |      |
| Driver population factor, $f_P$    | 1.00  |      |
| Flow rate, $v_p$                   | 4,763 | pcph |
| Number of lanes, N                 | 2     |      |

Speed Inputs and Adjustments

|  |      |          |
|--|------|----------|
| Lane width                             | 12.0 | ft       |
| Right-side lateral clearance           | 5.0  | ft       |
| Total ramp density, TRD                | 2.17 | ramps/mi |
| Lane width adjustment, $f_{LW}$        | 0.0  | mph      |
| Lateral clearance adjustment, $f_{LC}$ | 0.6  | mph      |
| TRD adjustment                         | 6.2  | mph      |
| Calculated free-flow speed, FFS        | 68.6 | mph      |
| Measured free-flow speed, FFS          | 65.0 | mph      |
| Free-flow speed curve                  | 65   | mph      |

Capacity Checks for Segments with Ramps

|                         | <u>Actual</u> |      | <u>Maximum</u> |      | <u>Violation?</u> |
|-------------------------|---------------|------|----------------|------|-------------------|
| Entering freeway volume |               | pcph |                | pcph |                   |
| Exiting freeway volume  |               | pcph |                | pcph |                   |
| On-ramp volume          |               | pcph |                | pcph |                   |
| Off-ramp volume         |               | pcph |                | pcph |                   |

LOS and Performance Measures

|                                 |       |        |
|---------------------------------|-------|--------|
| Flow rate, $v_p$                | 2,381 | pcphpl |
| Average passenger-car speed, S  | -     | mph    |
| Volume-to-capacity ratio, $v/c$ | 1.01  |        |
| Density, D                      | -     | pcpmpl |
| Level of service, LOS           | F     |        |

HCM 2010: Freeway Basic Segment

Basic Operational Analysis

|             |   |
|-------------|---|
| Project     | CSUMB Master Plan EIR   |
| Freeway     | Southbound SR 1   |
| Segment     | SR 1 between Del Monte Boulevard and Canyon Del Rey Boulevard |
| Alternative | Cumulative  |
| Time period | PM Peak Hour  |

Flow Inputs and Adjustments

|                                    |       |      |
|------------------------------------|-------|------|
| Volume, V                          | 3,170 | vph  |
| Peak-hour factor, PHF              | 0.96  |      |
| Peak 15-min volume, $v_{15}$       | 826   | veh  |
| Trucks and buses                   | 1.0%  |      |
| Recreational vehicles              | 0.0%  |      |
| Terrain type                       | Level |      |
| Grade                              |       |      |
| Length                             |       | mi   |
| Trucks and buses PCE, $E_T$        | 1.5   |      |
| Recreational vehicle PCE, $E_R$    | 1.2   |      |
| Heavy vehicle adjustment, $f_{HV}$ | 0.995 |      |
| Driver population factor, $f_p$    | 1.00  |      |
| Flow rate, $v_p$                   | 3,319 | pcph |
| Number of lanes, N                 | 2     |      |

Speed Inputs and Adjustments

|  |      |          |
|--|------|----------|
| Lane width                             | 12.0 | ft       |
| Right-side lateral clearance           | 5.0  | ft       |
| Total ramp density, TRD                | 2.17 | ramps/mi |
| Lane width adjustment, $f_{LW}$        | 0.0  | mph      |
| Lateral clearance adjustment, $f_{LC}$ | 0.6  | mph      |
| TRD adjustment                         | 6.2  | mph      |
| Calculated free-flow speed, FFS        | 68.6 | mph      |
| Measured free-flow speed, FFS          | 65.0 | mph      |
| Free-flow speed curve                  | 65   | mph      |

Capacity Checks for Segments with Ramps

|                         | Actual |      | Maximum |      | Violation? |
|-------------------------|--------|------|---------|------|------------|
| Entering freeway volume |        | pcph |         | pcph |            |
| Exiting freeway volume  |        | pcph |         | pcph |            |
| On-ramp volume          |        | pcph |         | pcph |            |
| Off-ramp volume         |        | pcph |         | pcph |            |

LOS and Performance Measures

|                                |       |        |
|--------------------------------|-------|--------|
| Flow rate, $v_p$               | 1,659 | pcphpl |
| Average passenger-car speed, S | 64.0  | mph    |
| Volume-to-capacity ratio, v/c  | 0.71  |        |
| Density, D                     | 25.9  | pcpmpl |
| Level of service, LOS          | C     |        |

HCM 2010: Freeway Basic Segment

Basic Operational Analysis

|             |   |
|-------------|---|
| Project     | CSUMB Master Plan EIR                                 |
| Freeway     | Northbound State Route 1                              |
| Segment     | SR 1 between Reservation Road and Del Monte Boulevard |
| Alternative | Cumulative  |
| Time period | AM Peak Hour  |

Flow Inputs and Adjustments

|                                    |       |      |
|------------------------------------|-------|------|
| Volume, V                          | 1,500 | vph  |
| Peak-hour factor, PHF              | 0.97  |      |
| Peak 15-min volume, $v_{15}$       | 387   | veh  |
| Trucks and buses                   | 6.4%  |      |
| Recreational vehicles              | 0.0%  |      |
| Terrain type                       | Level |      |
| Grade                              |       |      |
| Length                             |       | mi   |
| Trucks and buses PCE, $E_T$        | 1.5   |      |
| Recreational vehicle PCE, $E_R$    | 1.2   |      |
| Heavy vehicle adjustment, $f_{HV}$ | 0.969 |      |
| Driver population factor, $f_p$    | 1.00  |      |
| Flow rate, $v_p$                   | 1,596 | pcph |
| Number of lanes, N                 | 2     |      |

Speed Inputs and Adjustments

|  |      |          |
|--|------|----------|
| Lane width                             | 12.0 | ft       |
| Right-side lateral clearance           | >6   | ft       |
| Total ramp density, TRD                | 1.00 | ramps/mi |
| Lane width adjustment, $f_{LW}$        | 0.0  | mph      |
| Lateral clearance adjustment, $f_{LC}$ | 0.0  | mph      |
| TRD adjustment                         | 3.2  | mph      |
| Calculated free-flow speed, FFS        | 72.2 | mph      |
| Measured free-flow speed, FFS          | 65.0 | mph      |
| Free-flow speed curve                  | 65   | mph      |

Capacity Checks for Segments with Ramps

|                         | <u>Actual</u> |      | <u>Maximum</u> |      | <u>Violation?</u> |
|-------------------------|---------------|------|----------------|------|-------------------|
| Entering freeway volume |               | pcph |                | pcph |                   |
| Exiting freeway volume  |               | pcph |                | pcph |                   |
| On-ramp volume          |               | pcph |                | pcph |                   |
| Off-ramp volume         |               | pcph |                | pcph |                   |

LOS and Performance Measures

|                                |      |        |
|--------------------------------|------|--------|
| Flow rate, $v_p$               | 798  | pcphpl |
| Average passenger-car speed, S | 65.0 | mph    |
| Volume-to-capacity ratio, v/c  | 0.34 |        |
| Density, D                     | 12.3 | pcpmpl |
| Level of service, LOS          | B    |        |

HCM 2010: Freeway Basic Segment

Basic Operational Analysis

|             |   |
|-------------|---|
| Project     | CSUMB Master Plan EIR                                 |
| Freeway     | Northbound State Route 1                              |
| Segment     | SR 1 between Reservation Road and Del Monte Boulevard |
| Alternative | Cumulative  |
| Time period | PM Peak Hour  |

Flow Inputs and Adjustments

|                                    |       |      |
|------------------------------------|-------|------|
| Volume, V                          | 2,970 | vph  |
| Peak-hour factor, PHF              | 0.98  |      |
| Peak 15-min volume, $v_{15}$       | 758   | veh  |
| Trucks and buses                   | 2.2%  |      |
| Recreational vehicles              | 0.0%  |      |
| Terrain type                       | Level |      |
| Grade                              |       |      |
| Length                             |       | mi   |
| Trucks and buses PCE, $E_T$        | 1.5   |      |
| Recreational vehicle PCE, $E_R$    | 1.2   |      |
| Heavy vehicle adjustment, $f_{HV}$ | 0.989 |      |
| Driver population factor, $f_p$    | 1.00  |      |
| Flow rate, $v_p$                   | 3,064 | pcph |
| Number of lanes, N                 | 2     |      |

Speed Inputs and Adjustments

|  |      |          |
|--|------|----------|
| Lane width                             | 12.0 | ft       |
| Right-side lateral clearance           | >6   | ft       |
| Total ramp density, TRD                | 1.00 | ramps/mi |
| Lane width adjustment, $f_{LW}$        | 0.0  | mph      |
| Lateral clearance adjustment, $f_{LC}$ | 0.0  | mph      |
| TRD adjustment                         | 3.2  | mph      |
| Calculated free-flow speed, FFS        | 72.2 | mph      |
| Measured free-flow speed, FFS          | 65.0 | mph      |
| Free-flow speed curve                  | 65   | mph      |

Capacity Checks for Segments with Ramps

|                         | <u>Actual</u> |      | <u>Maximum</u> |      | <u>Violation?</u> |
|-------------------------|---------------|------|----------------|------|-------------------|
| Entering freeway volume |               | pcph |                | pcph |                   |
| Exiting freeway volume  |               | pcph |                | pcph |                   |
| On-ramp volume          |               | pcph |                | pcph |                   |
| Off-ramp volume         |               | pcph |                | pcph |                   |

LOS and Performance Measures

|                                |       |        |
|--------------------------------|-------|--------|
| Flow rate, $v_p$               | 1,532 | pcphpl |
| Average passenger-car speed, S | 64.8  | mph    |
| Volume-to-capacity ratio, v/c  | 0.65  |        |
| Density, D                     | 23.7  | pcpmpl |
| Level of service, LOS          | C     |        |

HCM 2010: Freeway Basic Segment

Basic Operational Analysis

|             |  |
|-------------|--|
| Project     | CSUMB Master Plan EIR                              |
| Freeway     | Northbound State Route 1                           |
| Segment     | SR 1 between Del Monte Boulevard and Imjin Parkway |
| Alternative | Cumulative   |
| Time period | AM Peak Hour                                       |

Flow Inputs and Adjustments

|                                    |       |      |
|------------------------------------|-------|------|
| Volume, V                          | 2,410 | vph  |
| Peak-hour factor, PHF              | 0.92  |      |
| Peak 15-min volume, $v_{15}$       | 655   | veh  |
| Trucks and buses                   | 5.7%  |      |
| Recreational vehicles              | 0.0%  |      |
| Terrain type                       | Level |      |
| Grade                              |       |      |
| Length                             |       | mi   |
| Trucks and buses PCE, $E_T$        | 1.5   |      |
| Recreational vehicle PCE, $E_R$    | 1.2   |      |
| Heavy vehicle adjustment, $f_{HV}$ | 0.972 |      |
| Driver population factor, $f_p$    | 1.00  |      |
| Flow rate, $v_p$                   | 2,695 | pcph |
| Number of lanes, N                 | 3     |      |

Speed Inputs and Adjustments

|  |      |          |
|--|------|----------|
| Lane width                             | 12.0 | ft       |
| Right-side lateral clearance           | >6   | ft       |
| Total ramp density, TRD                | 1.20 | ramps/mi |
| Lane width adjustment, $f_{LW}$        | 0.0  | mph      |
| Lateral clearance adjustment, $f_{LC}$ | 0.0  | mph      |
| TRD adjustment                         | 3.8  | mph      |
| Calculated free-flow speed, FFS        | 71.6 | mph      |
| Measured free-flow speed, FFS          | 65.0 | mph      |
| Free-flow speed curve                  | 65   | mph      |

Capacity Checks for Segments with Ramps

|                         | <u>Actual</u> |      | <u>Maximum</u> |      | <u>Violation?</u> |
|-------------------------|---------------|------|----------------|------|-------------------|
| Entering freeway volume |               | pcph |                | pcph |                   |
| Exiting freeway volume  |               | pcph |                | pcph |                   |
| On-ramp volume          |               | pcph |                | pcph |                   |
| Off-ramp volume         |               | pcph |                | pcph |                   |

LOS and Performance Measures

|                                |      |        |
|--------------------------------|------|--------|
| Flow rate, $v_p$               | 898  | pcphpl |
| Average passenger-car speed, S | 65.0 | mph    |
| Volume-to-capacity ratio, v/c  | 0.38 |        |
| Density, D                     | 13.8 | pcpmpl |
| Level of service, LOS          | B    |        |

HCM 2010: Freeway Basic Segment

Basic Operational Analysis

|             |  |
|-------------|--|
| Project     | CSUMB Master Plan EIR                              |
| Freeway     | Northbound State Route 1                           |
| Segment     | SR 1 between Del Monte Boulevard and Imjin Parkway |
| Alternative | Cumulative   |
| Time period | PM Peak Hour                                       |

Flow Inputs and Adjustments

|                                    |       |      |
|------------------------------------|-------|------|
| Volume, V                          | 4,850 | vph  |
| Peak-hour factor, PHF              | 0.96  |      |
| Peak 15-min volume, $v_{15}$       | 1,263 | veh  |
| Trucks and buses                   | 1.9%  |      |
| Recreational vehicles              | 0.0%  |      |
| Terrain type                       | Level |      |
| Grade                              |       |      |
| Length                             |       | mi   |
| Trucks and buses PCE, $E_T$        | 1.5   |      |
| Recreational vehicle PCE, $E_R$    | 1.2   |      |
| Heavy vehicle adjustment, $f_{HV}$ | 0.991 |      |
| Driver population factor, $f_p$    | 1.00  |      |
| Flow rate, $v_p$                   | 5,100 | pcph |
| Number of lanes, N                 | 3     |      |

Speed Inputs and Adjustments

|  |      |          |
|--|------|----------|
| Lane width                             | 12.0 | ft       |
| Right-side lateral clearance           | >6   | ft       |
| Total ramp density, TRD                | 1.17 | ramps/mi |
| Lane width adjustment, $f_{LW}$        | 0.0  | mph      |
| Lateral clearance adjustment, $f_{LC}$ | 0.0  | mph      |
| TRD adjustment                         | 3.7  | mph      |
| Calculated free-flow speed, FFS        | 71.7 | mph      |
| Measured free-flow speed, FFS          | 65.0 | mph      |
| Free-flow speed curve                  | 65   | mph      |

Capacity Checks for Segments with Ramps

|                         | <u>Actual</u> |      | <u>Maximum</u> |      | <u>Violation?</u> |
|-------------------------|---------------|------|----------------|------|-------------------|
| Entering freeway volume |               | pcph |                | pcph |                   |
| Exiting freeway volume  |               | pcph |                | pcph |                   |
| On-ramp volume          |               | pcph |                | pcph |                   |
| Off-ramp volume         |               | pcph |                | pcph |                   |

LOS and Performance Measures

|                                |       |        |
|--------------------------------|-------|--------|
| Flow rate, $v_p$               | 1,700 | pcphpl |
| Average passenger-car speed, S | 63.7  | mph    |
| Volume-to-capacity ratio, v/c  | 0.72  |        |
| Density, D                     | 26.7  | pcpmpl |
| Level of service, LOS          | D     |        |

HCM 2010: Freeway Basic Segment

Basic Operational Analysis

|             |   |
|-------------|---|
| Project     | CSUMB Master Plan EIR                             |
| Freeway     | Northbound State Route 1                          |
| Segment     | SR 1 between Imjin Parkway and Lightfighter Drive |
| Alternative | Cumulative  |
| Time period | AM Peak Hour                                      |

Flow Inputs and Adjustments

|                                    |       |      |
|------------------------------------|-------|------|
| Volume, V                          | 3,070 | vph  |
| Peak-hour factor, PHF              | 0.92  |      |
| Peak 15-min volume, $v_{15}$       | 836   | veh  |
| Trucks and buses                   | 3.8%  |      |
| Recreational vehicles              | 0.0%  |      |
| Terrain type                       | Level |      |
| Grade                              |       |      |
| Length                             |       | mi   |
| Trucks and buses PCE, $E_T$        | 1.5   |      |
| Recreational vehicle PCE, $E_R$    | 1.2   |      |
| Heavy vehicle adjustment, $f_{HV}$ | 0.982 |      |
| Driver population factor, $f_p$    | 1.00  |      |
| Flow rate, $v_p$                   | 3,408 | pcph |
| Number of lanes, N                 | 3     |      |

Speed Inputs and Adjustments

|  |      |          |
|--|------|----------|
| Lane width                             | 12.0 | ft       |
| Right-side lateral clearance           | >6   | ft       |
| Total ramp density, TRD                | 1.17 | ramps/mi |
| Lane width adjustment, $f_{LW}$        | 0.0  | mph      |
| Lateral clearance adjustment, $f_{LC}$ | 0.0  | mph      |
| TRD adjustment                         | 3.7  | mph      |
| Calculated free-flow speed, FFS        | 71.7 | mph      |
| Measured free-flow speed, FFS          | 65.0 | mph      |
| Free-flow speed curve                  | 65   | mph      |

Capacity Checks for Segments with Ramps

|                         | <u>Actual</u> |      | <u>Maximum</u> |      | <u>Violation?</u> |
|-------------------------|---------------|------|----------------|------|-------------------|
| Entering freeway volume |               | pcph |                | pcph |                   |
| Exiting freeway volume  |               | pcph |                | pcph |                   |
| On-ramp volume          |               | pcph |                | pcph |                   |
| Off-ramp volume         |               | pcph |                | pcph |                   |

LOS and Performance Measures

|                                |       |        |
|--------------------------------|-------|--------|
| Flow rate, $v_p$               | 1,136 | pcphpl |
| Average passenger-car speed, S | 65.0  | mph    |
| Volume-to-capacity ratio, v/c  | 0.48  |        |
| Density, D                     | 17.5  | pcpmpl |
| Level of service, LOS          | B     |        |



HCM 2010: Freeway Basic Segment

Basic Operational Analysis

|             |   |
|-------------|---|
| Project     | CSUMB Master Plan EIR                             |
| Freeway     | Northbound State Route 1                          |
| Segment     | SR 1 between Imjin Parkway and Lightfighter Drive |
| Alternative | Cumulative  |
| Time period | PM Peak Hour                                      |

Flow Inputs and Adjustments

|                                    |       |      |
|------------------------------------|-------|------|
| Volume, V                          | 5,530 | vph  |
| Peak-hour factor, PHF              | 0.97  |      |
| Peak 15-min volume, $v_{15}$       | 1,425 | veh  |
| Trucks and buses                   | 1.7%  |      |
| Recreational vehicles              | 0.0%  |      |
| Terrain type                       | Level |      |
| Grade                              |       |      |
| Length                             |       | mi   |
| Trucks and buses PCE, $E_T$        | 1.5   |      |
| Recreational vehicle PCE, $E_R$    | 1.2   |      |
| Heavy vehicle adjustment, $f_{HV}$ | 0.991 |      |
| Driver population factor, $f_P$    | 1.00  |      |
| Flow rate, $v_p$                   | 5,750 | pcph |
| Number of lanes, N                 | 3     |      |

Speed Inputs and Adjustments

|  |      |          |
|--|------|----------|
| Lane width                             | 12.0 | ft       |
| Right-side lateral clearance           | >6   | ft       |
| Total ramp density, TRD                | 1.17 | ramps/mi |
| Lane width adjustment, $f_{LW}$        | 0.0  | mph      |
| Lateral clearance adjustment, $f_{LC}$ | 0.0  | mph      |
| TRD adjustment                         | 3.7  | mph      |
| Calculated free-flow speed, FFS        | 71.7 | mph      |
| Measured free-flow speed, FFS          | 65.0 | mph      |
| Free-flow speed curve                  | 65   | mph      |

Capacity Checks for Segments with Ramps

|                         | <u>Actual</u> |      | <u>Maximum</u> |      | <u>Violation?</u> |
|-------------------------|---------------|------|----------------|------|-------------------|
| Entering freeway volume |               | pcph |                | pcph |                   |
| Exiting freeway volume  |               | pcph |                | pcph |                   |
| On-ramp volume          |               | pcph |                | pcph |                   |
| Off-ramp volume         |               | pcph |                | pcph |                   |

LOS and Performance Measures

|                                |       |        |
|--------------------------------|-------|--------|
| Flow rate, $v_p$               | 1,917 | pcphpl |
| Average passenger-car speed, S | 61.2  | mph    |
| Volume-to-capacity ratio, v/c  | 0.82  |        |
| Density, D                     | 31.3  | pcpmpl |
| Level of service, LOS          | D     |        |

HCM 2010: Freeway Basic Segment

Basic Operational Analysis

|             |   |
|-------------|---|
| Project     | CSUMB Master Plan EIR                                   |
| Freeway     | Northbound State Route 1                                |
| Segment     | SR 1 between Lightfighter Drive and Del Monte Boulevard |
| Alternative | Cumulative  |
| Time period | AM Peak Hour  |

Flow Inputs and Adjustments

|                                    |       |      |
|------------------------------------|-------|------|
| Volume, V                          | 3,480 | vph  |
| Peak-hour factor, PHF              | 0.93  |      |
| Peak 15-min volume, $v_{15}$       | 932   | veh  |
| Trucks and buses                   | 3.8%  |      |
| Recreational vehicles              | 0.0%  |      |
| Terrain type                       | Level |      |
| Grade                              |       |      |
| Length                             |       | mi   |
| Trucks and buses PCE, $E_T$        | 1.5   |      |
| Recreational vehicle PCE, $E_R$    | 1.2   |      |
| Heavy vehicle adjustment, $f_{HV}$ | 0.982 |      |
| Driver population factor, $f_p$    | 1.00  |      |
| Flow rate, $v_p$                   | 3,797 | pcph |
| Number of lanes, N                 | 3     |      |

Speed Inputs and Adjustments

|  |      |          |
|--|------|----------|
| Lane width                             | 12.0 | ft       |
| Right-side lateral clearance           | >6   | ft       |
| Total ramp density, TRD                | 1.17 | ramps/mi |
| Lane width adjustment, $f_{LW}$        | 0.0  | mph      |
| Lateral clearance adjustment, $f_{LC}$ | 0.0  | mph      |
| TRD adjustment                         | 3.7  | mph      |
| Calculated free-flow speed, FFS        | 71.7 | mph      |
| Measured free-flow speed, FFS          | 65.0 | mph      |
| Free-flow speed curve                  | 65   | mph      |

Capacity Checks for Segments with Ramps

|                         | <u>Actual</u> |      | <u>Maximum</u> |      | <u>Violation?</u> |
|-------------------------|---------------|------|----------------|------|-------------------|
| Entering freeway volume |               | pcph |                | pcph |                   |
| Exiting freeway volume  |               | pcph |                | pcph |                   |
| On-ramp volume          |               | pcph |                | pcph |                   |
| Off-ramp volume         |               | pcph |                | pcph |                   |

LOS and Performance Measures

|                                |       |        |
|--------------------------------|-------|--------|
| Flow rate, $v_p$               | 1,266 | pcphpl |
| Average passenger-car speed, S | 65.0  | mph    |
| Volume-to-capacity ratio, v/c  | 0.54  |        |
| Density, D                     | 19.5  | pcpmpl |
| Level of service, LOS          | C     |        |

HCM 2010: Freeway Basic Segment

Basic Operational Analysis

|             |   |
|-------------|---|
| Project     | CSUMB Master Plan EIR                                   |
| Freeway     | Northbound State Route 1                                |
| Segment     | SR 1 between Lightfighter Drive and Del Monte Boulevard |
| Alternative | Cumulative  |
| Time period | PM Peak Hour  |

Flow Inputs and Adjustments

|                                    |       |      |
|------------------------------------|-------|------|
| Volume, V                          | 5,380 | vph  |
| Peak-hour factor, PHF              | 0.98  |      |
| Peak 15-min volume, $v_{15}$       | 1,372 | veh  |
| Trucks and buses                   | 1.9%  |      |
| Recreational vehicles              | 0.0%  |      |
| Terrain type                       | Level |      |
| Grade                              |       |      |
| Length                             |       | mi   |
| Trucks and buses PCE, $E_T$        | 1.5   |      |
| Recreational vehicle PCE, $E_R$    | 1.2   |      |
| Heavy vehicle adjustment, $f_{HV}$ | 0.991 |      |
| Driver population factor, $f_p$    | 1.00  |      |
| Flow rate, $v_p$                   | 5,541 | pcph |
| Number of lanes, N                 | 3     |      |

Speed Inputs and Adjustments

|  |      |          |
|--|------|----------|
| Lane width                             | 12.0 | ft       |
| Right-side lateral clearance           | >6   | ft       |
| Total ramp density, TRD                | 1.17 | ramps/mi |
| Lane width adjustment, $f_{LW}$        | 0.0  | mph      |
| Lateral clearance adjustment, $f_{LC}$ | 0.0  | mph      |
| TRD adjustment                         | 3.7  | mph      |
| Calculated free-flow speed, FFS        | 71.7 | mph      |
| Measured free-flow speed, FFS          | 65.0 | mph      |
| Free-flow speed curve                  | 65   | mph      |

Capacity Checks for Segments with Ramps

|                         | <u>Actual</u> |      | <u>Maximum</u> |      | <u>Violation?</u> |
|-------------------------|---------------|------|----------------|------|-------------------|
| Entering freeway volume |               | pcph |                | pcph |                   |
| Exiting freeway volume  |               | pcph |                | pcph |                   |
| On-ramp volume          |               | pcph |                | pcph |                   |
| Off-ramp volume         |               | pcph |                | pcph |                   |

LOS and Performance Measures

|                                |       |        |
|--------------------------------|-------|--------|
| Flow rate, $v_p$               | 1,847 | pcphpl |
| Average passenger-car speed, S | 62.2  | mph    |
| Volume-to-capacity ratio, v/c  | 0.79  |        |
| Density, D                     | 29.7  | pcpmpl |
| Level of service, LOS          | D     |        |

HCM 2010: Freeway Basic Segment

Basic Operational Analysis

|             |   |
|-------------|---|
| Project     | CSUMB Master Plan EIR   |
| Freeway     | Northbound State Route 1                                      |
| Segment     | SR 1 between Del Monte Boulevard and Canyon Del Rey Boulevard |
| Alternative | Cumulative  |
| Time period | AM Peak Hour  |

Flow Inputs and Adjustments

|                                    |       |      |
|------------------------------------|-------|------|
| Volume, V                          | 2,970 | vph  |
| Peak-hour factor, PHF              | 0.92  |      |
| Peak 15-min volume, $v_{15}$       | 811   | veh  |
| Trucks and buses                   | 3.2%  |      |
| Recreational vehicles              | 0.0%  |      |
| Terrain type                       | Level |      |
| Grade                              |       |      |
| Length                             |       | mi   |
| Trucks and buses PCE, $E_T$        | 1.5   |      |
| Recreational vehicle PCE, $E_R$    | 1.2   |      |
| Heavy vehicle adjustment, $f_{HV}$ | 0.984 |      |
| Driver population factor, $f_p$    | 1.00  |      |
| Flow rate, $v_p$                   | 3,296 | pcph |
| Number of lanes, N                 | 2     |      |

Speed Inputs and Adjustments

|  |      |          |
|--|------|----------|
| Lane width                             | 12.0 | ft       |
| Right-side lateral clearance           | >6   | ft       |
| Total ramp density, TRD                | 2.00 | ramps/mi |
| Lane width adjustment, $f_{LW}$        | 0.0  | mph      |
| Lateral clearance adjustment, $f_{LC}$ | 0.0  | mph      |
| TRD adjustment                         | 5.8  | mph      |
| Calculated free-flow speed, FFS        | 69.6 | mph      |
| Measured free-flow speed, FFS          | 65.0 | mph      |
| Free-flow speed curve                  | 65   | mph      |

Capacity Checks for Segments with Ramps

|                         | <u>Actual</u> |      | <u>Maximum</u> |      | <u>Violation?</u> |
|-------------------------|---------------|------|----------------|------|-------------------|
| Entering freeway volume |               | pcph |                | pcph |                   |
| Exiting freeway volume  |               | pcph |                | pcph |                   |
| On-ramp volume          |               | pcph |                | pcph |                   |
| Off-ramp volume         |               | pcph |                | pcph |                   |

LOS and Performance Measures

|                                |       |        |
|--------------------------------|-------|--------|
| Flow rate, $v_p$               | 1,648 | pcphpl |
| Average passenger-car speed, S | 64.1  | mph    |
| Volume-to-capacity ratio, v/c  | 0.70  |        |
| Density, D                     | 25.7  | pcpmpl |
| Level of service, LOS          | C     |        |

HCM 2010: Freeway Basic Segment

Basic Operational Analysis

|             |   |
|-------------|---|
| Project     | CSUMB Master Plan EIR   |
| Freeway     | Northbound State Route 1                                      |
| Segment     | SR 1 between Del Monte Boulevard and Canyon Del Rey Boulevard |
| Alternative | Cumulative  |
| Time period | PM Peak Hour  |

Flow Inputs and Adjustments

|                                    |       |      |
|------------------------------------|-------|------|
| Volume, V                          | 4,290 | vph  |
| Peak-hour factor, PHF              | 0.97  |      |
| Peak 15-min volume, $v_{15}$       | 1,106 | veh  |
| Trucks and buses                   | 2.0%  |      |
| Recreational vehicles              | 0.0%  |      |
| Terrain type                       | Level |      |
| Grade                              |       |      |
| Length                             |       | mi   |
| Trucks and buses PCE, $E_T$        | 1.5   |      |
| Recreational vehicle PCE, $E_R$    | 1.2   |      |
| Heavy vehicle adjustment, $f_{HV}$ | 0.990 |      |
| Driver population factor, $f_p$    | 1.00  |      |
| Flow rate, $v_p$                   | 4,468 | pcph |
| Number of lanes, N                 | 2     |      |

Speed Inputs and Adjustments

|  |      |          |
|--|------|----------|
| Lane width                             | 12.0 | ft       |
| Right-side lateral clearance           | >6   | ft       |
| Total ramp density, TRD                | 2.00 | ramps/mi |
| Lane width adjustment, $f_{LW}$        | 0.0  | mph      |
| Lateral clearance adjustment, $f_{LC}$ | 0.0  | mph      |
| TRD adjustment                         | 5.8  | mph      |
| Calculated free-flow speed, FFS        | 69.6 | mph      |
| Measured free-flow speed, FFS          | 65.0 | mph      |
| Free-flow speed curve                  | 65   | mph      |

Capacity Checks for Segments with Ramps

|                         | <u>Actual</u> |      | <u>Maximum</u> |      | <u>Violation?</u> |
|-------------------------|---------------|------|----------------|------|-------------------|
| Entering freeway volume |               | pcph |                | pcph |                   |
| Exiting freeway volume  |               | pcph |                | pcph |                   |
| On-ramp volume          |               | pcph |                | pcph |                   |
| Off-ramp volume         |               | pcph |                | pcph |                   |

LOS and Performance Measures

|                                |       |        |
|--------------------------------|-------|--------|
| Flow rate, $v_p$               | 2,234 | pcphpl |
| Average passenger-car speed, S | 55.1  | mph    |
| Volume-to-capacity ratio, v/c  | 0.95  |        |
| Density, D                     | 40.5  | pcpmpl |
| Level of service, LOS          | E     |        |

HCM 2010: Freeway Basic Segment

Basic Operational Analysis

|             |   |
|-------------|---|
| Project     | CSUMB Master Plan EIR                                 |
| Freeway     | Southbound State Route 1                              |
| Segment     | SR 1 between Reservation Road and Del Monte Boulevard |
| Alternative | Cuml w/ Eastside Pkwy                                 |
| Time period | AM Peak Hour  |

Flow Inputs and Adjustments

|                                    |       |      |
|------------------------------------|-------|------|
| Volume, V                          | 3,460 | vph  |
| Peak-hour factor, PHF              | 0.76  |      |
| Peak 15-min volume, $v_{15}$       | 1,138 | veh  |
| Trucks and buses                   | 4.7%  |      |
| Recreational vehicles              | 0.0%  |      |
| Terrain type                       | Level |      |
| Grade                              |       |      |
| Length                             |       | mi   |
| Trucks and buses PCE, $E_T$        | 1.5   |      |
| Recreational vehicle PCE, $E_R$    | 1.2   |      |
| Heavy vehicle adjustment, $f_{HV}$ | 0.977 |      |
| Driver population factor, $f_P$    | 1.00  |      |
| Flow rate, $v_p$                   | 4,659 | pcph |
| Number of lanes, N                 | 2     |      |

Speed Inputs and Adjustments

|  |      |          |
|--|------|----------|
| Lane width                             | 12.0 | ft       |
| Right-side lateral clearance           | >6   | ft       |
| Total ramp density, TRD                | 1.00 | ramps/mi |
| Lane width adjustment, $f_{LW}$        | 0.0  | mph      |
| Lateral clearance adjustment, $f_{LC}$ | 0.0  | mph      |
| TRD adjustment                         | 3.2  | mph      |
| Calculated free-flow speed, FFS        | 72.2 | mph      |
| Measured free-flow speed, FFS          | 65.0 | mph      |
| Free-flow speed curve                  | 65   | mph      |

Capacity Checks for Segments with Ramps

|                         | <u>Actual</u> |      | <u>Maximum</u> |      | <u>Violation?</u> |
|-------------------------|---------------|------|----------------|------|-------------------|
| Entering freeway volume |               | pcph |                | pcph |                   |
| Exiting freeway volume  |               | pcph |                | pcph |                   |
| On-ramp volume          |               | pcph |                | pcph |                   |
| Off-ramp volume         |               | pcph |                | pcph |                   |

LOS and Performance Measures

|                                |       |        |
|--------------------------------|-------|--------|
| Flow rate, $v_p$               | 2,329 | pcphpl |
| Average passenger-car speed, S | 52.8  | mph    |
| Volume-to-capacity ratio, v/c  | 0.99  |        |
| Density, D                     | 44.2  | pcpmpl |
| Level of service, LOS          | E     |        |

HCM 2010: Freeway Basic Segment

Basic Operational Analysis

|             |   |
|-------------|---|
| Project     | CSUMB Master Plan EIR                                 |
| Freeway     | Southbound SR 1                                       |
| Segment     | SR 1 between Reservation Road and Del Monte Boulevard |
| Alternative | Cuml w/ Eastside Pkwy                                 |
| Time period | PM Peak Hour  |

Flow Inputs and Adjustments

|                                    |       |      |
|------------------------------------|-------|------|
| Volume, V                          | 1,870 | vph  |
| Peak-hour factor, PHF              | 0.97  |      |
| Peak 15-min volume, $v_{15}$       | 482   | veh  |
| Trucks and buses                   | 1.0%  |      |
| Recreational vehicles              | 0.0%  |      |
| Terrain type                       | Level |      |
| Grade                              |       |      |
| Length                             |       | mi   |
| Trucks and buses PCE, $E_T$        | 1.5   |      |
| Recreational vehicle PCE, $E_R$    | 1.2   |      |
| Heavy vehicle adjustment, $f_{HV}$ | 0.995 |      |
| Driver population factor, $f_p$    | 1.00  |      |
| Flow rate, $v_p$                   | 1,937 | pcph |
| Number of lanes, N                 | 2     |      |

Speed Inputs and Adjustments

|  |      |          |
|--|------|----------|
| Lane width                             | 12.0 | ft       |
| Right-side lateral clearance           | >6   | ft       |
| Total ramp density, TRD                | 1.00 | ramps/mi |
| Lane width adjustment, $f_{LW}$        | 0.0  | mph      |
| Lateral clearance adjustment, $f_{LC}$ | 0.0  | mph      |
| TRD adjustment                         | 3.2  | mph      |
| Calculated free-flow speed, FFS        | 72.2 | mph      |
| Measured free-flow speed, FFS          | 65.0 | mph      |
| Free-flow speed curve                  | 65   | mph      |

Capacity Checks for Segments with Ramps

|                         | <u>Actual</u> |      | <u>Maximum</u> |      | <u>Violation?</u> |
|-------------------------|---------------|------|----------------|------|-------------------|
| Entering freeway volume |               | pcph |                | pcph |                   |
| Exiting freeway volume  |               | pcph |                | pcph |                   |
| On-ramp volume          |               | pcph |                | pcph |                   |
| Off-ramp volume         |               | pcph |                | pcph |                   |

LOS and Performance Measures

|                                |      |        |
|--------------------------------|------|--------|
| Flow rate, $v_p$               | 969  | pcphpl |
| Average passenger-car speed, S | 65.0 | mph    |
| Volume-to-capacity ratio, v/c  | 0.41 |        |
| Density, D                     | 14.9 | pcmppl |
| Level of service, LOS          | B    |        |

HCM 2010: Freeway Basic Segment

Basic Operational Analysis

|             |  |
|-------------|--|
| Project     | CSUMB Master Plan EIR                              |
| Freeway     | Southbound State Route 1                           |
| Segment     | SR 1 between Del Monte Boulevard and Imjin Parkway |
| Alternative | Cuml w/ Eastside Pkwy                              |
| Time period | AM Peak Hour                                       |

Flow Inputs and Adjustments

|                                    |       |      |
|------------------------------------|-------|------|
| Volume, V                          | 5,050 | vph  |
| Peak-hour factor, PHF              | 0.81  |      |
| Peak 15-min volume, $v_{15}$       | 1,559 | veh  |
| Trucks and buses                   | 3.9%  |      |
| Recreational vehicles              | 0.0%  |      |
| Terrain type                       | Level |      |
| Grade                              |       |      |
| Length                             |       | mi   |
| Trucks and buses PCE, $E_T$        | 1.5   |      |
| Recreational vehicle PCE, $E_R$    | 1.2   |      |
| Heavy vehicle adjustment, $f_{HV}$ | 0.981 |      |
| Driver population factor, $f_p$    | 1.00  |      |
| Flow rate, $v_p$                   | 6,356 | pcph |
| Number of lanes, N                 | 3     |      |

Speed Inputs and Adjustments

|  |      |          |
|--|------|----------|
| Lane width                             | 12.0 | ft       |
| Right-side lateral clearance           | >6   | ft       |
| Total ramp density, TRD                | 1.17 | ramps/mi |
| Lane width adjustment, $f_{LW}$        | 0.0  | mph      |
| Lateral clearance adjustment, $f_{LC}$ | 0.0  | mph      |
| TRD adjustment                         | 3.7  | mph      |
| Calculated free-flow speed, FFS        | 71.7 | mph      |
| Measured free-flow speed, FFS          | 65.0 | mph      |
| Free-flow speed curve                  | 65   | mph      |

Capacity Checks for Segments with Ramps

|                         | <u>Actual</u> |      | <u>Maximum</u> |      | <u>Violation?</u> |
|-------------------------|---------------|------|----------------|------|-------------------|
| Entering freeway volume |               | pcph |                | pcph |                   |
| Exiting freeway volume  |               | pcph |                | pcph |                   |
| On-ramp volume          |               | pcph |                | pcph |                   |
| Off-ramp volume         |               | pcph |                | pcph |                   |

LOS and Performance Measures

|                                |       |        |
|--------------------------------|-------|--------|
| Flow rate, $v_p$               | 2,119 | pcphpl |
| Average passenger-car speed, S | 57.7  | mph    |
| Volume-to-capacity ratio, v/c  | 0.90  |        |
| Density, D                     | 36.7  | pcpmpl |
| Level of service, LOS          | E     |        |



HCM 2010: Freeway Basic Segment

Basic Operational Analysis

|             |  |
|-------------|--|
| Project     | CSUMB Master Plan EIR                              |
| Freeway     | Southbound SR 1                                    |
| Segment     | SR 1 between Del Monte Boulevard and Imjin Parkway |
| Alternative | Cuml w/ Eastside Pkwy                              |
| Time period | PM Peak Hour                                       |

Flow Inputs and Adjustments

|                                    |       |      |
|------------------------------------|-------|------|
| Volume, V                          | 2,910 | vph  |
| Peak-hour factor, PHF              | 0.95  |      |
| Peak 15-min volume, $v_{15}$       | 766   | veh  |
| Trucks and buses                   | 1.4%  |      |
| Recreational vehicles              | 0.0%  |      |
| Terrain type                       | Level |      |
| Grade                              |       |      |
| Length                             |       | mi   |
| Trucks and buses PCE, $E_T$        | 1.5   |      |
| Recreational vehicle PCE, $E_R$    | 1.2   |      |
| Heavy vehicle adjustment, $f_{HV}$ | 0.993 |      |
| Driver population factor, $f_p$    | 1.00  |      |
| Flow rate, $v_p$                   | 3,084 | pcph |
| Number of lanes, N                 | 3     |      |

Speed Inputs and Adjustments

|  |      |          |
|--|------|----------|
| Lane width                             | 12.0 | ft       |
| Right-side lateral clearance           | >6   | ft       |
| Total ramp density, TRD                | 1.17 | ramps/mi |
| Lane width adjustment, $f_{LW}$        | 0.0  | mph      |
| Lateral clearance adjustment, $f_{LC}$ | 0.0  | mph      |
| TRD adjustment                         | 3.7  | mph      |
| Calculated free-flow speed, FFS        | 71.7 | mph      |
| Measured free-flow speed, FFS          | 65.0 | mph      |
| Free-flow speed curve                  | 65   | mph      |

Capacity Checks for Segments with Ramps

|                         | <u>Actual</u> |      | <u>Maximum</u> |      | <u>Violation?</u> |
|-------------------------|---------------|------|----------------|------|-------------------|
| Entering freeway volume |               | pcph |                | pcph |                   |
| Exiting freeway volume  |               | pcph |                | pcph |                   |
| On-ramp volume          |               | pcph |                | pcph |                   |
| Off-ramp volume         |               | pcph |                | pcph |                   |

LOS and Performance Measures

|                                |       |        |
|--------------------------------|-------|--------|
| Flow rate, $v_p$               | 1,028 | pcphpl |
| Average passenger-car speed, S | 65.0  | mph    |
| Volume-to-capacity ratio, v/c  | 0.44  |        |
| Density, D                     | 15.8  | pcpmpl |
| Level of service, LOS          | B     |        |

HCM 2010: Freeway Basic Segment

Basic Operational Analysis

|             |   |
|-------------|---|
| Project     | CSUMB Master Plan EIR                             |
| Freeway     | Southbound State Route 1                          |
| Segment     | SR 1 between Imjin Parkway and Lightfighter Drive |
| Alternative | Cuml w/ Eastside Pkwy                             |
| Time period | AM Peak Hour                                      |

Flow Inputs and Adjustments

|                                    |       |      |
|------------------------------------|-------|------|
| Volume, V                          | 5,080 | vph  |
| Peak-hour factor, PHF              | 0.83  |      |
| Peak 15-min volume, $v_{15}$       | 1,530 | veh  |
| Trucks and buses                   | 3.5%  |      |
| Recreational vehicles              | 0.0%  |      |
| Terrain type                       | Level |      |
| Grade                              |       |      |
| Length                             |       | mi   |
| Trucks and buses PCE, $E_T$        | 1.5   |      |
| Recreational vehicle PCE, $E_R$    | 1.2   |      |
| Heavy vehicle adjustment, $f_{HV}$ | 0.983 |      |
| Driver population factor, $f_p$    | 1.00  |      |
| Flow rate, $v_p$                   | 6,229 | pcph |
| Number of lanes, N                 | 3     |      |

Speed Inputs and Adjustments

|  |      |          |
|--|------|----------|
| Lane width                             | 12.0 | ft       |
| Right-side lateral clearance           | >6   | ft       |
| Total ramp density, TRD                | 1.17 | ramps/mi |
| Lane width adjustment, $f_{LW}$        | 0.0  | mph      |
| Lateral clearance adjustment, $f_{LC}$ | 0.0  | mph      |
| TRD adjustment                         | 3.7  | mph      |
| Calculated free-flow speed, FFS        | 71.7 | mph      |
| Measured free-flow speed, FFS          | 65.0 | mph      |
| Free-flow speed curve                  | 65   | mph      |

Capacity Checks for Segments with Ramps

|                         | <u>Actual</u> |      | <u>Maximum</u> |      | <u>Violation?</u> |
|-------------------------|---------------|------|----------------|------|-------------------|
| Entering freeway volume |               | pcph |                | pcph |                   |
| Exiting freeway volume  |               | pcph |                | pcph |                   |
| On-ramp volume          |               | pcph |                | pcph |                   |
| Off-ramp volume         |               | pcph |                | pcph |                   |

LOS and Performance Measures

|                                |       |        |
|--------------------------------|-------|--------|
| Flow rate, $v_p$               | 2,076 | pcphpl |
| Average passenger-car speed, S | 58.5  | mph    |
| Volume-to-capacity ratio, v/c  | 0.88  |        |
| Density, D                     | 35.5  | pcpmpl |
| Level of service, LOS          | E     |        |

HCM 2010: Freeway Basic Segment

Basic Operational Analysis

|             |   |
|-------------|---|
| Project     | CSUMB Master Plan EIR                             |
| Freeway     | Southbound SR 1                                   |
| Segment     | SR 1 between Imjin Parkway and Lightfighter Drive |
| Alternative | Cuml w/ Eastside Pkwy                             |
| Time period | PM Peak Hour                                      |

Flow Inputs and Adjustments

|                                    |       |      |
|------------------------------------|-------|------|
| Volume, V                          | 3,380 | vph  |
| Peak-hour factor, PHF              | 0.95  |      |
| Peak 15-min volume, $v_{15}$       | 889   | veh  |
| Trucks and buses                   | 1.3%  |      |
| Recreational vehicles              | 0.0%  |      |
| Terrain type                       | Level |      |
| Grade                              |       |      |
| Length                             |       | mi   |
| Trucks and buses PCE, $E_T$        | 1.5   |      |
| Recreational vehicle PCE, $E_R$    | 1.2   |      |
| Heavy vehicle adjustment, $f_{HV}$ | 0.994 |      |
| Driver population factor, $f_p$    | 1.00  |      |
| Flow rate, $v_p$                   | 3,580 | pcph |
| Number of lanes, N                 | 3     |      |

Speed Inputs and Adjustments

|  |      |          |
|--|------|----------|
| Lane width                             | 12.0 | ft       |
| Right-side lateral clearance           | >6   | ft       |
| Total ramp density, TRD                | 1.17 | ramps/mi |
| Lane width adjustment, $f_{LW}$        | 0.0  | mph      |
| Lateral clearance adjustment, $f_{LC}$ | 0.0  | mph      |
| TRD adjustment                         | 3.7  | mph      |
| Calculated free-flow speed, FFS        | 71.7 | mph      |
| Measured free-flow speed, FFS          | 65.0 | mph      |
| Free-flow speed curve                  | 65   | mph      |

Capacity Checks for Segments with Ramps

|                         | <u>Actual</u> |      | <u>Maximum</u> |      | <u>Violation?</u> |
|-------------------------|---------------|------|----------------|------|-------------------|
| Entering freeway volume |               | pcph |                | pcph |                   |
| Exiting freeway volume  |               | pcph |                | pcph |                   |
| On-ramp volume          |               | pcph |                | pcph |                   |
| Off-ramp volume         |               | pcph |                | pcph |                   |

LOS and Performance Measures

|                                |       |        |
|--------------------------------|-------|--------|
| Flow rate, $v_p$               | 1,193 | pcphpl |
| Average passenger-car speed, S | 65.0  | mph    |
| Volume-to-capacity ratio, v/c  | 0.51  |        |
| Density, D                     | 18.4  | pcpmpl |
| Level of service, LOS          | C     |        |

HCM 2010: Freeway Basic Segment

Basic Operational Analysis

|             |   |
|-------------|---|
| Project     | CSUMB Master Plan EIR                                   |
| Freeway     | Southbound State Route 1                                |
| Segment     | SR 1 between Lightfighter Drive and Del Monte Boulevard |
| Alternative | Cuml w/ Eastside Pkwy                                   |
| Time period | AM Peak Hour  |

Flow Inputs and Adjustments

|                                    |       |      |
|------------------------------------|-------|------|
| Volume, V                          | 5,490 | vph  |
| Peak-hour factor, PHF              | 0.86  |      |
| Peak 15-min volume, $v_{15}$       | 1,596 | veh  |
| Trucks and buses                   | 3.2%  |      |
| Recreational vehicles              | 0.0%  |      |
| Terrain type                       | Level |      |
| Grade                              |       |      |
| Length                             |       | mi   |
| Trucks and buses PCE, $E_T$        | 1.5   |      |
| Recreational vehicle PCE, $E_R$    | 1.2   |      |
| Heavy vehicle adjustment, $f_{HV}$ | 0.984 |      |
| Driver population factor, $f_p$    | 1.00  |      |
| Flow rate, $v_p$                   | 6,486 | pcph |
| Number of lanes, N                 | 3     |      |

Speed Inputs and Adjustments

|  |      |          |
|--|------|----------|
| Lane width                             | 12.0 | ft       |
| Right-side lateral clearance           | >6   | ft       |
| Total ramp density, TRD                | 1.33 | ramps/mi |
| Lane width adjustment, $f_{LW}$        | 0.0  | mph      |
| Lateral clearance adjustment, $f_{LC}$ | 0.0  | mph      |
| TRD adjustment                         | 4.1  | mph      |
| Calculated free-flow speed, FFS        | 71.3 | mph      |
| Measured free-flow speed, FFS          | 65.0 | mph      |
| Free-flow speed curve                  | 65   | mph      |

Capacity Checks for Segments with Ramps

|                         | <u>Actual</u> |      | <u>Maximum</u> |      | <u>Violation?</u> |
|-------------------------|---------------|------|----------------|------|-------------------|
| Entering freeway volume |               | pcph |                | pcph |                   |
| Exiting freeway volume  |               | pcph |                | pcph |                   |
| On-ramp volume          |               | pcph |                | pcph |                   |
| Off-ramp volume         |               | pcph |                | pcph |                   |

LOS and Performance Measures

|                                |       |        |
|--------------------------------|-------|--------|
| Flow rate, $v_p$               | 2,162 | pcphpl |
| Average passenger-car speed, S | 56.8  | mph    |
| Volume-to-capacity ratio, v/c  | 0.92  |        |
| Density, D                     | 38.1  | pcpmpl |
| Level of service, LOS          | E     |        |

HCM 2010: Freeway Basic Segment

Basic Operational Analysis

|             |   |
|-------------|---|
| Project     | CSUMB Master Plan EIR                                   |
| Freeway     | Southbound SR 1   |
| Segment     | SR 1 between Lightfighter Drive and Del Monte Boulevard |
| Alternative | Cuml w/ Eastside Pkwy                                   |
| Time period | PM Peak Hour  |

Flow Inputs and Adjustments

|                                    |       |      |
|------------------------------------|-------|------|
| Volume, V                          | 3,940 | vph  |
| Peak-hour factor, PHF              | 0.97  |      |
| Peak 15-min volume, $v_{15}$       | 1,015 | veh  |
| Trucks and buses                   | 1.1%  |      |
| Recreational vehicles              | 0.0%  |      |
| Terrain type                       | Level |      |
| Grade                              |       |      |
| Length                             |       | mi   |
| Trucks and buses PCE, $E_T$        | 1.5   |      |
| Recreational vehicle PCE, $E_R$    | 1.2   |      |
| Heavy vehicle adjustment, $f_{HV}$ | 0.994 |      |
| Driver population factor, $f_p$    | 1.00  |      |
| Flow rate, $v_p$                   | 4,085 | pcph |
| Number of lanes, N                 | 3     |      |

Speed Inputs and Adjustments

|  |      |          |
|--|------|----------|
| Lane width                             | 12.0 | ft       |
| Right-side lateral clearance           | >6   | ft       |
| Total ramp density, TRD                | 1.33 | ramps/mi |
| Lane width adjustment, $f_{LW}$        | 0.0  | mph      |
| Lateral clearance adjustment, $f_{LC}$ | 0.0  | mph      |
| TRD adjustment                         | 4.1  | mph      |
| Calculated free-flow speed, FFS        | 71.3 | mph      |
| Measured free-flow speed, FFS          | 65.0 | mph      |
| Free-flow speed curve                  | 65   | mph      |

Capacity Checks for Segments with Ramps

|                         | <u>Actual</u> |      | <u>Maximum</u> |      | <u>Violation?</u> |
|-------------------------|---------------|------|----------------|------|-------------------|
| Entering freeway volume |               | pcph |                | pcph |                   |
| Exiting freeway volume  |               | pcph |                | pcph |                   |
| On-ramp volume          |               | pcph |                | pcph |                   |
| Off-ramp volume         |               | pcph |                | pcph |                   |

LOS and Performance Measures

|                                |       |        |
|--------------------------------|-------|--------|
| Flow rate, $v_p$               | 1,362 | pcphpl |
| Average passenger-car speed, S | 65.0  | mph    |
| Volume-to-capacity ratio, v/c  | 0.58  |        |
| Density, D                     | 20.9  | pcpmpl |
| Level of service, LOS          | C     |        |

HCM 2010: Freeway Basic Segment

Basic Operational Analysis

|             |   |
|-------------|---|
| Project     | CSUMB Master Plan EIR   |
| Freeway     | Southbound State Route 1                                      |
| Segment     | SR 1 between Del Monte Boulevard and Canyon Del Rey Boulevard |
| Alternative | Cuml w/ Eastside Pkwy   |
| Time period | AM Peak Hour  |

Flow Inputs and Adjustments

|                                    |       |      |
|------------------------------------|-------|------|
| Volume, V                          | 4,540 | vph  |
| Peak-hour factor, PHF              | 0.95  |      |
| Peak 15-min volume, $v_{15}$       | 1,195 | veh  |
| Trucks and buses                   | 2.4%  |      |
| Recreational vehicles              | 0.0%  |      |
| Terrain type                       | Level |      |
| Grade                              |       |      |
| Length                             |       | mi   |
| Trucks and buses PCE, $E_T$        | 1.5   |      |
| Recreational vehicle PCE, $E_R$    | 1.2   |      |
| Heavy vehicle adjustment, $f_{HV}$ | 0.988 |      |
| Driver population factor, $f_P$    | 1.00  |      |
| Flow rate, $v_p$                   | 4,837 | pcph |
| Number of lanes, N                 | 2     |      |

Speed Inputs and Adjustments

|  |      |          |
|--|------|----------|
| Lane width                             | 12.0 | ft       |
| Right-side lateral clearance           | 5.0  | ft       |
| Total ramp density, TRD                | 2.17 | ramps/mi |
| Lane width adjustment, $f_{LW}$        | 0.0  | mph      |
| Lateral clearance adjustment, $f_{LC}$ | 0.6  | mph      |
| TRD adjustment                         | 6.2  | mph      |
| Calculated free-flow speed, FFS        | 68.6 | mph      |
| Measured free-flow speed, FFS          | 65.0 | mph      |
| Free-flow speed curve                  | 65   | mph      |

Capacity Checks for Segments with Ramps

|                         | <u>Actual</u> |      | <u>Maximum</u> |      | <u>Violation?</u> |
|-------------------------|---------------|------|----------------|------|-------------------|
| Entering freeway volume |               | pcph |                | pcph |                   |
| Exiting freeway volume  |               | pcph |                | pcph |                   |
| On-ramp volume          |               | pcph |                | pcph |                   |
| Off-ramp volume         |               | pcph |                | pcph |                   |

LOS and Performance Measures

|                                |       |        |
|--------------------------------|-------|--------|
| Flow rate, $v_p$               | 2,419 | pcphpl |
| Average passenger-car speed, S | -     | mph    |
| Volume-to-capacity ratio, v/c  | 1.03  |        |
| Density, D                     | -     | pcpmpl |
| Level of service, LOS          | F     |        |

HCM 2010: Freeway Basic Segment

Basic Operational Analysis

|             |   |
|-------------|---|
| Project     | CSUMB Master Plan EIR   |
| Freeway     | Southbound SR 1   |
| Segment     | SR 1 between Del Monte Boulevard and Canyon Del Rey Boulevard |
| Alternative | Cuml w/ Eastside Pkwy   |
| Time period | PM Peak Hour  |

Flow Inputs and Adjustments

|                                    |       |      |
|------------------------------------|-------|------|
| Volume, V                          | 3,230 | vph  |
| Peak-hour factor, PHF              | 0.96  |      |
| Peak 15-min volume, $v_{15}$       | 841   | veh  |
| Trucks and buses                   | 1.0%  |      |
| Recreational vehicles              | 0.0%  |      |
| Terrain type                       | Level |      |
| Grade                              |       |      |
| Length                             |       | mi   |
| Trucks and buses PCE, $E_T$        | 1.5   |      |
| Recreational vehicle PCE, $E_R$    | 1.2   |      |
| Heavy vehicle adjustment, $f_{HV}$ | 0.995 |      |
| Driver population factor, $f_p$    | 1.00  |      |
| Flow rate, $v_p$                   | 3,381 | pcph |
| Number of lanes, N                 | 2     |      |

Speed Inputs and Adjustments

|  |      |          |
|--|------|----------|
| Lane width                             | 12.0 | ft       |
| Right-side lateral clearance           | 5.0  | ft       |
| Total ramp density, TRD                | 2.17 | ramps/mi |
| Lane width adjustment, $f_{LW}$        | 0.0  | mph      |
| Lateral clearance adjustment, $f_{LC}$ | 0.6  | mph      |
| TRD adjustment                         | 6.2  | mph      |
| Calculated free-flow speed, FFS        | 68.6 | mph      |
| Measured free-flow speed, FFS          | 65.0 | mph      |
| Free-flow speed curve                  | 65   | mph      |

Capacity Checks for Segments with Ramps

|                         | <u>Actual</u> |      | <u>Maximum</u> |      | <u>Violation?</u> |
|-------------------------|---------------|------|----------------|------|-------------------|
| Entering freeway volume |               | pcph |                | pcph |                   |
| Exiting freeway volume  |               | pcph |                | pcph |                   |
| On-ramp volume          |               | pcph |                | pcph |                   |
| Off-ramp volume         |               | pcph |                | pcph |                   |

LOS and Performance Measures

|                                |       |        |
|--------------------------------|-------|--------|
| Flow rate, $v_p$               | 1,691 | pcphpl |
| Average passenger-car speed, S | 63.8  | mph    |
| Volume-to-capacity ratio, v/c  | 0.72  |        |
| Density, D                     | 26.5  | pcpmpl |
| Level of service, LOS          | D     |        |

HCM 2010: Freeway Basic Segment

Basic Operational Analysis

|             |   |
|-------------|---|
| Project     | CSUMB Master Plan EIR                                 |
| Freeway     | Northbound State Route 1                              |
| Segment     | SR 1 between Reservation Road and Del Monte Boulevard |
| Alternative | Cuml w/ Eastside Pkwy                                 |
| Time period | AM Peak Hour  |

Flow Inputs and Adjustments

|                                    |       |      |
|------------------------------------|-------|------|
| Volume, V                          | 1,480 | vph  |
| Peak-hour factor, PHF              | 0.97  |      |
| Peak 15-min volume, $v_{15}$       | 381   | veh  |
| Trucks and buses                   | 6.4%  |      |
| Recreational vehicles              | 0.0%  |      |
| Terrain type                       | Level |      |
| Grade                              |       |      |
| Length                             |       | mi   |
| Trucks and buses PCE, $E_T$        | 1.5   |      |
| Recreational vehicle PCE, $E_R$    | 1.2   |      |
| Heavy vehicle adjustment, $f_{HV}$ | 0.969 |      |
| Driver population factor, $f_p$    | 1.00  |      |
| Flow rate, $v_p$                   | 1,574 | pcph |
| Number of lanes, N                 | 2     |      |

Speed Inputs and Adjustments

|  |      |          |
|--|------|----------|
| Lane width                             | 12.0 | ft       |
| Right-side lateral clearance           | >6   | ft       |
| Total ramp density, TRD                | 1.00 | ramps/mi |
| Lane width adjustment, $f_{LW}$        | 0.0  | mph      |
| Lateral clearance adjustment, $f_{LC}$ | 0.0  | mph      |
| TRD adjustment                         | 3.2  | mph      |
| Calculated free-flow speed, FFS        | 72.2 | mph      |
| Measured free-flow speed, FFS          | 65.0 | mph      |
| Free-flow speed curve                  | 65   | mph      |

Capacity Checks for Segments with Ramps

|                         | <u>Actual</u> |      | <u>Maximum</u> |      | <u>Violation?</u> |
|-------------------------|---------------|------|----------------|------|-------------------|
| Entering freeway volume |               | pcph |                | pcph |                   |
| Exiting freeway volume  |               | pcph |                | pcph |                   |
| On-ramp volume          |               | pcph |                | pcph |                   |
| Off-ramp volume         |               | pcph |                | pcph |                   |

LOS and Performance Measures

|                                |      |        |
|--------------------------------|------|--------|
| Flow rate, $v_p$               | 787  | pcphpl |
| Average passenger-car speed, S | 65.0 | mph    |
| Volume-to-capacity ratio, v/c  | 0.33 |        |
| Density, D                     | 12.1 | pcpmpl |
| Level of service, LOS          | B    |        |



HCM 2010: Freeway Basic Segment

Basic Operational Analysis

|             |   |
|-------------|---|
| Project     | CSUMB Master Plan EIR                                 |
| Freeway     | Northbound State Route 1                              |
| Segment     | SR 1 between Reservation Road and Del Monte Boulevard |
| Alternative | Cuml w/ Eastside Pkwy                                 |
| Time period | PM Peak Hour  |

Flow Inputs and Adjustments

|                                    |       |      |
|------------------------------------|-------|------|
| Volume, V                          | 2,940 | vph  |
| Peak-hour factor, PHF              | 0.98  |      |
| Peak 15-min volume, $v_{15}$       | 750   | veh  |
| Trucks and buses                   | 2.2%  |      |
| Recreational vehicles              | 0.0%  |      |
| Terrain type                       | Level |      |
| Grade                              |       |      |
| Length                             |       | mi   |
| Trucks and buses PCE, $E_T$        | 1.5   |      |
| Recreational vehicle PCE, $E_R$    | 1.2   |      |
| Heavy vehicle adjustment, $f_{HV}$ | 0.989 |      |
| Driver population factor, $f_p$    | 1.00  |      |
| Flow rate, $v_p$                   | 3,033 | pcph |
| Number of lanes, N                 | 2     |      |

Speed Inputs and Adjustments

|  |      |          |
|--|------|----------|
| Lane width                             | 12.0 | ft       |
| Right-side lateral clearance           | >6   | ft       |
| Total ramp density, TRD                | 1.00 | ramps/mi |
| Lane width adjustment, $f_{LW}$        | 0.0  | mph      |
| Lateral clearance adjustment, $f_{LC}$ | 0.0  | mph      |
| TRD adjustment                         | 3.2  | mph      |
| Calculated free-flow speed, FFS        | 72.2 | mph      |
| Measured free-flow speed, FFS          | 65.0 | mph      |
| Free-flow speed curve                  | 65   | mph      |

Capacity Checks for Segments with Ramps

|                         | <u>Actual</u> |      | <u>Maximum</u> |      | <u>Violation?</u> |
|-------------------------|---------------|------|----------------|------|-------------------|
| Entering freeway volume |               | pcph |                | pcph |                   |
| Exiting freeway volume  |               | pcph |                | pcph |                   |
| On-ramp volume          |               | pcph |                | pcph |                   |
| Off-ramp volume         |               | pcph |                | pcph |                   |

LOS and Performance Measures

|                                |       |        |
|--------------------------------|-------|--------|
| Flow rate, $v_p$               | 1,516 | pcphpl |
| Average passenger-car speed, S | 64.8  | mph    |
| Volume-to-capacity ratio, v/c  | 0.65  |        |
| Density, D                     | 23.4  | pcpmpl |
| Level of service, LOS          | C     |        |

HCM 2010: Freeway Basic Segment

Basic Operational Analysis

|             |  |
|-------------|--|
| Project     | CSUMB Master Plan EIR                              |
| Freeway     | Northbound State Route 1                           |
| Segment     | SR 1 between Del Monte Boulevard and Imjin Parkway |
| Alternative | Cuml w/ Eastside Pkwy                              |
| Time period | AM Peak Hour                                       |

Flow Inputs and Adjustments

|                                    |       |      |
|------------------------------------|-------|------|
| Volume, V                          | 2,400 | vph  |
| Peak-hour factor, PHF              | 0.92  |      |
| Peak 15-min volume, $v_{15}$       | 653   | veh  |
| Trucks and buses                   | 5.7%  |      |
| Recreational vehicles              | 0.0%  |      |
| Terrain type                       | Level |      |
| Grade                              |       |      |
| Length                             |       | mi   |
| Trucks and buses PCE, $E_T$        | 1.5   |      |
| Recreational vehicle PCE, $E_R$    | 1.2   |      |
| Heavy vehicle adjustment, $f_{HV}$ | 0.972 |      |
| Driver population factor, $f_p$    | 1.00  |      |
| Flow rate, $v_p$                   | 2,684 | pcph |
| Number of lanes, N                 | 3     |      |

Speed Inputs and Adjustments

|  |      |          |
|--|------|----------|
| Lane width                             | 12.0 | ft       |
| Right-side lateral clearance           | >6   | ft       |
| Total ramp density, TRD                | 1.20 | ramps/mi |
| Lane width adjustment, $f_{LW}$        | 0.0  | mph      |
| Lateral clearance adjustment, $f_{LC}$ | 0.0  | mph      |
| TRD adjustment                         | 3.8  | mph      |
| Calculated free-flow speed, FFS        | 71.6 | mph      |
| Measured free-flow speed, FFS          | 65.0 | mph      |
| Free-flow speed curve                  | 65   | mph      |

Capacity Checks for Segments with Ramps

|                         | <u>Actual</u> |      | <u>Maximum</u> |      | <u>Violation?</u> |
|-------------------------|---------------|------|----------------|------|-------------------|
| Entering freeway volume |               | pcph |                | pcph |                   |
| Exiting freeway volume  |               | pcph |                | pcph |                   |
| On-ramp volume          |               | pcph |                | pcph |                   |
| Off-ramp volume         |               | pcph |                | pcph |                   |

LOS and Performance Measures

|                                |      |        |
|--------------------------------|------|--------|
| Flow rate, $v_p$               | 895  | pcphpl |
| Average passenger-car speed, S | 65.0 | mph    |
| Volume-to-capacity ratio, v/c  | 0.38 |        |
| Density, D                     | 13.8 | pcpmpl |
| Level of service, LOS          | B    |        |

HCM 2010: Freeway Basic Segment

Basic Operational Analysis

|             |  |
|-------------|--|
| Project     | CSUMB Master Plan EIR                              |
| Freeway     | Northbound State Route 1                           |
| Segment     | SR 1 between Del Monte Boulevard and Imjin Parkway |
| Alternative | Cuml w/ Eastside Pkwy                              |
| Time period | PM Peak Hour                                       |

Flow Inputs and Adjustments

|                                    |       |      |
|------------------------------------|-------|------|
| Volume, V                          | 4,790 | vph  |
| Peak-hour factor, PHF              | 0.96  |      |
| Peak 15-min volume, $v_{15}$       | 1,247 | veh  |
| Trucks and buses                   | 1.9%  |      |
| Recreational vehicles              | 0.0%  |      |
| Terrain type                       | Level |      |
| Grade                              |       |      |
| Length                             |       | mi   |
| Trucks and buses PCE, $E_T$        | 1.5   |      |
| Recreational vehicle PCE, $E_R$    | 1.2   |      |
| Heavy vehicle adjustment, $f_{HV}$ | 0.991 |      |
| Driver population factor, $f_p$    | 1.00  |      |
| Flow rate, $v_p$                   | 5,037 | pcph |
| Number of lanes, N                 | 3     |      |

Speed Inputs and Adjustments

|  |      |          |
|--|------|----------|
| Lane width                             | 12.0 | ft       |
| Right-side lateral clearance           | >6   | ft       |
| Total ramp density, TRD                | 1.17 | ramps/mi |
| Lane width adjustment, $f_{LW}$        | 0.0  | mph      |
| Lateral clearance adjustment, $f_{LC}$ | 0.0  | mph      |
| TRD adjustment                         | 3.7  | mph      |
| Calculated free-flow speed, FFS        | 71.7 | mph      |
| Measured free-flow speed, FFS          | 65.0 | mph      |
| Free-flow speed curve                  | 65   | mph      |

Capacity Checks for Segments with Ramps

|                         | <u>Actual</u> |      | <u>Maximum</u> |      | <u>Violation?</u> |
|-------------------------|---------------|------|----------------|------|-------------------|
| Entering freeway volume |               | pcph |                | pcph |                   |
| Exiting freeway volume  |               | pcph |                | pcph |                   |
| On-ramp volume          |               | pcph |                | pcph |                   |
| Off-ramp volume         |               | pcph |                | pcph |                   |

LOS and Performance Measures

|                                |       |        |
|--------------------------------|-------|--------|
| Flow rate, $v_p$               | 1,679 | pcphpl |
| Average passenger-car speed, S | 63.9  | mph    |
| Volume-to-capacity ratio, v/c  | 0.71  |        |
| Density, D                     | 26.3  | pcpmpl |
| Level of service, LOS          | D     |        |

HCM 2010: Freeway Basic Segment

Basic Operational Analysis

|             |   |
|-------------|---|
| Project     | CSUMB Master Plan EIR                             |
| Freeway     | Northbound State Route 1                          |
| Segment     | SR 1 between Imjin Parkway and Lightfighter Drive |
| Alternative | Cuml w/ Eastside Pkwy                             |
| Time period | AM Peak Hour                                      |

Flow Inputs and Adjustments

|                                    |       |      |
|------------------------------------|-------|------|
| Volume, V                          | 2,950 | vph  |
| Peak-hour factor, PHF              | 0.92  |      |
| Peak 15-min volume, $v_{15}$       | 804   | veh  |
| Trucks and buses                   | 3.8%  |      |
| Recreational vehicles              | 0.0%  |      |
| Terrain type                       | Level |      |
| Grade                              |       |      |
| Length                             |       | mi   |
| Trucks and buses PCE, $E_T$        | 1.5   |      |
| Recreational vehicle PCE, $E_R$    | 1.2   |      |
| Heavy vehicle adjustment, $f_{HV}$ | 0.982 |      |
| Driver population factor, $f_p$    | 1.00  |      |
| Flow rate, $v_p$                   | 3,275 | pcph |
| Number of lanes, N                 | 3     |      |

Speed Inputs and Adjustments

|  |      |          |
|--|------|----------|
| Lane width                             | 12.0 | ft       |
| Right-side lateral clearance           | >6   | ft       |
| Total ramp density, TRD                | 1.17 | ramps/mi |
| Lane width adjustment, $f_{LW}$        | 0.0  | mph      |
| Lateral clearance adjustment, $f_{LC}$ | 0.0  | mph      |
| TRD adjustment                         | 3.7  | mph      |
| Calculated free-flow speed, FFS        | 71.7 | mph      |
| Measured free-flow speed, FFS          | 65.0 | mph      |
| Free-flow speed curve                  | 65   | mph      |

Capacity Checks for Segments with Ramps

|                         | <u>Actual</u> |      | <u>Maximum</u> |      | <u>Violation?</u> |
|-------------------------|---------------|------|----------------|------|-------------------|
| Entering freeway volume |               | pcph |                | pcph |                   |
| Exiting freeway volume  |               | pcph |                | pcph |                   |
| On-ramp volume          |               | pcph |                | pcph |                   |
| Off-ramp volume         |               | pcph |                | pcph |                   |

LOS and Performance Measures

|                                |       |        |
|--------------------------------|-------|--------|
| Flow rate, $v_p$               | 1,092 | pcphpl |
| Average passenger-car speed, S | 65.0  | mph    |
| Volume-to-capacity ratio, v/c  | 0.46  |        |
| Density, D                     | 16.8  | pcmppl |
| Level of service, LOS          | B     |        |

HCM 2010: Freeway Basic Segment

Basic Operational Analysis

|             |   |
|-------------|---|
| Project     | CSUMB Master Plan EIR                             |
| Freeway     | Northbound State Route 1                          |
| Segment     | SR 1 between Imjin Parkway and Lightfighter Drive |
| Alternative | Cuml w/ Eastside Pkwy                             |
| Time period | PM Peak Hour                                      |

Flow Inputs and Adjustments

|                                    |       |      |
|------------------------------------|-------|------|
| Volume, V                          | 5,080 | vph  |
| Peak-hour factor, PHF              | 0.97  |      |
| Peak 15-min volume, $v_{15}$       | 1,309 | veh  |
| Trucks and buses                   | 1.7%  |      |
| Recreational vehicles              | 0.0%  |      |
| Terrain type                       | Level |      |
| Grade                              |       |      |
| Length                             |       | mi   |
| Trucks and buses PCE, $E_T$        | 1.5   |      |
| Recreational vehicle PCE, $E_R$    | 1.2   |      |
| Heavy vehicle adjustment, $f_{HV}$ | 0.991 |      |
| Driver population factor, $f_p$    | 1.00  |      |
| Flow rate, $v_p$                   | 5,282 | pcph |
| Number of lanes, N                 | 3     |      |

Speed Inputs and Adjustments

|  |      |          |
|--|------|----------|
| Lane width                             | 12.0 | ft       |
| Right-side lateral clearance           | >6   | ft       |
| Total ramp density, TRD                | 1.17 | ramps/mi |
| Lane width adjustment, $f_{LW}$        | 0.0  | mph      |
| Lateral clearance adjustment, $f_{LC}$ | 0.0  | mph      |
| TRD adjustment                         | 3.7  | mph      |
| Calculated free-flow speed, FFS        | 71.7 | mph      |
| Measured free-flow speed, FFS          | 65.0 | mph      |
| Free-flow speed curve                  | 65   | mph      |

Capacity Checks for Segments with Ramps

|                         | <u>Actual</u> |      | <u>Maximum</u> |      | <u>Violation?</u> |
|-------------------------|---------------|------|----------------|------|-------------------|
| Entering freeway volume |               | pcph |                | pcph |                   |
| Exiting freeway volume  |               | pcph |                | pcph |                   |
| On-ramp volume          |               | pcph |                | pcph |                   |
| Off-ramp volume         |               | pcph |                | pcph |                   |

LOS and Performance Measures

|                                |       |        |
|--------------------------------|-------|--------|
| Flow rate, $v_p$               | 1,761 | pcphpl |
| Average passenger-car speed, S | 63.2  | mph    |
| Volume-to-capacity ratio, v/c  | 0.75  |        |
| Density, D                     | 27.9  | pcpmpl |
| Level of service, LOS          | D     |        |

HCM 2010: Freeway Basic Segment

Basic Operational Analysis

|             |   |
|-------------|---|
| Project     | CSUMB Master Plan EIR                                   |
| Freeway     | Northbound State Route 1                                |
| Segment     | SR 1 between Lightfighter Drive and Del Monte Boulevard |
| Alternative | Cuml w/ Eastside Pkwy                                   |
| Time period | AM Peak Hour  |

Flow Inputs and Adjustments

|                                    |       |      |
|------------------------------------|-------|------|
| Volume, V                          | 3,440 | vph  |
| Peak-hour factor, PHF              | 0.93  |      |
| Peak 15-min volume, $v_{15}$       | 921   | veh  |
| Trucks and buses                   | 3.8%  |      |
| Recreational vehicles              | 0.0%  |      |
| Terrain type                       | Level |      |
| Grade                              |       |      |
| Length                             |       | mi   |
| Trucks and buses PCE, $E_T$        | 1.5   |      |
| Recreational vehicle PCE, $E_R$    | 1.2   |      |
| Heavy vehicle adjustment, $f_{HV}$ | 0.982 |      |
| Driver population factor, $f_P$    | 1.00  |      |
| Flow rate, $v_p$                   | 3,753 | pcph |
| Number of lanes, N                 | 3     |      |

Speed Inputs and Adjustments

|  |      |          |
|--|------|----------|
| Lane width                             | 12.0 | ft       |
| Right-side lateral clearance           | >6   | ft       |
| Total ramp density, TRD                | 1.17 | ramps/mi |
| Lane width adjustment, $f_{LW}$        | 0.0  | mph      |
| Lateral clearance adjustment, $f_{LC}$ | 0.0  | mph      |
| TRD adjustment                         | 3.7  | mph      |
| Calculated free-flow speed, FFS        | 71.7 | mph      |
| Measured free-flow speed, FFS          | 65.0 | mph      |
| Free-flow speed curve                  | 65   | mph      |

Capacity Checks for Segments with Ramps

|                         | <u>Actual</u> |      | <u>Maximum</u> |      | <u>Violation?</u> |
|-------------------------|---------------|------|----------------|------|-------------------|
| Entering freeway volume |               | pcph |                | pcph |                   |
| Exiting freeway volume  |               | pcph |                | pcph |                   |
| On-ramp volume          |               | pcph |                | pcph |                   |
| Off-ramp volume         |               | pcph |                | pcph |                   |

LOS and Performance Measures

|                                |       |        |
|--------------------------------|-------|--------|
| Flow rate, $v_p$               | 1,251 | pcphpl |
| Average passenger-car speed, S | 65.0  | mph    |
| Volume-to-capacity ratio, v/c  | 0.53  |        |
| Density, D                     | 19.2  | pcpmpl |
| Level of service, LOS          | C     |        |

HCM 2010: Freeway Basic Segment

Basic Operational Analysis

|             |   |
|-------------|---|
| Project     | CSUMB Master Plan EIR                                   |
| Freeway     | Northbound State Route 1                                |
| Segment     | SR 1 between Lightfighter Drive and Del Monte Boulevard |
| Alternative | Cuml w/ Eastside Pkwy                                   |
| Time period | PM Peak Hour  |

Flow Inputs and Adjustments

|                                    |       |      |
|------------------------------------|-------|------|
| Volume, V                          | 5,360 | vph  |
| Peak-hour factor, PHF              | 0.98  |      |
| Peak 15-min volume, $v_{15}$       | 1,367 | veh  |
| Trucks and buses                   | 1.9%  |      |
| Recreational vehicles              | 0.0%  |      |
| Terrain type                       | Level |      |
| Grade                              |       |      |
| Length                             |       | mi   |
| Trucks and buses PCE, $E_T$        | 1.5   |      |
| Recreational vehicle PCE, $E_R$    | 1.2   |      |
| Heavy vehicle adjustment, $f_{HV}$ | 0.991 |      |
| Driver population factor, $f_p$    | 1.00  |      |
| Flow rate, $v_p$                   | 5,521 | pcph |
| Number of lanes, N                 | 3     |      |

Speed Inputs and Adjustments

|  |      |          |
|--|------|----------|
| Lane width                             | 12.0 | ft       |
| Right-side lateral clearance           | >6   | ft       |
| Total ramp density, TRD                | 1.17 | ramps/mi |
| Lane width adjustment, $f_{LW}$        | 0.0  | mph      |
| Lateral clearance adjustment, $f_{LC}$ | 0.0  | mph      |
| TRD adjustment                         | 3.7  | mph      |
| Calculated free-flow speed, FFS        | 71.7 | mph      |
| Measured free-flow speed, FFS          | 65.0 | mph      |
| Free-flow speed curve                  | 65   | mph      |

Capacity Checks for Segments with Ramps

|                         | <u>Actual</u> |      | <u>Maximum</u> |      | <u>Violation?</u> |
|-------------------------|---------------|------|----------------|------|-------------------|
| Entering freeway volume |               | pcph |                | pcph |                   |
| Exiting freeway volume  |               | pcph |                | pcph |                   |
| On-ramp volume          |               | pcph |                | pcph |                   |
| Off-ramp volume         |               | pcph |                | pcph |                   |

LOS and Performance Measures

|                                |       |        |
|--------------------------------|-------|--------|
| Flow rate, $v_p$               | 1,840 | pcphpl |
| Average passenger-car speed, S | 62.3  | mph    |
| Volume-to-capacity ratio, v/c  | 0.78  |        |
| Density, D                     | 29.6  | pcpmpl |
| Level of service, LOS          | D     |        |

HCM 2010: Freeway Basic Segment

Basic Operational Analysis

|             |   |
|-------------|---|
| Project     | CSUMB Master Plan EIR   |
| Freeway     | Northbound State Route 1                                      |
| Segment     | SR 1 between Del Monte Boulevard and Canyon Del Rey Boulevard |
| Alternative | Cuml w/ Eastside Pkwy   |
| Time period | AM Peak Hour  |

Flow Inputs and Adjustments

|                                    |       |      |
|------------------------------------|-------|------|
| Volume, V                          | 3,000 | vph  |
| Peak-hour factor, PHF              | 0.92  |      |
| Peak 15-min volume, $v_{15}$       | 819   | veh  |
| Trucks and buses                   | 3.2%  |      |
| Recreational vehicles              | 0.0%  |      |
| Terrain type                       | Level |      |
| Grade                              |       |      |
| Length                             |       | mi   |
| Trucks and buses PCE, $E_T$        | 1.5   |      |
| Recreational vehicle PCE, $E_R$    | 1.2   |      |
| Heavy vehicle adjustment, $f_{HV}$ | 0.984 |      |
| Driver population factor, $f_p$    | 1.00  |      |
| Flow rate, $v_p$                   | 3,329 | pcph |
| Number of lanes, N                 | 2     |      |

Speed Inputs and Adjustments

|  |      |          |
|--|------|----------|
| Lane width                             | 12.0 | ft       |
| Right-side lateral clearance           | >6   | ft       |
| Total ramp density, TRD                | 2.00 | ramps/mi |
| Lane width adjustment, $f_{LW}$        | 0.0  | mph      |
| Lateral clearance adjustment, $f_{LC}$ | 0.0  | mph      |
| TRD adjustment                         | 5.8  | mph      |
| Calculated free-flow speed, FFS        | 69.6 | mph      |
| Measured free-flow speed, FFS          | 65.0 | mph      |
| Free-flow speed curve                  | 65   | mph      |

Capacity Checks for Segments with Ramps

|                         | <u>Actual</u> |      | <u>Maximum</u> |      | <u>Violation?</u> |
|-------------------------|---------------|------|----------------|------|-------------------|
| Entering freeway volume |               | pcph |                | pcph |                   |
| Exiting freeway volume  |               | pcph |                | pcph |                   |
| On-ramp volume          |               | pcph |                | pcph |                   |
| Off-ramp volume         |               | pcph |                | pcph |                   |

LOS and Performance Measures

|                                |       |        |
|--------------------------------|-------|--------|
| Flow rate, $v_p$               | 1,665 | pcphpl |
| Average passenger-car speed, S | 64.0  | mph    |
| Volume-to-capacity ratio, v/c  | 0.71  |        |
| Density, D                     | 26.0  | pcpmpl |
| Level of service, LOS          | D     |        |



HCM 2010: Freeway Basic Segment

Basic Operational Analysis

|             |   |
|-------------|---|
| Project     | CSUMB Master Plan EIR   |
| Freeway     | Northbound State Route 1                                      |
| Segment     | SR 1 between Del Monte Boulevard and Canyon Del Rey Boulevard |
| Alternative | Cuml w/ Eastside Pkwy   |
| Time period | PM Peak Hour  |

Flow Inputs and Adjustments

|                                    |       |      |
|------------------------------------|-------|------|
| Volume, V                          | 4,330 | vph  |
| Peak-hour factor, PHF              | 0.97  |      |
| Peak 15-min volume, $v_{15}$       | 1,116 | veh  |
| Trucks and buses                   | 2.0%  |      |
| Recreational vehicles              | 0.0%  |      |
| Terrain type                       | Level |      |
| Grade                              |       |      |
| Length                             |       | mi   |
| Trucks and buses PCE, $E_T$        | 1.5   |      |
| Recreational vehicle PCE, $E_R$    | 1.2   |      |
| Heavy vehicle adjustment, $f_{HV}$ | 0.990 |      |
| Driver population factor, $f_p$    | 1.00  |      |
| Flow rate, $v_p$                   | 4,509 | pcph |
| Number of lanes, N                 | 2     |      |

Speed Inputs and Adjustments

|  |      |          |
|--|------|----------|
| Lane width                             | 12.0 | ft       |
| Right-side lateral clearance           | >6   | ft       |
| Total ramp density, TRD                | 2.00 | ramps/mi |
| Lane width adjustment, $f_{LW}$        | 0.0  | mph      |
| Lateral clearance adjustment, $f_{LC}$ | 0.0  | mph      |
| TRD adjustment                         | 5.8  | mph      |
| Calculated free-flow speed, FFS        | 69.6 | mph      |
| Measured free-flow speed, FFS          | 65.0 | mph      |
| Free-flow speed curve                  | 65   | mph      |

Capacity Checks for Segments with Ramps

|                         | <u>Actual</u> |      | <u>Maximum</u> |      | <u>Violation?</u> |
|-------------------------|---------------|------|----------------|------|-------------------|
| Entering freeway volume |               | pcph |                | pcph |                   |
| Exiting freeway volume  |               | pcph |                | pcph |                   |
| On-ramp volume          |               | pcph |                | pcph |                   |
| Off-ramp volume         |               | pcph |                | pcph |                   |

LOS and Performance Measures

|                                |       |        |
|--------------------------------|-------|--------|
| Flow rate, $v_p$               | 2,255 | pcphpl |
| Average passenger-car speed, S | 54.6  | mph    |
| Volume-to-capacity ratio, v/c  | 0.96  |        |
| Density, D                     | 41.3  | pcpmpl |
| Level of service, LOS          | E     |        |

HCM 2010: Freeway Basic Segment

Basic Operational Analysis

|             |   |
|-------------|---|
| Project     | CSUMB Master Plan EIR                                 |
| Freeway     | Southbound State Route 1                              |
| Segment     | SR 1 between Reservation Road and Del Monte Boulevard |
| Alternative | Cuml w/ Proj  |
| Time period | AM Peak Hour  |

Flow Inputs and Adjustments

|                                    |       |      |
|------------------------------------|-------|------|
| Volume, V                          | 3,560 | vph  |
| Peak-hour factor, PHF              | 0.76  |      |
| Peak 15-min volume, $v_{15}$       | 1,171 | veh  |
| Trucks and buses                   | 4.7%  |      |
| Recreational vehicles              | 0.0%  |      |
| Terrain type                       | Level |      |
| Grade                              |       |      |
| Length                             |       | mi   |
| Trucks and buses PCE, $E_T$        | 1.5   |      |
| Recreational vehicle PCE, $E_R$    | 1.2   |      |
| Heavy vehicle adjustment, $f_{HV}$ | 0.977 |      |
| Driver population factor, $f_p$    | 1.00  |      |
| Flow rate, $v_p$                   | 4,793 | pcph |
| Number of lanes, N                 | 2     |      |

Speed Inputs and Adjustments

|  |      |          |
|--|------|----------|
| Lane width                             | 12.0 | ft       |
| Right-side lateral clearance           | >6   | ft       |
| Total ramp density, TRD                | 1.00 | ramps/mi |
| Lane width adjustment, $f_{LW}$        | 0.0  | mph      |
| Lateral clearance adjustment, $f_{LC}$ | 0.0  | mph      |
| TRD adjustment                         | 3.2  | mph      |
| Calculated free-flow speed, FFS        | 72.2 | mph      |
| Measured free-flow speed, FFS          | 65.0 | mph      |
| Free-flow speed curve                  | 65   | mph      |

Capacity Checks for Segments with Ramps

|                         | <u>Actual</u> |      | <u>Maximum</u> |      | <u>Violation?</u> |
|-------------------------|---------------|------|----------------|------|-------------------|
| Entering freeway volume |               | pcph |                | pcph |                   |
| Exiting freeway volume  |               | pcph |                | pcph |                   |
| On-ramp volume          |               | pcph |                | pcph |                   |
| Off-ramp volume         |               | pcph |                | pcph |                   |

LOS and Performance Measures

|                                |       |        |
|--------------------------------|-------|--------|
| Flow rate, $v_p$               | 2,397 | pcphpl |
| Average passenger-car speed, S | -     | mph    |
| Volume-to-capacity ratio, v/c  | 1.02  |        |
| Density, D                     | -     | pcpmpl |
| Level of service, LOS          | F     |        |

HCM 2010: Freeway Basic Segment

Basic Operational Analysis

|             |   |
|-------------|---|
| Project     | CSUMB Master Plan EIR                                 |
| Freeway     | Southbound SR 1                                       |
| Segment     | SR 1 between Reservation Road and Del Monte Boulevard |
| Alternative | Cuml w/ Proj  |
| Time period | PM Peak Hour  |

Flow Inputs and Adjustments

|                                    |       |      |
|------------------------------------|-------|------|
| Volume, V                          | 1,870 | vph  |
| Peak-hour factor, PHF              | 0.97  |      |
| Peak 15-min volume, $v_{15}$       | 482   | veh  |
| Trucks and buses                   | 1.0%  |      |
| Recreational vehicles              | 0.0%  |      |
| Terrain type                       | Level |      |
| Grade                              |       |      |
| Length                             |       | mi   |
| Trucks and buses PCE, $E_T$        | 1.5   |      |
| Recreational vehicle PCE, $E_R$    | 1.2   |      |
| Heavy vehicle adjustment, $f_{HV}$ | 0.995 |      |
| Driver population factor, $f_p$    | 1.00  |      |
| Flow rate, $v_p$                   | 1,937 | pcph |
| Number of lanes, N                 | 2     |      |

Speed Inputs and Adjustments

|  |      |          |
|--|------|----------|
| Lane width                             | 12.0 | ft       |
| Right-side lateral clearance           | >6   | ft       |
| Total ramp density, TRD                | 1.00 | ramps/mi |
| Lane width adjustment, $f_{LW}$        | 0.0  | mph      |
| Lateral clearance adjustment, $f_{LC}$ | 0.0  | mph      |
| TRD adjustment                         | 3.2  | mph      |
| Calculated free-flow speed, FFS        | 72.2 | mph      |
| Measured free-flow speed, FFS          | 65.0 | mph      |
| Free-flow speed curve                  | 65   | mph      |

Capacity Checks for Segments with Ramps

|                         | <u>Actual</u> |      | <u>Maximum</u> |      | <u>Violation?</u> |
|-------------------------|---------------|------|----------------|------|-------------------|
| Entering freeway volume |               | pcph |                | pcph |                   |
| Exiting freeway volume  |               | pcph |                | pcph |                   |
| On-ramp volume          |               | pcph |                | pcph |                   |
| Off-ramp volume         |               | pcph |                | pcph |                   |

LOS and Performance Measures

|                                |      |        |
|--------------------------------|------|--------|
| Flow rate, $v_p$               | 969  | pcphpl |
| Average passenger-car speed, S | 65.0 | mph    |
| Volume-to-capacity ratio, v/c  | 0.41 |        |
| Density, D                     | 14.9 | pcmppl |
| Level of service, LOS          | B    |        |

HCM 2010: Freeway Basic Segment

Basic Operational Analysis

|             |  |
|-------------|--|
| Project     | CSUMB Master Plan EIR                              |
| Freeway     | Southbound State Route 1                           |
| Segment     | SR 1 between Del Monte Boulevard and Imjin Parkway |
| Alternative | Cuml w/ Proj                                       |
| Time period | AM Peak Hour                                       |

Flow Inputs and Adjustments

|                                    |       |      |
|------------------------------------|-------|------|
| Volume, V                          | 5,150 | vph  |
| Peak-hour factor, PHF              | 0.81  |      |
| Peak 15-min volume, $v_{15}$       | 1,590 | veh  |
| Trucks and buses                   | 3.9%  |      |
| Recreational vehicles              | 0.0%  |      |
| Terrain type                       | Level |      |
| Grade                              |       |      |
| Length                             |       | mi   |
| Trucks and buses PCE, $E_T$        | 1.5   |      |
| Recreational vehicle PCE, $E_R$    | 1.2   |      |
| Heavy vehicle adjustment, $f_{HV}$ | 0.981 |      |
| Driver population factor, $f_P$    | 1.00  |      |
| Flow rate, $v_p$                   | 6,482 | pcph |
| Number of lanes, N                 | 3     |      |

Speed Inputs and Adjustments

|  |      |          |
|--|------|----------|
| Lane width                             | 12.0 | ft       |
| Right-side lateral clearance           | >6   | ft       |
| Total ramp density, TRD                | 1.17 | ramps/mi |
| Lane width adjustment, $f_{LW}$        | 0.0  | mph      |
| Lateral clearance adjustment, $f_{LC}$ | 0.0  | mph      |
| TRD adjustment                         | 3.7  | mph      |
| Calculated free-flow speed, FFS        | 71.7 | mph      |
| Measured free-flow speed, FFS          | 65.0 | mph      |
| Free-flow speed curve                  | 65   | mph      |

Capacity Checks for Segments with Ramps

|                         | <u>Actual</u> |      | <u>Maximum</u> |      | <u>Violation?</u> |
|-------------------------|---------------|------|----------------|------|-------------------|
| Entering freeway volume |               | pcph |                | pcph |                   |
| Exiting freeway volume  |               | pcph |                | pcph |                   |
| On-ramp volume          |               | pcph |                | pcph |                   |
| Off-ramp volume         |               | pcph |                | pcph |                   |

LOS and Performance Measures

|                                |       |        |
|--------------------------------|-------|--------|
| Flow rate, $v_p$               | 2,161 | pcphpl |
| Average passenger-car speed, S | 56.8  | mph    |
| Volume-to-capacity ratio, v/c  | 0.92  |        |
| Density, D                     | 38.0  | pcpmpl |
| Level of service, LOS          | E     |        |

HCM 2010: Freeway Basic Segment

Basic Operational Analysis

|             |  |
|-------------|--|
| Project     | CSUMB Master Plan EIR                              |
| Freeway     | Southbound SR 1                                    |
| Segment     | SR 1 between Del Monte Boulevard and Imjin Parkway |
| Alternative | Cuml w/ Proj                                       |
| Time period | PM Peak Hour                                       |

Flow Inputs and Adjustments

|                                    |       |      |
|------------------------------------|-------|------|
| Volume, V                          | 2,920 | vph  |
| Peak-hour factor, PHF              | 0.95  |      |
| Peak 15-min volume, $v_{15}$       | 768   | veh  |
| Trucks and buses                   | 1.4%  |      |
| Recreational vehicles              | 0.0%  |      |
| Terrain type                       | Level |      |
| Grade                              |       |      |
| Length                             |       | mi   |
| Trucks and buses PCE, $E_T$        | 1.5   |      |
| Recreational vehicle PCE, $E_R$    | 1.2   |      |
| Heavy vehicle adjustment, $f_{HV}$ | 0.993 |      |
| Driver population factor, $f_p$    | 1.00  |      |
| Flow rate, $v_p$                   | 3,095 | pcph |
| Number of lanes, N                 | 3     |      |

Speed Inputs and Adjustments

|  |      |          |
|--|------|----------|
| Lane width                             | 12.0 | ft       |
| Right-side lateral clearance           | >6   | ft       |
| Total ramp density, TRD                | 1.17 | ramps/mi |
| Lane width adjustment, $f_{LW}$        | 0.0  | mph      |
| Lateral clearance adjustment, $f_{LC}$ | 0.0  | mph      |
| TRD adjustment                         | 3.7  | mph      |
| Calculated free-flow speed, FFS        | 71.7 | mph      |
| Measured free-flow speed, FFS          | 65.0 | mph      |
| Free-flow speed curve                  | 65   | mph      |

Capacity Checks for Segments with Ramps

|                         | <u>Actual</u> |      | <u>Maximum</u> |      | <u>Violation?</u> |
|-------------------------|---------------|------|----------------|------|-------------------|
| Entering freeway volume |               | pcph |                | pcph |                   |
| Exiting freeway volume  |               | pcph |                | pcph |                   |
| On-ramp volume          |               | pcph |                | pcph |                   |
| Off-ramp volume         |               | pcph |                | pcph |                   |

LOS and Performance Measures

|                                |       |        |
|--------------------------------|-------|--------|
| Flow rate, $v_p$               | 1,032 | pcphpl |
| Average passenger-car speed, S | 65.0  | mph    |
| Volume-to-capacity ratio, v/c  | 0.44  |        |
| Density, D                     | 15.9  | pcpmpl |
| Level of service, LOS          | B     |        |

HCM 2010: Freeway Basic Segment

Basic Operational Analysis

|             |   |
|-------------|---|
| Project     | CSUMB Master Plan EIR                             |
| Freeway     | Southbound State Route 1                          |
| Segment     | SR 1 between Imjin Parkway and Lightfighter Drive |
| Alternative | Cuml w/ Proj                                      |
| Time period | AM Peak Hour                                      |

Flow Inputs and Adjustments

|                                    |       |      |
|------------------------------------|-------|------|
| Volume, V                          | 5,250 | vph  |
| Peak-hour factor, PHF              | 0.83  |      |
| Peak 15-min volume, $v_{15}$       | 1,581 | veh  |
| Trucks and buses                   | 3.5%  |      |
| Recreational vehicles              | 0.0%  |      |
| Terrain type                       | Level |      |
| Grade                              |       |      |
| Length                             |       | mi   |
| Trucks and buses PCE, $E_T$        | 1.5   |      |
| Recreational vehicle PCE, $E_R$    | 1.2   |      |
| Heavy vehicle adjustment, $f_{HV}$ | 0.983 |      |
| Driver population factor, $f_p$    | 1.00  |      |
| Flow rate, $v_p$                   | 6,437 | pcph |
| Number of lanes, N                 | 3     |      |

Speed Inputs and Adjustments

|  |      |          |
|--|------|----------|
| Lane width                             | 12.0 | ft       |
| Right-side lateral clearance           | >6   | ft       |
| Total ramp density, TRD                | 1.17 | ramps/mi |
| Lane width adjustment, $f_{LW}$        | 0.0  | mph      |
| Lateral clearance adjustment, $f_{LC}$ | 0.0  | mph      |
| TRD adjustment                         | 3.7  | mph      |
| Calculated free-flow speed, FFS        | 71.7 | mph      |
| Measured free-flow speed, FFS          | 65.0 | mph      |
| Free-flow speed curve                  | 65   | mph      |

Capacity Checks for Segments with Ramps

|                         | <u>Actual</u> |      | <u>Maximum</u> |      | <u>Violation?</u> |
|-------------------------|---------------|------|----------------|------|-------------------|
| Entering freeway volume |               | pcph |                | pcph |                   |
| Exiting freeway volume  |               | pcph |                | pcph |                   |
| On-ramp volume          |               | pcph |                | pcph |                   |
| Off-ramp volume         |               | pcph |                | pcph |                   |

LOS and Performance Measures

|                                |       |        |
|--------------------------------|-------|--------|
| Flow rate, $v_p$               | 2,146 | pcphpl |
| Average passenger-car speed, S | 57.1  | mph    |
| Volume-to-capacity ratio, v/c  | 0.91  |        |
| Density, D                     | 37.6  | pcpmpl |
| Level of service, LOS          | E     |        |

HCM 2010: Freeway Basic Segment

Basic Operational Analysis

|             |   |
|-------------|---|
| Project     | CSUMB Master Plan EIR                             |
| Freeway     | Southbound SR 1                                   |
| Segment     | SR 1 between Imjin Parkway and Lightfighter Drive |
| Alternative | Cuml w/ Proj                                      |
| Time period | PM Peak Hour                                      |

Flow Inputs and Adjustments

|                                    |       |      |
|------------------------------------|-------|------|
| Volume, V                          | 3,450 | vph  |
| Peak-hour factor, PHF              | 0.95  |      |
| Peak 15-min volume, $v_{15}$       | 908   | veh  |
| Trucks and buses                   | 1.3%  |      |
| Recreational vehicles              | 0.0%  |      |
| Terrain type                       | Level |      |
| Grade                              |       |      |
| Length                             |       | mi   |
| Trucks and buses PCE, $E_T$        | 1.5   |      |
| Recreational vehicle PCE, $E_R$    | 1.2   |      |
| Heavy vehicle adjustment, $f_{HV}$ | 0.994 |      |
| Driver population factor, $f_p$    | 1.00  |      |
| Flow rate, $v_p$                   | 3,654 | pcph |
| Number of lanes, N                 | 3     |      |

Speed Inputs and Adjustments

|  |      |          |
|--|------|----------|
| Lane width                             | 12.0 | ft       |
| Right-side lateral clearance           | >6   | ft       |
| Total ramp density, TRD                | 1.17 | ramps/mi |
| Lane width adjustment, $f_{LW}$        | 0.0  | mph      |
| Lateral clearance adjustment, $f_{LC}$ | 0.0  | mph      |
| TRD adjustment                         | 3.7  | mph      |
| Calculated free-flow speed, FFS        | 71.7 | mph      |
| Measured free-flow speed, FFS          | 65.0 | mph      |
| Free-flow speed curve                  | 65   | mph      |

Capacity Checks for Segments with Ramps

|                         | <u>Actual</u> |      | <u>Maximum</u> |      | <u>Violation?</u> |
|-------------------------|---------------|------|----------------|------|-------------------|
| Entering freeway volume |               | pcph |                | pcph |                   |
| Exiting freeway volume  |               | pcph |                | pcph |                   |
| On-ramp volume          |               | pcph |                | pcph |                   |
| Off-ramp volume         |               | pcph |                | pcph |                   |

LOS and Performance Measures

|                                |       |        |
|--------------------------------|-------|--------|
| Flow rate, $v_p$               | 1,218 | pcphpl |
| Average passenger-car speed, S | 65.0  | mph    |
| Volume-to-capacity ratio, v/c  | 0.52  |        |
| Density, D                     | 18.7  | pcpmpl |
| Level of service, LOS          | C     |        |

HCM 2010: Freeway Basic Segment

Basic Operational Analysis

|             |   |
|-------------|---|
| Project     | CSUMB Master Plan EIR                                   |
| Freeway     | Southbound State Route 1                                |
| Segment     | SR 1 between Lightfighter Drive and Del Monte Boulevard |
| Alternative | Cuml w/ Proj  |
| Time period | AM Peak Hour  |

Flow Inputs and Adjustments

|                                    |       |      |
|------------------------------------|-------|------|
| Volume, V                          | 5,550 | vph  |
| Peak-hour factor, PHF              | 0.86  |      |
| Peak 15-min volume, $v_{15}$       | 1,613 | veh  |
| Trucks and buses                   | 3.2%  |      |
| Recreational vehicles              | 0.0%  |      |
| Terrain type                       | Level |      |
| Grade                              |       |      |
| Length                             |       | mi   |
| Trucks and buses PCE, $E_T$        | 1.5   |      |
| Recreational vehicle PCE, $E_R$    | 1.2   |      |
| Heavy vehicle adjustment, $f_{HV}$ | 0.984 |      |
| Driver population factor, $f_p$    | 1.00  |      |
| Flow rate, $v_p$                   | 6,557 | pcph |
| Number of lanes, N                 | 3     |      |

Speed Inputs and Adjustments

|  |      |          |
|--|------|----------|
| Lane width                             | 12.0 | ft       |
| Right-side lateral clearance           | >6   | ft       |
| Total ramp density, TRD                | 1.33 | ramps/mi |
| Lane width adjustment, $f_{LW}$        | 0.0  | mph      |
| Lateral clearance adjustment, $f_{LC}$ | 0.0  | mph      |
| TRD adjustment                         | 4.1  | mph      |
| Calculated free-flow speed, FFS        | 71.3 | mph      |
| Measured free-flow speed, FFS          | 65.0 | mph      |
| Free-flow speed curve                  | 65   | mph      |

Capacity Checks for Segments with Ramps

|                         | <u>Actual</u> |      | <u>Maximum</u> |      | <u>Violation?</u> |
|-------------------------|---------------|------|----------------|------|-------------------|
| Entering freeway volume |               | pcph |                | pcph |                   |
| Exiting freeway volume  |               | pcph |                | pcph |                   |
| On-ramp volume          |               | pcph |                | pcph |                   |
| Off-ramp volume         |               | pcph |                | pcph |                   |

LOS and Performance Measures

|                                |       |        |
|--------------------------------|-------|--------|
| Flow rate, $v_p$               | 2,186 | pcphpl |
| Average passenger-car speed, S | 56.2  | mph    |
| Volume-to-capacity ratio, v/c  | 0.93  |        |
| Density, D                     | 38.9  | pcpmpl |
| Level of service, LOS          | E     |        |



HCM 2010: Freeway Basic Segment

Basic Operational Analysis

|             |   |
|-------------|---|
| Project     | CSUMB Master Plan EIR                                   |
| Freeway     | Southbound SR 1   |
| Segment     | SR 1 between Lightfighter Drive and Del Monte Boulevard |
| Alternative | Cuml w/ Proj  |
| Time period | PM Peak Hour  |

Flow Inputs and Adjustments

|                                    |       |      |
|------------------------------------|-------|------|
| Volume, V                          | 4,010 | vph  |
| Peak-hour factor, PHF              | 0.97  |      |
| Peak 15-min volume, $v_{15}$       | 1,034 | veh  |
| Trucks and buses                   | 1.1%  |      |
| Recreational vehicles              | 0.0%  |      |
| Terrain type                       | Level |      |
| Grade                              |       |      |
| Length                             |       | mi   |
| Trucks and buses PCE, $E_T$        | 1.5   |      |
| Recreational vehicle PCE, $E_R$    | 1.2   |      |
| Heavy vehicle adjustment, $f_{HV}$ | 0.994 |      |
| Driver population factor, $f_p$    | 1.00  |      |
| Flow rate, $v_p$                   | 4,157 | pcph |
| Number of lanes, N                 | 3     |      |

Speed Inputs and Adjustments

|  |      |          |
|--|------|----------|
| Lane width                             | 12.0 | ft       |
| Right-side lateral clearance           | >6   | ft       |
| Total ramp density, TRD                | 1.33 | ramps/mi |
| Lane width adjustment, $f_{LW}$        | 0.0  | mph      |
| Lateral clearance adjustment, $f_{LC}$ | 0.0  | mph      |
| TRD adjustment                         | 4.1  | mph      |
| Calculated free-flow speed, FFS        | 71.3 | mph      |
| Measured free-flow speed, FFS          | 65.0 | mph      |
| Free-flow speed curve                  | 65   | mph      |

Capacity Checks for Segments with Ramps

|                         | <u>Actual</u> |      | <u>Maximum</u> |      | <u>Violation?</u> |
|-------------------------|---------------|------|----------------|------|-------------------|
| Entering freeway volume |               | pcph |                | pcph |                   |
| Exiting freeway volume  |               | pcph |                | pcph |                   |
| On-ramp volume          |               | pcph |                | pcph |                   |
| Off-ramp volume         |               | pcph |                | pcph |                   |

LOS and Performance Measures

|                                |       |        |
|--------------------------------|-------|--------|
| Flow rate, $v_p$               | 1,386 | pcphpl |
| Average passenger-car speed, S | 65.0  | mph    |
| Volume-to-capacity ratio, v/c  | 0.59  |        |
| Density, D                     | 21.3  | pcpmpl |
| Level of service, LOS          | C     |        |

HCM 2010: Freeway Basic Segment

Basic Operational Analysis

|             |   |
|-------------|---|
| Project     | CSUMB Master Plan EIR   |
| Freeway     | Southbound State Route 1                                      |
| Segment     | SR 1 between Del Monte Boulevard and Canyon Del Rey Boulevard |
| Alternative | Cuml w/ Proj  |
| Time period | AM Peak Hour  |

Flow Inputs and Adjustments

|                                    |       |      |
|------------------------------------|-------|------|
| Volume, V                          | 4,540 | vph  |
| Peak-hour factor, PHF              | 0.95  |      |
| Peak 15-min volume, $v_{15}$       | 1,195 | veh  |
| Trucks and buses                   | 2.4%  |      |
| Recreational vehicles              | 0.0%  |      |
| Terrain type                       | Level |      |
| Grade                              |       |      |
| Length                             |       | mi   |
| Trucks and buses PCE, $E_T$        | 1.5   |      |
| Recreational vehicle PCE, $E_R$    | 1.2   |      |
| Heavy vehicle adjustment, $f_{HV}$ | 0.988 |      |
| Driver population factor, $f_P$    | 1.00  |      |
| Flow rate, $v_p$                   | 4,837 | pcph |
| Number of lanes, N                 | 2     |      |

Speed Inputs and Adjustments

|  |      |          |
|--|------|----------|
| Lane width                             | 12.0 | ft       |
| Right-side lateral clearance           | 5.0  | ft       |
| Total ramp density, TRD                | 2.17 | ramps/mi |
| Lane width adjustment, $f_{LW}$        | 0.0  | mph      |
| Lateral clearance adjustment, $f_{LC}$ | 0.6  | mph      |
| TRD adjustment                         | 6.2  | mph      |
| Calculated free-flow speed, FFS        | 68.6 | mph      |
| Measured free-flow speed, FFS          | 65.0 | mph      |
| Free-flow speed curve                  | 65   | mph      |

Capacity Checks for Segments with Ramps

|                         | <u>Actual</u> |      | <u>Maximum</u> |      | <u>Violation?</u> |
|-------------------------|---------------|------|----------------|------|-------------------|
| Entering freeway volume |               | pcph |                | pcph |                   |
| Exiting freeway volume  |               | pcph |                | pcph |                   |
| On-ramp volume          |               | pcph |                | pcph |                   |
| Off-ramp volume         |               | pcph |                | pcph |                   |

LOS and Performance Measures

|                                 |       |        |
|---------------------------------|-------|--------|
| Flow rate, $v_p$                | 2,419 | pcphpl |
| Average passenger-car speed, S  | -     | mph    |
| Volume-to-capacity ratio, $v/c$ | 1.03  |        |
| Density, D                      | -     | pcpmpl |
| Level of service, LOS           | F     |        |

HCM 2010: Freeway Basic Segment

Basic Operational Analysis

|             |   |
|-------------|---|
| Project     | CSUMB Master Plan EIR   |
| Freeway     | Southbound SR 1   |
| Segment     | SR 1 between Del Monte Boulevard and Canyon Del Rey Boulevard |
| Alternative | Cuml w/ Proj  |
| Time period | PM Peak Hour  |

Flow Inputs and Adjustments

|                                    |       |      |
|------------------------------------|-------|------|
| Volume, V                          | 3,240 | vph  |
| Peak-hour factor, PHF              | 0.96  |      |
| Peak 15-min volume, $v_{15}$       | 844   | veh  |
| Trucks and buses                   | 1.0%  |      |
| Recreational vehicles              | 0.0%  |      |
| Terrain type                       | Level |      |
| Grade                              |       |      |
| Length                             |       | mi   |
| Trucks and buses PCE, $E_T$        | 1.5   |      |
| Recreational vehicle PCE, $E_R$    | 1.2   |      |
| Heavy vehicle adjustment, $f_{HV}$ | 0.995 |      |
| Driver population factor, $f_p$    | 1.00  |      |
| Flow rate, $v_p$                   | 3,392 | pcph |
| Number of lanes, N                 | 2     |      |

Speed Inputs and Adjustments

|  |      |          |
|--|------|----------|
| Lane width                             | 12.0 | ft       |
| Right-side lateral clearance           | 5.0  | ft       |
| Total ramp density, TRD                | 2.17 | ramps/mi |
| Lane width adjustment, $f_{LW}$        | 0.0  | mph      |
| Lateral clearance adjustment, $f_{LC}$ | 0.6  | mph      |
| TRD adjustment                         | 6.2  | mph      |
| Calculated free-flow speed, FFS        | 68.6 | mph      |
| Measured free-flow speed, FFS          | 65.0 | mph      |
| Free-flow speed curve                  | 65   | mph      |

Capacity Checks for Segments with Ramps

|                         | <u>Actual</u> |      | <u>Maximum</u> |      | <u>Violation?</u> |
|-------------------------|---------------|------|----------------|------|-------------------|
| Entering freeway volume |               | pcph |                | pcph |                   |
| Exiting freeway volume  |               | pcph |                | pcph |                   |
| On-ramp volume          |               | pcph |                | pcph |                   |
| Off-ramp volume         |               | pcph |                | pcph |                   |

LOS and Performance Measures

|                                |       |        |
|--------------------------------|-------|--------|
| Flow rate, $v_p$               | 1,696 | pcphpl |
| Average passenger-car speed, S | 63.8  | mph    |
| Volume-to-capacity ratio, v/c  | 0.72  |        |
| Density, D                     | 26.6  | pcmppl |
| Level of service, LOS          | D     |        |

HCM 2010: Freeway Basic Segment

Basic Operational Analysis

|             |   |
|-------------|---|
| Project     | CSUMB Master Plan EIR                                 |
| Freeway     | Northbound State Route 1                              |
| Segment     | SR 1 between Reservation Road and Del Monte Boulevard |
| Alternative | Cuml w/ Proj  |
| Time period | AM Peak Hour  |

Flow Inputs and Adjustments

|                                    |       |      |
|------------------------------------|-------|------|
| Volume, V                          | 1,520 | vph  |
| Peak-hour factor, PHF              | 0.97  |      |
| Peak 15-min volume, $v_{15}$       | 392   | veh  |
| Trucks and buses                   | 6.4%  |      |
| Recreational vehicles              | 0.0%  |      |
| Terrain type                       | Level |      |
| Grade                              |       |      |
| Length                             |       | mi   |
| Trucks and buses PCE, $E_T$        | 1.5   |      |
| Recreational vehicle PCE, $E_R$    | 1.2   |      |
| Heavy vehicle adjustment, $f_{HV}$ | 0.969 |      |
| Driver population factor, $f_p$    | 1.00  |      |
| Flow rate, $v_p$                   | 1,617 | pcph |
| Number of lanes, N                 | 2     |      |

Speed Inputs and Adjustments

|  |      |          |
|--|------|----------|
| Lane width                             | 12.0 | ft       |
| Right-side lateral clearance           | >6   | ft       |
| Total ramp density, TRD                | 1.00 | ramps/mi |
| Lane width adjustment, $f_{LW}$        | 0.0  | mph      |
| Lateral clearance adjustment, $f_{LC}$ | 0.0  | mph      |
| TRD adjustment                         | 3.2  | mph      |
| Calculated free-flow speed, FFS        | 72.2 | mph      |
| Measured free-flow speed, FFS          | 65.0 | mph      |
| Free-flow speed curve                  | 65   | mph      |

Capacity Checks for Segments with Ramps

|                         | <u>Actual</u> |      | <u>Maximum</u> |      | <u>Violation?</u> |
|-------------------------|---------------|------|----------------|------|-------------------|
| Entering freeway volume |               | pcph |                | pcph |                   |
| Exiting freeway volume  |               | pcph |                | pcph |                   |
| On-ramp volume          |               | pcph |                | pcph |                   |
| Off-ramp volume         |               | pcph |                | pcph |                   |

LOS and Performance Measures

|                                |      |        |
|--------------------------------|------|--------|
| Flow rate, $v_p$               | 808  | pcphpl |
| Average passenger-car speed, S | 65.0 | mph    |
| Volume-to-capacity ratio, v/c  | 0.34 |        |
| Density, D                     | 12.4 | pcpmpl |
| Level of service, LOS          | B    |        |

HCM 2010: Freeway Basic Segment

Basic Operational Analysis

|             |   |
|-------------|---|
| Project     | CSUMB Master Plan EIR                                 |
| Freeway     | Northbound State Route 1                              |
| Segment     | SR 1 between Reservation Road and Del Monte Boulevard |
| Alternative | Cuml w/ Proj  |
| Time period | PM Peak Hour  |

Flow Inputs and Adjustments

|                                    |       |      |
|------------------------------------|-------|------|
| Volume, V                          | 3,050 | vph  |
| Peak-hour factor, PHF              | 0.98  |      |
| Peak 15-min volume, $v_{15}$       | 778   | veh  |
| Trucks and buses                   | 2.2%  |      |
| Recreational vehicles              | 0.0%  |      |
| Terrain type                       | Level |      |
| Grade                              |       |      |
| Length                             |       | mi   |
| Trucks and buses PCE, $E_T$        | 1.5   |      |
| Recreational vehicle PCE, $E_R$    | 1.2   |      |
| Heavy vehicle adjustment, $f_{HV}$ | 0.989 |      |
| Driver population factor, $f_p$    | 1.00  |      |
| Flow rate, $v_p$                   | 3,146 | pcph |
| Number of lanes, N                 | 2     |      |

Speed Inputs and Adjustments

|  |      |          |
|--|------|----------|
| Lane width                             | 12.0 | ft       |
| Right-side lateral clearance           | >6   | ft       |
| Total ramp density, TRD                | 1.00 | ramps/mi |
| Lane width adjustment, $f_{LW}$        | 0.0  | mph      |
| Lateral clearance adjustment, $f_{LC}$ | 0.0  | mph      |
| TRD adjustment                         | 3.2  | mph      |
| Calculated free-flow speed, FFS        | 72.2 | mph      |
| Measured free-flow speed, FFS          | 65.0 | mph      |
| Free-flow speed curve                  | 65   | mph      |

Capacity Checks for Segments with Ramps

|                         | <u>Actual</u> |      | <u>Maximum</u> |      | <u>Violation?</u> |
|-------------------------|---------------|------|----------------|------|-------------------|
| Entering freeway volume |               | pcph |                | pcph |                   |
| Exiting freeway volume  |               | pcph |                | pcph |                   |
| On-ramp volume          |               | pcph |                | pcph |                   |
| Off-ramp volume         |               | pcph |                | pcph |                   |

LOS and Performance Measures

|                                |       |        |
|--------------------------------|-------|--------|
| Flow rate, $v_p$               | 1,573 | pcphpl |
| Average passenger-car speed, S | 64.6  | mph    |
| Volume-to-capacity ratio, v/c  | 0.67  |        |
| Density, D                     | 24.4  | pcpmpl |
| Level of service, LOS          | C     |        |

HCM 2010: Freeway Basic Segment

Basic Operational Analysis

|             |  |
|-------------|--|
| Project     | CSUMB Master Plan EIR                              |
| Freeway     | Northbound State Route 1                           |
| Segment     | SR 1 between Del Monte Boulevard and Imjin Parkway |
| Alternative | Cuml w/ Proj                                       |
| Time period | AM Peak Hour                                       |

Flow Inputs and Adjustments

|                                    |       |      |
|------------------------------------|-------|------|
| Volume, V                          | 2,440 | vph  |
| Peak-hour factor, PHF              | 0.92  |      |
| Peak 15-min volume, $v_{15}$       | 663   | veh  |
| Trucks and buses                   | 5.7%  |      |
| Recreational vehicles              | 0.0%  |      |
| Terrain type                       | Level |      |
| Grade                              |       |      |
| Length                             |       | mi   |
| Trucks and buses PCE, $E_T$        | 1.5   |      |
| Recreational vehicle PCE, $E_R$    | 1.2   |      |
| Heavy vehicle adjustment, $f_{HV}$ | 0.972 |      |
| Driver population factor, $f_P$    | 1.00  |      |
| Flow rate, $v_p$                   | 2,729 | pcph |
| Number of lanes, N                 | 3     |      |

Speed Inputs and Adjustments

|  |      |          |
|--|------|----------|
| Lane width                             | 12.0 | ft       |
| Right-side lateral clearance           | >6   | ft       |
| Total ramp density, TRD                | 1.20 | ramps/mi |
| Lane width adjustment, $f_{LW}$        | 0.0  | mph      |
| Lateral clearance adjustment, $f_{LC}$ | 0.0  | mph      |
| TRD adjustment                         | 3.8  | mph      |
| Calculated free-flow speed, FFS        | 71.6 | mph      |
| Measured free-flow speed, FFS          | 65.0 | mph      |
| Free-flow speed curve                  | 65   | mph      |

Capacity Checks for Segments with Ramps

|                         | <u>Actual</u> |      | <u>Maximum</u> |      | <u>Violation?</u> |
|-------------------------|---------------|------|----------------|------|-------------------|
| Entering freeway volume |               | pcph |                | pcph |                   |
| Exiting freeway volume  |               | pcph |                | pcph |                   |
| On-ramp volume          |               | pcph |                | pcph |                   |
| Off-ramp volume         |               | pcph |                | pcph |                   |

LOS and Performance Measures

|                                |      |        |
|--------------------------------|------|--------|
| Flow rate, $v_p$               | 910  | pcphpl |
| Average passenger-car speed, S | 65.0 | mph    |
| Volume-to-capacity ratio, v/c  | 0.39 |        |
| Density, D                     | 14.0 | pcpmpl |
| Level of service, LOS          | B    |        |

HCM 2010: Freeway Basic Segment

Basic Operational Analysis

|             |  |
|-------------|--|
| Project     | CSUMB Master Plan EIR                              |
| Freeway     | Northbound State Route 1                           |
| Segment     | SR 1 between Del Monte Boulevard and Imjin Parkway |
| Alternative | Cuml w/ Proj                                       |
| Time period | PM Peak Hour                                       |

Flow Inputs and Adjustments

|                                    |       |      |
|------------------------------------|-------|------|
| Volume, V                          | 4,940 | vph  |
| Peak-hour factor, PHF              | 0.96  |      |
| Peak 15-min volume, $v_{15}$       | 1,286 | veh  |
| Trucks and buses                   | 1.9%  |      |
| Recreational vehicles              | 0.0%  |      |
| Terrain type                       | Level |      |
| Grade                              |       |      |
| Length                             |       | mi   |
| Trucks and buses PCE, $E_T$        | 1.5   |      |
| Recreational vehicle PCE, $E_R$    | 1.2   |      |
| Heavy vehicle adjustment, $f_{HV}$ | 0.991 |      |
| Driver population factor, $f_p$    | 1.00  |      |
| Flow rate, $v_p$                   | 5,194 | pcph |
| Number of lanes, N                 | 3     |      |

Speed Inputs and Adjustments

|  |      |          |
|--|------|----------|
| Lane width                             | 12.0 | ft       |
| Right-side lateral clearance           | >6   | ft       |
| Total ramp density, TRD                | 1.17 | ramps/mi |
| Lane width adjustment, $f_{LW}$        | 0.0  | mph      |
| Lateral clearance adjustment, $f_{LC}$ | 0.0  | mph      |
| TRD adjustment                         | 3.7  | mph      |
| Calculated free-flow speed, FFS        | 71.7 | mph      |
| Measured free-flow speed, FFS          | 65.0 | mph      |
| Free-flow speed curve                  | 65   | mph      |

Capacity Checks for Segments with Ramps

|                         | <u>Actual</u> |      | <u>Maximum</u> |      | <u>Violation?</u> |
|-------------------------|---------------|------|----------------|------|-------------------|
| Entering freeway volume |               | pcph |                | pcph |                   |
| Exiting freeway volume  |               | pcph |                | pcph |                   |
| On-ramp volume          |               | pcph |                | pcph |                   |
| Off-ramp volume         |               | pcph |                | pcph |                   |

LOS and Performance Measures

|                                |       |        |
|--------------------------------|-------|--------|
| Flow rate, $v_p$               | 1,731 | pcphpl |
| Average passenger-car speed, S | 63.4  | mph    |
| Volume-to-capacity ratio, v/c  | 0.74  |        |
| Density, D                     | 27.3  | pcpmpl |
| Level of service, LOS          | D     |        |

HCM 2010: Freeway Basic Segment

Basic Operational Analysis

|             |   |
|-------------|---|
| Project     | CSUMB Master Plan EIR                             |
| Freeway     | Northbound State Route 1                          |
| Segment     | SR 1 between Imjin Parkway and Lightfighter Drive |
| Alternative | Cuml w/ Proj                                      |
| Time period | AM Peak Hour                                      |

Flow Inputs and Adjustments

|                                    |       |      |
|------------------------------------|-------|------|
| Volume, V                          | 3,070 | vph  |
| Peak-hour factor, PHF              | 0.92  |      |
| Peak 15-min volume, $v_{15}$       | 836   | veh  |
| Trucks and buses                   | 3.8%  |      |
| Recreational vehicles              | 0.0%  |      |
| Terrain type                       | Level |      |
| Grade                              |       |      |
| Length                             |       | mi   |
| Trucks and buses PCE, $E_T$        | 1.5   |      |
| Recreational vehicle PCE, $E_R$    | 1.2   |      |
| Heavy vehicle adjustment, $f_{HV}$ | 0.982 |      |
| Driver population factor, $f_p$    | 1.00  |      |
| Flow rate, $v_p$                   | 3,408 | pcph |
| Number of lanes, N                 | 3     |      |

Speed Inputs and Adjustments

|  |      |          |
|--|------|----------|
| Lane width                             | 12.0 | ft       |
| Right-side lateral clearance           | >6   | ft       |
| Total ramp density, TRD                | 1.17 | ramps/mi |
| Lane width adjustment, $f_{LW}$        | 0.0  | mph      |
| Lateral clearance adjustment, $f_{LC}$ | 0.0  | mph      |
| TRD adjustment                         | 3.7  | mph      |
| Calculated free-flow speed, FFS        | 71.7 | mph      |
| Measured free-flow speed, FFS          | 65.0 | mph      |
| Free-flow speed curve                  | 65   | mph      |

Capacity Checks for Segments with Ramps

|                         | <u>Actual</u> |      | <u>Maximum</u> |      | <u>Violation?</u> |
|-------------------------|---------------|------|----------------|------|-------------------|
| Entering freeway volume |               | pcph |                | pcph |                   |
| Exiting freeway volume  |               | pcph |                | pcph |                   |
| On-ramp volume          |               | pcph |                | pcph |                   |
| Off-ramp volume         |               | pcph |                | pcph |                   |

LOS and Performance Measures

|                                |       |        |
|--------------------------------|-------|--------|
| Flow rate, $v_p$               | 1,136 | pcphpl |
| Average passenger-car speed, S | 65.0  | mph    |
| Volume-to-capacity ratio, v/c  | 0.48  |        |
| Density, D                     | 17.5  | pcpmpl |
| Level of service, LOS          | B     |        |



HCM 2010: Freeway Basic Segment

Basic Operational Analysis

|             |   |
|-------------|---|
| Project     | CSUMB Master Plan EIR                             |
| Freeway     | Northbound State Route 1                          |
| Segment     | SR 1 between Imjin Parkway and Lightfighter Drive |
| Alternative | Cuml w/ Proj                                      |
| Time period | PM Peak Hour                                      |

Flow Inputs and Adjustments

|                                    |       |      |
|------------------------------------|-------|------|
| Volume, V                          | 5,520 | vph  |
| Peak-hour factor, PHF              | 0.97  |      |
| Peak 15-min volume, $v_{15}$       | 1,423 | veh  |
| Trucks and buses                   | 1.7%  |      |
| Recreational vehicles              | 0.0%  |      |
| Terrain type                       | Level |      |
| Grade                              |       |      |
| Length                             |       | mi   |
| Trucks and buses PCE, $E_T$        | 1.5   |      |
| Recreational vehicle PCE, $E_R$    | 1.2   |      |
| Heavy vehicle adjustment, $f_{HV}$ | 0.991 |      |
| Driver population factor, $f_P$    | 1.00  |      |
| Flow rate, $v_p$                   | 5,740 | pcph |
| Number of lanes, N                 | 3     |      |

Speed Inputs and Adjustments

|  |      |          |
|--|------|----------|
| Lane width                             | 12.0 | ft       |
| Right-side lateral clearance           | >6   | ft       |
| Total ramp density, TRD                | 1.17 | ramps/mi |
| Lane width adjustment, $f_{LW}$        | 0.0  | mph      |
| Lateral clearance adjustment, $f_{LC}$ | 0.0  | mph      |
| TRD adjustment                         | 3.7  | mph      |
| Calculated free-flow speed, FFS        | 71.7 | mph      |
| Measured free-flow speed, FFS          | 65.0 | mph      |
| Free-flow speed curve                  | 65   | mph      |

Capacity Checks for Segments with Ramps

|                         | <u>Actual</u> |      | <u>Maximum</u> |      | <u>Violation?</u> |
|-------------------------|---------------|------|----------------|------|-------------------|
| Entering freeway volume |               | pcph |                | pcph |                   |
| Exiting freeway volume  |               | pcph |                | pcph |                   |
| On-ramp volume          |               | pcph |                | pcph |                   |
| Off-ramp volume         |               | pcph |                | pcph |                   |

LOS and Performance Measures

|                                |       |        |
|--------------------------------|-------|--------|
| Flow rate, $v_p$               | 1,913 | pcphpl |
| Average passenger-car speed, S | 61.3  | mph    |
| Volume-to-capacity ratio, v/c  | 0.81  |        |
| Density, D                     | 31.2  | pcpmpl |
| Level of service, LOS          | D     |        |

HCM 2010: Freeway Basic Segment

Basic Operational Analysis

|             |   |
|-------------|---|
| Project     | CSUMB Master Plan EIR                                   |
| Freeway     | Northbound State Route 1                                |
| Segment     | SR 1 between Lightfighter Drive and Del Monte Boulevard |
| Alternative | Cuml w/ Proj  |
| Time period | AM Peak Hour  |

Flow Inputs and Adjustments

|                                    |       |      |
|------------------------------------|-------|------|
| Volume, V                          | 3,580 | vph  |
| Peak-hour factor, PHF              | 0.93  |      |
| Peak 15-min volume, $v_{15}$       | 958   | veh  |
| Trucks and buses                   | 3.8%  |      |
| Recreational vehicles              | 0.0%  |      |
| Terrain type                       | Level |      |
| Grade                              |       |      |
| Length                             |       | mi   |
| Trucks and buses PCE, $E_T$        | 1.5   |      |
| Recreational vehicle PCE, $E_R$    | 1.2   |      |
| Heavy vehicle adjustment, $f_{HV}$ | 0.982 |      |
| Driver population factor, $f_P$    | 1.00  |      |
| Flow rate, $v_p$                   | 3,906 | pcph |
| Number of lanes, N                 | 3     |      |

Speed Inputs and Adjustments

|  |      |          |
|--|------|----------|
| Lane width                             | 12.0 | ft       |
| Right-side lateral clearance           | >6   | ft       |
| Total ramp density, TRD                | 1.17 | ramps/mi |
| Lane width adjustment, $f_{LW}$        | 0.0  | mph      |
| Lateral clearance adjustment, $f_{LC}$ | 0.0  | mph      |
| TRD adjustment                         | 3.7  | mph      |
| Calculated free-flow speed, FFS        | 71.7 | mph      |
| Measured free-flow speed, FFS          | 65.0 | mph      |
| Free-flow speed curve                  | 65   | mph      |

Capacity Checks for Segments with Ramps

|                         | <u>Actual</u> |      | <u>Maximum</u> |      | <u>Violation?</u> |
|-------------------------|---------------|------|----------------|------|-------------------|
| Entering freeway volume |               | pcph |                | pcph |                   |
| Exiting freeway volume  |               | pcph |                | pcph |                   |
| On-ramp volume          |               | pcph |                | pcph |                   |
| Off-ramp volume         |               | pcph |                | pcph |                   |

LOS and Performance Measures

|                                |       |        |
|--------------------------------|-------|--------|
| Flow rate, $v_p$               | 1,302 | pcphpl |
| Average passenger-car speed, S | 65.0  | mph    |
| Volume-to-capacity ratio, v/c  | 0.55  |        |
| Density, D                     | 20.0  | pcpmpl |
| Level of service, LOS          | C     |        |

HCM 2010: Freeway Basic Segment

Basic Operational Analysis

|             |   |
|-------------|---|
| Project     | CSUMB Master Plan EIR                                   |
| Freeway     | Northbound State Route 1                                |
| Segment     | SR 1 between Lightfighter Drive and Del Monte Boulevard |
| Alternative | Cuml w/ Proj  |
| Time period | PM Peak Hour  |

Flow Inputs and Adjustments

|                                    |       |      |
|------------------------------------|-------|------|
| Volume, V                          | 5,470 | vph  |
| Peak-hour factor, PHF              | 0.98  |      |
| Peak 15-min volume, $v_{15}$       | 1,395 | veh  |
| Trucks and buses                   | 1.9%  |      |
| Recreational vehicles              | 0.0%  |      |
| Terrain type                       | Level |      |
| Grade                              |       |      |
| Length                             |       | mi   |
| Trucks and buses PCE, $E_T$        | 1.5   |      |
| Recreational vehicle PCE, $E_R$    | 1.2   |      |
| Heavy vehicle adjustment, $f_{HV}$ | 0.991 |      |
| Driver population factor, $f_p$    | 1.00  |      |
| Flow rate, $v_p$                   | 5,634 | pcph |
| Number of lanes, N                 | 3     |      |

Speed Inputs and Adjustments

|  |      |          |
|--|------|----------|
| Lane width                             | 12.0 | ft       |
| Right-side lateral clearance           | >6   | ft       |
| Total ramp density, TRD                | 1.17 | ramps/mi |
| Lane width adjustment, $f_{LW}$        | 0.0  | mph      |
| Lateral clearance adjustment, $f_{LC}$ | 0.0  | mph      |
| TRD adjustment                         | 3.7  | mph      |
| Calculated free-flow speed, FFS        | 71.7 | mph      |
| Measured free-flow speed, FFS          | 65.0 | mph      |
| Free-flow speed curve                  | 65   | mph      |

Capacity Checks for Segments with Ramps

|                         | <u>Actual</u> |      | <u>Maximum</u> |      | <u>Violation?</u> |
|-------------------------|---------------|------|----------------|------|-------------------|
| Entering freeway volume |               | pcph |                | pcph |                   |
| Exiting freeway volume  |               | pcph |                | pcph |                   |
| On-ramp volume          |               | pcph |                | pcph |                   |
| Off-ramp volume         |               | pcph |                | pcph |                   |

LOS and Performance Measures

|                                |       |        |
|--------------------------------|-------|--------|
| Flow rate, $v_p$               | 1,878 | pcphpl |
| Average passenger-car speed, S | 61.8  | mph    |
| Volume-to-capacity ratio, v/c  | 0.80  |        |
| Density, D                     | 30.4  | pcpmpl |
| Level of service, LOS          | D     |        |

HCM 2010: Freeway Basic Segment

Basic Operational Analysis

|             |   |
|-------------|---|
| Project     | CSUMB Master Plan EIR   |
| Freeway     | Northbound State Route 1                                      |
| Segment     | SR 1 between Del Monte Boulevard and Canyon Del Rey Boulevard |
| Alternative | Cuml w/ Proj  |
| Time period | AM Peak Hour  |

Flow Inputs and Adjustments

|                                    |       |      |
|------------------------------------|-------|------|
| Volume, V                          | 3,040 | vph  |
| Peak-hour factor, PHF              | 0.92  |      |
| Peak 15-min volume, $v_{15}$       | 830   | veh  |
| Trucks and buses                   | 3.2%  |      |
| Recreational vehicles              | 0.0%  |      |
| Terrain type                       | Level |      |
| Grade                              |       |      |
| Length                             |       | mi   |
| Trucks and buses PCE, $E_T$        | 1.5   |      |
| Recreational vehicle PCE, $E_R$    | 1.2   |      |
| Heavy vehicle adjustment, $f_{HV}$ | 0.984 |      |
| Driver population factor, $f_p$    | 1.00  |      |
| Flow rate, $v_p$                   | 3,373 | pcph |
| Number of lanes, N                 | 2     |      |

Speed Inputs and Adjustments

|  |      |          |
|--|------|----------|
| Lane width                             | 12.0 | ft       |
| Right-side lateral clearance           | >6   | ft       |
| Total ramp density, TRD                | 2.00 | ramps/mi |
| Lane width adjustment, $f_{LW}$        | 0.0  | mph      |
| Lateral clearance adjustment, $f_{LC}$ | 0.0  | mph      |
| TRD adjustment                         | 5.8  | mph      |
| Calculated free-flow speed, FFS        | 69.6 | mph      |
| Measured free-flow speed, FFS          | 65.0 | mph      |
| Free-flow speed curve                  | 65   | mph      |

Capacity Checks for Segments with Ramps

|                         | <u>Actual</u> |      | <u>Maximum</u> |      | <u>Violation?</u> |
|-------------------------|---------------|------|----------------|------|-------------------|
| Entering freeway volume |               | pcph |                | pcph |                   |
| Exiting freeway volume  |               | pcph |                | pcph |                   |
| On-ramp volume          |               | pcph |                | pcph |                   |
| Off-ramp volume         |               | pcph |                | pcph |                   |

LOS and Performance Measures

|                                |       |        |
|--------------------------------|-------|--------|
| Flow rate, $v_p$               | 1,687 | pcphpl |
| Average passenger-car speed, S | 63.8  | mph    |
| Volume-to-capacity ratio, v/c  | 0.72  |        |
| Density, D                     | 26.4  | pcpmpl |
| Level of service, LOS          | D     |        |

HCM 2010: Freeway Basic Segment

Basic Operational Analysis

|             |   |
|-------------|---|
| Project     | CSUMB Master Plan EIR   |
| Freeway     | Northbound State Route 1                                      |
| Segment     | SR 1 between Del Monte Boulevard and Canyon Del Rey Boulevard |
| Alternative | Cuml w/ Proj  |
| Time period | PM Peak Hour  |

Flow Inputs and Adjustments

|                                    |       |      |
|------------------------------------|-------|------|
| Volume, V                          | 4,350 | vph  |
| Peak-hour factor, PHF              | 0.97  |      |
| Peak 15-min volume, $v_{15}$       | 1,121 | veh  |
| Trucks and buses                   | 2.0%  |      |
| Recreational vehicles              | 0.0%  |      |
| Terrain type                       | Level |      |
| Grade                              |       |      |
| Length                             |       | mi   |
| Trucks and buses PCE, $E_T$        | 1.5   |      |
| Recreational vehicle PCE, $E_R$    | 1.2   |      |
| Heavy vehicle adjustment, $f_{HV}$ | 0.990 |      |
| Driver population factor, $f_p$    | 1.00  |      |
| Flow rate, $v_p$                   | 4,530 | pcph |
| Number of lanes, N                 | 2     |      |

Speed Inputs and Adjustments

|  |      |          |
|--|------|----------|
| Lane width                             | 12.0 | ft       |
| Right-side lateral clearance           | >6   | ft       |
| Total ramp density, TRD                | 2.00 | ramps/mi |
| Lane width adjustment, $f_{LW}$        | 0.0  | mph      |
| Lateral clearance adjustment, $f_{LC}$ | 0.0  | mph      |
| TRD adjustment                         | 5.8  | mph      |
| Calculated free-flow speed, FFS        | 69.6 | mph      |
| Measured free-flow speed, FFS          | 65.0 | mph      |
| Free-flow speed curve                  | 65   | mph      |

Capacity Checks for Segments with Ramps

|                         | <u>Actual</u> |      | <u>Maximum</u> |      | <u>Violation?</u> |
|-------------------------|---------------|------|----------------|------|-------------------|
| Entering freeway volume |               | pcph |                | pcph |                   |
| Exiting freeway volume  |               | pcph |                | pcph |                   |
| On-ramp volume          |               | pcph |                | pcph |                   |
| Off-ramp volume         |               | pcph |                | pcph |                   |

LOS and Performance Measures

|                                |       |        |
|--------------------------------|-------|--------|
| Flow rate, $v_p$               | 2,265 | pcphpl |
| Average passenger-car speed, S | 54.4  | mph    |
| Volume-to-capacity ratio, v/c  | 0.96  |        |
| Density, D                     | 41.6  | pcmppl |
| Level of service, LOS          | E     |        |

HCM 2010: Freeway Basic Segment

Basic Operational Analysis

|             |   |
|-------------|---|
| Project     | CSUMB Master Plan EIR                                 |
| Freeway     | Southbound State Route 1                              |
| Segment     | SR 1 between Reservation Road and Del Monte Boulevard |
| Alternative | Cuml w/ Eastside Pkwy w/ Proj                         |
| Time period | AM Peak Hour  |

Flow Inputs and Adjustments

|                                    |       |      |
|------------------------------------|-------|------|
| Volume, V                          | 3,550 | vph  |
| Peak-hour factor, PHF              | 0.76  |      |
| Peak 15-min volume, $v_{15}$       | 1,168 | veh  |
| Trucks and buses                   | 4.7%  |      |
| Recreational vehicles              | 0.0%  |      |
| Terrain type                       | Level |      |
| Grade                              |       |      |
| Length                             |       | mi   |
| Trucks and buses PCE, $E_T$        | 1.5   |      |
| Recreational vehicle PCE, $E_R$    | 1.2   |      |
| Heavy vehicle adjustment, $f_{HV}$ | 0.977 |      |
| Driver population factor, $f_P$    | 1.00  |      |
| Flow rate, $v_p$                   | 4,780 | pcph |
| Number of lanes, N                 | 2     |      |

Speed Inputs and Adjustments

|  |      |          |
|--|------|----------|
| Lane width                             | 12.0 | ft       |
| Right-side lateral clearance           | >6   | ft       |
| Total ramp density, TRD                | 1.00 | ramps/mi |
| Lane width adjustment, $f_{LW}$        | 0.0  | mph      |
| Lateral clearance adjustment, $f_{LC}$ | 0.0  | mph      |
| TRD adjustment                         | 3.2  | mph      |
| Calculated free-flow speed, FFS        | 72.2 | mph      |
| Measured free-flow speed, FFS          | 65.0 | mph      |
| Free-flow speed curve                  | 65   | mph      |

Capacity Checks for Segments with Ramps

|                         | <u>Actual</u> |      | <u>Maximum</u> |      | <u>Violation?</u> |
|-------------------------|---------------|------|----------------|------|-------------------|
| Entering freeway volume |               | pcph |                | pcph |                   |
| Exiting freeway volume  |               | pcph |                | pcph |                   |
| On-ramp volume          |               | pcph |                | pcph |                   |
| Off-ramp volume         |               | pcph |                | pcph |                   |

LOS and Performance Measures

|                                |       |        |
|--------------------------------|-------|--------|
| Flow rate, $v_p$               | 2,390 | pcphpl |
| Average passenger-car speed, S | -     | mph    |
| Volume-to-capacity ratio, v/c  | 1.02  |        |
| Density, D                     | -     | pcpmpl |
| Level of service, LOS          | F     |        |

HCM 2010: Freeway Basic Segment

Basic Operational Analysis

|             |   |
|-------------|---|
| Project     | CSUMB Master Plan EIR                                 |
| Freeway     | Southbound SR 1                                       |
| Segment     | SR 1 between Reservation Road and Del Monte Boulevard |
| Alternative | Cuml w/ Eastside Pkwy w/ Proj                         |
| Time period | PM Peak Hour  |

Flow Inputs and Adjustments

|                                    |       |      |
|------------------------------------|-------|------|
| Volume, V                          | 1,890 | vph  |
| Peak-hour factor, PHF              | 0.97  |      |
| Peak 15-min volume, $v_{15}$       | 487   | veh  |
| Trucks and buses                   | 1.0%  |      |
| Recreational vehicles              | 0.0%  |      |
| Terrain type                       | Level |      |
| Grade                              |       |      |
| Length                             |       | mi   |
| Trucks and buses PCE, $E_T$        | 1.5   |      |
| Recreational vehicle PCE, $E_R$    | 1.2   |      |
| Heavy vehicle adjustment, $f_{HV}$ | 0.995 |      |
| Driver population factor, $f_p$    | 1.00  |      |
| Flow rate, $v_p$                   | 1,958 | pcph |
| Number of lanes, N                 | 2     |      |

Speed Inputs and Adjustments

|  |      |          |
|--|------|----------|
| Lane width                             | 12.0 | ft       |
| Right-side lateral clearance           | >6   | ft       |
| Total ramp density, TRD                | 1.00 | ramps/mi |
| Lane width adjustment, $f_{LW}$        | 0.0  | mph      |
| Lateral clearance adjustment, $f_{LC}$ | 0.0  | mph      |
| TRD adjustment                         | 3.2  | mph      |
| Calculated free-flow speed, FFS        | 72.2 | mph      |
| Measured free-flow speed, FFS          | 65.0 | mph      |
| Free-flow speed curve                  | 65   | mph      |

Capacity Checks for Segments with Ramps

|                         | <u>Actual</u> |      | <u>Maximum</u> |      | <u>Violation?</u> |
|-------------------------|---------------|------|----------------|------|-------------------|
| Entering freeway volume |               | pcph |                | pcph |                   |
| Exiting freeway volume  |               | pcph |                | pcph |                   |
| On-ramp volume          |               | pcph |                | pcph |                   |
| Off-ramp volume         |               | pcph |                | pcph |                   |

LOS and Performance Measures

|                                |      |        |
|--------------------------------|------|--------|
| Flow rate, $v_p$               | 979  | pcphpl |
| Average passenger-car speed, S | 65.0 | mph    |
| Volume-to-capacity ratio, v/c  | 0.42 |        |
| Density, D                     | 15.1 | pcpmpl |
| Level of service, LOS          | B    |        |

HCM 2010: Freeway Basic Segment

Basic Operational Analysis

|             |  |
|-------------|--|
| Project     | CSUMB Master Plan EIR                              |
| Freeway     | Southbound State Route 1                           |
| Segment     | SR 1 between Del Monte Boulevard and Imjin Parkway |
| Alternative | Cuml w/ Eastside Pkwy w/ Proj                      |
| Time period | AM Peak Hour                                       |

Flow Inputs and Adjustments

|                                    |       |      |
|------------------------------------|-------|------|
| Volume, V                          | 5,150 | vph  |
| Peak-hour factor, PHF              | 0.81  |      |
| Peak 15-min volume, $v_{15}$       | 1,590 | veh  |
| Trucks and buses                   | 3.9%  |      |
| Recreational vehicles              | 0.0%  |      |
| Terrain type                       | Level |      |
| Grade                              |       |      |
| Length                             |       | mi   |
| Trucks and buses PCE, $E_T$        | 1.5   |      |
| Recreational vehicle PCE, $E_R$    | 1.2   |      |
| Heavy vehicle adjustment, $f_{HV}$ | 0.981 |      |
| Driver population factor, $f_p$    | 1.00  |      |
| Flow rate, $v_p$                   | 6,482 | pcph |
| Number of lanes, N                 | 3     |      |

Speed Inputs and Adjustments

|  |      |          |
|--|------|----------|
| Lane width                             | 12.0 | ft       |
| Right-side lateral clearance           | >6   | ft       |
| Total ramp density, TRD                | 1.17 | ramps/mi |
| Lane width adjustment, $f_{LW}$        | 0.0  | mph      |
| Lateral clearance adjustment, $f_{LC}$ | 0.0  | mph      |
| TRD adjustment                         | 3.7  | mph      |
| Calculated free-flow speed, FFS        | 71.7 | mph      |
| Measured free-flow speed, FFS          | 65.0 | mph      |
| Free-flow speed curve                  | 65   | mph      |

Capacity Checks for Segments with Ramps

|                         | <u>Actual</u> |      | <u>Maximum</u> |      | <u>Violation?</u> |
|-------------------------|---------------|------|----------------|------|-------------------|
| Entering freeway volume |               | pcph |                | pcph |                   |
| Exiting freeway volume  |               | pcph |                | pcph |                   |
| On-ramp volume          |               | pcph |                | pcph |                   |
| Off-ramp volume         |               | pcph |                | pcph |                   |

LOS and Performance Measures

|                                |       |        |
|--------------------------------|-------|--------|
| Flow rate, $v_p$               | 2,161 | pcphpl |
| Average passenger-car speed, S | 56.8  | mph    |
| Volume-to-capacity ratio, v/c  | 0.92  |        |
| Density, D                     | 38.0  | pcpmpl |
| Level of service, LOS          | E     |        |



HCM 2010: Freeway Basic Segment

Basic Operational Analysis

|             |  |
|-------------|--|
| Project     | CSUMB Master Plan EIR                              |
| Freeway     | Southbound SR 1                                    |
| Segment     | SR 1 between Del Monte Boulevard and Imjin Parkway |
| Alternative | Cuml w/ Eastside Pkwy w/ Proj                      |
| Time period | PM Peak Hour                                       |

Flow Inputs and Adjustments

|                                    |       |      |
|------------------------------------|-------|------|
| Volume, V                          | 2,940 | vph  |
| Peak-hour factor, PHF              | 0.95  |      |
| Peak 15-min volume, $v_{15}$       | 774   | veh  |
| Trucks and buses                   | 1.4%  |      |
| Recreational vehicles              | 0.0%  |      |
| Terrain type                       | Level |      |
| Grade                              |       |      |
| Length                             |       | mi   |
| Trucks and buses PCE, $E_T$        | 1.5   |      |
| Recreational vehicle PCE, $E_R$    | 1.2   |      |
| Heavy vehicle adjustment, $f_{HV}$ | 0.993 |      |
| Driver population factor, $f_p$    | 1.00  |      |
| Flow rate, $v_p$                   | 3,116 | pcph |
| Number of lanes, N                 | 3     |      |

Speed Inputs and Adjustments

|  |      |          |
|--|------|----------|
| Lane width                             | 12.0 | ft       |
| Right-side lateral clearance           | >6   | ft       |
| Total ramp density, TRD                | 1.17 | ramps/mi |
| Lane width adjustment, $f_{LW}$        | 0.0  | mph      |
| Lateral clearance adjustment, $f_{LC}$ | 0.0  | mph      |
| TRD adjustment                         | 3.7  | mph      |
| Calculated free-flow speed, FFS        | 71.7 | mph      |
| Measured free-flow speed, FFS          | 65.0 | mph      |
| Free-flow speed curve                  | 65   | mph      |

Capacity Checks for Segments with Ramps

|                         | <u>Actual</u> |      | <u>Maximum</u> |      | <u>Violation?</u> |
|-------------------------|---------------|------|----------------|------|-------------------|
| Entering freeway volume |               | pcph |                | pcph |                   |
| Exiting freeway volume  |               | pcph |                | pcph |                   |
| On-ramp volume          |               | pcph |                | pcph |                   |
| Off-ramp volume         |               | pcph |                | pcph |                   |

LOS and Performance Measures

|                                |       |        |
|--------------------------------|-------|--------|
| Flow rate, $v_p$               | 1,039 | pcphpl |
| Average passenger-car speed, S | 65.0  | mph    |
| Volume-to-capacity ratio, v/c  | 0.44  |        |
| Density, D                     | 16.0  | pcpmpl |
| Level of service, LOS          | B     |        |

HCM 2010: Freeway Basic Segment

Basic Operational Analysis

|             |   |
|-------------|---|
| Project     | CSUMB Master Plan EIR                             |
| Freeway     | Southbound State Route 1                          |
| Segment     | SR 1 between Imjin Parkway and Lightfighter Drive |
| Alternative | Cuml w/ Eastside Pkwy w/ Proj                     |
| Time period | AM Peak Hour                                      |

Flow Inputs and Adjustments

|                                    |       |      |
|------------------------------------|-------|------|
| Volume, V                          | 5,090 | vph  |
| Peak-hour factor, PHF              | 0.83  |      |
| Peak 15-min volume, $v_{15}$       | 1,533 | veh  |
| Trucks and buses                   | 3.5%  |      |
| Recreational vehicles              | 0.0%  |      |
| Terrain type                       | Level |      |
| Grade                              |       |      |
| Length                             |       | mi   |
| Trucks and buses PCE, $E_T$        | 1.5   |      |
| Recreational vehicle PCE, $E_R$    | 1.2   |      |
| Heavy vehicle adjustment, $f_{HV}$ | 0.983 |      |
| Driver population factor, $f_p$    | 1.00  |      |
| Flow rate, $v_p$                   | 6,241 | pcph |
| Number of lanes, N                 | 3     |      |

Speed Inputs and Adjustments

|  |      |          |
|--|------|----------|
| Lane width                             | 12.0 | ft       |
| Right-side lateral clearance           | >6   | ft       |
| Total ramp density, TRD                | 1.17 | ramps/mi |
| Lane width adjustment, $f_{LW}$        | 0.0  | mph      |
| Lateral clearance adjustment, $f_{LC}$ | 0.0  | mph      |
| TRD adjustment                         | 3.7  | mph      |
| Calculated free-flow speed, FFS        | 71.7 | mph      |
| Measured free-flow speed, FFS          | 65.0 | mph      |
| Free-flow speed curve                  | 65   | mph      |

Capacity Checks for Segments with Ramps

|                         | <u>Actual</u> |      | <u>Maximum</u> |      | <u>Violation?</u> |
|-------------------------|---------------|------|----------------|------|-------------------|
| Entering freeway volume |               | pcph |                | pcph |                   |
| Exiting freeway volume  |               | pcph |                | pcph |                   |
| On-ramp volume          |               | pcph |                | pcph |                   |
| Off-ramp volume         |               | pcph |                | pcph |                   |

LOS and Performance Measures

|                                |       |        |
|--------------------------------|-------|--------|
| Flow rate, $v_p$               | 2,080 | pcphpl |
| Average passenger-car speed, S | 58.4  | mph    |
| Volume-to-capacity ratio, v/c  | 0.89  |        |
| Density, D                     | 35.6  | pcpmpl |
| Level of service, LOS          | E     |        |

HCM 2010: Freeway Basic Segment

Basic Operational Analysis

|             |   |
|-------------|---|
| Project     | CSUMB Master Plan EIR                             |
| Freeway     | Southbound SR 1                                   |
| Segment     | SR 1 between Imjin Parkway and Lightfighter Drive |
| Alternative | Cuml w/ Eastside Pkwy w/ Proj                     |
| Time period | PM Peak Hour                                      |

Flow Inputs and Adjustments

|                                    |       |      |
|------------------------------------|-------|------|
| Volume, V                          | 3,340 | vph  |
| Peak-hour factor, PHF              | 0.95  |      |
| Peak 15-min volume, $v_{15}$       | 879   | veh  |
| Trucks and buses                   | 1.3%  |      |
| Recreational vehicles              | 0.0%  |      |
| Terrain type                       | Level |      |
| Grade                              |       |      |
| Length                             |       | mi   |
| Trucks and buses PCE, $E_T$        | 1.5   |      |
| Recreational vehicle PCE, $E_R$    | 1.2   |      |
| Heavy vehicle adjustment, $f_{HV}$ | 0.994 |      |
| Driver population factor, $f_p$    | 1.00  |      |
| Flow rate, $v_p$                   | 3,538 | pcph |
| Number of lanes, N                 | 3     |      |

Speed Inputs and Adjustments

|  |      |          |
|--|------|----------|
| Lane width                             | 12.0 | ft       |
| Right-side lateral clearance           | >6   | ft       |
| Total ramp density, TRD                | 1.17 | ramps/mi |
| Lane width adjustment, $f_{LW}$        | 0.0  | mph      |
| Lateral clearance adjustment, $f_{LC}$ | 0.0  | mph      |
| TRD adjustment                         | 3.7  | mph      |
| Calculated free-flow speed, FFS        | 71.7 | mph      |
| Measured free-flow speed, FFS          | 65.0 | mph      |
| Free-flow speed curve                  | 65   | mph      |

Capacity Checks for Segments with Ramps

|                         | <u>Actual</u> |      | <u>Maximum</u> |      | <u>Violation?</u> |
|-------------------------|---------------|------|----------------|------|-------------------|
| Entering freeway volume |               | pcph |                | pcph |                   |
| Exiting freeway volume  |               | pcph |                | pcph |                   |
| On-ramp volume          |               | pcph |                | pcph |                   |
| Off-ramp volume         |               | pcph |                | pcph |                   |

LOS and Performance Measures

|                                |       |        |
|--------------------------------|-------|--------|
| Flow rate, $v_p$               | 1,179 | pcphpl |
| Average passenger-car speed, S | 65.0  | mph    |
| Volume-to-capacity ratio, v/c  | 0.50  |        |
| Density, D                     | 18.1  | pcpmpl |
| Level of service, LOS          | C     |        |

HCM 2010: Freeway Basic Segment

Basic Operational Analysis

|             |   |
|-------------|---|
| Project     | CSUMB Master Plan EIR                                   |
| Freeway     | Southbound State Route 1                                |
| Segment     | SR 1 between Lightfighter Drive and Del Monte Boulevard |
| Alternative | Cuml w/ Eastside Pkwy w/ Proj                           |
| Time period | AM Peak Hour  |

Flow Inputs and Adjustments

|                                    |       |      |
|------------------------------------|-------|------|
| Volume, V                          | 5,580 | vph  |
| Peak-hour factor, PHF              | 0.86  |      |
| Peak 15-min volume, $v_{15}$       | 1,622 | veh  |
| Trucks and buses                   | 3.2%  |      |
| Recreational vehicles              | 0.0%  |      |
| Terrain type                       | Level |      |
| Grade                              |       |      |
| Length                             |       | mi   |
| Trucks and buses PCE, $E_T$        | 1.5   |      |
| Recreational vehicle PCE, $E_R$    | 1.2   |      |
| Heavy vehicle adjustment, $f_{HV}$ | 0.984 |      |
| Driver population factor, $f_p$    | 1.00  |      |
| Flow rate, $v_p$                   | 6,592 | pcph |
| Number of lanes, N                 | 3     |      |

Speed Inputs and Adjustments

|  |      |          |
|--|------|----------|
| Lane width                             | 12.0 | ft       |
| Right-side lateral clearance           | >6   | ft       |
| Total ramp density, TRD                | 1.33 | ramps/mi |
| Lane width adjustment, $f_{LW}$        | 0.0  | mph      |
| Lateral clearance adjustment, $f_{LC}$ | 0.0  | mph      |
| TRD adjustment                         | 4.1  | mph      |
| Calculated free-flow speed, FFS        | 71.3 | mph      |
| Measured free-flow speed, FFS          | 65.0 | mph      |
| Free-flow speed curve                  | 65   | mph      |

Capacity Checks for Segments with Ramps

|                         | <u>Actual</u> |      | <u>Maximum</u> |      | <u>Violation?</u> |
|-------------------------|---------------|------|----------------|------|-------------------|
| Entering freeway volume |               | pcph |                | pcph |                   |
| Exiting freeway volume  |               | pcph |                | pcph |                   |
| On-ramp volume          |               | pcph |                | pcph |                   |
| Off-ramp volume         |               | pcph |                | pcph |                   |

LOS and Performance Measures

|                                |       |        |
|--------------------------------|-------|--------|
| Flow rate, $v_p$               | 2,197 | pcphpl |
| Average passenger-car speed, S | 56.0  | mph    |
| Volume-to-capacity ratio, v/c  | 0.94  |        |
| Density, D                     | 39.3  | pcpmpl |
| Level of service, LOS          | E     |        |

HCM 2010: Freeway Basic Segment

Basic Operational Analysis

|             |   |
|-------------|---|
| Project     | CSUMB Master Plan EIR                                   |
| Freeway     | Southbound SR 1   |
| Segment     | SR 1 between Lightfighter Drive and Del Monte Boulevard |
| Alternative | Cuml w/ Eastside Pkwy w/ Proj                           |
| Time period | PM Peak Hour  |

Flow Inputs and Adjustments

|                                    |       |      |
|------------------------------------|-------|------|
| Volume, V                          | 4,030 | vph  |
| Peak-hour factor, PHF              | 0.97  |      |
| Peak 15-min volume, $v_{15}$       | 1,039 | veh  |
| Trucks and buses                   | 1.1%  |      |
| Recreational vehicles              | 0.0%  |      |
| Terrain type                       | Level |      |
| Grade                              |       |      |
| Length                             |       | mi   |
| Trucks and buses PCE, $E_T$        | 1.5   |      |
| Recreational vehicle PCE, $E_R$    | 1.2   |      |
| Heavy vehicle adjustment, $f_{HV}$ | 0.994 |      |
| Driver population factor, $f_p$    | 1.00  |      |
| Flow rate, $v_p$                   | 4,178 | pcph |
| Number of lanes, N                 | 3     |      |

Speed Inputs and Adjustments

|  |      |          |
|--|------|----------|
| Lane width                             | 12.0 | ft       |
| Right-side lateral clearance           | >6   | ft       |
| Total ramp density, TRD                | 1.33 | ramps/mi |
| Lane width adjustment, $f_{LW}$        | 0.0  | mph      |
| Lateral clearance adjustment, $f_{LC}$ | 0.0  | mph      |
| TRD adjustment                         | 4.1  | mph      |
| Calculated free-flow speed, FFS        | 71.3 | mph      |
| Measured free-flow speed, FFS          | 65.0 | mph      |
| Free-flow speed curve                  | 65   | mph      |

Capacity Checks for Segments with Ramps

|                         | <u>Actual</u> |      | <u>Maximum</u> |      | <u>Violation?</u> |
|-------------------------|---------------|------|----------------|------|-------------------|
| Entering freeway volume |               | pcph |                | pcph |                   |
| Exiting freeway volume  |               | pcph |                | pcph |                   |
| On-ramp volume          |               | pcph |                | pcph |                   |
| Off-ramp volume         |               | pcph |                | pcph |                   |

LOS and Performance Measures

|                                |       |        |
|--------------------------------|-------|--------|
| Flow rate, $v_p$               | 1,393 | pcphpl |
| Average passenger-car speed, S | 65.0  | mph    |
| Volume-to-capacity ratio, v/c  | 0.59  |        |
| Density, D                     | 21.4  | pcpmpl |
| Level of service, LOS          | C     |        |

HCM 2010: Freeway Basic Segment

Basic Operational Analysis

|             |   |
|-------------|---|
| Project     | CSUMB Master Plan EIR   |
| Freeway     | Southbound State Route 1                                      |
| Segment     | SR 1 between Del Monte Boulevard and Canyon Del Rey Boulevard |
| Alternative | Cuml w/ Eastside Pkwy w/ Proj                                 |
| Time period | AM Peak Hour  |

Flow Inputs and Adjustments

|                                    |       |      |
|------------------------------------|-------|------|
| Volume, V                          | 4,600 | vph  |
| Peak-hour factor, PHF              | 0.95  |      |
| Peak 15-min volume, $v_{15}$       | 1,211 | veh  |
| Trucks and buses                   | 2.4%  |      |
| Recreational vehicles              | 0.0%  |      |
| Terrain type                       | Level |      |
| Grade                              |       |      |
| Length                             |       | mi   |
| Trucks and buses PCE, $E_T$        | 1.5   |      |
| Recreational vehicle PCE, $E_R$    | 1.2   |      |
| Heavy vehicle adjustment, $f_{HV}$ | 0.988 |      |
| Driver population factor, $f_p$    | 1.00  |      |
| Flow rate, $v_p$                   | 4,901 | pcph |
| Number of lanes, N                 | 2     |      |

Speed Inputs and Adjustments

|  |      |          |
|--|------|----------|
| Lane width                             | 12.0 | ft       |
| Right-side lateral clearance           | 5.0  | ft       |
| Total ramp density, TRD                | 2.17 | ramps/mi |
| Lane width adjustment, $f_{LW}$        | 0.0  | mph      |
| Lateral clearance adjustment, $f_{LC}$ | 0.6  | mph      |
| TRD adjustment                         | 6.2  | mph      |
| Calculated free-flow speed, FFS        | 68.6 | mph      |
| Measured free-flow speed, FFS          | 65.0 | mph      |
| Free-flow speed curve                  | 65   | mph      |

Capacity Checks for Segments with Ramps

|                         | <u>Actual</u> |      | <u>Maximum</u> |      | <u>Violation?</u> |
|-------------------------|---------------|------|----------------|------|-------------------|
| Entering freeway volume |               | pcph |                | pcph |                   |
| Exiting freeway volume  |               | pcph |                | pcph |                   |
| On-ramp volume          |               | pcph |                | pcph |                   |
| Off-ramp volume         |               | pcph |                | pcph |                   |

LOS and Performance Measures

|                                 |       |        |
|---------------------------------|-------|--------|
| Flow rate, $v_p$                | 2,451 | pcphpl |
| Average passenger-car speed, S  | -     | mph    |
| Volume-to-capacity ratio, $v/c$ | 1.04  |        |
| Density, D                      | -     | pcpmpl |
| Level of service, LOS           | F     |        |

HCM 2010: Freeway Basic Segment

Basic Operational Analysis

|             |   |
|-------------|---|
| Project     | CSUMB Master Plan EIR   |
| Freeway     | Southbound SR 1   |
| Segment     | SR 1 between Del Monte Boulevard and Canyon Del Rey Boulevard |
| Alternative | Cuml w/ Eastside Pkwy w/ Proj                                 |
| Time period | PM Peak Hour  |

Flow Inputs and Adjustments

|                                    |       |      |
|------------------------------------|-------|------|
| Volume, V                          | 3,300 | vph  |
| Peak-hour factor, PHF              | 0.96  |      |
| Peak 15-min volume, $v_{15}$       | 859   | veh  |
| Trucks and buses                   | 1.0%  |      |
| Recreational vehicles              | 0.0%  |      |
| Terrain type                       | Level |      |
| Grade                              |       |      |
| Length                             |       | mi   |
| Trucks and buses PCE, $E_T$        | 1.5   |      |
| Recreational vehicle PCE, $E_R$    | 1.2   |      |
| Heavy vehicle adjustment, $f_{HV}$ | 0.995 |      |
| Driver population factor, $f_p$    | 1.00  |      |
| Flow rate, $v_p$                   | 3,455 | pcph |
| Number of lanes, N                 | 2     |      |

Speed Inputs and Adjustments

|  |      |          |
|--|------|----------|
| Lane width                             | 12.0 | ft       |
| Right-side lateral clearance           | 5.0  | ft       |
| Total ramp density, TRD                | 2.17 | ramps/mi |
| Lane width adjustment, $f_{LW}$        | 0.0  | mph      |
| Lateral clearance adjustment, $f_{LC}$ | 0.6  | mph      |
| TRD adjustment                         | 6.2  | mph      |
| Calculated free-flow speed, FFS        | 68.6 | mph      |
| Measured free-flow speed, FFS          | 65.0 | mph      |
| Free-flow speed curve                  | 65   | mph      |

Capacity Checks for Segments with Ramps

|                         | <u>Actual</u> |      | <u>Maximum</u> |      | <u>Violation?</u> |
|-------------------------|---------------|------|----------------|------|-------------------|
| Entering freeway volume |               | pcph |                | pcph |                   |
| Exiting freeway volume  |               | pcph |                | pcph |                   |
| On-ramp volume          |               | pcph |                | pcph |                   |
| Off-ramp volume         |               | pcph |                | pcph |                   |

LOS and Performance Measures

|                                |       |        |
|--------------------------------|-------|--------|
| Flow rate, $v_p$               | 1,727 | pcphpl |
| Average passenger-car speed, S | 63.5  | mph    |
| Volume-to-capacity ratio, v/c  | 0.74  |        |
| Density, D                     | 27.2  | pcpmpl |
| Level of service, LOS          | D     |        |

HCM 2010: Freeway Basic Segment

Basic Operational Analysis

|             |   |
|-------------|---|
| Project     | CSUMB Master Plan EIR   |
| Freeway     | Northbound State Route 1                                      |
| Segment     | SR 1 between Del Monte Boulevard and Canyon Del Rey Boulevard |
| Alternative | Cuml w/ Eastside Pkwy w/ Proj                                 |
| Time period | PM Peak Hour  |

Flow Inputs and Adjustments

|                                    |       |      |
|------------------------------------|-------|------|
| Volume, V                          | 4,420 | vph  |
| Peak-hour factor, PHF              | 0.97  |      |
| Peak 15-min volume, $v_{15}$       | 1,139 | veh  |
| Trucks and buses                   | 2.0%  |      |
| Recreational vehicles              | 0.0%  |      |
| Terrain type                       | Level |      |
| Grade                              |       |      |
| Length                             |       | mi   |
| Trucks and buses PCE, $E_T$        | 1.5   |      |
| Recreational vehicle PCE, $E_R$    | 1.2   |      |
| Heavy vehicle adjustment, $f_{HV}$ | 0.990 |      |
| Driver population factor, $f_p$    | 1.00  |      |
| Flow rate, $v_p$                   | 4,603 | pcph |
| Number of lanes, N                 | 2     |      |

Speed Inputs and Adjustments

|  |      |          |
|--|------|----------|
| Lane width                             | 12.0 | ft       |
| Right-side lateral clearance           | >6   | ft       |
| Total ramp density, TRD                | 2.00 | ramps/mi |
| Lane width adjustment, $f_{LW}$        | 0.0  | mph      |
| Lateral clearance adjustment, $f_{LC}$ | 0.0  | mph      |
| TRD adjustment                         | 5.8  | mph      |
| Calculated free-flow speed, FFS        | 69.6 | mph      |
| Measured free-flow speed, FFS          | 65.0 | mph      |
| Free-flow speed curve                  | 65   | mph      |

Capacity Checks for Segments with Ramps

|                         | <u>Actual</u> |      | <u>Maximum</u> |      | <u>Violation?</u> |
|-------------------------|---------------|------|----------------|------|-------------------|
| Entering freeway volume |               | pcph |                | pcph |                   |
| Exiting freeway volume  |               | pcph |                | pcph |                   |
| On-ramp volume          |               | pcph |                | pcph |                   |
| Off-ramp volume         |               | pcph |                | pcph |                   |

LOS and Performance Measures

|                                |       |        |
|--------------------------------|-------|--------|
| Flow rate, $v_p$               | 2,301 | pcphpl |
| Average passenger-car speed, S | 53.5  | mph    |
| Volume-to-capacity ratio, v/c  | 0.98  |        |
| Density, D                     | 43.0  | pcpmpl |
| Level of service, LOS          | E     |        |



## **APPENDIX N: INTERSECTION SIGNAL WARRANT ANALYSIS**



Signal warrant sheets have been added to the report since November 2021

**Table N-1: PEAK HOUR SIGNAL WARRANT SUMMARY**

|           | Intersection  | Peak Hour <sup>1</sup> | Existing with Project Conditions <sup>3</sup> | Signal Warrant Met <sup>2</sup>                |  |
|-----------|---|------------------------|---|--|--|
|           |   |                        |   | Year 2035 Cumulative with Project <sup>3</sup> | Year 2035 Cumulative with Project with Eastside Parkway <sup>3</sup> |
| <b>4</b>  | SR 1 Northbound Ramps and Imjin Parkway                     | AM                     | No  | No   | No   |
|           |   | PM                     | No  | No   | No   |
| <b>6</b>  | Third Avenue and Imjin Parkway                              | AM                     | No  | N/A  | N/A  |
|           |   | PM                     | No  | N/A  | N/A  |
| <b>7</b>  | Fourth Avenue and Imjin Parkway                             | AM                     | No  | N/A  | N/A  |
|           |   | PM                     | No  | N/A  | N/A  |
| <b>15</b> | Second Avenue and Ninth Street                              | AM                     | No  | Signalized                                     | Signalized   |
|           |   | PM                     | No  |  |  |
| <b>16</b> | Second Avenue and Eighth Street                             | AM                     | <b>Yes</b>                                    | Signalized                                     | Signalized   |
|           |   | PM                     | <b>Yes</b>                                    |  |  |
| <b>19</b> | Second Avenue and Inter-Garrison Road                       | AM                     | No  | Signalized                                     | Signalized   |
|           |   | PM                     | No  |  |  |
| <b>21</b> | <u>Eighth Street/Seventh Avenue and Inter-Garrison Road</u> | <u>AM</u>              | <u>No</u>                                     | <u>Signalized</u>                              | <u>Signalized</u>  |
|           |   | <u>PM</u>              | <u>Yes</u>                                    |  |  |
| <b>22</b> | Eighth Avenue and Inter-Garrison Road                       | AM                     | <b>Yes</b>                                    | <b>Yes</b>                                     | <b>Yes</b>   |
|           |   | PM                     | <b>Yes</b>                                    | <b>Yes</b>                                     | <b>Yes</b>   |
| <b>23</b> | Abrams Drive and Inter-Garrison Road                        | AM                     | <b>Yes</b>                                    | Signalized                                     | Signalized   |
|           |   | PM                     | <b>Yes</b>                                    |  |  |
| <b>24</b> | Schoonover Road and Inter-Garrison Road                     | AM                     | No  | No   | Signalized   |
|           |   | PM                     | No  | No   |  |
| <b>25</b> | Inter-Garrison Road Connection and Inter-Garrison Road      | AM                     | N/A   | <b>Yes</b>                                     | <b>Yes</b>   |
|           |   | PM                     | N/A   | <b>Yes</b>                                     | <b>Yes</b>   |
| <b>29</b> | Second Avenue and Divarty Street                            | AM                     | No  | Signalized                                     | Signalized   |
|           |   | PM                     | <b>Yes</b>                                    |  |  |
| <b>37</b> | Seventh Avenue and Colonel Durham Street                    | AM                     | N/A   | No   | N/A  |
|           |   | PM                     | N/A   | No   | N/A  |
| <b>38</b> | Eight Avenue and Colonel Durham Street                      | AM                     | N/A   | No   | N/A  |
|           |   | PM                     | N/A   | No   | N/A  |
| <b>40</b> | Malmedy road and Gigling Road                               | AM                     | No  | Signalized                                     | Signalized   |
|           |   | PM                     | No  |  |  |
| <b>41</b> | Parker Flatts Cut Off Road and Gigling Road                 | AM                     | No  | Signalized                                     | Signalized   |
|           |   | PM                     | No  |  |  |
| <b>42</b> | Sixth Avenue and Gigling Road                               | AM                     | No  | Signalized                                     | Signalized   |
|           |   | PM                     | No  |  |  |
| <b>47</b> | General Jim Moore Boulevard and Coe Avenue                  | AM                     | <b>Yes</b>                                    | <b>Yes</b>                                     | Signalized   |
|           |   | PM                     | <b>Yes</b>                                    | <b>Yes</b>                                     |  |

Notes:

1. AM = morning peak hour, PM = evening peak hour.
2. California MUTCD Section 4C.04: Signal Warrant #3 – Peak Hour Warrant completed for unsignalized intersections.
3. "N/A" indicated intersections that did not have an LOS below its designated LOS threshold in the corresponding scenario. "Signalized" indicates that intersection improvement for the corresponding scenario was to signalize.

**Bold text** indicates unsignalized warrant is met.

Source: Fehr & Peers, 2019



Major Street Imjin Parkway  
 Minor Street SR 1 NB Off-Ramp/SR 1 NB On-Ramp

Project CSUMB Master Plan EIR  
 Scenario Existing Plus Project AM  
 Peak Hour AM

Turn Movement Volumes

|         | NB | SB | EB  | WB    |
|---------|----|----|-----|-------|
| Left    | 10 | 0  | 10  | 0     |
| Through | 10 | 0  | 530 | 900   |
| Right   | 0  | 0  | 0   | 180   |
| Total   | 20 | 0  | 540 | 1,080 |

Major Street Direction

|   |             |
|---|-------------|
|   | North/South |
| X | East/West   |

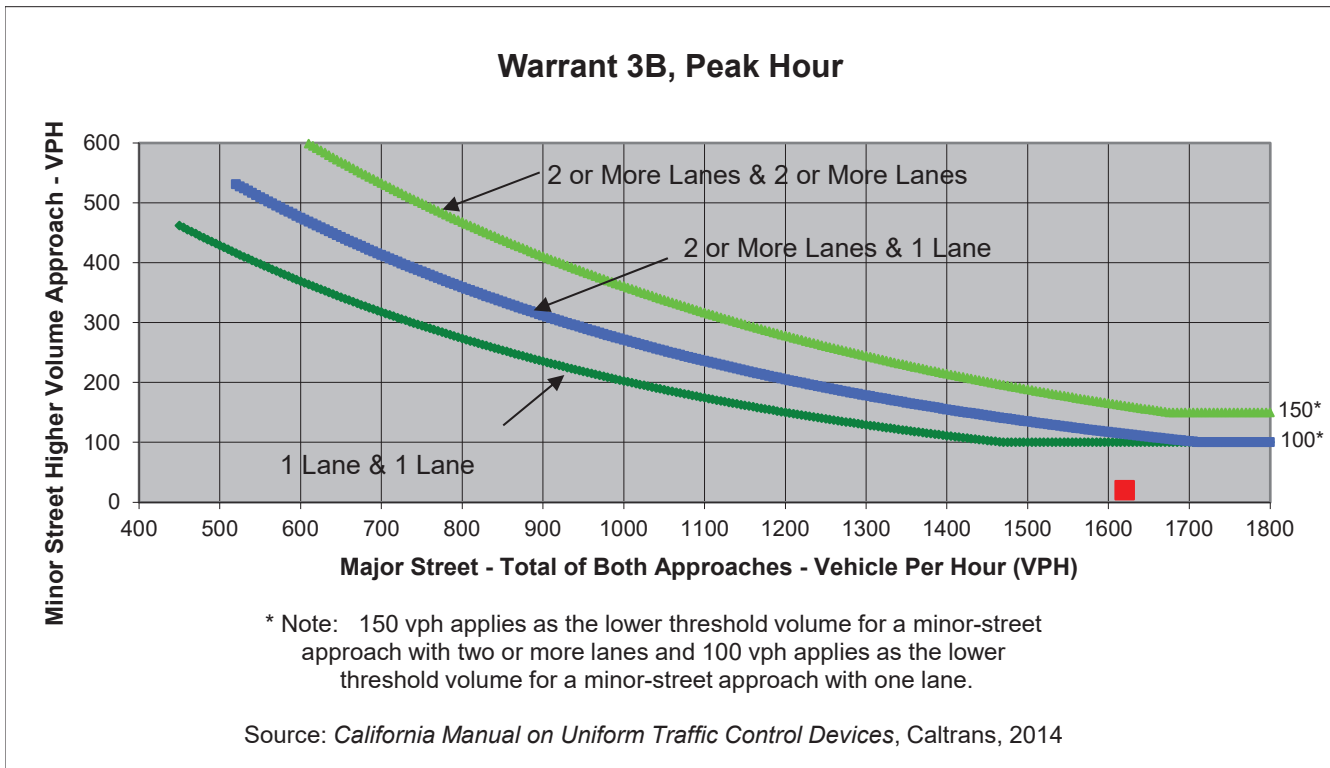

|                                 | Major Street  | Minor Street                     | Warrant Met      |
|---------------------------------|---------------|----------------------------------|------------------|
|                                 | Imjin Parkway | SR 1 NB Off-Ramp/SR 1 NB On-Ramp |                  |
| <b>Number of Approach Lanes</b> | <b>1</b>      | <b>1</b>                         | <b><u>NO</u></b> |
| <b>Traffic Volume (VPH) *</b>   | <b>1,620</b>  | <b>20</b>                        |                  |

\* Note: Traffic Volume for Major Street is Total Volume of Both Approches.  
 Traffic Volume for Minor Street is the Volume of High Volume Approach.



Major Street Imjin Parkway  
 Minor Street 3rd Avenue

Project CSUMB Master Plan EIR  
 Scenario Existing Plus Project AM  
 Peak Hour AM

Turn Movement Volumes

|         | NB | SB | EB  | WB    |
|---------|----|----|-----|-------|
| Left    | 10 | 10 | 50  | 240   |
| Through | 10 | 10 | 870 | 1,250 |
| Right   | 20 | 40 | 20  | 30    |
| Total   | 40 | 60 | 940 | 1,520 |

Major Street Direction

                     North/South  
          X           East/West

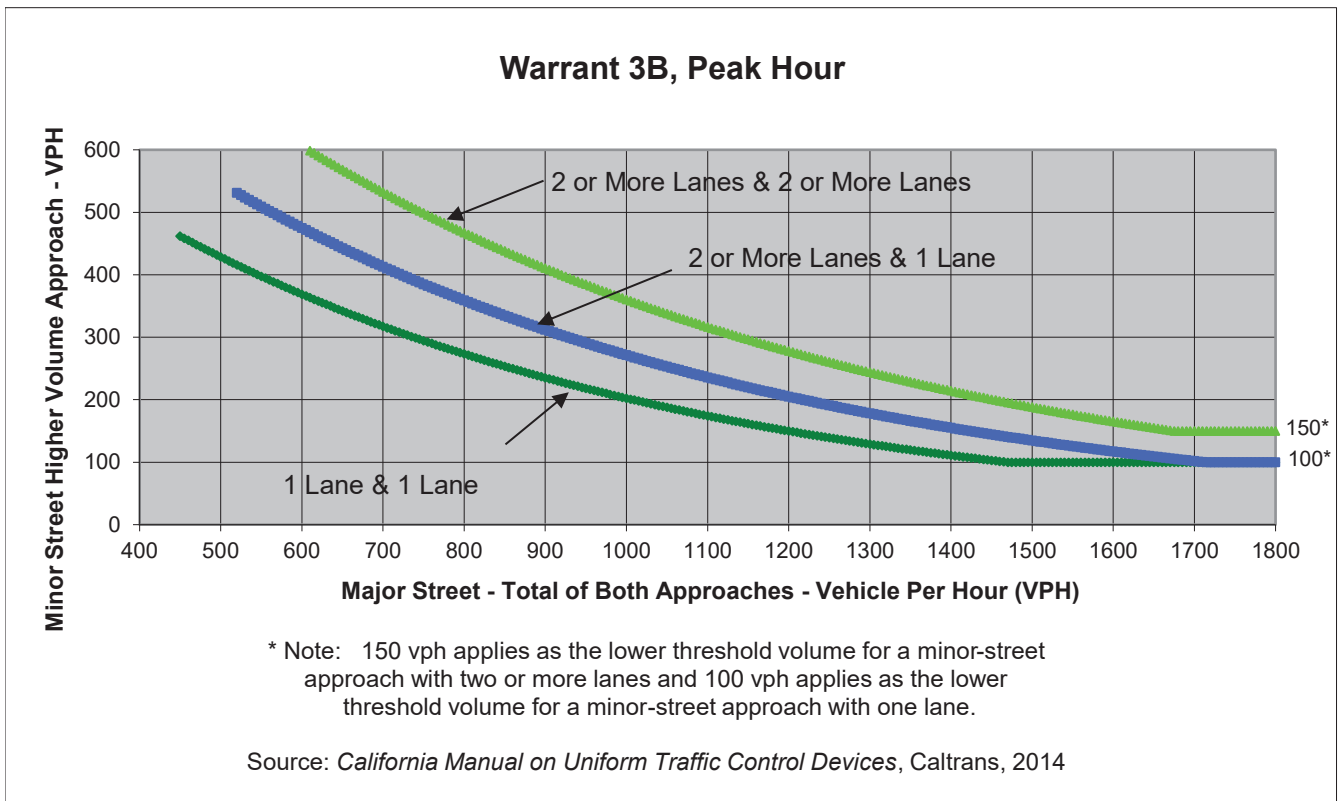

|                                 | Major Street  | Minor Street | Warrant Met |
|---------------------------------|---------------|--------------|-------------|
|                                 | Imjin Parkway | 3rd Avenue   |             |
| <b>Number of Approach Lanes</b> | <b>2</b>      | <b>1</b>     | <b>NO</b>   |
| <b>Traffic Volume (VPH) *</b>   | <b>2,460</b>  | <b>60</b>    |             |

\* Note: Traffic Volume for Major Street is Total Volume of Both Approaches.  
 Traffic Volume for Minor Street is the Volume of High Volume Approach.



Major Street Imjin Parkway  
 Minor Street 4th Avenue

Project CSUMB Master Plan EIR  
 Scenario Existing Plus Project AM  
 Peak Hour AM

Turn Movement Volumes

|         | NB | SB | EB  | WB    |
|---------|----|----|-----|-------|
| Left    | 10 | 10 | 10  | 10    |
| Through | 10 | 10 | 960 | 1,440 |
| Right   | 10 | 10 | 20  | 10    |
| Total   | 30 | 30 | 990 | 1,460 |

Major Street Direction

|   |             |
|---|-------------|
|   | North/South |
| X | East/West   |

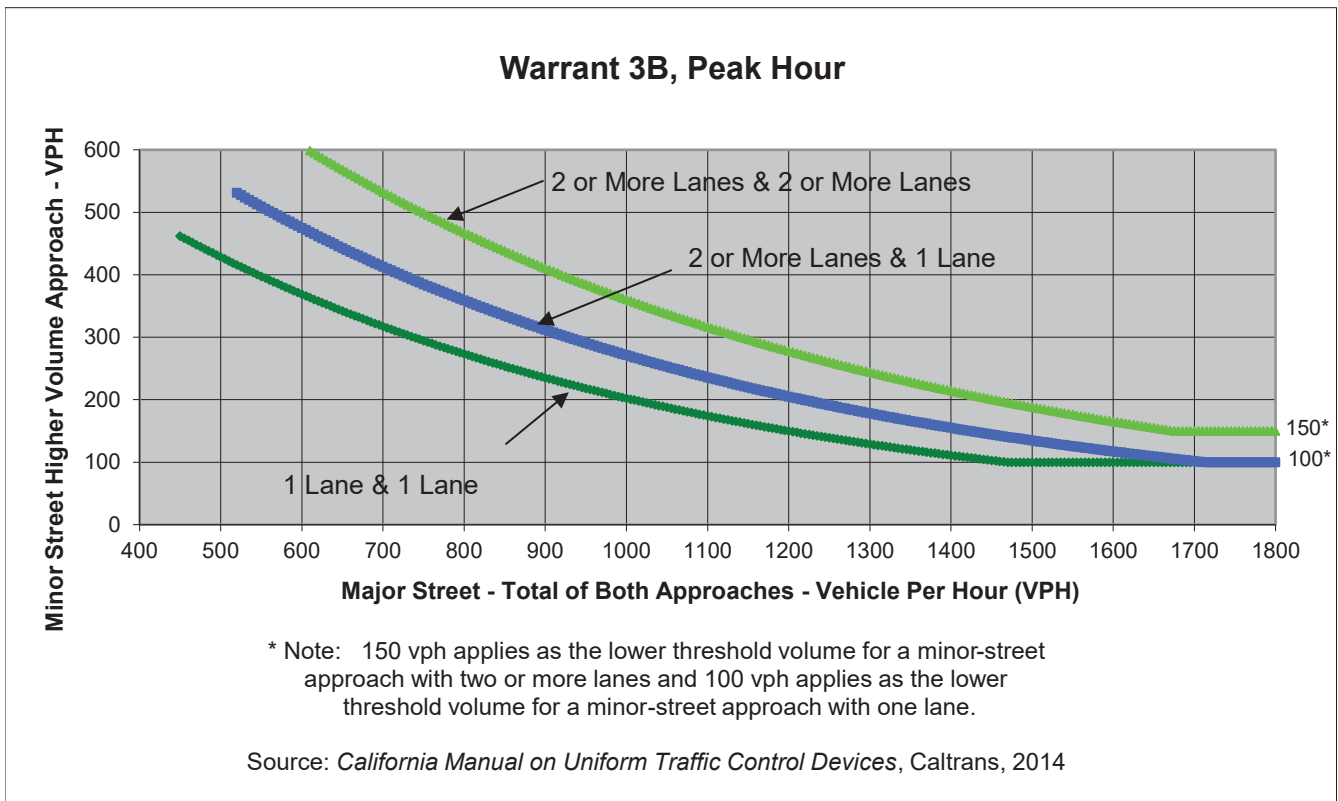

|                                 | Major Street  | Minor Street | Warrant Met      |
|---------------------------------|---------------|--------------|------------------|
|                                 | Imjin Parkway | 4th Avenue   |                  |
| <b>Number of Approach Lanes</b> | <b>2</b>      | <b>1</b>     | <b><u>NO</u></b> |
| <b>Traffic Volume (VPH) *</b>   | <b>2,450</b>  | <b>30</b>    |                  |

\* Note: Traffic Volume for Major Street is Total Volume of Both Approaches.  
 Traffic Volume for Minor Street is the Volume of High Volume Approach.



Major Street 2nd Avenue  
 Minor Street 9th Street

Project CSUMB Master Plan EIR  
 Scenario Existing Plus Project AM  
 Peak Hour AM

Turn Movement Volumes

|         | NB  | SB  | EB  | WB  |
|---------|-----|-----|-----|-----|
| Left    | 10  | 10  | 40  | 250 |
| Through | 140 | 520 | 10  | 10  |
| Right   | 10  | 30  | 50  | 10  |
| Total   | 160 | 560 | 100 | 270 |

Major Street Direction

|   |             |
|---|-------------|
| X | North/South |
|   | East/West   |

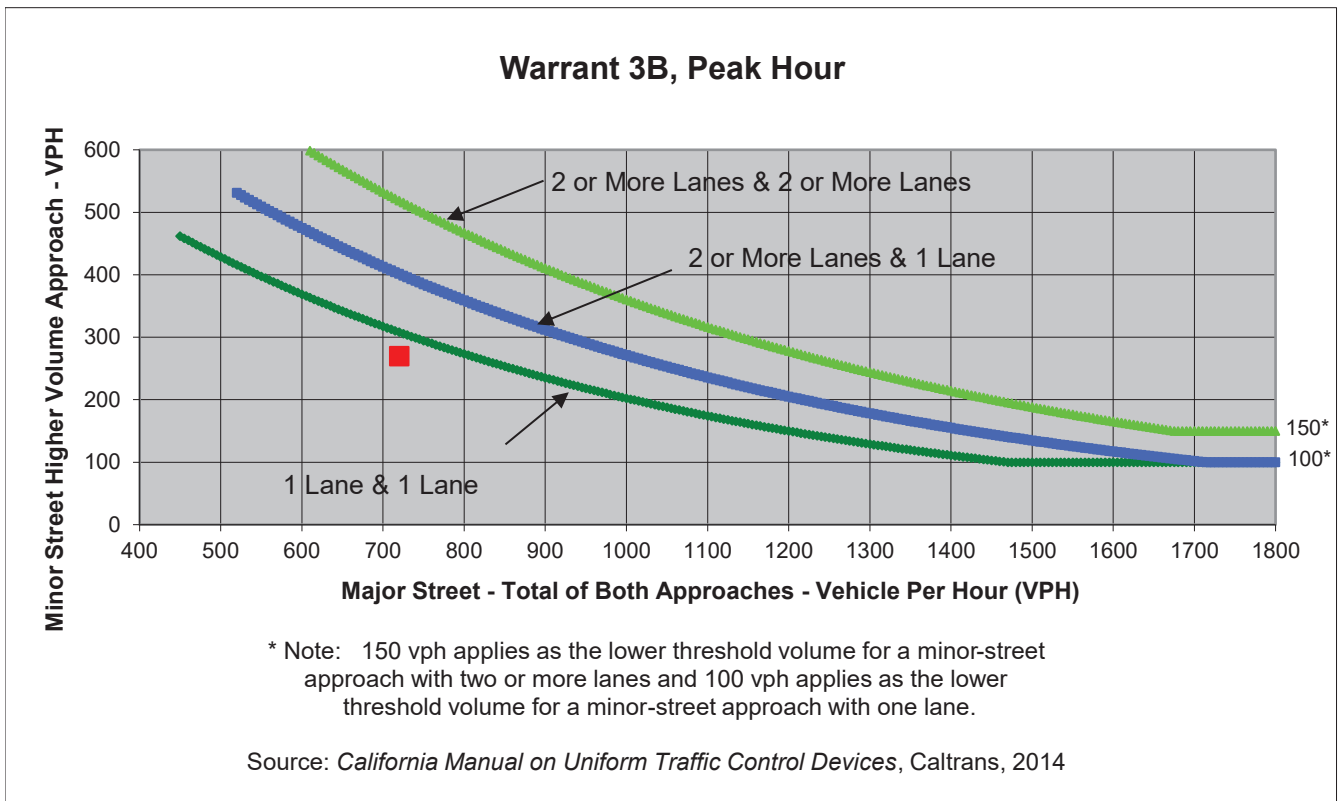

|                                 | Major Street | Minor Street | Warrant Met      |
|---------------------------------|--------------|--------------|------------------|
|                                 | 2nd Avenue   | 9th Street   |                  |
| <b>Number of Approach Lanes</b> | <b>1</b>     | <b>1</b>     | <b><u>NO</u></b> |
| <b>Traffic Volume (VPH) *</b>   | <b>720</b>   | <b>270</b>   |                  |

\* Note: Traffic Volume for Major Street is Total Volume of Both Approaches.  
 Traffic Volume for Minor Street is the Volume of High Volume Approach.



Major Street 2nd Avenue  
 Minor Street 8th Street

Project CSUMB Master Plan EIR  
 Scenario Existing Plus Project AM  
 Peak Hour AM

Turn Movement Volumes

|         | NB  | SB  | EB | WB  |
|---------|-----|-----|----|-----|
| Left    | 10  | 60  | 10 | 270 |
| Through | 210 | 770 | 10 | 10  |
| Right   | 130 | 10  | 10 | 30  |
| Total   | 350 | 840 | 30 | 310 |

Major Street Direction

|   |             |
|---|-------------|
| X | North/South |
|   | East/West   |

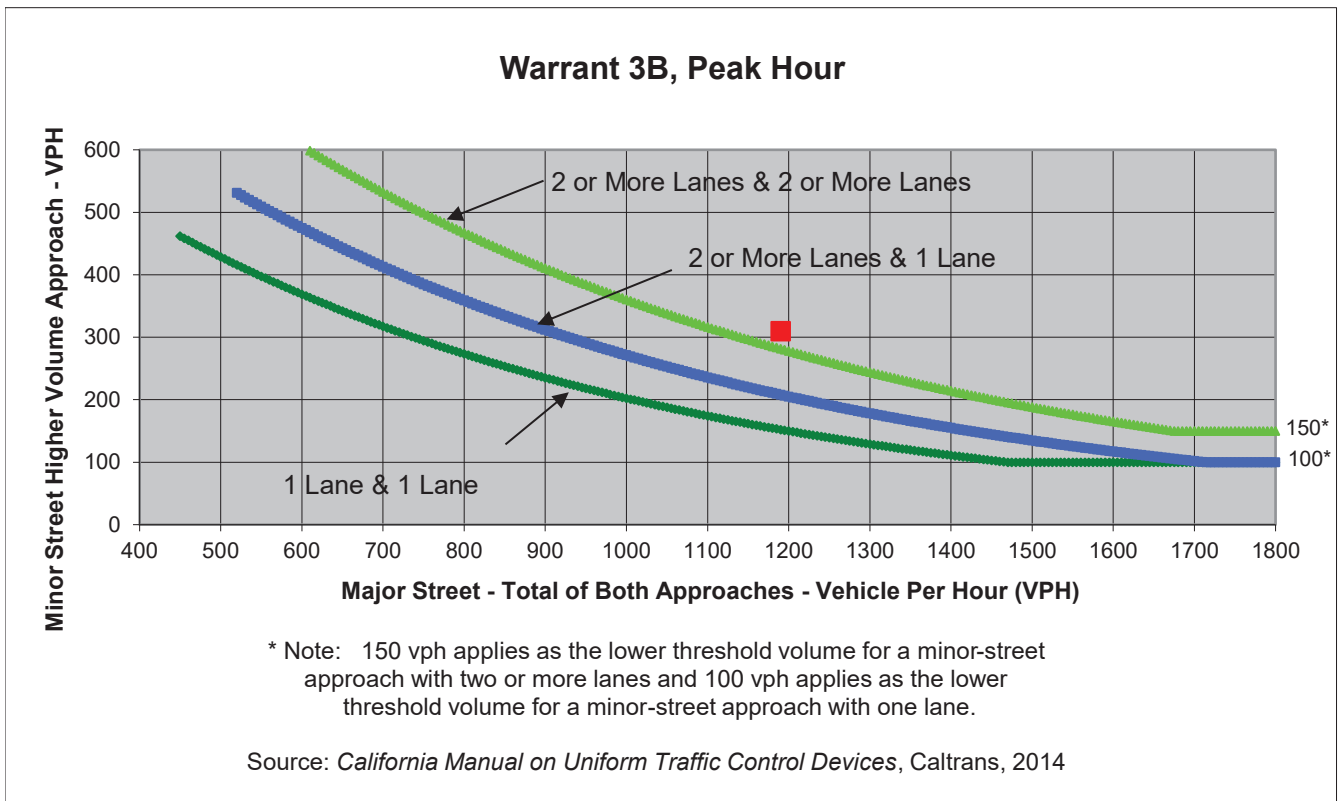

|                                 | Major Street | Minor Street | Warrant Met       |
|---------------------------------|--------------|--------------|-------------------|
|                                 | 2nd Avenue   | 8th Street   |                   |
| <b>Number of Approach Lanes</b> | <b>1</b>     | <b>1</b>     | <b><u>YES</u></b> |
| <b>Traffic Volume (VPH) *</b>   | <b>1,190</b> | <b>310</b>   |                   |

\* Note: Traffic Volume for Major Street is Total Volume of Both Approaches.  
 Traffic Volume for Minor Street is the Volume of High Volume Approach.

Major Street 2nd Avenue  
 Minor Street Inter-Garrison Road

Project CSUMB Master Plan EIR  
 Scenario Existing Plus Project AM  
 Peak Hour AM

Turn Movement Volumes

|         | NB  | SB    | EB | WB |
|---------|-----|-------|----|----|
| Left    | 0   | 10    | 0  | 30 |
| Through | 340 | 1,030 | 0  | 0  |
| Right   | 40  | 0     | 0  | 10 |
| Total   | 380 | 1,040 | 0  | 40 |

Major Street Direction

|   |             |
|---|-------------|
| X | North/South |
|   | East/West   |

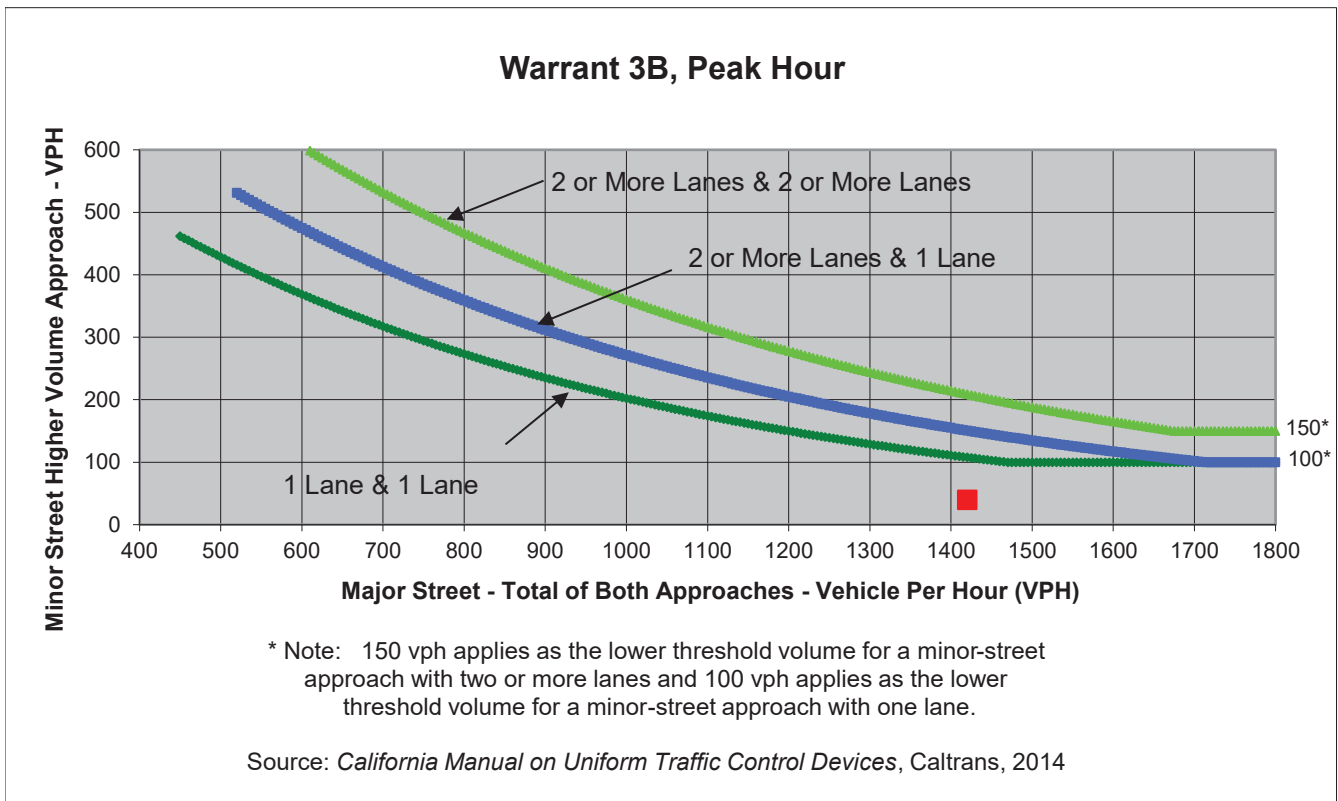

|                                 | Major Street | Minor Street        | Warrant Met      |
|---------------------------------|--------------|---------------------|------------------|
|                                 | 2nd Avenue   | Inter-Garrison Road |                  |
| <b>Number of Approach Lanes</b> | <b>1</b>     | <b>1</b>            | <b><u>NO</u></b> |
| <b>Traffic Volume (VPH) *</b>   | <b>1,420</b> | <b>40</b>           |                  |

\* Note: Traffic Volume for Major Street is Total Volume of Both Approaches.  
 Traffic Volume for Minor Street is the Volume of High Volume Approach.





Major Street **Inter-Garrison Road**  
 Minor Street **7th Avenue/8th Street**

Project **CSUMB Master Plan EIR**  
 Scenario **Existing Plus Project AM**  
 Peak Hour **AM**

Turn Movement Volumes

|         | NB  | SB  | EB | WB  |
|---------|-----|-----|----|-----|
| Left    | 30  | 170 | 10 | 310 |
| Through | 170 | 200 | 50 | 150 |
| Right   | 110 | 10  | 20 | 30  |
| Total   | 310 | 380 | 80 | 490 |

Major Street Direction

|   |             |
|---|-------------|
|   | North/South |
| X | East/West   |

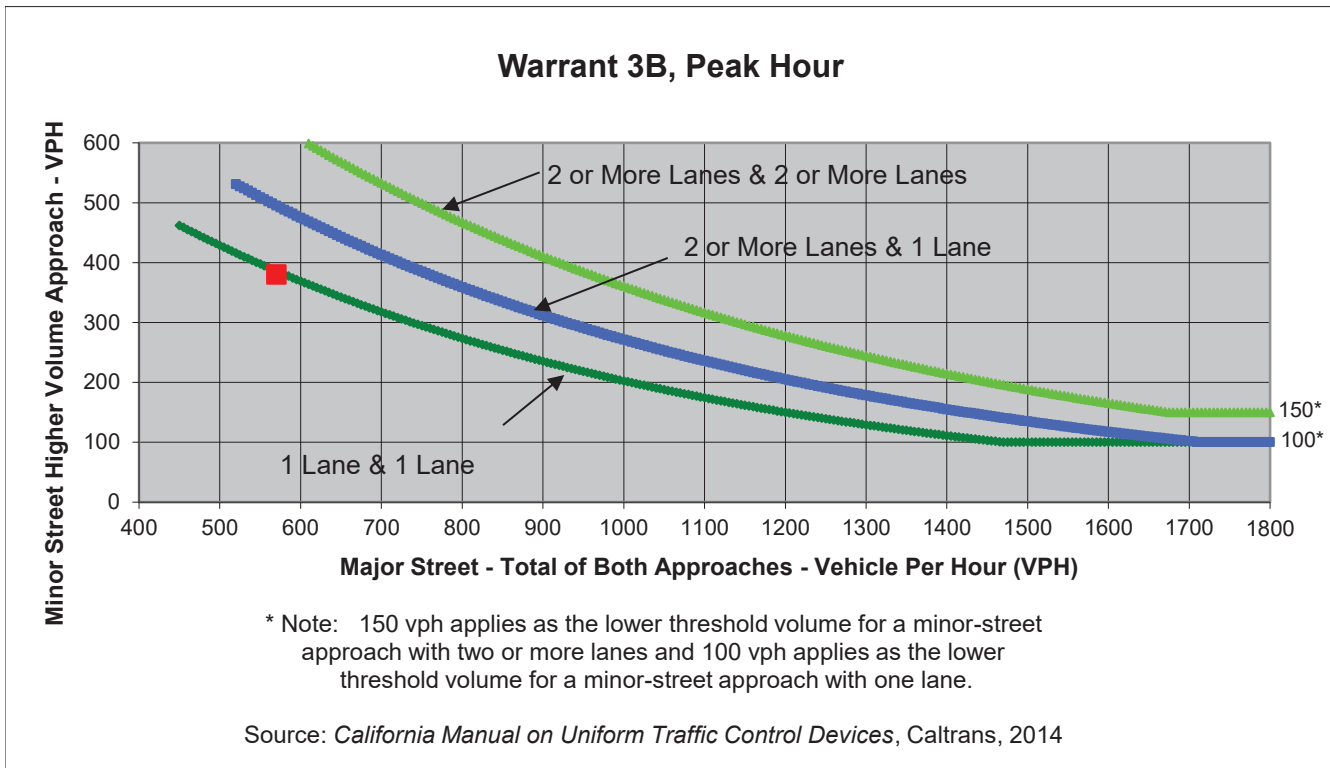

|                                 | <b>Major Street</b> | <b>Minor Street</b>   | <b>Warrant Met</b> |
|---------------------------------|---------------------|-----------------------|--------------------|
|                                 | Inter-Garrison Road | 7th Avenue/8th Street |                    |
| <b>Number of Approach Lanes</b> | <b>1</b>            | <b>1</b>              | <b><u>NO</u></b>   |
| <b>Traffic Volume (VPH) *</b>   | <b>570</b>          | <b>380</b>            |                    |

\* Note: Traffic Volume for Major Street is Total Volume of Both Approches.  
 Traffic Volume for Minor Street is the Volume of High Volume Approach.



Major Street Inter-Garrison Road  
 Minor Street 8th Avenue

Project CSUMB Master Plan EIR  
 Scenario Existing Plus Project AM  
 Peak Hour AM

Turn Movement Volumes

|         | NB  | SB | EB  | WB    |
|---------|-----|----|-----|-------|
| Left    | 10  | 0  | 0   | 730   |
| Through | 0   | 0  | 180 | 500   |
| Right   | 240 | 0  | 150 | 0     |
| Total   | 250 | 0  | 330 | 1,230 |

Major Street Direction

|   |             |
|---|-------------|
|   | North/South |
| X | East/West   |

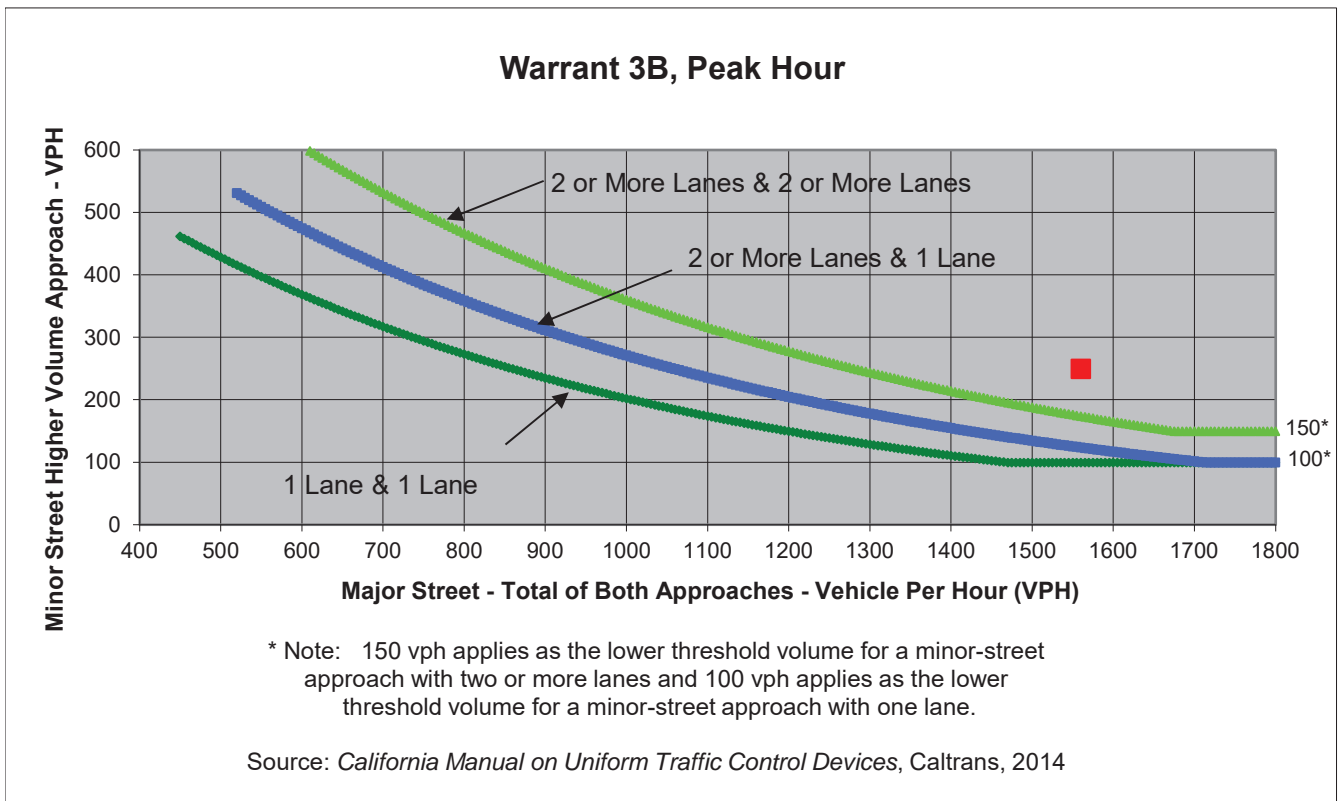

|                                 | Major Street        | Minor Street | Warrant Met       |
|---------------------------------|---------------------|--------------|-------------------|
|                                 | Inter-Garrison Road | 8th Avenue   |                   |
| <b>Number of Approach Lanes</b> | <b>1</b>            | <b>1</b>     | <b><u>YES</u></b> |
| <b>Traffic Volume (VPH) *</b>   | <b>1,560</b>        | <b>250</b>   |                   |

\* Note: Traffic Volume for Major Street is Total Volume of Both Approaches.  
 Traffic Volume for Minor Street is the Volume of High Volume Approach.

Major Street Inter-Garrison Road  
 Minor Street Abrams Drive

Project CSUMB Master Plan EIR  
 Scenario Existing Plus Project AM  
 Peak Hour AM

Turn Movement Volumes

|         | NB | SB  | EB  | WB  |
|---------|----|-----|-----|-----|
| Left    | 0  | 30  | 210 | 0   |
| Through | 0  | 0   | 200 | 740 |
| Right   | 0  | 490 | 0   | 10  |
| Total   | 0  | 520 | 410 | 750 |

Major Street Direction

|   |             |
|---|-------------|
|   | North/South |
| X | East/West   |

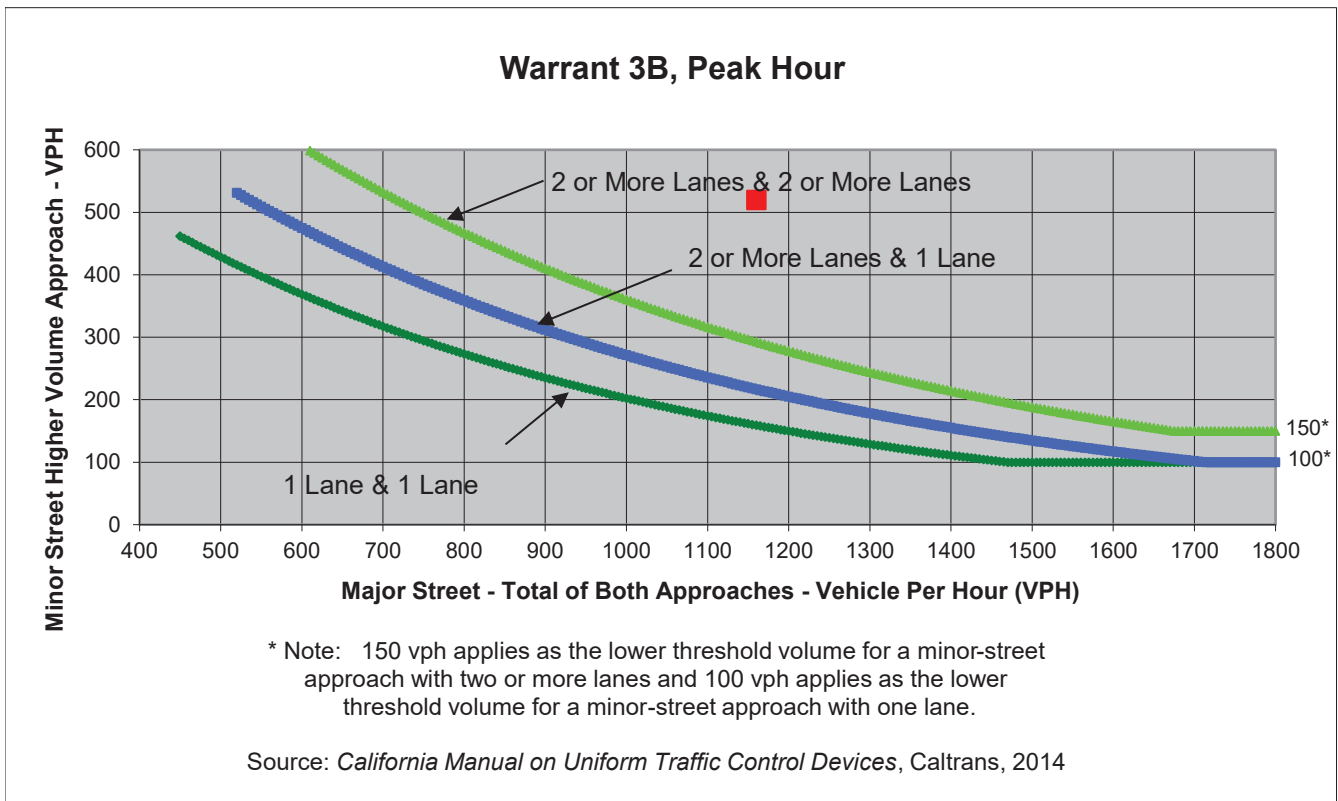

|                                 | Major Street        | Minor Street | Warrant Met |
|---------------------------------|---------------------|--------------|-------------|
|                                 | Inter-Garrison Road | Abrams Drive |             |
| <b>Number of Approach Lanes</b> | <b>1</b>            | <b>1</b>     | <b>YES</b>  |
| <b>Traffic Volume (VPH) *</b>   | <b>1,160</b>        | <b>520</b>   |             |

\* Note: Traffic Volume for Major Street is Total Volume of Both Approaches.  
 Traffic Volume for Minor Street is the Volume of High Volume Approach.

Major Street Inter-Garrison Road  
 Minor Street Schoonover Road

Project CSUMB Master Plan EIR  
 Scenario Existing Plus Project AM  
 Peak Hour AM

Turn Movement Volumes

|         | NB | SB  | EB  | WB  |
|---------|----|-----|-----|-----|
| Left    | 0  | 50  | 30  | 0   |
| Through | 0  | 0   | 200 | 590 |
| Right   | 0  | 160 | 0   | 10  |
| Total   | 0  | 210 | 230 | 600 |

Major Street Direction

|   |             |
|---|-------------|
|   | North/South |
| X | East/West   |

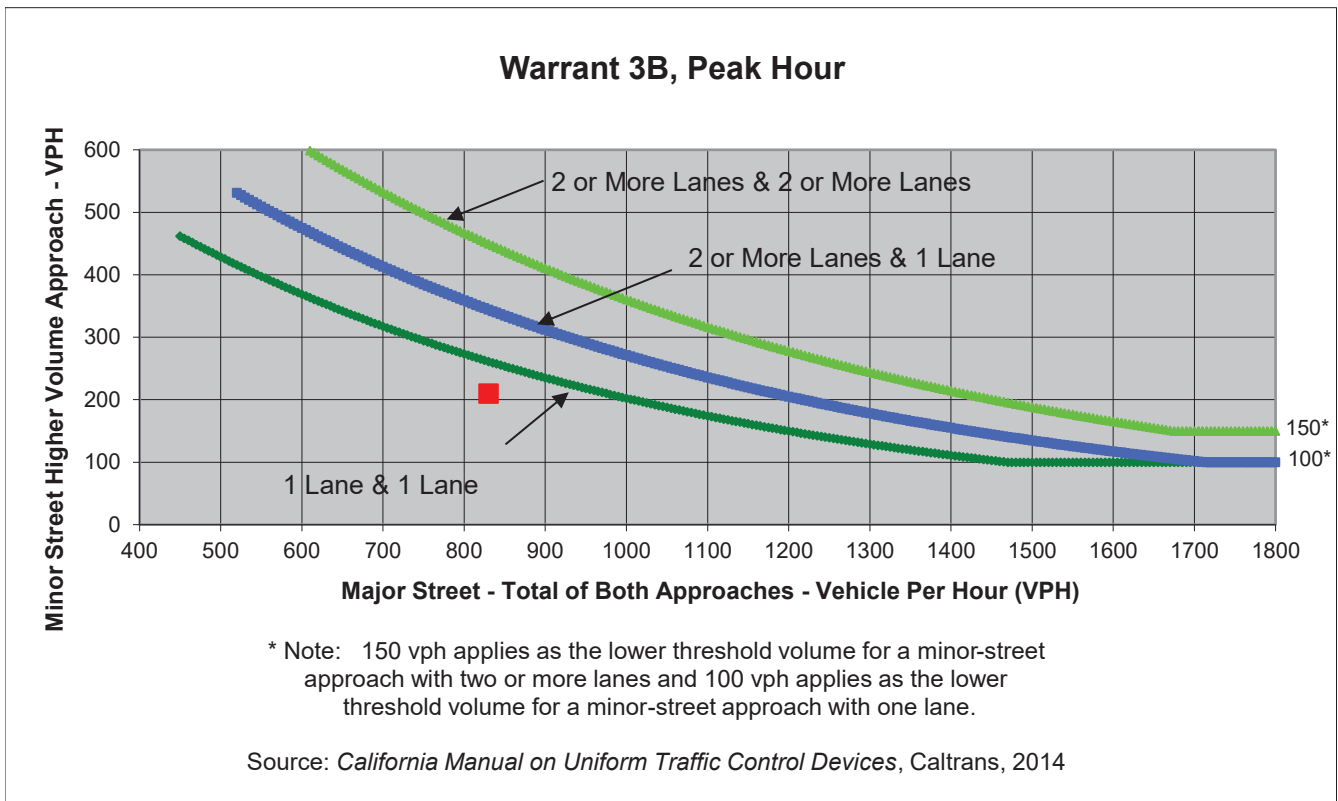

|                                 | Major Street        | Minor Street    | Warrant Met      |
|---------------------------------|---------------------|-----------------|------------------|
|                                 | Inter-Garrison Road | Schoonover Road |                  |
| <b>Number of Approach Lanes</b> | <b>1</b>            | <b>1</b>        | <b><u>NO</u></b> |
| <b>Traffic Volume (VPH) *</b>   | <b>830</b>          | <b>210</b>      |                  |

\* Note: Traffic Volume for Major Street is Total Volume of Both Approaches.  
 Traffic Volume for Minor Street is the Volume of High Volume Approach.



Major Street 2nd Avenue  
 Minor Street Divarty Street

Project CSUMB Master Plan EIR  
 Scenario Existing Plus Project AM  
 Peak Hour AM

Turn Movement Volumes

|         | NB  | SB    | EB | WB |
|---------|-----|-------|----|----|
| Left    | 10  | 10    | 10 | 70 |
| Through | 370 | 1,040 | 10 | 10 |
| Right   | 120 | 10    | 10 | 10 |
| Total   | 500 | 1,060 | 30 | 90 |

Major Street Direction

|   |             |
|---|-------------|
| X | North/South |
|   | East/West   |

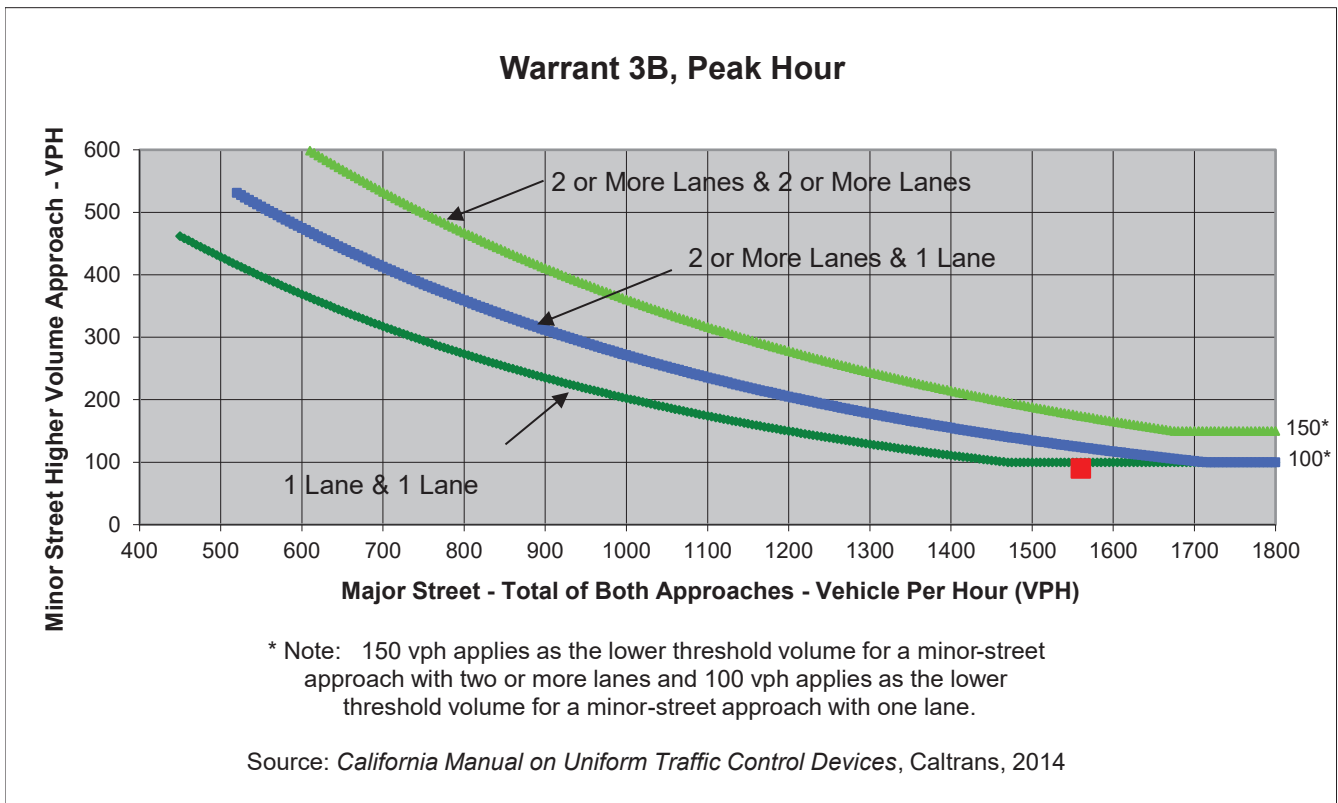

|                                 | Major Street | Minor Street   | Warrant Met      |
|---------------------------------|--------------|----------------|------------------|
|                                 | 2nd Avenue   | Divarty Street |                  |
| <b>Number of Approach Lanes</b> | <b>1</b>     | <b>1</b>       | <b><u>NO</u></b> |
| <b>Traffic Volume (VPH) *</b>   | <b>1,560</b> | <b>90</b>      |                  |

\* Note: Traffic Volume for Major Street is Total Volume of Both Approaches.  
 Traffic Volume for Minor Street is the Volume of High Volume Approach.



Major Street Gigling Road  
 Minor Street Malmedy Road

Project CSUMB Master Plan EIR  
 Scenario Existing Plus Project AM  
 Peak Hour AM

Turn Movement Volumes

|         | NB | SB | EB  | WB  |
|---------|----|----|-----|-----|
| Left    | 20 | 10 | 10  | 10  |
| Through | 10 | 30 | 460 | 860 |
| Right   | 10 | 20 | 50  | 10  |
| Total   | 40 | 60 | 520 | 880 |

Major Street Direction

|   |             |
|---|-------------|
|   | North/South |
| X | East/West   |

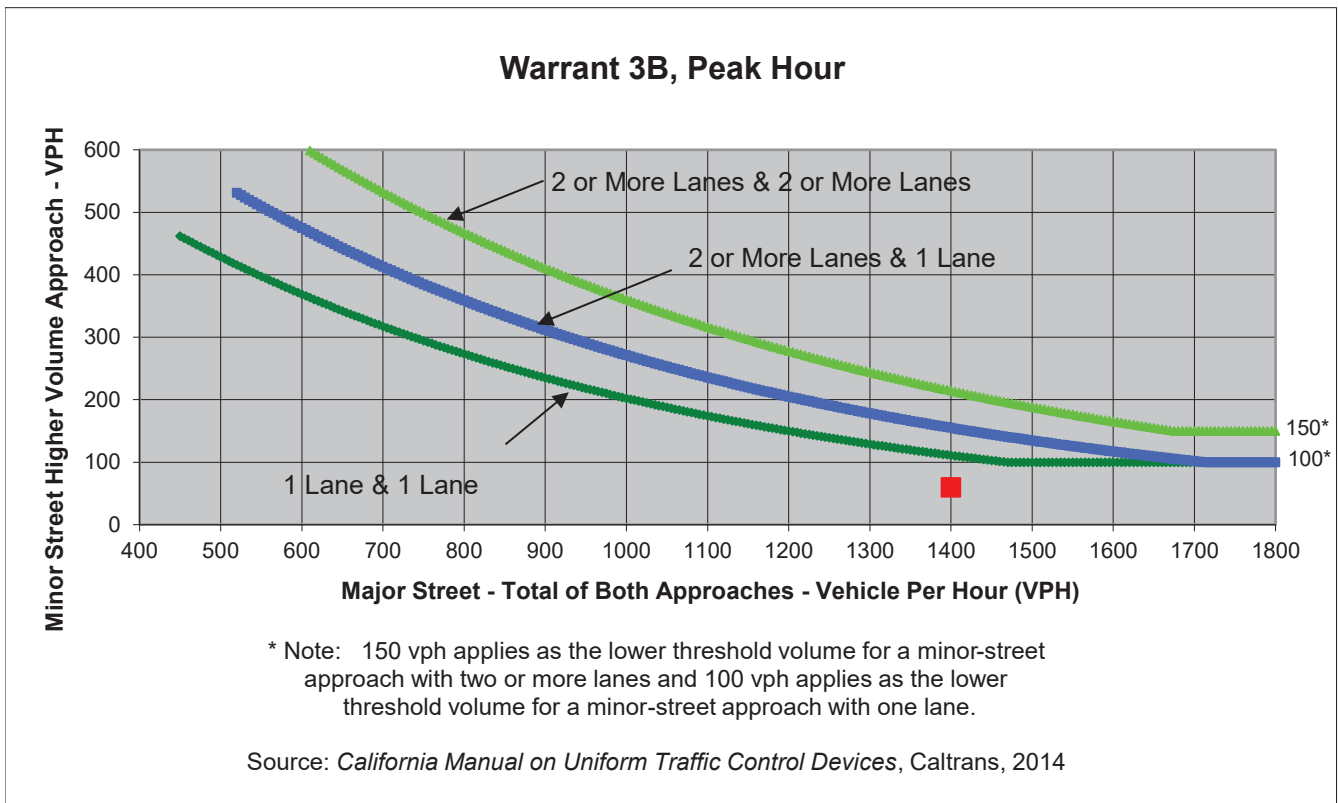

|                                 | Major Street | Minor Street | Warrant Met      |
|---------------------------------|--------------|--------------|------------------|
|                                 | Gigling Road | Malmedy Road |                  |
| <b>Number of Approach Lanes</b> | <b>1</b>     | <b>1</b>     | <b><u>NO</u></b> |
| <b>Traffic Volume (VPH) *</b>   | <b>1,400</b> | <b>60</b>    |                  |

\* Note: Traffic Volume for Major Street is Total Volume of Both Approaches.  
 Traffic Volume for Minor Street is the Volume of High Volume Approach.



Major Street Gigling Road  
 Minor Street Parker Flatts Cut Off Road

Project CSUMB Master Plan EIR  
 Scenario Existing Plus Project AM  
 Peak Hour AM

Turn Movement Volumes

|         | NB | SB | EB  | WB  |
|---------|----|----|-----|-----|
| Left    | 50 | 10 | 10  | 20  |
| Through | 10 | 10 | 370 | 830 |
| Right   | 10 | 10 | 110 | 10  |
| Total   | 70 | 30 | 490 | 860 |

Major Street Direction

|   |             |
|---|-------------|
|   | North/South |
| X | East/West   |

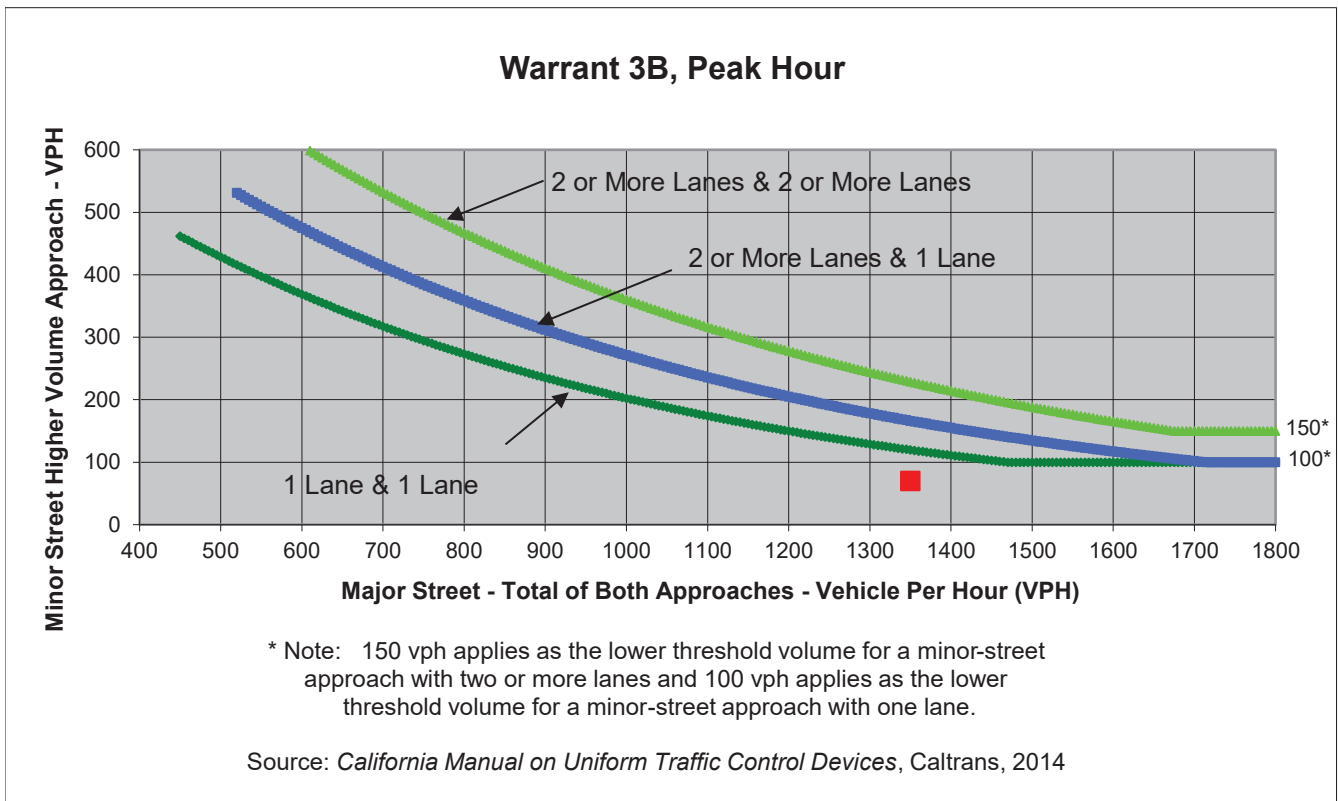

|                                 | Major Street | Minor Street               | Warrant Met      |
|---------------------------------|--------------|----------------------------|------------------|
|                                 | Gigling Road | Parker Flatts Cut Off Road |                  |
| <b>Number of Approach Lanes</b> | <b>1</b>     | <b>1</b>                   | <b><u>NO</u></b> |
| <b>Traffic Volume (VPH) *</b>   | <b>1,350</b> | <b>70</b>                  |                  |

\* Note: Traffic Volume for Major Street is Total Volume of Both Approaches.  
 Traffic Volume for Minor Street is the Volume of High Volume Approach.

Major Street Gigling Road  
 Minor Street 6th Avenue

Project CSUMB Master Plan EIR  
 Scenario Existing Plus Project AM  
 Peak Hour AM

Turn Movement Volumes

|         | NB | SB  | EB  | WB  |
|---------|----|-----|-----|-----|
| Left    | 10 | 10  | 140 | 10  |
| Through | 10 | 10  | 250 | 730 |
| Right   | 10 | 120 | 10  | 10  |
| Total   | 30 | 140 | 400 | 750 |

Major Street Direction

|   |             |
|---|-------------|
|   | North/South |
| X | East/West   |

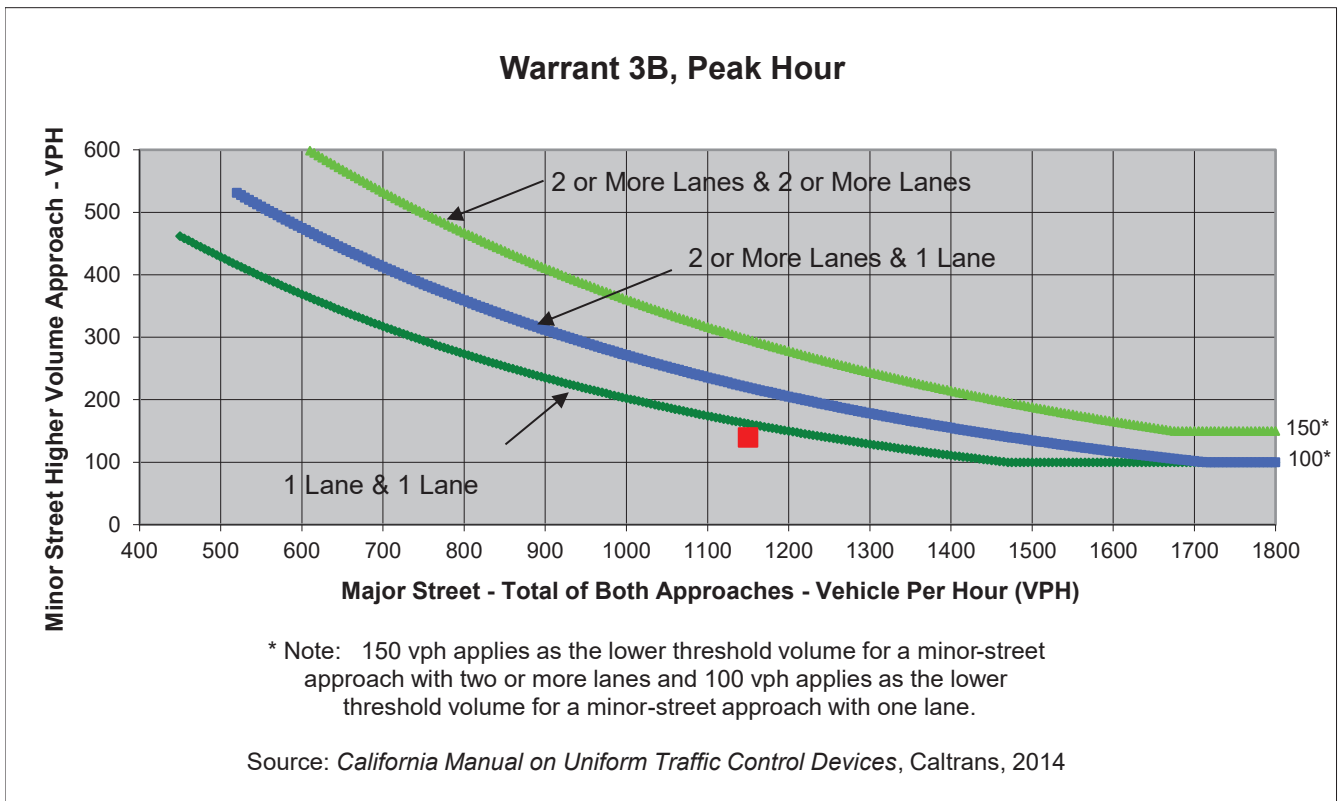

|                          | Major Street | Minor Street | Warrant Met |
|--------------------------|--------------|--------------|-------------|
|                          | Gigling Road | 6th Avenue   |             |
| Number of Approach Lanes | 1            | 1            | <b>NO</b>   |
| Traffic Volume (VPH) *   | 1,150        | 140          |             |

\* Note: Traffic Volume for Major Street is Total Volume of Both Approaches.  
 Traffic Volume for Minor Street is the Volume of High Volume Approach.





Major Street General Jim Moore Boulevard  
 Minor Street Coe Avenue

Project CSUMB Master Plan EIR  
 Scenario Existing Plus Project AM  
 Peak Hour AM

Turn Movement Volumes

|         | NB  | SB    | EB  | WB |
|---------|-----|-------|-----|----|
| Left    | 230 | 0     | 120 | 0  |
| Through | 370 | 900   | 0   | 0  |
| Right   | 0   | 140   | 430 | 0  |
| Total   | 600 | 1,040 | 550 | 0  |

Major Street Direction

|   |             |
|---|-------------|
| X | North/South |
|   | East/West   |

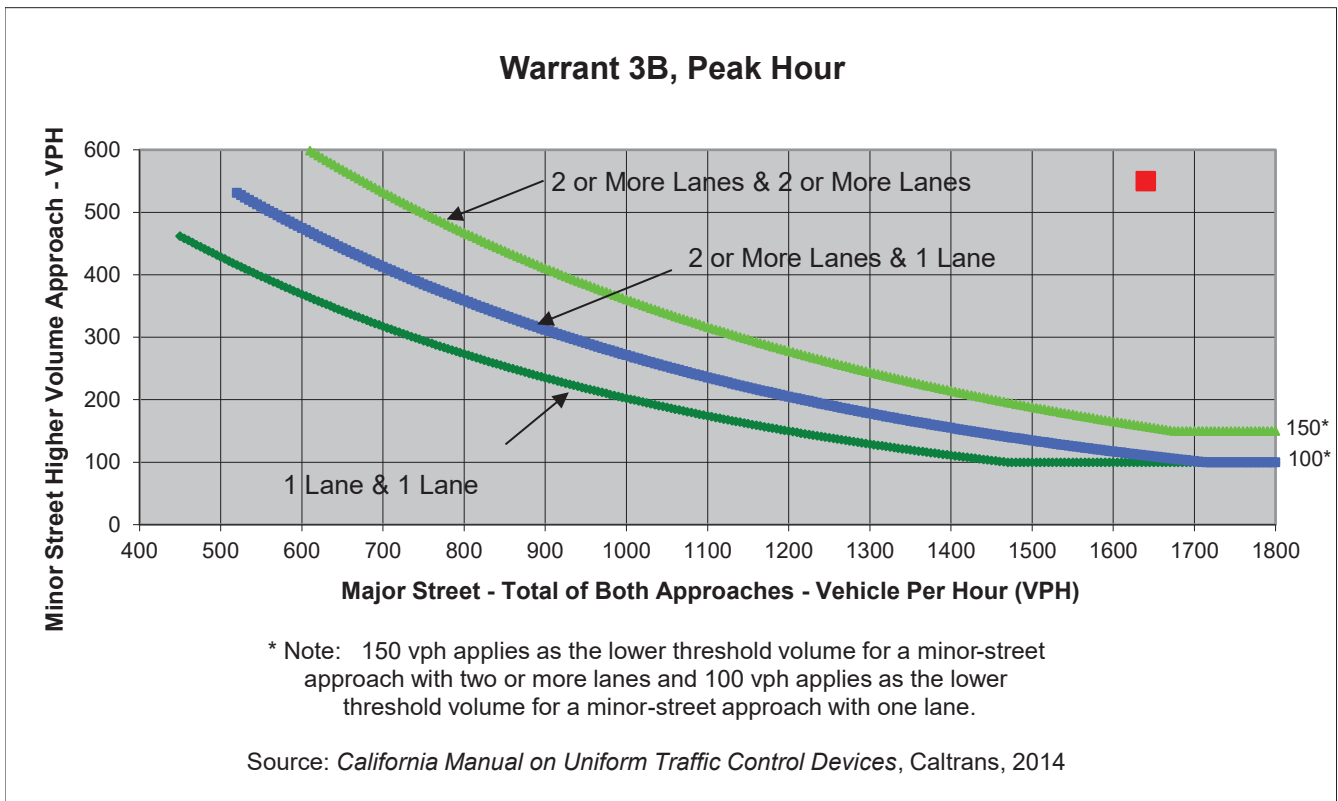

|                                 | Major Street                | Minor Street | Warrant Met       |
|---------------------------------|-----------------------------|--------------|-------------------|
|                                 | General Jim Moore Boulevard | Coe Avenue   |                   |
| <b>Number of Approach Lanes</b> | <b>2</b>                    | <b>1</b>     | <b><u>YES</u></b> |
| <b>Traffic Volume (VPH) *</b>   | <b>1,640</b>                | <b>550</b>   |                   |

\* Note: Traffic Volume for Major Street is Total Volume of Both Approaches.  
 Traffic Volume for Minor Street is the Volume of High Volume Approach.



Major Street Imjin Parkway  
 Minor Street SR 1 NB Off-Ramp/SR 1 NB On-Ramp

Project CSUMB Master Plan EIR  
 Scenario Existing Plus Project PM  
 Peak Hour PM

Turn Movement Volumes

|         | NB | SB | EB  | WB    |
|---------|----|----|-----|-------|
| Left    | 10 | 0  | 10  | 0     |
| Through | 10 | 0  | 270 | 970   |
| Right   | 0  | 0  | 0   | 550   |
| Total   | 20 | 0  | 280 | 1,520 |

Major Street Direction

|   |             |
|---|-------------|
|   | North/South |
| X | East/West   |

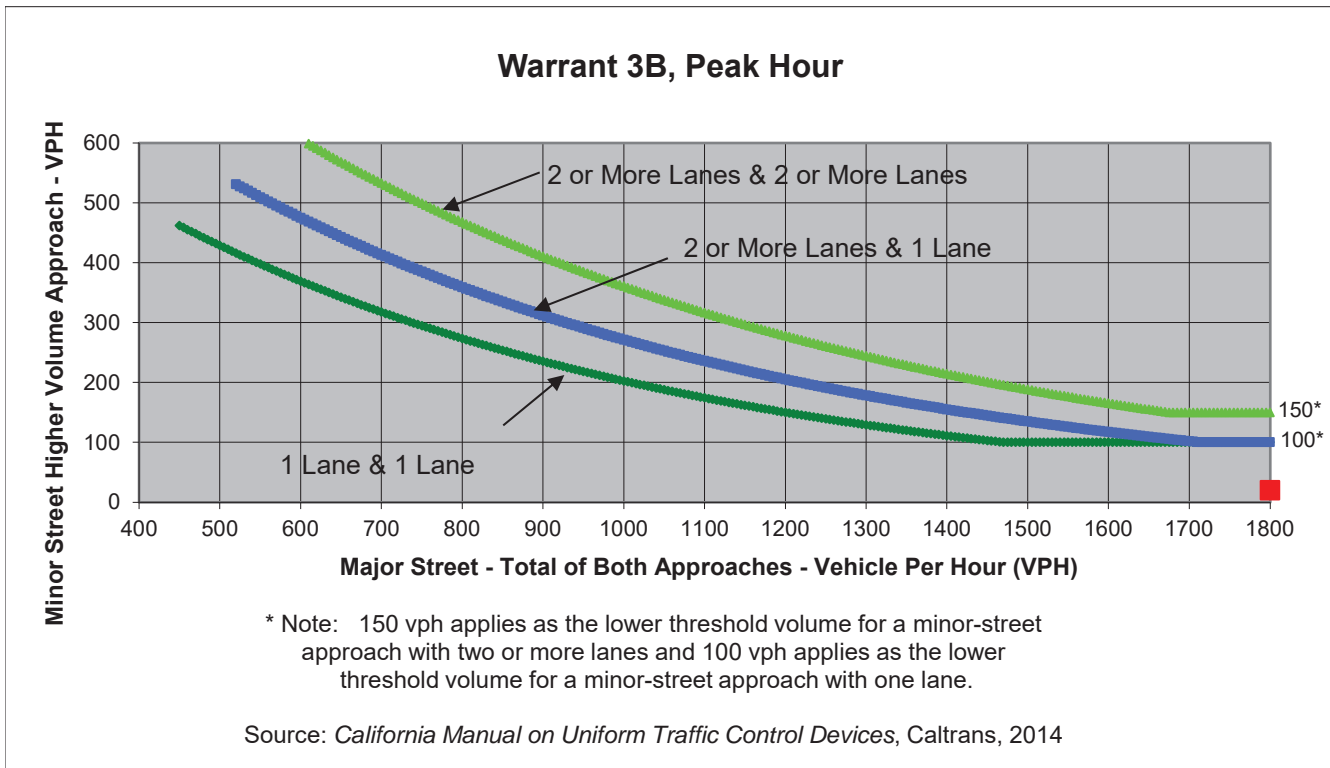

|                                 | Major Street  | Minor Street                     | Warrant Met      |
|---------------------------------|---------------|----------------------------------|------------------|
|                                 | Imjin Parkway | SR 1 NB Off-Ramp/SR 1 NB On-Ramp |                  |
| <b>Number of Approach Lanes</b> | <b>1</b>      | <b>1</b>                         | <b><u>NO</u></b> |
| <b>Traffic Volume (VPH) *</b>   | <b>1,800</b>  | <b>20</b>                        |                  |

\* Note: Traffic Volume for Major Street is Total Volume of Both Approches.  
 Traffic Volume for Minor Street is the Volume of High Volume Approach.



Major Street Imjin Parkway  
 Minor Street 3rd Avenue

Project CSUMB Master Plan EIR  
 Scenario Existing Plus Project PM  
 Peak Hour PM

Turn Movement Volumes

|         | NB | SB | EB    | WB    |
|---------|----|----|-------|-------|
| Left    | 10 | 10 | 50    | 30    |
| Through | 10 | 10 | 1,250 | 1,180 |
| Right   | 30 | 50 | 10    | 20    |
| Total   | 50 | 70 | 1,310 | 1,230 |

Major Street Direction

|   |             |
|---|-------------|
|   | North/South |
| X | East/West   |

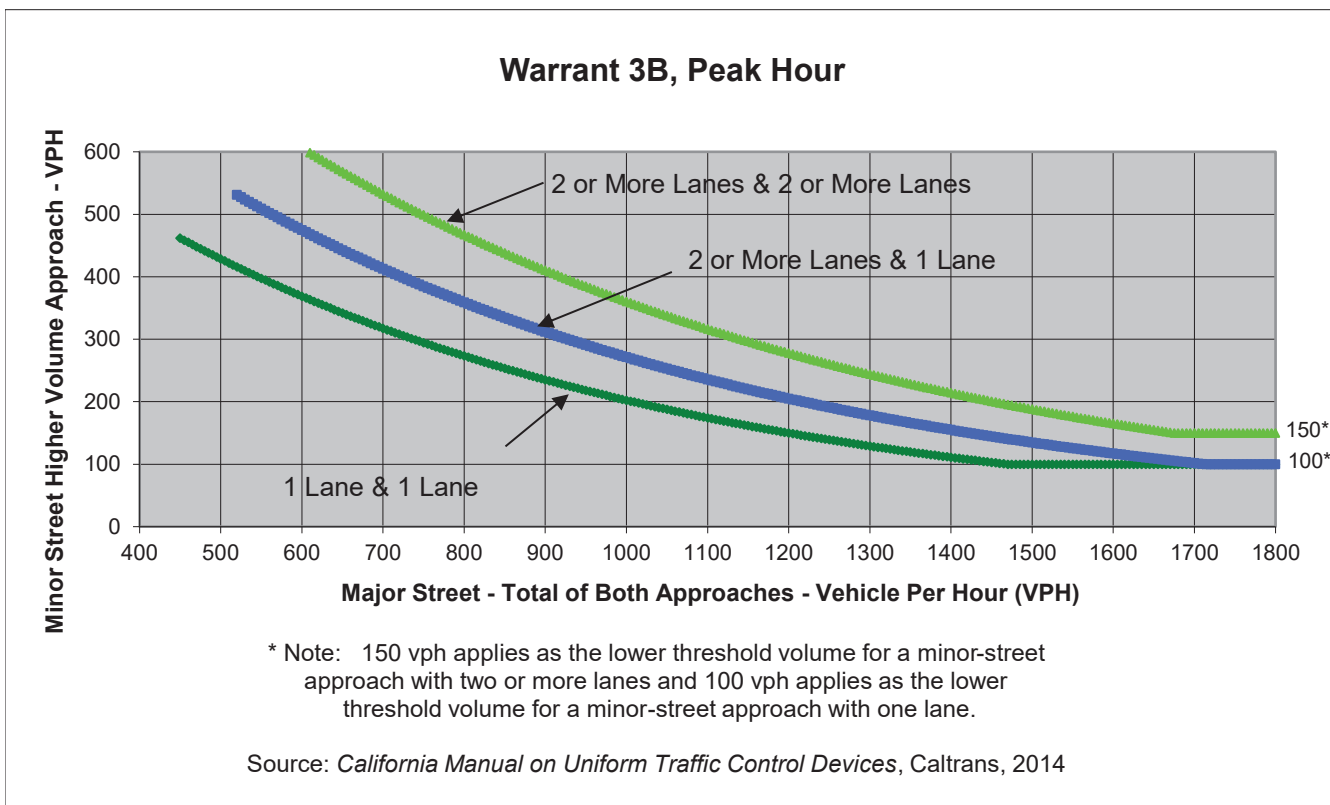

|                          | Major Street  | Minor Street | Warrant Met |
|--------------------------|---------------|--------------|-------------|
|                          | Imjin Parkway | 3rd Avenue   |             |
| Number of Approach Lanes | 2             | 1            | <b>NO</b>   |
| Traffic Volume (VPH) *   | 2,540         | 70           |             |

\* Note: Traffic Volume for Major Street is Total Volume of Both Approaches.  
 Traffic Volume for Minor Street is the Volume of High Volume Approach.

Major Street Imjin Parkway  
 Minor Street 4th Avenue

Project CSUMB Master Plan EIR  
 Scenario Existing Plus Project PM  
 Peak Hour PM

Turn Movement Volumes

|         | NB | SB | EB    | WB    |
|---------|----|----|-------|-------|
| Left    | 20 | 10 | 10    | 10    |
| Through | 10 | 10 | 1,370 | 1,190 |
| Right   | 10 | 10 | 10    | 10    |
| Total   | 40 | 30 | 1,390 | 1,210 |

Major Street Direction

|   |             |
|---|-------------|
|   | North/South |
| X | East/West   |

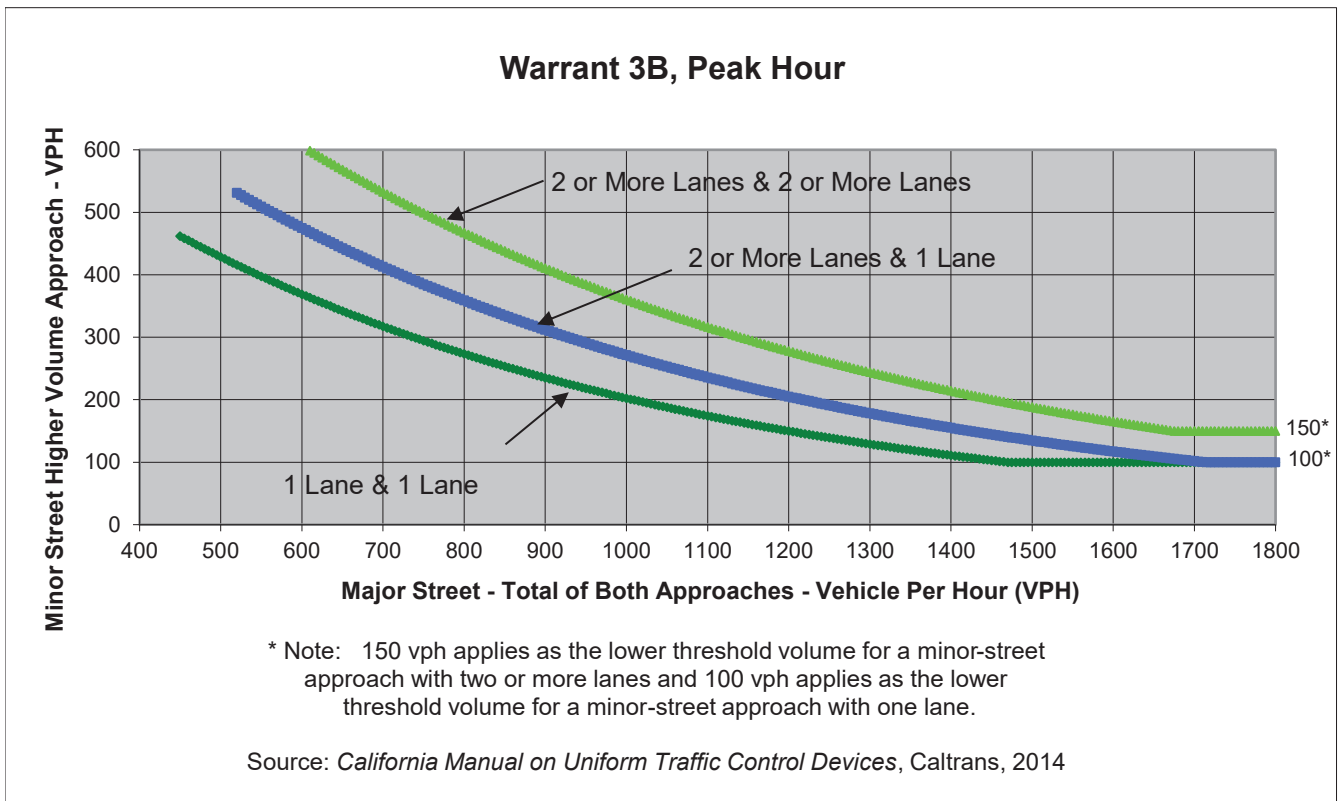

|                                 | Major Street  | Minor Street | Warrant Met      |
|---------------------------------|---------------|--------------|------------------|
|                                 | Imjin Parkway | 4th Avenue   |                  |
| <b>Number of Approach Lanes</b> | <b>2</b>      | <b>1</b>     | <b><u>NO</u></b> |
| <b>Traffic Volume (VPH) *</b>   | <b>2,600</b>  | <b>40</b>    |                  |

\* Note: Traffic Volume for Major Street is Total Volume of Both Approaches.  
 Traffic Volume for Minor Street is the Volume of High Volume Approach.



Major Street 2nd Avenue  
 Minor Street 9th Street

Project CSUMB Master Plan EIR  
 Scenario Existing Plus Project PM  
 Peak Hour PM

Turn Movement Volumes

|         | NB  | SB  | EB | WB |
|---------|-----|-----|----|----|
| Left    | 20  | 10  | 30 | 10 |
| Through | 400 | 260 | 10 | 10 |
| Right   | 30  | 30  | 10 | 10 |
| Total   | 450 | 300 | 50 | 30 |

Major Street Direction

|   |             |
|---|-------------|
| X | North/South |
|   | East/West   |

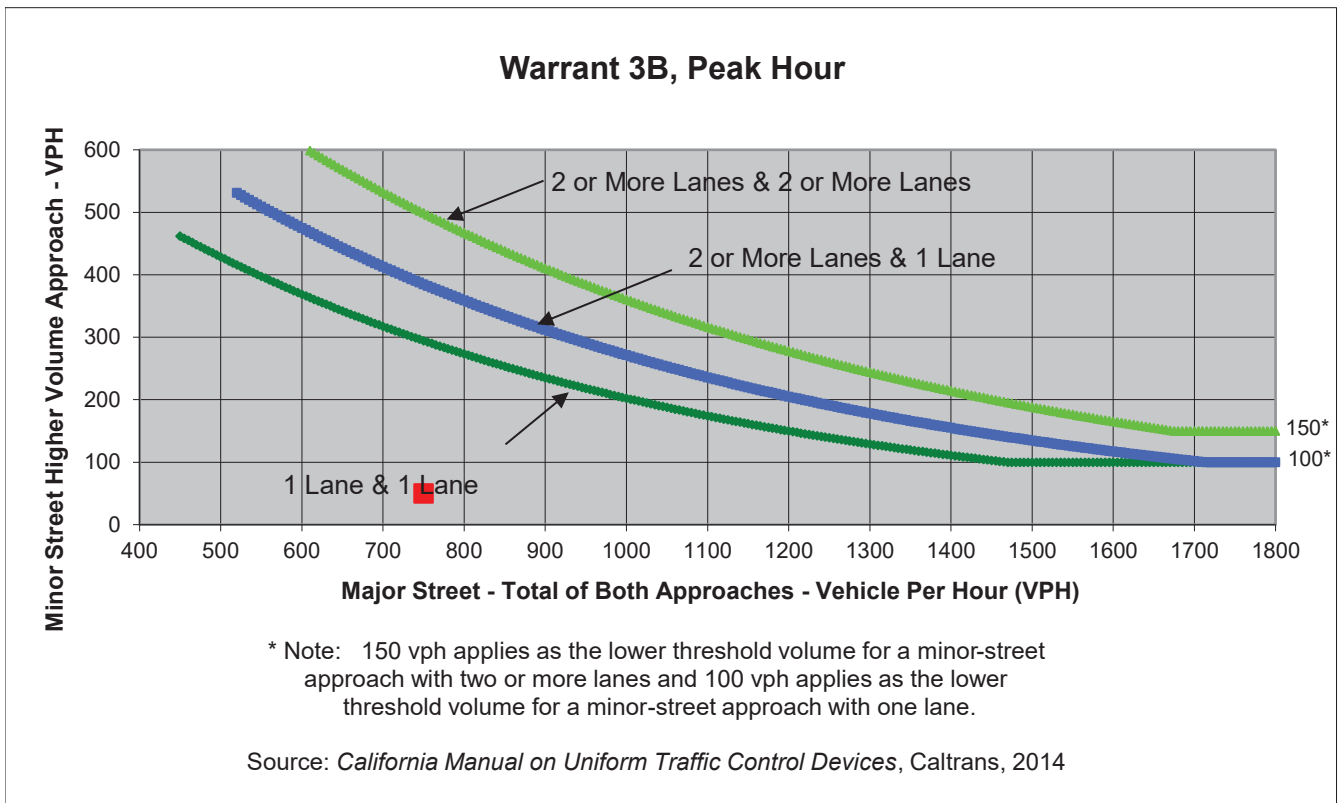

|                          | Major Street | Minor Street | Warrant Met |
|--------------------------|--------------|--------------|-------------|
|                          | 2nd Avenue   | 9th Street   |             |
| Number of Approach Lanes | 1            | 1            | <b>NO</b>   |
| Traffic Volume (VPH) *   | 750          | 50           |             |

\* Note: Traffic Volume for Major Street is Total Volume of Both Approaches.  
 Traffic Volume for Minor Street is the Volume of High Volume Approach.



Major Street 2nd Avenue  
 Minor Street 8th Street

Project CSUMB Master Plan EIR  
 Scenario Existing Plus Project PM  
 Peak Hour PM

Turn Movement Volumes

|         | NB  | SB  | EB | WB  |
|---------|-----|-----|----|-----|
| Left    | 10  | 50  | 10 | 180 |
| Through | 400 | 310 | 10 | 10  |
| Right   | 160 | 10  | 10 | 50  |
| Total   | 570 | 370 | 30 | 240 |

Major Street Direction

|   |             |
|---|-------------|
| X | North/South |
|   | East/West   |

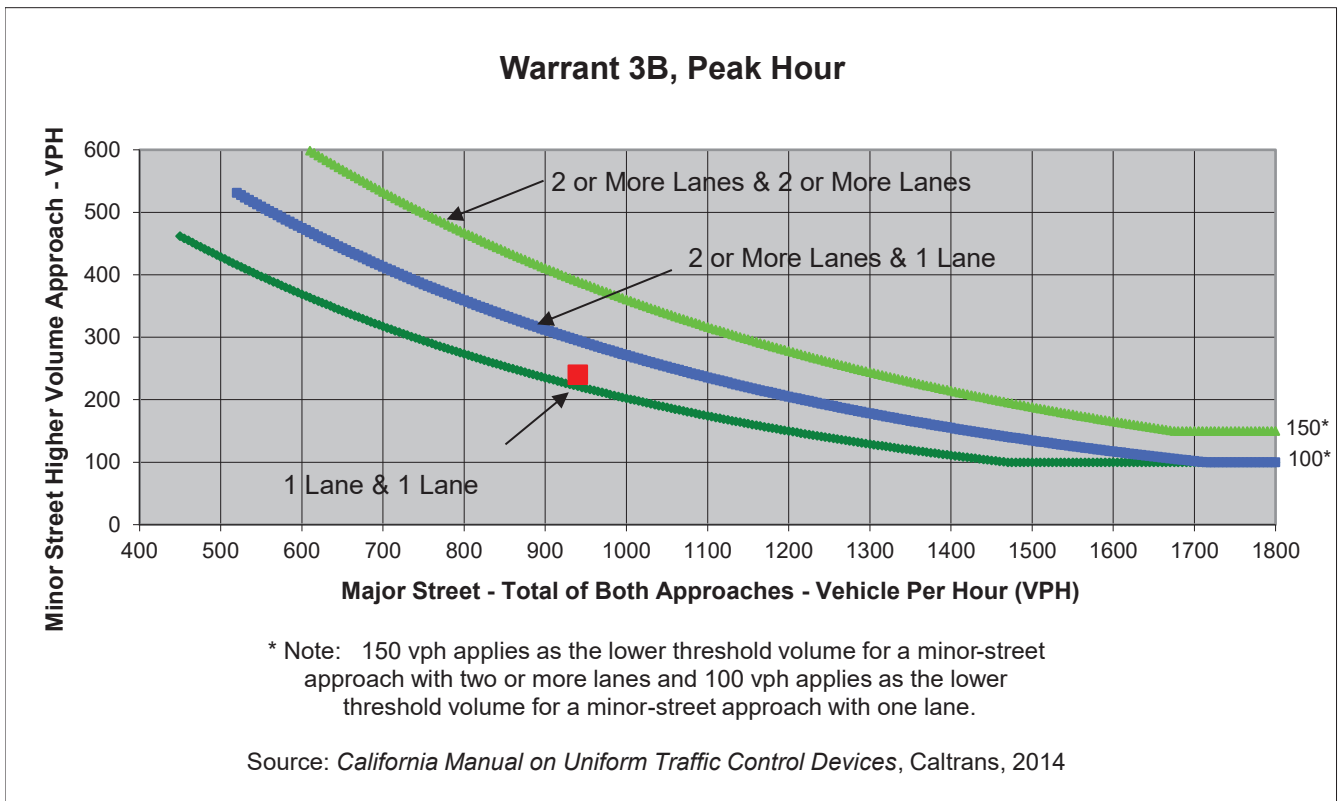

|                          | Major Street | Minor Street | Warrant Met |
|--------------------------|--------------|--------------|-------------|
|                          | 2nd Avenue   | 8th Street   |             |
| Number of Approach Lanes | 1            | 1            | <u>YES</u>  |
| Traffic Volume (VPH) *   | 940          | 240          |             |

\* Note: Traffic Volume for Major Street is Total Volume of Both Approaches.  
 Traffic Volume for Minor Street is the Volume of High Volume Approach.



Major Street 2nd Avenue  
 Minor Street Inter-Garrison Road

Project CSUMB Master Plan EIR  
 Scenario Existing Plus Project PM  
 Peak Hour PM

Turn Movement Volumes

|         | NB  | SB  | EB | WB |
|---------|-----|-----|----|----|
| Left    | 0   | 10  | 0  | 40 |
| Through | 550 | 490 | 0  | 0  |
| Right   | 30  | 0   | 0  | 10 |
| Total   | 580 | 500 | 0  | 50 |

Major Street Direction

|   |             |
|---|-------------|
| X | North/South |
|   | East/West   |

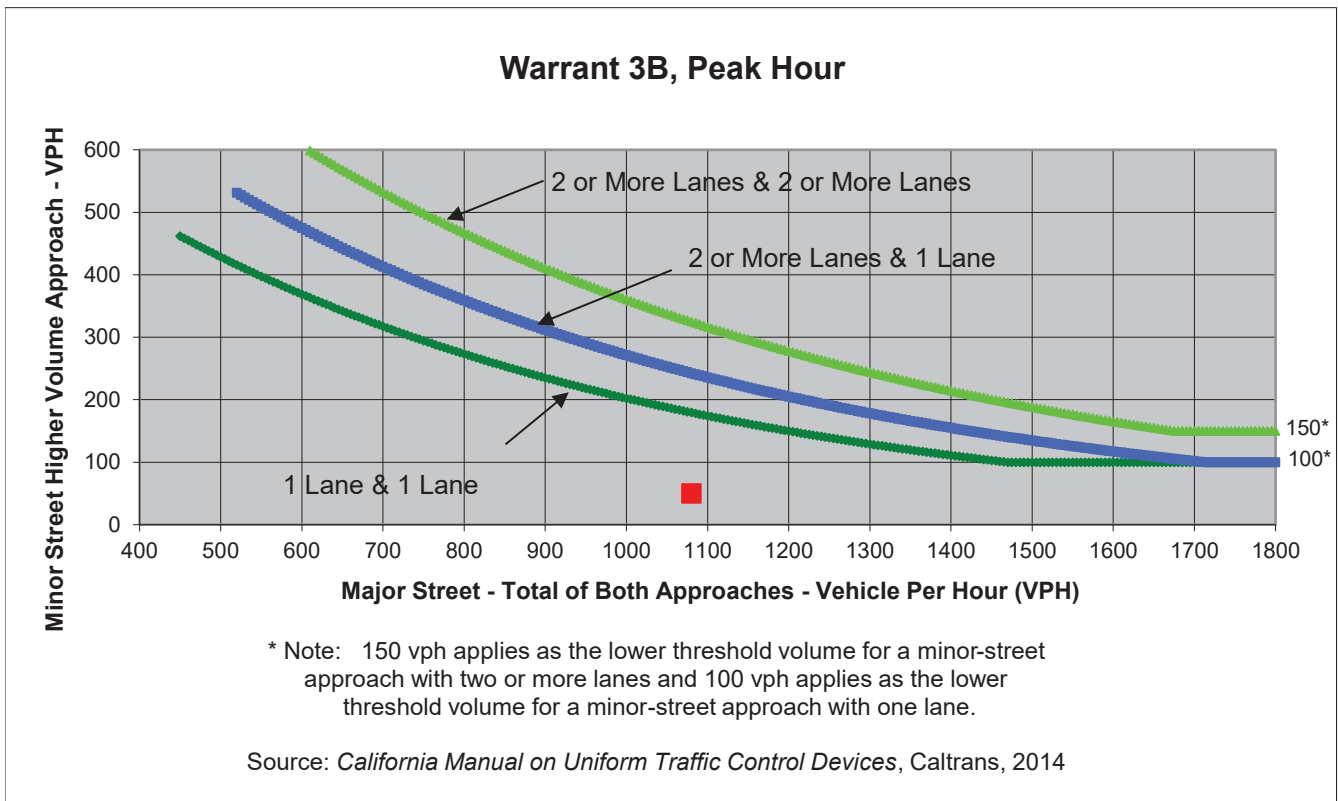

|                                 | Major Street | Minor Street        | Warrant Met      |
|---------------------------------|--------------|---------------------|------------------|
|                                 | 2nd Avenue   | Inter-Garrison Road |                  |
| <b>Number of Approach Lanes</b> | <b>1</b>     | <b>1</b>            | <b><u>NO</u></b> |
| <b>Traffic Volume (VPH) *</b>   | <b>1,080</b> | <b>50</b>           |                  |

\* Note: Traffic Volume for Major Street is Total Volume of Both Approaches.  
 Traffic Volume for Minor Street is the Volume of High Volume Approach.



Major Street **7th Avenue/8th Street**  
 Minor Street **Inter-Garrison Road**

Project **CSUMB Master Plan EIR**  
 Scenario **Existing Plus Project PM**  
 Peak Hour **PM**

Turn Movement Volumes

|         | NB  | SB  | EB  | WB  |
|---------|-----|-----|-----|-----|
| Left    | 10  | 80  | 10  | 180 |
| Through | 270 | 140 | 140 | 80  |
| Right   | 300 | 10  | 10  | 30  |
| Total   | 580 | 230 | 160 | 290 |

Major Street Direction

|   |             |
|---|-------------|
| X | North/South |
|   | East/West   |

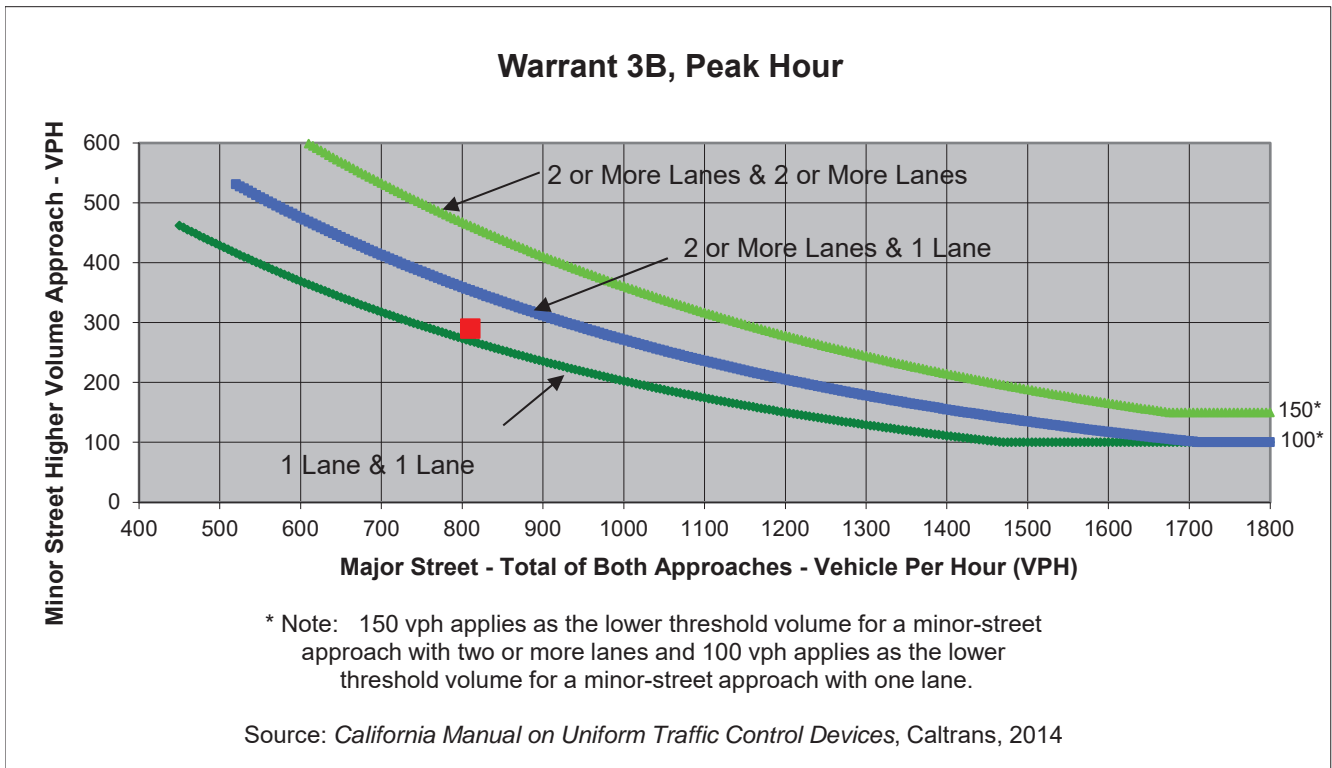

|                                 | <b>Major Street</b><br>7th Avenue/8th Street | <b>Minor Street</b><br>Inter-Garrison Road | <b>Warrant Met</b> |
|---------------------------------|--|--|--------------------|
| <b>Number of Approach Lanes</b> | <b>1</b>                                     | <b>1</b>                                   |                    |
| <b>Traffic Volume (VPH) *</b>   | <b>810</b>                                   | <b>290</b>                                 |                    |

\* Note: Traffic Volume for Major Street is Total Volume of Both Approches.  
 Traffic Volume for Minor Street is the Volume of High Volume Approach.





Major Street **Inter-Garrison Road**  
 Minor Street **8th Avenue**

Project **CSUMB Master Plan EIR**  
 Scenario **Existing Plus Project PM**  
 Peak Hour **PM**

Turn Movement Volumes

|         | NB  | SB | EB  | WB  |
|---------|-----|----|-----|-----|
| Left    | 10  | 0  | 0   | 390 |
| Through | 0   | 0  | 480 | 280 |
| Right   | 610 | 0  | 50  | 0   |
| Total   | 620 | 0  | 530 | 670 |

Major Street Direction

North/South  
**X** East/West

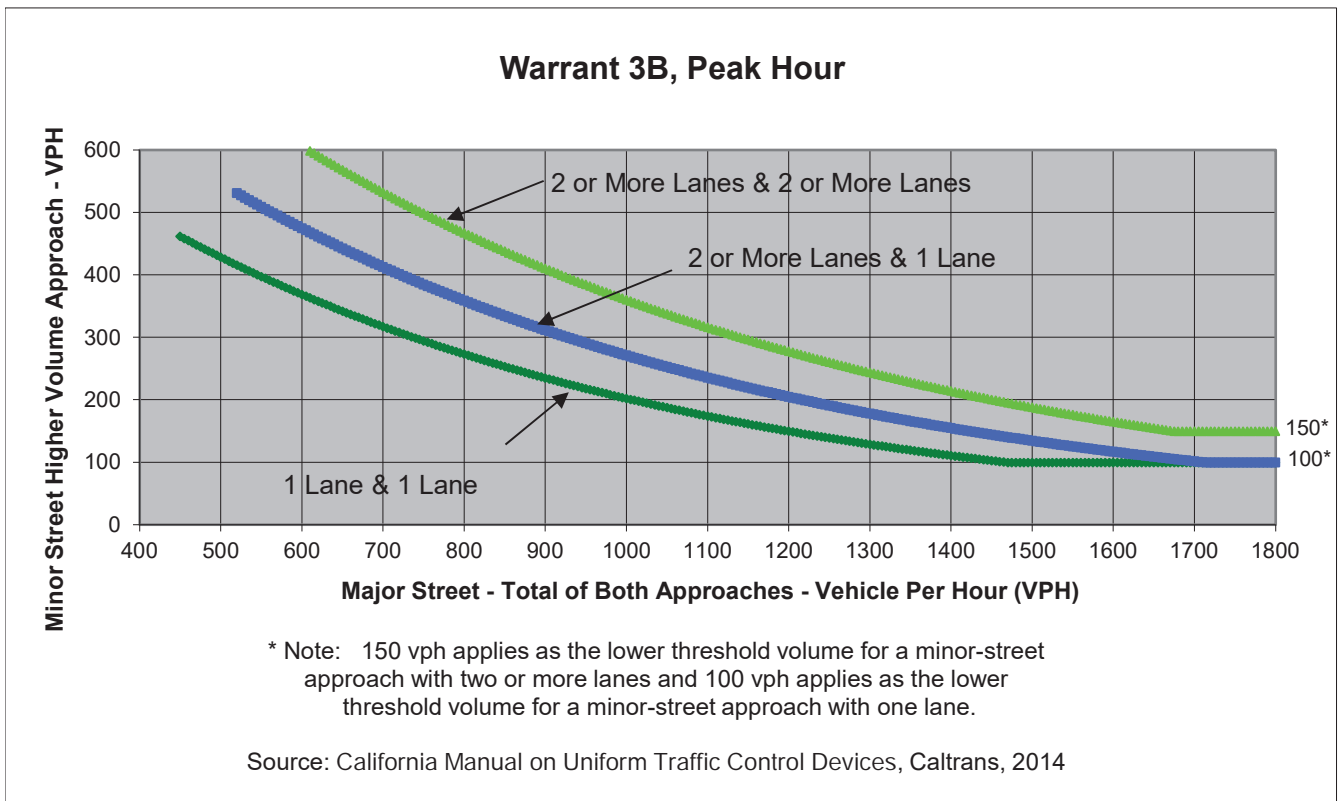

|                                 | Major Street        | Minor Street | Warrant Met |
|---------------------------------|---------------------|--------------|-------------|
|                                 | Inter-Garrison Road | 8th Avenue   |             |
| <b>Number of Approach Lanes</b> | <b>1</b>            | <b>1</b>     | <b>YES</b>  |
| <b>Traffic Volume (VPH) *</b>   | <b>1,200</b>        | <b>620</b>   |             |

\* Note: Traffic Volume for Major Street is Total Volume of Both Approaches.  
 Traffic Volume for Minor Street is the Volume of High Volume Approach.

Major Street Inter-Garrison Road  
 Minor Street Abrams Drive

Project CSUMB Master Plan EIR  
 Scenario Existing Plus Project PM  
 Peak Hour PM

Turn Movement Volumes

|         | NB | SB  | EB    | WB  |
|---------|----|-----|-------|-----|
| Left    | 0  | 10  | 540   | 0   |
| Through | 0  | 0   | 550   | 260 |
| Right   | 0  | 420 | 0     | 20  |
| Total   | 0  | 430 | 1,090 | 280 |

Major Street Direction

|   |             |
|---|-------------|
|   | North/South |
| X | East/West   |

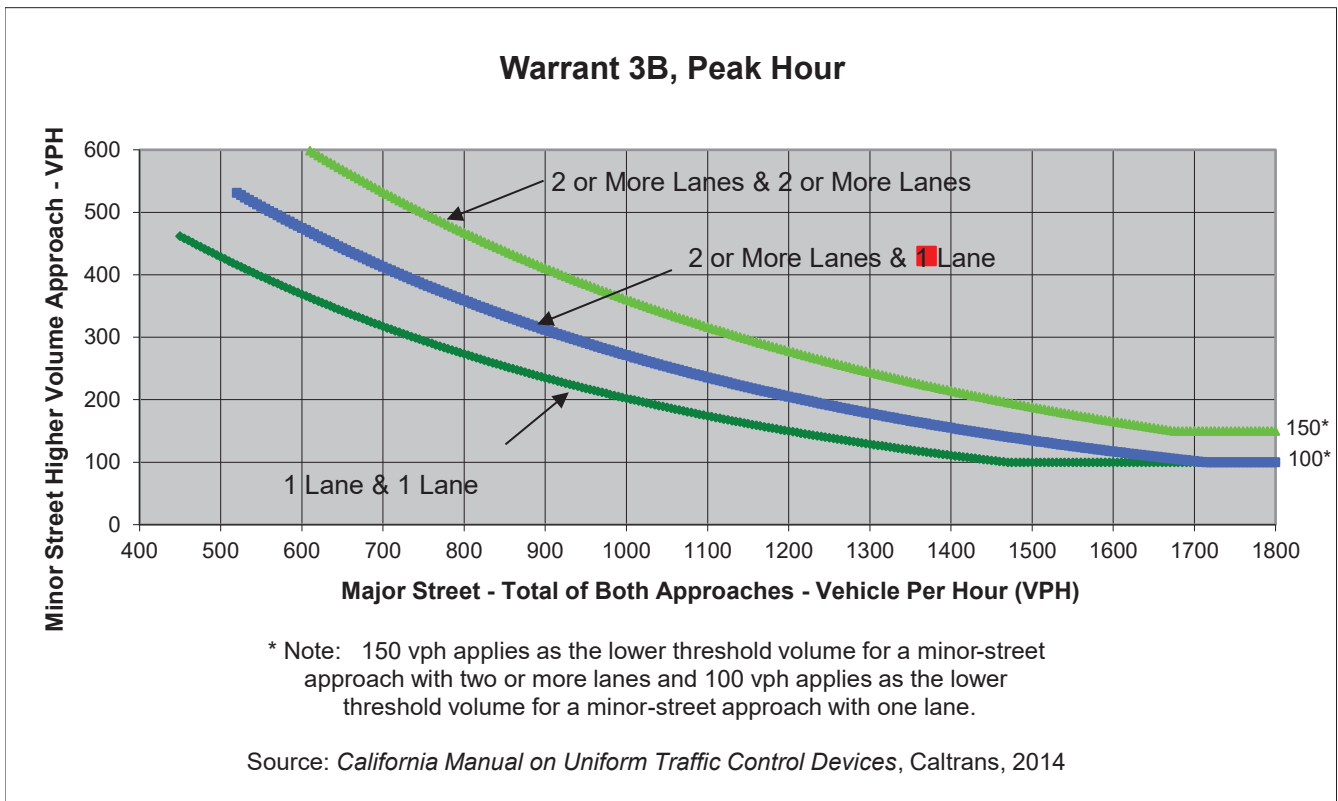

|                                 | Major Street        | Minor Street | Warrant Met |
|---------------------------------|---------------------|--------------|-------------|
|                                 | Inter-Garrison Road | Abrams Drive |             |
| <b>Number of Approach Lanes</b> | <b>1</b>            | <b>1</b>     | <b>YES</b>  |
| <b>Traffic Volume (VPH) *</b>   | <b>1,370</b>        | <b>430</b>   |             |

\* Note: Traffic Volume for Major Street is Total Volume of Both Approaches.  
 Traffic Volume for Minor Street is the Volume of High Volume Approach.

Major Street Inter-Garrison Road  
 Minor Street Schoonover Road

Project CSUMB Master Plan EIR  
 Scenario Existing Plus Project PM  
 Peak Hour PM

Turn Movement Volumes

|         | NB | SB | EB  | WB  |
|---------|----|----|-----|-----|
| Left    | 0  | 10 | 150 | 0   |
| Through | 0  | 0  | 410 | 210 |
| Right   | 0  | 70 | 0   | 30  |
| Total   | 0  | 80 | 560 | 240 |

Major Street Direction

|   |             |
|---|-------------|
|   | North/South |
| X | East/West   |

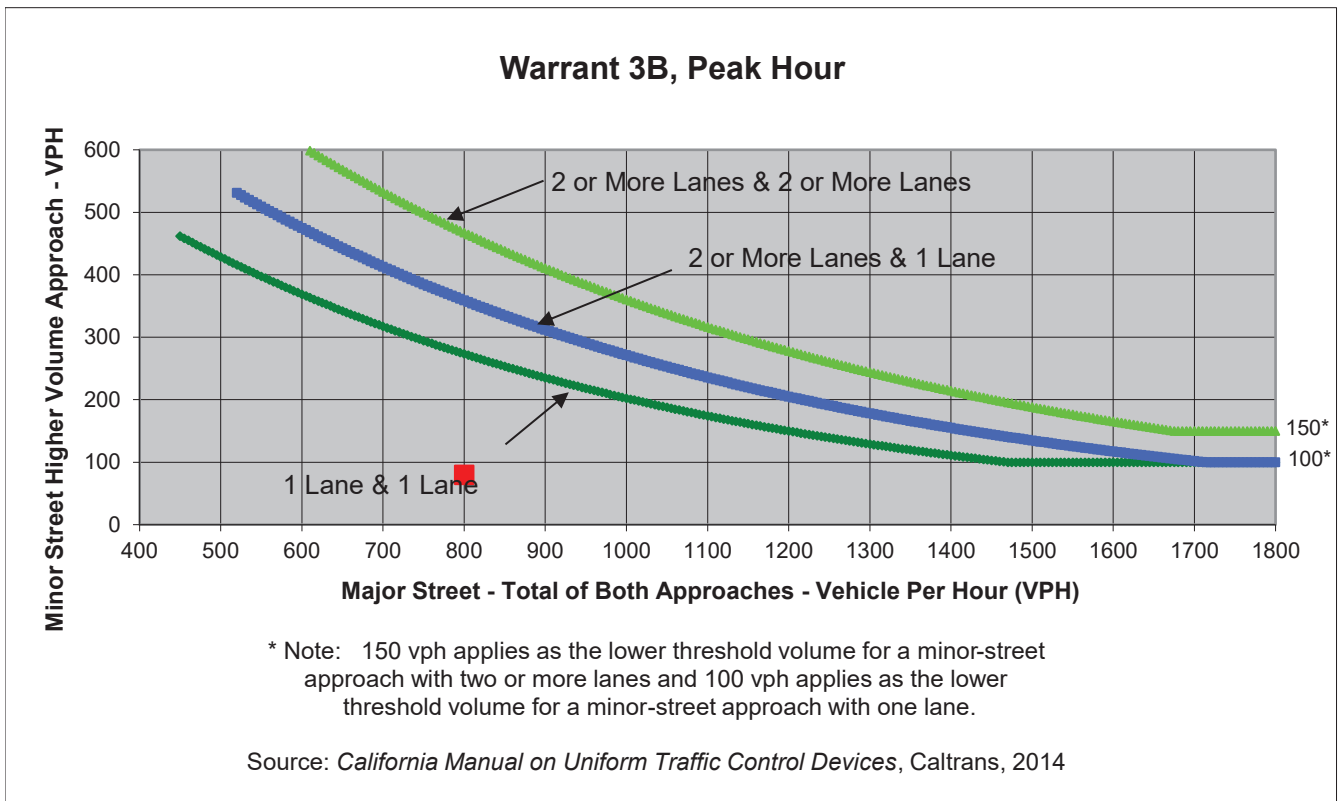

|                                 | Major Street        | Minor Street    | Warrant Met      |
|---------------------------------|---------------------|-----------------|------------------|
|                                 | Inter-Garrison Road | Schoonover Road |                  |
| <b>Number of Approach Lanes</b> | <b>1</b>            | <b>1</b>        | <b><u>NO</u></b> |
| <b>Traffic Volume (VPH) *</b>   | <b>800</b>          | <b>80</b>       |                  |

\* Note: Traffic Volume for Major Street is Total Volume of Both Approaches.  
 Traffic Volume for Minor Street is the Volume of High Volume Approach.



Major Street 2nd Avenue  
 Minor Street Divarty Street

Project CSUMB Master Plan EIR  
 Scenario Existing Plus Project PM  
 Peak Hour PM

Turn Movement Volumes

|         | NB  | SB  | EB | WB  |
|---------|-----|-----|----|-----|
| Left    | 10  | 10  | 10 | 130 |
| Through | 580 | 520 | 10 | 10  |
| Right   | 110 | 10  | 10 | 10  |
| Total   | 700 | 540 | 30 | 150 |

Major Street Direction

|   |             |
|---|-------------|
| X | North/South |
|   | East/West   |

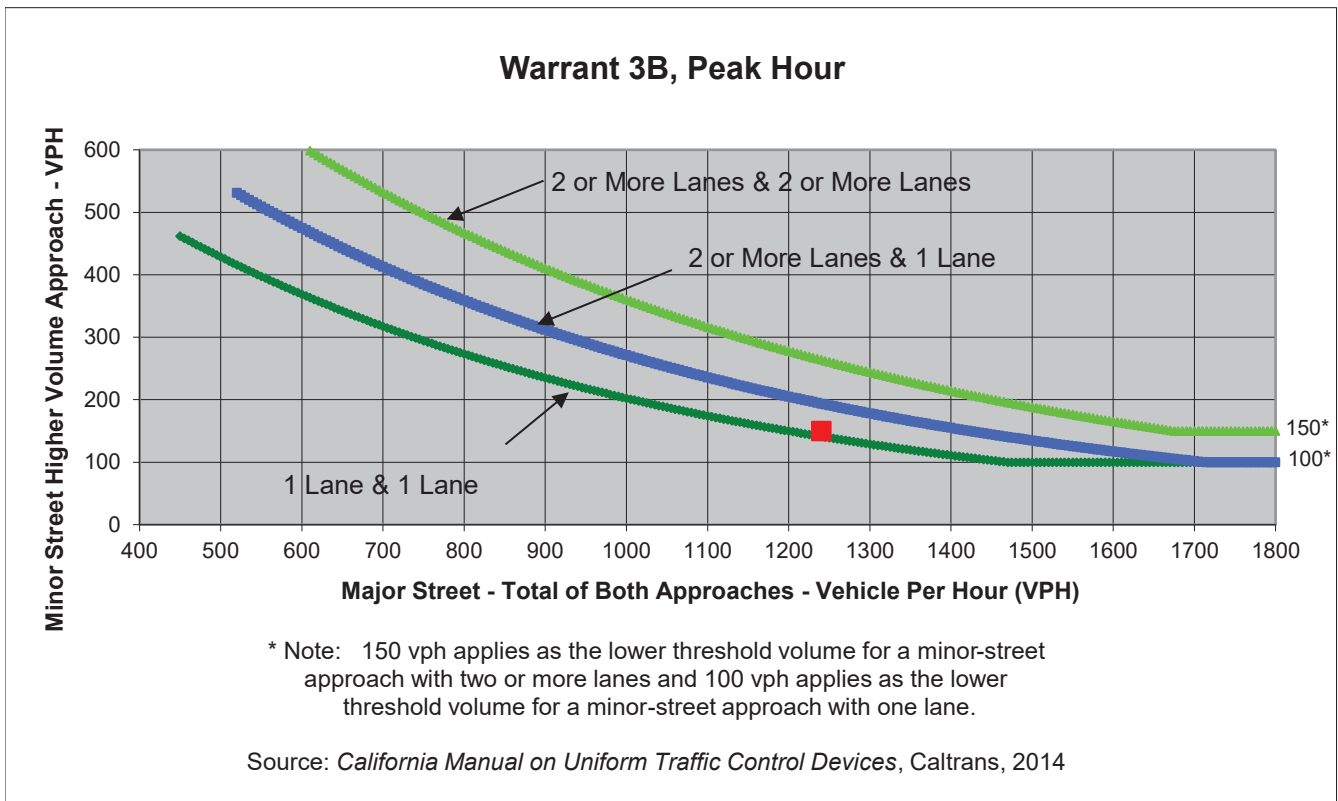

|                          | Major Street | Minor Street   | Warrant Met |
|--------------------------|--------------|----------------|-------------|
|                          | 2nd Avenue   | Divarty Street |             |
| Number of Approach Lanes | 1            | 1              | <u>YES</u>  |
| Traffic Volume (VPH) *   | 1,240        | 150            |             |

\* Note: Traffic Volume for Major Street is Total Volume of Both Approaches.  
 Traffic Volume for Minor Street is the Volume of High Volume Approach.



Major Street Gigling Road  
 Minor Street Malmedy Road

Project CSUMB Master Plan EIR  
 Scenario Existing Plus Project PM  
 Peak Hour PM

Turn Movement Volumes

|         | NB | SB | EB  | WB  |
|---------|----|----|-----|-----|
| Left    | 30 | 30 | 10  | 10  |
| Through | 30 | 10 | 590 | 530 |
| Right   | 20 | 10 | 10  | 30  |
| Total   | 80 | 50 | 610 | 570 |

Major Street Direction

|   |             |
|---|-------------|
|   | North/South |
| X | East/West   |

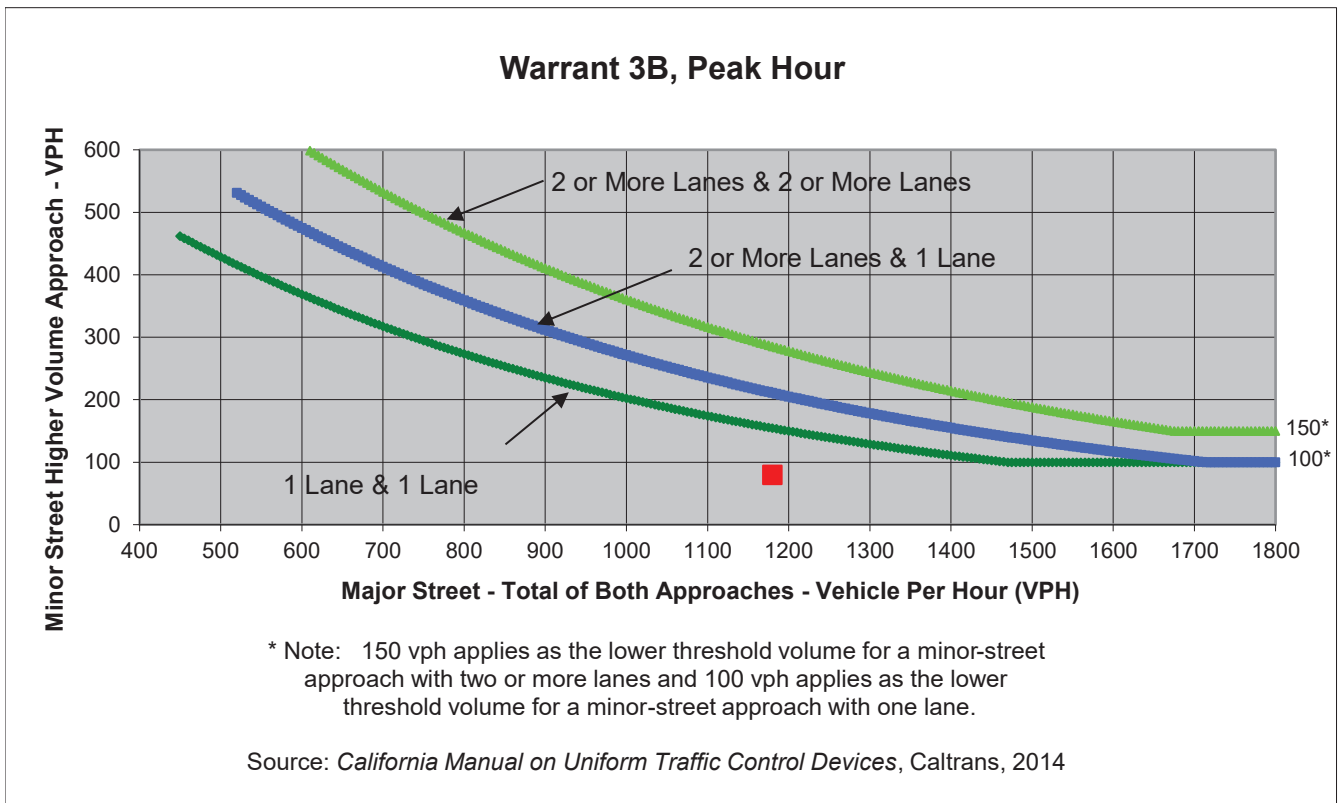

|                                 | Major Street | Minor Street | Warrant Met      |
|---------------------------------|--------------|--------------|------------------|
|                                 | Gigling Road | Malmedy Road |                  |
| <b>Number of Approach Lanes</b> | <b>1</b>     | <b>1</b>     | <b><u>NO</u></b> |
| <b>Traffic Volume (VPH) *</b>   | <b>1,180</b> | <b>80</b>    |                  |

\* Note: Traffic Volume for Major Street is Total Volume of Both Approaches.  
 Traffic Volume for Minor Street is the Volume of High Volume Approach.



Major Street Gigling Road  
 Minor Street Parker Flatts Cut Off Road

Project CSUMB Master Plan EIR  
 Scenario Existing Plus Project PM  
 Peak Hour PM

Turn Movement Volumes

|         | NB  | SB | EB  | WB  |
|---------|-----|----|-----|-----|
| Left    | 80  | 10 | 10  | 20  |
| Through | 10  | 10 | 610 | 490 |
| Right   | 50  | 10 | 20  | 20  |
| Total   | 140 | 30 | 640 | 530 |

Major Street Direction

|   |             |
|---|-------------|
|   | North/South |
| X | East/West   |

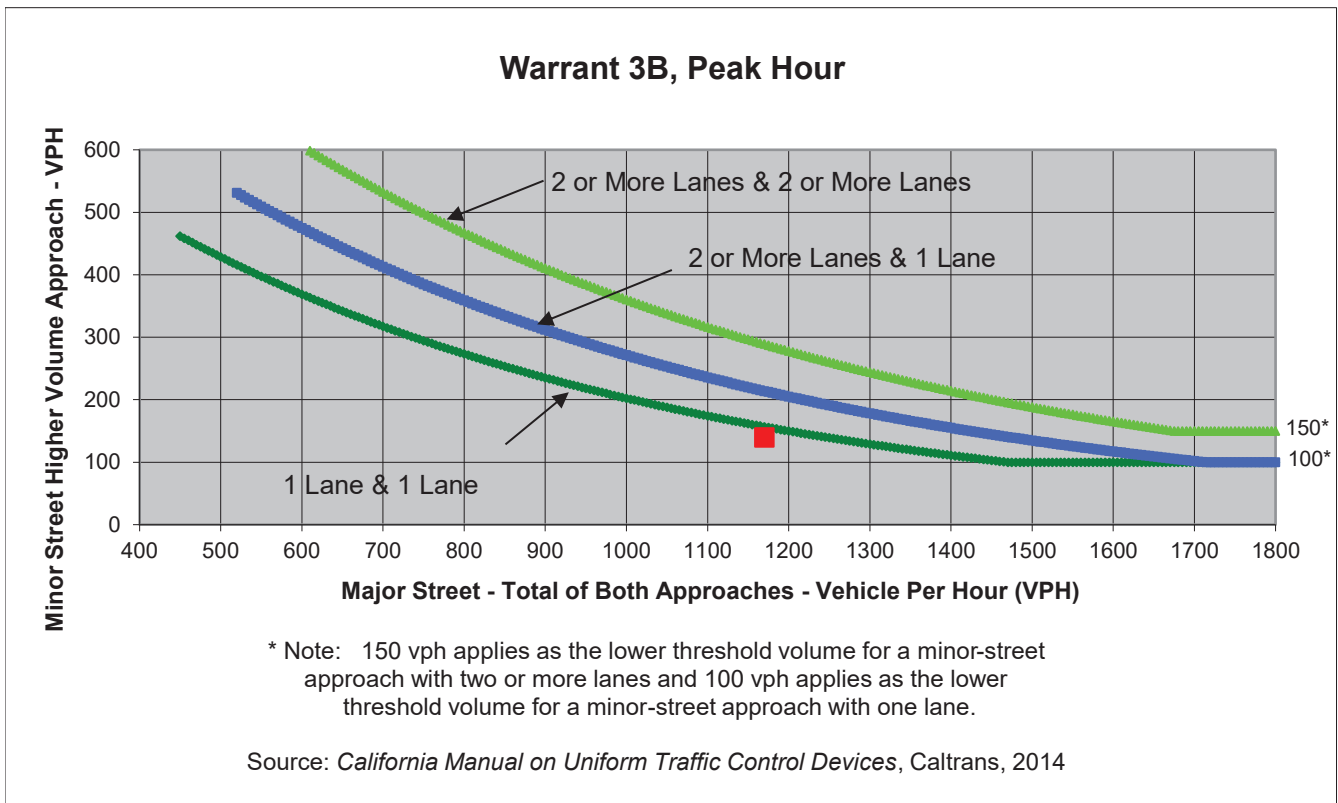

|                                 | Major Street | Minor Street               | Warrant Met      |
|---------------------------------|--------------|----------------------------|------------------|
|                                 | Gigling Road | Parker Flatts Cut Off Road |                  |
| <b>Number of Approach Lanes</b> | <b>1</b>     | <b>1</b>                   | <b><u>NO</u></b> |
| <b>Traffic Volume (VPH) *</b>   | <b>1,170</b> | <b>140</b>                 |                  |

\* Note: Traffic Volume for Major Street is Total Volume of Both Approaches.  
 Traffic Volume for Minor Street is the Volume of High Volume Approach.



Major Street Gigling Road  
 Minor Street 6th Avenue

Project CSUMB Master Plan EIR  
 Scenario Existing Plus Project PM  
 Peak Hour PM

Turn Movement Volumes

|         | NB | SB  | EB  | WB  |
|---------|----|-----|-----|-----|
| Left    | 10 | 10  | 180 | 10  |
| Through | 10 | 10  | 500 | 320 |
| Right   | 20 | 200 | 10  | 10  |
| Total   | 40 | 220 | 690 | 340 |

Major Street Direction

|   |             |
|---|-------------|
|   | North/South |
| X | East/West   |

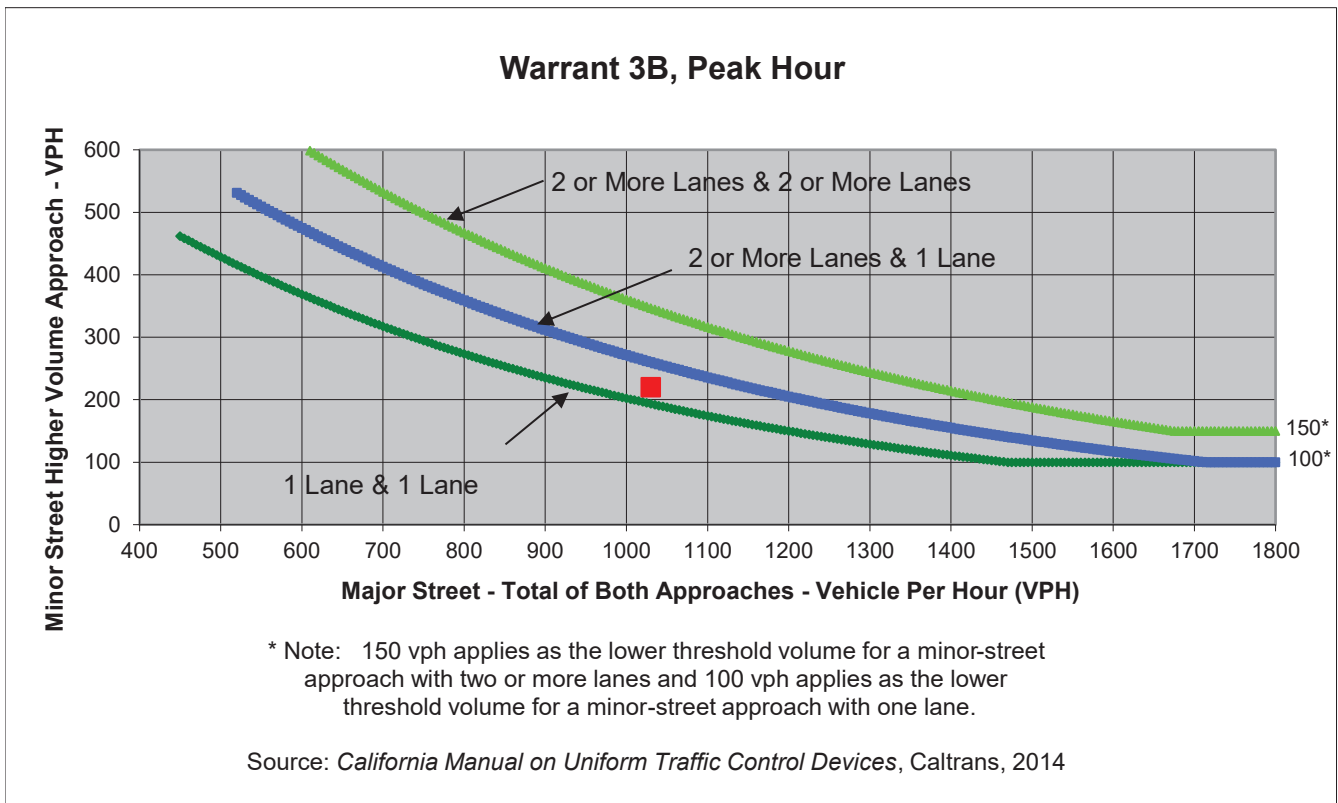

|                                 | Major Street | Minor Street | Warrant Met       |
|---------------------------------|--------------|--------------|-------------------|
|                                 | Gigling Road | 6th Avenue   |                   |
| <b>Number of Approach Lanes</b> | <b>1</b>     | <b>1</b>     | <b><u>YES</u></b> |
| <b>Traffic Volume (VPH) *</b>   | <b>1,030</b> | <b>220</b>   |                   |

\* Note: Traffic Volume for Major Street is Total Volume of Both Approaches.  
 Traffic Volume for Minor Street is the Volume of High Volume Approach.



Major Street General Jim Moore Boulevard  
 Minor Street Coe Avenue

Project CSUMB Master Plan EIR  
 Scenario Existing Plus Project PM  
 Peak Hour PM

Turn Movement Volumes

|         | NB    | SB  | EB  | WB |
|---------|-------|-----|-----|----|
| Left    | 160   | 0   | 60  | 0  |
| Through | 880   | 350 | 0   | 0  |
| Right   | 0     | 90  | 100 | 0  |
| Total   | 1,040 | 440 | 160 | 0  |

Major Street Direction

|   |             |
|---|-------------|
| X | North/South |
|   | East/West   |

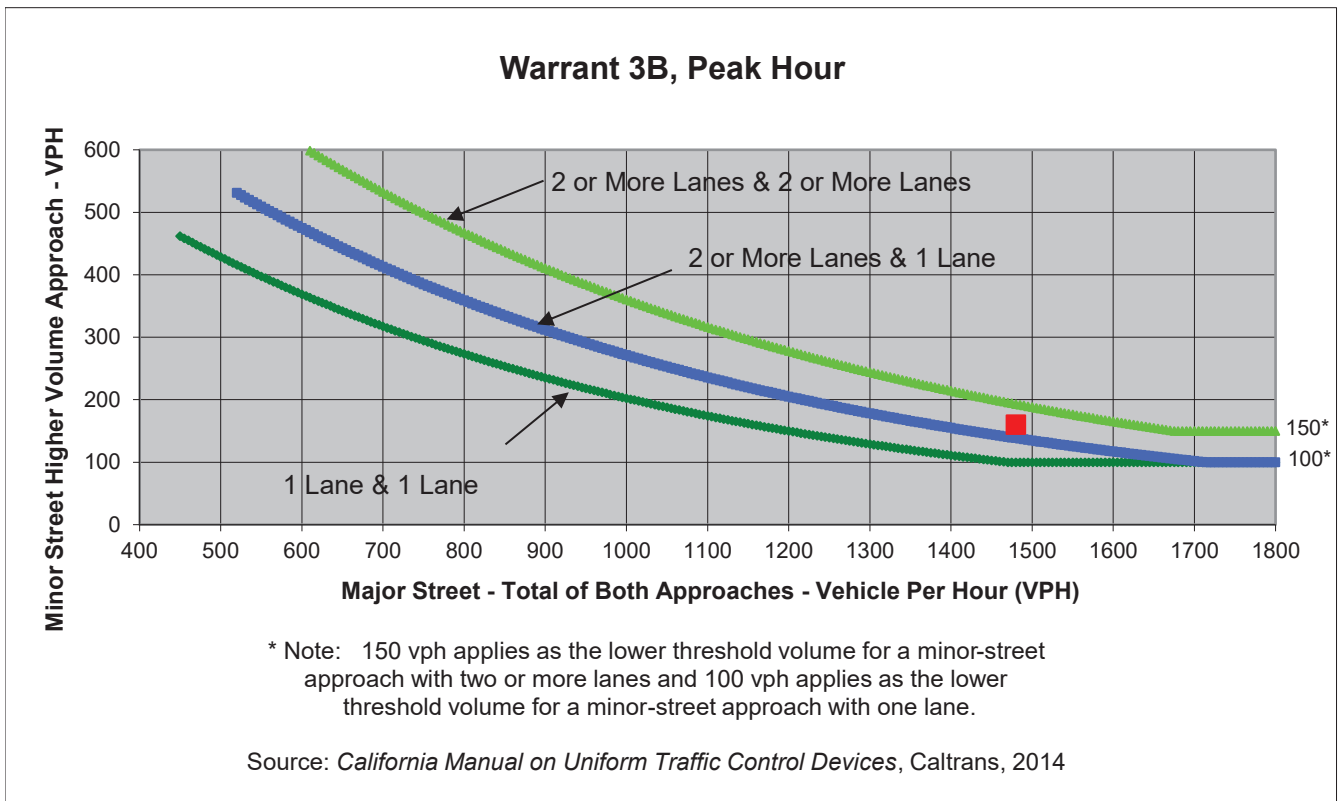

|                                 | Major Street                | Minor Street | Warrant Met       |
|---------------------------------|-----------------------------|--------------|-------------------|
|                                 | General Jim Moore Boulevard | Coe Avenue   |                   |
| <b>Number of Approach Lanes</b> | <b>2</b>                    | <b>1</b>     | <b><u>YES</u></b> |
| <b>Traffic Volume (VPH) *</b>   | <b>1,480</b>                | <b>160</b>   |                   |

\* Note: Traffic Volume for Major Street is Total Volume of Both Approaches.  
 Traffic Volume for Minor Street is the Volume of High Volume Approach.





Major Street **Imjin Parkway**  
 Minor Street **SR 1 NB Off-Ramp/SR 1 NB On-Ramp**

Project **CSUMB Master Plan EIR**  
 Scenario **Cumulative w/ Proj AM**  
 Peak Hour **AM**

Turn Movement Volumes

|         | NB | SB | EB    | WB    |
|---------|----|----|-------|-------|
| Left    | 10 | 0  | 10    | 0     |
| Through | 10 | 0  | 990   | 1,140 |
| Right   | 0  | 0  | 0     | 440   |
| Total   | 20 | 0  | 1,000 | 1,580 |

Major Street Direction

|   |             |
|---|-------------|
|   | North/South |
| X | East/West   |

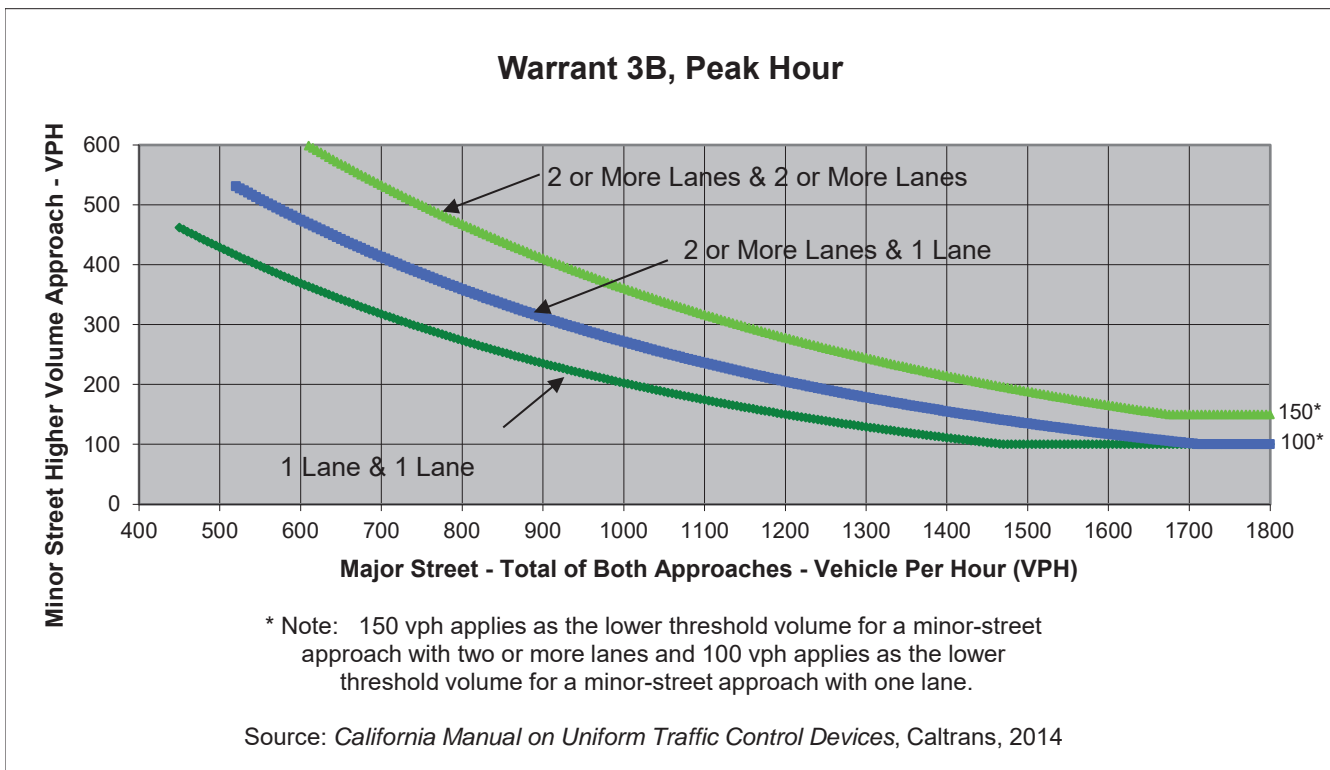

|  | Major Street  | Minor Street                     | Warrant Met      |
|--|---------------|----------------------------------|------------------|
|  | Imjin Parkway | SR 1 NB Off-Ramp/SR 1 NB On-Ramp |                  |
| <b>Number of Approach Lanes</b>  | <b>1</b>      | <b>1</b>                         | <b><u>NO</u></b> |
| <b>Traffic Volume (VPH) *</b>  | <b>2,580</b>  | <b>20</b>                        |                  |
| * Note: Traffic Volume for Major Street is Total Volume of Both Approches.<br>Traffic Volume for Minor Street is the Volume of High Volume Approach. |               |                                  |                  |



Major Street **Inter-Garrison Road**  
 Minor Street **8th Avenue**

Project **CSUMB Master Plan EIR**  
 Scenario **Cumulative w/ Proj AM**  
 Peak Hour **AM**

Turn Movement Volumes

|         | NB  | SB | EB  | WB    |
|---------|-----|----|-----|-------|
| Left    | 50  | 0  | 0   | 750   |
| Through | 0   | 0  | 240 | 570   |
| Right   | 410 | 0  | 250 | 0     |
| Total   | 460 | 0  | 490 | 1,320 |

Major Street Direction

|   |             |
|---|-------------|
|   | North/South |
| X | East/West   |

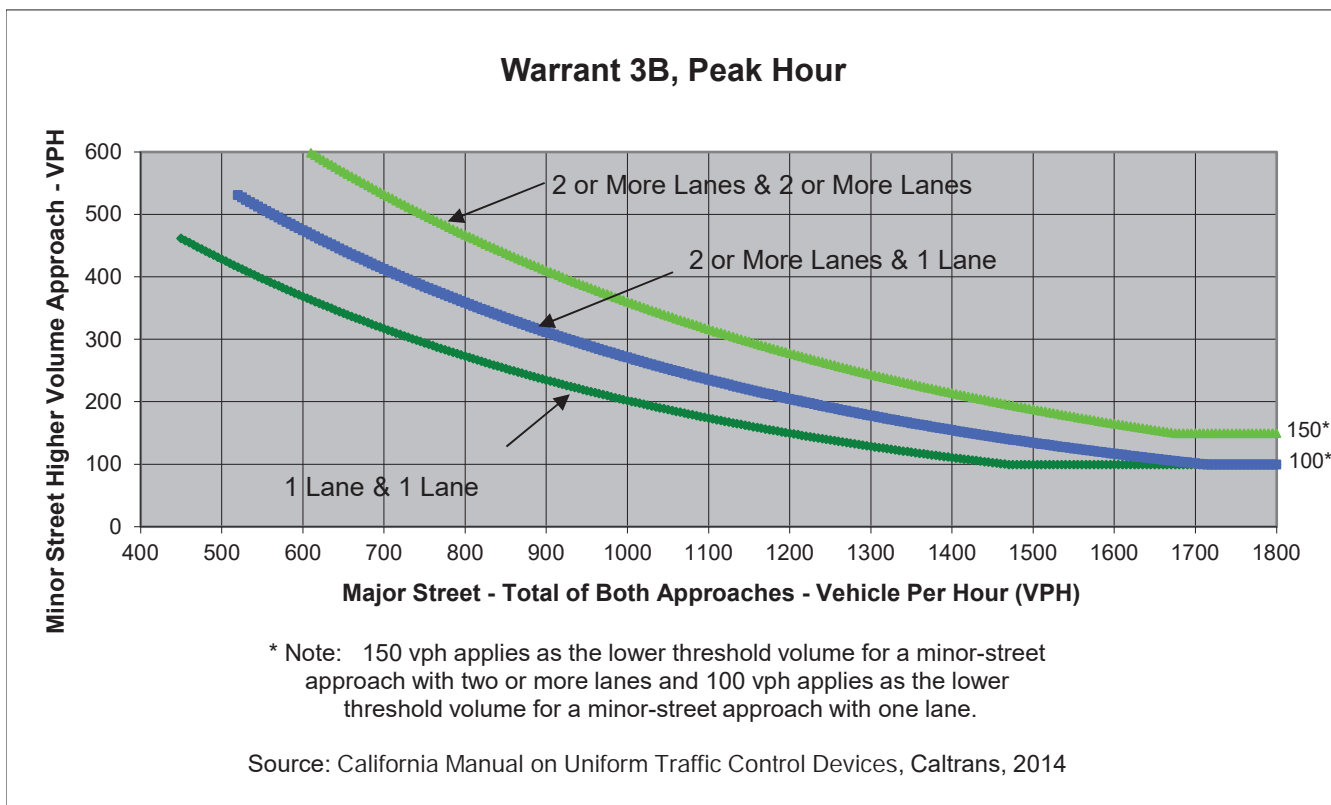

|  | Major Street        | Minor Street | Warrant Met |
|--|---------------------|--------------|-------------|
|  | Inter-Garrison Road | 8th Avenue   |             |
| <b>Number of Approach Lanes</b>  | <b>1</b>            | <b>1</b>     | <b>YES</b>  |
| <b>Traffic Volume (VPH) *</b>  | <b>1,810</b>        | <b>460</b>   |             |
| * Note: Traffic Volume for Major Street is Total Volume of Both Approches.<br>Traffic Volume for Minor Street is the Volume of High Volume Approach. |                     |              |             |



Major Street **Inter-Garrison Road**  
 Minor Street **Schoonover Road**

Project **CSUMB Master Plan EIR**  
 Scenario **Cumulative w/ Proj AM**  
 Peak Hour **AM**

Turn Movement Volumes

|         | NB | SB  | EB  | WB  |
|---------|----|-----|-----|-----|
| Left    | 0  | 70  | 70  | 0   |
| Through | 0  | 0   | 380 | 660 |
| Right   | 0  | 160 | 0   | 10  |
| Total   | 0  | 230 | 450 | 670 |

Major Street Direction

|   |             |
|---|-------------|
|   | North/South |
| X | East/West   |

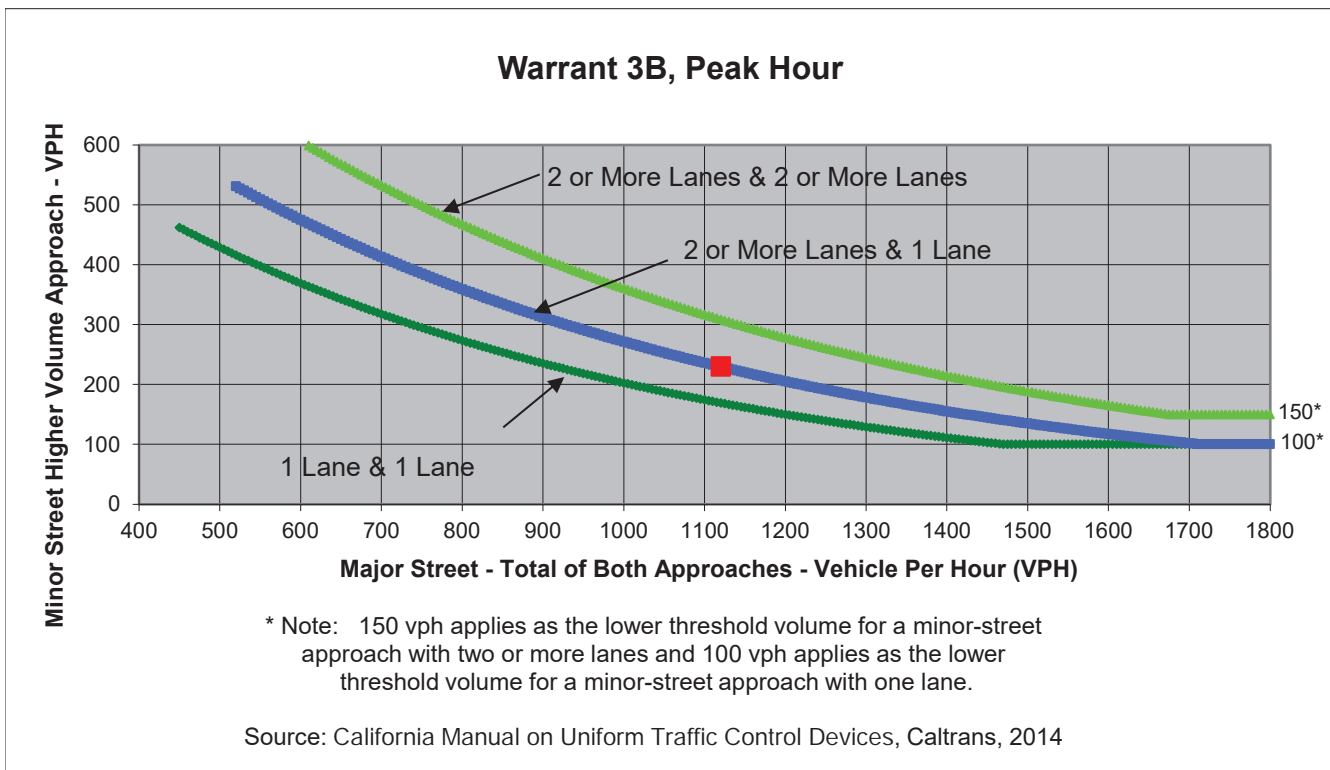

|                                 | <b>Major Street</b> | <b>Minor Street</b> | <b>Warrant Met</b> |
|---------------------------------|---------------------|---------------------|--------------------|
|                                 | Inter-Garrison Road | Schoonover Road     |                    |
| <b>Number of Approach Lanes</b> | <b>2</b>            | <b>2</b>            | <b><u>NO</u></b>   |
| <b>Traffic Volume (VPH) *</b>   | <b>1,120</b>        | <b>230</b>          |                    |

\* Note: Traffic Volume for Major Street is Total Volume of Both Approches.  
 Traffic Volume for Minor Street is the Volume of High Volume Approach.

Major Street Inter-Garrison Road/Sherman Boulevard  
 Minor Street Inter-Garrison Road

Project Sample Project Title  
 Scenario Cumulative PP AM  
 Peak Hour AM

Turn Movement Volumes

|         | NB | SB  | EB  | WB  |
|---------|----|-----|-----|-----|
| Left    | 0  | 110 | 370 | 0   |
| Through | 0  | 0   | 80  | 170 |
| Right   | 0  | 510 | 0   | 210 |
| Total   | 0  | 620 | 450 | 380 |

Major Street Direction

|   |             |
|---|-------------|
|   | North/South |
| X | East/West   |

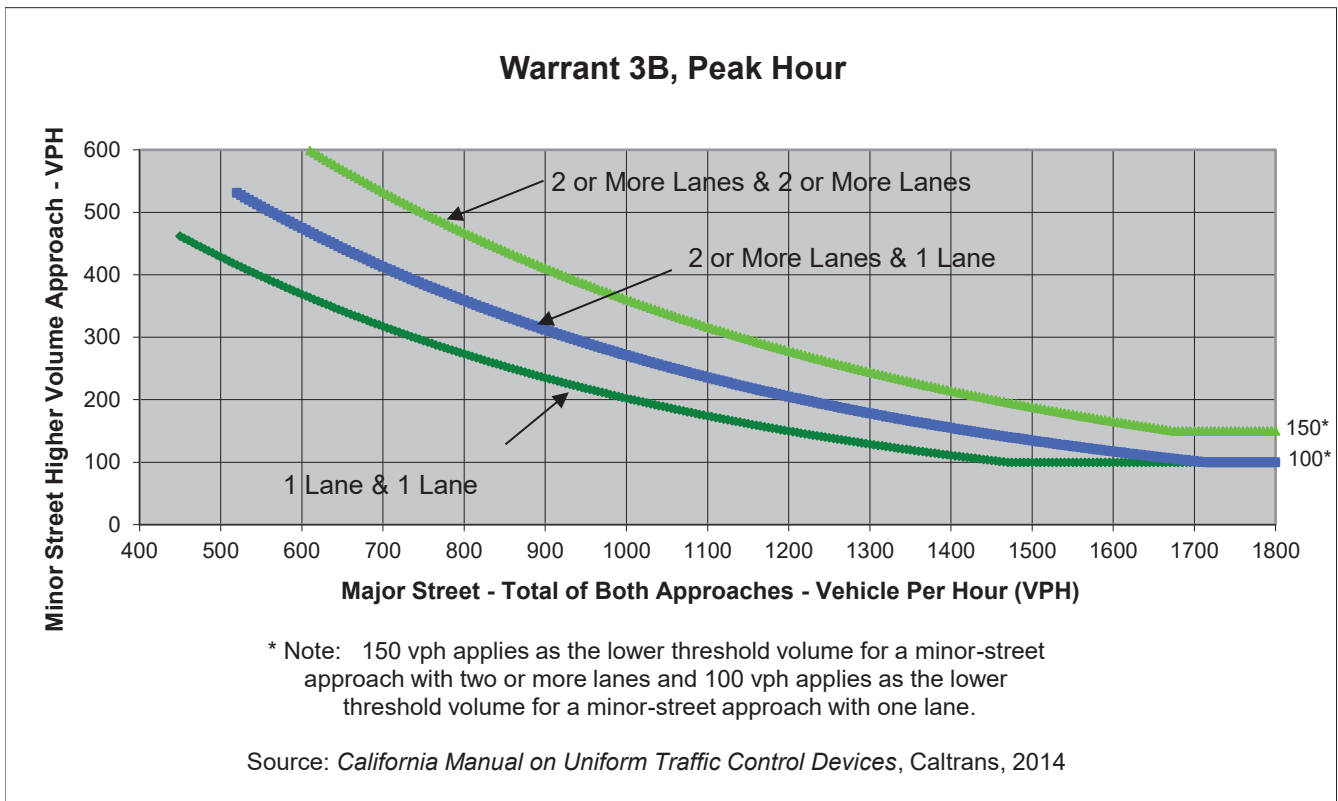

|                                 | Major Street                          | Minor Street        | Warrant Met |
|---------------------------------|---------------------------------------|---------------------|-------------|
|                                 | Inter-Garrison Road/Sherman Boulevard | Inter-Garrison Road |             |
| <b>Number of Approach Lanes</b> | <b>1</b>                              | <b>1</b>            | <b>YES</b>  |
| <b>Traffic Volume (VPH) *</b>   | <b>830</b>                            | <b>620</b>          |             |

\* Note: Traffic Volume for Major Street is Total Volume of Both Approaches.  
 Traffic Volume for Minor Street is the Volume of High Volume Approach.

Major Street 7th Avenue  
 Minor Street Colonel Durham Street

Project Sample Project Title  
 Scenario Cumulative PP AM  
 Peak Hour AM

Turn Movement Volumes

|              | NB         | SB       | EB         | WB         |
|--------------|------------|----------|------------|------------|
| Left         | 50         | 0        | 80         | 10         |
| Through      | 140        | 0        | 80         | 90         |
| Right        | 20         | 0        | 90         | 20         |
| <b>Total</b> | <b>210</b> | <b>0</b> | <b>250</b> | <b>120</b> |

Major Street Direction

|   |             |
|---|-------------|
| X | North/South |
|   | East/West   |

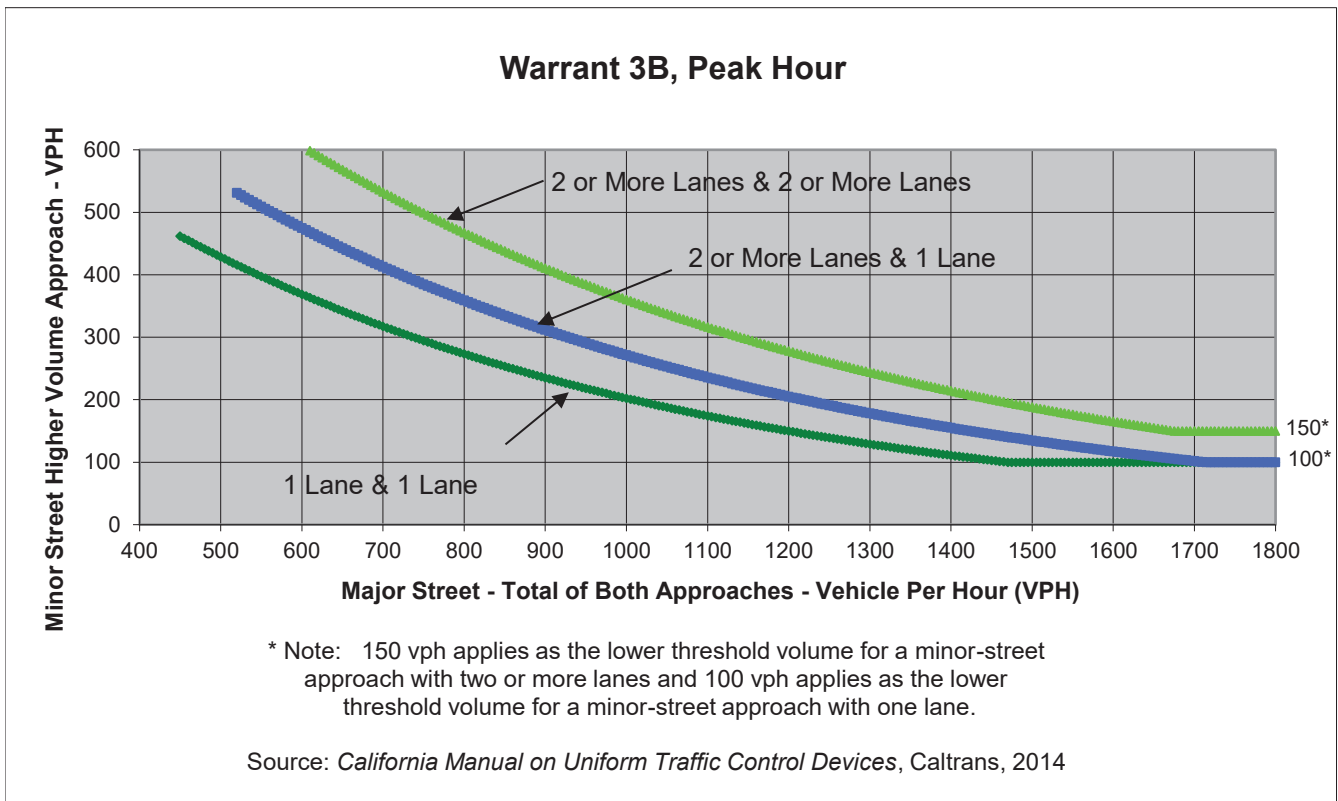

|   | Major Street | Minor Street          | Warrant Met      |
|---|--------------|-----------------------|------------------|
|   | 7th Avenue   | Colonel Durham Street |                  |
| <b>Number of Approach Lanes</b>   | <b>1</b>     | <b>1</b>              | <b><u>NO</u></b> |
| <b>Traffic Volume (VPH) *</b>   | <b>210</b>   | <b>250</b>            |                  |
| * Note: Traffic Volume for Major Street is Total Volume of Both Approaches.<br>Traffic Volume for Minor Street is the Volume of High Volume Approach. |              |                       |                  |



Major Street 8th Avenue  
 Minor Street Colonel Durham Street

Project Sample Project Title  
 Scenario Cumulative PP AM  
 Peak Hour AM

Turn Movement Volumes

|         | NB  | SB  | EB  | WB |
|---------|-----|-----|-----|----|
| Left    | 10  | 0   | 110 | 0  |
| Through | 260 | 780 | 0   | 0  |
| Right   | 0   | 120 | 10  | 0  |
| Total   | 270 | 900 | 120 | 0  |

Major Street Direction

|   |             |
|---|-------------|
| X | North/South |
|   | East/West   |

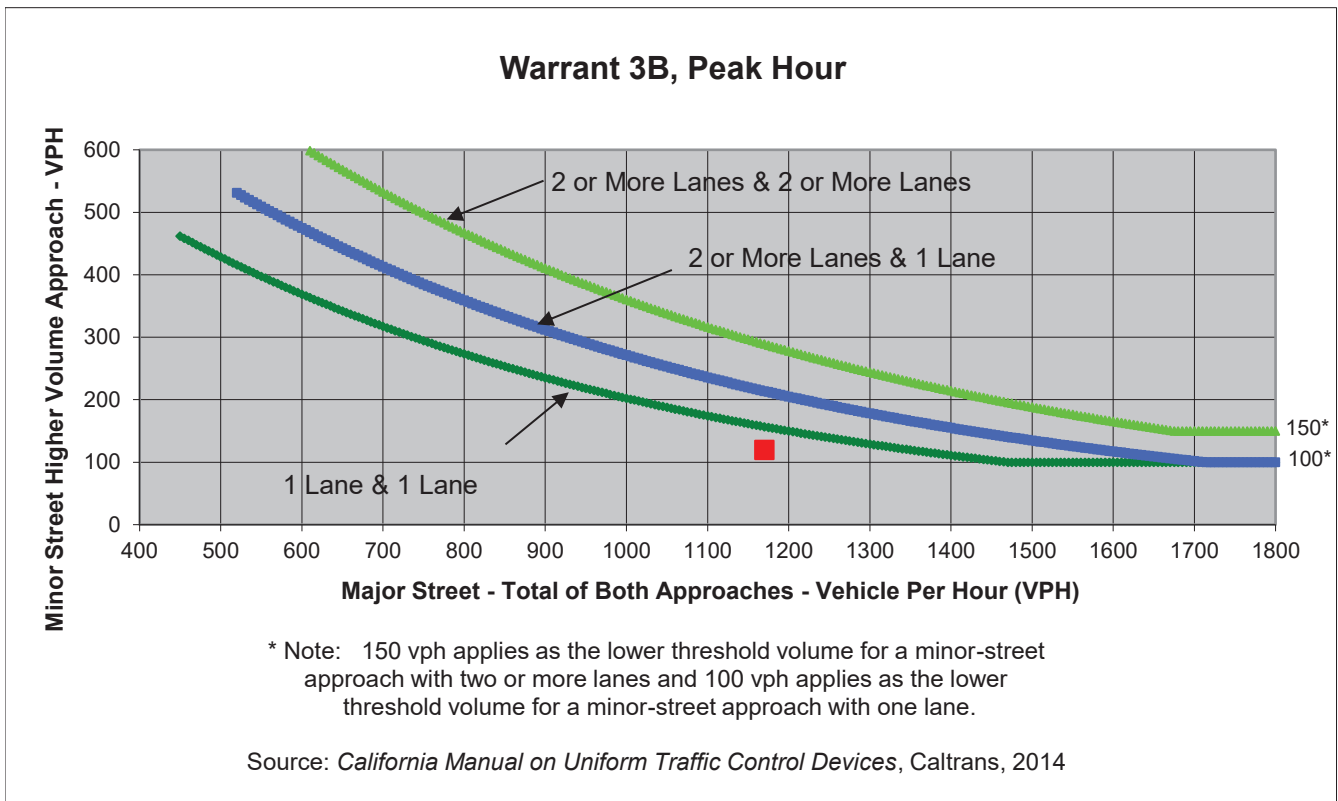

|                                 | Major Street | Minor Street          | Warrant Met      |
|---------------------------------|--------------|-----------------------|------------------|
|                                 | 8th Avenue   | Colonel Durham Street |                  |
| <b>Number of Approach Lanes</b> | <b>1</b>     | <b>1</b>              | <b><u>NO</u></b> |
| <b>Traffic Volume (VPH) *</b>   | <b>1,170</b> | <b>120</b>            |                  |

\* Note: Traffic Volume for Major Street is Total Volume of Both Approaches.  
 Traffic Volume for Minor Street is the Volume of High Volume Approach.



Major Street General Jim Moore Boulevard  
 Minor Street Coe Avenue

Project Sample Project Title  
 Scenario Cumulative PP AM  
 Peak Hour AM

Turn Movement Volumes

|         | NB  | SB    | EB  | WB |
|---------|-----|-------|-----|----|
| Left    | 230 | 0     | 90  | 0  |
| Through | 420 | 980   | 0   | 0  |
| Right   | 0   | 80    | 430 | 0  |
| Total   | 650 | 1,060 | 520 | 0  |

Major Street Direction

X North/South  
 East/West

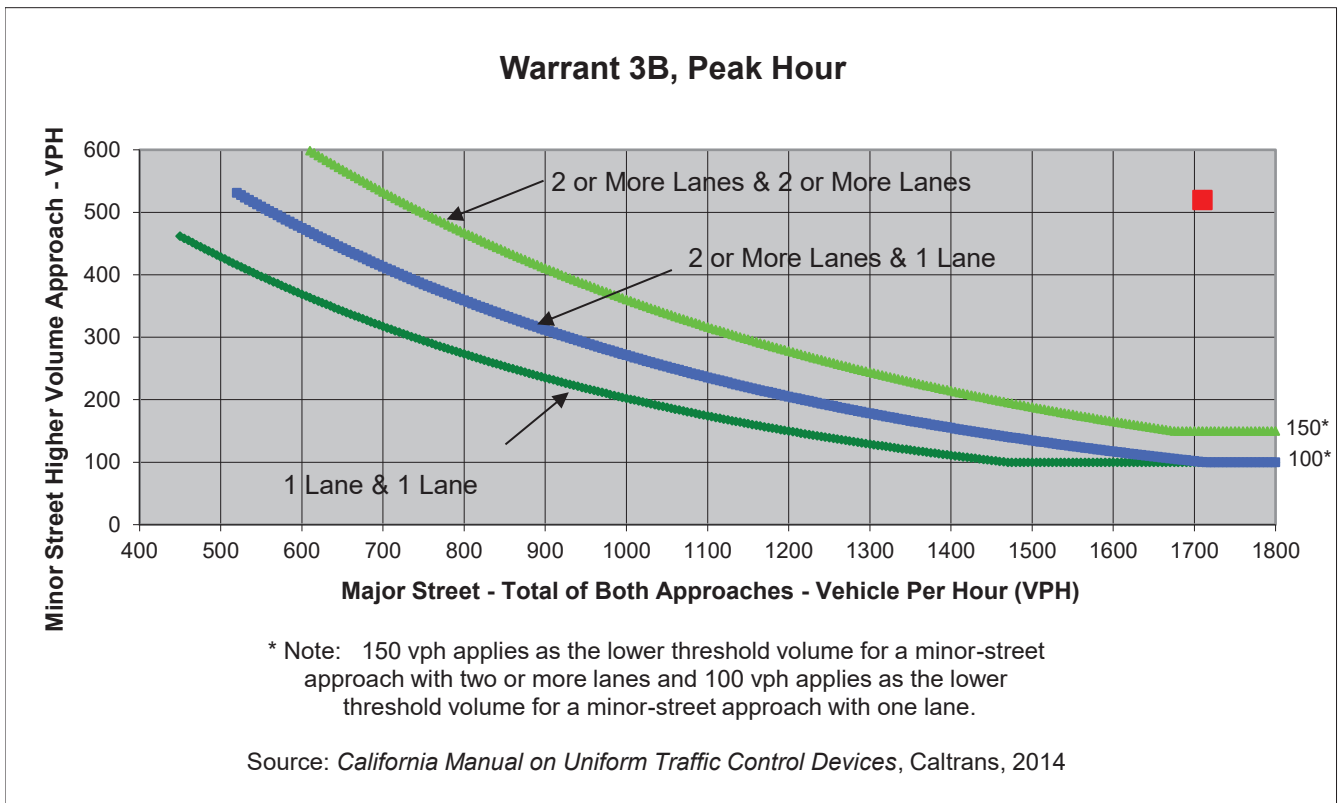

|                                 | Major Street                | Minor Street | Warrant Met       |
|---------------------------------|-----------------------------|--------------|-------------------|
|                                 | General Jim Moore Boulevard | Coe Avenue   |                   |
| <b>Number of Approach Lanes</b> | <b>2</b>                    | <b>1</b>     | <b><u>YES</u></b> |
| <b>Traffic Volume (VPH) *</b>   | <b>1,710</b>                | <b>520</b>   |                   |

\* Note: Traffic Volume for Major Street is Total Volume of Both Approaches.  
 Traffic Volume for Minor Street is the Volume of High Volume Approach.



Major Street **Imjin Parkway**  
 Minor Street **SR 1 NB Off-Ramp/SR 1 NB On-Ramp**

Project **CSUMB Master Plan EIR**  
 Scenario **Cumulative w/ Proj PM**  
 Peak Hour **PM**

Turn Movement Volumes

|         | NB | SB | EB  | WB    |
|---------|----|----|-----|-------|
| Left    | 10 | 0  | 10  | 0     |
| Through | 10 | 0  | 650 | 1,220 |
| Right   | 0  | 0  | 0   | 920   |
| Total   | 20 | 0  | 660 | 2,140 |

Major Street Direction

|   |             |
|---|-------------|
|   | North/South |
| X | East/West   |

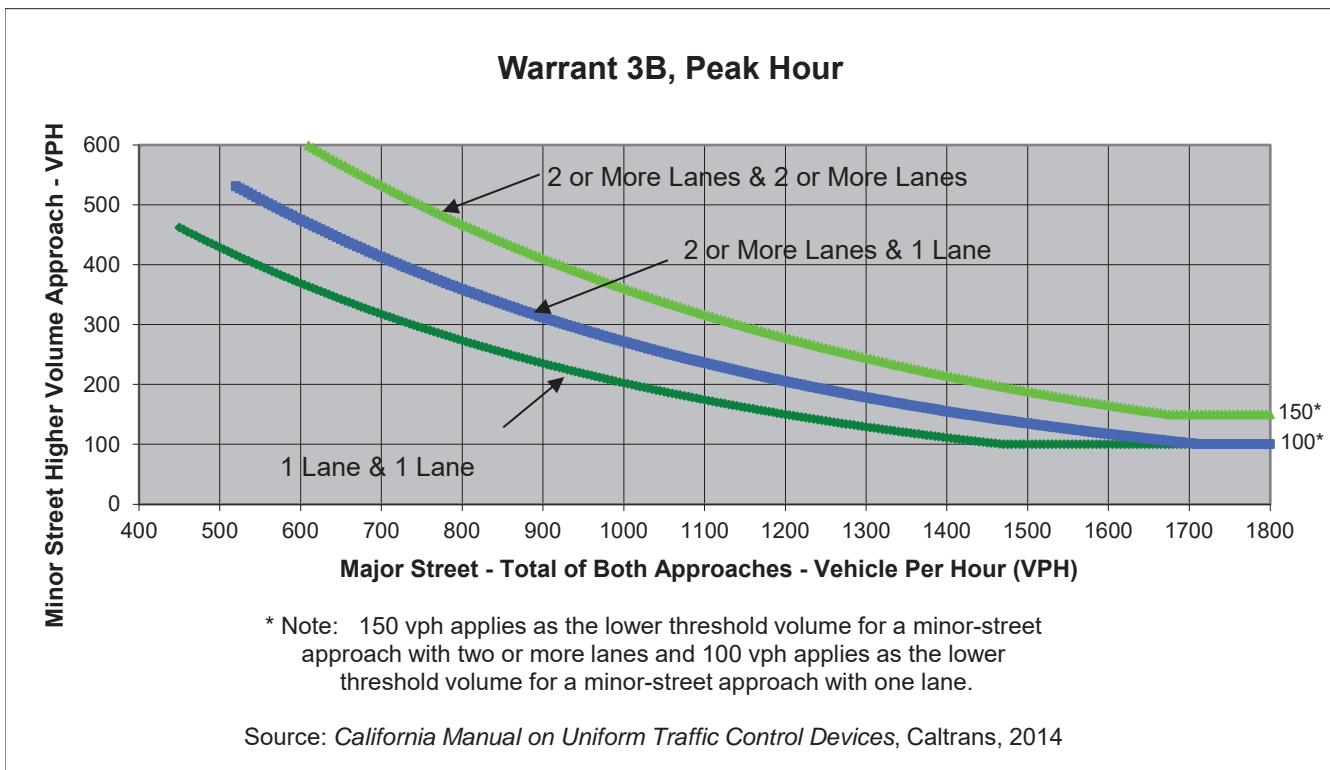

|                                 | Major Street  | Minor Street                     | Warrant Met      |
|---------------------------------|---------------|----------------------------------|------------------|
|                                 | Imjin Parkway | SR 1 NB Off-Ramp/SR 1 NB On-Ramp |                  |
| <b>Number of Approach Lanes</b> | <b>1</b>      | <b>1</b>                         | <b><u>NO</u></b> |
| <b>Traffic Volume (VPH) *</b>   | <b>2,800</b>  | <b>20</b>                        |                  |

\* Note: Traffic Volume for Major Street is Total Volume of Both Approches.  
 Traffic Volume for Minor Street is the Volume of High Volume Approach.





Major Street Inter-Garrison Road  
 Minor Street 8th Avenue

Project CSUMB Master Plan EIR  
 Scenario Cumulative w/ Proj PM  
 Peak Hour PM

Turn Movement Volumes

|         | NB  | SB | EB  | WB  |
|---------|-----|----|-----|-----|
| Left    | 50  | 0  | 0   | 430 |
| Through | 0   | 0  | 640 | 410 |
| Right   | 750 | 0  | 140 | 0   |
| Total   | 800 | 0  | 780 | 840 |

Major Street Direction

|   |             |
|---|-------------|
|   | North/South |
| X | East/West   |

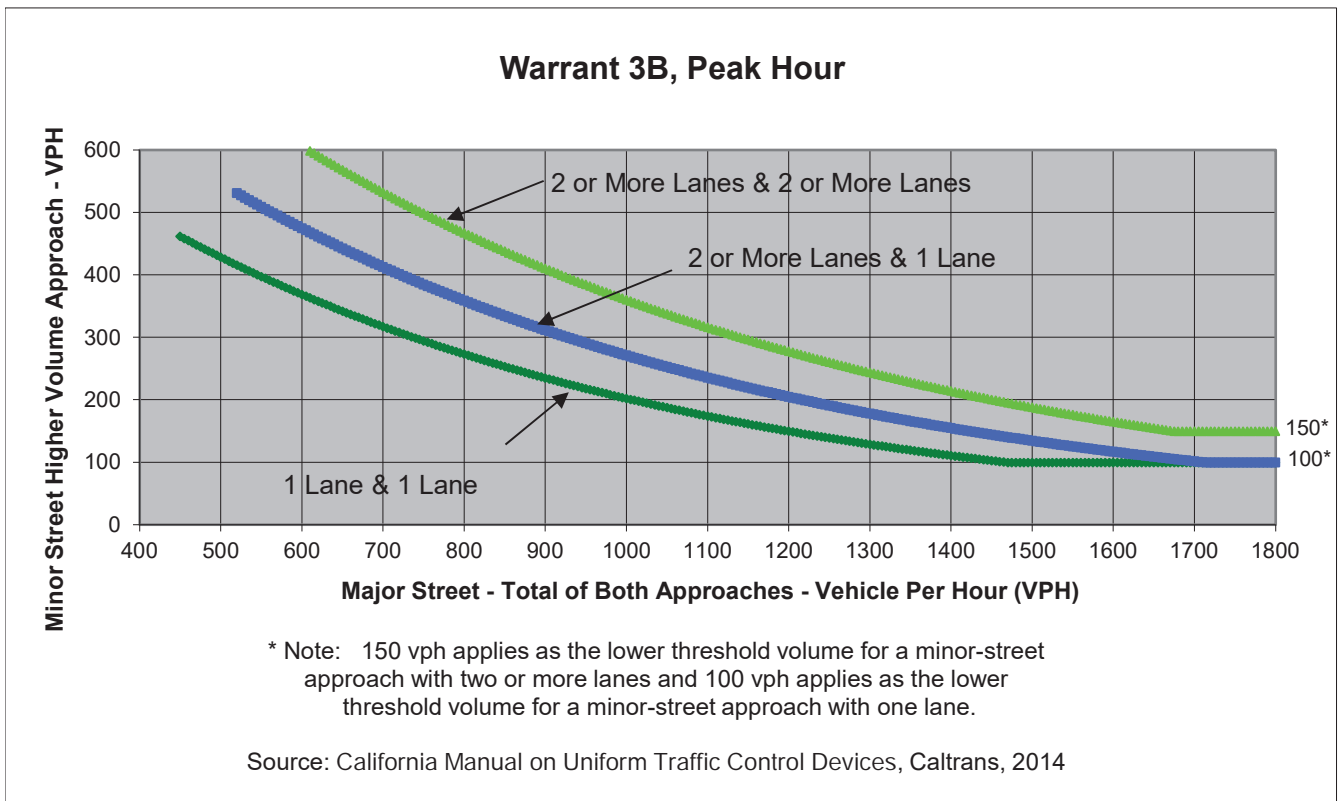

|                                 | Major Street        | Minor Street | Warrant Met       |
|---------------------------------|---------------------|--------------|-------------------|
|                                 | Inter-Garrison Road | 8th Avenue   |                   |
| <b>Number of Approach Lanes</b> | <b>1</b>            | <b>1</b>     | <b><u>YES</u></b> |
| <b>Traffic Volume (VPH) *</b>   | <b>1,620</b>        | <b>800</b>   |                   |

\* Note: Traffic Volume for Major Street is Total Volume of Both Approaches.  
 Traffic Volume for Minor Street is the Volume of High Volume Approach.



Major Street **Inter-Garrison Road**  
 Minor Street **Schoonover Road**

Project **CSUMB Master Plan EIR**  
 Scenario **Cumulative w/ Proj PM**  
 Peak Hour **PM**

Turn Movement Volumes

|         | NB | SB | EB  | WB  |
|---------|----|----|-----|-----|
| Left    | 0  | 20 | 200 | 0   |
| Through | 0  | 0  | 610 | 350 |
| Right   | 0  | 70 | 0   | 50  |
| Total   | 0  | 90 | 810 | 400 |

Major Street Direction

|   |             |
|---|-------------|
|   | North/South |
| X | East/West   |

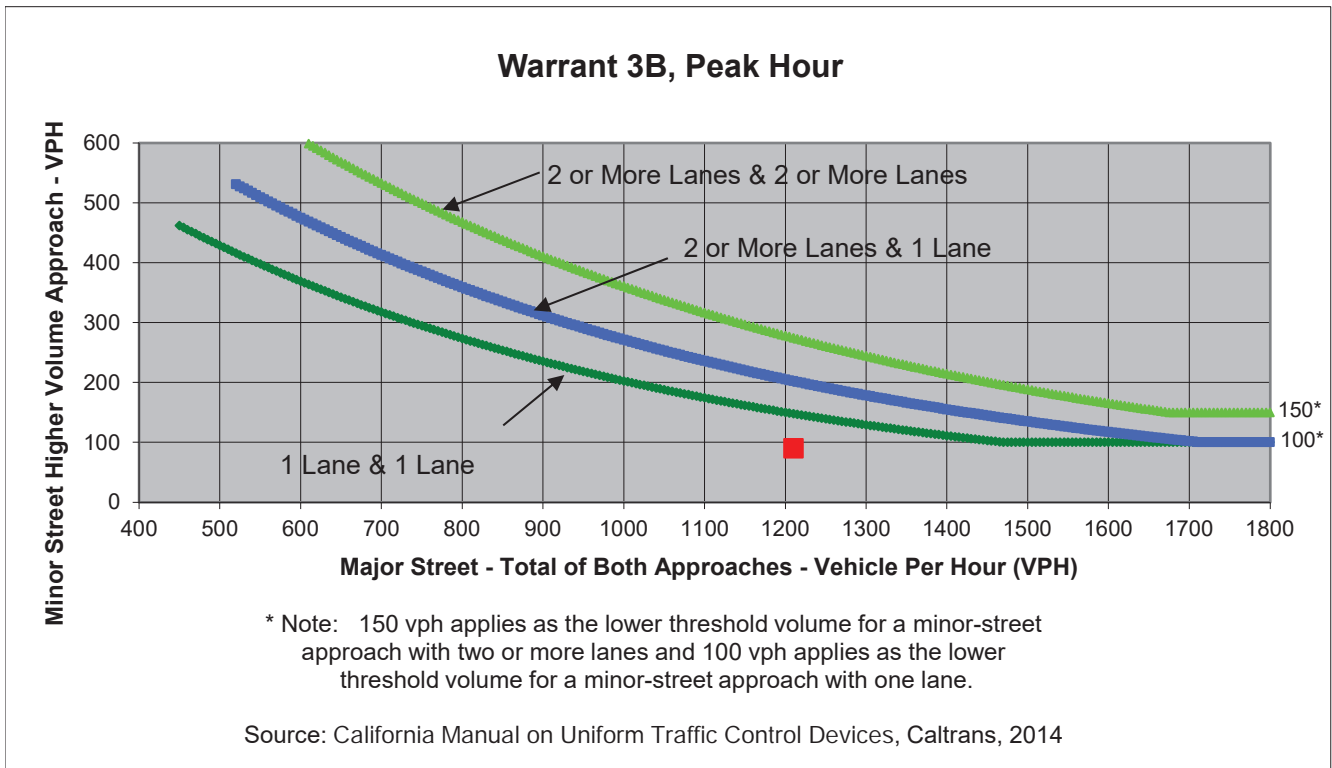

|                                 | Major Street        | Minor Street    | Warrant Met      |
|---------------------------------|---------------------|-----------------|------------------|
|                                 | Inter-Garrison Road | Schoonover Road |                  |
| <b>Number of Approach Lanes</b> | <b>2</b>            | <b>2</b>        | <b><u>NO</u></b> |
| <b>Traffic Volume (VPH) *</b>   | <b>1,210</b>        | <b>90</b>       |                  |

\* Note: Traffic Volume for Major Street is Total Volume of Both Approches.  
 Traffic Volume for Minor Street is the Volume of High Volume Approach.

Major Street Inter-Garrison Road/Sherman Boulevard  
 Minor Street Inter-Garrison Road

Project Sample Project Title  
 Scenario Cumulative PP PM  
 Peak Hour PM

Turn Movement Volumes

|         | NB | SB  | EB  | WB  |
|---------|----|-----|-----|-----|
| Left    | 0  | 190 | 460 | 0   |
| Through | 0  | 0   | 150 | 100 |
| Right   | 0  | 180 | 0   | 130 |
| Total   | 0  | 370 | 610 | 230 |

Major Street Direction

|   |             |
|---|-------------|
|   | North/South |
| X | East/West   |

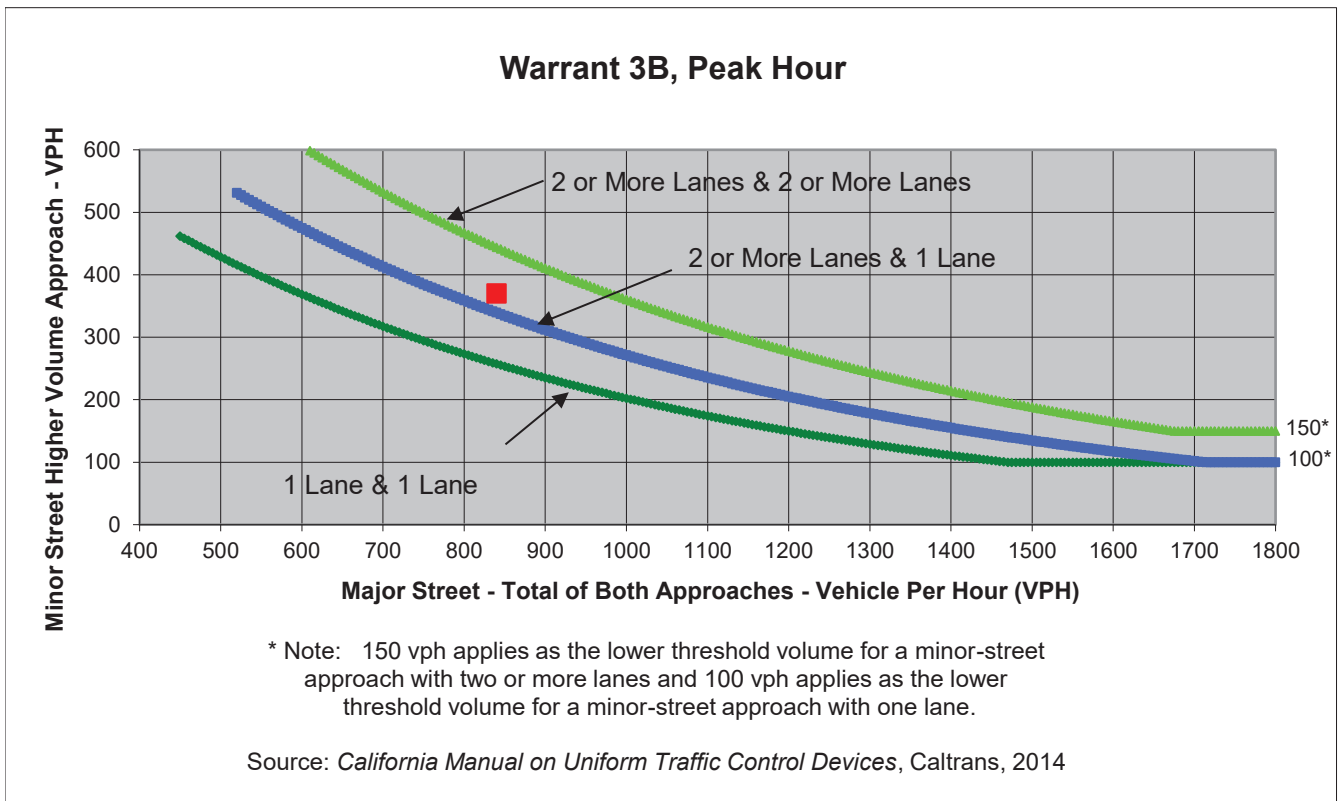

|   | Major Street                          | Minor Street        | Warrant Met |
|---|---------------------------------------|---------------------|-------------|
|   | Inter-Garrison Road/Sherman Boulevard | Inter-Garrison Road |             |
| <b>Number of Approach Lanes</b>   | <b>1</b>                              | <b>1</b>            | <b>YES</b>  |
| <b>Traffic Volume (VPH) *</b>   | <b>840</b>                            | <b>370</b>          |             |
| * Note: Traffic Volume for Major Street is Total Volume of Both Approaches.<br>Traffic Volume for Minor Street is the Volume of High Volume Approach. |                                       |                     |             |

Major Street 7th Avenue  
 Minor Street Colonel Durham Street

Project Sample Project Title  
 Scenario Cumulative PP PM  
 Peak Hour PM

Turn Movement Volumes

|         | NB  | SB | EB  | WB  |
|---------|-----|----|-----|-----|
| Left    | 90  | 0  | 70  | 30  |
| Through | 210 | 0  | 110 | 90  |
| Right   | 20  | 0  | 50  | 10  |
| Total   | 320 | 0  | 230 | 130 |

Major Street Direction

|   |             |
|---|-------------|
| X | North/South |
|   | East/West   |

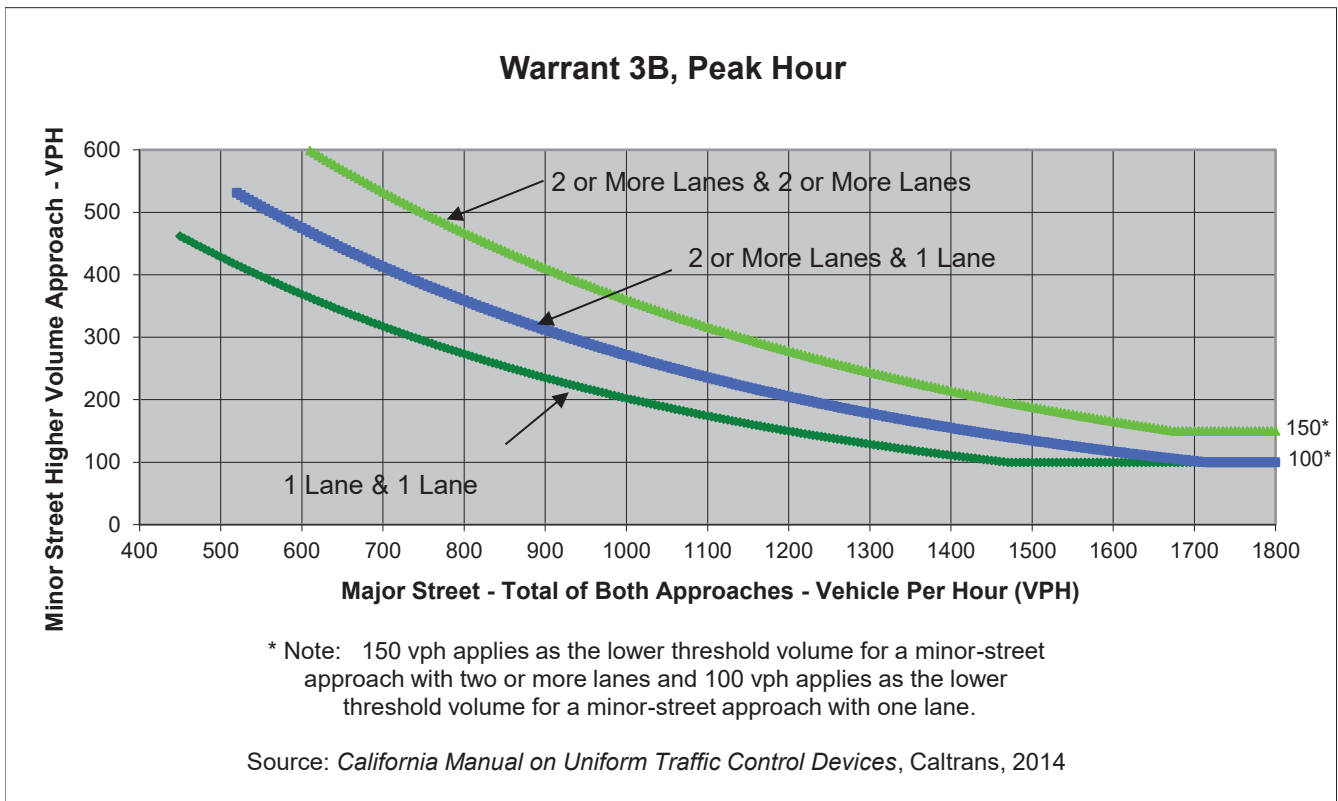

|                                 | Major Street | Minor Street          | Warrant Met      |
|---------------------------------|--------------|-----------------------|------------------|
|                                 | 7th Avenue   | Colonel Durham Street |                  |
| <b>Number of Approach Lanes</b> | <b>1</b>     | <b>1</b>              | <b><u>NO</u></b> |
| <b>Traffic Volume (VPH) *</b>   | <b>320</b>   | <b>230</b>            |                  |

\* Note: Traffic Volume for Major Street is Total Volume of Both Approaches.  
 Traffic Volume for Minor Street is the Volume of High Volume Approach.



Major Street 8th Avenue  
 Minor Street Colonel Durham Street

Project Sample Project Title  
 Scenario Cumulative PP PM  
 Peak Hour PM

Turn Movement Volumes

|         | NB  | SB  | EB  | WB |
|---------|-----|-----|-----|----|
| Left    | 10  | 0   | 130 | 0  |
| Through | 450 | 380 | 0   | 0  |
| Right   | 0   | 120 | 10  | 0  |
| Total   | 460 | 500 | 140 | 0  |

Major Street Direction

|   |             |
|---|-------------|
| X | North/South |
|   | East/West   |

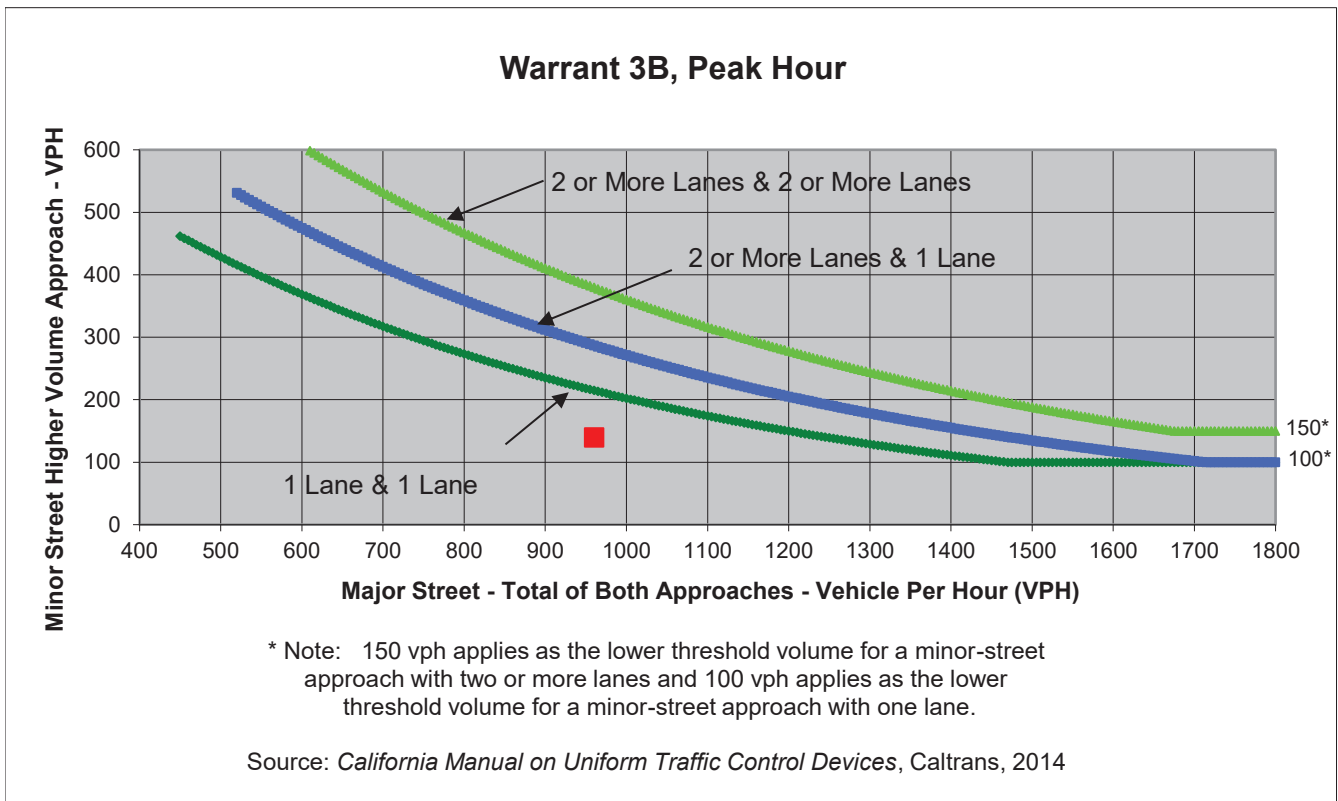

|                                 | Major Street | Minor Street          | Warrant Met      |
|---------------------------------|--------------|-----------------------|------------------|
|                                 | 8th Avenue   | Colonel Durham Street |                  |
| <b>Number of Approach Lanes</b> | <b>1</b>     | <b>1</b>              | <b><u>NO</u></b> |
| <b>Traffic Volume (VPH) *</b>   | <b>960</b>   | <b>140</b>            |                  |

\* Note: Traffic Volume for Major Street is Total Volume of Both Approaches.  
 Traffic Volume for Minor Street is the Volume of High Volume Approach.



Major Street General Jim Moore Boulevard  
 Minor Street Coe Avenue

Project Sample Project Title  
 Scenario Cumulative PP PM  
 Peak Hour PM

Turn Movement Volumes

|         | NB    | SB  | EB  | WB |
|---------|-------|-----|-----|----|
| Left    | 150   | 0   | 60  | 0  |
| Through | 980   | 440 | 0   | 0  |
| Right   | 0     | 50  | 100 | 0  |
| Total   | 1,130 | 490 | 160 | 0  |

Major Street Direction

|   |             |
|---|-------------|
| X | North/South |
|   | East/West   |

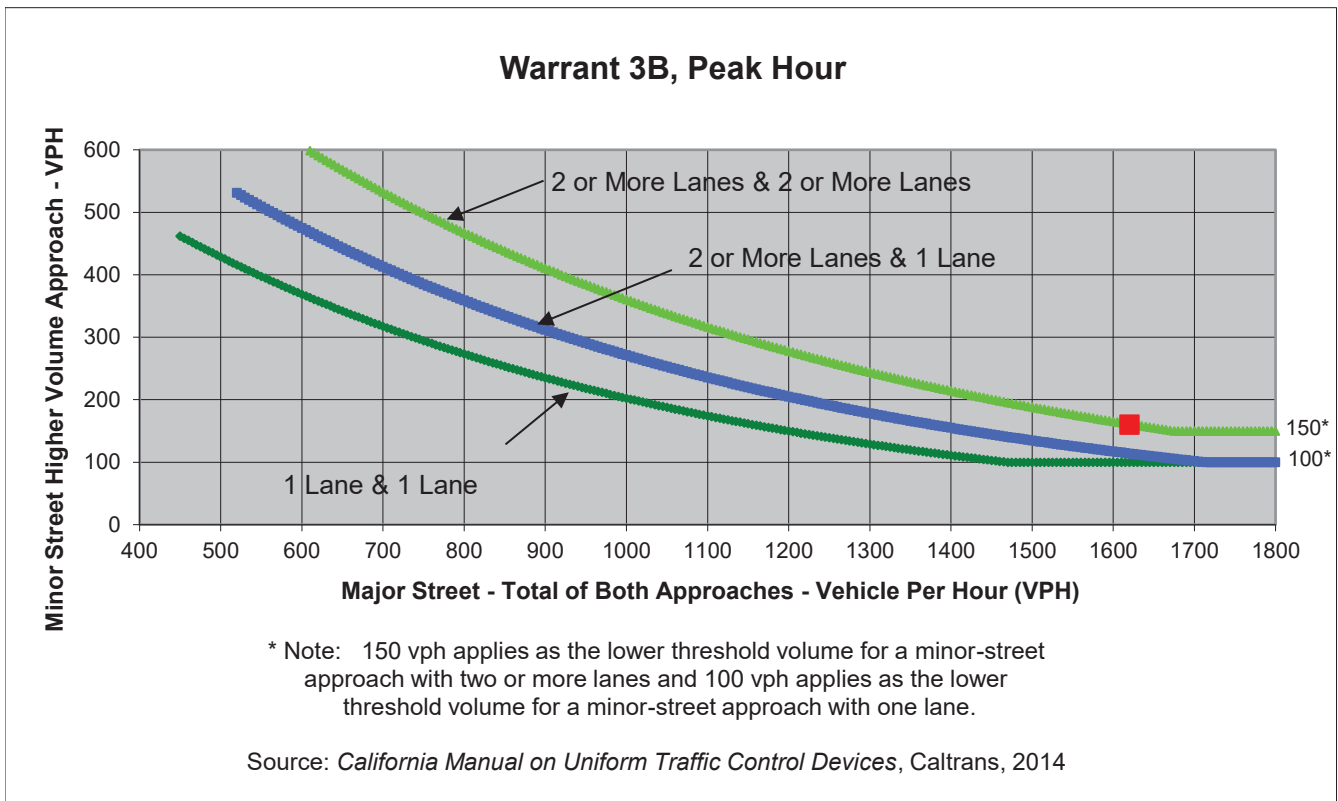

|                                 | Major Street                | Minor Street | Warrant Met       |
|---------------------------------|-----------------------------|--------------|-------------------|
|                                 | General Jim Moore Boulevard | Coe Avenue   |                   |
| <b>Number of Approach Lanes</b> | <b>2</b>                    | <b>1</b>     | <b><u>YES</u></b> |
| <b>Traffic Volume (VPH) *</b>   | <b>1,620</b>                | <b>160</b>   |                   |

\* Note: Traffic Volume for Major Street is Total Volume of Both Approaches.  
 Traffic Volume for Minor Street is the Volume of High Volume Approach.



Major Street Imjin Parkway  
 Minor Street SR 1 NB Off-Ramp/SR 1 NB On-Ramp

Project Sample Project Title  
 Scenario Cumulative PP ESP  
 Peak Hour AM

Turn Movement Volumes

|         | NB | SB | EB    | WB    |
|---------|----|----|-------|-------|
| Left    | 10 | 0  | 10    | 0     |
| Through | 10 | 0  | 1,010 | 990   |
| Right   | 0  | 0  | 0     | 470   |
| Total   | 20 | 0  | 1,020 | 1,460 |

Major Street Direction

|   |             |
|---|-------------|
|   | North/South |
| X | East/West   |

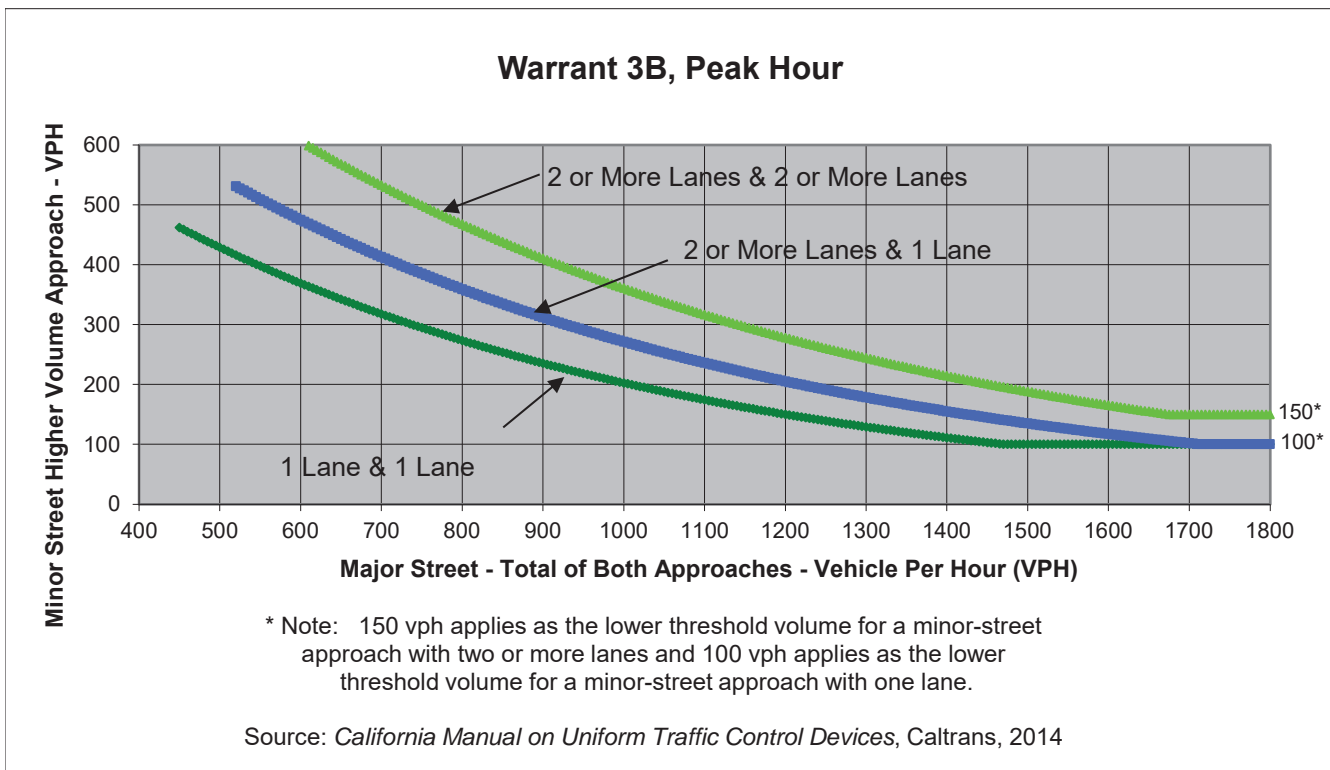

|                                 | Major Street  | Minor Street                     | Warrant Met      |
|---------------------------------|---------------|----------------------------------|------------------|
|                                 | Imjin Parkway | SR 1 NB Off-Ramp/SR 1 NB On-Ramp |                  |
| <b>Number of Approach Lanes</b> | <b>1</b>      | <b>1</b>                         | <b><u>NO</u></b> |
| <b>Traffic Volume (VPH) *</b>   | <b>2,480</b>  | <b>20</b>                        |                  |

\* Note: Traffic Volume for Major Street is Total Volume of Both Approches.  
 Traffic Volume for Minor Street is the Volume of High Volume Approach.



Major Street **Inter-Garrison Road**  
 Minor Street **8th Avenue**

Project **Sample Project Title**  
 Scenario **Cumulative PP ESP**  
 Peak Hour **AM**

Turn Movement Volumes

|         | NB  | SB | EB  | WB    |
|---------|-----|----|-----|-------|
| Left    | 50  | 0  | 0   | 520   |
| Through | 0   | 0  | 220 | 530   |
| Right   | 290 | 0  | 120 | 0     |
| Total   | 340 | 0  | 340 | 1,050 |

Major Street Direction

|   |             |
|---|-------------|
|   | North/South |
| X | East/West   |

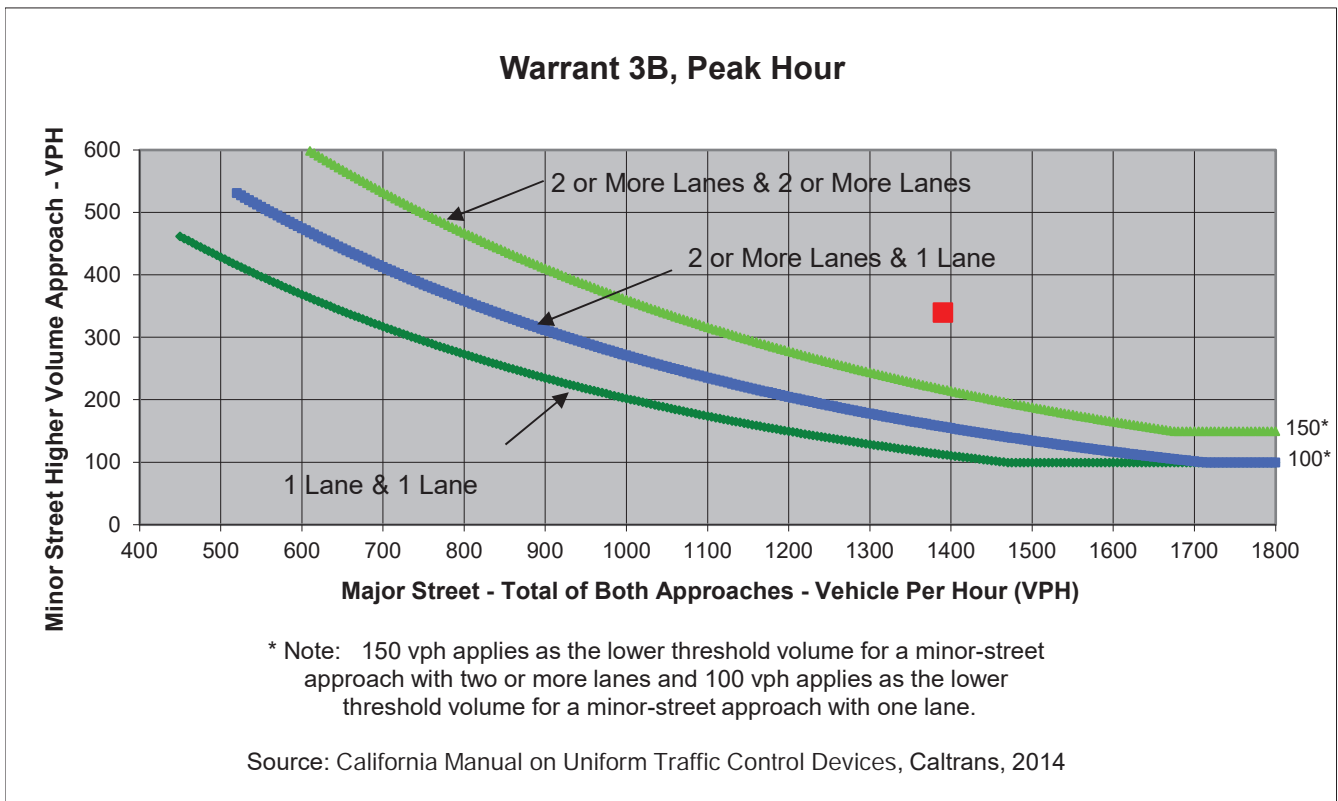

|                                 | Major Street        | Minor Street | Warrant Met |
|---------------------------------|---------------------|--------------|-------------|
|                                 | Inter-Garrison Road | 8th Avenue   |             |
| <b>Number of Approach Lanes</b> | <b>1</b>            | <b>1</b>     | <b>YES</b>  |
| <b>Traffic Volume (VPH) *</b>   | <b>1,390</b>        | <b>340</b>   |             |

\* Note: Traffic Volume for Major Street is Total Volume of Both Approaches.  
 Traffic Volume for Minor Street is the Volume of High Volume Approach.



Major Street Inter-Garrison Road/Sherman Boulevard  
 Minor Street Inter-Garrison Road

Project Sample Project Title  
 Scenario Cumulative PP ESP  
 Peak Hour AM

Turn Movement Volumes

|         | NB | SB  | EB  | WB  |
|---------|----|-----|-----|-----|
| Left    | 0  | 90  | 600 | 0   |
| Through | 0  | 0   | 130 | 310 |
| Right   | 0  | 820 | 0   | 130 |
| Total   | 0  | 910 | 730 | 440 |

Major Street Direction

|   |             |
|---|-------------|
|   | North/South |
| X | East/West   |

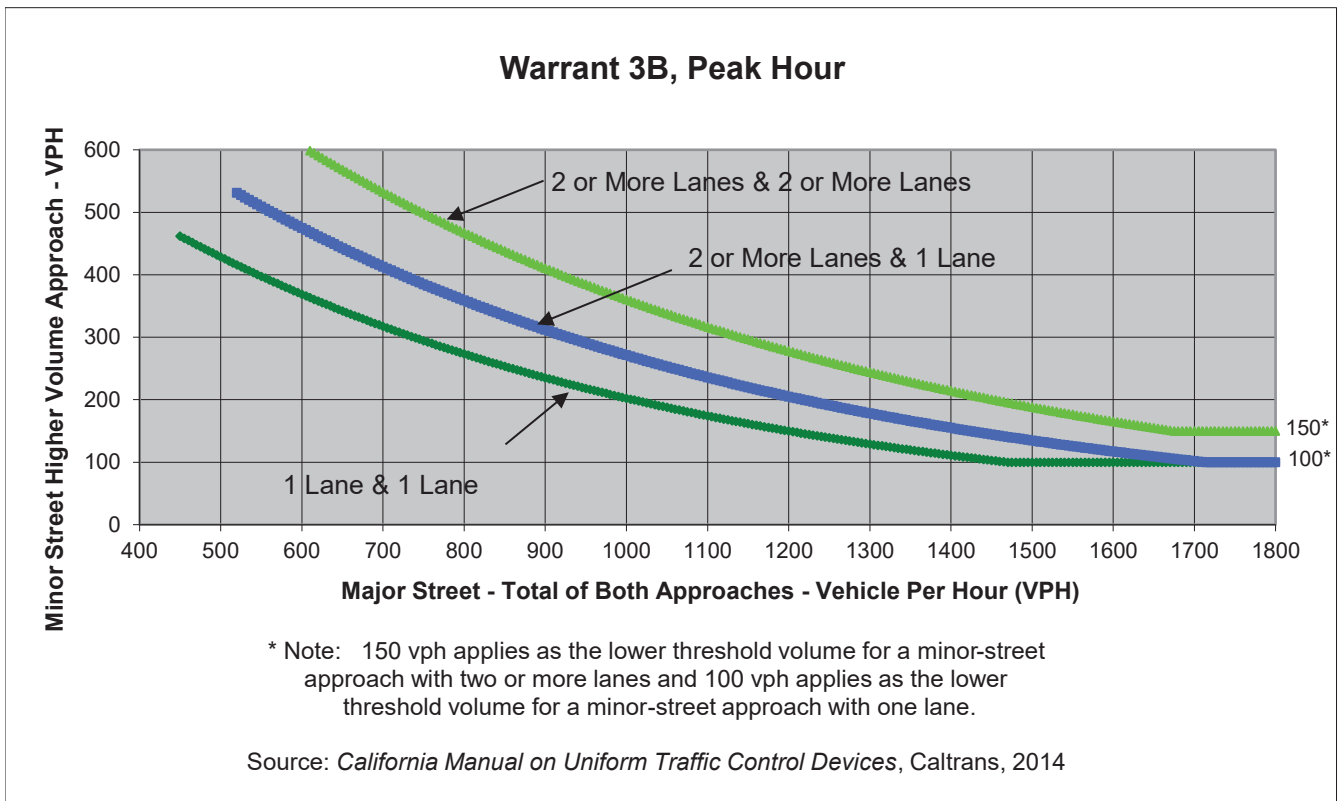

|   | Major Street                          | Minor Street        | Warrant Met       |
|---|---------------------------------------|---------------------|-------------------|
|   | Inter-Garrison Road/Sherman Boulevard | Inter-Garrison Road |                   |
| <b>Number of Approach Lanes</b>   | <b>1</b>                              | <b>1</b>            | <b><u>YES</u></b> |
| <b>Traffic Volume (VPH) *</b>   | <b>1,170</b>                          | <b>910</b>          |                   |
| * Note: Traffic Volume for Major Street is Total Volume of Both Approaches.<br>Traffic Volume for Minor Street is the Volume of High Volume Approach. |                                       |                     |                   |



Major Street **Imjin Parkway**  
 Minor Street **SR 1 NB Off-Ramp/SR 1 NB On-Ramp**

Project **Sample Project Title**  
 Scenario **Cumulative PP ESP**  
 Peak Hour **PM**

Turn Movement Volumes

|         | NB | SB | EB  | WB    |
|---------|----|----|-----|-------|
| Left    | 10 | 0  | 10  | 0     |
| Through | 10 | 0  | 700 | 1,150 |
| Right   | 0  | 0  | 0   | 950   |
| Total   | 20 | 0  | 710 | 2,100 |

Major Street Direction

|   |             |
|---|-------------|
|   | North/South |
| X | East/West   |

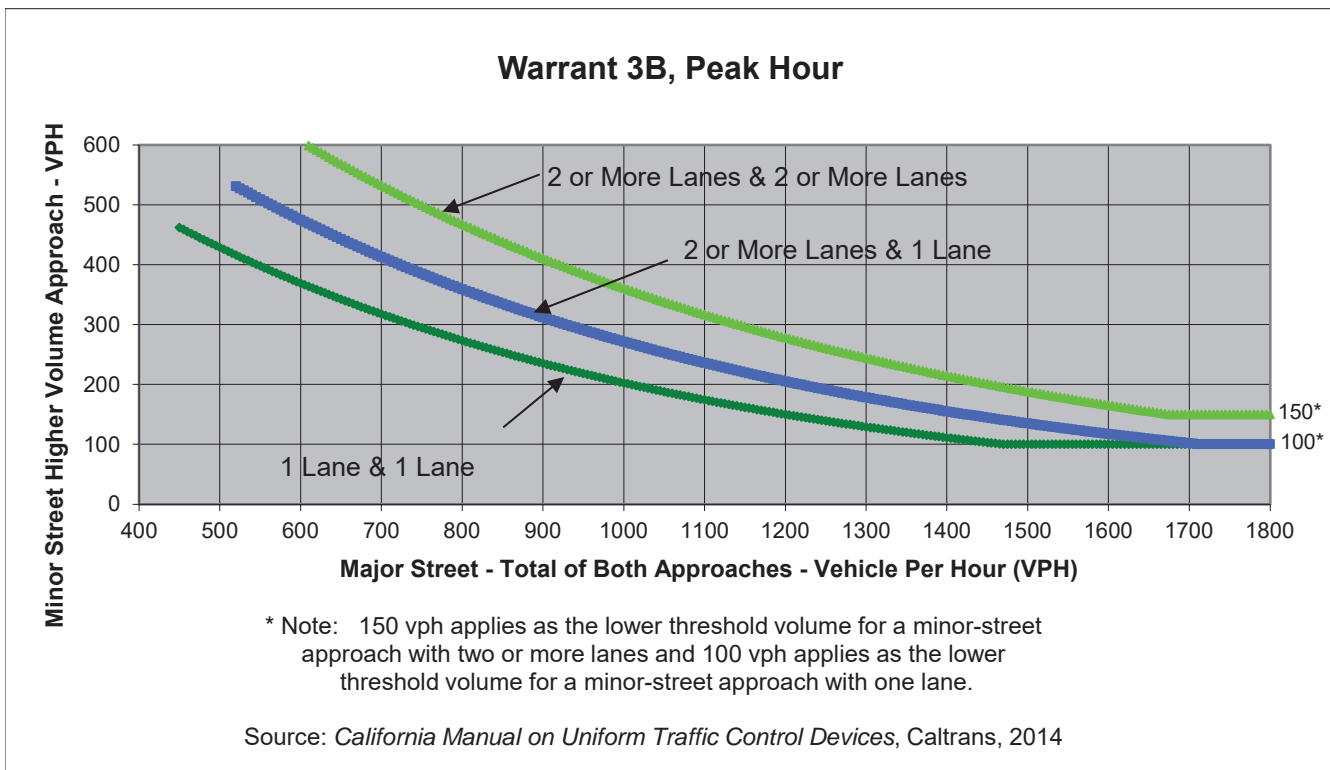

|                                 | Major Street  | Minor Street                     | Warrant Met      |
|---------------------------------|---------------|----------------------------------|------------------|
|                                 | Imjin Parkway | SR 1 NB Off-Ramp/SR 1 NB On-Ramp |                  |
| <b>Number of Approach Lanes</b> | <b>1</b>      | <b>1</b>                         | <b><u>NO</u></b> |
| <b>Traffic Volume (VPH) *</b>   | <b>2,810</b>  | <b>20</b>                        |                  |

\* Note: Traffic Volume for Major Street is Total Volume of Both Approches.  
 Traffic Volume for Minor Street is the Volume of High Volume Approach.



Major Street Inter-Garrison Road  
 Minor Street 8th Avenue

Project Sample Project Title  
 Scenario Cumulative PP ESP  
 Peak Hour PM

Turn Movement Volumes

|         | NB  | SB | EB  | WB  |
|---------|-----|----|-----|-----|
| Left    | 60  | 0  | 0   | 280 |
| Through | 0   | 0  | 580 | 380 |
| Right   | 420 | 0  | 80  | 0   |
| Total   | 480 | 0  | 660 | 660 |

Major Street Direction

|   |             |
|---|-------------|
|   | North/South |
| X | East/West   |

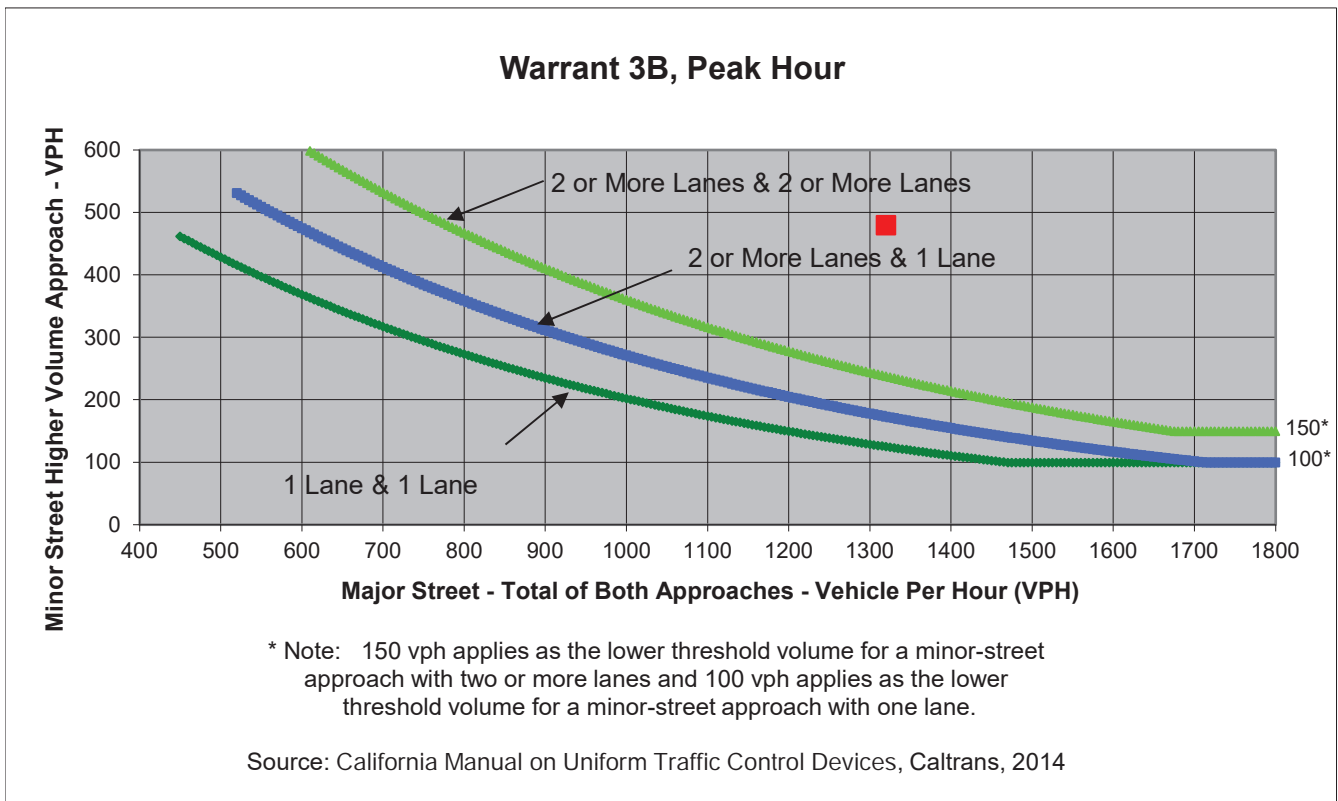

|                                 | Major Street        | Minor Street | Warrant Met       |
|---------------------------------|---------------------|--------------|-------------------|
|                                 | Inter-Garrison Road | 8th Avenue   |                   |
| <b>Number of Approach Lanes</b> | <b>1</b>            | <b>1</b>     | <b><u>YES</u></b> |
| <b>Traffic Volume (VPH) *</b>   | <b>1,320</b>        | <b>480</b>   |                   |

\* Note: Traffic Volume for Major Street is Total Volume of Both Approaches.  
 Traffic Volume for Minor Street is the Volume of High Volume Approach.

Major Street Inter-Garrison Road/Sherman Boulevard  
 Minor Street Inter-Garrison Road

Project Sample Project Title  
 Scenario Cumulative PP ESP  
 Peak Hour PM

Turn Movement Volumes

|         | NB | SB  | EB    | WB  |
|---------|----|-----|-------|-----|
| Left    | 0  | 120 | 990   | 0   |
| Through | 0  | 0   | 270   | 160 |
| Right   | 0  | 520 | 0     | 100 |
| Total   | 0  | 640 | 1,260 | 260 |

Major Street Direction

|   |             |
|---|-------------|
|   | North/South |
| X | East/West   |

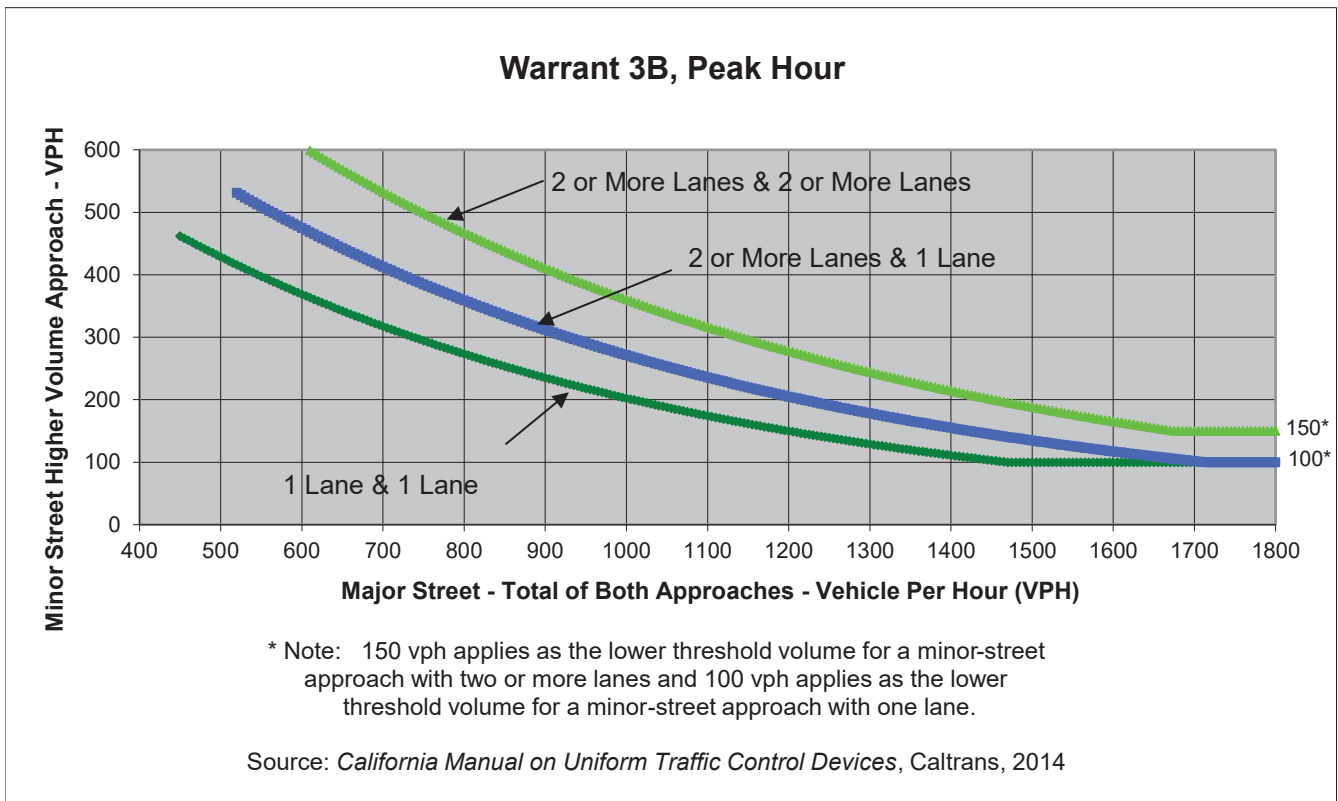

|   | Major Street                          | Minor Street        | Warrant Met       |
|---|---------------------------------------|---------------------|-------------------|
|   | Inter-Garrison Road/Sherman Boulevard | Inter-Garrison Road |                   |
| <b>Number of Approach Lanes</b>   | <b>1</b>                              | <b>1</b>            | <b><u>YES</u></b> |
| <b>Traffic Volume (VPH) *</b>   | <b>1,520</b>                          | <b>640</b>          |                   |
| * Note: Traffic Volume for Major Street is Total Volume of Both Approaches.<br>Traffic Volume for Minor Street is the Volume of High Volume Approach. |                                       |                     |                   |

**APPENDIX O: INTERSECTION WITH IMPROVEMENTS LEVEL OF  
SERVICE CALCULATIONS**



HCM 2010 Signalized Intersection Summary  
 16: 2nd Avenue & 8th Street























Existing with Project, AM  
 09/18/2019



| Movement                     | EBL  | EBT  | EBR  | WBL  | WBT  | WBR  | NBL  | NBT  | NBR  | SBL  | SBT  | SBR  |
|------------------------------|------|------|------|------|------|------|------|------|------|------|------|------|
| Lane Configurations          |      |      |      |      |      |      |      |      |      |      |      |      |
| Traffic Volume (veh/h)       | 10   | 10   | 10   | 270  | 10   | 30   | 10   | 210  | 130  | 60   | 770  | 10   |
| Future Volume (veh/h)        | 10   | 10   | 10   | 270  | 10   | 30   | 10   | 210  | 130  | 60   | 770  | 10   |
| Number                       | 7    | 4    | 14   | 3    | 8    | 18   | 5    | 2    | 12   | 1    | 6    | 16   |
| Initial Q (Qb), veh          | 0    | 0    | 0    | 0    | 0    | 0    | 0    | 0    | 0    | 0    | 0    | 0    |
| Ped-Bike Adj(A_pbT)          | 1.00 |      | 1.00 | 1.00 |      | 1.00 | 1.00 |      | 1.00 | 1.00 |      | 1.00 |
| Parking Bus, Adj             | 1.00 | 1.00 | 1.00 | 1.00 | 1.00 | 1.00 | 1.00 | 1.00 | 1.00 | 1.00 | 1.00 | 1.00 |
| Adj Sat Flow, veh/h/ln       | 1900 | 1900 | 1900 | 1900 | 1583 | 1583 | 1900 | 1863 | 1900 | 1881 | 1881 | 1900 |
| Adj Flow Rate, veh/h         | 11   | 11   | 5    | 284  | 11   | 12   | 11   | 221  | 55   | 63   | 811  | 11   |
| Adj No. of Lanes             | 1    | 1    | 1    | 0    | 1    | 1    | 0    | 2    | 0    | 1    | 2    | 0    |
| Peak Hour Factor             | 0.95 | 0.95 | 0.95 | 0.95 | 0.95 | 0.95 | 0.95 | 0.95 | 0.95 | 0.95 | 0.95 | 0.95 |
| Percent Heavy Veh, %         | 0    | 0    | 0    | 20   | 20   | 20   | 2    | 2    | 2    | 1    | 1    | 1    |
| Cap, veh/h                   | 365  | 608  | 517  | 588  | 14   | 431  | 137  | 1061 | 254  | 603  | 1423 | 19   |
| Arrive On Green              | 0.32 | 0.32 | 0.32 | 0.34 | 0.32 | 0.32 | 0.39 | 0.39 | 0.39 | 0.39 | 0.39 | 0.39 |
| Sat Flow, veh/h              | 1410 | 1900 | 1615 | 1136 | 44   | 1346 | 37   | 2693 | 645  | 1109 | 3611 | 49   |
| Grp Volume(v), veh/h         | 11   | 11   | 5    | 295  | 0    | 12   | 152  | 0    | 135  | 63   | 401  | 421  |
| Grp Sat Flow(s),veh/h/ln     | 1410 | 1900 | 1615 | 1180 | 0    | 1346 | 1795 | 0    | 1580 | 1109 | 1787 | 1872 |
| Q Serve(g_s), s              | 0.2  | 0.1  | 0.1  | 6.9  | 0.0  | 0.2  | 0.0  | 0.0  | 1.8  | 1.3  | 5.5  | 5.5  |
| Cycle Q Clear(g_c), s        | 7.3  | 0.1  | 0.1  | 7.0  | 0.0  | 0.2  | 1.7  | 0.0  | 1.8  | 3.0  | 5.5  | 5.5  |
| Prop In Lane                 | 1.00 |      | 1.00 | 0.96 |      | 1.00 | 0.07 |      | 0.41 | 1.00 |      | 0.03 |
| Lane Grp Cap(c), veh/h       | 365  | 608  | 517  | 621  | 0    | 431  | 830  | 0    | 623  | 603  | 704  | 738  |
| V/C Ratio(X)                 | 0.03 | 0.02 | 0.01 | 0.48 | 0.00 | 0.03 | 0.18 | 0.00 | 0.22 | 0.10 | 0.57 | 0.57 |
| Avail Cap(c_a), veh/h        | 1146 | 1659 | 1410 | 1281 | 0    | 1175 | 1410 | 0    | 1179 | 993  | 1334 | 1397 |
| HCM Platoon Ratio            | 1.00 | 1.00 | 1.00 | 1.00 | 1.00 | 1.00 | 1.00 | 1.00 | 1.00 | 1.00 | 1.00 | 1.00 |
| Upstream Filter(I)           | 1.00 | 1.00 | 1.00 | 1.00 | 0.00 | 1.00 | 1.00 | 0.00 | 1.00 | 1.00 | 1.00 | 1.00 |
| Uniform Delay (d), s/veh     | 12.9 | 7.3  | 7.3  | 9.5  | 0.0  | 7.3  | 6.3  | 0.0  | 6.3  | 7.3  | 7.5  | 7.5  |
| Incr Delay (d2), s/veh       | 0.0  | 0.0  | 0.0  | 0.6  | 0.0  | 0.0  | 0.1  | 0.0  | 0.2  | 0.1  | 0.7  | 0.7  |
| Initial Q Delay(d3),s/veh    | 0.0  | 0.0  | 0.0  | 0.0  | 0.0  | 0.0  | 0.0  | 0.0  | 0.0  | 0.0  | 0.0  | 0.0  |
| %ile BackOfQ(50%),veh/ln     | 0.1  | 0.1  | 0.0  | 2.3  | 0.0  | 0.1  | 0.9  | 0.0  | 0.8  | 0.4  | 2.8  | 2.9  |
| LnGrp Delay(d),s/veh         | 13.0 | 7.3  | 7.3  | 10.1 | 0.0  | 7.4  | 6.4  | 0.0  | 6.5  | 7.4  | 8.2  | 8.2  |
| LnGrp LOS                    | B    | A    | A    | B    |      | A    | A    |      | A    | A    | A    | A    |
| Approach Vol, veh/h          |      | 27   |      |      | 307  |      |      | 287  |      |      | 885  |      |
| Approach Delay, s/veh        |      | 9.6  |      |      | 10.0 |      |      | 6.4  |      |      | 8.1  |      |
| Approach LOS                 |      | A    |      |      | A    |      |      | A    |      |      | A    |      |
| Timer                        | 1    | 2    | 3    | 4    | 5    | 6    | 7    | 8    |      |      |      |      |
| Assigned Phs                 |      | 2    |      | 4    |      | 6    |      | 8    |      |      |      |      |
| Phs Duration (G+Y+Rc), s     |      | 16.9 |      | 14.6 |      | 16.9 |      | 14.6 |      |      |      |      |
| Change Period (Y+Rc), s      |      | 4.5  |      | 4.5  |      | 4.5  |      | 4.5  |      |      |      |      |
| Max Green Setting (Gmax), s  |      | 23.5 |      | 27.5 |      | 23.5 |      | 27.5 |      |      |      |      |
| Max Q Clear Time (g_c+I1), s |      | 3.8  |      | 9.3  |      | 7.5  |      | 9.0  |      |      |      |      |
| Green Ext Time (p_c), s      |      | 1.5  |      | 0.0  |      | 4.8  |      | 1.6  |      |      |      |      |
| <b>Intersection Summary</b>  |      |      |      |      |      |      |      |      |      |      |      |      |
| HCM 2010 Ctrl Delay          |      |      |      | 8.2  |      |      |      |      |      |      |      |      |
| HCM 2010 LOS                 |      |      |      | A    |      |      |      |      |      |      |      |      |

HCM 2010 Signalized Intersection Summary  
 21: 7th Avenue/8th Street & Inter-Garrison Road

Existing with Project, AM  
 04/25/2022

|                              |  |  |  |  |  |  |   |  |  |  |  |  |
|------------------------------|---|---|---|---|---|---|---|---|---|---|---|---|
| Movement                     | EBL   | EBT   | EBR   | WBL   | WBT   | WBR   | NBL   | NBT   | NBR   | SBL   | SBT   | SBR   |
| Lane Configurations          |  |  |   |  |  |   |  |  |  |  |  |  |
| Traffic Volume (veh/h)       | 10  | 50  | 20  | 310   | 150   | 30  | 30  | 170   | 110   | 170   | 200   | 10  |
| Future Volume (veh/h)        | 10  | 50  | 20  | 310   | 150   | 30  | 30  | 170   | 110   | 170   | 200   | 10  |
| Number                       | 5   | 2   | 12  | 1   | 6   | 16  | 3   | 8   | 18  | 7   | 4   | 14  |
| Initial Q (Qb), veh          | 0   | 0   | 0   | 0   | 0   | 0   | 0   | 0   | 0   | 0   | 0   | 0   |
| Ped-Bike Adj(A_pbT)          | 1.00  |   | 0.99  | 1.00  |   | 1.00  | 1.00  |   | 1.00  | 1.00  |   | 1.00  |
| Parking Bus, Adj             | 1.00  | 1.00  | 1.00  | 1.00  | 1.00  | 1.00  | 1.00  | 1.00  | 1.00  | 1.00  | 1.00  | 1.00  |
| Adj Sat Flow, veh/h/ln       | 1759  | 1759  | 1900  | 1845  | 1845  | 1900  | 1597  | 1597  | 1597  | 1776  | 1776  | 1900  |
| Adj Flow Rate, veh/h         | 12  | 62  | 25  | 383   | 185   | 0   | 37  | 210   | 136   | 210   | 247   | 12  |
| Adj No. of Lanes             | 1   | 1   | 0   | 1   | 1   | 0   | 1   | 1   | 1   | 1   | 1   | 0   |
| Peak Hour Factor             | 0.81  | 0.81  | 0.81  | 0.81  | 0.81  | 0.81  | 0.81  | 0.81  | 0.81  | 0.81  | 0.81  | 0.81  |
| Percent Heavy Veh, %         | 8   | 8   | 8   | 3   | 3   | 3   | 19  | 19  | 19  | 7   | 7   | 7   |
| Cap, veh/h                   | 26  | 142   | 57  | 456   | 671   | 0   | 377   | 573   | 487   | 397   | 603   | 29  |
| Arrive On Green              | 0.02  | 0.12  | 0.12  | 0.26  | 0.36  | 0.00  | 0.36  | 0.36  | 0.36  | 0.36  | 0.36  | 0.36  |
| Sat Flow, veh/h              | 1675  | 1188  | 479   | 1757  | 1845  | 0   | 956   | 1597  | 1357  | 982   | 1680  | 82  |
| Grp Volume(v), veh/h         | 12  | 0   | 87  | 383   | 185   | 0   | 37  | 210   | 136   | 210   | 0   | 259   |
| Grp Sat Flow(s),veh/h/ln     | 1675  | 0   | 1668  | 1757  | 1845  | 0   | 956   | 1597  | 1357  | 982   | 0   | 1761  |
| Q Serve(g_s), s              | 0.4   | 0.0   | 2.5   | 10.6  | 3.7   | 0.0   | 1.6   | 5.0   | 3.7   | 10.3  | 0.0   | 5.7   |
| Cycle Q Clear(g_c), s        | 0.4   | 0.0   | 2.5   | 10.6  | 3.7   | 0.0   | 7.3   | 5.0   | 3.7   | 15.4  | 0.0   | 5.7   |
| Prop In Lane                 | 1.00  |   | 0.29  | 1.00  |   | 0.00  | 1.00  |   | 1.00  | 1.00  |   | 0.05  |
| Lane Grp Cap(c), veh/h       | 26  | 0   | 199   | 456   | 671   | 0   | 377   | 573   | 487   | 397   | 0   | 633   |
| V/C Ratio(X)                 | 0.47  | 0.00  | 0.44  | 0.84  | 0.28  | 0.00  | 0.10  | 0.37  | 0.28  | 0.53  | 0.00  | 0.41  |
| Avail Cap(c_a), veh/h        | 162   | 0   | 1074  | 709   | 1753  | 0   | 451   | 697   | 592   | 473   | 0   | 769   |
| HCM Platoon Ratio            | 1.00  | 1.00  | 1.00  | 1.00  | 1.00  | 1.00  | 1.00  | 1.00  | 1.00  | 1.00  | 1.00  | 1.00  |
| Upstream Filter(I)           | 1.00  | 0.00  | 1.00  | 1.00  | 1.00  | 0.00  | 1.00  | 1.00  | 1.00  | 1.00  | 0.00  | 1.00  |
| Uniform Delay (d), s/veh     | 25.2  | 0.0   | 21.1  | 18.1  | 11.6  | 0.0   | 15.1  | 12.2  | 11.8  | 17.9  | 0.0   | 12.4  |
| Incr Delay (d2), s/veh       | 12.7  | 0.0   | 1.5   | 5.4   | 0.2   | 0.0   | 0.1   | 0.4   | 0.3   | 1.1   | 0.0   | 0.4   |
| Initial Q Delay(d3),s/veh    | 0.0   | 0.0   | 0.0   | 0.0   | 0.0   | 0.0   | 0.0   | 0.0   | 0.0   | 0.0   | 0.0   | 0.0   |
| %ile BackOfQ(50%),veh/ln     | 0.3   | 0.0   | 1.2   | 5.8   | 1.9   | 0.0   | 0.4   | 2.2   | 1.4   | 2.9   | 0.0   | 2.8   |
| LnGrp Delay(d),s/veh         | 37.8  | 0.0   | 22.6  | 23.4  | 11.8  | 0.0   | 15.3  | 12.6  | 12.1  | 19.0  | 0.0   | 12.8  |
| LnGrp LOS                    | D   |   | C   | C   | B   |   | B   | B   | B   | B   |   | B   |
| Approach Vol, veh/h          |   | 99  |   |   | 568   |   |   | 383   |   |   | 469   |   |
| Approach Delay, s/veh        |   | 24.4  |   |   | 19.7  |   |   | 12.7  |   |   | 15.6  |   |
| Approach LOS                 |   | C   |   |   | B   |   |   | B   |   |   | B   |   |
| Timer                        | 1   | 2   | 3   | 4   | 5   | 6   | 7   | 8   |   |   |   |   |
| Assigned Phs                 | 1   | 2   |   | 4   | 5   | 6   |   | 8   |   |   |   |   |
| Phs Duration (G+Y+Rc), s     | 17.9  | 10.7  |   | 23.0  | 5.3   | 23.3  |   | 23.0  |   |   |   |   |
| Change Period (Y+Rc), s      | 4.5   | 4.5   |   | 4.5   | 4.5   | 4.5   |   | 4.5   |   |   |   |   |
| Max Green Setting (Gmax), s  | 20.8  | 33.2  |   | 22.5  | 5.0   | 49.0  |   | 22.5  |   |   |   |   |
| Max Q Clear Time (g_c+I1), s | 12.6  | 4.5   |   | 17.4  | 2.4   | 5.7   |   | 9.3   |   |   |   |   |
| Green Ext Time (p_c), s      | 0.8   | 0.4   |   | 1.2   | 0.0   | 1.1   |   | 1.6   |   |   |   |   |
| <b>Intersection Summary</b>  |   |   |   |   |   |   |   |   |   |   |   |   |
| HCM 2010 Ctrl Delay          |   |   | 16.9  |   |   |   |   |   |   |   |   |   |
| HCM 2010 LOS                 |   |   | B   |   |   |   |   |   |   |   |   |   |



| Movement                     | EBT  | EBR  | WBL  | WBT   | NBL   | NBR  |   |      |
|------------------------------|------|------|------|-------|-------|------|---|------|
| Lane Configurations          | ↔    |      |      | ↔     | ↔     |      |   |      |
| Traffic Volume (veh/h)       | 180  | 150  | 730  | 500   | 10    | 240  |   |      |
| Future Volume (veh/h)        | 180  | 150  | 730  | 500   | 10    | 240  |   |      |
| Number                       | 4    | 14   | 3    | 8     | 5     | 12   |   |      |
| Initial Q (Qb), veh          | 0    | 0    | 0    | 0     | 0     | 0    |   |      |
| Ped-Bike Adj(A_pbT)          |      | 1.00 | 1.00 |       | 1.00  | 1.00 |   |      |
| Parking Bus, Adj             | 1.00 | 1.00 | 1.00 | 1.00  | 1.00  | 1.00 |   |      |
| Adj Sat Flow, veh/h/ln       | 1520 | 1900 | 1900 | 1881  | 1845  | 1900 |   |      |
| Adj Flow Rate, veh/h         | 207  | 121  | 839  | 575   | 11    | -29  |   |      |
| Adj No. of Lanes             | 1    | 0    | 0    | 1     | 0     | 0    |   |      |
| Peak Hour Factor             | 0.87 | 0.87 | 0.87 | 0.87  | 0.87  | 0.87 |   |      |
| Percent Heavy Veh, %         | 25   | 25   | 1    | 1     | 0     | 0    |   |      |
| Cap, veh/h                   | 581  | 340  | 0    | 1214  | 0     | 491  |   |      |
| Arrive On Green              | 0.65 | 0.68 | 0.00 | 0.65  | 0.00  | 0.00 |   |      |
| Sat Flow, veh/h              | 901  | 526  | 0    | 1881  | -941  | 2480 |   |      |
| Grp Volume(v), veh/h         | 0    | 328  | 0    | 575   | 0     | 0    |   |      |
| Grp Sat Flow(s),veh/h/ln     | 0    | 1427 | 0    | 1881  | 0     | 0    |   |      |
| Q Serve(g_s), s              | 0.0  | 1.3  | 0.0  | 2.0   | 0.0   | 0.0  |   |      |
| Cycle Q Clear(g_c), s        | 0.0  | 1.3  | 0.0  | 2.0   | 0.0   | 0.0  |   |      |
| Prop In Lane                 |      | 0.37 | 0.00 |       | -0.65 | 1.71 |   |      |
| Lane Grp Cap(c), veh/h       | 0    | 921  | 0    | 1214  | 0     | 0    |   |      |
| V/C Ratio(X)                 | 0.00 | 0.36 | 0.00 | 0.47  | 0.00  | 0.00 |   |      |
| Avail Cap(c_a), veh/h        | 0    | 6580 | 0    | 10083 | 0     | 0    |   |      |
| HCM Platoon Ratio            | 1.00 | 1.00 | 1.00 | 1.00  | 1.00  | 1.00 |   |      |
| Upstream Filter(I)           | 0.00 | 1.00 | 0.00 | 1.00  | 0.00  | 0.00 |   |      |
| Uniform Delay (d), s/veh     | 0.0  | 1.0  | 0.0  | 1.1   | 0.0   | 0.0  |   |      |
| Incr Delay (d2), s/veh       | 0.0  | 0.2  | 0.0  | 0.3   | 0.0   | 0.0  |   |      |
| Initial Q Delay(d3),s/veh    | 0.0  | 0.0  | 0.0  | 0.0   | 0.0   | 0.0  |   |      |
| %ile BackOfQ(50%),veh/ln     | 0.0  | 0.5  | 0.0  | 1.1   | 0.0   | 0.0  |   |      |
| LnGrp Delay(d),s/veh         | 0.0  | 1.2  | 0.0  | 1.4   | 0.0   | 0.0  |   |      |
| LnGrp LOS                    |      | A    |      | A     |       |      |   |      |
| Approach Vol, veh/h          | 328  |      |      | 575   | 0     |      |   |      |
| Approach Delay, s/veh        | 1.2  |      |      | 1.4   | 0.0   |      |   |      |
| Approach LOS                 | A    |      |      | A     |       |      |   |      |
| Timer                        | 1    | 2    | 3    | 4     | 5     | 6    | 7 | 8    |
| Assigned Phs                 |      | 2    | 3    | 4     |       |      |   | 8    |
| Phs Duration (G+Y+Rc), s     |      | 0.0  | 0.0  | 12.7  |       |      |   | 12.7 |
| Change Period (Y+Rc), s      |      | 4.5  | 4.5  | 4.5   |       |      |   | 4.5  |
| Max Green Setting (Gmax), s  |      | 33.0 | 5.0  | 58.5  |       |      |   | 68.0 |
| Max Q Clear Time (g_c+I1), s |      | 0.0  | 0.0  | 3.3   |       |      |   | 4.0  |
| Green Ext Time (p_c), s      |      | 0.0  | 0.0  | 2.3   |       |      |   | 4.2  |
| <b>Intersection Summary</b>  |      |      |      |       |       |      |   |      |
| HCM 2010 Ctrl Delay          |      |      | 1.4  |       |       |      |   |      |
| HCM 2010 LOS                 |      |      | A    |       |       |      |   |      |
| <b>Notes</b>                 |      |      |      |       |       |      |   |      |



| Intersection                |       |       |       |       |
|-----------------------------|-------|-------|-------|-------|
| Intersection Delay, s/veh   | 14.7  |       |       |       |
| Intersection LOS            | B     |       |       |       |
| Approach                    | EB    | WB    |       | NB    |
| Entry Lanes                 | 1     | 2     |       | 1     |
| Conflicting Circle Lanes    | 2     | 2     |       | 2     |
| Adj Approach Flow, veh/h    | 379   | 1414  |       | 287   |
| Demand Flow Rate, veh/h     | 474   | 1428  |       | 295   |
| Vehicles Circulating, veh/h | 847   | 11    |       | 259   |
| Vehicles Exiting, veh/h     | 592   | 543   |       | 1062  |
| Follow-Up Headway, s        | 3.186 | 3.186 |       | 3.186 |
| Ped Vol Crossing Leg, #/h   | 0     | 0     |       | 0     |
| Ped Cap Adj                 | 1.000 | 1.000 |       | 1.000 |
| Approach Delay, s/veh       | 30.3  | 12.1  |       | 7.3   |
| Approach LOS                | D     | B     |       | A     |
| Lane                        | Left  | Left  | Right | Left  |
| Designated Moves            | TR    | L     | LTR   | LR    |
| Assumed Moves               | TR    | L     | LTR   | LR    |
| RT Channelized              |       |       |       |       |
| Lane Util                   | 1.000 | 0.530 | 0.470 | 1.000 |
| Critical Headway, s         | 4.113 | 4.293 | 4.113 | 4.113 |
| Entry Flow, veh/h           | 474   | 757   | 671   | 295   |
| Cap Entry Lane, veh/h       | 625   | 1121  | 1121  | 943   |
| Entry HV Adj Factor         | 0.800 | 0.990 | 0.991 | 0.973 |
| Flow Entry, veh/h           | 379   | 750   | 665   | 287   |
| Cap Entry, veh/h            | 500   | 1110  | 1111  | 917   |
| V/C Ratio                   | 0.759 | 0.675 | 0.598 | 0.313 |
| Control Delay, s/veh        | 30.3  | 13.1  | 10.9  | 7.3   |
| LOS                         | D     | B     | B     | A     |
| 95th %tile Queue, veh       | 7     | 6     | 4     | 1     |



| Movement                     | EBL  | EBT  | WBT  | WBR  | SBL  | SBR  |   |   |
|------------------------------|------|------|------|------|------|------|---|---|
| Lane Configurations          |      |      |      |      |      |      |   |   |
| Traffic Volume (veh/h)       | 210  | 200  | 740  | 10   | 30   | 490  |   |   |
| Future Volume (veh/h)        | 210  | 200  | 740  | 10   | 30   | 490  |   |   |
| Number                       | 5    | 2    | 6    | 16   | 7    | 14   |   |   |
| Initial Q (Qb), veh          | 0    | 0    | 0    | 0    | 0    | 0    |   |   |
| Ped-Bike Adj(A_pbT)          | 1.00 |      |      | 1.00 | 1.00 | 1.00 |   |   |
| Parking Bus, Adj             | 1.00 | 1.00 | 1.00 | 1.00 | 1.00 | 1.00 |   |   |
| Adj Sat Flow, veh/h/ln       | 1759 | 1759 | 1881 | 1881 | 1881 | 1881 |   |   |
| Adj Flow Rate, veh/h         | 247  | 235  | 871  | 10   | 35   | 330  |   |   |
| Adj No. of Lanes             | 1    | 1    | 1    | 1    | 2    | 1    |   |   |
| Peak Hour Factor             | 0.85 | 0.85 | 0.85 | 0.85 | 0.85 | 0.85 |   |   |
| Percent Heavy Veh, %         | 8    | 8    | 1    | 1    | 1    | 1    |   |   |
| Cap, veh/h                   | 326  | 1225 | 1309 | 1113 | 772  | 355  |   |   |
| Arrive On Green              | 0.70 | 0.70 | 0.70 | 0.70 | 0.22 | 0.22 |   |   |
| Sat Flow, veh/h              | 593  | 1759 | 1881 | 1599 | 3476 | 1599 |   |   |
| Grp Volume(v), veh/h         | 247  | 235  | 871  | 10   | 35   | 330  |   |   |
| Grp Sat Flow(s),veh/h/ln     | 593  | 1759 | 1881 | 1599 | 1738 | 1599 |   |   |
| Q Serve(g_s), s              | 42.1 | 4.9  | 27.3 | 0.2  | 0.8  | 21.0 |   |   |
| Cycle Q Clear(g_c), s        | 69.3 | 4.9  | 27.3 | 0.2  | 0.8  | 21.0 |   |   |
| Prop In Lane                 | 1.00 |      |      | 1.00 | 1.00 | 1.00 |   |   |
| Lane Grp Cap(c), veh/h       | 326  | 1225 | 1309 | 1113 | 772  | 355  |   |   |
| V/C Ratio(X)                 | 0.76 | 0.19 | 0.67 | 0.01 | 0.05 | 0.93 |   |   |
| Avail Cap(c_a), veh/h        | 415  | 1488 | 1591 | 1353 | 1119 | 515  |   |   |
| HCM Platoon Ratio            | 1.00 | 1.00 | 1.00 | 1.00 | 1.00 | 1.00 |   |   |
| Upstream Filter(I)           | 1.00 | 1.00 | 1.00 | 1.00 | 1.00 | 1.00 |   |   |
| Uniform Delay (d), s/veh     | 28.6 | 5.5  | 8.9  | 4.8  | 31.8 | 39.7 |   |   |
| Incr Delay (d2), s/veh       | 4.2  | 0.0  | 0.5  | 0.0  | 0.0  | 15.2 |   |   |
| Initial Q Delay(d3),s/veh    | 0.0  | 0.0  | 0.0  | 0.0  | 0.0  | 0.0  |   |   |
| %ile BackOfQ(50%),veh/ln     | 7.2  | 2.4  | 14.2 | 0.1  | 0.4  | 10.8 |   |   |
| LnGrp Delay(d),s/veh         | 32.8 | 5.6  | 9.4  | 4.8  | 31.8 | 54.9 |   |   |
| LnGrp LOS                    | C    | A    | A    | A    | C    | D    |   |   |
| Approach Vol, veh/h          |      | 482  | 881  |      | 365  |      |   |   |
| Approach Delay, s/veh        |      | 19.5 | 9.4  |      | 52.6 |      |   |   |
| Approach LOS                 |      | B    | A    |      | D    |      |   |   |
| Timer                        | 1    | 2    | 3    | 4    | 5    | 6    | 7 | 8 |
| Assigned Phs                 |      | 2    |      | 4    |      | 6    |   |   |
| Phs Duration (G+Y+Rc), s     |      | 77.4 |      | 26.6 |      | 77.4 |   |   |
| Change Period (Y+Rc), s      |      | 5.0  |      | 3.5  |      | 5.0  |   |   |
| Max Green Setting (Gmax), s  |      | 88.0 |      | 33.5 |      | 88.0 |   |   |
| Max Q Clear Time (g_c+I1), s |      | 71.3 |      | 23.0 |      | 29.3 |   |   |
| Green Ext Time (p_c), s      |      | 1.1  |      | 0.1  |      | 0.9  |   |   |
| <b>Intersection Summary</b>  |      |      |      |      |      |      |   |   |
| HCM 2010 Ctrl Delay          |      |      | 21.3 |      |      |      |   |   |
| HCM 2010 LOS                 |      |      | C    |      |      |      |   |   |

HCM 2010 Signalized Intersection Summary  
 29: 2nd Avenue & Divarty Street

Existing with Project, AM  
 09/18/2019



| Movement                     | EBL  | EBT  | EBR  | WBL  | WBT  | WBR  | NBL  | NBT  | NBR  | SBL  | SBT  | SBR  |
|------------------------------|------|------|------|------|------|------|------|------|------|------|------|------|
| Lane Configurations          |      | ↕    |      |      | ↕    | ↕    | ↕    | ↕    |      | ↕    | ↕    |      |
| Traffic Volume (veh/h)       | 10   | 10   | 10   | 70   | 10   | 10   | 10   | 370  | 120  | 10   | 1040 | 10   |
| Future Volume (veh/h)        | 10   | 10   | 10   | 70   | 10   | 10   | 10   | 370  | 120  | 10   | 1040 | 10   |
| Number                       | 5    | 2    | 12   | 1    | 6    | 16   | 3    | 8    | 18   | 7    | 4    | 14   |
| Initial Q (Qb), veh          | 0    | 0    | 0    | 0    | 0    | 0    | 0    | 0    | 0    | 0    | 0    | 0    |
| Ped-Bike Adj(A_pbT)          | 1.00 |      | 1.00 | 1.00 |      | 1.00 | 1.00 |      | 1.00 | 1.00 |      | 1.00 |
| Parking Bus, Adj             | 1.00 | 1.00 | 1.00 | 1.00 | 1.00 | 1.00 | 1.00 | 1.00 | 1.00 | 1.00 | 1.00 | 1.00 |
| Adj Sat Flow, veh/h/ln       | 1900 | 1667 | 1900 | 1900 | 1900 | 1900 | 1863 | 1863 | 1900 | 1881 | 1881 | 1900 |
| Adj Flow Rate, veh/h         | 11   | 11   | 11   | 77   | 11   | 11   | 11   | 407  | 132  | 11   | 1143 | 11   |
| Adj No. of Lanes             | 0    | 1    | 0    | 0    | 1    | 1    | 1    | 2    | 0    | 1    | 2    | 0    |
| Peak Hour Factor             | 0.91 | 0.91 | 0.91 | 0.91 | 0.91 | 0.91 | 0.91 | 0.91 | 0.91 | 0.91 | 0.91 | 0.91 |
| Percent Heavy Veh, %         | 14   | 14   | 14   | 0    | 0    | 0    | 2    | 2    | 2    | 1    | 1    | 1    |
| Cap, veh/h                   | 163  | 132  | 93   | 389  | 46   | 303  | 20   | 1297 | 416  | 20   | 1786 | 17   |
| Arrive On Green              | 0.19 | 0.19 | 0.19 | 0.19 | 0.19 | 0.19 | 0.01 | 0.49 | 0.49 | 0.01 | 0.49 | 0.49 |
| Sat Flow, veh/h              | 286  | 700  | 493  | 1249 | 244  | 1613 | 1774 | 2636 | 846  | 1792 | 3627 | 35   |
| Grp Volume(v), veh/h         | 33   | 0    | 0    | 88   | 0    | 11   | 11   | 272  | 267  | 11   | 563  | 591  |
| Grp Sat Flow(s),veh/h/ln1479 | 0    | 0    | 1493 | 0    | 1613 | 1774 | 1770 | 1712 | 1792 | 1787 | 1875 |      |
| Q Serve(g_s), s              | 0.0  | 0.0  | 0.0  | 1.3  | 0.0  | 0.2  | 0.3  | 4.0  | 4.1  | 0.3  | 10.2 | 10.2 |
| Cycle Q Clear(g_c), s        | 0.8  | 0.0  | 0.0  | 2.1  | 0.0  | 0.2  | 0.3  | 4.0  | 4.1  | 0.3  | 10.2 | 10.2 |
| Prop In Lane                 | 0.33 |      | 0.33 | 0.87 |      | 1.00 | 1.00 |      | 0.49 | 1.00 |      | 0.02 |
| Lane Grp Cap(c), veh/h       | 388  | 0    | 0    | 435  | 0    | 303  | 20   | 871  | 843  | 20   | 880  | 923  |
| V/C Ratio(X)                 | 0.09 | 0.00 | 0.00 | 0.20 | 0.00 | 0.04 | 0.54 | 0.31 | 0.32 | 0.54 | 0.64 | 0.64 |
| Avail Cap(c_a), veh/h        | 1125 | 0    | 0    | 1192 | 0    | 1142 | 223  | 2021 | 1955 | 225  | 2041 | 2142 |
| HCM Platoon Ratio            | 1.00 | 1.00 | 1.00 | 1.00 | 1.00 | 1.00 | 1.00 | 1.00 | 1.00 | 1.00 | 1.00 | 1.00 |
| Upstream Filter(I)           | 1.00 | 0.00 | 0.00 | 1.00 | 0.00 | 1.00 | 1.00 | 1.00 | 1.00 | 1.00 | 1.00 | 1.00 |
| Uniform Delay (d), s/veh     | 14.7 | 0.0  | 0.0  | 15.2 | 0.0  | 14.5 | 21.5 | 6.7  | 6.7  | 21.5 | 8.2  | 8.2  |
| Incr Delay (d2), s/veh       | 0.1  | 0.0  | 0.0  | 0.2  | 0.0  | 0.0  | 20.6 | 0.2  | 0.2  | 20.1 | 0.8  | 0.7  |
| Initial Q Delay(d3),s/veh    | 0.0  | 0.0  | 0.0  | 0.0  | 0.0  | 0.0  | 0.0  | 0.0  | 0.0  | 0.0  | 0.0  | 0.0  |
| %ile BackOfQ(50%),veh/ln0.3  | 0.0  | 0.0  | 0.9  | 0.0  | 0.1  | 0.2  | 2.0  | 2.0  | 2.0  | 0.2  | 5.2  | 5.4  |
| LnGrp Delay(d),s/veh         | 14.8 | 0.0  | 0.0  | 15.4 | 0.0  | 14.6 | 42.1 | 6.9  | 6.9  | 41.6 | 9.0  | 9.0  |
| LnGrp LOS                    | B    |      |      | B    |      | B    | D    | A    | A    | D    | A    | A    |
| Approach Vol, veh/h          |      | 33   |      |      | 99   |      |      | 550  |      |      | 1165 |      |
| Approach Delay, s/veh        |      | 14.8 |      |      | 15.4 |      |      | 7.6  |      |      | 9.3  |      |
| Approach LOS                 |      | B    |      |      | B    |      |      | A    |      |      | A    |      |
| Timer                        | 1    | 2    | 3    | 4    | 5    | 6    | 7    | 8    |      |      |      |      |
| Assigned Phs                 |      | 2    | 3    | 4    |      | 6    | 7    | 8    |      |      |      |      |
| Phs Duration (G+Y+Rc), s     |      | 13.2 | 4.0  | 26.5 |      | 13.2 | 4.0  | 26.5 |      |      |      |      |
| Change Period (Y+Rc), s      |      | 5.0  | 3.5  | 5.0  |      | 5.0  | 3.5  | 5.0  |      |      |      |      |
| Max Green Setting (Gmax), s  |      | 31.0 | 5.5  | 50.0 |      | 31.0 | 5.5  | 50.0 |      |      |      |      |
| Max Q Clear Time (g_c+I1), s |      | 2.8  | 2.3  | 12.2 |      | 4.1  | 2.3  | 6.1  |      |      |      |      |
| Green Ext Time (p_c), s      |      | 0.1  | 0.0  | 9.3  |      | 0.4  | 0.0  | 3.5  |      |      |      |      |
| <b>Intersection Summary</b>  |      |      |      |      |      |      |      |      |      |      |      |      |
| HCM 2010 Ctrl Delay          |      |      |      | 9.2  |      |      |      |      |      |      |      |      |
| HCM 2010 LOS                 |      |      |      | A    |      |      |      |      |      |      |      |      |

HCM 2010 Signalized Intersection Summary  
 47: General Jim Moore Boulevard & Coe Avenue





















Existing with Project, AM  
 09/18/2019



| Movement                    | EBL  | EBR  | NBL  | NBT  | SBT  | SBR  |   |      |
|-----------------------------|------|------|------|------|------|------|---|------|
| Lane Configurations         |      |      |      |      |      |      |   |      |
| Traffic Volume (veh/h)      | 120  | 430  | 230  | 370  | 900  | 140  |   |      |
| Future Volume (veh/h)       | 120  | 430  | 230  | 370  | 900  | 140  |   |      |
| Number                      | 3    | 18   | 1    | 6    | 2    | 12   |   |      |
| Initial Q (Qb), veh         | 0    | 0    | 0    | 0    | 0    | 0    |   |      |
| Ped-Bike Adj(A_pbT)         | 1.00 | 1.00 | 1.00 |      |      | 1.00 |   |      |
| Parking Bus, Adj            | 1.00 | 1.00 | 1.00 | 1.00 | 1.00 | 1.00 |   |      |
| Adj Sat Flow, veh/h/ln      | 1881 | 1881 | 1881 | 1881 | 1863 | 1863 |   |      |
| Adj Flow Rate, veh/h        | 133  | 197  | 256  | 411  | 1000 | 54   |   |      |
| Adj No. of Lanes            | 1    | 1    | 1    | 2    | 2    | 1    |   |      |
| Peak Hour Factor            | 0.90 | 0.90 | 0.90 | 0.90 | 0.90 | 0.90 |   |      |
| Percent Heavy Veh, %        | 1    | 1    | 1    | 1    | 2    | 2    |   |      |
| Cap, veh/h                  | 293  | 261  | 316  | 2222 | 1195 | 535  |   |      |
| Arrive On Green             | 0.16 | 0.16 | 0.18 | 0.62 | 0.34 | 0.34 |   |      |
| Sat Flow, veh/h             | 1792 | 1599 | 1792 | 3668 | 3632 | 1583 |   |      |
| Grp Volume(v), veh/h        | 133  | 197  | 256  | 411  | 1000 | 54   |   |      |
| Grp Sat Flow(s),veh/h/ln    | 1792 | 1599 | 1792 | 1787 | 1770 | 1583 |   |      |
| Q Serve(g_s), s             | 2.8  | 4.9  | 5.8  | 2.1  | 10.9 | 1.0  |   |      |
| Cycle Q Clear(g_c), s       | 2.8  | 4.9  | 5.8  | 2.1  | 10.9 | 1.0  |   |      |
| Prop In Lane                | 1.00 | 1.00 | 1.00 |      |      | 1.00 |   |      |
| Lane Grp Cap(c), veh/h      | 293  | 261  | 316  | 2222 | 1195 | 535  |   |      |
| V/C Ratio(X)                | 0.45 | 0.75 | 0.81 | 0.18 | 0.84 | 0.10 |   |      |
| Avail Cap(c_a), veh/h       | 1860 | 1660 | 663  | 3882 | 2999 | 1342 |   |      |
| HCM Platoon Ratio           | 1.00 | 1.00 | 1.00 | 1.00 | 1.00 | 1.00 |   |      |
| Upstream Filter(I)          | 1.00 | 1.00 | 1.00 | 1.00 | 1.00 | 1.00 |   |      |
| Uniform Delay (d), s/veh    | 15.8 | 16.7 | 16.6 | 3.4  | 12.8 | 9.5  |   |      |
| Incr Delay (d2), s/veh      | 0.4  | 1.7  | 1.9  | 0.0  | 0.6  | 0.0  |   |      |
| Initial Q Delay(d3),s/veh   | 0.0  | 0.0  | 0.0  | 0.0  | 0.0  | 0.0  |   |      |
| %ile BackOfQ(50%),veh/ln    | 1.4  | 2.3  | 3.0  | 1.0  | 5.4  | 0.4  |   |      |
| LnGrp Delay(d),s/veh        | 16.2 | 18.4 | 18.5 | 3.4  | 13.4 | 9.5  |   |      |
| LnGrp LOS                   | B    | B    | B    | A    | B    | A    |   |      |
| Approach Vol, veh/h         | 330  |      |      | 667  | 1054 |      |   |      |
| Approach Delay, s/veh       | 17.5 |      |      | 9.2  | 13.2 |      |   |      |
| Approach LOS                | B    |      |      | A    | B    |      |   |      |
| Timer                       | 1    | 2    | 3    | 4    | 5    | 6    | 7 | 8    |
| Assigned Phs                | 1    | 2    |      |      |      | 6    |   | 8    |
| Phs Duration (G+Y+Rc), s    | 11.9 | 18.6 |      |      |      | 30.5 |   | 11.3 |
| Change Period (Y+Rc), s     | 4.5  | 4.5  |      |      |      | 4.5  |   | 4.5  |
| Max Green Setting (Gmax), s | 15.5 | 35.5 |      |      |      | 45.5 |   | 43.5 |
| Max Q Clear Time (g_c+1), s | 17.8 | 12.9 |      |      |      | 4.1  |   | 6.9  |
| Green Ext Time (p_c), s     | 0.0  | 1.2  |      |      |      | 0.5  |   | 0.1  |
| <b>Intersection Summary</b> |      |      |      |      |      |      |   |      |
| HCM 2010 Ctrl Delay         |      |      | 12.6 |      |      |      |   |      |
| HCM 2010 LOS                |      |      | B    |      |      |      |   |      |























HCM 2010 Signalized Intersection Summary  
 16: 2nd Avenue & 8th Street

Existing with Project, PM  
 09/18/2019

|                              |  |  |  |  |  |  |  |  |  |  |  |  |
|------------------------------|---|---|---|---|---|---|--|---|---|---|---|---|
| Movement                     | EBL   | EBT   | EBR   | WBL   | WBT   | WBR   | NBL  | NBT   | NBR   | SBL   | SBT   | SBR   |
| Lane Configurations          |  |  |  |   |  |  |  |  |   |  |  |  |
| Traffic Volume (veh/h)       | 10  | 10  | 10  | 180   | 10  | 50  | 10   | 400   | 160   | 50  | 310   | 10  |
| Future Volume (veh/h)        | 10  | 10  | 10  | 180   | 10  | 50  | 10   | 400   | 160   | 50  | 310   | 10  |
| Number                       | 7   | 4   | 14  | 3   | 8   | 18  | 5  | 2   | 12  | 1   | 6   | 16  |
| Initial Q (Qb), veh          | 0   | 0   | 0   | 0   | 0   | 0   | 0  | 0   | 0   | 0   | 0   | 0   |
| Ped-Bike Adj(A_pbT)          | 1.00  |   | 1.00  | 1.00  |   | 1.00  | 1.00   |   | 1.00  | 1.00  |   | 1.00  |
| Parking Bus, Adj             | 1.00  | 1.00  | 1.00  | 1.00  | 1.00  | 1.00  | 1.00   | 1.00  | 1.00  | 1.00  | 1.00  | 1.00  |
| Adj Sat Flow, veh/h/ln       | 1900  | 1900  | 1900  | 1900  | 1583  | 1583  | 1900   | 1863  | 1900  | 1881  | 1881  | 1900  |
| Adj Flow Rate, veh/h         | 11  | 11  | 4   | 191   | 11  | 17  | 11   | 426   | 64  | 53  | 330   | 11  |
| Adj No. of Lanes             | 1   | 1   | 1   | 0   | 1   | 1   | 0  | 2   | 0   | 1   | 2   | 0   |
| Peak Hour Factor             | 0.94  | 0.94  | 0.94  | 0.94  | 0.94  | 0.94  | 0.94   | 0.94  | 0.94  | 0.94  | 0.94  | 0.94  |
| Percent Heavy Veh, %         | 0   | 0   | 0   | 20  | 20  | 20  | 2  | 2   | 2   | 1   | 1   | 1   |
| Cap, veh/h                   | 434   | 453   | 385   | 586   | 15  | 321   | 182  | 1042  | 154   | 548   | 1232  | 41  |
| Arrive On Green              | 0.24  | 0.24  | 0.24  | 0.22  | 0.24  | 0.24  | 0.35   | 0.35  | 0.35  | 0.35  | 0.35  | 0.35  |
| Sat Flow, veh/h              | 1404  | 1900  | 1615  | 1112  | 64  | 1346  | 28   | 2986  | 442   | 911   | 3530  | 117   |
| Grp Volume(v), veh/h         | 11  | 11  | 4   | 202   | 0   | 17  | 267  | 0   | 234   | 53  | 167   | 174   |
| Grp Sat Flow(s),veh/h/ln     | 1404  | 1900  | 1615  | 1176  | 0   | 1346  | 1840   | 0   | 1616  | 911   | 1787  | 1860  |
| Q Serve(g_s), s              | 0.2   | 0.1   | 0.0   | 3.5   | 0.0   | 0.2   | 0.0  | 0.0   | 2.4   | 1.0   | 1.5   | 1.5   |
| Cycle Q Clear(g_c), s        | 3.7   | 0.1   | 0.0   | 3.6   | 0.0   | 0.2   | 2.4  | 0.0   | 2.4   | 3.4   | 1.5   | 1.5   |
| Prop In Lane                 | 1.00  |   | 1.00  | 0.95  |   | 1.00  | 0.04   |   | 0.27  | 1.00  |   | 0.06  |
| Lane Grp Cap(c), veh/h       | 434   | 453   | 385   | 574   | 0   | 321   | 814  | 0   | 564   | 548   | 623   | 649   |
| V/C Ratio(X)                 | 0.03  | 0.02  | 0.01  | 0.35  | 0.00  | 0.05  | 0.33   | 0.00  | 0.41  | 0.10  | 0.27  | 0.27  |
| Avail Cap(c_a), veh/h        | 1936  | 2485  | 2112  | 1858  | 0   | 1760  | 2419   | 0   | 2002  | 1359  | 2214  | 2305  |
| HCM Platoon Ratio            | 1.00  | 1.00  | 1.00  | 1.00  | 1.00  | 1.00  | 1.00   | 1.00  | 1.00  | 1.00  | 1.00  | 1.00  |
| Upstream Filter(I)           | 1.00  | 1.00  | 1.00  | 1.00  | 0.00  | 1.00  | 1.00   | 0.00  | 1.00  | 1.00  | 1.00  | 1.00  |
| Uniform Delay (d), s/veh     | 9.4   | 6.4   | 6.3   | 8.0   | 0.0   | 6.4   | 5.4  | 0.0   | 5.4   | 6.7   | 5.1   | 5.1   |
| Incr Delay (d2), s/veh       | 0.0   | 0.0   | 0.0   | 0.4   | 0.0   | 0.1   | 0.2  | 0.0   | 0.5   | 0.1   | 0.2   | 0.2   |
| Initial Q Delay(d3),s/veh    | 0.0   | 0.0   | 0.0   | 0.0   | 0.0   | 0.0   | 0.0  | 0.0   | 0.0   | 0.0   | 0.0   | 0.0   |
| %ile BackOfQ(50%),veh/ln     | 0.1   | 0.1   | 0.0   | 1.2   | 0.0   | 0.1   | 1.2  | 0.0   | 1.1   | 0.3   | 0.7   | 0.8   |
| LnGrp Delay(d),s/veh         | 9.4   | 6.4   | 6.4   | 8.3   | 0.0   | 6.5   | 5.6  | 0.0   | 5.9   | 6.8   | 5.3   | 5.3   |
| LnGrp LOS                    | A   | A   | A   | A   |   | A   | A  |   | A   | A   | A   | A   |
| Approach Vol, veh/h          |   | 26  |   |   | 219   |   |  | 501   |   |   | 394   |   |
| Approach Delay, s/veh        |   | 7.7   |   |   | 8.2   |   |  | 5.7   |   |   | 5.5   |   |
| Approach LOS                 |   | A   |   |   | A   |   |  | A   |   |   | A   |   |
| Timer                        | 1   | 2   | 3   | 4   | 5   | 6   | 7  | 8   |   |   |   |   |
| Assigned Phs                 |   | 2   |   | 4   |   | 6   |  | 8   |   |   |   |   |
| Phs Duration (G+Y+Rc), s     |   | 12.1  |   | 9.7   |   | 12.1  |  | 9.7   |   |   |   |   |
| Change Period (Y+Rc), s      |   | 4.5   |   | 4.5   |   | 4.5   |  | 4.5   |   |   |   |   |
| Max Green Setting (Gmax), s  |   | 27.0  |   | 28.5  |   | 27.0  |  | 28.5  |   |   |   |   |
| Max Q Clear Time (g_c+I1), s |   | 4.4   |   | 5.7   |   | 5.4   |  | 5.6   |   |   |   |   |
| Green Ext Time (p_c), s      |   | 2.9   |   | 0.0   |   | 2.1   |  | 1.1   |   |   |   |   |
| <b>Intersection Summary</b>  |   |   |   |   |   |   |  |   |   |   |   |   |
| HCM 2010 Ctrl Delay          |   |   | 6.2   |   |   |   |  |   |   |   |   |   |
| HCM 2010 LOS                 |   |   | A   |   |   |   |  |   |   |   |   |   |

HCM 2010 Signalized Intersection Summary  
 21: 7th Avenue/8th Street & Inter-Garrison Road

Existing with Project, PM  
 04/25/2022

|                              |  |  |  |  |  |  |   |  |  |  |  |  |
|------------------------------|---|---|---|---|---|---|---|---|---|---|---|---|
| Movement                     | EBL   | EBT   | EBR   | WBL   | WBT   | WBR   | NBL   | NBT   | NBR   | SBL   | SBT   | SBR   |
| Lane Configurations          |  |  |   |  |  |   |  |  |  |  |  |  |
| Traffic Volume (veh/h)       | 10  | 140   | 10  | 180   | 80  | 30  | 10  | 270   | 300   | 80  | 140   | 10  |
| Future Volume (veh/h)        | 10  | 140   | 10  | 180   | 80  | 30  | 10  | 270   | 300   | 80  | 140   | 10  |
| Number                       | 5   | 2   | 12  | 1   | 6   | 16  | 3   | 8   | 18  | 7   | 4   | 14  |
| Initial Q (Qb), veh          | 0   | 0   | 0   | 0   | 0   | 0   | 0   | 0   | 0   | 0   | 0   | 0   |
| Ped-Bike Adj(A_pbT)          | 1.00  |   | 0.99  | 1.00  |   | 1.00  | 1.00  |   | 1.00  | 1.00  |   | 1.00  |
| Parking Bus, Adj             | 1.00  | 1.00  | 1.00  | 1.00  | 1.00  | 1.00  | 1.00  | 1.00  | 1.00  | 1.00  | 1.00  | 1.00  |
| Adj Sat Flow, veh/h/ln       | 1759  | 1759  | 1900  | 1845  | 1845  | 1900  | 1597  | 1597  | 1597  | 1776  | 1776  | 1900  |
| Adj Flow Rate, veh/h         | 12  | 173   | 12  | 222   | 99  | 0   | 12  | 333   | 370   | 99  | 173   | 12  |
| Adj No. of Lanes             | 1   | 1   | 0   | 1   | 1   | 0   | 1   | 1   | 1   | 1   | 1   | 0   |
| Peak Hour Factor             | 0.81  | 0.81  | 0.81  | 0.81  | 0.81  | 0.81  | 0.81  | 0.81  | 0.81  | 0.81  | 0.81  | 0.81  |
| Percent Heavy Veh, %         | 8   | 8   | 8   | 3   | 3   | 3   | 19  | 19  | 19  | 7   | 7   | 7   |
| Cap, veh/h                   | 26  | 297   | 21  | 283   | 605   | 0   | 450   | 578   | 491   | 294   | 594   | 41  |
| Arrive On Green              | 0.02  | 0.18  | 0.18  | 0.16  | 0.33  | 0.00  | 0.36  | 0.36  | 0.36  | 0.36  | 0.36  | 0.36  |
| Sat Flow, veh/h              | 1675  | 1626  | 113   | 1757  | 1845  | 0   | 1023  | 1597  | 1357  | 706   | 1642  | 114   |
| Grp Volume(v), veh/h         | 12  | 0   | 185   | 222   | 99  | 0   | 12  | 333   | 370   | 99  | 0   | 185   |
| Grp Sat Flow(s),veh/h/ln     | 1675  | 0   | 1738  | 1757  | 1845  | 0   | 1023  | 1597  | 1357  | 706   | 0   | 1756  |
| Q Serve(g_s), s              | 0.3   | 0.0   | 4.5   | 5.6   | 1.7   | 0.0   | 0.4   | 7.7   | 11.0  | 6.0   | 0.0   | 3.4   |
| Cycle Q Clear(g_c), s        | 0.3   | 0.0   | 4.5   | 5.6   | 1.7   | 0.0   | 3.8   | 7.7   | 11.0  | 13.7  | 0.0   | 3.4   |
| Prop In Lane                 | 1.00  |   | 0.06  | 1.00  |   | 0.00  | 1.00  |   | 1.00  | 1.00  |   | 0.06  |
| Lane Grp Cap(c), veh/h       | 26  | 0   | 318   | 283   | 605   | 0   | 450   | 578   | 491   | 294   | 0   | 636   |
| V/C Ratio(X)                 | 0.46  | 0.00  | 0.58  | 0.79  | 0.16  | 0.00  | 0.03  | 0.58  | 0.75  | 0.34  | 0.00  | 0.29  |
| Avail Cap(c_a), veh/h        | 183   | 0   | 1213  | 479   | 1589  | 0   | 571   | 766   | 651   | 377   | 0   | 842   |
| HCM Platoon Ratio            | 1.00  | 1.00  | 1.00  | 1.00  | 1.00  | 1.00  | 1.00  | 1.00  | 1.00  | 1.00  | 1.00  | 1.00  |
| Upstream Filter(I)           | 1.00  | 0.00  | 1.00  | 1.00  | 1.00  | 0.00  | 1.00  | 1.00  | 1.00  | 1.00  | 0.00  | 1.00  |
| Uniform Delay (d), s/veh     | 22.4  | 0.0   | 17.1  | 18.5  | 10.9  | 0.0   | 11.8  | 11.8  | 12.8  | 17.3  | 0.0   | 10.4  |
| Incr Delay (d2), s/veh       | 12.3  | 0.0   | 1.7   | 4.8   | 0.1   | 0.0   | 0.0   | 0.9   | 3.5   | 0.7   | 0.0   | 0.3   |
| Initial Q Delay(d3),s/veh    | 0.0   | 0.0   | 0.0   | 0.0   | 0.0   | 0.0   | 0.0   | 0.0   | 0.0   | 0.0   | 0.0   | 0.0   |
| %ile BackOfQ(50%),veh/ln     | 0.2   | 0.0   | 2.3   | 3.0   | 0.9   | 0.0   | 0.1   | 3.5   | 4.5   | 1.2   | 0.0   | 1.7   |
| LnGrp Delay(d),s/veh         | 34.7  | 0.0   | 18.8  | 23.3  | 11.1  | 0.0   | 11.8  | 12.7  | 16.3  | 18.0  | 0.0   | 10.7  |
| LnGrp LOS                    | C   |   | B   | C   | B   |   | B   | B   | B   | B   |   | B   |
| Approach Vol, veh/h          |   | 197   |   |   | 321   |   |   | 715   |   |   | 284   |   |
| Approach Delay, s/veh        |   | 19.8  |   |   | 19.5  |   |   | 14.6  |   |   | 13.2  |   |
| Approach LOS                 |   | B   |   |   | B   |   |   | B   |   |   | B   |   |
| Timer                        | 1   | 2   | 3   | 4   | 5   | 6   | 7   | 8   |   |   |   |   |
| Assigned Phs                 | 1   | 2   |   | 4   | 5   | 6   |   | 8   |   |   |   |   |
| Phs Duration (G+Y+Rc), s     | 11.9  | 12.9  |   | 21.1  | 5.2   | 19.6  |   | 21.1  |   |   |   |   |
| Change Period (Y+Rc), s      | 4.5   | 4.5   |   | 4.5   | 4.5   | 4.5   |   | 4.5   |   |   |   |   |
| Max Green Setting (Gmax), s  | 12.5  | 32.0  |   | 22.0  | 5.0   | 39.5  |   | 22.0  |   |   |   |   |
| Max Q Clear Time (g_c+I1), s | 7.6   | 6.5   |   | 15.7  | 2.3   | 3.7   |   | 13.0  |   |   |   |   |
| Green Ext Time (p_c), s      | 0.3   | 1.0   |   | 0.9   | 0.0   | 0.5   |   | 2.5   |   |   |   |   |
| <b>Intersection Summary</b>  |   |   |   |   |   |   |   |   |   |   |   |   |
| HCM 2010 Ctrl Delay          |   |   | 16.0  |   |   |   |   |   |   |   |   |   |
| HCM 2010 LOS                 |   |   | B   |   |   |   |   |   |   |   |   |   |



| Movement                     | EBT  | EBR  | WBL  | WBT  | NBL  | NBR  |   |      |
|------------------------------|------|------|------|------|------|------|---|------|
| Lane Configurations          | T    |      |      | T    |      | T    |   |      |
| Traffic Volume (veh/h)       | 480  | 50   | 390  | 280  | 10   | 610  |   |      |
| Future Volume (veh/h)        | 480  | 50   | 390  | 280  | 10   | 610  |   |      |
| Number                       | 4    | 14   | 3    | 8    | 5    | 12   |   |      |
| Initial Q (Qb), veh          | 0    | 0    | 0    | 0    | 0    | 0    |   |      |
| Ped-Bike Adj(A_pbT)          |      | 1.00 | 1.00 |      | 1.00 | 1.00 |   |      |
| Parking Bus, Adj             | 1.00 | 1.00 | 1.00 | 1.00 | 1.00 | 1.00 |   |      |
| Adj Sat Flow, veh/h/ln       | 1520 | 1900 | 1900 | 1881 | 1845 | 1900 |   |      |
| Adj Flow Rate, veh/h         | 495  | 40   | 402  | 289  | 10   | 311  |   |      |
| Adj No. of Lanes             | 1    | 0    | 0    | 1    | 0    | 0    |   |      |
| Peak Hour Factor             | 0.97 | 0.97 | 0.97 | 0.97 | 0.97 | 0.97 |   |      |
| Percent Heavy Veh, %         | 25   | 25   | 1    | 1    | 0    | 0    |   |      |
| Cap, veh/h                   | 630  | 51   | 0    | 854  | 13   | 401  |   |      |
| Arrive On Green              | 0.45 | 0.44 | 0.00 | 0.45 | 0.26 | 0.25 |   |      |
| Sat Flow, veh/h              | 1388 | 112  | 0    | 1881 | 49   | 1520 |   |      |
| Grp Volume(v), veh/h         | 0    | 535  | 0    | 289  | 322  | 0    |   |      |
| Grp Sat Flow(s),veh/h/ln     | 0    | 1500 | 0    | 1881 | 1574 | 0    |   |      |
| Q Serve(g_s), s              | 0.0  | 9.7  | 0.0  | 3.2  | 6.1  | 0.0  |   |      |
| Cycle Q Clear(g_c), s        | 0.0  | 9.7  | 0.0  | 3.2  | 6.1  | 0.0  |   |      |
| Prop In Lane                 |      | 0.07 | 0.00 |      | 0.03 | 0.97 |   |      |
| Lane Grp Cap(c), veh/h       | 0    | 681  | 0    | 854  | 415  | 0    |   |      |
| V/C Ratio(X)                 | 0.00 | 0.79 | 0.00 | 0.34 | 0.78 | 0.00 |   |      |
| Avail Cap(c_a), veh/h        | 0    | 1153 | 0    | 2774 | 938  | 0    |   |      |
| HCM Platoon Ratio            | 1.00 | 1.00 | 1.00 | 1.00 | 1.00 | 1.00 |   |      |
| Upstream Filter(I)           | 0.00 | 1.00 | 0.00 | 1.00 | 1.00 | 0.00 |   |      |
| Uniform Delay (d), s/veh     | 0.0  | 7.4  | 0.0  | 5.6  | 11.1 | 0.0  |   |      |
| Incr Delay (d2), s/veh       | 0.0  | 2.0  | 0.0  | 0.2  | 3.2  | 0.0  |   |      |
| Initial Q Delay(d3),s/veh    | 0.0  | 0.0  | 0.0  | 0.0  | 0.0  | 0.0  |   |      |
| %ile BackOfQ(50%),veh/ln     | 0.0  | 4.3  | 0.0  | 1.7  | 3.0  | 0.0  |   |      |
| LnGrp Delay(d),s/veh         | 0.0  | 9.4  | 0.0  | 5.8  | 14.3 | 0.0  |   |      |
| LnGrp LOS                    |      | A    |      | A    | B    |      |   |      |
| Approach Vol, veh/h          | 535  |      |      | 289  | 322  |      |   |      |
| Approach Delay, s/veh        | 9.4  |      |      | 5.8  | 14.3 |      |   |      |
| Approach LOS                 | A    |      |      | A    | B    |      |   |      |
| Timer                        | 1    | 2    | 3    | 4    | 5    | 6    | 7 | 8    |
| Assigned Phs                 |      | 2    | 3    | 4    |      |      |   | 8    |
| Phs Duration (G+Y+Rc), s     |      | 12.9 | 0.0  | 19.0 |      |      |   | 19.0 |
| Change Period (Y+Rc), s      |      | 4.5  | 4.5  | 4.5  |      |      |   | 4.5  |
| Max Green Setting (Gmax), s  |      | 19.0 | 18.0 | 24.5 |      |      |   | 47.0 |
| Max Q Clear Time (g_c+I1), s |      | 8.1  | 0.0  | 11.7 |      |      |   | 5.2  |
| Green Ext Time (p_c), s      |      | 0.8  | 0.0  | 2.8  |      |      |   | 1.8  |
| <b>Intersection Summary</b>  |      |      |      |      |      |      |   |      |
| HCM 2010 Ctrl Delay          |      |      | 9.9  |      |      |      |   |      |
| HCM 2010 LOS                 |      |      | A    |      |      |      |   |      |
| <b>Notes</b>                 |      |      |      |      |      |      |   |      |

| Intersection                |       |       |       |       |
|-----------------------------|-------|-------|-------|-------|
| Intersection Delay, s/veh   | 23.0  |       |       |       |
| Intersection LOS            | C     |       |       |       |
| Approach                    | EB    | WB    | NB    |       |
| Entry Lanes                 | 1     | 2     | 1     |       |
| Conflicting Circle Lanes    | 2     | 2     | 2     |       |
| Adj Approach Flow, veh/h    | 547   | 691   | 639   |       |
| Demand Flow Rate, veh/h     | 684   | 698   | 658   |       |
| Vehicles Circulating, veh/h | 406   | 10    | 619   |       |
| Vehicles Exiting, veh/h     | 302   | 1267  | 471   |       |
| Follow-Up Headway, s        | 3.186 | 3.186 | 3.186 |       |
| Ped Vol Crossing Leg, #/h   | 0     | 0     | 0     |       |
| Ped Cap Adj                 | 1.000 | 1.000 | 1.000 |       |
| Approach Delay, s/veh       | 27.4  | 6.3   | 37.3  |       |
| Approach LOS                | D     | A     | E     |       |
| Lane                        | Left  | Left  | Right | Left  |
| Designated Moves            | TR    | L     | LTR   | LR    |
| Assumed Moves               | TR    | L     | LTR   | LR    |
| RT Channelized              |       |       |       |       |
| Lane Util                   | 1.000 | 0.530 | 0.470 | 1.000 |
| Critical Headway, s         | 4.113 | 4.293 | 4.113 | 4.113 |
| Entry Flow, veh/h           | 684   | 370   | 328   | 658   |
| Cap Entry Lane, veh/h       | 850   | 1122  | 1122  | 733   |
| Entry HV Adj Factor         | 0.800 | 0.990 | 0.990 | 0.971 |
| Flow Entry, veh/h           | 547   | 366   | 325   | 639   |
| Cap Entry, veh/h            | 680   | 1110  | 1111  | 711   |
| V/C Ratio                   | 0.804 | 0.330 | 0.292 | 0.898 |
| Control Delay, s/veh        | 27.4  | 6.5   | 6.0   | 37.3  |
| LOS                         | D     | A     | A     | E     |
| 95th %tile Queue, veh       | 8     | 1     | 1     | 12    |





| Movement                     | EBL  | EBT  | WBT  | WBR  | SBL  | SBR  |   |   |
|------------------------------|------|------|------|------|------|------|---|---|
| Lane Configurations          |      |      |      |      |      |      |   |   |
| Traffic Volume (veh/h)       | 540  | 550  | 260  | 20   | 10   | 420  |   |   |
| Future Volume (veh/h)        | 540  | 550  | 260  | 20   | 10   | 420  |   |   |
| Number                       | 5    | 2    | 6    | 16   | 7    | 14   |   |   |
| Initial Q (Qb), veh          | 0    | 0    | 0    | 0    | 0    | 0    |   |   |
| Ped-Bike Adj(A_pbT)          | 1.00 |      |      | 1.00 | 1.00 | 1.00 |   |   |
| Parking Bus, Adj             | 1.00 | 1.00 | 1.00 | 1.00 | 1.00 | 1.00 |   |   |
| Adj Sat Flow, veh/h/ln       | 1759 | 1759 | 1881 | 1881 | 1881 | 1881 |   |   |
| Adj Flow Rate, veh/h         | 568  | 579  | 274  | 17   | 11   | 35   |   |   |
| Adj No. of Lanes             | 1    | 1    | 1    | 1    | 2    | 1    |   |   |
| Peak Hour Factor             | 0.95 | 0.95 | 0.95 | 0.95 | 0.95 | 0.95 |   |   |
| Percent Heavy Veh, %         | 8    | 8    | 1    | 1    | 1    | 1    |   |   |
| Cap, veh/h                   | 869  | 1154 | 1234 | 1049 | 150  | 69   |   |   |
| Arrive On Green              | 0.66 | 0.66 | 0.66 | 0.66 | 0.04 | 0.04 |   |   |
| Sat Flow, veh/h              | 1024 | 1759 | 1881 | 1599 | 3476 | 1599 |   |   |
| Grp Volume(v), veh/h         | 568  | 579  | 274  | 17   | 11   | 35   |   |   |
| Grp Sat Flow(s),veh/h/ln     | 1024 | 1759 | 1881 | 1599 | 1738 | 1599 |   |   |
| Q Serve(g_s), s              | 14.1 | 4.8  | 1.7  | 0.1  | 0.1  | 0.6  |   |   |
| Cycle Q Clear(g_c), s        | 15.7 | 4.8  | 1.7  | 0.1  | 0.1  | 0.6  |   |   |
| Prop In Lane                 | 1.00 |      |      | 1.00 | 1.00 | 1.00 |   |   |
| Lane Grp Cap(c), veh/h       | 869  | 1154 | 1234 | 1049 | 150  | 69   |   |   |
| V/C Ratio(X)                 | 0.65 | 0.50 | 0.22 | 0.02 | 0.07 | 0.51 |   |   |
| Avail Cap(c_a), veh/h        | 2536 | 4018 | 4297 | 3652 | 3323 | 1529 |   |   |
| HCM Platoon Ratio            | 1.00 | 1.00 | 1.00 | 1.00 | 1.00 | 1.00 |   |   |
| Upstream Filter(I)           | 1.00 | 1.00 | 1.00 | 1.00 | 1.00 | 1.00 |   |   |
| Uniform Delay (d), s/veh     | 5.1  | 2.5  | 2.0  | 1.7  | 13.0 | 13.2 |   |   |
| Incr Delay (d2), s/veh       | 0.3  | 0.1  | 0.0  | 0.0  | 0.1  | 2.1  |   |   |
| Initial Q Delay(d3),s/veh    | 0.0  | 0.0  | 0.0  | 0.0  | 0.0  | 0.0  |   |   |
| %ile BackOfQ(50%),veh/ln     | 8.9  | 2.3  | 0.8  | 0.0  | 0.0  | 0.3  |   |   |
| LnGrp Delay(d),s/veh         | 5.4  | 2.6  | 2.0  | 1.7  | 13.0 | 15.4 |   |   |
| LnGrp LOS                    | A    | A    | A    | A    | B    | B    |   |   |
| Approach Vol, veh/h          |      | 1147 | 291  |      | 46   |      |   |   |
| Approach Delay, s/veh        |      | 4.0  | 2.0  |      | 14.8 |      |   |   |
| Approach LOS                 |      | A    | A    |      | B    |      |   |   |
| Timer                        | 1    | 2    | 3    | 4    | 5    | 6    | 7 | 8 |
| Assigned Phs                 |      | 2    |      | 4    |      | 6    |   |   |
| Phs Duration (G+Y+Rc), s     |      | 23.5 |      | 4.7  |      | 23.5 |   |   |
| Change Period (Y+Rc), s      |      | 5.0  |      | 3.5  |      | 5.0  |   |   |
| Max Green Setting (Gmax), s  |      | 64.5 |      | 27.0 |      | 64.5 |   |   |
| Max Q Clear Time (g_c+I1), s |      | 17.7 |      | 2.6  |      | 3.7  |   |   |
| Green Ext Time (p_c), s      |      | 0.8  |      | 0.0  |      | 0.2  |   |   |
| <b>Intersection Summary</b>  |      |      |      |      |      |      |   |   |
| HCM 2010 Ctrl Delay          |      |      | 3.9  |      |      |      |   |   |
| HCM 2010 LOS                 |      |      | A    |      |      |      |   |   |

HCM 2010 Signalized Intersection Summary  
 29: 2nd Avenue & Divarty Street

Existing with Project, PM  
 09/18/2019



| Movement                     | EBL  | EBT  | EBR  | WBL  | WBT  | WBR  | NBL  | NBT  | NBR  | SBL  | SBT  | SBR  |
|------------------------------|------|------|------|------|------|------|------|------|------|------|------|------|
| Lane Configurations          |      | ↕    |      |      | ↕    | ↕    | ↕    | ↕    |      | ↕    | ↕    |      |
| Traffic Volume (veh/h)       | 10   | 10   | 10   | 130  | 10   | 10   | 10   | 580  | 110  | 10   | 520  | 10   |
| Future Volume (veh/h)        | 10   | 10   | 10   | 130  | 10   | 10   | 10   | 580  | 110  | 10   | 520  | 10   |
| Number                       | 5    | 2    | 12   | 1    | 6    | 16   | 3    | 8    | 18   | 7    | 4    | 14   |
| Initial Q (Qb), veh          | 0    | 0    | 0    | 0    | 0    | 0    | 0    | 0    | 0    | 0    | 0    | 0    |
| Ped-Bike Adj(A_pbT)          | 1.00 |      | 1.00 | 1.00 |      | 1.00 | 1.00 |      | 1.00 | 1.00 |      | 1.00 |
| Parking Bus, Adj             | 1.00 | 1.00 | 1.00 | 1.00 | 1.00 | 1.00 | 1.00 | 1.00 | 1.00 | 1.00 | 1.00 | 1.00 |
| Adj Sat Flow, veh/h/ln       | 1900 | 1667 | 1900 | 1900 | 1900 | 1900 | 1863 | 1863 | 1900 | 1881 | 1881 | 1900 |
| Adj Flow Rate, veh/h         | 11   | 11   | 11   | 138  | 11   | 11   | 11   | 617  | 117  | 11   | 553  | 11   |
| Adj No. of Lanes             | 0    | 1    | 0    | 0    | 1    | 1    | 1    | 2    | 0    | 1    | 2    | 0    |
| Peak Hour Factor             | 0.94 | 0.94 | 0.94 | 0.94 | 0.94 | 0.94 | 0.94 | 0.94 | 0.94 | 0.94 | 0.94 | 0.94 |
| Percent Heavy Veh, %         | 14   | 14   | 14   | 0    | 0    | 0    | 2    | 2    | 2    | 1    | 1    | 1    |
| Cap, veh/h                   | 206  | 169  | 120  | 517  | 34   | 393  | 21   | 1090 | 206  | 21   | 1316 | 26   |
| Arrive On Green              | 0.24 | 0.24 | 0.24 | 0.24 | 0.24 | 0.24 | 0.01 | 0.37 | 0.37 | 0.01 | 0.37 | 0.37 |
| Sat Flow, veh/h              | 293  | 692  | 492  | 1324 | 140  | 1613 | 1774 | 2969 | 562  | 1792 | 3584 | 71   |
| Grp Volume(v), veh/h         | 33   | 0    | 0    | 149  | 0    | 11   | 11   | 367  | 367  | 11   | 276  | 288  |
| Grp Sat Flow(s),veh/h/ln1477 | 0    | 0    | 0    | 1464 | 0    | 1613 | 1774 | 1770 | 1762 | 1792 | 1787 | 1868 |
| Q Serve(g_s), s              | 0.0  | 0.0  | 0.0  | 2.4  | 0.0  | 0.2  | 0.2  | 5.9  | 6.0  | 0.2  | 4.1  | 4.1  |
| Cycle Q Clear(g_c), s        | 0.6  | 0.0  | 0.0  | 2.9  | 0.0  | 0.2  | 0.2  | 5.9  | 6.0  | 0.2  | 4.1  | 4.1  |
| Prop In Lane                 | 0.33 |      | 0.33 | 0.93 |      | 1.00 | 1.00 |      | 0.32 | 1.00 |      | 0.04 |
| Lane Grp Cap(c), veh/h       | 494  | 0    | 0    | 551  | 0    | 393  | 21   | 650  | 647  | 21   | 656  | 686  |
| V/C Ratio(X)                 | 0.07 | 0.00 | 0.00 | 0.27 | 0.00 | 0.03 | 0.54 | 0.57 | 0.57 | 0.53 | 0.42 | 0.42 |
| Avail Cap(c_a), veh/h        | 1656 | 0    | 0    | 1728 | 0    | 1714 | 322  | 2078 | 2069 | 326  | 2099 | 2194 |
| HCM Platoon Ratio            | 1.00 | 1.00 | 1.00 | 1.00 | 1.00 | 1.00 | 1.00 | 1.00 | 1.00 | 1.00 | 1.00 | 1.00 |
| Upstream Filter(I)           | 1.00 | 0.00 | 0.00 | 1.00 | 0.00 | 1.00 | 1.00 | 1.00 | 1.00 | 1.00 | 1.00 | 1.00 |
| Uniform Delay (d), s/veh     | 10.4 | 0.0  | 0.0  | 11.3 | 0.0  | 10.3 | 17.6 | 9.0  | 9.0  | 17.6 | 8.5  | 8.5  |
| Incr Delay (d2), s/veh       | 0.1  | 0.0  | 0.0  | 0.3  | 0.0  | 0.0  | 19.9 | 0.8  | 0.8  | 19.4 | 0.4  | 0.4  |
| Initial Q Delay(d3),s/veh    | 0.0  | 0.0  | 0.0  | 0.0  | 0.0  | 0.0  | 0.0  | 0.0  | 0.0  | 0.0  | 0.0  | 0.0  |
| %ile BackOfQ(50%),veh/ln0.3  | 0.0  | 0.0  | 0.0  | 1.2  | 0.0  | 0.1  | 0.2  | 3.0  | 3.0  | 0.2  | 2.1  | 2.2  |
| LnGrp Delay(d),s/veh         | 10.5 | 0.0  | 0.0  | 11.6 | 0.0  | 10.3 | 37.5 | 9.8  | 9.8  | 37.0 | 8.9  | 8.9  |
| LnGrp LOS                    | B    |      |      | B    |      | B    | D    | A    | A    | D    | A    | A    |
| Approach Vol, veh/h          |      | 33   |      |      | 160  |      |      | 745  |      |      | 575  |      |
| Approach Delay, s/veh        |      | 10.5 |      |      | 11.5 |      |      | 10.2 |      |      | 9.4  |      |
| Approach LOS                 |      | B    |      |      | B    |      |      | B    |      |      | A    |      |
| Timer                        | 1    | 2    | 3    | 4    | 5    | 6    | 7    | 8    |      |      |      |      |
| Assigned Phs                 |      | 2    | 3    | 4    |      | 6    | 7    | 8    |      |      |      |      |
| Phs Duration (G+Y+Rc), s     |      | 13.7 | 3.9  | 18.1 |      | 13.7 | 3.9  | 18.1 |      |      |      |      |
| Change Period (Y+Rc), s      |      | 5.0  | 3.5  | 5.0  |      | 5.0  | 3.5  | 5.0  |      |      |      |      |
| Max Green Setting (Gmax), s  |      | 38.0 | 6.5  | 42.0 |      | 38.0 | 6.5  | 42.0 |      |      |      |      |
| Max Q Clear Time (g_c+I1), s |      | 2.6  | 2.2  | 6.1  |      | 4.9  | 2.2  | 8.0  |      |      |      |      |
| Green Ext Time (p_c), s      |      | 0.1  | 0.0  | 3.6  |      | 0.9  | 0.0  | 5.0  |      |      |      |      |
| <b>Intersection Summary</b>  |      |      |      |      |      |      |      |      |      |      |      |      |
| HCM 2010 Ctrl Delay          |      |      |      | 10.1 |      |      |      |      |      |      |      |      |
| HCM 2010 LOS                 |      |      |      | B    |      |      |      |      |      |      |      |      |

HCM 2010 Signalized Intersection Summary  
 47: General Jim Moore Boulevard & Coe Avenue

Existing with Project, PM  
 09/18/2019



| Movement                    | EBL  | EBR  | NBL  | NBT  | SBT  | SBR  |   |      |
|-----------------------------|------|------|------|------|------|------|---|------|
| Lane Configurations         |      |      |      |      |      |      |   |      |
| Traffic Volume (veh/h)      | 60   | 100  | 160  | 880  | 350  | 90   |   |      |
| Future Volume (veh/h)       | 60   | 100  | 160  | 880  | 350  | 90   |   |      |
| Number                      | 3    | 18   | 1    | 6    | 2    | 12   |   |      |
| Initial Q (Qb), veh         | 0    | 0    | 0    | 0    | 0    | 0    |   |      |
| Ped-Bike Adj(A_pbT)         | 1.00 | 1.00 | 1.00 |      |      | 1.00 |   |      |
| Parking Bus, Adj            | 1.00 | 1.00 | 1.00 | 1.00 | 1.00 | 1.00 |   |      |
| Adj Sat Flow, veh/h/ln      | 1881 | 1881 | 1881 | 1881 | 1863 | 1863 |   |      |
| Adj Flow Rate, veh/h        | 67   | 15   | 180  | 989  | 393  | 21   |   |      |
| Adj No. of Lanes            | 1    | 1    | 1    | 2    | 2    | 1    |   |      |
| Peak Hour Factor            | 0.89 | 0.89 | 0.89 | 0.89 | 0.89 | 0.89 |   |      |
| Percent Heavy Veh, %        | 1    | 1    | 1    | 1    | 2    | 2    |   |      |
| Cap, veh/h                  | 157  | 140  | 260  | 1927 | 734  | 328  |   |      |
| Arrive On Green             | 0.09 | 0.09 | 0.15 | 0.54 | 0.21 | 0.21 |   |      |
| Sat Flow, veh/h             | 1792 | 1599 | 1792 | 3668 | 3632 | 1583 |   |      |
| Grp Volume(v), veh/h        | 67   | 15   | 180  | 989  | 393  | 21   |   |      |
| Grp Sat Flow(s),veh/h/ln    | 1792 | 1599 | 1792 | 1787 | 1770 | 1583 |   |      |
| Q Serve(g_s), s             | 0.9  | 0.2  | 2.3  | 4.3  | 2.4  | 0.3  |   |      |
| Cycle Q Clear(g_c), s       | 0.9  | 0.2  | 2.3  | 4.3  | 2.4  | 0.3  |   |      |
| Prop In Lane                | 1.00 | 1.00 | 1.00 |      |      | 1.00 |   |      |
| Lane Grp Cap(c), veh/h      | 157  | 140  | 260  | 1927 | 734  | 328  |   |      |
| V/C Ratio(X)                | 0.43 | 0.11 | 0.69 | 0.51 | 0.54 | 0.06 |   |      |
| Avail Cap(c_a), veh/h       | 3380 | 3017 | 409  | 5262 | 5210 | 2331 |   |      |
| HCM Platoon Ratio           | 1.00 | 1.00 | 1.00 | 1.00 | 1.00 | 1.00 |   |      |
| Upstream Filter(I)          | 1.00 | 1.00 | 1.00 | 1.00 | 1.00 | 1.00 |   |      |
| Uniform Delay (d), s/veh    | 10.4 | 10.1 | 9.8  | 3.5  | 8.5  | 7.7  |   |      |
| Incr Delay (d2), s/veh      | 0.7  | 0.1  | 1.2  | 0.1  | 0.2  | 0.0  |   |      |
| Initial Q Delay(d3),s/veh   | 0.0  | 0.0  | 0.0  | 0.0  | 0.0  | 0.0  |   |      |
| %ile BackOfQ(50%),veh/ln    | 0.4  | 0.1  | 1.2  | 2.1  | 1.2  | 0.1  |   |      |
| LnGrp Delay(d),s/veh        | 11.1 | 10.3 | 11.0 | 3.6  | 8.7  | 7.7  |   |      |
| LnGrp LOS                   | B    | B    | B    | A    | A    | A    |   |      |
| Approach Vol, veh/h         | 82   |      |      | 1169 | 414  |      |   |      |
| Approach Delay, s/veh       | 11.0 |      |      | 4.8  | 8.7  |      |   |      |
| Approach LOS                | B    |      |      | A    | A    |      |   |      |
| Timer                       | 1    | 2    | 3    | 4    | 5    | 6    | 7 | 8    |
| Assigned Phs                | 1    | 2    |      |      |      | 6    |   | 8    |
| Phs Duration (G+Y+Rc), s    | 8.0  | 9.5  |      |      |      | 17.5 |   | 6.6  |
| Change Period (Y+Rc), s     | 4.5  | 4.5  |      |      |      | 4.5  |   | 4.5  |
| Max Green Setting (Gmax), s | 5.5  | 35.5 |      |      |      | 35.5 |   | 45.5 |
| Max Q Clear Time (g_c+I), s | 14.3 | 4.4  |      |      |      | 6.3  |   | 2.9  |
| Green Ext Time (p_c), s     | 0.0  | 0.4  |      |      |      | 1.2  |   | 0.0  |
| <b>Intersection Summary</b> |      |      |      |      |      |      |   |      |
| HCM 2010 Ctrl Delay         |      |      | 6.0  |      |      |      |   |      |
| HCM 2010 LOS                |      |      | A    |      |      |      |   |      |

HCM 2010 Signalized Intersection Summary  
5: 2nd Avenue & Imjin Parkway

Cuml w/ Proj, AM  
09/06/2019



| Movement                    | EBL  | EBT  | EBR  | WBL  | WBT  | WBR  | NBL  | NBT  | NBR  | SBL  | SBT  | SBR  |
|-----------------------------|------|------|------|------|------|------|------|------|------|------|------|------|
| Lane Configurations         | ↔↔   | ↑↑↑  | ↔↔   | ↔↔↔  | ↑↑↑  | ↔↔   | ↔↔↔  | ↑    | ↔↔   | ↔↔   | ↑↑   | ↔    |
| Traffic Volume (veh/h)      | 180  | 1160 | 880  | 520  | 1010 | 120  | 370  | 90   | 200  | 50   | 100  | 210  |
| Future Volume (veh/h)       | 180  | 1160 | 880  | 520  | 1010 | 120  | 370  | 90   | 200  | 50   | 100  | 210  |
| Number                      | 5    | 2    | 12   | 1    | 6    | 16   | 3    | 8    | 18   | 7    | 4    | 14   |
| Initial Q (Qb), veh         | 0    | 0    | 0    | 0    | 0    | 0    | 0    | 0    | 0    | 0    | 0    | 0    |
| Ped-Bike Adj(A_pbT)         | 1.00 |      | 1.00 | 1.00 |      | 1.00 | 1.00 |      | 1.00 | 1.00 |      | 1.00 |
| Parking Bus, Adj            | 1.00 | 1.00 | 1.00 | 1.00 | 1.00 | 1.00 | 1.00 | 1.00 | 1.00 | 1.00 | 1.00 | 1.00 |
| Adj Sat Flow, veh/h/ln      | 1863 | 1863 | 1863 | 1863 | 1863 | 1863 | 1810 | 1810 | 1810 | 1900 | 1900 | 1900 |
| Adj Flow Rate, veh/h        | 184  | 1184 | 679  | 531  | 1031 | 122  | 378  | 92   | 82   | 51   | 102  | 209  |
| Adj No. of Lanes            | 2    | 3    | 2    | 3    | 3    | 1    | 3    | 1    | 2    | 2    | 2    | 1    |
| Peak Hour Factor            | 0.98 | 0.98 | 0.98 | 0.98 | 0.98 | 0.98 | 0.98 | 0.98 | 0.98 | 0.98 | 0.98 | 0.98 |
| Percent Heavy Veh, %        | 2    | 2    | 2    | 2    | 2    | 2    | 5    | 5    | 5    | 0    | 0    | 0    |
| Cap, veh/h                  | 297  | 1489 | 816  | 690  | 1752 | 627  | 534  | 378  | 564  | 182  | 544  | 382  |
| Arrive On Green             | 0.09 | 0.29 | 0.29 | 0.14 | 0.34 | 0.34 | 0.11 | 0.21 | 0.21 | 0.05 | 0.15 | 0.15 |
| Sat Flow, veh/h             | 3442 | 5085 | 2787 | 5003 | 5085 | 1583 | 4860 | 1810 | 2701 | 3510 | 3610 | 1612 |
| Grp Volume(v), veh/h        | 184  | 1184 | 679  | 531  | 1031 | 122  | 378  | 92   | 82   | 51   | 102  | 209  |
| Grp Sat Flow(s),veh/h/ln    | 1721 | 1695 | 1393 | 1668 | 1695 | 1583 | 1620 | 1810 | 1350 | 1755 | 1805 | 1612 |
| Q Serve(g_s), s             | 3.0  | 12.4 | 13.2 | 5.9  | 9.7  | 2.9  | 4.4  | 2.5  | 1.4  | 0.8  | 1.4  | 6.6  |
| Cycle Q Clear(g_c), s       | 3.0  | 12.4 | 13.2 | 5.9  | 9.7  | 2.9  | 4.4  | 2.5  | 1.4  | 0.8  | 1.4  | 6.6  |
| Prop In Lane                | 1.00 |      | 1.00 | 1.00 |      | 1.00 | 1.00 |      | 1.00 | 1.00 |      | 1.00 |
| Lane Grp Cap(c), veh/h      | 297  | 1489 | 816  | 690  | 1752 | 627  | 534  | 378  | 564  | 182  | 544  | 382  |
| V/C Ratio(X)                | 0.62 | 0.80 | 0.83 | 0.77 | 0.59 | 0.19 | 0.71 | 0.24 | 0.15 | 0.28 | 0.19 | 0.55 |
| Avail Cap(c_a), veh/h       | 392  | 2025 | 1110 | 906  | 2367 | 819  | 628  | 767  | 1145 | 236  | 1307 | 723  |
| HCM Platoon Ratio           | 1.00 | 1.00 | 1.00 | 1.00 | 1.00 | 1.00 | 1.00 | 1.00 | 1.00 | 1.00 | 1.00 | 1.00 |
| Upstream Filter(I)          | 1.00 | 1.00 | 1.00 | 1.00 | 1.00 | 1.00 | 1.00 | 1.00 | 1.00 | 1.00 | 1.00 | 1.00 |
| Uniform Delay (d), s/veh    | 25.6 | 18.9 | 19.2 | 24.1 | 15.6 | 11.5 | 24.9 | 19.1 | 18.7 | 26.5 | 21.5 | 19.4 |
| Incr Delay (d2), s/veh      | 0.8  | 1.1  | 3.0  | 2.0  | 0.1  | 0.1  | 2.1  | 0.1  | 0.0  | 0.3  | 0.1  | 0.5  |
| Initial Q Delay(d3),s/veh   | 0.0  | 0.0  | 0.0  | 0.0  | 0.0  | 0.0  | 0.0  | 0.0  | 0.0  | 0.0  | 0.0  | 0.0  |
| %ile BackOfQ(50%),veh/ln    | 1.5  | 6.0  | 5.3  | 2.8  | 4.5  | 1.3  | 2.0  | 1.2  | 0.5  | 0.4  | 0.7  | 3.0  |
| LnGrp Delay(d),s/veh        | 26.4 | 20.0 | 22.2 | 26.1 | 15.7 | 11.5 | 27.1 | 19.2 | 18.8 | 26.8 | 21.6 | 19.9 |
| LnGrp LOS                   | C    | C    | C    | C    | B    | B    | C    | B    | B    | C    | C    | B    |
| Approach Vol, veh/h         |      | 2047 |      |      | 1684 |      |      | 552  |      |      | 362  |      |
| Approach Delay, s/veh       |      | 21.3 |      |      | 18.7 |      |      | 24.5 |      |      | 21.3 |      |
| Approach LOS                |      | C    |      |      | B    |      |      | C    |      |      | C    |      |
| Timer                       | 1    | 2    | 3    | 4    | 5    | 6    | 7    | 8    |      |      |      |      |
| Assigned Phs                | 1    | 2    | 3    | 4    | 5    | 6    | 7    | 8    |      |      |      |      |
| Phs Duration (G+Y+Rc), s    | 12.5 | 22.3 | 9.9  | 13.3 | 9.5  | 25.3 | 6.5  | 16.7 |      |      |      |      |
| Change Period (Y+Rc), s     | 4.5  | 5.3  | 3.5  | 4.6  | 4.5  | 5.3  | 3.5  | 4.6  |      |      |      |      |
| Max Green Setting (Gmax), s | 10.5 | 23.1 | 7.5  | 21.0 | 6.6  | 27.0 | 3.9  | 24.6 |      |      |      |      |
| Max Q Clear Time (g_c+1), s | 17.5 | 15.2 | 6.4  | 8.6  | 5.0  | 11.7 | 2.8  | 4.5  |      |      |      |      |
| Green Ext Time (p_c), s     | 0.1  | 1.8  | 0.0  | 0.1  | 0.0  | 1.6  | 0.0  | 0.1  |      |      |      |      |
| <b>Intersection Summary</b> |      |      |      |      |      |      |      |      |      |      |      |      |
| HCM 2010 Ctrl Delay         |      |      |      |      | 20.7 |      |      |      |      |      |      |      |
| HCM 2010 LOS                |      |      |      |      | C    |      |      |      |      |      |      |      |

HCM 2010 Signalized Intersection Summary  
 10: Imjin Road & Imjin Parkway

Cuml w/ Proj, AM  
 09/06/2019



| Movement                     | EBT  | EBR  | WBL  | WBT  | NBL  | NBR  |   |      |
|------------------------------|------|------|------|------|------|------|---|------|
| Lane Configurations          | ↑↑   |      | ↵↵   | ↑↑   | ↵↵   | ↵    |   |      |
| Traffic Volume (veh/h)       | 900  | 250  | 550  | 1170 | 100  | 160  |   |      |
| Future Volume (veh/h)        | 900  | 250  | 550  | 1170 | 100  | 160  |   |      |
| Number                       | 2    | 12   | 1    | 6    | 3    | 18   |   |      |
| Initial Q (Qb), veh          | 0    | 0    | 0    | 0    | 0    | 0    |   |      |
| Ped-Bike Adj(A_pbT)          |      | 1.00 | 1.00 |      | 1.00 | 1.00 |   |      |
| Parking Bus, Adj             | 1.00 | 1.00 | 1.00 | 1.00 | 1.00 | 1.00 |   |      |
| Adj Sat Flow, veh/h/ln       | 1863 | 1900 | 1845 | 1845 | 1810 | 1810 |   |      |
| Adj Flow Rate, veh/h         | 947  | 250  | 579  | 1232 | 91   | 183  |   |      |
| Adj No. of Lanes             | 2    | 0    | 2    | 2    | 1    | 2    |   |      |
| Peak Hour Factor             | 0.95 | 0.95 | 0.95 | 0.95 | 0.95 | 0.95 |   |      |
| Percent Heavy Veh, %         | 2    | 2    | 3    | 3    | 5    | 5    |   |      |
| Cap, veh/h                   | 1216 | 320  | 736  | 2575 | 180  | 321  |   |      |
| Arrive On Green              | 0.44 | 0.44 | 0.22 | 0.73 | 0.10 | 0.10 |   |      |
| Sat Flow, veh/h              | 2866 | 730  | 3408 | 3597 | 1723 | 3076 |   |      |
| Grp Volume(v), veh/h         | 604  | 593  | 579  | 1232 | 91   | 183  |   |      |
| Grp Sat Flow(s),veh/h/ln     | 1770 | 1734 | 1704 | 1752 | 1723 | 1538 |   |      |
| Q Serve(g_s), s              | 16.3 | 16.4 | 9.0  | 8.0  | 2.8  | 3.2  |   |      |
| Cycle Q Clear(g_c), s        | 16.3 | 16.4 | 9.0  | 8.0  | 2.8  | 3.2  |   |      |
| Prop In Lane                 |      | 0.42 | 1.00 |      | 1.00 | 1.00 |   |      |
| Lane Grp Cap(c), veh/h       | 776  | 760  | 736  | 2575 | 180  | 321  |   |      |
| V/C Ratio(X)                 | 0.78 | 0.78 | 0.79 | 0.48 | 0.51 | 0.57 |   |      |
| Avail Cap(c_a), veh/h        | 1009 | 988  | 1005 | 3313 | 557  | 995  |   |      |
| HCM Platoon Ratio            | 1.00 | 1.00 | 1.00 | 1.00 | 1.00 | 1.00 |   |      |
| Upstream Filter(I)           | 1.00 | 1.00 | 1.00 | 1.00 | 1.00 | 1.00 |   |      |
| Uniform Delay (d), s/veh     | 13.4 | 13.4 | 20.7 | 3.0  | 23.7 | 23.9 |   |      |
| Incr Delay (d2), s/veh       | 2.9  | 3.1  | 2.9  | 0.1  | 2.2  | 1.6  |   |      |
| Initial Q Delay(d3),s/veh    | 0.0  | 0.0  | 0.0  | 0.0  | 0.0  | 0.0  |   |      |
| %ile BackOfQ(50%),veh/ln     | 8.5  | 8.4  | 4.5  | 3.8  | 1.4  | 1.4  |   |      |
| LnGrp Delay(d),s/veh         | 16.3 | 16.5 | 23.7 | 3.2  | 25.9 | 25.5 |   |      |
| LnGrp LOS                    | B    | B    | C    | A    | C    | C    |   |      |
| Approach Vol, veh/h          | 1197 |      |      | 1811 | 274  |      |   |      |
| Approach Delay, s/veh        | 16.4 |      |      | 9.7  | 25.6 |      |   |      |
| Approach LOS                 | B    |      |      | A    | C    |      |   |      |
| Timer                        | 1    | 2    | 3    | 4    | 5    | 6    | 7 | 8    |
| Assigned Phs                 | 1    | 2    |      |      |      | 6    |   | 8    |
| Phs Duration (G+Y+Rc), s     | 16.6 | 29.0 |      |      |      | 45.6 |   | 10.3 |
| Change Period (Y+Rc), s      | 4.5  | 4.5  |      |      |      | 4.5  |   | 4.5  |
| Max Green Setting (Gmax), s  | 16.5 | 31.9 |      |      |      | 52.9 |   | 18.1 |
| Max Q Clear Time (g_c+I1), s | 16.3 | 18.4 |      |      |      | 10.0 |   | 5.2  |
| Green Ext Time (p_c), s      | 1.1  | 6.2  |      |      |      | 10.9 |   | 0.8  |
| <b>Intersection Summary</b>  |      |      |      |      |      |      |   |      |
| HCM 2010 Ctrl Delay          |      |      | 13.5 |      |      |      |   |      |
| HCM 2010 LOS                 |      |      | B    |      |      |      |   |      |
| <b>Notes</b>                 |      |      |      |      |      |      |   |      |

HCM 2010 Roundabout  
10: Imjin Road & Imjin Parkway

Cumulative with Project (Roundabouts), AM  
04/22/2022

| Intersection                |       |       |       |       |       |       |
|-----------------------------|-------|-------|-------|-------|-------|-------|
| Intersection Delay, s/veh   | 28.7  |       |       |       |       |       |
| Intersection LOS            | D     |       |       |       |       |       |
| Approach                    | EB    |       | WB    |       | NB    |       |
| Entry Lanes                 | 2     |       | 2     |       | 2     |       |
| Conflicting Circle Lanes    | 2     |       | 2     |       | 2     |       |
| Adj Approach Flow, veh/h    | 1210  |       | 1811  |       | 273   |       |
| Demand Flow Rate, veh/h     | 1234  |       | 1865  |       | 286   |       |
| Vehicles Circulating, veh/h | 596   |       | 110   |       | 966   |       |
| Vehicles Exiting, veh/h     | 1379  |       | 1142  |       | 864   |       |
| Follow-Up Headway, s        | 3.186 |       | 3.186 |       | 3.186 |       |
| Ped Vol Crossing Leg, #/h   | 0     |       | 0     |       | 0     |       |
| Ped Cap Adj                 | 1.000 |       | 1.000 |       | 1.000 |       |
| Approach Delay, s/veh       | 30.4  |       | 30.4  |       | 10.4  |       |
| Approach LOS                | D     |       | D     |       | B     |       |
| Lane                        | Left  | Right | Left  | Right | Left  | Right |
| Designated Moves            | LT    | TR    | LT    | TR    | L     | TR    |
| Assumed Moves               | LT    | TR    | LT    | TR    | L     | TR    |
| RT Channelized              |       |       |       |       |       |       |
| Lane Util                   | 0.470 | 0.530 | 0.470 | 0.530 | 0.385 | 0.615 |
| Critical Headway, s         | 4.293 | 4.113 | 4.293 | 4.113 | 4.293 | 4.113 |
| Entry Flow, veh/h           | 580   | 654   | 877   | 988   | 110   | 176   |
| Cap Entry Lane, veh/h       | 723   | 745   | 1040  | 1046  | 548   | 575   |
| Entry HV Adj Factor         | 0.981 | 0.981 | 0.971 | 0.972 | 0.955 | 0.955 |
| Flow Entry, veh/h           | 569   | 641   | 851   | 960   | 105   | 168   |
| Cap Entry, veh/h            | 709   | 730   | 1010  | 1016  | 523   | 549   |
| V/C Ratio                   | 0.803 | 0.878 | 0.843 | 0.944 | 0.201 | 0.306 |
| Control Delay, s/veh        | 26.4  | 33.9  | 23.4  | 36.5  | 9.6   | 11.0  |
| LOS                         | D     | D     | C     | E     | A     | B     |
| 95th %tile Queue, veh       | 8     | 11    | 11    | 16    | 1     | 1     |

HCM 2010 Roundabout  
11: Abrams Drive & Imjin Parkway

Cumulative with Project (Roundabouts), AM  
04/22/2022

| Intersection                |       |       |       |       |       |        |       |        |  |
|-----------------------------|-------|-------|-------|-------|-------|--------|-------|--------|--|
| Intersection Delay, s/veh   | 26.5  |       |       |       |       |        |       |        |  |
| Intersection LOS            | D     |       |       |       |       |        |       |        |  |
| Approach                    | EB    |       | WB    |       | NB    |        | SB    |        |  |
| Entry Lanes                 | 2     |       | 2     |       | 1     |        | 1     |        |  |
| Conflicting Circle Lanes    | 2     |       | 2     |       | 2     |        | 2     |        |  |
| Adj Approach Flow, veh/h    | 1043  |       | 1516  |       | 473   |        | 420   |        |  |
| Demand Flow Rate, veh/h     | 1054  |       | 1546  |       | 487   |        | 428   |        |  |
| Vehicles Circulating, veh/h | 253   |       | 442   |       | 1066  |        | 1824  |        |  |
| Vehicles Exiting, veh/h     | 1725  |       | 1011  |       | 241   |        | 164   |        |  |
| Follow-Up Headway, s        | 3.186 |       | 3.186 |       | 3.186 |        | 3.186 |        |  |
| Ped Vol Crossing Leg, #/h   | 0     |       | 1     |       | 0     |        | 1     |        |  |
| Ped Cap Adj                 | 1.000 |       | 0.999 |       | 1.000 |        | 1.000 |        |  |
| Approach Delay, s/veh       | 11.6  |       | 43.3  |       | 21.0  |        | 8.9   |        |  |
| Approach LOS                | B     |       | E     |       | C     |        | A     |        |  |
| Lane                        | Left  | Right | Left  | Right | Left  | Bypass | Left  | Bypass |  |
| Designated Moves            | LT    | TR    | LT    | TR    | LT    | R      | LT    | R      |  |
| Assumed Moves               | LT    | TR    | LT    | TR    | LT    | R      | LT    | R      |  |
| RT Channelized              |       |       |       |       |       | Free   |       | Free   |  |
| Lane Util                   | 0.470 | 0.530 | 0.470 | 0.530 | 1.000 |        | 1.000 |        |  |
| Critical Headway, s         | 4.293 | 4.113 | 4.293 | 4.113 | 4.113 |        | 4.113 |        |  |
| Entry Flow, veh/h           | 495   | 559   | 727   | 819   | 387   | 100    | 154   | 274    |  |
| Cap Entry Lane, veh/h       | 935   | 947   | 811   | 829   | 536   | 1957   | 315   | 1938   |  |
| Entry HV Adj Factor         | 0.990 | 0.989 | 0.980 | 0.981 | 0.972 | 0.971  | 0.980 | 0.980  |  |
| Flow Entry, veh/h           | 490   | 553   | 713   | 804   | 376   | 97     | 151   | 269    |  |
| Cap Entry, veh/h            | 926   | 936   | 794   | 813   | 521   | 1900   | 309   | 1900   |  |
| V/C Ratio                   | 0.530 | 0.591 | 0.897 | 0.988 | 0.722 | 0.051  | 0.489 | 0.142  |  |
| Control Delay, s/veh        | 10.8  | 12.2  | 34.5  | 51.2  | 26.5  | 0.0    | 24.7  | 0.0    |  |
| LOS                         | B     | B     | D     | F     | D     | A      | C     | A      |  |
| 95th %tile Queue, veh       | 3     | 4     | 12    | 17    | 6     | 0      | 3     | 0      |  |

HCM 2010 Signalized Intersection Summary  
 12: Reservation Road & Imjin Parkway

Cuml w/ Proj, AM  
 09/06/2019



| Movement                    | EBL  | EBT   | EBR  | WBL  | WBT  | WBR   | NBL  | NBT  | NBR  | SBL  | SBT  | SBR  |
|-----------------------------|------|-------|------|------|------|-------|------|------|------|------|------|------|
| Lane Configurations         |      |       |      |      |      |       |      |      |      |      |      |      |
| Traffic Volume (veh/h)      | 180  | 50    | 810  | 10   | 20   | 30    | 1220 | 890  | 20   | 60   | 590  | 90   |
| Future Volume (veh/h)       | 180  | 50    | 810  | 10   | 20   | 30    | 1220 | 890  | 20   | 60   | 590  | 90   |
| Number                      | 3    | 8     | 18   | 7    | 4    | 14    | 1    | 6    | 16   | 5    | 2    | 12   |
| Initial Q (Qb), veh         | 0    | 0     | 0    | 0    | 0    | 0     | 0    | 0    | 0    | 0    | 0    | 0    |
| Ped-Bike Adj(A_pbT)         | 1.00 |       | 1.00 | 1.00 |      | 0.99  | 1.00 |      | 1.00 | 1.00 |      | 0.98 |
| Parking Bus, Adj            | 1.00 | 1.00  | 1.00 | 1.00 | 1.00 | 1.00  | 1.00 | 1.00 | 1.00 | 1.00 | 1.00 | 1.00 |
| Adj Sat Flow, veh/h/ln      | 1863 | 1863  | 1863 | 1638 | 1638 | 1638  | 1863 | 1863 | 1863 | 1863 | 1863 | 1863 |
| Adj Flow Rate, veh/h        | 194  | 54    | 457  | 11   | 22   | 19    | 1312 | 957  | 16   | 65   | 634  | 34   |
| Adj No. of Lanes            | 2    | 1     | 2    | 1    | 1    | 1     | 2    | 2    | 1    | 2    | 3    | 1    |
| Peak Hour Factor            | 0.93 | 0.93  | 0.93 | 0.93 | 0.93 | 0.93  | 0.93 | 0.93 | 0.93 | 0.93 | 0.93 | 0.93 |
| Percent Heavy Veh, %        | 2    | 2     | 2    | 16   | 16   | 16    | 2    | 2    | 2    | 2    | 2    | 2    |
| Cap, veh/h                  | 472  | 256   | 1405 | 55   | 58   | 49    | 1265 | 2033 | 908  | 119  | 1228 | 376  |
| Arrive On Green             | 0.14 | 0.14  | 0.14 | 0.04 | 0.04 | 0.04  | 0.37 | 0.57 | 0.57 | 0.03 | 0.24 | 0.24 |
| Sat Flow, veh/h             | 3442 | 1863  | 2777 | 1560 | 1638 | 1382  | 3442 | 3539 | 1581 | 3442 | 5085 | 1557 |
| Grp Volume(v), veh/h        | 194  | 54    | 457  | 11   | 22   | 19    | 1312 | 957  | 16   | 65   | 634  | 34   |
| Grp Sat Flow(s),veh/h/ln    | 1721 | 1863  | 1388 | 1560 | 1638 | 1382  | 1721 | 1770 | 1581 | 1721 | 1695 | 1557 |
| Q Serve(g_s), s             | 4.9  | 2.5   | 9.3  | 0.7  | 1.3  | 1.3   | 35.0 | 15.0 | 0.4  | 1.8  | 10.3 | 1.6  |
| Cycle Q Clear(g_c), s       | 4.9  | 2.5   | 9.3  | 0.7  | 1.3  | 1.3   | 35.0 | 15.0 | 0.4  | 1.8  | 10.3 | 1.6  |
| Prop In Lane                | 1.00 |       | 1.00 | 1.00 |      | 1.00  | 1.00 |      | 1.00 | 1.00 |      | 1.00 |
| Lane Grp Cap(c), veh/h      | 472  | 256   | 1405 | 55   | 58   | 49    | 1265 | 2033 | 908  | 119  | 1228 | 376  |
| V/C Ratio(X)                | 0.41 | 0.21  | 0.33 | 0.20 | 0.38 | 0.39  | 1.04 | 0.47 | 0.02 | 0.55 | 0.52 | 0.09 |
| Avail Cap(c_a), veh/h       | 1265 | 684   | 2044 | 508  | 533  | 450   | 1265 | 2033 | 908  | 723  | 3203 | 981  |
| HCM Platoon Ratio           | 1.00 | 1.00  | 1.00 | 1.00 | 1.00 | 1.00  | 1.00 | 1.00 | 1.00 | 1.00 | 1.00 | 1.00 |
| Upstream Filter(I)          | 1.00 | 1.00  | 1.00 | 1.00 | 1.00 | 1.00  | 1.00 | 1.00 | 1.00 | 1.00 | 1.00 | 1.00 |
| Uniform Delay (d), s/veh    | 37.6 | 36.5  | 14.0 | 44.6 | 44.9 | 44.9  | 30.1 | 11.8 | 8.7  | 45.3 | 31.3 | 28.0 |
| Incr Delay (d2), s/veh      | 0.2  | 0.2   | 0.0  | 0.7  | 1.5  | 1.9   | 35.5 | 0.5  | 0.0  | 1.5  | 0.9  | 0.3  |
| Initial Q Delay(d3),s/veh   | 0.0  | 0.0   | 0.0  | 0.0  | 0.0  | 0.0   | 0.0  | 0.0  | 0.0  | 0.0  | 0.0  | 0.0  |
| %ile BackOfQ(50%),veh/ln    | 2.4  | 1.3   | 3.6  | 0.3  | 0.6  | 0.5   | 22.8 | 7.4  | 0.2  | 0.9  | 4.9  | 0.7  |
| LnGrp Delay(d),s/veh        | 37.8 | 36.7  | 14.0 | 45.3 | 46.4 | 46.8  | 65.7 | 12.3 | 8.7  | 46.7 | 32.2 | 28.3 |
| LnGrp LOS                   | D    | D     | B    | D    | D    | D     | F    | B    | A    | D    | C    | C    |
| Approach Vol, veh/h         |      | 705   |      |      | 52   |       |      | 2285 |      |      | 733  |      |
| Approach Delay, s/veh       |      | 22.3  |      |      | 46.3 |       |      | 42.9 |      |      | 33.3 |      |
| Approach LOS                |      | C     |      |      | D    |       |      | D    |      |      | C    |      |
| Timer                       | 1    | 2     | 3    | 4    | 5    | 6     | 7    | 8    |      |      |      |      |
| Assigned Phs                | 1    | 2     |      | 4    | 5    | 6     |      | 8    |      |      |      |      |
| Phs Duration (G+Y+Rc), s    | 39.1 | 29.2  |      | 8.4  | 7.4  | 60.9  |      | 18.6 |      |      |      |      |
| Change Period (Y+Rc), s     | 4.1  | * 6.2 |      | 5.0  | 4.1  | * 6.2 |      | 5.5  |      |      |      |      |
| Max Green Setting (Gmax), s | 35.0 | * 60  |      | 31.0 | 20.0 | * 50  |      | 35.0 |      |      |      |      |
| Max Q Clear Time (g_c+R), s | 17.0 | 12.3  |      | 3.3  | 3.8  | 17.0  |      | 11.3 |      |      |      |      |
| Green Ext Time (p_c), s     | 0.0  | 10.6  |      | 0.1  | 0.0  | 15.4  |      | 1.5  |      |      |      |      |
| <b>Intersection Summary</b> |      |       |      |      |      |       |      |      |      |      |      |      |
| HCM 2010 Ctrl Delay         |      |       | 37.2 |      |      |       |      |      |      |      |      |      |
| HCM 2010 LOS                |      |       | D    |      |      |       |      |      |      |      |      |      |
| <b>Notes</b>                |      |       |      |      |      |       |      |      |      |      |      |      |



HCM 2010 Signalized Intersection Summary  
 14: Reservation Road & Inter-Garrison Road

Cuml w/ Proj, AM  
 09/06/2019



| Movement                     | EBL  | EBR  | NBL  | NBT  | SBT  | SBR  |   |      |
|------------------------------|------|------|------|------|------|------|---|------|
| Lane Configurations          |      |      |      |      |      |      |   |      |
| Traffic Volume (veh/h)       | 190  | 370  | 600  | 600  | 310  | 190  |   |      |
| Future Volume (veh/h)        | 190  | 370  | 600  | 600  | 310  | 190  |   |      |
| Number                       | 3    | 18   | 1    | 6    | 2    | 12   |   |      |
| Initial Q (Qb), veh          | 0    | 0    | 0    | 0    | 0    | 0    |   |      |
| Ped-Bike Adj(A_pbT)          | 1.00 | 1.00 | 1.00 |      |      | 1.00 |   |      |
| Parking Bus, Adj             | 1.00 | 1.00 | 1.00 | 1.00 | 1.00 | 1.00 |   |      |
| Adj Sat Flow, veh/h/ln       | 1845 | 1845 | 1863 | 1863 | 1845 | 1900 |   |      |
| Adj Flow Rate, veh/h         | 202  | 355  | 638  | 638  | 330  | 186  |   |      |
| Adj No. of Lanes             | 1    | 2    | 2    | 2    | 2    | 0    |   |      |
| Peak Hour Factor             | 0.94 | 0.94 | 0.94 | 0.94 | 0.94 | 0.94 |   |      |
| Percent Heavy Veh, %         | 3    | 3    | 2    | 2    | 3    | 3    |   |      |
| Cap, veh/h                   | 323  | 1146 | 796  | 2139 | 615  | 340  |   |      |
| Arrive On Green              | 0.18 | 0.18 | 0.23 | 0.60 | 0.28 | 0.28 |   |      |
| Sat Flow, veh/h              | 1757 | 2760 | 3442 | 3632 | 2273 | 1204 |   |      |
| Grp Volume(v), veh/h         | 202  | 355  | 638  | 638  | 264  | 252  |   |      |
| Grp Sat Flow(s),veh/h/ln     | 1757 | 1380 | 1721 | 1770 | 1752 | 1632 |   |      |
| Q Serve(g_s), s              | 5.5  | 4.4  | 9.0  | 4.5  | 6.6  | 6.8  |   |      |
| Cycle Q Clear(g_c), s        | 5.5  | 4.4  | 9.0  | 4.5  | 6.6  | 6.8  |   |      |
| Prop In Lane                 | 1.00 | 1.00 | 1.00 |      |      | 0.74 |   |      |
| Lane Grp Cap(c), veh/h       | 323  | 1146 | 796  | 2139 | 494  | 460  |   |      |
| V/C Ratio(X)                 | 0.62 | 0.31 | 0.80 | 0.30 | 0.53 | 0.55 |   |      |
| Avail Cap(c_a), veh/h        | 920  | 2084 | 1335 | 4120 | 2040 | 1900 |   |      |
| HCM Platoon Ratio            | 1.00 | 1.00 | 1.00 | 1.00 | 1.00 | 1.00 |   |      |
| Upstream Filter(I)           | 1.00 | 1.00 | 1.00 | 1.00 | 1.00 | 1.00 |   |      |
| Uniform Delay (d), s/veh     | 19.4 | 10.1 | 18.7 | 4.9  | 15.6 | 15.7 |   |      |
| Incr Delay (d2), s/veh       | 2.0  | 0.2  | 0.7  | 0.1  | 1.7  | 1.9  |   |      |
| Initial Q Delay(d3),s/veh    | 0.0  | 0.0  | 0.0  | 0.0  | 0.0  | 0.0  |   |      |
| %ile BackOfQ(50%),veh/ln     | 2.8  | 1.7  | 4.3  | 2.2  | 3.4  | 3.3  |   |      |
| LnGrp Delay(d),s/veh         | 21.4 | 10.3 | 19.4 | 5.1  | 17.3 | 17.6 |   |      |
| LnGrp LOS                    | C    | B    | B    | A    | B    | B    |   |      |
| Approach Vol, veh/h          | 557  |      |      | 1276 | 516  |      |   |      |
| Approach Delay, s/veh        | 14.3 |      |      | 12.2 | 17.5 |      |   |      |
| Approach LOS                 | B    |      |      | B    | B    |      |   |      |
| Timer                        | 1    | 2    | 3    | 4    | 5    | 6    | 7 | 8    |
| Assigned Phs                 | 1    | 2    |      |      |      | 6    |   | 8    |
| Phs Duration (G+Y+Rc), s     | 6.6  | 20.9 |      |      |      | 37.6 |   | 14.0 |
| Change Period (Y+Rc), s      | 4.7  | 6.4  |      |      |      | 6.4  |   | 4.5  |
| Max Green Setting (Gmax), s  | 26   | 60.0 |      |      |      | 60.0 |   | 27.0 |
| Max Q Clear Time (g_c+I1), s | 8.8  |      |      |      |      | 6.5  |   | 7.5  |
| Green Ext Time (p_c), s      | 0.9  | 5.8  |      |      |      | 8.1  |   | 2.0  |
| <b>Intersection Summary</b>  |      |      |      |      |      |      |   |      |
| HCM 2010 Ctrl Delay          |      |      | 13.9 |      |      |      |   |      |
| HCM 2010 LOS                 |      |      | B    |      |      |      |   |      |
| <b>Notes</b>                 |      |      |      |      |      |      |   |      |

HCM 2010 Signalized Intersection Summary  
 22: 8th Avenue & Inter-Garrison Road

Cuml w/ Proj, AM  
 09/06/2019



| Movement                     | EBT  | EBR  | WBL  | WBT  | NBL   | NBR  |   |      |
|------------------------------|------|------|------|------|-------|------|---|------|
| Lane Configurations          |      |      |      |      |       |      |   |      |
| Traffic Volume (veh/h)       | 240  | 250  | 750  | 570  | 50    | 410  |   |      |
| Future Volume (veh/h)        | 240  | 250  | 750  | 570  | 50    | 410  |   |      |
| Number                       | 4    | 14   | 3    | 8    | 5     | 12   |   |      |
| Initial Q (Qb), veh          | 0    | 0    | 0    | 0    | 0     | 0    |   |      |
| Ped-Bike Adj(A_pbT)          |      | 1.00 | 1.00 |      | 1.00  | 1.00 |   |      |
| Parking Bus, Adj             | 1.00 | 1.00 | 1.00 | 1.00 | 1.00  | 1.00 |   |      |
| Adj Sat Flow, veh/h/ln       | 1505 | 1881 | 1881 | 1881 | 1845  | 1900 |   |      |
| Adj Flow Rate, veh/h         | 276  | 169  | 862  | 655  | 57    | 230  |   |      |
| Adj No. of Lanes             | 1    | 0    | 2    | 1    | 0     | 0    |   |      |
| Peak Hour Factor             | 0.87 | 0.87 | 0.87 | 0.87 | 0.87  | 0.87 |   |      |
| Percent Heavy Veh, %         | 25   | 25   | 1    | 1    | 0     | 0    |   |      |
| Cap, veh/h                   | 299  | 183  | 1029 | 1362 | 33    | 134  |   |      |
| Arrive On Green              | 0.34 | 0.34 | 0.30 | 0.72 | 0.10  | 0.10 |   |      |
| Sat Flow, veh/h              | 875  | 536  | 3476 | 1881 | 317   | 1280 |   |      |
| Grp Volume(v), veh/h         | 0    | 445  | 862  | 655  | 288   | 0    |   |      |
| Grp Sat Flow(s),veh/h/ln     | 0    | 1410 | 1738 | 1881 | 1603  | 0    |   |      |
| Q Serve(g_s), s              | 0.0  | 15.9 | 12.2 | 7.7  | 5.5   | 0.0  |   |      |
| Cycle Q Clear(g_c), s        | 0.0  | 15.9 | 12.2 | 7.7  | 5.5   | 0.0  |   |      |
| Prop In Lane                 |      | 0.38 | 1.00 |      | 0.20  | 0.80 |   |      |
| Lane Grp Cap(c), veh/h       | 0    | 482  | 1029 | 1362 | 168   | 0    |   |      |
| V/C Ratio(X)                 | 0.00 | 0.92 | 0.84 | 0.48 | 1.72  | 0.00 |   |      |
| Avail Cap(c_a), veh/h        | 0    | 484  | 1192 | 1451 | 168   | 0    |   |      |
| HCM Platoon Ratio            | 1.00 | 1.00 | 1.00 | 1.00 | 1.00  | 1.00 |   |      |
| Upstream Filter(I)           | 0.00 | 1.00 | 1.00 | 1.00 | 1.00  | 0.00 |   |      |
| Uniform Delay (d), s/veh     | 0.0  | 16.6 | 17.3 | 3.1  | 23.5  | 0.0  |   |      |
| Incr Delay (d2), s/veh       | 0.0  | 23.4 | 4.8  | 0.3  | 345.7 | 0.0  |   |      |
| Initial Q Delay(d3),s/veh    | 0.0  | 0.0  | 0.0  | 0.0  | 0.0   | 0.0  |   |      |
| %ile BackOfQ(50%),veh/ln     | 0.0  | 9.3  | 6.4  | 3.9  | 18.5  | 0.0  |   |      |
| LnGrp Delay(d),s/veh         | 0.0  | 40.0 | 22.1 | 3.3  | 369.2 | 0.0  |   |      |
| LnGrp LOS                    |      | D    | C    | A    | F     |      |   |      |
| Approach Vol, veh/h          | 445  |      |      | 1517 | 288   |      |   |      |
| Approach Delay, s/veh        | 40.0 |      |      | 14.0 | 369.2 |      |   |      |
| Approach LOS                 | D    |      |      | B    | F     |      |   |      |
| Timer                        | 1    | 2    | 3    | 4    | 5     | 6    | 7 | 8    |
| Assigned Phs                 |      | 2    | 3    | 4    |       |      |   | 8    |
| Phs Duration (G+Y+Rc), s     |      | 10.0 | 20.1 | 22.5 |       |      |   | 42.5 |
| Change Period (Y+Rc), s      |      | 4.5  | 4.5  | 4.5  |       |      |   | 4.5  |
| Max Green Setting (Gmax), s  |      | 5.5  | 18.0 | 18.0 |       |      |   | 40.5 |
| Max Q Clear Time (g_c+I1), s |      | 7.5  | 14.2 | 17.9 |       |      |   | 9.7  |
| Green Ext Time (p_c), s      |      | 0.0  | 1.4  | 0.0  |       |      |   | 4.8  |
| <b>Intersection Summary</b>  |      |      |      |      |       |      |   |      |
| HCM 2010 Ctrl Delay          |      |      | 64.6 |      |       |      |   |      |
| HCM 2010 LOS                 |      |      | E    |      |       |      |   |      |
| <b>Notes</b>                 |      |      |      |      |       |      |   |      |

| Intersection                |       |       |       |       |
|-----------------------------|-------|-------|-------|-------|
| Intersection Delay, s/veh   | 36.2  |       |       |       |
| Intersection LOS            | E     |       |       |       |
| Approach                    | EB    | WB    |       | NB    |
| Entry Lanes                 | 1     | 2     |       | 1     |
| Conflicting Circle Lanes    | 2     | 2     |       | 2     |
| Adj Approach Flow, veh/h    | 563   | 1517  |       | 528   |
| Demand Flow Rate, veh/h     | 704   | 1533  |       | 544   |
| Vehicles Circulating, veh/h | 871   | 59    |       | 345   |
| Vehicles Exiting, veh/h     | 721   | 830   |       | 1230  |
| Follow-Up Headway, s        | 3.186 | 3.186 |       | 3.186 |
| Ped Vol Crossing Leg, #/h   | 0     | 0     |       | 0     |
| Ped Cap Adj                 | 1.000 | 1.000 |       | 1.000 |
| Approach Delay, s/veh       | 115.0 | 14.9  |       | 13.6  |
| Approach LOS                | F     | B     |       | B     |
| Lane                        | Left  | Left  | Right | Left  |
| Designated Moves            | TR    | L     | LTR   | LR    |
| Assumed Moves               | TR    | L     | LTR   | LR    |
| RT Channelized              |       |       |       |       |
| Lane Util                   | 1.000 | 0.530 | 0.470 | 1.000 |
| Critical Headway, s         | 4.113 | 4.293 | 4.113 | 4.113 |
| Entry Flow, veh/h           | 704   | 812   | 721   | 544   |
| Cap Entry Lane, veh/h       | 614   | 1081  | 1084  | 888   |
| Entry HV Adj Factor         | 0.800 | 0.990 | 0.989 | 0.971 |
| Flow Entry, veh/h           | 563   | 804   | 713   | 528   |
| Cap Entry, veh/h            | 491   | 1071  | 1072  | 861   |
| V/C Ratio                   | 1.146 | 0.751 | 0.665 | 0.613 |
| Control Delay, s/veh        | 115.0 | 16.5  | 13.1  | 13.6  |
| LOS                         | F     | C     | B     | B     |
| 95th %tile Queue, veh       | 20    | 7     | 5     | 4     |

HCM 2010 Signalized Intersection Summary  
23: Inter-Garrison Road & Abrams Drive

Cuml w/ Proj, AM  
09/06/2019



| Movement                     | EBL  | EBT  | WBT  | WBR  | SBL  | SBR  |   |   |
|------------------------------|------|------|------|------|------|------|---|---|
| Lane Configurations          | ↔↔   | ↑    | ↑    | ↔    | ↔↔   | ↔    |   |   |
| Traffic Volume (veh/h)       | 260  | 390  | 820  | 10   | 40   | 500  |   |   |
| Future Volume (veh/h)        | 260  | 390  | 820  | 10   | 40   | 500  |   |   |
| Number                       | 5    | 2    | 6    | 16   | 7    | 14   |   |   |
| Initial Q (Qb), veh          | 0    | 0    | 0    | 0    | 0    | 0    |   |   |
| Ped-Bike Adj(A_pbT)          | 1.00 |      |      | 1.00 | 1.00 | 1.00 |   |   |
| Parking Bus, Adj             | 1.00 | 1.00 | 1.00 | 1.00 | 1.00 | 1.00 |   |   |
| Adj Sat Flow, veh/h/ln       | 1759 | 1759 | 1881 | 1881 | 1881 | 1881 |   |   |
| Adj Flow Rate, veh/h         | 306  | 459  | 965  | 6    | 47   | 370  |   |   |
| Adj No. of Lanes             | 2    | 1    | 1    | 1    | 2    | 1    |   |   |
| Peak Hour Factor             | 0.85 | 0.85 | 0.85 | 0.85 | 0.85 | 0.85 |   |   |
| Percent Heavy Veh, %         | 8    | 8    | 1    | 1    | 1    | 1    |   |   |
| Cap, veh/h                   | 337  | 1168 | 986  | 838  | 861  | 396  |   |   |
| Arrive On Green              | 0.10 | 0.66 | 0.52 | 0.52 | 0.25 | 0.25 |   |   |
| Sat Flow, veh/h              | 3250 | 1759 | 1881 | 1599 | 3476 | 1599 |   |   |
| Grp Volume(v), veh/h         | 306  | 459  | 965  | 6    | 47   | 370  |   |   |
| Grp Sat Flow(s),veh/h/ln     | 1625 | 1759 | 1881 | 1599 | 1738 | 1599 |   |   |
| Q Serve(g_s), s              | 9.0  | 11.4 | 48.3 | 0.2  | 1.0  | 21.8 |   |   |
| Cycle Q Clear(g_c), s        | 9.0  | 11.4 | 48.3 | 0.2  | 1.0  | 21.8 |   |   |
| Prop In Lane                 | 1.00 |      |      | 1.00 | 1.00 | 1.00 |   |   |
| Lane Grp Cap(c), veh/h       | 337  | 1168 | 986  | 838  | 861  | 396  |   |   |
| V/C Ratio(X)                 | 0.91 | 0.39 | 0.98 | 0.01 | 0.05 | 0.93 |   |   |
| Avail Cap(c_a), veh/h        | 337  | 1178 | 996  | 847  | 974  | 448  |   |   |
| HCM Platoon Ratio            | 1.00 | 1.00 | 1.00 | 1.00 | 1.00 | 1.00 |   |   |
| Upstream Filter(I)           | 1.00 | 1.00 | 1.00 | 1.00 | 1.00 | 1.00 |   |   |
| Uniform Delay (d), s/veh     | 42.7 | 7.4  | 22.4 | 11.0 | 27.6 | 35.5 |   |   |
| Incr Delay (d2), s/veh       | 26.4 | 0.1  | 23.2 | 0.0  | 0.0  | 24.1 |   |   |
| Initial Q Delay(d3),s/veh    | 0.0  | 0.0  | 0.0  | 0.0  | 0.0  | 0.0  |   |   |
| %ile BackOfQ(50%),veh/ln     | 5.3  | 5.5  | 31.3 | 0.1  | 0.5  | 20.0 |   |   |
| LnGrp Delay(d),s/veh         | 69.1 | 7.4  | 45.7 | 11.0 | 27.6 | 59.6 |   |   |
| LnGrp LOS                    | E    | A    | D    | B    | C    | E    |   |   |
| Approach Vol, veh/h          |      | 765  | 971  |      | 417  |      |   |   |
| Approach Delay, s/veh        |      | 32.1 | 45.4 |      | 56.0 |      |   |   |
| Approach LOS                 |      | C    | D    |      | E    |      |   |   |
| Timer                        | 1    | 2    | 3    | 4    | 5    | 6    | 7 | 8 |
| Assigned Phs                 |      | 2    |      | 4    | 5    | 6    |   |   |
| Phs Duration (G+Y+Rc), s     |      | 69.0 |      | 27.4 | 13.5 | 55.5 |   |   |
| Change Period (Y+Rc), s      |      | 5.0  |      | 3.5  | 3.5  | 5.0  |   |   |
| Max Green Setting (Gmax), s  |      | 64.5 |      | 27.0 | 10.0 | 51.0 |   |   |
| Max Q Clear Time (g_c+I1), s |      | 13.4 |      | 23.8 | 11.0 | 50.3 |   |   |
| Green Ext Time (p_c), s      |      | 0.4  |      | 0.0  | 0.0  | 0.2  |   |   |
| <b>Intersection Summary</b>  |      |      |      |      |      |      |   |   |
| HCM 2010 Ctrl Delay          |      |      | 42.7 |      |      |      |   |   |
| HCM 2010 LOS                 |      |      | D    |      |      |      |   |   |

HCM 2010 Signalized Intersection Summary  
 28: Davis Road & Reservation Road

Cuml w/ Proj, AM  
 09/06/2019



| Movement                    | EBL  | EBT  | EBR  | WBL  | WBT   | WBR  | NBL  | NBT  | NBR  | SBL  | SBT  | SBR  |
|-----------------------------|------|------|------|------|-------|------|------|------|------|------|------|------|
| Lane Configurations         |      |      |      |      |       |      |      |      |      |      |      |      |
| Traffic Volume (veh/h)      | 550  | 310  | 10   | 10   | 560   | 90   | 10   | 10   | 10   | 150  | 10   | 640  |
| Future Volume (veh/h)       | 550  | 310  | 10   | 10   | 560   | 90   | 10   | 10   | 10   | 150  | 10   | 640  |
| Number                      | 5    | 2    | 12   | 1    | 6     | 16   | 3    | 8    | 18   | 7    | 4    | 14   |
| Initial Q (Qb), veh         | 0    | 0    | 0    | 0    | 0     | 0    | 0    | 0    | 0    | 0    | 0    | 0    |
| Ped-Bike Adj(A_pbT)         | 1.00 |      | 1.00 | 1.00 |       | 1.00 | 1.00 |      | 1.00 | 1.00 |      | 1.00 |
| Parking Bus, Adj            | 1.00 | 1.00 | 1.00 | 1.00 | 1.00  | 1.00 | 1.00 | 1.00 | 1.00 | 1.00 | 1.00 | 1.00 |
| Adj Sat Flow, veh/h/ln      | 1863 | 1863 | 1900 | 1863 | 1863  | 1900 | 1900 | 1900 | 1900 | 1900 | 1845 | 1845 |
| Adj Flow Rate, veh/h        | 640  | 360  | 12   | 12   | 651   | 105  | 12   | 12   | 9    | 174  | 12   | 502  |
| Adj No. of Lanes            | 2    | 2    | 0    | 1    | 1     | 0    | 0    | 1    | 0    | 0    | 1    | 1    |
| Peak Hour Factor            | 0.86 | 0.86 | 0.86 | 0.86 | 0.86  | 0.86 | 0.86 | 0.86 | 0.86 | 0.86 | 0.86 | 0.86 |
| Percent Heavy Veh, %        | 2    | 2    | 2    | 2    | 2     | 2    | 0    | 0    | 0    | 3    | 3    | 3    |
| Cap, veh/h                  | 684  | 2155 | 72   | 19   | 672   | 108  | 17   | 17   | 13   | 358  | 25   | 652  |
| Arrive On Green             | 0.20 | 0.62 | 0.62 | 0.01 | 0.43  | 0.43 | 0.03 | 0.03 | 0.03 | 0.22 | 0.22 | 0.22 |
| Sat Flow, veh/h             | 3442 | 3496 | 116  | 1774 | 1566  | 253  | 648  | 648  | 486  | 1649 | 114  | 1568 |
| Grp Volume(v), veh/h        | 640  | 182  | 190  | 12   | 0     | 756  | 33   | 0    | 0    | 186  | 0    | 502  |
| Grp Sat Flow(s),veh/h/ln    | 1721 | 1770 | 1842 | 1774 | 0     | 1818 | 1782 | 0    | 0    | 1762 | 0    | 1568 |
| Q Serve(g_s), s             | 25.3 | 6.1  | 6.1  | 0.9  | 0.0   | 56.1 | 2.5  | 0.0  | 0.0  | 12.8 | 0.0  | 30.0 |
| Cycle Q Clear(g_c), s       | 25.3 | 6.1  | 6.1  | 0.9  | 0.0   | 56.1 | 2.5  | 0.0  | 0.0  | 12.8 | 0.0  | 30.0 |
| Prop In Lane                | 1.00 |      | 0.06 | 1.00 |       | 0.14 | 0.36 |      | 0.27 | 0.94 |      | 1.00 |
| Lane Grp Cap(c), veh/h      | 684  | 1091 | 1136 | 19   | 0     | 780  | 46   | 0    | 0    | 383  | 0    | 652  |
| V/C Ratio(X)                | 0.94 | 0.17 | 0.17 | 0.63 | 0.00  | 0.97 | 0.71 | 0.00 | 0.00 | 0.49 | 0.00 | 0.77 |
| Avail Cap(c_a), veh/h       | 748  | 1091 | 1136 | 385  | 0     | 790  | 387  | 0    | 0    | 383  | 0    | 652  |
| HCM Platoon Ratio           | 1.00 | 1.00 | 1.00 | 1.00 | 1.00  | 1.00 | 1.00 | 1.00 | 1.00 | 1.00 | 1.00 | 1.00 |
| Upstream Filter(I)          | 1.00 | 1.00 | 1.00 | 1.00 | 0.00  | 1.00 | 1.00 | 0.00 | 0.00 | 1.00 | 0.00 | 1.00 |
| Uniform Delay (d), s/veh    | 54.4 | 11.3 | 11.3 | 68.0 | 0.0   | 38.5 | 66.7 | 0.0  | 0.0  | 47.3 | 0.0  | 34.6 |
| Incr Delay (d2), s/veh      | 17.4 | 0.1  | 0.1  | 12.2 | 0.0   | 24.7 | 7.3  | 0.0  | 0.0  | 0.4  | 0.0  | 5.1  |
| Initial Q Delay(d3),s/veh   | 0.0  | 0.0  | 0.0  | 0.0  | 0.0   | 0.0  | 0.0  | 0.0  | 0.0  | 0.0  | 0.0  | 0.0  |
| %ile BackOfQ(50%),veh/ln    | 13.7 | 3.0  | 3.1  | 0.5  | 0.0   | 33.5 | 1.3  | 0.0  | 0.0  | 6.2  | 0.0  | 17.3 |
| LnGrp Delay(d),s/veh        | 71.9 | 11.4 | 11.4 | 80.2 | 0.0   | 63.2 | 74.0 | 0.0  | 0.0  | 47.7 | 0.0  | 39.7 |
| LnGrp LOS                   | E    | B    | B    | F    |       | E    | E    |      |      | D    |      | D    |
| Approach Vol, veh/h         |      | 1012 |      |      | 768   |      |      | 33   |      |      | 688  |      |
| Approach Delay, s/veh       |      | 49.7 |      |      | 63.5  |      |      | 74.0 |      |      | 41.8 |      |
| Approach LOS                |      | D    |      |      | E     |      |      | E    |      |      | D    |      |
| Timer                       | 1    | 2    | 3    | 4    | 5     | 6    | 7    | 8    |      |      |      |      |
| Assigned Phs                | 1    | 2    |      | 4    | 5     | 6    |      | 8    |      |      |      |      |
| Phs Duration (G+Y+Rc), s    | 90.1 |      |      | 35.0 | 31.3  | 64.2 |      | 7.6  |      |      |      |      |
| Change Period (Y+Rc), s     | 3.9  | 5.0  |      | 5.0  | * 3.8 | 5.0  |      | 4.0  |      |      |      |      |
| Max Green Setting (Gmax), s | 30   | 60.0 |      | 30.0 | * 30  | 60.0 |      | 30.0 |      |      |      |      |
| Max Q Clear Time (g_c+I), s | 12.5 | 8.1  |      | 32.0 | 27.3  | 58.1 |      | 4.5  |      |      |      |      |
| Green Ext Time (p_c), s     | 0.0  | 3.3  |      | 0.0  | 0.2   | 1.1  |      | 0.0  |      |      |      |      |
| <b>Intersection Summary</b> |      |      |      |      |       |      |      |      |      |      |      |      |
| HCM 2010 Ctrl Delay         |      |      |      | 52.1 |       |      |      |      |      |      |      |      |
| HCM 2010 LOS                |      |      |      | D    |       |      |      |      |      |      |      |      |
| <b>Notes</b>                |      |      |      |      |       |      |      |      |      |      |      |      |

HCM 2010 Signalized Intersection Summary  
 33: General Jim Moore Boulevard & Lightfighter Drive

Cuml w/ Proj, AM  
 09/06/2019



| Movement                    | EBL  | EBT  | EBR  | WBL  | WBT  | WBR  | NBL  | NBT  | NBR  | SBL  | SBT  | SBR  |
|-----------------------------|------|------|------|------|------|------|------|------|------|------|------|------|
| Lane Configurations         | ↖↗   | ↑    | ↗    | ↖↗   | ↖↗   |      | ↖↗   | ↖↗   |      | ↖    | ↖↗   | ↗    |
| Traffic Volume (veh/h)      | 50   | 280  | 880  | 20   | 170  | 70   | 810  | 70   | 10   | 40   | 50   | 20   |
| Future Volume (veh/h)       | 50   | 280  | 880  | 20   | 170  | 70   | 810  | 70   | 10   | 40   | 50   | 20   |
| Number                      | 3    | 8    | 18   | 7    | 4    | 14   | 1    | 6    | 16   | 5    | 2    | 12   |
| Initial Q (Qb), veh         | 0    | 0    | 0    | 0    | 0    | 0    | 0    | 0    | 0    | 0    | 0    | 0    |
| Ped-Bike Adj(A_pbT)         | 1.00 |      | 1.00 | 1.00 |      | 1.00 | 1.00 |      | 1.00 | 1.00 |      | 0.99 |
| Parking Bus, Adj            | 1.00 | 1.00 | 1.00 | 1.00 | 1.00 | 1.00 | 1.00 | 1.00 | 1.00 | 1.00 | 1.00 | 1.00 |
| Adj Sat Flow, veh/h/ln      | 1863 | 1863 | 1863 | 1792 | 1792 | 1900 | 1881 | 1881 | 1900 | 1863 | 1863 | 1863 |
| Adj Flow Rate, veh/h        | 56   | 315  | 0    | 22   | 191  | 77   | 910  | 79   | 10   | 45   | 56   | 22   |
| Adj No. of Lanes            | 2    | 1    | 1    | 2    | 2    | 0    | 3    | 2    | 0    | 1    | 2    | 1    |
| Peak Hour Factor            | 0.89 | 0.89 | 0.89 | 0.89 | 0.89 | 0.89 | 0.89 | 0.89 | 0.89 | 0.89 | 0.89 | 0.89 |
| Percent Heavy Veh, %        | 2    | 2    | 2    | 6    | 6    | 6    | 1    | 1    | 1    | 2    | 2    | 2    |
| Cap, veh/h                  | 190  | 423  | 359  | 88   | 475  | 185  | 1260 | 1011 | 126  | 84   | 403  | 267  |
| Arrive On Green             | 0.06 | 0.23 | 0.00 | 0.03 | 0.20 | 0.20 | 0.25 | 0.32 | 0.32 | 0.05 | 0.11 | 0.11 |
| Sat Flow, veh/h             | 3442 | 1863 | 1583 | 3312 | 2395 | 932  | 5052 | 3199 | 398  | 1774 | 3539 | 1575 |
| Grp Volume(v), veh/h        | 56   | 315  | 0    | 22   | 134  | 134  | 910  | 44   | 45   | 45   | 56   | 22   |
| Grp Sat Flow(s),veh/h/ln    | 1863 | 1863 | 1583 | 1656 | 1703 | 1625 | 1684 | 1787 | 1810 | 1774 | 1770 | 1575 |
| Q Serve(g_s), s             | 0.7  | 7.4  | 0.0  | 0.3  | 3.2  | 3.4  | 7.7  | 0.8  | 0.8  | 1.2  | 0.7  | 0.6  |
| Cycle Q Clear(g_c), s       | 0.7  | 7.4  | 0.0  | 0.3  | 3.2  | 3.4  | 7.7  | 0.8  | 0.8  | 1.2  | 0.7  | 0.6  |
| Prop In Lane                | 1.00 |      | 1.00 | 1.00 |      | 0.57 | 1.00 |      | 0.22 | 1.00 |      | 1.00 |
| Lane Grp Cap(c), veh/h      | 190  | 423  | 359  | 88   | 338  | 322  | 1260 | 565  | 572  | 84   | 403  | 267  |
| V/C Ratio(X)                | 0.29 | 0.75 | 0.00 | 0.25 | 0.40 | 0.42 | 0.72 | 0.08 | 0.08 | 0.54 | 0.14 | 0.08 |
| Avail Cap(c_a), veh/h       | 366  | 714  | 607  | 353  | 653  | 623  | 1668 | 1058 | 1072 | 234  | 1394 | 708  |
| HCM Platoon Ratio           | 1.00 | 1.00 | 1.00 | 1.00 | 1.00 | 1.00 | 1.00 | 1.00 | 1.00 | 1.00 | 1.00 | 1.00 |
| Upstream Filter(I)          | 1.00 | 1.00 | 0.00 | 1.00 | 1.00 | 1.00 | 1.00 | 1.00 | 1.00 | 1.00 | 1.00 | 1.00 |
| Uniform Delay (d), s/veh    | 21.3 | 16.9 | 0.0  | 22.4 | 16.4 | 16.5 | 16.1 | 11.3 | 11.3 | 21.9 | 18.7 | 16.4 |
| Incr Delay (d2), s/veh      | 0.9  | 2.6  | 0.0  | 1.5  | 0.8  | 0.9  | 1.1  | 0.1  | 0.1  | 5.2  | 0.2  | 0.1  |
| Initial Q Delay(d3),s/veh   | 0.0  | 0.0  | 0.0  | 0.0  | 0.0  | 0.0  | 0.0  | 0.0  | 0.0  | 0.0  | 0.0  | 0.0  |
| %ile BackOfQ(50%),veh/ln    | 0.4  | 4.1  | 0.0  | 0.2  | 1.6  | 1.6  | 3.7  | 0.4  | 0.4  | 0.7  | 0.3  | 0.2  |
| LnGrp Delay(d),s/veh        | 22.2 | 19.5 | 0.0  | 23.9 | 17.1 | 17.3 | 17.2 | 11.3 | 11.3 | 27.1 | 18.9 | 16.6 |
| LnGrp LOS                   | C    | B    |      | C    | B    | B    | B    | B    | B    | C    | B    | B    |
| Approach Vol, veh/h         |      | 371  |      |      | 290  |      |      | 999  |      |      | 123  |      |
| Approach Delay, s/veh       |      | 19.9 |      |      | 17.7 |      |      | 16.7 |      |      | 21.5 |      |
| Approach LOS                |      | B    |      |      | B    |      |      | B    |      |      | C    |      |
| Timer                       | 1    | 2    | 3    | 4    | 5    | 6    | 7    | 8    |      |      |      |      |
| Assigned Phs                | 1    | 2    | 3    | 4    | 5    | 6    | 7    | 8    |      |      |      |      |
| Phs Duration (G+Y+Rc), s    | 16.2 | 9.8  | 7.1  | 13.8 | 6.7  | 19.3 | 5.7  | 15.2 |      |      |      |      |
| Change Period (Y+Rc), s     | 4.5  | 4.5  | 4.5  | 4.5  | 4.5  | 4.5  | 4.5  | 4.5  |      |      |      |      |
| Max Green Setting (Gmax), s | 15.5 | 18.5 | 5.0  | 18.0 | 6.2  | 27.8 | 5.0  | 18.0 |      |      |      |      |
| Max Q Clear Time (g_c+I), s | 19.7 | 2.7  | 2.7  | 5.4  | 3.2  | 2.8  | 2.3  | 9.4  |      |      |      |      |
| Green Ext Time (p_c), s     | 2.0  | 0.2  | 0.0  | 1.3  | 0.0  | 0.4  | 0.0  | 1.1  |      |      |      |      |
| <b>Intersection Summary</b> |      |      |      |      |      |      |      |      |      |      |      |      |
| HCM 2010 Ctrl Delay         |      |      |      | 17.8 |      |      |      |      |      |      |      |      |
| HCM 2010 LOS                |      |      |      | B    |      |      |      |      |      |      |      |      |

HCM 2010 Roundabout  
33: General Jim Moore Boulevard & Lightfighter Drive

Cumulative with Project (Roundabouts), AM

04/22/2022

| Intersection                |       |       |       |       |       |       |       |       |  |
|-----------------------------|-------|-------|-------|-------|-------|-------|-------|-------|--|
| Intersection Delay, s/veh   | 13.7  |       |       |       |       |       |       |       |  |
| Intersection LOS            | B     |       |       |       |       |       |       |       |  |
| Approach                    | EB    |       | WB    |       | NB    |       | SB    |       |  |
| Entry Lanes                 | 2     |       | 2     |       | 2     |       | 2     |       |  |
| Conflicting Circle Lanes    | 2     |       | 2     |       | 2     |       | 2     |       |  |
| Adj Approach Flow, veh/h    | 1360  |       | 292   |       | 1000  |       | 123   |       |  |
| Demand Flow Rate, veh/h     | 1387  |       | 309   |       | 1010  |       | 125   |       |  |
| Vehicles Circulating, veh/h | 126   |       | 1056  |       | 424   |       | 1144  |       |  |
| Vehicles Exiting, veh/h     | 1143  |       | 378   |       | 1089  |       | 221   |       |  |
| Follow-Up Headway, s        | 3.186 |       | 3.186 |       | 3.186 |       | 3.186 |       |  |
| Ped Vol Crossing Leg, #/h   | 2     |       | 1     |       | 2     |       | 0     |       |  |
| Ped Cap Adj                 | 0.998 |       | 1.000 |       | 0.999 |       | 1.000 |       |  |
| Approach Delay, s/veh       | 14.2  |       | 11.7  |       | 14.2  |       | 9.1   |       |  |
| Approach LOS                | B     |       | B     |       | B     |       | A     |       |  |
| Lane                        | Left  | Right | Left  | Right | Left  | Right | Left  | Right |  |
| Designated Moves            | LTR   | R     | LT    | TR    | L     | LTR   | LT    | TR    |  |
| Assumed Moves               | LTR   | R     | LT    | TR    | L     | LTR   | LT    | TR    |  |
| RT Channelized              |       |       |       |       |       |       |       |       |  |
| Lane Util                   | 0.470 | 0.530 | 0.469 | 0.531 | 0.530 | 0.470 | 0.472 | 0.528 |  |
| Critical Headway, s         | 4.293 | 4.113 | 4.293 | 4.113 | 4.293 | 4.113 | 4.293 | 4.113 |  |
| Entry Flow, veh/h           | 652   | 735   | 145   | 164   | 535   | 475   | 59    | 66    |  |
| Cap Entry Lane, veh/h       | 1028  | 1035  | 512   | 540   | 822   | 840   | 479   | 507   |  |
| Entry HV Adj Factor         | 0.980 | 0.980 | 0.945 | 0.942 | 0.991 | 0.990 | 0.979 | 0.987 |  |
| Flow Entry, veh/h           | 639   | 721   | 137   | 155   | 530   | 470   | 58    | 65    |  |
| Cap Entry, veh/h            | 1006  | 1012  | 484   | 508   | 813   | 830   | 469   | 501   |  |
| V/C Ratio                   | 0.636 | 0.712 | 0.283 | 0.304 | 0.652 | 0.566 | 0.123 | 0.130 |  |
| Control Delay, s/veh        | 12.8  | 15.4  | 11.8  | 11.7  | 15.6  | 12.7  | 9.4   | 8.9   |  |
| LOS                         | B     | C     | B     | B     | C     | B     | A     | A     |  |
| 95th %tile Queue, veh       | 5     | 6     | 1     | 1     | 5     | 4     | 0     | 0     |  |

HCM 2010 Signalized Intersection Summary  
 39: General Jim Moore Boulevard & Gigling Road

Cuml w/ Proj, AM  
 09/06/2019



| Movement                    | EBL  | EBT  | EBR  | WBL  | WBT  | WBR  | NBL  | NBT  | NBR  | SBL  | SBT  | SBR  |
|-----------------------------|------|------|------|------|------|------|------|------|------|------|------|------|
| Lane Configurations         |      |      |      |      |      |      |      |      |      |      |      |      |
| Traffic Volume (veh/h)      | 30   | 100  | 80   | 510  | 40   | 410  | 50   | 410  | 280  | 310  | 650  | 50   |
| Future Volume (veh/h)       | 30   | 100  | 80   | 510  | 40   | 410  | 50   | 410  | 280  | 310  | 650  | 50   |
| Number                      | 3    | 8    | 18   | 7    | 4    | 14   | 1    | 6    | 16   | 5    | 2    | 12   |
| Initial Q (Qb), veh         | 0    | 0    | 0    | 0    | 0    | 0    | 0    | 0    | 0    | 0    | 0    | 0    |
| Ped-Bike Adj(A_pbT)         | 1.00 |      | 1.00 | 1.00 |      | 1.00 | 1.00 |      | 1.00 | 1.00 |      | 1.00 |
| Parking Bus, Adj            | 1.00 | 1.00 | 1.00 | 1.00 | 1.00 | 1.00 | 1.00 | 1.00 | 1.00 | 1.00 | 1.00 | 1.00 |
| Adj Sat Flow, veh/h/ln      | 1810 | 1810 | 1900 | 1863 | 1863 | 1863 | 1881 | 1881 | 1881 | 1863 | 1863 | 1863 |
| Adj Flow Rate, veh/h        | 34   | 115  | 60   | 586  | 46   | 0    | 57   | 471  | 0    | 356  | 747  | 0    |
| Adj No. of Lanes            | 1    | 2    | 0    | 2    | 2    | 1    | 1    | 2    | 1    | 1    | 2    | 1    |
| Peak Hour Factor            | 0.87 | 0.87 | 0.87 | 0.87 | 0.87 | 0.87 | 0.87 | 0.87 | 0.87 | 0.87 | 0.87 | 0.87 |
| Percent Heavy Veh, %        | 5    | 5    | 5    | 2    | 2    | 2    | 1    | 1    | 1    | 2    | 2    | 2    |
| Cap, veh/h                  | 148  | 205  | 101  | 689  | 730  | 327  | 93   | 608  | 272  | 405  | 1226 | 548  |
| Arrive On Green             | 0.09 | 0.09 | 0.09 | 0.20 | 0.21 | 0.00 | 0.05 | 0.17 | 0.00 | 0.23 | 0.35 | 0.00 |
| Sat Flow, veh/h             | 1723 | 2232 | 1098 | 3442 | 3539 | 1583 | 1792 | 3574 | 1599 | 1774 | 3539 | 1583 |
| Grp Volume(v), veh/h        | 34   | 87   | 88   | 586  | 46   | 0    | 57   | 471  | 0    | 356  | 747  | 0    |
| Grp Sat Flow(s),veh/h/ln    | 1723 | 1719 | 1611 | 1721 | 1770 | 1583 | 1792 | 1787 | 1599 | 1774 | 1770 | 1583 |
| Q Serve(g_s), s             | 1.1  | 2.8  | 3.0  | 9.5  | 0.6  | 0.0  | 1.8  | 7.3  | 0.0  | 11.3 | 10.2 | 0.0  |
| Cycle Q Clear(g_c), s       | 1.1  | 2.8  | 3.0  | 9.5  | 0.6  | 0.0  | 1.8  | 7.3  | 0.0  | 11.3 | 10.2 | 0.0  |
| Prop In Lane                | 1.00 |      | 0.68 | 1.00 |      | 1.00 | 1.00 |      | 1.00 | 1.00 |      | 1.00 |
| Lane Grp Cap(c), veh/h      | 148  | 158  | 148  | 689  | 730  | 327  | 93   | 608  | 272  | 405  | 1226 | 548  |
| V/C Ratio(X)                | 0.23 | 0.55 | 0.59 | 0.85 | 0.06 | 0.00 | 0.61 | 0.77 | 0.00 | 0.88 | 0.61 | 0.00 |
| Avail Cap(c_a), veh/h       | 311  | 917  | 859  | 1214 | 2496 | 1117 | 170  | 1537 | 688  | 473  | 2131 | 953  |
| HCM Platoon Ratio           | 1.00 | 1.00 | 1.00 | 1.00 | 1.00 | 1.00 | 1.00 | 1.00 | 1.00 | 1.00 | 1.00 | 1.00 |
| Upstream Filter(I)          | 1.00 | 1.00 | 1.00 | 1.00 | 1.00 | 0.00 | 1.00 | 1.00 | 0.00 | 1.00 | 1.00 | 0.00 |
| Uniform Delay (d), s/veh    | 24.8 | 25.2 | 25.3 | 22.4 | 18.6 | 0.0  | 27.0 | 23.1 | 0.0  | 21.7 | 15.7 | 0.0  |
| Incr Delay (d2), s/veh      | 0.3  | 1.1  | 1.4  | 1.2  | 0.0  | 0.0  | 2.4  | 0.8  | 0.0  | 14.1 | 0.2  | 0.0  |
| Initial Q Delay(d3),s/veh   | 0.0  | 0.0  | 0.0  | 0.0  | 0.0  | 0.0  | 0.0  | 0.0  | 0.0  | 0.0  | 0.0  | 0.0  |
| %ile BackOfQ(50%),veh/ln    | 0.5  | 1.4  | 1.4  | 4.6  | 0.3  | 0.0  | 0.9  | 3.7  | 0.0  | 7.0  | 4.9  | 0.0  |
| LnGrp Delay(d),s/veh        | 25.1 | 26.3 | 26.7 | 23.6 | 18.6 | 0.0  | 29.4 | 23.9 | 0.0  | 35.8 | 15.9 | 0.0  |
| LnGrp LOS                   | C    | C    | C    | C    | B    |      | C    | C    |      | D    | B    |      |
| Approach Vol, veh/h         |      | 209  |      |      | 632  |      |      | 528  |      |      | 1103 |      |
| Approach Delay, s/veh       |      | 26.3 |      |      | 23.2 |      |      | 24.5 |      |      | 22.3 |      |
| Approach LOS                |      | C    |      |      | C    |      |      | C    |      |      | C    |      |
| Timer                       | 1    | 2    | 3    | 4    | 5    | 6    | 7    | 8    |      |      |      |      |
| Assigned Phs                | 1    | 2    | 3    | 4    | 5    | 6    | 7    | 8    |      |      |      |      |
| Phs Duration (G+Y+Rc), s    | 7.5  | 24.6 | 9.5  | 16.5 | 17.8 | 14.4 | 16.1 | 9.9  |      |      |      |      |
| Change Period (Y+Rc), s     | 4.5  | 4.5  | 4.5  | 4.5  | 4.5  | 4.5  | 4.5  | 4.5  |      |      |      |      |
| Max Green Setting (Gmax), s | 5.5  | 35.0 | 10.5 | 41.0 | 15.5 | 25.0 | 20.5 | 31.0 |      |      |      |      |
| Max Q Clear Time (g_c+I), s | 13.8 | 12.2 | 3.1  | 2.6  | 13.3 | 9.3  | 11.5 | 5.0  |      |      |      |      |
| Green Ext Time (p_c), s     | 0.0  | 1.0  | 0.0  | 0.1  | 0.0  | 0.6  | 0.1  | 0.2  |      |      |      |      |
| <b>Intersection Summary</b> |      |      |      |      |      |      |      |      |      |      |      |      |
| HCM 2010 Ctrl Delay         |      |      |      | 23.3 |      |      |      |      |      |      |      |      |
| HCM 2010 LOS                |      |      |      | C    |      |      |      |      |      |      |      |      |
| <b>Notes</b>                |      |      |      |      |      |      |      |      |      |      |      |      |



HCM 2010 Roundabout  
39: General Jim Moore Boulevard & Gigling Road

| Intersection                |       |       |       |       |       |       |       |       |  |
|-----------------------------|-------|-------|-------|-------|-------|-------|-------|-------|--|
| Intersection Delay, s/veh   | 24.8  |       |       |       |       |       |       |       |  |
| Intersection LOS            | C     |       |       |       |       |       |       |       |  |
| Approach                    | EB    |       | WB    |       | NB    |       | SB    |       |  |
| Entry Lanes                 | 2     |       | 2     |       | 2     |       | 2     |       |  |
| Conflicting Circle Lanes    | 2     |       | 2     |       | 2     |       | 2     |       |  |
| Adj Approach Flow, veh/h    | 241   |       | 1103  |       | 850   |       | 1160  |       |  |
| Demand Flow Rate, veh/h     | 254   |       | 1125  |       | 859   |       | 1183  |       |  |
| Vehicles Circulating, veh/h | 1723  |       | 570   |       | 520   |       | 703   |       |  |
| Vehicles Exiting, veh/h     | 163   |       | 809   |       | 1457  |       | 992   |       |  |
| Follow-Up Headway, s        | 3.186 |       | 3.186 |       | 3.186 |       | 3.186 |       |  |
| Ped Vol Crossing Leg, #/h   | 0     |       | 0     |       | 0     |       | 1     |       |  |
| Ped Cap Adj                 | 1.000 |       | 1.000 |       | 1.000 |       | 1.000 |       |  |
| Approach Delay, s/veh       | 21.0  |       | 22.9  |       | 13.2  |       | 35.9  |       |  |
| Approach LOS                | C     |       | C     |       | B     |       | E     |       |  |
| Lane                        | Left  | Right | Left  | Right | Left  | Right | Left  | Right |  |
| Designated Moves            | LT    | TR    | LT    | TR    | LT    | TR    | LT    | TR    |  |
| Assumed Moves               | LT    | TR    | L     | TR    | LT    | TR    | LT    | TR    |  |
| RT Channelized              |       |       |       |       |       |       |       |       |  |
| Lane Util                   | 0.469 | 0.531 | 0.532 | 0.468 | 0.470 | 0.530 | 0.470 | 0.530 |  |
| Critical Headway, s         | 4.293 | 4.113 | 4.293 | 4.113 | 4.293 | 4.113 | 4.293 | 4.113 |  |
| Entry Flow, veh/h           | 119   | 135   | 598   | 527   | 404   | 455   | 556   | 627   |  |
| Cap Entry Lane, veh/h       | 310   | 338   | 737   | 758   | 765   | 785   | 667   | 691   |  |
| Entry HV Adj Factor         | 0.953 | 0.947 | 0.980 | 0.981 | 0.989 | 0.990 | 0.981 | 0.981 |  |
| Flow Entry, veh/h           | 113   | 128   | 586   | 517   | 400   | 451   | 545   | 615   |  |
| Cap Entry, veh/h            | 296   | 320   | 722   | 744   | 757   | 778   | 654   | 677   |  |
| V/C Ratio                   | 0.383 | 0.399 | 0.812 | 0.695 | 0.528 | 0.579 | 0.834 | 0.908 |  |
| Control Delay, s/veh        | 21.5  | 20.5  | 26.8  | 18.6  | 12.6  | 13.7  | 31.2  | 40.2  |  |
| LOS                         | C     | C     | D     | C     | B     | B     | D     | E     |  |
| 95th %tile Queue, veh       | 2     | 2     | 9     | 6     | 3     | 4     | 9     | 12    |  |

HCM 2010 Signalized Intersection Summary  
 47: General Jim Moore Boulevard & Coe Avenue

Cuml w/ Proj, AM  
 09/06/2019



| Movement                     | EBL  | EBT  | EBR  | WBL | WBT | WBR  | NBL  | NBT  | NBR  | SBL  | SBT  | SBR  |
|------------------------------|------|------|------|-----|-----|------|------|------|------|------|------|------|
| Lane Configurations          |      |      |      |     |     |      |      |      |      |      |      |      |
| Traffic Volume (veh/h)       | 90   | 0    | 430  | 0   | 0   | 0    | 230  | 420  | 0    | 0    | 980  | 80   |
| Future Volume (veh/h)        | 90   | 0    | 430  | 0   | 0   | 0    | 230  | 420  | 0    | 0    | 980  | 80   |
| Number                       | 3    | 8    | 18   |     |     |      | 1    | 6    | 16   | 5    | 2    | 12   |
| Initial Q (Qb), veh          | 0    | 0    | 0    |     |     |      | 0    | 0    | 0    | 0    | 0    | 0    |
| Ped-Bike Adj(A_pbT)          | 1.00 |      | 1.00 |     |     |      | 1.00 |      | 1.00 | 1.00 |      | 1.00 |
| Parking Bus, Adj             | 1.00 | 1.00 | 1.00 |     |     |      | 1.00 | 1.00 | 1.00 | 1.00 | 1.00 | 1.00 |
| Adj Sat Flow, veh/h/ln       | 1881 | 1881 | 1900 |     |     |      | 1881 | 1881 | 0    | 0    | 1863 | 1863 |
| Adj Flow Rate, veh/h         | 100  | 0    | 367  |     |     |      | 256  | 467  | 0    | 0    | 1089 | 28   |
| Adj No. of Lanes             | 1    | 1    | 0    |     |     |      | 1    | 2    | 0    | 0    | 2    | 1    |
| Peak Hour Factor             | 0.90 | 0.92 | 0.90 |     |     |      | 0.90 | 0.90 | 0.92 | 0.92 | 0.90 | 0.90 |
| Percent Heavy Veh, %         | 1    | 2    | 1    |     |     |      | 1    | 1    | 0    | 0    | 2    | 2    |
| Cap, veh/h                   | 515  | 0    | 459  |     |     |      | 301  | 2064 | 0    | 0    | 1211 | 542  |
| Arrive On Green              | 0.29 | 0.00 | 0.29 |     |     |      | 0.17 | 0.58 | 0.00 | 0.00 | 0.34 | 0.34 |
| Sat Flow, veh/h              | 1792 | 0    | 1597 |     |     |      | 1792 | 3668 | 0    | 0    | 3632 | 1583 |
| Grp Volume(v), veh/h         | 100  | 0    | 367  |     |     |      | 256  | 467  | 0    | 0    | 1089 | 28   |
| Grp Sat Flow(s),veh/h/ln     | 1792 | 0    | 1597 |     |     |      | 1792 | 1787 | 0    | 0    | 1770 | 1583 |
| Q Serve(g_s), s              | 2.8  | 0.0  | 14.2 |     |     |      | 9.2  | 4.2  | 0.0  | 0.0  | 19.5 | 0.8  |
| Cycle Q Clear(g_c), s        | 2.8  | 0.0  | 14.2 |     |     |      | 9.2  | 4.2  | 0.0  | 0.0  | 19.5 | 0.8  |
| Prop In Lane                 | 1.00 |      | 1.00 |     |     |      | 1.00 |      | 0.00 | 0.00 |      | 1.00 |
| Lane Grp Cap(c), veh/h       | 515  | 0    | 459  |     |     |      | 301  | 2064 | 0    | 0    | 1211 | 542  |
| V/C Ratio(X)                 | 0.19 | 0.00 | 0.80 |     |     |      | 0.85 | 0.23 | 0.00 | 0.00 | 0.90 | 0.05 |
| Avail Cap(c_a), veh/h        | 1129 | 0    | 1007 |     |     |      | 417  | 2897 | 0    | 0    | 1806 | 808  |
| HCM Platoon Ratio            | 1.00 | 1.00 | 1.00 |     |     |      | 1.00 | 1.00 | 1.00 | 1.00 | 1.00 | 1.00 |
| Upstream Filter(l)           | 1.00 | 0.00 | 1.00 |     |     |      | 1.00 | 1.00 | 0.00 | 0.00 | 1.00 | 1.00 |
| Uniform Delay (d), s/veh     | 17.9 | 0.0  | 22.0 |     |     |      | 26.9 | 6.8  | 0.0  | 0.0  | 20.8 | 14.7 |
| Incr Delay (d2), s/veh       | 0.2  | 0.0  | 3.2  |     |     |      | 8.8  | 0.0  | 0.0  | 0.0  | 3.3  | 0.0  |
| Initial Q Delay(d3),s/veh    | 0.0  | 0.0  | 0.0  |     |     |      | 0.0  | 0.0  | 0.0  | 0.0  | 0.0  | 0.0  |
| %ile BackOfQ(50%),veh/ln     | 1.4  | 0.0  | 6.6  |     |     |      | 5.3  | 2.1  | 0.0  | 0.0  | 9.9  | 0.3  |
| LnGrp Delay(d),s/veh         | 18.1 | 0.0  | 25.2 |     |     |      | 35.7 | 6.9  | 0.0  | 0.0  | 24.2 | 14.7 |
| LnGrp LOS                    | B    |      | C    |     |     |      | D    | A    |      |      | C    | B    |
| Approach Vol, veh/h          |      | 467  |      |     |     |      |      | 723  |      |      | 1117 |      |
| Approach Delay, s/veh        |      | 23.7 |      |     |     |      |      | 17.1 |      |      | 23.9 |      |
| Approach LOS                 |      | C    |      |     |     |      |      | B    |      |      | C    |      |
| Timer                        | 1    | 2    | 3    | 4   | 5   | 6    | 7    | 8    |      |      |      |      |
| Assigned Phs                 | 1    | 2    |      |     |     | 6    |      | 8    |      |      |      |      |
| Phs Duration (G+Y+Rc), s     | 15.7 | 27.3 |      |     |     | 43.0 |      | 23.7 |      |      |      |      |
| Change Period (Y+Rc), s      | 4.5  | 4.5  |      |     |     | 4.5  |      | 4.5  |      |      |      |      |
| Max Green Setting (Gmax), s  | 15.5 | 34.0 |      |     |     | 54.0 |      | 42.0 |      |      |      |      |
| Max Q Clear Time (g_c+ll), s | 11.2 | 21.5 |      |     |     | 6.2  |      | 16.2 |      |      |      |      |
| Green Ext Time (p_c), s      | 0.0  | 1.3  |      |     |     | 0.5  |      | 2.8  |      |      |      |      |
| <b>Intersection Summary</b>  |      |      |      |     |     |      |      |      |      |      |      |      |
| HCM 2010 Ctrl Delay          |      |      | 21.7 |     |     |      |      |      |      |      |      |      |
| HCM 2010 LOS                 |      |      | C    |     |     |      |      |      |      |      |      |      |

HCM 2010 Signalized Intersection Summary  
 5: 2nd Avenue & Imjin Parkway

Cuml w/ Proj, PM  
 09/06/2019



| Movement                     | EBL  | EBT  | EBR  | WBL  | WBT  | WBR  | NBL  | NBT  | NBR  | SBL  | SBT  | SBR  |
|------------------------------|------|------|------|------|------|------|------|------|------|------|------|------|
| Lane Configurations          | ↖↗   | ↖↗↖  | ↖↗   | ↖↗↖  | ↖↗↖  | ↖↗   | ↖↗↖  | ↑    | ↖↗   | ↖↗   | ↖↗   | ↖    |
| Traffic Volume (veh/h)       | 140  | 1370 | 710  | 330  | 1160 | 140  | 830  | 110  | 540  | 90   | 100  | 150  |
| Future Volume (veh/h)        | 140  | 1370 | 710  | 330  | 1160 | 140  | 830  | 110  | 540  | 90   | 100  | 150  |
| Number                       | 5    | 2    | 12   | 1    | 6    | 16   | 3    | 8    | 18   | 7    | 4    | 14   |
| Initial Q (Qb), veh          | 0    | 0    | 0    | 0    | 0    | 0    | 0    | 0    | 0    | 0    | 0    | 0    |
| Ped-Bike Adj(A_pbT)          | 1.00 |      | 1.00 | 1.00 |      | 1.00 | 1.00 |      | 1.00 | 1.00 |      | 1.00 |
| Parking Bus, Adj             | 1.00 | 1.00 | 1.00 | 1.00 | 1.00 | 1.00 | 1.00 | 1.00 | 1.00 | 1.00 | 1.00 | 1.00 |
| Adj Sat Flow, veh/h/ln       | 1863 | 1863 | 1863 | 1863 | 1863 | 1863 | 1810 | 1810 | 1810 | 1900 | 1900 | 1900 |
| Adj Flow Rate, veh/h         | 146  | 1427 | 516  | 344  | 1208 | 146  | 865  | 115  | 437  | 94   | 104  | 151  |
| Adj No. of Lanes             | 2    | 3    | 2    | 3    | 3    | 1    | 3    | 1    | 2    | 2    | 2    | 1    |
| Peak Hour Factor             | 0.96 | 0.96 | 0.96 | 0.96 | 0.96 | 0.96 | 0.96 | 0.96 | 0.96 | 0.96 | 0.96 | 0.96 |
| Percent Heavy Veh, %         | 2    | 2    | 2    | 2    | 2    | 2    | 5    | 5    | 5    | 0    | 0    | 0    |
| Cap, veh/h                   | 242  | 1643 | 900  | 481  | 1773 | 640  | 989  | 478  | 714  | 194  | 418  | 300  |
| Arrive On Green              | 0.07 | 0.32 | 0.32 | 0.10 | 0.35 | 0.35 | 0.20 | 0.26 | 0.26 | 0.06 | 0.12 | 0.12 |
| Sat Flow, veh/h              | 3442 | 5085 | 2787 | 5003 | 5085 | 1583 | 4860 | 1810 | 2702 | 3510 | 3610 | 1611 |
| Grp Volume(v), veh/h         | 146  | 1427 | 516  | 344  | 1208 | 146  | 865  | 115  | 437  | 94   | 104  | 151  |
| Grp Sat Flow(s),veh/h/ln     | 1721 | 1695 | 1393 | 1668 | 1695 | 1583 | 1620 | 1810 | 1351 | 1755 | 1805 | 1611 |
| Q Serve(g_s), s              | 2.8  | 18.1 | 10.5 | 4.6  | 13.9 | 4.1  | 11.8 | 3.4  | 9.7  | 1.8  | 1.8  | 5.8  |
| Cycle Q Clear(g_c), s        | 2.8  | 18.1 | 10.5 | 4.6  | 13.9 | 4.1  | 11.8 | 3.4  | 9.7  | 1.8  | 1.8  | 5.8  |
| Prop In Lane                 | 1.00 |      | 1.00 | 1.00 |      | 1.00 | 1.00 |      | 1.00 | 1.00 |      | 1.00 |
| Lane Grp Cap(c), veh/h       | 242  | 1643 | 900  | 481  | 1773 | 640  | 989  | 478  | 714  | 194  | 418  | 300  |
| V/C Ratio(X)                 | 0.60 | 0.87 | 0.57 | 0.72 | 0.68 | 0.23 | 0.87 | 0.24 | 0.61 | 0.48 | 0.25 | 0.50 |
| Avail Cap(c_a), veh/h        | 307  | 2028 | 1111 | 519  | 2102 | 742  | 1185 | 846  | 1263 | 292  | 1107 | 608  |
| HCM Platoon Ratio            | 1.00 | 1.00 | 1.00 | 1.00 | 1.00 | 1.00 | 1.00 | 1.00 | 1.00 | 1.00 | 1.00 | 1.00 |
| Upstream Filter(I)           | 1.00 | 1.00 | 1.00 | 1.00 | 1.00 | 1.00 | 1.00 | 1.00 | 1.00 | 1.00 | 1.00 | 1.00 |
| Uniform Delay (d), s/veh     | 30.9 | 21.8 | 19.3 | 30.0 | 19.0 | 13.4 | 26.4 | 19.8 | 22.1 | 31.4 | 27.6 | 25.0 |
| Incr Delay (d2), s/veh       | 0.9  | 3.1  | 0.2  | 3.5  | 0.5  | 0.1  | 5.8  | 0.1  | 0.3  | 0.7  | 0.1  | 0.5  |
| Initial Q Delay(d3),s/veh    | 0.0  | 0.0  | 0.0  | 0.0  | 0.0  | 0.0  | 0.0  | 0.0  | 0.0  | 0.0  | 0.0  | 0.0  |
| %ile BackOfQ(50%),veh/ln     | 4    | 8.9  | 4.1  | 2.3  | 6.6  | 1.8  | 5.8  | 1.7  | 3.6  | 0.9  | 0.9  | 2.6  |
| LnGrp Delay(d),s/veh         | 31.8 | 24.9 | 19.5 | 33.5 | 19.5 | 13.5 | 32.2 | 19.9 | 22.4 | 32.1 | 27.7 | 25.5 |
| LnGrp LOS                    | C    | C    | B    | C    | B    | B    | C    | B    | C    | C    | C    | C    |
| Approach Vol, veh/h          |      | 2089 |      |      | 1698 |      |      | 1417 |      |      | 349  |      |
| Approach Delay, s/veh        |      | 24.1 |      |      | 21.8 |      |      | 28.2 |      |      | 27.9 |      |
| Approach LOS                 |      | C    |      |      | C    |      |      | C    |      |      | C    |      |
| Timer                        | 1    | 2    | 3    | 4    | 5    | 6    | 7    | 8    |      |      |      |      |
| Assigned Phs                 | 1    | 2    | 3    | 4    | 5    | 6    | 7    | 8    |      |      |      |      |
| Phs Duration (G+Y+Rc), s     | 11.1 | 27.4 | 17.4 | 12.5 | 9.3  | 29.2 | 7.3  | 22.7 |      |      |      |      |
| Change Period (Y+Rc), s      | 4.5  | 5.3  | 3.5  | 4.6  | 4.5  | 5.3  | 3.5  | 4.6  |      |      |      |      |
| Max Green Setting (Gmax), s  | 27.3 | 16.7 | 21.0 | 6.1  | 28.3 | 5.7  | 32.0 |      |      |      |      |      |
| Max Q Clear Time (g_c+10), s | 10.6 | 20.1 | 13.8 | 7.8  | 4.8  | 15.9 | 3.8  | 11.7 |      |      |      |      |
| Green Ext Time (p_c), s      | 0.0  | 2.0  | 0.1  | 0.1  | 0.0  | 1.9  | 0.0  | 0.2  |      |      |      |      |
| <b>Intersection Summary</b>  |      |      |      |      |      |      |      |      |      |      |      |      |
| HCM 2010 Ctrl Delay          |      |      |      |      | 24.7 |      |      |      |      |      |      |      |
| HCM 2010 LOS                 |      |      |      |      | C    |      |      |      |      |      |      |      |

HCM 2010 Signalized Intersection Summary  
 10: Imjin Road & Imjin Parkway

Cuml w/ Proj, PM  
 09/06/2019



| Movement                     | EBT  | EBR  | WBL  | WBT  | NBL  | NBR  |   |      |
|------------------------------|------|------|------|------|------|------|---|------|
| Lane Configurations          | ↑↑   |      | ↵↵   | ↑↑   | ↵↵   | ↵    |   |      |
| Traffic Volume (veh/h)       | 1590 | 150  | 260  | 920  | 250  | 520  |   |      |
| Future Volume (veh/h)        | 1590 | 150  | 260  | 920  | 250  | 520  |   |      |
| Number                       | 2    | 12   | 1    | 6    | 3    | 18   |   |      |
| Initial Q (Qb), veh          | 0    | 0    | 0    | 0    | 0    | 0    |   |      |
| Ped-Bike Adj(A_pbT)          |      | 1.00 | 1.00 |      | 1.00 | 1.00 |   |      |
| Parking Bus, Adj             | 1.00 | 1.00 | 1.00 | 1.00 | 1.00 | 1.00 |   |      |
| Adj Sat Flow, veh/h/ln       | 1863 | 1900 | 1845 | 1845 | 1810 | 1810 |   |      |
| Adj Flow Rate, veh/h         | 1674 | 145  | 274  | 968  | 263  | 547  |   |      |
| Adj No. of Lanes             | 2    | 0    | 2    | 2    | 1    | 2    |   |      |
| Peak Hour Factor             | 0.95 | 0.95 | 0.95 | 0.95 | 0.95 | 0.95 |   |      |
| Percent Heavy Veh, %         | 2    | 2    | 3    | 3    | 5    | 5    |   |      |
| Cap, veh/h                   | 1798 | 154  | 348  | 2446 | 344  | 615  |   |      |
| Arrive On Green              | 0.54 | 0.54 | 0.10 | 0.70 | 0.20 | 0.20 |   |      |
| Sat Flow, veh/h              | 3393 | 283  | 3408 | 3597 | 1723 | 3076 |   |      |
| Grp Volume(v), veh/h         | 889  | 930  | 274  | 968  | 263  | 547  |   |      |
| Grp Sat Flow(s),veh/h/ln     | 1770 | 1813 | 1704 | 1752 | 1723 | 1538 |   |      |
| Q Serve(g_s), s              | 40.5 | 42.2 | 6.9  | 10.1 | 12.7 | 15.2 |   |      |
| Cycle Q Clear(g_c), s        | 40.5 | 42.2 | 6.9  | 10.1 | 12.7 | 15.2 |   |      |
| Prop In Lane                 |      | 0.16 | 1.00 |      | 1.00 | 1.00 |   |      |
| Lane Grp Cap(c), veh/h       | 964  | 988  | 348  | 2446 | 344  | 615  |   |      |
| V/C Ratio(X)                 | 0.92 | 0.94 | 0.79 | 0.40 | 0.76 | 0.89 |   |      |
| Avail Cap(c_a), veh/h        | 980  | 1004 | 376  | 2506 | 355  | 633  |   |      |
| HCM Platoon Ratio            | 1.00 | 1.00 | 1.00 | 1.00 | 1.00 | 1.00 |   |      |
| Upstream Filter(I)           | 1.00 | 1.00 | 1.00 | 1.00 | 1.00 | 1.00 |   |      |
| Uniform Delay (d), s/veh     | 18.3 | 18.7 | 38.6 | 5.5  | 33.2 | 34.3 |   |      |
| Incr Delay (d2), s/veh       | 13.6 | 16.1 | 10.0 | 0.1  | 9.3  | 14.5 |   |      |
| Initial Q Delay(d3),s/veh    | 0.0  | 0.0  | 0.0  | 0.0  | 0.0  | 0.0  |   |      |
| %ile BackOfQ(50%),veh/ln     | 23.2 | 25.3 | 3.7  | 4.9  | 6.9  | 7.7  |   |      |
| LnGrp Delay(d),s/veh         | 32.0 | 34.8 | 48.6 | 5.6  | 42.5 | 48.7 |   |      |
| LnGrp LOS                    | C    | C    | D    | A    | D    | D    |   |      |
| Approach Vol, veh/h          | 1819 |      |      | 1242 | 810  |      |   |      |
| Approach Delay, s/veh        | 33.4 |      |      | 15.1 | 46.7 |      |   |      |
| Approach LOS                 | C    |      |      | B    | D    |      |   |      |
| Timer                        | 1    | 2    | 3    | 4    | 5    | 6    | 7 | 8    |
| Assigned Phs                 | 1    | 2    |      |      |      | 6    |   | 8    |
| Phs Duration (G+Y+Rc), s     | 3.5  | 52.4 |      |      |      | 65.9 |   | 22.1 |
| Change Period (Y+Rc), s      | 4.5  | 4.5  |      |      |      | 4.5  |   | 4.5  |
| Max Green Setting (Gmax), s  | 48.7 |      |      |      |      | 62.9 |   | 18.1 |
| Max Q Clear Time (g_c+10), s | 44.2 |      |      |      |      | 12.1 |   | 17.2 |
| Green Ext Time (p_c), s      | 0.1  | 3.8  |      |      |      | 7.7  |   | 0.3  |
| <b>Intersection Summary</b>  |      |      |      |      |      |      |   |      |
| HCM 2010 Ctrl Delay          |      |      | 30.3 |      |      |      |   |      |
| HCM 2010 LOS                 |      |      | C    |      |      |      |   |      |
| <b>Notes</b>                 |      |      |      |      |      |      |   |      |

HCM 2010 Roundabout  
10: Imjin Road & Imjin Parkway

| Intersection                |       |       |       |       |       |       |
|-----------------------------|-------|-------|-------|-------|-------|-------|
| Intersection Delay, s/veh   | 85.2  |       |       |       |       |       |
| Intersection LOS            | F     |       |       |       |       |       |
| Approach                    | EB    |       | WB    |       | NB    |       |
| Entry Lanes                 | 2     |       | 2     |       | 2     |       |
| Conflicting Circle Lanes    | 2     |       | 2     |       | 2     |       |
| Adj Approach Flow, veh/h    | 1832  |       | 1242  |       | 810   |       |
| Demand Flow Rate, veh/h     | 1868  |       | 1279  |       | 850   |       |
| Vehicles Circulating, veh/h | 282   |       | 276   |       | 1707  |       |
| Vehicles Exiting, veh/h     | 1273  |       | 2281  |       | 443   |       |
| Follow-Up Headway, s        | 3.186 |       | 3.186 |       | 3.186 |       |
| Ped Vol Crossing Leg, #/h   | 0     |       | 0     |       | 0     |       |
| Ped Cap Adj                 | 1.000 |       | 1.000 |       | 1.000 |       |
| Approach Delay, s/veh       | 57.2  |       | 16.1  |       | 254.5 |       |
| Approach LOS                | F     |       | C     |       | F     |       |
| Lane                        | Left  | Right | Left  | Right | Left  | Right |
| Designated Moves            | LT    | TR    | LT    | TR    | L     | TR    |
| Assumed Moves               | LT    | TR    | LT    | TR    | L     | TR    |
| RT Channelized              |       |       |       |       |       |       |
| Lane Util                   | 0.470 | 0.530 | 0.470 | 0.530 | 0.325 | 0.675 |
| Critical Headway, s         | 4.293 | 4.113 | 4.293 | 4.113 | 4.293 | 4.113 |
| Entry Flow, veh/h           | 878   | 990   | 601   | 678   | 276   | 574   |
| Cap Entry Lane, veh/h       | 915   | 928   | 919   | 931   | 314   | 342   |
| Entry HV Adj Factor         | 0.980 | 0.981 | 0.971 | 0.971 | 0.953 | 0.953 |
| Flow Entry, veh/h           | 861   | 971   | 584   | 658   | 263   | 547   |
| Cap Entry, veh/h            | 897   | 909   | 892   | 904   | 299   | 326   |
| V/C Ratio                   | 0.960 | 1.067 | 0.654 | 0.728 | 0.879 | 1.678 |
| Control Delay, s/veh        | 42.4  | 70.3  | 14.6  | 17.5  | 63.3  | 346.4 |
| LOS                         | E     | F     | B     | C     | F     | F     |
| 95th %tile Queue, veh       | 16    | 23    | 5     | 7     | 8     | 34    |

HCM 2010 Roundabout  
11: Abrams Drive & Imjin Parkway

| Intersection                |       |       |       |       |       |        |       |        |  |
|-----------------------------|-------|-------|-------|-------|-------|--------|-------|--------|--|
| Intersection Delay, s/veh   | 71.2  |       |       |       |       |        |       |        |  |
| Intersection LOS            | F     |       |       |       |       |        |       |        |  |
| Approach                    | EB    |       | WB    |       | NB    |        | SB    |        |  |
| Entry Lanes                 | 2     |       | 2     |       | 1     |        | 1     |        |  |
| Conflicting Circle Lanes    | 2     |       | 2     |       | 2     |        | 2     |        |  |
| Adj Approach Flow, veh/h    | 2162  |       | 1345  |       | 430   |        | 227   |        |  |
| Demand Flow Rate, veh/h     | 2184  |       | 1372  |       | 443   |        | 231   |        |  |
| Vehicles Circulating, veh/h | 286   |       | 374   |       | 1978  |        | 1440  |        |  |
| Vehicles Exiting, veh/h     | 1242  |       | 1837  |       | 492   |        | 306   |        |  |
| Follow-Up Headway, s        | 3.186 |       | 3.186 |       | 3.186 |        | 3.186 |        |  |
| Ped Vol Crossing Leg, #/h   | 0     |       | 1     |       | 0     |        | 1     |        |  |
| Ped Cap Adj                 | 1.000 |       | 0.999 |       | 1.000 |        | 1.000 |        |  |
| Approach Delay, s/veh       | 116.2 |       | 23.2  |       | 30.3  |        | 4.7   |        |  |
| Approach LOS                | F     |       | C     |       | D     |        | A     |        |  |
| Lane                        | Left  | Right | Left  | Right | Left  | Bypass | Left  | Bypass |  |
| Designated Moves            | LT    | TR    | LT    | TR    | LT    | R      | LT    | R      |  |
| Assumed Moves               | LT    | TR    | LT    | TR    | LT    | R      | LT    | R      |  |
| RT Channelized              |       |       |       |       |       | Free   |       | Free   |  |
| Lane Util                   | 0.470 | 0.530 | 0.470 | 0.530 | 1.000 |        | 1.000 |        |  |
| Critical Headway, s         | 4.293 | 4.113 | 4.293 | 4.113 | 4.113 |        | 4.113 |        |  |
| Entry Flow, veh/h           | 1026  | 1158  | 645   | 727   | 233   | 210    | 88    | 143    |  |
| Cap Entry Lane, veh/h       | 912   | 925   | 854   | 870   | 283   | 1957   | 412   | 1938   |  |
| Entry HV Adj Factor         | 0.991 | 0.990 | 0.980 | 0.980 | 0.970 | 0.971  | 0.984 | 0.980  |  |
| Flow Entry, veh/h           | 1016  | 1146  | 632   | 713   | 226   | 204    | 87    | 140    |  |
| Cap Entry, veh/h            | 903   | 915   | 836   | 852   | 275   | 1900   | 406   | 1900   |  |
| V/C Ratio                   | 1.125 | 1.252 | 0.756 | 0.837 | 0.823 | 0.107  | 0.213 | 0.074  |  |
| Control Delay, s/veh        | 90.2  | 139.3 | 20.1  | 25.9  | 57.7  | 0.0    | 12.3  | 0.0    |  |
| LOS                         | F     | F     | C     | D     | F     | A      | B     | A      |  |
| 95th %tile Queue, veh       | 28    | 40    | 7     | 10    | 7     | 0      | 1     | 0      |  |

HCM 2010 Signalized Intersection Summary  
 12: Reservation Road & Imjin Parkway

Cuml w/ Proj, PM  
 09/06/2019



| Movement                    | EBL  | EBT   | EBR  | WBL  | WBT  | WBR   | NBL   | NBT   | NBR  | SBL  | SBT  | SBR  |
|-----------------------------|------|-------|------|------|------|-------|-------|-------|------|------|------|------|
| Lane Configurations         |      |       |      |      |      |       |       |       |      |      |      |      |
| Traffic Volume (veh/h)      | 110  | 20    | 1730 | 10   | 40   | 30    | 1000  | 630   | 10   | 20   | 950  | 200  |
| Future Volume (veh/h)       | 110  | 20    | 1730 | 10   | 40   | 30    | 1000  | 630   | 10   | 20   | 950  | 200  |
| Number                      | 3    | 8     | 18   | 7    | 4    | 14    | 1     | 6     | 16   | 5    | 2    | 12   |
| Initial Q (Qb), veh         | 0    | 0     | 0    | 0    | 0    | 0     | 0     | 0     | 0    | 0    | 0    | 0    |
| Ped-Bike Adj(A_pbT)         | 1.00 |       | 1.00 | 1.00 |      | 0.99  | 1.00  |       | 1.00 | 1.00 |      | 0.98 |
| Parking Bus, Adj            | 1.00 | 1.00  | 1.00 | 1.00 | 1.00 | 1.00  | 1.00  | 1.00  | 1.00 | 1.00 | 1.00 | 1.00 |
| Adj Sat Flow, veh/h/ln      | 1863 | 1863  | 1863 | 1638 | 1638 | 1638  | 1863  | 1863  | 1863 | 1863 | 1863 | 1863 |
| Adj Flow Rate, veh/h        | 124  | 22    | 1511 | 11   | 45   | 21    | 1124  | 708   | 4    | 22   | 1067 | 159  |
| Adj No. of Lanes            | 2    | 1     | 2    | 1    | 1    | 1     | 2     | 2     | 1    | 2    | 3    | 1    |
| Peak Hour Factor            | 0.89 | 0.89  | 0.89 | 0.89 | 0.89 | 0.89  | 0.89  | 0.89  | 0.89 | 0.89 | 0.89 | 0.89 |
| Percent Heavy Veh, %        | 2    | 2     | 2    | 16   | 16   | 16    | 2     | 2     | 2    | 2    | 2    | 2    |
| Cap, veh/h                  | 842  | 456   | 1362 | 68   | 72   | 61    | 842   | 1946  | 869  | 56   | 1636 | 501  |
| Arrive On Green             | 0.24 | 0.24  | 0.24 | 0.04 | 0.04 | 0.04  | 0.24  | 0.55  | 0.55 | 0.02 | 0.32 | 0.32 |
| Sat Flow, veh/h             | 3442 | 1863  | 2781 | 1560 | 1638 | 1383  | 3442  | 3539  | 1581 | 3442 | 5085 | 1559 |
| Grp Volume(v), veh/h        | 124  | 22    | 1511 | 11   | 45   | 21    | 1124  | 708   | 4    | 22   | 1067 | 159  |
| Grp Sat Flow(s),veh/h/ln    | 1721 | 1863  | 1390 | 1560 | 1638 | 1383  | 1721  | 1770  | 1581 | 1721 | 1695 | 1559 |
| Q Serve(g_s), s             | 4.0  | 1.3   | 35.0 | 1.0  | 3.9  | 2.1   | 35.0  | 16.1  | 0.2  | 0.9  | 25.8 | 11.0 |
| Cycle Q Clear(g_c), s       | 4.0  | 1.3   | 35.0 | 1.0  | 3.9  | 2.1   | 35.0  | 16.1  | 0.2  | 0.9  | 25.8 | 11.0 |
| Prop In Lane                | 1.00 |       | 1.00 | 1.00 |      | 1.00  | 1.00  |       | 1.00 | 1.00 |      | 1.00 |
| Lane Grp Cap(c), veh/h      | 842  | 456   | 1362 | 68   | 72   | 61    | 842   | 1946  | 869  | 56   | 1636 | 501  |
| V/C Ratio(X)                | 0.15 | 0.05  | 1.11 | 0.16 | 0.63 | 0.35  | 1.34  | 0.36  | 0.00 | 0.39 | 0.65 | 0.32 |
| Avail Cap(c_a), veh/h       | 842  | 456   | 1362 | 338  | 355  | 300   | 842   | 1946  | 869  | 481  | 2132 | 654  |
| HCM Platoon Ratio           | 1.00 | 1.00  | 1.00 | 1.00 | 1.00 | 1.00  | 1.00  | 1.00  | 1.00 | 1.00 | 1.00 | 1.00 |
| Upstream Filter(I)          | 1.00 | 1.00  | 1.00 | 1.00 | 1.00 | 1.00  | 1.00  | 1.00  | 1.00 | 1.00 | 1.00 | 1.00 |
| Uniform Delay (d), s/veh    | 42.4 | 41.3  | 36.6 | 65.9 | 67.3 | 66.4  | 54.0  | 18.1  | 14.5 | 69.7 | 41.7 | 36.7 |
| Incr Delay (d2), s/veh      | 0.0  | 0.0   | 60.2 | 0.4  | 3.3  | 1.3   | 158.9 | 0.3   | 0.0  | 1.6  | 1.2  | 1.0  |
| Initial Q Delay(d3),s/veh   | 0.0  | 0.0   | 0.0  | 0.0  | 0.0  | 0.0   | 0.0   | 0.0   | 0.0  | 0.0  | 0.0  | 0.0  |
| %ile BackOfQ(50%),veh/ln    | 1.9  | 0.7   | 38.3 | 0.4  | 1.8  | 0.8   | 35.2  | 8.0   | 0.1  | 0.4  | 12.2 | 4.9  |
| LnGrp Delay(d),s/veh        | 42.4 | 41.3  | 96.8 | 66.3 | 70.6 | 67.7  | 213.0 | 18.4  | 14.5 | 71.3 | 42.9 | 37.7 |
| LnGrp LOS                   | D    | D     | F    | E    | E    | E     | F     | B     | B    | E    | D    | D    |
| Approach Vol, veh/h         |      | 1657  |      |      | 77   |       |       | 1836  |      |      | 1248 |      |
| Approach Delay, s/veh       |      | 92.0  |      |      | 69.2 |       |       | 137.5 |      |      | 42.7 |      |
| Approach LOS                |      | F     |      |      | E    |       |       | F     |      |      | D    |      |
| Timer                       | 1    | 2     | 3    | 4    | 5    | 6     | 7     | 8     |      |      |      |      |
| Assigned Phs                | 1    | 2     |      | 4    | 5    | 6     |       | 8     |      |      |      |      |
| Phs Duration (G+Y+Rc), s    | 39.1 | 52.2  |      | 11.3 | 6.4  | 84.9  |       | 40.5  |      |      |      |      |
| Change Period (Y+Rc), s     | 4.1  | * 6.2 |      | 5.0  | 4.1  | * 6.2 |       | 5.5   |      |      |      |      |
| Max Green Setting (Gmax), s | 35.0 | * 60  |      | 31.0 | 20.0 | * 50  |       | 35.0  |      |      |      |      |
| Max Q Clear Time (g_c+R), s | 17.0 | 27.8  |      | 5.9  | 2.9  | 18.1  |       | 37.0  |      |      |      |      |
| Green Ext Time (p_c), s     | 0.0  | 18.2  |      | 0.2  | 0.0  | 10.5  |       | 0.0   |      |      |      |      |
| <b>Intersection Summary</b> |      |       |      |      |      |       |       |       |      |      |      |      |
| HCM 2010 Ctrl Delay         |      |       | 96.2 |      |      |       |       |       |      |      |      |      |
| HCM 2010 LOS                |      |       | F    |      |      |       |       |       |      |      |      |      |
| <b>Notes</b>                |      |       |      |      |      |       |       |       |      |      |      |      |

HCM 2010 Signalized Intersection Summary  
 14: Reservation Road & Inter-Garrison Road

Cuml w/ Proj, PM  
 09/06/2019



| Movement                    | EBL  | EBR  | NBL  | NBT  | SBT  | SBR  |   |      |
|-----------------------------|------|------|------|------|------|------|---|------|
| Lane Configurations         |      |      |      |      |      |      |   |      |
| Traffic Volume (veh/h)      | 110  | 430  | 290  | 450  | 1350 | 270  |   |      |
| Future Volume (veh/h)       | 110  | 430  | 290  | 450  | 1350 | 270  |   |      |
| Number                      | 3    | 18   | 1    | 6    | 2    | 12   |   |      |
| Initial Q (Qb), veh         | 0    | 0    | 0    | 0    | 0    | 0    |   |      |
| Ped-Bike Adj(A_pbT)         | 1.00 | 1.00 | 1.00 |      |      | 1.00 |   |      |
| Parking Bus, Adj            | 1.00 | 1.00 | 1.00 | 1.00 | 1.00 | 1.00 |   |      |
| Adj Sat Flow, veh/h/ln      | 1845 | 1845 | 1863 | 1863 | 1845 | 1900 |   |      |
| Adj Flow Rate, veh/h        | 134  | 479  | 354  | 549  | 1646 | 311  |   |      |
| Adj No. of Lanes            | 1    | 2    | 2    | 2    | 2    | 0    |   |      |
| Peak Hour Factor            | 0.82 | 0.82 | 0.82 | 0.82 | 0.82 | 0.82 |   |      |
| Percent Heavy Veh, %        | 3    | 3    | 2    | 2    | 3    | 3    |   |      |
| Cap, veh/h                  | 318  | 838  | 422  | 2543 | 1636 | 300  |   |      |
| Arrive On Green             | 0.18 | 0.18 | 0.12 | 0.72 | 0.55 | 0.55 |   |      |
| Sat Flow, veh/h             | 1757 | 2760 | 3442 | 3632 | 3052 | 542  |   |      |
| Grp Volume(v), veh/h        | 134  | 479  | 354  | 549  | 953  | 1004 |   |      |
| Grp Sat Flow(s),veh/h/ln    | 1757 | 1380 | 1721 | 1770 | 1752 | 1749 |   |      |
| Q Serve(g_s), s             | 7.3  | 15.9 | 10.9 | 5.6  | 57.9 | 60.0 |   |      |
| Cycle Q Clear(g_c), s       | 7.3  | 15.9 | 10.9 | 5.6  | 57.9 | 60.0 |   |      |
| Prop In Lane                | 1.00 | 1.00 | 1.00 |      |      | 0.31 |   |      |
| Lane Grp Cap(c), veh/h      | 318  | 838  | 422  | 2543 | 969  | 967  |   |      |
| V/C Ratio(X)                | 0.42 | 0.57 | 0.84 | 0.22 | 0.98 | 1.04 |   |      |
| Avail Cap(c_a), veh/h       | 437  | 1025 | 634  | 2543 | 969  | 967  |   |      |
| HCM Platoon Ratio           | 1.00 | 1.00 | 1.00 | 1.00 | 1.00 | 1.00 |   |      |
| Upstream Filter(I)          | 1.00 | 1.00 | 1.00 | 1.00 | 1.00 | 1.00 |   |      |
| Uniform Delay (d), s/veh    | 39.4 | 31.9 | 46.6 | 5.1  | 23.8 | 24.3 |   |      |
| Incr Delay (d2), s/veh      | 0.9  | 0.6  | 3.9  | 0.1  | 25.1 | 39.3 |   |      |
| Initial Q Delay(d3),s/veh   | 0.0  | 0.0  | 0.0  | 0.0  | 0.0  | 0.0  |   |      |
| %ile BackOfQ(50%),veh/ln    | 3.7  | 6.1  | 5.4  | 2.8  | 34.6 | 39.3 |   |      |
| LnGrp Delay(d),s/veh        | 40.3 | 32.5 | 50.5 | 5.2  | 48.9 | 63.6 |   |      |
| LnGrp LOS                   | D    | C    | D    | A    | D    | F    |   |      |
| Approach Vol, veh/h         | 613  |      |      | 903  | 1957 |      |   |      |
| Approach Delay, s/veh       | 34.2 |      |      | 22.9 | 56.4 |      |   |      |
| Approach LOS                | C    |      |      | C    | E    |      |   |      |
| Timer                       | 1    | 2    | 3    | 4    | 5    | 6    | 7 | 8    |
| Assigned Phs                | 1    | 2    |      |      |      | 6    |   | 8    |
| Phs Duration (G+Y+Rc), s    | 18.0 | 66.4 |      |      |      | 84.4 |   | 24.1 |
| Change Period (Y+Rc), s     | 4.7  | 6.4  |      |      |      | 6.4  |   | 4.5  |
| Max Green Setting (Gmax), s | 26   | 60.0 |      |      |      | 60.0 |   | 27.0 |
| Max Q Clear Time (g_c+I), s | 11.2 | 62.0 |      |      |      | 7.6  |   | 17.9 |
| Green Ext Time (p_c), s     | 0.4  | 0.0  |      |      |      | 6.7  |   | 1.8  |
| <b>Intersection Summary</b> |      |      |      |      |      |      |   |      |
| HCM 2010 Ctrl Delay         |      |      | 43.8 |      |      |      |   |      |
| HCM 2010 LOS                |      |      | D    |      |      |      |   |      |
| <b>Notes</b>                |      |      |      |      |      |      |   |      |



HCM 2010 Signalized Intersection Summary  
 22: 8th Avenue & Inter-Garrison Road

Cuml w/ Proj, PM  
 09/06/2019



| Movement                     | EBT   | EBR   | WBL  | WBT  | NBL   | NBR  |   |      |
|------------------------------|-------|-------|------|------|-------|------|---|------|
| Lane Configurations          | ↑     |       | ↙↘   | ↑    | ↙↘    |      |   |      |
| Traffic Volume (veh/h)       | 640   | 140   | 430  | 410  | 50    | 750  |   |      |
| Future Volume (veh/h)        | 640   | 140   | 430  | 410  | 50    | 750  |   |      |
| Number                       | 4     | 14    | 3    | 8    | 5     | 12   |   |      |
| Initial Q (Qb), veh          | 0     | 0     | 0    | 0    | 0     | 0    |   |      |
| Ped-Bike Adj(A_pbT)          |       | 1.00  | 1.00 |      | 1.00  | 1.00 |   |      |
| Parking Bus, Adj             | 1.00  | 1.00  | 1.00 | 1.00 | 1.00  | 1.00 |   |      |
| Adj Sat Flow, veh/h/ln       | 1520  | 1900  | 1881 | 1881 | 1845  | 1900 |   |      |
| Adj Flow Rate, veh/h         | 660   | 131   | 443  | 423  | 52    | 492  |   |      |
| Adj No. of Lanes             | 1     | 0     | 2    | 1    | 0     | 0    |   |      |
| Peak Hour Factor             | 0.97  | 0.97  | 0.97 | 0.97 | 0.97  | 0.97 |   |      |
| Percent Heavy Veh, %         | 25    | 25    | 1    | 1    | 0     | 0    |   |      |
| Cap, veh/h                   | 545   | 108   | 481  | 1158 | 48    | 451  |   |      |
| Arrive On Green              | 0.44  | 0.44  | 0.14 | 0.62 | 0.32  | 0.32 |   |      |
| Sat Flow, veh/h              | 1232  | 245   | 3476 | 1881 | 151   | 1431 |   |      |
| Grp Volume(v), veh/h         | 0     | 791   | 443  | 423  | 545   | 0    |   |      |
| Grp Sat Flow(s),veh/h/ln     | 0     | 1477  | 1738 | 1881 | 1585  | 0    |   |      |
| Q Serve(g_s), s              | 0.0   | 57.5  | 16.4 | 14.5 | 41.0  | 0.0  |   |      |
| Cycle Q Clear(g_c), s        | 0.0   | 57.5  | 16.4 | 14.5 | 41.0  | 0.0  |   |      |
| Prop In Lane                 |       | 0.17  | 1.00 |      | 0.10  | 0.90 |   |      |
| Lane Grp Cap(c), veh/h       | 0     | 653   | 481  | 1158 | 500   | 0    |   |      |
| V/C Ratio(X)                 | 0.00  | 1.21  | 0.92 | 0.37 | 1.09  | 0.00 |   |      |
| Avail Cap(c_a), veh/h        | 0     | 653   | 481  | 1158 | 500   | 0    |   |      |
| HCM Platoon Ratio            | 1.00  | 1.00  | 1.00 | 1.00 | 1.00  | 1.00 |   |      |
| Upstream Filter(I)           | 0.00  | 1.00  | 1.00 | 1.00 | 1.00  | 0.00 |   |      |
| Uniform Delay (d), s/veh     | 0.0   | 36.3  | 55.3 | 12.4 | 44.5  | 0.0  |   |      |
| Incr Delay (d2), s/veh       | 0.0   | 108.7 | 23.1 | 0.2  | 67.1  | 0.0  |   |      |
| Initial Q Delay(d3),s/veh    | 0.0   | 0.0   | 0.0  | 0.0  | 0.0   | 0.0  |   |      |
| %ile BackOfQ(50%),veh/ln     | 0.0   | 43.1  | 9.4  | 7.6  | 27.2  | 0.0  |   |      |
| LnGrp Delay(d),s/veh         | 0.0   | 145.0 | 78.3 | 12.6 | 111.6 | 0.0  |   |      |
| LnGrp LOS                    |       | F     | E    | B    | F     |      |   |      |
| Approach Vol, veh/h          | 791   |       |      | 866  | 545   |      |   |      |
| Approach Delay, s/veh        | 145.0 |       |      | 46.2 | 111.6 |      |   |      |
| Approach LOS                 | F     |       |      | D    | F     |      |   |      |
| Timer                        | 1     | 2     | 3    | 4    | 5     | 6    | 7 | 8    |
| Assigned Phs                 |       | 2     | 3    | 4    |       |      |   | 8    |
| Phs Duration (G+Y+Rc), s     |       | 45.5  | 22.5 | 62.0 |       |      |   | 84.5 |
| Change Period (Y+Rc), s      |       | 4.5   | 4.5  | 4.5  |       |      |   | 4.5  |
| Max Green Setting (Gmax), s  |       | 41.0  | 18.0 | 57.5 |       |      |   | 80.0 |
| Max Q Clear Time (g_c+I1), s |       | 43.0  | 18.4 | 59.5 |       |      |   | 16.5 |
| Green Ext Time (p_c), s      |       | 0.0   | 0.0  | 0.0  |       |      |   | 2.8  |
| <b>Intersection Summary</b>  |       |       |      |      |       |      |   |      |
| HCM 2010 Ctrl Delay          |       |       | 97.9 |      |       |      |   |      |
| HCM 2010 LOS                 |       |       | F    |      |       |      |   |      |
| <b>Notes</b>                 |       |       |      |      |       |      |   |      |

| Intersection                |       |       |       |       |
|-----------------------------|-------|-------|-------|-------|
| Intersection Delay, s/veh   | 106.2 |       |       |       |
| Intersection LOS            | F     |       |       |       |
| Approach                    | EB    | WB    |       | NB    |
| Entry Lanes                 | 1     | 2     |       | 1     |
| Conflicting Circle Lanes    | 2     | 2     |       | 2     |
| Adj Approach Flow, veh/h    | 804   | 866   |       | 825   |
| Demand Flow Rate, veh/h     | 1005  | 874   |       | 850   |
| Vehicles Circulating, veh/h | 447   | 54    |       | 825   |
| Vehicles Exiting, veh/h     | 481   | 1621  |       | 627   |
| Follow-Up Headway, s        | 3.186 | 3.186 |       | 3.186 |
| Ped Vol Crossing Leg, #/h   | 0     | 0     |       | 0     |
| Ped Cap Adj                 | 1.000 | 1.000 |       | 1.000 |
| Approach Delay, s/veh       | 132.2 | 7.6   |       | 184.3 |
| Approach LOS                | F     | A     |       | F     |
| Lane                        | Left  | Left  | Right | Left  |
| Designated Moves            | TR    | L     | LTR   | LR    |
| Assumed Moves               | TR    | L     | LTR   | LR    |
| RT Channelized              |       |       |       |       |
| Lane Util                   | 1.000 | 0.530 | 0.470 | 1.000 |
| Critical Headway, s         | 4.113 | 4.293 | 4.113 | 4.113 |
| Entry Flow, veh/h           | 1005  | 463   | 411   | 850   |
| Cap Entry Lane, veh/h       | 826   | 1085  | 1088  | 634   |
| Entry HV Adj Factor         | 0.800 | 0.991 | 0.990 | 0.971 |
| Flow Entry, veh/h           | 804   | 459   | 407   | 825   |
| Cap Entry, veh/h            | 661   | 1075  | 1077  | 616   |
| V/C Ratio                   | 1.216 | 0.427 | 0.378 | 1.340 |
| Control Delay, s/veh        | 132.2 | 7.9   | 7.2   | 184.3 |
| LOS                         | F     | A     | A     | F     |
| 95th %tile Queue, veh       | 28    | 2     | 2     | 35    |

HCM 2010 Signalized Intersection Summary  
 23: Inter-Garrison Road & Abrams Drive

Cuml w/ Proj, PM  
 09/06/2019



| Movement                     | EBL  | EBT  | WBT  | WBR  | SBL  | SBR  |   |   |
|------------------------------|------|------|------|------|------|------|---|---|
| Lane Configurations          |      |      |      |      |      |      |   |   |
| Traffic Volume (veh/h)       | 630  | 760  | 420  | 30   | 20   | 420  |   |   |
| Future Volume (veh/h)        | 630  | 760  | 420  | 30   | 20   | 420  |   |   |
| Number                       | 5    | 2    | 6    | 16   | 7    | 14   |   |   |
| Initial Q (Qb), veh          | 0    | 0    | 0    | 0    | 0    | 0    |   |   |
| Ped-Bike Adj(A_pbT)          | 1.00 |      |      | 1.00 | 1.00 | 1.00 |   |   |
| Parking Bus, Adj             | 1.00 | 1.00 | 1.00 | 1.00 | 1.00 | 1.00 |   |   |
| Adj Sat Flow, veh/h/ln       | 1759 | 1759 | 1881 | 1881 | 1881 | 1881 |   |   |
| Adj Flow Rate, veh/h         | 663  | 800  | 442  | 27   | 21   | 247  |   |   |
| Adj No. of Lanes             | 2    | 1    | 1    | 1    | 2    | 1    |   |   |
| Peak Hour Factor             | 0.95 | 0.95 | 0.95 | 0.95 | 0.95 | 0.95 |   |   |
| Percent Heavy Veh, %         | 8    | 8    | 1    | 1    | 1    | 1    |   |   |
| Cap, veh/h                   | 794  | 1068 | 524  | 446  | 656  | 302  |   |   |
| Arrive On Green              | 0.24 | 0.61 | 0.28 | 0.28 | 0.19 | 0.19 |   |   |
| Sat Flow, veh/h              | 3250 | 1759 | 1881 | 1599 | 3476 | 1599 |   |   |
| Grp Volume(v), veh/h         | 663  | 800  | 442  | 27   | 21   | 247  |   |   |
| Grp Sat Flow(s),veh/h/ln     | 1625 | 1759 | 1881 | 1599 | 1738 | 1599 |   |   |
| Q Serve(g_s), s              | 8.1  | 13.6 | 9.2  | 0.5  | 0.2  | 6.2  |   |   |
| Cycle Q Clear(g_c), s        | 8.1  | 13.6 | 9.2  | 0.5  | 0.2  | 6.2  |   |   |
| Prop In Lane                 | 1.00 |      |      | 1.00 | 1.00 | 1.00 |   |   |
| Lane Grp Cap(c), veh/h       | 794  | 1068 | 524  | 446  | 656  | 302  |   |   |
| V/C Ratio(X)                 | 0.84 | 0.75 | 0.84 | 0.06 | 0.03 | 0.82 |   |   |
| Avail Cap(c_a), veh/h        | 2148 | 2727 | 1514 | 1287 | 2255 | 1037 |   |   |
| HCM Platoon Ratio            | 1.00 | 1.00 | 1.00 | 1.00 | 1.00 | 1.00 |   |   |
| Upstream Filter(I)           | 1.00 | 1.00 | 1.00 | 1.00 | 1.00 | 1.00 |   |   |
| Uniform Delay (d), s/veh     | 14.9 | 5.9  | 14.1 | 11.0 | 13.8 | 16.2 |   |   |
| Incr Delay (d2), s/veh       | 0.9  | 0.4  | 1.4  | 0.0  | 0.0  | 2.1  |   |   |
| Initial Q Delay(d3),s/veh    | 0.0  | 0.0  | 0.0  | 0.0  | 0.0  | 0.0  |   |   |
| %ile BackOfQ(50%),veh/ln     | 3.7  | 6.6  | 5.0  | 0.2  | 0.1  | 5.3  |   |   |
| LnGrp Delay(d),s/veh         | 15.8 | 6.3  | 15.6 | 11.0 | 13.8 | 18.3 |   |   |
| LnGrp LOS                    | B    | A    | B    | B    | B    | B    |   |   |
| Approach Vol, veh/h          |      | 1463 | 469  |      | 268  |      |   |   |
| Approach Delay, s/veh        |      | 10.6 | 15.3 |      | 18.0 |      |   |   |
| Approach LOS                 |      | B    | B    |      | B    |      |   |   |
| Timer                        | 1    | 2    | 3    | 4    | 5    | 6    | 7 | 8 |
| Assigned Phs                 |      | 2    |      | 4    | 5    | 6    |   |   |
| Phs Duration (G+Y+Rc), s     |      | 30.3 |      | 11.4 | 13.7 | 16.6 |   |   |
| Change Period (Y+Rc), s      |      | 5.0  |      | 3.5  | 3.5  | 5.0  |   |   |
| Max Green Setting (Gmax), s  |      | 64.5 |      | 27.0 | 27.5 | 33.5 |   |   |
| Max Q Clear Time (g_c+I1), s |      | 15.6 |      | 8.2  | 10.1 | 11.2 |   |   |
| Green Ext Time (p_c), s      |      | 0.8  |      | 0.1  | 0.1  | 0.4  |   |   |
| <b>Intersection Summary</b>  |      |      |      |      |      |      |   |   |
| HCM 2010 Ctrl Delay          |      |      | 12.5 |      |      |      |   |   |
| HCM 2010 LOS                 |      |      | B    |      |      |      |   |   |

HCM 2010 Signalized Intersection Summary  
 28: Davis Road & Reservation Road

Cuml w/ Proj, PM  
 09/06/2019



| Movement                      | EBL   | EBT   | EBR  | WBL  | WBT   | WBR  | NBL  | NBT  | NBR  | SBL  | SBT  | SBR  |
|-------------------------------|-------|-------|------|------|-------|------|------|------|------|------|------|------|
| Lane Configurations           |       |       |      |      |       |      |      |      |      |      |      |      |
| Traffic Volume (veh/h)        | 1260  | 500   | 10   | 10   | 360   | 100  | 10   | 10   | 10   | 120  | 10   | 540  |
| Future Volume (veh/h)         | 1260  | 500   | 10   | 10   | 360   | 100  | 10   | 10   | 10   | 120  | 10   | 540  |
| Number                        | 5     | 2     | 12   | 1    | 6     | 16   | 3    | 8    | 18   | 7    | 4    | 14   |
| Initial Q (Qb), veh           | 0     | 0     | 0    | 0    | 0     | 0    | 0    | 0    | 0    | 0    | 0    | 0    |
| Ped-Bike Adj(A_pbT)           | 1.00  |       | 1.00 | 1.00 |       | 1.00 | 1.00 |      | 1.00 | 1.00 |      | 1.00 |
| Parking Bus, Adj              | 1.00  | 1.00  | 1.00 | 1.00 | 1.00  | 1.00 | 1.00 | 1.00 | 1.00 | 1.00 | 1.00 | 1.00 |
| Adj Sat Flow, veh/h/ln        | 1863  | 1863  | 1900 | 1863 | 1863  | 1900 | 1900 | 1900 | 1900 | 1900 | 1845 | 1845 |
| Adj Flow Rate, veh/h          | 1340  | 532   | 11   | 11   | 383   | 106  | 11   | 11   | 8    | 128  | 11   | 353  |
| Adj No. of Lanes              | 2     | 2     | 0    | 1    | 1     | 0    | 0    | 1    | 0    | 0    | 1    | 1    |
| Peak Hour Factor              | 0.94  | 0.94  | 0.94 | 0.94 | 0.94  | 0.94 | 0.94 | 0.94 | 0.94 | 0.94 | 0.94 | 0.94 |
| Percent Heavy Veh, %          | 2     | 2     | 2    | 2    | 2     | 2    | 0    | 0    | 0    | 3    | 3    | 3    |
| Cap, veh/h                    | 1023  | 2154  | 45   | 19   | 452   | 125  | 18   | 18   | 13   | 287  | 25   | 743  |
| Arrive On Green               | 0.30  | 0.61  | 0.61 | 0.01 | 0.32  | 0.32 | 0.03 | 0.03 | 0.03 | 0.18 | 0.18 | 0.18 |
| Sat Flow, veh/h               | 3442  | 3546  | 73   | 1774 | 1405  | 389  | 654  | 654  | 476  | 1624 | 140  | 1568 |
| Grp Volume(v), veh/h          | 1340  | 265   | 278  | 11   | 0     | 489  | 30   | 0    | 0    | 139  | 0    | 353  |
| Grp Sat Flow(s),veh/h/ln      | 1721  | 1770  | 1850 | 1774 | 0     | 1794 | 1783 | 0    | 0    | 1763 | 0    | 1568 |
| Q Serve(g_s), s               | 30.0  | 7.0   | 7.0  | 0.6  | 0.0   | 25.6 | 1.7  | 0.0  | 0.0  | 7.1  | 0.0  | 15.4 |
| Cycle Q Clear(g_c), s         | 30.0  | 7.0   | 7.0  | 0.6  | 0.0   | 25.6 | 1.7  | 0.0  | 0.0  | 7.1  | 0.0  | 15.4 |
| Prop In Lane                  | 1.00  |       | 0.04 | 1.00 |       | 0.22 | 0.37 |      | 0.27 | 0.92 |      | 1.00 |
| Lane Grp Cap(c), veh/h        | 1023  | 1075  | 1124 | 19   | 0     | 577  | 50   | 0    | 0    | 311  | 0    | 743  |
| V/C Ratio(X)                  | 1.31  | 0.25  | 0.25 | 0.59 | 0.00  | 0.85 | 0.60 | 0.00 | 0.00 | 0.45 | 0.00 | 0.48 |
| Avail Cap(c_a), veh/h         | 1023  | 1075  | 1124 | 528  | 0     | 1067 | 530  | 0    | 0    | 524  | 0    | 933  |
| HCM Platoon Ratio             | 1.00  | 1.00  | 1.00 | 1.00 | 1.00  | 1.00 | 1.00 | 1.00 | 1.00 | 1.00 | 1.00 | 1.00 |
| Upstream Filter(I)            | 1.00  | 1.00  | 1.00 | 1.00 | 0.00  | 1.00 | 1.00 | 0.00 | 0.00 | 1.00 | 0.00 | 1.00 |
| Uniform Delay (d), s/veh      | 35.4  | 9.1   | 9.1  | 49.7 | 0.0   | 31.9 | 48.5 | 0.0  | 0.0  | 37.1 | 0.0  | 18.0 |
| Incr Delay (d2), s/veh        | 146.3 | 0.2   | 0.2  | 10.5 | 0.0   | 5.5  | 4.1  | 0.0  | 0.0  | 0.4  | 0.0  | 0.2  |
| Initial Q Delay(d3),s/veh     | 0.0   | 0.0   | 0.0  | 0.0  | 0.0   | 0.0  | 0.0  | 0.0  | 0.0  | 0.0  | 0.0  | 0.0  |
| %ile BackOfQ(50%),veh/ln      | 35.0  | 3.4   | 3.6  | 0.4  | 0.0   | 13.5 | 0.9  | 0.0  | 0.0  | 3.5  | 0.0  | 6.7  |
| LnGrp Delay(d),s/veh          | 181.7 | 9.3   | 9.3  | 60.2 | 0.0   | 37.4 | 52.6 | 0.0  | 0.0  | 37.5 | 0.0  | 18.2 |
| LnGrp LOS                     | F     | A     | A    | E    |       | D    | D    |      |      | D    |      | B    |
| Approach Vol, veh/h           |       | 1883  |      |      | 500   |      |      | 30   |      |      | 492  |      |
| Approach Delay, s/veh         |       | 132.0 |      |      | 37.9  |      |      | 52.6 |      |      | 23.7 |      |
| Approach LOS                  |       | F     |      |      | D     |      |      | D    |      |      | C    |      |
| Timer                         | 1     | 2     | 3    | 4    | 5     | 6    | 7    | 8    |      |      |      |      |
| Assigned Phs                  | 1     | 2     |      | 4    | 5     | 6    |      | 8    |      |      |      |      |
| Phs Duration (G+Y+Rc), s      | 5.0   | 66.3  |      | 22.8 | 33.8  | 37.4 |      | 6.8  |      |      |      |      |
| Change Period (Y+Rc), s       | 3.9   | 5.0   |      | 5.0  | * 3.8 | 5.0  |      | 4.0  |      |      |      |      |
| Max Green Setting (Gmax), s   | 30    | 60.0  |      | 30.0 | * 30  | 60.0 |      | 30.0 |      |      |      |      |
| Max Q Clear Time (g_c+1/2), s | 12.6  | 9.0   |      | 17.4 | 32.0  | 27.6 |      | 3.7  |      |      |      |      |
| Green Ext Time (p_c), s       | 0.0   | 5.1   |      | 0.4  | 0.0   | 4.8  |      | 0.0  |      |      |      |      |
| <b>Intersection Summary</b>   |       |       |      |      |       |      |      |      |      |      |      |      |
| HCM 2010 Ctrl Delay           |       |       |      | 96.6 |       |      |      |      |      |      |      |      |
| HCM 2010 LOS                  |       |       |      | F    |       |      |      |      |      |      |      |      |
| <b>Notes</b>                  |       |       |      |      |       |      |      |      |      |      |      |      |

HCM 2010 Signalized Intersection Summary  
 33: General Jim Moore Boulevard & Lightfighter Drive

Cuml w/ Proj, PM  
 09/06/2019



| Movement                    | EBL  | EBT  | EBR  | WBL  | WBT  | WBR  | NBL  | NBT  | NBR  | SBL  | SBT  | SBR  |
|-----------------------------|------|------|------|------|------|------|------|------|------|------|------|------|
| Lane Configurations         | ↔↔   | ↑    | ↗    | ↔↔   | ↕↔   |      | ↔↔↔  | ↕↔   |      | ↗    | ↕↕   | ↗    |
| Traffic Volume (veh/h)      | 50   | 280  | 690  | 40   | 250  | 50   | 670  | 70   | 20   | 60   | 100  | 40   |
| Future Volume (veh/h)       | 50   | 280  | 690  | 40   | 250  | 50   | 670  | 70   | 20   | 60   | 100  | 40   |
| Number                      | 3    | 8    | 18   | 7    | 4    | 14   | 1    | 6    | 16   | 5    | 2    | 12   |
| Initial Q (Qb), veh         | 0    | 0    | 0    | 0    | 0    | 0    | 0    | 0    | 0    | 0    | 0    | 0    |
| Ped-Bike Adj(A_pbT)         | 1.00 |      | 1.00 | 1.00 |      | 1.00 | 1.00 |      | 1.00 | 1.00 |      | 0.99 |
| Parking Bus, Adj            | 1.00 | 1.00 | 1.00 | 1.00 | 1.00 | 1.00 | 1.00 | 1.00 | 1.00 | 1.00 | 1.00 | 1.00 |
| Adj Sat Flow, veh/h/ln      | 1863 | 1863 | 1863 | 1792 | 1792 | 1900 | 1881 | 1881 | 1900 | 1863 | 1863 | 1863 |
| Adj Flow Rate, veh/h        | 52   | 292  | 0    | 42   | 1000 | 50   | 698  | 73   | 20   | 62   | 104  | 42   |
| Adj No. of Lanes            | 2    | 1    | 1    | 2    | 2    | 0    | 3    | 2    | 0    | 1    | 2    | 1    |
| Peak Hour Factor            | 0.96 | 0.96 | 0.96 | 0.96 | 0.25 | 0.96 | 0.96 | 0.96 | 0.96 | 0.96 | 0.96 | 0.96 |
| Percent Heavy Veh, %        | 2    | 2    | 2    | 6    | 6    | 6    | 1    | 1    | 1    | 2    | 2    | 2    |
| Cap, veh/h                  | 173  | 634  | 539  | 144  | 1100 | 55   | 909  | 628  | 166  | 100  | 356  | 238  |
| Arrive On Green             | 0.05 | 0.34 | 0.00 | 0.04 | 0.33 | 0.33 | 0.18 | 0.22 | 0.22 | 0.06 | 0.10 | 0.10 |
| Sat Flow, veh/h             | 3442 | 1863 | 1583 | 3312 | 3301 | 165  | 5052 | 2797 | 738  | 1774 | 3539 | 1574 |
| Grp Volume(v), veh/h        | 52   | 292  | 0    | 42   | 516  | 534  | 698  | 46   | 47   | 62   | 104  | 42   |
| Grp Sat Flow(s),veh/h/ln    | 1721 | 1863 | 1583 | 1656 | 1703 | 1763 | 1684 | 1787 | 1749 | 1774 | 1770 | 1574 |
| Q Serve(g_s), s             | 0.8  | 6.6  | 0.0  | 0.7  | 15.5 | 15.5 | 7.0  | 1.1  | 1.2  | 1.8  | 1.5  | 1.2  |
| Cycle Q Clear(g_c), s       | 0.8  | 6.6  | 0.0  | 0.7  | 15.5 | 15.5 | 7.0  | 1.1  | 1.2  | 1.8  | 1.5  | 1.2  |
| Prop In Lane                | 1.00 |      | 1.00 | 1.00 |      | 0.09 | 1.00 |      | 0.42 | 1.00 |      | 1.00 |
| Lane Grp Cap(c), veh/h      | 173  | 634  | 539  | 144  | 567  | 587  | 909  | 401  | 392  | 100  | 356  | 238  |
| V/C Ratio(X)                | 0.30 | 0.46 | 0.00 | 0.29 | 0.91 | 0.91 | 0.77 | 0.11 | 0.12 | 0.62 | 0.29 | 0.18 |
| Avail Cap(c_a), veh/h       | 321  | 634  | 539  | 309  | 572  | 592  | 1028 | 737  | 721  | 228  | 1196 | 611  |
| HCM Platoon Ratio           | 1.00 | 1.00 | 1.00 | 1.00 | 1.00 | 1.00 | 1.00 | 1.00 | 1.00 | 1.00 | 1.00 | 1.00 |
| Upstream Filter(I)          | 1.00 | 1.00 | 0.00 | 1.00 | 1.00 | 1.00 | 1.00 | 1.00 | 1.00 | 1.00 | 1.00 | 1.00 |
| Uniform Delay (d), s/veh    | 24.5 | 13.8 | 0.0  | 24.8 | 17.1 | 17.1 | 20.9 | 16.5 | 16.6 | 24.7 | 22.3 | 19.8 |
| Incr Delay (d2), s/veh      | 1.0  | 0.5  | 0.0  | 1.1  | 18.5 | 18.0 | 3.2  | 0.1  | 0.1  | 6.2  | 0.5  | 0.4  |
| Initial Q Delay(d3),s/veh   | 0.0  | 0.0  | 0.0  | 0.0  | 0.0  | 0.0  | 0.0  | 0.0  | 0.0  | 0.0  | 0.0  | 0.0  |
| %ile BackOfQ(50%),veh/ln    | 0.4  | 3.4  | 0.0  | 0.3  | 10.1 | 10.4 | 3.5  | 0.5  | 0.6  | 1.1  | 0.7  | 0.6  |
| LnGrp Delay(d),s/veh        | 25.5 | 14.4 | 0.0  | 25.9 | 35.6 | 35.1 | 24.1 | 16.7 | 16.7 | 30.9 | 22.8 | 20.2 |
| LnGrp LOS                   | C    | B    |      | C    | D    | D    | C    | B    | B    | C    | C    | C    |
| Approach Vol, veh/h         |      | 344  |      |      | 1092 |      |      | 791  |      |      | 208  |      |
| Approach Delay, s/veh       |      | 16.0 |      |      | 35.0 |      |      | 23.2 |      |      | 24.7 |      |
| Approach LOS                |      | B    |      |      | C    |      |      | C    |      |      | C    |      |
| Timer                       | 1    | 2    | 3    | 4    | 5    | 6    | 7    | 8    |      |      |      |      |
| Assigned Phs                | 1    | 2    | 3    | 4    | 5    | 6    | 7    | 8    |      |      |      |      |
| Phs Duration (G+Y+Rc), s    | 4.1  | 9.9  | 7.2  | 22.4 | 7.5  | 16.5 | 6.8  | 22.7 |      |      |      |      |
| Change Period (Y+Rc), s     | 4.5  | 4.5  | 4.5  | 4.5  | 4.5  | 4.5  | 4.5  | 4.5  |      |      |      |      |
| Max Green Setting (Gmax), s | 10.9 | 18.1 | 5.0  | 18.0 | 6.9  | 22.1 | 5.0  | 18.0 |      |      |      |      |
| Max Q Clear Time (g_c+I), s | 19.0 | 3.5  | 2.8  | 17.5 | 3.8  | 3.2  | 2.7  | 8.6  |      |      |      |      |
| Green Ext Time (p_c), s     | 0.6  | 0.5  | 0.0  | 0.3  | 0.0  | 0.4  | 0.0  | 1.0  |      |      |      |      |
| <b>Intersection Summary</b> |      |      |      |      |      |      |      |      |      |      |      |      |
| HCM 2010 Ctrl Delay         |      |      | 27.6 |      |      |      |      |      |      |      |      |      |
| HCM 2010 LOS                |      |      | C    |      |      |      |      |      |      |      |      |      |

HCM 2010 Roundabout  
33: General Jim Moore Boulevard & Lightfighter Drive

Cumulative with Project (Roundabouts), PM

04/22/2022

| Intersection                |       |       |       |       |       |       |       |       |  |
|-----------------------------|-------|-------|-------|-------|-------|-------|-------|-------|--|
| Intersection Delay, s/veh   | 12.2  |       |       |       |       |       |       |       |  |
| Intersection LOS            | B     |       |       |       |       |       |       |       |  |
| Approach                    | EB    |       | WB    |       | NB    |       | SB    |       |  |
| Entry Lanes                 | 2     |       | 2     |       | 2     |       | 2     |       |  |
| Conflicting Circle Lanes    | 2     |       | 2     |       | 2     |       | 2     |       |  |
| Adj Approach Flow, veh/h    | 1146  |       | 382   |       | 854   |       | 224   |       |  |
| Demand Flow Rate, veh/h     | 1168  |       | 405   |       | 863   |       | 228   |       |  |
| Vehicles Circulating, veh/h | 230   |       | 898   |       | 446   |       | 1107  |       |  |
| Vehicles Exiting, veh/h     | 1105  |       | 411   |       | 952   |       | 196   |       |  |
| Follow-Up Headway, s        | 3.186 |       | 3.186 |       | 3.186 |       | 3.186 |       |  |
| Ped Vol Crossing Leg, #/h   | 2     |       | 1     |       | 2     |       | 0     |       |  |
| Ped Cap Adj                 | 0.998 |       | 1.000 |       | 0.999 |       | 1.000 |       |  |
| Approach Delay, s/veh       | 12.9  |       | 11.5  |       | 12.1  |       | 10.4  |       |  |
| Approach LOS                | B     |       | B     |       | B     |       | B     |       |  |
| Lane                        | Left  | Right | Left  | Right | Left  | Right | Left  | Right |  |
| Designated Moves            | LTR   | R     | LT    | TR    | L     | LTR   | LT    | TR    |  |
| Assumed Moves               | LTR   | R     | LT    | TR    | L     | LTR   | LT    | TR    |  |
| RT Channelized              |       |       |       |       |       |       |       |       |  |
| Lane Util                   | 0.470 | 0.530 | 0.469 | 0.531 | 0.530 | 0.470 | 0.469 | 0.531 |  |
| Critical Headway, s         | 4.293 | 4.113 | 4.293 | 4.113 | 4.293 | 4.113 | 4.293 | 4.113 |  |
| Entry Flow, veh/h           | 549   | 619   | 190   | 215   | 457   | 406   | 107   | 121   |  |
| Cap Entry Lane, veh/h       | 951   | 962   | 576   | 603   | 809   | 827   | 493   | 521   |  |
| Entry HV Adj Factor         | 0.981 | 0.981 | 0.945 | 0.942 | 0.991 | 0.989 | 0.983 | 0.980 |  |
| Flow Entry, veh/h           | 538   | 607   | 180   | 203   | 453   | 401   | 105   | 119   |  |
| Cap Entry, veh/h            | 931   | 942   | 545   | 568   | 800   | 817   | 484   | 510   |  |
| V/C Ratio                   | 0.578 | 0.645 | 0.330 | 0.357 | 0.566 | 0.492 | 0.217 | 0.232 |  |
| Control Delay, s/veh        | 11.9  | 13.7  | 11.5  | 11.6  | 13.0  | 11.1  | 10.6  | 10.3  |  |
| LOS                         | B     | B     | B     | B     | B     | B     | B     | B     |  |
| 95th %tile Queue, veh       | 4     | 5     | 1     | 2     | 4     | 3     | 1     | 1     |  |

HCM 2010 Signalized Intersection Summary  
 39: General Jim Moore Boulevard & Gigling Road

Cuml w/ Proj, PM  
 09/06/2019



| Movement                    | EBL  | EBT  | EBR  | WBL  | WBT  | WBR  | NBL  | NBT  | NBR  | SBL  | SBT  | SBR  |
|-----------------------------|------|------|------|------|------|------|------|------|------|------|------|------|
| Lane Configurations         |      |      |      |      |      |      |      |      |      |      |      |      |
| Traffic Volume (veh/h)      | 20   | 20   | 30   | 290  | 50   | 380  | 60   | 340  | 460  | 400  | 350  | 50   |
| Future Volume (veh/h)       | 20   | 20   | 30   | 290  | 50   | 380  | 60   | 340  | 460  | 400  | 350  | 50   |
| Number                      | 3    | 8    | 18   | 7    | 4    | 14   | 1    | 6    | 16   | 5    | 2    | 12   |
| Initial Q (Qb), veh         | 0    | 0    | 0    | 0    | 0    | 0    | 0    | 0    | 0    | 0    | 0    | 0    |
| Ped-Bike Adj(A_pbT)         | 1.00 |      | 1.00 | 1.00 |      | 1.00 | 1.00 |      | 1.00 | 1.00 |      | 1.00 |
| Parking Bus, Adj            | 1.00 | 1.00 | 1.00 | 1.00 | 1.00 | 1.00 | 1.00 | 1.00 | 1.00 | 1.00 | 1.00 | 1.00 |
| Adj Sat Flow, veh/h/ln      | 1810 | 1810 | 1900 | 1863 | 1863 | 1863 | 1881 | 1881 | 1881 | 1863 | 1863 | 1863 |
| Adj Flow Rate, veh/h        | 22   | 22   | 3    | 326  | 56   | 0    | 67   | 382  | 0    | 449  | 393  | 0    |
| Adj No. of Lanes            | 1    | 2    | 0    | 2    | 2    | 1    | 1    | 2    | 1    | 1    | 2    | 1    |
| Peak Hour Factor            | 0.89 | 0.89 | 0.89 | 0.89 | 0.89 | 0.89 | 0.89 | 0.89 | 0.89 | 0.89 | 0.89 | 0.89 |
| Percent Heavy Veh, %        | 5    | 5    | 5    | 2    | 2    | 2    | 1    | 1    | 1    | 2    | 2    | 2    |
| Cap, veh/h                  | 187  | 267  | 36   | 463  | 404  | 181  | 112  | 553  | 248  | 407  | 1138 | 509  |
| Arrive On Green             | 0.11 | 0.09 | 0.09 | 0.13 | 0.11 | 0.00 | 0.06 | 0.15 | 0.00 | 0.23 | 0.32 | 0.00 |
| Sat Flow, veh/h             | 1723 | 3049 | 407  | 3442 | 3539 | 1583 | 1792 | 3574 | 1599 | 1774 | 3539 | 1583 |
| Grp Volume(v), veh/h        | 22   | 12   | 13   | 326  | 56   | 0    | 67   | 382  | 0    | 449  | 393  | 0    |
| Grp Sat Flow(s),veh/h/ln    | 1723 | 1719 | 1736 | 1721 | 1770 | 1583 | 1792 | 1787 | 1599 | 1774 | 1770 | 1583 |
| Q Serve(g_s), s             | 0.5  | 0.3  | 0.3  | 4.1  | 0.7  | 0.0  | 1.7  | 4.6  | 0.0  | 10.5 | 3.9  | 0.0  |
| Cycle Q Clear(g_c), s       | 0.5  | 0.3  | 0.3  | 4.1  | 0.7  | 0.0  | 1.7  | 4.6  | 0.0  | 10.5 | 3.9  | 0.0  |
| Prop In Lane                | 1.00 |      | 0.23 | 1.00 |      | 1.00 | 1.00 |      | 1.00 | 1.00 |      | 1.00 |
| Lane Grp Cap(c), veh/h      | 187  | 151  | 152  | 463  | 404  | 181  | 112  | 553  | 248  | 407  | 1138 | 509  |
| V/C Ratio(X)                | 0.12 | 0.08 | 0.08 | 0.70 | 0.14 | 0.00 | 0.60 | 0.69 | 0.00 | 1.10 | 0.35 | 0.00 |
| Avail Cap(c_a), veh/h       | 772  | 1146 | 1157 | 1542 | 2359 | 1055 | 411  | 1992 | 891  | 407  | 1972 | 882  |
| HCM Platoon Ratio           | 1.00 | 1.00 | 1.00 | 1.00 | 1.00 | 1.00 | 1.00 | 1.00 | 1.00 | 1.00 | 1.00 | 1.00 |
| Upstream Filter(I)          | 1.00 | 1.00 | 1.00 | 1.00 | 1.00 | 0.00 | 1.00 | 1.00 | 0.00 | 1.00 | 1.00 | 0.00 |
| Uniform Delay (d), s/veh    | 18.4 | 19.2 | 19.2 | 18.9 | 18.2 | 0.0  | 20.9 | 18.3 | 0.0  | 17.6 | 11.8 | 0.0  |
| Incr Delay (d2), s/veh      | 0.1  | 0.1  | 0.1  | 0.7  | 0.1  | 0.0  | 1.9  | 0.6  | 0.0  | 75.4 | 0.1  | 0.0  |
| Initial Q Delay(d3),s/veh   | 0.0  | 0.0  | 0.0  | 0.0  | 0.0  | 0.0  | 0.0  | 0.0  | 0.0  | 0.0  | 0.0  | 0.0  |
| %ile BackOfQ(50%),veh/ln    | 0.3  | 0.1  | 0.2  | 2.0  | 0.3  | 0.0  | 0.9  | 2.3  | 0.0  | 13.5 | 1.9  | 0.0  |
| LnGrp Delay(d),s/veh        | 18.5 | 19.3 | 19.3 | 19.7 | 18.3 | 0.0  | 22.8 | 18.9 | 0.0  | 93.1 | 11.9 | 0.0  |
| LnGrp LOS                   | B    | B    | B    | B    | B    |      | C    | B    |      | F    | B    |      |
| Approach Vol, veh/h         |      | 47   |      |      | 382  |      |      | 449  |      |      | 842  |      |
| Approach Delay, s/veh       |      | 18.9 |      |      | 19.5 |      |      | 19.5 |      |      | 55.2 |      |
| Approach LOS                |      | B    |      |      | B    |      |      | B    |      |      | E    |      |
| Timer                       | 1    | 2    | 3    | 4    | 5    | 6    | 7    | 8    |      |      |      |      |
| Assigned Phs                | 1    | 2    | 3    | 4    | 5    | 6    | 7    | 8    |      |      |      |      |
| Phs Duration (G+Y+Rc), s    | 7.4  | 19.2 | 9.5  | 9.7  | 15.0 | 11.6 | 10.7 | 8.5  |      |      |      |      |
| Change Period (Y+Rc), s     | 4.5  | 4.5  | 4.5  | 4.5  | 4.5  | 4.5  | 4.5  | 4.5  |      |      |      |      |
| Max Green Setting (Gmax), s | 10.5 | 25.5 | 20.5 | 30.5 | 10.5 | 25.5 | 20.5 | 30.5 |      |      |      |      |
| Max Q Clear Time (g_c+1), s | 13.5 | 5.9  | 2.5  | 2.7  | 12.5 | 6.6  | 6.1  | 2.3  |      |      |      |      |
| Green Ext Time (p_c), s     | 0.0  | 0.5  | 0.0  | 0.1  | 0.0  | 0.5  | 0.1  | 0.0  |      |      |      |      |
| <b>Intersection Summary</b> |      |      |      |      |      |      |      |      |      |      |      |      |
| HCM 2010 Ctrl Delay         |      |      | 36.9 |      |      |      |      |      |      |      |      |      |
| HCM 2010 LOS                |      |      | D    |      |      |      |      |      |      |      |      |      |
| <b>Notes</b>                |      |      |      |      |      |      |      |      |      |      |      |      |

HCM 2010 Roundabout  
39: General Jim Moore Boulevard & Gigling Road

| Intersection                |       |       |       |       |       |       |       |       |  |
|-----------------------------|-------|-------|-------|-------|-------|-------|-------|-------|--|
| Intersection Delay, s/veh   | 14.0  |       |       |       |       |       |       |       |  |
| Intersection LOS            | B     |       |       |       |       |       |       |       |  |
| Approach                    | EB    |       | WB    |       | NB    |       | SB    |       |  |
| Entry Lanes                 | 2     |       | 2     |       | 2     |       | 2     |       |  |
| Conflicting Circle Lanes    | 2     |       | 2     |       | 2     |       | 2     |       |  |
| Adj Approach Flow, veh/h    | 80    |       | 827   |       | 989   |       | 919   |       |  |
| Demand Flow Rate, veh/h     | 84    |       | 844   |       | 999   |       | 937   |       |  |
| Vehicles Circulating, veh/h | 1219  |       | 489   |       | 517   |       | 468   |       |  |
| Vehicles Exiting, veh/h     | 186   |       | 1027  |       | 786   |       | 865   |       |  |
| Follow-Up Headway, s        | 3.186 |       | 3.186 |       | 3.186 |       | 3.186 |       |  |
| Ped Vol Crossing Leg, #/h   | 0     |       | 0     |       | 0     |       | 1     |       |  |
| Ped Cap Adj                 | 1.000 |       | 1.000 |       | 1.000 |       | 0.999 |       |  |
| Approach Delay, s/veh       | 9.3   |       | 12.5  |       | 16.1  |       | 13.6  |       |  |
| Approach LOS                | A     |       | B     |       | C     |       | B     |       |  |
| Lane                        | Left  | Right | Left  | Right | Left  | Right | Left  | Right |  |
| Designated Moves            | LT    | TR    | LT    | TR    | LT    | TR    | LT    | TR    |  |
| Assumed Moves               | LT    | TR    | LT    | R     | LT    | R     | L     | TR    |  |
| RT Channelized              |       |       |       |       |       |       |       |       |  |
| Lane Util                   | 0.464 | 0.536 | 0.472 | 0.528 | 0.465 | 0.535 | 0.501 | 0.499 |  |
| Critical Headway, s         | 4.293 | 4.113 | 4.293 | 4.113 | 4.293 | 4.113 | 4.293 | 4.113 |  |
| Entry Flow, veh/h           | 39    | 45    | 398   | 446   | 465   | 534   | 469   | 468   |  |
| Cap Entry Lane, veh/h       | 453   | 481   | 783   | 802   | 767   | 787   | 795   | 814   |  |
| Entry HV Adj Factor         | 0.962 | 0.941 | 0.980 | 0.980 | 0.989 | 0.991 | 0.981 | 0.981 |  |
| Flow Entry, veh/h           | 38    | 42    | 390   | 437   | 460   | 529   | 460   | 459   |  |
| Cap Entry, veh/h            | 436   | 453   | 767   | 786   | 759   | 779   | 780   | 798   |  |
| V/C Ratio                   | 0.086 | 0.093 | 0.508 | 0.556 | 0.606 | 0.679 | 0.590 | 0.575 |  |
| Control Delay, s/veh        | 9.5   | 9.2   | 12.0  | 12.9  | 14.8  | 17.2  | 14.0  | 13.3  |  |
| LOS                         | A     | A     | B     | B     | B     | C     | B     | B     |  |
| 95th %tile Queue, veh       | 0     | 0     | 3     | 3     | 4     | 5     | 4     | 4     |  |



HCM 2010 Signalized Intersection Summary  
 47: General Jim Moore Boulevard & Coe Avenue

Cuml w/ Proj, PM  
 09/06/2019



| Movement                    | EBL  | EBT  | EBR  | WBL | WBT | WBR  | NBL  | NBT  | NBR  | SBL  | SBT  | SBR   |
|-----------------------------|------|------|------|-----|-----|------|------|------|------|------|------|-------|
| Lane Configurations         | ↖    | ↗    |      |     |     |      | ↖    | ↕    |      |      | ↕    | ↗     |
| Traffic Volume (veh/h)      | 60   | 0    | 100  | 0   | 0   | 0    | 150  | 980  | 0    | 0    | 440  | 50    |
| Future Volume (veh/h)       | 60   | 0    | 100  | 0   | 0   | 0    | 150  | 980  | 0    | 0    | 440  | 50    |
| Number                      | 3    | 8    | 18   |     |     |      | 1    | 6    | 16   | 5    | 2    | 12    |
| Initial Q (Qb), veh         | 0    | 0    | 0    |     |     |      | 0    | 0    | 0    | 0    | 0    | 0     |
| Ped-Bike Adj(A_pbT)         | 1.00 |      | 1.00 |     |     |      | 1.00 |      | 1.00 | 1.00 |      | 1.00  |
| Parking Bus, Adj            | 1.00 | 1.00 | 1.00 |     |     |      | 1.00 | 1.00 | 1.00 | 1.00 | 1.00 | 1.00  |
| Adj Sat Flow, veh/h/ln      | 1881 | 1881 | 1900 |     |     |      | 1881 | 1881 | 0    | 0    | 1863 | 1863  |
| Adj Flow Rate, veh/h        | 67   | 0    | 0    |     |     |      | 169  | 1101 | 0    | 0    | 494  | -6    |
| Adj No. of Lanes            | 1    | 1    | 0    |     |     |      | 1    | 2    | 0    | 0    | 2    | 1     |
| Peak Hour Factor            | 0.89 | 0.89 | 0.89 |     |     |      | 0.89 | 0.89 | 0.89 | 0.89 | 0.89 | 0.89  |
| Percent Heavy Veh, %        | 1    | 2    | 1    |     |     |      | 1    | 1    | 0    | 0    | 2    | 2     |
| Cap, veh/h                  | 144  | 151  | 0    |     |     |      | 250  | 1975 | 0    | 0    | 812  | 363   |
| Arrive On Green             | 0.08 | 0.00 | 0.00 |     |     |      | 0.14 | 0.55 | 0.00 | 0.00 | 0.23 | 0.00  |
| Sat Flow, veh/h             | 1792 | 1881 | 0    |     |     |      | 1792 | 3668 | 0    | 0    | 3632 | 1583  |
| Grp Volume(v), veh/h        | 67   | 0    | 0    |     |     |      | 169  | 1101 | 0    | 0    | 494  | -6    |
| Grp Sat Flow(s),veh/h/ln    | 1792 | 1881 | 0    |     |     |      | 1792 | 1787 | 0    | 0    | 1770 | 1583  |
| Q Serve(g_s), s             | 0.9  | 0.0  | 0.0  |     |     |      | 2.2  | 4.9  | 0.0  | 0.0  | 3.1  | 0.0   |
| Cycle Q Clear(g_c), s       | 0.9  | 0.0  | 0.0  |     |     |      | 2.2  | 4.9  | 0.0  | 0.0  | 3.1  | 0.0   |
| Prop In Lane                | 1.00 |      | 0.00 |     |     |      | 1.00 |      | 0.00 | 0.00 |      | 1.00  |
| Lane Grp Cap(c), veh/h      | 144  | 151  | 0    |     |     |      | 250  | 1975 | 0    | 0    | 812  | 363   |
| V/C Ratio(X)                | 0.47 | 0.00 | 0.00 |     |     |      | 0.68 | 0.56 | 0.00 | 0.00 | 0.61 | -0.02 |
| Avail Cap(c_a), veh/h       | 3070 | 3223 | 0    |     |     |      | 402  | 6416 | 0    | 0    | 4909 | 2196  |
| HCM Platoon Ratio           | 1.00 | 1.00 | 1.00 |     |     |      | 1.00 | 1.00 | 1.00 | 1.00 | 1.00 | 1.00  |
| Upstream Filter(I)          | 1.00 | 0.00 | 0.00 |     |     |      | 1.00 | 1.00 | 0.00 | 0.00 | 1.00 | 0.00  |
| Uniform Delay (d), s/veh    | 10.8 | 0.0  | 0.0  |     |     |      | 10.0 | 3.5  | 0.0  | 0.0  | 8.5  | 0.0   |
| Incr Delay (d2), s/veh      | 0.9  | 0.0  | 0.0  |     |     |      | 1.2  | 0.1  | 0.0  | 0.0  | 0.3  | 0.0   |
| Initial Q Delay(d3),s/veh   | 0.0  | 0.0  | 0.0  |     |     |      | 0.0  | 0.0  | 0.0  | 0.0  | 0.0  | 0.0   |
| %ile BackOfQ(50%),veh/ln    | 0.5  | 0.0  | 0.0  |     |     |      | 1.2  | 2.3  | 0.0  | 0.0  | 1.5  | 0.0   |
| LnGrp Delay(d),s/veh        | 11.6 | 0.0  | 0.0  |     |     |      | 11.2 | 3.6  | 0.0  | 0.0  | 8.7  | 0.0   |
| LnGrp LOS                   | B    |      |      |     |     |      | B    | A    |      |      | A    |       |
| Approach Vol, veh/h         |      | 67   |      |     |     |      |      | 1270 |      |      | 488  |       |
| Approach Delay, s/veh       |      | 11.6 |      |     |     |      |      | 4.6  |      |      | 8.8  |       |
| Approach LOS                |      | B    |      |     |     |      |      | A    |      |      | A    |       |
| Timer                       | 1    | 2    | 3    | 4   | 5   | 6    | 7    | 8    |      |      |      |       |
| Assigned Phs                | 1    | 2    |      |     |     | 6    |      | 8    |      |      |      |       |
| Phs Duration (G+Y+Rc), s    | 7.9  | 10.1 |      |     |     | 18.0 |      | 6.5  |      |      |      |       |
| Change Period (Y+Rc), s     | 4.5  | 4.5  |      |     |     | 4.5  |      | 4.5  |      |      |      |       |
| Max Green Setting (Gmax), s | 5.5  | 34.0 |      |     |     | 44.0 |      | 42.0 |      |      |      |       |
| Max Q Clear Time (g_c+I), s | 14.2 | 5.1  |      |     |     | 6.9  |      | 2.9  |      |      |      |       |
| Green Ext Time (p_c), s     | 0.0  | 0.6  |      |     |     | 1.4  |      | 0.0  |      |      |      |       |
| <b>Intersection Summary</b> |      |      |      |     |     |      |      |      |      |      |      |       |
| HCM 2010 Ctrl Delay         |      |      | 6.0  |     |     |      |      |      |      |      |      |       |
| HCM 2010 LOS                |      |      | A    |     |     |      |      |      |      |      |      |       |

HCM 2010 Signalized Intersection Summary  
5: 2nd Avenue & Imjin Parkway

Cuml w/ Eastside Pkwy w/ Proj, AM  
09/06/2019



| Movement                    | EBL  | EBT  | EBR  | WBL  | WBT  | WBR  | NBL  | NBT  | NBR  | SBL  | SBT  | SBR  |
|-----------------------------|------|------|------|------|------|------|------|------|------|------|------|------|
| Lane Configurations         | ↖↗   | ↑↑↑  | ↖↗   | ↖↗↖  | ↑↑↑  | ↖    | ↖↗↖  | ↑    | ↖↗   | ↖↗   | ↑↑   | ↖    |
| Traffic Volume (veh/h)      | 180  | 1050 | 910  | 460  | 860  | 120  | 420  | 90   | 200  | 50   | 100  | 210  |
| Future Volume (veh/h)       | 180  | 1050 | 910  | 460  | 860  | 120  | 420  | 90   | 200  | 50   | 100  | 210  |
| Number                      | 5    | 2    | 12   | 1    | 6    | 16   | 3    | 8    | 18   | 7    | 4    | 14   |
| Initial Q (Qb), veh         | 0    | 0    | 0    | 0    | 0    | 0    | 0    | 0    | 0    | 0    | 0    | 0    |
| Ped-Bike Adj(A_pbT)         | 1.00 |      | 1.00 | 1.00 |      | 1.00 | 1.00 |      | 1.00 | 1.00 |      | 1.00 |
| Parking Bus, Adj            | 1.00 | 1.00 | 1.00 | 1.00 | 1.00 | 1.00 | 1.00 | 1.00 | 1.00 | 1.00 | 1.00 | 1.00 |
| Adj Sat Flow, veh/h/ln      | 1863 | 1863 | 1863 | 1863 | 1863 | 1863 | 1810 | 1810 | 1810 | 1900 | 1900 | 1900 |
| Adj Flow Rate, veh/h        | 184  | 1071 | 710  | 469  | 878  | 122  | 429  | 92   | 82   | 51   | 102  | 209  |
| Adj No. of Lanes            | 2    | 3    | 2    | 3    | 3    | 1    | 3    | 1    | 2    | 2    | 2    | 1    |
| Peak Hour Factor            | 0.98 | 0.98 | 0.98 | 0.98 | 0.98 | 0.98 | 0.98 | 0.98 | 0.98 | 0.98 | 0.98 | 0.98 |
| Percent Heavy Veh, %        | 2    | 2    | 2    | 2    | 2    | 2    | 5    | 5    | 5    | 0    | 0    | 0    |
| Cap, veh/h                  | 295  | 1538 | 843  | 629  | 1742 | 622  | 585  | 398  | 594  | 177  | 542  | 380  |
| Arrive On Green             | 0.09 | 0.30 | 0.30 | 0.13 | 0.34 | 0.34 | 0.12 | 0.22 | 0.22 | 0.05 | 0.15 | 0.15 |
| Sat Flow, veh/h             | 3442 | 5085 | 2787 | 5003 | 5085 | 1583 | 4860 | 1810 | 2701 | 3510 | 3610 | 1612 |
| Grp Volume(v), veh/h        | 184  | 1071 | 710  | 469  | 878  | 122  | 429  | 92   | 82   | 51   | 102  | 209  |
| Grp Sat Flow(s),veh/h/ln    | 1721 | 1695 | 1393 | 1668 | 1695 | 1583 | 1620 | 1810 | 1350 | 1755 | 1805 | 1612 |
| Q Serve(g_s), s             | 3.1  | 11.1 | 14.2 | 5.4  | 8.2  | 3.0  | 5.1  | 2.5  | 1.5  | 0.8  | 1.5  | 6.8  |
| Cycle Q Clear(g_c), s       | 3.1  | 11.1 | 14.2 | 5.4  | 8.2  | 3.0  | 5.1  | 2.5  | 1.5  | 0.8  | 1.5  | 6.8  |
| Prop In Lane                | 1.00 |      | 1.00 | 1.00 |      | 1.00 | 1.00 |      | 1.00 | 1.00 |      | 1.00 |
| Lane Grp Cap(c), veh/h      | 295  | 1538 | 843  | 629  | 1742 | 622  | 585  | 398  | 594  | 177  | 542  | 380  |
| V/C Ratio(X)                | 0.62 | 0.70 | 0.84 | 0.75 | 0.50 | 0.20 | 0.73 | 0.23 | 0.14 | 0.29 | 0.19 | 0.55 |
| Avail Cap(c_a), veh/h       | 869  | 2568 | 1407 | 1263 | 2568 | 879  | 1636 | 640  | 955  | 591  | 1276 | 708  |
| HCM Platoon Ratio           | 1.00 | 1.00 | 1.00 | 1.00 | 1.00 | 1.00 | 1.00 | 1.00 | 1.00 | 1.00 | 1.00 | 1.00 |
| Upstream Filter(I)          | 1.00 | 1.00 | 1.00 | 1.00 | 1.00 | 1.00 | 1.00 | 1.00 | 1.00 | 1.00 | 1.00 | 1.00 |
| Uniform Delay (d), s/veh    | 26.2 | 18.3 | 19.4 | 25.1 | 15.5 | 11.9 | 25.2 | 19.0 | 18.6 | 27.2 | 22.1 | 19.9 |
| Incr Delay (d2), s/veh      | 0.8  | 0.2  | 1.0  | 0.7  | 0.1  | 0.1  | 0.7  | 0.1  | 0.0  | 0.3  | 0.1  | 0.5  |
| Initial Q Delay(d3),s/veh   | 0.0  | 0.0  | 0.0  | 0.0  | 0.0  | 0.0  | 0.0  | 0.0  | 0.0  | 0.0  | 0.0  | 0.0  |
| %ile BackOfQ(50%),veh/ln    | 1.5  | 5.2  | 5.5  | 2.5  | 3.8  | 1.3  | 2.3  | 1.2  | 0.5  | 0.4  | 0.7  | 3.0  |
| LnGrp Delay(d),s/veh        | 27.0 | 18.5 | 20.4 | 25.7 | 15.6 | 11.9 | 25.9 | 19.1 | 18.7 | 27.5 | 22.1 | 20.4 |
| LnGrp LOS                   | C    | B    | C    | C    | B    | B    | C    | B    | B    | C    | C    | C    |
| Approach Vol, veh/h         |      | 1965 |      |      | 1469 |      |      | 603  |      |      | 362  |      |
| Approach Delay, s/veh       |      | 20.0 |      |      | 18.5 |      |      | 23.9 |      |      | 21.9 |      |
| Approach LOS                |      | B    |      |      | B    |      |      | C    |      |      | C    |      |
| Timer                       | 1    | 2    | 3    | 4    | 5    | 6    | 7    | 8    |      |      |      |      |
| Assigned Phs                | 1    | 2    | 3    | 4    | 5    | 6    | 7    | 8    |      |      |      |      |
| Phs Duration (G+Y+Rc), s    | 2.0  | 23.3 | 10.7 | 13.5 | 9.6  | 25.6 | 6.5  | 17.7 |      |      |      |      |
| Change Period (Y+Rc), s     | 4.5  | 5.3  | 3.5  | 4.6  | 4.5  | 5.3  | 3.5  | 4.6  |      |      |      |      |
| Max Green Setting (Gmax), s | 15.0 | 30.0 | 20.0 | 21.0 | 15.0 | 30.0 | 10.0 | 21.0 |      |      |      |      |
| Max Q Clear Time (g_c+1), s | 17.5 | 16.2 | 7.1  | 8.8  | 5.1  | 10.2 | 2.8  | 4.5  |      |      |      |      |
| Green Ext Time (p_c), s     | 0.1  | 1.8  | 0.1  | 0.1  | 0.0  | 1.4  | 0.0  | 0.1  |      |      |      |      |
| <b>Intersection Summary</b> |      |      |      |      |      |      |      |      |      |      |      |      |
| HCM 2010 Ctrl Delay         |      |      |      | 20.2 |      |      |      |      |      |      |      |      |
| HCM 2010 LOS                |      |      |      | C    |      |      |      |      |      |      |      |      |

HCM 2010 Signalized Intersection Summary  
 12: Reservation Road & Imjin Parkway

Cuml w/ Eastside Pkwy w/ Proj, AM  
 09/06/2019



| Movement                       | EBL  | EBT   | EBR  | WBL  | WBT  | WBR   | NBL  | NBT  | NBR  | SBL  | SBT  | SBR  |
|--------------------------------|------|-------|------|------|------|-------|------|------|------|------|------|------|
| Lane Configurations            | ↔↔   | ↑     | ↔↔   | ↔    | ↑    | ↔     | ↔↔   | ↑↑   | ↔    | ↔↔   | ↑↑↑  | ↔    |
| Traffic Volume (veh/h)         | 190  | 50    | 670  | 10   | 20   | 30    | 950  | 880  | 20   | 60   | 590  | 90   |
| Future Volume (veh/h)          | 190  | 50    | 670  | 10   | 20   | 30    | 950  | 880  | 20   | 60   | 590  | 90   |
| Number                         | 3    | 8     | 18   | 7    | 4    | 14    | 1    | 6    | 16   | 5    | 2    | 12   |
| Initial Q (Qb), veh            | 0    | 0     | 0    | 0    | 0    | 0     | 0    | 0    | 0    | 0    | 0    | 0    |
| Ped-Bike Adj(A_pbT)            | 1.00 |       | 1.00 | 1.00 |      | 0.99  | 1.00 |      | 1.00 | 1.00 |      | 0.98 |
| Parking Bus, Adj               | 1.00 | 1.00  | 1.00 | 1.00 | 1.00 | 1.00  | 1.00 | 1.00 | 1.00 | 1.00 | 1.00 | 1.00 |
| Adj Sat Flow, veh/h/ln         | 1863 | 1863  | 1863 | 1638 | 1638 | 1638  | 1863 | 1863 | 1863 | 1863 | 1863 | 1863 |
| Adj Flow Rate, veh/h           | 204  | 54    | 306  | 11   | 22   | 19    | 1022 | 946  | 16   | 65   | 634  | 34   |
| Adj No. of Lanes               | 2    | 1     | 2    | 1    | 1    | 1     | 2    | 2    | 1    | 2    | 3    | 1    |
| Peak Hour Factor               | 0.93 | 0.93  | 0.93 | 0.93 | 0.93 | 0.93  | 0.93 | 0.93 | 0.93 | 0.93 | 0.93 | 0.93 |
| Percent Heavy Veh, %           | 2    | 2     | 2    | 16   | 16   | 16    | 2    | 2    | 2    | 2    | 2    | 2    |
| Cap, veh/h                     | 388  | 210   | 1217 | 60   | 63   | 53    | 1116 | 1952 | 872  | 131  | 1350 | 414  |
| Arrive On Green                | 0.11 | 0.11  | 0.11 | 0.04 | 0.04 | 0.04  | 0.32 | 0.55 | 0.55 | 0.04 | 0.27 | 0.27 |
| Sat Flow, veh/h                | 3442 | 1863  | 2774 | 1560 | 1638 | 1384  | 3442 | 3539 | 1581 | 3442 | 5085 | 1558 |
| Grp Volume(v), veh/h           | 204  | 54    | 306  | 11   | 22   | 19    | 1022 | 946  | 16   | 65   | 634  | 34   |
| Grp Sat Flow(s),veh/h/ln       | 1721 | 1863  | 1387 | 1560 | 1638 | 1384  | 1721 | 1770 | 1581 | 1721 | 1695 | 1558 |
| Q Serve(g_s), s                | 4.5  | 2.1   | 5.6  | 0.5  | 1.1  | 1.1   | 22.9 | 13.1 | 0.4  | 1.5  | 8.4  | 1.3  |
| Cycle Q Clear(g_c), s          | 4.5  | 2.1   | 5.6  | 0.5  | 1.1  | 1.1   | 22.9 | 13.1 | 0.4  | 1.5  | 8.4  | 1.3  |
| Prop In Lane                   | 1.00 |       | 1.00 | 1.00 |      | 1.00  | 1.00 |      | 1.00 | 1.00 |      | 1.00 |
| Lane Grp Cap(c), veh/h         | 388  | 210   | 1217 | 60   | 63   | 53    | 1116 | 1952 | 872  | 131  | 1350 | 414  |
| V/C Ratio(X)                   | 0.53 | 0.26  | 0.25 | 0.18 | 0.35 | 0.36  | 0.92 | 0.48 | 0.02 | 0.50 | 0.47 | 0.08 |
| Avail Cap(c_a), veh/h          | 1501 | 812   | 2114 | 603  | 633  | 535   | 1501 | 2205 | 985  | 858  | 3802 | 1165 |
| HCM Platoon Ratio              | 1.00 | 1.00  | 1.00 | 1.00 | 1.00 | 1.00  | 1.00 | 1.00 | 1.00 | 1.00 | 1.00 | 1.00 |
| Upstream Filter(I)             | 1.00 | 1.00  | 1.00 | 1.00 | 1.00 | 1.00  | 1.00 | 1.00 | 1.00 | 1.00 | 1.00 | 1.00 |
| Uniform Delay (d), s/veh       | 33.6 | 32.5  | 14.3 | 37.4 | 37.6 | 37.6  | 26.1 | 11.0 | 8.1  | 37.8 | 24.7 | 22.1 |
| Incr Delay (d2), s/veh         | 0.4  | 0.2   | 0.0  | 0.5  | 1.2  | 1.5   | 6.2  | 0.5  | 0.0  | 1.1  | 0.7  | 0.2  |
| Initial Q Delay(d3),s/veh      | 0.0  | 0.0   | 0.0  | 0.0  | 0.0  | 0.0   | 0.0  | 0.0  | 0.0  | 0.0  | 0.0  | 0.0  |
| %ile BackOfQ(50%),veh/ln       | 2.1  | 1.1   | 2.1  | 0.2  | 0.5  | 0.4   | 11.7 | 6.4  | 0.2  | 0.7  | 4.0  | 0.6  |
| LnGrp Delay(d),s/veh           | 34.0 | 32.8  | 14.3 | 37.9 | 38.9 | 39.2  | 32.3 | 11.5 | 8.2  | 38.9 | 25.4 | 22.4 |
| LnGrp LOS                      | C    | C     | B    | D    | D    | D     | C    | B    | A    | D    | C    | C    |
| Approach Vol, veh/h            |      | 564   |      |      | 52   |       |      | 1984 |      |      | 733  |      |
| Approach Delay, s/veh          |      | 23.2  |      |      | 38.8 |       |      | 22.2 |      |      | 26.5 |      |
| Approach LOS                   |      | C     |      |      | D    |       |      | C    |      |      | C    |      |
| Timer                          | 1    | 2     | 3    | 4    | 5    | 6     | 7    | 8    |      |      |      |      |
| Assigned Phs                   | 1    | 2     |      | 4    | 5    | 6     |      | 8    |      |      |      |      |
| Phs Duration (G+Y+Rc), s       | 30.1 | 27.5  |      | 8.1  | 7.2  | 50.5  |      | 14.6 |      |      |      |      |
| Change Period (Y+Rc), s        | 4.1  | * 6.2 |      | 5.0  | 4.1  | * 6.2 |      | 5.5  |      |      |      |      |
| Max Green Setting (Gmax), s    | 35.0 | * 60  |      | 31.0 | 20.0 | * 50  |      | 35.0 |      |      |      |      |
| Max Q Clear Time (g_c+24.9), s | 24.9 | 10.4  |      | 3.1  | 3.5  | 15.1  |      | 7.6  |      |      |      |      |
| Green Ext Time (p_c), s        | 1.1  | 10.7  |      | 0.1  | 0.0  | 15.6  |      | 1.2  |      |      |      |      |
| <b>Intersection Summary</b>    |      |       |      |      |      |       |      |      |      |      |      |      |
| HCM 2010 Ctrl Delay            |      |       | 23.6 |      |      |       |      |      |      |      |      |      |
| HCM 2010 LOS                   |      |       | C    |      |      |       |      |      |      |      |      |      |
| <b>Notes</b>                   |      |       |      |      |      |       |      |      |      |      |      |      |

HCM 2010 Signalized Intersection Summary  
 14: Reservation Road & Inter-Garrison Road

Cuml w/ Eastside Pkwy w/ Proj, AM  
 09/06/2019



| Movement                      | EBL  | EBR  | NBL  | NBT  | SBT  | SBR  |   |      |
|-------------------------------|------|------|------|------|------|------|---|------|
| Lane Configurations           |      |      |      |      |      |      |   |      |
| Traffic Volume (veh/h)        | 110  | 610  | 900  | 460  | 260  | 160  |   |      |
| Future Volume (veh/h)         | 110  | 610  | 900  | 460  | 260  | 160  |   |      |
| Number                        | 3    | 18   | 1    | 6    | 2    | 12   |   |      |
| Initial Q (Qb), veh           | 0    | 0    | 0    | 0    | 0    | 0    |   |      |
| Ped-Bike Adj(A_pbT)           | 1.00 | 1.00 | 1.00 |      |      | 1.00 |   |      |
| Parking Bus, Adj              | 1.00 | 1.00 | 1.00 | 1.00 | 1.00 | 1.00 |   |      |
| Adj Sat Flow, veh/h/ln        | 1845 | 1845 | 1863 | 1863 | 1845 | 1900 |   |      |
| Adj Flow Rate, veh/h          | 117  | 381  | 957  | 489  | 277  | 154  |   |      |
| Adj No. of Lanes              | 1    | 2    | 2    | 2    | 2    | 0    |   |      |
| Peak Hour Factor              | 0.94 | 0.94 | 0.94 | 0.94 | 0.94 | 0.94 |   |      |
| Percent Heavy Veh, %          | 3    | 3    | 2    | 2    | 3    | 3    |   |      |
| Cap, veh/h                    | 274  | 1307 | 1092 | 2271 | 522  | 282  |   |      |
| Arrive On Green               | 0.16 | 0.16 | 0.32 | 0.64 | 0.24 | 0.24 |   |      |
| Sat Flow, veh/h               | 1757 | 2760 | 3442 | 3632 | 2291 | 1188 |   |      |
| Grp Volume(v), veh/h          | 117  | 381  | 957  | 489  | 219  | 212  |   |      |
| Grp Sat Flow(s),veh/h/ln      | 1757 | 1380 | 1721 | 1770 | 1752 | 1635 |   |      |
| Q Serve(g_s), s               | 3.2  | 4.5  | 14.2 | 3.1  | 5.9  | 6.1  |   |      |
| Cycle Q Clear(g_c), s         | 3.2  | 4.5  | 14.2 | 3.1  | 5.9  | 6.1  |   |      |
| Prop In Lane                  | 1.00 | 1.00 | 1.00 |      |      | 0.73 |   |      |
| Lane Grp Cap(c), veh/h        | 274  | 1307 | 1092 | 2271 | 416  | 388  |   |      |
| V/C Ratio(X)                  | 0.43 | 0.29 | 0.88 | 0.22 | 0.53 | 0.55 |   |      |
| Avail Cap(c_a), veh/h         | 880  | 2257 | 1277 | 3938 | 1950 | 1819 |   |      |
| HCM Platoon Ratio             | 1.00 | 1.00 | 1.00 | 1.00 | 1.00 | 1.00 |   |      |
| Upstream Filter(I)            | 1.00 | 1.00 | 1.00 | 1.00 | 1.00 | 1.00 |   |      |
| Uniform Delay (d), s/veh      | 20.6 | 8.7  | 17.4 | 4.0  | 17.9 | 18.0 |   |      |
| Incr Delay (d2), s/veh        | 1.0  | 0.1  | 5.7  | 0.1  | 1.9  | 2.2  |   |      |
| Initial Q Delay(d3),s/veh     | 0.0  | 0.0  | 0.0  | 0.0  | 0.0  | 0.0  |   |      |
| %ile BackOfQ(50%),veh/ln      | 1.6  | 1.7  | 7.5  | 1.5  | 3.0  | 3.0  |   |      |
| LnGrp Delay(d),s/veh          | 21.6 | 8.8  | 23.1 | 4.1  | 19.9 | 20.3 |   |      |
| LnGrp LOS                     | C    | A    | C    | A    | B    | C    |   |      |
| Approach Vol, veh/h           | 498  |      |      | 1446 | 431  |      |   |      |
| Approach Delay, s/veh         | 11.8 |      |      | 16.7 | 20.1 |      |   |      |
| Approach LOS                  | B    |      |      | B    | C    |      |   |      |
| Timer                         | 1    | 2    | 3    | 4    | 5    | 6    | 7 | 8    |
| Assigned Phs                  | 1    | 2    |      |      |      | 6    |   | 8    |
| Phs Duration (G+Y+Rc), s      | 11.8 | 19.2 |      |      |      | 41.0 |   | 12.9 |
| Change Period (Y+Rc), s       | 4.7  | 6.4  |      |      |      | 6.4  |   | 4.5  |
| Max Green Setting (Gmax), s   | 26   | 60.0 |      |      |      | 60.0 |   | 27.0 |
| Max Q Clear Time (g_c+110), s | 110  | 8.1  |      |      |      | 5.1  |   | 6.5  |
| Green Ext Time (p_c), s       | 0.9  | 4.7  |      |      |      | 5.8  |   | 1.9  |
| <b>Intersection Summary</b>   |      |      |      |      |      |      |   |      |
| HCM 2010 Ctrl Delay           |      |      | 16.3 |      |      |      |   |      |
| HCM 2010 LOS                  |      |      | B    |      |      |      |   |      |
| <b>Notes</b>                  |      |      |      |      |      |      |   |      |

HCM 2010 Signalized Intersection Summary  
 22: 8th Avenue & Inter-Garrison Road

Cuml w/ Eastside Pkwy w/ Proj, AM  
 09/06/2019



| Movement                     | EBT  | EBR  | WBL  | WBT  | NBL  | NBR  |   |      |
|------------------------------|------|------|------|------|------|------|---|------|
| Lane Configurations          | 1    |      | 2    | 1    | 2    |      |   |      |
| Traffic Volume (veh/h)       | 220  | 120  | 520  | 530  | 50   | 290  |   |      |
| Future Volume (veh/h)        | 220  | 120  | 520  | 530  | 50   | 290  |   |      |
| Number                       | 4    | 14   | 3    | 8    | 5    | 12   |   |      |
| Initial Q (Qb), veh          | 0    | 0    | 0    | 0    | 0    | 0    |   |      |
| Ped-Bike Adj(A_pbT)          |      | 1.00 | 1.00 |      | 1.00 | 1.00 |   |      |
| Parking Bus, Adj             | 1.00 | 1.00 | 1.00 | 1.00 | 1.00 | 1.00 |   |      |
| Adj Sat Flow, veh/h/ln       | 1520 | 1900 | 1881 | 1881 | 1845 | 1900 |   |      |
| Adj Flow Rate, veh/h         | 253  | 46   | 598  | 609  | 57   | 149  |   |      |
| Adj No. of Lanes             | 1    | 0    | 2    | 1    | 0    | 0    |   |      |
| Peak Hour Factor             | 0.87 | 0.87 | 0.87 | 0.87 | 0.87 | 0.87 |   |      |
| Percent Heavy Veh, %         | 25   | 25   | 1    | 1    | 0    | 0    |   |      |
| Cap, veh/h                   | 335  | 61   | 865  | 1171 | 74   | 192  |   |      |
| Arrive On Green              | 0.27 | 0.27 | 0.25 | 0.62 | 0.17 | 0.17 |   |      |
| Sat Flow, veh/h              | 1252 | 228  | 3476 | 1881 | 445  | 1164 |   |      |
| Grp Volume(v), veh/h         | 0    | 299  | 598  | 609  | 207  | 0    |   |      |
| Grp Sat Flow(s),veh/h/ln     | 0    | 1480 | 1738 | 1881 | 1617 | 0    |   |      |
| Q Serve(g_s), s              | 0.0  | 7.9  | 6.6  | 7.7  | 5.2  | 0.0  |   |      |
| Cycle Q Clear(g_c), s        | 0.0  | 7.9  | 6.6  | 7.7  | 5.2  | 0.0  |   |      |
| Prop In Lane                 |      | 0.15 | 1.00 |      | 0.28 | 0.72 |   |      |
| Lane Grp Cap(c), veh/h       | 0    | 396  | 865  | 1171 | 267  | 0    |   |      |
| V/C Ratio(X)                 | 0.00 | 0.76 | 0.69 | 0.52 | 0.77 | 0.00 |   |      |
| Avail Cap(c_a), veh/h        | 0    | 855  | 1861 | 2294 | 736  | 0    |   |      |
| HCM Platoon Ratio            | 1.00 | 1.00 | 1.00 | 1.00 | 1.00 | 1.00 |   |      |
| Upstream Filter(I)           | 0.00 | 1.00 | 1.00 | 1.00 | 1.00 | 0.00 |   |      |
| Uniform Delay (d), s/veh     | 0.0  | 14.3 | 14.4 | 4.5  | 16.9 | 0.0  |   |      |
| Incr Delay (d2), s/veh       | 0.0  | 3.0  | 1.0  | 0.4  | 4.8  | 0.0  |   |      |
| Initial Q Delay(d3),s/veh    | 0.0  | 0.0  | 0.0  | 0.0  | 0.0  | 0.0  |   |      |
| %ile BackOfQ(50%),veh/ln     | 0.0  | 3.5  | 3.3  | 4.0  | 2.7  | 0.0  |   |      |
| LnGrp Delay(d),s/veh         | 0.0  | 17.2 | 15.5 | 4.8  | 21.7 | 0.0  |   |      |
| LnGrp LOS                    |      | B    | B    | A    | C    |      |   |      |
| Approach Vol, veh/h          | 299  |      |      | 1207 | 207  |      |   |      |
| Approach Delay, s/veh        | 17.2 |      |      | 10.1 | 21.7 |      |   |      |
| Approach LOS                 | B    |      |      | B    | C    |      |   |      |
| Timer                        | 1    | 2    | 3    | 4    | 5    | 6    | 7 | 8    |
| Assigned Phs                 |      | 2    | 3    | 4    |      |      |   | 8    |
| Phs Duration (G+Y+Rc), s     |      | 11.5 | 15.0 | 15.8 |      |      |   | 30.9 |
| Change Period (Y+Rc), s      |      | 4.5  | 4.5  | 4.5  |      |      |   | 4.5  |
| Max Green Setting (Gmax), s  |      | 19.3 | 22.7 | 24.5 |      |      |   | 51.7 |
| Max Q Clear Time (g_c+I1), s |      | 7.2  | 8.6  | 9.9  |      |      |   | 9.7  |
| Green Ext Time (p_c), s      |      | 0.5  | 1.9  | 1.5  |      |      |   | 4.5  |
| <b>Intersection Summary</b>  |      |      |      |      |      |      |   |      |
| HCM 2010 Ctrl Delay          |      |      | 12.7 |      |      |      |   |      |
| HCM 2010 LOS                 |      |      | B    |      |      |      |   |      |
| <b>Notes</b>                 |      |      |      |      |      |      |   |      |

| Intersection                |       |       |       |       |
|-----------------------------|-------|-------|-------|-------|
| Intersection Delay, s/veh   | 12.2  |       |       |       |
| Intersection LOS            | B     |       |       |       |
| Approach                    | EB    | WB    |       | NB    |
| Entry Lanes                 | 1     | 2     | 1     |       |
| Conflicting Circle Lanes    | 2     | 2     | 2     |       |
| Adj Approach Flow, veh/h    | 391   | 1207  | 390   |       |
| Demand Flow Rate, veh/h     | 488   | 1219  | 402   |       |
| Vehicles Circulating, veh/h | 604   | 59    | 316   |       |
| Vehicles Exiting, veh/h     | 674   | 659   | 776   |       |
| Follow-Up Headway, s        | 3.186 | 3.186 | 3.186 |       |
| Ped Vol Crossing Leg, #/h   | 0     | 0     | 0     |       |
| Ped Cap Adj                 | 1.000 | 1.000 | 1.000 |       |
| Approach Delay, s/veh       | 20.3  | 10.4  | 9.5   |       |
| Approach LOS                | C     | B     | A     |       |
| Lane                        | Left  | Left  | Right | Left  |
| Designated Moves            | TR    | L     | LTR   | LR    |
| Assumed Moves               | TR    | L     | TR    | LR    |
| RT Channelized              |       |       |       |       |
| Lane Util                   | 1.000 | 0.495 | 0.505 | 1.000 |
| Critical Headway, s         | 4.113 | 4.293 | 4.113 | 4.113 |
| Entry Flow, veh/h           | 488   | 604   | 615   | 402   |
| Cap Entry Lane, veh/h       | 740   | 1081  | 1084  | 906   |
| Entry HV Adj Factor         | 0.801 | 0.990 | 0.990 | 0.970 |
| Flow Entry, veh/h           | 391   | 598   | 609   | 390   |
| Cap Entry, veh/h            | 593   | 1070  | 1073  | 879   |
| V/C Ratio                   | 0.659 | 0.559 | 0.567 | 0.444 |
| Control Delay, s/veh        | 20.3  | 10.3  | 10.5  | 9.5   |
| LOS                         | C     | B     | B     | A     |
| 95th %tile Queue, veh       | 5     | 4     | 4     | 2     |

HCM 2010 Signalized Intersection Summary  
 25: Inter-Garrison Road & Sherman Boulevard

Cuml w/ Eastside Pkwy w/ Proj, AM  
 09/06/2019



| Movement                     | EBL  | EBT  | WBT  | WBR  | SBL  | SBR  |      |      |
|------------------------------|------|------|------|------|------|------|------|------|
| Lane Configurations          |      |      |      |      |      |      |      |      |
| Traffic Volume (veh/h)       | 600  | 130  | 310  | 130  | 90   | 820  |      |      |
| Future Volume (veh/h)        | 600  | 130  | 310  | 130  | 90   | 820  |      |      |
| Number                       | 7    | 4    | 8    | 18   | 1    | 16   |      |      |
| Initial Q (Qb), veh          | 0    | 0    | 0    | 0    | 0    | 0    |      |      |
| Ped-Bike Adj(A_pbT)          | 1.00 |      |      | 1.00 | 1.00 | 1.00 |      |      |
| Parking Bus, Adj             | 1.00 | 1.00 | 1.00 | 1.00 | 1.00 | 1.00 |      |      |
| Adj Sat Flow, veh/h/ln       | 1810 | 1810 | 1881 | 1900 | 1900 | 1900 |      |      |
| Adj Flow Rate, veh/h         | 732  | 159  | 378  | 146  | 110  | 921  |      |      |
| Adj No. of Lanes             | 1    | 1    | 1    | 0    | 1    | 1    |      |      |
| Peak Hour Factor             | 0.82 | 0.82 | 0.82 | 0.82 | 0.82 | 0.82 |      |      |
| Percent Heavy Veh, %         | 5    | 5    | 1    | 1    | 0    | 0    |      |      |
| Cap, veh/h                   | 729  | 1341 | 359  | 139  | 321  | 969  |      |      |
| Arrive On Green              | 0.42 | 0.74 | 0.28 | 0.28 | 0.18 | 0.18 |      |      |
| Sat Flow, veh/h              | 1723 | 1810 | 1293 | 500  | 1810 | 1615 |      |      |
| Grp Volume(v), veh/h         | 732  | 159  | 0    | 524  | 110  | 921  |      |      |
| Grp Sat Flow(s),veh/h/ln     | 1723 | 1810 | 0    | 1793 | 1810 | 1615 |      |      |
| Q Serve(g_s), s              | 46.5 | 2.7  | 0.0  | 30.5 | 5.9  | 19.5 |      |      |
| Cycle Q Clear(g_c), s        | 46.5 | 2.7  | 0.0  | 30.5 | 5.9  | 19.5 |      |      |
| Prop In Lane                 | 1.00 |      |      | 0.28 | 1.00 | 1.00 |      |      |
| Lane Grp Cap(c), veh/h       | 729  | 1341 | 0    | 497  | 321  | 969  |      |      |
| V/C Ratio(X)                 | 1.00 | 0.12 | 0.00 | 1.05 | 0.34 | 0.95 |      |      |
| Avail Cap(c_a), veh/h        | 729  | 1341 | 0    | 497  | 321  | 969  |      |      |
| HCM Platoon Ratio            | 1.00 | 1.00 | 1.00 | 1.00 | 1.00 | 1.00 |      |      |
| Upstream Filter(I)           | 1.00 | 1.00 | 0.00 | 1.00 | 1.00 | 1.00 |      |      |
| Uniform Delay (d), s/veh     | 31.7 | 4.0  | 0.0  | 39.8 | 39.6 | 20.5 |      |      |
| Incr Delay (d2), s/veh       | 34.5 | 0.0  | 0.0  | 55.3 | 0.6  | 18.1 |      |      |
| Initial Q Delay(d3),s/veh    | 0.0  | 0.0  | 0.0  | 0.0  | 0.0  | 0.0  |      |      |
| %ile BackOfQ(50%),veh/ln     | 29.0 | 1.4  | 0.0  | 22.7 | 3.0  | 44.0 |      |      |
| LnGrp Delay(d),s/veh         | 66.3 | 4.1  | 0.0  | 95.1 | 40.3 | 38.6 |      |      |
| LnGrp LOS                    | F    | A    |      | F    | D    | D    |      |      |
| Approach Vol, veh/h          |      | 891  | 524  |      | 1031 |      |      |      |
| Approach Delay, s/veh        |      | 55.2 | 95.1 |      | 38.8 |      |      |      |
| Approach LOS                 |      | E    | F    |      | D    |      |      |      |
| Timer                        | 1    | 2    | 3    | 4    | 5    | 6    | 7    | 8    |
| Assigned Phs                 |      |      |      | 4    |      | 6    | 7    | 8    |
| Phs Duration (G+Y+Rc), s     |      |      |      | 86.0 |      | 24.0 | 51.0 | 35.0 |
| Change Period (Y+Rc), s      |      |      |      | 4.5  |      | 4.5  | 4.5  | 4.5  |
| Max Green Setting (Gmax), s  |      |      |      | 81.5 |      | 19.5 | 46.5 | 30.5 |
| Max Q Clear Time (g_c+I1), s |      |      |      | 4.7  |      | 21.5 | 48.5 | 32.5 |
| Green Ext Time (p_c), s      |      |      |      | 1.1  |      | 0.0  | 0.0  | 0.0  |
| <b>Intersection Summary</b>  |      |      |      |      |      |      |      |      |
| HCM 2010 Ctrl Delay          |      |      | 56.8 |      |      |      |      |      |
| HCM 2010 LOS                 |      |      | E    |      |      |      |      |      |

HCM 2010 Signalized Intersection Summary  
28: Davis Road & Reservation Road

Cuml w/ Eastside Pkwy w/ Proj, AM  
09/06/2019



| Movement                    | EBL   | EBT   | EBR  | WBL  | WBT   | WBR  | NBL  | NBT  | NBR  | SBL  | SBT  | SBR  |
|-----------------------------|-------|-------|------|------|-------|------|------|------|------|------|------|------|
| Lane Configurations         | ↖↗    | ↕     |      | ↖    | ↗     |      |      | ↕    |      |      | ↕    | ↖↗   |
| Traffic Volume (veh/h)      | 750   | 320   | 10   | 10   | 570   | 90   | 10   | 10   | 10   | 150  | 10   | 850  |
| Future Volume (veh/h)       | 750   | 320   | 10   | 10   | 570   | 90   | 10   | 10   | 10   | 150  | 10   | 850  |
| Number                      | 5     | 2     | 12   | 1    | 6     | 16   | 3    | 8    | 18   | 7    | 4    | 14   |
| Initial Q (Qb), veh         | 0     | 0     | 0    | 0    | 0     | 0    | 0    | 0    | 0    | 0    | 0    | 0    |
| Ped-Bike Adj(A_pbT)         | 1.00  |       | 1.00 | 1.00 |       | 1.00 | 1.00 |      | 1.00 | 1.00 |      | 1.00 |
| Parking Bus, Adj            | 1.00  | 1.00  | 1.00 | 1.00 | 1.00  | 1.00 | 1.00 | 1.00 | 1.00 | 1.00 | 1.00 | 1.00 |
| Adj Sat Flow, veh/h/ln      | 1863  | 1863  | 1900 | 1863 | 1863  | 1900 | 1900 | 1900 | 1900 | 1900 | 1845 | 1845 |
| Adj Flow Rate, veh/h        | 872   | 372   | 12   | 12   | 663   | 105  | 12   | 12   | 9    | 174  | 12   | 746  |
| Adj No. of Lanes            | 2     | 2     | 0    | 1    | 1     | 0    | 0    | 1    | 0    | 0    | 1    | 2    |
| Peak Hour Factor            | 0.86  | 0.86  | 0.86 | 0.86 | 0.86  | 0.86 | 0.86 | 0.86 | 0.86 | 0.86 | 0.86 | 0.86 |
| Percent Heavy Veh, %        | 2     | 2     | 2    | 2    | 2     | 2    | 0    | 0    | 0    | 3    | 3    | 3    |
| Cap, veh/h                  | 730   | 2187  | 70   | 19   | 666   | 105  | 17   | 17   | 12   | 350  | 24   | 1171 |
| Arrive On Green             | 0.21  | 0.63  | 0.63 | 0.01 | 0.42  | 0.42 | 0.03 | 0.03 | 0.03 | 0.21 | 0.21 | 0.21 |
| Sat Flow, veh/h             | 3442  | 3500  | 113  | 1774 | 1570  | 249  | 648  | 648  | 486  | 1649 | 114  | 2760 |
| Grp Volume(v), veh/h        | 872   | 188   | 196  | 12   | 0     | 768  | 33   | 0    | 0    | 186  | 0    | 746  |
| Grp Sat Flow(s),veh/h/ln    | 1721  | 1770  | 1843 | 1774 | 0     | 1819 | 1782 | 0    | 0    | 1762 | 0    | 1380 |
| Q Serve(g_s), s             | 30.0  | 6.3   | 6.3  | 1.0  | 0.0   | 59.5 | 2.6  | 0.0  | 0.0  | 13.1 | 0.0  | 30.0 |
| Cycle Q Clear(g_c), s       | 30.0  | 6.3   | 6.3  | 1.0  | 0.0   | 59.5 | 2.6  | 0.0  | 0.0  | 13.1 | 0.0  | 30.0 |
| Prop In Lane                | 1.00  |       | 0.06 | 1.00 |       | 0.14 | 0.36 |      | 0.27 | 0.94 |      | 1.00 |
| Lane Grp Cap(c), veh/h      | 730   | 1106  | 1152 | 19   | 0     | 772  | 46   | 0    | 0    | 374  | 0    | 1171 |
| V/C Ratio(X)                | 1.19  | 0.17  | 0.17 | 0.64 | 0.00  | 1.00 | 0.72 | 0.00 | 0.00 | 0.50 | 0.00 | 0.64 |
| Avail Cap(c_a), veh/h       | 730   | 1106  | 1152 | 376  | 0     | 772  | 378  | 0    | 0    | 374  | 0    | 1171 |
| HCM Platoon Ratio           | 1.00  | 1.00  | 1.00 | 1.00 | 1.00  | 1.00 | 1.00 | 1.00 | 1.00 | 1.00 | 1.00 | 1.00 |
| Upstream Filter(I)          | 1.00  | 1.00  | 1.00 | 1.00 | 0.00  | 1.00 | 1.00 | 0.00 | 0.00 | 1.00 | 0.00 | 1.00 |
| Uniform Delay (d), s/veh    | 55.7  | 11.1  | 11.1 | 69.7 | 0.0   | 40.6 | 68.4 | 0.0  | 0.0  | 49.1 | 0.0  | 32.1 |
| Incr Delay (d2), s/veh      | 100.7 | 0.1   | 0.1  | 12.4 | 0.0   | 31.2 | 7.7  | 0.0  | 0.0  | 0.4  | 0.0  | 0.9  |
| Initial Q Delay(d3),s/veh   | 0.0   | 0.0   | 0.0  | 0.0  | 0.0   | 0.0  | 0.0  | 0.0  | 0.0  | 0.0  | 0.0  | 0.0  |
| %ile BackOfQ(50%),veh/ln    | 24.4  | 3.1   | 3.3  | 0.5  | 0.0   | 36.6 | 1.4  | 0.0  | 0.0  | 6.4  | 0.0  | 11.6 |
| LnGrp Delay(d),s/veh        | 156.4 | 11.2  | 11.2 | 82.1 | 0.0   | 71.8 | 76.1 | 0.0  | 0.0  | 49.5 | 0.0  | 33.0 |
| LnGrp LOS                   | F     | B     | B    | F    |       | E    | E    |      |      | D    |      | C    |
| Approach Vol, veh/h         |       | 1256  |      |      | 780   |      |      | 33   |      |      | 932  |      |
| Approach Delay, s/veh       |       | 112.0 |      |      | 71.9  |      |      | 76.1 |      |      | 36.3 |      |
| Approach LOS                |       | F     |      |      | E     |      |      | E    |      |      | D    |      |
| Timer                       | 1     | 2     | 3    | 4    | 5     | 6    | 7    | 8    |      |      |      |      |
| Assigned Phs                | 1     | 2     |      | 4    | 5     | 6    |      | 8    |      |      |      |      |
| Phs Duration (G+Y+Rc), s    | 5.4   | 93.4  |      | 35.0 | 33.8  | 65.0 |      | 7.6  |      |      |      |      |
| Change Period (Y+Rc), s     | 3.9   | 5.0   |      | 5.0  | * 3.8 | 5.0  |      | 4.0  |      |      |      |      |
| Max Green Setting (Gmax), s | 30    | 60.0  |      | 30.0 | * 30  | 60.0 |      | 30.0 |      |      |      |      |
| Max Q Clear Time (g_c+1), s | 13    | 8.3   |      | 32.0 | 32.0  | 61.5 |      | 4.6  |      |      |      |      |
| Green Ext Time (p_c), s     | 0.0   | 3.4   |      | 0.0  | 0.0   | 0.0  |      | 0.0  |      |      |      |      |
| <b>Intersection Summary</b> |       |       |      |      |       |      |      |      |      |      |      |      |
| HCM 2010 Ctrl Delay         |       |       |      | 77.7 |       |      |      |      |      |      |      |      |
| HCM 2010 LOS                |       |       |      | E    |       |      |      |      |      |      |      |      |
| <b>Notes</b>                |       |       |      |      |       |      |      |      |      |      |      |      |



HCM 2010 Signalized Intersection Summary  
 33: General Jim Moore Boulevard & Lightfighter Drive

Cuml w/ Eastside Pkwy w/ Proj, AM  
 09/06/2019



| Movement                     | EBL  | EBT  | EBR  | WBL  | WBT  | WBR  | NBL  | NBT  | NBR  | SBL  | SBT  | SBR  |
|------------------------------|------|------|------|------|------|------|------|------|------|------|------|------|
| Lane Configurations          | ↖↗   | ↑    | ↖    | ↖↗   | ↖↗   |      | ↖↗   | ↖↗   |      | ↖    | ↖↗   | ↖    |
| Traffic Volume (veh/h)       | 50   | 280  | 830  | 20   | 170  | 70   | 960  | 60   | 10   | 40   | 50   | 20   |
| Future Volume (veh/h)        | 50   | 280  | 830  | 20   | 170  | 70   | 960  | 60   | 10   | 40   | 50   | 20   |
| Number                       | 3    | 8    | 18   | 7    | 4    | 14   | 1    | 6    | 16   | 5    | 2    | 12   |
| Initial Q (Qb), veh          | 0    | 0    | 0    | 0    | 0    | 0    | 0    | 0    | 0    | 0    | 0    | 0    |
| Ped-Bike Adj(A_pbT)          | 1.00 |      | 1.00 | 1.00 |      | 0.99 | 1.00 |      | 1.00 | 1.00 |      | 1.00 |
| Parking Bus, Adj             | 1.00 | 1.00 | 1.00 | 1.00 | 1.00 | 1.00 | 1.00 | 1.00 | 1.00 | 1.00 | 1.00 | 1.00 |
| Adj Sat Flow, veh/h/ln       | 1863 | 1863 | 1863 | 1792 | 1792 | 1900 | 1881 | 1881 | 1900 | 1863 | 1863 | 1863 |
| Adj Flow Rate, veh/h         | 56   | 315  | 0    | 22   | 191  | 77   | 1079 | 67   | 10   | 45   | 56   | 22   |
| Adj No. of Lanes             | 2    | 1    | 1    | 2    | 2    | 0    | 3    | 2    | 0    | 1    | 2    | 1    |
| Peak Hour Factor             | 0.89 | 0.89 | 0.89 | 0.89 | 0.89 | 0.89 | 0.89 | 0.89 | 0.89 | 0.89 | 0.89 | 0.89 |
| Percent Heavy Veh, %         | 2    | 2    | 2    | 6    | 6    | 6    | 1    | 1    | 1    | 2    | 2    | 2    |
| Cap, veh/h                   | 148  | 404  | 343  | 70   | 466  | 181  | 1415 | 1159 | 169  | 66   | 450  | 201  |
| Arrive On Green              | 0.04 | 0.22 | 0.00 | 0.02 | 0.19 | 0.19 | 0.28 | 0.37 | 0.37 | 0.04 | 0.13 | 0.13 |
| Sat Flow, veh/h              | 3442 | 1863 | 1583 | 3312 | 2394 | 931  | 5052 | 3129 | 457  | 1774 | 3539 | 1576 |
| Grp Volume(v), veh/h         | 56   | 315  | 0    | 22   | 134  | 134  | 1079 | 38   | 39   | 45   | 56   | 22   |
| Grp Sat Flow(s),veh/h/ln     | 1721 | 1863 | 1583 | 1656 | 1703 | 1622 | 1684 | 1787 | 1800 | 1774 | 1770 | 1576 |
| Q Serve(g_s), s              | 0.8  | 8.1  | 0.0  | 0.3  | 3.5  | 3.7  | 9.9  | 0.7  | 0.7  | 1.3  | 0.7  | 0.6  |
| Cycle Q Clear(g_c), s        | 0.8  | 8.1  | 0.0  | 0.3  | 3.5  | 3.7  | 9.9  | 0.7  | 0.7  | 1.3  | 0.7  | 0.6  |
| Prop In Lane                 | 1.00 |      | 1.00 | 1.00 |      | 0.57 | 1.00 |      | 0.25 | 1.00 |      | 1.00 |
| Lane Grp Cap(c), veh/h       | 148  | 404  | 343  | 70   | 331  | 316  | 1415 | 662  | 667  | 66   | 450  | 201  |
| V/C Ratio(X)                 | 0.38 | 0.78 | 0.00 | 0.32 | 0.40 | 0.42 | 0.76 | 0.06 | 0.06 | 0.68 | 0.12 | 0.11 |
| Avail Cap(c_a), veh/h        | 271  | 569  | 484  | 261  | 520  | 496  | 1943 | 1276 | 1285 | 220  | 1605 | 715  |
| HCM Platoon Ratio            | 1.00 | 1.00 | 1.00 | 1.00 | 1.00 | 1.00 | 1.00 | 1.00 | 1.00 | 1.00 | 1.00 | 1.00 |
| Upstream Filter(I)           | 1.00 | 1.00 | 0.00 | 1.00 | 1.00 | 1.00 | 1.00 | 1.00 | 1.00 | 1.00 | 1.00 | 1.00 |
| Uniform Delay (d), s/veh     | 23.6 | 18.7 | 0.0  | 24.5 | 17.9 | 17.9 | 16.7 | 10.3 | 10.3 | 24.1 | 19.6 | 19.6 |
| Incr Delay (d2), s/veh       | 1.6  | 5.1  | 0.0  | 1.0  | 1.0  | 1.1  | 1.0  | 0.1  | 0.1  | 4.6  | 0.1  | 0.3  |
| Initial Q Delay(d3),s/veh    | 0.0  | 0.0  | 0.0  | 0.0  | 0.0  | 0.0  | 0.0  | 0.0  | 0.0  | 0.0  | 0.0  | 0.0  |
| %ile BackOfQ(50%),veh/ln     | 0.4  | 4.7  | 0.0  | 0.2  | 1.7  | 1.7  | 4.7  | 0.3  | 0.4  | 0.7  | 0.4  | 0.3  |
| LnGrp Delay(d),s/veh         | 25.2 | 23.9 | 0.0  | 25.4 | 18.8 | 19.0 | 17.7 | 10.3 | 10.4 | 28.7 | 19.8 | 19.9 |
| LnGrp LOS                    | C    | C    |      | C    | B    | B    | B    | B    | B    | C    | B    | B    |
| Approach Vol, veh/h          |      | 371  |      |      | 290  |      |      | 1156 |      |      | 123  |      |
| Approach Delay, s/veh        |      | 24.1 |      |      | 19.4 |      |      | 17.2 |      |      | 23.1 |      |
| Approach LOS                 |      | C    |      |      | B    |      |      | B    |      |      | C    |      |
| Timer                        | 1    | 2    | 3    | 4    | 5    | 6    | 7    | 8    |      |      |      |      |
| Assigned Phs                 | 1    | 2    | 3    | 4    | 5    | 6    | 7    | 8    |      |      |      |      |
| Phs Duration (G+Y+Rc), s     | 18.7 | 11.0 | 6.7  | 14.4 | 6.4  | 23.3 | 5.6  | 15.5 |      |      |      |      |
| Change Period (Y+Rc), s      | 4.5  | 4.5  | 4.5  | 4.5  | 4.5  | 4.5  | 4.5  | 4.5  |      |      |      |      |
| Max Green Setting (Gmax), s  | 19.5 | 23.0 | 4.0  | 15.5 | 6.3  | 36.2 | 4.0  | 15.5 |      |      |      |      |
| Max Q Clear Time (g_c+I1), s | 9.5  | 2.7  | 2.8  | 5.7  | 3.3  | 2.7  | 2.3  | 10.1 |      |      |      |      |
| Green Ext Time (p_c), s      | 2.3  | 0.3  | 0.0  | 1.3  | 0.0  | 0.7  | 0.0  | 0.9  |      |      |      |      |
| <b>Intersection Summary</b>  |      |      |      |      |      |      |      |      |      |      |      |      |
| HCM 2010 Ctrl Delay          |      |      |      | 19.2 |      |      |      |      |      |      |      |      |
| HCM 2010 LOS                 |      |      |      | B    |      |      |      |      |      |      |      |      |

HCM 2010 Roundabout Cumulative with Eastside Parkway with Project (Roundabouts), AM  
 33: General Jim Moore Boulevard & Lightfighter Drive 04/22/2022

| Intersection                |       |       |       |       |       |       |       |       |  |
|-----------------------------|-------|-------|-------|-------|-------|-------|-------|-------|--|
| Intersection Delay, s/veh   | 15.1  |       |       |       |       |       |       |       |  |
| Intersection LOS            | C     |       |       |       |       |       |       |       |  |
| Approach                    | EB    |       | WB    |       | NB    |       | SB    |       |  |
| Entry Lanes                 | 2     |       | 2     |       | 2     |       | 2     |       |  |
| Conflicting Circle Lanes    | 2     |       | 2     |       | 2     |       | 2     |       |  |
| Adj Approach Flow, veh/h    | 1304  |       | 292   |       | 1157  |       | 123   |       |  |
| Demand Flow Rate, veh/h     | 1330  |       | 309   |       | 1169  |       | 125   |       |  |
| Vehicles Circulating, veh/h | 126   |       | 1215  |       | 424   |       | 1315  |       |  |
| Vehicles Exiting, veh/h     | 1314  |       | 378   |       | 1032  |       | 209   |       |  |
| Follow-Up Headway, s        | 3.186 |       | 3.186 |       | 3.186 |       | 3.186 |       |  |
| Ped Vol Crossing Leg, #/h   | 2     |       | 1     |       | 2     |       | 0     |       |  |
| Ped Cap Adj                 | 0.998 |       | 1.000 |       | 0.999 |       | 1.000 |       |  |
| Approach Delay, s/veh       | 13.2  |       | 13.7  |       | 18.1  |       | 10.5  |       |  |
| Approach LOS                | B     |       | B     |       | C     |       | B     |       |  |
| Lane                        | Left  | Right | Left  | Right | Left  | Right | Left  | Right |  |
| Designated Moves            | LTR   | R     | LT    | TR    | L     | LTR   | LT    | TR    |  |
| Assumed Moves               | LTR   | R     | LT    | TR    | L     | LTR   | LT    | TR    |  |
| RT Channelized              |       |       |       |       |       |       |       |       |  |
| Lane Util                   | 0.470 | 0.530 | 0.469 | 0.531 | 0.530 | 0.470 | 0.472 | 0.528 |  |
| Critical Headway, s         | 4.293 | 4.113 | 4.293 | 4.113 | 4.293 | 4.113 | 4.293 | 4.113 |  |
| Entry Flow, veh/h           | 625   | 705   | 145   | 164   | 620   | 549   | 59    | 66    |  |
| Cap Entry Lane, veh/h       | 1028  | 1035  | 454   | 483   | 822   | 840   | 421   | 450   |  |
| Entry HV Adj Factor         | 0.980 | 0.980 | 0.945 | 0.942 | 0.989 | 0.991 | 0.979 | 0.987 |  |
| Flow Entry, veh/h           | 613   | 691   | 137   | 155   | 613   | 544   | 58    | 65    |  |
| Cap Entry, veh/h            | 1006  | 1012  | 429   | 455   | 812   | 831   | 413   | 444   |  |
| V/C Ratio                   | 0.609 | 0.683 | 0.319 | 0.340 | 0.755 | 0.655 | 0.140 | 0.147 |  |
| Control Delay, s/veh        | 12.0  | 14.3  | 13.9  | 13.6  | 20.5  | 15.4  | 10.8  | 10.2  |  |
| LOS                         | B     | B     | B     | B     | C     | C     | B     | B     |  |
| 95th %tile Queue, veh       | 4     | 6     | 1     | 1     | 7     | 5     | 0     | 1     |  |

HCM 2010 Signalized Intersection Summary  
 39: General Jim Moore Boulevard & Gigling Road

Cuml w/ Eastside Pkwy w/ Proj, AM  
 09/06/2019



| Movement                      | EBL  | EBT  | EBR  | WBL  | WBT  | WBR  | NBL  | NBT  | NBR  | SBL  | SBT  | SBR  |
|-------------------------------|------|------|------|------|------|------|------|------|------|------|------|------|
| Lane Configurations           |      |      |      |      |      |      |      |      |      |      |      |      |
| Traffic Volume (veh/h)        | 30   | 100  | 80   | 460  | 40   | 630  | 50   | 340  | 300  | 430  | 470  | 50   |
| Future Volume (veh/h)         | 30   | 100  | 80   | 460  | 40   | 630  | 50   | 340  | 300  | 430  | 470  | 50   |
| Number                        | 3    | 8    | 18   | 7    | 4    | 14   | 1    | 6    | 16   | 5    | 2    | 12   |
| Initial Q (Qb), veh           | 0    | 0    | 0    | 0    | 0    | 0    | 0    | 0    | 0    | 0    | 0    | 0    |
| Ped-Bike Adj(A_pbT)           | 1.00 |      | 1.00 | 1.00 |      | 1.00 | 1.00 |      | 1.00 | 1.00 |      | 1.00 |
| Parking Bus, Adj              | 1.00 | 1.00 | 1.00 | 1.00 | 1.00 | 1.00 | 1.00 | 1.00 | 1.00 | 1.00 | 1.00 | 1.00 |
| Adj Sat Flow, veh/h/ln        | 1810 | 1810 | 1810 | 1863 | 1863 | 1863 | 1881 | 1881 | 1881 | 1863 | 1863 | 1863 |
| Adj Flow Rate, veh/h          | 34   | 115  | 60   | 529  | 46   | 0    | 57   | 391  | 0    | 494  | 540  | 0    |
| Adj No. of Lanes              | 1    | 1    | 1    | 2    | 2    | 1    | 2    | 3    | 1    | 2    | 3    | 1    |
| Peak Hour Factor              | 0.87 | 0.87 | 0.87 | 0.87 | 0.87 | 0.87 | 0.87 | 0.87 | 0.87 | 0.87 | 0.87 | 0.87 |
| Percent Heavy Veh, %          | 5    | 5    | 5    | 2    | 2    | 2    | 1    | 1    | 1    | 2    | 2    | 2    |
| Cap, veh/h                    | 66   | 196  | 253  | 660  | 927  | 415  | 195  | 651  | 203  | 625  | 1282 | 399  |
| Arrive On Green               | 0.04 | 0.11 | 0.11 | 0.19 | 0.26 | 0.00 | 0.06 | 0.13 | 0.00 | 0.18 | 0.25 | 0.00 |
| Sat Flow, veh/h               | 1723 | 1810 | 1534 | 3442 | 3539 | 1583 | 3476 | 5136 | 1599 | 3442 | 5085 | 1583 |
| Grp Volume(v), veh/h          | 34   | 115  | 60   | 529  | 46   | 0    | 57   | 391  | 0    | 494  | 540  | 0    |
| Grp Sat Flow(s),veh/h/ln      | 1723 | 1810 | 1534 | 1721 | 1770 | 1583 | 1738 | 1712 | 1599 | 1721 | 1695 | 1583 |
| Q Serve(g_s), s               | 0.9  | 2.8  | 1.6  | 6.8  | 0.4  | 0.0  | 0.7  | 3.3  | 0.0  | 6.3  | 4.1  | 0.0  |
| Cycle Q Clear(g_c), s         | 0.9  | 2.8  | 1.6  | 6.8  | 0.4  | 0.0  | 0.7  | 3.3  | 0.0  | 6.3  | 4.1  | 0.0  |
| Prop In Lane                  | 1.00 |      | 1.00 | 1.00 |      | 1.00 | 1.00 |      | 1.00 | 1.00 |      | 1.00 |
| Lane Grp Cap(c), veh/h        | 66   | 196  | 253  | 660  | 927  | 415  | 195  | 651  | 203  | 625  | 1282 | 399  |
| V/C Ratio(X)                  | 0.52 | 0.59 | 0.24 | 0.80 | 0.05 | 0.00 | 0.29 | 0.60 | 0.00 | 0.79 | 0.42 | 0.00 |
| Avail Cap(c_a), veh/h         | 229  | 747  | 720  | 1115 | 2139 | 957  | 385  | 2691 | 838  | 1048 | 3648 | 1136 |
| HCM Platoon Ratio             | 1.00 | 1.00 | 1.00 | 1.00 | 1.00 | 1.00 | 1.00 | 1.00 | 1.00 | 1.00 | 1.00 | 1.00 |
| Upstream Filter(I)            | 1.00 | 1.00 | 1.00 | 1.00 | 1.00 | 0.00 | 1.00 | 1.00 | 0.00 | 1.00 | 1.00 | 0.00 |
| Uniform Delay (d), s/veh      | 21.7 | 19.5 | 16.7 | 17.8 | 12.7 | 0.0  | 20.8 | 19.0 | 0.0  | 18.0 | 14.4 | 0.0  |
| Incr Delay (d2), s/veh        | 2.3  | 1.0  | 0.2  | 0.9  | 0.0  | 0.0  | 0.3  | 0.3  | 0.0  | 0.9  | 0.1  | 0.0  |
| Initial Q Delay(d3),s/veh     | 0.0  | 0.0  | 0.0  | 0.0  | 0.0  | 0.0  | 0.0  | 0.0  | 0.0  | 0.0  | 0.0  | 0.0  |
| %ile BackOfQ(50%),veh/ln      | 0.5  | 1.4  | 0.7  | 3.2  | 0.2  | 0.0  | 0.4  | 1.6  | 0.0  | 3.0  | 1.9  | 0.0  |
| LnGrp Delay(d),s/veh          | 24.0 | 20.5 | 16.9 | 18.6 | 12.7 | 0.0  | 21.1 | 19.3 | 0.0  | 18.8 | 14.5 | 0.0  |
| LnGrp LOS                     | C    | C    | B    | B    | B    |      | C    | B    |      | B    | B    |      |
| Approach Vol, veh/h           |      | 209  |      |      | 575  |      |      | 448  |      |      | 1034 |      |
| Approach Delay, s/veh         |      | 20.1 |      |      | 18.2 |      |      | 19.5 |      |      | 16.6 |      |
| Approach LOS                  |      | C    |      |      | B    |      |      | B    |      |      | B    |      |
| Timer                         | 1    | 2    | 3    | 4    | 5    | 6    | 7    | 8    |      |      |      |      |
| Assigned Phs                  | 1    | 2    | 3    | 4    | 5    | 6    | 7    | 8    |      |      |      |      |
| Phs Duration (G+Y+Rc), s      | 7.1  | 16.1 | 6.3  | 16.5 | 12.9 | 10.3 | 13.3 | 9.5  |      |      |      |      |
| Change Period (Y+Rc), s       | 4.5  | 4.5  | 4.5  | 4.5  | 4.5  | 4.5  | 4.5  | 4.5  |      |      |      |      |
| Max Green Setting (Gmax), s   | 33.0 | 33.0 | 6.1  | 27.8 | 14.0 | 24.1 | 14.9 | 19.0 |      |      |      |      |
| Max Q Clear Time (g_c+1/2), s | 12.5 | 6.1  | 2.9  | 2.4  | 8.3  | 5.3  | 8.8  | 4.8  |      |      |      |      |
| Green Ext Time (p_c), s       | 0.0  | 0.8  | 0.0  | 0.0  | 0.1  | 0.5  | 0.1  | 0.1  |      |      |      |      |
| <b>Intersection Summary</b>   |      |      |      |      |      |      |      |      |      |      |      |      |
| HCM 2010 Ctrl Delay           |      |      |      |      | 17.9 |      |      |      |      |      |      |      |
| HCM 2010 LOS                  |      |      |      |      | B    |      |      |      |      |      |      |      |

HCM 2010 Roundabout Cumulative with Eastside Parkway with Project (Roundabouts), AM  
 39: General Jim Moore Boulevard & Gigling Road 04/22/2022

| Intersection                |       |       |       |       |       |       |       |       |  |
|-----------------------------|-------|-------|-------|-------|-------|-------|-------|-------|--|
| Intersection Delay, s/veh   | 24.6  |       |       |       |       |       |       |       |  |
| Intersection LOS            | C     |       |       |       |       |       |       |       |  |
| Approach                    | EB    |       | WB    |       | NB    |       | SB    |       |  |
| Entry Lanes                 | 2     |       | 2     |       | 2     |       | 2     |       |  |
| Conflicting Circle Lanes    | 2     |       | 2     |       | 2     |       | 2     |       |  |
| Adj Approach Flow, veh/h    | 241   |       | 1299  |       | 793   |       | 1091  |       |  |
| Demand Flow Rate, veh/h     | 254   |       | 1325  |       | 801   |       | 1113  |       |  |
| Vehicles Circulating, veh/h | 1595  |       | 489   |       | 661   |       | 645   |       |  |
| Vehicles Exiting, veh/h     | 163   |       | 973   |       | 1188  |       | 1169  |       |  |
| Follow-Up Headway, s        | 3.186 |       | 3.186 |       | 3.186 |       | 3.186 |       |  |
| Ped Vol Crossing Leg, #/h   | 0     |       | 0     |       | 0     |       | 1     |       |  |
| Ped Cap Adj                 | 1.000 |       | 1.000 |       | 1.000 |       | 1.000 |       |  |
| Approach Delay, s/veh       | 18.2  |       | 30.6  |       | 14.8  |       | 25.8  |       |  |
| Approach LOS                | C     |       | D     |       | B     |       | D     |       |  |
| Lane                        | Left  | Right | Left  | Right | Left  | Right | Left  | Right |  |
| Designated Moves            | LT    | TR    | LT    | TR    | LT    | TR    | LT    | TR    |  |
| Assumed Moves               | LT    | TR    | LT    | R     | LT    | TR    | LT    | TR    |  |
| RT Channelized              |       |       |       |       |       |       |       |       |  |
| Lane Util                   | 0.469 | 0.531 | 0.443 | 0.557 | 0.469 | 0.531 | 0.470 | 0.530 |  |
| Critical Headway, s         | 4.293 | 4.113 | 4.293 | 4.113 | 4.293 | 4.113 | 4.293 | 4.113 |  |
| Entry Flow, veh/h           | 119   | 135   | 587   | 738   | 376   | 425   | 523   | 590   |  |
| Cap Entry Lane, veh/h       | 342   | 370   | 783   | 802   | 688   | 711   | 697   | 719   |  |
| Entry HV Adj Factor         | 0.953 | 0.947 | 0.980 | 0.981 | 0.991 | 0.989 | 0.981 | 0.980 |  |
| Flow Entry, veh/h           | 113   | 128   | 575   | 724   | 373   | 420   | 513   | 578   |  |
| Cap Entry, veh/h            | 325   | 350   | 767   | 787   | 682   | 704   | 683   | 705   |  |
| V/C Ratio                   | 0.348 | 0.365 | 0.750 | 0.920 | 0.546 | 0.597 | 0.751 | 0.820 |  |
| Control Delay, s/veh        | 18.6  | 17.9  | 21.1  | 38.2  | 14.2  | 15.4  | 23.2  | 28.1  |  |
| LOS                         | C     | C     | C     | E     | B     | C     | C     | D     |  |
| 95th %tile Queue, veh       | 2     | 2     | 7     | 13    | 3     | 4     | 7     | 9     |  |

HCM 2010 Signalized Intersection Summary  
 46: General Jim Moore Boulevard & Normandy Road

Cuml w/ Eastside Pkwy w/ Proj, AM  
 09/06/2019



| Movement                      | EBL  | EBT  | EBR  | WBL  | WBT  | WBR  | NBL   | NBT  | NBR  | SBL   | SBT  | SBR  |
|-------------------------------|------|------|------|------|------|------|-------|------|------|-------|------|------|
| Lane Configurations           |      | ↕    |      |      | ↕    |      | ↕ ↑↑↑ |      |      | ↕ ↑↑↑ |      | ↕    |
| Traffic Volume (veh/h)        | 90   | 110  | 150  | 380  | 80   | 40   | 200   | 420  | 310  | 80    | 760  | 250  |
| Future Volume (veh/h)         | 90   | 110  | 150  | 380  | 80   | 40   | 200   | 420  | 310  | 80    | 760  | 250  |
| Number                        | 3    | 8    | 18   | 7    | 4    | 14   | 1     | 6    | 16   | 5     | 2    | 12   |
| Initial Q (Qb), veh           | 0    | 0    | 0    | 0    | 0    | 0    | 0     | 0    | 0    | 0     | 0    | 0    |
| Ped-Bike Adj(A_pbT)           | 1.00 |      | 0.98 | 0.99 |      | 0.98 | 1.00  |      | 0.99 | 1.00  |      | 0.98 |
| Parking Bus, Adj              | 1.00 | 1.00 | 1.00 | 1.00 | 1.00 | 1.00 | 1.00  | 1.00 | 1.00 | 1.00  | 1.00 | 1.00 |
| Adj Sat Flow, veh/h/ln        | 1900 | 1881 | 1900 | 1900 | 1863 | 1900 | 1881  | 1881 | 1900 | 1863  | 1863 | 1863 |
| Adj Flow Rate, veh/h          | 115  | 141  | 163  | 487  | 103  | 47   | 256   | 538  | 370  | 103   | 974  | 252  |
| Adj No. of Lanes              | 0    | 1    | 0    | 0    | 1    | 0    | 1     | 3    | 0    | 1     | 3    | 1    |
| Peak Hour Factor              | 0.78 | 0.78 | 0.78 | 0.78 | 0.78 | 0.78 | 0.78  | 0.78 | 0.78 | 0.78  | 0.78 | 0.78 |
| Percent Heavy Veh, %          | 1    | 1    | 1    | 2    | 2    | 2    | 1     | 1    | 1    | 2     | 2    | 2    |
| Cap, veh/h                    | 283  | 347  | 374  | 513  | 96   | 44   | 205   | 859  | 396  | 128   | 1060 | 325  |
| Arrive On Green               | 0.55 | 0.55 | 0.55 | 0.55 | 0.55 | 0.55 | 0.11  | 0.25 | 0.25 | 0.07  | 0.21 | 0.21 |
| Sat Flow, veh/h               | 434  | 626  | 675  | 821  | 174  | 79   | 1792  | 3424 | 1577 | 1774  | 5085 | 1557 |
| Grp Volume(v), veh/h          | 419  | 0    | 0    | 637  | 0    | 0    | 256   | 538  | 370  | 103   | 974  | 252  |
| Grp Sat Flow(s),veh/h/ln      | 1736 | 0    | 0    | 1074 | 0    | 0    | 1792  | 1712 | 1577 | 1774  | 1695 | 1557 |
| Q Serve(g_s), s               | 0.0  | 0.0  | 0.0  | 45.0 | 0.0  | 0.0  | 12.5  | 15.3 | 25.1 | 6.3   | 20.5 | 16.7 |
| Cycle Q Clear(g_c), s         | 15.5 | 0.0  | 0.0  | 60.5 | 0.0  | 0.0  | 12.5  | 15.3 | 25.1 | 6.3   | 20.5 | 16.7 |
| Prop In Lane                  | 0.27 |      | 0.39 | 0.76 |      | 0.07 | 1.00  |      | 1.00 | 1.00  |      | 1.00 |
| Lane Grp Cap(c), veh/h        | 1003 | 0    | 0    | 653  | 0    | 0    | 205   | 859  | 396  | 128   | 1060 | 325  |
| V/C Ratio(X)                  | 0.42 | 0.00 | 0.00 | 0.98 | 0.00 | 0.00 | 1.25  | 0.63 | 0.94 | 0.81  | 0.92 | 0.78 |
| Avail Cap(c_a), veh/h         | 1003 | 0    | 0    | 653  | 0    | 0    | 205   | 893  | 411  | 128   | 1093 | 335  |
| HCM Platoon Ratio             | 1.00 | 1.00 | 1.00 | 1.00 | 1.00 | 1.00 | 1.00  | 1.00 | 1.00 | 1.00  | 1.00 | 1.00 |
| Upstream Filter(I)            | 1.00 | 0.00 | 0.00 | 1.00 | 0.00 | 0.00 | 1.00  | 1.00 | 1.00 | 1.00  | 1.00 | 1.00 |
| Uniform Delay (d), s/veh      | 14.3 | 0.0  | 0.0  | 28.3 | 0.0  | 0.0  | 48.4  | 36.4 | 40.1 | 50.0  | 42.3 | 40.8 |
| Incr Delay (d2), s/veh        | 0.1  | 0.0  | 0.0  | 29.0 | 0.0  | 0.0  | 146.0 | 0.9  | 27.6 | 28.5  | 11.6 | 9.6  |
| Initial Q Delay(d3),s/veh     | 0.0  | 0.0  | 0.0  | 0.0  | 0.0  | 0.0  | 0.0   | 0.0  | 0.0  | 0.0   | 0.0  | 0.0  |
| %ile BackOfQ(50%),veh/ln      | 7.4  | 0.0  | 0.0  | 24.4 | 0.0  | 0.0  | 14.5  | 7.3  | 13.9 | 4.1   | 10.7 | 8.1  |
| LnGrp Delay(d),s/veh          | 14.4 | 0.0  | 0.0  | 57.3 | 0.0  | 0.0  | 194.4 | 37.3 | 67.6 | 78.4  | 54.0 | 50.4 |
| LnGrp LOS                     | B    |      |      | E    |      |      | F     | D    | E    | E     | D    | D    |
| Approach Vol, veh/h           |      | 419  |      |      | 637  |      |       | 1164 |      |       | 1329 |      |
| Approach Delay, s/veh         |      | 14.4 |      |      | 57.3 |      |       | 81.5 |      |       | 55.2 |      |
| Approach LOS                  |      | B    |      |      | E    |      |       | F    |      |       | E    |      |
| Timer                         | 1    | 2    | 3    | 4    | 5    | 6    | 7     | 8    |      |       |      |      |
| Assigned Phs                  | 1    | 2    |      | 4    | 5    | 6    |       | 8    |      |       |      |      |
| Phs Duration (G+Y+Rc), s      | 7.0  | 27.3 |      | 65.0 | 12.4 | 31.9 |       | 65.0 |      |       |      |      |
| Change Period (Y+Rc), s       | 4.5  | 4.5  |      | 4.5  | 4.5  | 4.5  |       | 4.5  |      |       |      |      |
| Max Green Setting (Gmax), s   | 12.5 | 23.5 |      | 60.5 | 7.5  | 28.5 |       | 60.5 |      |       |      |      |
| Max Q Clear Time (g_c+1/4), s | 14.5 | 22.5 |      | 62.5 | 8.3  | 27.1 |       | 17.5 |      |       |      |      |
| Green Ext Time (p_c), s       | 0.0  | 0.3  |      | 0.0  | 0.0  | 0.3  |       | 0.6  |      |       |      |      |
| <b>Intersection Summary</b>   |      |      |      |      |      |      |       |      |      |       |      |      |
| HCM 2010 Ctrl Delay           |      |      |      | 59.4 |      |      |       |      |      |       |      |      |
| HCM 2010 LOS                  |      |      |      | E    |      |      |       |      |      |       |      |      |

HCM 2010 Signalized Intersection Summary  
5: 2nd Avenue & Imjin Parkway

Cuml w/ Eastside Pkwy w/ Proj, PM  
09/06/2019



| Movement                    | EBL  | EBT  | EBR  | WBL  | WBT  | WBR  | NBL  | NBT  | NBR  | SBL  | SBT  | SBR  |
|-----------------------------|------|------|------|------|------|------|------|------|------|------|------|------|
| Lane Configurations         | ↖↗   | ↗↖   | ↖↗   | ↖↗↖↗ | ↖↗↖↗ | ↖↗   | ↖↗↖↗ | ↑    | ↖↗   | ↖↗   | ↖↗   | ↖↗   |
| Traffic Volume (veh/h)      | 140  | 1010 | 760  | 330  | 1060 | 140  | 900  | 110  | 500  | 90   | 100  | 150  |
| Future Volume (veh/h)       | 140  | 1010 | 760  | 330  | 1060 | 140  | 900  | 110  | 500  | 90   | 100  | 150  |
| Number                      | 5    | 2    | 12   | 1    | 6    | 16   | 3    | 8    | 18   | 7    | 4    | 14   |
| Initial Q (Qb), veh         | 0    | 0    | 0    | 0    | 0    | 0    | 0    | 0    | 0    | 0    | 0    | 0    |
| Ped-Bike Adj(A_pbT)         | 1.00 |      | 0.99 | 1.00 |      | 0.99 | 1.00 |      | 0.99 | 1.00 |      | 0.98 |
| Parking Bus, Adj            | 1.00 | 1.00 | 1.00 | 1.00 | 1.00 | 1.00 | 1.00 | 1.00 | 1.00 | 1.00 | 1.00 | 1.00 |
| Adj Sat Flow, veh/h/ln      | 1881 | 1881 | 1881 | 1881 | 1881 | 1881 | 1900 | 1900 | 1900 | 1900 | 1900 | 1900 |
| Adj Flow Rate, veh/h        | 146  | 1052 | 592  | 344  | 1104 | 146  | 938  | 115  | 287  | 94   | 104  | 125  |
| Adj No. of Lanes            | 2    | 3    | 2    | 3    | 3    | 1    | 3    | 1    | 2    | 2    | 2    | 1    |
| Peak Hour Factor            | 0.96 | 0.96 | 0.96 | 0.96 | 0.96 | 0.96 | 0.96 | 0.96 | 0.96 | 0.96 | 0.96 | 0.96 |
| Percent Heavy Veh, %        | 1    | 1    | 1    | 1    | 1    | 1    | 0    | 0    | 0    | 0    | 0    | 0    |
| Cap, veh/h                  | 259  | 1356 | 736  | 507  | 1489 | 555  | 1091 | 525  | 775  | 209  | 440  | 193  |
| Arrive On Green             | 0.07 | 0.26 | 0.26 | 0.10 | 0.29 | 0.29 | 0.21 | 0.28 | 0.28 | 0.06 | 0.12 | 0.12 |
| Sat Flow, veh/h             | 3476 | 5136 | 2788 | 5052 | 5136 | 1585 | 5103 | 1900 | 2806 | 3510 | 3610 | 1587 |
| Grp Volume(v), veh/h        | 146  | 1052 | 592  | 344  | 1104 | 146  | 938  | 115  | 287  | 94   | 104  | 125  |
| Grp Sat Flow(s),veh/h/ln    | 1738 | 1712 | 1394 | 1684 | 1712 | 1585 | 1701 | 1900 | 1403 | 1755 | 1805 | 1587 |
| Q Serve(g_s), s             | 2.4  | 11.3 | 11.8 | 3.9  | 11.6 | 3.9  | 10.6 | 2.8  | 4.9  | 1.5  | 1.6  | 4.5  |
| Cycle Q Clear(g_c), s       | 2.4  | 11.3 | 11.8 | 3.9  | 11.6 | 3.9  | 10.6 | 2.8  | 4.9  | 1.5  | 1.6  | 4.5  |
| Prop In Lane                | 1.00 |      | 1.00 | 1.00 |      | 1.00 | 1.00 |      | 1.00 | 1.00 |      | 1.00 |
| Lane Grp Cap(c), veh/h      | 259  | 1356 | 736  | 507  | 1489 | 555  | 1091 | 525  | 775  | 209  | 440  | 193  |
| V/C Ratio(X)                | 0.56 | 0.78 | 0.80 | 0.68 | 0.74 | 0.26 | 0.86 | 0.22 | 0.37 | 0.45 | 0.24 | 0.65 |
| Avail Cap(c_a), veh/h       | 874  | 2581 | 1401 | 1270 | 2581 | 892  | 1710 | 669  | 987  | 588  | 1270 | 558  |
| HCM Platoon Ratio           | 1.00 | 1.00 | 1.00 | 1.00 | 1.00 | 1.00 | 1.00 | 1.00 | 1.00 | 1.00 | 1.00 | 1.00 |
| Upstream Filter(I)          | 1.00 | 1.00 | 1.00 | 1.00 | 1.00 | 1.00 | 1.00 | 1.00 | 1.00 | 1.00 | 1.00 | 1.00 |
| Uniform Delay (d), s/veh    | 26.7 | 20.3 | 20.5 | 25.9 | 19.2 | 13.9 | 22.6 | 16.6 | 17.4 | 27.1 | 23.7 | 25.0 |
| Incr Delay (d2), s/veh      | 0.7  | 0.4  | 0.8  | 0.6  | 0.3  | 0.1  | 1.7  | 0.1  | 0.1  | 0.6  | 0.1  | 1.3  |
| Initial Q Delay(d3),s/veh   | 0.0  | 0.0  | 0.0  | 0.0  | 0.0  | 0.0  | 0.0  | 0.0  | 0.0  | 0.0  | 0.0  | 0.0  |
| %ile BackOfQ(50%),veh/ln    | 1.2  | 5.4  | 4.6  | 1.8  | 5.5  | 1.7  | 5.1  | 1.5  | 1.9  | 0.8  | 0.8  | 2.0  |
| LnGrp Delay(d),s/veh        | 27.4 | 20.7 | 21.3 | 26.5 | 19.4 | 14.0 | 24.3 | 16.7 | 17.5 | 27.7 | 23.8 | 26.3 |
| LnGrp LOS                   | C    | C    | C    | C    | B    | B    | C    | B    | B    | C    | C    | C    |
| Approach Vol, veh/h         |      | 1790 |      |      | 1594 |      |      | 1340 |      |      | 323  |      |
| Approach Delay, s/veh       |      | 21.5 |      |      | 20.5 |      |      | 22.2 |      |      | 25.9 |      |
| Approach LOS                |      | C    |      |      | C    |      |      | C    |      |      | C    |      |
| Timer                       | 1    | 2    | 3    | 4    | 5    | 6    | 7    | 8    |      |      |      |      |
| Assigned Phs                | 1    | 2    | 3    | 4    | 5    | 6    | 7    | 8    |      |      |      |      |
| Phs Duration (G+Y+Rc), s    | 10.5 | 21.1 | 16.3 | 11.9 | 8.9  | 22.6 | 7.1  | 21.1 |      |      |      |      |
| Change Period (Y+Rc), s     | 4.5  | 5.3  | 3.5  | 4.6  | 4.5  | 5.3  | 3.5  | 4.6  |      |      |      |      |
| Max Green Setting (Gmax), s | 15.0 | 30.0 | 20.0 | 21.0 | 15.0 | 30.0 | 10.0 | 21.0 |      |      |      |      |
| Max Q Clear Time (g_c+I), s | 15.0 | 13.8 | 12.6 | 6.5  | 4.4  | 13.6 | 3.5  | 6.9  |      |      |      |      |
| Green Ext Time (p_c), s     | 0.1  | 1.8  | 0.2  | 0.1  | 0.0  | 1.7  | 0.0  | 0.2  |      |      |      |      |
| <b>Intersection Summary</b> |      |      |      |      |      |      |      |      |      |      |      |      |
| HCM 2010 Ctrl Delay         |      |      |      | 21.6 |      |      |      |      |      |      |      |      |
| HCM 2010 LOS                |      |      |      | C    |      |      |      |      |      |      |      |      |

HCM 2010 Signalized Intersection Summary  
 12: Reservation Road & Imjin Parkway

Cuml w/ Eastside Pkwy w/ Proj, PM  
 09/06/2019



| Movement                    | EBL  | EBT   | EBR  | WBL  | WBT  | WBR   | NBL   | NBT  | NBR  | SBL  | SBT  | SBR  |
|-----------------------------|------|-------|------|------|------|-------|-------|------|------|------|------|------|
| Lane Configurations         | ↔↔   | ↑     | ↔↔   | ↔    | ↑    | ↔     | ↔↔    | ↑↑   | ↔    | ↔↔   | ↑↑↑  | ↔    |
| Traffic Volume (veh/h)      | 110  | 20    | 1280 | 10   | 40   | 30    | 820   | 630  | 10   | 20   | 940  | 190  |
| Future Volume (veh/h)       | 110  | 20    | 1280 | 10   | 40   | 30    | 820   | 630  | 10   | 20   | 940  | 190  |
| Number                      | 3    | 8     | 18   | 7    | 4    | 14    | 1     | 6    | 16   | 5    | 2    | 12   |
| Initial Q (Qb), veh         | 0    | 0     | 0    | 0    | 0    | 0     | 0     | 0    | 0    | 0    | 0    | 0    |
| Ped-Bike Adj(A_pbT)         | 1.00 |       | 1.00 | 1.00 |      | 0.99  | 1.00  |      | 1.00 | 1.00 |      | 1.00 |
| Parking Bus, Adj            | 1.00 | 1.00  | 1.00 | 1.00 | 1.00 | 1.00  | 1.00  | 1.00 | 1.00 | 1.00 | 1.00 | 1.00 |
| Adj Sat Flow, veh/h/ln      | 1881 | 1881  | 1881 | 1827 | 1827 | 1827  | 1881  | 1881 | 1881 | 1881 | 1881 | 1881 |
| Adj Flow Rate, veh/h        | 124  | 22    | 1037 | 11   | 45   | 12    | 921   | 708  | 10   | 22   | 1056 | 79   |
| Adj No. of Lanes            | 2    | 1     | 2    | 1    | 1    | 1     | 2     | 2    | 1    | 2    | 3    | 1    |
| Peak Hour Factor            | 0.89 | 0.89  | 0.89 | 0.89 | 0.89 | 0.89  | 0.89  | 0.89 | 0.89 | 0.89 | 0.89 | 0.89 |
| Percent Heavy Veh, %        | 1    | 1     | 1    | 4    | 4    | 4     | 1     | 1    | 1    | 1    | 1    | 1    |
| Cap, veh/h                  | 860  | 465   | 1390 | 76   | 80   | 67    | 860   | 1949 | 872  | 57   | 1614 | 503  |
| Arrive On Green             | 0.25 | 0.25  | 0.25 | 0.04 | 0.04 | 0.04  | 0.25  | 0.55 | 0.55 | 0.02 | 0.31 | 0.31 |
| Sat Flow, veh/h             | 3476 | 1881  | 2803 | 1740 | 1827 | 1532  | 3476  | 3574 | 1599 | 3476 | 5136 | 1599 |
| Grp Volume(v), veh/h        | 124  | 22    | 1037 | 11   | 45   | 12    | 921   | 708  | 10   | 22   | 1056 | 79   |
| Grp Sat Flow(s),veh/h/ln    | 1738 | 1881  | 1401 | 1740 | 1827 | 1532  | 1738  | 1787 | 1599 | 1738 | 1712 | 1599 |
| Q Serve(g_s), s             | 3.9  | 1.3   | 35.0 | 0.9  | 3.4  | 1.1   | 35.0  | 15.9 | 0.4  | 0.9  | 25.1 | 5.0  |
| Cycle Q Clear(g_c), s       | 3.9  | 1.3   | 35.0 | 0.9  | 3.4  | 1.1   | 35.0  | 15.9 | 0.4  | 0.9  | 25.1 | 5.0  |
| Prop In Lane                | 1.00 |       | 1.00 | 1.00 |      | 1.00  | 1.00  |      | 1.00 | 1.00 |      | 1.00 |
| Lane Grp Cap(c), veh/h      | 860  | 465   | 1390 | 76   | 80   | 67    | 860   | 1949 | 872  | 57   | 1614 | 503  |
| V/C Ratio(X)                | 0.14 | 0.05  | 0.75 | 0.14 | 0.56 | 0.18  | 1.07  | 0.36 | 0.01 | 0.39 | 0.65 | 0.16 |
| Avail Cap(c_a), veh/h       | 860  | 465   | 1390 | 381  | 400  | 336   | 860   | 1949 | 872  | 491  | 2178 | 678  |
| HCM Platoon Ratio           | 1.00 | 1.00  | 1.00 | 1.00 | 1.00 | 1.00  | 1.00  | 1.00 | 1.00 | 1.00 | 1.00 | 1.00 |
| Upstream Filter(I)          | 1.00 | 1.00  | 1.00 | 1.00 | 1.00 | 1.00  | 1.00  | 1.00 | 1.00 | 1.00 | 1.00 | 1.00 |
| Uniform Delay (d), s/veh    | 41.5 | 40.5  | 28.6 | 65.1 | 66.3 | 65.2  | 53.2  | 18.2 | 14.7 | 68.9 | 41.9 | 35.0 |
| Incr Delay (d2), s/veh      | 0.0  | 0.0   | 2.0  | 0.3  | 2.3  | 0.5   | 51.5  | 0.3  | 0.0  | 1.6  | 1.2  | 0.4  |
| Initial Q Delay(d3),s/veh   | 0.0  | 0.0   | 0.0  | 0.0  | 0.0  | 0.0   | 0.0   | 0.0  | 0.0  | 0.0  | 0.0  | 0.0  |
| %ile BackOfQ(50%),veh/ln    | 1.9  | 0.7   | 16.6 | 0.4  | 1.8  | 0.5   | 22.9  | 8.0  | 0.2  | 0.4  | 12.0 | 2.3  |
| LnGrp Delay(d),s/veh        | 41.6 | 40.5  | 30.6 | 65.4 | 68.6 | 65.6  | 104.7 | 18.5 | 14.7 | 70.5 | 43.1 | 35.4 |
| LnGrp LOS                   | D    | D     | C    | E    | E    | E     | F     | B    | B    | E    | D    | D    |
| Approach Vol, veh/h         |      | 1183  |      |      | 68   |       |       | 1639 |      |      | 1157 |      |
| Approach Delay, s/veh       |      | 32.0  |      |      | 67.5 |       |       | 67.0 |      |      | 43.1 |      |
| Approach LOS                |      | C     |      |      | E    |       |       | E    |      |      | D    |      |
| Timer                       | 1    | 2     | 3    | 4    | 5    | 6     | 7     | 8    |      |      |      |      |
| Assigned Phs                | 1    | 2     |      | 4    | 5    | 6     |       | 8    |      |      |      |      |
| Phs Duration (G+Y+Rc), s    | 39.1 | 50.7  |      | 11.2 | 6.4  | 83.3  |       | 40.5 |      |      |      |      |
| Change Period (Y+Rc), s     | 4.1  | * 6.2 |      | 5.0  | 4.1  | * 6.2 |       | 5.5  |      |      |      |      |
| Max Green Setting (Gmax), s | 35.0 | * 60  |      | 31.0 | 20.0 | * 50  |       | 35.0 |      |      |      |      |
| Max Q Clear Time (g_c+R), s | 17.0 | 27.1  |      | 5.4  | 2.9  | 17.9  |       | 37.0 |      |      |      |      |
| Green Ext Time (p_c), s     | 0.0  | 17.3  |      | 0.2  | 0.0  | 10.6  |       | 0.0  |      |      |      |      |
| <b>Intersection Summary</b> |      |       |      |      |      |       |       |      |      |      |      |      |
| HCM 2010 Ctrl Delay         |      |       | 49.9 |      |      |       |       |      |      |      |      |      |
| HCM 2010 LOS                |      |       | D    |      |      |       |       |      |      |      |      |      |
| <b>Notes</b>                |      |       |      |      |      |       |       |      |      |      |      |      |

HCM 2010 Signalized Intersection Summary  
 14: Reservation Road & Inter-Garrison Road

Cuml w/ Eastside Pkwy w/ Proj, PM  
 09/06/2019



| Movement                     | EBL  | EBR  | NBL   | NBT   | SBT  | SBR  |   |      |
|------------------------------|------|------|-------|-------|------|------|---|------|
| Lane Configurations          |      |      |       |       |      |      |   |      |
| Traffic Volume (veh/h)       | 80   | 960  | 620   | 380   | 940  | 210  |   |      |
| Future Volume (veh/h)        | 80   | 960  | 620   | 380   | 940  | 210  |   |      |
| Number                       | 3    | 18   | 1     | 6     | 2    | 12   |   |      |
| Initial Q (Qb), veh          | 0    | 0    | 0     | 0     | 0    | 0    |   |      |
| Ped-Bike Adj(A_pbT)          | 1.00 | 1.00 | 1.00  |       |      | 1.00 |   |      |
| Parking Bus, Adj             | 1.00 | 1.00 | 1.00  | 1.00  | 1.00 | 1.00 |   |      |
| Adj Sat Flow, veh/h/ln       | 1881 | 1881 | 1845  | 1845  | 1881 | 1900 |   |      |
| Adj Flow Rate, veh/h         | 98   | 1016 | 756   | 463   | 1146 | 247  |   |      |
| Adj No. of Lanes             | 1    | 2    | 2     | 2     | 2    | 0    |   |      |
| Peak Hour Factor             | 0.82 | 0.82 | 0.82  | 0.82  | 0.82 | 0.82 |   |      |
| Percent Heavy Veh, %         | 1    | 1    | 3     | 3     | 1    | 1    |   |      |
| Cap, veh/h                   | 412  | 1126 | 580   | 2374  | 1368 | 293  |   |      |
| Arrive On Green              | 0.23 | 0.23 | 0.17  | 0.68  | 0.47 | 0.47 |   |      |
| Sat Flow, veh/h              | 1792 | 2814 | 3408  | 3597  | 3024 | 627  |   |      |
| Grp Volume(v), veh/h         | 98   | 1016 | 756   | 463   | 696  | 697  |   |      |
| Grp Sat Flow(s),veh/h/ln     | 1792 | 1407 | 1704  | 1752  | 1787 | 1770 |   |      |
| Q Serve(g_s), s              | 5.2  | 27.0 | 20.0  | 5.8   | 39.9 | 40.7 |   |      |
| Cycle Q Clear(g_c), s        | 5.2  | 27.0 | 20.0  | 5.8   | 39.9 | 40.7 |   |      |
| Prop In Lane                 | 1.00 | 1.00 | 1.00  |       |      | 0.35 |   |      |
| Lane Grp Cap(c), veh/h       | 412  | 1126 | 580   | 2374  | 835  | 827  |   |      |
| V/C Ratio(X)                 | 0.24 | 0.90 | 1.30  | 0.20  | 0.83 | 0.84 |   |      |
| Avail Cap(c_a), veh/h        | 412  | 1126 | 580   | 2374  | 913  | 904  |   |      |
| HCM Platoon Ratio            | 1.00 | 1.00 | 1.00  | 1.00  | 1.00 | 1.00 |   |      |
| Upstream Filter(I)           | 1.00 | 1.00 | 1.00  | 1.00  | 1.00 | 1.00 |   |      |
| Uniform Delay (d), s/veh     | 36.8 | 33.1 | 48.7  | 7.0   | 27.3 | 27.5 |   |      |
| Incr Delay (d2), s/veh       | 0.3  | 10.1 | 148.4 | 0.1   | 7.1  | 7.7  |   |      |
| Initial Q Delay(d3),s/veh    | 0.0  | 0.0  | 0.0   | 0.0   | 0.0  | 0.0  |   |      |
| %ile BackOfQ(50%),veh/ln     | 2.6  | 17.0 | 21.3  | 2.8   | 21.2 | 21.5 |   |      |
| LnGrp Delay(d),s/veh         | 37.1 | 43.2 | 197.1 | 7.1   | 34.4 | 35.2 |   |      |
| LnGrp LOS                    | D    | D    | F     | A     | C    | D    |   |      |
| Approach Vol, veh/h          | 1114 |      |       | 1219  | 1393 |      |   |      |
| Approach Delay, s/veh        | 42.7 |      |       | 125.0 | 34.8 |      |   |      |
| Approach LOS                 | D    |      |       | F     | C    |      |   |      |
| Timer                        | 1    | 2    | 3     | 4     | 5    | 6    | 7 | 8    |
| Assigned Phs                 | 1    | 2    |       |       |      | 6    |   | 8    |
| Phs Duration (G+Y+Rc), s     | 24.7 | 61.2 |       |       |      | 85.9 |   | 31.5 |
| Change Period (Y+Rc), s      | 4.7  | 6.4  |       |       |      | 6.4  |   | 4.5  |
| Max Green Setting (Gmax), s  | 26   | 60.0 |       |       |      | 60.0 |   | 27.0 |
| Max Q Clear Time (g_c+Yc), s | 22.6 | 42.7 |       |       |      | 7.8  |   | 29.0 |
| Green Ext Time (p_c), s      | 0.0  | 12.2 |       |       |      | 5.4  |   | 0.0  |
| <b>Intersection Summary</b>  |      |      |       |       |      |      |   |      |
| HCM 2010 Ctrl Delay          |      |      | 66.6  |       |      |      |   |      |
| HCM 2010 LOS                 |      |      | E     |       |      |      |   |      |
| <b>Notes</b>                 |      |      |       |       |      |      |   |      |



HCM 2010 Signalized Intersection Summary  
22: 8th Avenue & Inter-Garrison Road

Cuml w/ Eastside Pkwy w/ Proj, PM  
09/06/2019



| Movement                     | EBT  | EBR  | WBL  | WBT  | NBL  | NBR  |   |      |
|------------------------------|------|------|------|------|------|------|---|------|
| Lane Configurations          |      |      |      |      |      |      |   |      |
| Traffic Volume (veh/h)       | 580  | 80   | 280  | 380  | 60   | 420  |   |      |
| Future Volume (veh/h)        | 580  | 80   | 280  | 380  | 60   | 420  |   |      |
| Number                       | 4    | 14   | 3    | 8    | 5    | 12   |   |      |
| Initial Q (Qb), veh          | 0    | 0    | 0    | 0    | 0    | 0    |   |      |
| Ped-Bike Adj(A_pbT)          |      | 1.00 | 1.00 |      | 1.00 | 1.00 |   |      |
| Parking Bus, Adj             | 1.00 | 1.00 | 1.00 | 1.00 | 1.00 | 1.00 |   |      |
| Adj Sat Flow, veh/h/ln       | 1863 | 1900 | 1863 | 1863 | 1900 | 1900 |   |      |
| Adj Flow Rate, veh/h         | 598  | 62   | 289  | 392  | 62   | 37   |   |      |
| Adj No. of Lanes             | 1    | 0    | 2    | 1    | 0    | 0    |   |      |
| Peak Hour Factor             | 0.97 | 0.97 | 0.97 | 0.97 | 0.97 | 0.97 |   |      |
| Percent Heavy Veh, %         | 2    | 2    | 2    | 2    | 0    | 0    |   |      |
| Cap, veh/h                   | 756  | 78   | 478  | 1308 | 88   | 53   |   |      |
| Arrive On Green              | 0.46 | 0.46 | 0.14 | 0.70 | 0.08 | 0.08 |   |      |
| Sat Flow, veh/h              | 1660 | 172  | 3442 | 1863 | 1075 | 641  |   |      |
| Grp Volume(v), veh/h         | 0    | 660  | 289  | 392  | 100  | 0    |   |      |
| Grp Sat Flow(s),veh/h/ln     | 0    | 1832 | 1721 | 1863 | 1733 | 0    |   |      |
| Q Serve(g_s), s              | 0.0  | 12.8 | 3.3  | 3.3  | 2.3  | 0.0  |   |      |
| Cycle Q Clear(g_c), s        | 0.0  | 12.8 | 3.3  | 3.3  | 2.3  | 0.0  |   |      |
| Prop In Lane                 |      | 0.09 | 1.00 |      | 0.62 | 0.37 |   |      |
| Lane Grp Cap(c), veh/h       | 0    | 834  | 478  | 1308 | 143  | 0    |   |      |
| V/C Ratio(X)                 | 0.00 | 0.79 | 0.61 | 0.30 | 0.70 | 0.00 |   |      |
| Avail Cap(c_a), veh/h        | 0    | 1428 | 1279 | 2345 | 1184 | 0    |   |      |
| HCM Platoon Ratio            | 1.00 | 1.00 | 1.00 | 1.00 | 1.00 | 1.00 |   |      |
| Upstream Filter(I)           | 0.00 | 1.00 | 1.00 | 1.00 | 1.00 | 0.00 |   |      |
| Uniform Delay (d), s/veh     | 0.0  | 9.7  | 16.9 | 2.3  | 18.6 | 0.0  |   |      |
| Incr Delay (d2), s/veh       | 0.0  | 1.7  | 1.2  | 0.1  | 6.1  | 0.0  |   |      |
| Initial Q Delay(d3),s/veh    | 0.0  | 0.0  | 0.0  | 0.0  | 0.0  | 0.0  |   |      |
| %ile BackOfQ(50%),veh/ln     | 0.0  | 6.8  | 1.6  | 1.7  | 1.4  | 0.0  |   |      |
| LnGrp Delay(d),s/veh         | 0.0  | 11.4 | 18.1 | 2.5  | 24.8 | 0.0  |   |      |
| LnGrp LOS                    |      | B    | B    | A    | C    |      |   |      |
| Approach Vol, veh/h          | 660  |      |      | 681  | 100  |      |   |      |
| Approach Delay, s/veh        | 11.4 |      |      | 9.1  | 24.8 |      |   |      |
| Approach LOS                 | B    |      |      | A    | C    |      |   |      |
| Timer                        | 1    | 2    | 3    | 4    | 5    | 6    | 7 | 8    |
| Assigned Phs                 |      | 2    | 3    | 4    |      |      |   | 8    |
| Phs Duration (G+Y+Rc), s     |      | 7.9  | 10.3 | 23.5 |      |      |   | 33.8 |
| Change Period (Y+Rc), s      |      | 4.5  | 4.5  | 4.5  |      |      |   | 4.5  |
| Max Green Setting (Gmax), s  |      | 28.5 | 15.5 | 32.5 |      |      |   | 52.5 |
| Max Q Clear Time (g_c+I1), s |      | 4.3  | 5.3  | 14.8 |      |      |   | 5.3  |
| Green Ext Time (p_c), s      |      | 0.2  | 0.7  | 4.2  |      |      |   | 2.6  |
| <b>Intersection Summary</b>  |      |      |      |      |      |      |   |      |
| HCM 2010 Ctrl Delay          |      |      | 11.3 |      |      |      |   |      |
| HCM 2010 LOS                 |      |      | B    |      |      |      |   |      |
| <b>Notes</b>                 |      |      |      |      |      |      |   |      |

| Intersection                |       |       |       |       |
|-----------------------------|-------|-------|-------|-------|
| Intersection Delay, s/veh   | 14.1  |       |       |       |
| Intersection LOS            | B     |       |       |       |
| Approach                    | EB    | WB    |       | NB    |
| Entry Lanes                 | 1     | 2     |       | 1     |
| Conflicting Circle Lanes    | 2     | 2     |       | 2     |
| Adj Approach Flow, veh/h    | 680   | 681   |       | 495   |
| Demand Flow Rate, veh/h     | 694   | 695   |       | 495   |
| Vehicles Circulating, veh/h | 295   | 62    |       | 610   |
| Vehicles Exiting, veh/h     | 462   | 1043  |       | 379   |
| Follow-Up Headway, s        | 3.186 | 3.186 |       | 3.186 |
| Ped Vol Crossing Leg, #/h   | 0     | 0     |       | 0     |
| Ped Cap Adj                 | 1.000 | 1.000 |       | 1.000 |
| Approach Delay, s/veh       | 19.0  | 6.7   |       | 17.6  |
| Approach LOS                | C     | A     |       | C     |
| Lane                        | Left  | Left  | Right | Left  |
| Designated Moves            | TR    | L     | LTR   | LR    |
| Assumed Moves               | TR    | L     | TR    | LR    |
| RT Channelized              |       |       |       |       |
| Lane Util                   | 1.000 | 0.424 | 0.576 | 1.000 |
| Critical Headway, s         | 4.113 | 4.293 | 4.113 | 4.113 |
| Entry Flow, veh/h           | 694   | 295   | 400   | 495   |
| Cap Entry Lane, veh/h       | 919   | 1079  | 1082  | 737   |
| Entry HV Adj Factor         | 0.980 | 0.980 | 0.980 | 1.000 |
| Flow Entry, veh/h           | 680   | 289   | 392   | 495   |
| Cap Entry, veh/h            | 901   | 1057  | 1061  | 737   |
| V/C Ratio                   | 0.755 | 0.274 | 0.370 | 0.671 |
| Control Delay, s/veh        | 19.0  | 6.1   | 7.2   | 17.6  |
| LOS                         | C     | A     | A     | C     |
| 95th %tile Queue, veh       | 7     | 1     | 2     | 5     |

HCM 2010 Signalized Intersection Summary  
 25: Inter-Garrison Road & Sherman Boulevard

Cuml w/ Eastside Pkwy w/ Proj, PM  
 09/06/2019



| Movement                     | EBL  | EBT  | WBT   | WBR   | SBL  | SBR  |      |      |
|------------------------------|------|------|-------|-------|------|------|------|------|
| Lane Configurations          |      |      |       |       |      |      |      |      |
| Traffic Volume (veh/h)       | 990  | 270  | 160   | 100   | 120  | 520  |      |      |
| Future Volume (veh/h)        | 990  | 270  | 160   | 100   | 120  | 520  |      |      |
| Number                       | 7    | 4    | 8     | 18    | 1    | 16   |      |      |
| Initial Q (Qb), veh          | 0    | 0    | 0     | 0     | 0    | 0    |      |      |
| Ped-Bike Adj(A_pbT)          | 1.00 |      |       | 1.00  | 1.00 | 1.00 |      |      |
| Parking Bus, Adj             | 1.00 | 1.00 | 1.00  | 1.00  | 1.00 | 1.00 |      |      |
| Adj Sat Flow, veh/h/ln       | 1881 | 1881 | 1792  | 1900  | 1845 | 1845 |      |      |
| Adj Flow Rate, veh/h         | 1138 | 310  | 184   | 100   | 138  | 534  |      |      |
| Adj No. of Lanes             | 1    | 1    | 1     | 0     | 1    | 1    |      |      |
| Peak Hour Factor             | 0.87 | 0.87 | 0.87  | 0.87  | 0.87 | 0.87 |      |      |
| Percent Heavy Veh, %         | 1    | 1    | 6     | 6     | 3    | 3    |      |      |
| Cap, veh/h                   | 1106 | 1525 | 179   | 97    | 227  | 1171 |      |      |
| Arrive On Green              | 0.62 | 0.81 | 0.16  | 0.16  | 0.13 | 0.13 |      |      |
| Sat Flow, veh/h              | 1792 | 1881 | 1093  | 594   | 1757 | 1568 |      |      |
| Grp Volume(v), veh/h         | 1138 | 310  | 0     | 284   | 138  | 534  |      |      |
| Grp Sat Flow(s),veh/h/ln     | 1792 | 1881 | 0     | 1688  | 1757 | 1568 |      |      |
| Q Serve(g_s), s              | 92.6 | 5.6  | 0.0   | 24.5  | 11.1 | 19.4 |      |      |
| Cycle Q Clear(g_c), s        | 92.6 | 5.6  | 0.0   | 24.5  | 11.1 | 19.4 |      |      |
| Prop In Lane                 | 1.00 |      |       | 0.35  | 1.00 | 1.00 |      |      |
| Lane Grp Cap(c), veh/h       | 1106 | 1525 | 0     | 276   | 227  | 1171 |      |      |
| V/C Ratio(X)                 | 1.03 | 0.20 | 0.00  | 1.03  | 0.61 | 0.46 |      |      |
| Avail Cap(c_a), veh/h        | 1106 | 1525 | 0     | 276   | 227  | 1171 |      |      |
| HCM Platoon Ratio            | 1.00 | 1.00 | 1.00  | 1.00  | 1.00 | 1.00 |      |      |
| Upstream Filter(I)           | 1.00 | 1.00 | 0.00  | 1.00  | 1.00 | 1.00 |      |      |
| Uniform Delay (d), s/veh     | 28.7 | 3.2  | 0.0   | 62.8  | 61.7 | 7.3  |      |      |
| Incr Delay (d2), s/veh       | 34.7 | 0.1  | 0.0   | 62.3  | 11.5 | 1.3  |      |      |
| Initial Q Delay(d3),s/veh    | 0.0  | 0.0  | 0.0   | 0.0   | 0.0  | 0.0  |      |      |
| %ile BackOfQ(50%),veh/ln     | 56.1 | 2.9  | 0.0   | 16.2  | 6.1  | 28.2 |      |      |
| LnGrp Delay(d),s/veh         | 63.4 | 3.3  | 0.0   | 125.0 | 73.2 | 8.6  |      |      |
| LnGrp LOS                    | F    | A    |       | F     | E    | A    |      |      |
| Approach Vol, veh/h          |      | 1448 | 284   |       | 672  |      |      |      |
| Approach Delay, s/veh        |      | 50.5 | 125.0 |       | 21.9 |      |      |      |
| Approach LOS                 |      | D    | F     |       | C    |      |      |      |
| Timer                        | 1    | 2    | 3     | 4     | 5    | 6    | 7    | 8    |
| Assigned Phs                 |      |      |       | 4     |      | 6    | 7    | 8    |
| Phs Duration (G+Y+Rc), s     |      |      |       | 126.1 |      | 23.9 | 97.1 | 29.0 |
| Change Period (Y+Rc), s      |      |      |       | 4.5   |      | 4.5  | 4.5  | 4.5  |
| Max Green Setting (Gmax), s  |      |      |       | 121.6 |      | 19.4 | 92.6 | 24.5 |
| Max Q Clear Time (g_c+I1), s |      |      |       | 7.6   |      | 21.4 | 94.6 | 26.5 |
| Green Ext Time (p_c), s      |      |      |       | 2.2   |      | 0.0  | 0.0  | 0.0  |
| <b>Intersection Summary</b>  |      |      |       |       |      |      |      |      |
| HCM 2010 Ctrl Delay          |      |      | 51.3  |       |      |      |      |      |
| HCM 2010 LOS                 |      |      | D     |       |      |      |      |      |

HCM 2010 Signalized Intersection Summary  
 28: Davis Road & Reservation Road

Cuml w/ Eastside Pkwy w/ Proj, PM  
 09/06/2019



| Movement                      | EBL   | EBT   | EBR   | WBL  | WBT   | WBR  | NBL  | NBT  | NBR  | SBL  | SBT  | SBR  |
|-------------------------------|-------|-------|-------|------|-------|------|------|------|------|------|------|------|
| Lane Configurations           | ↖↗    | ↕     |       | ↖    | ↗     |      |      | ↕    |      |      | ↕    | ↖↗   |
| Traffic Volume (veh/h)        | 1410  | 520   | 10    | 10   | 370   | 100  | 10   | 10   | 10   | 120  | 10   | 830  |
| Future Volume (veh/h)         | 1410  | 520   | 10    | 10   | 370   | 100  | 10   | 10   | 10   | 120  | 10   | 830  |
| Number                        | 5     | 2     | 12    | 1    | 6     | 16   | 3    | 8    | 18   | 7    | 4    | 14   |
| Initial Q (Qb), veh           | 0     | 0     | 0     | 0    | 0     | 0    | 0    | 0    | 0    | 0    | 0    | 0    |
| Ped-Bike Adj(A_pbT)           | 1.00  |       | 1.00  | 1.00 |       | 1.00 | 1.00 |      | 1.00 | 1.00 |      | 1.00 |
| Parking Bus, Adj              | 1.00  | 1.00  | 1.00  | 1.00 | 1.00  | 1.00 | 1.00 | 1.00 | 1.00 | 1.00 | 1.00 | 1.00 |
| Adj Sat Flow, veh/h/ln        | 1863  | 1863  | 1900  | 1827 | 1834  | 1900 | 1900 | 1900 | 1900 | 1900 | 1881 | 1881 |
| Adj Flow Rate, veh/h          | 1500  | 553   | 11    | 11   | 394   | 106  | 11   | 11   | 9    | 128  | 11   | 748  |
| Adj No. of Lanes              | 2     | 2     | 0     | 1    | 1     | 0    | 0    | 1    | 0    | 0    | 1    | 2    |
| Peak Hour Factor              | 0.94  | 0.94  | 0.94  | 0.94 | 0.94  | 0.94 | 0.94 | 0.94 | 0.94 | 0.94 | 0.94 | 0.94 |
| Percent Heavy Veh, %          | 2     | 2     | 2     | 4    | 4     | 4    | 0    | 0    | 0    | 1    | 1    | 1    |
| Cap, veh/h                    | 936   | 2086  | 41    | 18   | 456   | 123  | 18   | 18   | 14   | 351  | 30   | 1362 |
| Arrive On Green               | 0.27  | 0.59  | 0.59  | 0.01 | 0.33  | 0.33 | 0.03 | 0.03 | 0.03 | 0.21 | 0.21 | 0.21 |
| Sat Flow, veh/h               | 3442  | 3549  | 71    | 1740 | 1393  | 375  | 631  | 631  | 516  | 1656 | 142  | 2814 |
| Grp Volume(v), veh/h          | 1500  | 276   | 288   | 11   | 0     | 500  | 31   | 0    | 0    | 139  | 0    | 748  |
| Grp Sat Flow(s),veh/h/ln      | 1721  | 1770  | 1850  | 1740 | 0     | 1768 | 1777 | 0    | 0    | 1798 | 0    | 1407 |
| Q Serve(g_s), s               | 30.0  | 8.4   | 8.4   | 0.7  | 0.0   | 29.3 | 1.9  | 0.0  | 0.0  | 7.3  | 0.0  | 20.6 |
| Cycle Q Clear(g_c), s         | 30.0  | 8.4   | 8.4   | 0.7  | 0.0   | 29.3 | 1.9  | 0.0  | 0.0  | 7.3  | 0.0  | 20.6 |
| Prop In Lane                  | 1.00  |       | 0.04  | 1.00 |       | 0.21 | 0.35 |      | 0.29 | 0.92 |      | 1.00 |
| Lane Grp Cap(c), veh/h        | 936   | 1040  | 1087  | 18   | 0     | 578  | 49   | 0    | 0    | 381  | 0    | 1362 |
| V/C Ratio(X)                  | 1.60  | 0.26  | 0.27  | 0.61 | 0.00  | 0.86 | 0.63 | 0.00 | 0.00 | 0.36 | 0.00 | 0.55 |
| Avail Cap(c_a), veh/h         | 936   | 1040  | 1087  | 473  | 0     | 962  | 483  | 0    | 0    | 489  | 0    | 1531 |
| HCM Platoon Ratio             | 1.00  | 1.00  | 1.00  | 1.00 | 1.00  | 1.00 | 1.00 | 1.00 | 1.00 | 1.00 | 1.00 | 1.00 |
| Upstream Filter(I)            | 1.00  | 1.00  | 1.00  | 1.00 | 0.00  | 1.00 | 1.00 | 0.00 | 0.00 | 1.00 | 0.00 | 1.00 |
| Uniform Delay (d), s/veh      | 40.2  | 11.1  | 11.1  | 54.4 | 0.0   | 34.8 | 53.1 | 0.0  | 0.0  | 37.1 | 0.0  | 20.0 |
| Incr Delay (d2), s/veh        | 276.2 | 0.2   | 0.2   | 11.7 | 0.0   | 6.6  | 4.8  | 0.0  | 0.0  | 0.2  | 0.0  | 0.1  |
| Initial Q Delay(d3),s/veh     | 0.0   | 0.0   | 0.0   | 0.0  | 0.0   | 0.0  | 0.0  | 0.0  | 0.0  | 0.0  | 0.0  | 0.0  |
| %ile BackOfQ(50%),veh/ln      | 50.1  | 4.1   | 4.3   | 0.4  | 0.0   | 15.4 | 1.0  | 0.0  | 0.0  | 3.7  | 0.0  | 8.0  |
| LnGrp Delay(d),s/veh          | 316.4 | 11.3  | 11.3  | 66.0 | 0.0   | 41.5 | 57.8 | 0.0  | 0.0  | 37.3 | 0.0  | 20.1 |
| LnGrp LOS                     | F     | B     | B     | E    |       | D    | E    |      |      | D    |      | C    |
| Approach Vol, veh/h           |       | 2064  |       |      | 511   |      |      | 31   |      |      | 887  |      |
| Approach Delay, s/veh         |       | 233.0 |       |      | 42.0  |      |      | 57.8 |      |      | 22.8 |      |
| Approach LOS                  |       | F     |       |      | D     |      |      | E    |      |      | C    |      |
| Timer                         | 1     | 2     | 3     | 4    | 5     | 6    | 7    | 8    |      |      |      |      |
| Assigned Phs                  | 1     | 2     |       | 4    | 5     | 6    |      | 8    |      |      |      |      |
| Phs Duration (G+Y+Rc), s      | 5.0   | 69.8  |       | 28.4 | 33.8  | 41.1 |      | 7.1  |      |      |      |      |
| Change Period (Y+Rc), s       | 3.9   | 5.0   |       | 5.0  | * 3.8 | 5.0  |      | 4.0  |      |      |      |      |
| Max Green Setting (Gmax), s   | 30    | 60.0  |       | 30.0 | * 30  | 60.0 |      | 30.0 |      |      |      |      |
| Max Q Clear Time (g_c+1/2), s | 12.5  | 10.4  |       | 22.6 | 32.0  | 31.3 |      | 3.9  |      |      |      |      |
| Green Ext Time (p_c), s       | 0.0   | 5.3   |       | 0.8  | 0.0   | 4.8  |      | 0.0  |      |      |      |      |
| <b>Intersection Summary</b>   |       |       |       |      |       |      |      |      |      |      |      |      |
| HCM 2010 Ctrl Delay           |       |       | 150.2 |      |       |      |      |      |      |      |      |      |
| HCM 2010 LOS                  |       |       | F     |      |       |      |      |      |      |      |      |      |
| <b>Notes</b>                  |       |       |       |      |       |      |      |      |      |      |      |      |

HCM 2010 Signalized Intersection Summary  
 33: General Jim Moore Boulevard & Lightfighter Drive

Cuml w/ Eastside Pkwy w/ Proj, PM  
 09/06/2019



| Movement                      | EBL  | EBT  | EBR  | WBL  | WBT  | WBR  | NBL  | NBT  | NBR  | SBL  | SBT  | SBR   |
|-------------------------------|------|------|------|------|------|------|------|------|------|------|------|-------|
| Lane Configurations           | ↔↔   | ↑    | ↗    | ↔↔   | ↑↑   |      | ↔↔↔  | ↑↑   |      | ↗    | ↑↑   | ↗     |
| Traffic Volume (veh/h)        | 50   | 230  | 940  | 40   | 240  | 50   | 750  | 60   | 20   | 60   | 100  | 40    |
| Future Volume (veh/h)         | 50   | 230  | 940  | 40   | 240  | 50   | 750  | 60   | 20   | 60   | 100  | 40    |
| Number                        | 3    | 8    | 18   | 7    | 4    | 14   | 1    | 6    | 16   | 5    | 2    | 12    |
| Initial Q (Qb), veh           | 0    | 0    | 0    | 0    | 0    | 0    | 0    | 0    | 0    | 0    | 0    | 0     |
| Ped-Bike Adj(A_pbT)           | 1.00 |      | 1.00 | 1.00 |      | 1.00 | 1.00 |      | 1.00 | 1.00 |      | 1.00  |
| Parking Bus, Adj              | 1.00 | 1.00 | 1.00 | 1.00 | 1.00 | 1.00 | 1.00 | 1.00 | 1.00 | 1.00 | 1.00 | 1.00  |
| Adj Sat Flow, veh/h/ln        | 1881 | 1881 | 1881 | 1900 | 1900 | 1900 | 1881 | 1881 | 1900 | 1900 | 1900 | 1900  |
| Adj Flow Rate, veh/h          | 52   | 240  | 0    | 42   | 250  | 51   | 781  | 62   | 19   | 62   | 104  | -70   |
| Adj No. of Lanes              | 2    | 1    | 1    | 2    | 2    | 0    | 3    | 2    | 0    | 1    | 2    | 1     |
| Peak Hour Factor              | 0.96 | 0.96 | 0.96 | 0.96 | 0.96 | 0.96 | 0.96 | 0.96 | 0.96 | 0.96 | 0.96 | 0.96  |
| Percent Heavy Veh, %          | 1    | 1    | 1    | 0    | 0    | 0    | 1    | 1    | 1    | 0    | 0    | 0     |
| Cap, veh/h                    | 150  | 327  | 278  | 129  | 503  | 101  | 1173 | 880  | 258  | 88   | 503  | 225   |
| Arrive On Green               | 0.04 | 0.17 | 0.00 | 0.04 | 0.17 | 0.17 | 0.23 | 0.32 | 0.32 | 0.05 | 0.14 | 0.00  |
| Sat Flow, veh/h               | 3476 | 1881 | 1599 | 3510 | 2997 | 602  | 5052 | 2726 | 801  | 1810 | 3610 | 1615  |
| Grp Volume(v), veh/h          | 52   | 240  | 0    | 42   | 149  | 152  | 781  | 40   | 41   | 62   | 104  | -70   |
| Grp Sat Flow(s),veh/h/ln      | 1738 | 1881 | 1599 | 1755 | 1805 | 1794 | 1684 | 1787 | 1740 | 1810 | 1805 | 1615  |
| Q Serve(g_s), s               | 0.6  | 5.2  | 0.0  | 0.5  | 3.2  | 3.3  | 6.0  | 0.7  | 0.7  | 1.5  | 1.1  | 0.0   |
| Cycle Q Clear(g_c), s         | 0.6  | 5.2  | 0.0  | 0.5  | 3.2  | 3.3  | 6.0  | 0.7  | 0.7  | 1.5  | 1.1  | 0.0   |
| Prop In Lane                  | 1.00 |      | 1.00 | 1.00 |      | 0.34 | 1.00 |      | 0.46 | 1.00 |      | 1.00  |
| Lane Grp Cap(c), veh/h        | 150  | 327  | 278  | 129  | 303  | 301  | 1173 | 577  | 562  | 88   | 503  | 225   |
| V/C Ratio(X)                  | 0.35 | 0.73 | 0.00 | 0.33 | 0.49 | 0.51 | 0.67 | 0.07 | 0.07 | 0.70 | 0.21 | -0.31 |
| Avail Cap(c_a), veh/h         | 323  | 415  | 353  | 326  | 398  | 396  | 1302 | 1120 | 1090 | 273  | 1877 | 840   |
| HCM Platoon Ratio             | 1.00 | 1.00 | 1.00 | 1.00 | 1.00 | 1.00 | 1.00 | 1.00 | 1.00 | 1.00 | 1.00 | 1.00  |
| Upstream Filter(I)            | 1.00 | 1.00 | 0.00 | 1.00 | 1.00 | 1.00 | 1.00 | 1.00 | 1.00 | 1.00 | 1.00 | 0.00  |
| Uniform Delay (d), s/veh      | 20.0 | 16.8 | 0.0  | 20.2 | 16.3 | 16.3 | 15.0 | 10.1 | 10.1 | 20.2 | 16.4 | 0.0   |
| Incr Delay (d2), s/veh        | 1.4  | 5.4  | 0.0  | 0.5  | 1.5  | 1.6  | 1.0  | 0.1  | 0.1  | 3.8  | 0.2  | 0.0   |
| Initial Q Delay(d3),s/veh     | 0.0  | 0.0  | 0.0  | 0.0  | 0.0  | 0.0  | 0.0  | 0.0  | 0.0  | 0.0  | 0.0  | 0.0   |
| %ile BackOfQ(50%),veh/ln      | 0.3  | 3.2  | 0.0  | 0.2  | 1.7  | 1.8  | 2.9  | 0.3  | 0.4  | 0.8  | 0.6  | 0.0   |
| LnGrp Delay(d),s/veh          | 21.4 | 22.3 | 0.0  | 20.8 | 17.8 | 17.9 | 16.0 | 10.2 | 10.2 | 24.0 | 16.7 | 0.0   |
| LnGrp LOS                     | C    | C    |      | C    | B    | B    | B    | B    | B    | C    | B    |       |
| Approach Vol, veh/h           |      | 292  |      |      | 343  |      |      | 862  |      |      | 96   |       |
| Approach Delay, s/veh         |      | 22.1 |      |      | 18.2 |      |      | 15.5 |      |      | 33.5 |       |
| Approach LOS                  |      | C    |      |      | B    |      |      | B    |      |      | C    |       |
| Timer                         | 1    | 2    | 3    | 4    | 5    | 6    | 7    | 8    |      |      |      |       |
| Assigned Phs                  | 1    | 2    | 3    | 4    | 5    | 6    | 7    | 8    |      |      |      |       |
| Phs Duration (G+Y+Rc), s      | 4.5  | 10.5 | 6.4  | 11.7 | 6.6  | 18.4 | 6.1  | 12.0 |      |      |      |       |
| Change Period (Y+Rc), s       | 4.5  | 4.5  | 4.5  | 4.5  | 4.5  | 4.5  | 4.5  | 4.5  |      |      |      |       |
| Max Green Setting (Gmax), s   | 22.4 | 4.0  | 9.5  | 6.5  | 27.0 | 4.0  | 9.5  |      |      |      |      |       |
| Max Q Clear Time (g_c+1/3), s | 3.1  | 2.6  | 5.3  | 3.5  | 2.7  | 2.5  | 7.2  |      |      |      |      |       |
| Green Ext Time (p_c), s       | 0.9  | 0.6  | 0.0  | 0.7  | 0.0  | 0.7  | 0.0  | 0.3  |      |      |      |       |
| <b>Intersection Summary</b>   |      |      |      |      |      |      |      |      |      |      |      |       |
| HCM 2010 Ctrl Delay           |      |      | 18.4 |      |      |      |      |      |      |      |      |       |
| HCM 2010 LOS                  |      |      | B    |      |      |      |      |      |      |      |      |       |

HCM 2010 Roundabout Cumulative with Eastside Parkway with Project (Roundabouts), PM  
 33: General Jim Moore Boulevard & Lightfighter Drive 04/22/2022

| Intersection                |       |       |       |       |       |       |       |       |  |
|-----------------------------|-------|-------|-------|-------|-------|-------|-------|-------|--|
| Intersection Delay, s/veh   | 12.2  |       |       |       |       |       |       |       |  |
| Intersection LOS            | B     |       |       |       |       |       |       |       |  |
| Approach                    | EB    |       | WB    |       | NB    |       | SB    |       |  |
| Entry Lanes                 | 2     |       | 2     |       | 2     |       | 2     |       |  |
| Conflicting Circle Lanes    | 2     |       | 2     |       | 2     |       | 2     |       |  |
| Adj Approach Flow, veh/h    | 1271  |       | 344   |       | 864   |       | 208   |       |  |
| Demand Flow Rate, veh/h     | 1284  |       | 344   |       | 873   |       | 208   |       |  |
| Vehicles Circulating, veh/h | 208   |       | 905   |       | 357   |       | 1081  |       |  |
| Vehicles Exiting, veh/h     | 1081  |       | 325   |       | 1135  |       | 168   |       |  |
| Follow-Up Headway, s        | 3.186 |       | 3.186 |       | 3.186 |       | 3.186 |       |  |
| Ped Vol Crossing Leg, #/h   | 0     |       | 0     |       | 0     |       | 0     |       |  |
| Ped Cap Adj                 | 1.000 |       | 1.000 |       | 1.000 |       | 1.000 |       |  |
| Approach Delay, s/veh       | 14.2  |       | 10.1  |       | 10.9  |       | 9.7   |       |  |
| Approach LOS                | B     |       | B     |       | B     |       | A     |       |  |
| Lane                        | Left  | Right | Left  | Right | Left  | Right | Left  | Right |  |
| Designated Moves            | LTR   | R     | LT    | TR    | L     | LTR   | LT    | TR    |  |
| Assumed Moves               | LTR   | R     | LT    | TR    | L     | LTR   | LT    | TR    |  |
| RT Channelized              |       |       |       |       |       |       |       |       |  |
| Lane Util                   | 0.470 | 0.530 | 0.471 | 0.529 | 0.530 | 0.470 | 0.471 | 0.529 |  |
| Critical Headway, s         | 4.293 | 4.113 | 4.293 | 4.113 | 4.293 | 4.113 | 4.293 | 4.113 |  |
| Entry Flow, veh/h           | 603   | 681   | 162   | 182   | 463   | 410   | 98    | 110   |  |
| Cap Entry Lane, veh/h       | 967   | 977   | 573   | 600   | 865   | 880   | 502   | 530   |  |
| Entry HV Adj Factor         | 0.990 | 0.989 | 0.998 | 1.002 | 0.989 | 0.991 | 0.998 | 1.002 |  |
| Flow Entry, veh/h           | 597   | 673   | 162   | 182   | 458   | 406   | 98    | 110   |  |
| Cap Entry, veh/h            | 957   | 966   | 572   | 601   | 855   | 872   | 501   | 531   |  |
| V/C Ratio                   | 0.624 | 0.697 | 0.283 | 0.303 | 0.536 | 0.466 | 0.195 | 0.207 |  |
| Control Delay, s/veh        | 12.9  | 15.3  | 10.2  | 10.1  | 11.6  | 10.0  | 9.9   | 9.6   |  |
| LOS                         | B     | C     | B     | B     | B     | B     | A     | A     |  |
| 95th %tile Queue, veh       | 5     | 6     | 1     | 1     | 3     | 3     | 1     | 1     |  |

HCM 2010 Signalized Intersection Summary  
 39: General Jim Moore Boulevard & Gigling Road

Cuml w/ Eastside Pkwy w/ Proj, PM  
 09/06/2019



| Movement                       | EBL  | EBT  | EBR  | WBL  | WBT  | WBR  | NBL  | NBT  | NBR  | SBL  | SBT  | SBR  |
|--------------------------------|------|------|------|------|------|------|------|------|------|------|------|------|
| Lane Configurations            |      |      |      |      |      |      |      |      |      |      |      |      |
| Traffic Volume (veh/h)         | 20   | 20   | 30   | 270  | 50   | 530  | 60   | 260  | 430  | 750  | 250  | 50   |
| Future Volume (veh/h)          | 20   | 20   | 30   | 270  | 50   | 530  | 60   | 260  | 430  | 750  | 250  | 50   |
| Number                         | 3    | 8    | 18   | 7    | 4    | 14   | 1    | 6    | 16   | 5    | 2    | 12   |
| Initial Q (Qb), veh            | 0    | 0    | 0    | 0    | 0    | 0    | 0    | 0    | 0    | 0    | 0    | 0    |
| Ped-Bike Adj(A_pbT)            | 1.00 |      | 0.99 | 1.00 |      | 1.00 | 1.00 |      | 1.00 | 1.00 |      | 1.00 |
| Parking Bus, Adj               | 1.00 | 1.00 | 1.00 | 1.00 | 1.00 | 1.00 | 1.00 | 1.00 | 1.00 | 1.00 | 1.00 | 1.00 |
| Adj Sat Flow, veh/h/ln         | 1776 | 1776 | 1776 | 1881 | 1881 | 1881 | 1863 | 1863 | 1863 | 1863 | 1863 | 1863 |
| Adj Flow Rate, veh/h           | 22   | 22   | 3    | 303  | 56   | 0    | 67   | 292  | 0    | 843  | 281  | 0    |
| Adj No. of Lanes               | 1    | 1    | 1    | 2    | 2    | 1    | 2    | 3    | 1    | 2    | 3    | 1    |
| Peak Hour Factor               | 0.89 | 0.89 | 0.89 | 0.89 | 0.89 | 0.89 | 0.89 | 0.89 | 0.89 | 0.89 | 0.89 | 0.89 |
| Percent Heavy Veh, %           | 7    | 7    | 7    | 1    | 1    | 1    | 2    | 2    | 2    | 2    | 2    | 2    |
| Cap, veh/h                     | 45   | 161  | 230  | 433  | 674  | 302  | 214  | 599  | 186  | 962  | 1704 | 530  |
| Arrive On Green                | 0.03 | 0.09 | 0.09 | 0.12 | 0.19 | 0.00 | 0.06 | 0.12 | 0.00 | 0.28 | 0.33 | 0.00 |
| Sat Flow, veh/h                | 1691 | 1776 | 1501 | 3476 | 3574 | 1599 | 3442 | 5085 | 1583 | 3442 | 5085 | 1583 |
| Grp Volume(v), veh/h           | 22   | 22   | 3    | 303  | 56   | 0    | 67   | 292  | 0    | 843  | 281  | 0    |
| Grp Sat Flow(s),veh/h/ln       | 1691 | 1776 | 1501 | 1738 | 1787 | 1599 | 1721 | 1695 | 1583 | 1721 | 1695 | 1583 |
| Q Serve(g_s), s                | 0.6  | 0.5  | 0.1  | 3.9  | 0.6  | 0.0  | 0.9  | 2.5  | 0.0  | 10.9 | 1.8  | 0.0  |
| Cycle Q Clear(g_c), s          | 0.6  | 0.5  | 0.1  | 3.9  | 0.6  | 0.0  | 0.9  | 2.5  | 0.0  | 10.9 | 1.8  | 0.0  |
| Prop In Lane                   | 1.00 |      | 1.00 | 1.00 |      | 1.00 | 1.00 |      | 1.00 | 1.00 |      | 1.00 |
| Lane Grp Cap(c), veh/h         | 45   | 161  | 230  | 433  | 674  | 302  | 214  | 599  | 186  | 962  | 1704 | 530  |
| V/C Ratio(X)                   | 0.49 | 0.14 | 0.01 | 0.70 | 0.08 | 0.00 | 0.31 | 0.49 | 0.00 | 0.88 | 0.16 | 0.00 |
| Avail Cap(c_a), veh/h          | 208  | 917  | 870  | 711  | 2139 | 957  | 393  | 2627 | 818  | 1815 | 4729 | 1472 |
| HCM Platoon Ratio              | 1.00 | 1.00 | 1.00 | 1.00 | 1.00 | 1.00 | 1.00 | 1.00 | 1.00 | 1.00 | 1.00 | 1.00 |
| Upstream Filter(I)             | 1.00 | 1.00 | 1.00 | 1.00 | 1.00 | 0.00 | 1.00 | 1.00 | 0.00 | 1.00 | 1.00 | 0.00 |
| Uniform Delay (d), s/veh       | 22.3 | 19.5 | 16.7 | 19.5 | 15.5 | 0.0  | 20.8 | 19.2 | 0.0  | 16.0 | 10.9 | 0.0  |
| Incr Delay (d2), s/veh         | 3.0  | 0.1  | 0.0  | 0.8  | 0.0  | 0.0  | 0.3  | 0.2  | 0.0  | 1.0  | 0.0  | 0.0  |
| Initial Q Delay(d3),s/veh      | 0.0  | 0.0  | 0.0  | 0.0  | 0.0  | 0.0  | 0.0  | 0.0  | 0.0  | 0.0  | 0.0  | 0.0  |
| %ile BackOfQ(50%),veh/ln       | 0.3  | 0.3  | 0.0  | 1.9  | 0.3  | 0.0  | 0.4  | 1.2  | 0.0  | 5.3  | 0.8  | 0.0  |
| LnGrp Delay(d),s/veh           | 25.3 | 19.6 | 16.7 | 20.3 | 15.6 | 0.0  | 21.1 | 19.4 | 0.0  | 17.0 | 10.9 | 0.0  |
| LnGrp LOS                      | C    | B    | B    | C    | B    |      | C    | B    |      | B    | B    |      |
| Approach Vol, veh/h            |      | 47   |      |      | 359  |      |      | 359  |      |      | 1124 |      |
| Approach Delay, s/veh          |      | 22.1 |      |      | 19.5 |      |      | 19.7 |      |      | 15.5 |      |
| Approach LOS                   |      | C    |      |      | B    |      |      | B    |      |      | B    |      |
| Timer                          | 1    | 2    | 3    | 4    | 5    | 6    | 7    | 8    |      |      |      |      |
| Assigned Phs                   | 1    | 2    | 3    | 4    | 5    | 6    | 7    | 8    |      |      |      |      |
| Phs Duration (G+Y+Rc), s       | 7.4  | 20.1 | 5.7  | 13.3 | 17.5 | 10.0 | 10.3 | 8.7  |      |      |      |      |
| Change Period (Y+Rc), s        | 4.5  | 4.5  | 4.5  | 4.5  | 4.5  | 4.5  | 4.5  | 4.5  |      |      |      |      |
| Max Green Setting (Gmax), s    | 5.3  | 43.2 | 5.7  | 27.8 | 24.5 | 24.0 | 9.5  | 24.0 |      |      |      |      |
| Max Q Clear Time (g_c+1/2g), s | 12.9 | 3.8  | 2.6  | 2.6  | 12.9 | 4.5  | 5.9  | 2.5  |      |      |      |      |
| Green Ext Time (p_c), s        | 0.0  | 0.4  | 0.0  | 0.1  | 0.1  | 0.4  | 0.0  | 0.0  |      |      |      |      |
| <b>Intersection Summary</b>    |      |      |      |      |      |      |      |      |      |      |      |      |
| HCM 2010 Ctrl Delay            |      |      |      | 17.2 |      |      |      |      |      |      |      |      |
| HCM 2010 LOS                   |      |      |      | B    |      |      |      |      |      |      |      |      |
| <b>Notes</b>                   |      |      |      |      |      |      |      |      |      |      |      |      |

HCM 2010 Roundabout Cumulative with Eastside Parkway with Project (Roundabouts), PM  
 39: General Jim Moore Boulevard & Gigling Road 04/22/2022

| Intersection                |       |       |       |       |       |       |       |       |  |
|-----------------------------|-------|-------|-------|-------|-------|-------|-------|-------|--|
| Intersection Delay, s/veh   | 32.4  |       |       |       |       |       |       |       |  |
| Intersection LOS            | D     |       |       |       |       |       |       |       |  |
| Approach                    | EB    |       | WB    |       | NB    |       | SB    |       |  |
| Entry Lanes                 | 2     |       | 2     |       | 2     |       | 2     |       |  |
| Conflicting Circle Lanes    | 2     |       | 2     |       | 2     |       | 2     |       |  |
| Adj Approach Flow, veh/h    | 78    |       | 955   |       | 842   |       | 1180  |       |  |
| Demand Flow Rate, veh/h     | 84    |       | 965   |       | 859   |       | 1204  |       |  |
| Vehicles Circulating, veh/h | 1453  |       | 390   |       | 908   |       | 431   |       |  |
| Vehicles Exiting, veh/h     | 182   |       | 1377  |       | 629   |       | 924   |       |  |
| Follow-Up Headway, s        | 3.186 |       | 3.186 |       | 3.186 |       | 3.186 |       |  |
| Ped Vol Crossing Leg, #/h   | 1     |       | 2     |       | 0     |       | 2     |       |  |
| Ped Cap Adj                 | 1.000 |       | 0.998 |       | 1.000 |       | 0.999 |       |  |
| Approach Delay, s/veh       | 11.5  |       | 14.3  |       | 27.4  |       | 52.1  |       |  |
| Approach LOS                | B     |       | B     |       | D     |       | F     |       |  |
| Lane                        | Left  | Right | Left  | Right | Left  | Right | Left  | Right |  |
| Designated Moves            | LT    | TR    | LT    | TR    | LT    | TR    | LT    | TR    |  |
| Assumed Moves               | LT    | TR    | LT    | R     | LT    | R     | L     | TR    |  |
| RT Channelized              |       |       |       |       |       |       |       |       |  |
| Lane Util                   | 0.464 | 0.536 | 0.376 | 0.624 | 0.426 | 0.574 | 0.714 | 0.286 |  |
| Critical Headway, s         | 4.293 | 4.113 | 4.293 | 4.113 | 4.293 | 4.113 | 4.293 | 4.113 |  |
| Entry Flow, veh/h           | 39    | 45    | 363   | 602   | 366   | 493   | 860   | 344   |  |
| Cap Entry Lane, veh/h       | 380   | 409   | 843   | 860   | 572   | 598   | 818   | 836   |  |
| Entry HV Adj Factor         | 0.945 | 0.924 | 0.990 | 0.990 | 0.981 | 0.980 | 0.980 | 0.981 |  |
| Flow Entry, veh/h           | 37    | 42    | 359   | 596   | 359   | 483   | 843   | 337   |  |
| Cap Entry, veh/h            | 359   | 377   | 834   | 850   | 561   | 586   | 801   | 818   |  |
| V/C Ratio                   | 0.103 | 0.110 | 0.431 | 0.701 | 0.640 | 0.824 | 1.053 | 0.412 |  |
| Control Delay, s/veh        | 11.7  | 11.3  | 9.7   | 17.0  | 20.3  | 32.6  | 69.1  | 9.5   |  |
| LOS                         | B     | B     | A     | C     | C     | D     | F     | A     |  |
| 95th %tile Queue, veh       | 0     | 0     | 2     | 6     | 5     | 8     | 21    | 2     |  |



HCM 2010 Signalized Intersection Summary  
 46: General Jim Moore Boulevard & Normandy Road

Cuml w/ Eastside Pkwy w/ Proj, PM  
 09/06/2019



| Movement                    | EBL  | EBT  | EBR  | WBL  | WBT  | WBR  | NBL   | NBT  | NBR  | SBL   | SBT  | SBR  |
|-----------------------------|------|------|------|------|------|------|-------|------|------|-------|------|------|
| Lane Configurations         |      | ↕    |      |      | ↕    |      | ↕ ↑↑↑ |      |      | ↕ ↑↑↑ |      | ↕    |
| Traffic Volume (veh/h)      | 140  | 40   | 100  | 290  | 50   | 10   | 90    | 790  | 320  | 30    | 480  | 80   |
| Future Volume (veh/h)       | 140  | 40   | 100  | 290  | 50   | 10   | 90    | 790  | 320  | 30    | 480  | 80   |
| Number                      | 3    | 8    | 18   | 7    | 4    | 14   | 1     | 6    | 16   | 5     | 2    | 12   |
| Initial Q (Qb), veh         | 0    | 0    | 0    | 0    | 0    | 0    | 0     | 0    | 0    | 0     | 0    | 0    |
| Ped-Bike Adj(A_pbT)         | 1.00 |      | 1.00 | 1.00 |      | 1.00 | 1.00  |      | 1.00 | 1.00  |      | 1.00 |
| Parking Bus, Adj            | 1.00 | 1.00 | 1.00 | 1.00 | 1.00 | 1.00 | 1.00  | 1.00 | 1.00 | 1.00  | 1.00 | 1.00 |
| Adj Sat Flow, veh/h/ln      | 1900 | 1863 | 1900 | 1900 | 1881 | 1900 | 1881  | 1881 | 1900 | 1900  | 1900 | 1900 |
| Adj Flow Rate, veh/h        | 152  | 43   | 84   | 315  | 54   | 8    | 98    | 859  | 325  | 33    | 522  | 28   |
| Adj No. of Lanes            | 0    | 1    | 0    | 0    | 1    | 0    | 1     | 3    | 0    | 1     | 3    | 1    |
| Peak Hour Factor            | 0.92 | 0.92 | 0.92 | 0.92 | 0.92 | 0.92 | 0.92  | 0.92 | 0.92 | 0.92  | 0.92 | 0.92 |
| Percent Heavy Veh, %        | 2    | 2    | 2    | 1    | 1    | 1    | 1     | 1    | 1    | 0     | 0    | 0    |
| Cap, veh/h                  | 386  | 121  | 159  | 546  | 65   | 10   | 319   | 1117 | 421  | 69    | 851  | 264  |
| Arrive On Green             | 0.32 | 0.32 | 0.32 | 0.32 | 0.32 | 0.32 | 0.18  | 0.30 | 0.30 | 0.04  | 0.16 | 0.16 |
| Sat Flow, veh/h             | 773  | 379  | 497  | 1190 | 204  | 30   | 1792  | 3674 | 1384 | 1810  | 5187 | 1610 |
| Grp Volume(v), veh/h        | 279  | 0    | 0    | 377  | 0    | 0    | 98    | 800  | 384  | 33    | 522  | 28   |
| Grp Sat Flow(s),veh/h/ln    | 1649 | 0    | 0    | 1424 | 0    | 0    | 1792  | 1712 | 1634 | 1810  | 1729 | 1610 |
| Q Serve(g_s), s             | 0.0  | 0.0  | 0.0  | 4.3  | 0.0  | 0.0  | 1.9   | 8.5  | 8.5  | 0.7   | 3.7  | 0.6  |
| Cycle Q Clear(g_c), s       | 5.3  | 0.0  | 0.0  | 9.5  | 0.0  | 0.0  | 1.9   | 8.5  | 8.5  | 0.7   | 3.7  | 0.6  |
| Prop In Lane                | 0.54 |      | 0.30 | 0.84 |      | 0.02 | 1.00  |      | 0.85 | 1.00  |      | 1.00 |
| Lane Grp Cap(c), veh/h      | 666  | 0    | 0    | 621  | 0    | 0    | 319   | 1041 | 497  | 69    | 851  | 264  |
| V/C Ratio(X)                | 0.42 | 0.00 | 0.00 | 0.61 | 0.00 | 0.00 | 0.31  | 0.77 | 0.77 | 0.48  | 0.61 | 0.11 |
| Avail Cap(c_a), veh/h       | 1409 | 0    | 0    | 1298 | 0    | 0    | 319   | 2007 | 958  | 231   | 2806 | 871  |
| HCM Platoon Ratio           | 1.00 | 1.00 | 1.00 | 1.00 | 1.00 | 1.00 | 1.00  | 1.00 | 1.00 | 1.00  | 1.00 | 1.00 |
| Upstream Filter(I)          | 1.00 | 0.00 | 0.00 | 1.00 | 0.00 | 0.00 | 1.00  | 1.00 | 1.00 | 1.00  | 1.00 | 1.00 |
| Uniform Delay (d), s/veh    | 11.0 | 0.0  | 0.0  | 12.3 | 0.0  | 0.0  | 14.3  | 12.6 | 12.6 | 18.8  | 15.5 | 14.2 |
| Incr Delay (d2), s/veh      | 0.2  | 0.0  | 0.0  | 0.4  | 0.0  | 0.0  | 0.2   | 0.5  | 1.0  | 1.9   | 0.3  | 0.1  |
| Initial Q Delay(d3),s/veh   | 0.0  | 0.0  | 0.0  | 0.0  | 0.0  | 0.0  | 0.0   | 0.0  | 0.0  | 0.0   | 0.0  | 0.0  |
| %ile BackOfQ(50%),veh/ln    | 2.5  | 0.0  | 0.0  | 3.8  | 0.0  | 0.0  | 0.9   | 4.0  | 4.0  | 0.4   | 1.8  | 0.3  |
| LnGrp Delay(d),s/veh        | 11.2 | 0.0  | 0.0  | 12.7 | 0.0  | 0.0  | 14.5  | 13.1 | 13.6 | 20.7  | 15.8 | 14.3 |
| LnGrp LOS                   | B    |      |      | B    |      |      | B     | B    | B    | C     | B    | B    |
| Approach Vol, veh/h         |      | 279  |      |      | 377  |      |       | 1282 |      |       | 583  |      |
| Approach Delay, s/veh       |      | 11.2 |      |      | 12.7 |      |       | 13.3 |      |       | 16.0 |      |
| Approach LOS                |      | B    |      |      | B    |      |       | B    |      |       | B    |      |
| Timer                       | 1    | 2    | 3    | 4    | 5    | 6    | 7     | 8    |      |       |      |      |
| Assigned Phs                | 1    | 2    |      | 4    | 5    | 6    |       | 8    |      |       |      |      |
| Phs Duration (G+Y+Rc), s    | 11.6 | 11.0 |      | 17.3 | 6.0  | 16.6 |       | 17.3 |      |       |      |      |
| Change Period (Y+Rc), s     | 4.5  | 4.5  |      | 4.5  | 4.5  | 4.5  |       | 4.5  |      |       |      |      |
| Max Green Setting (Gmax), s | 21.6 | 21.6 |      | 33.0 | 5.1  | 23.4 |       | 33.0 |      |       |      |      |
| Max Q Clear Time (g_c+I), s | 5.7  | 5.7  |      | 11.5 | 2.7  | 10.5 |       | 7.3  |      |       |      |      |
| Green Ext Time (p_c), s     | 0.0  | 0.7  |      | 0.6  | 0.0  | 1.5  |       | 0.4  |      |       |      |      |
| <b>Intersection Summary</b> |      |      |      |      |      |      |       |      |      |       |      |      |
| HCM 2010 Ctrl Delay         |      |      |      | 13.6 |      |      |       |      |      |       |      |      |
| HCM 2010 LOS                |      |      |      | B    |      |      |       |      |      |       |      |      |

# **APPENDIX I**

## **2022 California State University Sustainability Policy**

INTENTIONALLY LEFT BLANK

## California State University Sustainability Policy

### Summary

This policy is intended to position the nation's largest university system as a leader in the teaching and use of applied research to educate climate literate students equipped to solve the complex challenges of the world and prepare them for an evolving workforce. In addition, the policy encompasses the tenets of human and ecological health, social justice, economic vitality, and promotes the environmental sustainability of CSU's operations for our built environment.

### University Sustainability

1. The CSU will seek to further integrate sustainability and climate literacy into the academic curriculum working within the normal campus consultative process. Activities can include but will not be limited to supporting multi-disciplinary course development, utilizing the campus as a living laboratory model, connecting sustainability with social justice, strengthening community partnerships, and creating appropriate learning outcomes. Progress shall be measured through the use of the AASHE STARS<sup>1</sup> platform. (14-New; 22-Revise)
2. The CSU shall promote environmental and social justice through new and existing Diversity, Equity, & Inclusion (DE&I) programs such as the CSU Basic Needs Initiative. (22-New)
3. The CSU will develop employee and student workforce skills in the green jobs industry, climate-related industry, promote the development of sustainable products and services, and foster economic development. (14-New; 22-Revise)
4. The CSU will pursue sustainable practices, using AASHE STARS for guidance and reporting, in all areas of the university, including:
  - a. business operations such as procurement; information technology; student and employee services; food services; events, habitat and land-use management, facilities operations; design and construction; and
  - b. self-funded entities such as student housing, student unions, parking and transportation, children's centers, and auxiliary operations. (14-New; 22-Revise)
5. Each CSU will designate a sustainability officer/staff member responsible for planning and/or coordinating campus sustainability program efforts. (14-New; 22-Revise)

---

<sup>1</sup> Association for the Advancement of Sustainability in Higher Education's Sustainability Tracking and Reporting System (STARS). For more information and to access the reporting platform, please visit: <https://stars.aashe.org/>

## **Climate Action Plan**

1. CSU will strive to reduce systemwide facility carbon emissions to forty percent (40%) below 1990 levels consistent with SB 32, California's Global Warming Solutions Act of 2006 (HSC §38566, effective January 1, 2017). Emissions will include both state and auxiliary organization purchases of electricity and natural gas; fleet, marine vessel usage; and other emissions the university or self-support entity has direct control over. The Chancellor's Office staff will provide the baseline 1990 facility emission levels (for purchased electricity and natural gas) for the campuses that existed at that time and assist campuses added to the CSU after 1990 to determine their appropriate baseline. (14-New; 22-Revise)
2. The CSU will strive to reduce facility carbon emissions to eighty percent (80%) below 1990 levels by 2040 in order to achieve carbon neutrality by 2045 in accordance with Statewide mandates. Metrics will include GHG emissions per FTE. (14-New; 22-Revise)

## **Energy Resilience and Procurement**

1. The CSU will pursue energy procurement and production to reduce energy capacity requirements from fossil fuels, enhance electrical demand flexibility, and promote energy resilience using available economically feasible technology for on-site renewable generation, microgrids, and other fossil fuel-free energy storage solutions. The CSU shall endeavor to increase its self-generated renewable energy and battery capacity from 32 to 80 megawatts (MW) by 2030. (05-New; 14-Revise; 22-Revise)
2. The CSU will consider cost effective opportunities to exceed the State of California and California Public Utilities Commission Renewable Portfolio Standard (RPS) sooner than the established goal of procuring sixty percent (60%) of its electricity needs from renewable sources by 2030 consistent with SB 100 (PUC§399.11). (05-New; 14-Revise; 22-Revise)
3. To minimize use of natural gas, campuses will transition from fossil-fuel sourced equipment to electric equipment as replacements or renovations are needed. Any in-kind fossil-fuel sourced equipment will be justified through an analysis which demonstrates why that solution represents the most cost-effective option and what alternatives were analyzed for comparative purposes. The intention of this item shall be limited to no new investment in, or renewal of, natural gas assets or infrastructure as part of campus projects starting July 1, 2035, with the exception of critical academic program needs. (22-New)

## **Energy Conservation, Carbon Reduction and Utility Management**

1. All CSU buildings and facilities, regardless of the source of funding for their operation, will be operated in the most energy efficient manner and transition to a low carbon strategy without endangering public health and safety and without diminishing the quality of education and the academic program. (78-Adopt; 88-Revise; 01-No Change; 04-No Change; 14-Revise; 22-Revise)
2. All CSU campuses shall continue to identify energy efficiency and carbon reduction improvement measures to the greatest extent possible, undertake steps to seek funding for their implementation and, upon securing available funds, expeditiously implement the measures. (78-Adopt; 88-Revise; 01-No Change; 04-No Change; 14-Revise; 22-Revise)
3. The CSU will cooperate with federal, state, and local governments and other appropriate organizations in accomplishing energy conservation, and carbon reduction, and utilities management objectives throughout the state; and inform students, faculty, staff and the general public of the need for and methods of energy conservation, and carbon reduction, and utilities management. (78-Adopt; 88-Revise; 01-No Change, 04-No Change; 14-No Change; 22-Revise)
4. Each CSU campus shall designate an energy/utilities staff with the responsibility and the authority for carrying out energy conservation and utilities management programs. The Chancellor's Office will have the responsibility to coordinate the individual campus programs into a systemwide program. (78-Adopt; 88-Revise; 01-No Change; 04-No Change; 14-No Change; 22-Revise)
5. The CSU will monitor monthly energy and utility usage on all campuses and the Chancellor's Office and will prepare a systemwide annual report on energy utilization and greenhouse gas emissions. The Chancellor's Office will maintain a systemwide energy database in which monthly campus data will be compiled to produce systemwide energy reporting. Campuses will provide the Chancellor's Office the necessary energy and utility data, such as electricity and natural gas consumption; water and sewer usage; fuel consumed by fleet vehicles, boats, and ships; waste disposal for the systemwide database in a timely manner. (78-; 88- Adopt; 01-Revise; 04-No Change; 14-Revise; 22-No Change)
6. Each CSU campus shall develop and maintain a campuswide utility master plan which includes an integrated strategic energy resource plan, with tactical recommendations in the areas of new construction, decarbonization, deferred maintenance, climate resilience, facility renewal, energy projects, water conservation, solid waste management, and an energy management plan. This plan will be updated every 10 years and guide the overall energy and climate action program at each campus. (78-Adopt; 88-Revise; 01-Revise; 04-Revise; 14-Revise; 22-Revise)

## **Water Conservation**

1. All CSU campuses shall pursue cost effective water resource conservation to reduce consumption by ten percent (10%) by 2030, as compared to a 2019 baseline, consistent with AB 1668 (California Water Code § 10609) including steps to develop sustainable, drought tolerant or native landscaping, reduce turf, install controls to optimize irrigation water use, reduce water usage in restrooms, showers, fountains and decorative water features, and promote the use of reclaimed/recycled water. In the event of a declaration of drought, the CSU will cooperate with the state, city, and county governments to the greatest extent possible to reduce water use. (78-; 88-Adopt; 01-No Change; 04-No Change; 14-Revise; 22-Revise)

## **Sustainable Procurement**

1. Campuses shall promote use of suppliers and/or vendors who reduce waste, re-purpose recycled material, or support other environmentally friendly practices in the provision of goods or services to the CSU under contract. This may include additional evaluation points in solicitation evaluations for suppliers integrating sustainable and socially responsible practices. (14-New; 22-Revise)
2. To move to zero waste, campus practices should: (1) encourage use of products that minimize the volume of trash sent to landfill or incinerators; (2) participate in the CalRecycle Buy-Recycled program or equivalent; and (3) increase recycled content purchases in all Buy-Recycled program product categories. (14-New; 22-No Change)
3. Campuses shall continue to report on all recycled content product categories, consistent with PCC § 12153-12217 and shall implement improved tracking and reporting procedures for their recycled content purchases. (14-New; 22-No change)
4. Campuses shall align procedures with state initiatives to report environmental product declarations for select construction materials, consistent with PCC §3500-3505 and state mandates. (22-New)
5. Campuses shall promote circular economies<sup>2</sup> by seeking to reduce waste when considering materials purchases, including but not limited to, office supplies, equipment, classroom supplies, and promotional and giveaway items by minimizing purchase of items that have a

---

<sup>2</sup> Circular economies promote reduced use of resources and generation of waste in products/services, recycling and reuse of materials and products and improved re-generation of waste to promote natural resources.

short useful life, are unable to be recycled, and/or are made of unsustainable or carbon intensive materials. (22-New)

### **Waste Management**

1. Campuses shall seek to reduce landfill bound waste to fifty percent (50%) of total campus waste by 2030, divert at least eighty percent (80%) from landfill by 2040, and move toward zero waste. (14-New; 22-Revise)
2. Campuses shall identify and implement cost effective opportunities for organics diversion, collection, and disposal and shall designate zero waste responsibilities for coordinating campus waste prevention, reduction and diversion efforts. Campuses will continue to report on all disposal activities using the CalRecycle State Agency Reporting Center (SARC) and are encouraged to coordinate and maintain a solid waste management plan as it is a requirement in the utility master plan. (22-New)
3. The CSU will continue to reduce hazardous waste disposal while supporting the academic program. (14-New)

### **Sustainable Food Service**

1. All campus food service organizations should track and increase/improve their sustainable food purchases. (14-New; 22-Revise)
2. Campuses and food service organizations shall collaborate to provide information and/or training to staff and patrons on the benefits of, and how to successfully participate in sustainable food service operations. (14-New; 22-Revise)

### **Sustainable Building & Lands Practices**

1. All future CSU new construction, remodeling, renovation, and repair projects, regardless of funding source, will be designed with consideration of optimum energy utilization, decarbonization, and low life-cycle operating costs and shall exceed all applicable energy codes and regulations (Building Energy Efficiency Standards, Tit. 24 CCR § 6) by ten percent (10%). In the areas of specialized construction that are not regulated through the current energy standards, such as historical buildings, museums, and auditoriums, the CSU will ensure that these facilities are designed to maximize energy efficiency. Energy efficient and sustainable



design features in the project plans and specifications will be considered in balance with the academic program needs of the project within the available project budget. (78-Adopt; 88-Revise; 01-Revise; 04-Revise; 14-Revise; 22-Revise)

2. Capital planning for state, non-state facilities and infrastructure shall consider features of a sustainable and durable design to achieve a low life cycle cost. Campuses shall design, construct, operate, and maintain green building certified high performing buildings, regardless of funding source, that improve occupant productivity and wellness, optimize life-cycle costs, and minimize carbon impact. Principles and best practices established by leading industry standards or professional organizations shall be implemented to the greatest extent possible. (04-Adopt; 14-Move; 22-Return & Revise)
3. Existing building energy performance will be optimized through improved operation, maintenance and repair, and capital improvement, enabling campuses to meet carbon reduction goals. Sustainable design for capital projects is a process of balancing long-term institutional needs for academic and related programs with environmental concerns. In the context of designing to provide for university and academic needs, the following attributes will be considered “sustainable:”
  - a. Siting and design considerations that optimize local geographic features to improve sustainability of the project, such as proximity to public transportation and maximizing use of vistas, microclimate, and prevailing winds;
  - b. Durable systems and finishes with long life cycles that minimize maintenance and replacement.
  - c. Optimization of layouts and designing spaces that can be reconfigured with the expectation that the facility will be renovated and re-used (versus demolished);
  - d. Systems designed for optimization of energy, water, and other natural resources;
  - e. Optimization of indoor environmental quality for occupants;
  - f. Utilization of environmentally preferable products and processes, such as long life-cycle materials and components, recycled-content and recyclable materials;
  - g. Procedures that monitor, trend, and report operational performance as compared to the optimal design and operating parameters.
  - h. Cost-effective design features which align with CSU Basic Needs Initiative and support campus diversity, equity and inclusion efforts. (04-Adopt; 14-Move, 22-Return & Revise)
4. In order to implement the sustainable building goal in a cost-effective manner, the process will: identify economic and environmental performance measures; determine cost savings; use extended life cycle costing; and adopt an integrated systems approach. Such an approach treats the entire building as one system and recognizes that individual building features, such as

lighting, windows, heating and cooling systems, or control systems are not stand-alone systems. (04-Adopt; 14-Move; 22-Return)

5. Capital Planning, Design and Construction in the Chancellor's Office shall monitor building sustainability/energy performance and maintain information on design best practices to support the energy efficiency goals and guidelines of this policy. The sustainability performance shall be based on Leadership in Energy and Environmental Design (LEED) principles with consideration to the physical diversity and microclimates within the CSU. (05-New; 14-Revise; 22-No Change)
6. The CSU shall design and build all new buildings and major renovations to meet or exceed the minimum requirements equivalent to LEED Silver. Each campus shall strive to achieve a higher standard equivalent to LEED Gold or Platinum within project budget constraints. Each campus may pursue external certification through the LEED process or alternative sustainable building rating systems. If the project is not registered through U.S. Green Building Council, then a qualified campus staff member shall evaluate the documentation necessary to determine LEED equivalence and shall attest that equivalence has been achieved. (05-New; 14-Revise; 22-Revise)
7. In informal or unlandscaped areas, and where appropriate, campuses will work to support a naturally functioning habitat, promote biodiversity, and preserve native landscapes. (22-New)

### **Physical Plant Management**

1. Each campus shall operate and maintain a comprehensive energy management system that will provide centralized reporting and control of the campus energy and carbon reduction related activities. (78-Adopt; 88-Revise; 01-Revise; 04-No Change; 14-Revise; 22-Revise)
2. Campus energy/utilities managers will make the necessary arrangements to achieve optimum efficiency in the use of natural gas, electricity, or any other purchased energy resources to meet the heating, cooling, and lighting needs of the buildings and/or facilities. Campuses shall strive to adhere to Statewide energy efficiency guidance regarding appropriate indoor temperature setpoints during heating and cooling periods (State Administrative Manual, Section: 1805.3). Except for areas requiring special operating conditions, such as electronic data processing facilities, or other scientifically critical areas, where rigid temperature controls are required, building and/or facility temperatures will be allowed to fluctuate between the limits stated above. Simultaneous heating and cooling operations to maintain a specific temperature in work

areas will not be allowed unless special operating conditions dictate such a scheme to be implemented. (78-; 88-Adopt; 01-No Change; 04-No Change, 14-Revise; 22- Return & Revise)

3. To the extent possible, academic and non-academic programs will be consolidated in a manner to achieve the highest building utilization. (78-; 88-Adopt; 01-No Change; 04-No Change; 14-Revise; 22-No Change)
4. All CSU campuses shall implement a utilities chargeback system to recover direct and indirect costs of utilities provided to self-supporting and external organizations pursuant to procedures in the CSU Policy Library. (78-; 88-Adopt; 01-No Change; 04-No Change; 14-Revise;22-Revise)

### **Transportation**

1. The CSU will encourage and promote the use of alternative transportation and/or alternative fuels to reduce GHG emissions related to university associated transportation, including commuter and business travel. The Chancellor's Office will establish a baseline for carbon emissions from student, faculty and staff commuting and establish a systemwide reduction target. (14-New; 22-Revise)
2. All CSU campuses shall develop and maintain a transportation demand management (TDM) plan to reduce Vehicle Miles Traveled (VMT) and carbon emissions. This plan will be updated every five years and guide the overall transportation and parking program at each campus. (22-New)
3. Campuses shall strive to increase Electric Vehicle (EV), electric bicycle, and other electric mobility and transportation device charging infrastructure and incentive programs to further support campus carbon reduction strategies. (22-New)
4. Campuses shall strive to develop and maintain a long-range plan for transitioning fleet, and grounds equipment to zero emissions, excluding public safety patrol vehicles if necessary. Fifty percent (50%) of all light duty vehicle purchases will be ZEV by 2035, with no addition of gas-powered light duty vehicles to the fleet after 2035. All small off-road engine (SORE) equipment used for campus grounds will be all-electric by 2035. All buses and heavy-duty vehicles will be ZEV by 2045 in alignment with State regulations. (22-New)



California State University  
**MONTEREY BAY**

Prepared by:

**DUDEK**

725 Front Street, Suite 400

Santa Cruz, CA 95060

831.600.1400 | HELLO@DUDEK.COM

**DUDEK.COM**